



FCC RF TEST REPORT

47 CFR FCC Part 15 Subpart C § 15.249

EQUIPMENT : GSM/WCDMA/LTE Phone + Bluetooth, DTS/UNII
a/b/g/n/ac, ANT+, and NFC

BRAND NAME : Sony

FCC ID : PY7-PM0881

We, SPORTON INTERNATIONAL INC., would like to declare that the tested sample has been evaluated in accordance with the test procedures and has been in compliance with the applicable technical standards.

The test results in this report apply exclusively to the tested model / sample. Without written approval of SPORTON INTERNATIONAL INC., the test report shall not be reproduced except in full.

Reviewed by: Joseph Lin / Supervisor

Approved by: Jones Tsai / Manager



SPORTON INTERNATIONAL INC.

No. 52, Hwa Ya 1st Rd., Hwa Ya Technology Park, Kwei-Shan District, Tao Yuan City, Taiwan, R.O.C.



Table of Contents

1. SUMMARY OF THE TEST RESULT2

2. GENERAL INFORMATION.....3

2.1 Applicant..... 3

2.2 Manufacturer..... 3

2.3 Product Details 3

2.4 Table for Test Modes..... 4

2.5 Table for Testing Locations 5

2.6 Table for Supporting Units..... 5

2.7 Test Configurations 6

3. TEST RESULT7

3.1 AC Power Line Conducted Emissions Measurement..... 7

3.2 20dB and & 99% Occupied Bandwidth 11

3.3 Field Strength of Fundamental Emissions and Radiated Spurious Emissions..... 14

3.4 Antenna Requirements 27

4. LIST OF MEASURING EQUIPMENT28



1. SUMMARY OF THE TEST RESULT

Applied Standard:				
Part	FCC Rule	Description of Test	Result	Under Limit
3.1	15.207	AC Power Line Conducted Emissions	Complies	22.30 dB at 0.606MHz
3.2	2.1049	20dB & 99% Occupied Bandwidth	Complies	-
3.3	15.249(a)	Field Strength of Fundamental Emissions	Complies	14.03 dB at 2440.900MHz
3.3	15.249(a)(d)	Radiated Spurious Emissions	Complies	7.24 dB at 43.500MHz
3.4	15.203	Antenna Requirements	Complies	-

Remark: The FR571618E report reuses test data from the FR571617E report.

Uncertainty of Conducted Emission Measurement (150kHz ~ 30MHz)

Measuring Uncertainty for a Level of Confidence of 95% (U = 2Uc(y))	2.26
---	------

Uncertainty of Radiated Emission Measurement (30 MHz ~ 1000 MHz)

Measuring Uncertainty for a Level of Confidence of 95% (U = 2Uc(y))	4.80
---	------



2. GENERAL INFORMATION

2.1 Applicant

Sony Mobile Communications Inc.
Nya Vattentornet, 22188 Lund, Sweden

2.2 Manufacturer

Sony Mobile Communications Inc.
1-8-15 Konan, Minato-ku, Tokyo, 108-0075, Japan

2.3 Product Details

For more detailed features description, please refer to the manufacturer's specifications or user's manual.

Items	Description
Modulation	GFSK
Channel Bandwidth (99%)	1.023MHz
Max. Field Strength (Peak)	99.97dBμV/m
Max. Field Strength (Average)	73.03dBμV/m
ANT+ Channel Number	78
ANT+ Frequency Range	2403-2480MHz

EUT Information List				
IMEI	HW Version	SW Version	S/N	Performed Test Item
004402455123178	A	32.0.A.0.287	CB5A273TPX	RF conducted measurement
004402455122311			CB5A273TF4	Radiated Spurious Emission
004402455122410			CB5A273THY	Conducted Emission



Accessory List	
AC Adapter	Model No. : UCH20
	Type No. : AC-0061-US
	S/N :
	2115W15500021 (for radiated spurious emission) 5815W22500112 (for conducted emission)
Earphone	Model No. : MDR-NC31E
	Type No. : AG-1110
USB Cable	Model No. : UCB11
	Type No. : AI-0120
	S/N :
	1522A731000010A (for radiated spurious emission) 1512A73E0001BD0 (for conducted emission)

Note:

1. Above EUT list and accessory list used are electrically identical per declared by manufacturer.
2. Above the accessories list are used to exercise the EUT during test.
3. For other wireless features of this EUT, test report will be issued separately.

2.4 Table for Test Modes

Investigation has been done on all the possible configurations for searching the worst cases. The following table is a list of the test modes shown in this test report.

Test Items	Mode
AC Power Line Conducted Emissions	CTX
Field Strength of Fundamental Emissions	CTX
Bandwidth	CTX
Radiated Emissions	CTX

Note:

1. CTX=continuously transmitting.
2. The programmed RF utility, "CMD" installed in the notebook to make the EUT get into the engineering modes to continuously transmit.



2.5 Table for Testing Locations

Test Site	SPORTON INTERNATIONAL INC.	
Test Site Location	No. 52, Hwa Ya 1 st Rd., Hwa Ya Technology Park, Kwei-Shan District, Tao Yuan City, Taiwan, R.O.C. TEL: +886-3-327-3456 FAX: +886-3-328-4978	
Test Site No.	Sporton Site No.	
	TH05-HY	03CH07-HY

Note: The test site complies with ANSI C63.4 2009 requirement.

2.6 Table for Supporting Units

Item	Equipment	Trade Name	Model Name	FCC ID	Data Cable	Power Cord
1.	SD Card	SanDisk	MicroSD HC	FCC DoC	N/A	N/A

2.7 Test Configurations

<AC Conducted Emissions>

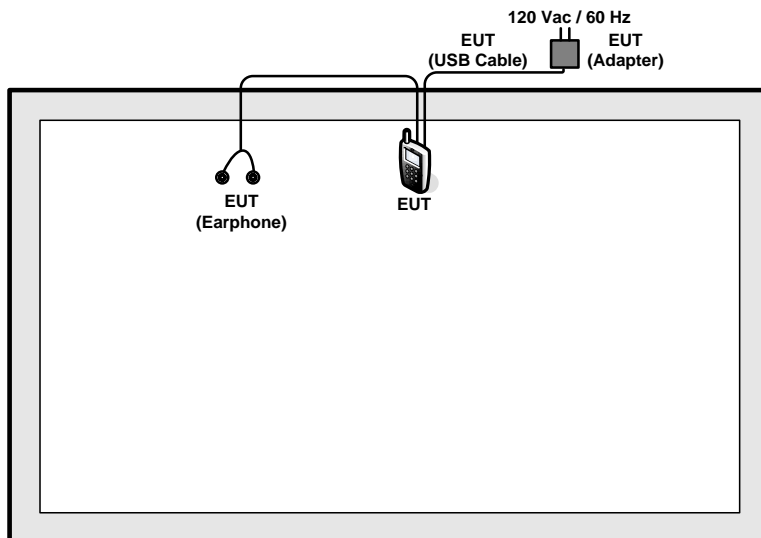

<Radiated Spurious Emissions>

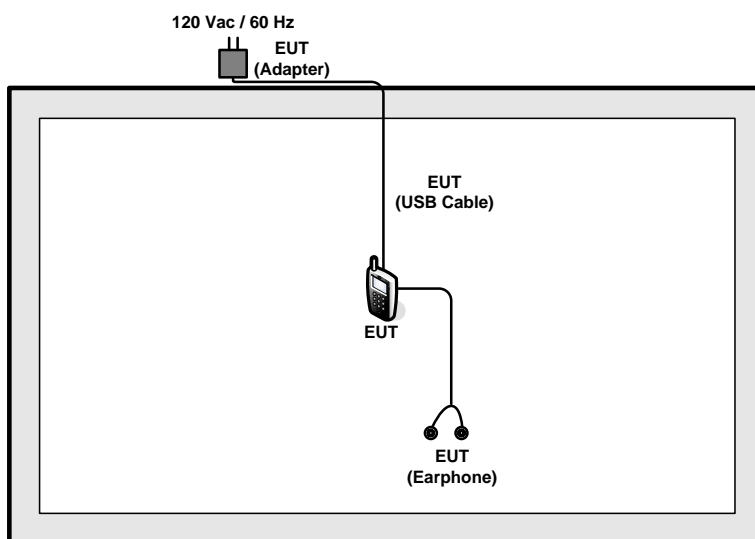



3. TEST RESULT

3.1 AC Power Line Conducted Emissions Measurement

3.1.1 Limit

For a Low-power Radio-frequency device which is designed to be connected to the AC power line, the radio frequency voltage that is conducted back onto the AC power line on any frequency or frequencies within the band 150 kHz to 30 MHz shall not exceed below limits table.

Frequency (MHz)	QP Limit (dB μ V)	AV Limit (dB μ V)
0.15~0.5	66~56	56~46
0.5~5	56	46
5~30	60	50

3.1.2 Measuring Instruments

Please refer to section 4 of equipment list in this report.

3.1.3 Test Procedures

1. Configure the EUT according to ANSI C63.4. The EUT or host of EUT has to be placed 0.4 meter far from the conducting wall of the shielding room and at least 80 centimeters from any other grounded conducting surface.
2. Connect EUT or host of EUT to the power mains through a line impedance stabilization network (LISN).
3. All the support units are connected to the other LISNs. The LISN should provide 50uH/50ohms coupling impedance.
4. The frequency range from 150 kHz to 30 MHz was searched.
5. Set the test-receiver system to Peak Detect Function and Specified Bandwidth (IF bandwidth = 9kHz) with Maximum Hold Mode.
6. The measurement has to be done between each power line and ground at the power terminal.

3.1.4 Test Setup Layout

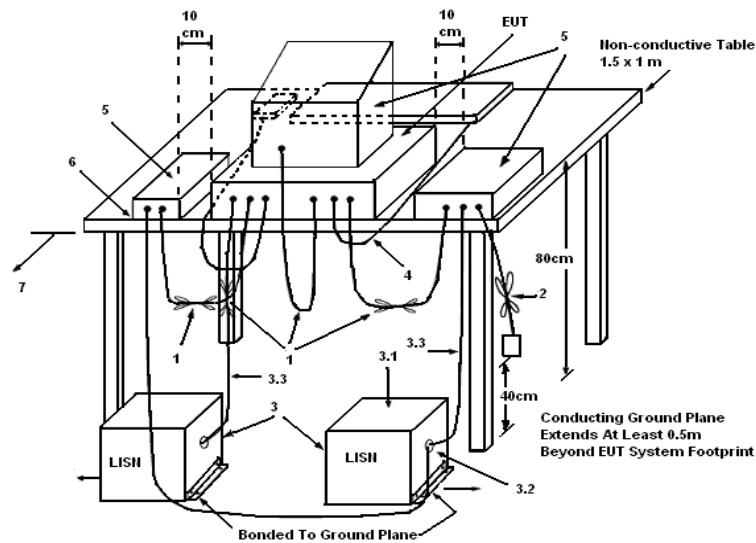

LEGEND:

- (1) Interconnecting cables that hang closer than 40 cm to the ground plane shall be folded back and forth in the center forming a bundle 30 to 40 cm long.
- (2) I/O cables that are not connected to a peripheral shall be bundled in the center. The end of the cable may be terminated, if required, using the correct terminating impedance. The overall length shall not exceed 1 m.
- (3) EUT connected to one LISN. Unused LISN measuring port connectors shall be terminated in 50 Ω. LISN can be placed on top of, or immediately beneath, reference ground plane.
 - (3.1) All other equipment powered from additional LISN(s).
 - (3.2) Multiple outlet strip can be used for multiple power cords of non-EUT equipment.
 - (3.3) LISN at least 80 cm from nearest part of EUT chassis.
- (4) Cables of hand-operated devices, such as keyboards, mice, etc., shall be placed as for normal use.
- (5) Non-EUT components of EUT system being tested.
- (6) Rear of EUT, including peripherals, shall all be aligned and flush with rear of tabletop.
- (7) Rear of tabletop shall be 40 cm removed from a vertical conducting plane that is bonded to the ground plane.

3.1.5 Test Deviation

There is no deviation with the original standard.

3.1.6 EUT Operation during Test

The EUT was placed on the test table and programmed in transmitting function.



3.1.7 Results of AC Power Line Conducted Emissions Measurement

Test Date	Aug. 15, 2015	Test Site No.	CO05-HY
Temperature	23~25°C	Humidity	58~61%
Test Engineer	Eric Jeng		
Mode	ANT+ Tx (2441 MHz) + Earphone + USB Cable (Charging from Adapter)		

Line

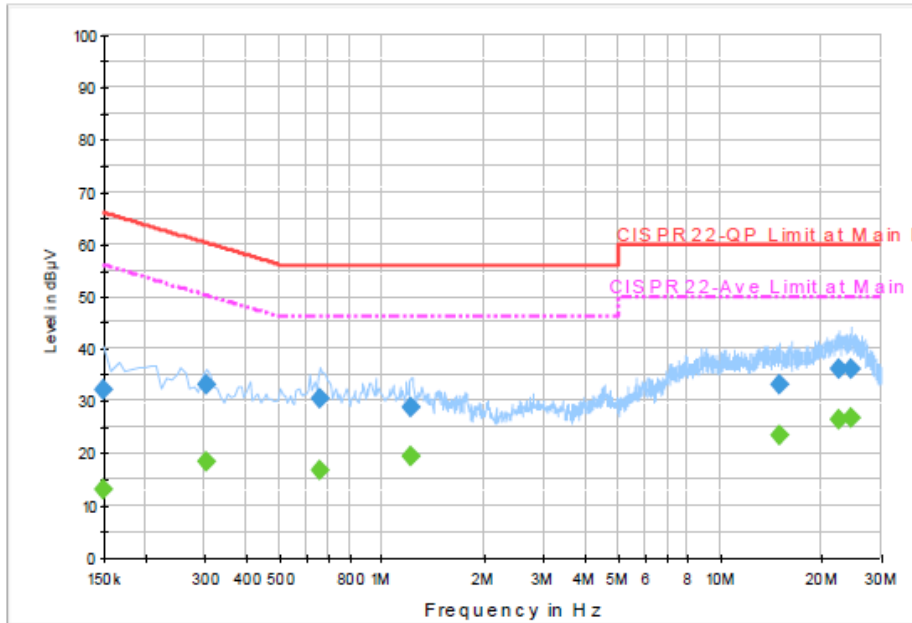

Final Result: Quasi-Peak

Frequency (MHz)	Quasi-Peak (dBµV)	Filter	Line	Corr. (dB)	Margin (dB)	Limit (dBµV)
0.150000	32.0	Off	L1	19.5	34.0	66.0
0.302000	33.0	Off	L1	19.5	27.2	60.2
0.654000	30.5	Off	L1	19.5	25.5	56.0
1.214000	28.7	Off	L1	19.6	27.3	56.0
14.982000	33.1	Off	L1	20.0	26.9	60.0
22.446000	36.0	Off	L1	20.0	24.0	60.0
24.582000	36.2	Off	L1	20.0	23.8	60.0

Final Result: Average

Frequency (MHz)	Average (dBµV)	Filter	Line	Corr. (dB)	Margin (dB)	Limit (dBµV)
0.150000	13.0	Off	L1	19.5	43.0	56.0
0.302000	18.5	Off	L1	19.5	31.7	50.2
0.654000	16.9	Off	L1	19.5	29.1	46.0
1.214000	19.5	Off	L1	19.6	26.5	46.0
14.982000	23.5	Off	L1	20.0	26.5	50.0
22.446000	26.4	Off	L1	20.0	23.6	50.0
24.582000	26.8	Off	L1	20.0	23.2	50.0



Test Date	Aug. 15, 2015	Test Site No.	CO05-HY
Temperature	23~25°C	Humidity	58~61%
Test Engineer	Eric Jeng		
Mode	ANT+ Tx (2441 MHz) + Earphone + USB Cable (Charging from Adapter)		

Neutral

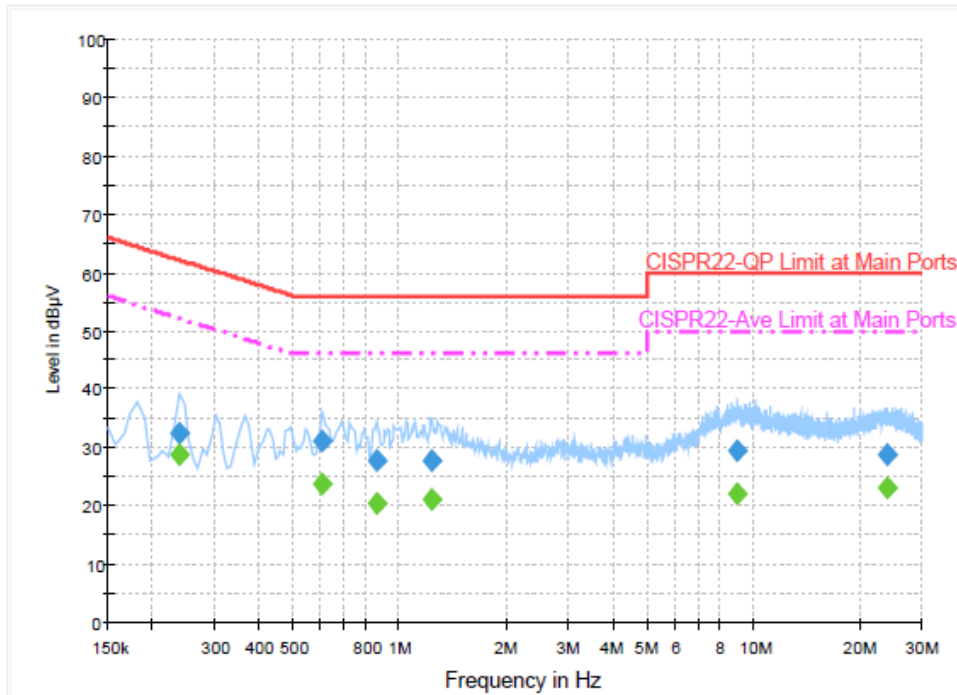

Final Result: Quasi-Peak

Frequency (MHz)	Quasi-Peak (dBµV)	Filter	Line	Corr. (dB)	Margin (dB)	Limit (dBµV)
0.238000	32.4	Off	N	19.5	29.8	62.2
0.606000	31.0	Off	N	19.5	25.0	56.0
0.862000	27.7	Off	N	19.5	28.3	56.0
1.238000	27.9	Off	N	19.6	28.1	56.0
9.046000	29.6	Off	N	19.9	30.4	60.0
23.926000	28.7	Off	N	20.1	31.3	60.0

Final Result: Average

Frequency (MHz)	Average (dBµV)	Filter	Line	Corr. (dB)	Margin (dB)	Limit (dBµV)
0.238000	28.9	Off	N	19.5	23.3	52.2
0.606000	23.7	Off	N	19.5	22.3	46.0
0.862000	20.6	Off	N	19.5	25.4	46.0
1.238000	21.1	Off	N	19.6	24.9	46.0
9.046000	22.0	Off	N	19.9	28.0	50.0
23.926000	23.1	Off	N	20.1	26.9	50.0

3.2 20dB and & 99% Occupied Bandwidth

3.2.1 Limit

Intentional radiators must be designed to ensure that the 20 dB bandwidth of the emissions in the specific band.

3.2.2 Measuring Instruments

Please refer to section 4 of equipment list in this report.

3.2.3 Test Procedures

1. The transmitter output port was connected to the spectrum analyzer.
2. Measured the spectrum width with highest power setting.

3.2.4 Test Setup Layout

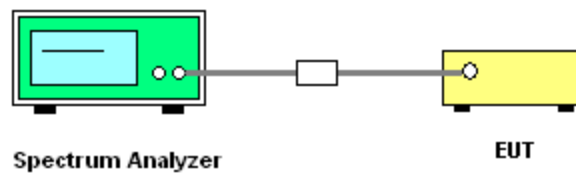

3.2.5 Test Deviation

There is no deviation with the original standard.

3.2.6 EUT Operation during Test

The EUT was programmed to be in continuously transmitting mode.



3.2.7 Test Result of 20dB Spectrum Bandwidth

Final Test Date	Aug. 04, 2015 ~ Aug. 09, 2015	Test Site No.	TH05-HY
Temperature	22~25°C	Humidity	51~55%
Test Engineer	Derek Hsu		

Frequency	20dB BW (MHz)	99% OBW (MHz)
2403MHz	1.044	1.020
2441MHz	1.050	1.023
2480MHz	1.050	1.023

20 dB Bandwidth Plot on 2403MHz

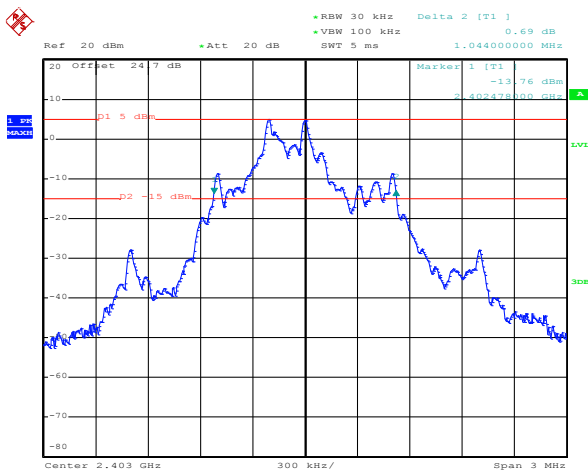

99% Bandwidth Plot on 2403MHz

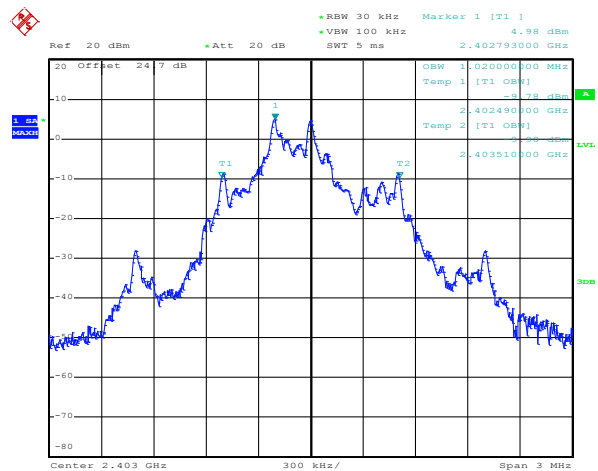

Date: 9.AUG.2015 14:31:24

Date: 9.AUG.2015 14:30:13



20 dB Bandwidth Plot on 2441MHz

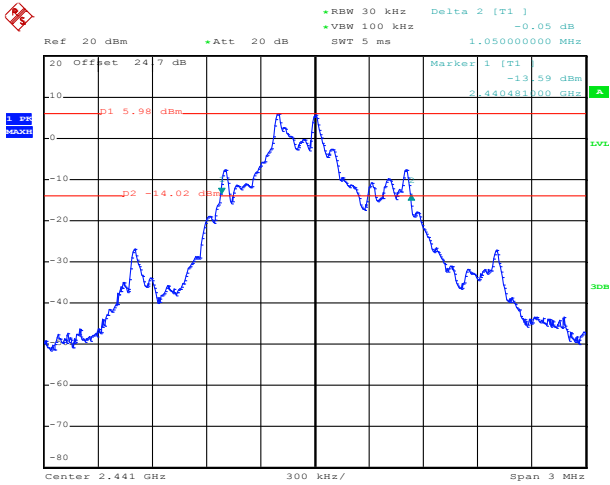

99% Bandwidth Plot on 2441MHz

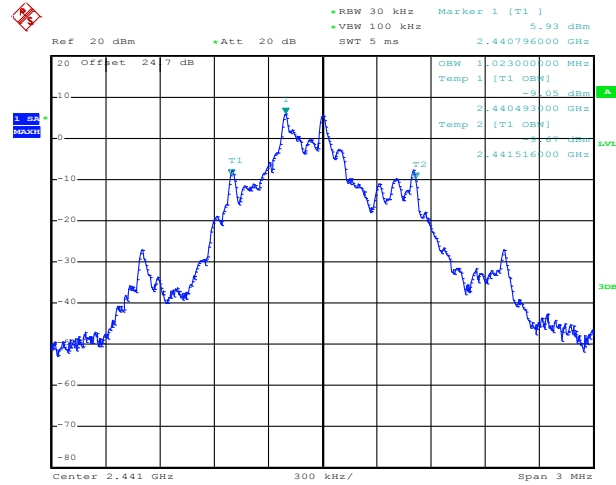

Date: 9.AUG.2015 14:27:03

Date: 9.AUG.2015 14:28:17

20 dB Bandwidth Plot on 2480MHz

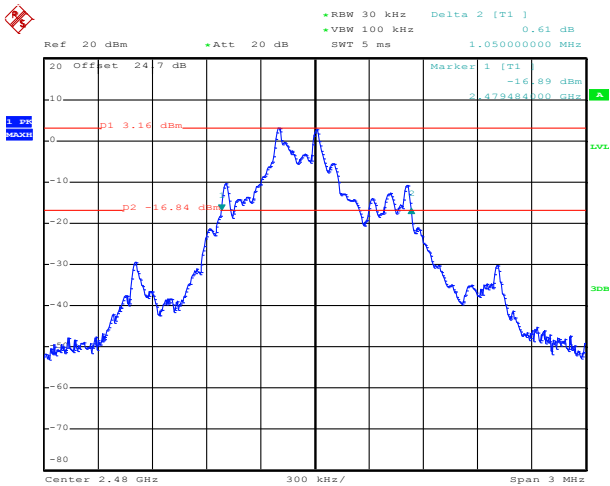

99% Bandwidth Plot on 2480MHz

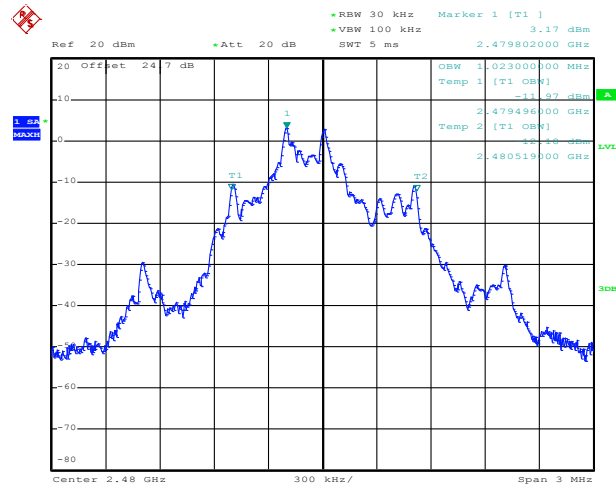

Date: 9.AUG.2015 14:23:29

Date: 9.AUG.2015 14:22:26



3.3 Field Strength of Fundamental Emissions and Radiated Spurious Emissions

3.3.1 Limit

The field strength measured at 3 meters shall not exceed the limits in the following table:

Fundamental Frequencies(MHz)	Field Strength(millivolts/m)	
	Fundamental	Harmonics
902~928	50	0.5
2400~2483.5	50	0.5
5725~5875	50	0.5

Note: The limits shown in the above table are based on measurements using an average detector, except for the fundamental emission in the frequency band 902-928 MHz, which is based on measurements using a CISPR quasi-peak detector.

Emissions radiated outside of the specified frequency bands, except for harmonics, shall be attenuated by at least 50 dB below the level of the fundamental or to the general field strength limits listed in 15.209 as below, whichever is less stringent.

Frequency (MHz)	Field Strength (microvolts/meter)	Measurement Distance (meters)
0.009 – 0.490	2400/F(kHz)	300
0.490 – 1.705	24000/F(kHz)	30
1.705 – 30.0	30	30
30 – 88	100	3
88 – 216	150	3
216 - 960	200	3
Above 960	500	3



3.3.2 Measuring Instruments

Please refer to section 4 of equipment list in this report.

3.3.3 Test Procedures

1. The EUT was placed on a turntable with 0.8 meter for frequency below 1GHz and 1.5 meter for frequency above 1GHz respectively above ground.
2. The EUT was set 3 meters from the interference receiving antenna, which was mounted on the top of a variable height antenna tower.
3. For each suspected emission, the EUT was arranged to its worst case and then tune the Antenna tower (from 1 m to 4 m) and turntable (from 0 degree to 360 degrees) to find the maximum reading. A pre-amp and a high pass filter are used for the test in order to get better signal level to comply with the guidelines.
4. Set to the maximum power setting and enable the EUT transmit continuously.

Remark:

1. Corrected Reading: Antenna Factor + Cable Loss + Read Level - Preamp Factor = Level
2. For average measurement: use duty cycle correction factor method per 15.35(c).

Duty cycle = On time/100 milliseconds

On time = $N1*L1+N2*L2+...+Nn-1*LNn-1+Nn*Ln$

Where N1 is number of type 1 pulses, L1 is length of type 1 pulses, etc.

Average Emission Level = Peak Emission Level + 20*log(Duty cycle)

3.3.4 Test Setup Layout

For radiated emissions below 30MHz

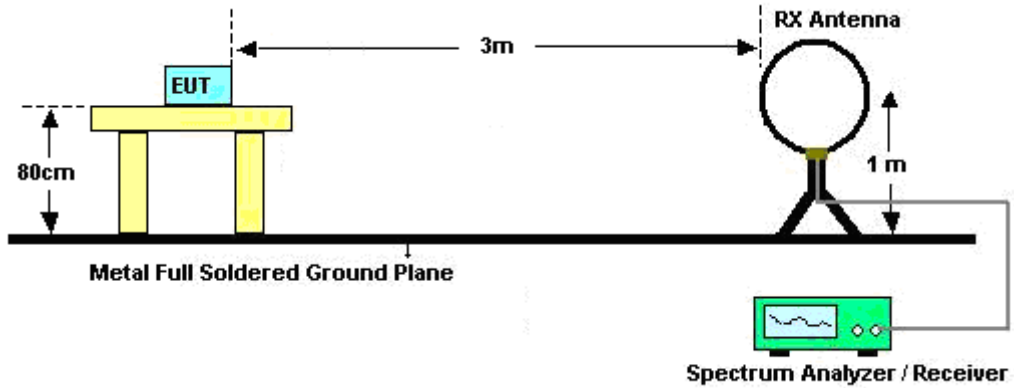

For radiated emissions from 30MHz to 1GHz

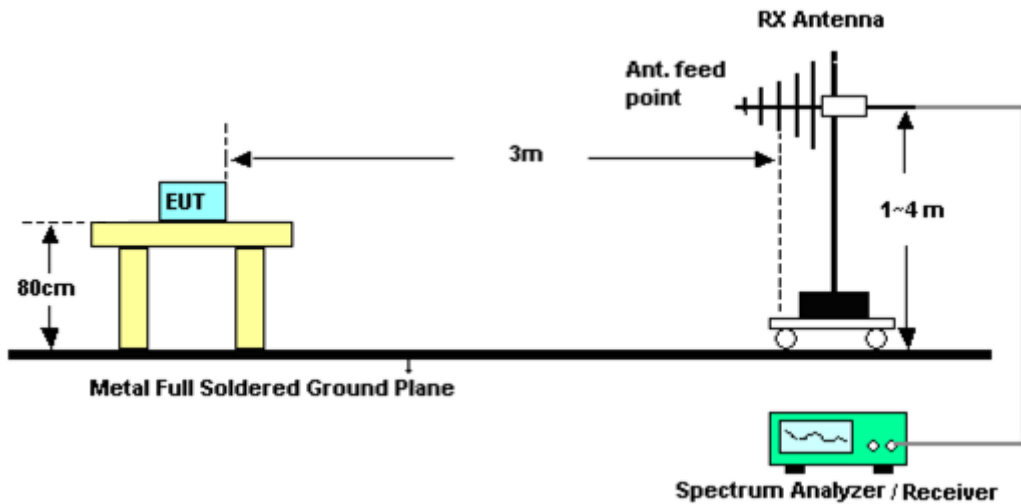

For radiated emissions above 1GHz

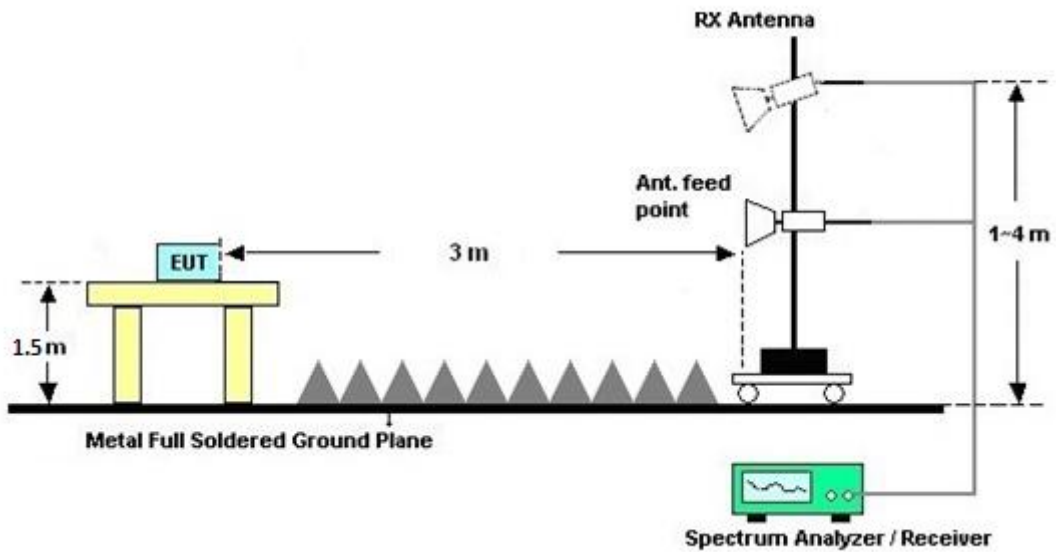

3.3.5 Test Deviation

There is no deviation with the original standard.

3.3.6 EUT Operation during Test

The EUT was programmed to be in continuously transmitting mode.

3.3.7 Test Results of Radiated Spurious Emissions (9 kHz ~ 30 MHz)

The low frequency, which started from 9 kHz to 30MHz, was pre-scanned and the result which was 20dB lower than the limit line per 15.31(o) was not reported.



3.3.8 Duty cycle correction factor for average measurement

On time (One Pulse) Plot on 2441MHz

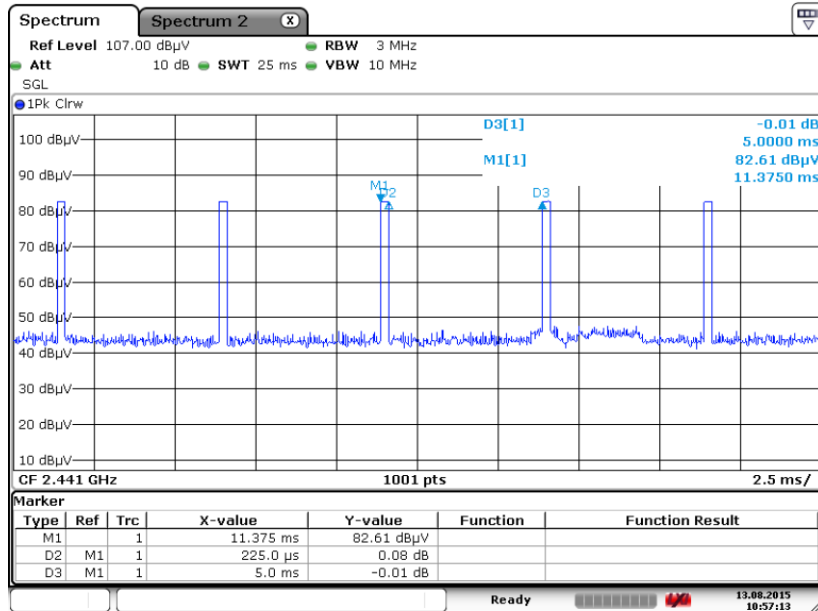

Date: 13.AUG.2015 10:57:13

On time (Count Pulses) Plot on 2441MHz

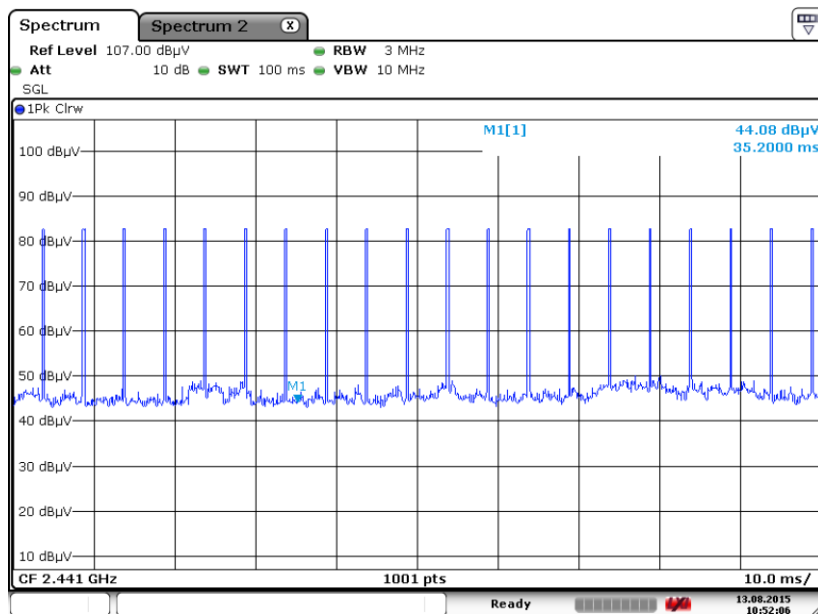

Date: 13.AUG.2015 10:52:06

Note:

1. Worst case Duty cycle = on time/100 milliseconds = 20 * 0.225 / 100 = 4.50 %
2. Worst case Duty cycle correction factor = 20*log(Duty cycle) = -26.94 dB



3.3.9 Test Result of Field Strength of Fundamental Emissions and Spurious Emissions

Test Date	Aug.12, 201~ Aug. 13, 2015	Test Engineer	Wei Chan and Ken Wu and James Chiu
Temperature	23~25°C	Humidity	45~47%

<30MHz ~ 1GHz>

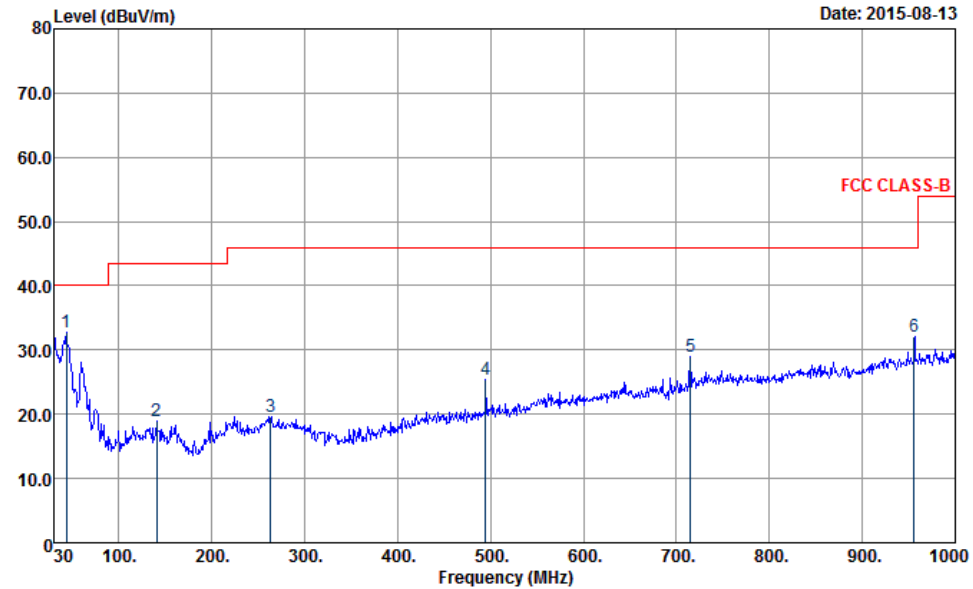

Site : 03CH07-HY
 Condition : FCC CLASS-B 3m LF-ANT(131102) HORIZONTAL
 Detector : Peak

	Freq	Level	Over Limit	Limit Line	ReadAntenna Level	Antenna Factor	Cable Loss	Preamp Factor	A/Pos	T/Pos	Remark
	MHz	dBuV/m	dB	dBuV/m	dBuV	dB/m	dB	dB	cm	deg	
1	43.50	32.76	-7.24	40.00	50.99	11.20	1.77	31.20	---	---	Peak
2	140.43	18.93	-24.57	43.50	35.92	11.50	2.61	31.10	---	---	Peak
3	263.55	19.65	-26.35	46.00	33.93	13.56	3.16	31.00	---	---	Peak
4	494.60	25.40	-20.60	46.00	34.33	17.95	3.77	30.65	---	---	Peak
5	715.10	29.05	-16.95	46.00	33.84	21.20	4.41	30.40	---	---	Peak
6	955.90	32.02	-13.98	46.00	32.87	24.59	4.94	30.38	---	---	Peak

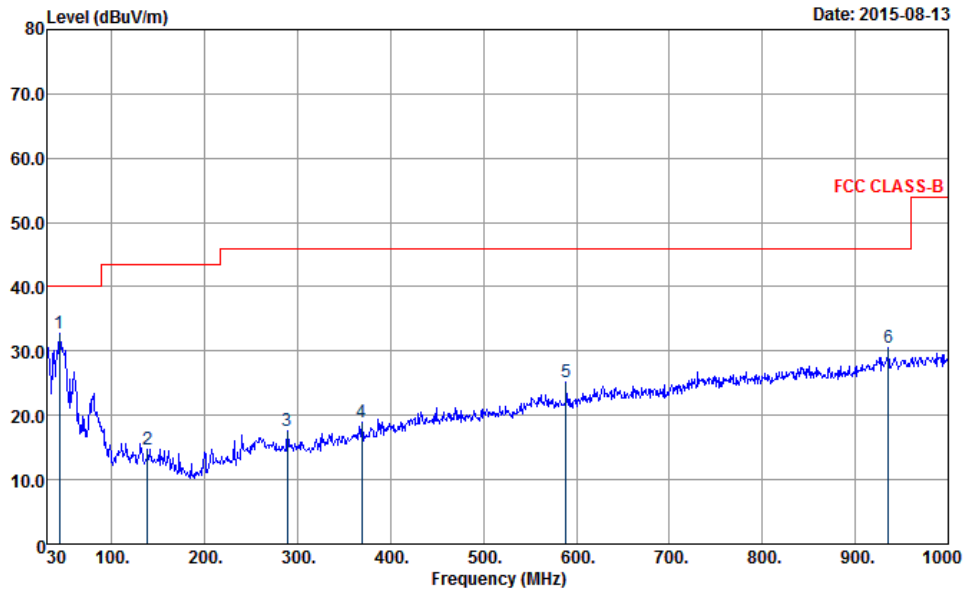

Date: 2015-08-13

Site : 03CH07-HY
 Condition : FCC CLASS-B 3m LF-ANT(131102) VERTICAL
 Detector : Peak

	Freq	Level	Over	Limit	ReadAntenna	Cable	Preamp	A/Pos	T/Pos	Remark
	MHz	dBuV/m	dB	dBuV/m	dBuV	dB	dB	cm	deg	
1	43.77	32.72	-7.28	40.00	50.95	11.20	1.77	31.20	---	Peak
2	138.27	14.70	-28.80	43.50	31.92	11.50	2.38	31.10	---	Peak
3	288.93	17.51	-28.49	46.00	32.36	13.07	3.16	31.08	---	Peak
4	368.60	18.95	-27.05	46.00	31.76	14.86	3.39	31.06	---	Peak
5	588.40	25.14	-20.86	46.00	32.20	19.51	4.08	30.65	---	Peak
6	935.60	30.59	-15.41	46.00	31.86	24.30	4.80	30.37	---	Peak



<1GHz ~ 25GHz>

2403MHz

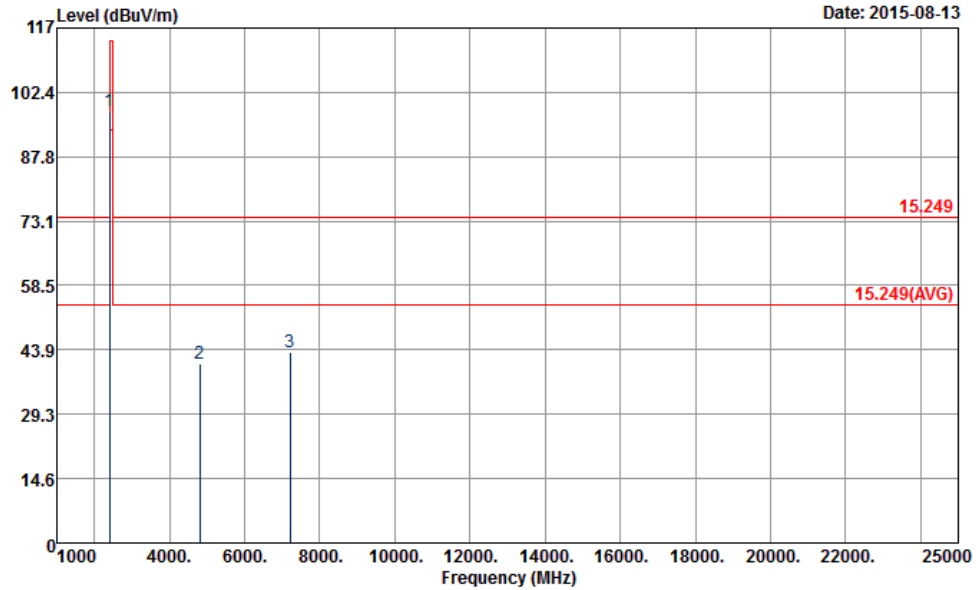

Site : 03CH07-HY
 Condition : 15.249 3m SHF-EHF_131029 HORIZONTAL

Freq	Level	Over Limit	Limit Line	ReadAntenna Level	Antenna Factor	Cable Loss	Preamp Loss	A/Pos	T/Pos	Remark
MHz	dBUV/m	dB	dBUV/m	dBuV	dB/m	dB	dB	cm	deg	
1	2403.00	98.02	-15.98	114.00	92.37	32.20	7.75	34.30	143	184 Peak
2	4806.00	40.70	-33.30	74.00	55.01	34.25	11.11	59.67	100	0 Peak
3	7209.00	43.33	-30.67	74.00	51.08	35.60	15.00	58.35	100	0 Peak

Frequency (MHz)	Level (dBµV/m)	Over Limit (dB)	Limit Line (dBµV/m)	Read Level (dBµV)	Antenna Factor (dB)	Cable Loss (dB)	Preamp Factor (dB)	Ant Pos (cm)	Table Pos (deg)	Remark
2403	98.02	-15.98	114	92.37	32.2	7.75	34.3	143	184	Peak
2403	71.08	-22.92	94	-	-	-	-	-	-	Average

Note: For average measurement: use duty cycle correction factor method per 15.35(c).

Average measurement was not performed if peak level went lower than the average limit.

Test result of emissions which are 20 dB lower than the limit is not reported per 15.31.

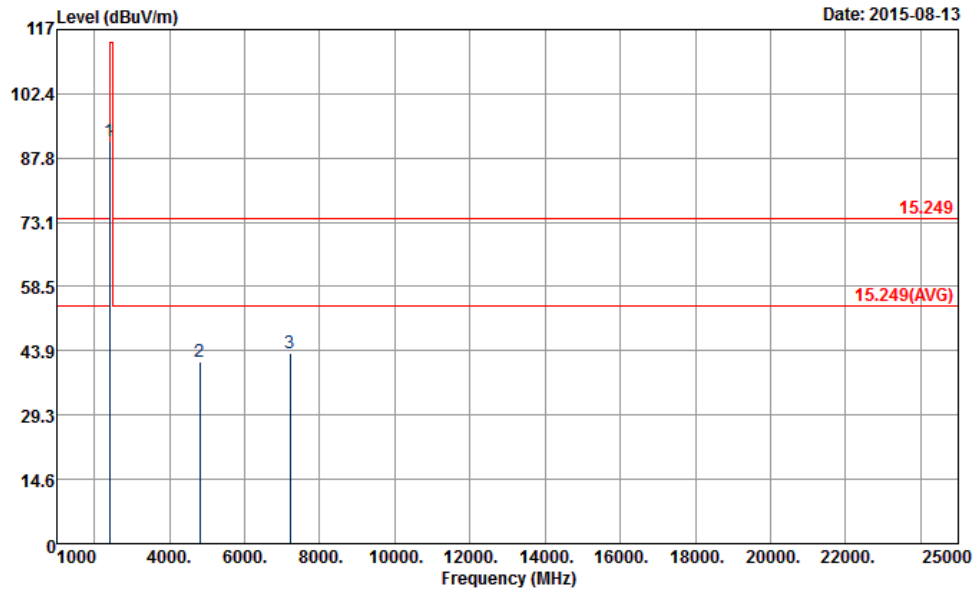

Site : 03CH07-HY
 Condition : 15.249 3m SHF-EHF_131029 VERTICAL

	Freq	Level	Over Limit	Limit Line	Read Level	Antenna Factor	Cable Loss	Preamp Factor	A/Pos	T/Pos	Remark
	MHz	dBuV/m	dB	dBuV/m	dBuV	dB/m	dB	dB	cm	deg	
1	2403.00	91.43	-22.57	114.00	85.78	32.20	7.75	34.30	102	18	Peak
2	4806.00	41.45	-32.55	74.00	55.76	34.25	11.11	59.67	100	0	Peak
3	7209.00	43.49	-30.51	74.00	51.24	35.60	15.00	58.35	100	0	Peak

Frequency (MHz)	Level (dBμV/m)	Over Limit (dB)	Limit Line (dBμV/m)	Read Level (dBμV)	Antenna Factor (dB)	Cable Loss (dB)	Preamp Factor (dB)	Ant Pos (cm)	Table Pos (deg)	Remark
2403	91.43	-22.57	114	85.78	32.2	7.75	34.3	102	18	Peak
2403	64.49	-29.51	94	-	-	-	-	-	-	Average

Note: For average measurement: use duty cycle correction factor method per 15.35(c).

Average measurement was not performed if peak level went lower than the average limit.

Test result of emissions which are 20 dB lower than the limit is not reported per 15.31.



2441MHz

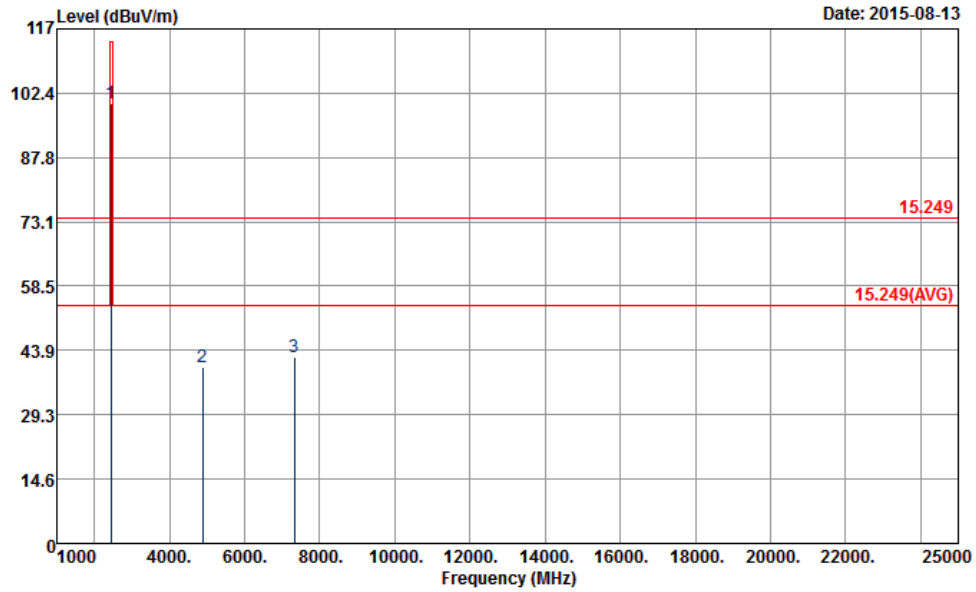

Site : 03CH07-HY
 Condition : 15.249 3m SHF-FHF_131029 HORIZONTAL

	Freq	Level	Over	Limit	ReadAntenna	Cable	Preamp	A/Pos	T/Pos	Remark
	MHz	dBuV/m	dB	dBuV/m	dBuV	dB/m	dB	dB	cm	deg
1	2442.00	99.97	-14.03	114.00	94.29	32.24	7.83	34.39	143	183 Peak
2	4884.00	40.15	-33.85	74.00	54.21	34.30	11.21	59.57	100	0 Peak
3	7323.00	42.22	-31.78	74.00	50.03	35.60	15.08	58.49	100	0 Peak

Frequency (MHz)	Level (dBμV/m)	Over Limit (dB)	Limit Line (dBμV/m)	Read Level (dBμV)	Antenna Factor (dB)	Cable Loss (dB)	Preamp Factor (dB)	Ant Pos (cm)	Table Pos (deg)	Remark
2442	99.97	-14.03	114	94.29	32.24	7.83	34.39	143	183	Peak
2442	73.03	-20.97	94	-	-	-	-	-	-	Average

Note: For average measurement: use duty cycle correction factor method per 15.35(c).
 Average measurement was not performed if peak level went lower than the average limit.
 Test result of emissions which are 20 dB lower than the limit is not reported per 15.31.

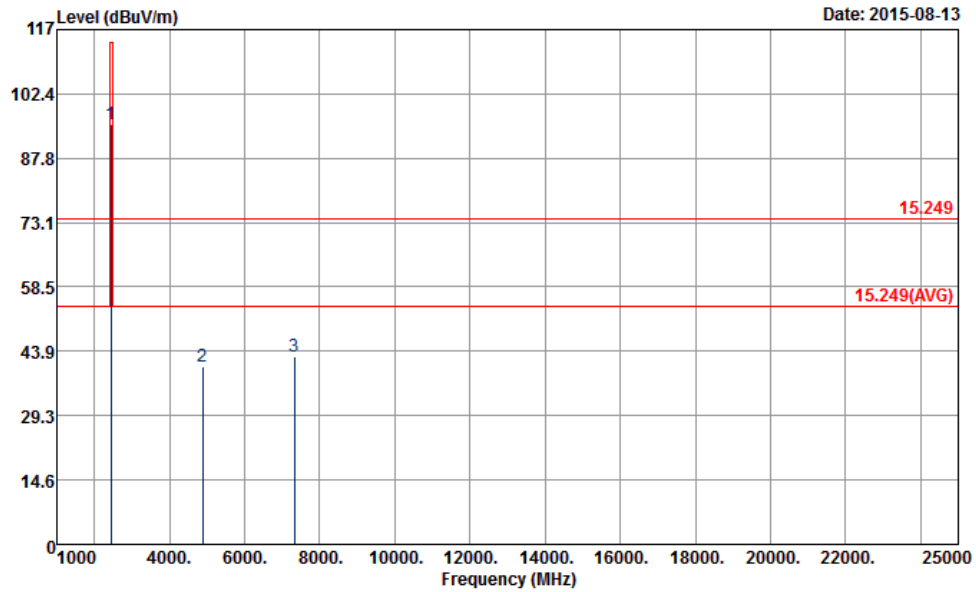

Site : 03CH07-HY
 Condition : 15.249 3m SHF-EHF_131029 VERTICAL

	Freq MHz	Level dBuV/m	Over Limit dB	Limit Line dBuV/m	Read Level dBuV	Antenna Factor dB/m	Cable Loss dB	Preamp Factor dB	A/Pos cm	T/Pos deg	Remark
1	2442.00	95.63	-18.37	114.00	89.95	32.24	7.83	34.39	386	345	Peak
2	4884.00	40.30	-33.70	74.00	54.36	34.30	11.21	59.57	100	0	Peak
3	7323.00	42.63	-31.37	74.00	50.44	35.60	15.08	58.49	100	0	Peak

Frequency (MHz)	Level (dBμV/m)	Over Limit (dB)	Limit Line (dBμV/m)	Read Level (dBμV)	Antenna Factor (dB)	Cable Loss (dB)	Preamp Factor (dB)	Ant Pos (cm)	Table Pos (deg)	Remark
2442	95.63	-18.37	114	89.95	32.24	7.83	34.39	386	345	Peak
2442	68.69	-25.31	94	-	-	-	-	-	-	Average

Note: For average measurement: use duty cycle correction factor method per 15.35(c).

Average measurement was not performed if peak level went lower than the average limit.

Test result of emissions which are 20 dB lower than the limit is not reported per 15.31.



2480MHz

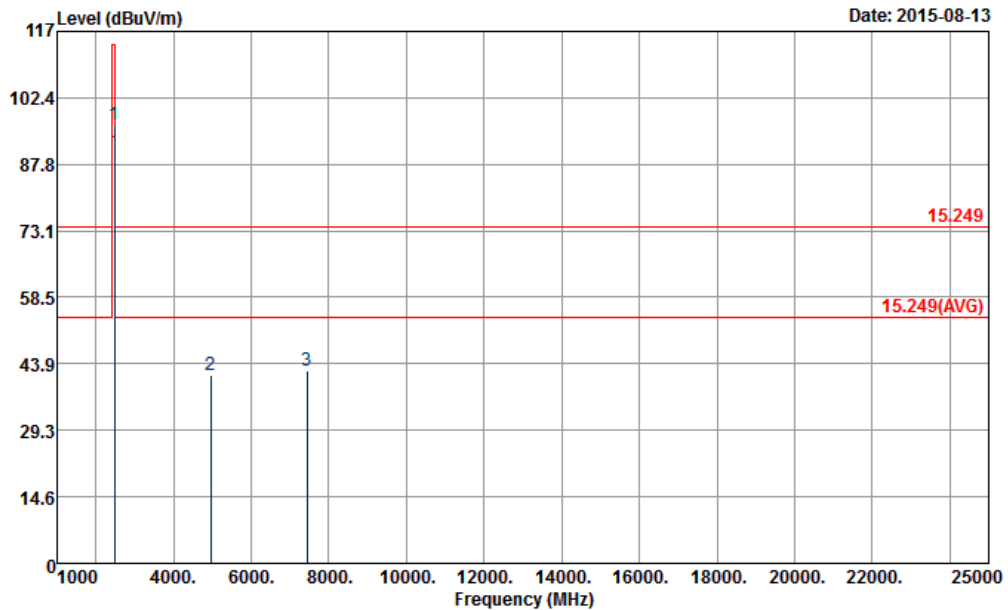

Site : 03CH07-HY
 Condition : 15 249 3m SHF-EHF_131029 HORIZONTAL

	Freq	Level	Over	Limit	Read	Antenna	Cable	Preamp	A/Pos	T/Pos	Remark
	MHz	dBuV/m	dB	dBuV/m	dBuV	dB/m	dB	dB	cm	deg	
1	2480.00	96.47	-17.53	114.00	90.71	32.28	7.91	34.43	227	186	Peak
2	4960.00	41.46	-32.54	74.00	55.22	34.37	11.32	59.45	100	0	Peak
3	7440.00	42.27	-31.73	74.00	50.18	35.60	15.13	58.64	100	0	Peak

Frequency (MHz)	Level (dBμV/m)	Over Limit (dB)	Limit Line (dBμV/m)	Read Level (dBμV)	Antenna Factor (dB)	Cable Loss (dB)	Preamp Factor (dB)	Ant Pos (cm)	Table Pos (deg)	Remark
2480	96.47	-17.53	114	90.71	32.28	7.91	34.43	227	186	Peak
2480	69.53	-24.47	94	-	-	-	-	-	-	Average

Note: For average measurement: use duty cycle correction factor method per 15.35(c).

Average measurement was not performed if peak level went lower than the average limit.

Test result of emissions which are 20 dB lower than the limit is not reported per 15.31.

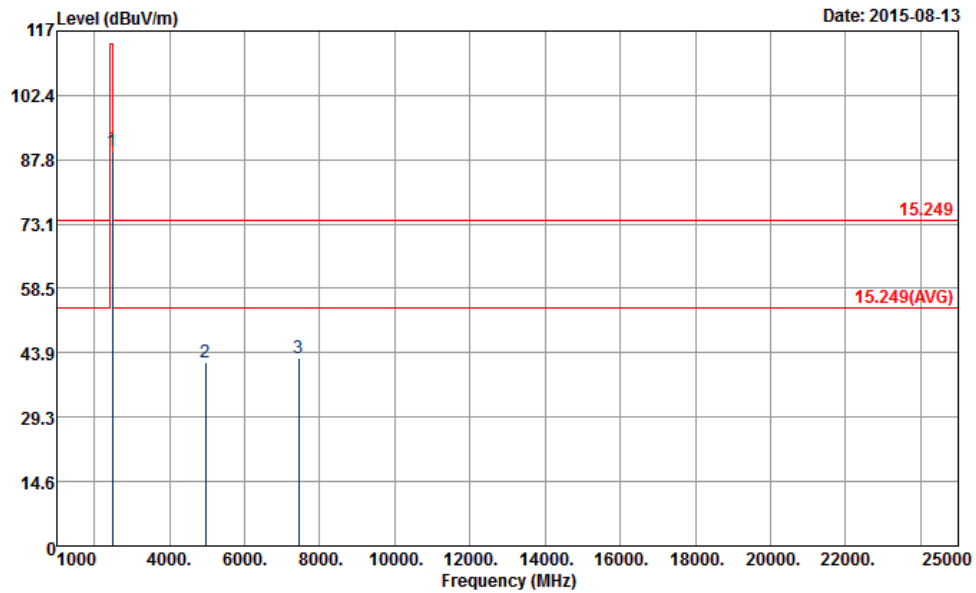

Site : 03CH07-HY
 Condition : 15 249 3m SHF-EHF_131029 VERTICAL

	Freq	Level	Over Limit	Limit Line	Read Level	Antenna Factor	Cable Loss	Preamp Loss	A/Pos	T/Pos	Remark
	MHz	dBuV/m	dB	dBuV/m	dBuV	dB/m	dB	dB	cm	deg	
1	2480.00	89.57	-24.43	114.00	83.81	32.28	7.91	34.43	292	16	Peak
2	4960.00	41.62	-32.38	74.00	55.38	34.37	11.32	59.45	100	0	Peak
3	7440.00	42.66	-31.34	74.00	50.57	35.60	15.13	58.64	100	0	Peak

Frequency (MHz)	Level (dBμV/m)	Over Limit (dB)	Limit Line (dBμV/m)	Read Level (dBμV)	Antenna Factor (dB)	Cable Loss (dB)	Preamp Factor (dB)	Ant Pos (cm)	Table Pos (deg)	Remark
2480	89.57	-24.43	114	83.81	32.28	7.91	34.43	292	16	Peak
2480	62.63	-31.37	94	-	-	-	-	-	-	Average

Note: For average measurement: use duty cycle correction factor method per 15.35(c).

Average measurement was not performed if peak level went lower than the average limit.

Test result of emissions which are 20 dB lower than the limit is not reported per 15.31.



3.4 Antenna Requirements

3.4.1 Limit

Except for special regulations, the Low-power Radio-frequency Devices must not be equipped with any jacket for installing an antenna with extension cable. An intentional radiator shall be designed to ensure that no antenna other than that furnished by the responsible party shall be used with the device. The use of a permanently attached antenna or of an antenna that uses a unique coupling to the intentional radiator shall be considered sufficient to comply with the provisions of this Section. The manufacturer may design the unit so that the user can replace a broken antenna, but the use of a standard antenna jack or electrical connector is prohibited.

3.4.2 Antenna Connector Construction

Embedded in Antenna.



4. LIST OF MEASURING EQUIPMENT

Instrument	Manufacturer	Model No.	Serial No.	Characteristics	Calibration Date	Test Date	Due Date	Remark
Power Meter	Agilent	E4416A	GB41292344	300MHz~40GHz	Jan. 14, 2015	Aug. 04, 2015 ~ Aug. 09, 2015	Jan. 13, 2016	Conducted (TH05-HY)
Power Sensor	Agilent	E9327A	US40441548	300MHz~40GHz	Jan. 14, 2015	Aug. 04, 2015 ~ Aug. 09, 2015	Jan. 13, 2016	Conducted (TH05-HY)
Spectrum Analyzer	Rohde & Schwarz	FSP40	100055	9kHz-40GHz	Jun. 18, 2015	Aug. 04, 2015 ~ Aug. 09, 2015	Jun. 17, 2016	Conducted (TH05-HY)
Hygrometer	Testo	608-H1	34897199	N/A	May 04, 2015	Aug. 04, 2015 ~ Aug. 09, 2015	May 03, 2016	Conducted (TH05-HY)
RF Cable	HARBOUR INDUSTRIES	LL142	Infinet CA3601-3601-DLL	0.1MHz~40GHz	Mar. 06, 2015	Aug. 04, 2015 ~ Aug. 09, 2015	Mar. 05, 2016	Conducted (TH05-HY)
EMI Test Receiver	Rohde & Schwarz	ESCS 30	100356	9kHz – 2.75GHz	Dec. 01, 2014	Aug. 15, 2015	Nov. 30, 2015	Conduction (CO05-HY)
Hygrometer	Testo	608-H1	34913912	N/A	Apr. 20, 2015	Aug. 15, 2015	Apr. 19, 2016	Conduction (CO05-HY)
LISN	Rohde & Schwarz	ENV216	100080	9kHz~30MHz	Dec. 02, 2014	Aug. 15, 2015	Dec. 01, 2015	Conduction (CO05-HY)
AC Power Source	ChainTek	APC-1000W	N/A	N/A	N/A	Aug. 15, 2015	N/A	Conduction (CO05-HY)
LF Cable	HUBER + SUHNER	RG-214/U	LF01	N/A	Jan. 07, 2015	Aug. 15, 2015	Jan. 06, 2016	Conduction (CO05-HY)
Test Software	N/A	EMC32	8.40.0	N/A	N/A	Aug. 15, 2015	N/A	Conduction (CO05-HY)
Bilog Antenna	Schaffner	CBL6111C	2726	30MHz ~ 1GHz	Sep. 27, 2014	Aug. 12, 2015 ~ Aug. 13, 2015	Sep. 26, 2015	Radiation (03CH07-HY)
Double Ridge Horn Antenna	EMCO	3117	00066583	1GHz~18GHz	Jul. 20, 2015	Aug. 12, 2015 ~ Aug. 13, 2015	Jul. 19, 2016	Radiation (03CH07-HY)
Loop Antenna	TESEQ	HLA 6120	31244	9kHz~30MHz	Feb. 02, 2015	Aug. 12, 2015 ~ Aug. 13, 2015	Feb. 01, 2016	Radiation (03CH10-HY)
EMI Test Receiver	Rohde & Schwarz	ESCI 7	100724	9kHz~7GHz	Aug. 30, 2014	Aug. 12, 2015 ~ Aug. 13, 2015	Aug. 29, 2015	Radiation (03CH07-HY)
Horn Antenna	SCHWARZBECK	BBHA 9170	BBHA9170584	18GHz- 40GHz	Nov. 03, 2014	Aug. 12, 2015 ~ Aug. 13, 2015	Nov. 02, 2015	Radiation (03CH07-HY)
Hygrometer	Testo	608-H1	34897197	N/A	May 04, 2015	Aug. 12, 2015 ~ Aug. 13, 2015	May 03, 2016	Radiation (03CH07-HY)
Preamplifier	MITEQ	AMF-7D-0010 1800-30-10P	1590075	1GHz ~ 18GHz	Apr. 20, 2015	Aug. 12, 2015 ~ Aug. 13, 2015	Apr. 19, 2016	Radiation (03CH07-HY)
Preamplifier	COM-POWER	PA-103A	161241	10MHz-1000MHz	Mar. 12, 2015	Aug. 12, 2015 ~ Aug. 13, 2015	Mar. 11, 2016	Radiation (03CH07-HY)
Preamplifier	Agilent	8449B	3008A02362	1GHz~ 26.5GHz	Oct. 21, 2014	Aug. 12, 2015 ~ Aug. 13, 2015	Oct. 20, 2015	Radiation (03CH07-HY)
Signal Analyzer	Rohde & Schwarz	FSV 30	101749	10Hz~30GHz	Mar. 10, 2015	Aug. 12, 2015 ~ Aug. 13, 2015	Mar. 09, 2016	Radiation (03CH07-HY)



Instrument	Manufacturer	Model No.	Serial No.	Characteristics	Calibration Date	Test Date	Due Date	Remark
RF Cable	HUBER + SUHNER	SUCOFLEX 104	MY84209521	1GHz~40GHz	Dec. 04, 2014	Aug. 12, 2015 ~ Aug. 13, 2015	Dec. 03, 2015	Radiation (03CH07-HY)
RF Cable	HUBER + SUHNER	SUCOFLEX 104	MY84209521	9KHz~1GHz	Dec. 04, 2014	Aug. 12, 2015 ~ Aug. 13, 2015	Dec. 03, 2015	Radiation (03CH07-HY)
Controller	ChainTek	Chaintek 3000	N/A	Control Turn table	N/A	Aug. 12, 2015 ~ Aug. 13, 2015	N/A	Radiation (03CH07-HY)
Controller	Max-Full	MF7802	MF780208368	Control Ant Mast	N/A	Aug. 12, 2015 ~ Aug. 13, 2015	N/A	Radiation (03CH07-HY)
Antenna Mast	Max-Full	MFA520BS	N/A	1m~4m	N/A	Aug. 12, 2015 ~ Aug. 13, 2015	N/A	Radiation (03CH07-HY)
Turn Table	ChainTek	Chaintek 3000	N/A	0~360 degree	N/A	Aug. 12, 2015 ~ Aug. 13, 2015	N/A	Radiation (03CH07-HY)
Preamplifier	MITEQ	JS44-18004 000-33-8P	1840917	18GHz ~ 40GHz	Jun. 02, 2015	Aug. 12, 2015 ~ Aug. 13, 2015	Jun. 01, 2016	Radiation (03CH07-HY)
Filter	Wainwright	WLKS1200-8SS	SN3	1.2G Low Pass	Oct. 01, 2014	Aug. 12, 2015 ~ Aug. 13, 2015	Sep. 30, 2015	Radiation (03CH07-HY)
Filter	Microwave	H3G018G1	SN477220	3.0G High Pass	Oct. 01, 2014	Aug. 12, 2015 ~ Aug. 13, 2015	Sep. 30, 2015	Radiation (03CH07-HY)

Note: Test equipment calibration is traceable to the procedure of ISO17025.