

9. FIELD STRENGTH OF SPURIOUS RADIATION MEASUREMENT

9.1. Standard Applicable

According to FCC §2.1053,

FCC §22.917(a) , §24.238(a) , §27.53(g)(h) , the magnitude of each spurious and harmonic emission that can be detected when the equipment is operated under the conditions specified in the instruction manual and/ or alignment procedure, shall not be less than $43 + 10 \log$ (mean output power in watts) dBc below the mean power output outside a license's frequency block (-13dBm).

FCC §27.53 (m) (4) shall not be less than $55 + 10 \log$ (mean output power in watt) dBc below the mean power output outside a license's frequency block (-25dBm).

§27.53 (c)

(2) On any frequency outside the 776– 788 MHz band, the power of any emission shall be attenuated outside the band below the transmitter power (P) by at least $43 + 10 \log$ (P) dB (-13dBm)

(4) On all frequencies between 763-775 MHz and 793-805 MHz, by a factor not less than $65 + 10 \log$ (P) dB in a 6.25 kHz band segment, for mobile and portable stations;

§27.53 (f) For operations in the 746-758 MHz, 775-788 MHz, and 805-806 MHz bands, emissions in the band 1559-1610 MHz shall be limited to -70 dBW/MHz equivalent isotropically radiated power (EIRP) for wideband signals, and -80 dBW EIRP for discrete emissions of less than 700 Hz bandwidth. For the purpose of equipment authorization, a transmitter shall be tested with an antenna that is representative of the type that will be used with the equipment in normal operation.

Unless otherwise stated the results shown in this test report refer only to the sample(s) tested and such sample(s) are retained for 90 days only.

除非另有說明，此報告結果僅對測試之樣品負責，同時此樣品僅保留90天。本報告未經本公司書面許可，不可部份複製。

This document is issued by the Company subject to its General Conditions of Service printed overleaf, available on request or accessible at www.sgs.com/terms_and_conditions.htm and, for electronic format documents, subject to Terms and Conditions for Electronic Documents at www.sgs.com/terms_e-document.htm. Attention is drawn to the limitation of liability, indemnification and jurisdiction issues defined therein. Any holder of this document is advised that information contained hereon reflects the Company's findings at the time of its intervention only and within the limits of Client's instructions, if any. The Company's sole responsibility is to its Client and this document does not exonerate parties to a transaction from exercising all their rights and obligations under the transaction documents. This document cannot be reproduced except in full, without prior written approval of the Company. Any unauthorized alteration, forgery or falsification of the content or appearance of this document is unlawful and offenders may be prosecuted to the fullest extent of the law.

SGS Taiwan Ltd.

台灣檢驗科技股份有限公司

No.134,WuKungRoad,NewTaipeiIndustrialPark,WukuDistrict,NewTaipeiCity,Taiwan24803/新北市五股區新北產業園區五工路 134 號

t (886-2) 2299-3279

f (886-2) 2298-0488

www.tw.sgs.com

Member of SGS Group

9.2. EUT Setup

Radiated Emission Test Set-Up, Frequency Below 1000MHz

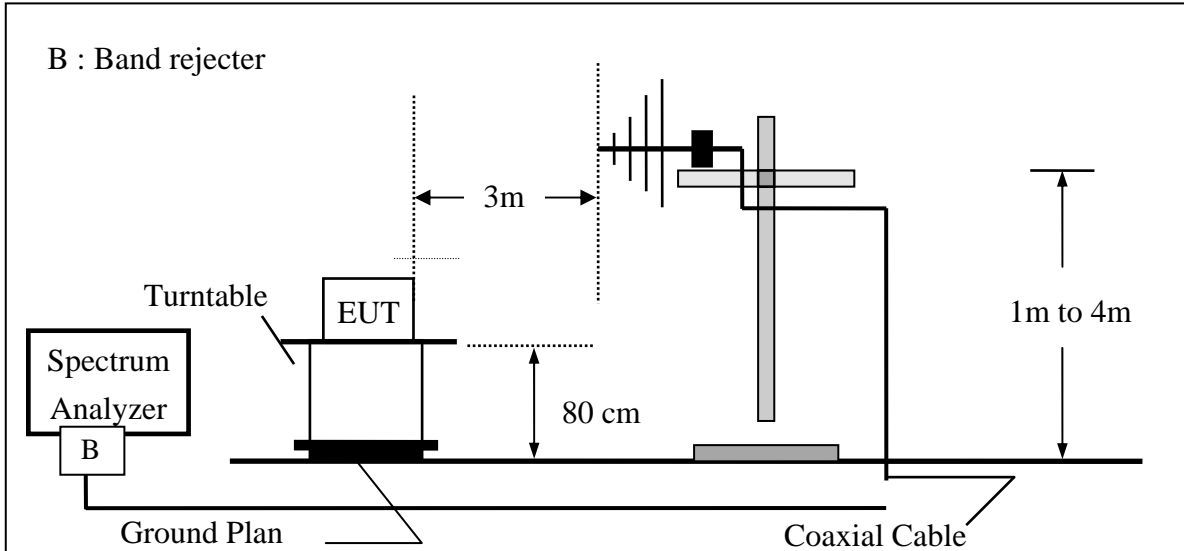

Radiated Emission Test Set-UP Frequency Over 1 GHz

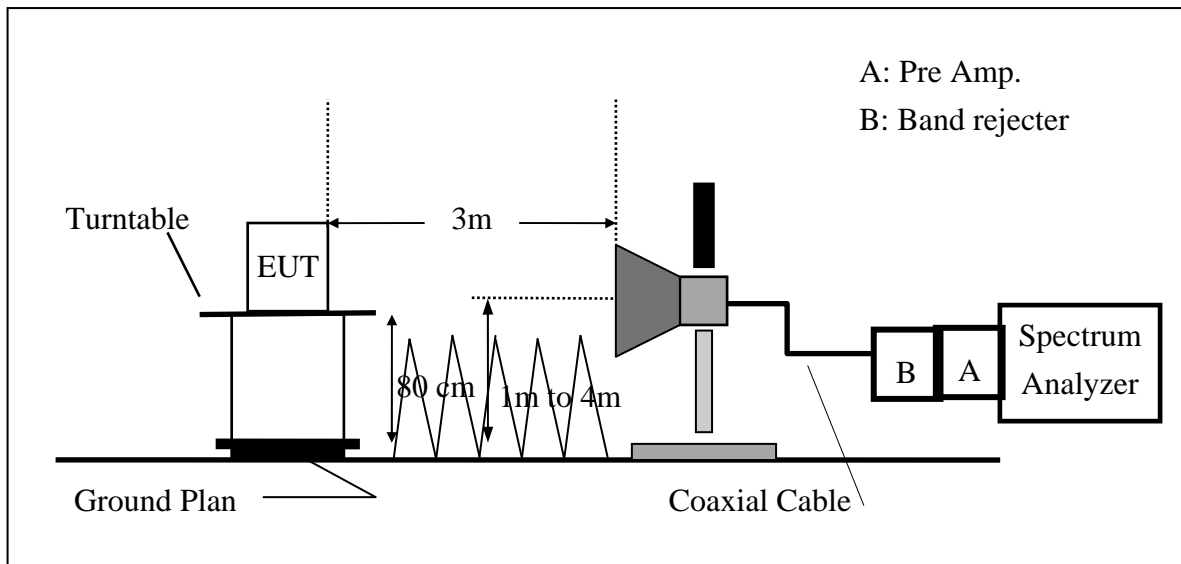

Unless otherwise stated the results shown in this test report refer only to the sample(s) tested and such sample(s) are retained for 90 days only.

除非另有說明，此報告結果僅對測試之樣品負責，同時此樣品僅保留90天。本報告未經本公司書面許可，不可部份複製。

This document is issued by the Company subject to its General Conditions of Service printed overleaf, available on request or accessible at www.sgs.com/terms_and_conditions.htm and, for electronic format documents, subject to Terms and Conditions for Electronic Documents at www.sgs.com/terms_e-document.htm. Attention is drawn to the limitation of liability, indemnification and jurisdiction issues defined therein. Any holder of this document is advised that information contained hereon reflects the Company's findings at the time of its intervention only and within the limits of Client's instructions, if any. The Company's sole responsibility is to its Client and this document does not exonerate parties to a transaction from exercising all their rights and obligations under the transaction documents. This document cannot be reproduced except in full, without prior written approval of the Company. Any unauthorized alteration, forgery or falsification of the content or appearance of this document is unlawful and offenders may be prosecuted to the fullest extent of the law.

9.3. Measurement Procedure:

The EUT was placed on a non-conductive; the measurement antenna was placed at a distance of 3 meters from the EUT. During the tests, the antenna height and the EUT azimuth were varied in order to identify the maximum level of emissions from the EUT. This maximization process was repeated with the EUT positioned in each of its three orthogonal orientations.

The frequency range up to tenth harmonic was investigated for each of three fundamental frequencies (low, middle and high channels). Once spurious emission was identified, the power of the emission was determined using the substitution method.

The spurious emissions attenuation was calculated as the difference between radiated power at the fundamental frequency and the spurious emissions frequency.

$$\text{ERP (dBm)} = \text{SG Level(dBm)} + \text{Antenna Gain(dBd)} + \text{Cable Loss(dB)}$$

$$\text{EIRP (dBm)} = \text{SG Level(dBm)} + \text{Antenna Gain(dBi)} + \text{Cable Loss(dB)}$$

Note : “F” : denotes Fundamental Frequency. ; “H” : denotes Harmonic Frequency.

“E” : denotes Band Edge Frequency. ; “S” : denotes Spurious Frequency.

“---“ : denotes Noise Floor.

Unless otherwise stated the results shown in this test report refer only to the sample(s) tested and such sample(s) are retained for 90 days only.

除非另有說明，此報告結果僅對測試之樣品負責，同時此樣品僅保留90天。本報告未經本公司書面許可，不可部份複製。

This document is issued by the Company subject to its General Conditions of Service printed overleaf, available on request or accessible at www.sgs.com/terms_and_conditions.htm and, for electronic format documents, subject to Terms and Conditions for Electronic Documents at www.sgs.com/terms_e-document.htm. Attention is drawn to the limitation of liability, indemnification and jurisdiction issues defined therein. Any holder of this document is advised that information contained hereon reflects the Company's findings at the time of its intervention only and within the limits of Client's instructions, if any. The Company's sole responsibility is to its Client and this document does not exonerate parties to a transaction from exercising all their rights and obligations under the transaction documents. This document cannot be reproduced except in full, without prior written approval of the Company. Any unauthorized alteration, forgery or falsification of the content or appearance of this document is unlawful and offenders may be prosecuted to the fullest extent of the law.

SGS Taiwan Ltd.

No.134,WuKungRoad,NewTaipeiIndustrialPark,WukuDistrict,NewTaipeiCity,Taiwan24803/新北市五股區新北產業園區五工路 134 號

台灣檢驗科技股份有限公司

t (886-2) 2299-3279

f (886-2) 2298-0488

www.tw.sgs.com

Member of SGS Group

9.4. Measurement Equipment Used:

ERP, EIRP MEASUREMENT EQUIPMENT List 966 Chamber					
EQUIPMENT TYPE	MFR	MODEL NUMBER	SERIAL NUMBER	LAST CAL.	CAL DUE.
EXA Spectrum Analyzer	Agilent	N9010A	MY50420195	12/22/2014	12/21/2015
Bilog Antenna	SCHWAZBECK	VULB9168	378	12/23/2014	12/22/2015
Bilog Antenna	SCHWAZBECK	VULB9160	3158	10/31/2014	10/30/2015
Horn antenna	ETS.LINDGREN	3117	123995	05/05/2015	05/04/2016
Horn antenna	ETS.LINDGREN	3117	123991	12/19/2014	12/18/2015
Horn Antenna	Schwarzbeck	BBHA9170	184	12/25/2014	12/24/2015
Horn Antenna	Schwarzbeck	BBHA9170	185	07/29/2014	07/28/2015
Network Analyze	Anritsu	MS4644A	1216312	05/23/2015	05/22/2016
Signal Generator	Agilent	E4438C	MY45093613	08/06/2014	08/05/2015
Pre-Amplifier	Agilent	8447D	1937A02834	01/02/2015	01/01/2016
Pre-Amplifier	Agilent	8449B	3008A00578	01/02/2015	01/01/2016
Pre-Amplifier	EMC Instruments Corp.	EMC184045	980135	01/02/2015	01/01/2016
Attenuator	Mini-Circuit	BW-S10W2+	004	01/02/2015	01/01/2016
Radio Communication Analyzer	R&S	CMU200	102189	02/11/2015	02/10/2016
Radio Communication Analyzer	Anritsu	MT8820C	6200995019	10/08/2014	10/09/2015
Turn Table	HD	DT420	N/A	N.C.R	N.C.R
Antenna Tower	HD	MA240-N	240/657	N.C.R	N.C.R
Controller	HD	HD100	N/A	N.C.R	N.C.R
Low Loss Cable	HUBER+SUHNER	966_Tx	10m	01/02/2015	01/01/2016
Low Loss Cable	HUBER+SUHNER	966_Rx	3m	01/02/2015	01/01/2016
Filter 800-1000	Micro-Tronics	EWT	M2	01/02/2015	01/01/2016
Filter 1800-2000	Micro-Tronics	EWT	M2	01/02/2015	01/01/2016
Filter 1700-1800	Micro-Tronics	BRC15751	001	01/02/2015	01/01/2016
1GHz High Pass Filter	Micro-Tronics	HPM50108	32	01/02/2015	01/01/2016
2GHz High Pass Filter	Micro-Tronics	HPM50110	36	01/02/2015	01/01/2016
3m Site NSA	SGS	966 chamber	N/A	07/15/2014	07/14/2015

Unless otherwise stated the results shown in this test report refer only to the sample(s) tested and such sample(s) are retained for 90 days only.

除非另有說明，此報告結果僅對測試之樣品負責，同時此樣品僅保留90天。本報告未經本公司書面許可，不可部份複製。

This document is issued by the Company subject to its General Conditions of Service printed overleaf, available on request or accessible at www.sgs.com/terms_and_conditions.htm and, for electronic format documents, subject to Terms and Conditions for Electronic Documents at www.sgs.com/terms_e-document.htm. Attention is drawn to the limitation of liability, indemnification and jurisdiction issues defined therein. Any holder of this document is advised that information contained hereon reflects the Company's findings at the time of its intervention only and within the limits of Client's instructions, if any. The Company's sole responsibility is to its Client and this document does not exonerate parties to a transaction from exercising all their rights and obligations under the transaction documents. This document cannot be reproduced except in full, without prior written approval of the Company. Any unauthorized alteration, forgery or falsification of the content or appearance of this document is unlawful and offenders may be prosecuted to the fullest extent of the law.

SGS Taiwan Ltd.

No.134,WuKungRoad,NewTaipeiIndustrialPark,WukuDistrict,NewTaipeiCity,Taiwan24803/新北市五股區新北產業園區五工路 134 號

台灣檢驗科技股份有限公司

t (886-2) 2299-3279

f (886-2) 2298-0488

www.tw.sgs.com

Member of SGS Group

9.5. Measurement Result:

Radiated Spurious Emission Measurement Result: GSM 850 Mode

ARFCN	:CH 128	Test Date	:2015-06-11
Operation Band	:GSM 850	Temp./Humi.	:22 deg_C / 53 RH
Fundamental Frequency	:824.2 MHz	Engineer	:Curry
Operation Mode	:TX LOW		
EUT Pol.	:E1 Plan	Measurement Antenna Pol.	:VERTICAL

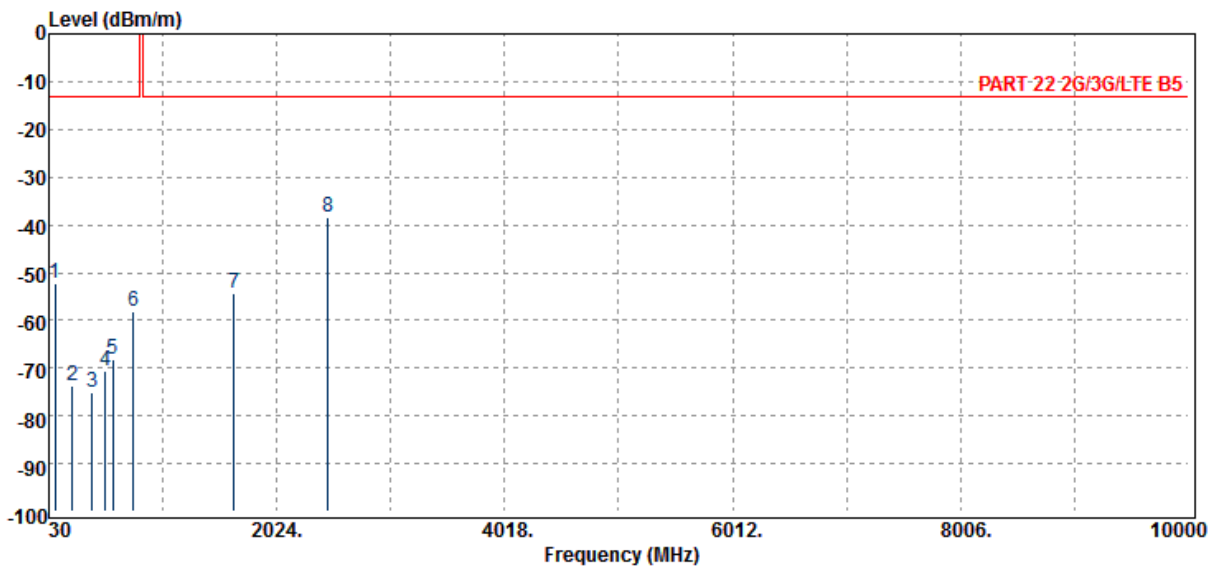

Freq. MHz	Note F/H/E/S	ERP dBm	SG Output Level dBm	Antenna Gain dBd	Cable Loss dB	Limit dBm	Margin dB
82.38	S	-52.37	-49.13	-2.18	-1.06	-13.00	-39.37
235.64	S	-73.87	-75.58	3.30	-1.59	-13.00	-60.87
412.18	S	-75.20	-76.80	3.55	-1.95	-13.00	-62.20
524.70	S	-70.70	-71.93	3.67	-2.44	-13.00	-57.70
590.66	S	-68.10	-68.81	3.47	-2.77	-13.00	-55.10
772.05	S	-58.17	-58.77	3.35	-2.75	-13.00	-45.17
1648.40	H	-54.43	-53.27	3.05	-4.21	-13.00	-41.43
2472.60	H	-38.42	-36.69	3.59	-5.32	-13.00	-25.42

Unless otherwise stated the results shown in this test report refer only to the sample(s) tested and such sample(s) are retained for 90 days only.

除非另有說明，此報告結果僅對測試之樣品負責，同時此樣品僅保留90天。本報告未經本公司書面許可，不可部份複製。

This document is issued by the Company subject to its General Conditions of Service printed overleaf, available on request or accessible at www.sgs.com/terms_and_conditions.htm and, for electronic format documents, subject to Terms and Conditions for Electronic Documents at www.sgs.com/terms_e-document.htm. Attention is drawn to the limitation of liability, indemnification and jurisdiction issues defined therein. Any holder of this document is advised that information contained hereon reflects the Company's findings at the time of its intervention only and within the limits of Client's instructions, if any. The Company's sole responsibility is to its Client and this document does not exonerate parties to a transaction from exercising all their rights and obligations under the transaction documents. This document cannot be reproduced except in full, without prior written approval of the Company. Any unauthorized alteration, forgery or falsification of the content or appearance of this document is unlawful and offenders may be prosecuted to the fullest extent of the law.

ARFCN	:CH 128	Test Date	:2015-06-11
Operation Band	:GSM 850	Temp./Humi.	:22 deg_C / 53 RH
Fundamental Frequency	:824.2 MHz	Engineer	:Curry
Operation Mode	:TX LOW		
EUT Pol.	:E1 Plan	Measurement Antenna Pol.	:HORIZONTAL

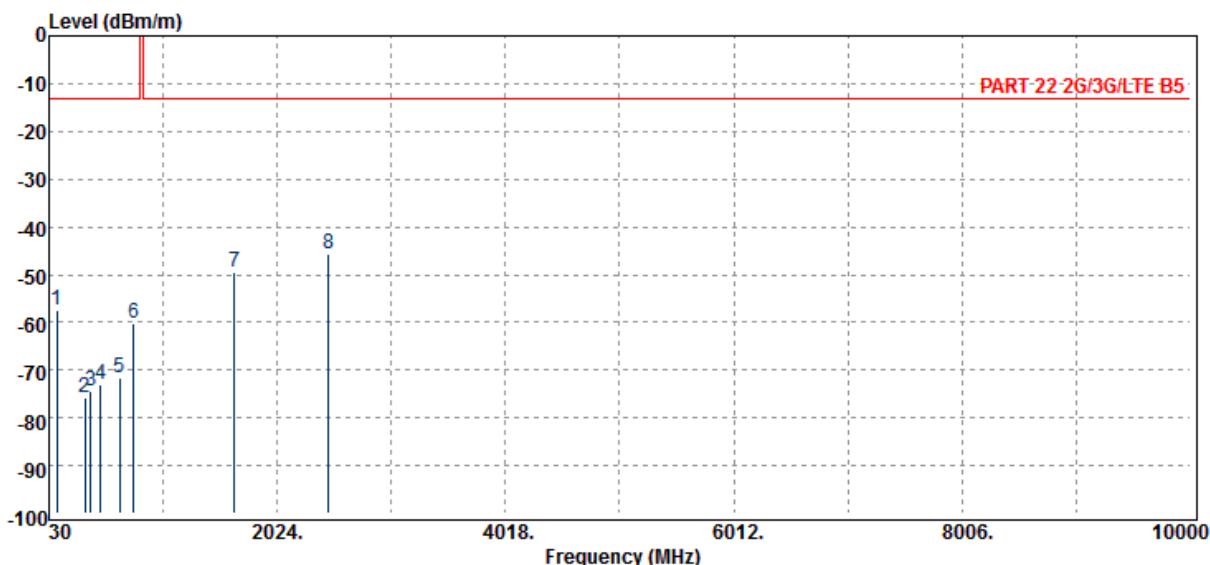

Freq. MHz	Note F/H/E/S	ERP dBm	SG Output Level dBm	Antenna Gain dBd	Cable Loss dB	Limit dBm	Margin dB
96.93	S	-57.54	-55.23	-1.20	-1.11	-13.00	-44.54
340.40	S	-75.92	-77.72	3.74	-1.93	-13.00	-62.92
397.63	S	-74.56	-76.24	3.63	-1.95	-13.00	-61.56
479.11	S	-73.09	-74.50	3.59	-2.18	-13.00	-60.09
649.83	S	-71.46	-72.44	3.64	-2.66	-13.00	-58.46
772.05	S	-60.05	-60.66	3.35	-2.75	-13.00	-47.05
1648.40	H	-49.41	-48.25	3.05	-4.21	-13.00	-36.41
2472.60	H	-45.78	-44.05	3.59	-5.32	-13.00	-32.78

Unless otherwise stated the results shown in this test report refer only to the sample(s) tested and such sample(s) are retained for 90 days only.
 除非另有說明，此報告結果僅對測試之樣品負責，同時此樣品僅保留90天。本報告未經本公司書面許可，不可部份複製。
 This document is issued by the Company subject to its General Conditions of Service printed overleaf, available on request or accessible at www.sgs.com/terms_and_conditions.htm and, for electronic format documents, subject to Terms and Conditions for Electronic Documents at www.sgs.com/terms_e-document.htm. Attention is drawn to the limitation of liability, indemnification and jurisdiction issues defined therein. Any holder of this document is advised that information contained hereon reflects the Company's findings at the time of its intervention only and within the limits of Client's instructions, if any. The Company's sole responsibility is to its Client and this document does not exonerate parties to a transaction from exercising all their rights and obligations under the transaction documents. This document cannot be reproduced except in full, without prior written approval of the Company. Any unauthorized alteration, forgery or falsification of the content or appearance of this document is unlawful and offenders may be prosecuted to the fullest extent of the law.

ARFCN	:CH 190	Test Date	:2015-06-11
Operation Band	:GSM 850	Temp./Humi.	:22 deg_C / 53 RH
Fundamental Frequency	:836.6 MHz	Engineer	:Curry
Operation Mode	:TX MID	Measurement Antenna Pol.	:VERTICAL
EUT Pol.	:E1 Plan		

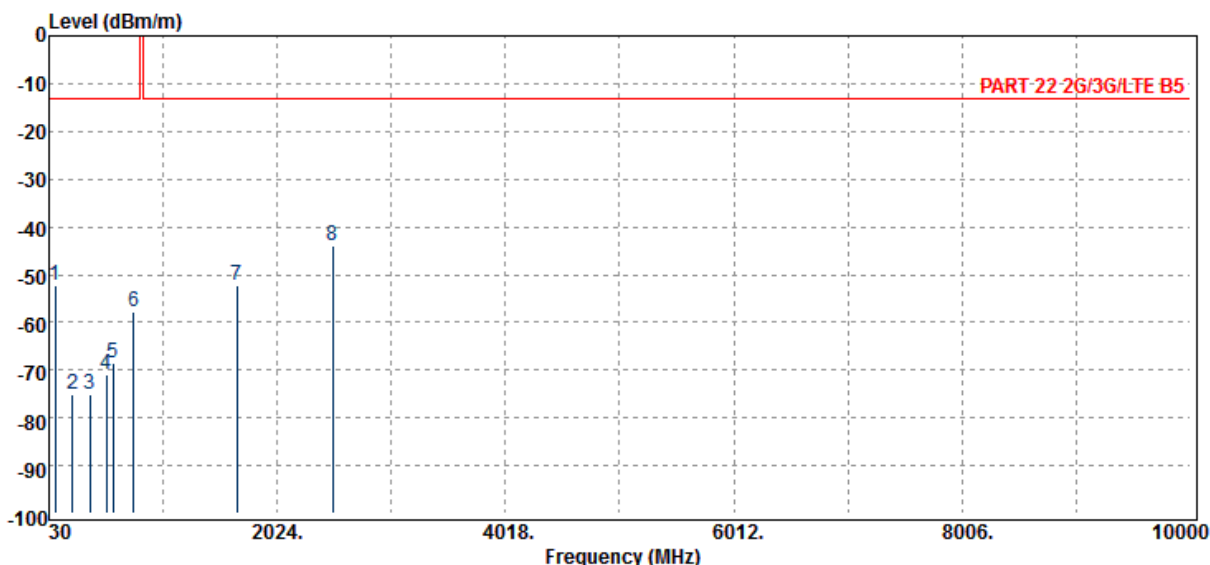

Freq. MHz	Note F/H/E/S	ERP dBm	SG Output Level dBm	Antenna Gain dBd	Cable Loss dB	Limit dBm	Margin dB
82.38	S	-52.38	-49.14	-2.18	-1.06	-13.00	-39.38
238.55	S	-75.16	-76.85	3.29	-1.60	-13.00	-62.16
388.90	S	-74.97	-76.67	3.65	-1.95	-13.00	-61.97
529.55	S	-70.80	-71.99	3.66	-2.47	-13.00	-57.80
588.72	S	-68.41	-69.12	3.47	-2.76	-13.00	-55.41
773.02	S	-57.67	-58.28	3.36	-2.75	-13.00	-44.67
1673.20	H	-52.17	-50.92	3.01	-4.26	-13.00	-39.17
2509.80	H	-44.02	-42.34	3.67	-5.35	-13.00	-31.02

Unless otherwise stated the results shown in this test report refer only to the sample(s) tested and such sample(s) are retained for 90 days only.
 除非另有說明，此報告結果僅對測試之樣品負責，同時此樣品僅保留90天。本報告未經本公司書面許可，不可部份複製。
 This document is issued by the Company subject to its General Conditions of Service printed overleaf, available on request or accessible at www.sgs.com/terms_and_conditions.htm and, for electronic format documents, subject to Terms and Conditions for Electronic Documents at www.sgs.com/terms_e-document.htm. Attention is drawn to the limitation of liability, indemnification and jurisdiction issues defined therein. Any holder of this document is advised that information contained hereon reflects the Company's findings at the time of its intervention only and within the limits of Client's instructions, if any. The Company's sole responsibility is to its Client and this document does not exonerate parties to a transaction from exercising all their rights and obligations under the transaction documents. This document cannot be reproduced except in full, without prior written approval of the Company. Any unauthorized alteration, forgery or falsification of the content or appearance of this document is unlawful and offenders may be prosecuted to the fullest extent of the law.

ARFCN	:CH 190	Test Date	:2015-06-11
Operation Band	:GSM 850	Temp./Humi.	:22 deg_C / 53 RH
Fundamental Frequency	:836.6 MHz	Engineer	:Curry
Operation Mode	:TX MID	Measurement Antenna Pol.	:HORIZONTAL
EUT Pol.	:E1 Plan		

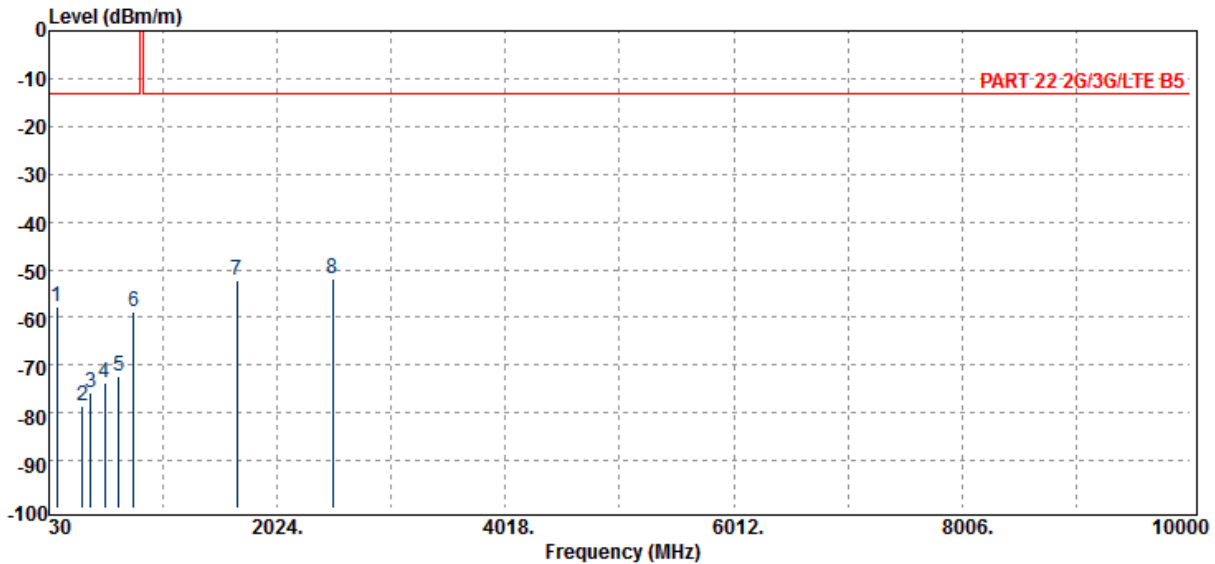

Freq. MHz	Note F/H/E/S	ERP dBm	SG Output Level dBm	Antenna Gain dBd	Cable Loss dB	Limit dBm	Margin dB
44.55	S	-65.88	-53.11	-11.87	-0.90	-13.00	-52.88
449.04	S	-69.70	-71.33	3.85	-2.22	-13.00	-56.70
645.95	S	-70.04	-71.28	3.92	-2.68	-13.00	-57.04
741.98	S	-66.97	-67.85	3.71	-2.83	-13.00	-53.97
771.08	S	-48.34	-49.15	3.71	-2.89	-13.00	-35.34
938.89	S	-60.85	-60.91	3.38	-3.32	-13.00	-47.85
1673.20	H	-52.28	-51.03	3.01	-4.26	-13.00	-39.28
2509.80	H	-52.06	-50.38	3.67	-5.35	-13.00	-39.06

Unless otherwise stated the results shown in this test report refer only to the sample(s) tested and such sample(s) are retained for 90 days only.

除非另有說明，此報告結果僅對測試之樣品負責，同時此樣品僅保留90天。本報告未經本公司書面許可，不可部份複製。

This document is issued by the Company subject to its General Conditions of Service printed overleaf, available on request or accessible at www.sgs.com/terms_and_conditions.htm and, for electronic format documents, subject to Terms and Conditions for Electronic Documents at www.sgs.com/terms_e-document.htm. Attention is drawn to the limitation of liability, indemnification and jurisdiction issues defined therein. Any holder of this document is advised that information contained hereon reflects the Company's findings at the time of its intervention only and within the limits of Client's instructions, if any. The Company's sole responsibility is to its Client and this document does not exonerate parties to a transaction from exercising all their rights and obligations under the transaction documents. This document cannot be reproduced except in full, without prior written approval of the Company. Any unauthorized alteration, forgery or falsification of the content or appearance of this document is unlawful and offenders may be prosecuted to the fullest extent of the law.

ARFCN	:CH 251	Test Date	:2015-06-11
Operation Band	:GSM 850	Temp./Humi.	:22 deg_C / 53 RH
Fundamental Frequency	:848.8 MHz	Engineer	:Curry
Operation Mode	:TX HIGH	Measurement Antenna Pol.	:VERTICAL
EUT Pol.	:E1 Plan		

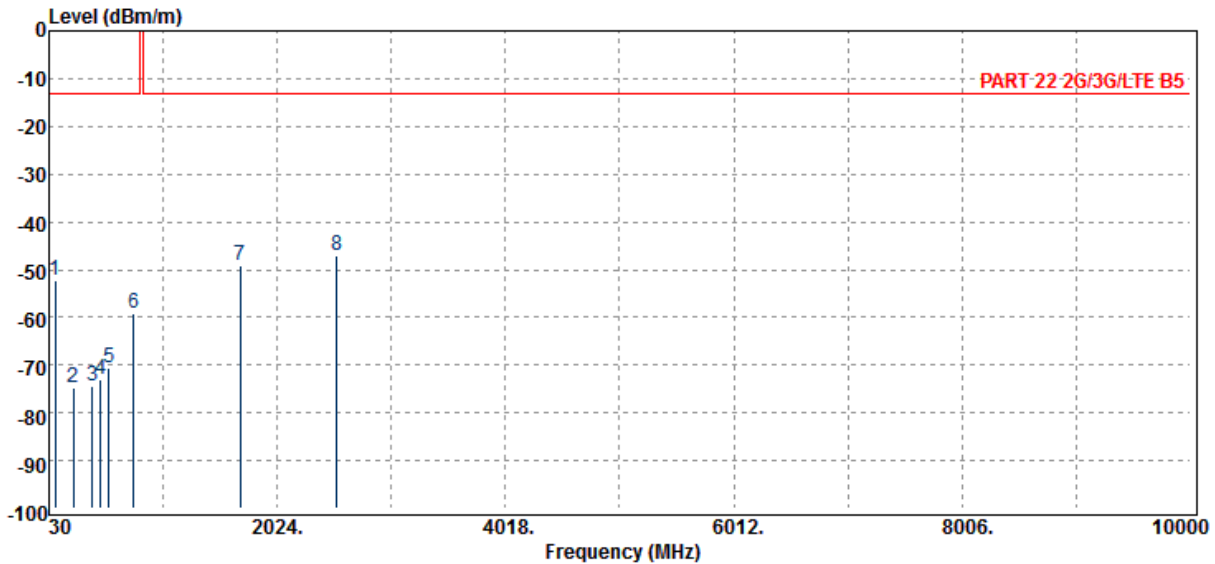

Freq. MHz	Note F/H/E/S	ERP dBm	SG Output Level dBm	Antenna Gain dBd	Cable Loss dB	Limit dBm	Margin dB
81.41	S	-52.38	-48.91	-2.41	-1.06	-13.00	-39.38
239.52	S	-74.76	-76.43	3.29	-1.61	-13.00	-61.76
405.39	S	-74.46	-76.11	3.59	-1.94	-13.00	-61.46
479.11	S	-72.95	-74.37	3.59	-2.18	-13.00	-59.95
551.86	S	-70.59	-71.59	3.58	-2.58	-13.00	-57.59
772.05	S	-59.21	-59.81	3.35	-2.75	-13.00	-46.21
1697.60	H	-49.12	-47.81	2.96	-4.28	-13.00	-36.12
2546.40	H	-47.13	-45.47	3.75	-5.41	-13.00	-34.13

Unless otherwise stated the results shown in this test report refer only to the sample(s) tested and such sample(s) are retained for 90 days only.

除非另有說明，此報告結果僅對測試之樣品負責，同時此樣品僅保留90天。本報告未經本公司書面許可，不可部份複製。

This document is issued by the Company subject to its General Conditions of Service printed overleaf, available on request or accessible at www.sgs.com/terms_and_conditions.htm and, for electronic format documents, subject to Terms and Conditions for Electronic Documents at www.sgs.com/terms_e-document.htm. Attention is drawn to the limitation of liability, indemnification and jurisdiction issues defined therein. Any holder of this document is advised that information contained hereon reflects the Company's findings at the time of its intervention only and within the limits of Client's instructions, if any. The Company's sole responsibility is to its Client and this document does not exonerate parties to a transaction from exercising all their rights and obligations under the transaction documents. This document cannot be reproduced except in full, without prior written approval of the Company. Any unauthorized alteration, forgery or falsification of the content or appearance of this document is unlawful and offenders may be prosecuted to the fullest extent of the law.

ARFCN	:CH 251	Test Date	:2015-06-11
Operation Band	:GSM 850	Temp./Humi.	:22 deg_C / 53 RH
Fundamental Frequency	:848.8 MHz	Engineer	:Curry
Operation Mode	:TX HIGH		
EUT Pol.	:E1 Plan	Measurement Antenna Pol.	:HORIZONTAL

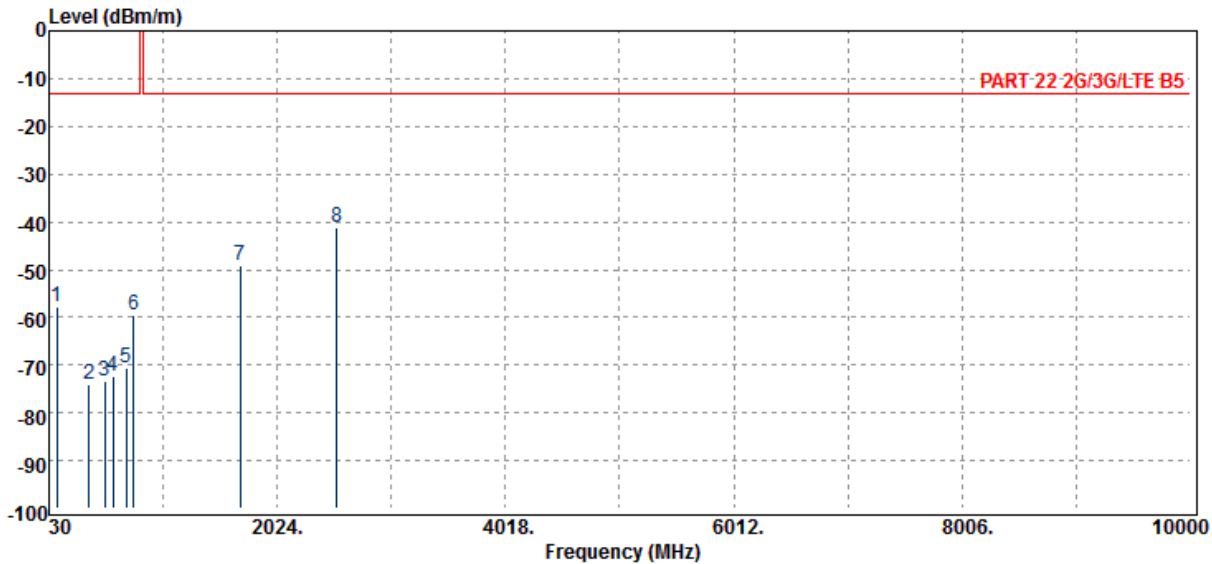

Freq. MHz	Note F/H/E/S	ERP dBm	SG Output Level dBm	Antenna Gain dBd	Cable Loss dB	Limit dBm	Margin dB
95.96	S	-57.79	-55.59	-1.10	-1.11	-13.00	-44.79
380.17	S	-74.00	-75.72	3.67	-1.95	-13.00	-61.00
514.03	S	-73.30	-74.63	3.71	-2.38	-13.00	-60.30
585.81	S	-72.45	-73.19	3.48	-2.75	-13.00	-59.45
706.09	S	-70.71	-71.48	3.37	-2.60	-13.00	-57.71
773.02	S	-59.63	-60.24	3.36	-2.75	-13.00	-46.63
1697.60	H	-48.99	-47.68	2.96	-4.28	-13.00	-35.99
2546.40	H	-41.29	-39.64	3.75	-5.41	-13.00	-28.29

Unless otherwise stated the results shown in this test report refer only to the sample(s) tested and such sample(s) are retained for 90 days only.

除非另有說明，此報告結果僅對測試之樣品負責，同時此樣品僅保留90天。本報告未經本公司書面許可，不可部份複製。

This document is issued by the Company subject to its General Conditions of Service printed overleaf, available on request or accessible at www.sgs.com/terms_and_conditions.htm and, for electronic format documents, subject to Terms and Conditions for Electronic Documents at www.sgs.com/terms_e-document.htm. Attention is drawn to the limitation of liability, indemnification and jurisdiction issues defined therein. Any holder of this document is advised that information contained hereon reflects the Company's findings at the time of its intervention only and within the limits of Client's instructions, if any. The Company's sole responsibility is to its Client and this document does not exonerate parties to a transaction from exercising all their rights and obligations under the transaction documents. This document cannot be reproduced except in full, without prior written approval of the Company. Any unauthorized alteration, forgery or falsification of the content or appearance of this document is unlawful and offenders may be prosecuted to the fullest extent of the law.

Radiated Spurious Emission Measurement Result: GSM 1900 Mode

ARFCN	:CH 512	Test Date	:2015-06-11
Operation Band	:GSM 1900	Temp./Humi.	:22 deg_C / 53 RH
Fundamental Frequency	:1850.2 MHz	Engineer	:Curry
Operation Mode	:TX LOW		
EUT Pol.	:E2 Plan	Measurement Antenna Pol.	:VERTICAL

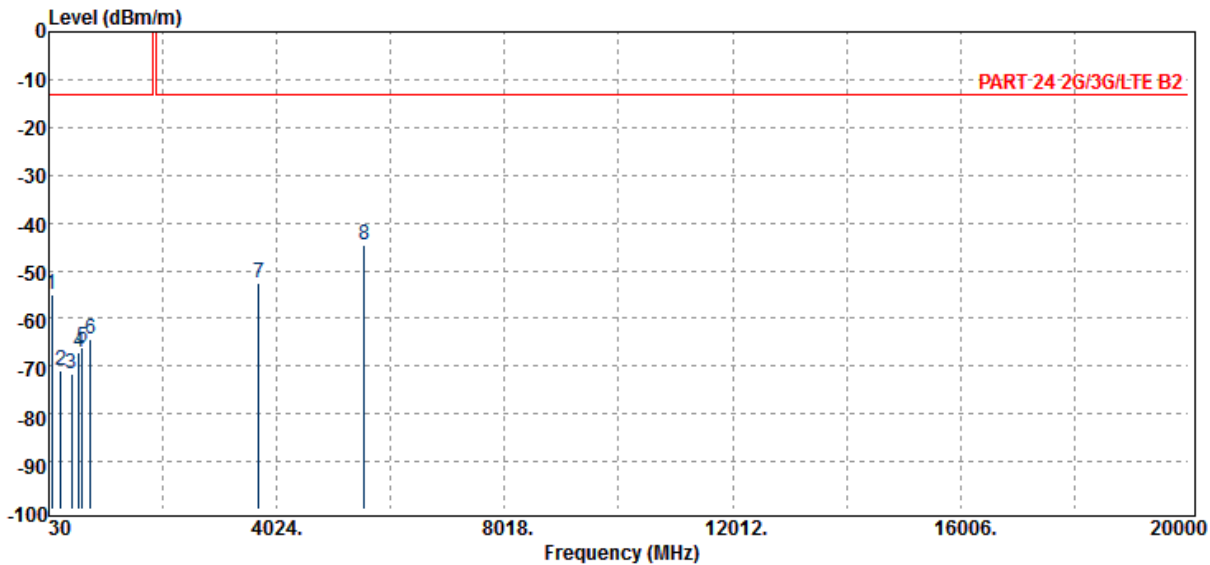

Freq. MHz	Note F/H/E/S	EIRP dBm	SG Output Level dBm	Antenna Gain dBi	Cable Loss dB	Limit dBm	Margin dB
87.23	S	-55.08	-55.10	1.10	-1.08	-13.00	-42.08
235.64	S	-70.89	-74.75	5.45	-1.59	-13.00	-57.89
420.91	S	-71.63	-75.30	5.65	-1.98	-13.00	-58.63
554.77	S	-67.22	-70.35	5.72	-2.60	-13.00	-54.22
608.12	S	-66.17	-69.07	5.63	-2.73	-13.00	-53.17
756.53	S	-64.47	-67.21	5.45	-2.71	-13.00	-51.47
3700.40	H	-52.70	-54.24	8.43	-6.88	-13.00	-39.70
5550.60	H	-44.79	-46.35	10.10	-8.55	-13.00	-31.79

Unless otherwise stated the results shown in this test report refer only to the sample(s) tested and such sample(s) are retained for 90 days only.

除非另有說明，此報告結果僅對測試之樣品負責，同時此樣品僅保留90天。本報告未經本公司書面許可，不可部份複製。

This document is issued by the Company subject to its General Conditions of Service printed overleaf, available on request or accessible at www.sgs.com/terms_and_conditions.htm and, for electronic format documents, subject to Terms and Conditions for Electronic Documents at www.sgs.com/terms_e-document.htm. Attention is drawn to the limitation of liability, indemnification and jurisdiction issues defined therein. Any holder of this document is advised that information contained hereon reflects the Company's findings at the time of its intervention only and within the limits of Client's instructions, if any. The Company's sole responsibility is to its Client and this document does not exonerate parties to a transaction from exercising all their rights and obligations under the transaction documents. This document cannot be reproduced except in full, without prior written approval of the Company. Any unauthorized alteration, forgery or falsification of the content or appearance of this document is unlawful and offenders may be prosecuted to the fullest extent of the law.

SGS Taiwan Ltd.

No.134,WuKungRoad,NewTaipeiIndustrialPark,WukuDistrict,NewTaipeiCity,Taiwan24803/新北市五股區新北產業園區五工路 134 號

台灣檢驗科技股份有限公司

t (886-2) 2299-3279

f (886-2) 2298-0488

www.tw.sgs.com

Member of SGS Group

ARFCN	:CH 512	Test Date	:2015-06-11
Operation Band	:GSM 1900	Temp./Humi.	:22 deg_C / 53 RH
Fundamental Frequency	:1850.2 MHz	Engineer	:Curry
Operation Mode	:TX LOW		
EUT Pol.	:E2 Plan	Measurement Antenna Pol.	:HORIZONTAL

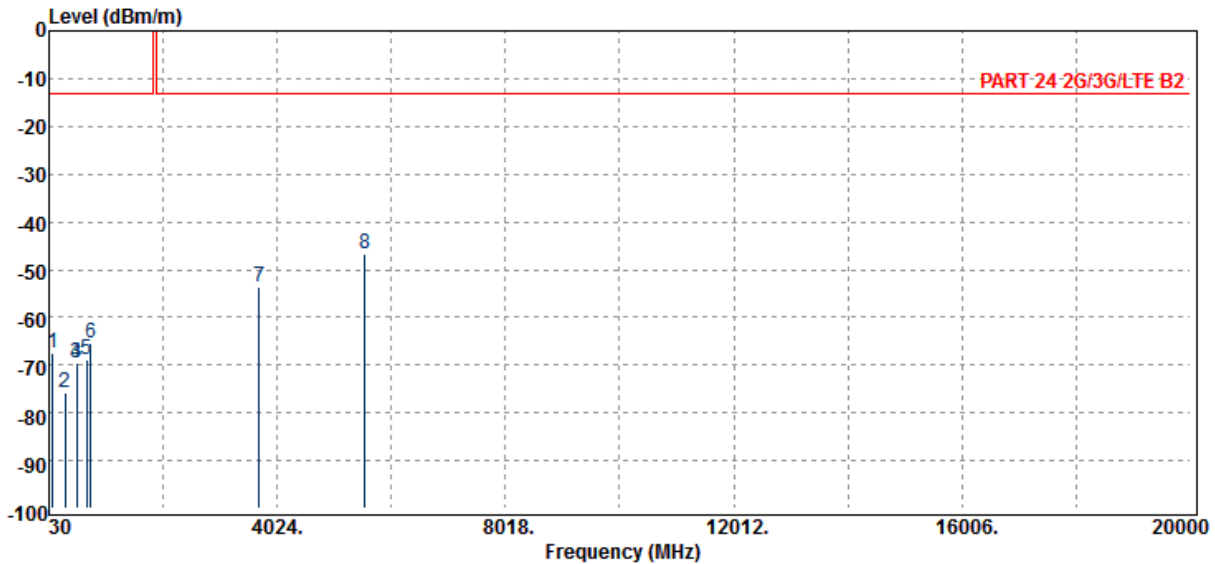

Freq. MHz	Note F/H/E/S	EIRP dBm	SG Output Level dBm	Antenna Gain dBi	Cable Loss dB	Limit dBm	Margin dB
94.99	S	-67.43	-67.49	1.16	-1.11	-13.00	-54.43
316.15	S	-75.90	-79.88	5.82	-1.85	-13.00	-62.90
513.06	S	-69.61	-73.10	5.86	-2.38	-13.00	-56.61
513.06	S	-69.61	-73.10	5.86	-2.38	-13.00	-56.61
693.48	S	-68.83	-71.78	5.56	-2.61	-13.00	-55.83
764.29	S	-65.49	-68.24	5.48	-2.73	-13.00	-52.49
3700.40	H	-53.62	-55.17	8.43	-6.88	-13.00	-40.62
5550.60	H	-46.78	-48.34	10.10	-8.55	-13.00	-33.78

Unless otherwise stated the results shown in this test report refer only to the sample(s) tested and such sample(s) are retained for 90 days only.

除非另有說明，此報告結果僅對測試之樣品負責，同時此樣品僅保留90天。本報告未經本公司書面許可，不可部份複製。

This document is issued by the Company subject to its General Conditions of Service printed overleaf, available on request or accessible at www.sgs.com/terms_and_conditions.htm and, for electronic format documents, subject to Terms and Conditions for Electronic Documents at www.sgs.com/terms_e-document.htm. Attention is drawn to the limitation of liability, indemnification and jurisdiction issues defined therein. Any holder of this document is advised that information contained hereon reflects the Company's findings at the time of its intervention only and within the limits of Client's instructions, if any. The Company's sole responsibility is to its Client and this document does not exonerate parties to a transaction from exercising all their rights and obligations under the transaction documents. This document cannot be reproduced except in full, without prior written approval of the Company. Any unauthorized alteration, forgery or falsification of the content or appearance of this document is unlawful and offenders may be prosecuted to the fullest extent of the law.

ARFCN	:CH 661	Test Date	:2015-06-11
Operation Band	:GSM 1900	Temp./Humi.	:22 deg_C / 53 RH
Fundamental Frequency	:1880.0 MHz	Engineer	:Curry
Operation Mode	:TX MID	Measurement Antenna Pol.	:VERTICAL
EUT Pol.	:E2 Plan		

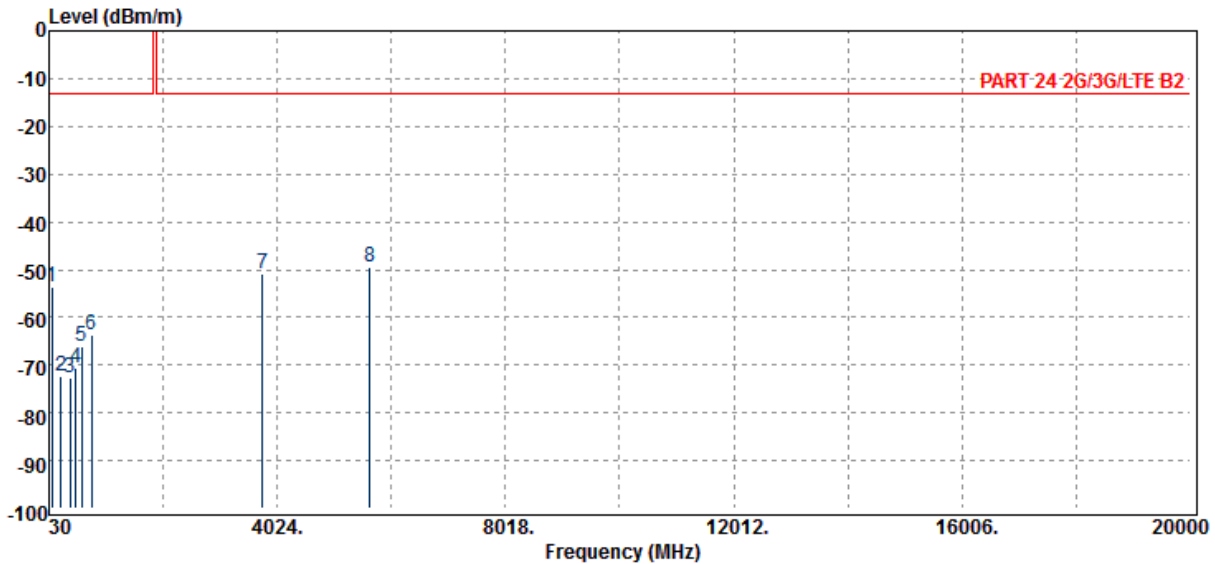

Freq. MHz	Note F/H/E/S	EIRP dBm	SG Output Level dBm	Antenna Gain dBi	Cable Loss dB	Limit dBm	Margin dB
86.26	S	-53.75	-53.55	0.88	-1.08	-13.00	-40.75
235.64	S	-72.39	-76.25	5.45	-1.59	-13.00	-59.39
395.69	S	-72.52	-76.36	5.78	-1.95	-13.00	-59.52
492.69	S	-70.52	-74.11	5.85	-2.26	-13.00	-57.52
606.18	S	-65.94	-68.82	5.62	-2.74	-13.00	-52.94
775.93	S	-63.84	-66.59	5.52	-2.76	-13.00	-50.84
3760.00	H	-50.93	-52.37	8.46	-7.02	-13.00	-37.93
5640.00	H	-49.42	-50.95	10.11	-8.59	-13.00	-36.42

Unless otherwise stated the results shown in this test report refer only to the sample(s) tested and such sample(s) are retained for 90 days only.

除非另有說明，此報告結果僅對測試之樣品負責，同時此樣品僅保留90天。本報告未經本公司書面許可，不可部份複製。

This document is issued by the Company subject to its General Conditions of Service printed overleaf, available on request or accessible at www.sgs.com/terms_and_conditions.htm and, for electronic format documents, subject to Terms and Conditions for Electronic Documents at www.sgs.com/terms_e-document.htm. Attention is drawn to the limitation of liability, indemnification and jurisdiction issues defined therein. Any holder of this document is advised that information contained hereon reflects the Company's findings at the time of its intervention only and within the limits of Client's instructions, if any. The Company's sole responsibility is to its Client and this document does not exonerate parties to a transaction from exercising all their rights and obligations under the transaction documents. This document cannot be reproduced except in full, without prior written approval of the Company. Any unauthorized alteration, forgery or falsification of the content or appearance of this document is unlawful and offenders may be prosecuted to the fullest extent of the law.

ARFCN	:CH 661	Test Date	:2015-06-11
Operation Band	:GSM 1900	Temp./Humi.	:22 deg_C / 53 RH
Fundamental Frequency	:1880.0 MHz	Engineer	:Curry
Operation Mode	:TX MID	Measurement Antenna Pol.	:HORIZONTAL
EUT Pol.	:E2 Plan		

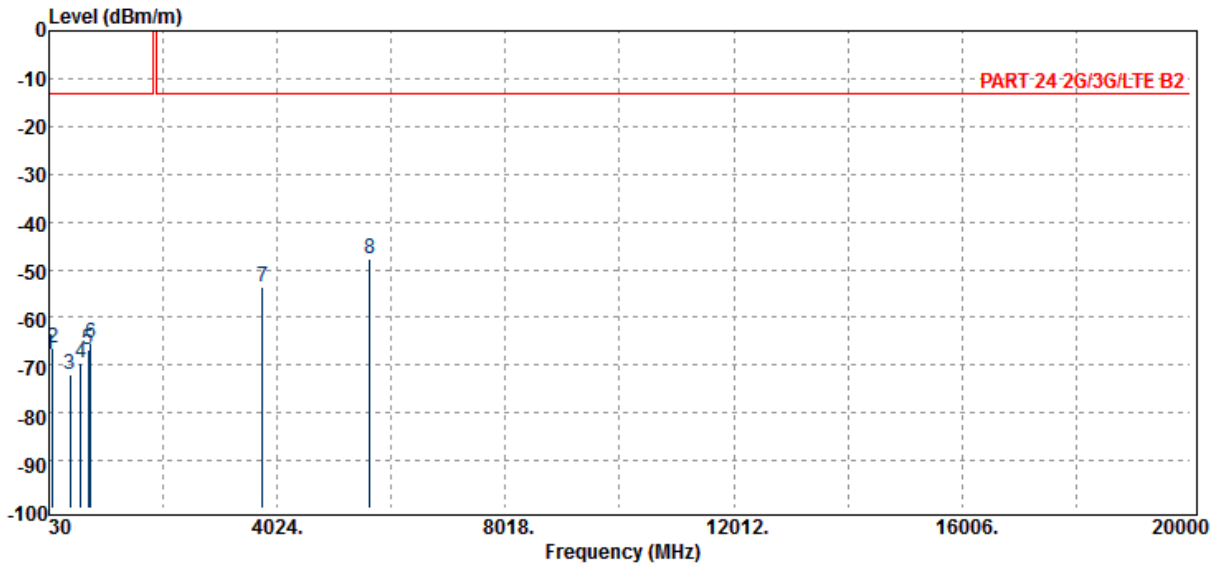

Freq. MHz	Note F/H/E/S	EIRP dBm	SG Output Level dBm	Antenna Gain dBi	Cable Loss dB	Limit dBm	Margin dB
34.85	S	-67.86	-55.55	-11.52	-0.78	-13.00	-54.86
99.84	S	-66.35	-65.88	0.65	-1.12	-13.00	-53.35
405.39	S	-72.13	-75.92	5.74	-1.94	-13.00	-59.13
582.90	S	-69.62	-72.53	5.64	-2.73	-13.00	-56.62
719.67	S	-66.78	-69.65	5.49	-2.62	-13.00	-53.78
765.26	S	-65.24	-67.99	5.48	-2.73	-13.00	-52.24
3760.00	H	-53.74	-55.18	8.46	-7.02	-13.00	-40.74
5640.00	H	-47.85	-49.37	10.11	-8.59	-13.00	-34.85

Unless otherwise stated the results shown in this test report refer only to the sample(s) tested and such sample(s) are retained for 90 days only.

除非另有說明，此報告結果僅對測試之樣品負責，同時此樣品僅保留90天。本報告未經本公司書面許可，不可部份複製。

This document is issued by the Company subject to its General Conditions of Service printed overleaf, available on request or accessible at www.sgs.com/terms_and_conditions.htm and, for electronic format documents, subject to Terms and Conditions for Electronic Documents at www.sgs.com/terms_e-document.htm. Attention is drawn to the limitation of liability, indemnification and jurisdiction issues defined therein. Any holder of this document is advised that information contained hereon reflects the Company's findings at the time of its intervention only and within the limits of Client's instructions, if any. The Company's sole responsibility is to its Client and this document does not exonerate parties to a transaction from exercising all their rights and obligations under the transaction documents. This document cannot be reproduced except in full, without prior written approval of the Company. Any unauthorized alteration, forgery or falsification of the content or appearance of this document is unlawful and offenders may be prosecuted to the fullest extent of the law.

ARFCN	:CH 810	Test Date	:2015-06-11
Operation Band	:GSM 1900	Temp./Humi.	:22 deg_C / 53 RH
Fundamental Frequency	:1909.8 MHz	Engineer	:Curry
Operation Mode	:TX HIGH	Measurement Antenna Pol.	:VERTICAL
EUT Pol.	:E2 Plan		

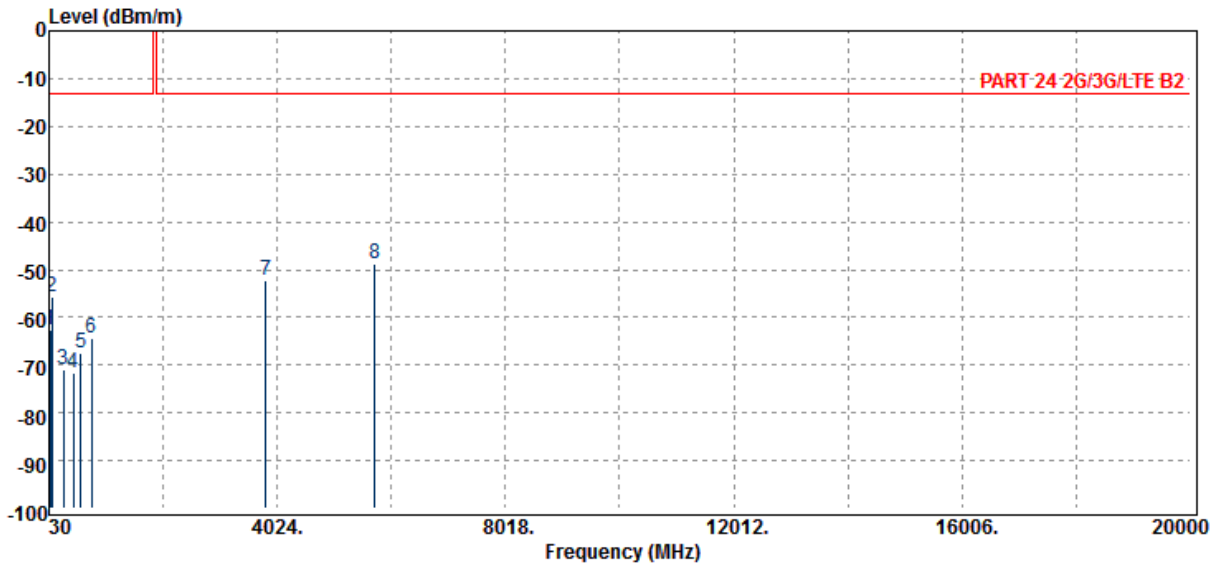

Freq. MHz	Note F/H/E/S	EIRP dBm	SG Output Level dBm	Antenna Gain dBi	Cable Loss dB	Limit dBm	Margin dB
47.46	S	-62.48	-51.85	-9.74	-0.89	-13.00	-49.48
83.35	S	-55.70	-54.84	0.20	-1.06	-13.00	-42.70
286.08	S	-71.08	-74.89	5.54	-1.73	-13.00	-58.08
459.71	S	-71.47	-74.96	5.58	-2.09	-13.00	-58.47
580.96	S	-67.40	-70.33	5.65	-2.72	-13.00	-54.40
767.20	S	-64.35	-67.10	5.49	-2.74	-13.00	-51.35
3819.60	H	-52.18	-53.63	8.50	-7.05	-13.00	-39.18
5729.40	H	-48.67	-50.15	10.12	-8.64	-13.00	-35.67

Unless otherwise stated the results shown in this test report refer only to the sample(s) tested and such sample(s) are retained for 90 days only.

除非另有說明，此報告結果僅對測試之樣品負責，同時此樣品僅保留90天。本報告未經本公司書面許可，不可部份複製。

This document is issued by the Company subject to its General Conditions of Service printed overleaf, available on request or accessible at www.sgs.com/terms_and_conditions.htm and, for electronic format documents, subject to Terms and Conditions for Electronic Documents at www.sgs.com/terms_e-document.htm. Attention is drawn to the limitation of liability, indemnification and jurisdiction issues defined therein. Any holder of this document is advised that information contained hereon reflects the Company's findings at the time of its intervention only and within the limits of Client's instructions, if any. The Company's sole responsibility is to its Client and this document does not exonerate parties to a transaction from exercising all their rights and obligations under the transaction documents. This document cannot be reproduced except in full, without prior written approval of the Company. Any unauthorized alteration, forgery or falsification of the content or appearance of this document is unlawful and offenders may be prosecuted to the fullest extent of the law.

ARFCN	:CH 810	Test Date	:2015-06-11
Operation Band	:GSM 1900	Temp./Humi.	:22 deg_C / 53 RH
Fundamental Frequency	:1909.8 MHz	Engineer	:Curry
Operation Mode	:TX HIGH	Measurement Antenna Pol.	:HORIZONTAL
EUT Pol.	:E2 Plan		

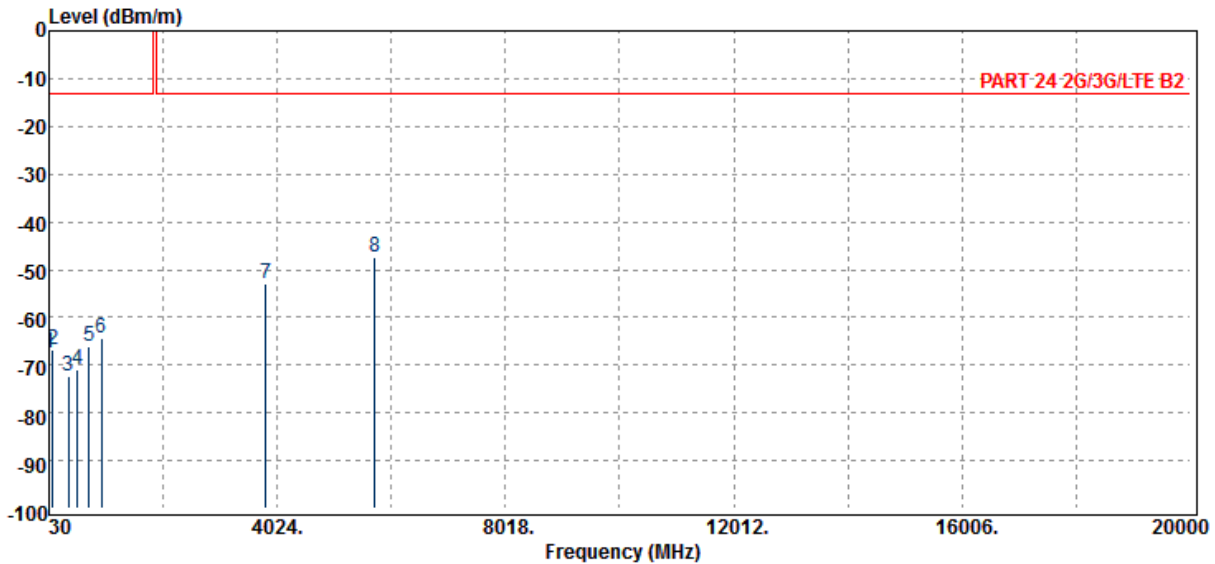

Freq. MHz	Note F/H/E/S	EIRP dBm	SG Output Level dBm	Antenna Gain dBi	Cable Loss dB	Limit dBm	Margin dB
33.88	S	-67.59	-55.07	-11.75	-0.77	-13.00	-54.59
97.90	S	-66.92	-66.66	0.85	-1.11	-13.00	-53.92
368.53	S	-72.46	-76.36	5.86	-1.96	-13.00	-59.46
528.58	S	-71.06	-74.41	5.81	-2.46	-13.00	-58.06
725.49	S	-66.20	-69.04	5.48	-2.64	-13.00	-53.20
946.65	S	-64.36	-66.55	5.39	-3.20	-13.00	-51.36
3819.60	H	-53.01	-54.46	8.50	-7.05	-13.00	-40.01
5729.40	H	-47.47	-48.95	10.12	-8.64	-13.00	-34.47

Unless otherwise stated the results shown in this test report refer only to the sample(s) tested and such sample(s) are retained for 90 days only.

除非另有說明，此報告結果僅對測試之樣品負責，同時此樣品僅保留90天。本報告未經本公司書面許可，不可部份複製。

This document is issued by the Company subject to its General Conditions of Service printed overleaf, available on request or accessible at www.sgs.com/terms_and_conditions.htm and, for electronic format documents, subject to Terms and Conditions for Electronic Documents at www.sgs.com/terms_e-document.htm. Attention is drawn to the limitation of liability, indemnification and jurisdiction issues defined therein. Any holder of this document is advised that information contained hereon reflects the Company's findings at the time of its intervention only and within the limits of Client's instructions, if any. The Company's sole responsibility is to its Client and this document does not exonerate parties to a transaction from exercising all their rights and obligations under the transaction documents. This document cannot be reproduced except in full, without prior written approval of the Company. Any unauthorized alteration, forgery or falsification of the content or appearance of this document is unlawful and offenders may be prosecuted to the fullest extent of the law.

Radiated Spurious Emission Measurement Result: HSDPA II Mode

ARFCN	:CH 9262	Test Date	:2015-06-11
Operation Band	:HSDPA B2	Temp./Humi.	:22 deg_C / 53 RH
Fundamental Frequency	:1852.4 MHz	Engineer	:Curry
Operation Mode	:TX LOW		
EUT Pol.	:E2 Plan	Measurement Antenna Pol.	:VERTICAL

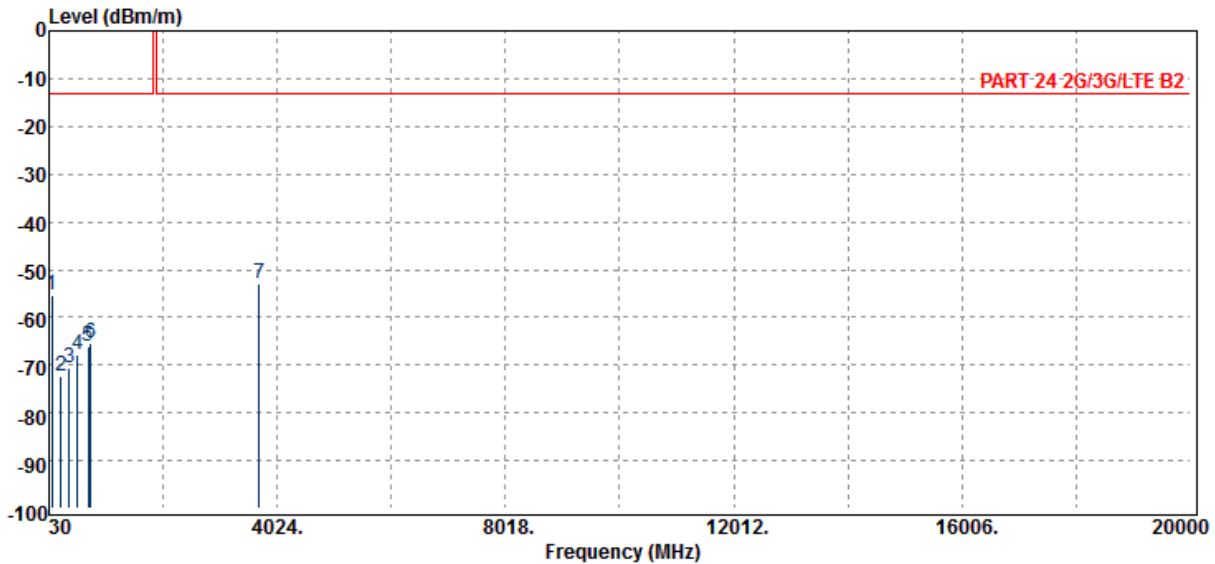

Freq. MHz	Note F/H/E/S	EIRP dBm	SG Output Level dBm	Antenna Gain dBi	Cable Loss dB	Limit dBm	Margin dB
85.29	S	-55.50	-55.08	0.65	-1.07	-13.00	-42.50
235.64	S	-72.30	-76.15	5.45	-1.59	-13.00	-59.30
383.08	S	-70.47	-74.34	5.82	-1.95	-13.00	-57.47
526.64	S	-67.72	-71.08	5.82	-2.45	-13.00	-54.72
712.88	S	-66.02	-68.92	5.51	-2.61	-13.00	-53.02
759.44	S	-65.24	-67.98	5.46	-2.72	-13.00	-52.24
3704.80	H	-53.01	-54.55	8.43	-6.89	-13.00	-40.01

Unless otherwise stated the results shown in this test report refer only to the sample(s) tested and such sample(s) are retained for 90 days only.

除非另有說明，此報告結果僅對測試之樣品負責，同時此樣品僅保留90天。本報告未經本公司書面許可，不可部份複製。

This document is issued by the Company subject to its General Conditions of Service printed overleaf, available on request or accessible at www.sgs.com/terms_and_conditions.htm and, for electronic format documents, subject to Terms and Conditions for Electronic Documents at www.sgs.com/terms_e-document.htm. Attention is drawn to the limitation of liability, indemnification and jurisdiction issues defined therein. Any holder of this document is advised that information contained hereon reflects the Company's findings at the time of its intervention only and within the limits of Client's instructions, if any. The Company's sole responsibility is to its Client and this document does not exonerate parties to a transaction from exercising all their rights and obligations under the transaction documents. This document cannot be reproduced except in full, without prior written approval of the Company. Any unauthorized alteration, forgery or falsification of the content or appearance of this document is unlawful and offenders may be prosecuted to the fullest extent of the law.

ARFCN	:CH 9262	Test Date	:2015-06-11
Operation Band	:HSDPA B2	Temp./Humi.	:22 deg_C / 53 RH
Fundamental Frequency	:1852.4 MHz	Engineer	:Curry
Operation Mode	:TX LOW		
EUT Pol.	:E2 Plan	Measurement Antenna Pol.	:HORIZONTAL

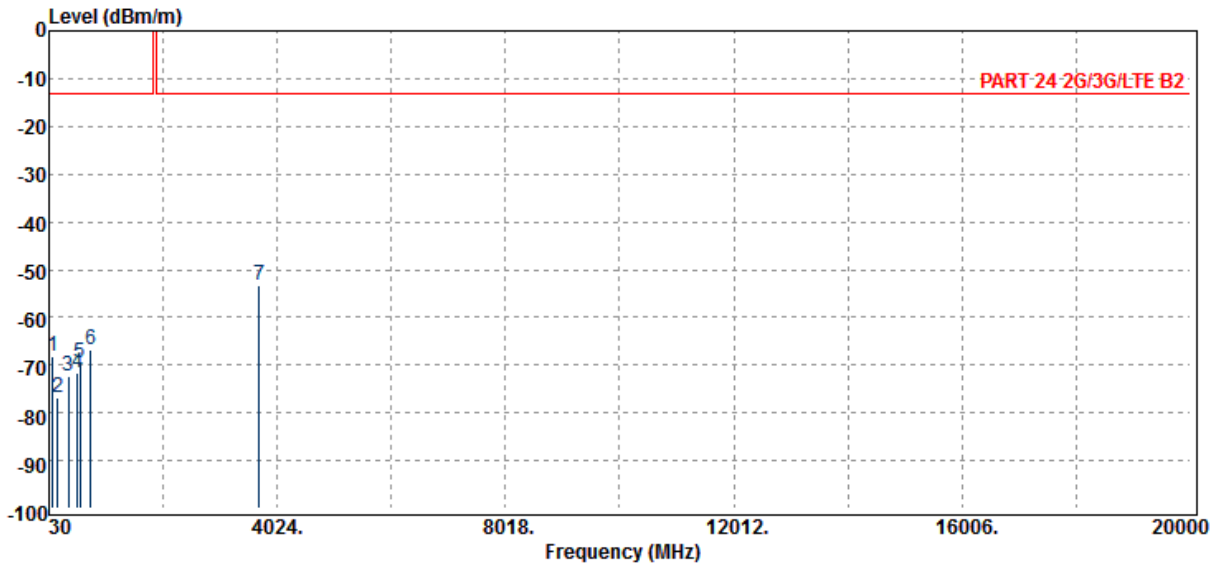

Freq. MHz	Note F/H/E/S	EIRP dBm	SG Output Level dBm	Antenna Gain dBi	Cable Loss dB	Limit dBm	Margin dB
96.93	S	-68.13	-67.97	0.95	-1.11	-13.00	-55.13
181.32	S	-76.77	-78.63	3.36	-1.50	-13.00	-63.77
367.56	S	-72.47	-76.37	5.86	-1.96	-13.00	-59.47
526.64	S	-71.50	-74.86	5.82	-2.45	-13.00	-58.50
578.05	S	-69.50	-72.45	5.65	-2.71	-13.00	-56.50
754.59	S	-66.66	-69.40	5.45	-2.71	-13.00	-53.66
3704.80	H	-53.15	-54.69	8.43	-6.89	-13.00	-40.15

Unless otherwise stated the results shown in this test report refer only to the sample(s) tested and such sample(s) are retained for 90 days only.

除非另有說明，此報告結果僅對測試之樣品負責，同時此樣品僅保留90天。本報告未經本公司書面許可，不可部份複製。

This document is issued by the Company subject to its General Conditions of Service printed overleaf, available on request or accessible at www.sgs.com/terms_and_conditions.htm and, for electronic format documents, subject to Terms and Conditions for Electronic Documents at www.sgs.com/terms_e-document.htm. Attention is drawn to the limitation of liability, indemnification and jurisdiction issues defined therein. Any holder of this document is advised that information contained hereon reflects the Company's findings at the time of its intervention only and within the limits of Client's instructions, if any. The Company's sole responsibility is to its Client and this document does not exonerate parties to a transaction from exercising all their rights and obligations under the transaction documents. This document cannot be reproduced except in full, without prior written approval of the Company. Any unauthorized alteration, forgery or falsification of the content or appearance of this document is unlawful and offenders may be prosecuted to the fullest extent of the law.

ARFCN	:CH 9400	Test Date	:2015-06-11
Operation Band	:HSDPA B2	Temp./Humi.	:22 deg_C / 53 RH
Fundamental Frequency	:1880.0 MHz	Engineer	:Curry
Operation Mode	:TX MID	Measurement Antenna Pol.	:VERTICAL
EUT Pol.	:E2 Plan		

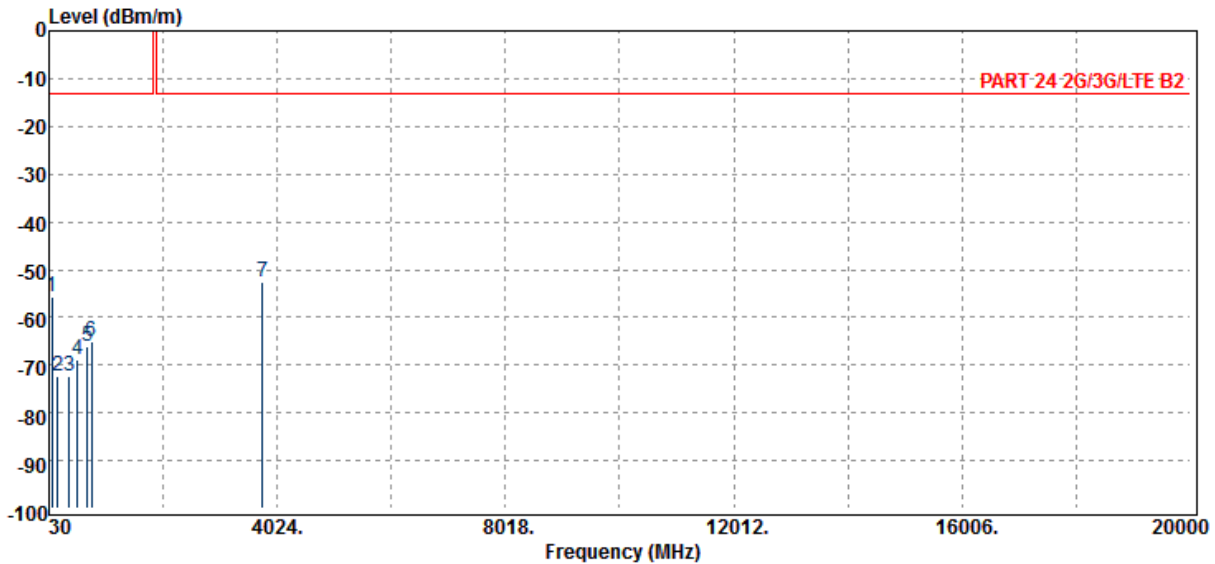

Freq. MHz	Note F/H/E/S	EIRP dBm	SG Output Level dBm	Antenna Gain dBi	Cable Loss dB	Limit dBm	Margin dB
83.35	S	-55.68	-54.82	0.20	-1.06	-13.00	-42.68
179.38	S	-72.46	-73.99	3.03	-1.50	-13.00	-59.46
379.20	S	-72.44	-76.31	5.83	-1.95	-13.00	-59.44
528.58	S	-68.78	-72.12	5.81	-2.46	-13.00	-55.78
696.39	S	-66.03	-68.97	5.55	-2.61	-13.00	-53.03
771.08	S	-65.09	-67.84	5.50	-2.75	-13.00	-52.09
3760.00	H	-52.53	-53.97	8.46	-7.02	-13.00	-39.53

Unless otherwise stated the results shown in this test report refer only to the sample(s) tested and such sample(s) are retained for 90 days only.

除非另有說明，此報告結果僅對測試之樣品負責，同時此樣品僅保留90天。本報告未經本公司書面許可，不可部份複製。

This document is issued by the Company subject to its General Conditions of Service printed overleaf, available on request or accessible at www.sgs.com/terms_and_conditions.htm and, for electronic format documents, subject to Terms and Conditions for Electronic Documents at www.sgs.com/terms_e-document.htm. Attention is drawn to the limitation of liability, indemnification and jurisdiction issues defined therein. Any holder of this document is advised that information contained hereon reflects the Company's findings at the time of its intervention only and within the limits of Client's instructions, if any. The Company's sole responsibility is to its Client and this document does not exonerate parties to a transaction from exercising all their rights and obligations under the transaction documents. This document cannot be reproduced except in full, without prior written approval of the Company. Any unauthorized alteration, forgery or falsification of the content or appearance of this document is unlawful and offenders may be prosecuted to the fullest extent of the law.

ARFCN	:CH 9400	Test Date	:2015-06-11
Operation Band	:HSDPA B2	Temp./Humi.	:22 deg_C / 53 RH
Fundamental Frequency	:1880.0 MHz	Engineer	:Curry
Operation Mode	:TX MID	Measurement Antenna Pol.	:HORIZONTAL
EUT Pol.	:E2 Plan		

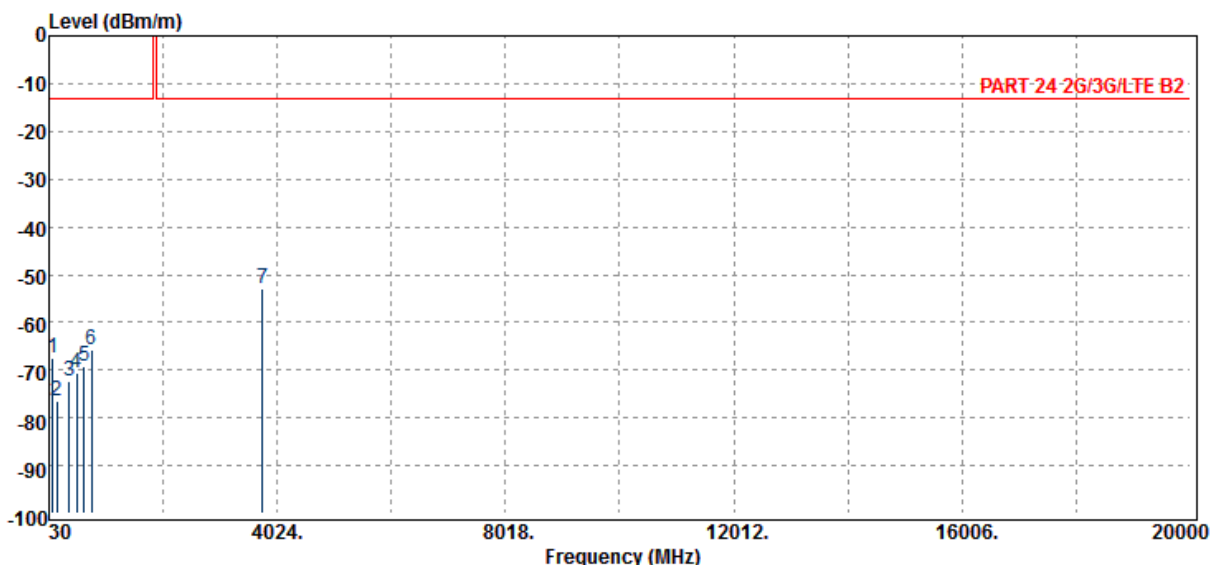

Freq. MHz	Note F/H/E/S	EIRP dBm	SG Output Level dBm	Antenna Gain dBi	Cable Loss dB	Limit dBm	Margin dB
100.81	S	-67.49	-66.93	0.56	-1.12	-13.00	-54.49
172.59	S	-76.45	-76.85	1.89	-1.49	-13.00	-63.45
380.17	S	-72.39	-76.26	5.82	-1.95	-13.00	-59.39
517.91	S	-70.50	-73.95	5.85	-2.40	-13.00	-57.50
648.86	S	-69.21	-72.33	5.78	-2.66	-13.00	-56.21
774.96	S	-65.63	-68.38	5.51	-2.76	-13.00	-52.63
3760.00	H	-53.07	-54.51	8.46	-7.02	-13.00	-40.07

Unless otherwise stated the results shown in this test report refer only to the sample(s) tested and such sample(s) are retained for 90 days only.
 除非另有說明，此報告結果僅對測試之樣品負責，同時此樣品僅保留90天。本報告未經本公司書面許可，不可部份複製。
 This document is issued by the Company subject to its General Conditions of Service printed overleaf, available on request or accessible at www.sgs.com/terms_and_conditions.htm and, for electronic format documents, subject to Terms and Conditions for Electronic Documents at www.sgs.com/terms_e-document.htm. Attention is drawn to the limitation of liability, indemnification and jurisdiction issues defined therein. Any holder of this document is advised that information contained hereon reflects the Company's findings at the time of its intervention only and within the limits of Client's instructions, if any. The Company's sole responsibility is to its Client and this document does not exonerate parties to a transaction from exercising all their rights and obligations under the transaction documents. This document cannot be reproduced except in full, without prior written approval of the Company. Any unauthorized alteration, forgery or falsification of the content or appearance of this document is unlawful and offenders may be prosecuted to the fullest extent of the law.

ARFCN	:CH 9538	Test Date	:2015-06-11
Operation Band	:HSDPA B2	Temp./Humi.	:22 deg_C / 53 RH
Fundamental Frequency	:1907.6 MHz	Engineer	:Curry
Operation Mode	:TX HIGH	Measurement Antenna Pol.	:VERTICAL
EUT Pol.	:E2 Plan		

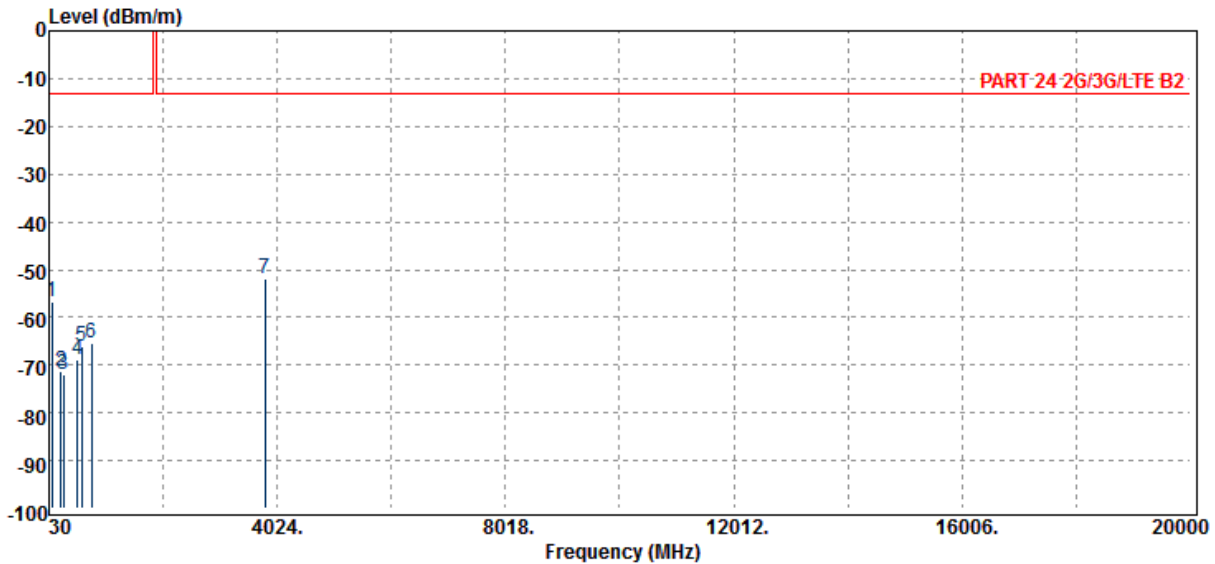

Freq. MHz	Note F/H/E/S	EIRP dBm	SG Output Level dBm	Antenna Gain dBi	Cable Loss dB	Limit dBm	Margin dB
86.26	S	-56.72	-56.53	0.88	-1.08	-13.00	-43.72
236.61	S	-71.39	-75.24	5.44	-1.60	-13.00	-58.39
286.08	S	-72.01	-75.81	5.54	-1.73	-13.00	-59.01
524.70	S	-68.82	-72.21	5.82	-2.44	-13.00	-55.82
602.30	S	-65.92	-68.78	5.60	-2.74	-13.00	-52.92
767.20	S	-65.27	-68.02	5.49	-2.74	-13.00	-52.27
3815.20	H	-52.07	-53.52	8.49	-7.05	-13.00	-39.07

Unless otherwise stated the results shown in this test report refer only to the sample(s) tested and such sample(s) are retained for 90 days only.

除非另有說明，此報告結果僅對測試之樣品負責，同時此樣品僅保留90天。本報告未經本公司書面許可，不可部份複製。

This document is issued by the Company subject to its General Conditions of Service printed overleaf, available on request or accessible at www.sgs.com/terms_and_conditions.htm and, for electronic format documents, subject to Terms and Conditions for Electronic Documents at www.sgs.com/terms_e-document.htm. Attention is drawn to the limitation of liability, indemnification and jurisdiction issues defined therein. Any holder of this document is advised that information contained hereon reflects the Company's findings at the time of its intervention only and within the limits of Client's instructions, if any. The Company's sole responsibility is to its Client and this document does not exonerate parties to a transaction from exercising all their rights and obligations under the transaction documents. This document cannot be reproduced except in full, without prior written approval of the Company. Any unauthorized alteration, forgery or falsification of the content or appearance of this document is unlawful and offenders may be prosecuted to the fullest extent of the law.

ARFCN	:CH 9538	Test Date	:2015-06-11
Operation Band	:HSDPA B2	Temp./Humi.	:22 deg_C / 53 RH
Fundamental Frequency	:1907.6 MHz	Engineer	:Curry
Operation Mode	:TX HIGH	Measurement Antenna Pol.	:HORIZONTAL
EUT Pol.	:E2 Plan		

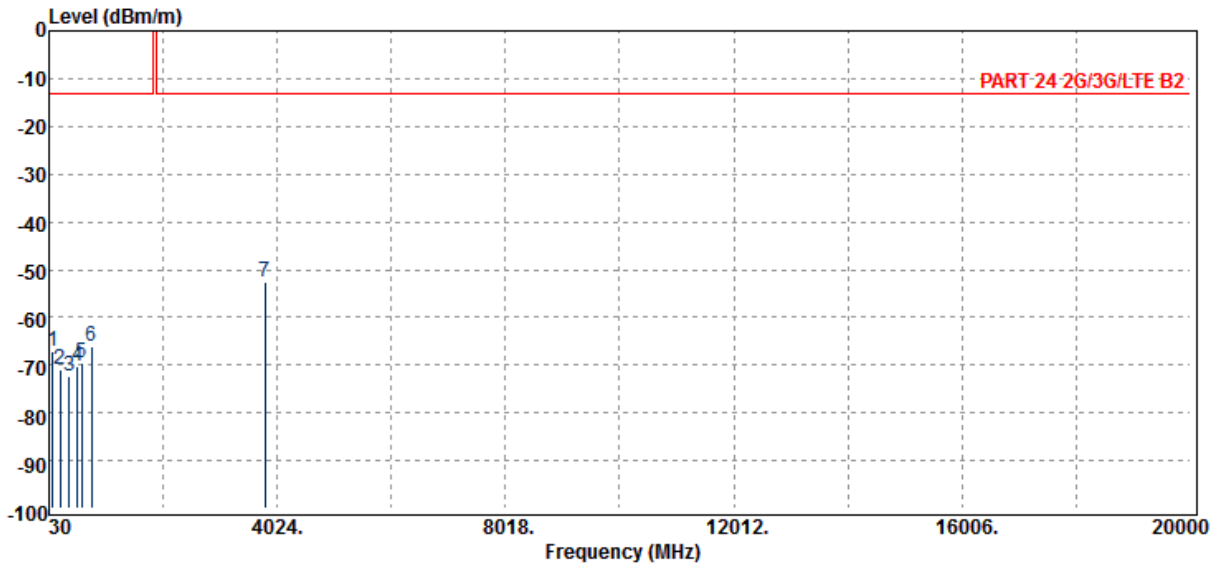

Freq. MHz	Note F/H/E/S	EIRP dBm	SG Output Level dBm	Antenna Gain dBi	Cable Loss dB	Limit dBm	Margin dB
98.87	S	-66.96	-66.59	0.75	-1.12	-13.00	-53.96
223.03	S	-70.80	-74.71	5.47	-1.57	-13.00	-57.80
378.23	S	-72.17	-76.05	5.83	-1.95	-13.00	-59.17
535.37	S	-70.35	-73.63	5.79	-2.50	-13.00	-57.35
597.45	S	-69.61	-72.45	5.60	-2.75	-13.00	-56.61
775.93	S	-66.18	-68.93	5.52	-2.76	-13.00	-53.18
3815.20	H	-52.56	-54.00	8.49	-7.05	-13.00	-39.56

Unless otherwise stated the results shown in this test report refer only to the sample(s) tested and such sample(s) are retained for 90 days only.

除非另有說明，此報告結果僅對測試之樣品負責，同時此樣品僅保留90天。本報告未經本公司書面許可，不可部份複製。

This document is issued by the Company subject to its General Conditions of Service printed overleaf, available on request or accessible at www.sgs.com/terms_and_conditions.htm and, for electronic format documents, subject to Terms and Conditions for Electronic Documents at www.sgs.com/terms_e-document.htm. Attention is drawn to the limitation of liability, indemnification and jurisdiction issues defined therein. Any holder of this document is advised that information contained hereon reflects the Company's findings at the time of its intervention only and within the limits of Client's instructions, if any. The Company's sole responsibility is to its Client and this document does not exonerate parties to a transaction from exercising all their rights and obligations under the transaction documents. This document cannot be reproduced except in full, without prior written approval of the Company. Any unauthorized alteration, forgery or falsification of the content or appearance of this document is unlawful and offenders may be prosecuted to the fullest extent of the law.

Radiated Spurious Emission Measurement Result: HSDPA IV Mode

ARFCN	:CH 1312	Test Date	:2015-06-11
Operation Band	:HSDPA B4	Temp./Humi.	:22 deg_C / 53 RH
Fundamental Frequency	:1712.4 MHz	Engineer	:Curry
Operation Mode	:TX LOW		
EUT Pol.	:E1 Plan	Measurement Antenna Pol.	:VERTICAL

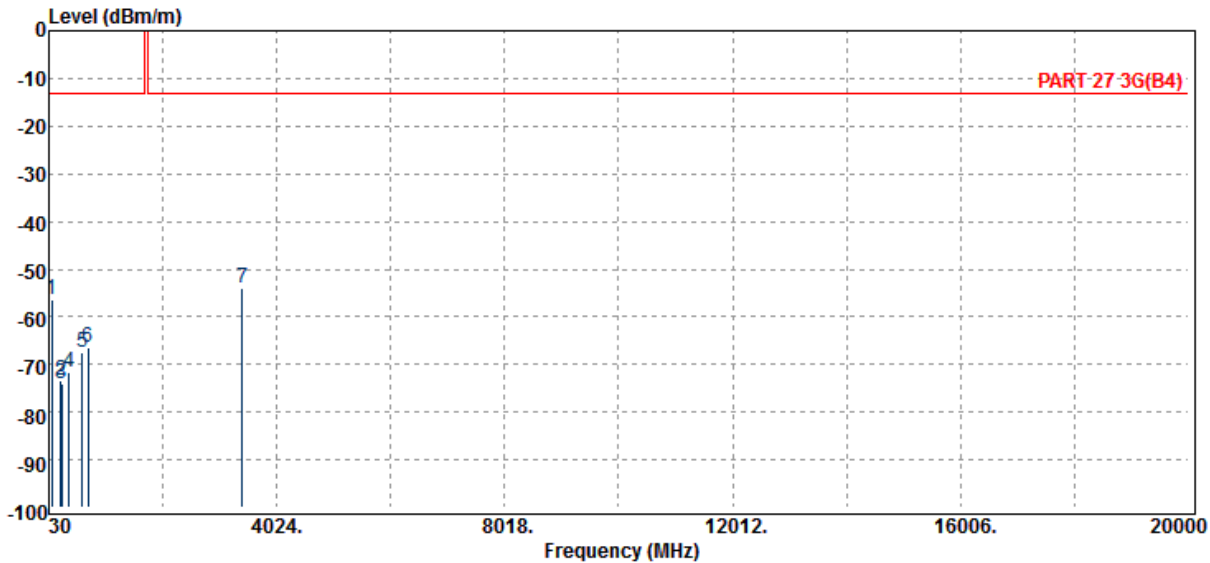

Freq. MHz	Note F/H/E/S	EIRP dBm	SG Output Level dBm	Antenna Gain dBi	Cable Loss dB	Limit dBm	Margin dB
85.29	S	-56.50	-56.08	0.65	-1.07	-13.00	-43.50
235.64	S	-73.30	-77.15	5.45	-1.59	-13.00	-60.30
252.13	S	-73.89	-77.89	5.64	-1.64	-13.00	-60.89
383.08	S	-71.47	-75.34	5.82	-1.95	-13.00	-58.47
609.09	S	-67.45	-70.35	5.63	-2.73	-13.00	-54.45
718.70	S	-66.28	-69.16	5.49	-2.62	-13.00	-53.28
3424.80	H	-53.83	-55.38	8.09	-6.54	-13.00	-40.83

Unless otherwise stated the results shown in this test report refer only to the sample(s) tested and such sample(s) are retained for 90 days only.

除非另有說明，此報告結果僅對測試之樣品負責，同時此樣品僅保留90天。本報告未經本公司書面許可，不可部份複製。

This document is issued by the Company subject to its General Conditions of Service printed overleaf, available on request or accessible at www.sgs.com/terms_and_conditions.htm and, for electronic format documents, subject to Terms and Conditions for Electronic Documents at www.sgs.com/terms_e-document.htm. Attention is drawn to the limitation of liability, indemnification and jurisdiction issues defined therein. Any holder of this document is advised that information contained hereon reflects the Company's findings at the time of its intervention only and within the limits of Client's instructions, if any. The Company's sole responsibility is to its Client and this document does not exonerate parties to a transaction from exercising all their rights and obligations under the transaction documents. This document cannot be reproduced except in full, without prior written approval of the Company. Any unauthorized alteration, forgery or falsification of the content or appearance of this document is unlawful and offenders may be prosecuted to the fullest extent of the law.

SGS Taiwan Ltd.

No.134,WuKungRoad,NewTaipeiIndustrialPark,WukuDistrict,NewTaipeiCity,Taiwan24803/新北市五股區新北產業園區五工路 134 號

台灣檢驗科技股份有限公司

t (886-2) 2299-3279

f (886-2) 2298-0488

www.tw.sgs.com

Member of SGS Group

ARFCN	:CH 1312	Test Date	:2015-06-11
Operation Band	:HSDPA B4	Temp./Humi.	:22 deg_C / 53 RH
Fundamental Frequency	:1712.4 MHz	Engineer	:Curry
Operation Mode	:TX LOW		
EUT Pol.	:E1 Plan	Measurement Antenna Pol.	:HORIZONTAL

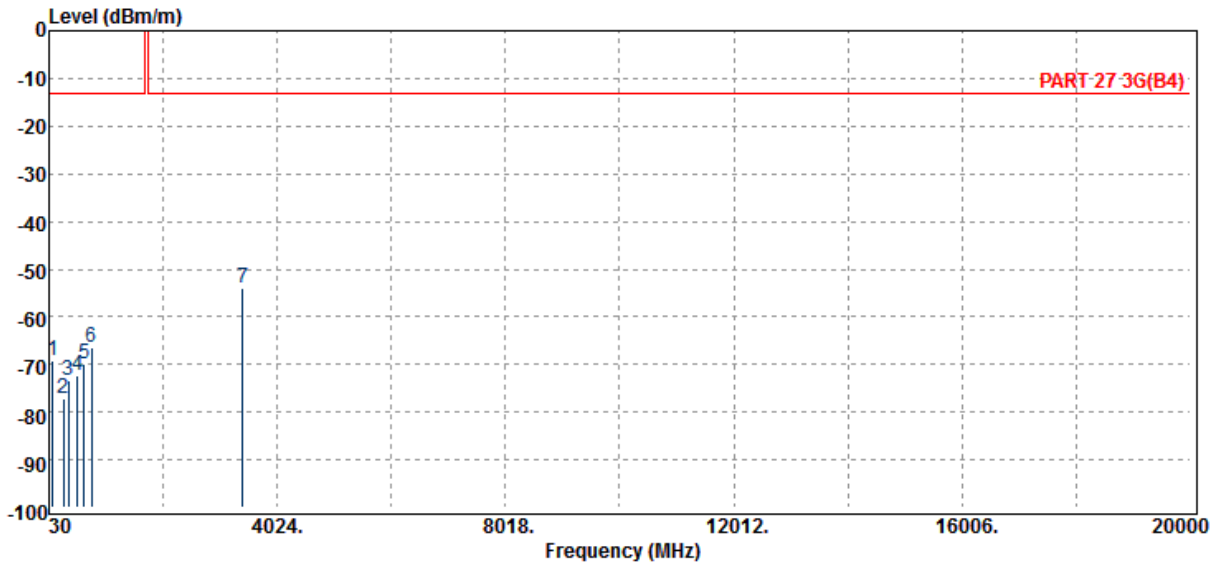

Freq. MHz	Note F/H/E/S	EIRP dBm	SG Output Level dBm	Antenna Gain dBi	Cable Loss dB	Limit dBm	Margin dB
96.93	S	-69.13	-68.97	0.95	-1.11	-13.00	-56.13
287.05	S	-77.33	-81.14	5.55	-1.74	-13.00	-64.33
367.56	S	-73.47	-77.37	5.86	-1.96	-13.00	-60.47
529.55	S	-72.23	-75.57	5.81	-2.47	-13.00	-59.23
647.89	S	-69.81	-72.93	5.78	-2.66	-13.00	-56.81
767.20	S	-66.40	-69.15	5.49	-2.74	-13.00	-53.40
3424.80	H	-54.08	-55.62	8.09	-6.54	-13.00	-41.08

Unless otherwise stated the results shown in this test report refer only to the sample(s) tested and such sample(s) are retained for 90 days only.

除非另有說明，此報告結果僅對測試之樣品負責，同時此樣品僅保留90天。本報告未經本公司書面許可，不可部份複製。

This document is issued by the Company subject to its General Conditions of Service printed overleaf, available on request or accessible at www.sgs.com/terms_and_conditions.htm and, for electronic format documents, subject to Terms and Conditions for Electronic Documents at www.sgs.com/terms_e-document.htm. Attention is drawn to the limitation of liability, indemnification and jurisdiction issues defined therein. Any holder of this document is advised that information contained hereon reflects the Company's findings at the time of its intervention only and within the limits of Client's instructions, if any. The Company's sole responsibility is to its Client and this document does not exonerate parties to a transaction from exercising all their rights and obligations under the transaction documents. This document cannot be reproduced except in full, without prior written approval of the Company. Any unauthorized alteration, forgery or falsification of the content or appearance of this document is unlawful and offenders may be prosecuted to the fullest extent of the law.

SGS Taiwan Ltd.

No.134,WuKungRoad,NewTaipeiIndustrialPark,WukuDistrict,NewTaipeiCity,Taiwan24803/新北市五股區新北產業園區五工路 134 號

台灣檢驗科技股份有限公司

t (886-2) 2299-3279

f (886-2) 2298-0488

www.tw.sgs.com

Member of SGS Group

ARFCN	:CH 1413	Test Date	:2015-06-11
Operation Band	:HSDPA B4	Temp./Humi.	:22 deg_C / 53 RH
Fundamental Frequency	:1732.6 MHz	Engineer	:Curry
Operation Mode	:TX MID		
EUT Pol.	:E1 Plan	Measurement Antenna Pol.	:VERTICAL

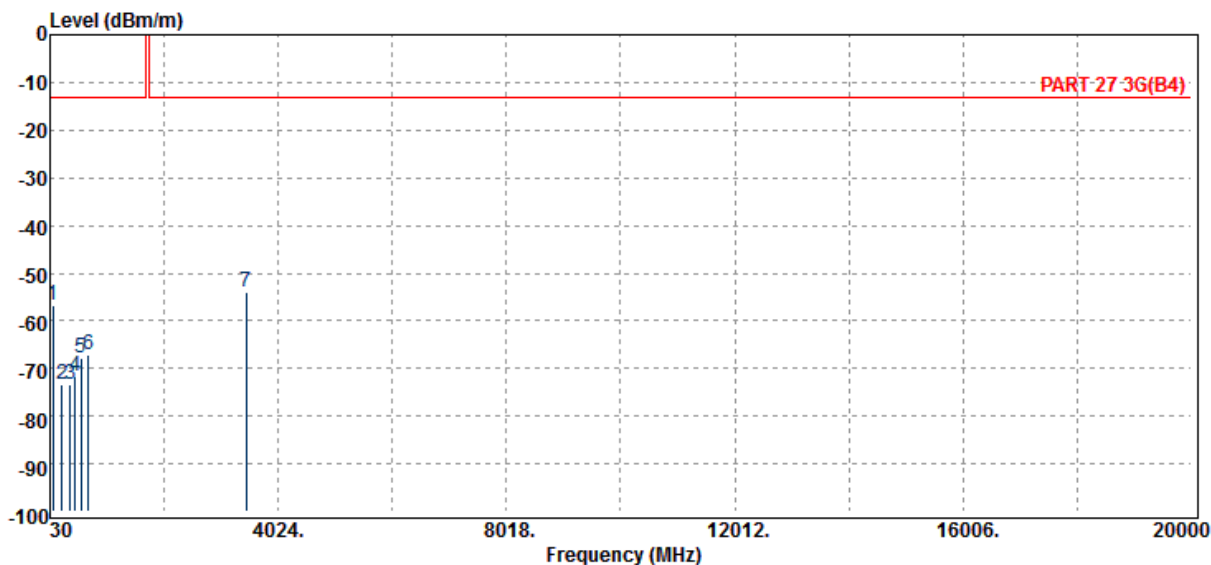

Freq. MHz	Note F/H/E/S	EIRP dBm	SG Output Level dBm	Antenna Gain dBi	Cable Loss dB	Limit dBm	Margin dB
83.35	S	-56.68	-55.82	0.20	-1.06	-13.00	-43.68
237.58	S	-73.20	-77.04	5.44	-1.60	-13.00	-60.20
388.90	S	-73.20	-77.05	5.80	-1.95	-13.00	-60.20
471.35	S	-71.47	-75.01	5.68	-2.13	-13.00	-58.47
574.17	S	-67.73	-70.70	5.67	-2.69	-13.00	-54.73
696.39	S	-67.03	-69.97	5.55	-2.61	-13.00	-54.03
3465.20	H	-54.02	-55.69	8.20	-6.53	-13.00	-41.02

Unless otherwise stated the results shown in this test report refer only to the sample(s) tested and such sample(s) are retained for 90 days only.

除非另有說明，此報告結果僅對測試之樣品負責，同時此樣品僅保留90天。本報告未經本公司書面許可，不可部份複製。

This document is issued by the Company subject to its General Conditions of Service printed overleaf, available on request or accessible at www.sgs.com/terms_and_conditions.htm and, for electronic format documents, subject to Terms and Conditions for Electronic Documents at www.sgs.com/terms_e-document.htm. Attention is drawn to the limitation of liability, indemnification and jurisdiction issues defined therein. Any holder of this document is advised that information contained hereon reflects the Company's findings at the time of its intervention only and within the limits of Client's instructions, if any. The Company's sole responsibility is to its Client and this document does not exonerate parties to a transaction from exercising all their rights and obligations under the transaction documents. This document cannot be reproduced except in full, without prior written approval of the Company. Any unauthorized alteration, forgery or falsification of the content or appearance of this document is unlawful and offenders may be prosecuted to the fullest extent of the law.

SGS Taiwan Ltd.

No.134,WuKungRoad,NewTaipeiIndustrialPark,WukuDistrict,NewTaipeiCity,Taiwan24803/新北市五股區新北產業園區五工路 134 號

台灣檢驗科技股份有限公司

t (886-2) 2299-3279

f (886-2) 2298-0488

www.tw.sgs.com

Member of SGS Group

ARFCN	:CH 1413	Test Date	:2015-06-11
Operation Band	:HSDPA B4	Temp./Humi.	:22 deg_C / 53 RH
Fundamental Frequency	:1732.6 MHz	Engineer	:Curry
Operation Mode	:TX MID		
EUT Pol.	:E1 Plan	Measurement Antenna Pol.	:HORIZONTAL

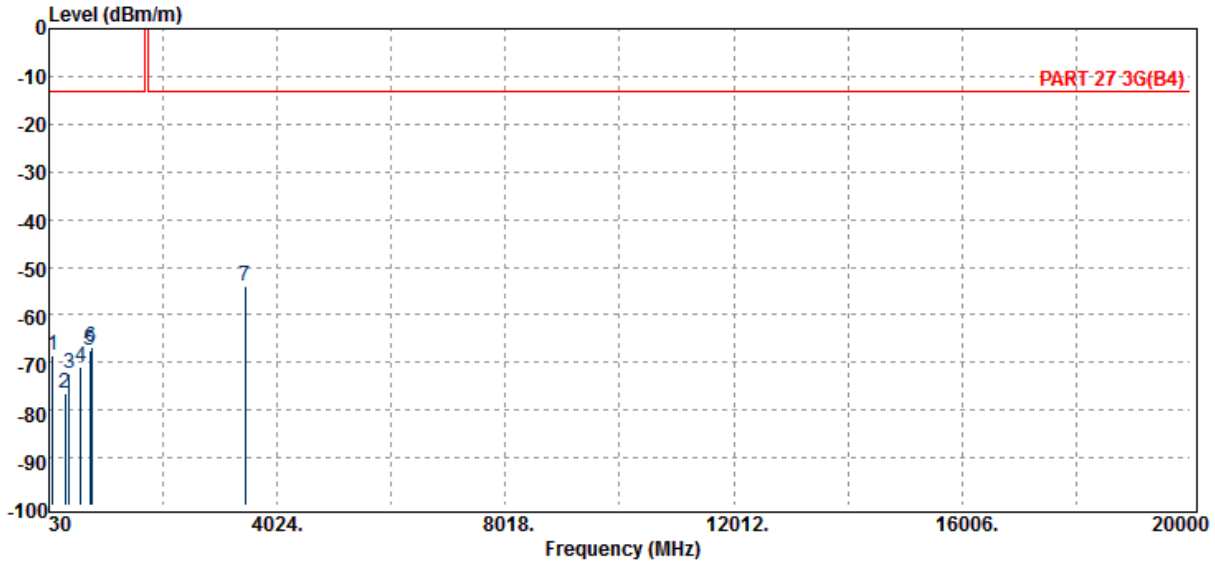

Freq. MHz	Note F/H/E/S	EIRP dBm	SG Output Level dBm	Antenna Gain dBi	Cable Loss dB	Limit dBm	Margin dB
100.81	S	-68.49	-67.93	0.56	-1.12	-13.00	-55.49
317.12	S	-76.36	-80.33	5.82	-1.85	-13.00	-63.36
388.90	S	-72.38	-76.23	5.80	-1.95	-13.00	-59.38
584.84	S	-70.98	-73.87	5.64	-2.74	-13.00	-57.98
738.10	S	-67.44	-70.23	5.45	-2.67	-13.00	-54.44
774.96	S	-66.63	-69.38	5.51	-2.76	-13.00	-53.63
3465.20	H	-54.05	-55.72	8.20	-6.53	-13.00	-41.05

Unless otherwise stated the results shown in this test report refer only to the sample(s) tested and such sample(s) are retained for 90 days only.

除非另有說明，此報告結果僅對測試之樣品負責，同時此樣品僅保留90天。本報告未經本公司書面許可，不可部份複製。

This document is issued by the Company subject to its General Conditions of Service printed overleaf, available on request or accessible at www.sgs.com/terms_and_conditions.htm and, for electronic format documents, subject to Terms and Conditions for Electronic Documents at www.sgs.com/terms_e-document.htm. Attention is drawn to the limitation of liability, indemnification and jurisdiction issues defined therein. Any holder of this document is advised that information contained hereon reflects the Company's findings at the time of its intervention only and within the limits of Client's instructions, if any. The Company's sole responsibility is to its Client and this document does not exonerate parties to a transaction from exercising all their rights and obligations under the transaction documents. This document cannot be reproduced except in full, without prior written approval of the Company. Any unauthorized alteration, forgery or falsification of the content or appearance of this document is unlawful and offenders may be prosecuted to the fullest extent of the law.

SGS Taiwan Ltd.

No.134,WuKungRoad,NewTaipeiIndustrialPark,WukuDistrict,NewTaipeiCity,Taiwan24803/新北市五股區新北產業園區五工路 134 號

台灣檢驗科技股份有限公司

t (886-2) 2299-3279

f (886-2) 2298-0488

www.tw.sgs.com

Member of SGS Group

ARFCN	:CH 1513	Test Date	:2015-06-11
Operation Band	:HSDPA B4	Temp./Humi.	:22 deg_C / 53 RH
Fundamental Frequency	:1752.6 MHz	Engineer	:Curry
Operation Mode	:TX HIGH		
EUT Pol.	:E1 Plan	Measurement Antenna Pol.	:VERTICAL

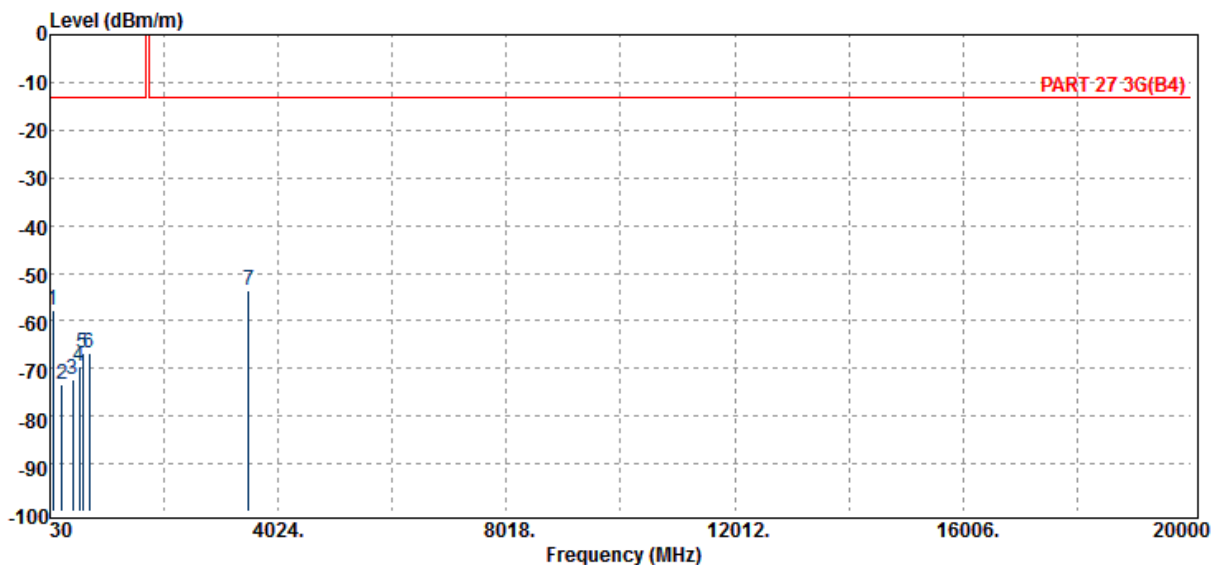

Freq. MHz	Note F/H/E/S	EIRP dBm	SG Output Level dBm	Antenna Gain dBi	Cable Loss dB	Limit dBm	Margin dB
86.26	S	-57.72	-57.53	0.88	-1.08	-13.00	-44.72
236.61	S	-73.39	-77.24	5.44	-1.60	-13.00	-60.39
420.91	S	-72.15	-75.83	5.65	-1.98	-13.00	-59.15
540.22	S	-69.49	-72.74	5.77	-2.52	-13.00	-56.49
602.30	S	-66.92	-69.78	5.60	-2.74	-13.00	-53.92
723.55	S	-66.67	-69.52	5.48	-2.63	-13.00	-53.67
3505.20	H	-53.68	-55.31	8.30	-6.68	-13.00	-40.68

Unless otherwise stated the results shown in this test report refer only to the sample(s) tested and such sample(s) are retained for 90 days only.

除非另有說明，此報告結果僅對測試之樣品負責，同時此樣品僅保留90天。本報告未經本公司書面許可，不可部份複製。

This document is issued by the Company subject to its General Conditions of Service printed overleaf, available on request or accessible at www.sgs.com/terms_and_conditions.htm and, for electronic format documents, subject to Terms and Conditions for Electronic Documents at www.sgs.com/terms_e-document.htm. Attention is drawn to the limitation of liability, indemnification and jurisdiction issues defined therein. Any holder of this document is advised that information contained hereon reflects the Company's findings at the time of its intervention only and within the limits of Client's instructions, if any. The Company's sole responsibility is to its Client and this document does not exonerate parties to a transaction from exercising all their rights and obligations under the transaction documents. This document cannot be reproduced except in full, without prior written approval of the Company. Any unauthorized alteration, forgery or falsification of the content or appearance of this document is unlawful and offenders may be prosecuted to the fullest extent of the law.

SGS Taiwan Ltd.

No.134,WuKungRoad,NewTaipeiIndustrialPark,WukuDistrict,NewTaipeiCity,Taiwan24803/新北市五股區新北產業園區五工路 134 號

台灣檢驗科技股份有限公司

t (886-2) 2299-3279

f (886-2) 2298-0488

www.tw.sgs.com

Member of SGS Group

ARFCN	:CH 1513	Test Date	:2015-06-11
Operation Band	:HSDPA B4	Temp./Humi.	:22 deg_C / 53 RH
Fundamental Frequency	:1752.6 MHz	Engineer	:Curry
Operation Mode	:TX HIGH		
EUT Pol.	:E1 Plan	Measurement Antenna Pol.	:HORIZONTAL

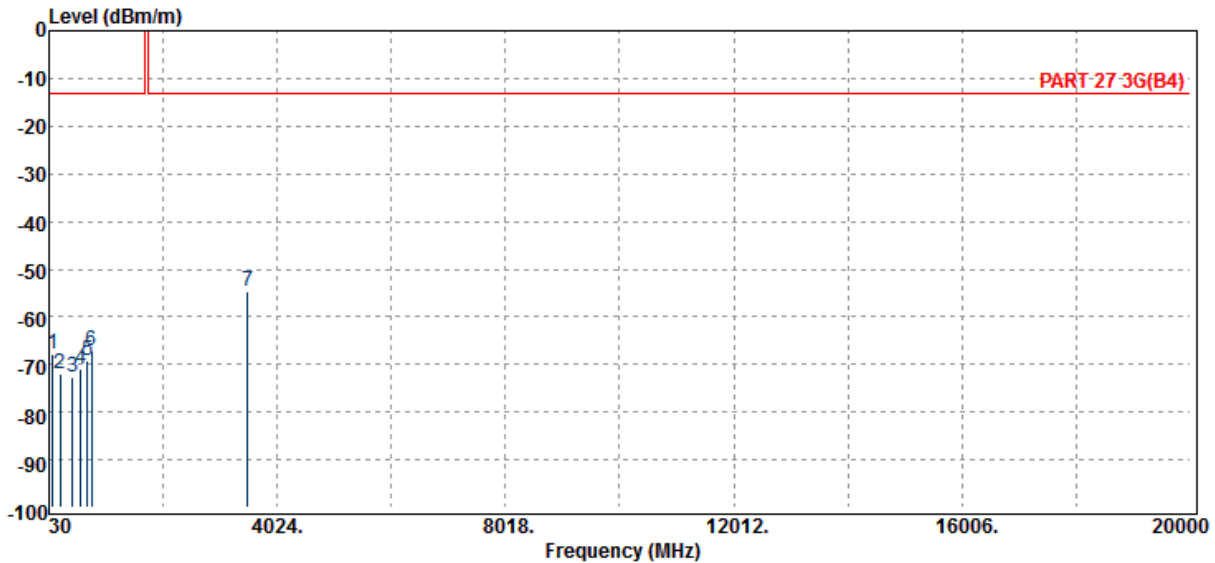

Freq. MHz	Note F/H/E/S	EIRP dBm	SG Output Level dBm	Antenna Gain dBi	Cable Loss dB	Limit dBm	Margin dB
98.87	S	-67.96	-67.59	0.75	-1.12	-13.00	-54.96
223.03	S	-71.80	-75.71	5.47	-1.57	-13.00	-58.80
441.28	S	-72.68	-76.18	5.54	-2.04	-13.00	-59.68
591.63	S	-71.03	-73.89	5.62	-2.76	-13.00	-58.03
695.42	S	-69.25	-72.20	5.55	-2.61	-13.00	-56.25
775.93	S	-67.18	-69.93	5.52	-2.76	-13.00	-54.18
3505.20	H	-54.52	-56.15	8.30	-6.68	-13.00	-41.52

Unless otherwise stated the results shown in this test report refer only to the sample(s) tested and such sample(s) are retained for 90 days only.

除非另有說明，此報告結果僅對測試之樣品負責，同時此樣品僅保留90天。本報告未經本公司書面許可，不可部份複製。

This document is issued by the Company subject to its General Conditions of Service printed overleaf, available on request or accessible at www.sgs.com/terms_and_conditions.htm and, for electronic format documents, subject to Terms and Conditions for Electronic Documents at www.sgs.com/terms_e-document.htm. Attention is drawn to the limitation of liability, indemnification and jurisdiction issues defined therein. Any holder of this document is advised that information contained hereon reflects the Company's findings at the time of its intervention only and within the limits of Client's instructions, if any. The Company's sole responsibility is to its Client and this document does not exonerate parties to a transaction from exercising all their rights and obligations under the transaction documents. This document cannot be reproduced except in full, without prior written approval of the Company. Any unauthorized alteration, forgery or falsification of the content or appearance of this document is unlawful and offenders may be prosecuted to the fullest extent of the law.

SGS Taiwan Ltd.

No.134,WuKungRoad,NewTaipeiIndustrialPark,WukuDistrict,NewTaipeiCity,Taiwan24803/新北市五股區新北產業園區五工路 134 號

台灣檢驗科技股份有限公司

t (886-2) 2299-3279

f (886-2) 2298-0488

www.tw.sgs.com

Member of SGS Group

Radiated Spurious Emission Measurement Result: HSDPA V Mode

ARFCN	:CH 4132	Test Date	:2015-06-11
Operation Band	:HSDPA B5	Temp./Humi.	:22 deg_C / 53 RH
Fundamental Frequency	:826.4 MHz	Engineer	:Curry
Operation Mode	:TX LOW		
EUT Pol.	:E1 Plan	Measurement Antenna Pol.	:VERTICAL

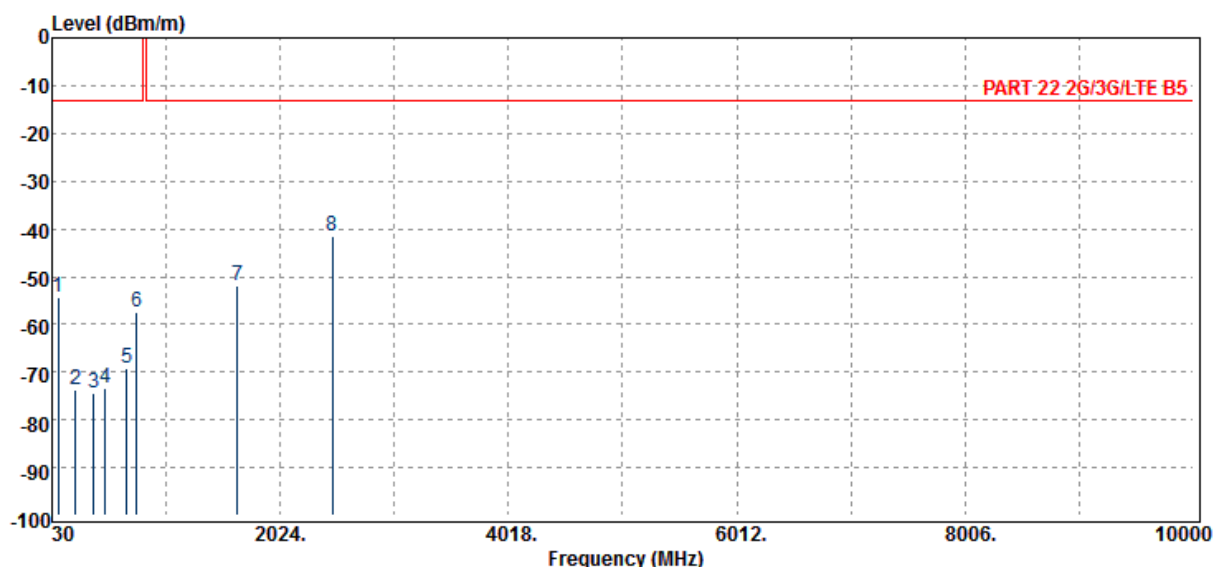

Freq. MHz	Note F/H/E/S	ERP dBm	SG Output Level dBm	Antenna Gain dBd	Cable Loss dB	Limit dBm	Margin dB
85.29	S	-54.26	-51.70	-1.50	-1.07	-13.00	-41.26
235.64	S	-73.83	-75.53	3.30	-1.59	-13.00	-60.83
390.84	S	-74.48	-76.18	3.65	-1.95	-13.00	-61.48
496.57	S	-73.30	-74.75	3.73	-2.28	-13.00	-60.30
683.78	S	-69.04	-69.88	3.46	-2.62	-13.00	-56.04
773.02	S	-57.49	-58.09	3.36	-2.75	-13.00	-44.49
1652.80	H	-51.87	-50.70	3.05	-4.22	-13.00	-38.87
2479.20	H	-41.57	-39.85	3.61	-5.32	-13.00	-28.57

Unless otherwise stated the results shown in this test report refer only to the sample(s) tested and such sample(s) are retained for 90 days only.
 除非另有說明，此報告結果僅對測試之樣品負責，同時此樣品僅保留90天。本報告未經本公司書面許可，不可部份複製。
 This document is issued by the Company subject to its General Conditions of Service printed overleaf, available on request or accessible at www.sgs.com/terms_and_conditions.htm and, for electronic format documents, subject to Terms and Conditions for Electronic Documents at www.sgs.com/terms_e-document.htm. Attention is drawn to the limitation of liability, indemnification and jurisdiction issues defined therein. Any holder of this document is advised that information contained hereon reflects the Company's findings at the time of its intervention only and within the limits of Client's instructions, if any. The Company's sole responsibility is to its Client and this document does not exonerate parties to a transaction from exercising all their rights and obligations under the transaction documents. This document cannot be reproduced except in full, without prior written approval of the Company. Any unauthorized alteration, forgery or falsification of the content or appearance of this document is unlawful and offenders may be prosecuted to the fullest extent of the law.

ARFCN	:CH 4132	Test Date	:2015-06-11
Operation Band	:HSDPA B5	Temp./Humi.	:22 deg_C / 53 RH
Fundamental Frequency	:826.4 MHz	Engineer	:Curry
Operation Mode	:TX LOW	Measurement Antenna Pol.	:HORIZONTAL
EUT Pol.	:E1 Plan		

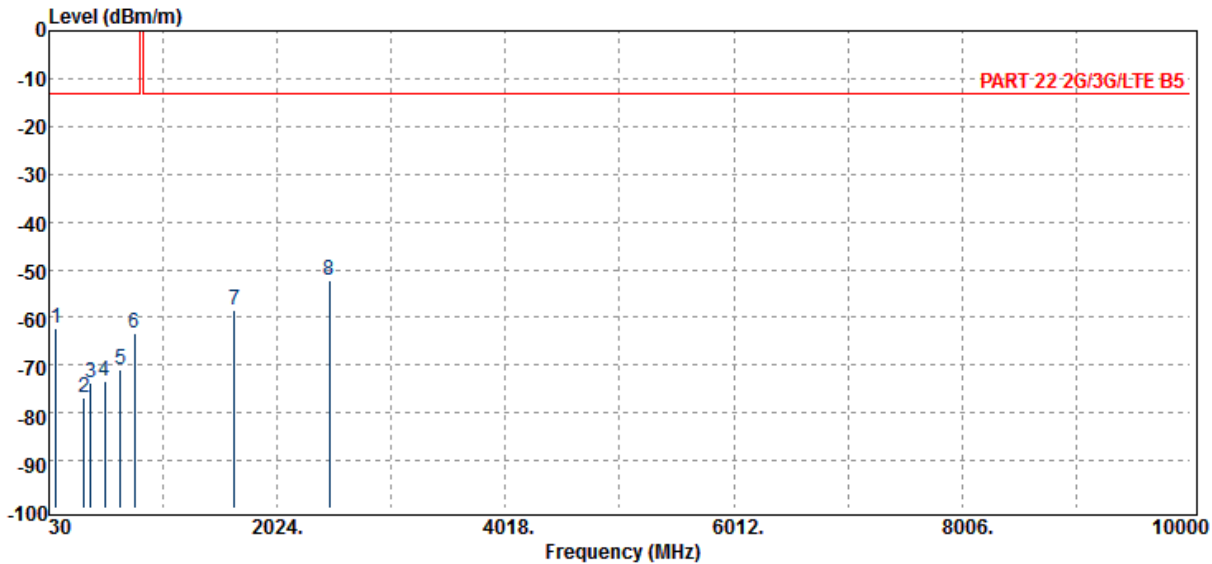

Freq. MHz	Note F/H/E/S	ERP dBm	SG Output Level dBm	Antenna Gain dBd	Cable Loss dB	Limit dBm	Margin dB
92.08	S	-62.17	-60.41	-0.67	-1.10	-13.00	-49.17
335.55	S	-76.96	-78.77	3.72	-1.92	-13.00	-63.96
392.78	S	-73.61	-75.30	3.64	-1.95	-13.00	-60.61
517.91	S	-73.42	-74.71	3.70	-2.40	-13.00	-60.42
650.80	S	-70.93	-71.90	3.63	-2.66	-13.00	-57.93
776.90	S	-63.45	-64.05	3.37	-2.77	-13.00	-50.45
1652.80	H	-58.35	-57.17	3.05	-4.22	-13.00	-45.35
2479.20	H	-52.37	-50.65	3.61	-5.32	-13.00	-39.37

Unless otherwise stated the results shown in this test report refer only to the sample(s) tested and such sample(s) are retained for 90 days only.

除非另有說明，此報告結果僅對測試之樣品負責，同時此樣品僅保留90天。本報告未經本公司書面許可，不可部份複製。

This document is issued by the Company subject to its General Conditions of Service printed overleaf, available on request or accessible at www.sgs.com/terms_and_conditions.htm and, for electronic format documents, subject to Terms and Conditions for Electronic Documents at www.sgs.com/terms_e-document.htm. Attention is drawn to the limitation of liability, indemnification and jurisdiction issues defined therein. Any holder of this document is advised that information contained hereon reflects the Company's findings at the time of its intervention only and within the limits of Client's instructions, if any. The Company's sole responsibility is to its Client and this document does not exonerate parties to a transaction from exercising all their rights and obligations under the transaction documents. This document cannot be reproduced except in full, without prior written approval of the Company. Any unauthorized alteration, forgery or falsification of the content or appearance of this document is unlawful and offenders may be prosecuted to the fullest extent of the law.

ARFCN	:CH 4183	Test Date	:2015-06-11
Operation Band	:HSDPA B5	Temp./Humi.	:22 deg_C / 53 RH
Fundamental Frequency	:836.6 MHz	Engineer	:Curry
Operation Mode	:TX MID	Measurement Antenna Pol.	:VERTICAL
EUT Pol.	:E1 Plan		

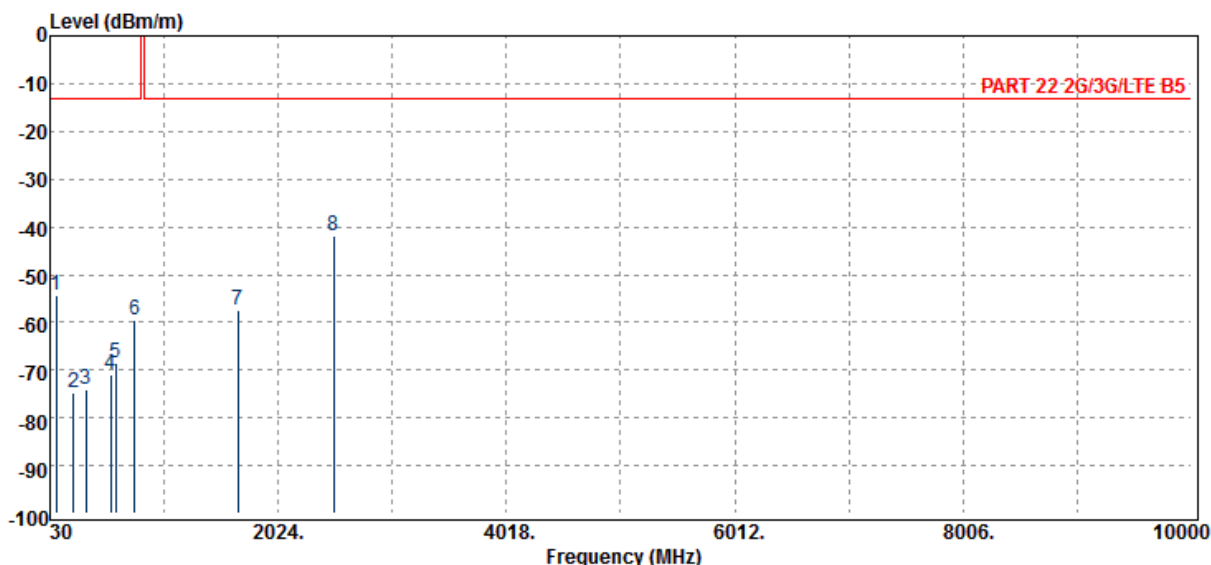

Freq. MHz	Note F/H/E/S	ERP dBm	SG Output Level dBm	Antenna Gain dBd	Cable Loss dB	Limit dBm	Margin dB
84.32	S	-54.43	-51.64	-1.72	-1.07	-13.00	-41.43
235.64	S	-74.67	-76.37	3.30	-1.59	-13.00	-61.67
344.28	S	-74.14	-75.94	3.75	-1.95	-13.00	-61.14
556.71	S	-70.92	-71.88	3.57	-2.61	-13.00	-57.92
600.36	S	-68.59	-69.29	3.44	-2.75	-13.00	-55.59
773.02	S	-59.38	-59.98	3.36	-2.75	-13.00	-46.38
1673.20	H	-57.43	-56.18	3.01	-4.26	-13.00	-44.43
2509.80	H	-41.79	-40.12	3.67	-5.35	-13.00	-28.79

Unless otherwise stated the results shown in this test report refer only to the sample(s) tested and such sample(s) are retained for 90 days only.
 除非另有說明，此報告結果僅對測試之樣品負責，同時此樣品僅保留90天。本報告未經本公司書面許可，不可部份複製。
 This document is issued by the Company subject to its General Conditions of Service printed overleaf, available on request or accessible at www.sgs.com/terms_and_conditions.htm and, for electronic format documents, subject to Terms and Conditions for Electronic Documents at www.sgs.com/terms_e-document.htm. Attention is drawn to the limitation of liability, indemnification and jurisdiction issues defined therein. Any holder of this document is advised that information contained hereon reflects the Company's findings at the time of its intervention only and within the limits of Client's instructions, if any. The Company's sole responsibility is to its Client and this document does not exonerate parties to a transaction from exercising all their rights and obligations under the transaction documents. This document cannot be reproduced except in full, without prior written approval of the Company. Any unauthorized alteration, forgery or falsification of the content or appearance of this document is unlawful and offenders may be prosecuted to the fullest extent of the law.

ARFCN	:CH 4183	Test Date	:2015-06-11
Operation Band	:HSDPA B5	Temp./Humi.	:22 deg_C / 53 RH
Fundamental Frequency	:836.6 MHz	Engineer	:Curry
Operation Mode	:TX MID	Measurement Antenna Pol.	:HORIZONTAL
EUT Pol.	:E1 Plan		

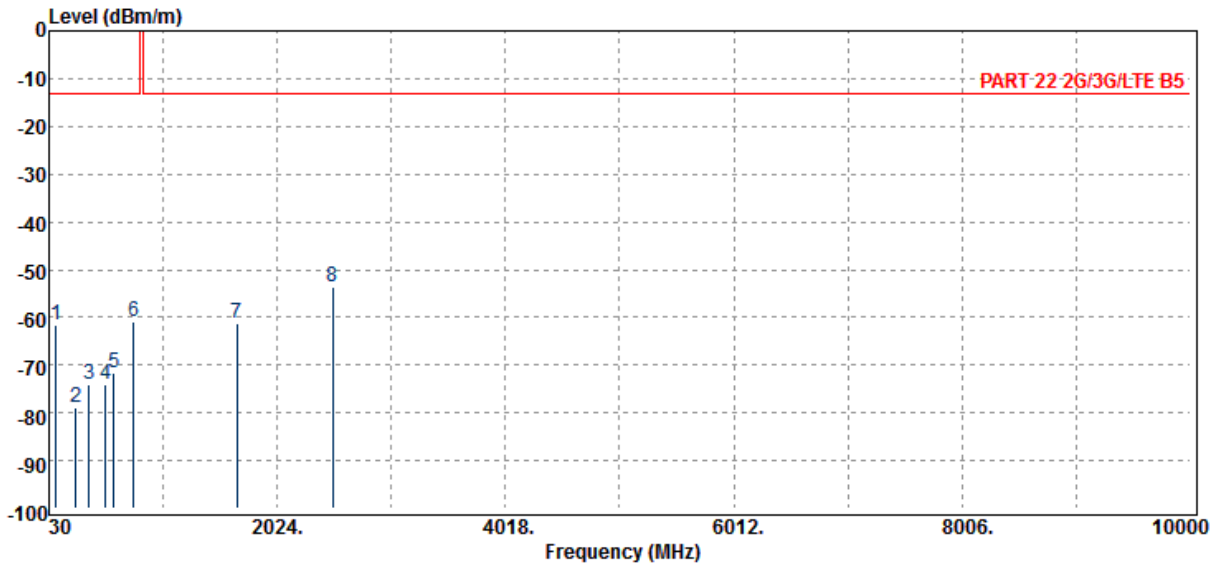

Freq. MHz	Note F/H/E/S	ERP dBm	SG Output Level dBm	Antenna Gain dBd	Cable Loss dB	Limit dBm	Margin dB
93.05	S	-61.65	-59.77	-0.78	-1.10	-13.00	-48.65
263.77	S	-78.99	-80.97	3.65	-1.68	-13.00	-65.99
377.26	S	-74.17	-75.90	3.68	-1.96	-13.00	-61.17
520.82	S	-74.05	-75.32	3.69	-2.42	-13.00	-61.05
594.54	S	-71.76	-72.46	3.46	-2.76	-13.00	-58.76
773.02	S	-61.04	-61.64	3.36	-2.75	-13.00	-48.04
1673.20	H	-61.22	-59.98	3.01	-4.26	-13.00	-48.22
2509.80	H	-53.50	-51.82	3.67	-5.35	-13.00	-40.50

Unless otherwise stated the results shown in this test report refer only to the sample(s) tested and such sample(s) are retained for 90 days only.

除非另有說明，此報告結果僅對測試之樣品負責，同時此樣品僅保留90天。本報告未經本公司書面許可，不可部份複製。

This document is issued by the Company subject to its General Conditions of Service printed overleaf, available on request or accessible at www.sgs.com/terms_and_conditions.htm and, for electronic format documents, subject to Terms and Conditions for Electronic Documents at www.sgs.com/terms_e-document.htm. Attention is drawn to the limitation of liability, indemnification and jurisdiction issues defined therein. Any holder of this document is advised that information contained hereon reflects the Company's findings at the time of its intervention only and within the limits of Client's instructions, if any. The Company's sole responsibility is to its Client and this document does not exonerate parties to a transaction from exercising all their rights and obligations under the transaction documents. This document cannot be reproduced except in full, without prior written approval of the Company. Any unauthorized alteration, forgery or falsification of the content or appearance of this document is unlawful and offenders may be prosecuted to the fullest extent of the law.

ARFCN	:CH 4233	Test Date	:2015-06-11
Operation Band	:HSDPA B5	Temp./Humi.	:22 deg_C / 53 RH
Fundamental Frequency	:846.6 MHz	Engineer	:Curry
Operation Mode	:TX HIGH	Measurement Antenna Pol.	:VERTICAL
EUT Pol.	:E1 Plan		

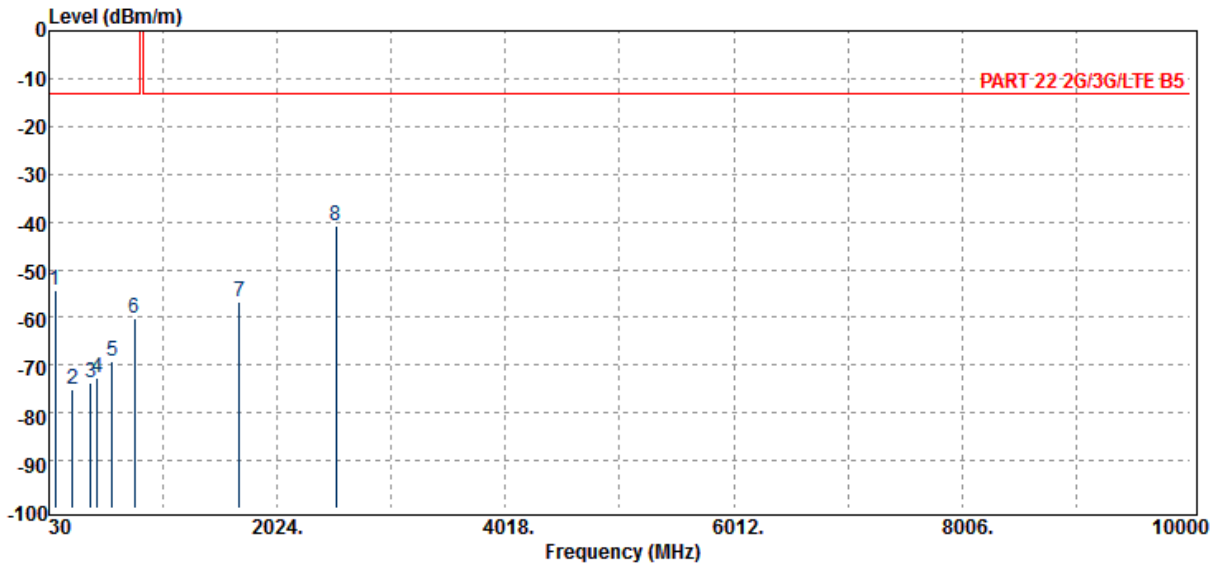

Freq. MHz	Note F/H/E/S	ERP dBm	SG Output Level dBm	Antenna Gain dBd	Cable Loss dB	Limit dBm	Margin dB
85.29	S	-54.18	-51.61	-1.50	-1.07	-13.00	-41.18
236.61	S	-75.13	-76.83	3.29	-1.60	-13.00	-62.13
393.75	S	-73.87	-75.56	3.64	-1.95	-13.00	-60.87
453.89	S	-72.72	-74.02	3.38	-2.08	-13.00	-59.72
582.90	S	-69.18	-69.94	3.49	-2.73	-13.00	-56.18
774.96	S	-60.16	-60.77	3.36	-2.76	-13.00	-47.16
1693.20	H	-56.58	-55.28	2.97	-4.27	-13.00	-43.58
2539.80	H	-40.82	-39.16	3.74	-5.40	-13.00	-27.82

Unless otherwise stated the results shown in this test report refer only to the sample(s) tested and such sample(s) are retained for 90 days only.

除非另有說明，此報告結果僅對測試之樣品負責，同時此樣品僅保留90天。本報告未經本公司書面許可，不可部份複製。

This document is issued by the Company subject to its General Conditions of Service printed overleaf, available on request or accessible at www.sgs.com/terms_and_conditions.htm and, for electronic format documents, subject to Terms and Conditions for Electronic Documents at www.sgs.com/terms_e-document.htm. Attention is drawn to the limitation of liability, indemnification and jurisdiction issues defined therein. Any holder of this document is advised that information contained hereon reflects the Company's findings at the time of its intervention only and within the limits of Client's instructions, if any. The Company's sole responsibility is to its Client and this document does not exonerate parties to a transaction from exercising all their rights and obligations under the transaction documents. This document cannot be reproduced except in full, without prior written approval of the Company. Any unauthorized alteration, forgery or falsification of the content or appearance of this document is unlawful and offenders may be prosecuted to the fullest extent of the law.

ARFCN	:CH 4233	Test Date	:2015-06-11
Operation Band	:HSDPA B5	Temp./Humi.	:22 deg_C / 53 RH
Fundamental Frequency	:846.6 MHz	Engineer	:Curry
Operation Mode	:TX HIGH	Measurement Antenna Pol.	:HORIZONTAL
EUT Pol.	:E1 Plan		

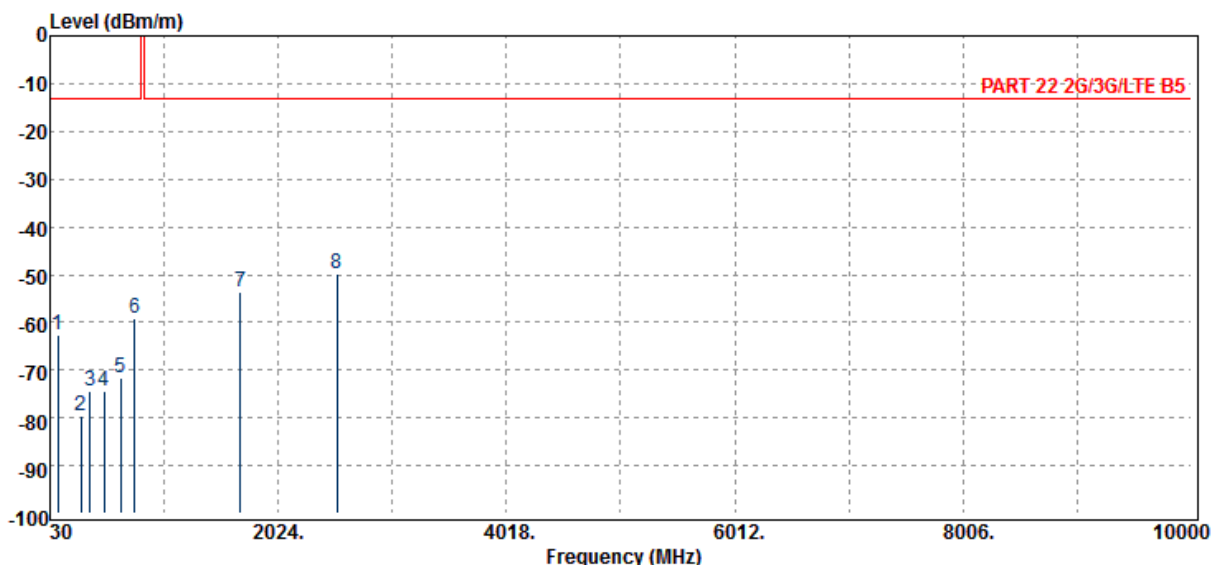

Freq. MHz	Note F/H/E/S	ERP dBm	SG Output Level dBm	Antenna Gain dBd	Cable Loss dB	Limit dBm	Margin dB
95.96	S	-62.68	-60.48	-1.10	-1.11	-13.00	-49.68
300.63	S	-79.43	-81.27	3.62	-1.79	-13.00	-66.43
379.20	S	-74.47	-76.20	3.68	-1.95	-13.00	-61.47
501.42	S	-74.35	-75.80	3.75	-2.31	-13.00	-61.35
644.98	S	-71.61	-72.57	3.62	-2.67	-13.00	-58.61
771.08	S	-59.32	-59.93	3.35	-2.75	-13.00	-46.32
1693.20	H	-53.65	-52.35	2.97	-4.27	-13.00	-40.65
2539.80	H	-49.75	-48.09	3.74	-5.40	-13.00	-36.75

Unless otherwise stated the results shown in this test report refer only to the sample(s) tested and such sample(s) are retained for 90 days only.

除非另有說明，此報告結果僅對測試之樣品負責，同時此樣品僅保留90天。本報告未經本公司書面許可，不可部份複製。

This document is issued by the Company subject to its General Conditions of Service printed overleaf, available on request or accessible at www.sgs.com/terms_and_conditions.htm and, for electronic format documents, subject to Terms and Conditions for Electronic Documents at www.sgs.com/terms_e-document.htm. Attention is drawn to the limitation of liability, indemnification and jurisdiction issues defined therein. Any holder of this document is advised that information contained hereon reflects the Company's findings at the time of its intervention only and within the limits of Client's instructions, if any. The Company's sole responsibility is to its Client and this document does not exonerate parties to a transaction from exercising all their rights and obligations under the transaction documents. This document cannot be reproduced except in full, without prior written approval of the Company. Any unauthorized alteration, forgery or falsification of the content or appearance of this document is unlawful and offenders may be prosecuted to the fullest extent of the law.

Radiated Spurious Emission Measurement Result: 15MHz BW LTE-Band 2(The Worst Case)

ARFCN	:CH 18675 16QAM BW 15 RB 1 74	Test Date	:2015-05-29
Operation Band	:LTE B2	Temp./Humi.	:21 deg_C / 52 RH
Fundamental Frequency	:1857.5 MHz	Engineer	:Curry
Operation Mode	:TX LOW		
EUT Pol.	:E1 Plan	Measurement Antenna Pol.	:VERTICAL

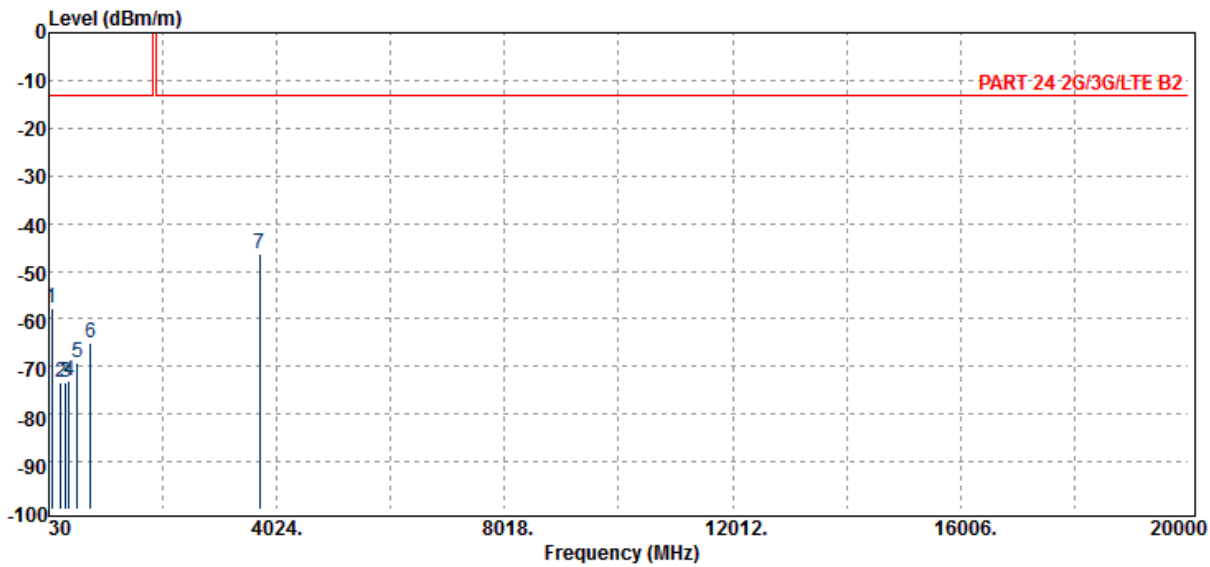

Freq. MHz	Note F/H/E/S	EIRP dBm	SG Output Level dBm	Antenna Gain dBi	Cable Loss dB	Limit dBm	Margin dB
78.50	S	-57.83	-55.74	-1.04	-1.05	-13.00	-44.83
235.64	S	-73.21	-77.06	5.45	-1.59	-13.00	-60.21
330.70	S	-73.43	-77.39	5.86	-1.90	-13.00	-60.43
382.11	S	-73.03	-76.90	5.82	-1.95	-13.00	-60.03
531.49	S	-69.12	-72.45	5.80	-2.48	-13.00	-56.12
765.26	S	-65.15	-67.90	5.48	-2.73	-13.00	-52.15
3715.00	H	-46.53	-48.06	8.43	-6.91	-13.00	-33.53

Unless otherwise stated the results shown in this test report refer only to the sample(s) tested and such sample(s) are retained for 90 days only.

除非另有說明，此報告結果僅對測試之樣品負責，同時此樣品僅保留90天。本報告未經本公司書面許可，不可部份複製。

This document is issued by the Company subject to its General Conditions of Service printed overleaf, available on request or accessible at www.sgs.com/terms_and_conditions.htm and, for electronic format documents, subject to Terms and Conditions for Electronic Documents at www.sgs.com/terms_e-document.htm. Attention is drawn to the limitation of liability, indemnification and jurisdiction issues defined therein. Any holder of this document is advised that information contained hereon reflects the Company's findings at the time of its intervention only and within the limits of Client's instructions, if any. The Company's sole responsibility is to its Client and this document does not exonerate parties to a transaction from exercising all their rights and obligations under the transaction documents. This document cannot be reproduced except in full, without prior written approval of the Company. Any unauthorized alteration, forgery or falsification of the content or appearance of this document is unlawful and offenders may be prosecuted to the fullest extent of the law.

ARFCN	:CH 18675 16QAM BW 15 RB 1 74	Test Date	:2015-05-29
Operation Band	:LTE B2	Temp./Humi.	:21 deg_C / 52 RH
Fundamental Frequency	:1857.5 MHz	Engineer	:Curry
Operation Mode	:TX LOW		
EUT Pol.	:E1 Plan	Measurement Antenna Pol.	:HORIZONTAL

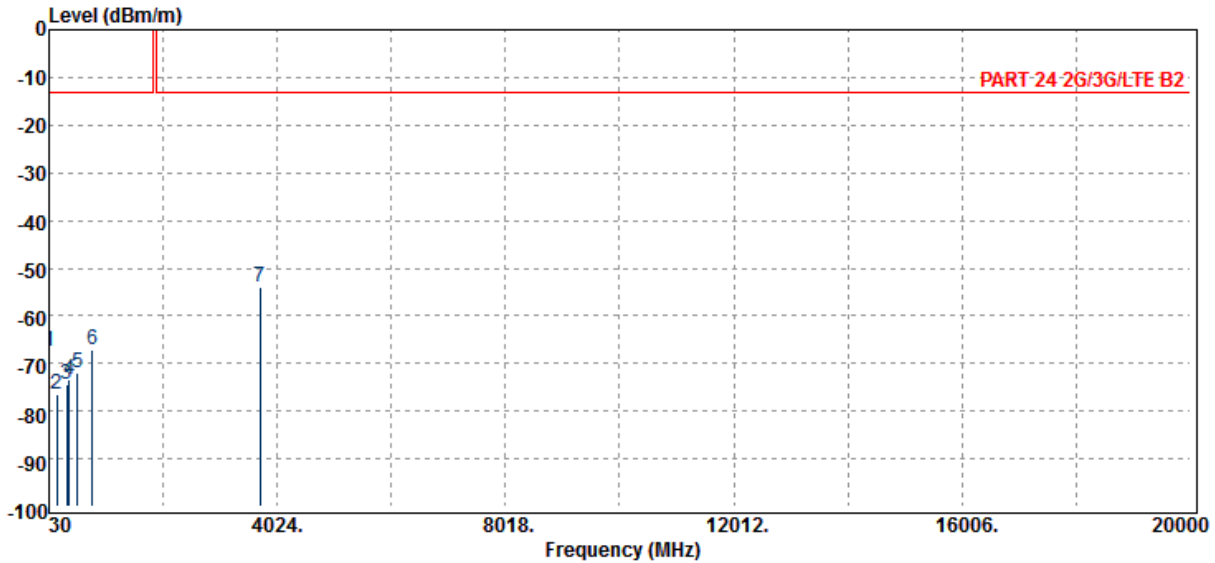

Freq. MHz	Note F/H/E/S	EIRP dBm	SG Output Level dBm	Antenna Gain dBi	Cable Loss dB	Limit dBm	Margin dB
31.94	S	-67.54	-54.57	-12.22	-0.75	-13.00	-54.54
173.56	S	-76.62	-77.18	2.05	-1.49	-13.00	-63.62
337.49	S	-74.48	-78.43	5.88	-1.92	-13.00	-61.48
386.96	S	-73.32	-77.18	5.81	-1.95	-13.00	-60.32
532.46	S	-71.96	-75.27	5.80	-2.48	-13.00	-58.96
781.75	S	-67.26	-70.01	5.53	-2.79	-13.00	-54.26
3715.00	H	-54.08	-55.61	8.43	-6.91	-13.00	-41.08

Unless otherwise stated the results shown in this test report refer only to the sample(s) tested and such sample(s) are retained for 90 days only.

除非另有說明，此報告結果僅對測試之樣品負責，同時此樣品僅保留90天。本報告未經本公司書面許可，不可部份複製。

This document is issued by the Company subject to its General Conditions of Service printed overleaf, available on request or accessible at www.sgs.com/terms_and_conditions.htm and, for electronic format documents, subject to Terms and Conditions for Electronic Documents at www.sgs.com/terms_e-document.htm. Attention is drawn to the limitation of liability, indemnification and jurisdiction issues defined therein. Any holder of this document is advised that information contained hereon reflects the Company's findings at the time of its intervention only and within the limits of Client's instructions, if any. The Company's sole responsibility is to its Client and this document does not exonerate parties to a transaction from exercising all their rights and obligations under the transaction documents. This document cannot be reproduced except in full, without prior written approval of the Company. Any unauthorized alteration, forgery or falsification of the content or appearance of this document is unlawful and offenders may be prosecuted to the fullest extent of the law.

SGS Taiwan Ltd.

No.134,WuKungRoad,NewTaipeiIndustrialPark,WukuDistrict,NewTaipeiCity,Taiwan24803/新北市五股區新北產業園區五工路 134 號

台灣檢驗科技股份有限公司

t (886-2) 2299-3279

f (886-2) 2298-0488

www.tw.sgs.com

Member of SGS Group

ARFCN	:CH 18900 16QAM BW 15 RB 1 74	Test Date	:2015-05-29
Operation Band	:LTE B2	Temp./Humi.	:21 deg_C / 52 RH
Fundamental Frequency	:1880 MHz	Engineer	:Curry
Operation Mode	:TX MID		
EUT Pol.	:E1 Plan	Measurement Antenna Pol.	:VERTICAL

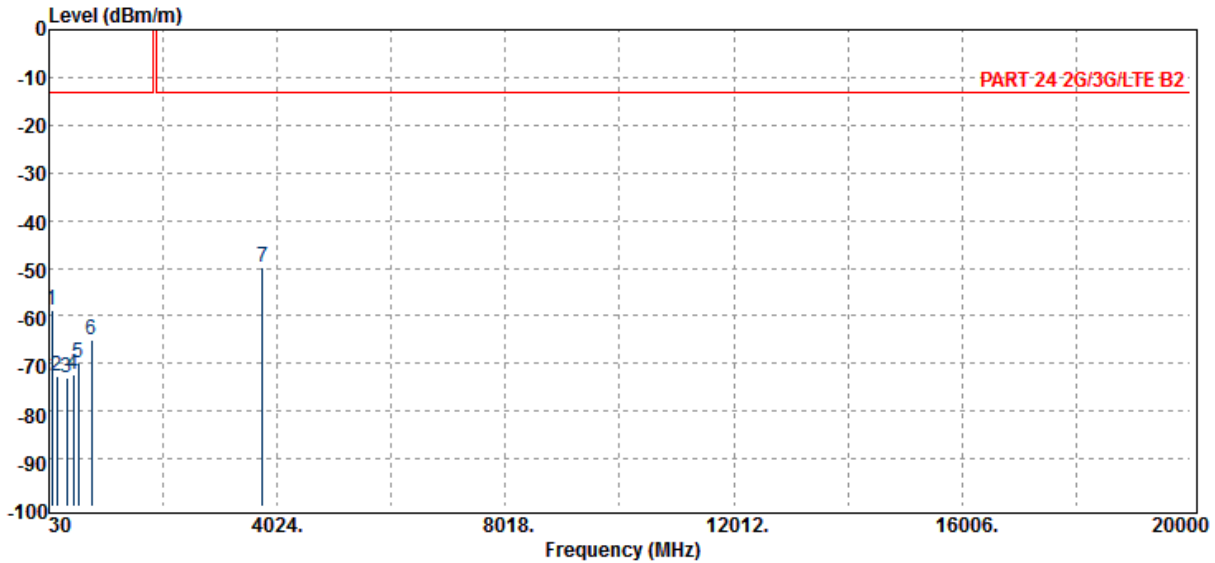

Freq. MHz	Note F/H/E/S	EIRP dBm	SG Output Level dBm	Antenna Gain dBi	Cable Loss dB	Limit dBm	Margin dB
76.56	S	-58.89	-56.23	-1.62	-1.04	-13.00	-45.89
167.74	S	-72.63	-72.43	1.28	-1.47	-13.00	-59.63
342.34	S	-73.02	-76.98	5.89	-1.94	-13.00	-60.02
450.01	S	-72.42	-75.85	5.49	-2.07	-13.00	-59.42
546.04	S	-69.94	-73.14	5.75	-2.55	-13.00	-56.94
776.90	S	-64.94	-67.69	5.52	-2.77	-13.00	-51.94
3760.00	H	-49.84	-51.28	8.46	-7.02	-13.00	-36.84

Unless otherwise stated the results shown in this test report refer only to the sample(s) tested and such sample(s) are retained for 90 days only.

除非另有說明，此報告結果僅對測試之樣品負責，同時此樣品僅保留90天。本報告未經本公司書面許可，不可部份複製。

This document is issued by the Company subject to its General Conditions of Service printed overleaf, available on request or accessible at www.sgs.com/terms_and_conditions.htm and, for electronic format documents, subject to Terms and Conditions for Electronic Documents at www.sgs.com/terms_e-document.htm. Attention is drawn to the limitation of liability, indemnification and jurisdiction issues defined therein. Any holder of this document is advised that information contained hereon reflects the Company's findings at the time of its intervention only and within the limits of Client's instructions, if any. The Company's sole responsibility is to its Client and this document does not exonerate parties to a transaction from exercising all their rights and obligations under the transaction documents. This document cannot be reproduced except in full, without prior written approval of the Company. Any unauthorized alteration, forgery or falsification of the content or appearance of this document is unlawful and offenders may be prosecuted to the fullest extent of the law.

SGS Taiwan Ltd.

No.134,WuKungRoad,NewTaipeiIndustrialPark,WukuDistrict,NewTaipeiCity,Taiwan24803/新北市五股區新北產業園區五工路 134 號

台灣檢驗科技股份有限公司

t (886-2) 2299-3279

f (886-2) 2298-0488

www.tw.sgs.com

Member of SGS Group

ARFCN	:CH 18900 16QAM BW 15 RB 1 74	Test Date	:2015-05-29
Operation Band	:LTE B2	Temp./Humi.	:21 deg_C / 52 RH
Fundamental Frequency	:1880 MHz	Engineer	:Curry
Operation Mode	:TX MID		
EUT Pol.	:E1 Plan	Measurement Antenna Pol.	:HORIZONTAL

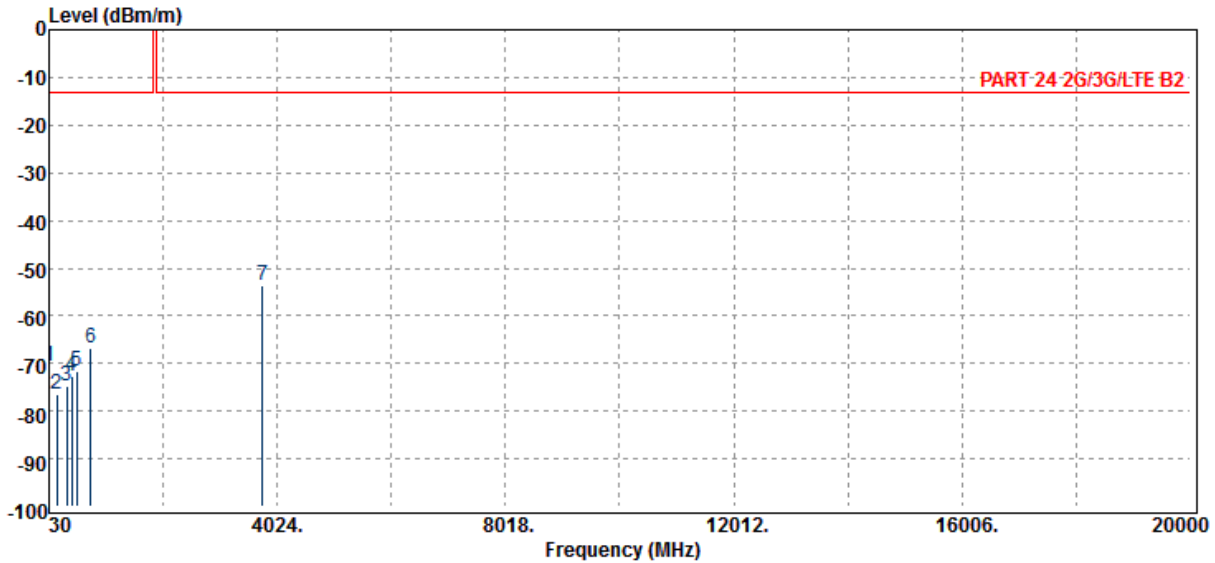

Freq. MHz	Note F/H/E/S	EIRP dBm	SG Output Level dBm	Antenna Gain dBi	Cable Loss dB	Limit dBm	Margin dB
31.94	S	-70.59	-57.61	-12.22	-0.75	-13.00	-57.59
167.74	S	-76.36	-76.17	1.28	-1.47	-13.00	-63.36
343.31	S	-74.87	-78.82	5.89	-1.94	-13.00	-61.87
430.61	S	-72.75	-76.34	5.60	-2.01	-13.00	-59.75
508.21	S	-71.66	-75.20	5.88	-2.35	-13.00	-58.66
764.29	S	-66.86	-69.61	5.48	-2.73	-13.00	-53.86
3760.00	H	-53.67	-55.11	8.46	-7.02	-13.00	-40.67

Unless otherwise stated the results shown in this test report refer only to the sample(s) tested and such sample(s) are retained for 90 days only.

除非另有說明，此報告結果僅對測試之樣品負責，同時此樣品僅保留90天。本報告未經本公司書面許可，不可部份複製。

This document is issued by the Company subject to its General Conditions of Service printed overleaf, available on request or accessible at www.sgs.com/terms_and_conditions.htm and, for electronic format documents, subject to Terms and Conditions for Electronic Documents at www.sgs.com/terms_e-document.htm. Attention is drawn to the limitation of liability, indemnification and jurisdiction issues defined therein. Any holder of this document is advised that information contained hereon reflects the Company's findings at the time of its intervention only and within the limits of Client's instructions, if any. The Company's sole responsibility is to its Client and this document does not exonerate parties to a transaction from exercising all their rights and obligations under the transaction documents. This document cannot be reproduced except in full, without prior written approval of the Company. Any unauthorized alteration, forgery or falsification of the content or appearance of this document is unlawful and offenders may be prosecuted to the fullest extent of the law.

SGS Taiwan Ltd.

No.134,WuKungRoad,NewTaipeiIndustrialPark,WukuDistrict,NewTaipeiCity,Taiwan24803/新北市五股區新北產業園區五工路 134 號

台灣檢驗科技股份有限公司

t (886-2) 2299-3279

f (886-2) 2298-0488

www.tw.sgs.com

Member of SGS Group

ARFCN	:CH 19125 16QAM BW 15 RB 1 74	Test Date	:2015-05-29
Operation Band	:LTE B2	Temp./Humi.	:21 deg_C / 52 RH
Fundamental Frequency	:1902.5 MHz	Engineer	:Curry
Operation Mode	:TX HIGH		
EUT Pol.	:E1 Plan	Measurement Antenna Pol.	:VERTICAL

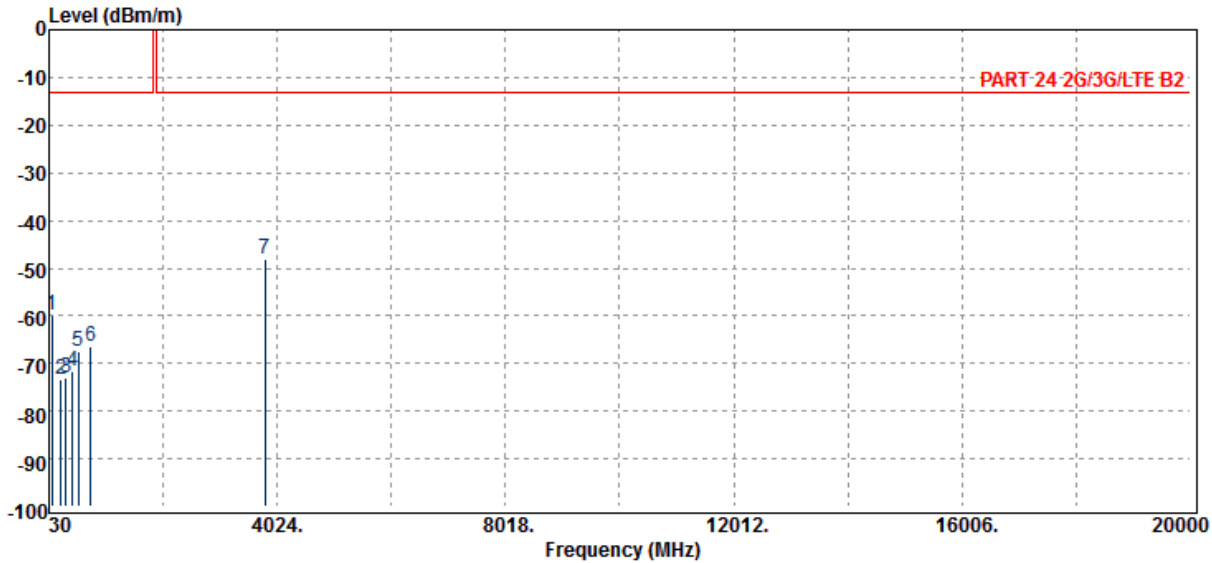

Freq. MHz	Note F/H/E/S	EIRP dBm	SG Output Level dBm	Antenna Gain dBi	Cable Loss dB	Limit dBm	Margin dB
75.59	S	-60.02	-57.08	-1.91	-1.03	-13.00	-47.02
241.46	S	-73.36	-77.21	5.46	-1.61	-13.00	-60.36
323.91	S	-73.17	-77.14	5.84	-1.88	-13.00	-60.17
447.10	S	-71.73	-75.18	5.51	-2.06	-13.00	-58.73
542.16	S	-67.63	-70.86	5.76	-2.53	-13.00	-54.63
752.65	S	-66.31	-69.05	5.44	-2.70	-13.00	-53.31
3805.00	H	-48.13	-49.57	8.49	-7.05	-13.00	-35.13

Unless otherwise stated the results shown in this test report refer only to the sample(s) tested and such sample(s) are retained for 90 days only.

除非另有說明，此報告結果僅對測試之樣品負責，同時此樣品僅保留90天。本報告未經本公司書面許可，不可部份複製。

This document is issued by the Company subject to its General Conditions of Service printed overleaf, available on request or accessible at www.sgs.com/terms_and_conditions.htm and, for electronic format documents, subject to Terms and Conditions for Electronic Documents at www.sgs.com/terms_e-document.htm. Attention is drawn to the limitation of liability, indemnification and jurisdiction issues defined therein. Any holder of this document is advised that information contained hereon reflects the Company's findings at the time of its intervention only and within the limits of Client's instructions, if any. The Company's sole responsibility is to its Client and this document does not exonerate parties to a transaction from exercising all their rights and obligations under the transaction documents. This document cannot be reproduced except in full, without prior written approval of the Company. Any unauthorized alteration, forgery or falsification of the content or appearance of this document is unlawful and offenders may be prosecuted to the fullest extent of the law.

ARFCN	:CH 19125 16QAM BW 15 RB 1 74	Test Date	:2015-05-29
Operation Band	:LTE B2	Temp./Humi.	:21 deg_C / 52 RH
Fundamental Frequency	:1902.5 MHz	Engineer	:Curry
Operation Mode	:TX HIGH		
EUT Pol.	:E1 Plan	Measurement Antenna Pol.	:HORIZONTAL

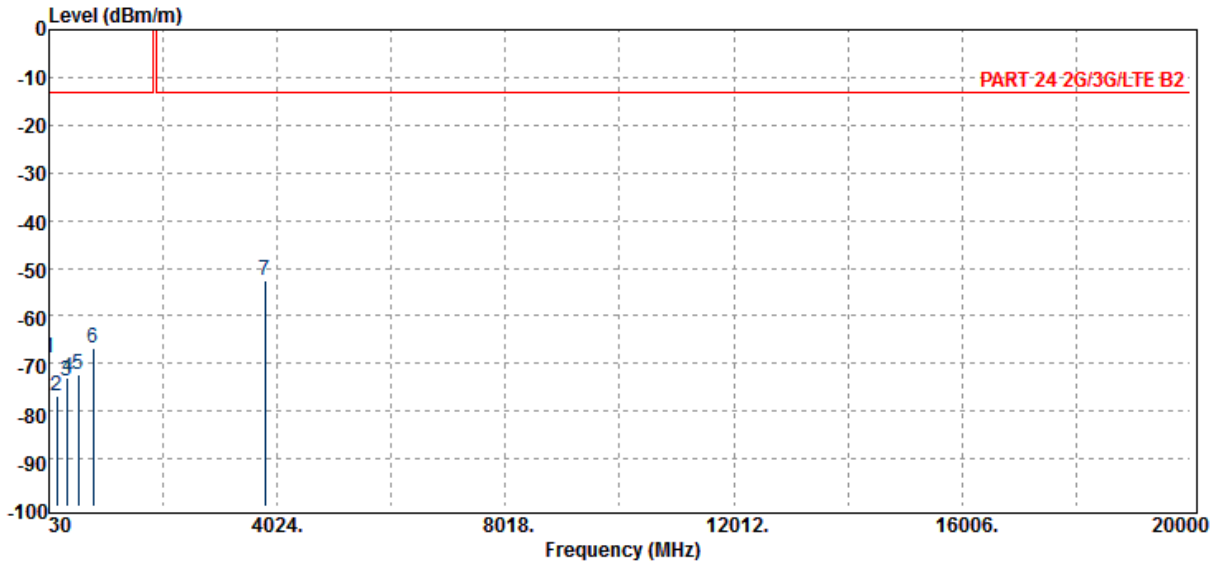

Freq. MHz	Note F/H/E/S	EIRP dBm	SG Output Level dBm	Antenna Gain dBi	Cable Loss dB	Limit dBm	Margin dB
34.85	S	-68.93	-56.62	-11.52	-0.78	-13.00	-55.93
167.74	S	-76.72	-76.53	1.28	-1.47	-13.00	-63.72
335.55	S	-73.71	-77.67	5.87	-1.92	-13.00	-60.71
352.04	S	-72.84	-76.78	5.91	-1.97	-13.00	-59.84
537.31	S	-72.46	-75.73	5.78	-2.51	-13.00	-59.46
799.21	S	-66.71	-69.45	5.59	-2.85	-13.00	-53.71
3805.00	H	-52.73	-54.17	8.49	-7.05	-13.00	-39.73

Unless otherwise stated the results shown in this test report refer only to the sample(s) tested and such sample(s) are retained for 90 days only.

除非另有說明，此報告結果僅對測試之樣品負責，同時此樣品僅保留90天。本報告未經本公司書面許可，不可部份複製。

This document is issued by the Company subject to its General Conditions of Service printed overleaf, available on request or accessible at www.sgs.com/terms_and_conditions.htm and, for electronic format documents, subject to Terms and Conditions for Electronic Documents at www.sgs.com/terms_e-document.htm. Attention is drawn to the limitation of liability, indemnification and jurisdiction issues defined therein. Any holder of this document is advised that information contained hereon reflects the Company's findings at the time of its intervention only and within the limits of Client's instructions, if any. The Company's sole responsibility is to its Client and this document does not exonerate parties to a transaction from exercising all their rights and obligations under the transaction documents. This document cannot be reproduced except in full, without prior written approval of the Company. Any unauthorized alteration, forgery or falsification of the content or appearance of this document is unlawful and offenders may be prosecuted to the fullest extent of the law.

Radiated Spurious Emission Measurement Result: 15MHz BW LTE-Band 4(The Worst Case)

ARFCN	:CH 20025 16QAM BW 15 RB 1 74	Test Date	:2015-05-29
Operation Band	:LTE B4	Temp./Humi.	:21 deg_C / 52 RH
Fundamental Frequency	:1717.5 MHz	Engineer	:Curry
Operation Mode	:TX LOW		
EUT Pol.	:E1 Plan	Measurement Antenna Pol.	:VERTICAL

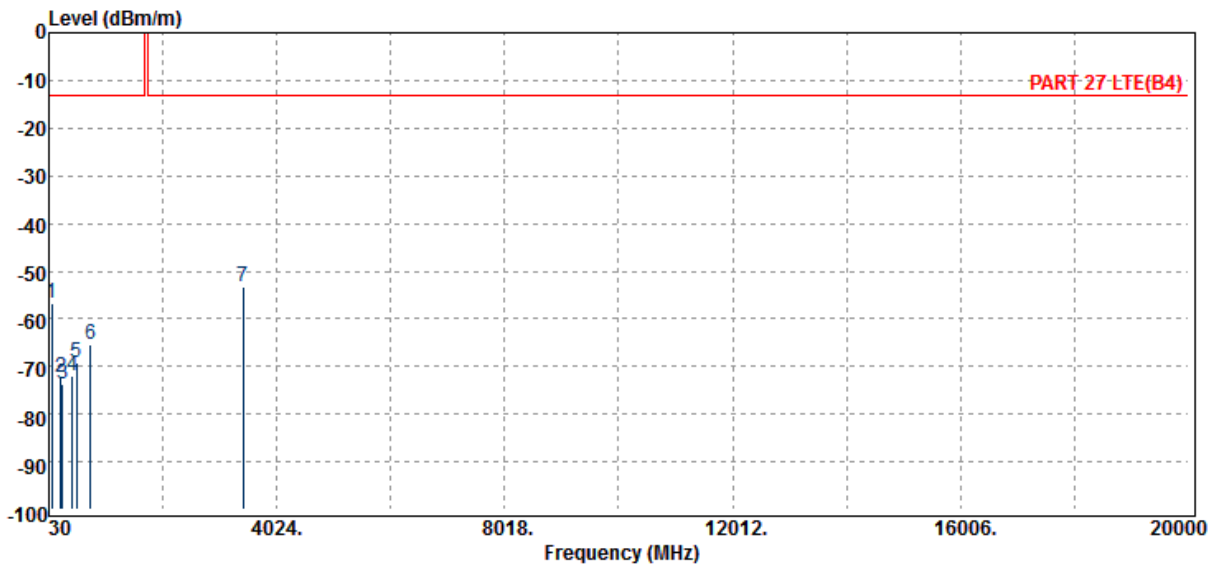

Freq. MHz	Note F/H/E/S	EIRP dBm	SG Output Level dBm	Antenna Gain dBi	Cable Loss dB	Limit dBm	Margin dB
75.59	S	-56.81	-53.87	-1.91	-1.03	-13.00	-43.81
236.61	S	-72.47	-76.31	5.44	-1.60	-13.00	-59.47
262.80	S	-73.74	-77.87	5.81	-1.67	-13.00	-60.74
449.04	S	-71.92	-75.36	5.50	-2.06	-13.00	-58.92
517.91	S	-69.27	-72.72	5.85	-2.40	-13.00	-56.27
764.29	S	-65.33	-68.08	5.48	-2.73	-13.00	-52.33
3435.00	H	-53.17	-54.75	8.12	-6.54	-13.00	-40.17

Unless otherwise stated the results shown in this test report refer only to the sample(s) tested and such sample(s) are retained for 90 days only.

除非另有說明，此報告結果僅對測試之樣品負責，同時此樣品僅保留90天。本報告未經本公司書面許可，不可部份複製。

This document is issued by the Company subject to its General Conditions of Service printed overleaf, available on request or accessible at www.sgs.com/terms_and_conditions.htm and, for electronic format documents, subject to Terms and Conditions for Electronic Documents at www.sgs.com/terms_e-document.htm. Attention is drawn to the limitation of liability, indemnification and jurisdiction issues defined therein. Any holder of this document is advised that information contained hereon reflects the Company's findings at the time of its intervention only and within the limits of Client's instructions, if any. The Company's sole responsibility is to its Client and this document does not exonerate parties to a transaction from exercising all their rights and obligations under the transaction documents. This document cannot be reproduced except in full, without prior written approval of the Company. Any unauthorized alteration, forgery or falsification of the content or appearance of this document is unlawful and offenders may be prosecuted to the fullest extent of the law.

ARFCN	:CH 20025 16QAM BW 15 RB 1 74	Test Date	:2015-05-29
Operation Band	:LTE B4	Temp./Humi.	:21 deg_C / 52 RH
Fundamental Frequency	:1717.5 MHz	Engineer	:Curry
Operation Mode	:TX LOW		
EUT Pol.	:E1 Plan	Measurement Antenna Pol.	:HORIZONTAL

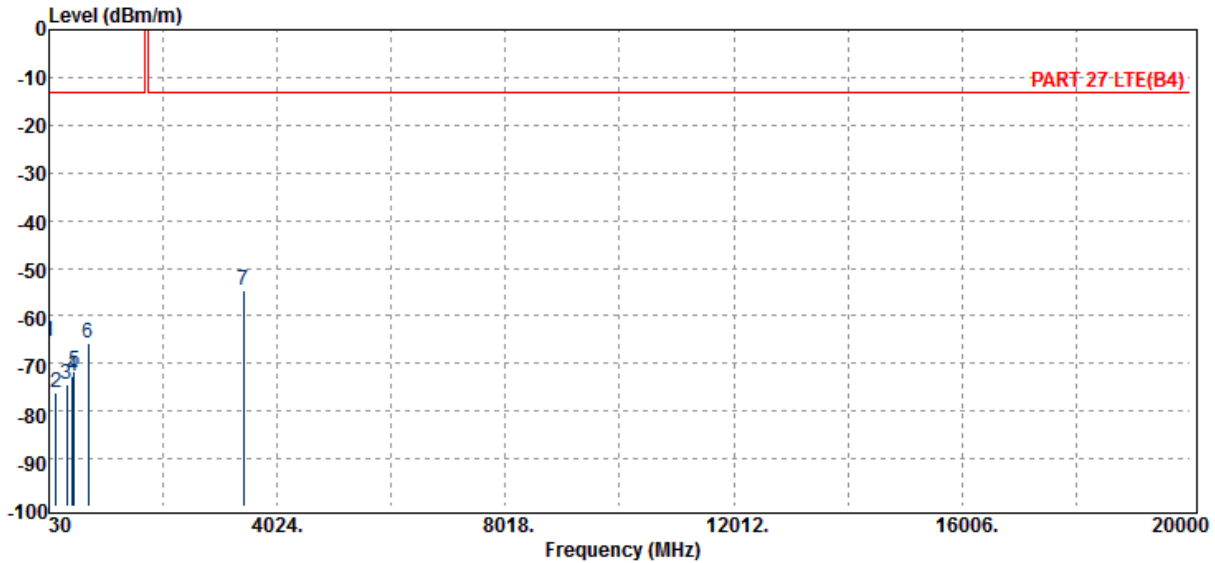

Freq. MHz	Note F/H/E/S	EIRP dBm	SG Output Level dBm	Antenna Gain dBi	Cable Loss dB	Limit dBm	Margin dB
31.94	S	-65.28	-52.30	-12.22	-0.75	-13.00	-52.28
154.16	S	-76.25	-75.17	0.33	-1.41	-13.00	-63.25
338.46	S	-74.28	-78.23	5.88	-1.93	-13.00	-61.28
442.25	S	-72.82	-76.31	5.54	-2.04	-13.00	-59.82
473.29	S	-71.68	-75.23	5.69	-2.14	-13.00	-58.68
713.85	S	-65.80	-68.70	5.50	-2.61	-13.00	-52.80
3435.00	H	-54.69	-56.26	8.12	-6.54	-13.00	-41.69

Unless otherwise stated the results shown in this test report refer only to the sample(s) tested and such sample(s) are retained for 90 days only.
 除非另有說明，此報告結果僅對測試之樣品負責，同時此樣品僅保留90天。本報告未經本公司書面許可，不可部份複製。

This document is issued by the Company subject to its General Conditions of Service printed overleaf, available on request or accessible at www.sgs.com/terms_and_conditions.htm and, for electronic format documents, subject to Terms and Conditions for Electronic Documents at www.sgs.com/terms_e-document.htm. Attention is drawn to the limitation of liability, indemnification and jurisdiction issues defined therein. Any holder of this document is advised that information contained hereon reflects the Company's findings at the time of its intervention only and within the limits of Client's instructions, if any. The Company's sole responsibility is to its Client and this document does not exonerate parties to a transaction from exercising all their rights and obligations under the transaction documents. This document cannot be reproduced except in full, without prior written approval of the Company. Any unauthorized alteration, forgery or falsification of the content or appearance of this document is unlawful and offenders may be prosecuted to the fullest extent of the law.

ARFCN	:CH 20175 16QAM BW 15 RB 1 74	Test Date	:2015-05-29
Operation Band	:LTE B4	Temp./Humi.	:21 deg_C / 52 RH
Fundamental Frequency	:1732.5 MHz	Engineer	:Curry
Operation Mode	:TX MID		
EUT Pol.	:E1 Plan	Measurement Antenna Pol.	:VERTICAL

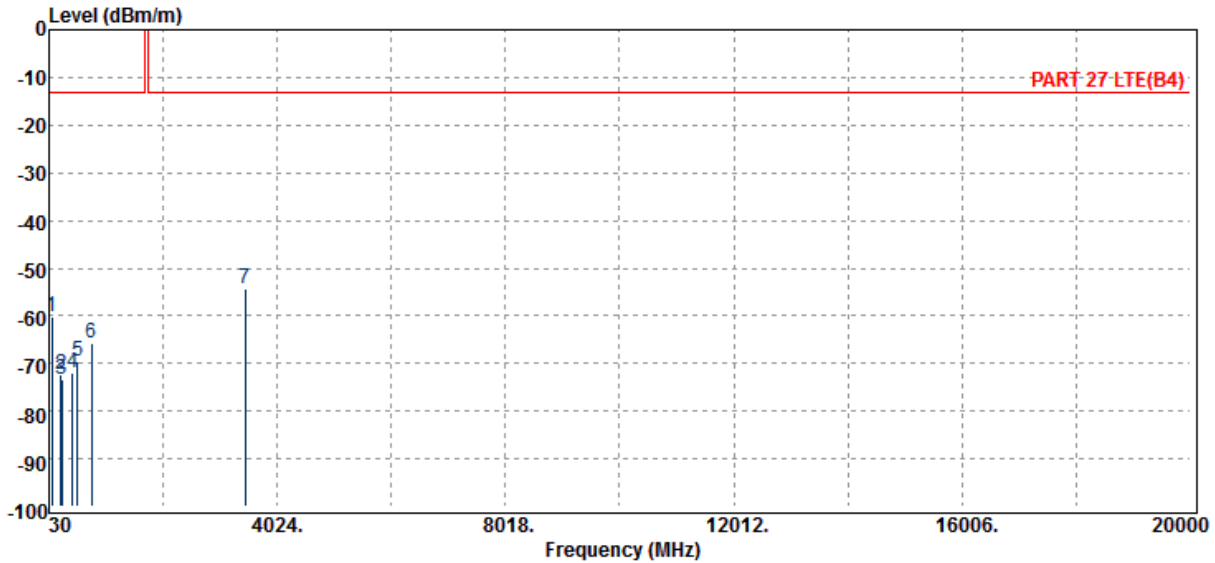

Freq. MHz	Note F/H/E/S	EIRP dBm	SG Output Level dBm	Antenna Gain dBi	Cable Loss dB	Limit dBm	Margin dB
73.65	S	-60.25	-56.72	-2.50	-1.03	-13.00	-47.25
236.61	S	-72.29	-76.14	5.44	-1.60	-13.00	-59.29
250.19	S	-73.24	-77.20	5.59	-1.64	-13.00	-60.24
435.46	S	-71.86	-75.41	5.57	-2.02	-13.00	-58.86
531.49	S	-69.65	-72.98	5.80	-2.48	-13.00	-56.65
778.84	S	-65.73	-68.48	5.53	-2.78	-13.00	-52.73
3465.00	H	-54.18	-55.84	8.20	-6.53	-13.00	-41.18

Unless otherwise stated the results shown in this test report refer only to the sample(s) tested and such sample(s) are retained for 90 days only.

除非另有說明，此報告結果僅對測試之樣品負責，同時此樣品僅保留90天。本報告未經本公司書面許可，不可部份複製。

This document is issued by the Company subject to its General Conditions of Service printed overleaf, available on request or accessible at www.sgs.com/terms_and_conditions.htm and, for electronic format documents, subject to Terms and Conditions for Electronic Documents at www.sgs.com/terms_e-document.htm. Attention is drawn to the limitation of liability, indemnification and jurisdiction issues defined therein. Any holder of this document is advised that information contained hereon reflects the Company's findings at the time of its intervention only and within the limits of Client's instructions, if any. The Company's sole responsibility is to its Client and this document does not exonerate parties to a transaction from exercising all their rights and obligations under the transaction documents. This document cannot be reproduced except in full, without prior written approval of the Company. Any unauthorized alteration, forgery or falsification of the content or appearance of this document is unlawful and offenders may be prosecuted to the fullest extent of the law.

SGS Taiwan Ltd.

No.134,WuKungRoad,NewTaipeiIndustrialPark,WukuDistrict,NewTaipeiCity,Taiwan24803/新北市五股區新北產業園區五工路 134 號

台灣檢驗科技股份有限公司

t (886-2) 2299-3279

f (886-2) 2298-0488

www.tw.sgs.com

Member of SGS Group

ARFCN	:CH 20175 16QAM BW 15 RB 1 74	Test Date	:2015-05-29
Operation Band	:LTE B4	Temp./Humi.	:21 deg_C / 52 RH
Fundamental Frequency	:1732.5 MHz	Engineer	:Curry
Operation Mode	:TX MID		
EUT Pol.	:E1 Plan	Measurement Antenna Pol.	:HORIZONTAL

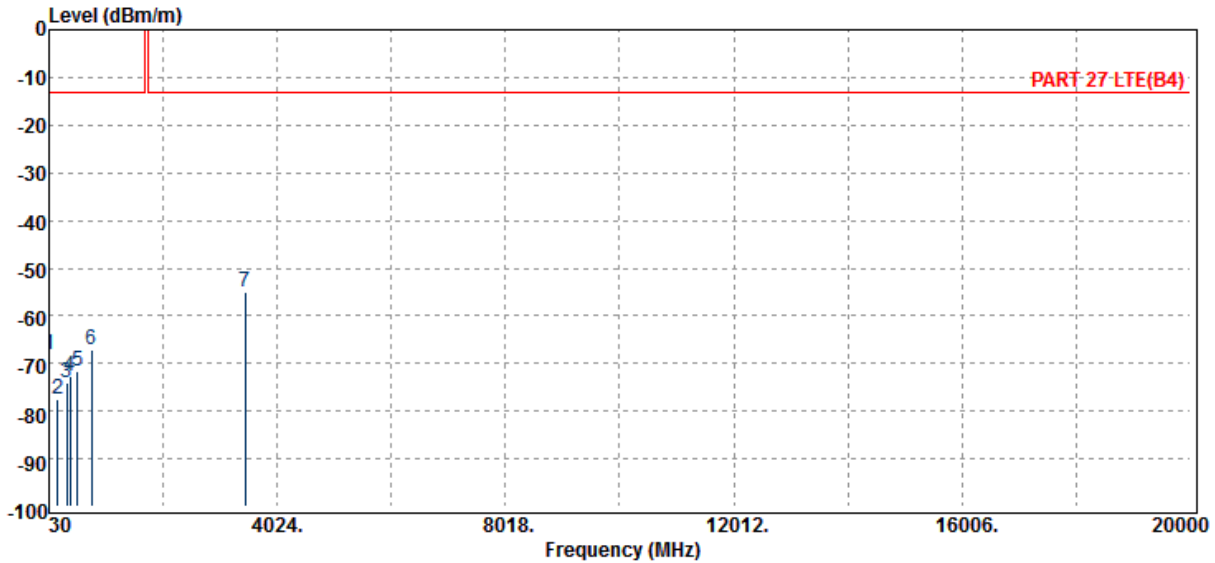

Freq. MHz	Note F/H/E/S	EIRP dBm	SG Output Level dBm	Antenna Gain dBi	Cable Loss dB	Limit dBm	Margin dB
30.00	S	-68.32	-54.86	-12.73	-0.73	-13.00	-55.32
178.41	S	-77.38	-78.76	2.87	-1.50	-13.00	-64.38
342.34	S	-73.96	-77.91	5.89	-1.94	-13.00	-60.96
395.69	S	-72.65	-76.49	5.78	-1.95	-13.00	-59.65
522.76	S	-71.62	-75.02	5.83	-2.43	-13.00	-58.62
767.20	S	-67.27	-70.03	5.49	-2.74	-13.00	-54.27
3465.00	H	-55.09	-56.75	8.20	-6.53	-13.00	-42.09

Unless otherwise stated the results shown in this test report refer only to the sample(s) tested and such sample(s) are retained for 90 days only.

除非另有說明，此報告結果僅對測試之樣品負責，同時此樣品僅保留90天。本報告未經本公司書面許可，不可部份複製。

This document is issued by the Company subject to its General Conditions of Service printed overleaf, available on request or accessible at www.sgs.com/terms_and_conditions.htm and, for electronic format documents, subject to Terms and Conditions for Electronic Documents at www.sgs.com/terms_e-document.htm. Attention is drawn to the limitation of liability, indemnification and jurisdiction issues defined therein. Any holder of this document is advised that information contained hereon reflects the Company's findings at the time of its intervention only and within the limits of Client's instructions, if any. The Company's sole responsibility is to its Client and this document does not exonerate parties to a transaction from exercising all their rights and obligations under the transaction documents. This document cannot be reproduced except in full, without prior written approval of the Company. Any unauthorized alteration, forgery or falsification of the content or appearance of this document is unlawful and offenders may be prosecuted to the fullest extent of the law.

ARFCN	:CH 20325 16QAM BW 15 RB 1 74	Test Date	:2015-05-29
Operation Band	:LTE B4	Temp./Humi.	:21 deg_C / 52 RH
Fundamental Frequency	:1747.5 MHz	Engineer	:Curry
Operation Mode	:TX HIGH		
EUT Pol.	:E1 Plan	Measurement Antenna Pol.	:VERTICAL

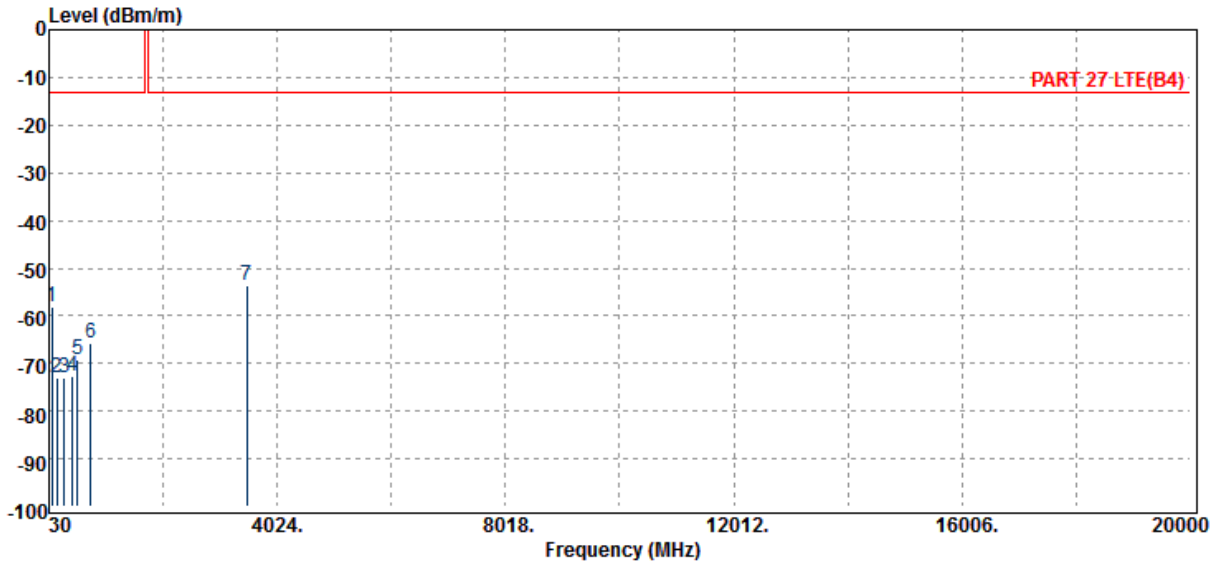

Freq. MHz	Note F/H/E/S	EIRP dBm	SG Output Level dBm	Antenna Gain dBi	Cable Loss dB	Limit dBm	Margin dB
76.56	S	-58.15	-55.50	-1.62	-1.04	-13.00	-45.15
170.65	S	-73.17	-73.24	1.55	-1.48	-13.00	-60.17
293.84	S	-72.97	-76.86	5.65	-1.76	-13.00	-59.97
439.34	S	-72.52	-76.04	5.55	-2.03	-13.00	-59.52
526.64	S	-69.37	-72.74	5.82	-2.45	-13.00	-56.37
754.59	S	-65.72	-68.46	5.45	-2.71	-13.00	-52.72
3495.00	H	-53.46	-55.11	8.29	-6.64	-13.00	-40.46

Unless otherwise stated the results shown in this test report refer only to the sample(s) tested and such sample(s) are retained for 90 days only.

除非另有說明，此報告結果僅對測試之樣品負責，同時此樣品僅保留90天。本報告未經本公司書面許可，不可部份複製。

This document is issued by the Company subject to its General Conditions of Service printed overleaf, available on request or accessible at www.sgs.com/terms_and_conditions.htm and, for electronic format documents, subject to Terms and Conditions for Electronic Documents at www.sgs.com/terms_e-document.htm. Attention is drawn to the limitation of liability, indemnification and jurisdiction issues defined therein. Any holder of this document is advised that information contained hereon reflects the Company's findings at the time of its intervention only and within the limits of Client's instructions, if any. The Company's sole responsibility is to its Client and this document does not exonerate parties to a transaction from exercising all their rights and obligations under the transaction documents. This document cannot be reproduced except in full, without prior written approval of the Company. Any unauthorized alteration, forgery or falsification of the content or appearance of this document is unlawful and offenders may be prosecuted to the fullest extent of the law.

ARFCN	:CH 20325 16QAM BW 15 RB 1 74	Test Date	:2015-05-29
Operation Band	:LTE B4	Temp./Humi.	:21 deg_C / 52 RH
Fundamental Frequency	:1747.5 MHz	Engineer	:Curry
Operation Mode	:TX HIGH		
EUT Pol.	:E1 Plan	Measurement Antenna Pol.	:HORIZONTAL

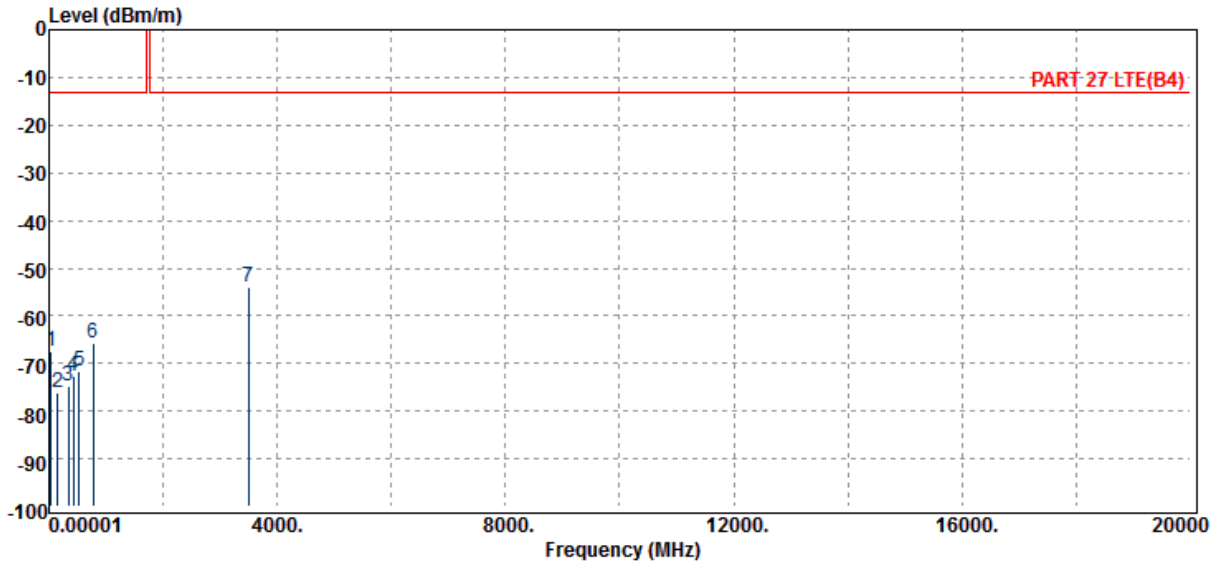

Freq. MHz	Note F/H/E/S	EIRP dBm	SG Output Level dBm	Antenna Gain dBi	Cable Loss dB	Limit dBm	Margin dB
32.91	S	-67.56	-54.82	-11.98	-0.76	-13.00	-54.56
153.19	S	-76.07	-74.94	0.27	-1.40	-13.00	-63.07
337.49	S	-74.85	-78.81	5.88	-1.92	-13.00	-61.85
429.64	S	-72.58	-76.18	5.60	-2.00	-13.00	-59.58
524.70	S	-71.57	-74.95	5.82	-2.44	-13.00	-58.57
770.11	S	-65.61	-68.37	5.50	-2.74	-13.00	-52.61
3495.00	H	-54.13	-55.78	8.29	-6.64	-13.00	-41.13

Unless otherwise stated the results shown in this test report refer only to the sample(s) tested and such sample(s) are retained for 90 days only.

除非另有說明，此報告結果僅對測試之樣品負責，同時此樣品僅保留90天。本報告未經本公司書面許可，不可部份複製。

This document is issued by the Company subject to its General Conditions of Service printed overleaf, available on request or accessible at www.sgs.com/terms_and_conditions.htm and, for electronic format documents, subject to Terms and Conditions for Electronic Documents at www.sgs.com/terms_e-document.htm. Attention is drawn to the limitation of liability, indemnification and jurisdiction issues defined therein. Any holder of this document is advised that information contained hereon reflects the Company's findings at the time of its intervention only and within the limits of Client's instructions, if any. The Company's sole responsibility is to its Client and this document does not exonerate parties to a transaction from exercising all their rights and obligations under the transaction documents. This document cannot be reproduced except in full, without prior written approval of the Company. Any unauthorized alteration, forgery or falsification of the content or appearance of this document is unlawful and offenders may be prosecuted to the fullest extent of the law.

SGS Taiwan Ltd.

No.134,WuKungRoad,NewTaipeiIndustrialPark,WukuDistrict,NewTaipeiCity,Taiwan24803/新北市五股區新北產業園區五工路 134 號

台灣檢驗科技股份有限公司

t (886-2) 2299-3279

f (886-2) 2298-0488

www.tw.sgs.com

Member of SGS Group

Radiated Spurious Emission Measurement Result: 5MHz BW LTE-Band 5(The Worst Case)

ARFCN	:CH 20425 16QAM BW 5	Test Date	:2015-05-29
	RB 1 0		
Operation Band	:LTE B5	Temp./Humi.	:21 deg_C / 52 RH
Fundamental Frequency	:826.5 MHz	Engineer	:Curry
Operation Mode	:TX LOW		
EUT Pol.	:E1 Plan	Measurement Antenna Pol.	:VERTICAL

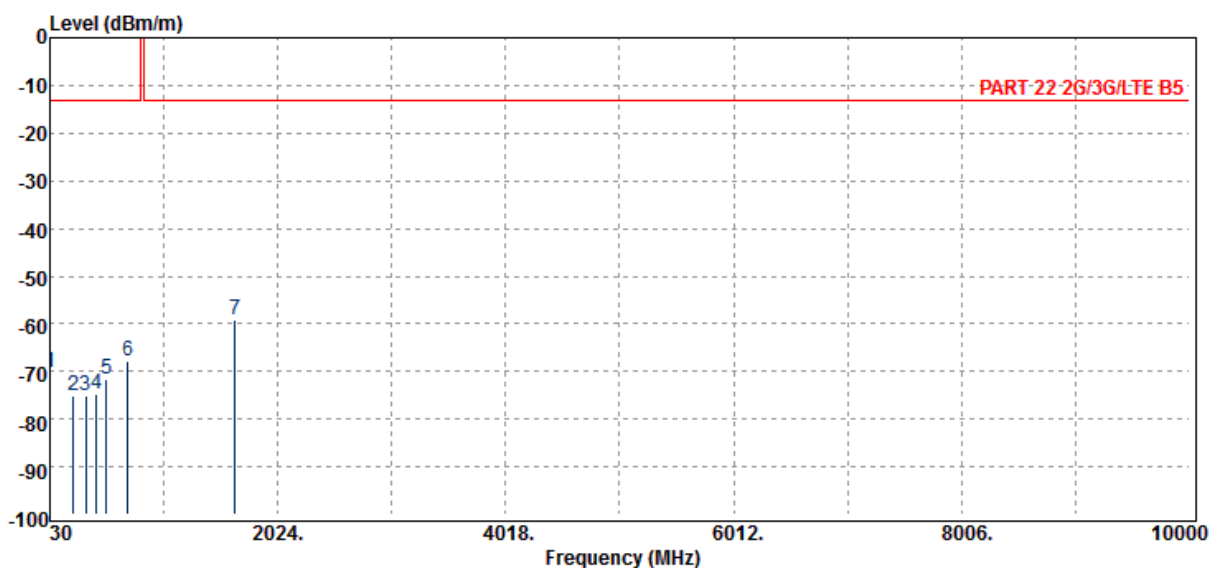

Freq. MHz	Note F/H/E/S	ERP dBm	SG Output Level dBm	Antenna Gain dBd	Cable Loss dB	Limit dBm	Margin dB
31.94	S	-70.34	-55.21	-14.37	-0.75	-13.00	-57.34
236.61	S	-74.98	-76.68	3.29	-1.60	-13.00	-61.98
342.34	S	-75.16	-76.96	3.74	-1.94	-13.00	-62.16
435.46	S	-74.81	-76.21	3.42	-2.02	-13.00	-61.81
524.70	S	-71.47	-72.70	3.67	-2.44	-13.00	-58.47
711.91	S	-67.97	-68.72	3.36	-2.60	-13.00	-54.97
1653.00	H	-59.28	-58.10	3.05	-4.22	-13.00	-46.28

Unless otherwise stated the results shown in this test report refer only to the sample(s) tested and such sample(s) are retained for 90 days only.
 除非另有說明，此報告結果僅對測試之樣品負責，同時此樣品僅保留90天。本報告未經本公司書面許可，不可部份複製。
 This document is issued by the Company subject to its General Conditions of Service printed overleaf, available on request or accessible at www.sgs.com/terms_and_conditions.htm and, for electronic format documents, subject to Terms and Conditions for Electronic Documents at www.sgs.com/terms_e-document.htm. Attention is drawn to the limitation of liability, indemnification and jurisdiction issues defined therein. Any holder of this document is advised that information contained hereon reflects the Company's findings at the time of its intervention only and within the limits of Client's instructions, if any. The Company's sole responsibility is to its Client and this document does not exonerate parties to a transaction from exercising all their rights and obligations under the transaction documents. This document cannot be reproduced except in full, without prior written approval of the Company. Any unauthorized alteration, forgery or falsification of the content or appearance of this document is unlawful and offenders may be prosecuted to the fullest extent of the law.

ARFCN	:CH 20425 16QAM BW 5 RB 1 0	Test Date	:2015-05-29
Operation Band	:LTE B5	Temp./Humi.	:21 deg_C / 52 RH
Fundamental Frequency	:826.5 MHz	Engineer	:Curry
Operation Mode	:TX LOW		
EUT Pol.	:E1 Plan	Measurement Antenna Pol.	:HORIZONTAL

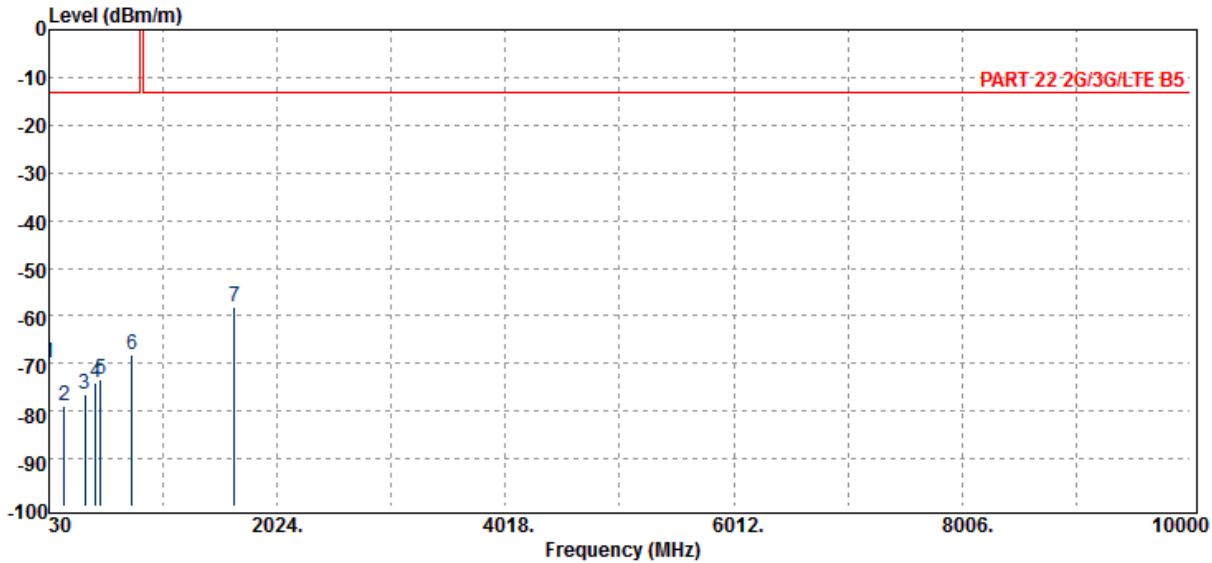

Freq. MHz	Note F/H/E/S	ERP dBm	SG Output Level dBm	Antenna Gain dBd	Cable Loss dB	Limit dBm	Margin dB
34.85	S	-70.03	-55.57	-13.67	-0.78	-13.00	-57.03
165.80	S	-78.87	-76.40	-1.01	-1.46	-13.00	-65.87
345.25	S	-76.34	-78.14	3.75	-1.95	-13.00	-63.34
434.49	S	-74.03	-75.44	3.43	-2.02	-13.00	-61.03
479.11	S	-73.23	-74.64	3.59	-2.18	-13.00	-60.23
754.59	S	-68.20	-68.79	3.30	-2.71	-13.00	-55.20
1653.00	H	-58.10	-56.92	3.05	-4.22	-13.00	-45.10

Unless otherwise stated the results shown in this test report refer only to the sample(s) tested and such sample(s) are retained for 90 days only.

除非另有說明，此報告結果僅對測試之樣品負責，同時此樣品僅保留90天。本報告未經本公司書面許可，不可部份複製。

This document is issued by the Company subject to its General Conditions of Service printed overleaf, available on request or accessible at www.sgs.com/terms_and_conditions.htm and, for electronic format documents, subject to Terms and Conditions for Electronic Documents at www.sgs.com/terms_e-document.htm. Attention is drawn to the limitation of liability, indemnification and jurisdiction issues defined therein. Any holder of this document is advised that information contained hereon reflects the Company's findings at the time of its intervention only and within the limits of Client's instructions, if any. The Company's sole responsibility is to its Client and this document does not exonerate parties to a transaction from exercising all their rights and obligations under the transaction documents. This document cannot be reproduced except in full, without prior written approval of the Company. Any unauthorized alteration, forgery or falsification of the content or appearance of this document is unlawful and offenders may be prosecuted to the fullest extent of the law.

ARFCN	:CH 20525 16QAM BW 5 RB 1 0	Test Date	:2015-05-29
Operation Band	:LTE B5	Temp./Humi.	:21 deg_C / 52 RH
Fundamental Frequency	:836.5 MHz	Engineer	:Curry
Operation Mode	:TX MID		
EUT Pol.	:E1 Plan	Measurement Antenna Pol.	:VERTICAL

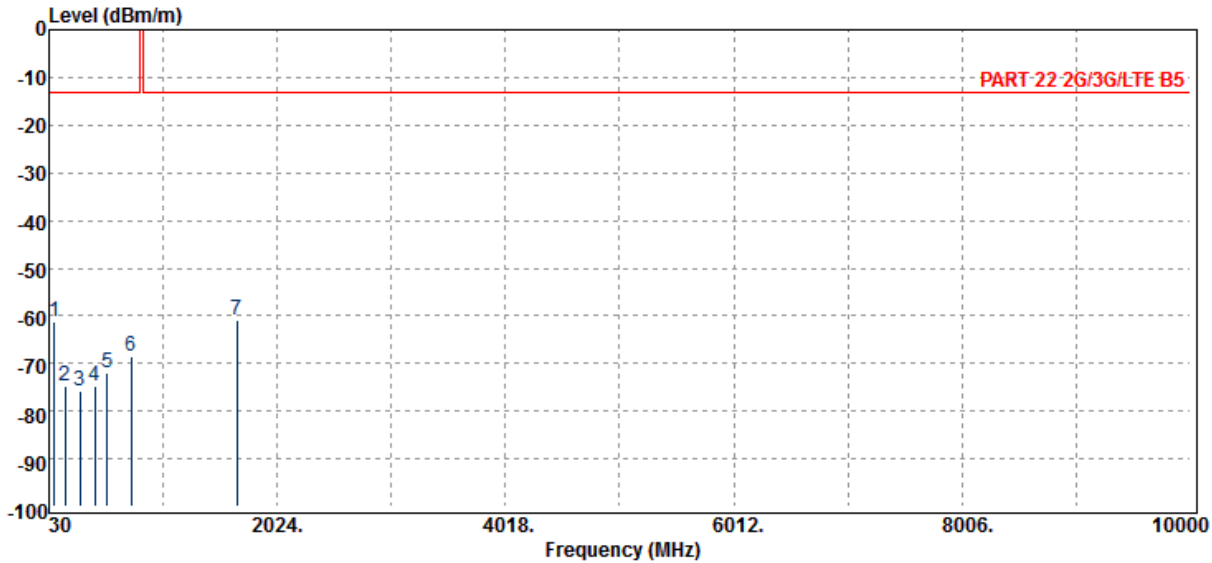

Freq. MHz	Note F/H/E/S	ERP dBm	SG Output Level dBm	Antenna Gain dBd	Cable Loss dB	Limit dBm	Margin dB
76.56	S	-61.15	-56.35	-3.77	-1.04	-13.00	-48.15
173.56	S	-74.73	-73.14	-0.10	-1.49	-13.00	-61.73
299.66	S	-75.76	-77.60	3.62	-1.78	-13.00	-62.76
432.55	S	-74.71	-76.14	3.44	-2.01	-13.00	-61.71
542.16	S	-71.81	-72.90	3.61	-2.53	-13.00	-58.81
750.71	S	-68.62	-69.21	3.28	-2.70	-13.00	-55.62
1673.00	H	-61.02	-59.77	3.01	-4.26	-13.00	-48.02

Unless otherwise stated the results shown in this test report refer only to the sample(s) tested and such sample(s) are retained for 90 days only.

除非另有說明，此報告結果僅對測試之樣品負責，同時此樣品僅保留90天。本報告未經本公司書面許可，不可部份複製。

This document is issued by the Company subject to its General Conditions of Service printed overleaf, available on request or accessible at www.sgs.com/terms_and_conditions.htm and, for electronic format documents, subject to Terms and Conditions for Electronic Documents at www.sgs.com/terms_e-document.htm. Attention is drawn to the limitation of liability, indemnification and jurisdiction issues defined therein. Any holder of this document is advised that information contained hereon reflects the Company's findings at the time of its intervention only and within the limits of Client's instructions, if any. The Company's sole responsibility is to its Client and this document does not exonerate parties to a transaction from exercising all their rights and obligations under the transaction documents. This document cannot be reproduced except in full, without prior written approval of the Company. Any unauthorized alteration, forgery or falsification of the content or appearance of this document is unlawful and offenders may be prosecuted to the fullest extent of the law.

SGS Taiwan Ltd.

No.134,WuKungRoad,NewTaipeiIndustrialPark,WukuDistrict,NewTaipeiCity,Taiwan24803/新北市五股區新北產業園區五工路 134 號

台灣檢驗科技股份有限公司

t (886-2) 2299-3279

f (886-2) 2298-0488

www.tw.sgs.com

Member of SGS Group

ARFCN	:CH 20525 16QAM BW 5 RB 1 0	Test Date	:2015-05-29
Operation Band	:LTE B5	Temp./Humi.	:21 deg_C / 52 RH
Fundamental Frequency	:836.5 MHz	Engineer	:Curry
Operation Mode	:TX MID		
EUT Pol.	:E1 Plan	Measurement Antenna Pol.	:HORIZONTAL

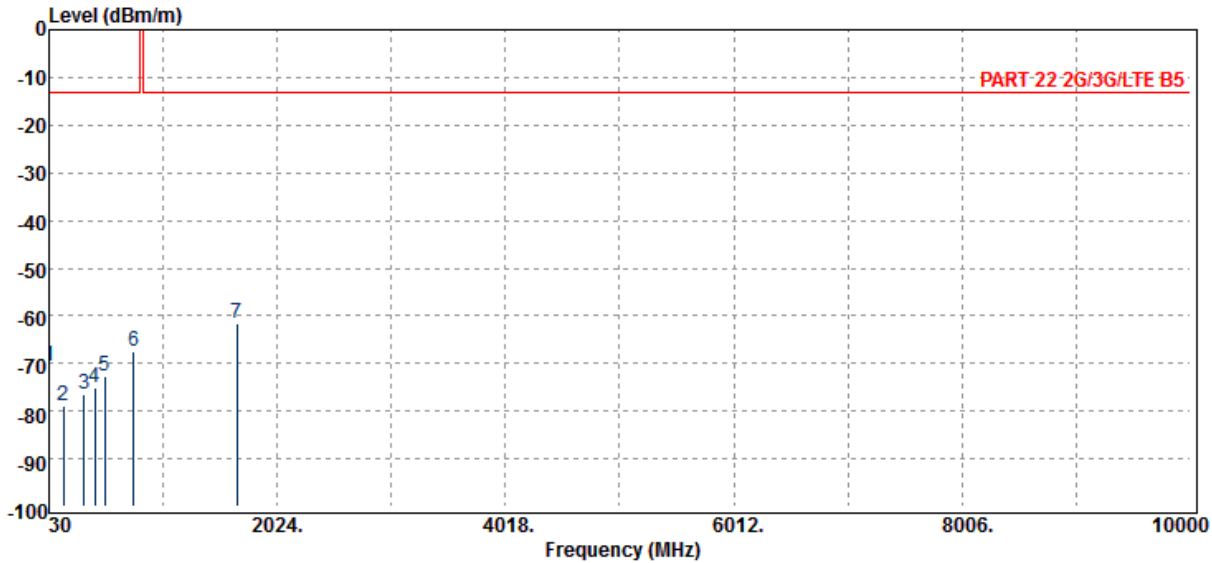

Freq. MHz	Note F/H/E/S	ERP dBm	SG Output Level dBm	Antenna Gain dBd	Cable Loss dB	Limit dBm	Margin dB
34.85	S	-70.49	-56.03	-13.67	-0.78	-13.00	-57.49
153.19	S	-78.96	-75.67	-1.88	-1.40	-13.00	-65.96
338.46	S	-76.30	-78.11	3.73	-1.93	-13.00	-63.30
429.64	S	-75.24	-76.69	3.45	-2.00	-13.00	-62.24
516.94	S	-72.83	-74.14	3.70	-2.40	-13.00	-59.83
772.05	S	-67.63	-68.23	3.35	-2.75	-13.00	-54.63
1673.00	H	-61.71	-60.46	3.01	-4.26	-13.00	-48.71

Unless otherwise stated the results shown in this test report refer only to the sample(s) tested and such sample(s) are retained for 90 days only.

除非另有說明，此報告結果僅對測試之樣品負責，同時此樣品僅保留90天。本報告未經本公司書面許可，不可部份複製。

This document is issued by the Company subject to its General Conditions of Service printed overleaf, available on request or accessible at www.sgs.com/terms_and_conditions.htm and, for electronic format documents, subject to Terms and Conditions for Electronic Documents at www.sgs.com/terms_e-document.htm. Attention is drawn to the limitation of liability, indemnification and jurisdiction issues defined therein. Any holder of this document is advised that information contained hereon reflects the Company's findings at the time of its intervention only and within the limits of Client's instructions, if any. The Company's sole responsibility is to its Client and this document does not exonerate parties to a transaction from exercising all their rights and obligations under the transaction documents. This document cannot be reproduced except in full, without prior written approval of the Company. Any unauthorized alteration, forgery or falsification of the content or appearance of this document is unlawful and offenders may be prosecuted to the fullest extent of the law.

ARFCN	:CH 20625 16QAM BW 5 RB 1 0	Test Date	:2015-05-29
Operation Band	:LTE B5	Temp./Humi.	:21 deg_C / 52 RH
Fundamental Frequency	:846.5 MHz	Engineer	:Curry
Operation Mode	:TX HIGH		
EUT Pol.	:E1 Plan	Measurement Antenna Pol.	:VERTICAL

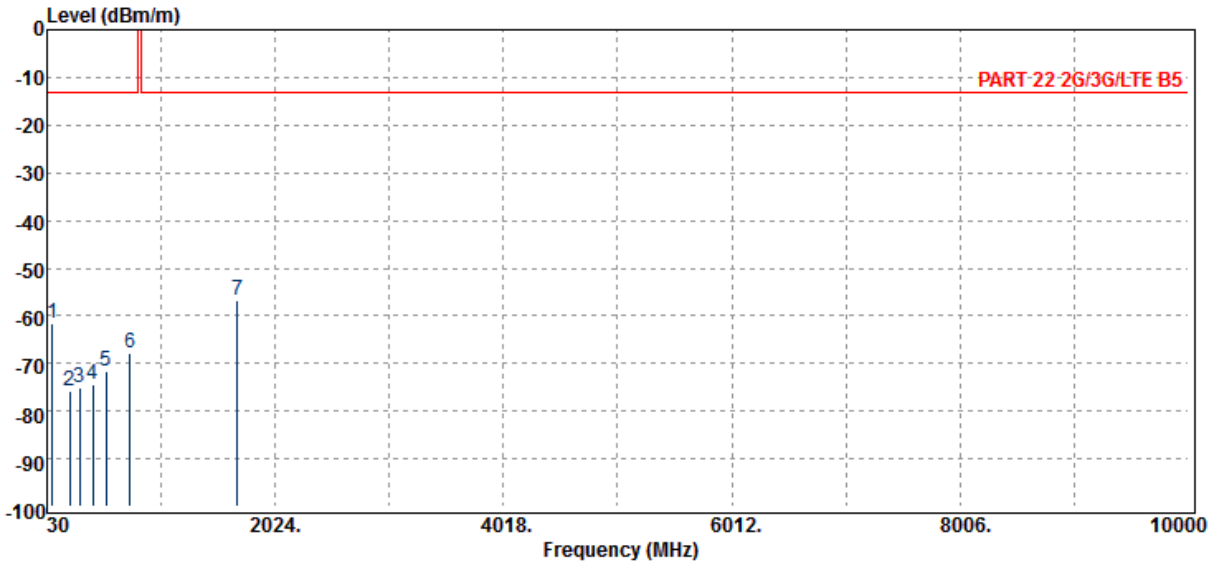

Freq. MHz	Note F/H/E/S	ERP dBm	SG Output Level dBm	Antenna Gain dBd	Cable Loss dB	Limit dBm	Margin dB
76.56	S	-61.47	-56.67	-3.77	-1.04	-13.00	-48.47
231.76	S	-75.73	-77.45	3.31	-1.58	-13.00	-62.73
314.21	S	-75.11	-76.93	3.66	-1.84	-13.00	-62.11
430.61	S	-74.27	-75.71	3.45	-2.01	-13.00	-61.27
547.01	S	-71.68	-72.72	3.60	-2.56	-13.00	-58.68
757.50	S	-67.86	-68.45	3.31	-2.71	-13.00	-54.86
1693.00	H	-56.83	-55.53	2.97	-4.27	-13.00	-43.83

Unless otherwise stated the results shown in this test report refer only to the sample(s) tested and such sample(s) are retained for 90 days only.

除非另有說明，此報告結果僅對測試之樣品負責，同時此樣品僅保留90天。本報告未經本公司書面許可，不可部份複製。

This document is issued by the Company subject to its General Conditions of Service printed overleaf, available on request or accessible at www.sgs.com/terms_and_conditions.htm and, for electronic format documents, subject to Terms and Conditions for Electronic Documents at www.sgs.com/terms_e-document.htm. Attention is drawn to the limitation of liability, indemnification and jurisdiction issues defined therein. Any holder of this document is advised that information contained hereon reflects the Company's findings at the time of its intervention only and within the limits of Client's instructions, if any. The Company's sole responsibility is to its Client and this document does not exonerate parties to a transaction from exercising all their rights and obligations under the transaction documents. This document cannot be reproduced except in full, without prior written approval of the Company. Any unauthorized alteration, forgery or falsification of the content or appearance of this document is unlawful and offenders may be prosecuted to the fullest extent of the law.

ARFCN	:CH 20625 16QAM BW 5 RB 1 0	Test Date	:2015-05-29
Operation Band	:LTE B5	Temp./Humi.	:21 deg_C / 52 RH
Fundamental Frequency	:846.5 MHz	Engineer	:Curry
Operation Mode	:TX HIGH		
EUT Pol.	:E1 Plan	Measurement Antenna Pol.	:HORIZONTAL

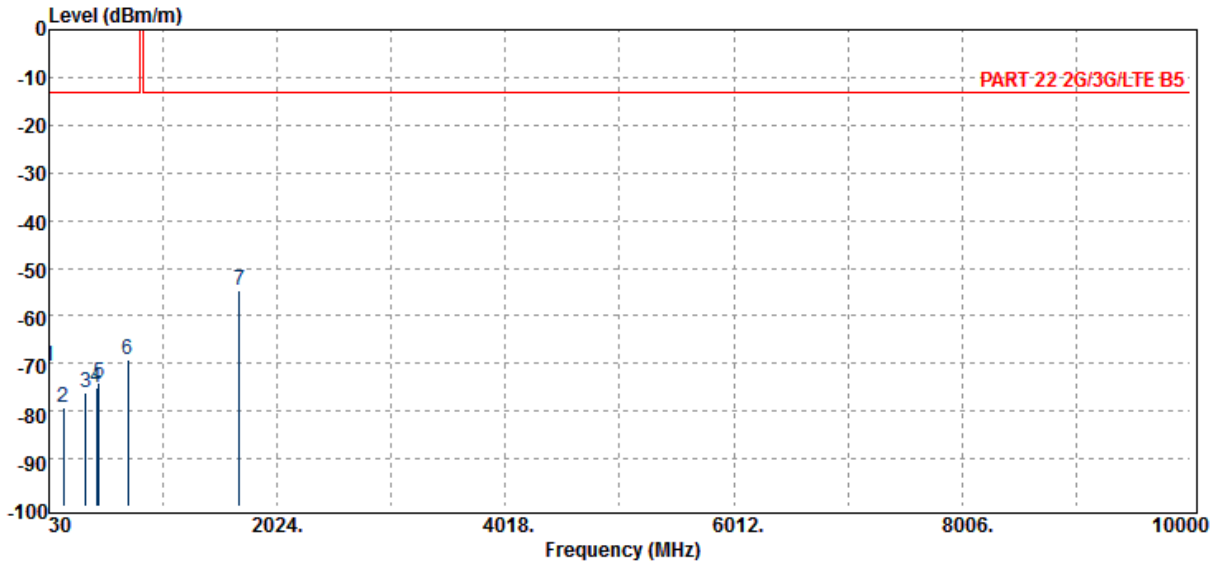

Freq. MHz	Note F/H/E/S	ERP dBm	SG Output Level dBm	Antenna Gain dBd	Cable Loss dB	Limit dBm	Margin dB
30.00	S	-70.63	-55.02	-14.88	-0.73	-13.00	-57.63
154.16	S	-79.11	-75.88	-1.82	-1.41	-13.00	-66.11
348.16	S	-76.23	-78.03	3.76	-1.96	-13.00	-63.23
442.25	S	-75.26	-76.60	3.39	-2.04	-13.00	-62.26
469.41	S	-74.08	-75.47	3.51	-2.12	-13.00	-61.08
715.79	S	-69.37	-70.11	3.35	-2.61	-13.00	-56.37
1693.00	H	-54.64	-53.34	2.97	-4.27	-13.00	-41.64

Unless otherwise stated the results shown in this test report refer only to the sample(s) tested and such sample(s) are retained for 90 days only.
 除非另有說明，此報告結果僅對測試之樣品負責，同時此樣品僅保留90天。本報告未經本公司書面許可，不可部份複製。

This document is issued by the Company subject to its General Conditions of Service printed overleaf, available on request or accessible at www.sgs.com/terms_and_conditions.htm and, for electronic format documents, subject to Terms and Conditions for Electronic Documents at www.sgs.com/terms_e-document.htm. Attention is drawn to the limitation of liability, indemnification and jurisdiction issues defined therein. Any holder of this document is advised that information contained hereon reflects the Company's findings at the time of its intervention only and within the limits of Client's instructions, if any. The Company's sole responsibility is to its Client and this document does not exonerate parties to a transaction from exercising all their rights and obligations under the transaction documents. This document cannot be reproduced except in full, without prior written approval of the Company. Any unauthorized alteration, forgery or falsification of the content or appearance of this document is unlawful and offenders may be prosecuted to the fullest extent of the law.

Radiated Spurious Emission Measurement Result: 5MHz BW LTE-Band 7(The Worst Case)

ARFCN	:CH 20775 16QAM BW 5	Test Date	:2015-05-29
	RB 1 0		
Operation Band	:LTE B7	Temp./Humi.	:24 deg_C / 59 RH
Fundamental Frequency	:2502.5 MHz	Engineer	:Curry
Operation Mode	:TX LOW		
EUT Pol.	:E2 Plan	Measurement Antenna Pol.	:VERTICAL

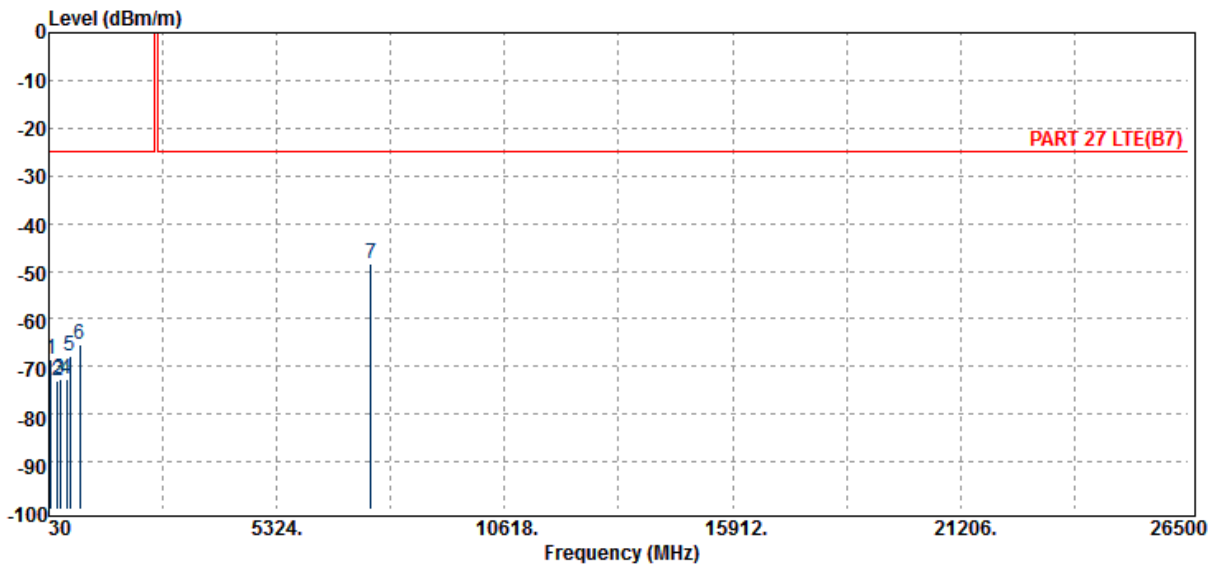

Freq. MHz	Note F/H/E/S	EIRP dBm	SG Output Level dBm	Antenna Gain dBi	Cable Loss dB	Limit dBm	Margin dB
78.50	S	-68.56	-66.47	-1.04	-1.05	-25.00	-43.56
235.64	S	-72.92	-76.78	5.45	-1.59	-25.00	-47.92
284.14	S	-72.59	-76.37	5.52	-1.73	-25.00	-47.59
435.46	S	-72.73	-76.28	5.57	-2.02	-25.00	-47.73
527.61	S	-67.90	-71.26	5.81	-2.46	-25.00	-42.90
757.50	S	-65.36	-68.10	5.46	-2.71	-25.00	-40.36
7507.50	H	-48.31	-50.30	11.71	-9.71	-25.00	-23.31

Unless otherwise stated the results shown in this test report refer only to the sample(s) tested and such sample(s) are retained for 90 days only.

除非另有說明，此報告結果僅對測試之樣品負責，同時此樣品僅保留90天。本報告未經本公司書面許可，不可部份複製。

This document is issued by the Company subject to its General Conditions of Service printed overleaf, available on request or accessible at www.sgs.com/terms_and_conditions.htm and, for electronic format documents, subject to Terms and Conditions for Electronic Documents at www.sgs.com/terms_e-document.htm. Attention is drawn to the limitation of liability, indemnification and jurisdiction issues defined therein. Any holder of this document is advised that information contained hereon reflects the Company's findings at the time of its intervention only and within the limits of Client's instructions, if any. The Company's sole responsibility is to its Client and this document does not exonerate parties to a transaction from exercising all their rights and obligations under the transaction documents. This document cannot be reproduced except in full, without prior written approval of the Company. Any unauthorized alteration, forgery or falsification of the content or appearance of this document is unlawful and offenders may be prosecuted to the fullest extent of the law.

ARFCN	:CH 20775 16QAM BW 5 RB 1 0	Test Date	:2015-05-29
Operation Band	:LTE B7	Temp./Humi.	:24 deg_C / 59 RH
Fundamental Frequency	:2502.5 MHz	Engineer	:Curry
Operation Mode	:TX LOW		
EUT Pol.	:E2 Plan	Measurement Antenna Pol.	:HORIZONTAL

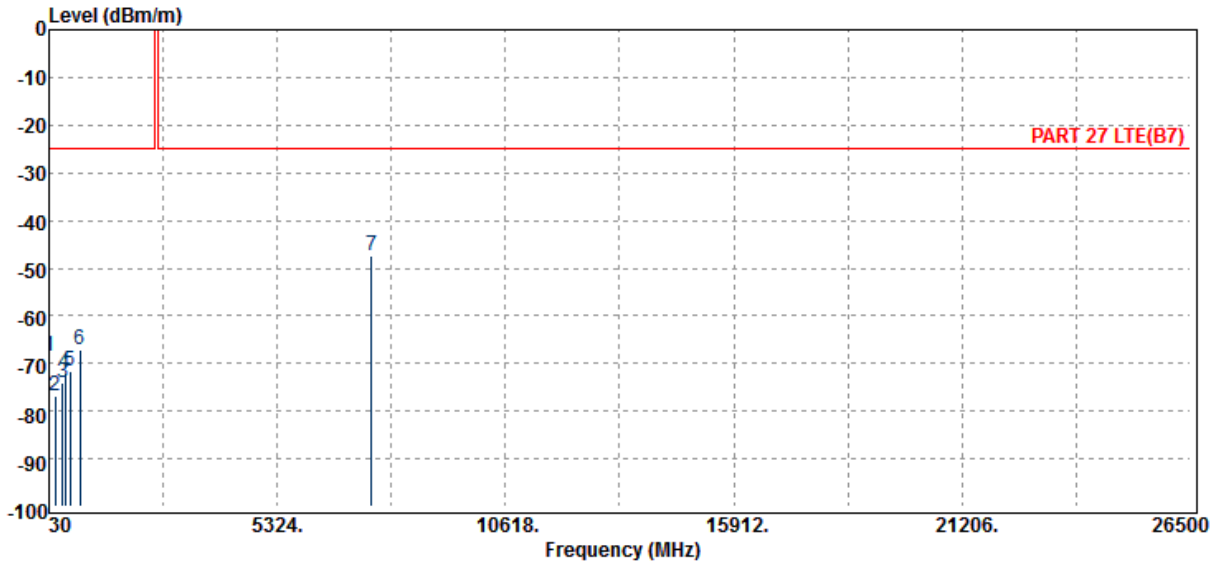

Freq. MHz	Note F/H/E/S	EIRP dBm	SG Output Level dBm	Antenna Gain dBi	Cable Loss dB	Limit dBm	Margin dB
36.79	S	-68.55	-56.58	-11.17	-0.80	-25.00	-43.55
173.56	S	-76.82	-77.38	2.05	-1.49	-25.00	-51.82
337.49	S	-73.96	-77.92	5.88	-1.92	-25.00	-48.96
410.24	S	-71.95	-75.72	5.71	-1.94	-25.00	-46.95
522.76	S	-71.62	-75.02	5.83	-2.43	-25.00	-46.62
752.65	S	-67.22	-69.95	5.44	-2.70	-25.00	-42.22
7507.50	H	-47.45	-49.44	11.71	-9.71	-25.00	-22.45

Unless otherwise stated the results shown in this test report refer only to the sample(s) tested and such sample(s) are retained for 90 days only.

除非另有說明，此報告結果僅對測試之樣品負責，同時此樣品僅保留90天。本報告未經本公司書面許可，不可部份複製。

This document is issued by the Company subject to its General Conditions of Service printed overleaf, available on request or accessible at www.sgs.com/terms_and_conditions.htm and, for electronic format documents, subject to Terms and Conditions for Electronic Documents at www.sgs.com/terms_e-document.htm. Attention is drawn to the limitation of liability, indemnification and jurisdiction issues defined therein. Any holder of this document is advised that information contained hereon reflects the Company's findings at the time of its intervention only and within the limits of Client's instructions, if any. The Company's sole responsibility is to its Client and this document does not exonerate parties to a transaction from exercising all their rights and obligations under the transaction documents. This document cannot be reproduced except in full, without prior written approval of the Company. Any unauthorized alteration, forgery or falsification of the content or appearance of this document is unlawful and offenders may be prosecuted to the fullest extent of the law.

ARFCN	:CH 21100 16QAM BW 5 RB 1 0	Test Date	:2015-05-29
Operation Band	:LTE B7	Temp./Humi.	:24 deg_C / 59 RH
Fundamental Frequency	:2535 MHz	Engineer	:Curry
Operation Mode	:TX MID		
EUT Pol.	:E2 Plan	Measurement Antenna Pol.	:VERTICAL

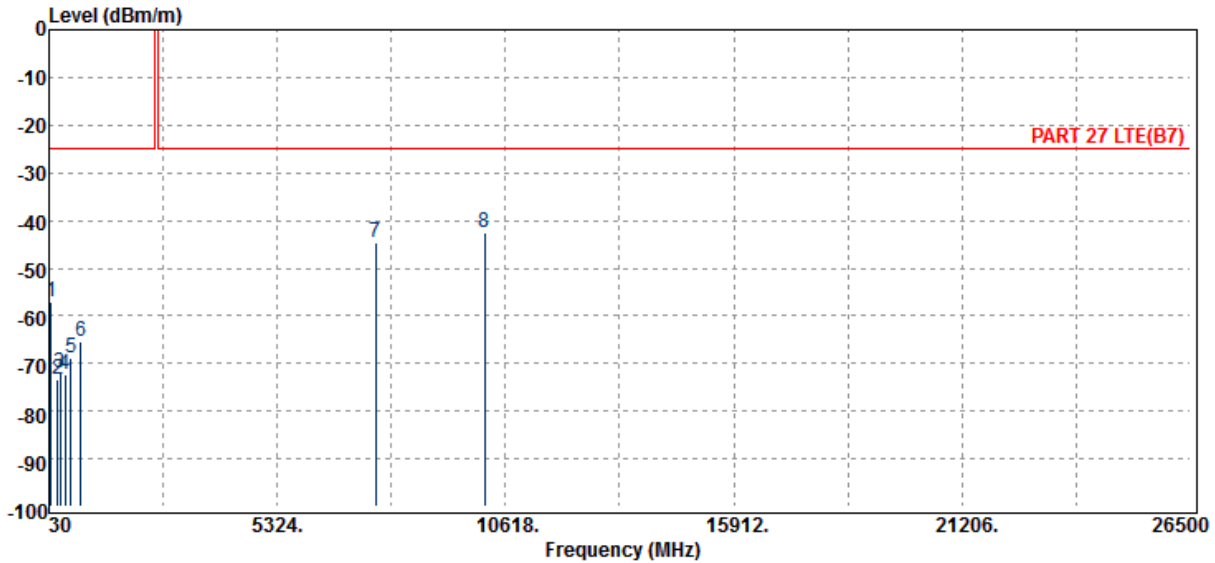

Freq. MHz	Note F/H/E/S	EIRP dBm	SG Output Level dBm	Antenna Gain dBi	Cable Loss dB	Limit dBm	Margin dB
78.50	S	-57.16	-55.07	-1.04	-1.05	-25.00	-32.16
235.64	S	-73.44	-77.29	5.45	-1.59	-25.00	-48.44
280.26	S	-72.14	-75.89	5.48	-1.72	-25.00	-47.14
406.36	S	-72.19	-75.98	5.73	-1.94	-25.00	-47.19
544.10	S	-68.74	-71.96	5.76	-2.54	-25.00	-43.74
759.44	S	-65.47	-68.22	5.46	-2.72	-25.00	-40.47
7605.00	H	-44.69	-46.73	11.79	-9.75	-25.00	-19.69
10140.00	H	-42.68	-44.02	12.63	-11.30	-25.00	-17.68

Unless otherwise stated the results shown in this test report refer only to the sample(s) tested and such sample(s) are retained for 90 days only.

除非另有說明，此報告結果僅對測試之樣品負責，同時此樣品僅保留90天。本報告未經本公司書面許可，不可部份複製。

This document is issued by the Company subject to its General Conditions of Service printed overleaf, available on request or accessible at www.sgs.com/terms_and_conditions.htm and, for electronic format documents, subject to Terms and Conditions for Electronic Documents at www.sgs.com/terms_e-document.htm. Attention is drawn to the limitation of liability, indemnification and jurisdiction issues defined therein. Any holder of this document is advised that information contained hereon reflects the Company's findings at the time of its intervention only and within the limits of Client's instructions, if any. The Company's sole responsibility is to its Client and this document does not exonerate parties to a transaction from exercising all their rights and obligations under the transaction documents. This document cannot be reproduced except in full, without prior written approval of the Company. Any unauthorized alteration, forgery or falsification of the content or appearance of this document is unlawful and offenders may be prosecuted to the fullest extent of the law.

ARFCN	:CH 21100 16QAM BW 5 RB 1 0	Test Date	:2015-05-29
Operation Band	:LTE B7	Temp./Humi.	:24 deg_C / 59 RH
Fundamental Frequency	:2535 MHz	Engineer	:Curry
Operation Mode	:TX MID		
EUT Pol.	:E2 Plan	Measurement Antenna Pol.	:HORIZONTAL

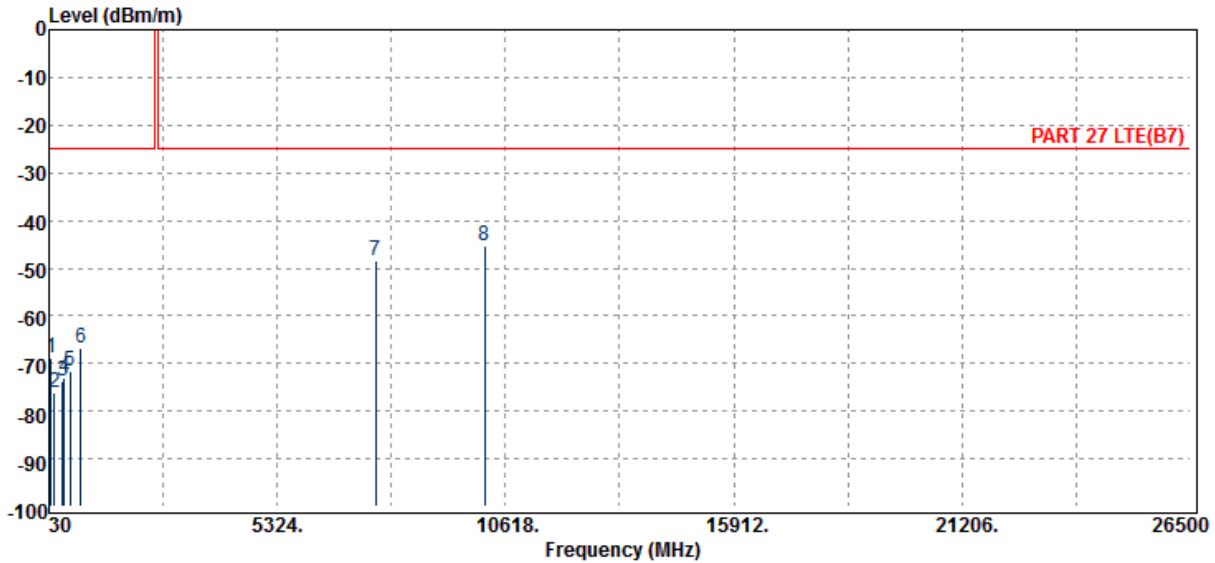

Freq. MHz	Note F/H/E/S	EIRP dBm	SG Output Level dBm	Antenna Gain dBi	Cable Loss dB	Limit dBm	Margin dB
73.65	S	-69.03	-65.50	-2.50	-1.03	-25.00	-44.03
159.01	S	-76.27	-75.48	0.65	-1.43	-25.00	-51.27
348.16	S	-73.67	-77.62	5.91	-1.96	-25.00	-48.67
382.11	S	-72.96	-76.83	5.82	-1.95	-25.00	-47.96
510.15	S	-71.48	-74.99	5.87	-2.36	-25.00	-46.48
765.26	S	-66.78	-69.53	5.48	-2.73	-25.00	-41.78
7605.00	H	-48.45	-50.49	11.79	-9.75	-25.00	-23.45
10140.00	H	-45.30	-46.63	12.63	-11.30	-25.00	-20.30

Unless otherwise stated the results shown in this test report refer only to the sample(s) tested and such sample(s) are retained for 90 days only.

除非另有說明，此報告結果僅對測試之樣品負責，同時此樣品僅保留90天。本報告未經本公司書面許可，不可部份複製。

This document is issued by the Company subject to its General Conditions of Service printed overleaf, available on request or accessible at www.sgs.com/terms_and_conditions.htm and, for electronic format documents, subject to Terms and Conditions for Electronic Documents at www.sgs.com/terms_e-document.htm. Attention is drawn to the limitation of liability, indemnification and jurisdiction issues defined therein. Any holder of this document is advised that information contained hereon reflects the Company's findings at the time of its intervention only and within the limits of Client's instructions, if any. The Company's sole responsibility is to its Client and this document does not exonerate parties to a transaction from exercising all their rights and obligations under the transaction documents. This document cannot be reproduced except in full, without prior written approval of the Company. Any unauthorized alteration, forgery or falsification of the content or appearance of this document is unlawful and offenders may be prosecuted to the fullest extent of the law.

ARFCN	:CH 21425 16QAM BW 5 RB 1 0	Test Date	:2015-05-29
Operation Band	:LTE B7	Temp./Humi.	:24 deg_C / 59 RH
Fundamental Frequency	:2567.5 MHz	Engineer	:Curry
Operation Mode	:TX HIGH		
EUT Pol.	:E2 Plan	Measurement Antenna Pol.	:VERTICAL

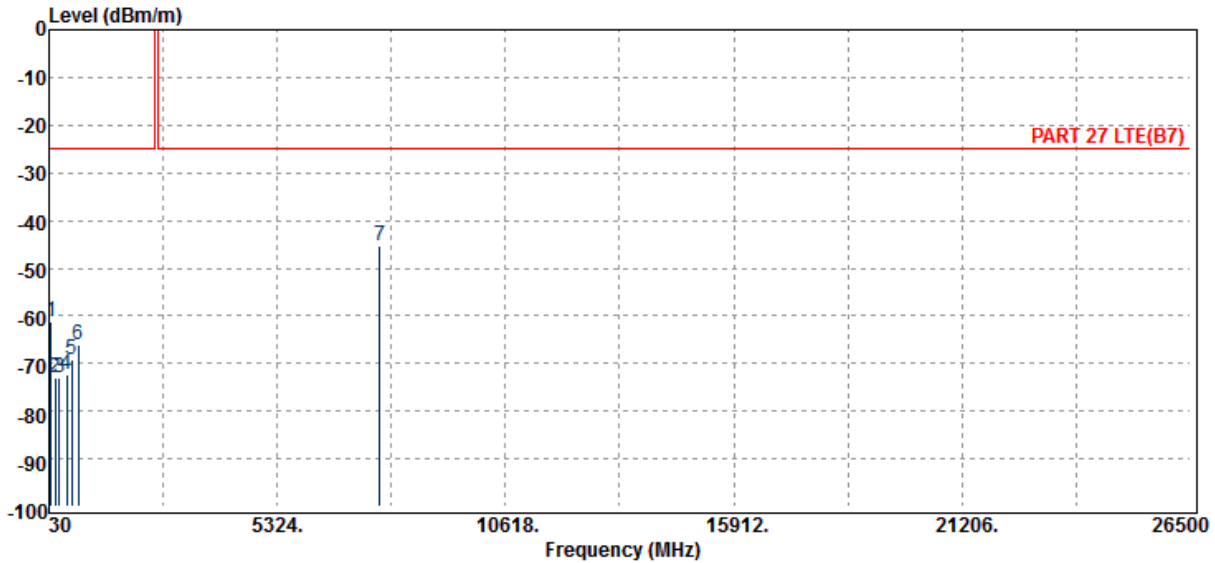

Freq. MHz	Note F/H/E/S	EIRP dBm	SG Output Level dBm	Antenna Gain dBi	Cable Loss dB	Limit dBm	Margin dB
73.65	S	-61.31	-57.78	-2.50	-1.03	-25.00	-36.31
180.35	S	-73.03	-74.73	3.20	-1.50	-25.00	-48.03
272.50	S	-73.18	-77.16	5.69	-1.70	-25.00	-48.18
450.01	S	-72.34	-75.77	5.49	-2.07	-25.00	-47.34
548.95	S	-69.10	-72.27	5.74	-2.57	-25.00	-44.10
711.91	S	-66.07	-68.97	5.51	-2.60	-25.00	-41.07
7702.50	H	-45.26	-47.26	11.87	-9.87	-25.00	-20.26

Unless otherwise stated the results shown in this test report refer only to the sample(s) tested and such sample(s) are retained for 90 days only.

除非另有說明，此報告結果僅對測試之樣品負責，同時此樣品僅保留90天。本報告未經本公司書面許可，不可部份複製。

This document is issued by the Company subject to its General Conditions of Service printed overleaf, available on request or accessible at www.sgs.com/terms_and_conditions.htm and, for electronic format documents, subject to Terms and Conditions for Electronic Documents at www.sgs.com/terms_e-document.htm. Attention is drawn to the limitation of liability, indemnification and jurisdiction issues defined therein. Any holder of this document is advised that information contained hereon reflects the Company's findings at the time of its intervention only and within the limits of Client's instructions, if any. The Company's sole responsibility is to its Client and this document does not exonerate parties to a transaction from exercising all their rights and obligations under the transaction documents. This document cannot be reproduced except in full, without prior written approval of the Company. Any unauthorized alteration, forgery or falsification of the content or appearance of this document is unlawful and offenders may be prosecuted to the fullest extent of the law.

SGS Taiwan Ltd.

No. 134, WuKung Road, New Taipei Industrial Park, Wuku District, New Taipei City, Taiwan 24803 / 新北市五股區新北產業園區五工路 134 號

台灣檢驗科技股份有限公司

t (886-2) 2299-3279

f (886-2) 2298-0488

www.tw.sgs.com

Member of SGS Group

ARFCN	:CH 21425 16QAM BW 5 RB 1 0	Test Date	:2015-05-29
Operation Band	:LTE B7	Temp./Humi.	:24 deg_C / 59 RH
Fundamental Frequency	:2567.5 MHz	Engineer	:Curry
Operation Mode	:TX HIGH		
EUT Pol.	:E2 Plan	Measurement Antenna Pol.	:HORIZONTAL

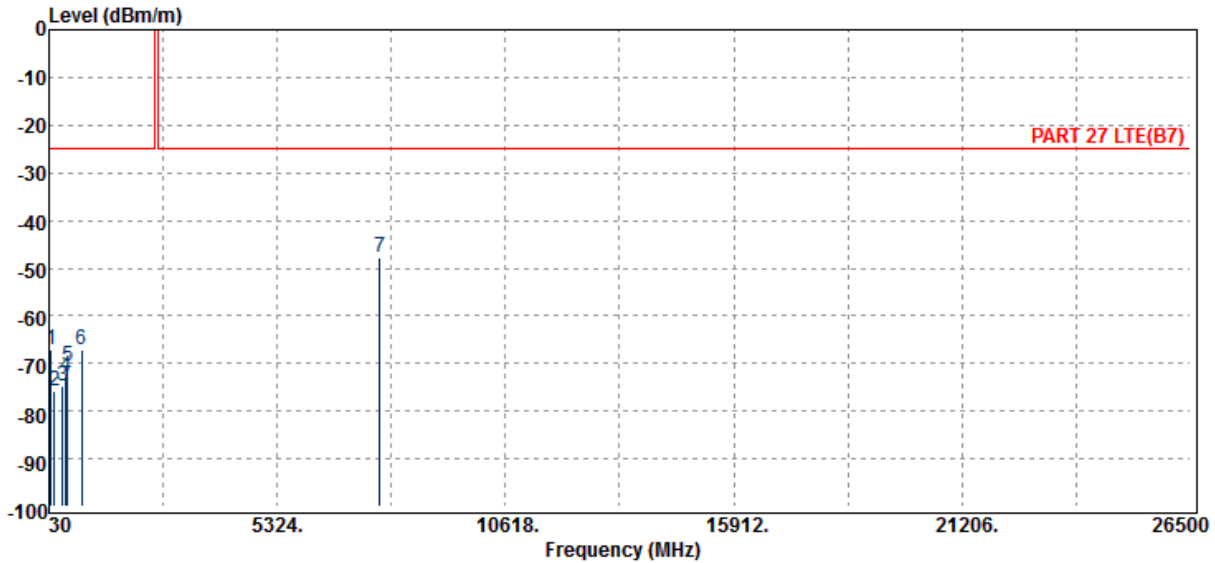

Freq. MHz	Note F/H/E/S	EIRP dBm	SG Output Level dBm	Antenna Gain dBi	Cable Loss dB	Limit dBm	Margin dB
73.65	S	-67.07	-63.54	-2.50	-1.03	-25.00	-42.07
154.16	S	-75.79	-74.72	0.33	-1.41	-25.00	-50.79
342.34	S	-74.71	-78.66	5.89	-1.94	-25.00	-49.71
420.91	S	-72.62	-76.30	5.65	-1.98	-25.00	-47.62
464.56	S	-70.74	-74.25	5.62	-2.11	-25.00	-45.74
781.75	S	-67.04	-69.79	5.53	-2.79	-25.00	-42.04
7702.50	H	-47.86	-49.85	11.87	-9.87	-25.00	-22.86

Unless otherwise stated the results shown in this test report refer only to the sample(s) tested and such sample(s) are retained for 90 days only.

除非另有說明，此報告結果僅對測試之樣品負責，同時此樣品僅保留90天。本報告未經本公司書面許可，不可部份複製。

This document is issued by the Company subject to its General Conditions of Service printed overleaf, available on request or accessible at www.sgs.com/terms_and_conditions.htm and, for electronic format documents, subject to Terms and Conditions for Electronic Documents at www.sgs.com/terms_e-document.htm. Attention is drawn to the limitation of liability, indemnification and jurisdiction issues defined therein. Any holder of this document is advised that information contained hereon reflects the Company's findings at the time of its intervention only and within the limits of Client's instructions, if any. The Company's sole responsibility is to its Client and this document does not exonerate parties to a transaction from exercising all their rights and obligations under the transaction documents. This document cannot be reproduced except in full, without prior written approval of the Company. Any unauthorized alteration, forgery or falsification of the content or appearance of this document is unlawful and offenders may be prosecuted to the fullest extent of the law.

Radiated Spurious Emission Measurement Result: 3MHz BW LTE-Band 12(The Worst Case)

ARFCN	:CH 23025 16QAM BW 3	Test Date	:2015-05-29
	RB 1 0		
Operation Band	:LTE B12	Temp./Humi.	:24 deg_C / 59 RH
Fundamental Frequency	:700.5 MHz	Engineer	:Curry
Operation Mode	:TX LOW		
EUT Pol.	:H Plan	Measurement Antenna Pol.	:VERTICAL

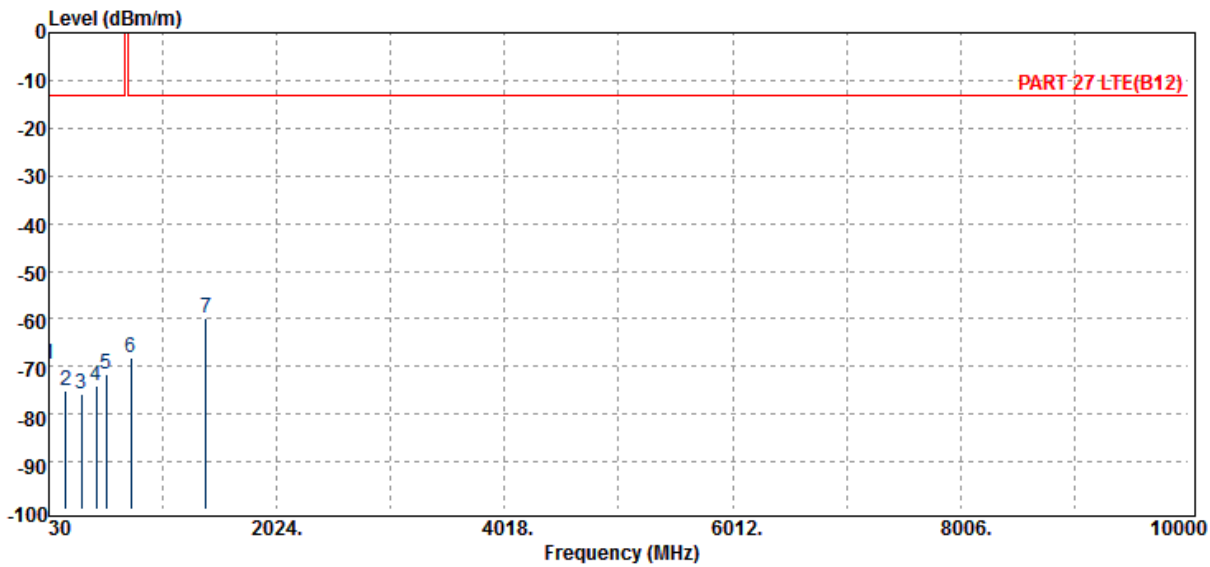

Freq. MHz	Note F/H/E/S	ERP dBm	SG Output Level dBm	Antenna Gain dBd	Cable Loss dB	Limit dBm	Margin dB
31.94	S	-69.65	-54.53	-14.37	-0.75	-13.00	-56.65
180.35	S	-75.23	-74.78	1.05	-1.50	-13.00	-62.23
316.15	S	-75.62	-77.44	3.67	-1.85	-13.00	-62.62
447.10	S	-73.91	-75.21	3.36	-2.06	-13.00	-60.91
534.40	S	-71.67	-72.82	3.64	-2.49	-13.00	-58.67
750.71	S	-68.10	-68.69	3.28	-2.70	-13.00	-55.10
1401.00	H	-59.85	-58.70	2.78	-3.92	-13.00	-46.85

Unless otherwise stated the results shown in this test report refer only to the sample(s) tested and such sample(s) are retained for 90 days only.

除非另有說明，此報告結果僅對測試之樣品負責，同時此樣品僅保留90天。本報告未經本公司書面許可，不可部份複製。

This document is issued by the Company subject to its General Conditions of Service printed overleaf, available on request or accessible at www.sgs.com/terms_and_conditions.htm and, for electronic format documents, subject to Terms and Conditions for Electronic Documents at www.sgs.com/terms_e-document.htm. Attention is drawn to the limitation of liability, indemnification and jurisdiction issues defined therein. Any holder of this document is advised that information contained hereon reflects the Company's findings at the time of its intervention only and within the limits of Client's instructions, if any. The Company's sole responsibility is to its Client and this document does not exonerate parties to a transaction from exercising all their rights and obligations under the transaction documents. This document cannot be reproduced except in full, without prior written approval of the Company. Any unauthorized alteration, forgery or falsification of the content or appearance of this document is unlawful and offenders may be prosecuted to the fullest extent of the law.

ARFCN	:CH 23025 16QAM BW 3 RB 1 0	Test Date	:2015-05-29
Operation Band	:LTE B12	Temp./Humi.	:24 deg_C / 59 RH
Fundamental Frequency	:700.5 MHz	Engineer	:Curry
Operation Mode	:TX LOW		
EUT Pol.	:H Plan	Measurement Antenna Pol.	:HORIZONTAL

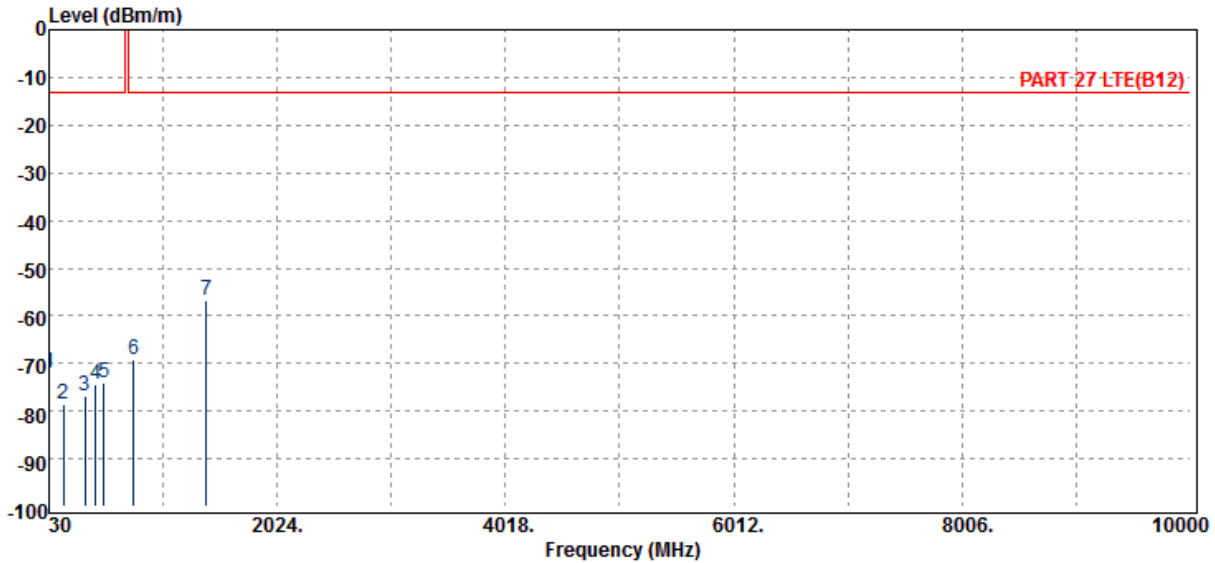

Freq. MHz	Note F/H/E/S	ERP dBm	SG Output Level dBm	Antenna Gain dBd	Cable Loss dB	Limit dBm	Margin dB
30.00	S	-71.98	-56.38	-14.88	-0.73	-13.00	-58.98
153.19	S	-78.62	-75.34	-1.88	-1.40	-13.00	-65.62
342.34	S	-76.70	-78.50	3.74	-1.94	-13.00	-63.70
440.31	S	-74.33	-75.69	3.40	-2.04	-13.00	-61.33
513.06	S	-74.07	-75.40	3.71	-2.38	-13.00	-61.07
767.20	S	-69.07	-69.68	3.34	-2.74	-13.00	-56.07
1401.00	H	-56.72	-55.57	2.78	-3.92	-13.00	-43.72

Unless otherwise stated the results shown in this test report refer only to the sample(s) tested and such sample(s) are retained for 90 days only.

除非另有說明，此報告結果僅對測試之樣品負責，同時此樣品僅保留90天。本報告未經本公司書面許可，不可部份複製。

This document is issued by the Company subject to its General Conditions of Service printed overleaf, available on request or accessible at www.sgs.com/terms_and_conditions.htm and, for electronic format documents, subject to Terms and Conditions for Electronic Documents at www.sgs.com/terms_e-document.htm. Attention is drawn to the limitation of liability, indemnification and jurisdiction issues defined therein. Any holder of this document is advised that information contained hereon reflects the Company's findings at the time of its intervention only and within the limits of Client's instructions, if any. The Company's sole responsibility is to its Client and this document does not exonerate parties to a transaction from exercising all their rights and obligations under the transaction documents. This document cannot be reproduced except in full, without prior written approval of the Company. Any unauthorized alteration, forgery or falsification of the content or appearance of this document is unlawful and offenders may be prosecuted to the fullest extent of the law.

ARFCN	:CH 23095 16QAM BW 3 RB 1 0	Test Date	:2015-05-29
Operation Band	:LTE B12	Temp./Humi.	:24 deg_C / 59 RH
Fundamental Frequency	:707.5 MHz	Engineer	:Curry
Operation Mode	:TX MID		
EUT Pol.	:H Plan	Measurement Antenna Pol.	:VERTICAL

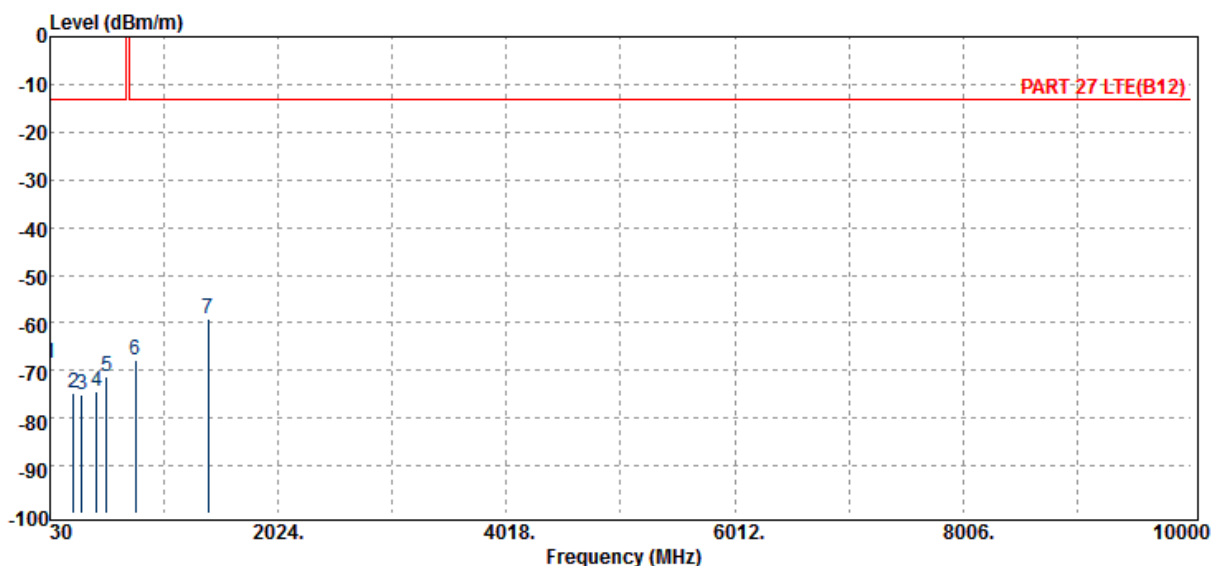

Freq. MHz	Note F/H/E/S	ERP dBm	SG Output Level dBm	Antenna Gain dBd	Cable Loss dB	Limit dBm	Margin dB
30.00	S	-68.62	-53.01	-14.88	-0.73	-13.00	-55.62
236.61	S	-74.70	-76.40	3.29	-1.60	-13.00	-61.70
306.45	S	-75.06	-76.89	3.64	-1.81	-13.00	-62.06
437.40	S	-74.48	-75.87	3.41	-2.03	-13.00	-61.48
526.64	S	-71.13	-72.34	3.67	-2.45	-13.00	-58.13
774.96	S	-67.93	-68.53	3.36	-2.76	-13.00	-54.93
1415.00	H	-59.14	-58.06	2.86	-3.95	-13.00	-46.14

Unless otherwise stated the results shown in this test report refer only to the sample(s) tested and such sample(s) are retained for 90 days only.

除非另有說明，此報告結果僅對測試之樣品負責，同時此樣品僅保留90天。本報告未經本公司書面許可，不可部份複製。

This document is issued by the Company subject to its General Conditions of Service printed overleaf, available on request or accessible at www.sgs.com/terms_and_conditions.htm and, for electronic format documents, subject to Terms and Conditions for Electronic Documents at www.sgs.com/terms_e-document.htm. Attention is drawn to the limitation of liability, indemnification and jurisdiction issues defined therein. Any holder of this document is advised that information contained hereon reflects the Company's findings at the time of its intervention only and within the limits of Client's instructions, if any. The Company's sole responsibility is to its Client and this document does not exonerate parties to a transaction from exercising all their rights and obligations under the transaction documents. This document cannot be reproduced except in full, without prior written approval of the Company. Any unauthorized alteration, forgery or falsification of the content or appearance of this document is unlawful and offenders may be prosecuted to the fullest extent of the law.

ARFCN	:CH 23095 16QAM BW 3 RB 1 0	Test Date	:2015-05-29
Operation Band	:LTE B12	Temp./Humi.	:24 deg_C / 59 RH
Fundamental Frequency	:707.5 MHz	Engineer	:Curry
Operation Mode	:TX MID		
EUT Pol.	:H Plan	Measurement Antenna Pol.	:HORIZONTAL

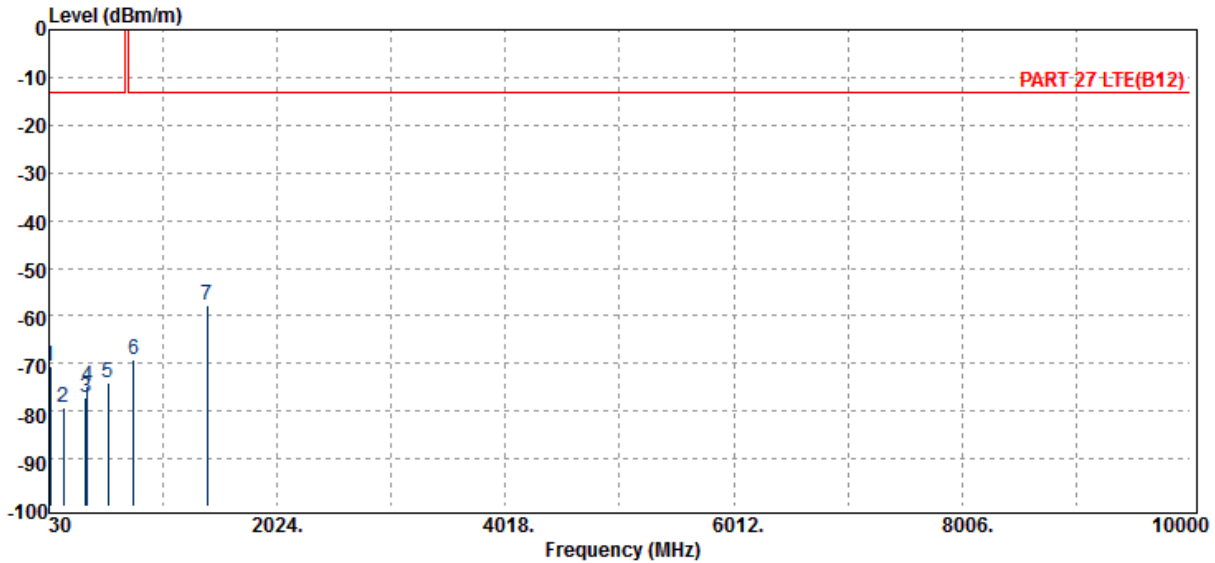

Freq. MHz	Note F/H/E/S	ERP dBm	SG Output Level dBm	Antenna Gain dBd	Cable Loss dB	Limit dBm	Margin dB
39.70	S	-70.53	-56.87	-12.83	-0.83	-13.00	-57.53
153.19	S	-79.23	-75.94	-1.88	-1.40	-13.00	-66.23
348.16	S	-77.00	-78.80	3.76	-1.96	-13.00	-64.00
364.65	S	-74.58	-76.34	3.72	-1.96	-13.00	-61.58
546.04	S	-74.10	-75.15	3.60	-2.55	-13.00	-61.10
770.11	S	-69.20	-69.80	3.35	-2.74	-13.00	-56.20
1415.00	H	-57.91	-56.83	2.86	-3.95	-13.00	-44.91

Unless otherwise stated the results shown in this test report refer only to the sample(s) tested and such sample(s) are retained for 90 days only.

除非另有說明，此報告結果僅對測試之樣品負責，同時此樣品僅保留90天。本報告未經本公司書面許可，不可部份複製。

This document is issued by the Company subject to its General Conditions of Service printed overleaf, available on request or accessible at www.sgs.com/terms_and_conditions.htm and, for electronic format documents, subject to Terms and Conditions for Electronic Documents at www.sgs.com/terms_e-document.htm. Attention is drawn to the limitation of liability, indemnification and jurisdiction issues defined therein. Any holder of this document is advised that information contained hereon reflects the Company's findings at the time of its intervention only and within the limits of Client's instructions, if any. The Company's sole responsibility is to its Client and this document does not exonerate parties to a transaction from exercising all their rights and obligations under the transaction documents. This document cannot be reproduced except in full, without prior written approval of the Company. Any unauthorized alteration, forgery or falsification of the content or appearance of this document is unlawful and offenders may be prosecuted to the fullest extent of the law.

ARFCN	:CH 23165 16QAM BW 3 RB 1 0	Test Date	:2015-05-29
Operation Band	:LTE B12	Temp./Humi.	:24 deg_C / 59 RH
Fundamental Frequency	:714.5 MHz	Engineer	:Curry
Operation Mode	:TX HIGH		
EUT Pol.	:H Plan	Measurement Antenna Pol.	:VERTICAL

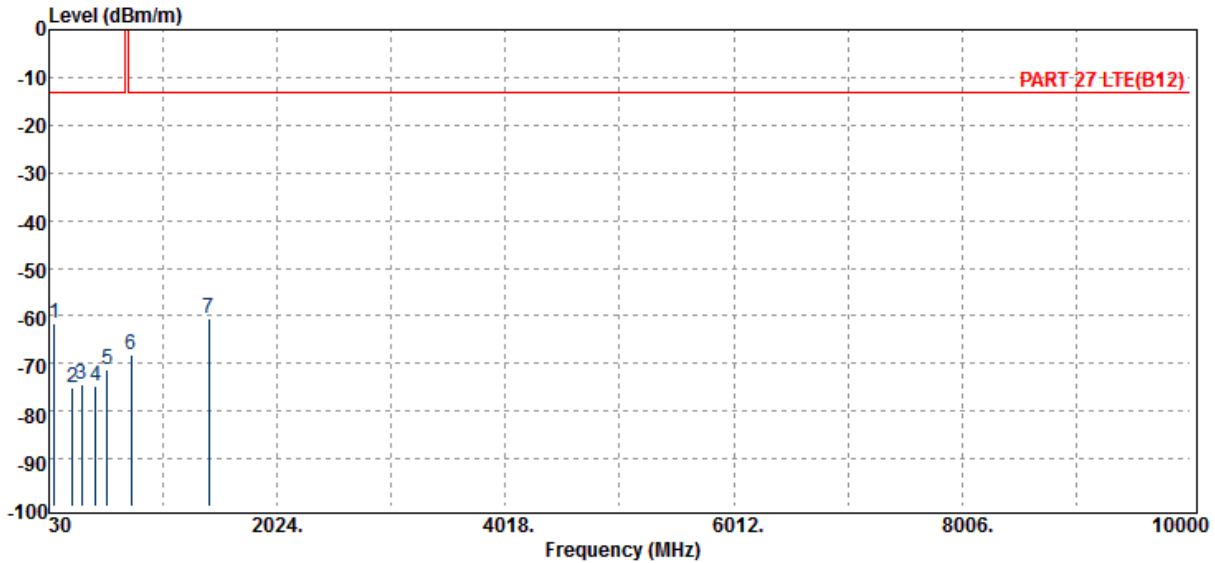

Freq. MHz	Note F/H/E/S	ERP dBm	SG Output Level dBm	Antenna Gain dBd	Cable Loss dB	Limit dBm	Margin dB
76.56	S	-61.63	-56.83	-3.77	-1.04	-13.00	-48.63
238.55	S	-75.22	-76.90	3.29	-1.60	-13.00	-62.22
316.15	S	-74.42	-76.24	3.67	-1.85	-13.00	-61.42
439.34	S	-74.57	-75.94	3.40	-2.03	-13.00	-61.57
537.31	S	-71.40	-72.52	3.63	-2.51	-13.00	-58.40
750.71	S	-68.25	-68.83	3.28	-2.70	-13.00	-55.25
1429.00	H	-60.58	-59.55	2.94	-3.97	-13.00	-47.58

Unless otherwise stated the results shown in this test report refer only to the sample(s) tested and such sample(s) are retained for 90 days only.
 除非另有說明，此報告結果僅對測試之樣品負責，同時此樣品僅保留90天。本報告未經本公司書面許可，不可部份複製。

This document is issued by the Company subject to its General Conditions of Service printed overleaf, available on request or accessible at www.sgs.com/terms_and_conditions.htm and, for electronic format documents, subject to Terms and Conditions for Electronic Documents at www.sgs.com/terms_e-document.htm. Attention is drawn to the limitation of liability, indemnification and jurisdiction issues defined therein. Any holder of this document is advised that information contained hereon reflects the Company's findings at the time of its intervention only and within the limits of Client's instructions, if any. The Company's sole responsibility is to its Client and this document does not exonerate parties to a transaction from exercising all their rights and obligations under the transaction documents. This document cannot be reproduced except in full, without prior written approval of the Company. Any unauthorized alteration, forgery or falsification of the content or appearance of this document is unlawful and offenders may be prosecuted to the fullest extent of the law.

ARFCN	:CH 23165 16QAM BW 3 RB 1 0	Test Date	:2015-05-29
Operation Band	:LTE B12	Temp./Humi.	:24 deg_C / 59 RH
Fundamental Frequency	:714.5 MHz	Engineer	:Curry
Operation Mode	:TX HIGH		
EUT Pol.	:H Plan	Measurement Antenna Pol.	:HORIZONTAL

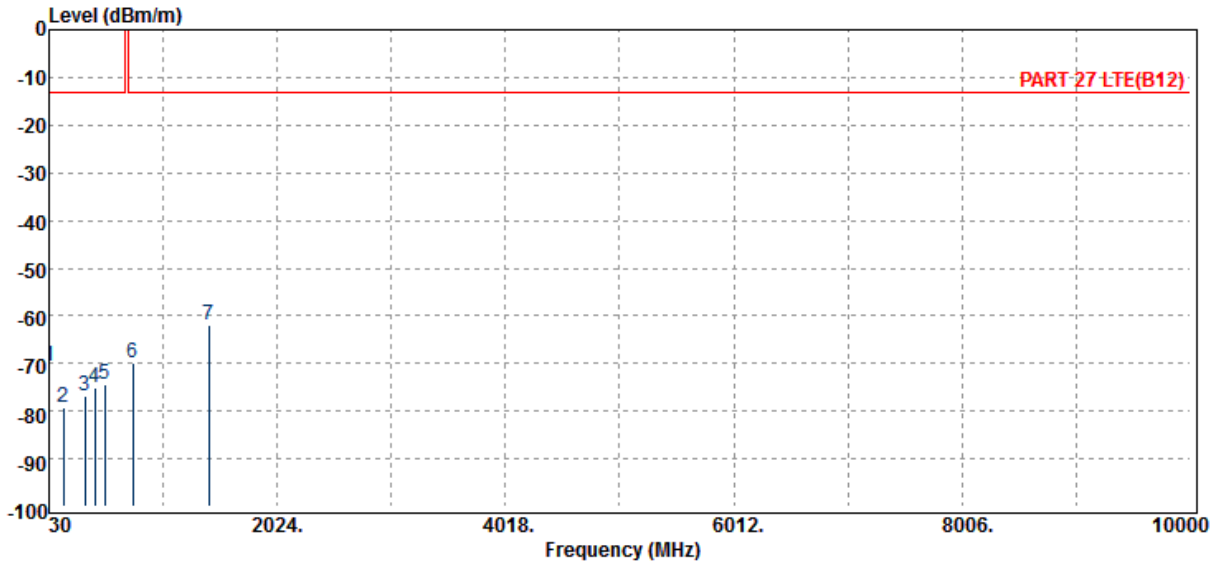

Freq. MHz	Note F/H/E/S	ERP dBm	SG Output Level dBm	Antenna Gain dBd	Cable Loss dB	Limit dBm	Margin dB
34.85	S	-70.64	-56.18	-13.67	-0.78	-13.00	-57.64
154.16	S	-79.16	-75.94	-1.82	-1.41	-13.00	-66.16
343.31	S	-76.90	-78.70	3.74	-1.94	-13.00	-63.90
432.55	S	-75.21	-76.64	3.44	-2.01	-13.00	-62.21
517.91	S	-74.24	-75.53	3.70	-2.40	-13.00	-61.24
764.29	S	-69.82	-70.42	3.33	-2.73	-13.00	-56.82
1429.00	H	-61.87	-60.84	2.94	-3.97	-13.00	-48.87

Unless otherwise stated the results shown in this test report refer only to the sample(s) tested and such sample(s) are retained for 90 days only.

除非另有說明，此報告結果僅對測試之樣品負責，同時此樣品僅保留90天。本報告未經本公司書面許可，不可部份複製。

This document is issued by the Company subject to its General Conditions of Service printed overleaf, available on request or accessible at www.sgs.com/terms_and_conditions.htm and, for electronic format documents, subject to Terms and Conditions for Electronic Documents at www.sgs.com/terms_e-document.htm. Attention is drawn to the limitation of liability, indemnification and jurisdiction issues defined therein. Any holder of this document is advised that information contained hereon reflects the Company's findings at the time of its intervention only and within the limits of Client's instructions, if any. The Company's sole responsibility is to its Client and this document does not exonerate parties to a transaction from exercising all their rights and obligations under the transaction documents. This document cannot be reproduced except in full, without prior written approval of the Company. Any unauthorized alteration, forgery or falsification of the content or appearance of this document is unlawful and offenders may be prosecuted to the fullest extent of the law.

SGS Taiwan Ltd.

No.134,WuKungRoad,NewTaipeiIndustrialPark,WukuDistrict,NewTaipeiCity,Taiwan24803/新北市五股區新北產業園區五工路 134 號

台灣檢驗科技股份有限公司

t (886-2) 2299-3279

f (886-2) 2298-0488

www.tw.sgs.com

Member of SGS Group

Radiated Spurious Emission Measurement Result: 10MHz BW LTE-Band 13(The Worst Case)

ARFCN	:CH 23230 16QAM BW 10 RB1 0	Test Date	:2015-05-29
Operation Band	:LTE B13	Temp./Humi.	:23 deg_C / 52 RH
Fundamental Frequency	:782 MHz	Engineer	:Curry
Operation Mode	:TX MID		
EUT Pol.	:H Plan	Measurement Antenna Pol.	:VERTICAL

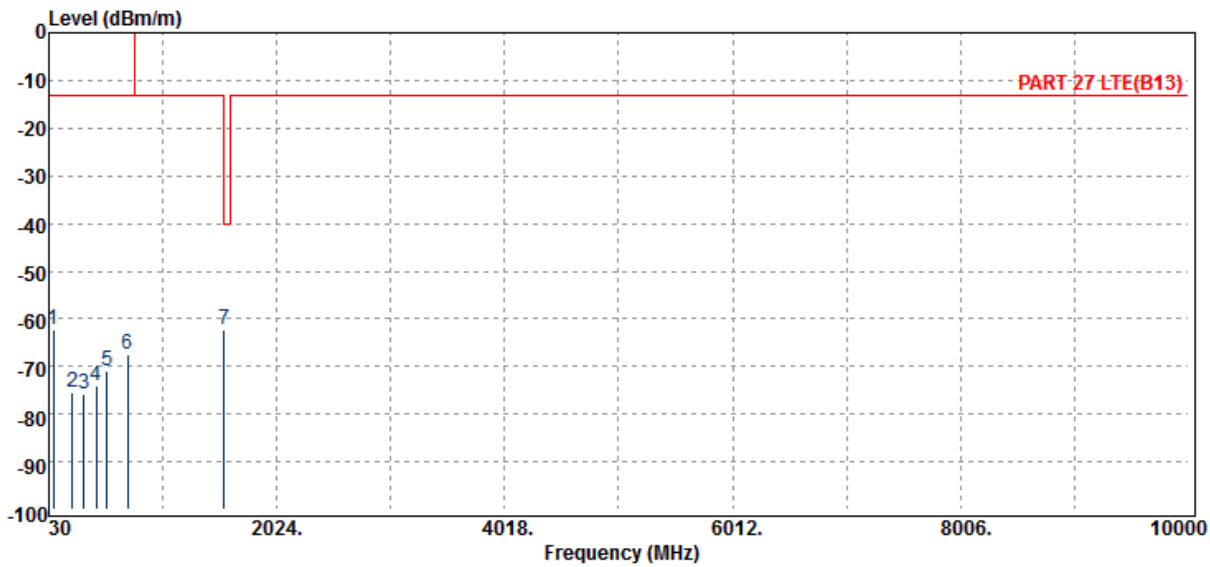

Freq. MHz	Note F/H/E/S	ERP dBm	SG Output Level dBm	Antenna Gain dBd	Cable Loss dB	Limit dBm	Margin dB
66.86	S	-62.24	-54.55	-6.69	-1.00	-13.00	-49.24
235.64	S	-75.30	-77.00	3.30	-1.59	-13.00	-62.30
335.55	S	-75.72	-77.53	3.72	-1.92	-13.00	-62.72
443.22	S	-74.11	-75.44	3.38	-2.05	-13.00	-61.11
537.31	S	-70.87	-71.99	3.63	-2.51	-13.00	-57.87
720.64	S	-67.62	-68.34	3.34	-2.63	-13.00	-54.62
1564.00	H	-62.35	-61.46	3.22	-4.11	-40.00	-22.35

Unless otherwise stated the results shown in this test report refer only to the sample(s) tested and such sample(s) are retained for 90 days only.

除非另有說明，此報告結果僅對測試之樣品負責，同時此樣品僅保留90天。本報告未經本公司書面許可，不可部份複製。

This document is issued by the Company subject to its General Conditions of Service printed overleaf, available on request or accessible at www.sgs.com/terms_and_conditions.htm and, for electronic format documents, subject to Terms and Conditions for Electronic Documents at www.sgs.com/terms_e-document.htm. Attention is drawn to the limitation of liability, indemnification and jurisdiction issues defined therein. Any holder of this document is advised that information contained hereon reflects the Company's findings at the time of its intervention only and within the limits of Client's instructions, if any. The Company's sole responsibility is to its Client and this document does not exonerate parties to a transaction from exercising all their rights and obligations under the transaction documents. This document cannot be reproduced except in full, without prior written approval of the Company. Any unauthorized alteration, forgery or falsification of the content or appearance of this document is unlawful and offenders may be prosecuted to the fullest extent of the law.

ARFCN	:CH 23230 16QAM BW 10 RB1 0	Test Date	:2015-05-29
Operation Band	:LTE B13	Temp./Humi.	:23 deg_C / 52 RH
Fundamental Frequency	:782 MHz	Engineer	:Curry
Operation Mode	:TX MID		
EUT Pol.	:H Plan	Measurement Antenna Pol.	:HORIZONTAL

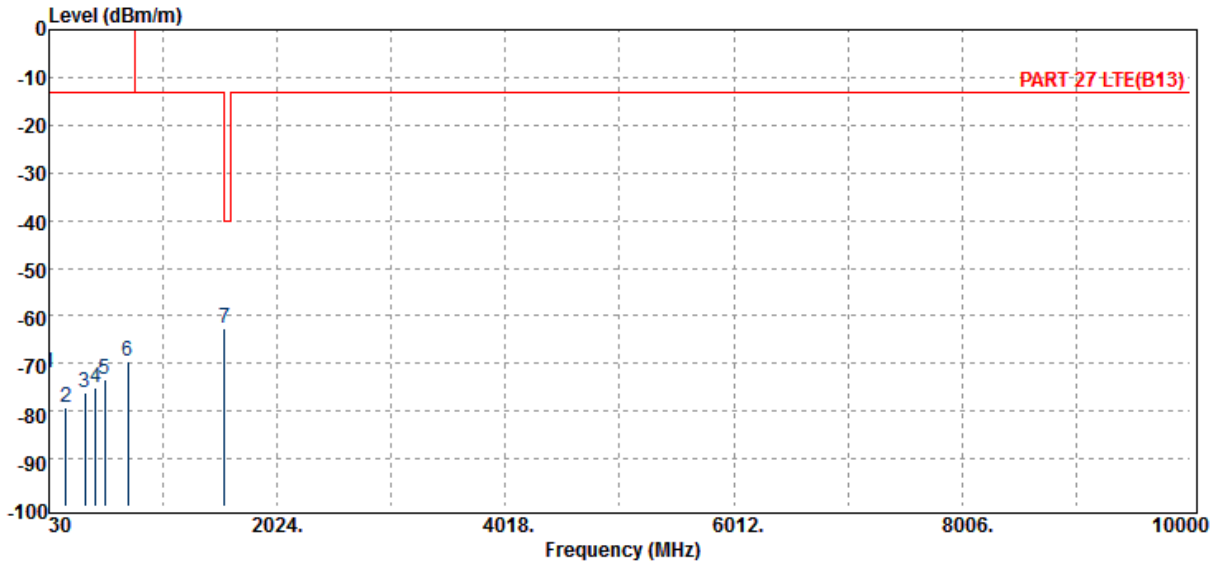

Freq. MHz	Note F/H/E/S	ERP dBm	SG Output Level dBm	Antenna Gain dBd	Cable Loss dB	Limit dBm	Margin dB
33.88	S	-71.87	-57.20	-13.90	-0.77	-13.00	-58.87
174.53	S	-79.24	-77.81	0.07	-1.49	-13.00	-66.24
340.40	S	-76.12	-77.92	3.74	-1.93	-13.00	-63.12
434.49	S	-75.25	-76.66	3.43	-2.02	-13.00	-62.25
516.94	S	-73.46	-74.77	3.70	-2.40	-13.00	-60.46
716.76	S	-69.72	-70.45	3.35	-2.62	-13.00	-56.72
1564.00	H	-62.72	-61.83	3.22	-4.11	-40.00	-22.72

Unless otherwise stated the results shown in this test report refer only to the sample(s) tested and such sample(s) are retained for 90 days only.

除非另有說明，此報告結果僅對測試之樣品負責，同時此樣品僅保留90天。本報告未經本公司書面許可，不可部份複製。

This document is issued by the Company subject to its General Conditions of Service printed overleaf, available on request or accessible at www.sgs.com/terms_and_conditions.htm and, for electronic format documents, subject to Terms and Conditions for Electronic Documents at www.sgs.com/terms_e-document.htm. Attention is drawn to the limitation of liability, indemnification and jurisdiction issues defined therein. Any holder of this document is advised that information contained hereon reflects the Company's findings at the time of its intervention only and within the limits of Client's instructions, if any. The Company's sole responsibility is to its Client and this document does not exonerate parties to a transaction from exercising all their rights and obligations under the transaction documents. This document cannot be reproduced except in full, without prior written approval of the Company. Any unauthorized alteration, forgery or falsification of the content or appearance of this document is unlawful and offenders may be prosecuted to the fullest extent of the law.

**Radiated Spurious Emission Measurement Result: 763MHz -775MHz
 10MHz BW LTE-Band 13(The Worst Case)**

ARFCN	:CH 23230 16QAM BW 10 RB1 0	Test Date	:2015-05-29
Operation Band	:LTE B13	Temp./Humi.	:23 deg_C / 52 RH
Fundamental Frequency	:782 MHz	Engineer	:Curry
Operation Mode	:TX MID		
EUT Pol.	:H Plan	Measurement Antenna Pol.	:VERTICAL

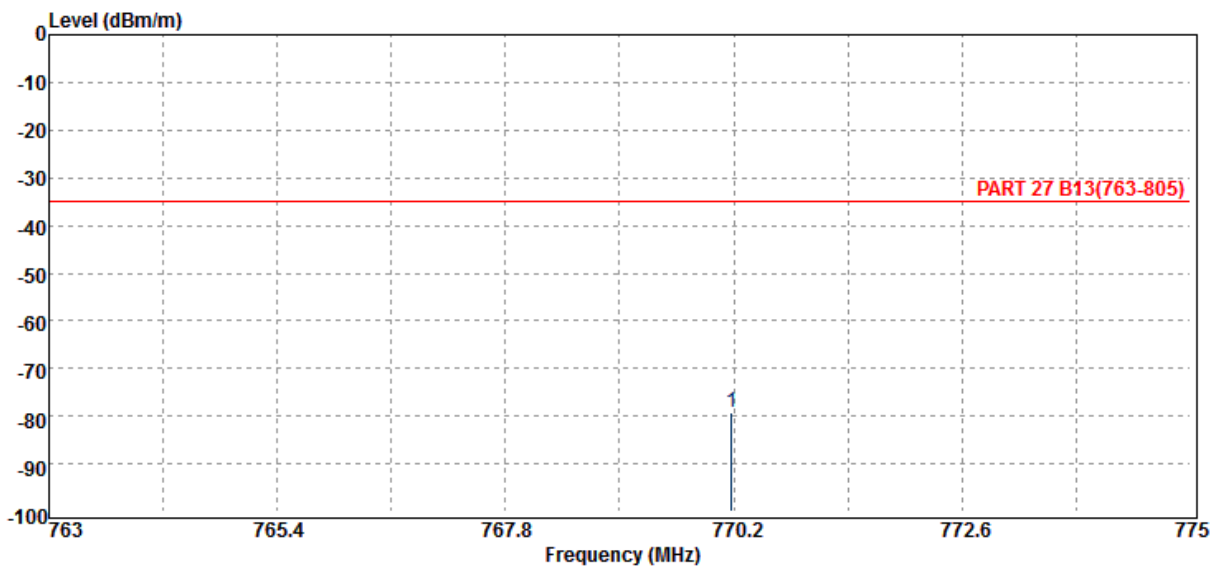

Freq. MHz	Note F/H/E/S	ERP dBm	SG Output Level dBm	Antenna Gain dBd	Cable Loss dB	Limit dBm	Margin dB
770.18	S	-79.34	-79.94	3.35	-2.74	-35.00	-44.34

Unless otherwise stated the results shown in this test report refer only to the sample(s) tested and such sample(s) are retained for 90 days only.

除非另有說明，此報告結果僅對測試之樣品負責，同時此樣品僅保留90天。本報告未經本公司書面許可，不可部份複製。

This document is issued by the Company subject to its General Conditions of Service printed overleaf, available on request or accessible at www.sgs.com/terms_and_conditions.htm and, for electronic format documents, subject to Terms and Conditions for Electronic Documents at www.sgs.com/terms_e-document.htm. Attention is drawn to the limitation of liability, indemnification and jurisdiction issues defined therein. Any holder of this document is advised that information contained hereon reflects the Company's findings at the time of its intervention only and within the limits of Client's instructions, if any. The Company's sole responsibility is to its Client and this document does not exonerate parties to a transaction from exercising all their rights and obligations under the transaction documents. This document cannot be reproduced except in full, without prior written approval of the Company. Any unauthorized alteration, forgery or falsification of the content or appearance of this document is unlawful and offenders may be prosecuted to the fullest extent of the law.

ARFCN	:CH 23230 16QAM BW 10 RB1 0	Test Date	:2015-05-29
Operation Band	:LTE B13	Temp./Humi.	:23 deg_C / 52 RH
Fundamental Frequency	:782 MHz	Engineer	:Curry
Operation Mode	:TX MID		
EUT Pol.	:H Plan	Measurement Antenna Pol.	:HORIZONTAL

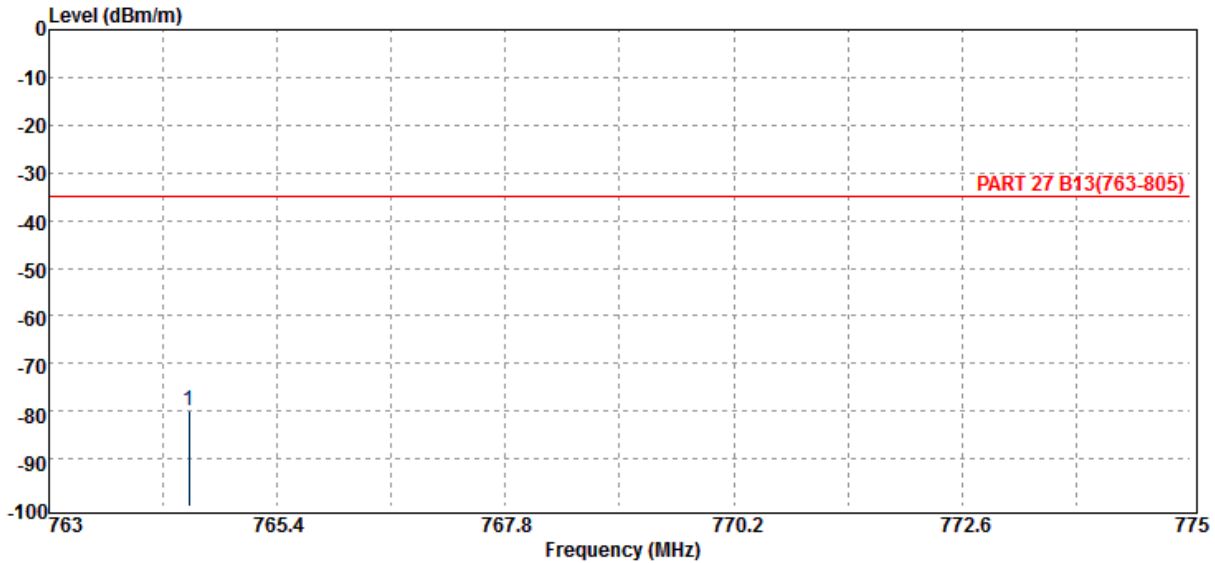

Freq.	Note	ERP	SG	Antenna	Cable	Limit	Margin
MHz	F/H/E/S	dBm	Output Level dBm	Gain dBd	Loss dB	dBm	dB
764.48	S	-80.07	-80.67	3.33	-2.73	-35.00	-45.07

Unless otherwise stated the results shown in this test report refer only to the sample(s) tested and such sample(s) are retained for 90 days only.

除非另有說明，此報告結果僅對測試之樣品負責，同時此樣品僅保留90天。本報告未經本公司書面許可，不可部份複製。

This document is issued by the Company subject to its General Conditions of Service printed overleaf, available on request or accessible at www.sgs.com/terms_and_conditions.htm and, for electronic format documents, subject to Terms and Conditions for Electronic Documents at www.sgs.com/terms_e-document.htm. Attention is drawn to the limitation of liability, indemnification and jurisdiction issues defined therein. Any holder of this document is advised that information contained hereon reflects the Company's findings at the time of its intervention only and within the limits of Client's instructions, if any. The Company's sole responsibility is to its Client and this document does not exonerate parties to a transaction from exercising all their rights and obligations under the transaction documents. This document cannot be reproduced except in full, without prior written approval of the Company. Any unauthorized alteration, forgery or falsification of the content or appearance of this document is unlawful and offenders may be prosecuted to the fullest extent of the law.

Radiated Spurious Emission Measurement Result: 793MHz ~ 805MHz
10MHz BW LTE-Band 13(The Worst Case)

ARFCN	:CH 23230 16QAM BW 10 RB1 0	Test Date	:2015-05-29
Operation Band	:LTE B13	Temp./Humi.	:23 deg_C / 52 RH
Fundamental Frequency	:782 MHz	Engineer	:Curry
Operation Mode	:TX MID		
EUT Pol.	:H Plan	Measurement Antenna Pol.	:VERTICAL

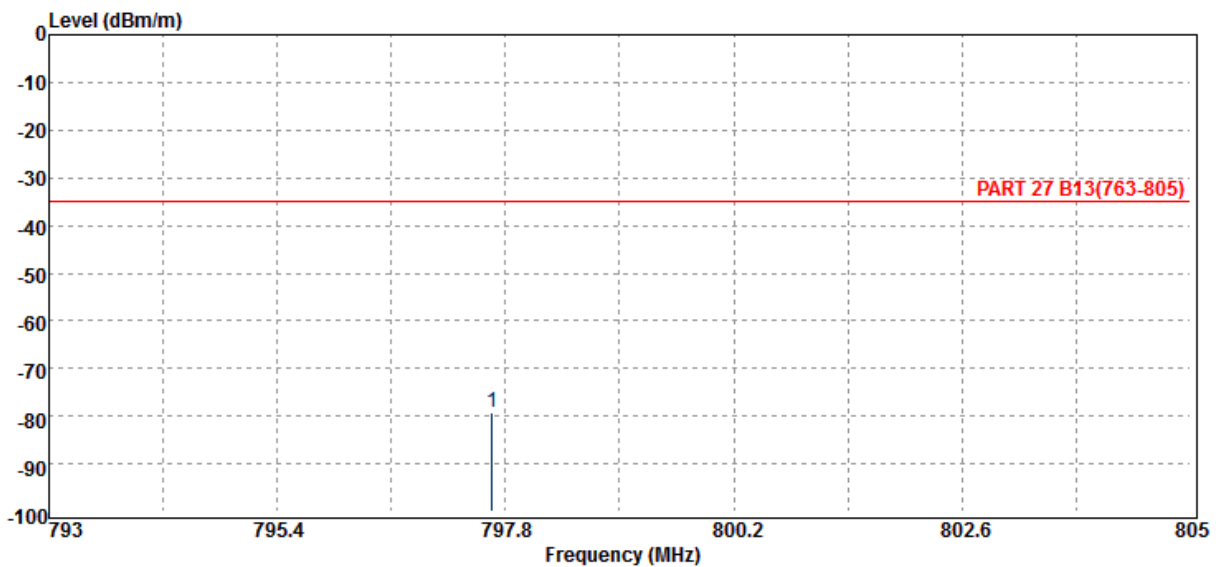

Freq.	Note	ERP	SG	Antenna	Cable	Limit	Margin
MHz	F/H/E/S	dBm	Output Level dBm	Gain dBd	Loss dB	dBm	dB
797.66	S	-79.37	-79.96	3.43	-2.84	-35.00	-44.37

Unless otherwise stated the results shown in this test report refer only to the sample(s) tested and such sample(s) are retained for 90 days only.

除非另有說明，此報告結果僅對測試之樣品負責，同時此樣品僅保留90天。本報告未經本公司書面許可，不可部份複製。

This document is issued by the Company subject to its General Conditions of Service printed overleaf, available on request or accessible at www.sgs.com/terms_and_conditions.htm and, for electronic format documents, subject to Terms and Conditions for Electronic Documents at www.sgs.com/terms_e-document.htm. Attention is drawn to the limitation of liability, indemnification and jurisdiction issues defined therein. Any holder of this document is advised that information contained hereon reflects the Company's findings at the time of its intervention only and within the limits of Client's instructions, if any. The Company's sole responsibility is to its Client and this document does not exonerate parties to a transaction from exercising all their rights and obligations under the transaction documents. This document cannot be reproduced except in full, without prior written approval of the Company. Any unauthorized alteration, forgery or falsification of the content or appearance of this document is unlawful and offenders may be prosecuted to the fullest extent of the law.

SGS Taiwan Ltd.

No.134,WuKungRoad,NewTaipeiIndustrialPark,WukuDistrict,NewTaipeiCity,Taiwan24803/新北市五股區新北產業園區五工路 134 號

台灣檢驗科技股份有限公司

t (886-2) 2299-3279

f (886-2) 2298-0488

www.tw.sgs.com

Member of SGS Group

ARFCN	:CH 23230 16QAM BW 10 RB1 0	Test Date	:2015-05-29
Operation Band	:LTE B13	Temp./Humi.	:23 deg_C / 52 RH
Fundamental Frequency	:782 MHz	Engineer	:Curry
Operation Mode	:TX MID		
EUT Pol.	:H Plan	Measurement Antenna Pol.	:HORIZONTAL

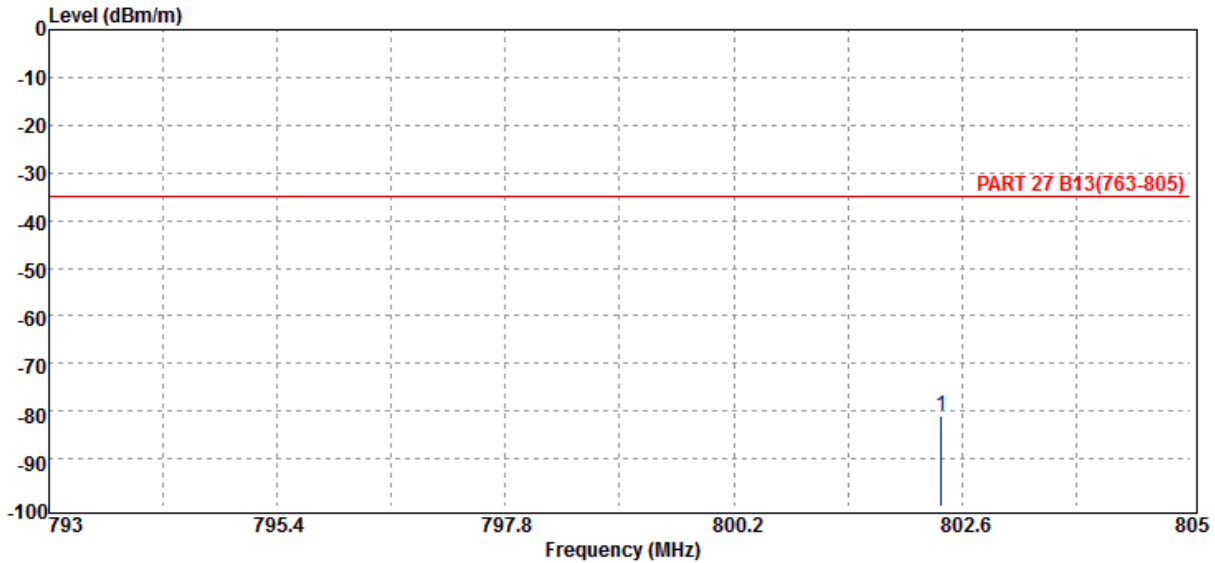

Freq.	Note	ERP	SG	Antenna	Cable	Limit	Margin
MHz	F/H/E/S	dBm	Output Level dBm	Gain dBd	Loss dB	dBm	dB
802.38	S	-80.93	-81.52	3.44	-2.86	-35.00	-45.93

Unless otherwise stated the results shown in this test report refer only to the sample(s) tested and such sample(s) are retained for 90 days only.
 除非另有說明，此報告結果僅對測試之樣品負責，同時此樣品僅保留90天。本報告未經本公司書面許可，不可部份複製。

This document is issued by the Company subject to its General Conditions of Service printed overleaf, available on request or accessible at www.sgs.com/terms_and_conditions.htm and, for electronic format documents, subject to Terms and Conditions for Electronic Documents at www.sgs.com/terms_e-document.htm. Attention is drawn to the limitation of liability, indemnification and jurisdiction issues defined therein. Any holder of this document is advised that information contained hereon reflects the Company's findings at the time of its intervention only and within the limits of Client's instructions, if any. The Company's sole responsibility is to its Client and this document does not exonerate parties to a transaction from exercising all their rights and obligations under the transaction documents. This document cannot be reproduced except in full, without prior written approval of the Company. Any unauthorized alteration, forgery or falsification of the content or appearance of this document is unlawful and offenders may be prosecuted to the fullest extent of the law.

Radiated Spurious Emission Measurement Result: 10MHz BW LTE-Band 17(The Worst Case)

ARFCN	:CH 23780 16QAM BW 10 RB1 0	Test Date	:2015-05-29
Operation Band	:LTE B17	Temp./Humi.	:23 deg_C / 52 RH
Fundamental Frequency	:709 MHz	Engineer	:Curry
Operation Mode	:TX LOW		
EUT Pol.	:H Plan	Measurement Antenna Pol.	:VERTICAL

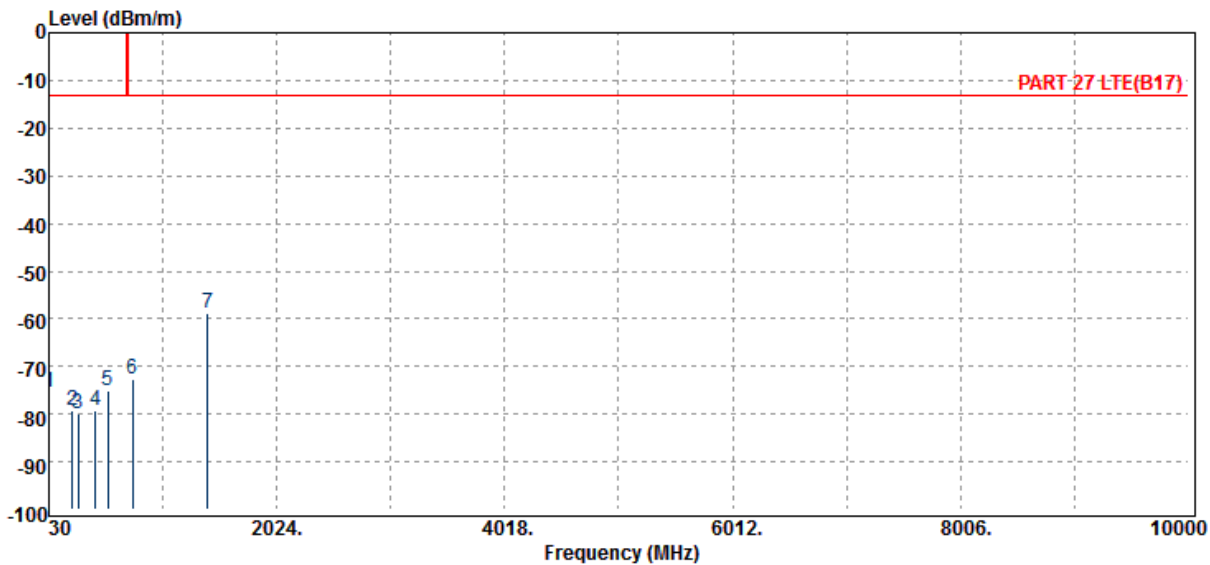

Freq. MHz	Note F/H/E/S	ERP dBm	SG Output Level dBm	Antenna Gain dBd	Cable Loss dB	Limit dBm	Margin dB
30.00	S	-75.44	-59.83	-14.88	-0.73	-13.00	-62.44
238.55	S	-79.30	-80.98	3.29	-1.60	-13.00	-66.30
287.05	S	-79.78	-81.44	3.40	-1.74	-13.00	-66.78
434.49	S	-79.31	-80.72	3.43	-2.02	-13.00	-66.31
548.95	S	-75.25	-76.27	3.59	-2.57	-13.00	-62.25
762.35	S	-72.59	-73.19	3.32	-2.72	-13.00	-59.59
1418.00	H	-58.69	-57.61	2.88	-3.95	-13.00	-45.69

Unless otherwise stated the results shown in this test report refer only to the sample(s) tested and such sample(s) are retained for 90 days only.

除非另有說明，此報告結果僅對測試之樣品負責，同時此樣品僅保留90天。本報告未經本公司書面許可，不可部份複製。

This document is issued by the Company subject to its General Conditions of Service printed overleaf, available on request or accessible at www.sgs.com/terms_and_conditions.htm and, for electronic format documents, subject to Terms and Conditions for Electronic Documents at www.sgs.com/terms_e-document.htm. Attention is drawn to the limitation of liability, indemnification and jurisdiction issues defined therein. Any holder of this document is advised that information contained hereon reflects the Company's findings at the time of its intervention only and within the limits of Client's instructions, if any. The Company's sole responsibility is to its Client and this document does not exonerate parties to a transaction from exercising all their rights and obligations under the transaction documents. This document cannot be reproduced except in full, without prior written approval of the Company. Any unauthorized alteration, forgery or falsification of the content or appearance of this document is unlawful and offenders may be prosecuted to the fullest extent of the law.

ARFCN	:CH 23780 16QAM BW 10 RB1 0	Test Date	:2015-05-29
Operation Band	:LTE B17	Temp./Humi.	:23 deg_C / 52 RH
Fundamental Frequency	:709 MHz	Engineer	:Curry
Operation Mode	:TX LOW		
EUT Pol.	:H Plan	Measurement Antenna Pol.	:HORIZONTAL

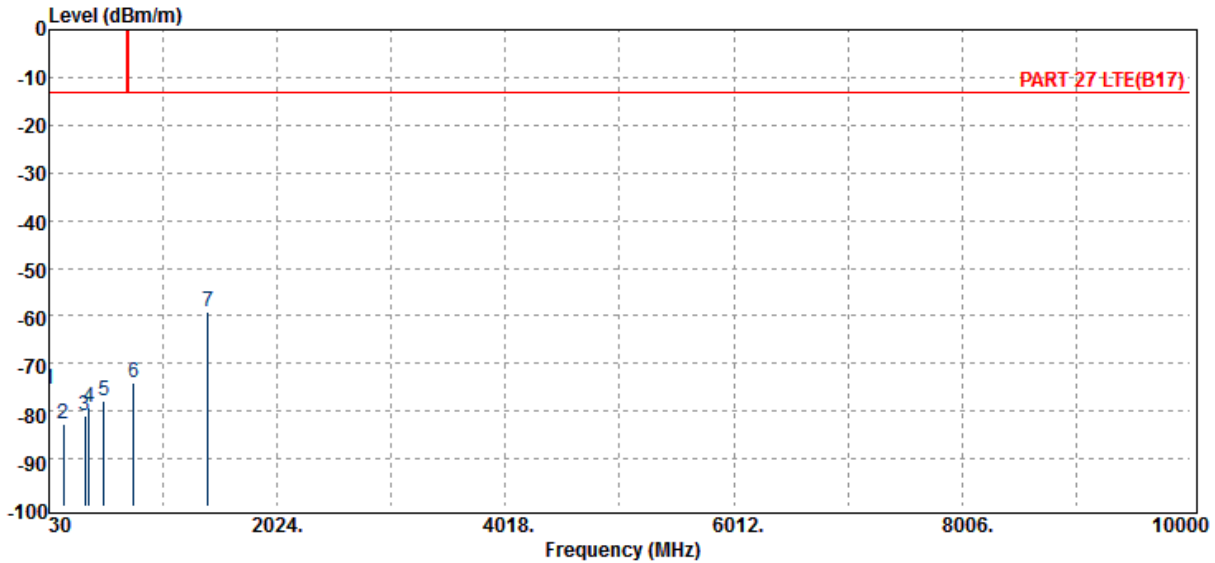

Freq. MHz	Note F/H/E/S	ERP dBm	SG Output Level dBm	Antenna Gain dBd	Cable Loss dB	Limit dBm	Margin dB
34.85	S	-75.59	-61.14	-13.67	-0.78	-13.00	-62.59
156.10	S	-82.76	-79.65	-1.69	-1.42	-13.00	-69.76
343.31	S	-80.80	-82.60	3.74	-1.94	-13.00	-67.80
377.26	S	-79.22	-80.95	3.68	-1.96	-13.00	-66.22
512.09	S	-77.81	-79.16	3.72	-2.37	-13.00	-64.81
767.20	S	-73.97	-74.58	3.34	-2.74	-13.00	-60.97
1418.00	H	-59.11	-58.04	2.88	-3.95	-13.00	-46.11

Unless otherwise stated the results shown in this test report refer only to the sample(s) tested and such sample(s) are retained for 90 days only.

除非另有說明，此報告結果僅對測試之樣品負責，同時此樣品僅保留90天。本報告未經本公司書面許可，不可部份複製。

This document is issued by the Company subject to its General Conditions of Service printed overleaf, available on request or accessible at www.sgs.com/terms_and_conditions.htm and, for electronic format documents, subject to Terms and Conditions for Electronic Documents at www.sgs.com/terms_e-document.htm. Attention is drawn to the limitation of liability, indemnification and jurisdiction issues defined therein. Any holder of this document is advised that information contained hereon reflects the Company's findings at the time of its intervention only and within the limits of Client's instructions, if any. The Company's sole responsibility is to its Client and this document does not exonerate parties to a transaction from exercising all their rights and obligations under the transaction documents. This document cannot be reproduced except in full, without prior written approval of the Company. Any unauthorized alteration, forgery or falsification of the content or appearance of this document is unlawful and offenders may be prosecuted to the fullest extent of the law.

SGS Taiwan Ltd.

No.134,WuKungRoad,NewTaipeiIndustrialPark,WukuDistrict,NewTaipeiCity,Taiwan24803/新北市五股區新北產業園區五工路 134 號

台灣檢驗科技股份有限公司

t (886-2) 2299-3279

f (886-2) 2298-0488

www.tw.sgs.com

Member of SGS Group

ARFCN	:CH 23790 16QAM BW 10 RB1 0	Test Date	:2015-05-29
Operation Band	:LTE B17	Temp./Humi.	:23 deg_C / 52 RH
Fundamental Frequency	:710 MHz	Engineer	:Curry
Operation Mode	:TX MID		
EUT Pol.	:H Plan	Measurement Antenna Pol.	:VERTICAL

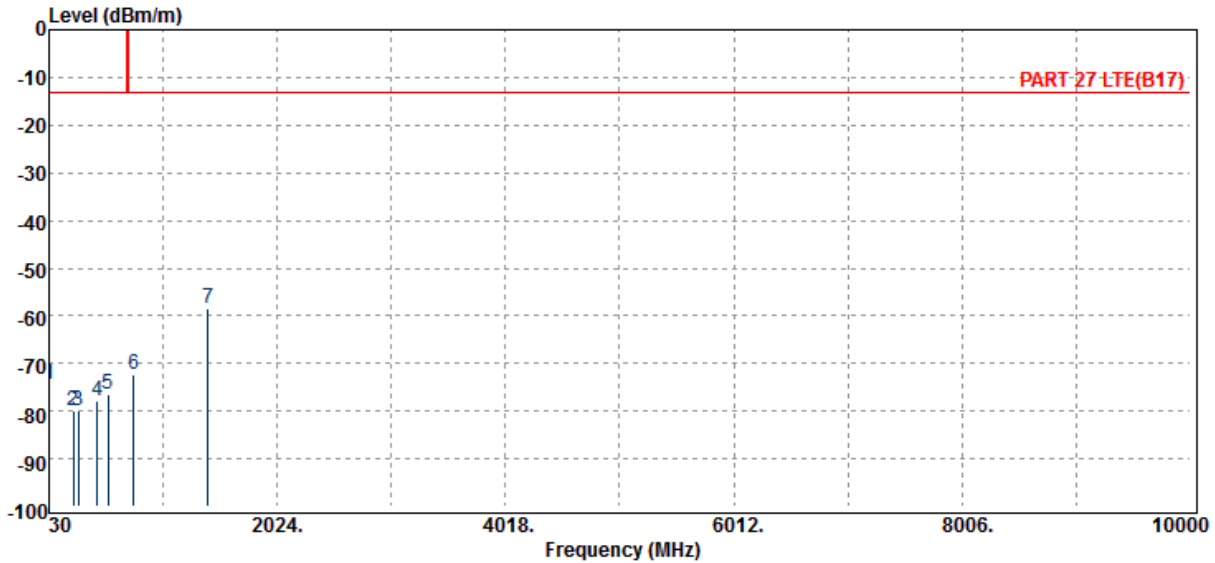

Freq. MHz	Note F/H/E/S	ERP dBm	SG Output Level dBm	Antenna Gain dBd	Cable Loss dB	Limit dBm	Margin dB
30.00	S	-74.43	-58.82	-14.88	-0.73	-13.00	-61.43
241.46	S	-79.78	-81.48	3.31	-1.61	-13.00	-66.78
287.05	S	-79.88	-81.54	3.40	-1.74	-13.00	-66.88
449.04	S	-77.80	-79.09	3.35	-2.06	-13.00	-64.80
547.01	S	-76.37	-77.41	3.60	-2.56	-13.00	-63.37
767.20	S	-72.24	-72.84	3.34	-2.74	-13.00	-59.24
1420.00	H	-58.52	-57.45	2.89	-3.96	-13.00	-45.52

Unless otherwise stated the results shown in this test report refer only to the sample(s) tested and such sample(s) are retained for 90 days only.

除非另有說明，此報告結果僅對測試之樣品負責，同時此樣品僅保留90天。本報告未經本公司書面許可，不可部份複製。

This document is issued by the Company subject to its General Conditions of Service printed overleaf, available on request or accessible at www.sgs.com/terms_and_conditions.htm and, for electronic format documents, subject to Terms and Conditions for Electronic Documents at www.sgs.com/terms_e-document.htm. Attention is drawn to the limitation of liability, indemnification and jurisdiction issues defined therein. Any holder of this document is advised that information contained hereon reflects the Company's findings at the time of its intervention only and within the limits of Client's instructions, if any. The Company's sole responsibility is to its Client and this document does not exonerate parties to a transaction from exercising all their rights and obligations under the transaction documents. This document cannot be reproduced except in full, without prior written approval of the Company. Any unauthorized alteration, forgery or falsification of the content or appearance of this document is unlawful and offenders may be prosecuted to the fullest extent of the law.

ARFCN	:CH 23790 16QAM BW 10 RB1 0	Test Date	:2015-05-29
Operation Band	:LTE B17	Temp./Humi.	:23 deg_C / 52 RH
Fundamental Frequency	:710 MHz	Engineer	:Curry
Operation Mode	:TX MID		
EUT Pol.	:H Plan	Measurement Antenna Pol.	:HORIZONTAL

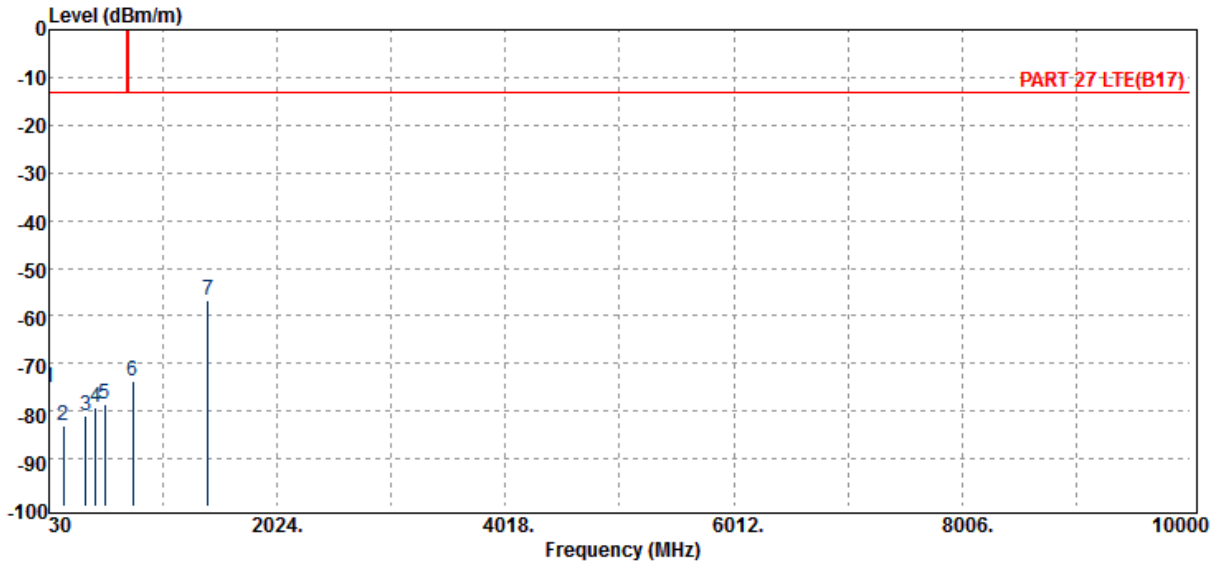

Freq. MHz	Note F/H/E/S	ERP dBm	SG Output Level dBm	Antenna Gain dBd	Cable Loss dB	Limit dBm	Margin dB
34.85	S	-74.93	-60.47	-13.67	-0.78	-13.00	-61.93
158.04	S	-82.99	-80.00	-1.56	-1.43	-13.00	-69.99
350.10	S	-80.97	-82.77	3.76	-1.97	-13.00	-67.97
440.31	S	-79.36	-80.72	3.40	-2.04	-13.00	-66.36
515.00	S	-78.64	-79.96	3.71	-2.39	-13.00	-65.64
765.26	S	-73.79	-74.39	3.33	-2.73	-13.00	-60.79
1420.00	H	-56.89	-55.83	2.89	-3.96	-13.00	-43.89

Unless otherwise stated the results shown in this test report refer only to the sample(s) tested and such sample(s) are retained for 90 days only.

除非另有說明，此報告結果僅對測試之樣品負責，同時此樣品僅保留90天。本報告未經本公司書面許可，不可部份複製。

This document is issued by the Company subject to its General Conditions of Service printed overleaf, available on request or accessible at www.sgs.com/terms_and_conditions.htm and, for electronic format documents, subject to Terms and Conditions for Electronic Documents at www.sgs.com/terms_e-document.htm. Attention is drawn to the limitation of liability, indemnification and jurisdiction issues defined therein. Any holder of this document is advised that information contained hereon reflects the Company's findings at the time of its intervention only and within the limits of Client's instructions, if any. The Company's sole responsibility is to its Client and this document does not exonerate parties to a transaction from exercising all their rights and obligations under the transaction documents. This document cannot be reproduced except in full, without prior written approval of the Company. Any unauthorized alteration, forgery or falsification of the content or appearance of this document is unlawful and offenders may be prosecuted to the fullest extent of the law.

ARFCN	:CH 23800 16QAM BW 10 RB1 0	Test Date	:2015-05-29
Operation Band	:LTE B17	Temp./Humi.	:23 deg_C / 52 RH
Fundamental Frequency	:711 MHz	Engineer	:Curry
Operation Mode	:TX HIGH		
EUT Pol.	:H Plan	Measurement Antenna Pol.	:VERTICAL

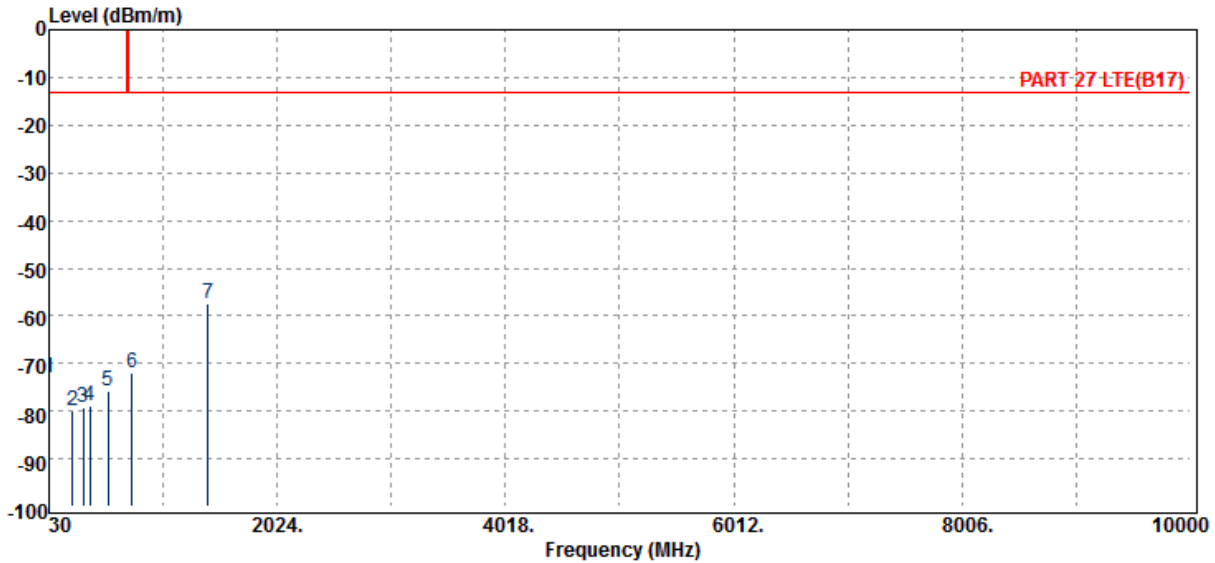

Freq. MHz	Note F/H/E/S	ERP dBm	SG Output Level dBm	Antenna Gain dBd	Cable Loss dB	Limit dBm	Margin dB
30.00	S	-73.12	-57.51	-14.88	-0.73	-13.00	-60.12
235.64	S	-79.89	-81.59	3.30	-1.59	-13.00	-66.89
325.85	S	-79.35	-81.16	3.70	-1.88	-13.00	-66.35
385.99	S	-78.77	-80.48	3.66	-1.95	-13.00	-65.77
548.95	S	-75.90	-76.92	3.59	-2.57	-13.00	-62.90
755.56	S	-71.89	-72.48	3.30	-2.71	-13.00	-58.89
1422.00	H	-57.43	-56.37	2.90	-3.96	-13.00	-44.43

Unless otherwise stated the results shown in this test report refer only to the sample(s) tested and such sample(s) are retained for 90 days only.

除非另有說明，此報告結果僅對測試之樣品負責，同時此樣品僅保留90天。本報告未經本公司書面許可，不可部份複製。

This document is issued by the Company subject to its General Conditions of Service printed overleaf, available on request or accessible at www.sgs.com/terms_and_conditions.htm and, for electronic format documents, subject to Terms and Conditions for Electronic Documents at www.sgs.com/terms_e-document.htm. Attention is drawn to the limitation of liability, indemnification and jurisdiction issues defined therein. Any holder of this document is advised that information contained hereon reflects the Company's findings at the time of its intervention only and within the limits of Client's instructions, if any. The Company's sole responsibility is to its Client and this document does not exonerate parties to a transaction from exercising all their rights and obligations under the transaction documents. This document cannot be reproduced except in full, without prior written approval of the Company. Any unauthorized alteration, forgery or falsification of the content or appearance of this document is unlawful and offenders may be prosecuted to the fullest extent of the law.

ARFCN	:CH 23800 16QAM BW 10 RB1 0	Test Date	:2015-05-29
Operation Band	:LTE B17	Temp./Humi.	:23 deg_C / 52 RH
Fundamental Frequency	:711 MHz	Engineer	:Curry
Operation Mode	:TX HIGH		
EUT Pol.	:H Plan	Measurement Antenna Pol.	:HORIZONTAL

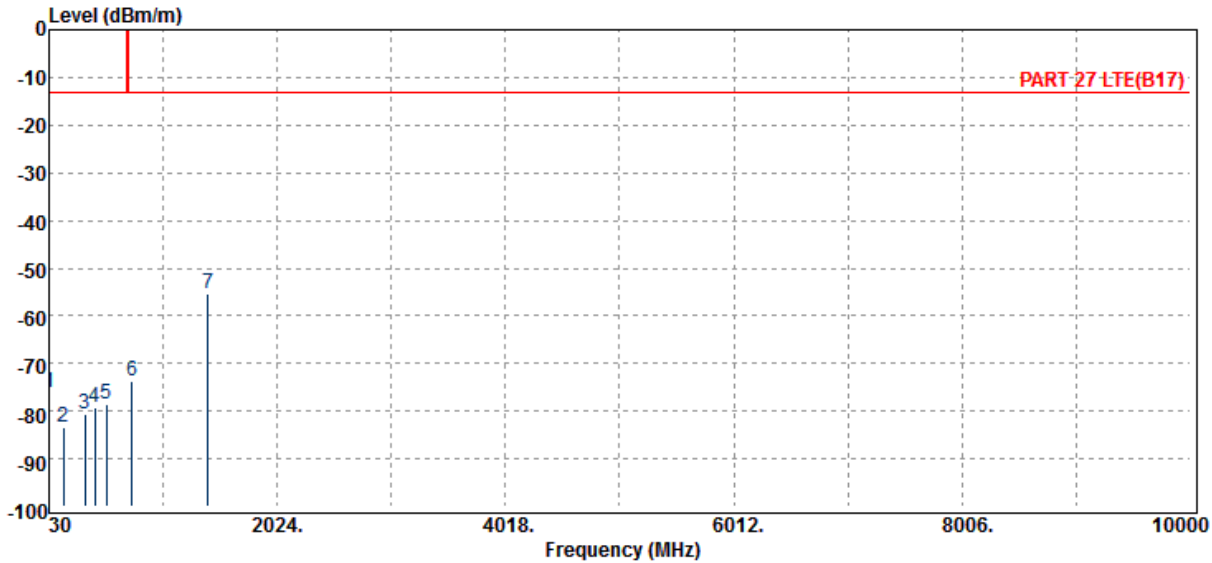

Freq. MHz	Note F/H/E/S	ERP dBm	SG Output Level dBm	Antenna Gain dBd	Cable Loss dB	Limit dBm	Margin dB
34.85	S	-76.05	-61.60	-13.67	-0.78	-13.00	-63.05
153.19	S	-83.29	-80.01	-1.88	-1.40	-13.00	-70.29
345.25	S	-80.60	-82.39	3.75	-1.95	-13.00	-67.60
427.70	S	-79.21	-80.68	3.46	-2.00	-13.00	-66.21
532.46	S	-78.67	-79.83	3.65	-2.48	-13.00	-65.67
754.59	S	-73.63	-74.22	3.30	-2.71	-13.00	-60.63
1422.00	H	-55.33	-54.28	2.90	-3.96	-13.00	-42.33

Unless otherwise stated the results shown in this test report refer only to the sample(s) tested and such sample(s) are retained for 90 days only.
 除非另有說明，此報告結果僅對測試之樣品負責，同時此樣品僅保留90天。本報告未經本公司書面許可，不可部份複製。

This document is issued by the Company subject to its General Conditions of Service printed overleaf, available on request or accessible at www.sgs.com/terms_and_conditions.htm and, for electronic format documents, subject to Terms and Conditions for Electronic Documents at www.sgs.com/terms_e-document.htm. Attention is drawn to the limitation of liability, indemnification and jurisdiction issues defined therein. Any holder of this document is advised that information contained hereon reflects the Company's findings at the time of its intervention only and within the limits of Client's instructions, if any. The Company's sole responsibility is to its Client and this document does not exonerate parties to a transaction from exercising all their rights and obligations under the transaction documents. This document cannot be reproduced except in full, without prior written approval of the Company. Any unauthorized alteration, forgery or falsification of the content or appearance of this document is unlawful and offenders may be prosecuted to the fullest extent of the law.

10. FREQUENCY STABILITY MEASUREMENT

10.1. Standard Applicable:

The frequency stability shall be sufficient to ensure that the fundamental emission stays within the authorized frequency block.

10.2. Test Set-up:

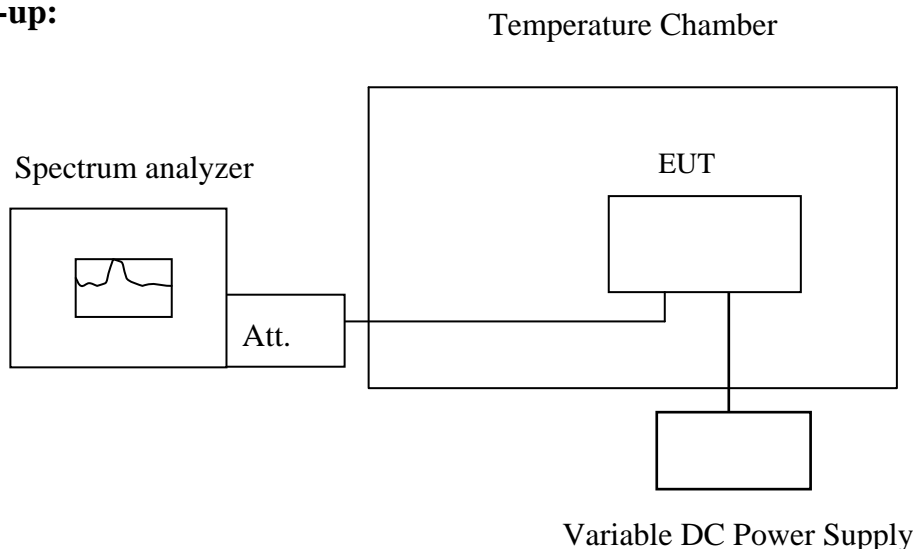

Note: Measurement setup for testing on Antenna connector

10.3. Measurement Procedure:

The equipment under test was connected to an external AC or DC power supply and input rated voltage. RF output was connected to a frequency counter or spectrum analyzer via feed through attenuators. The EUT was placed inside the temperature chamber. Set the spectrum analyzer RBW low enough to obtain the desired frequency resolution and measure EUT 25°C operating frequency as reference frequency. Turn EUT off and set the chamber temperature to -30°C. After the temperature stabilized for approximately 30 minutes recorded the frequency. Repeat step measure with 10°C increased per stage until the highest temperature of +50°C reached.

Set chamber temperature to 25 . Use a variable AC power supply / DC power source to power the EUT and set the voltage to rated voltage. Set the spectrum analyzer RBW low enough to obtain the desired frequency resolution and recorded the frequency.

Reduce the input voltage to specify extreme voltage variation (+/- 15%) and endpoint as declared by the manufacturer, record the maximum frequency change.

Unless otherwise stated the results shown in this test report refer only to the sample(s) tested and such sample(s) are retained for 90 days only.

除非另有說明，此報告結果僅對測試之樣品負責，同時此樣品僅保留90天。本報告未經本公司書面許可，不可部份複製。

This document is issued by the Company subject to its General Conditions of Service printed overleaf, available on request or accessible at www.sgs.com/terms_and_conditions.htm and, for electronic format documents, subject to Terms and Conditions for Electronic Documents at www.sgs.com/terms_e-document.htm. Attention is drawn to the limitation of liability, indemnification and jurisdiction issues defined therein. Any holder of this document is advised that information contained hereon reflects the Company's findings at the time of its intervention only and within the limits of Client's instructions, if any. The Company's sole responsibility is to its Client and this document does not exonerate parties to a transaction from exercising all their rights and obligations under the transaction documents. This document cannot be reproduced except in full, without prior written approval of the Company. Any unauthorized alteration, forgery or falsification of the content or appearance of this document is unlawful and offenders may be prosecuted to the fullest extent of the law.

10.4. Measurement Equipment Used:

Conducted Emission (measured at antenna port) Test Site					
EQUIPMENT TYPE	MFR	MODEL NUMBER	SERIAL NUMBER	LAST CAL.	CAL DUE.
Spectrum Analyzer	Agilent	E4440A	MY45304525	05/05/2015	05/04/2016
Radio Communication Analyzer	R&S	CMU200	102189	02/11/2015	02/10/2016
Radio Communication Analyzer	Anritsu	MT8820C	6200995019	10/08/2014	10/09/2015
Temperature Chamber	TERCHY	MHG-120LF	911009	05/06/2015	05/05/2016
DC Block	Mini-Circuits	BLK-18-S+	1	01/02/2015	01/01/2016
Attenuator	Mini-Circuit	BW-S10W2+	002	01/02/2015	01/01/2016
Splitter	Agilent	11636B	N/A	01/02/2015	01/01/2016
DC Power Supply	Agilent	E3640A	MY52410006	11/10/2014	11/09/2015

Unless otherwise stated the results shown in this test report refer only to the sample(s) tested and such sample(s) are retained for 90 days only.

除非另有說明，此報告結果僅對測試之樣品負責，同時此樣品僅保留90天。本報告未經本公司書面許可，不可部份複製。

This document is issued by the Company subject to its General Conditions of Service printed overleaf, available on request or accessible at www.sgs.com/terms_and_conditions.htm and, for electronic format documents, subject to Terms and Conditions for Electronic Documents at www.sgs.com/terms_e-document.htm. Attention is drawn to the limitation of liability, indemnification and jurisdiction issues defined therein. Any holder of this document is advised that information contained hereon reflects the Company's findings at the time of its intervention only and within the limits of Client's instructions, if any. The Company's sole responsibility is to its Client and this document does not exonerate parties to a transaction from exercising all their rights and obligations under the transaction documents. This document cannot be reproduced except in full, without prior written approval of the Company. Any unauthorized alteration, forgery or falsification of the content or appearance of this document is unlawful and offenders may be prosecuted to the fullest extent of the law.

SGS Taiwan Ltd.

No.134,WuKungRoad,NewTaipeiIndustrialPark,WukuDistrict,NewTaipeiCity,Taiwan24803/新北市五股區新北產業園區五工路 134 號

台灣檢驗科技股份有限公司

t (886-2) 2299-3279

f (886-2) 2298-0488

www.tw.sgs.com

Member of SGS Group

10.5. Measurement Result:

FREQUENCY ERROR vs. VOLTAGE

Reference Frequency: GPRS 850 Mid Channel 836.6 MHz				
Limit: +/- 2.5 ppm				
Power Supply	Environment	Frequency	Delta (Hz)	Limit (Hz)
Vdc	Temperature ()	(MHz)		
4.4	20	836599996	0	2091
3.8	20	836599996	0	2091
3.2	20	836599993	-3	2091
2.9 (End point)	20	836599999	3	2091

FREQUENCY ERROR vs. TEMPERATURE

Reference Frequency: GPRS 850 Mid Channel 836.6 MHz				
Limit: +/- 2.5 ppm				
Power Supply	Environment	Frequency	Delta (Hz)	Limit (Hz)
Vdc	Temperature ()	(MHz)		
3.8	50	836599993	-3	2091
3.8	40	836599991	-5	2091
3.8	30	836599989	-7	2091
3.8	20	836599996	0	2091
3.8	10	836599994	-2	2091
3.8	0	836600000	4	2091
3.8	-10	836599995	-1	2091
3.8	-20	836599992	-4	2091
3.8	-30	836599994	-2	2091

Unless otherwise stated the results shown in this test report refer only to the sample(s) tested and such sample(s) are retained for 90 days only.

除非另有說明，此報告結果僅對測試之樣品負責，同時此樣品僅保留90天。本報告未經本公司書面許可，不可部份複製。

This document is issued by the Company subject to its General Conditions of Service printed overleaf, available on request or accessible at www.sgs.com/terms_and_conditions.htm and, for electronic format documents, subject to Terms and Conditions for Electronic Documents at www.sgs.com/terms_e-document.htm. Attention is drawn to the limitation of liability, indemnification and jurisdiction issues defined therein. Any holder of this document is advised that information contained hereon reflects the Company's findings at the time of its intervention only and within the limits of Client's instructions, if any. The Company's sole responsibility is to its Client and this document does not exonerate parties to a transaction from exercising all their rights and obligations under the transaction documents. This document cannot be reproduced except in full, without prior written approval of the Company. Any unauthorized alteration, forgery or falsification of the content or appearance of this document is unlawful and offenders may be prosecuted to the fullest extent of the law.

SGS Taiwan Ltd.

No.134,WuKungRoad,NewTaipeiIndustrialPark,WukuDistrict,NewTaipeiCity,Taiwan24803/新北市五股區新北產業園區五工路 134 號

台灣檢驗科技股份有限公司

t (886-2) 2299-3279

f (886-2) 2298-0488

www.tw.sgs.com

Member of SGS Group

FREQUENCY ERROR vs. VOLTAGE

Reference Frequency: GPRS 1900 Mid Channel 1880 MHz				
Limit: +/- 2.5 ppm				
Power Supply	Environment	Frequency	Delta (Hz)	Limit (Hz)
Vdc	Temperature ()	(MHz)		
4.4	20	1879999995	-1	4700
3.8	20	1879999996	0	4700
3.2	20	1879999994	-2	4700
2.9 (End point)	20	1880000002	6	4700

FREQUENCY ERROR vs. TEMPERATURE

Reference Frequency: GPRS 1900 Mid Channel 1880 MHz				
Limit: +/- 2.5 ppm = Hz				
Power Supply	Environment	Frequency	Delta (Hz)	Limit (Hz)
Vdc	Temperature ()	(MHz)		
3.8	50	1879999995	-1	4700
3.8	40	1879999997	1	4700
3.8	30	1879999993	-3	4700
3.8	20	1879999996	0	4700
3.8	10	1879999995	-1	4700
3.8	0	1879999998	2	4700
3.8	-10	1880000000	4	4700
3.8	-20	1880000001	5	4700
3.8	-30	1879999999	3	4700

Unless otherwise stated the results shown in this test report refer only to the sample(s) tested and such sample(s) are retained for 90 days only.

除非另有說明，此報告結果僅對測試之樣品負責，同時此樣品僅保留90天。本報告未經本公司書面許可，不可部份複製。

This document is issued by the Company subject to its General Conditions of Service printed overleaf, available on request or accessible at www.sgs.com/terms_and_conditions.htm and, for electronic format documents, subject to Terms and Conditions for Electronic Documents at www.sgs.com/terms_e-document.htm. Attention is drawn to the limitation of liability, indemnification and jurisdiction issues defined therein. Any holder of this document is advised that information contained hereon reflects the Company's findings at the time of its intervention only and within the limits of Client's instructions, if any. The Company's sole responsibility is to its Client and this document does not exonerate parties to a transaction from exercising all their rights and obligations under the transaction documents. This document cannot be reproduced except in full, without prior written approval of the Company. Any unauthorized alteration, forgery or falsification of the content or appearance of this document is unlawful and offenders may be prosecuted to the fullest extent of the law.

SGS Taiwan Ltd.

No.134,WuKungRoad,NewTaipeiIndustrialPark,WukuDistrict,NewTaipeiCity,Taiwan24803/新北市五股區新北產業園區五工路 134 號

台灣檢驗科技股份有限公司

t (886-2) 2299-3279

f (886-2) 2298-0488

www.tw.sgs.com

Member of SGS Group

FREQUENCY ERROR vs. VOLTAGE

Reference Frequency: WCDMA II Mid Channel 1880 MHz				
Limit: +/- 2.5 ppm				
Power Supply	Environment	Frequency	Delta (Hz)	Limit (Hz)
Vdc	Temperature ()	(MHz)		
4.4	20	1879999999	-2	4700
3.8	20	1880000001	0	4700
3.2	20	1879999997	-4	4700
2.9 (End point)	20	1879999999	-2	4700

FREQUENCY ERROR vs. TEMPERATURE

Reference Frequency: WCDMA II Mid Channel 1880				
Limit: +/- 2.5 ppm				
Power Supply	Environment	Frequency	Delta (Hz)	Limit (Hz)
Vdc	Temperature ()	(MHz)		
3.8	50	1880000001	0	4700
3.8	40	1879999998	-3	4700
3.8	30	1880000000	-1	4700
3.8	20	1880000001	0	4700
3.8	10	1879999998	-3	4700
3.8	0	1879999997	-4	4700
3.8	-10	1880000001	0	4700
3.8	-20	1879999995	-6	4700
3.8	-30	1880000000	-1	4700

Unless otherwise stated the results shown in this test report refer only to the sample(s) tested and such sample(s) are retained for 90 days only.

除非另有說明，此報告結果僅對測試之樣品負責，同時此樣品僅保留90天。本報告未經本公司書面許可，不可部份複製。

This document is issued by the Company subject to its General Conditions of Service printed overleaf, available on request or accessible at www.sgs.com/terms_and_conditions.htm and, for electronic format documents, subject to Terms and Conditions for Electronic Documents at www.sgs.com/terms_e-document.htm. Attention is drawn to the limitation of liability, indemnification and jurisdiction issues defined therein. Any holder of this document is advised that information contained hereon reflects the Company's findings at the time of its intervention only and within the limits of Client's instructions, if any. The Company's sole responsibility is to its Client and this document does not exonerate parties to a transaction from exercising all their rights and obligations under the transaction documents. This document cannot be reproduced except in full, without prior written approval of the Company. Any unauthorized alteration, forgery or falsification of the content or appearance of this document is unlawful and offenders may be prosecuted to the fullest extent of the law.

SGS Taiwan Ltd.

No.134,WuKungRoad,NewTaipeiIndustrialPark,WukuDistrict,NewTaipeiCity,Taiwan24803/新北市五股區新北產業園區五工路 134 號

台灣檢驗科技股份有限公司

t (886-2) 2299-3279

f (886-2) 2298-0488

www.tw.sgs.com

Member of SGS Group

FREQUENCY ERROR vs. VOLTAGE

Reference Frequency: WCDMA IV Mid Channel 1732.6 MHz				
Limit: +/- 2.5 ppm				
Power Supply	Environment	Frequency	Delta (Hz)	Limit (Hz)
Vdc	Temperature ()	(MHz)		
4.4	20	173259999	-2	4331
3.8	20	173260001	0	4331
3.2	20	173259997	-4	4331
2.9 (End point)	20	173260001	0	4331

FREQUENCY ERROR vs. TEMPERATURE

Reference Frequency: WCDMA IV Mid Channel 1732.6 MHz				
Limit: +/- 2.5 ppm				
Power Supply	Environment	Frequency	Delta (Hz)	Limit (Hz)
Vdc	Temperature ()	(MHz)		
3.8	50	173259998	-3	4331
3.8	40	173259999	-2	4331
3.8	30	173260003	2	4331
3.8	20	173260001	0	4331
3.8	10	173259999	-2	4331
3.8	0	173260002	1	4331
3.8	-10	173259999	-2	4331
3.8	-20	173260003	2	4331
3.8	-30	173260000	-1	4331

Unless otherwise stated the results shown in this test report refer only to the sample(s) tested and such sample(s) are retained for 90 days only.

除非另有說明，此報告結果僅對測試之樣品負責，同時此樣品僅保留90天。本報告未經本公司書面許可，不可部份複製。

This document is issued by the Company subject to its General Conditions of Service printed overleaf, available on request or accessible at www.sgs.com/terms_and_conditions.htm and, for electronic format documents, subject to Terms and Conditions for Electronic Documents at www.sgs.com/terms_e-document.htm. Attention is drawn to the limitation of liability, indemnification and jurisdiction issues defined therein. Any holder of this document is advised that information contained hereon reflects the Company's findings at the time of its intervention only and within the limits of Client's instructions, if any. The Company's sole responsibility is to its Client and this document does not exonerate parties to a transaction from exercising all their rights and obligations under the transaction documents. This document cannot be reproduced except in full, without prior written approval of the Company. Any unauthorized alteration, forgery or falsification of the content or appearance of this document is unlawful and offenders may be prosecuted to the fullest extent of the law.

SGS Taiwan Ltd.

No.134,WuKungRoad,NewTaipeiIndustrialPark,WukuDistrict,NewTaipeiCity,Taiwan24803/新北市五股區新北產業園區五工路 134 號

台灣檢驗科技股份有限公司

t (886-2) 2299-3279

f (886-2) 2298-0488

www.tw.sgs.com

Member of SGS Group

FREQUENCY ERROR vs. VOLTAGE

Reference Frequency: WCDMA V Mid Channel 836.6 MHz				
Limit: +/- 2.5 ppm				
Power Supply	Environment	Frequency	Delta (Hz)	Limit (Hz)
Vdc	Temperature ()	(MHz)		
4.4	20	836600000	1	2091
3.8	20	836599999	0	2091
3.2	20	836600000	1	2091
2.9 (End Point)	20	836599997	-2	2091

FREQUENCY ERROR vs. TEMPERATURE

Reference Frequency: WCDMA V Mid Channel 836.6 MHz				
Limit: +/- 2.5 ppm				
Power Supply	Environment	Frequency	Delta (Hz)	Limit (Hz)
Vdc	Temperature ()	(MHz)		
3.8	50	836599999	0	2091
3.8	40	836600000	1	2091
3.8	30	836600002	3	2091
3.8	20	836599999	0	2091
3.8	10	836599997	-2	2091
3.8	0	836600000	1	2091
3.8	-10	836600001	2	2091
3.8	-20	836599997	-2	2091
3.8	-30	836599998	-1	2091

Unless otherwise stated the results shown in this test report refer only to the sample(s) tested and such sample(s) are retained for 90 days only.

除非另有說明，此報告結果僅對測試之樣品負責，同時此樣品僅保留90天。本報告未經本公司書面許可，不可部份複製。

This document is issued by the Company subject to its General Conditions of Service printed overleaf, available on request or accessible at www.sgs.com/terms_and_conditions.htm and, for electronic format documents, subject to Terms and Conditions for Electronic Documents at www.sgs.com/terms_e-document.htm. Attention is drawn to the limitation of liability, indemnification and jurisdiction issues defined therein. Any holder of this document is advised that information contained hereon reflects the Company's findings at the time of its intervention only and within the limits of Client's instructions, if any. The Company's sole responsibility is to its Client and this document does not exonerate parties to a transaction from exercising all their rights and obligations under the transaction documents. This document cannot be reproduced except in full, without prior written approval of the Company. Any unauthorized alteration, forgery or falsification of the content or appearance of this document is unlawful and offenders may be prosecuted to the fullest extent of the law.

SGS Taiwan Ltd.

No.134,WuKungRoad,NewTaipeiIndustrialPark,WukuDistrict,NewTaipeiCity,Taiwan24803/新北市五股區新北產業園區五工路 134 號

台灣檢驗科技股份有限公司

t (886-2) 2299-3279

f (886-2) 2298-0488

www.tw.sgs.com

Member of SGS Group

FREQUENCY ERROR vs. VOLTAGE

Reference Frequency:		LTE B2 Mid Channel	1880	MHz	10M QPSK CH 18900
Limit: +/- 2.5 ppm					
Power Supply	Environment	Frequency	Delta (Hz)	Limit (Hz)	
Vdc	Temperature ()	(MHz)			
4.37	25	1879.999992	-2.80	4700	
3.8	25	1879.999995	0.00	4700	
3.23	25	1879.999996	0.90	4700	
3.16 (End Point)	25	1879.999992	-2.50	4700	

FREQUENCY ERROR vs. TEMPERATURE

Reference Frequency:		LTE B2 Mid Channel	1880	MHz	10M QPSK CH 18900
Limit: +/- 2.5 ppm					
Power Supply	Environment	Frequency	Delta (Hz)	Limit (Hz)	
Vdc	Temperature ()	(MHz)			
3.8	-30	1879.999993	-1.40	4700	
3.8	-20	1879.999993	-1.10	4700	
3.8	-10	1879.999994	0.00	4700	
3.8	0	1879.999994	-0.60	4700	
3.8	10	1879.999995	1.10	4700	
3.8	20	1879.999994	0.00	4700	
3.8	30	1879.999996	2.00	4700	
3.8	40	1879.999995	0.30	4700	
3.8	50	1879.999994	-0.30	4700	

Unless otherwise stated the results shown in this test report refer only to the sample(s) tested and such sample(s) are retained for 90 days only.

除非另有說明，此報告結果僅對測試之樣品負責，同時此樣品僅保留90天。本報告未經本公司書面許可，不可部份複製。

This document is issued by the Company subject to its General Conditions of Service printed overleaf, available on request or accessible at www.sgs.com/terms_and_conditions.htm and, for electronic format documents, subject to Terms and Conditions for Electronic Documents at www.sgs.com/terms_e-document.htm. Attention is drawn to the limitation of liability, indemnification and jurisdiction issues defined therein. Any holder of this document is advised that information contained hereon reflects the Company's findings at the time of its intervention only and within the limits of Client's instructions, if any. The Company's sole responsibility is to its Client and this document does not exonerate parties to a transaction from exercising all their rights and obligations under the transaction documents. This document cannot be reproduced except in full, without prior written approval of the Company. Any unauthorized alteration, forgery or falsification of the content or appearance of this document is unlawful and offenders may be prosecuted to the fullest extent of the law.

SGS Taiwan Ltd.

No.134,WuKungRoad,NewTaipeiIndustrialPark,WukuDistrict,NewTaipeiCity,Taiwan24803/新北市五股區新北產業園區五工路 134 號

台灣檢驗科技股份有限公司

t (886-2) 2299-3279

f (886-2) 2298-0488

www.tw.sgs.com

Member of SGS Group

FREQUENCY ERROR vs. VOLTAGE

Reference Frequency:		LTE B4 Mid Channel	1732.5	MHz	10M QPSK CH 20175
Limit: +/- 2.5 ppm					
Power Supply	Environment	Frequency	Delta (Hz)	Limit (Hz)	
Vdc	Temperature ()	(MHz)			
4.370	25	1732.499993	-2.60	4331	
3.800	25	1732.499996	0.00	4331	
3.230	25	1732.499994	-1.90	4331	
3.20 (End Point)	25	1732.499995	-0.50	4331	

FREQUENCY ERROR vs. TEMPERATURE

Reference Frequency:		LTE B4 Mid Channel	1732.5	MHz	10M QPSK CH 20175
Limit: +/- 2.5 ppm					
Power Supply	Environment	Frequency	Delta (Hz)	Limit (Hz)	
Vdc	Temperature ()	(MHz)			
3.8	-30	1732.499994	-1.40	4331	
3.8	-20	1732.499994	-1.10	4331	
3.8	-10	1732.499994	-1.00	4331	
3.8	0	1732.499995	-0.20	4331	
3.8	10	1732.499995	-0.60	4331	
3.8	20	1732.499995	0.00	4331	
3.8	30	1732.499996	0.50	4331	
3.8	40	1732.499996	0.70	4331	
3.8	50	1732.499997	1.40	4331	

Unless otherwise stated the results shown in this test report refer only to the sample(s) tested and such sample(s) are retained for 90 days only.

除非另有說明，此報告結果僅對測試之樣品負責，同時此樣品僅保留90天。本報告未經本公司書面許可，不可部份複製。

This document is issued by the Company subject to its General Conditions of Service printed overleaf, available on request or accessible at www.sgs.com/terms_and_conditions.htm and, for electronic format documents, subject to Terms and Conditions for Electronic Documents at www.sgs.com/terms_e-document.htm. Attention is drawn to the limitation of liability, indemnification and jurisdiction issues defined therein. Any holder of this document is advised that information contained hereon reflects the Company's findings at the time of its intervention only and within the limits of Client's instructions, if any. The Company's sole responsibility is to its Client and this document does not exonerate parties to a transaction from exercising all their rights and obligations under the transaction documents. This document cannot be reproduced except in full, without prior written approval of the Company. Any unauthorized alteration, forgery or falsification of the content or appearance of this document is unlawful and offenders may be prosecuted to the fullest extent of the law.

SGS Taiwan Ltd.

No.134,WuKungRoad,NewTaipeiIndustrialPark,WukuDistrict,NewTaipeiCity,Taiwan24803/新北市五股區新北產業園區五工路 134 號

台灣檢驗科技股份有限公司

t (886-2) 2299-3279

f (886-2) 2298-0488

www.tw.sgs.com

Member of SGS Group

FREQUENCY ERROR vs. VOLTAGE

Reference Frequency:		LTE B5 Mid Channel	836.5	MHz	10M QPSK CH 20525
Limit: +/- 2.5 ppm					
Power Supply	Environment	Frequency	Delta (Hz)	Limit (Hz)	
Vdc	Temperature ()	(MHz)			
4.37	25	836.500005	1.70	2091	
3.8	25	836.500003	0.00	2091	
3.23	25	836.500003	0.40	2091	
3.22 (End Point)	25	836.500004	1.10	2091	

FREQUENCY ERROR vs. TEMPERATURE

Reference Frequency:		LTE B5 Mid Channel	836.5	MHz	10M QPSK CH 20525
Limit: +/- 2.5 ppm					
Power Supply	Environment	Frequency	Delta (Hz)	Limit (Hz)	
Vdc	Temperature ()	(MHz)			
3.8	-30	836.500006	2.40	2091	
3.8	-20	836.500006	2.80	2091	
3.8	-10	836.500005	2.00	2091	
3.8	0	836.500005	1.60	2091	
3.8	10	836.500004	0.50	2091	
3.8	20	836.500003	0.00	2091	
3.8	30	836.500004	0.60	2091	
3.8	40	836.500005	1.80	2091	
3.8	50	836.500006	2.40	2091	

Unless otherwise stated the results shown in this test report refer only to the sample(s) tested and such sample(s) are retained for 90 days only.

除非另有說明，此報告結果僅對測試之樣品負責，同時此樣品僅保留90天。本報告未經本公司書面許可，不可部份複製。

This document is issued by the Company subject to its General Conditions of Service printed overleaf, available on request or accessible at www.sgs.com/terms_and_conditions.htm and, for electronic format documents, subject to Terms and Conditions for Electronic Documents at www.sgs.com/terms_e-document.htm. Attention is drawn to the limitation of liability, indemnification and jurisdiction issues defined therein. Any holder of this document is advised that information contained hereon reflects the Company's findings at the time of its intervention only and within the limits of Client's instructions, if any. The Company's sole responsibility is to its Client and this document does not exonerate parties to a transaction from exercising all their rights and obligations under the transaction documents. This document cannot be reproduced except in full, without prior written approval of the Company. Any unauthorized alteration, forgery or falsification of the content or appearance of this document is unlawful and offenders may be prosecuted to the fullest extent of the law.

SGS Taiwan Ltd.

No.134,WuKungRoad,NewTaipeiIndustrialPark,WukuDistrict,NewTaipeiCity,Taiwan24803/新北市五股區新北產業園區五工路 134 號

台灣檢驗科技股份有限公司

t (886-2) 2299-3279

f (886-2) 2298-0488

www.tw.sgs.com

Member of SGS Group

FREQUENCY ERROR vs. VOLTAGE

Reference Frequency:		LTE B7 Mid Channel	2535.0	MHz	10M QPSK CH
					21100
Limit: +/- 2.5 ppm					
Power Supply	Environment	Frequency	Delta (Hz)	Limit (Hz)	
Vdc	Temperature ()	(MHz)			
4.37	25	2535.000010	3.30	6338	
3.8	25	2535.000006	0.00	6338	
3.23	25	2535.000007	0.30	6338	
3.15 (End Point)	25	2535.000007	0.70	6338	

FREQUENCY ERROR vs. TEMPERATURE

Reference Frequency:		LTE B7 Mid Channel	2535.0	MHz	10M QPSK CH	21100
Limit: +/- 2.5 ppm						
Power Supply	Environment	Frequency	Delta (Hz)	Limit (Hz)		
Vdc	Temperature ()	(MHz)				
3.8	-30	2535.000011	4.40	6338		
3.8	-20	2535.000010	2.70	6338		
3.8	-10	2535.000009	1.90	6338		
3.8	0	2535.000008	1.40	6338		
3.8	10	2535.000008	0.70	6338		
3.8	20	2535.000007	0.00	6338		
3.8	30	2535.000007	-0.40	6338		
3.8	40	2535.000007	-0.10	6338		
3.8	50	2535.000007	0.40	6338		

Unless otherwise stated the results shown in this test report refer only to the sample(s) tested and such sample(s) are retained for 90 days only.

除非另有說明，此報告結果僅對測試之樣品負責，同時此樣品僅保留90天。本報告未經本公司書面許可，不可部份複製。

This document is issued by the Company subject to its General Conditions of Service printed overleaf, available on request or accessible at www.sgs.com/terms_and_conditions.htm and, for electronic format documents, subject to Terms and Conditions for Electronic Documents at www.sgs.com/terms_e-document.htm. Attention is drawn to the limitation of liability, indemnification and jurisdiction issues defined therein. Any holder of this document is advised that information contained hereon reflects the Company's findings at the time of its intervention only and within the limits of Client's instructions, if any. The Company's sole responsibility is to its Client and this document does not exonerate parties to a transaction from exercising all their rights and obligations under the transaction documents. This document cannot be reproduced except in full, without prior written approval of the Company. Any unauthorized alteration, forgery or falsification of the content or appearance of this document is unlawful and offenders may be prosecuted to the fullest extent of the law.

SGS Taiwan Ltd.

No.134,WuKungRoad,NewTaipeiIndustrialPark,WukuDistrict,NewTaipeiCity,Taiwan24803/新北市五股區新北產業園區五工路 134 號

台灣檢驗科技股份有限公司

t (886-2) 2299-3279

f (886-2) 2298-0488

www.tw.sgs.com

Member of SGS Group

FREQUENCY ERROR vs. VOLTAGE

Reference Frequency:		LTE B12 Mid Channel	707.5	MHz	10M QPSK CH 23095
Limit: +/- 2.5 ppm					
Power Supply	Environment	Frequency	Delta (Hz)	Limit (Hz)	
Vdc	Temperature ()	(MHz)			
4.37	25	707.499996	-0.80	1769	
3.8	25	707.499997	0.00	1769	
3.23	25	707.499997	0.20	1769	
3.21 (End Point)	25	707.499996	-0.50	1769	

FREQUENCY ERROR vs. TEMPERATURE

Reference Frequency:		LTE B12 Mid Channel	707.5	MHz	10M QPSK CH 23095
Limit: +/- 2.5 ppm					
Power Supply	Environment	Frequency	Delta (Hz)	Limit (Hz)	
Vdc	Temperature ()	(MHz)			
3.8	-30	707.499996	-0.90	1769	
3.8	-20	707.499995	-1.10	1769	
3.8	-10	707.499995	-1.60	1769	
3.8	0	707.499995	-1.30	1769	
3.8	10	707.499997	0.30	1769	
3.8	20	707.499997	0.00	1769	
3.8	30	707.499996	-0.60	1769	
3.8	40	707.499995	-1.10	1769	
3.8	50	707.499996	-0.50	1769	

Unless otherwise stated the results shown in this test report refer only to the sample(s) tested and such sample(s) are retained for 90 days only.

除非另有說明，此報告結果僅對測試之樣品負責，同時此樣品僅保留90天。本報告未經本公司書面許可，不可部份複製。

This document is issued by the Company subject to its General Conditions of Service printed overleaf, available on request or accessible at www.sgs.com/terms_and_conditions.htm and, for electronic format documents, subject to Terms and Conditions for Electronic Documents at www.sgs.com/terms_e-document.htm. Attention is drawn to the limitation of liability, indemnification and jurisdiction issues defined therein. Any holder of this document is advised that information contained hereon reflects the Company's findings at the time of its intervention only and within the limits of Client's instructions, if any. The Company's sole responsibility is to its Client and this document does not exonerate parties to a transaction from exercising all their rights and obligations under the transaction documents. This document cannot be reproduced except in full, without prior written approval of the Company. Any unauthorized alteration, forgery or falsification of the content or appearance of this document is unlawful and offenders may be prosecuted to the fullest extent of the law.

SGS Taiwan Ltd.

No.134,WuKungRoad,NewTaipeiIndustrialPark,WukuDistrict,NewTaipeiCity,Taiwan24803/新北市五股區新北產業園區五工路 134 號

台灣檢驗科技股份有限公司

t (886-2) 2299-3279

f (886-2) 2298-0488

www.tw.sgs.com

Member of SGS Group

FREQUENCY ERROR vs. VOLTAGE

Reference Frequency:		LTE B13 Mid Channel	782.0	MHz	10M QPSK CH 23230
Limit: +/- 2.5 ppm					
Power Supply	Environment	Frequency	Delta (Hz)	Limit (Hz)	
Vdc	Temperature ()	(MHz)			
4.370	25	781.999997	0.90	1955	
3.800	25	781.999997	0.00	1955	
3.230	25	781.999996	-0.60	1955	
3.22 (End Point)	25	781.999995	-1.30	1955	

FREQUENCY ERROR vs. TEMPERATURE

Reference Frequency:		LTE B13 Mid Channel	782.0	MHz	10M QPSK CH 23230
Limit: +/- 2.5 ppm					
Power Supply	Environment	Frequency	Delta (Hz)	Limit (Hz)	
Vdc	Temperature ()	(MHz)			
3.8	-30	781.999994	-1.80	1955	
3.8	-20	781.999995	-1.70	1955	
3.8	-10	781.999995	-1.20	1955	
3.8	0	781.999996	-0.30	1955	
3.8	10	781.999997	0.30	1955	
3.8	20	781.999996	0.00	1955	
3.8	30	781.999997	0.50	1955	
3.8	40	781.999996	-0.10	1955	
3.8	50	781.999997	0.40	1955	

Unless otherwise stated the results shown in this test report refer only to the sample(s) tested and such sample(s) are retained for 90 days only.

除非另有說明，此報告結果僅對測試之樣品負責，同時此樣品僅保留90天。本報告未經本公司書面許可，不可部份複製。

This document is issued by the Company subject to its General Conditions of Service printed overleaf, available on request or accessible at www.sgs.com/terms_and_conditions.htm and, for electronic format documents, subject to Terms and Conditions for Electronic Documents at www.sgs.com/terms_e-document.htm. Attention is drawn to the limitation of liability, indemnification and jurisdiction issues defined therein. Any holder of this document is advised that information contained hereon reflects the Company's findings at the time of its intervention only and within the limits of Client's instructions, if any. The Company's sole responsibility is to its Client and this document does not exonerate parties to a transaction from exercising all their rights and obligations under the transaction documents. This document cannot be reproduced except in full, without prior written approval of the Company. Any unauthorized alteration, forgery or falsification of the content or appearance of this document is unlawful and offenders may be prosecuted to the fullest extent of the law.

SGS Taiwan Ltd.

No.134,WuKungRoad,NewTaipeiIndustrialPark,WukuDistrict,NewTaipeiCity,Taiwan24803/新北市五股區新北產業園區五工路 134 號

台灣檢驗科技股份有限公司

t (886-2) 2299-3279

f (886-2) 2298-0488

www.tw.sgs.com

Member of SGS Group

FREQUENCY ERROR vs. VOLTAGE

Reference Frequency:		LTE B17 Mid Channel	710.0	MHz	10M QPSK CH 23790
Limit: +/- 2.5 ppm					
Power Supply	Environment	Frequency	Delta (Hz)	Limit (Hz)	
Vdc	Temperature ()	(MHz)			
4.37	25	710.000002	-0.30	1775	
3.8	25	710.000002	0.00	1775	
3.23	25	710.000002	0.10	1775	
3.15 (End Point)	25	710.000005	2.70	1775	

FREQUENCY ERROR vs. TEMPERATURE

Reference Frequency:		LTE B17 Mid Channel	710.0	MHz	10M QPSK CH 23790
Limit: +/- 2.5 ppm					
Power Supply	Environment	Frequency	Delta (Hz)	Limit (Hz)	
Vdc	Temperature ()	(MHz)			
3.8	-30	709.999995	-3.20	1775	
3.8	-20	709.999996	-2.00	1775	
3.8	-10	709.999997	-1.90	1775	
3.8	0	709.999998	-0.80	1775	
3.8	10	709.999998	-0.40	1775	
3.8	20	709.999998	0.00	1775	
3.8	30	709.999999	0.50	1775	
3.8	40	709.999998	-0.90	1775	
3.8	50	709.999997	-1.50	1775	

Note: The battery is rated 3.8V dc.

Unless otherwise stated the results shown in this test report refer only to the sample(s) tested and such sample(s) are retained for 90 days only.

除非另有說明，此報告結果僅對測試之樣品負責，同時此樣品僅保留90天。本報告未經本公司書面許可，不可部份複製。

This document is issued by the Company subject to its General Conditions of Service printed overleaf, available on request or accessible at www.sgs.com/terms_and_conditions.htm and, for electronic format documents, subject to Terms and Conditions for Electronic Documents at www.sgs.com/terms_e-document.htm. Attention is drawn to the limitation of liability, indemnification and jurisdiction issues defined therein. Any holder of this document is advised that information contained hereon reflects the Company's findings at the time of its intervention only and within the limits of Client's instructions, if any. The Company's sole responsibility is to its Client and this document does not exonerate parties to a transaction from exercising all their rights and obligations under the transaction documents. This document cannot be reproduced except in full, without prior written approval of the Company. Any unauthorized alteration, forgery or falsification of the content or appearance of this document is unlawful and offenders may be prosecuted to the fullest extent of the law.

SGS Taiwan Ltd.

No.134,WuKungRoad,NewTaipeiIndustrialPark,WukuDistrict,NewTaipeiCity,Taiwan24803/新北市五股區新北產業園區五工路 134 號

台灣檢驗科技股份有限公司

t (886-2) 2299-3279

f (886-2) 2298-0488

www.tw.sgs.com

Member of SGS Group

11. PEAK TO AVERAGE RATIO

11.1. Standard Applicable

The peak-to-average ration (PAR) of the transmission may not exceed 13dB.

11.2. Test SET-UP

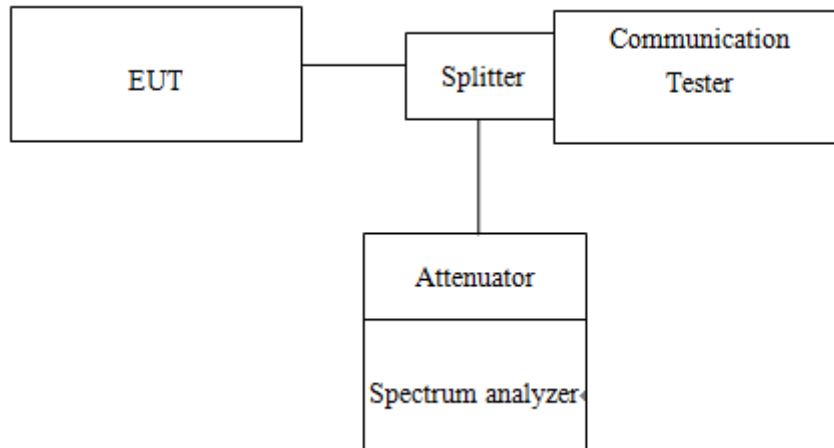

11.3. Measurement Procedure

1. KDB 971168 D01 is employed as the following procedure is proper adjusted accordingly:
2. Set resolution/measurement bandwidth \geq signal's occupied bandwidth; & internal =1ms
3. Set the number of counts to a value that stabilizes the measured CCDF curve.

11.4. Measurement Equipment Used

Conducted Emission (measured at antenna port) Test Site					
EQUIPMENT TYPE	MFR	MODEL NUMBER	SERIAL NUMBER	LAST CAL.	CAL DUE.
Spectrum Analyzer	Agilent	E4440A	MY45304525	05/05/2015	05/04/2016
Radio Communication Analyzer	R&S	CMU200	102189	02/11/2015	02/10/2016
Radio Communication Analyzer	Anritsu	MT8820C	6200995019	10/08/2014	10/09/2015
Temperature Chamber	TERCHY	MHG-120LF	911009	05/06/2015	05/05/2016
DC Block	Mini-Circuits	BLK-18-S+	1	01/02/2015	01/01/2016
Attenuator	Mini-Circuit	BW-S10W2+	002	01/02/2015	01/01/2016
Splitter	Agilent	11636B	N/A	01/02/2015	01/01/2016

Unless otherwise stated the results shown in this test report refer only to the sample(s) tested and such sample(s) are retained for 90 days only.

除非另有說明，此報告結果僅對測試之樣品負責，同時此樣品僅保留90天。本報告未經本公司書面許可，不可部份複製。

This document is issued by the Company subject to its General Conditions of Service printed overleaf, available on request or accessible at www.sgs.com/terms_and_conditions.htm and, for electronic format documents, subject to Terms and Conditions for Electronic Documents at www.sgs.com/terms_e-document.htm. Attention is drawn to the limitation of liability, indemnification and jurisdiction issues defined therein. Any holder of this document is advised that information contained hereon reflects the Company's findings at the time of its intervention only and within the limits of Client's instructions, if any. The Company's sole responsibility is to its Client and this document does not exonerate parties to a transaction from exercising all their rights and obligations under the transaction documents. This document cannot be reproduced except in full, without prior written approval of the Company. Any unauthorized alteration, forgery or falsification of the content or appearance of this document is unlawful and offenders may be prosecuted to the fullest extent of the law.

11.5. Measurement Result

Tabular Results:

Frequency (MHz)	CH	Peak-to-Average Ratio (dB)		
		GSM	GPRS	EDGE
824.20	128	9.81	9.88	12.53
836.60	190	9.53	10.47	12.40
848.80	251	9.69	9.74	12.55

Frequency (MHz)	CH	Peak-to-Average Ratio (dB)		
		GSM	GPRS	EDGE
1850.20	512	9.75	9.72	12.90
1880.00	661	8.80	9.53	12.32
1909.80	810	9.37	9.47	12.95

Frequency (MHz)	CH	Peak-to-Average Ratio (dB)		
		WCDMA II	HSDPA II	HSUPA II
1712.40	1312	2.67	3.63	3.65
1732.60	1413	2.76	3.67	3.74
1752.6	1513	2.53	3.47	3.48

Frequency (MHz)	CH	Peak-to-Average Ratio (dB)		
		WCDMA IV	HSDPA IV	HSUPA IV
1850.20	9262	2.74	3.75	3.83
1880.00	9400	2.84	3.93	4.00
1909.80	9538	2.68	3.78	3.85

Unless otherwise stated the results shown in this test report refer only to the sample(s) tested and such sample(s) are retained for 90 days only.

除非另有說明，此報告結果僅對測試之樣品負責，同時此樣品僅保留90天。本報告未經本公司書面許可，不可部份複製。

This document is issued by the Company subject to its General Conditions of Service printed overleaf, available on request or accessible at www.sgs.com/terms_and_conditions.htm and, for electronic format documents, subject to Terms and Conditions for Electronic Documents at www.sgs.com/terms_e-document.htm. Attention is drawn to the limitation of liability, indemnification and jurisdiction issues defined therein. Any holder of this document is advised that information contained hereon reflects the Company's findings at the time of its intervention only and within the limits of Client's instructions, if any. The Company's sole responsibility is to its Client and this document does not exonerate parties to a transaction from exercising all their rights and obligations under the transaction documents. This document cannot be reproduced except in full, without prior written approval of the Company. Any unauthorized alteration, forgery or falsification of the content or appearance of this document is unlawful and offenders may be prosecuted to the fullest extent of the law.

Frequency (MHz)	CH	Peak-to-Average Ratio (dB)		
		WCDMA V	HSDPA V	HSUPA V
826.40	4132	2.67	3.63	3.65
836.60	4183	2.76	3.67	3.74
846.60	4233	2.53	3.47	3.48

Unless otherwise stated the results shown in this test report refer only to the sample(s) tested and such sample(s) are retained for 90 days only.

除非另有說明，此報告結果僅對測試之樣品負責，同時此樣品僅保留90天。本報告未經本公司書面許可，不可部份複製。

This document is issued by the Company subject to its General Conditions of Service printed overleaf, available on request or accessible at www.sgs.com/terms_and_conditions.htm and, for electronic format documents, subject to Terms and Conditions for Electronic Documents at www.sgs.com/terms_e-document.htm. Attention is drawn to the limitation of liability, indemnification and jurisdiction issues defined therein. Any holder of this document is advised that information contained hereon reflects the Company's findings at the time of its intervention only and within the limits of Client's instructions, if any. The Company's sole responsibility is to its Client and this document does not exonerate parties to a transaction from exercising all their rights and obligations under the transaction documents. This document cannot be reproduced except in full, without prior written approval of the Company. Any unauthorized alteration, forgery or falsification of the content or appearance of this document is unlawful and offenders may be prosecuted to the fullest extent of the law.

SGS Taiwan Ltd.

No.134,WuKungRoad,NewTaipeiIndustrialPark,WukuDistrict,NewTaipeiCity,Taiwan24803/新北市五股區新北產業園區五工路 134 號

台灣檢驗科技股份有限公司

t (886-2) 2299-3279

f (886-2) 2298-0488

www.tw.sgs.com

Member of SGS Group

LTE BAND 2							
Channel bandwidth: 1.4MHz				Channel bandwidth: 3MHz			
Frequency (MHz)	CH	Peak-to-Average Ratio (dB)		Frequency (MHz)	CH	Peak-to-Average Ratio (dB)	
		16QAM	LIMIT			16QAM	LIMIT
1850.7	18607	5.81	13	1851.5	18615	5.63	13
1880.0	18900	6.50	13	1880.0	18900	6.25	13
1909.3	19193	5.35	13	1908.5	19185	5.44	13

LTE BAND 2							
Channel bandwidth: 5MHz				Channel bandwidth: 10MHz			
Frequency (MHz)	CH	Peak-to-Average Ratio (dB)		Frequency (MHz)	CH	Peak-to-Average Ratio (dB)	
		16QAM	LIMIT			16QAM	LIMIT
1852.5	18625	6.09	13	1855.0	18650	6.11	13
1880.0	18900	6.55	13	1880.0	18900	6.44	13
1907.5	19175	6.04	13	1905.0	19150	6.13	13

LTE BAND 2							
Channel bandwidth: 15MHz				Channel bandwidth: 20MHz			
Frequency (MHz)	CH	Peak-to-Average Ratio (dB)		Frequency (MHz)	CH	Peak-to-Average Ratio (dB)	
		16QAM	LIMIT			16QAM	LIMIT
1857.5	18675	6.64	13	1860.0	18700	6.93	13
1880.0	18900	6.75	13	1880.0	18900	7.11	13
1902.5	19125	6.71	13	1900.0	19100	7.02	13

Unless otherwise stated the results shown in this test report refer only to the sample(s) tested and such sample(s) are retained for 90 days only.

除非另有說明，此報告結果僅對測試之樣品負責，同時此樣品僅保留90天。本報告未經本公司書面許可，不可部份複製。

This document is issued by the Company subject to its General Conditions of Service printed overleaf, available on request or accessible at www.sgs.com/terms_and_conditions.htm and, for electronic format documents, subject to Terms and Conditions for Electronic Documents at www.sgs.com/terms_e-document.htm. Attention is drawn to the limitation of liability, indemnification and jurisdiction issues defined therein. Any holder of this document is advised that information contained hereon reflects the Company's findings at the time of its intervention only and within the limits of Client's instructions, if any. The Company's sole responsibility is to its Client and this document does not exonerate parties to a transaction from exercising all their rights and obligations under the transaction documents. This document cannot be reproduced except in full, without prior written approval of the Company. Any unauthorized alteration, forgery or falsification of the content or appearance of this document is unlawful and offenders may be prosecuted to the fullest extent of the law.

SGS Taiwan Ltd.

No.134,WuKungRoad,NewTaipeiIndustrialPark,WukuDistrict,NewTaipeiCity,Taiwan24803/新北市五股區新北產業園區五工路 134 號

台灣檢驗科技股份有限公司

t (886-2) 2299-3279

f (886-2) 2298-0488

www.tw.sgs.com

Member of SGS Group

LTE BAND 4							
Channel bandwidth: 1.4MHz				Channel bandwidth: 3MHz			
Frequency (MHz)	CH	Peak-to-Average Ratio (dB)		Frequency (MHz)	CH	Peak-to-Average Ratio (dB)	
		16QAM	LIMIT			16QAM	LIMIT
1710.7	19957	5.56	13	1711.5	19965	5.47	13
1732.5	20175	5.83	13	1732.5	20175	5.79	13
1754.3	20393	5.21	13	1753.5	20385	5.19	13

LTE BAND 4							
Channel bandwidth: 5MHz				Channel bandwidth: 10MHz			
Frequency (MHz)	CH	Peak-to-Average Ratio (dB)		Frequency (MHz)	CH	Peak-to-Average Ratio (dB)	
		16QAM	LIMIT			16QAM	LIMIT
1712.5	19957	5.75	13	1715.0	20000	5.99	13
1732.5	20175	6.04	13	1732.5	20175	6.06	13
1752.5	20375	5.57	13	1750.0	20350	5.81	13

LTE BAND 4							
Channel bandwidth: 15MHz				Channel bandwidth: 20MHz			
Frequency (MHz)	CH	Peak-to-Average Ratio (dB)		Frequency (MHz)	CH	Peak-to-Average Ratio (dB)	
		16QAM	LIMIT			16QAM	LIMIT
1717.5	20025	6.67	13	1720.0	20050	7.07	13
1732.5	20175	6.63	13	1732.5	20175	6.99	13
1747.5	20325	6.57	13	1745.0	20300	6.95	13

Unless otherwise stated the results shown in this test report refer only to the sample(s) tested and such sample(s) are retained for 90 days only.

除非另有說明，此報告結果僅對測試之樣品負責，同時此樣品僅保留90天。本報告未經本公司書面許可，不可部份複製。

This document is issued by the Company subject to its General Conditions of Service printed overleaf, available on request or accessible at www.sgs.com/terms_and_conditions.htm and, for electronic format documents, subject to Terms and Conditions for Electronic Documents at www.sgs.com/terms_e-document.htm. Attention is drawn to the limitation of liability, indemnification and jurisdiction issues defined therein. Any holder of this document is advised that information contained hereon reflects the Company's findings at the time of its intervention only and within the limits of Client's instructions, if any. The Company's sole responsibility is to its Client and this document does not exonerate parties to a transaction from exercising all their rights and obligations under the transaction documents. This document cannot be reproduced except in full, without prior written approval of the Company. Any unauthorized alteration, forgery or falsification of the content or appearance of this document is unlawful and offenders may be prosecuted to the fullest extent of the law.

SGS Taiwan Ltd.

No.134,WuKungRoad,NewTaipeiIndustrialPark,WukuDistrict,NewTaipeiCity,Taiwan24803/新北市五股區新北產業園區五工路 134 號

台灣檢驗科技股份有限公司

t (886-2) 2299-3279

f (886-2) 2298-0488

www.tw.sgs.com

Member of SGS Group

LTE BAND 5							
Channel bandwidth: 1.4MHz				Channel bandwidth: 3MHz			
Frequency (MHz)	CH	Peak-to-Average Ratio (dB)		Frequency (MHz)	CH	Peak-to-Average Ratio (dB)	
		16QAM	LIMIT			16QAM	LIMIT
824.7	20407	6.61	13	825.5	20415	6.31	13
836.5	20525	6.89	13	836.5	20525	6.65	13
848.3	20643	6.64	13	847.5	20635	6.44	13

LTE BAND 5							
Channel bandwidth: 5MHz				Channel bandwidth: 10MHz			
Frequency (MHz)	CH	Peak-to-Average Ratio (dB)		Frequency (MHz)	CH	Peak-to-Average Ratio (dB)	
		16QAM	LIMIT			16QAM	LIMIT
826.5	20425	6.56	13	2505.0	20800	6.51	13
836.5	20525	6.78	13	2535.0	21100	6.66	13
846.5	20625	6.52	13	2565.0	21400	6.53	13

LTE BAND 7							
Channel bandwidth: 5MHz				Channel bandwidth: 10MHz			
Frequency (MHz)	CH	Peak-to-Average Ratio (dB)		Frequency (MHz)	CH	Peak-to-Average Ratio (dB)	
		16QAM	LIMIT			16QAM	LIMIT
2502.5	20775	6.40	13	2505.0	20800	6.42	13
2535.0	21100	6.48	13	2535.0	21100	6.44	13
2567.5	21425	6.06	13	2565.0	21400	5.99	13

Unless otherwise stated the results shown in this test report refer only to the sample(s) tested and such sample(s) are retained for 90 days only.

除非另有說明，此報告結果僅對測試之樣品負責，同時此樣品僅保留90天。本報告未經本公司書面許可，不可部份複製。

This document is issued by the Company subject to its General Conditions of Service printed overleaf, available on request or accessible at www.sgs.com/terms_and_conditions.htm and, for electronic format documents, subject to Terms and Conditions for Electronic Documents at www.sgs.com/terms_e-document.htm. Attention is drawn to the limitation of liability, indemnification and jurisdiction issues defined therein. Any holder of this document is advised that information contained hereon reflects the Company's findings at the time of its intervention only and within the limits of Client's instructions, if any. The Company's sole responsibility is to its Client and this document does not exonerate parties to a transaction from exercising all their rights and obligations under the transaction documents. This document cannot be reproduced except in full, without prior written approval of the Company. Any unauthorized alteration, forgery or falsification of the content or appearance of this document is unlawful and offenders may be prosecuted to the fullest extent of the law.

LTE BAND 7							
Channel bandwidth: 15MHz				Channel bandwidth: 20MHz			
Frequency (MHz)	CH	Peak-to-Average Ratio (dB)		Frequency (MHz)	CH	Peak-to-Average Ratio (dB)	
		16QAM	LIMIT			16QAM	LIMIT
2507.5	20425	6.67	13	2510.0	20850	7.11	13
2535.0	20525	6.62	13	2535.0	21100	7.04	13
2562.5	20625	6.63	13	2560.0	21350	6.97	13

LTE BAND 12							
Channel bandwidth: 1.4MHz				Channel bandwidth: 3MHz			
Frequency (MHz)	CH	Peak-to-Average Ratio (dB)		Frequency (MHz)	CH	Peak-to-Average Ratio (dB)	
		16QAM	LIMIT			16QAM	LIMIT
699.7	23017	6.41	13	700.5	23025	5.99	13
707.5	23095	5.91	13	707.5	23095	5.92	13
715.3	23173	5.70	13	714.5	23165	5.85	13

LTE BAND 12							
Channel bandwidth: 5MHz				Channel bandwidth: 10MHz			
Frequency (MHz)	CH	Peak-to-Average Ratio (dB)		Frequency (MHz)	CH	Peak-to-Average Ratio (dB)	
		16QAM	LIMIT			16QAM	LIMIT
701.5	23035	6.08	13	704.0	23060	6.13	13
707.5	23095	6.15	13	707.5	23095	6.21	13
713.5	23155	6.34	13	711.0	23130	6.38	13

Unless otherwise stated the results shown in this test report refer only to the sample(s) tested and such sample(s) are retained for 90 days only.

除非另有說明，此報告結果僅對測試之樣品負責，同時此樣品僅保留90天。本報告未經本公司書面許可，不可部份複製。

This document is issued by the Company subject to its General Conditions of Service printed overleaf, available on request or accessible at www.sgs.com/terms_and_conditions.htm and, for electronic format documents, subject to Terms and Conditions for Electronic Documents at www.sgs.com/terms_e-document.htm. Attention is drawn to the limitation of liability, indemnification and jurisdiction issues defined therein. Any holder of this document is advised that information contained hereon reflects the Company's findings at the time of its intervention only and within the limits of Client's instructions, if any. The Company's sole responsibility is to its Client and this document does not exonerate parties to a transaction from exercising all their rights and obligations under the transaction documents. This document cannot be reproduced except in full, without prior written approval of the Company. Any unauthorized alteration, forgery or falsification of the content or appearance of this document is unlawful and offenders may be prosecuted to the fullest extent of the law.

SGS Taiwan Ltd.

No.134,WuKungRoad,NewTaipeiIndustrialPark,WukuDistrict,NewTaipeiCity,Taiwan24803/新北市五股區新北產業園區五工路 134 號

台灣檢驗科技股份有限公司

t (886-2) 2299-3279

f (886-2) 2298-0488

www.tw.sgs.com

Member of SGS Group

LTE BAND 13							
Channel bandwidth: 5MHz				Channel bandwidth: 10MHz			
Frequency (MHz)	CH	Peak-to-Average Ratio (dB)		Frequency (MHz)	CH	Peak-to-Average Ratio (dB)	
		16QAM	LIMIT			16QAM	LIMIT
779.5	23205	6.08	13	23230	782	6.19	13
782.0	23230	6.17	13				
782.0	23255	6.33	13				

LTE BAND 17							
Channel bandwidth: 5MHz				Channel bandwidth: 10MHz			
Frequency (MHz)	CH	Peak-to-Average Ratio (dB)		Frequency (MHz)	CH	Peak-to-Average Ratio (dB)	
		16QAM	LIMIT			16QAM	LIMIT
706.5	23755	5.98	13	709.0	23780	6.34	13
710.0	23790	6.55	13	710.0	23790	6.33	13
713.5	23825	6.29	13	711.0	23780	6.50	13

Unless otherwise stated the results shown in this test report refer only to the sample(s) tested and such sample(s) are retained for 90 days only.

除非另有說明，此報告結果僅對測試之樣品負責，同時此樣品僅保留90天。本報告未經本公司書面許可，不可部份複製。

This document is issued by the Company subject to its General Conditions of Service printed overleaf, available on request or accessible at www.sgs.com/terms_and_conditions.htm and, for electronic format documents, subject to Terms and Conditions for Electronic Documents at www.sgs.com/terms_e-document.htm. Attention is drawn to the limitation of liability, indemnification and jurisdiction issues defined therein. Any holder of this document is advised that information contained hereon reflects the Company's findings at the time of its intervention only and within the limits of Client's instructions, if any. The Company's sole responsibility is to its Client and this document does not exonerate parties to a transaction from exercising all their rights and obligations under the transaction documents. This document cannot be reproduced except in full, without prior written approval of the Company. Any unauthorized alteration, forgery or falsification of the content or appearance of this document is unlawful and offenders may be prosecuted to the fullest extent of the law.

SGS Taiwan Ltd.

No.134,WuKungRoad,NewTaipeiIndustrialPark,WukuDistrict,NewTaipeiCity,Taiwan24803/新北市五股區新北產業園區五工路 134 號

台灣檢驗科技股份有限公司

t (886-2) 2299-3279

f (886-2) 2298-0488

www.tw.sgs.com

Member of SGS Group

Measurement Results:

GSM 850 Channel Low

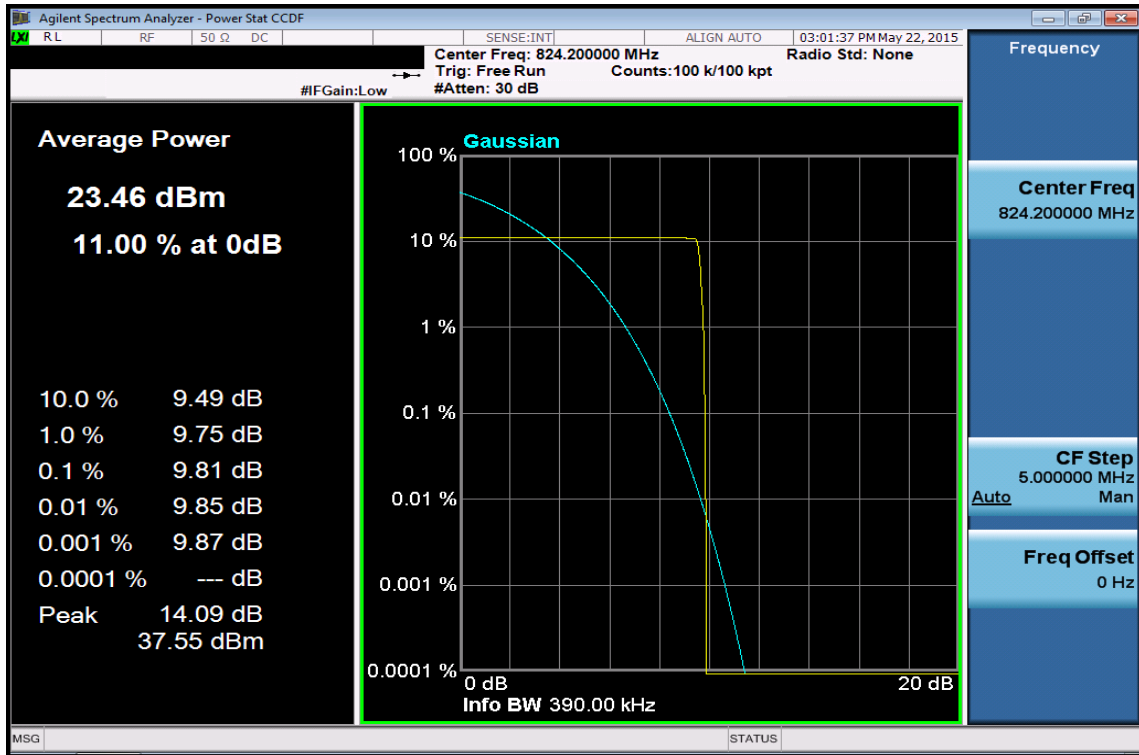

GSM 850 Channel Mid

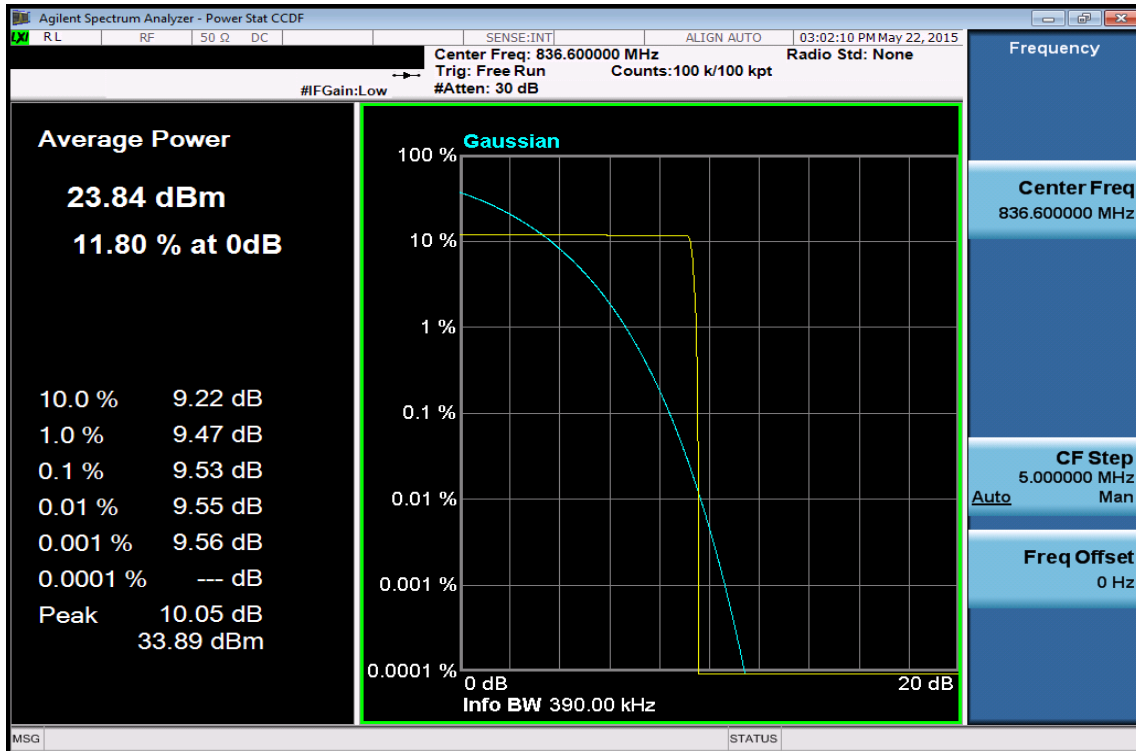

Unless otherwise stated the results shown in this test report refer only to the sample(s) tested and such sample(s) are retained for 90 days only.

除非另有說明，此報告結果僅對測試之樣品負責，同時此樣品僅保留90天。本報告未經本公司書面許可，不可部份複製。

This document is issued by the Company subject to its General Conditions of Service printed overleaf, available on request or accessible at www.sgs.com/terms_and_conditions.htm and, for electronic format documents, subject to Terms and Conditions for Electronic Documents at www.sgs.com/terms_e-document.htm. Attention is drawn to the limitation of liability, indemnification and jurisdiction issues defined therein. Any holder of this document is advised that information contained hereon reflects the Company's findings at the time of its intervention only and within the limits of Client's instructions, if any. The Company's sole responsibility is to its Client and this document does not exonerate parties to a transaction from exercising all their rights and obligations under the transaction documents. This document cannot be reproduced except in full, without prior written approval of the Company. Any unauthorized alteration, forgery or falsification of the content or appearance of this document is unlawful and offenders may be prosecuted to the fullest extent of the law.

SGS Taiwan Ltd.

No. 134, WuKungRoad, NewTaipeiIndustrialPark, WukuDistrict, NewTaipeiCity, Taiwan24803/新北市五股區新北產業園區五工路 134 號

台灣檢驗科技股份有限公司

t (886-2) 2299-3279

f (886-2) 2298-0488

www.tw.sgs.com

Member of SGS Group

GSM 850 Channel High

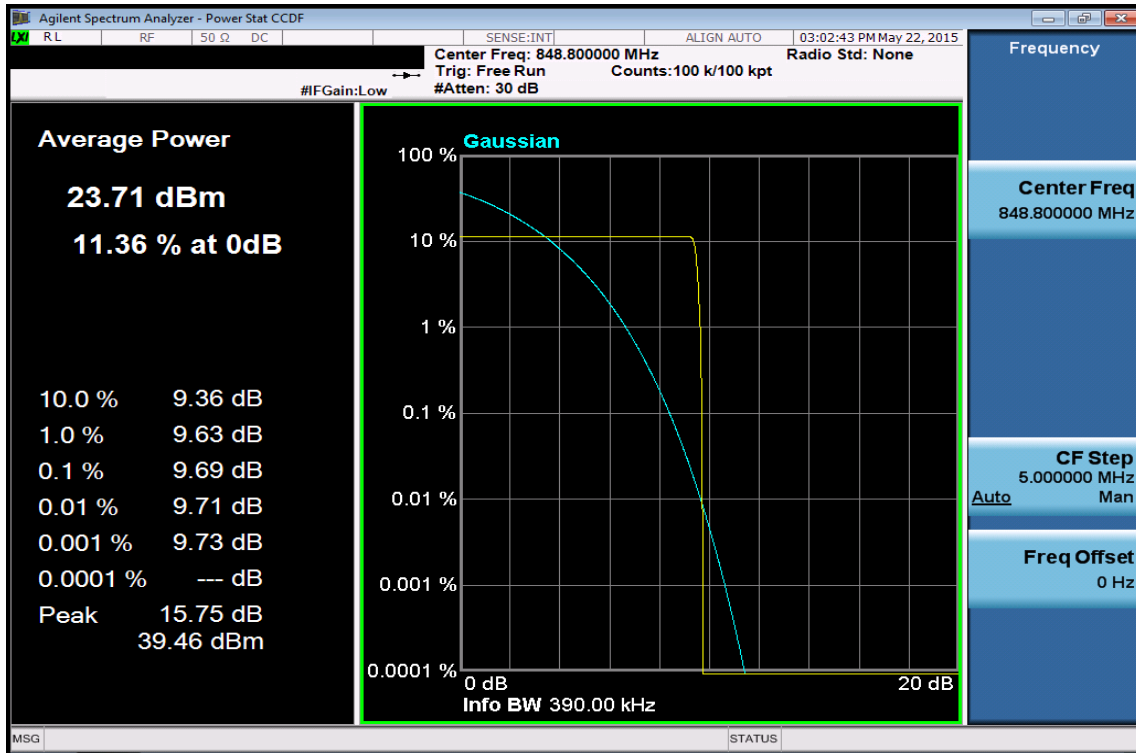

GSM 1900 Channel Low

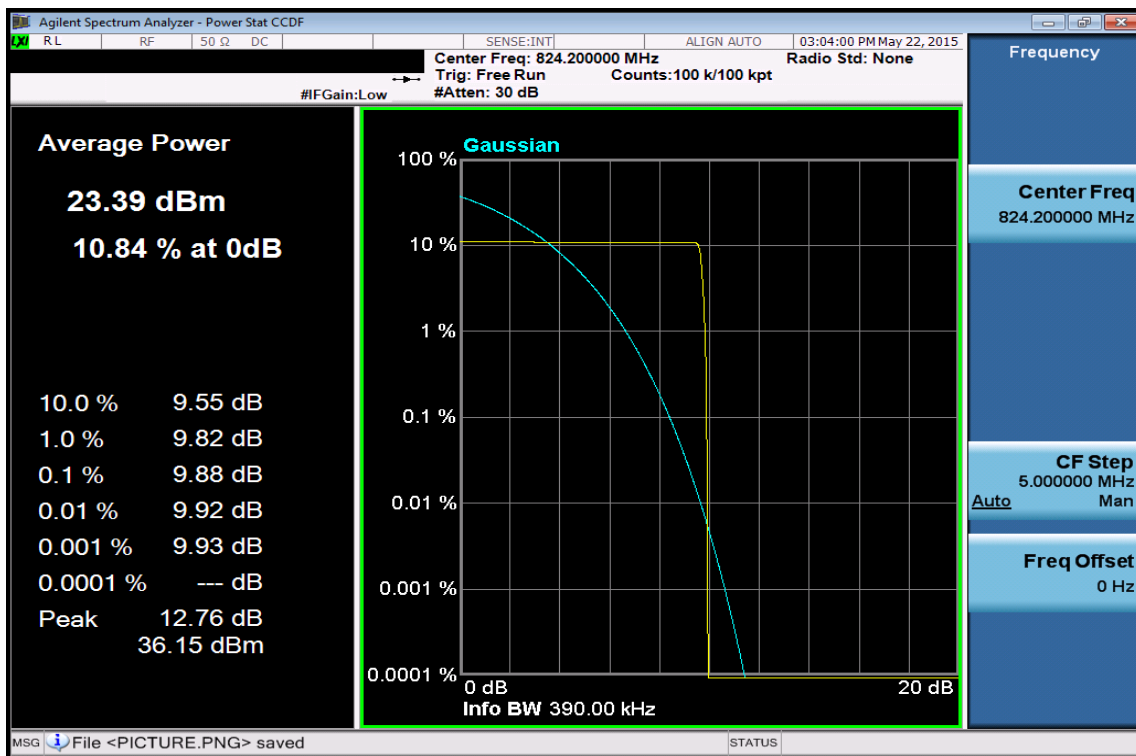

Unless otherwise stated the results shown in this test report refer only to the sample(s) tested and such sample(s) are retained for 90 days only.

除非另有說明，此報告結果僅對測試之樣品負責，同時此樣品僅保留90天。本報告未經本公司書面許可，不可部份複製。

This document is issued by the Company subject to its General Conditions of Service printed overleaf, available on request or accessible at www.sgs.com/terms_and_conditions.htm and, for electronic format documents, subject to Terms and Conditions for Electronic Documents at www.sgs.com/terms_e-document.htm. Attention is drawn to the limitation of liability, indemnification and jurisdiction issues defined therein. Any holder of this document is advised that information contained hereon reflects the Company's findings at the time of its intervention only and within the limits of Client's instructions, if any. The Company's sole responsibility is to its Client and this document does not exonerate parties to a transaction from exercising all their rights and obligations under the transaction documents. This document cannot be reproduced except in full, without prior written approval of the Company. Any unauthorized alteration, forgery or falsification of the content or appearance of this document is unlawful and offenders may be prosecuted to the fullest extent of the law.

SGS Taiwan Ltd.

No. 134, WuKungRoad, NewTaipeiIndustrialPark, WukuDistrict, NewTaipeiCity, Taiwan24803/新北市五股區新北產業園區五工路 134 號

台灣檢驗科技股份有限公司

t (886-2) 2299-3279

f (886-2) 2298-0488

www.tw.sgs.com

Member of SGS Group

GSM 1900 Channel Mid

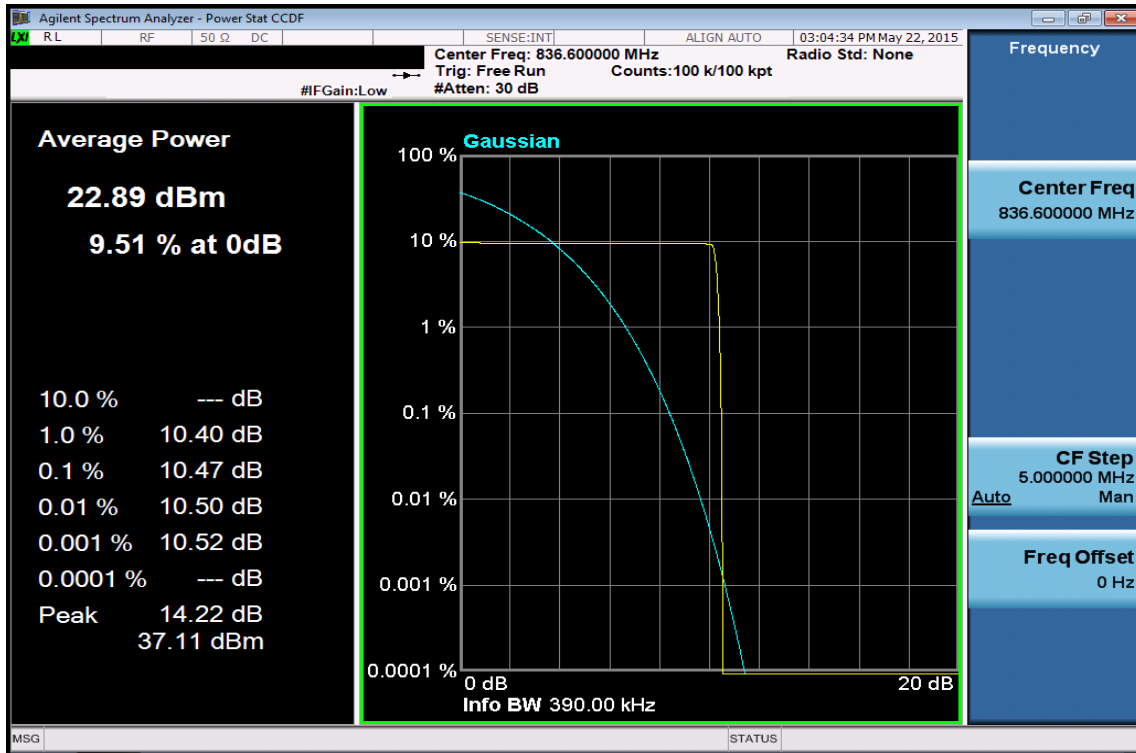

GSM 1900 Channel High

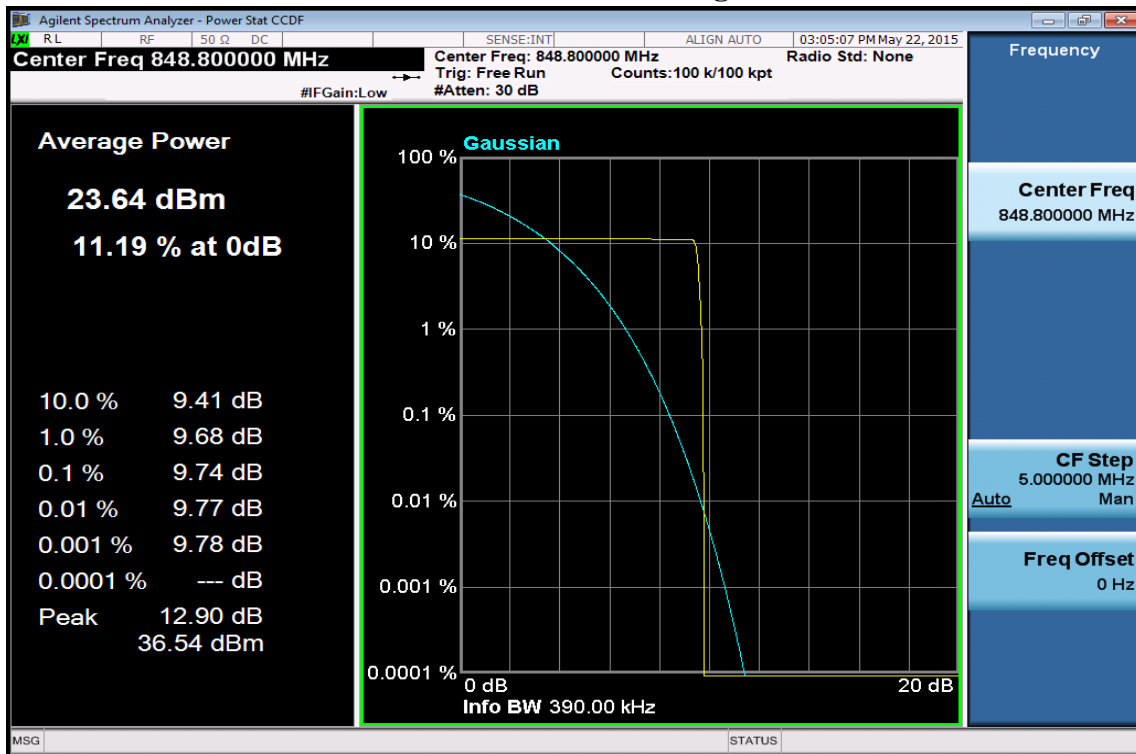

Unless otherwise stated the results shown in this test report refer only to the sample(s) tested and such sample(s) are retained for 90 days only.

除非另有說明，此報告結果僅對測試之樣品負責，同時此樣品僅保留90天。本報告未經本公司書面許可，不可部份複製。

This document is issued by the Company subject to its General Conditions of Service printed overleaf, available on request or accessible at www.sgs.com/terms_and_conditions.htm and, for electronic format documents, subject to Terms and Conditions for Electronic Documents at www.sgs.com/terms_e-document.htm. Attention is drawn to the limitation of liability, indemnification and jurisdiction issues defined therein. Any holder of this document is advised that information contained hereon reflects the Company's findings at the time of its intervention only and within the limits of Client's instructions, if any. The Company's sole responsibility is to its Client and this document does not exonerate parties to a transaction from exercising all their rights and obligations under the transaction documents. This document cannot be reproduced except in full, without prior written approval of the Company. Any unauthorized alteration, forgery or falsification of the content or appearance of this document is unlawful and offenders may be prosecuted to the fullest extent of the law.

SGS Taiwan Ltd.

No. 134, WuKungRoad, NewTaipeiIndustrialPark, WukuDistrict, NewTaipeiCity, Taiwan24803/新北市五股區新北產業園區五工路 134 號

台灣檢驗科技股份有限公司

t (886-2) 2299-3279

f (886-2) 2298-0488

www.tw.sgs.com

Member of SGS Group

GPRS 850 Channel Low

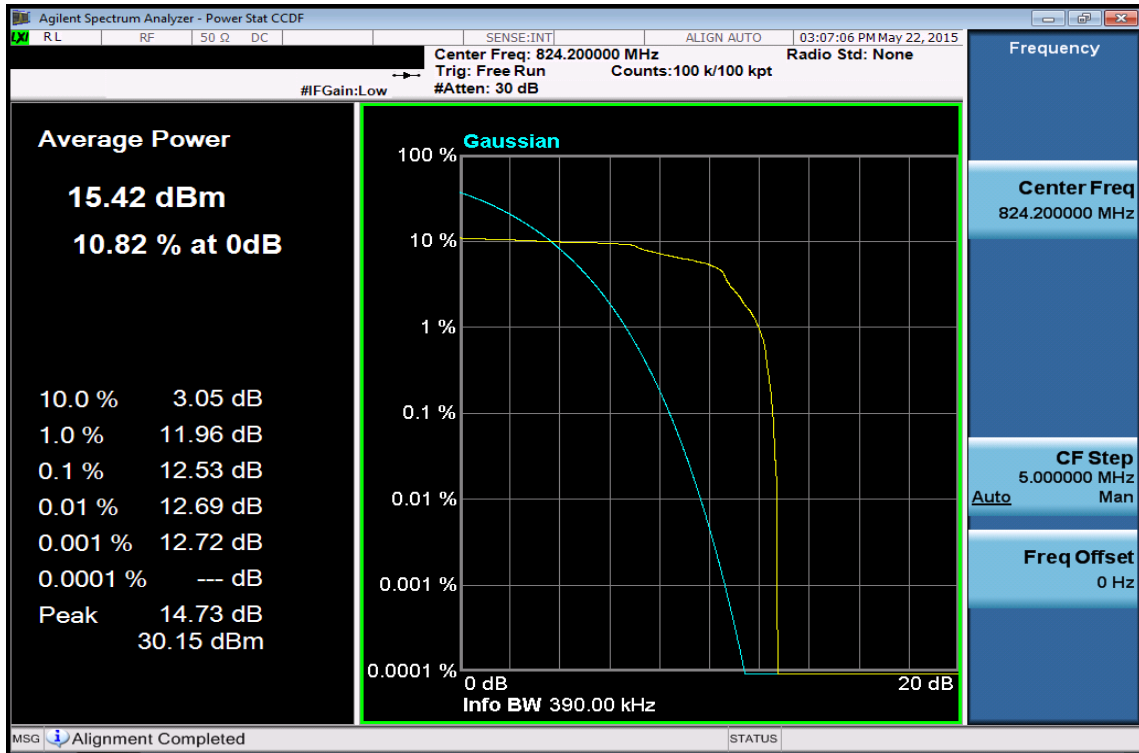

GPRS 850 Channel Mid

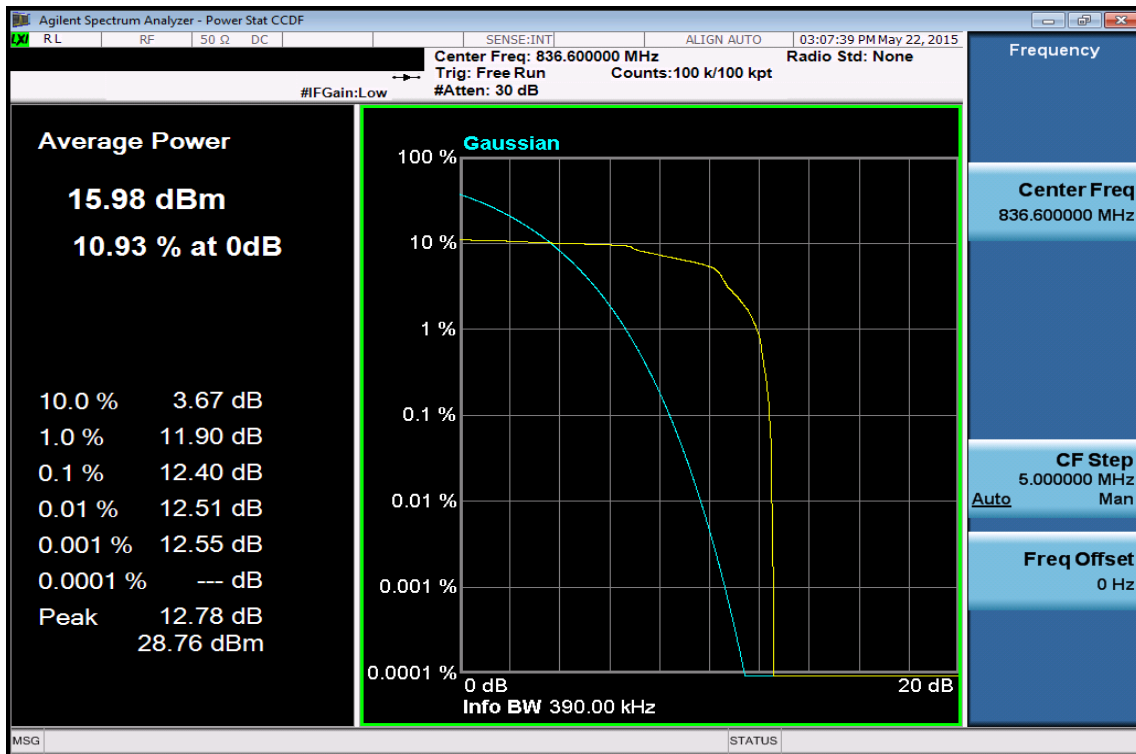

Unless otherwise stated the results shown in this test report refer only to the sample(s) tested and such sample(s) are retained for 90 days only.

除非另有說明，此報告結果僅對測試之樣品負責，同時此樣品僅保留90天。本報告未經本公司書面許可，不可部份複製。

This document is issued by the Company subject to its General Conditions of Service printed overleaf, available on request or accessible at www.sgs.com/terms_and_conditions.htm and, for electronic format documents, subject to Terms and Conditions for Electronic Documents at www.sgs.com/terms_e-document.htm. Attention is drawn to the limitation of liability, indemnification and jurisdiction issues defined therein. Any holder of this document is advised that information contained hereon reflects the Company's findings at the time of its intervention only and within the limits of Client's instructions, if any. The Company's sole responsibility is to its Client and this document does not exonerate parties to a transaction from exercising all their rights and obligations under the transaction documents. This document cannot be reproduced except in full, without prior written approval of the Company. Any unauthorized alteration, forgery or falsification of the content or appearance of this document is unlawful and offenders may be prosecuted to the fullest extent of the law.

SGS Taiwan Ltd.

No. 134, WuKungRoad, NewTaipeiIndustrialPark, WukuDistrict, NewTaipeiCity, Taiwan24803/新北市五股區新北產業園區五工路 134 號

台灣檢驗科技股份有限公司

t (886-2) 2299-3279

f (886-2) 2298-0488

www.tw.sgs.com

Member of SGS Group

GPRS 850 Channel High

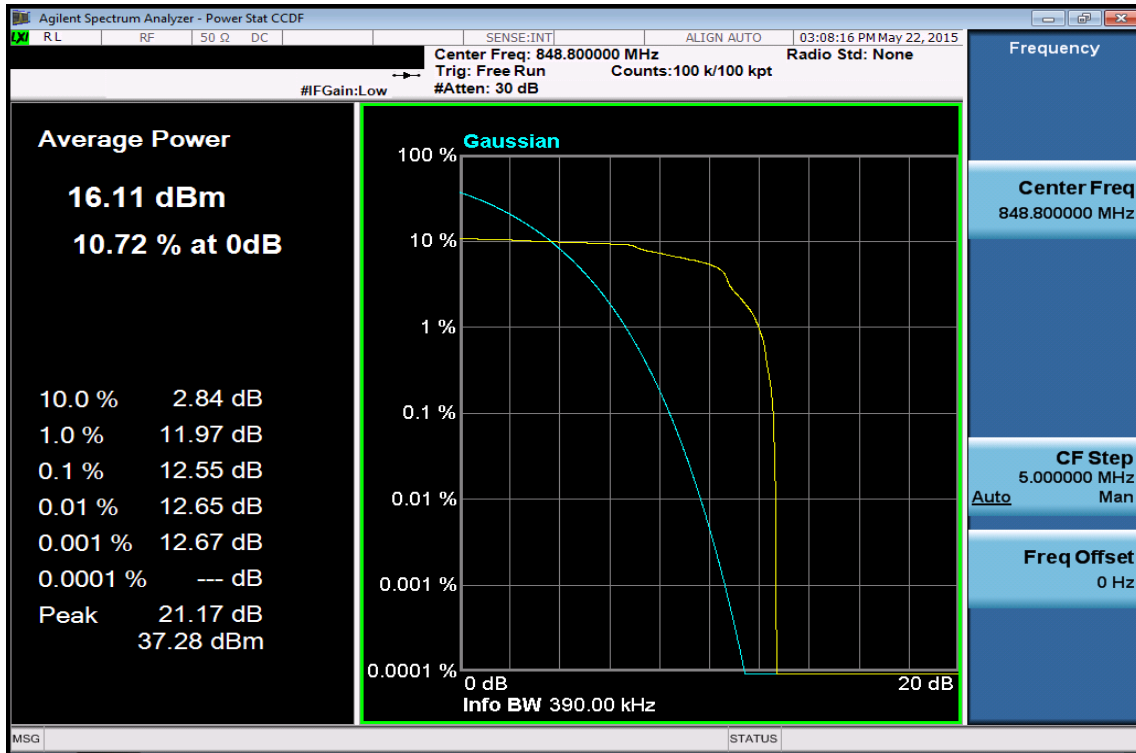

GPRS 1900 Channel Low

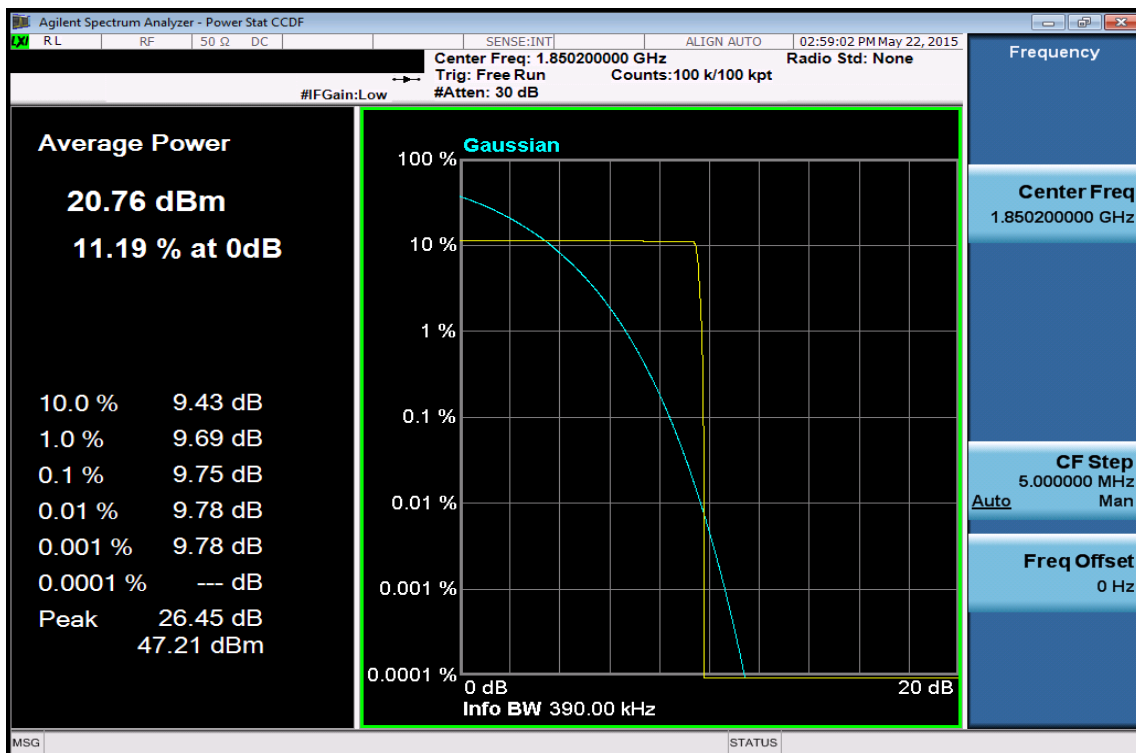

Unless otherwise stated the results shown in this test report refer only to the sample(s) tested and such sample(s) are retained for 90 days only.

除非另有說明，此報告結果僅對測試之樣品負責，同時此樣品僅保留90天。本報告未經本公司書面許可，不可部份複製。

This document is issued by the Company subject to its General Conditions of Service printed overleaf, available on request or accessible at www.sgs.com/terms_and_conditions.htm and, for electronic format documents, subject to Terms and Conditions for Electronic Documents at www.sgs.com/terms_e-document.htm. Attention is drawn to the limitation of liability, indemnification and jurisdiction issues defined therein. Any holder of this document is advised that information contained hereon reflects the Company's findings at the time of its intervention only and within the limits of Client's instructions, if any. The Company's sole responsibility is to its Client and this document does not exonerate parties to a transaction from exercising all their rights and obligations under the transaction documents. This document cannot be reproduced except in full, without prior written approval of the Company. Any unauthorized alteration, forgery or falsification of the content or appearance of this document is unlawful and offenders may be prosecuted to the fullest extent of the law.

SGS Taiwan Ltd.

No. 134, WuKungRoad, NewTaipeiIndustrialPark, WukuDistrict, NewTaipeiCity, Taiwan24803/新北市五股區新北產業園區五工路 134 號

台灣檢驗科技股份有限公司

t (886-2) 2299-3279

f (886-2) 2298-0488

www.tw.sgs.com

Member of SGS Group

GPRS 1900 Channel Mid

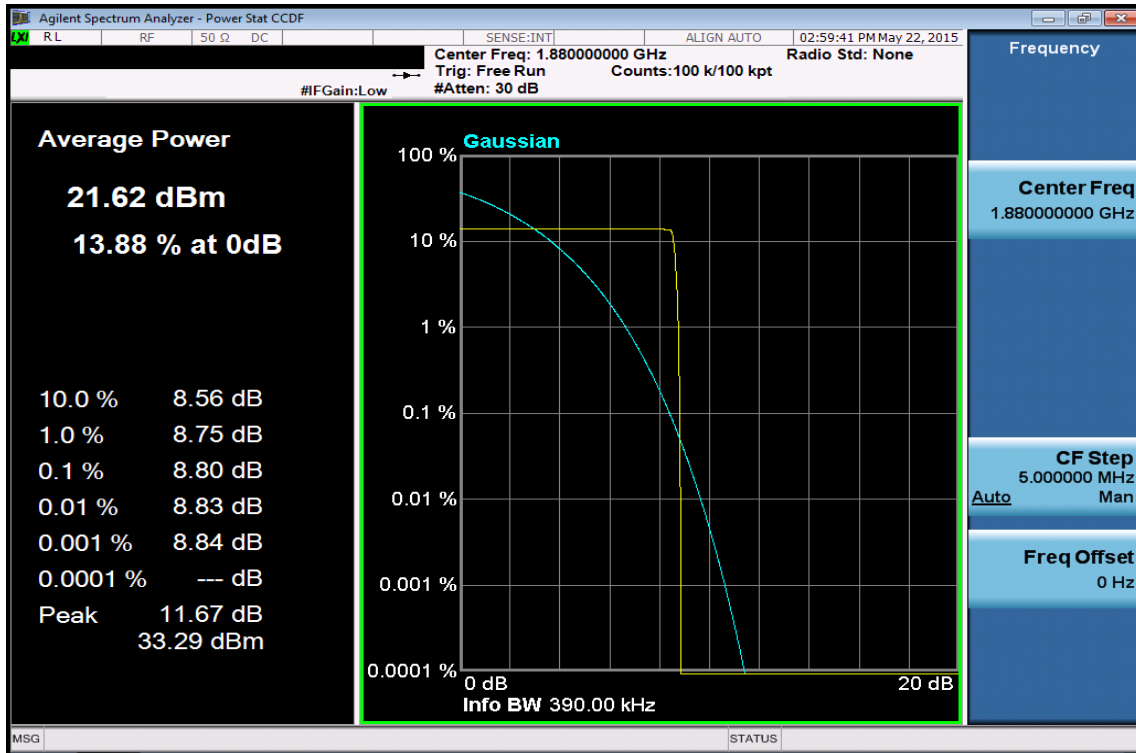

GPRS 1900 Channel High

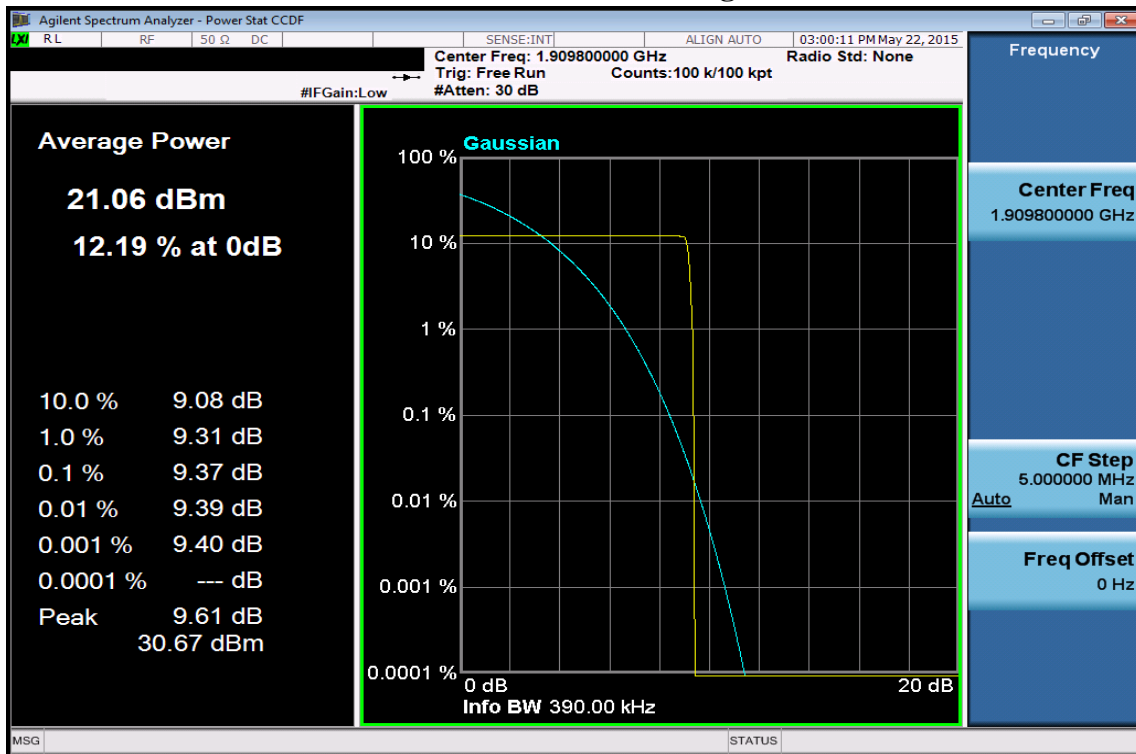

Unless otherwise stated the results shown in this test report refer only to the sample(s) tested and such sample(s) are retained for 90 days only.

除非另有說明，此報告結果僅對測試之樣品負責，同時此樣品僅保留90天。本報告未經本公司書面許可，不可部份複製。

This document is issued by the Company subject to its General Conditions of Service printed overleaf, available on request or accessible at www.sgs.com/terms_and_conditions.htm and, for electronic format documents, subject to Terms and Conditions for Electronic Documents at www.sgs.com/terms_e-document.htm. Attention is drawn to the limitation of liability, indemnification and jurisdiction issues defined therein. Any holder of this document is advised that information contained hereon reflects the Company's findings at the time of its intervention only and within the limits of Client's instructions, if any. The Company's sole responsibility is to its Client and this document does not exonerate parties to a transaction from exercising all their rights and obligations under the transaction documents. This document cannot be reproduced except in full, without prior written approval of the Company. Any unauthorized alteration, forgery or falsification of the content or appearance of this document is unlawful and offenders may be prosecuted to the fullest extent of the law.

SGS Taiwan Ltd.

No. 134, WuKungRoad, NewTaipeiIndustrialPark, WukuDistrict, NewTaipeiCity, Taiwan24803/新北市五股區新北產業園區五工路 134 號

台灣檢驗科技股份有限公司

t (886-2) 2299-3279

f (886-2) 2298-0488

www.tw.sgs.com

Member of SGS Group

EDGE 850 Channel Low

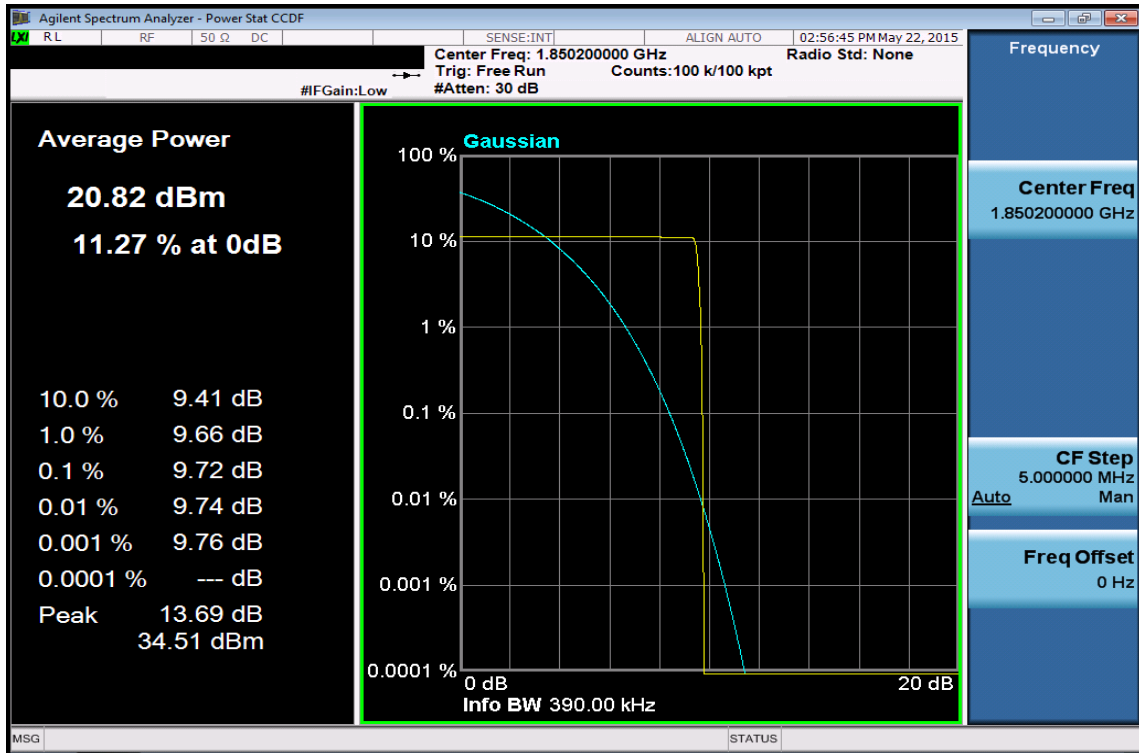

EDGE 850 Channel Mid

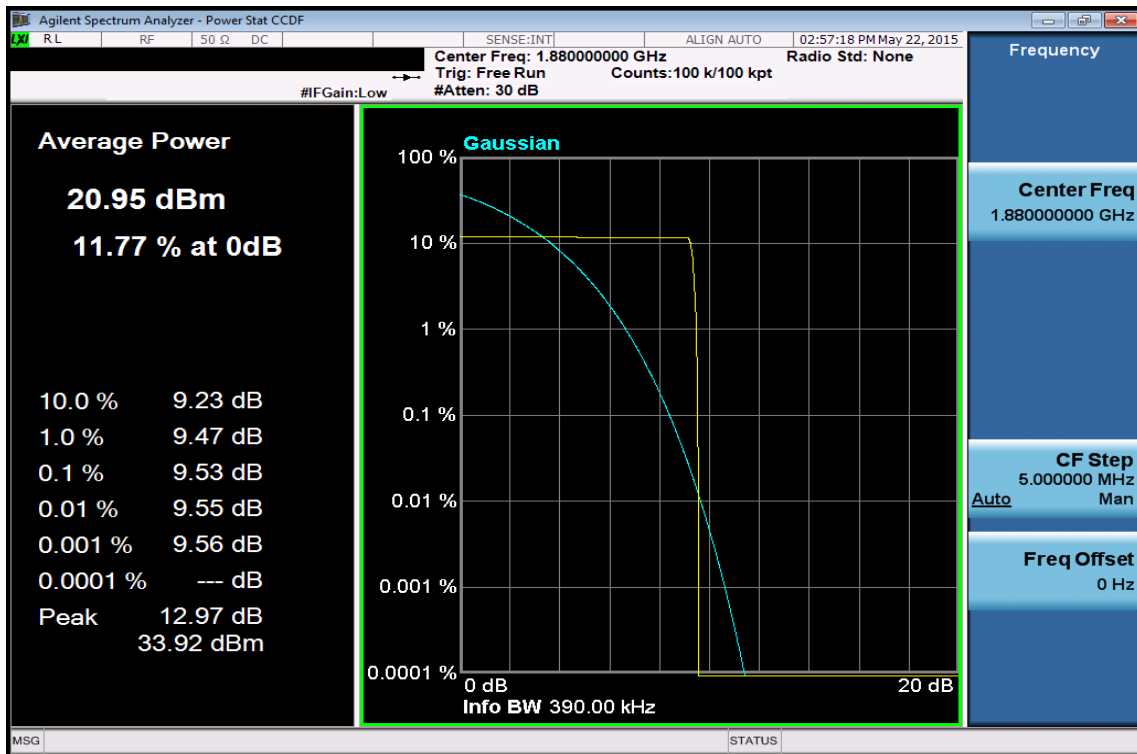

Unless otherwise stated the results shown in this test report refer only to the sample(s) tested and such sample(s) are retained for 90 days only.

除非另有說明，此報告結果僅對測試之樣品負責，同時此樣品僅保留90天。本報告未經本公司書面許可，不可部份複製。

This document is issued by the Company subject to its General Conditions of Service printed overleaf, available on request or accessible at www.sgs.com/terms_and_conditions.htm and, for electronic format documents, subject to Terms and Conditions for Electronic Documents at www.sgs.com/terms_e-document.htm. Attention is drawn to the limitation of liability, indemnification and jurisdiction issues defined therein. Any holder of this document is advised that information contained hereon reflects the Company's findings at the time of its intervention only and within the limits of Client's instructions, if any. The Company's sole responsibility is to its Client and this document does not exonerate parties to a transaction from exercising all their rights and obligations under the transaction documents. This document cannot be reproduced except in full, without prior written approval of the Company. Any unauthorized alteration, forgery or falsification of the content or appearance of this document is unlawful and offenders may be prosecuted to the fullest extent of the law.

SGS Taiwan Ltd.

No. 134, WuKungRoad, NewTaipeiIndustrialPark, WukuDistrict, NewTaipeiCity, Taiwan24803/新北市五股區新北產業園區五工路 134 號

台灣檢驗科技股份有限公司

t (886-2) 2299-3279

f (886-2) 2298-0488

www.tw.sgs.com

Member of SGS Group

EDGE 850 Channel High

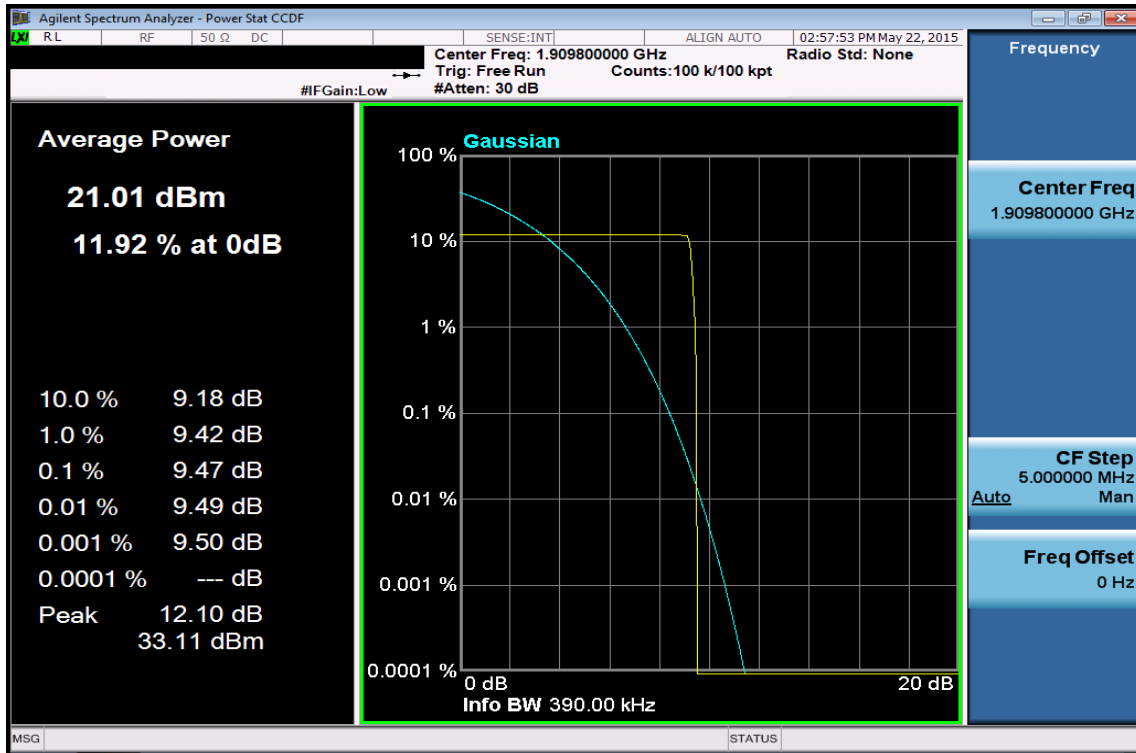

EDGE 1900 Channel Low

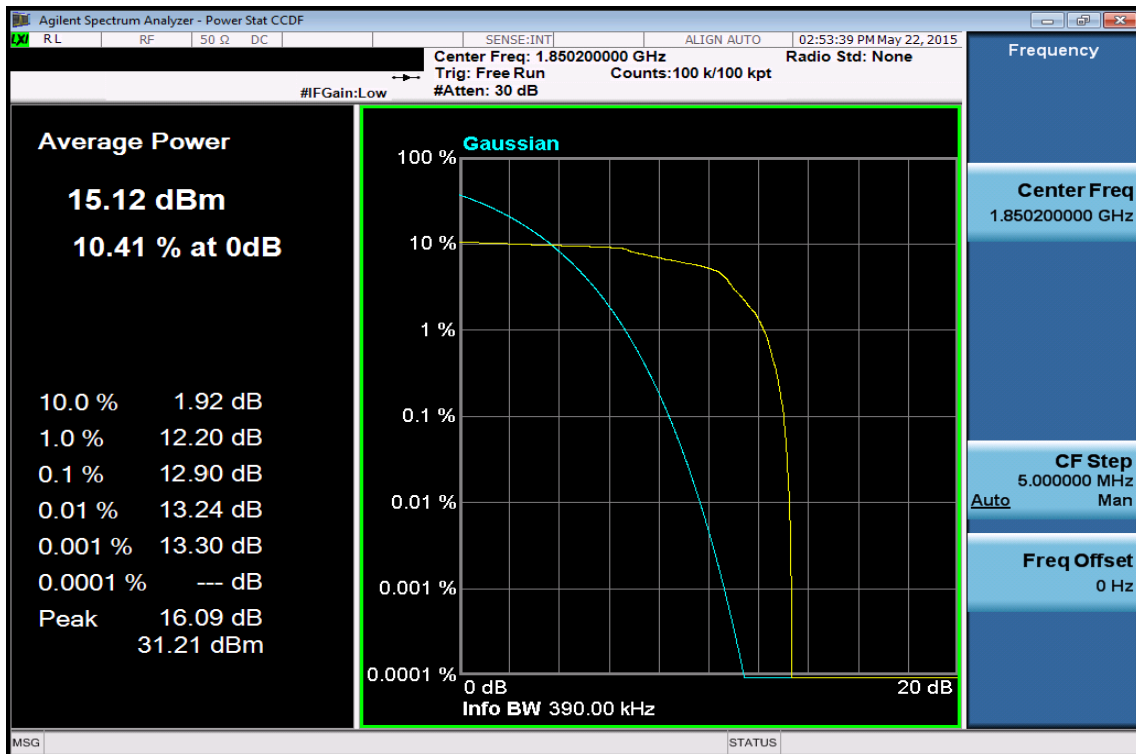

Unless otherwise stated the results shown in this test report refer only to the sample(s) tested and such sample(s) are retained for 90 days only.

除非另有說明，此報告結果僅對測試之樣品負責，同時此樣品僅保留90天。本報告未經本公司書面許可，不可部份複製。

This document is issued by the Company subject to its General Conditions of Service printed overleaf, available on request or accessible at www.sgs.com/terms_and_conditions.htm and, for electronic format documents, subject to Terms and Conditions for Electronic Documents at www.sgs.com/terms_e-document.htm. Attention is drawn to the limitation of liability, indemnification and jurisdiction issues defined therein. Any holder of this document is advised that information contained hereon reflects the Company's findings at the time of its intervention only and within the limits of Client's instructions, if any. The Company's sole responsibility is to its Client and this document does not exonerate parties to a transaction from exercising all their rights and obligations under the transaction documents. This document cannot be reproduced except in full, without prior written approval of the Company. Any unauthorized alteration, forgery or falsification of the content or appearance of this document is unlawful and offenders may be prosecuted to the fullest extent of the law.

SGS Taiwan Ltd.

No. 134, WuKungRoad, NewTaipeiIndustrialPark, WukuDistrict, NewTaipeiCity, Taiwan24803/新北市五股區新北產業園區五工路 134 號

台灣檢驗科技股份有限公司

t (886-2) 2299-3279

f (886-2) 2298-0488

www.tw.sgs.com

Member of SGS Group

EDGE 1900 Channel Mid

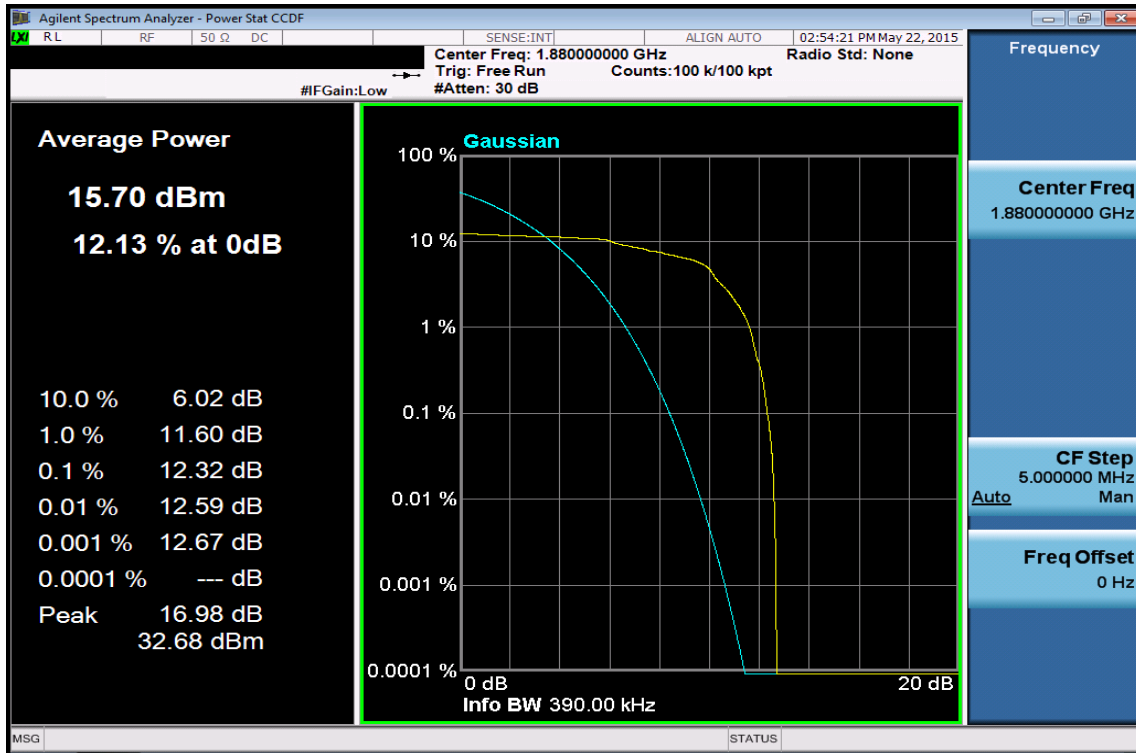

EDGE 1900 Channel High

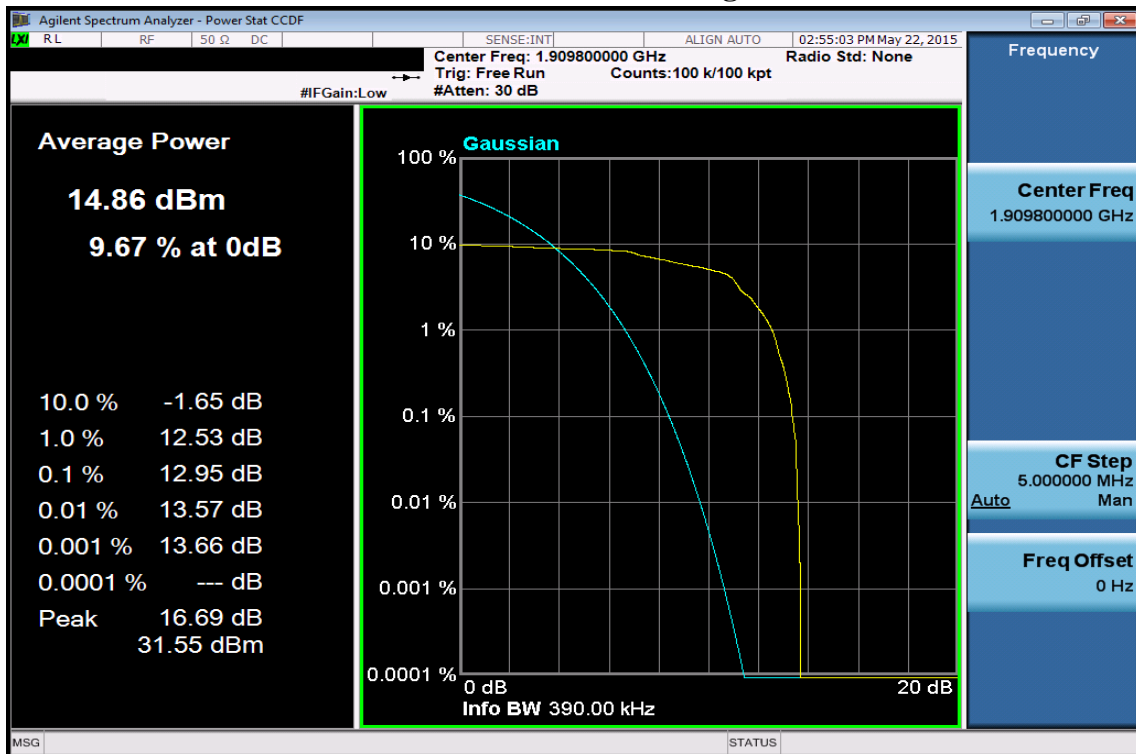

Unless otherwise stated the results shown in this test report refer only to the sample(s) tested and such sample(s) are retained for 90 days only.

除非另有說明，此報告結果僅對測試之樣品負責，同時此樣品僅保留90天。本報告未經本公司書面許可，不可部份複製。

This document is issued by the Company subject to its General Conditions of Service printed overleaf, available on request or accessible at www.sgs.com/terms_and_conditions.htm and, for electronic format documents, subject to Terms and Conditions for Electronic Documents at www.sgs.com/terms_e-document.htm. Attention is drawn to the limitation of liability, indemnification and jurisdiction issues defined therein. Any holder of this document is advised that information contained hereon reflects the Company's findings at the time of its intervention only and within the limits of Client's instructions, if any. The Company's sole responsibility is to its Client and this document does not exonerate parties to a transaction from exercising all their rights and obligations under the transaction documents. This document cannot be reproduced except in full, without prior written approval of the Company. Any unauthorized alteration, forgery or falsification of the content or appearance of this document is unlawful and offenders may be prosecuted to the fullest extent of the law.

SGS Taiwan Ltd.

No. 134, WuKungRoad, NewTaipeiIndustrialPark, WukuDistrict, NewTaipeiCity, Taiwan24803/新北市五股區新北產業園區五工路 134 號

台灣檢驗科技股份有限公司

t (886-2) 2299-3279

f (886-2) 2298-0488

www.tw.sgs.com

Member of SGS Group

WCDMA Band II Channel Low

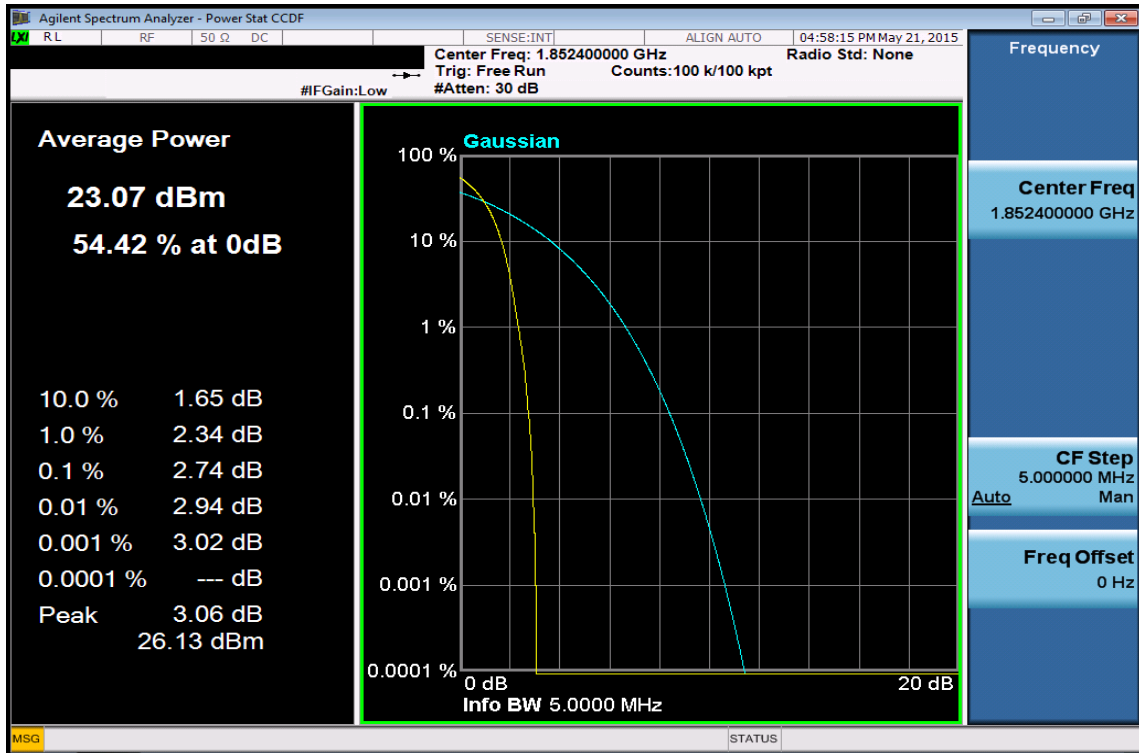

WCDMA Band II Channel Mid

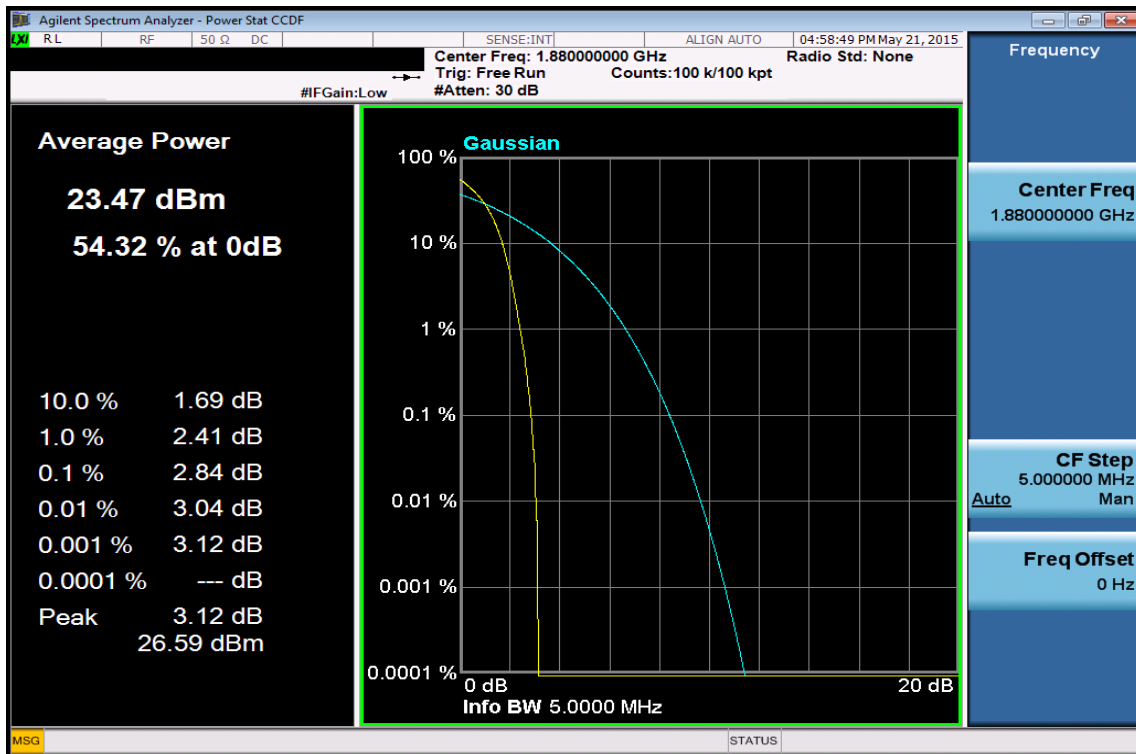

Unless otherwise stated the results shown in this test report refer only to the sample(s) tested and such sample(s) are retained for 90 days only.

除非另有說明，此報告結果僅對測試之樣品負責，同時此樣品僅保留90天。本報告未經本公司書面許可，不可部份複製。

This document is issued by the Company subject to its General Conditions of Service printed overleaf, available on request or accessible at www.sgs.com/terms_and_conditions.htm and, for electronic format documents, subject to Terms and Conditions for Electronic Documents at www.sgs.com/terms_e-document.htm. Attention is drawn to the limitation of liability, indemnification and jurisdiction issues defined therein. Any holder of this document is advised that information contained hereon reflects the Company's findings at the time of its intervention only and within the limits of Client's instructions, if any. The Company's sole responsibility is to its Client and this document does not exonerate parties to a transaction from exercising all their rights and obligations under the transaction documents. This document cannot be reproduced except in full, without prior written approval of the Company. Any unauthorized alteration, forgery or falsification of the content or appearance of this document is unlawful and offenders may be prosecuted to the fullest extent of the law.

SGS Taiwan Ltd.

No. 134, WuKungRoad, NewTaipeiIndustrialPark, WukuDistrict, NewTaipeiCity, Taiwan24803/新北市五股區新北產業園區五工路 134 號

台灣檢驗科技股份有限公司

t (886-2) 2299-3279

f (886-2) 2298-0488

www.tw.sgs.com

Member of SGS Group

WCDMA Band II Channel High

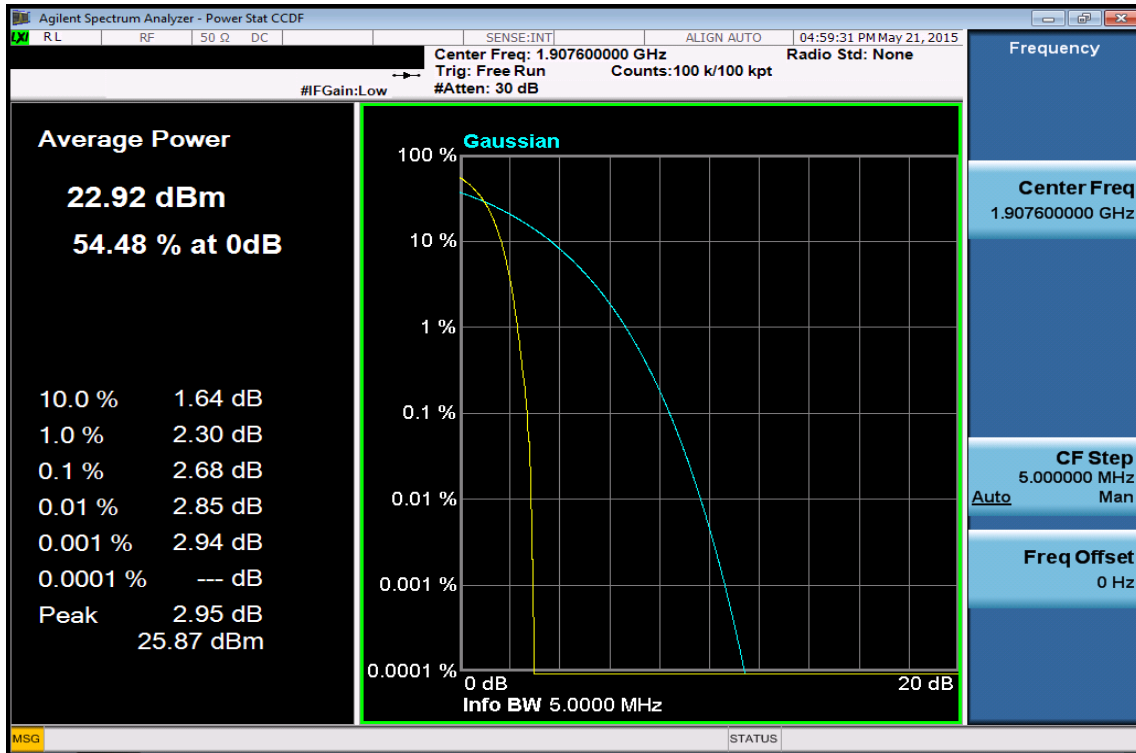

WCDMA Band IV Channel Low

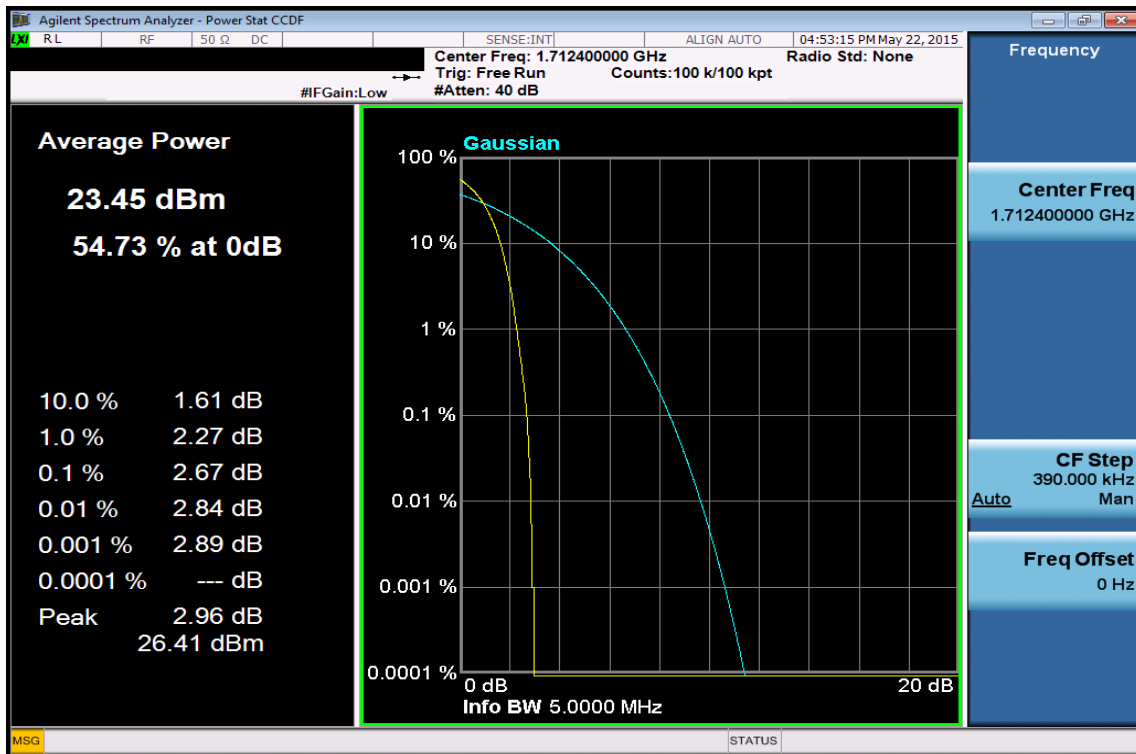

Unless otherwise stated the results shown in this test report refer only to the sample(s) tested and such sample(s) are retained for 90 days only.

除非另有說明，此報告結果僅對測試之樣品負責，同時此樣品僅保留90天。本報告未經本公司書面許可，不可部份複製。

This document is issued by the Company subject to its General Conditions of Service printed overleaf, available on request or accessible at www.sgs.com/terms_and_conditions.htm and, for electronic format documents, subject to Terms and Conditions for Electronic Documents at www.sgs.com/terms_e-document.htm. Attention is drawn to the limitation of liability, indemnification and jurisdiction issues defined therein. Any holder of this document is advised that information contained hereon reflects the Company's findings at the time of its intervention only and within the limits of Client's instructions, if any. The Company's sole responsibility is to its Client and this document does not exonerate parties to a transaction from exercising all their rights and obligations under the transaction documents. This document cannot be reproduced except in full, without prior written approval of the Company. Any unauthorized alteration, forgery or falsification of the content or appearance of this document is unlawful and offenders may be prosecuted to the fullest extent of the law.

SGS Taiwan Ltd.

No. 134, WuKungRoad, NewTaipeiIndustrialPark, WukuDistrict, NewTaipeiCity, Taiwan24803/新北市五股區新北產業園區五工路 134 號

台灣檢驗科技股份有限公司

t (886-2) 2299-3279

f (886-2) 2298-0488

www.tw.sgs.com

Member of SGS Group

WCDMA Band IV Channel Mid

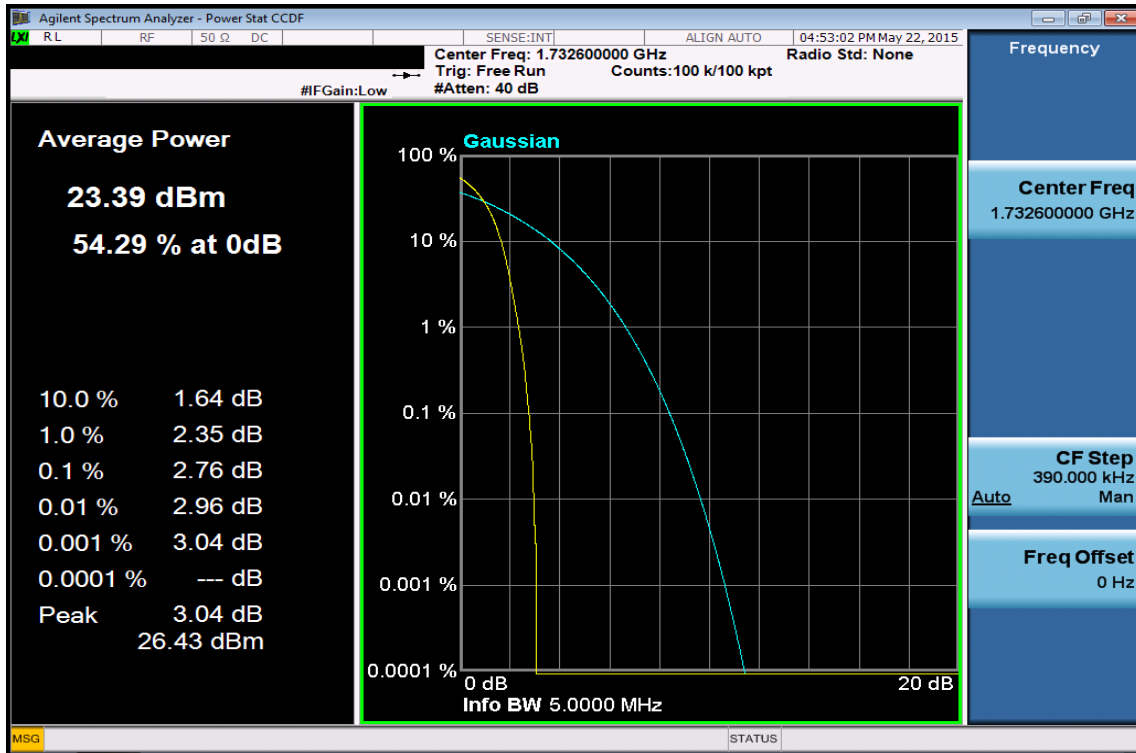

WCDMA Band IV Channel High

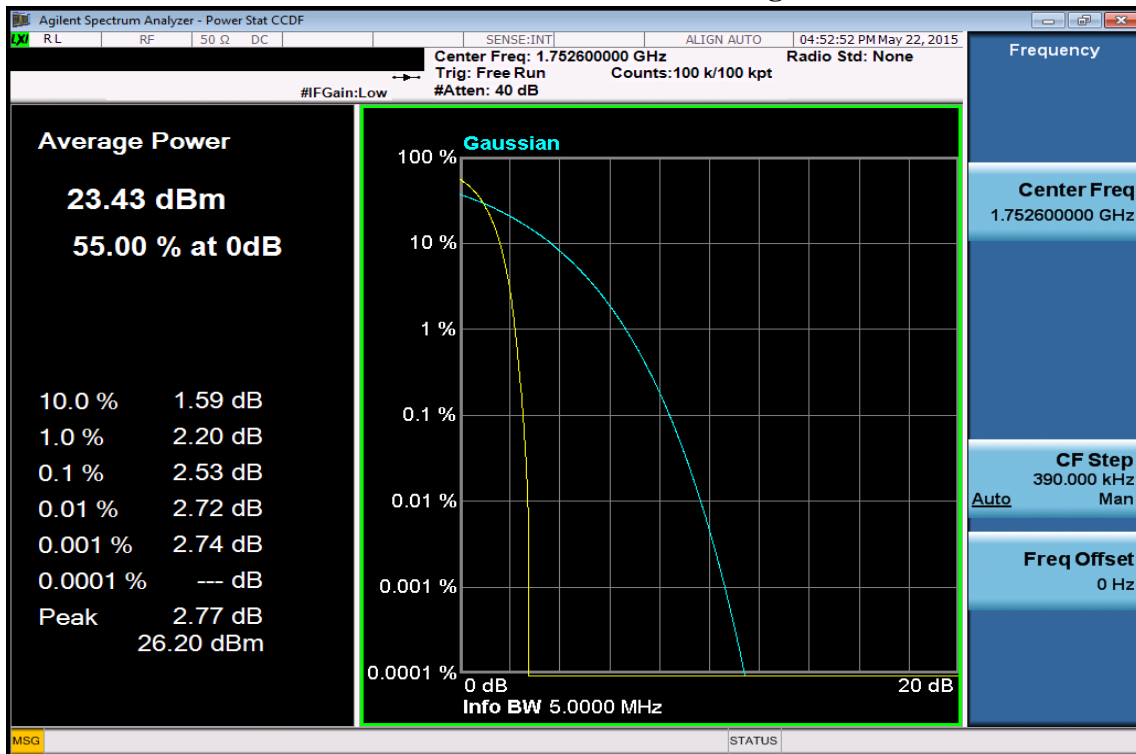

Unless otherwise stated the results shown in this test report refer only to the sample(s) tested and such sample(s) are retained for 90 days only.

除非另有說明，此報告結果僅對測試之樣品負責，同時此樣品僅保留90天。本報告未經本公司書面許可，不可部份複製。

This document is issued by the Company subject to its General Conditions of Service printed overleaf, available on request or accessible at www.sgs.com/terms_and_conditions.htm and, for electronic format documents, subject to Terms and Conditions for Electronic Documents at www.sgs.com/terms_e-document.htm. Attention is drawn to the limitation of liability, indemnification and jurisdiction issues defined therein. Any holder of this document is advised that information contained hereon reflects the Company's findings at the time of its intervention only and within the limits of Client's instructions, if any. The Company's sole responsibility is to its Client and this document does not exonerate parties to a transaction from exercising all their rights and obligations under the transaction documents. This document cannot be reproduced except in full, without prior written approval of the Company. Any unauthorized alteration, forgery or falsification of the content or appearance of this document is unlawful and offenders may be prosecuted to the fullest extent of the law.

SGS Taiwan Ltd.

No. 134, WuKungRoad, NewTaipeiIndustrialPark, WukuDistrict, NewTaipeiCity, Taiwan24803/新北市五股區新北產業園區五工路 134 號

台灣檢驗科技股份有限公司

t (886-2) 2299-3279

f (886-2) 2298-0488

www.tw.sgs.com

Member of SGS Group

WCDMA Band V Channel Low

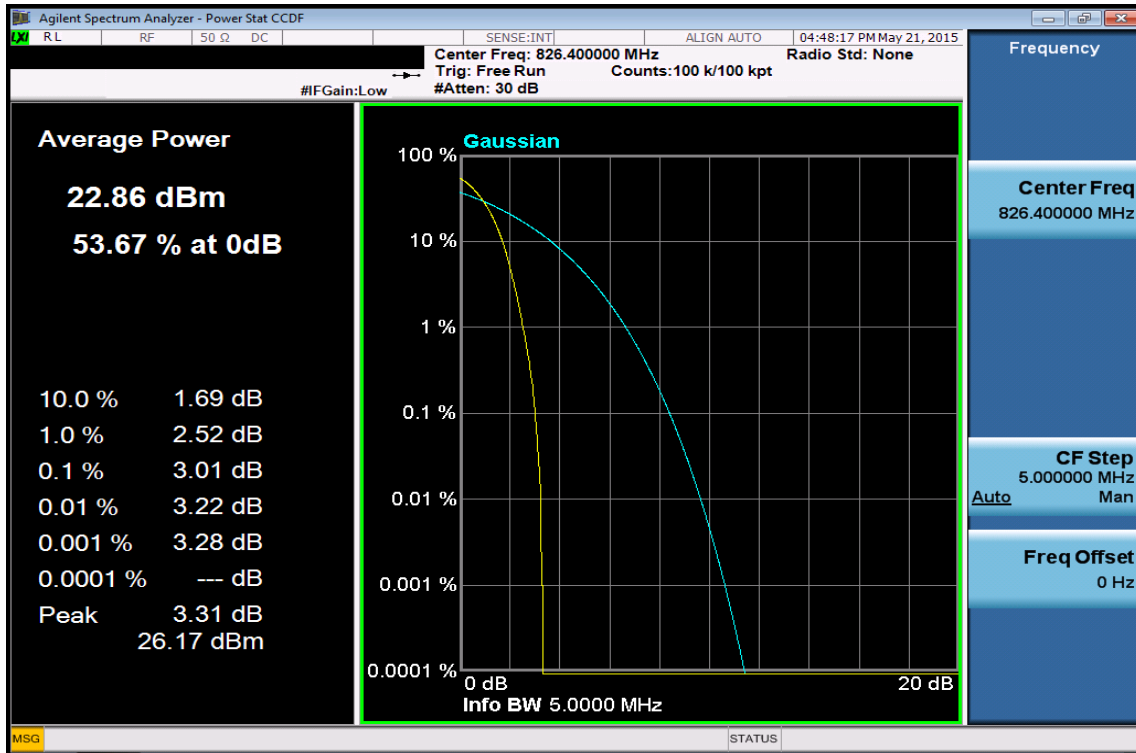

WCDMA Band V Channel Mid

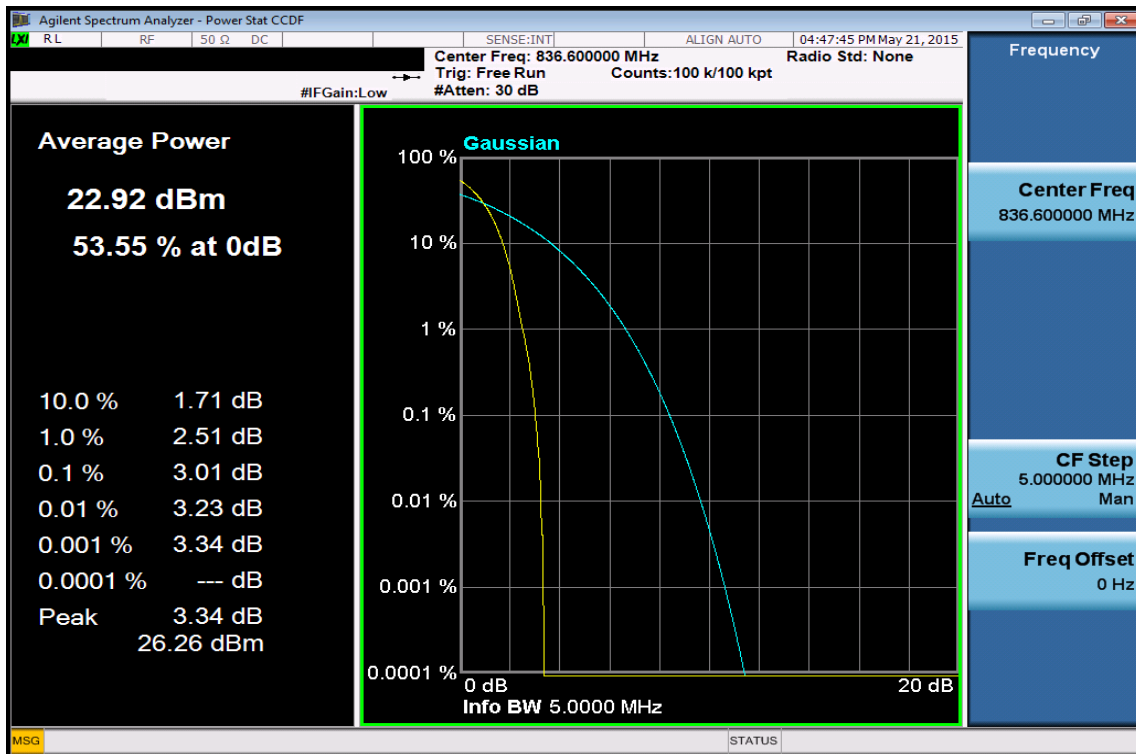

Unless otherwise stated the results shown in this test report refer only to the sample(s) tested and such sample(s) are retained for 90 days only.

除非另有說明，此報告結果僅對測試之樣品負責，同時此樣品僅保留90天。本報告未經本公司書面許可，不可部份複製。

This document is issued by the Company subject to its General Conditions of Service printed overleaf, available on request or accessible at www.sgs.com/terms_and_conditions.htm and, for electronic format documents, subject to Terms and Conditions for Electronic Documents at www.sgs.com/terms_e-document.htm. Attention is drawn to the limitation of liability, indemnification and jurisdiction issues defined therein. Any holder of this document is advised that information contained hereon reflects the Company's findings at the time of its intervention only and within the limits of Client's instructions, if any. The Company's sole responsibility is to its Client and this document does not exonerate parties to a transaction from exercising all their rights and obligations under the transaction documents. This document cannot be reproduced except in full, without prior written approval of the Company. Any unauthorized alteration, forgery or falsification of the content or appearance of this document is unlawful and offenders may be prosecuted to the fullest extent of the law.

SGS Taiwan Ltd.

No. 134, WuKungRoad, NewTaipeiIndustrialPark, WukuDistrict, NewTaipeiCity, Taiwan24803/新北市五股區新北產業園區五工路 134 號

台灣檢驗科技股份有限公司

t (886-2) 2299-3279

f (886-2) 2298-0488

www.tw.sgs.com

Member of SGS Group

WCDMA Band V Channel High

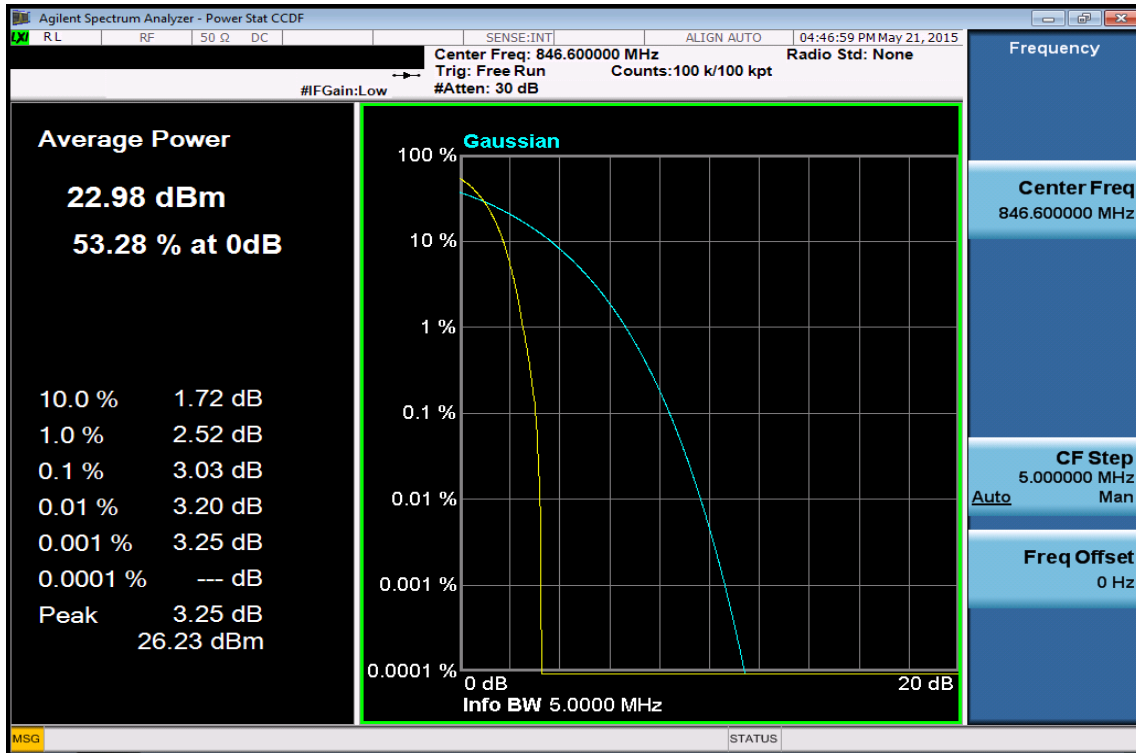

HSDPA Band II Channel Low

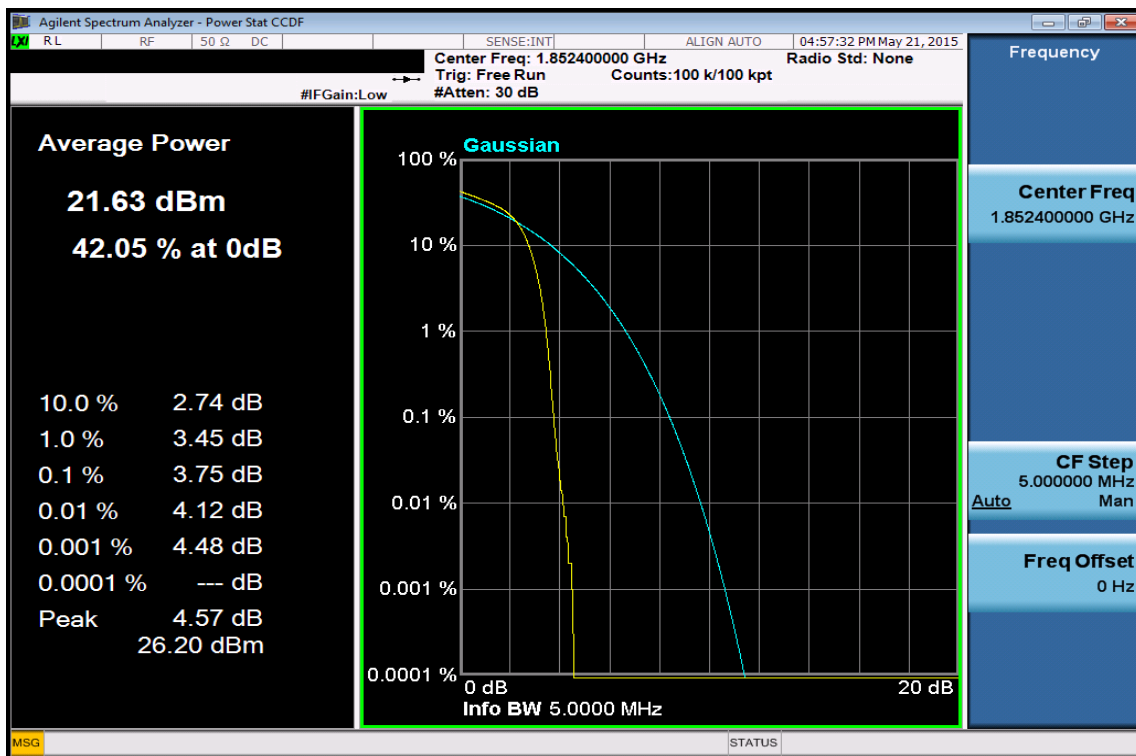

Unless otherwise stated the results shown in this test report refer only to the sample(s) tested and such sample(s) are retained for 90 days only.

除非另有說明，此報告結果僅對測試之樣品負責，同時此樣品僅保留90天。本報告未經本公司書面許可，不可部份複製。

This document is issued by the Company subject to its General Conditions of Service printed overleaf, available on request or accessible at www.sgs.com/terms_and_conditions.htm and, for electronic format documents, subject to Terms and Conditions for Electronic Documents at www.sgs.com/terms_e-document.htm. Attention is drawn to the limitation of liability, indemnification and jurisdiction issues defined therein. Any holder of this document is advised that information contained hereon reflects the Company's findings at the time of its intervention only and within the limits of Client's instructions, if any. The Company's sole responsibility is to its Client and this document does not exonerate parties to a transaction from exercising all their rights and obligations under the transaction documents. This document cannot be reproduced except in full, without prior written approval of the Company. Any unauthorized alteration, forgery or falsification of the content or appearance of this document is unlawful and offenders may be prosecuted to the fullest extent of the law.

SGS Taiwan Ltd.

No. 134, WuKungRoad, NewTaipeiIndustrialPark, WukuDistrict, NewTaipeiCity, Taiwan24803/新北市五股區新北產業園區五工路 134 號

台灣檢驗科技股份有限公司

t (886-2) 2299-3279

f (886-2) 2298-0488

www.tw.sgs.com

Member of SGS Group

HSDPA Band II Channel Mid

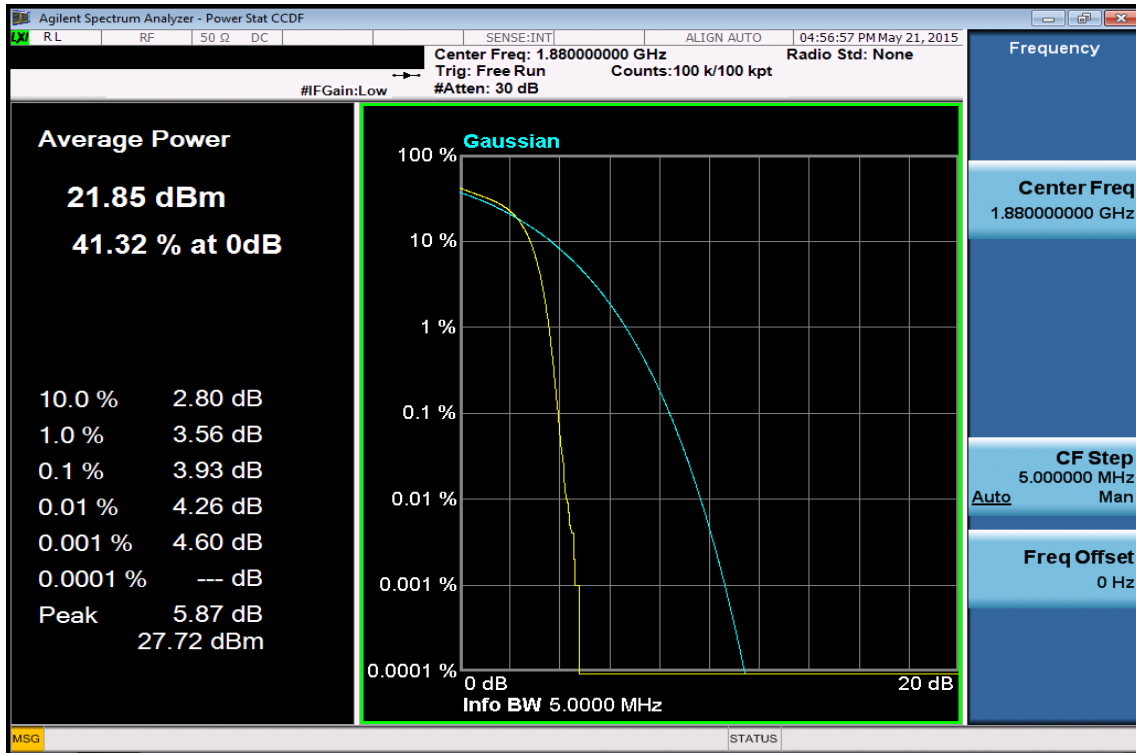

HSDPA Band II Channel High

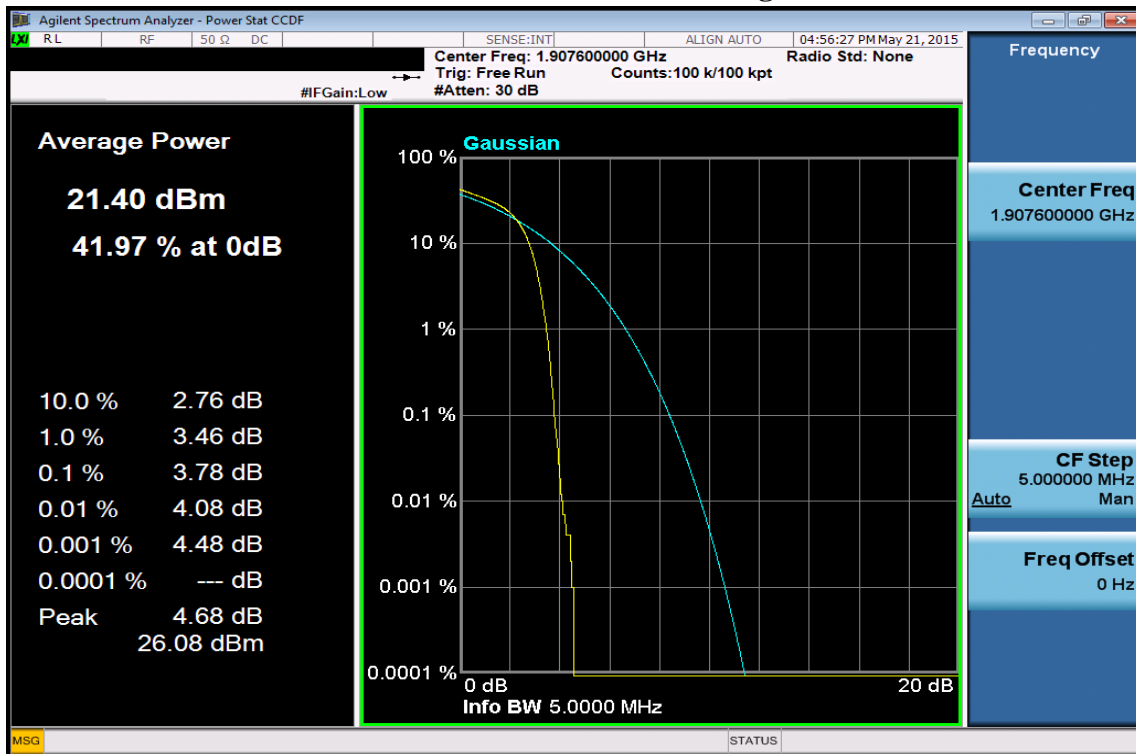

Unless otherwise stated the results shown in this test report refer only to the sample(s) tested and such sample(s) are retained for 90 days only.

除非另有說明，此報告結果僅對測試之樣品負責，同時此樣品僅保留90天。本報告未經本公司書面許可，不可部份複製。

This document is issued by the Company subject to its General Conditions of Service printed overleaf, available on request or accessible at www.sgs.com/terms_and_conditions.htm and, for electronic format documents, subject to Terms and Conditions for Electronic Documents at www.sgs.com/terms_e-document.htm. Attention is drawn to the limitation of liability, indemnification and jurisdiction issues defined therein. Any holder of this document is advised that information contained hereon reflects the Company's findings at the time of its intervention only and within the limits of Client's instructions, if any. The Company's sole responsibility is to its Client and this document does not exonerate parties to a transaction from exercising all their rights and obligations under the transaction documents. This document cannot be reproduced except in full, without prior written approval of the Company. Any unauthorized alteration, forgery or falsification of the content or appearance of this document is unlawful and offenders may be prosecuted to the fullest extent of the law.

SGS Taiwan Ltd.

No. 134, WuKungRoad, NewTaipeiIndustrialPark, WukuDistrict, NewTaipeiCity, Taiwan24803/新北市五股區新北產業園區五工路 134 號

台灣檢驗科技股份有限公司

t (886-2) 2299-3279

f (886-2) 2298-0488

www.tw.sgs.com

Member of SGS Group

HSDPA Band IV Channel Low

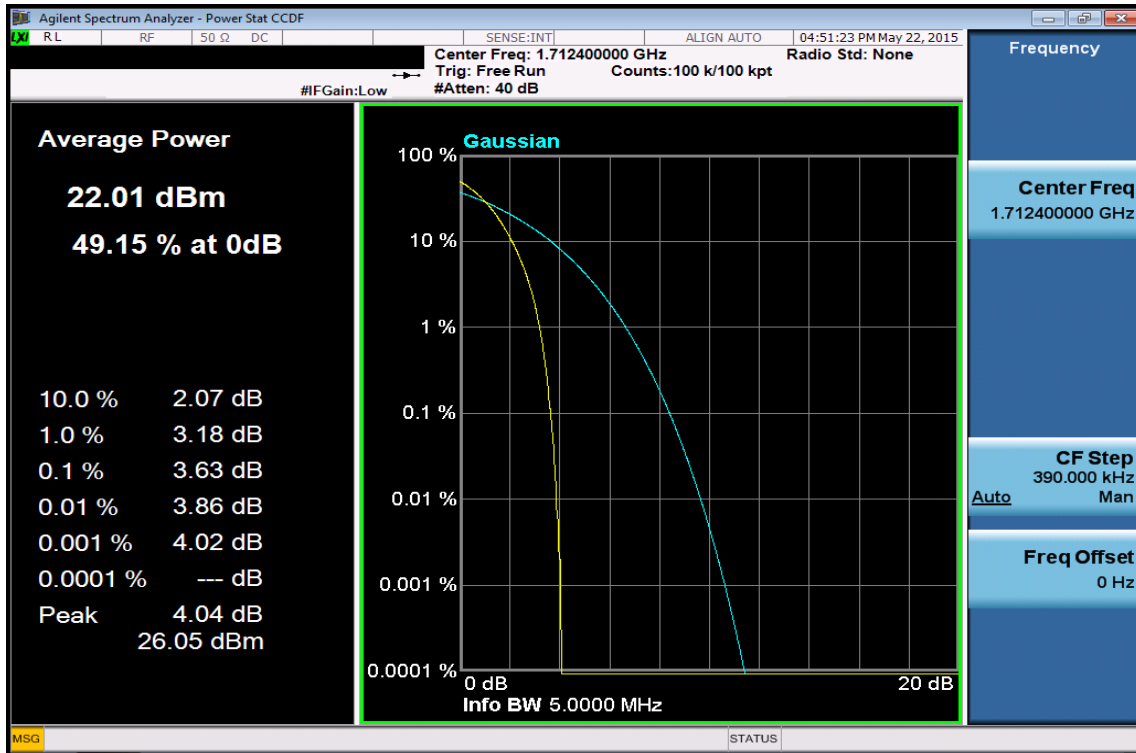

HSDPA Band IV Channel Mid

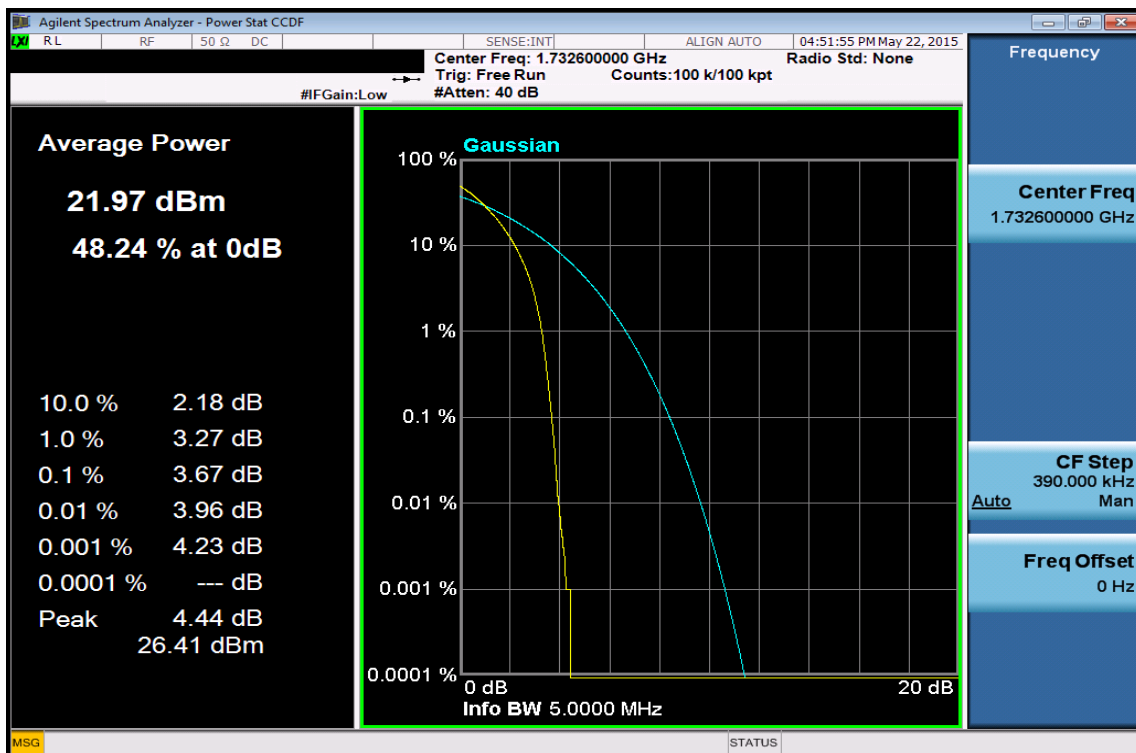

Unless otherwise stated the results shown in this test report refer only to the sample(s) tested and such sample(s) are retained for 90 days only.

除非另有說明，此報告結果僅對測試之樣品負責，同時此樣品僅保留90天。本報告未經本公司書面許可，不可部份複製。

This document is issued by the Company subject to its General Conditions of Service printed overleaf, available on request or accessible at www.sgs.com/terms_and_conditions.htm and, for electronic format documents, subject to Terms and Conditions for Electronic Documents at www.sgs.com/terms_e-document.htm. Attention is drawn to the limitation of liability, indemnification and jurisdiction issues defined therein. Any holder of this document is advised that information contained hereon reflects the Company's findings at the time of its intervention only and within the limits of Client's instructions, if any. The Company's sole responsibility is to its Client and this document does not exonerate parties to a transaction from exercising all their rights and obligations under the transaction documents. This document cannot be reproduced except in full, without prior written approval of the Company. Any unauthorized alteration, forgery or falsification of the content or appearance of this document is unlawful and offenders may be prosecuted to the fullest extent of the law.

SGS Taiwan Ltd.

No. 134, WuKungRoad, NewTaipeiIndustrialPark, WukuDistrict, NewTaipeiCity, Taiwan24803/新北市五股區新北產業園區五工路 134 號

台灣檢驗科技股份有限公司

t (886-2) 2299-3279

f (886-2) 2298-0488

www.tw.sgs.com

Member of SGS Group

HSDPA Band IV Channel High

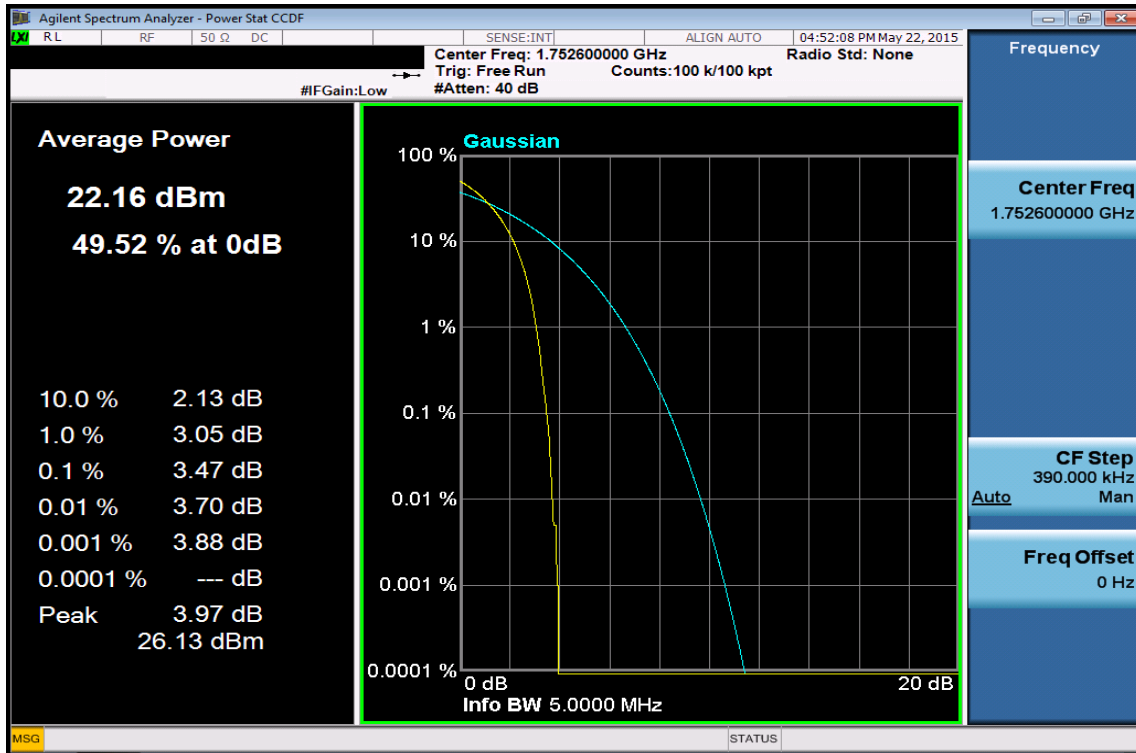

HSDPA Band V Channel Low

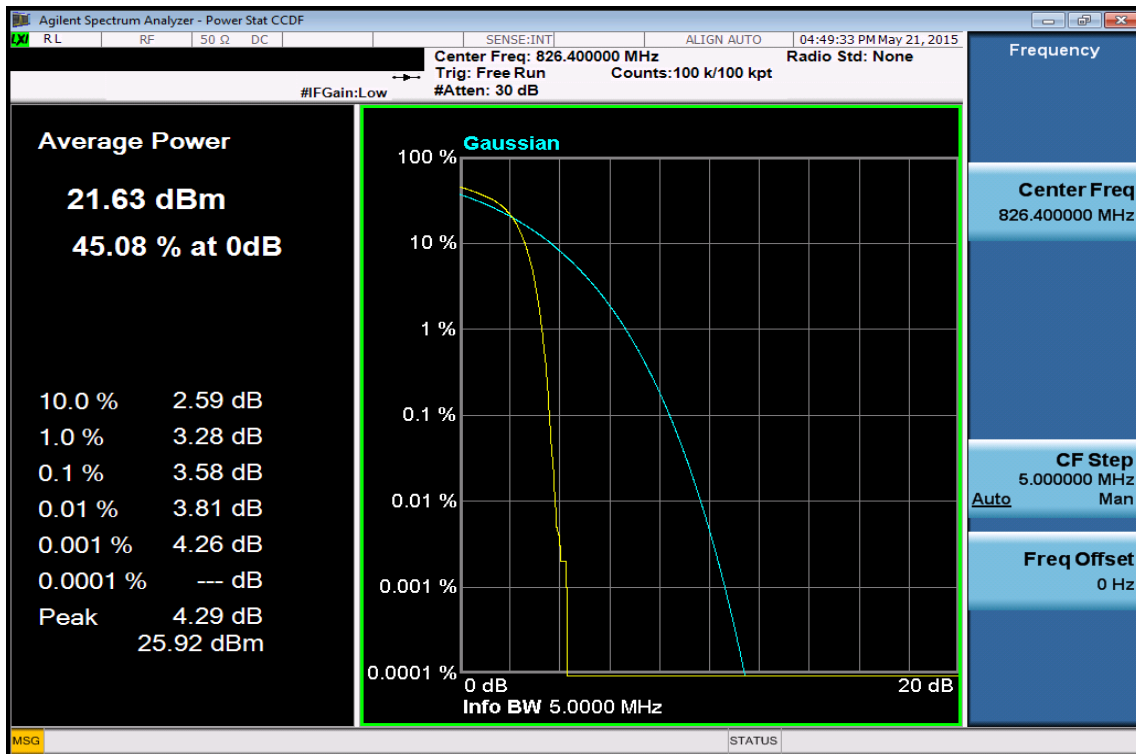

Unless otherwise stated the results shown in this test report refer only to the sample(s) tested and such sample(s) are retained for 90 days only.

除非另有說明，此報告結果僅對測試之樣品負責，同時此樣品僅保留90天。本報告未經本公司書面許可，不可部份複製。

This document is issued by the Company subject to its General Conditions of Service printed overleaf, available on request or accessible at www.sgs.com/terms_and_conditions.htm and, for electronic format documents, subject to Terms and Conditions for Electronic Documents at www.sgs.com/terms_e-document.htm. Attention is drawn to the limitation of liability, indemnification and jurisdiction issues defined therein. Any holder of this document is advised that information contained hereon reflects the Company's findings at the time of its intervention only and within the limits of Client's instructions, if any. The Company's sole responsibility is to its Client and this document does not exonerate parties to a transaction from exercising all their rights and obligations under the transaction documents. This document cannot be reproduced except in full, without prior written approval of the Company. Any unauthorized alteration, forgery or falsification of the content or appearance of this document is unlawful and offenders may be prosecuted to the fullest extent of the law.

SGS Taiwan Ltd.

No. 134, WuKungRoad, NewTaipeiIndustrialPark, WukuDistrict, NewTaipeiCity, Taiwan24803/新北市五股區新北產業園區五工路 134 號

台灣檢驗科技股份有限公司

t (886-2) 2299-3279

f (886-2) 2298-0488

www.tw.sgs.com

Member of SGS Group

HSDPA Band V Channel Mid

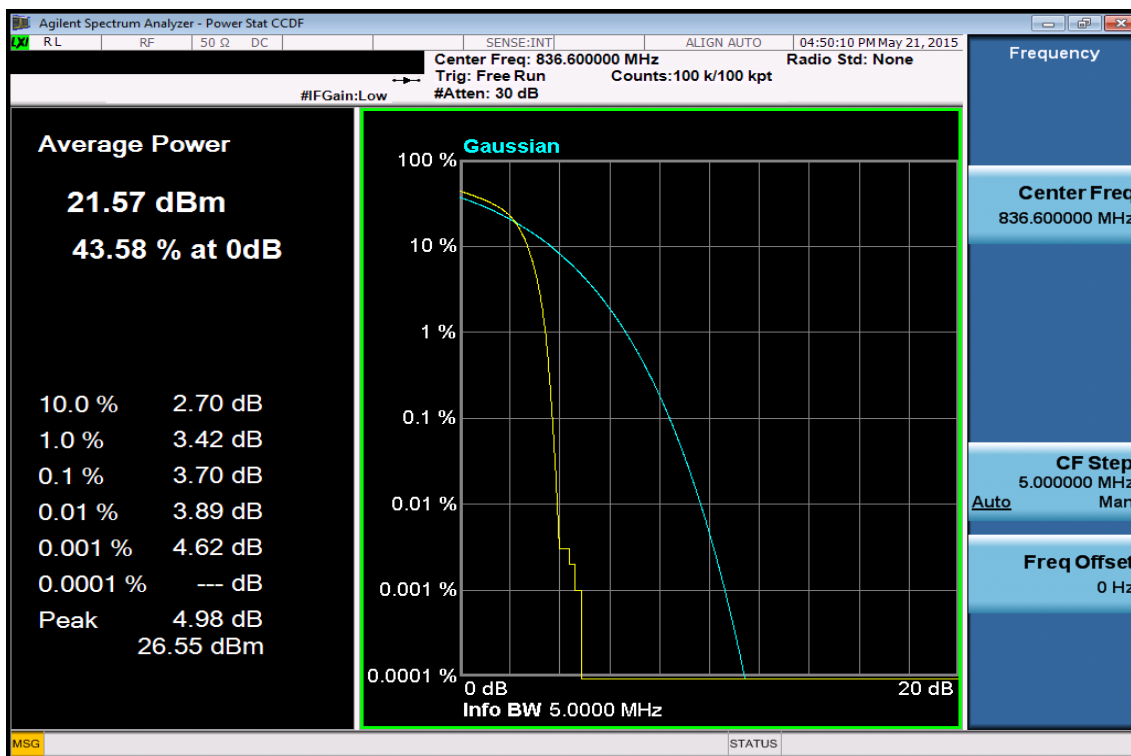

HSDPA Band V Channel High

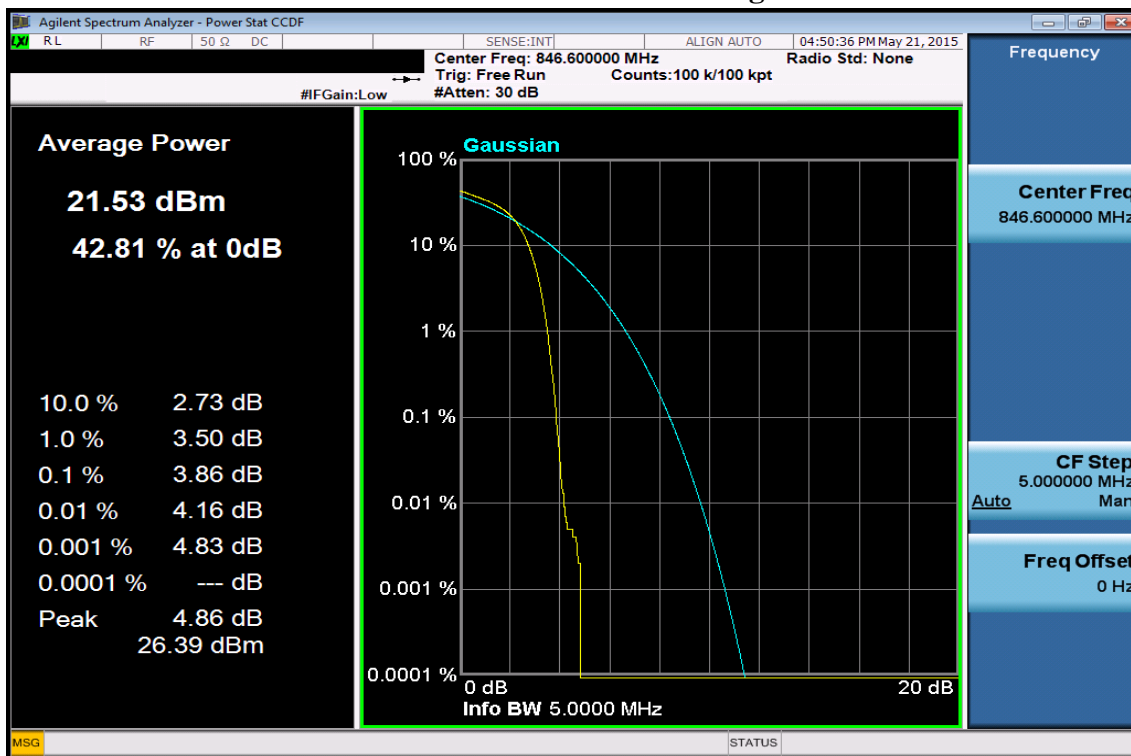

Unless otherwise stated the results shown in this test report refer only to the sample(s) tested and such sample(s) are retained for 90 days only.

除非另有說明，此報告結果僅對測試之樣品負責，同時此樣品僅保留90天。本報告未經本公司書面許可，不可部份複製。

This document is issued by the Company subject to its General Conditions of Service printed overleaf, available on request or accessible at www.sgs.com/terms_and_conditions.htm and, for electronic format documents, subject to Terms and Conditions for Electronic Documents at www.sgs.com/terms_e-document.htm. Attention is drawn to the limitation of liability, indemnification and jurisdiction issues defined therein. Any holder of this document is advised that information contained hereon reflects the Company's findings at the time of its intervention only and within the limits of Client's instructions, if any. The Company's sole responsibility is to its Client and this document does not exonerate parties to a transaction from exercising all their rights and obligations under the transaction documents. This document cannot be reproduced except in full, without prior written approval of the Company. Any unauthorized alteration, forgery or falsification of the content or appearance of this document is unlawful and offenders may be prosecuted to the fullest extent of the law.

SGS Taiwan Ltd.

No. 134, WuKungRoad, NewTaipeiIndustrialPark, WukuDistrict, NewTaipeiCity, Taiwan24803/新北市五股區新北產業園區五工路 134 號

台灣檢驗科技股份有限公司

t (886-2) 2299-3279

f (886-2) 2298-0488

www.tw.sgs.com

Member of SGS Group

HSUPA Band II Channel Low

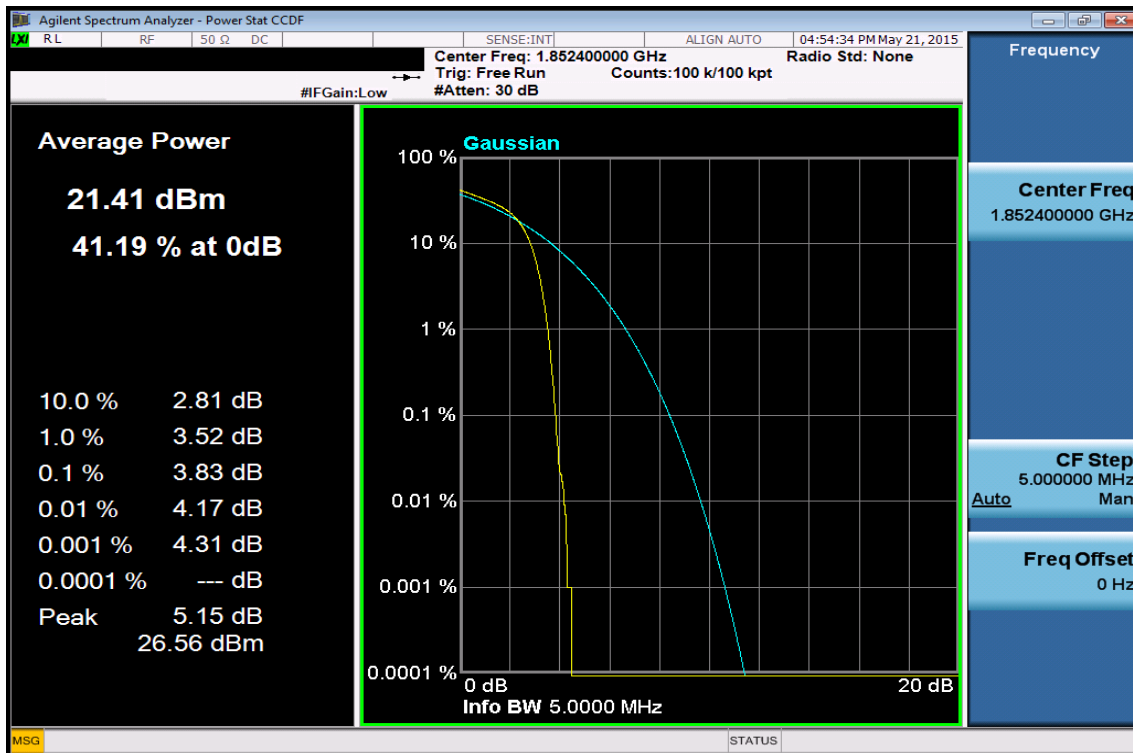

HSUPA Band II Channel Mid

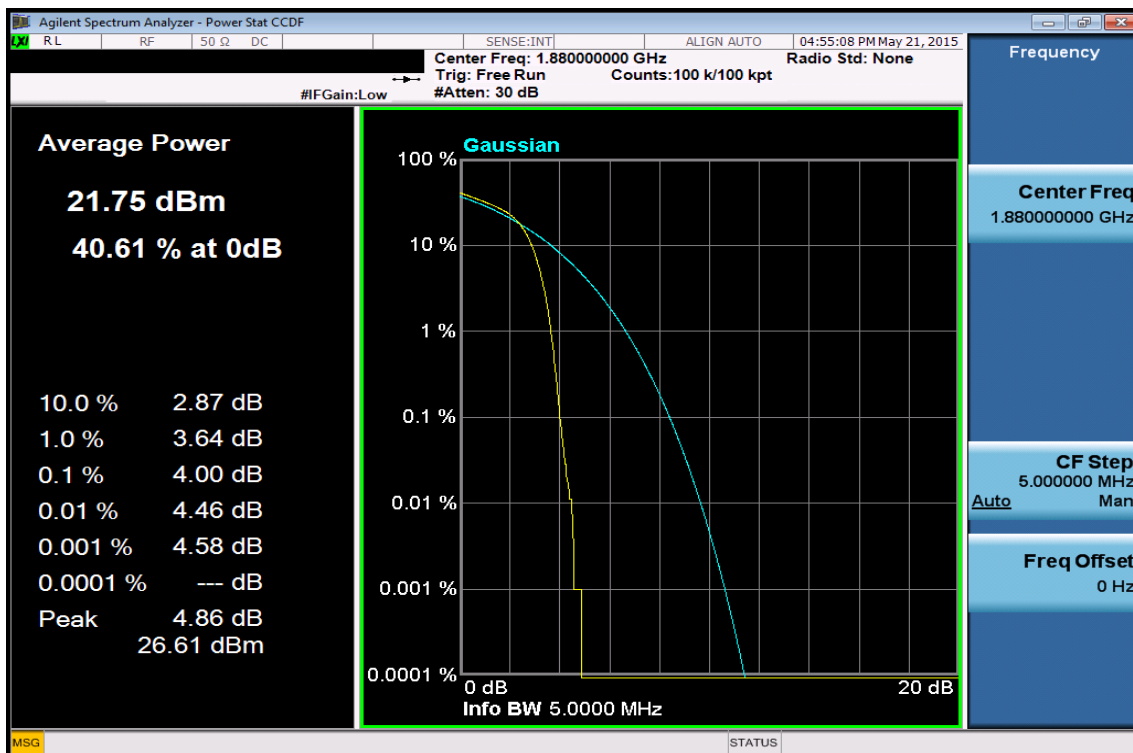

Unless otherwise stated the results shown in this test report refer only to the sample(s) tested and such sample(s) are retained for 90 days only.

除非另有說明，此報告結果僅對測試之樣品負責，同時此樣品僅保留90天。本報告未經本公司書面許可，不可部份複製。

This document is issued by the Company subject to its General Conditions of Service printed overleaf, available on request or accessible at www.sgs.com/terms_and_conditions.htm and, for electronic format documents, subject to Terms and Conditions for Electronic Documents at www.sgs.com/terms_e-document.htm. Attention is drawn to the limitation of liability, indemnification and jurisdiction issues defined therein. Any holder of this document is advised that information contained hereon reflects the Company's findings at the time of its intervention only and within the limits of Client's instructions, if any. The Company's sole responsibility is to its Client and this document does not exonerate parties to a transaction from exercising all their rights and obligations under the transaction documents. This document cannot be reproduced except in full, without prior written approval of the Company. Any unauthorized alteration, forgery or falsification of the content or appearance of this document is unlawful and offenders may be prosecuted to the fullest extent of the law.

SGS Taiwan Ltd.

No. 134, WuKungRoad, NewTaipeiIndustrialPark, WukuDistrict, NewTaipeiCity, Taiwan24803/新北市五股區新北產業園區五工路 134 號

台灣檢驗科技股份有限公司

t (886-2) 2299-3279

f (886-2) 2298-0488

www.tw.sgs.com

Member of SGS Group

HSUPA Band II Channel High

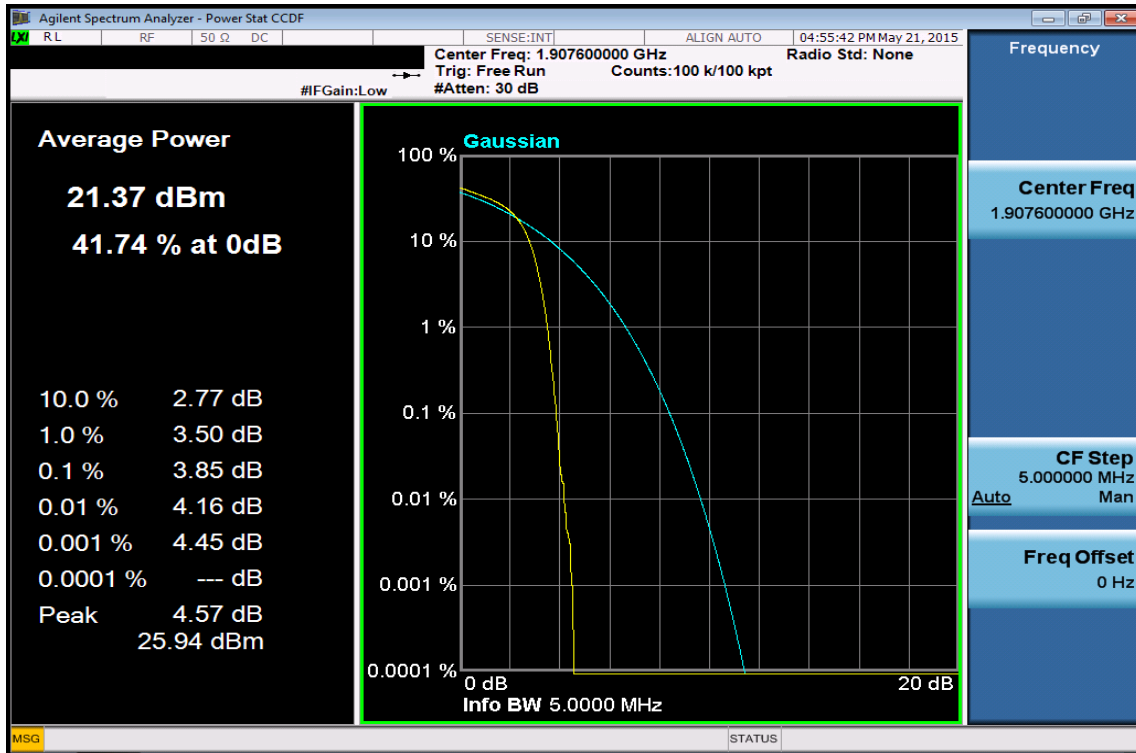

HSUPA Band IV Channel Low

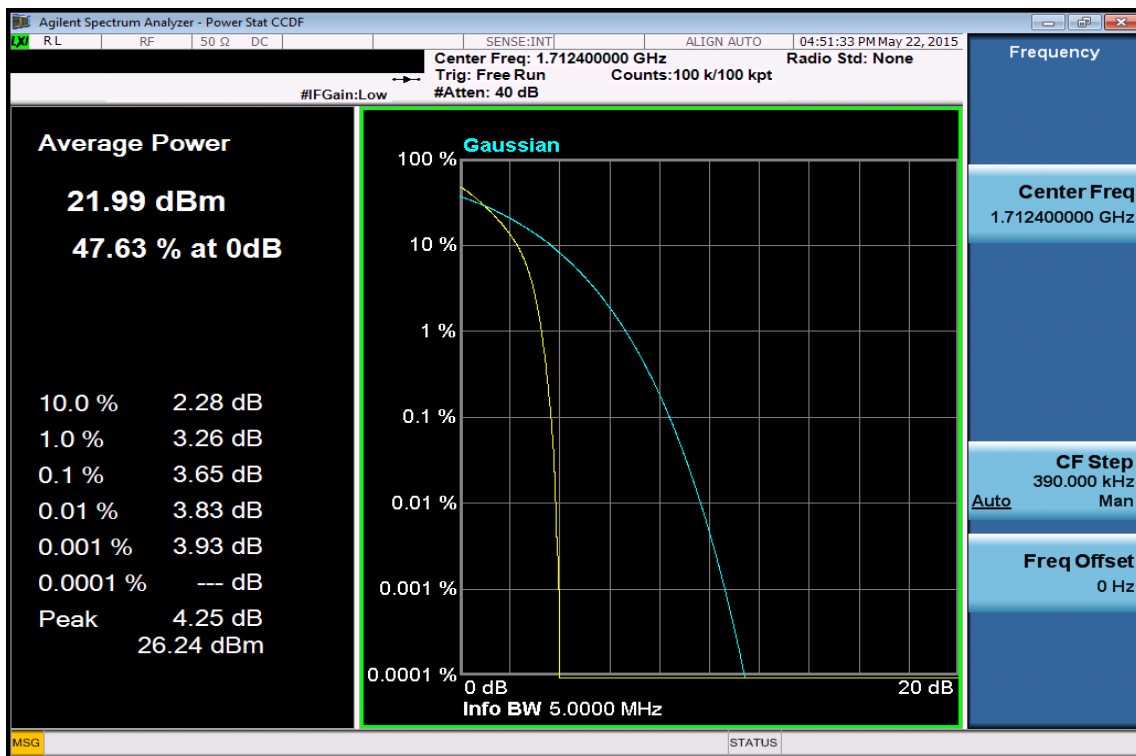

Unless otherwise stated the results shown in this test report refer only to the sample(s) tested and such sample(s) are retained for 90 days only.

除非另有說明，此報告結果僅對測試之樣品負責，同時此樣品僅保留90天。本報告未經本公司書面許可，不可部份複製。

This document is issued by the Company subject to its General Conditions of Service printed overleaf, available on request or accessible at www.sgs.com/terms_and_conditions.htm and, for electronic format documents, subject to Terms and Conditions for Electronic Documents at www.sgs.com/terms_e-document.htm. Attention is drawn to the limitation of liability, indemnification and jurisdiction issues defined therein. Any holder of this document is advised that information contained hereon reflects the Company's findings at the time of its intervention only and within the limits of Client's instructions, if any. The Company's sole responsibility is to its Client and this document does not exonerate parties to a transaction from exercising all their rights and obligations under the transaction documents. This document cannot be reproduced except in full, without prior written approval of the Company. Any unauthorized alteration, forgery or falsification of the content or appearance of this document is unlawful and offenders may be prosecuted to the fullest extent of the law.

SGS Taiwan Ltd.

No. 134, WuKungRoad, NewTaipeiIndustrialPark, WukuDistrict, NewTaipeiCity, Taiwan24803/新北市五股區新北產業園區五工路 134 號

台灣檢驗科技股份有限公司

t (886-2) 2299-3279

f (886-2) 2298-0488

www.tw.sgs.com

Member of SGS Group

HSUPA Band IV Channel Mid

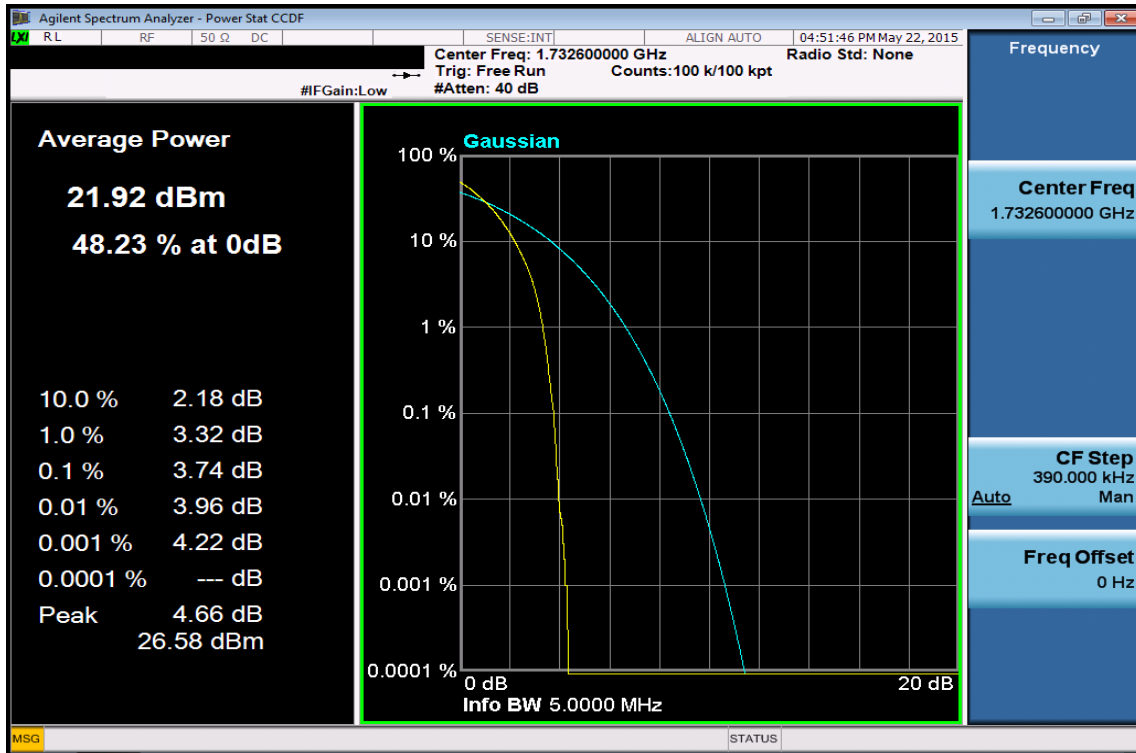

HSUPA Band IV Channel High

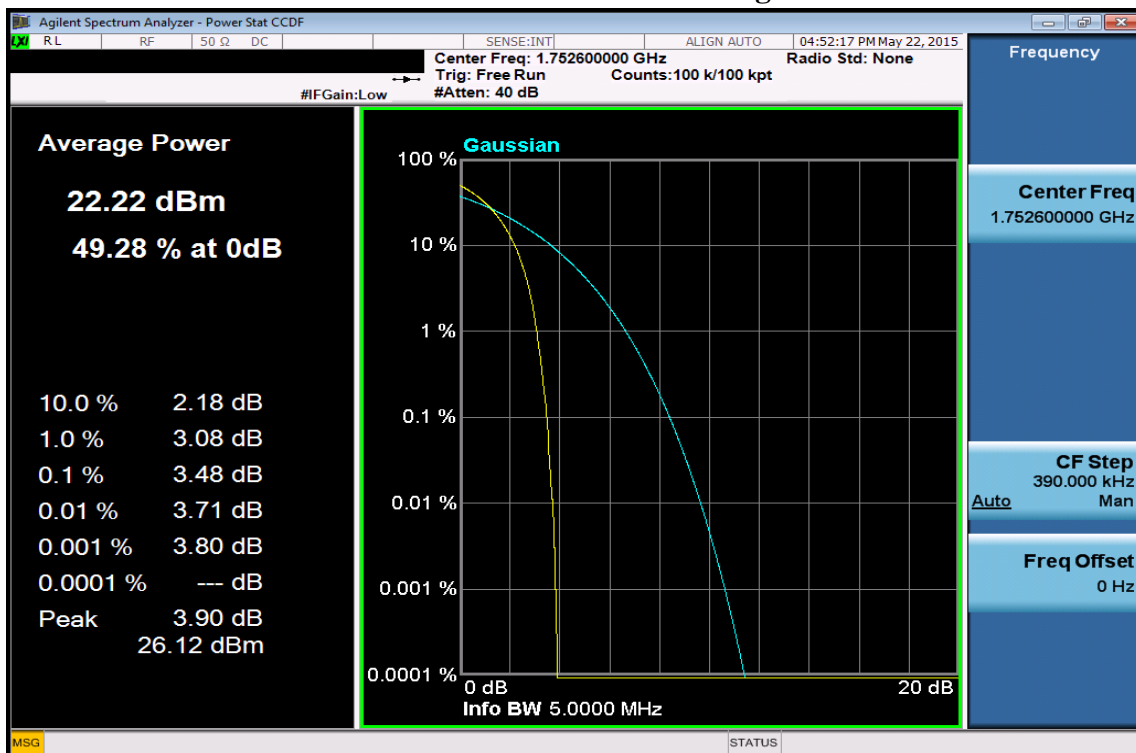

Unless otherwise stated the results shown in this test report refer only to the sample(s) tested and such sample(s) are retained for 90 days only.

除非另有說明，此報告結果僅對測試之樣品負責，同時此樣品僅保留90天。本報告未經本公司書面許可，不可部份複製。

This document is issued by the Company subject to its General Conditions of Service printed overleaf, available on request or accessible at www.sgs.com/terms_and_conditions.htm and, for electronic format documents, subject to Terms and Conditions for Electronic Documents at www.sgs.com/terms_e-document.htm. Attention is drawn to the limitation of liability, indemnification and jurisdiction issues defined therein. Any holder of this document is advised that information contained hereon reflects the Company's findings at the time of its intervention only and within the limits of Client's instructions, if any. The Company's sole responsibility is to its Client and this document does not exonerate parties to a transaction from exercising all their rights and obligations under the transaction documents. This document cannot be reproduced except in full, without prior written approval of the Company. Any unauthorized alteration, forgery or falsification of the content or appearance of this document is unlawful and offenders may be prosecuted to the fullest extent of the law.

SGS Taiwan Ltd.

No. 134, WuKungRoad, NewTaipeiIndustrialPark, WukuDistrict, NewTaipeiCity, Taiwan24803/新北市五股區新北產業園區五工路 134 號

台灣檢驗科技股份有限公司

t (886-2) 2299-3279

f (886-2) 2298-0488

www.tw.sgs.com

Member of SGS Group

HSUPA Band V Channel Low

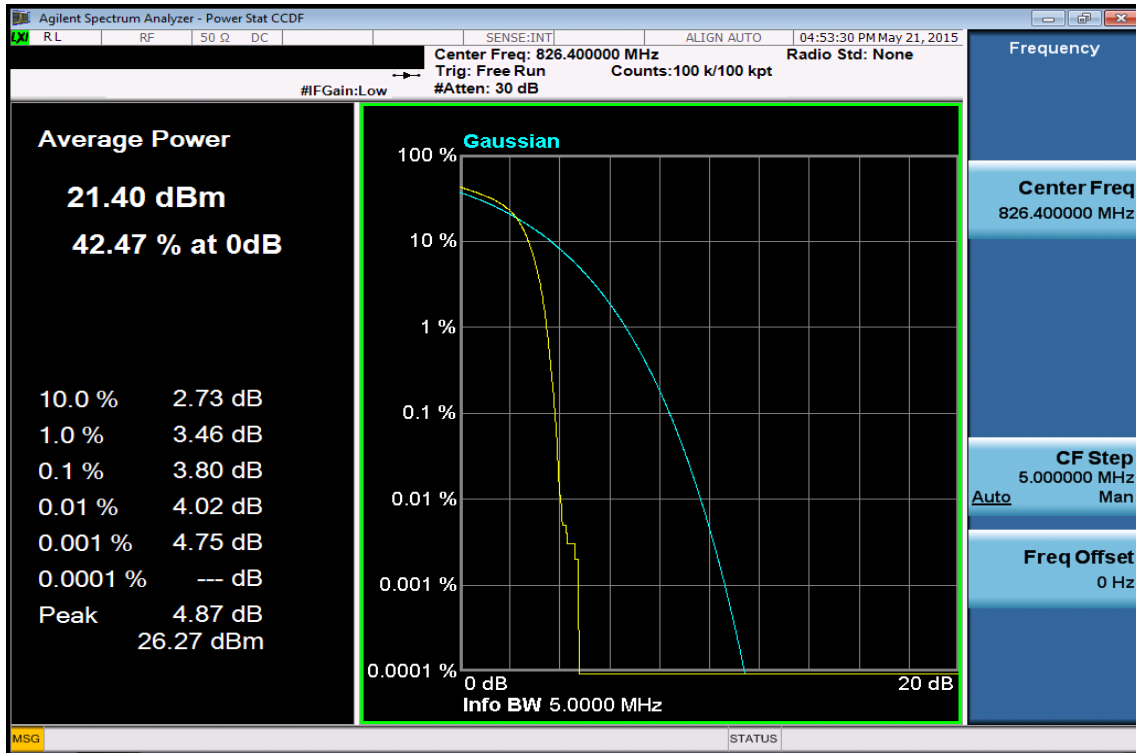

HSUPA Band V Channel Mid

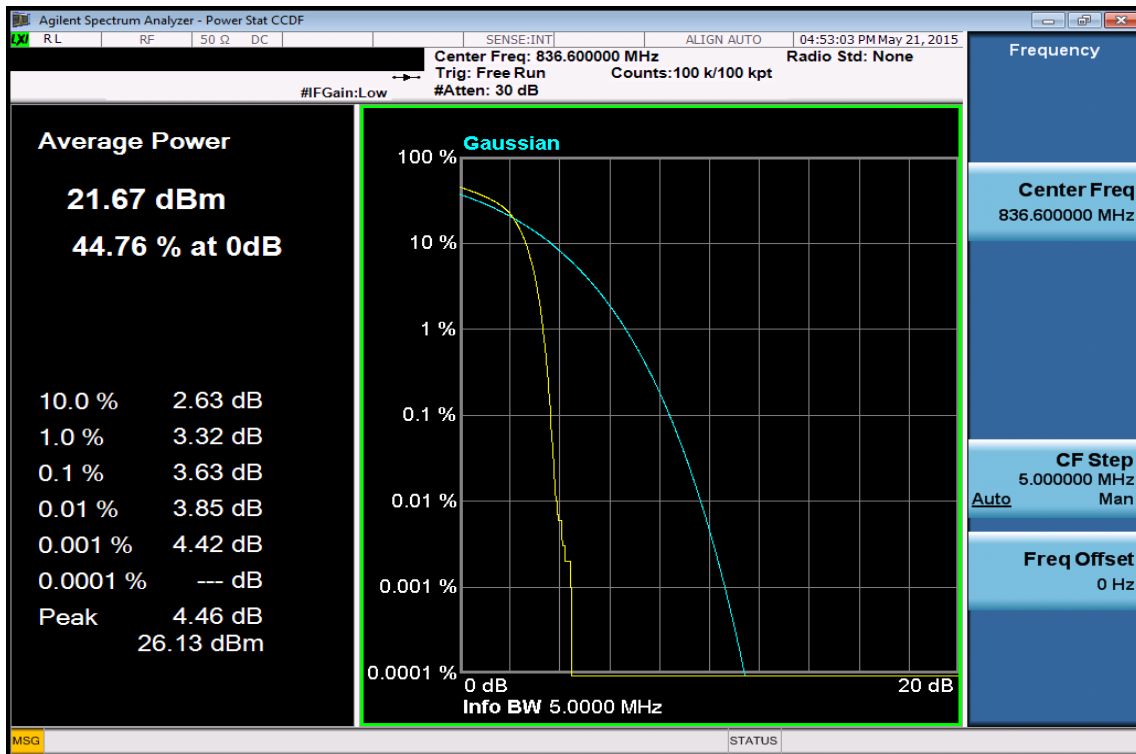

Unless otherwise stated the results shown in this test report refer only to the sample(s) tested and such sample(s) are retained for 90 days only.

除非另有說明，此報告結果僅對測試之樣品負責，同時此樣品僅保留90天。本報告未經本公司書面許可，不可部份複製。

This document is issued by the Company subject to its General Conditions of Service printed overleaf, available on request or accessible at www.sgs.com/terms_and_conditions.htm and, for electronic format documents, subject to Terms and Conditions for Electronic Documents at www.sgs.com/terms_e-document.htm. Attention is drawn to the limitation of liability, indemnification and jurisdiction issues defined therein. Any holder of this document is advised that information contained hereon reflects the Company's findings at the time of its intervention only and within the limits of Client's instructions, if any. The Company's sole responsibility is to its Client and this document does not exonerate parties to a transaction from exercising all their rights and obligations under the transaction documents. This document cannot be reproduced except in full, without prior written approval of the Company. Any unauthorized alteration, forgery or falsification of the content or appearance of this document is unlawful and offenders may be prosecuted to the fullest extent of the law.

SGS Taiwan Ltd.

No. 134, WuKungRoad, NewTaipeiIndustrialPark, WukuDistrict, NewTaipeiCity, Taiwan24803/新北市五股區新北產業園區五工路 134 號

台灣檢驗科技股份有限公司

t (886-2) 2299-3279

f (886-2) 2298-0488

www.tw.sgs.com

Member of SGS Group

HSUPA Band V Channel High

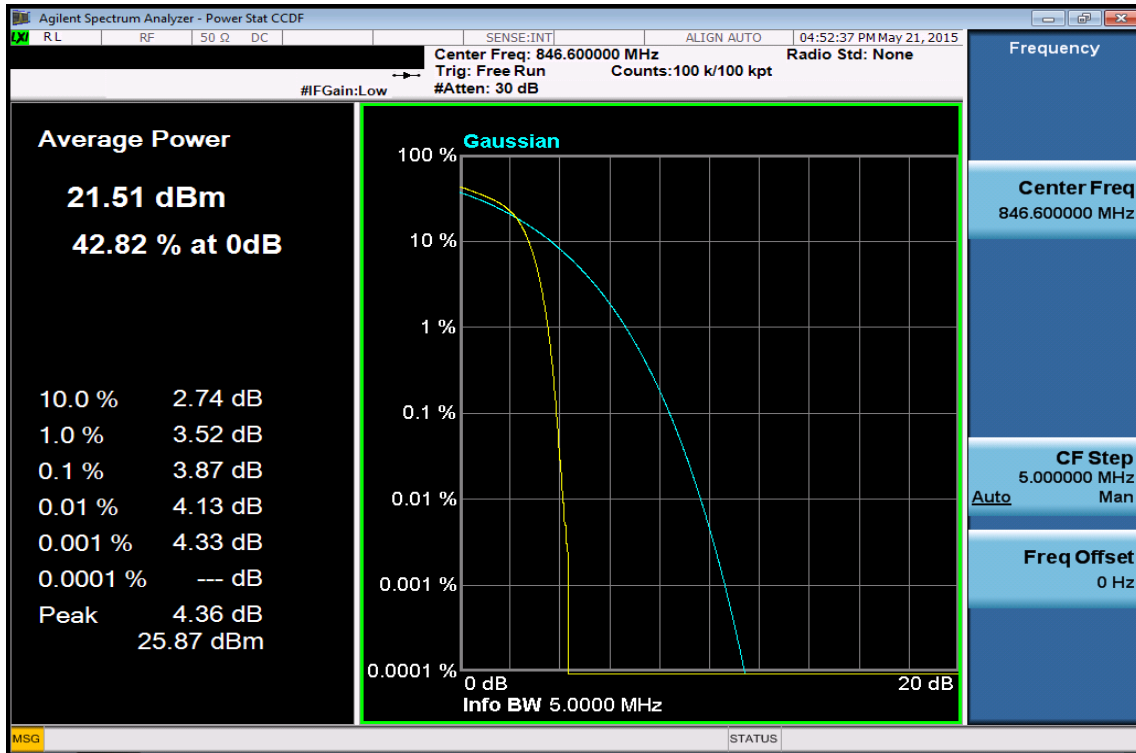

1.4MHz BW LTE-Band 2(16QAM Number: 6 Offset: 0) Channel Low



Unless otherwise stated the results shown in this test report refer only to the sample(s) tested and such sample(s) are retained for 90 days only.

除非另有說明，此報告結果僅對測試之樣品負責，同時此樣品僅保留90天。本報告未經本公司書面許可，不可部份複製。

This document is issued by the Company subject to its General Conditions of Service printed overleaf, available on request or accessible at www.sgs.com/terms_and_conditions.htm and, for electronic format documents, subject to Terms and Conditions for Electronic Documents at www.sgs.com/terms_e-document.htm. Attention is drawn to the limitation of liability, indemnification and jurisdiction issues defined therein. Any holder of this document is advised that information contained hereon reflects the Company's findings at the time of its intervention only and within the limits of Client's instructions, if any. The Company's sole responsibility is to its Client and this document does not exonerate parties to a transaction from exercising all their rights and obligations under the transaction documents. This document cannot be reproduced except in full, without prior written approval of the Company. Any unauthorized alteration, forgery or falsification of the content or appearance of this document is unlawful and offenders may be prosecuted to the fullest extent of the law.

SGS Taiwan Ltd.

No.134,WuKungRoad,NewTaipeiIndustrialPark,WukuDistrict,NewTaipeiCity,Taiwan24803/新北市五股區新北產業園區五工路 134 號

台灣檢驗科技股份有限公司

t (886-2) 2299-3279

f (886-2) 2298-0488

www.tw.sgs.com

Member of SGS Group

1.4MHz BW LTE-Band 2(16QAM Number: 6 Offset: 0) Channel Mid

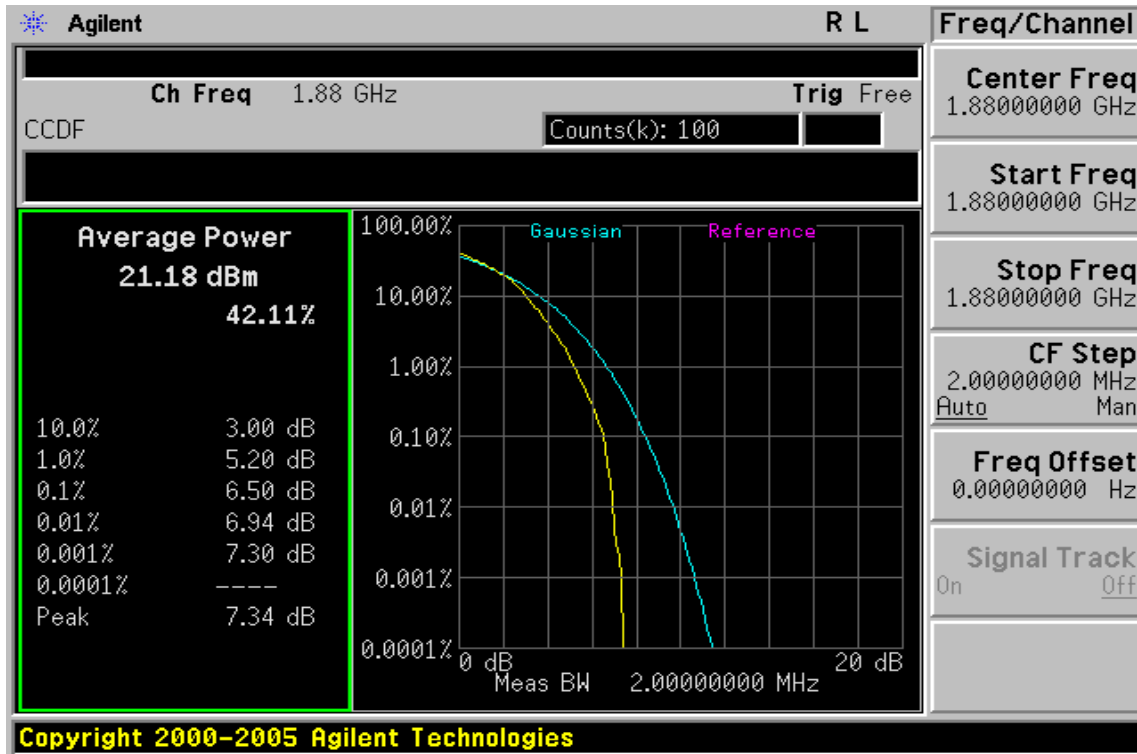

1.4MHz BW LTE-Band 2(16QAM Number: 6 Offset: 0) Channel High

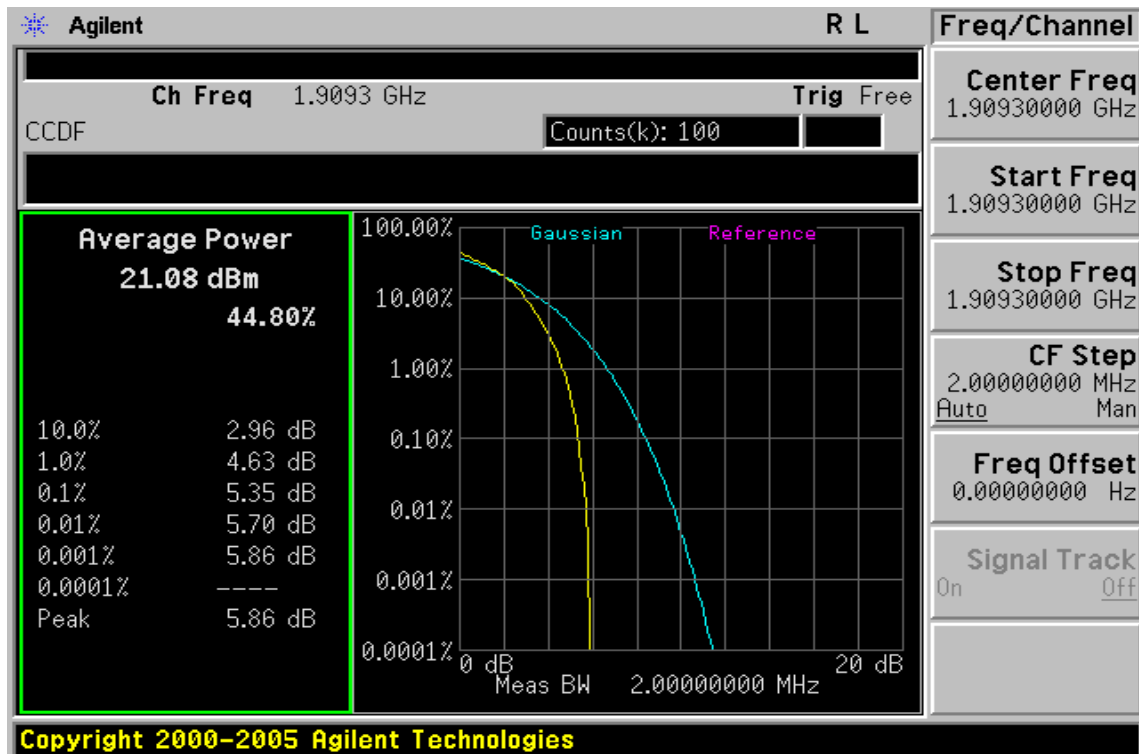

Unless otherwise stated the results shown in this test report refer only to the sample(s) tested and such sample(s) are retained for 90 days only.

除非另有說明，此報告結果僅對測試之樣品負責，同時此樣品僅保留90天。本報告未經本公司書面許可，不可部份複製。

This document is issued by the Company subject to its General Conditions of Service printed overleaf, available on request or accessible at www.sgs.com/terms_and_conditions.htm and, for electronic format documents, subject to Terms and Conditions for Electronic Documents at www.sgs.com/terms_e-document.htm. Attention is drawn to the limitation of liability, indemnification and jurisdiction issues defined therein. Any holder of this document is advised that information contained hereon reflects the Company's findings at the time of its intervention only and within the limits of Client's instructions, if any. The Company's sole responsibility is to its Client and this document does not exonerate parties to a transaction from exercising all their rights and obligations under the transaction documents. This document cannot be reproduced except in full, without prior written approval of the Company. Any unauthorized alteration, forgery or falsification of the content or appearance of this document is unlawful and offenders may be prosecuted to the fullest extent of the law.

SGS Taiwan Ltd.

No.134,WuKungRoad,NewTaipeiIndustrialPark,WukuDistrict,NewTaipeiCity,Taiwan24803/新北市五股區新北產業園區五工路 134 號

台灣檢驗科技股份有限公司

t (886-2) 2299-3279

f (886-2) 2298-0488

www.tw.sgs.com

Member of SGS Group

3MHz BW LTE-Band 2(16QAM Number: 15 Offset: 0) Channel Low

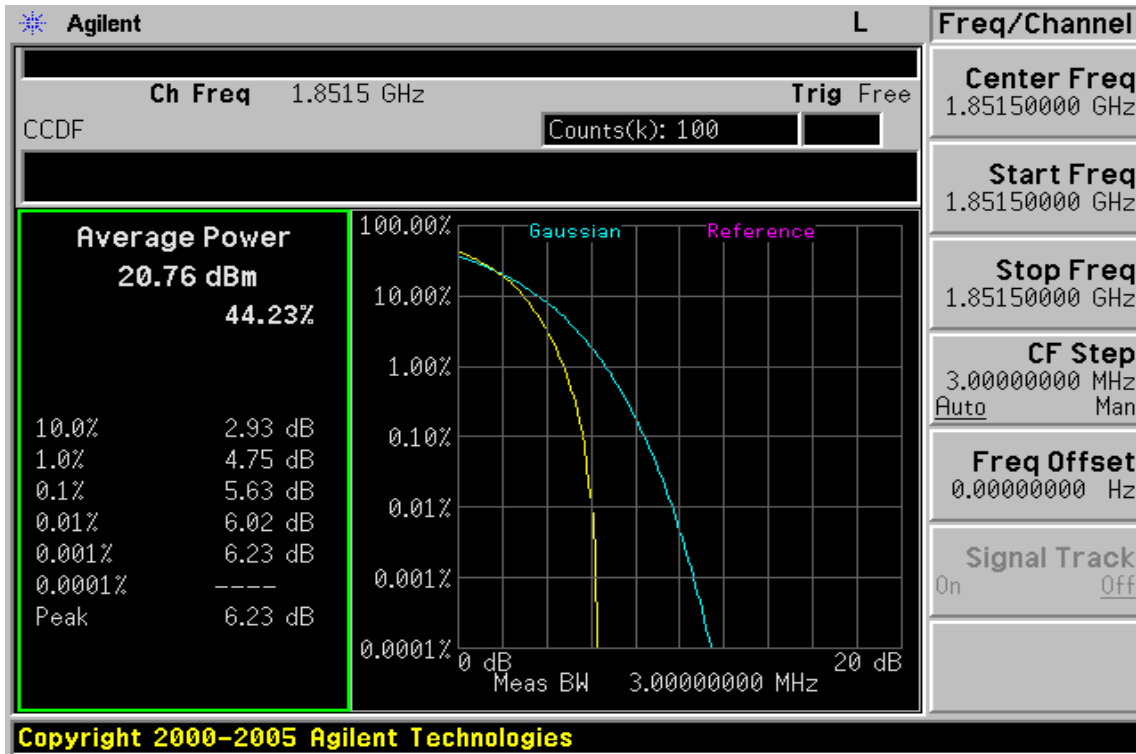

3MHz BW LTE-Band 2(16QAM Number: 15 Offset: 0) Channel Mid

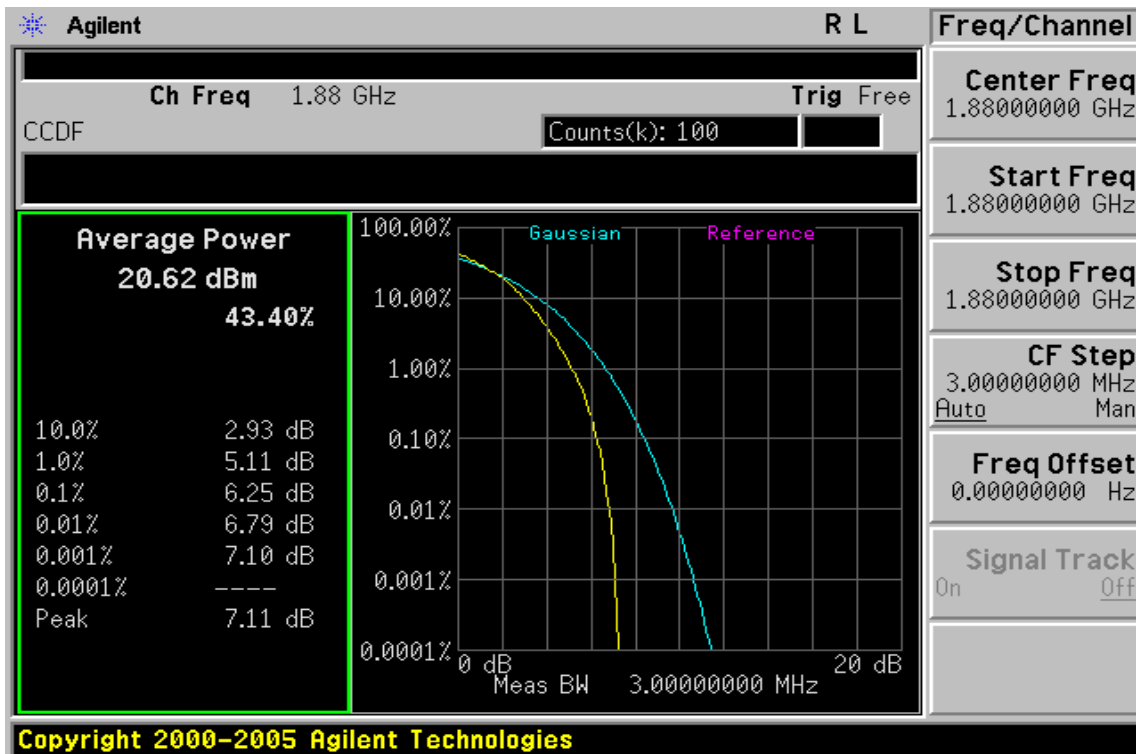

Unless otherwise stated the results shown in this test report refer only to the sample(s) tested and such sample(s) are retained for 90 days only.

除非另有說明，此報告結果僅對測試之樣品負責，同時此樣品僅保留90天。本報告未經本公司書面許可，不可部份複製。

This document is issued by the Company subject to its General Conditions of Service printed overleaf, available on request or accessible at www.sgs.com/terms_and_conditions.htm and, for electronic format documents, subject to Terms and Conditions for Electronic Documents at www.sgs.com/terms_e-document.htm. Attention is drawn to the limitation of liability, indemnification and jurisdiction issues defined therein. Any holder of this document is advised that information contained hereon reflects the Company's findings at the time of its intervention only and within the limits of Client's instructions, if any. The Company's sole responsibility is to its Client and this document does not exonerate parties to a transaction from exercising all their rights and obligations under the transaction documents. This document cannot be reproduced except in full, without prior written approval of the Company. Any unauthorized alteration, forgery or falsification of the content or appearance of this document is unlawful and offenders may be prosecuted to the fullest extent of the law.

SGS Taiwan Ltd.

No.134,WuKungRoad,NewTaipeiIndustrialPark,WukuDistrict,NewTaipeiCity,Taiwan24803/新北市五股區新北產業園區五工路 134 號

台灣檢驗科技股份有限公司

t (886-2) 2299-3279

f (886-2) 2298-0488

www.tw.sgs.com

Member of SGS Group

3MHz BW LTE-Band 2(16QAM Number: 15 Offset: 0) Channel High

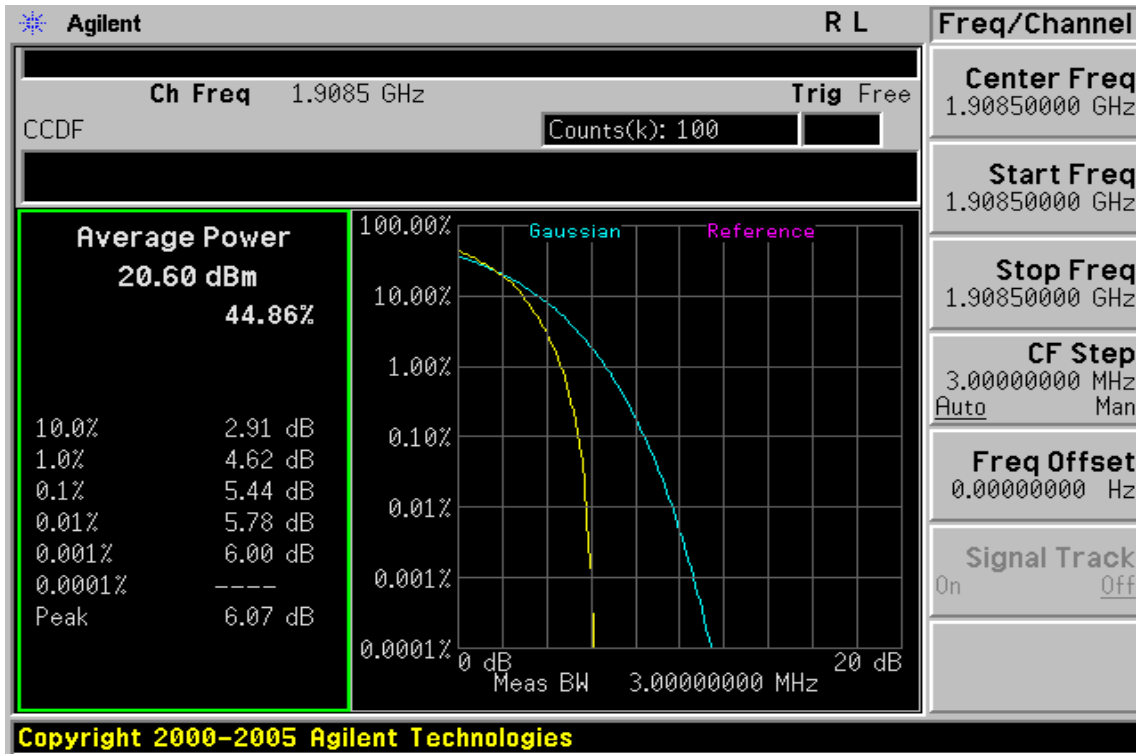

5MHz BW LTE-Band 2(16QAM Number: 25 Offset: 0) Channel Low

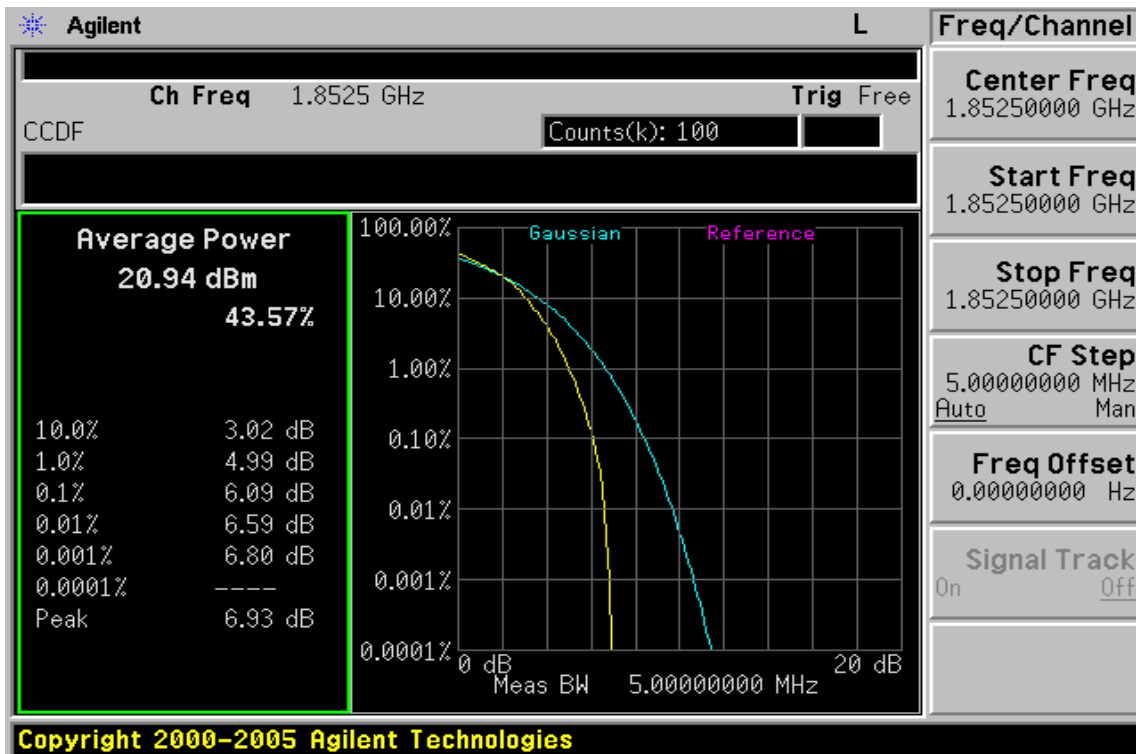

Unless otherwise stated the results shown in this test report refer only to the sample(s) tested and such sample(s) are retained for 90 days only.

除非另有說明，此報告結果僅對測試之樣品負責，同時此樣品僅保留90天。本報告未經本公司書面許可，不可部份複製。

This document is issued by the Company subject to its General Conditions of Service printed overleaf, available on request or accessible at www.sgs.com/terms_and_conditions.htm and, for electronic format documents, subject to Terms and Conditions for Electronic Documents at www.sgs.com/terms_e-document.htm. Attention is drawn to the limitation of liability, indemnification and jurisdiction issues defined therein. Any holder of this document is advised that information contained hereon reflects the Company's findings at the time of its intervention only and within the limits of Client's instructions, if any. The Company's sole responsibility is to its Client and this document does not exonerate parties to a transaction from exercising all their rights and obligations under the transaction documents. This document cannot be reproduced except in full, without prior written approval of the Company. Any unauthorized alteration, forgery or falsification of the content or appearance of this document is unlawful and offenders may be prosecuted to the fullest extent of the law.

SGS Taiwan Ltd.

No.134,WuKungRoad,NewTaipeiIndustrialPark,WukuDistrict,NewTaipeiCity,Taiwan24803/新北市五股區新北產業園區五工路 134 號

台灣檢驗科技股份有限公司

t (886-2) 2299-3279

f (886-2) 2298-0488

www.tw.sgs.com

Member of SGS Group

5MHz BW LTE-Band 2(16QAM Number: 25 Offset: 0) Channel Mid

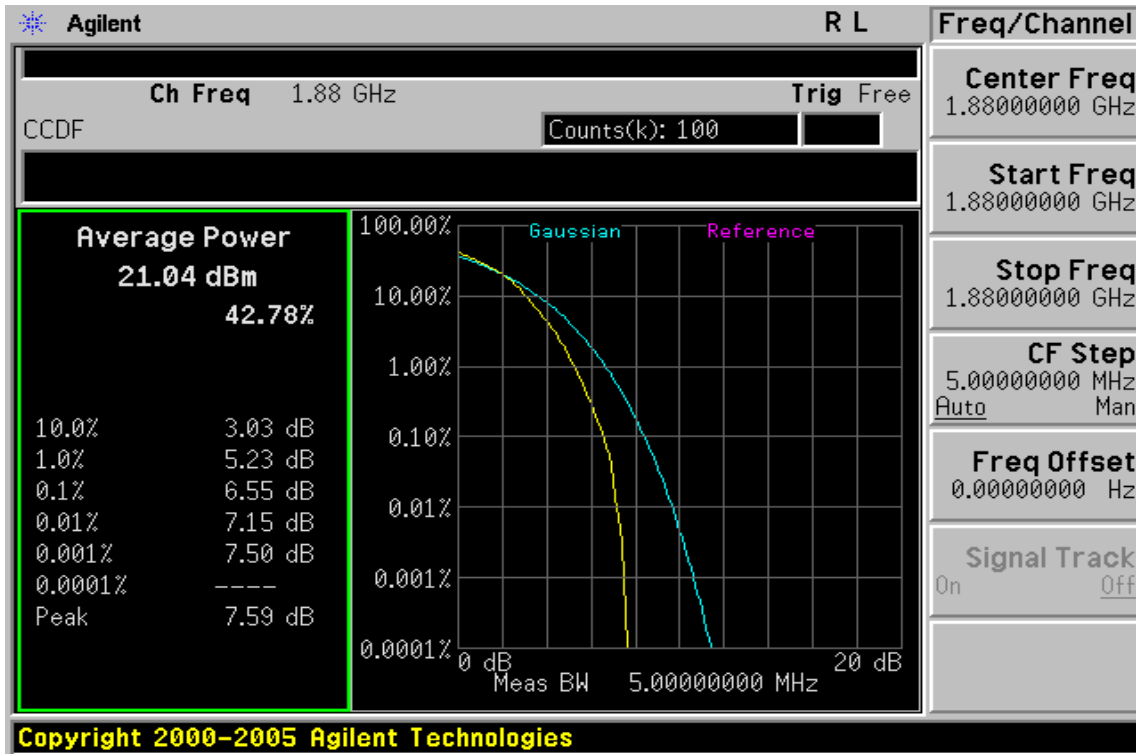

5MHz BW LTE-Band 2(16QAM Number: 25 Offset: 0) Channel High

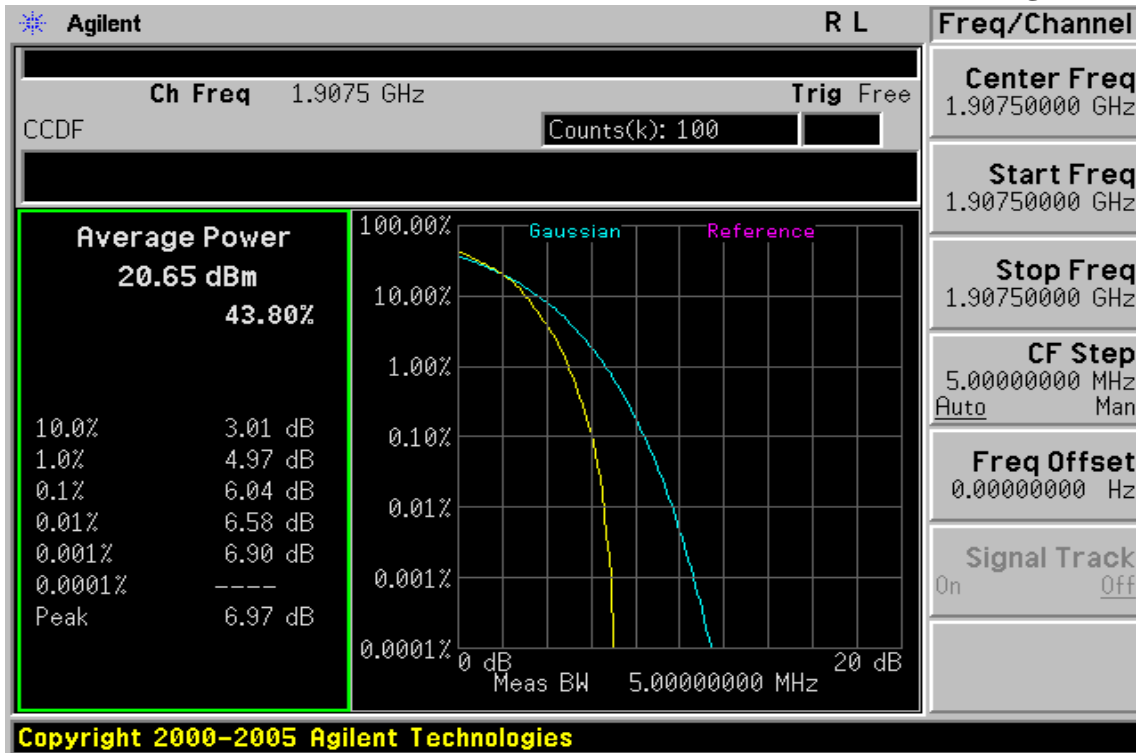

Unless otherwise stated the results shown in this test report refer only to the sample(s) tested and such sample(s) are retained for 90 days only.

除非另有說明，此報告結果僅對測試之樣品負責，同時此樣品僅保留90天。本報告未經本公司書面許可，不可部份複製。

This document is issued by the Company subject to its General Conditions of Service printed overleaf, available on request or accessible at www.sgs.com/terms_and_conditions.htm and, for electronic format documents, subject to Terms and Conditions for Electronic Documents at www.sgs.com/terms_e-document.htm. Attention is drawn to the limitation of liability, indemnification and jurisdiction issues defined therein. Any holder of this document is advised that information contained hereon reflects the Company's findings at the time of its intervention only and within the limits of Client's instructions, if any. The Company's sole responsibility is to its Client and this document does not exonerate parties to a transaction from exercising all their rights and obligations under the transaction documents. This document cannot be reproduced except in full, without prior written approval of the Company. Any unauthorized alteration, forgery or falsification of the content or appearance of this document is unlawful and offenders may be prosecuted to the fullest extent of the law.

SGS Taiwan Ltd.

No.134,WuKungRoad,NewTaipeiIndustrialPark,WukuDistrict,NewTaipeiCity,Taiwan24803/新北市五股區新北產業園區五工路 134 號

台灣檢驗科技股份有限公司

t (886-2) 2299-3279

f (886-2) 2298-0488

www.tw.sgs.com

Member of SGS Group

10MHz BW LTE-Band 2(16QAM Number: 50 Offset: 0) Channel Low

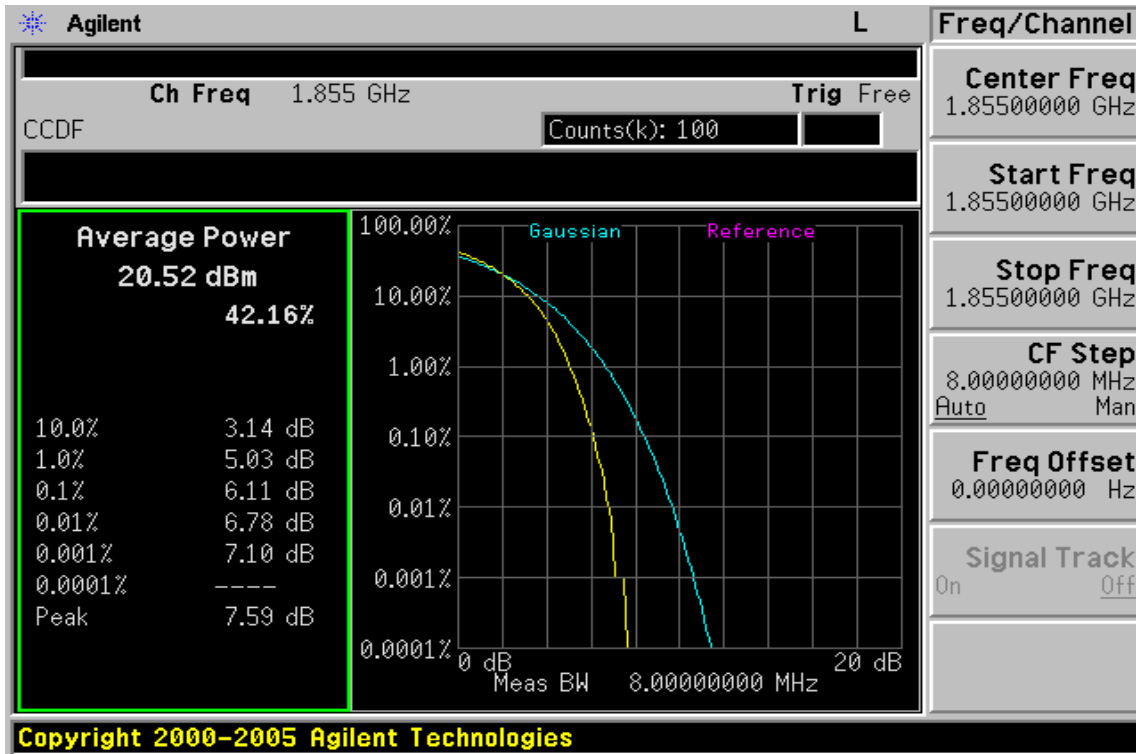

10MHz BW LTE-Band 2(16QAM Number: 50 Offset: 0) Channel Mid

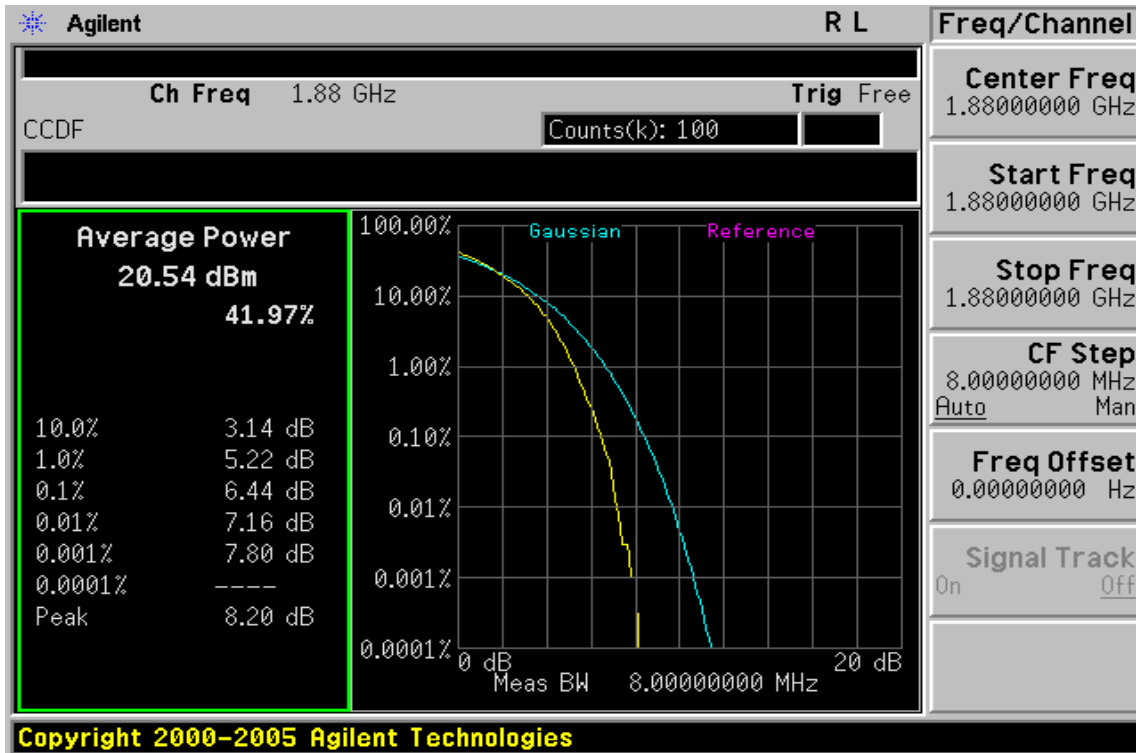

Unless otherwise stated the results shown in this test report refer only to the sample(s) tested and such sample(s) are retained for 90 days only.

除非另有說明，此報告結果僅對測試之樣品負責，同時此樣品僅保留90天。本報告未經本公司書面許可，不可部份複製。

This document is issued by the Company subject to its General Conditions of Service printed overleaf, available on request or accessible at www.sgs.com/terms_and_conditions.htm and, for electronic format documents, subject to Terms and Conditions for Electronic Documents at www.sgs.com/terms_e-document.htm. Attention is drawn to the limitation of liability, indemnification and jurisdiction issues defined therein. Any holder of this document is advised that information contained hereon reflects the Company's findings at the time of its intervention only and within the limits of Client's instructions, if any. The Company's sole responsibility is to its Client and this document does not exonerate parties to a transaction from exercising all their rights and obligations under the transaction documents. This document cannot be reproduced except in full, without prior written approval of the Company. Any unauthorized alteration, forgery or falsification of the content or appearance of this document is unlawful and offenders may be prosecuted to the fullest extent of the law.

10MHz BW LTE-Band 2(16QAM Number: 50 Offset: 0) Channel High

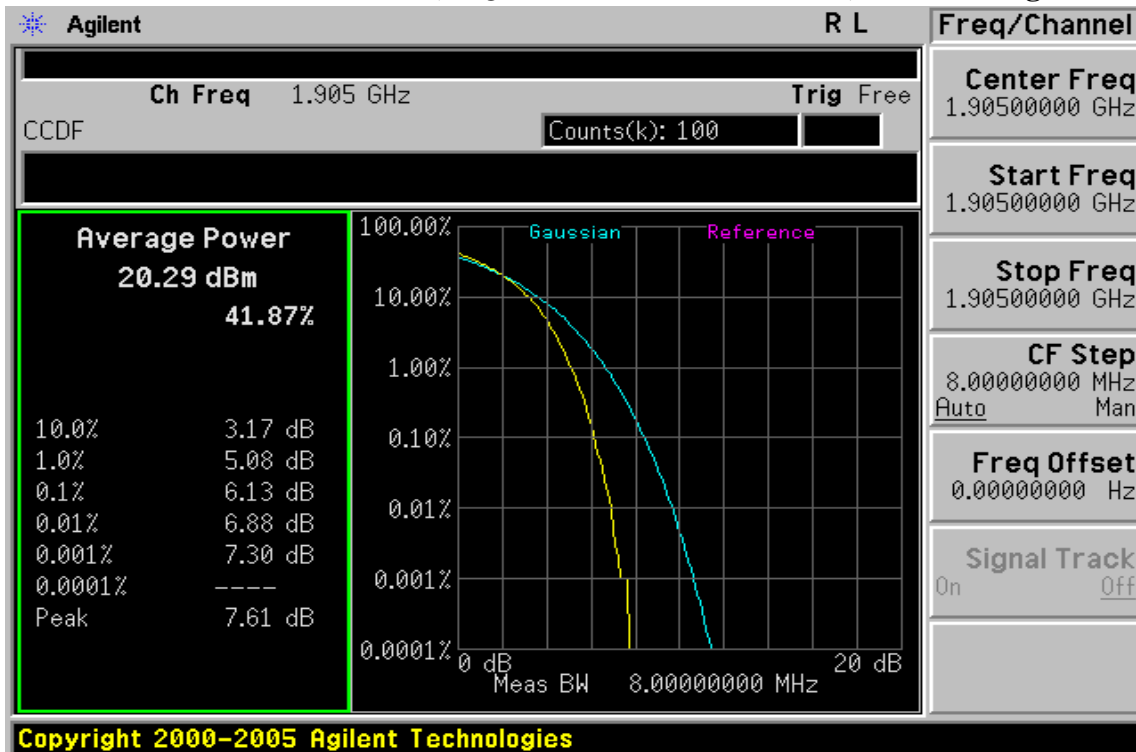

15MHz BW LTE-Band 2(16QAM Number: 75 Offset: 0) Channel Low



Unless otherwise stated the results shown in this test report refer only to the sample(s) tested and such sample(s) are retained for 90 days only.
 除非另有說明，此報告結果僅對測試之樣品負責，同時此樣品僅保留90天。本報告未經本公司書面許可，不可部份複製。
 This document is issued by the Company subject to its General Conditions of Service printed overleaf, available on request or accessible at www.sgs.com/terms_and_conditions.htm and, for electronic format documents, subject to Terms and Conditions for Electronic Documents at www.sgs.com/terms_e-document.htm. Attention is drawn to the limitation of liability, indemnification and jurisdiction issues defined therein. Any holder of this document is advised that information contained hereon reflects the Company's findings at the time of its intervention only and within the limits of Client's instructions, if any. The Company's sole responsibility is to its Client and this document does not exonerate parties to a transaction from exercising all their rights and obligations under the transaction documents. This document cannot be reproduced except in full, without prior written approval of the Company. Any unauthorized alteration, forgery or falsification of the content or appearance of this document is unlawful and offenders may be prosecuted to the fullest extent of the law.

15MHz BW LTE-Band 2(16QAM Number: 75 Offset: 0) Channel Mid

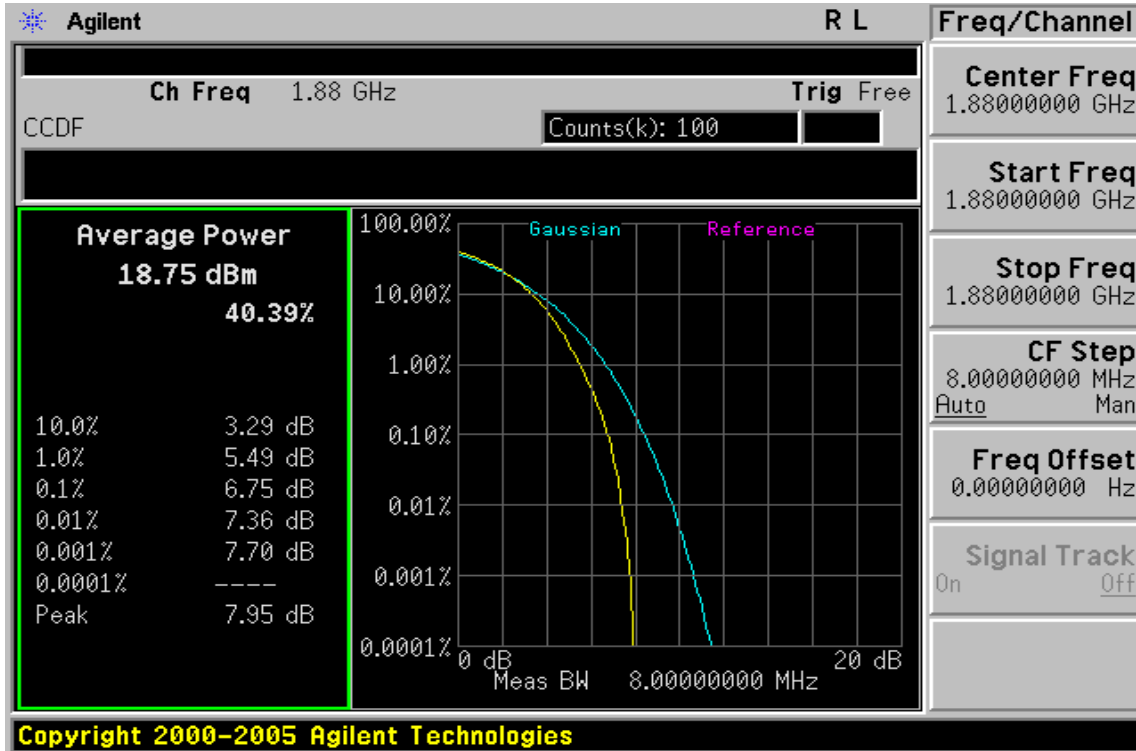

15MHz BW LTE-Band 2(16QAM Number: 75 Offset: 0) Channel High

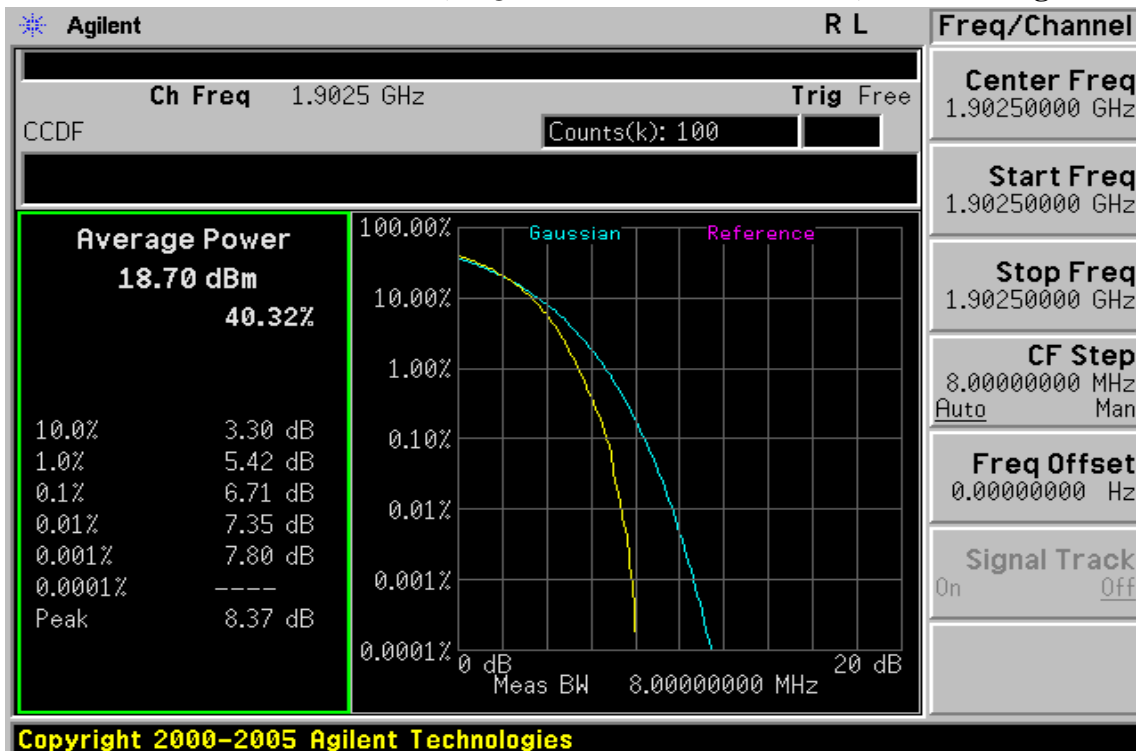

Unless otherwise stated the results shown in this test report refer only to the sample(s) tested and such sample(s) are retained for 90 days only.

除非另有說明，此報告結果僅對測試之樣品負責，同時此樣品僅保留90天。本報告未經本公司書面許可，不可部份複製。

This document is issued by the Company subject to its General Conditions of Service printed overleaf, available on request or accessible at www.sgs.com/terms_and_conditions.htm and, for electronic format documents, subject to Terms and Conditions for Electronic Documents at www.sgs.com/terms_e-document.htm. Attention is drawn to the limitation of liability, indemnification and jurisdiction issues defined therein. Any holder of this document is advised that information contained hereon reflects the Company's findings at the time of its intervention only and within the limits of Client's instructions, if any. The Company's sole responsibility is to its Client and this document does not exonerate parties to a transaction from exercising all their rights and obligations under the transaction documents. This document cannot be reproduced except in full, without prior written approval of the Company. Any unauthorized alteration, forgery or falsification of the content or appearance of this document is unlawful and offenders may be prosecuted to the fullest extent of the law.

SGS Taiwan Ltd.

No.134,WuKungRoad,NewTaipeiIndustrialPark,WukuDistrict,NewTaipeiCity,Taiwan24803/新北市五股區新北產業園區五工路 134 號

台灣檢驗科技股份有限公司

t (886-2) 2299-3279

f (886-2) 2298-0488

www.tw.sgs.com

Member of SGS Group

20MHz BW LTE-Band 2(16QAM Number: 100 Offset: 0) Channel Low

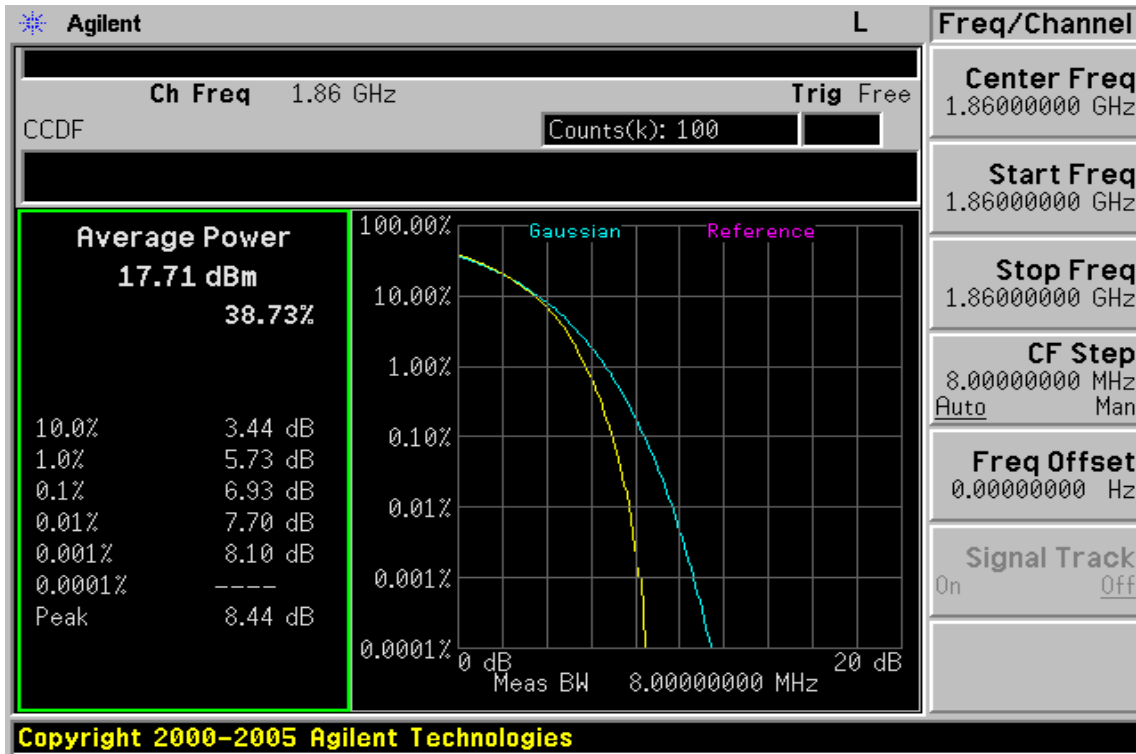

20MHz BW LTE-Band 2(16QAM Number: 100 Offset: 0) Channel Mid

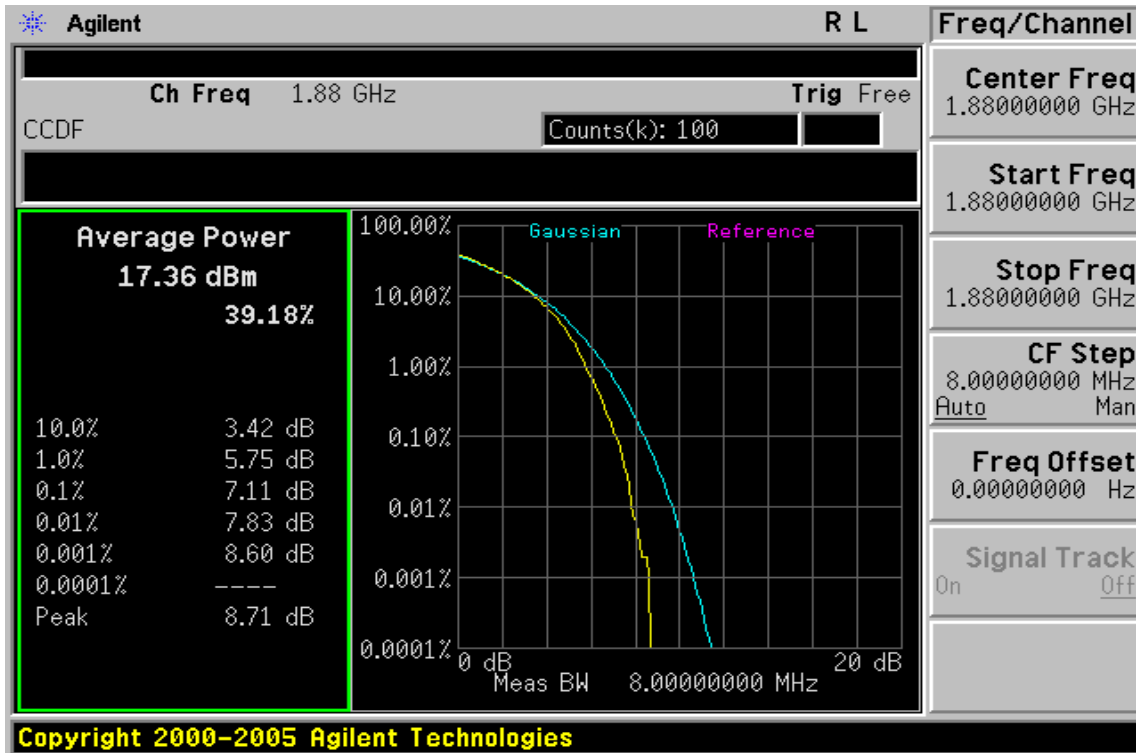

Unless otherwise stated the results shown in this test report refer only to the sample(s) tested and such sample(s) are retained for 90 days only.

除非另有說明，此報告結果僅對測試之樣品負責，同時此樣品僅保留90天。本報告未經本公司書面許可，不可部份複製。

This document is issued by the Company subject to its General Conditions of Service printed overleaf, available on request or accessible at www.sgs.com/terms_and_conditions.htm and, for electronic format documents, subject to Terms and Conditions for Electronic Documents at www.sgs.com/terms_e-document.htm. Attention is drawn to the limitation of liability, indemnification and jurisdiction issues defined therein. Any holder of this document is advised that information contained hereon reflects the Company's findings at the time of its intervention only and within the limits of Client's instructions, if any. The Company's sole responsibility is to its Client and this document does not exonerate parties to a transaction from exercising all their rights and obligations under the transaction documents. This document cannot be reproduced except in full, without prior written approval of the Company. Any unauthorized alteration, forgery or falsification of the content or appearance of this document is unlawful and offenders may be prosecuted to the fullest extent of the law.

SGS Taiwan Ltd.

No.134,WuKungRoad,NewTaipeiIndustrialPark,WukuDistrict,NewTaipeiCity,Taiwan24803/新北市五股區新北產業園區五工路 134 號

台灣檢驗科技股份有限公司

t (886-2) 2299-3279

f (886-2) 2298-0488

www.tw.sgs.com

Member of SGS Group

20MHz BW LTE-Band 2(16QAM Number: 100 Offset: 0) Channel High

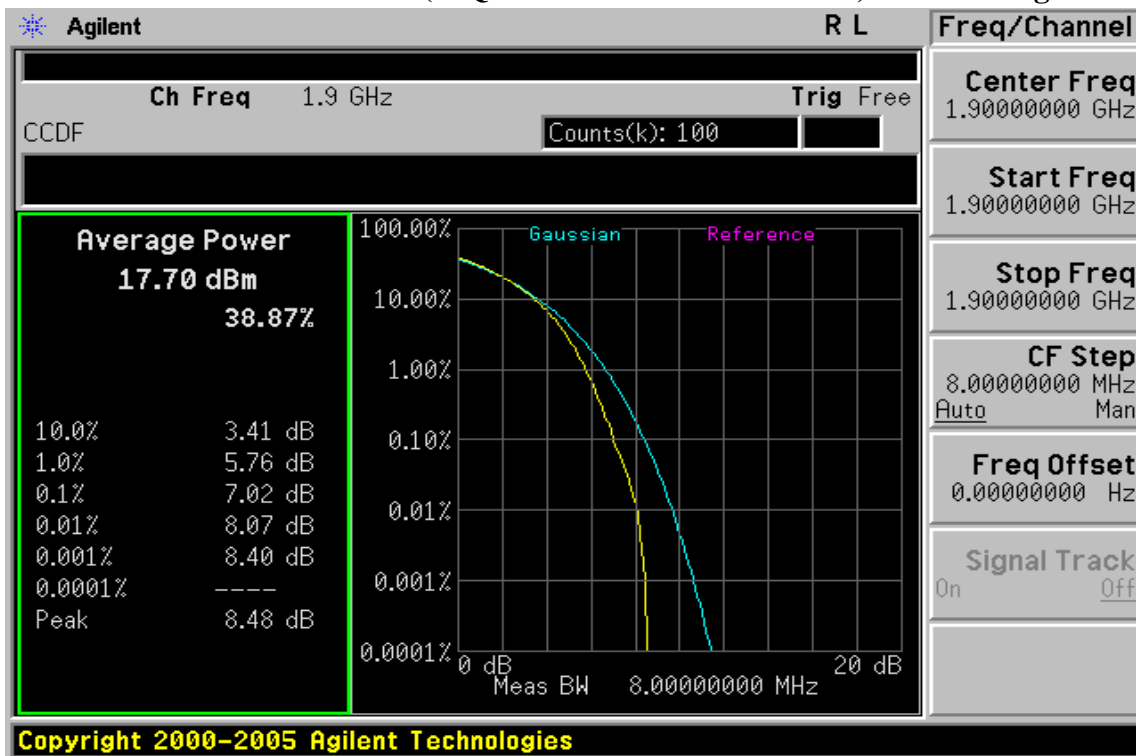

1.4MHz BW LTE-Band 4(16QAM Number: 6 Offset: 0) Channel Low

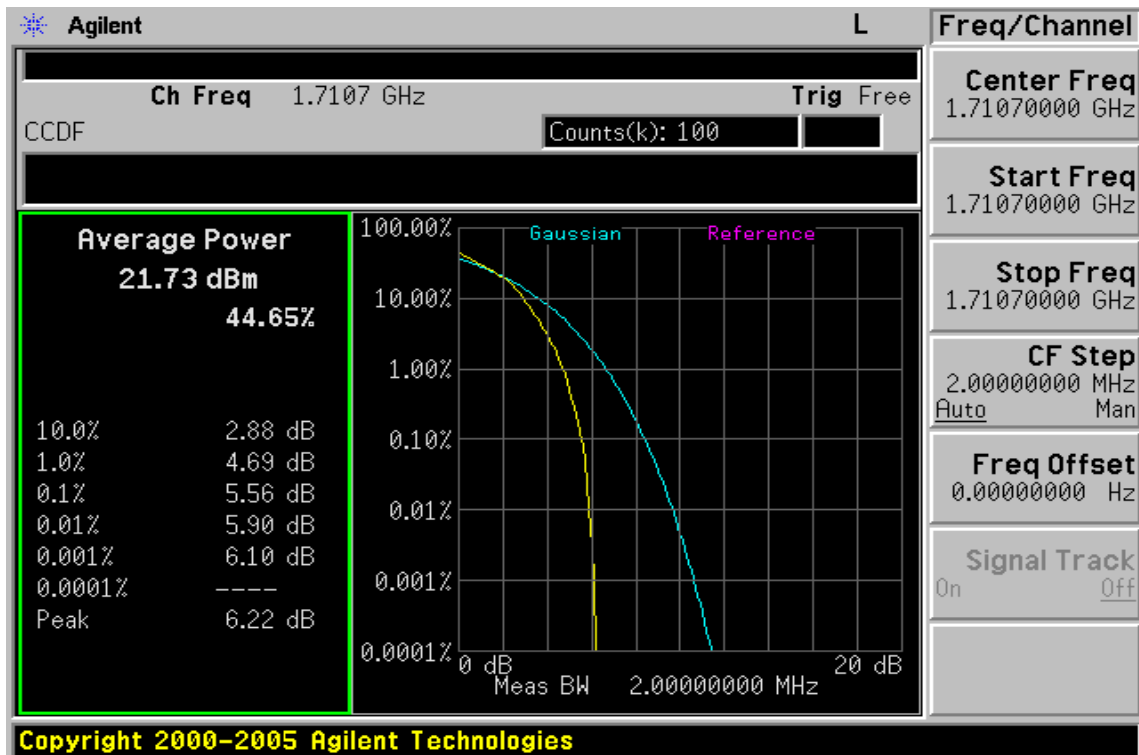

Unless otherwise stated the results shown in this test report refer only to the sample(s) tested and such sample(s) are retained for 90 days only.

除非另有說明，此報告結果僅對測試之樣品負責，同時此樣品僅保留90天。本報告未經本公司書面許可，不可部份複製。

This document is issued by the Company subject to its General Conditions of Service printed overleaf, available on request or accessible at www.sgs.com/terms_and_conditions.htm and, for electronic format documents, subject to Terms and Conditions for Electronic Documents at www.sgs.com/terms_e-document.htm. Attention is drawn to the limitation of liability, indemnification and jurisdiction issues defined therein. Any holder of this document is advised that information contained hereon reflects the Company's findings at the time of its intervention only and within the limits of Client's instructions, if any. The Company's sole responsibility is to its Client and this document does not exonerate parties to a transaction from exercising all their rights and obligations under the transaction documents. This document cannot be reproduced except in full, without prior written approval of the Company. Any unauthorized alteration, forgery or falsification of the content or appearance of this document is unlawful and offenders may be prosecuted to the fullest extent of the law.

1.4MHz BW LTE-Band 4(16QAM Number: 6 Offset: 0) Channel Mid

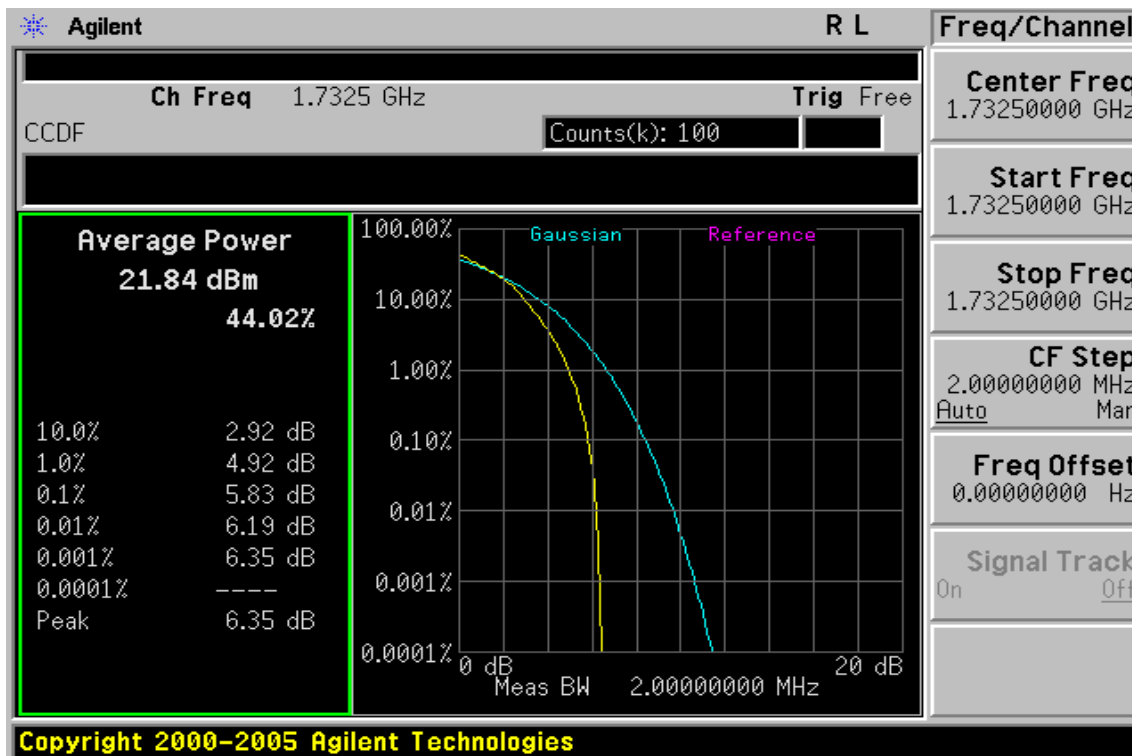

1.4MHz BW LTE-Band 4(16QAM Number: 6 Offset: 0) Channel High

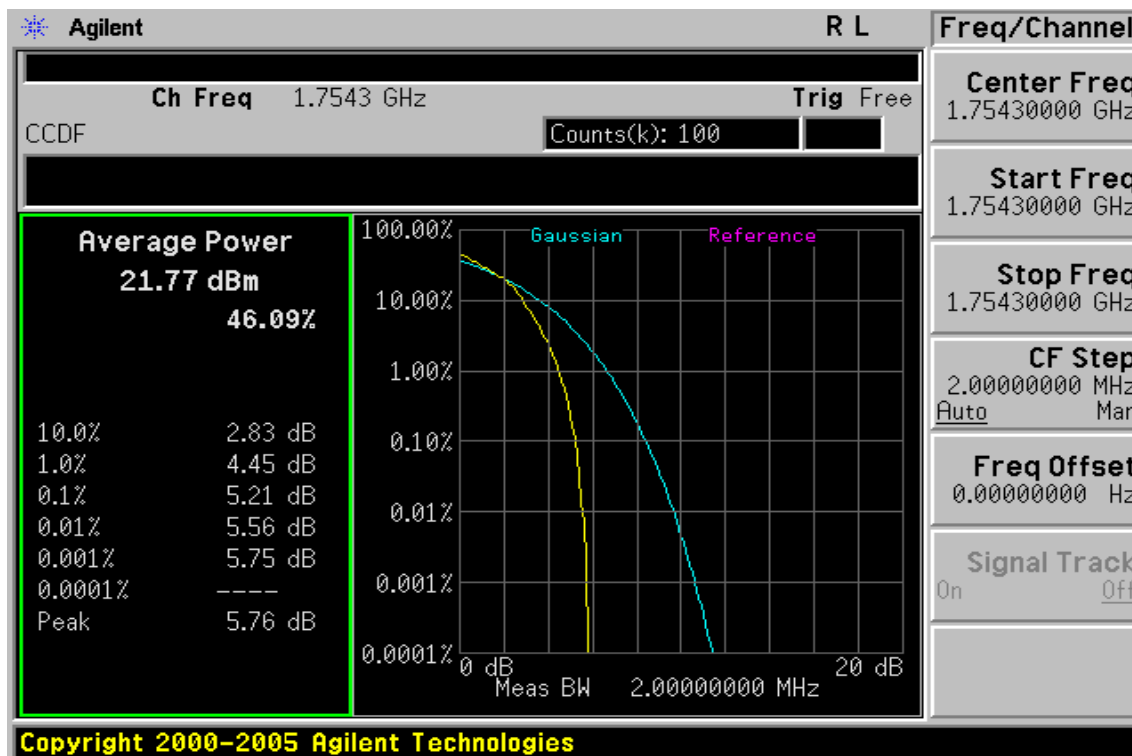

Unless otherwise stated the results shown in this test report refer only to the sample(s) tested and such sample(s) are retained for 90 days only.

除非另有說明，此報告結果僅對測試之樣品負責，同時此樣品僅保留90天。本報告未經本公司書面許可，不可部份複製。

This document is issued by the Company subject to its General Conditions of Service printed overleaf, available on request or accessible at www.sgs.com/terms_and_conditions.htm and, for electronic format documents, subject to Terms and Conditions for Electronic Documents at www.sgs.com/terms_e-document.htm. Attention is drawn to the limitation of liability, indemnification and jurisdiction issues defined therein. Any holder of this document is advised that information contained hereon reflects the Company's findings at the time of its intervention only and within the limits of Client's instructions, if any. The Company's sole responsibility is to its Client and this document does not exonerate parties to a transaction from exercising all their rights and obligations under the transaction documents. This document cannot be reproduced except in full, without prior written approval of the Company. Any unauthorized alteration, forgery or falsification of the content or appearance of this document is unlawful and offenders may be prosecuted to the fullest extent of the law.

SGS Taiwan Ltd.

No.134,WuKungRoad,NewTaipeiIndustrialPark,WukuDistrict,NewTaipeiCity,Taiwan24803/新北市五股區新北產業園區五工路 134 號

台灣檢驗科技股份有限公司

t (886-2) 2299-3279

f (886-2) 2298-0488

www.tw.sgs.com

Member of SGS Group

3MHz BW LTE-Band 4(16QAM Number: 15 Offset: 0) Channel Low

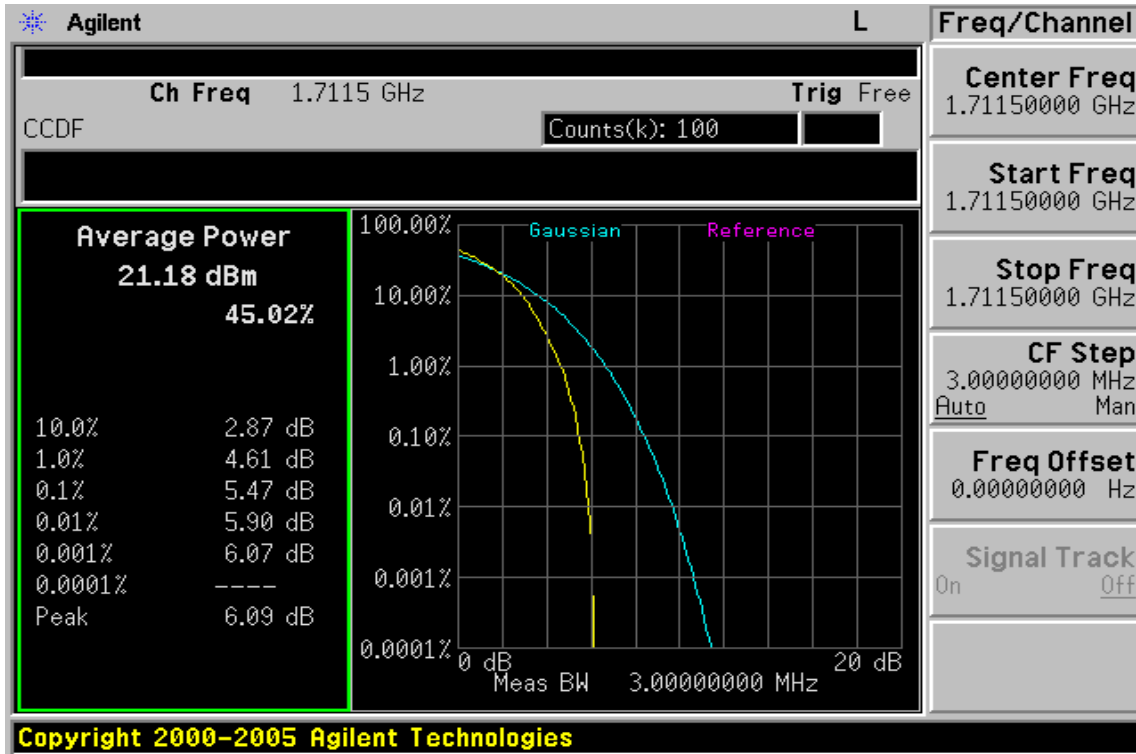

3MHz BW LTE-Band 4(16QAM Number: 15 Offset: 0) Channel Mid

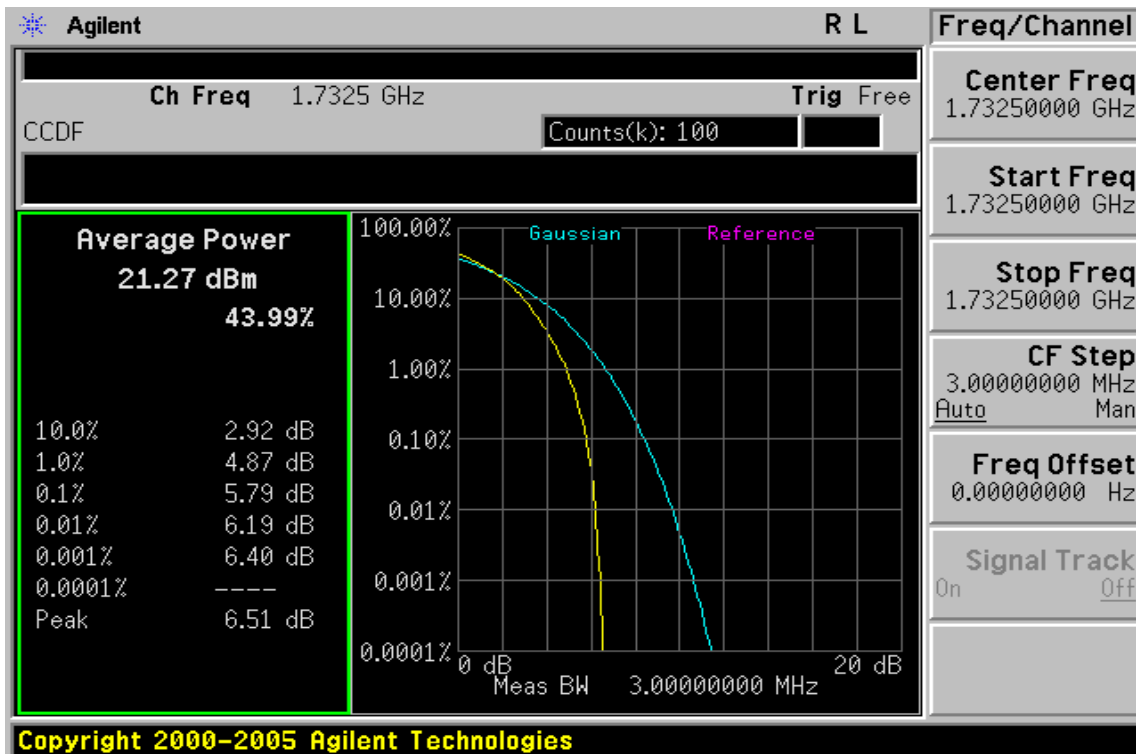

Unless otherwise stated the results shown in this test report refer only to the sample(s) tested and such sample(s) are retained for 90 days only.

除非另有說明，此報告結果僅對測試之樣品負責，同時此樣品僅保留90天。本報告未經本公司書面許可，不可部份複製。

This document is issued by the Company subject to its General Conditions of Service printed overleaf, available on request or accessible at www.sgs.com/terms_and_conditions.htm and, for electronic format documents, subject to Terms and Conditions for Electronic Documents at www.sgs.com/terms_e-document.htm. Attention is drawn to the limitation of liability, indemnification and jurisdiction issues defined therein. Any holder of this document is advised that information contained hereon reflects the Company's findings at the time of its intervention only and within the limits of Client's instructions, if any. The Company's sole responsibility is to its Client and this document does not exonerate parties to a transaction from exercising all their rights and obligations under the transaction documents. This document cannot be reproduced except in full, without prior written approval of the Company. Any unauthorized alteration, forgery or falsification of the content or appearance of this document is unlawful and offenders may be prosecuted to the fullest extent of the law.

SGS Taiwan Ltd.

No.134,WuKungRoad,NewTaipeiIndustrialPark,WukuDistrict,NewTaipeiCity,Taiwan24803/新北市五股區新北產業園區五工路 134 號

台灣檢驗科技股份有限公司

t (886-2) 2299-3279

f (886-2) 2298-0488

www.tw.sgs.com

Member of SGS Group

3MHz BW LTE-Band 4(16QAM Number: 15 Offset: 0) Channel High

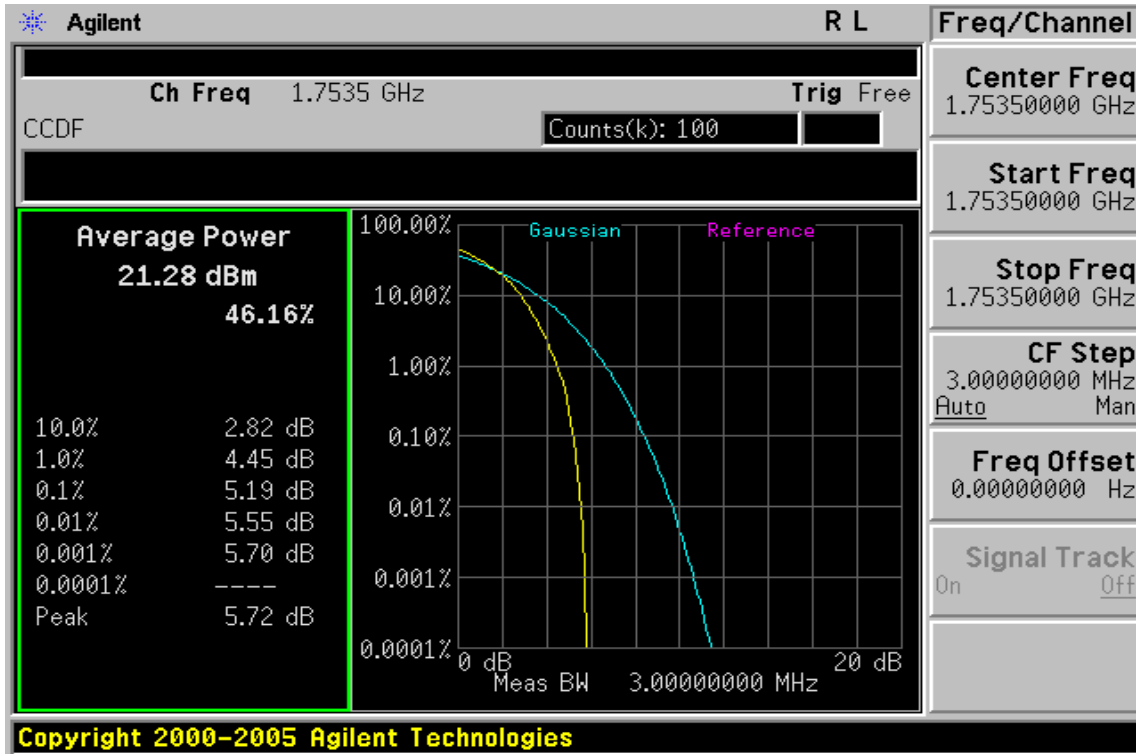

5MHz BW LTE-Band 4(16QAM Number: 25 Offset: 0) Channel Low

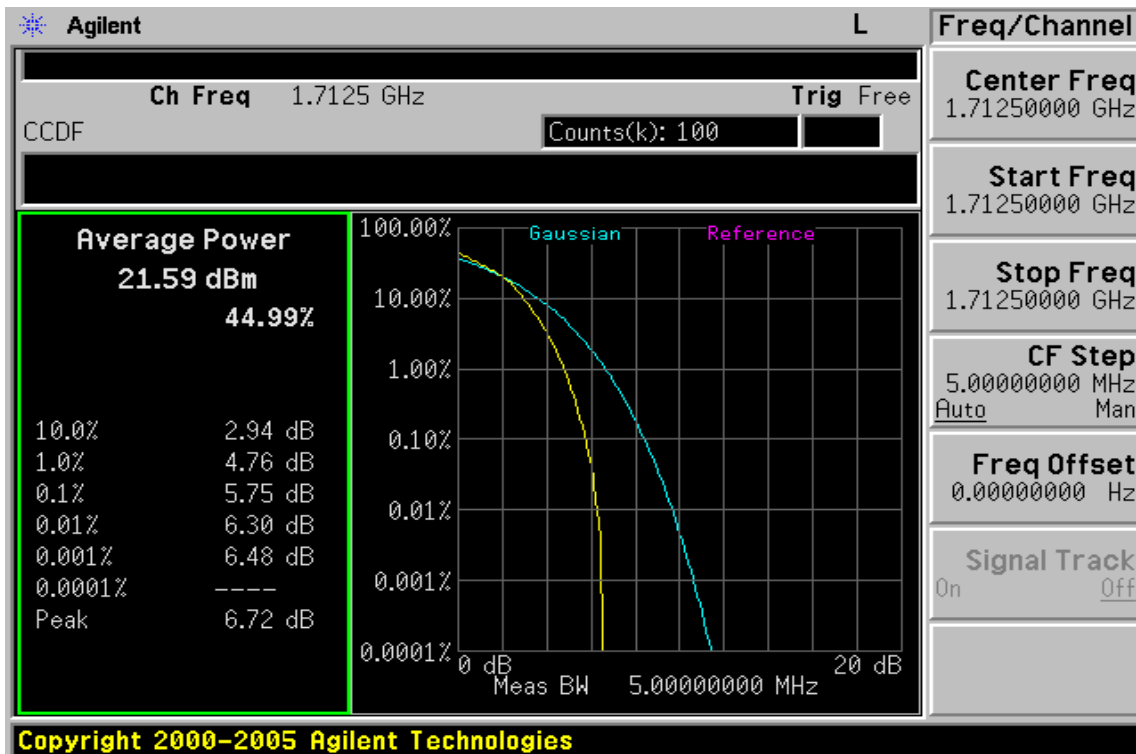

Unless otherwise stated the results shown in this test report refer only to the sample(s) tested and such sample(s) are retained for 90 days only.

除非另有說明，此報告結果僅對測試之樣品負責，同時此樣品僅保留90天。本報告未經本公司書面許可，不可部份複製。

This document is issued by the Company subject to its General Conditions of Service printed overleaf, available on request or accessible at www.sgs.com/terms_and_conditions.htm and, for electronic format documents, subject to Terms and Conditions for Electronic Documents at www.sgs.com/terms_e-document.htm. Attention is drawn to the limitation of liability, indemnification and jurisdiction issues defined therein. Any holder of this document is advised that information contained hereon reflects the Company's findings at the time of its intervention only and within the limits of Client's instructions, if any. The Company's sole responsibility is to its Client and this document does not exonerate parties to a transaction from exercising all their rights and obligations under the transaction documents. This document cannot be reproduced except in full, without prior written approval of the Company. Any unauthorized alteration, forgery or falsification of the content or appearance of this document is unlawful and offenders may be prosecuted to the fullest extent of the law.

SGS Taiwan Ltd.

No.134,WuKungRoad,NewTaipeiIndustrialPark,WukuDistrict,NewTaipeiCity,Taiwan24803/新北市五股區新北產業園區五工路 134 號

台灣檢驗科技股份有限公司

t (886-2) 2299-3279

f (886-2) 2298-0488

www.tw.sgs.com

Member of SGS Group

5MHz BW LTE-Band 4(16QAM Number: 25 Offset: 0) Channel Mid

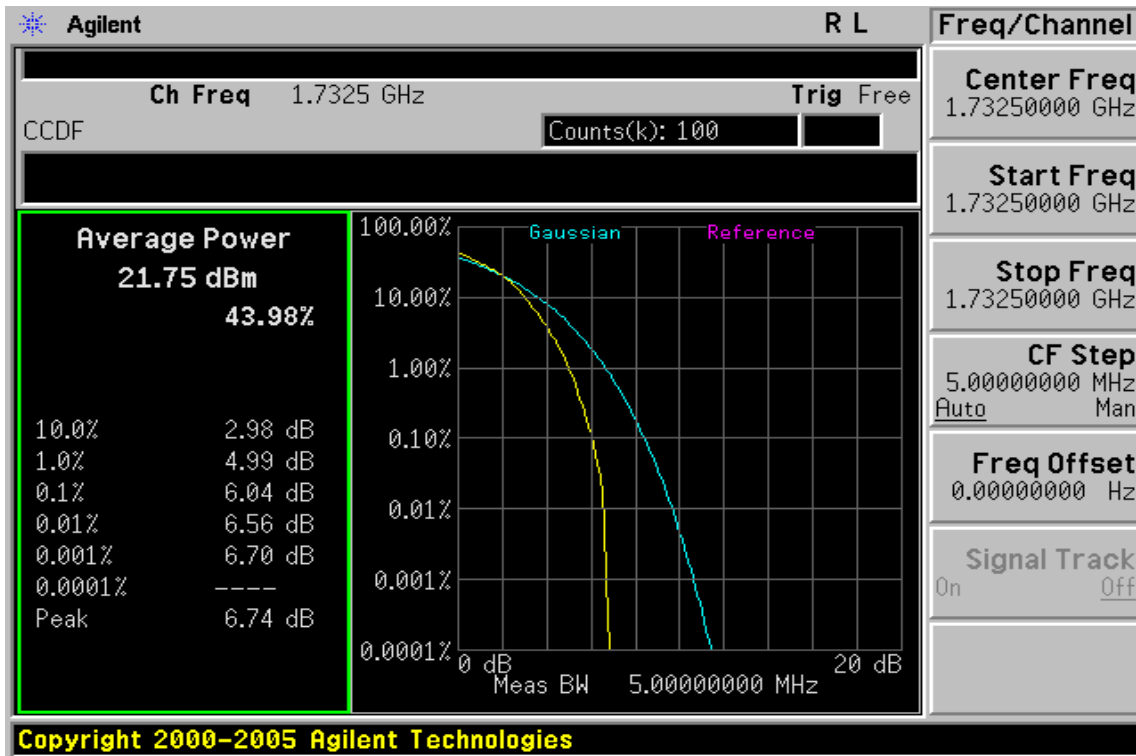

5MHz BW LTE-Band 4(16QAM Number: 25 Offset: 0) Channel High

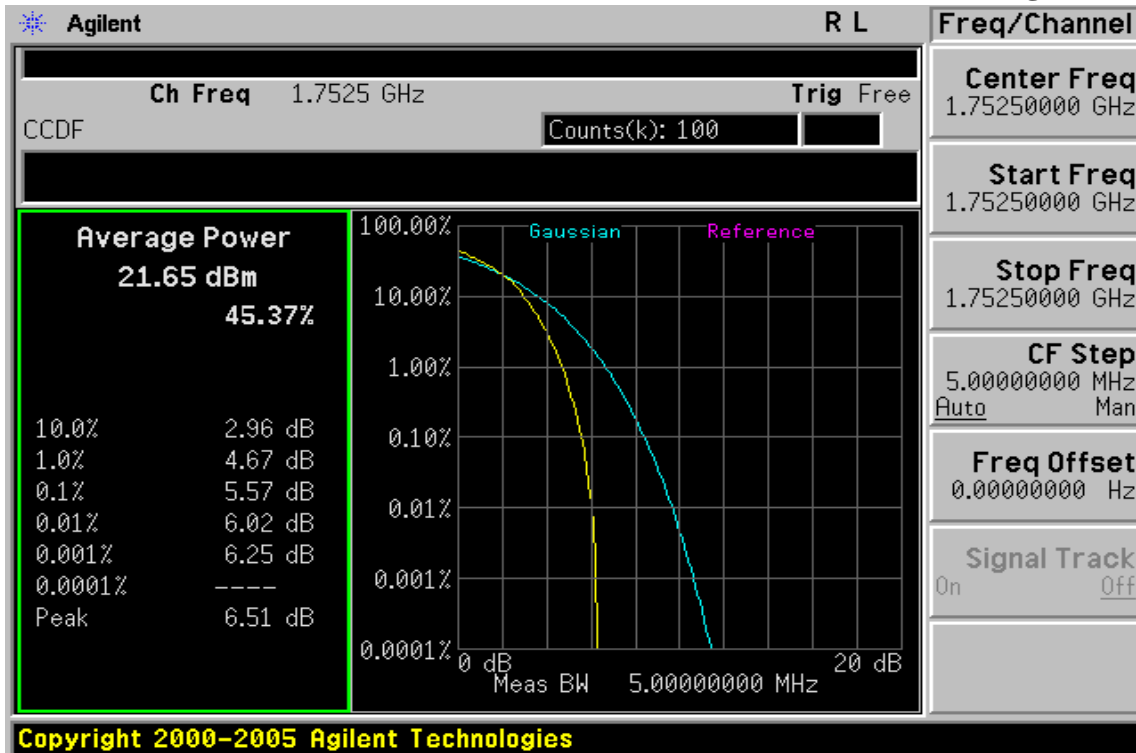

Unless otherwise stated the results shown in this test report refer only to the sample(s) tested and such sample(s) are retained for 90 days only.

除非另有說明，此報告結果僅對測試之樣品負責，同時此樣品僅保留90天。本報告未經本公司書面許可，不可部份複製。

This document is issued by the Company subject to its General Conditions of Service printed overleaf, available on request or accessible at www.sgs.com/terms_and_conditions.htm and, for electronic format documents, subject to Terms and Conditions for Electronic Documents at www.sgs.com/terms_e-document.htm. Attention is drawn to the limitation of liability, indemnification and jurisdiction issues defined therein. Any holder of this document is advised that information contained hereon reflects the Company's findings at the time of its intervention only and within the limits of Client's instructions, if any. The Company's sole responsibility is to its Client and this document does not exonerate parties to a transaction from exercising all their rights and obligations under the transaction documents. This document cannot be reproduced except in full, without prior written approval of the Company. Any unauthorized alteration, forgery or falsification of the content or appearance of this document is unlawful and offenders may be prosecuted to the fullest extent of the law.

SGS Taiwan Ltd.

No.134,WuKungRoad,NewTaipeiIndustrialPark,WukuDistrict,NewTaipeiCity,Taiwan24803/新北市五股區新北產業園區五工路 134 號

台灣檢驗科技股份有限公司

t (886-2) 2299-3279

f (886-2) 2298-0488

www.tw.sgs.com

Member of SGS Group

10MHz BW LTE-Band 4(16QAM Number: 50 Offset: 0) Channel Low

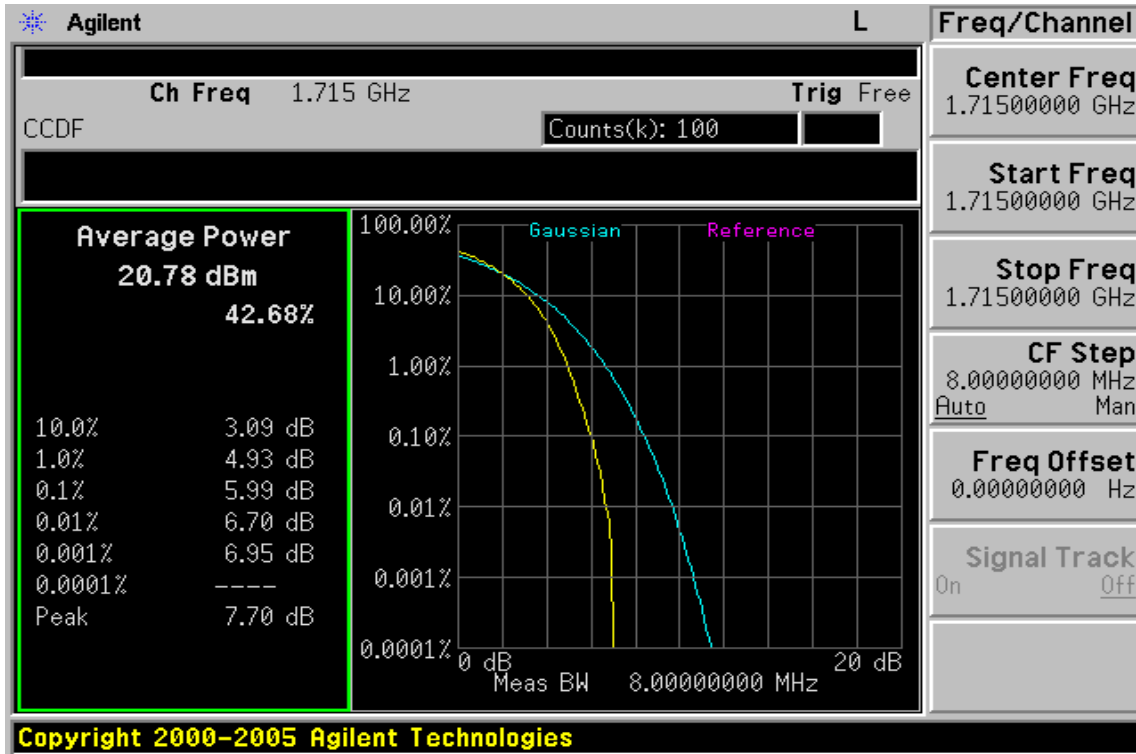

10MHz BW LTE-Band 4(16QAM Number: 50 Offset: 0) Channel Mid

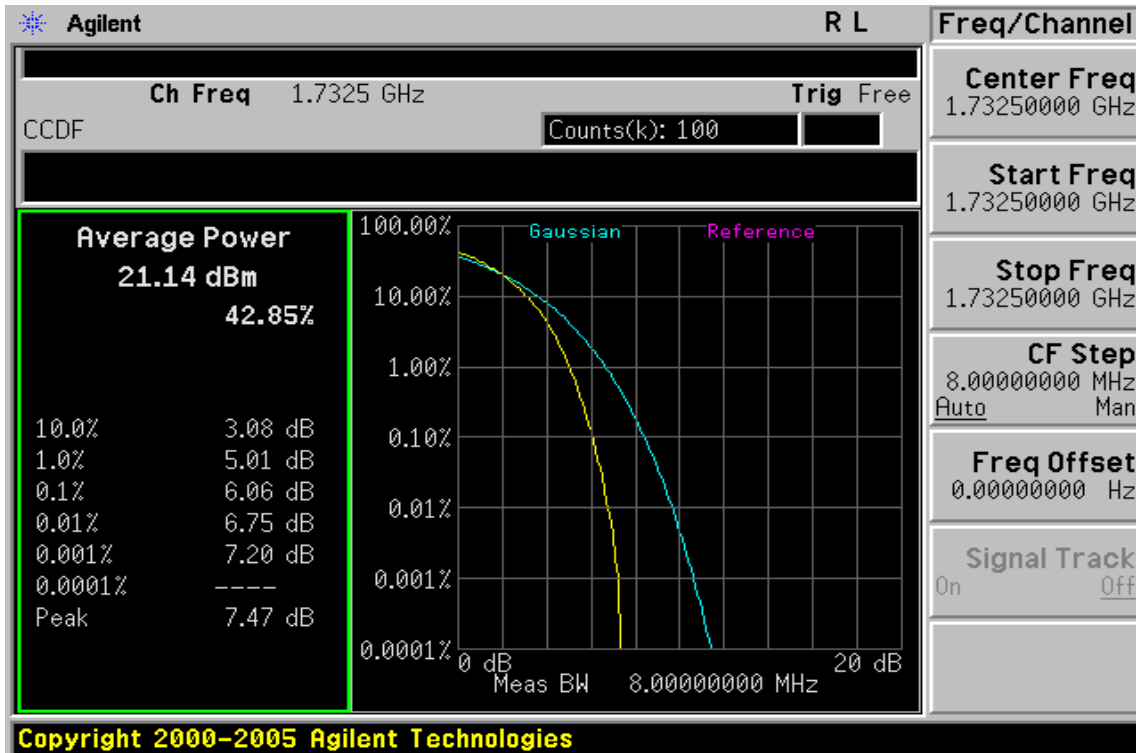

Unless otherwise stated the results shown in this test report refer only to the sample(s) tested and such sample(s) are retained for 90 days only.

除非另有說明，此報告結果僅對測試之樣品負責，同時此樣品僅保留90天。本報告未經本公司書面許可，不可部份複製。

This document is issued by the Company subject to its General Conditions of Service printed overleaf, available on request or accessible at www.sgs.com/terms_and_conditions.htm and, for electronic format documents, subject to Terms and Conditions for Electronic Documents at www.sgs.com/terms_e-document.htm. Attention is drawn to the limitation of liability, indemnification and jurisdiction issues defined therein. Any holder of this document is advised that information contained hereon reflects the Company's findings at the time of its intervention only and within the limits of Client's instructions, if any. The Company's sole responsibility is to its Client and this document does not exonerate parties to a transaction from exercising all their rights and obligations under the transaction documents. This document cannot be reproduced except in full, without prior written approval of the Company. Any unauthorized alteration, forgery or falsification of the content or appearance of this document is unlawful and offenders may be prosecuted to the fullest extent of the law.

SGS Taiwan Ltd.

No.134,WuKungRoad,NewTaipeiIndustrialPark,WukuDistrict,NewTaipeiCity,Taiwan24803/新北市五股區新北產業園區五工路 134 號

台灣檢驗科技股份有限公司

t (886-2) 2299-3279

f (886-2) 2298-0488

www.tw.sgs.com

Member of SGS Group

10MHz BW LTE-Band 4(16QAM Number: 50 Offset: 0) Channel High

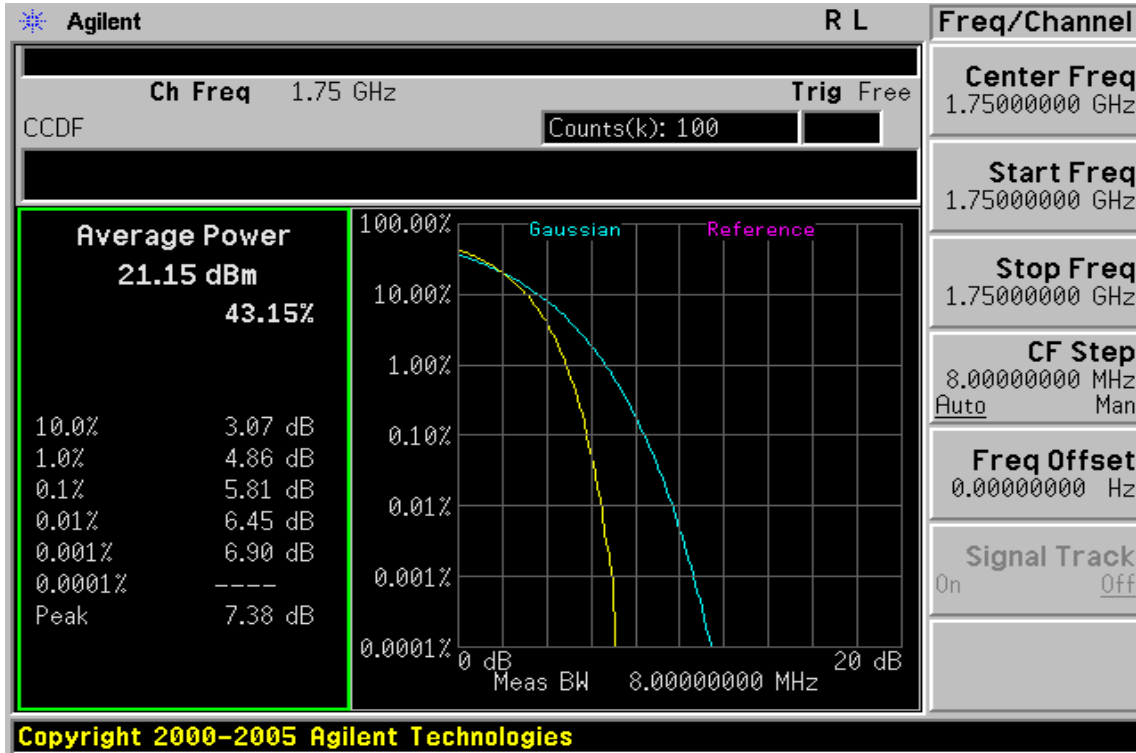

15MHz BW LTE-Band 4(16QAM Number: 75 Offset: 0) Channel Low



Unless otherwise stated the results shown in this test report refer only to the sample(s) tested and such sample(s) are retained for 90 days only.

除非另有說明，此報告結果僅對測試之樣品負責，同時此樣品僅保留90天。本報告未經本公司書面許可，不可部份複製。

This document is issued by the Company subject to its General Conditions of Service printed overleaf, available on request or accessible at www.sgs.com/terms_and_conditions.htm and, for electronic format documents, subject to Terms and Conditions for Electronic Documents at www.sgs.com/terms_e-document.htm. Attention is drawn to the limitation of liability, indemnification and jurisdiction issues defined therein. Any holder of this document is advised that information contained hereon reflects the Company's findings at the time of its intervention only and within the limits of Client's instructions, if any. The Company's sole responsibility is to its Client and this document does not exonerate parties to a transaction from exercising all their rights and obligations under the transaction documents. This document cannot be reproduced except in full, without prior written approval of the Company. Any unauthorized alteration, forgery or falsification of the content or appearance of this document is unlawful and offenders may be prosecuted to the fullest extent of the law.

SGS Taiwan Ltd.

No. 134, WuKungRoad, NewTaipeiIndustrialPark, WukuDistrict, NewTaipeiCity, Taiwan24803/新北市五股區新北產業園區五工路 134 號

台灣檢驗科技股份有限公司

t (886-2) 2299-3279

f (886-2) 2298-0488

www.tw.sgs.com

Member of SGS Group

15MHz BW LTE-Band 4(16QAM Number: 75 Offset: 0) Channel Mid

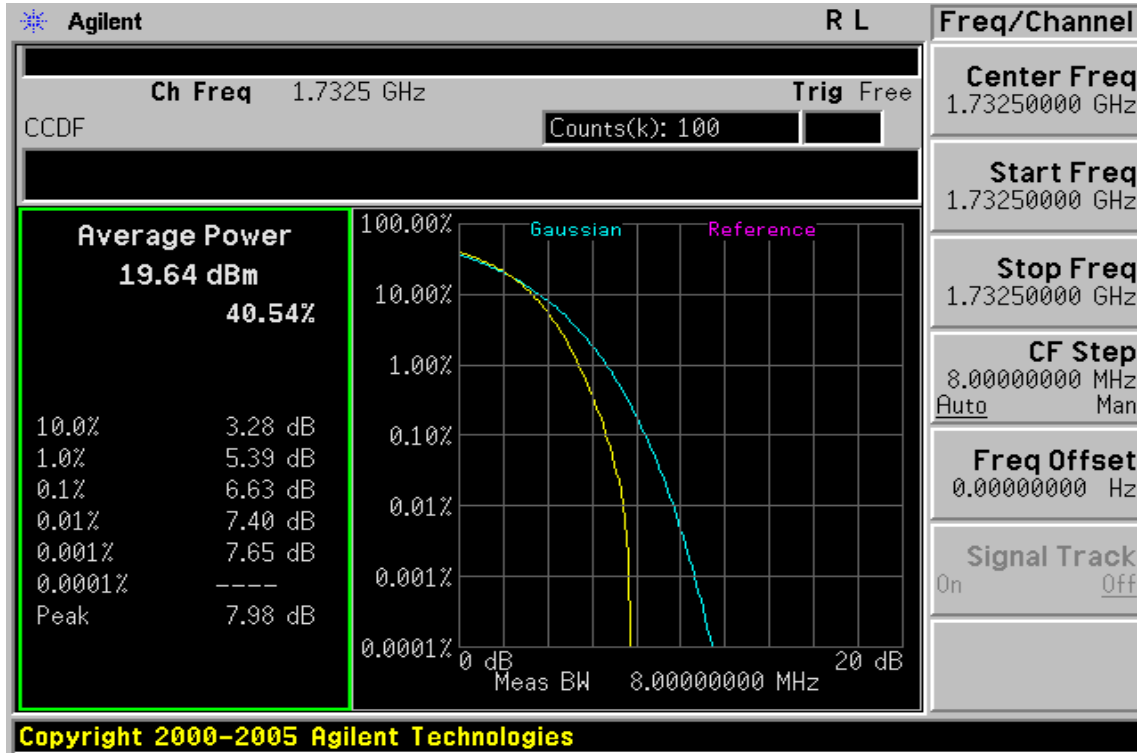

15MHz BW LTE-Band 4(16QAM Number: 75 Offset: 0) Channel High

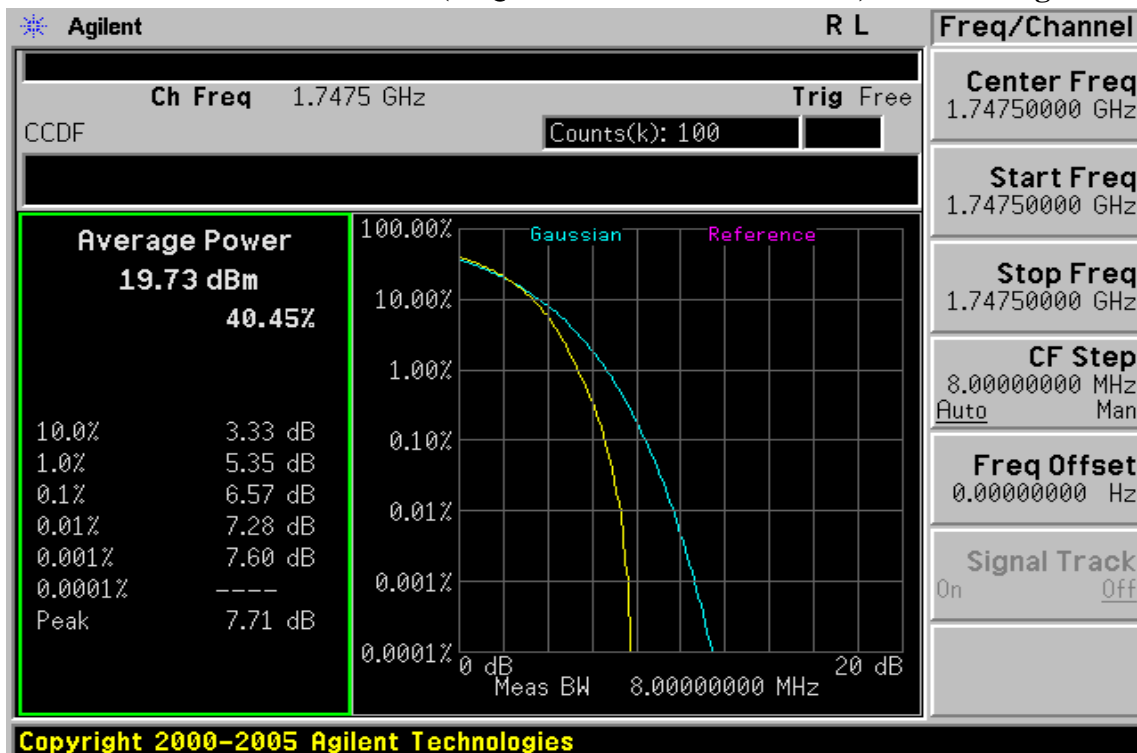

Unless otherwise stated the results shown in this test report refer only to the sample(s) tested and such sample(s) are retained for 90 days only.

除非另有說明，此報告結果僅對測試之樣品負責，同時此樣品僅保留90天。本報告未經本公司書面許可，不可部份複製。

This document is issued by the Company subject to its General Conditions of Service printed overleaf, available on request or accessible at www.sgs.com/terms_and_conditions.htm and, for electronic format documents, subject to Terms and Conditions for Electronic Documents at www.sgs.com/terms_e-document.htm. Attention is drawn to the limitation of liability, indemnification and jurisdiction issues defined therein. Any holder of this document is advised that information contained hereon reflects the Company's findings at the time of its intervention only and within the limits of Client's instructions, if any. The Company's sole responsibility is to its Client and this document does not exonerate parties to a transaction from exercising all their rights and obligations under the transaction documents. This document cannot be reproduced except in full, without prior written approval of the Company. Any unauthorized alteration, forgery or falsification of the content or appearance of this document is unlawful and offenders may be prosecuted to the fullest extent of the law.

SGS Taiwan Ltd.

No.134,WuKungRoad,NewTaipeiIndustrialPark,WukuDistrict,NewTaipeiCity,Taiwan24803/新北市五股區新北產業園區五工路 134 號

台灣檢驗科技股份有限公司

t (886-2) 2299-3279

f (886-2) 2298-0488

www.tw.sgs.com

Member of SGS Group

20MHz BW LTE-Band 4(16QAM Number: 100 Offset: 0) Channel Low

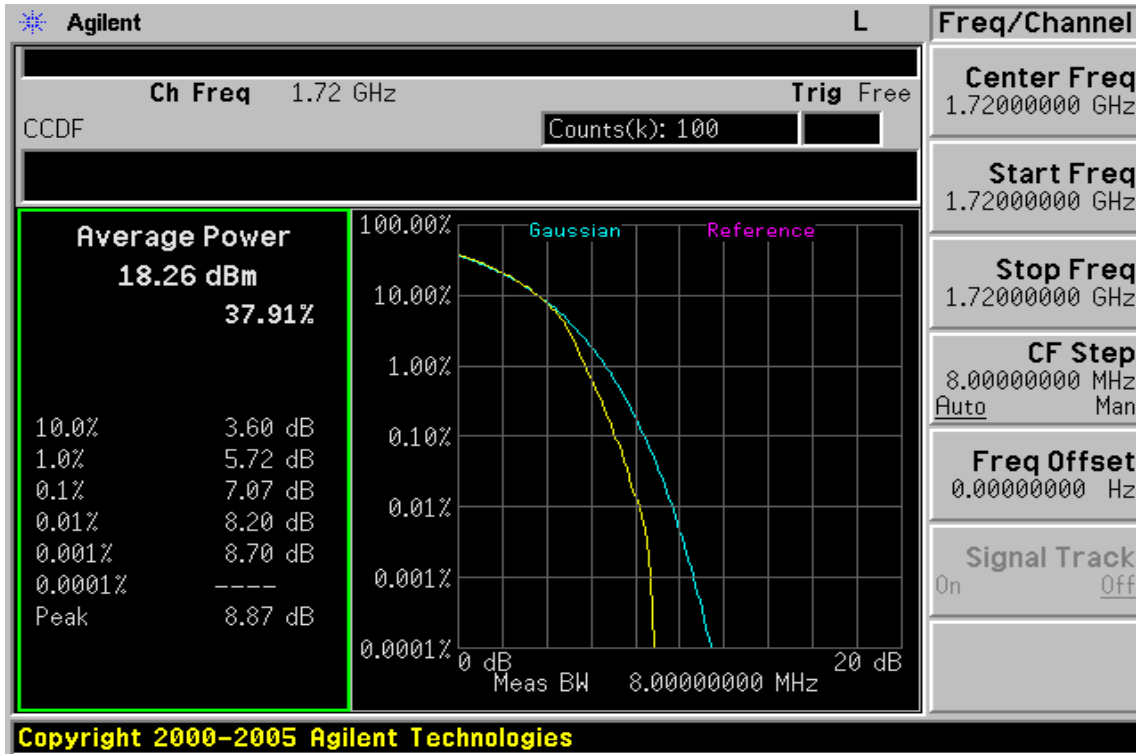

20MHz BW LTE-Band 4(16QAM Number: 100 Offset: 0) Channel Mid

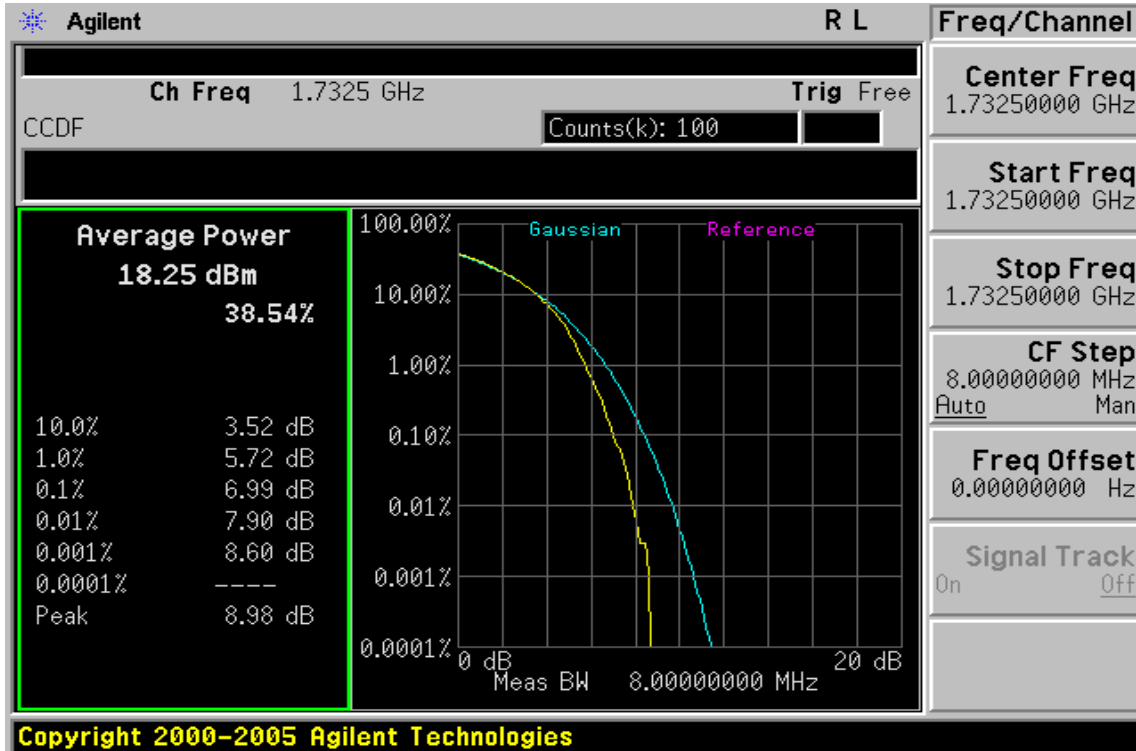

Unless otherwise stated the results shown in this test report refer only to the sample(s) tested and such sample(s) are retained for 90 days only.

除非另有說明，此報告結果僅對測試之樣品負責，同時此樣品僅保留90天。本報告未經本公司書面許可，不可部份複製。

This document is issued by the Company subject to its General Conditions of Service printed overleaf, available on request or accessible at www.sgs.com/terms_and_conditions.htm and, for electronic format documents, subject to Terms and Conditions for Electronic Documents at www.sgs.com/terms_e-document.htm. Attention is drawn to the limitation of liability, indemnification and jurisdiction issues defined therein. Any holder of this document is advised that information contained hereon reflects the Company's findings at the time of its intervention only and within the limits of Client's instructions, if any. The Company's sole responsibility is to its Client and this document does not exonerate parties to a transaction from exercising all their rights and obligations under the transaction documents. This document cannot be reproduced except in full, without prior written approval of the Company. Any unauthorized alteration, forgery or falsification of the content or appearance of this document is unlawful and offenders may be prosecuted to the fullest extent of the law.

SGS Taiwan Ltd.

No.134,WuKungRoad,NewTaipeiIndustrialPark,WukuDistrict,NewTaipeiCity,Taiwan24803/新北市五股區新北產業園區五工路 134 號

台灣檢驗科技股份有限公司

t (886-2) 2299-3279

f (886-2) 2298-0488

www.tw.sgs.com

Member of SGS Group

20MHz BW LTE-Band 4(16QAM Number: 100 Offset: 0) Channel High

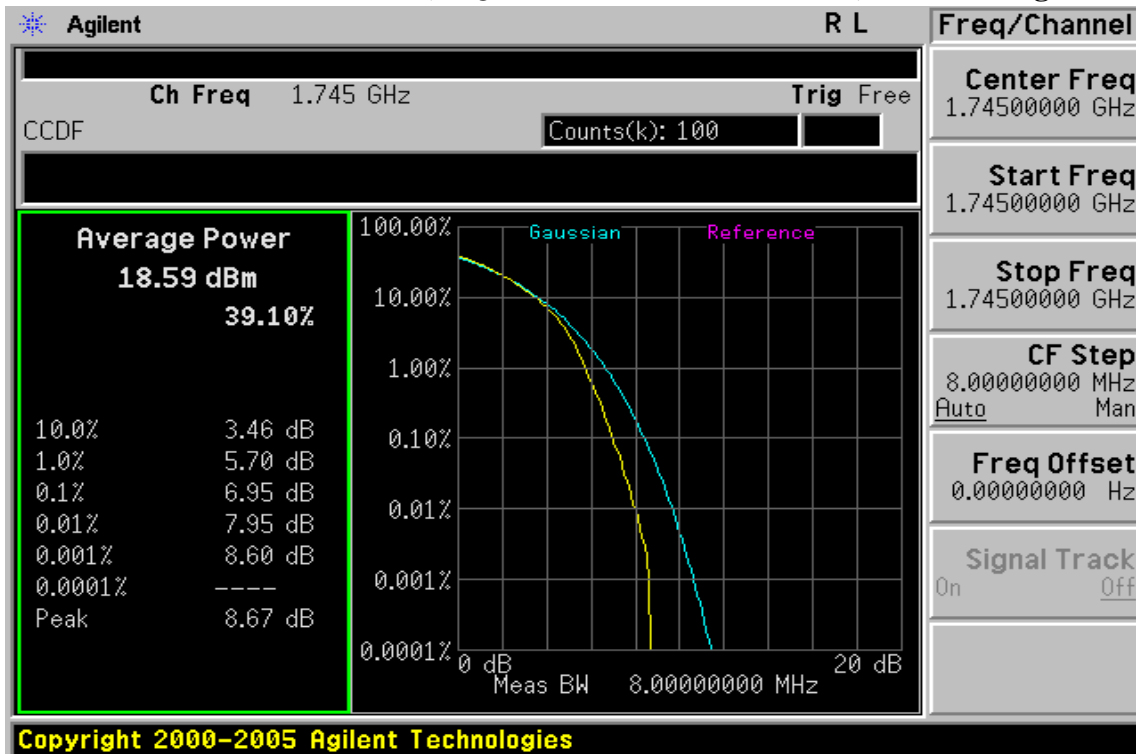

1.4MHz BW LTE-Band 5(16QAM Number: 6 Offset: 0) Channel Low

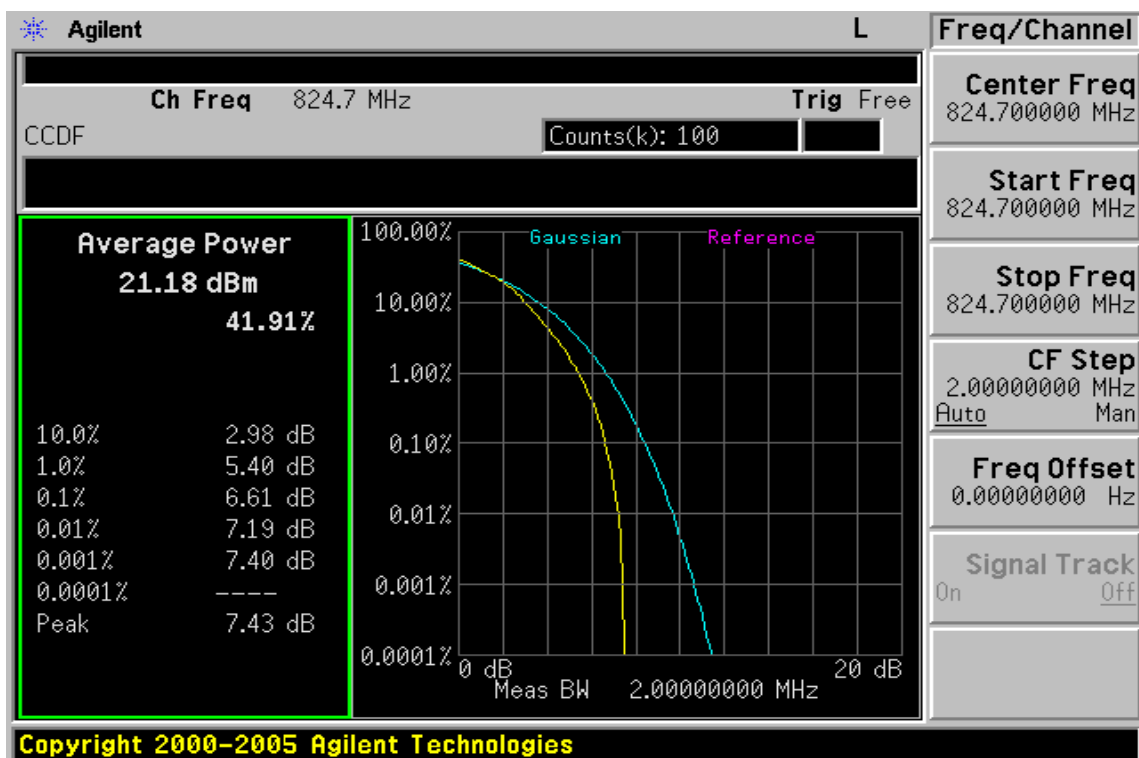

Unless otherwise stated the results shown in this test report refer only to the sample(s) tested and such sample(s) are retained for 90 days only.

除非另有說明，此報告結果僅對測試之樣品負責，同時此樣品僅保留90天。本報告未經本公司書面許可，不可部份複製。

This document is issued by the Company subject to its General Conditions of Service printed overleaf, available on request or accessible at www.sgs.com/terms_and_conditions.htm and, for electronic format documents, subject to Terms and Conditions for Electronic Documents at www.sgs.com/terms_e-document.htm. Attention is drawn to the limitation of liability, indemnification and jurisdiction issues defined therein. Any holder of this document is advised that information contained hereon reflects the Company's findings at the time of its intervention only and within the limits of Client's instructions, if any. The Company's sole responsibility is to its Client and this document does not exonerate parties to a transaction from exercising all their rights and obligations under the transaction documents. This document cannot be reproduced except in full, without prior written approval of the Company. Any unauthorized alteration, forgery or falsification of the content or appearance of this document is unlawful and offenders may be prosecuted to the fullest extent of the law.

SGS Taiwan Ltd.

No. 134, WuKungRoad, NewTaipeiIndustrialPark, WukuDistrict, NewTaipeiCity, Taiwan24803/新北市五股區新北產業園區五工路 134 號

台灣檢驗科技股份有限公司

t (886-2) 2299-3279

f (886-2) 2298-0488

www.tw.sgs.com

Member of SGS Group

1.4MHz BW LTE-Band 5(16QAM Number: 6 Offset: 0) Channel Mid

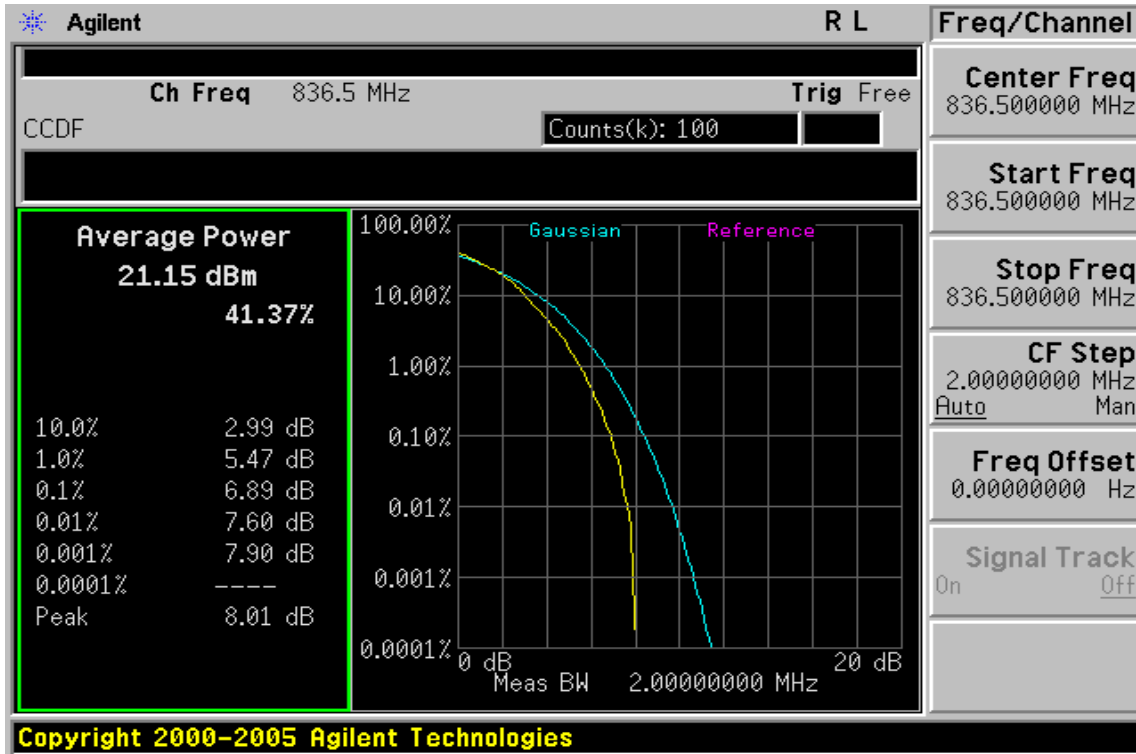

1.4MHz BW LTE-Band 5(16QAM Number: 6 Offset: 0) Channel High

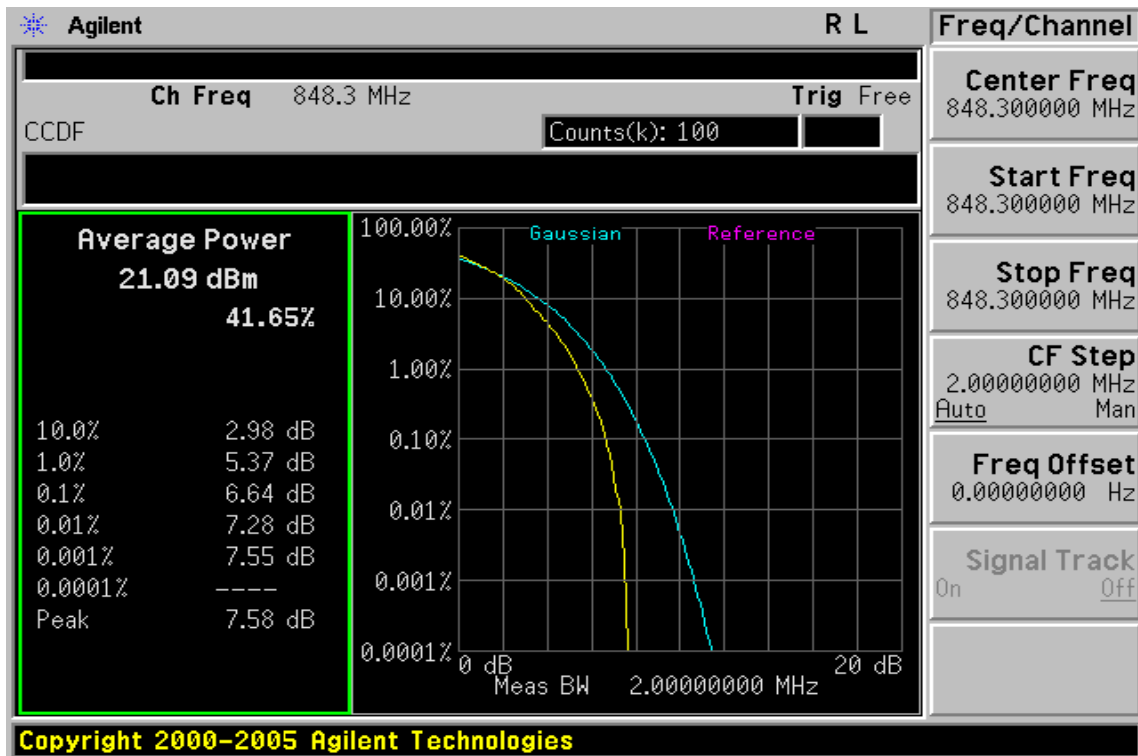

Unless otherwise stated the results shown in this test report refer only to the sample(s) tested and such sample(s) are retained for 90 days only.

除非另有說明，此報告結果僅對測試之樣品負責，同時此樣品僅保留90天。本報告未經本公司書面許可，不可部份複製。

This document is issued by the Company subject to its General Conditions of Service printed overleaf, available on request or accessible at www.sgs.com/terms_and_conditions.htm and, for electronic format documents, subject to Terms and Conditions for Electronic Documents at www.sgs.com/terms_e-document.htm. Attention is drawn to the limitation of liability, indemnification and jurisdiction issues defined therein. Any holder of this document is advised that information contained hereon reflects the Company's findings at the time of its intervention only and within the limits of Client's instructions, if any. The Company's sole responsibility is to its Client and this document does not exonerate parties to a transaction from exercising all their rights and obligations under the transaction documents. This document cannot be reproduced except in full, without prior written approval of the Company. Any unauthorized alteration, forgery or falsification of the content or appearance of this document is unlawful and offenders may be prosecuted to the fullest extent of the law.

SGS Taiwan Ltd.

No.134,WuKungRoad,NewTaipeiIndustrialPark,WukuDistrict,NewTaipeiCity,Taiwan24803/新北市五股區新北產業園區五工路 134 號

台灣檢驗科技股份有限公司

t (886-2) 2299-3279

f (886-2) 2298-0488

www.tw.sgs.com

Member of SGS Group

3MHz BW LTE-Band 5(16QAM Number: 15 Offset: 0) Channel Low

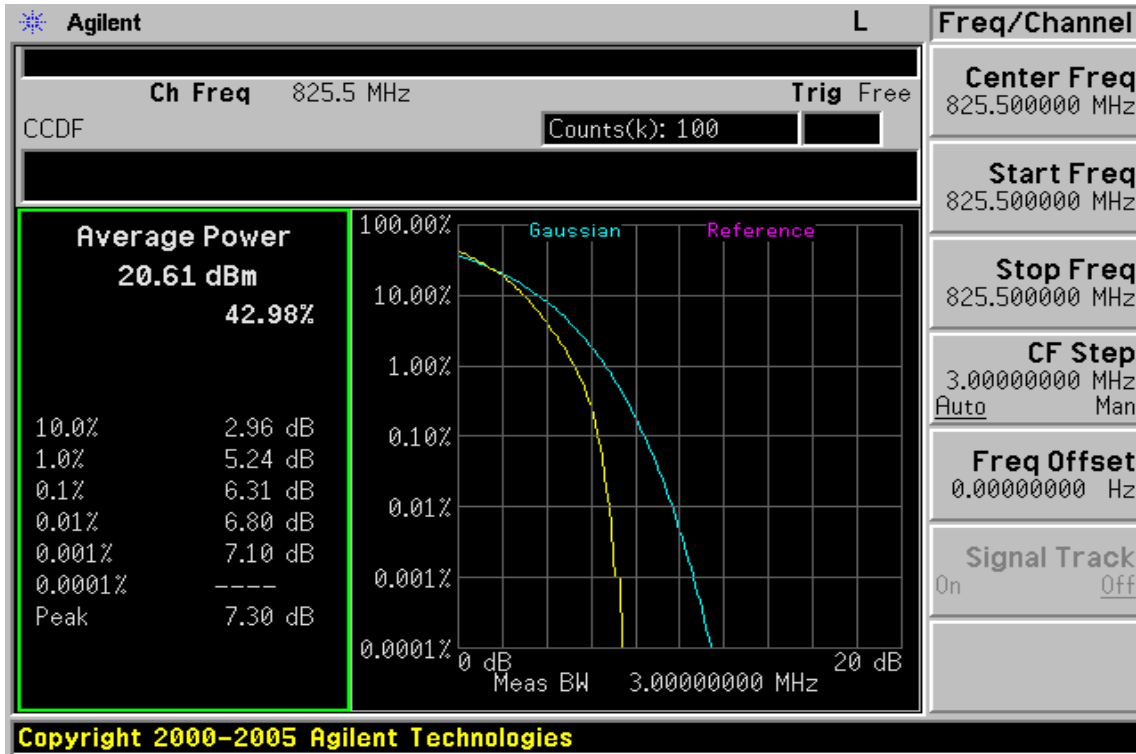

3MHz BW LTE-Band 5(16QAM Number: 15 Offset: 0) Channel Mid

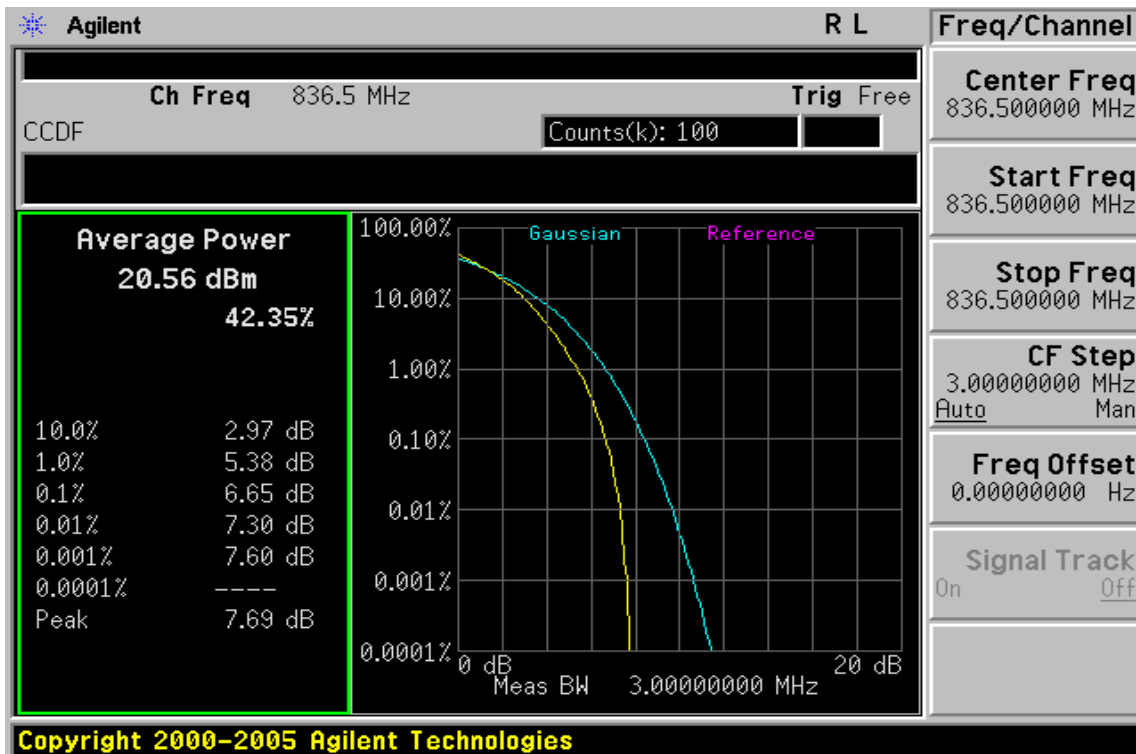

Unless otherwise stated the results shown in this test report refer only to the sample(s) tested and such sample(s) are retained for 90 days only.

除非另有說明，此報告結果僅對測試之樣品負責，同時此樣品僅保留90天。本報告未經本公司書面許可，不可部份複製。

This document is issued by the Company subject to its General Conditions of Service printed overleaf, available on request or accessible at www.sgs.com/terms_and_conditions.htm and, for electronic format documents, subject to Terms and Conditions for Electronic Documents at www.sgs.com/terms_e-document.htm. Attention is drawn to the limitation of liability, indemnification and jurisdiction issues defined therein. Any holder of this document is advised that information contained hereon reflects the Company's findings at the time of its intervention only and within the limits of Client's instructions, if any. The Company's sole responsibility is to its Client and this document does not exonerate parties to a transaction from exercising all their rights and obligations under the transaction documents. This document cannot be reproduced except in full, without prior written approval of the Company. Any unauthorized alteration, forgery or falsification of the content or appearance of this document is unlawful and offenders may be prosecuted to the fullest extent of the law.

SGS Taiwan Ltd.

No.134,WuKungRoad,NewTaipeiIndustrialPark,WukuDistrict,NewTaipeiCity,Taiwan24803/新北市五股區新北產業園區五工路 134 號

台灣檢驗科技股份有限公司

t (886-2) 2299-3279

f (886-2) 2298-0488

www.tw.sgs.com

Member of SGS Group

3MHz BW LTE-Band 5(16QAM Number: 15 Offset: 0) Channel High

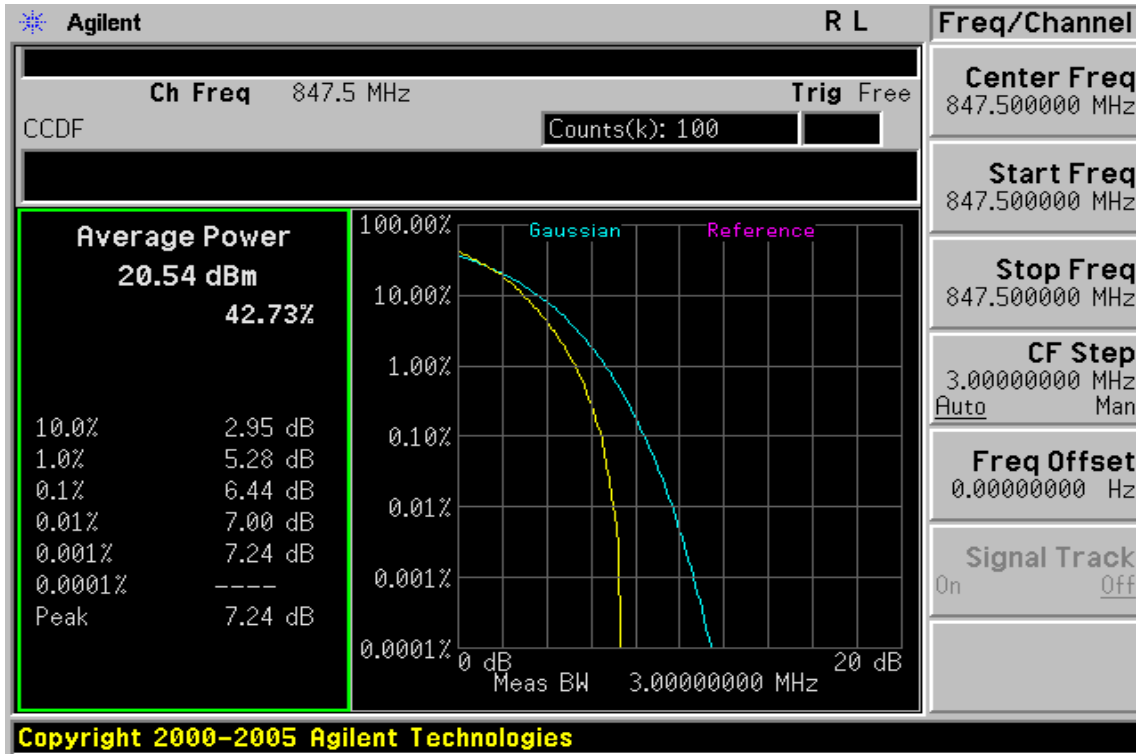

5MHz BW LTE-Band 5(16QAM Number: 25 Offset: 0) Channel Low

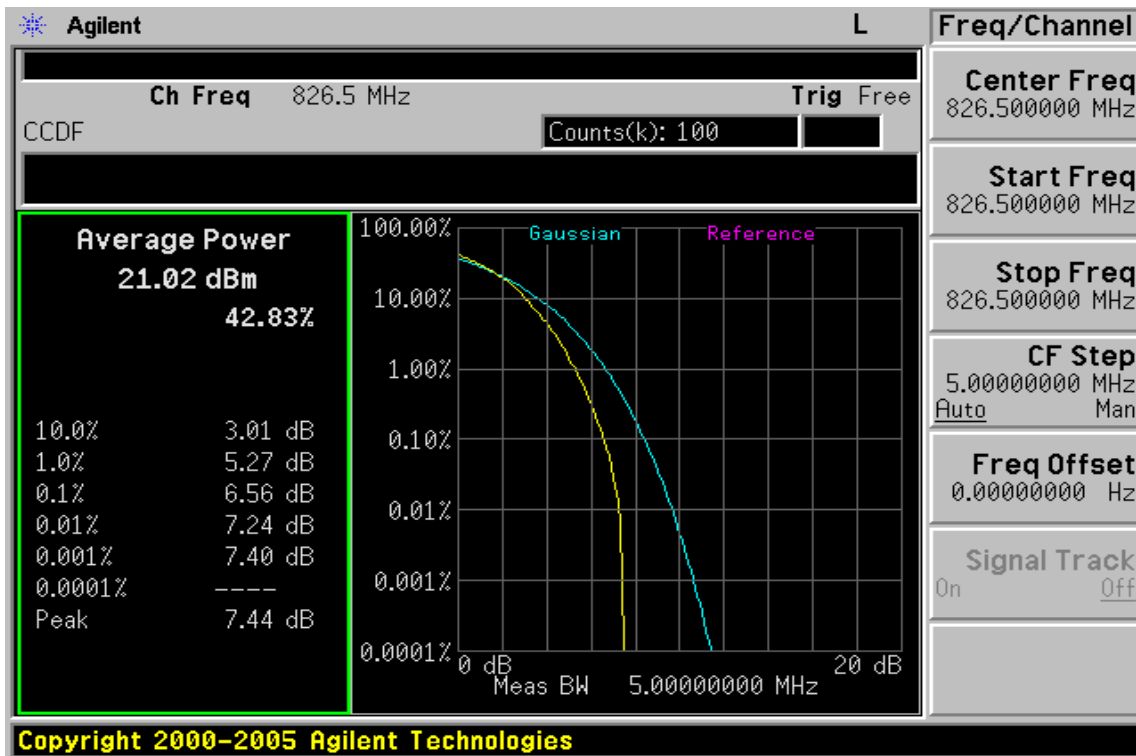

Unless otherwise stated the results shown in this test report refer only to the sample(s) tested and such sample(s) are retained for 90 days only.

除非另有說明，此報告結果僅對測試之樣品負責，同時此樣品僅保留90天。本報告未經本公司書面許可，不可部份複製。

This document is issued by the Company subject to its General Conditions of Service printed overleaf, available on request or accessible at www.sgs.com/terms_and_conditions.htm and, for electronic format documents, subject to Terms and Conditions for Electronic Documents at www.sgs.com/terms_e-document.htm. Attention is drawn to the limitation of liability, indemnification and jurisdiction issues defined therein. Any holder of this document is advised that information contained hereon reflects the Company's findings at the time of its intervention only and within the limits of Client's instructions, if any. The Company's sole responsibility is to its Client and this document does not exonerate parties to a transaction from exercising all their rights and obligations under the transaction documents. This document cannot be reproduced except in full, without prior written approval of the Company. Any unauthorized alteration, forgery or falsification of the content or appearance of this document is unlawful and offenders may be prosecuted to the fullest extent of the law.

SGS Taiwan Ltd.

No.134,WuKungRoad,NewTaipeiIndustrialPark,WukuDistrict,NewTaipeiCity,Taiwan24803/新北市五股區新北產業園區五工路 134 號

台灣檢驗科技股份有限公司

t (886-2) 2299-3279

f (886-2) 2298-0488

www.tw.sgs.com

Member of SGS Group

5MHz BW LTE-Band 5(16QAM Number: 25 Offset: 0) Channel Mid

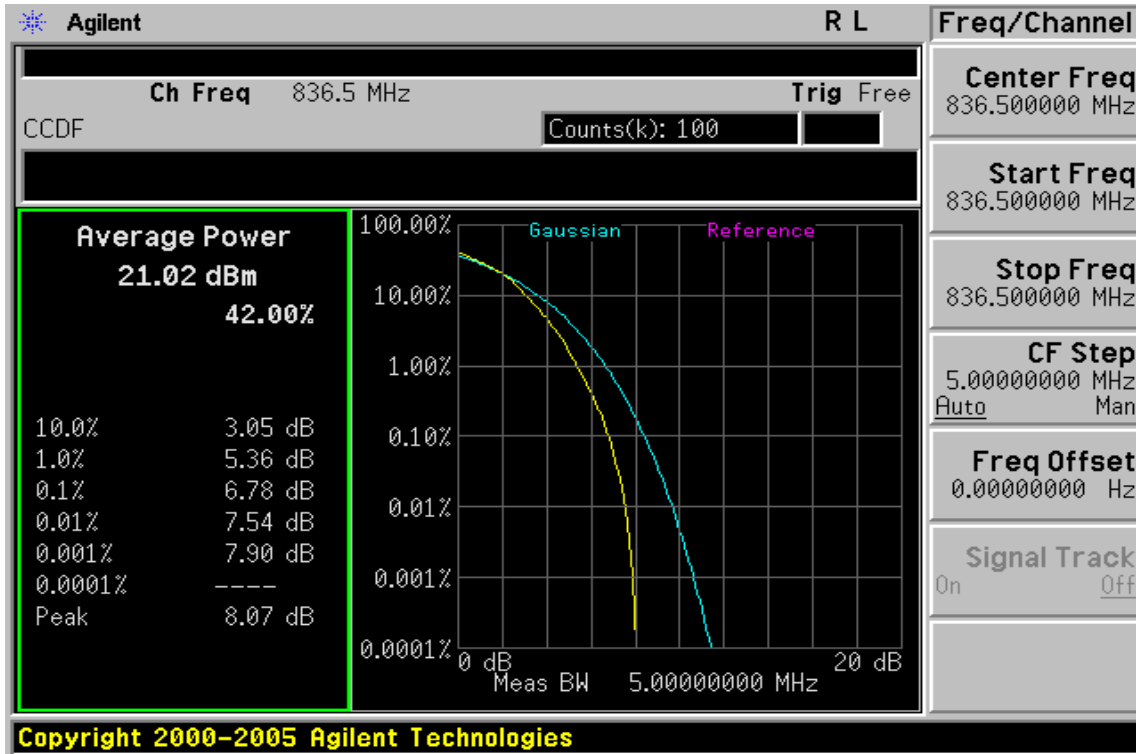

5MHz BW LTE-Band 5(16QAM Number: 25 Offset: 0) Channel High

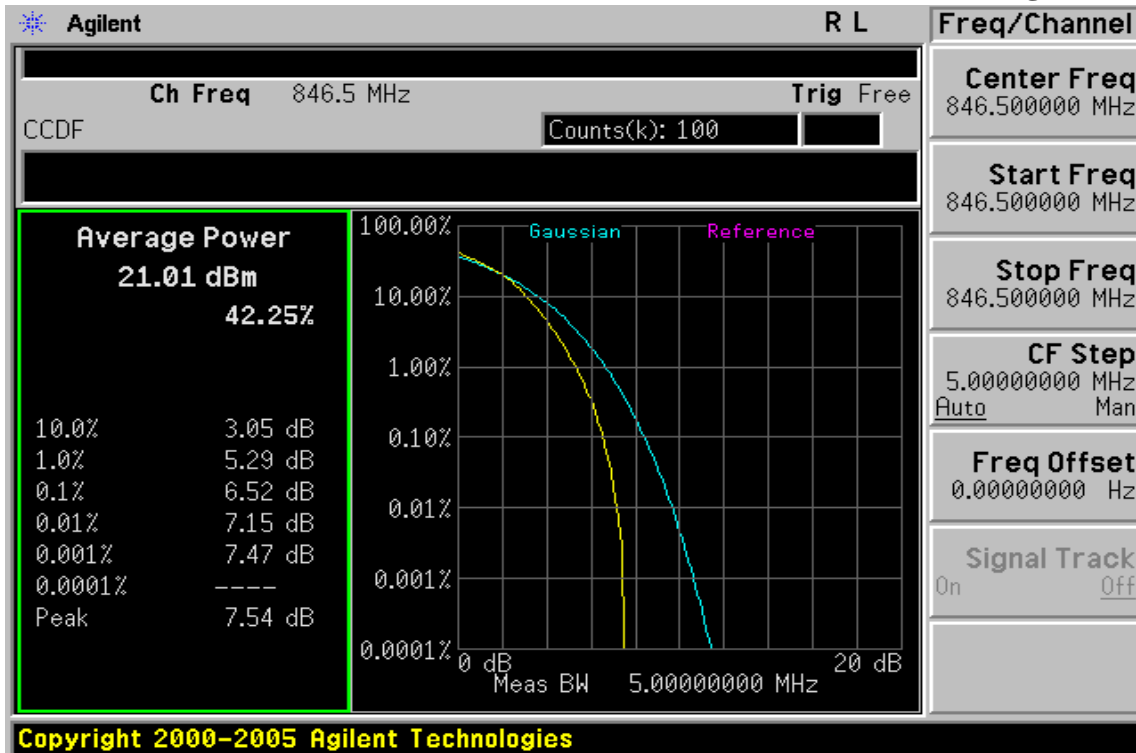

Unless otherwise stated the results shown in this test report refer only to the sample(s) tested and such sample(s) are retained for 90 days only.

除非另有說明，此報告結果僅對測試之樣品負責，同時此樣品僅保留90天。本報告未經本公司書面許可，不可部份複製。

This document is issued by the Company subject to its General Conditions of Service printed overleaf, available on request or accessible at www.sgs.com/terms_and_conditions.htm and, for electronic format documents, subject to Terms and Conditions for Electronic Documents at www.sgs.com/terms_e-document.htm. Attention is drawn to the limitation of liability, indemnification and jurisdiction issues defined therein. Any holder of this document is advised that information contained hereon reflects the Company's findings at the time of its intervention only and within the limits of Client's instructions, if any. The Company's sole responsibility is to its Client and this document does not exonerate parties to a transaction from exercising all their rights and obligations under the transaction documents. This document cannot be reproduced except in full, without prior written approval of the Company. Any unauthorized alteration, forgery or falsification of the content or appearance of this document is unlawful and offenders may be prosecuted to the fullest extent of the law.

SGS Taiwan Ltd.

No.134,WuKungRoad,NewTaipeiIndustrialPark,WukuDistrict,NewTaipeiCity,Taiwan24803/新北市五股區新北產業園區五工路 134 號

台灣檢驗科技股份有限公司

t (886-2) 2299-3279

f (886-2) 2298-0488

www.tw.sgs.com

Member of SGS Group

10MHz BW LTE-Band 5(16QAM Number: 50 Offset: 0) Channel Low

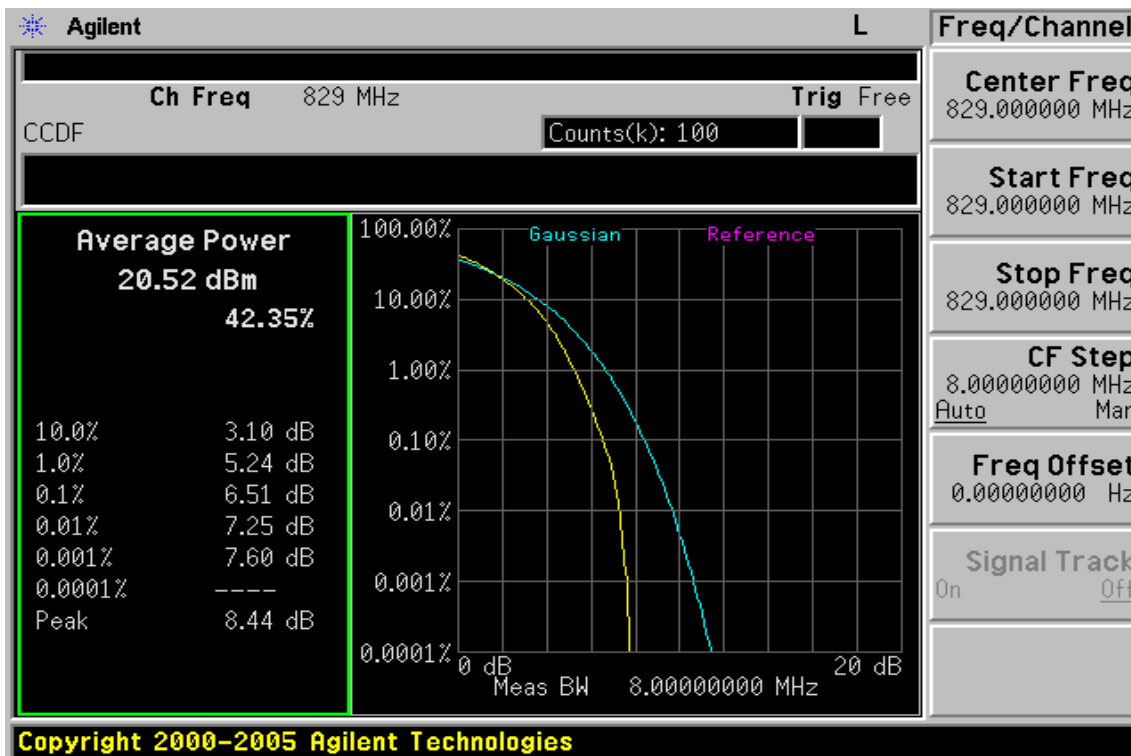

10MHz BW LTE-Band 5(16QAM Number: 50 Offset: 0) Channel Mid

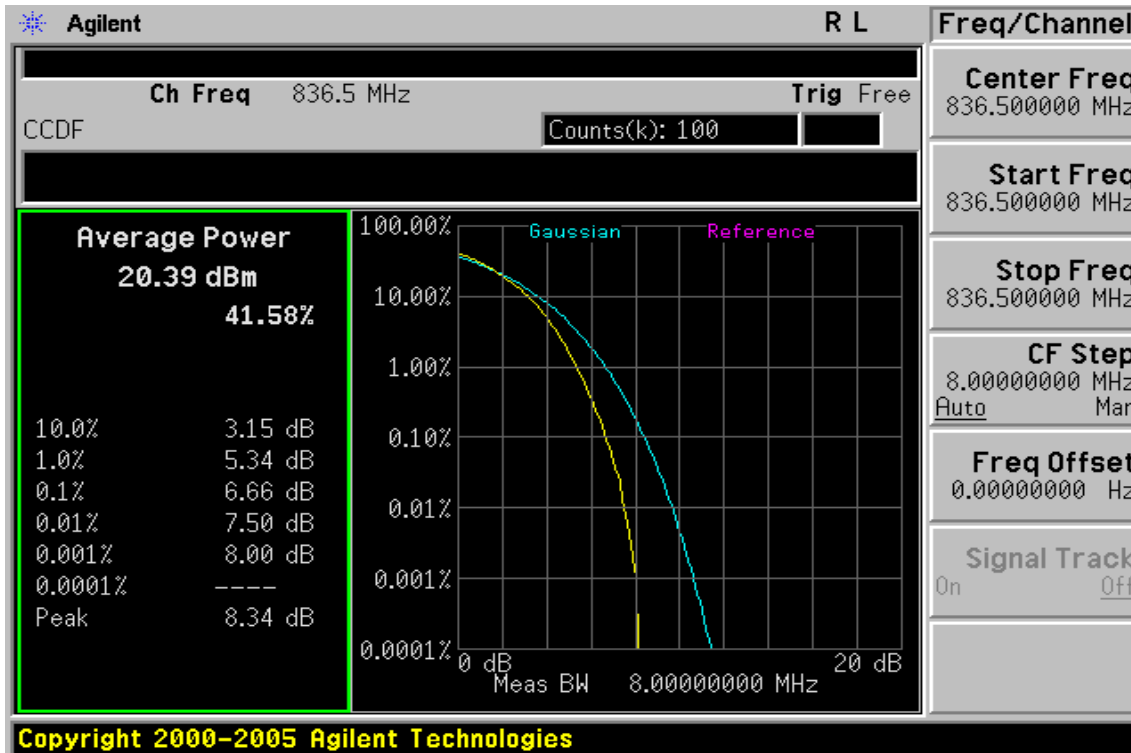

Unless otherwise stated the results shown in this test report refer only to the sample(s) tested and such sample(s) are retained for 90 days only.

除非另有說明，此報告結果僅對測試之樣品負責，同時此樣品僅保留90天。本報告未經本公司書面許可，不可部份複製。

This document is issued by the Company subject to its General Conditions of Service printed overleaf, available on request or accessible at www.sgs.com/terms_and_conditions.htm and, for electronic format documents, subject to Terms and Conditions for Electronic Documents at www.sgs.com/terms_e-document.htm. Attention is drawn to the limitation of liability, indemnification and jurisdiction issues defined therein. Any holder of this document is advised that information contained hereon reflects the Company's findings at the time of its intervention only and within the limits of Client's instructions, if any. The Company's sole responsibility is to its Client and this document does not exonerate parties to a transaction from exercising all their rights and obligations under the transaction documents. This document cannot be reproduced except in full, without prior written approval of the Company. Any unauthorized alteration, forgery or falsification of the content or appearance of this document is unlawful and offenders may be prosecuted to the fullest extent of the law.

SGS Taiwan Ltd.

No.134,WuKungRoad,NewTaipeiIndustrialPark,WukuDistrict,NewTaipeiCity,Taiwan24803/新北市五股區新北產業園區五工路 134 號

台灣檢驗科技股份有限公司

t (886-2) 2299-3279

f (886-2) 2298-0488

www.tw.sgs.com

Member of SGS Group

10MHz BW LTE-Band 5(16QAM Number: 50 Offset: 0) Channel High

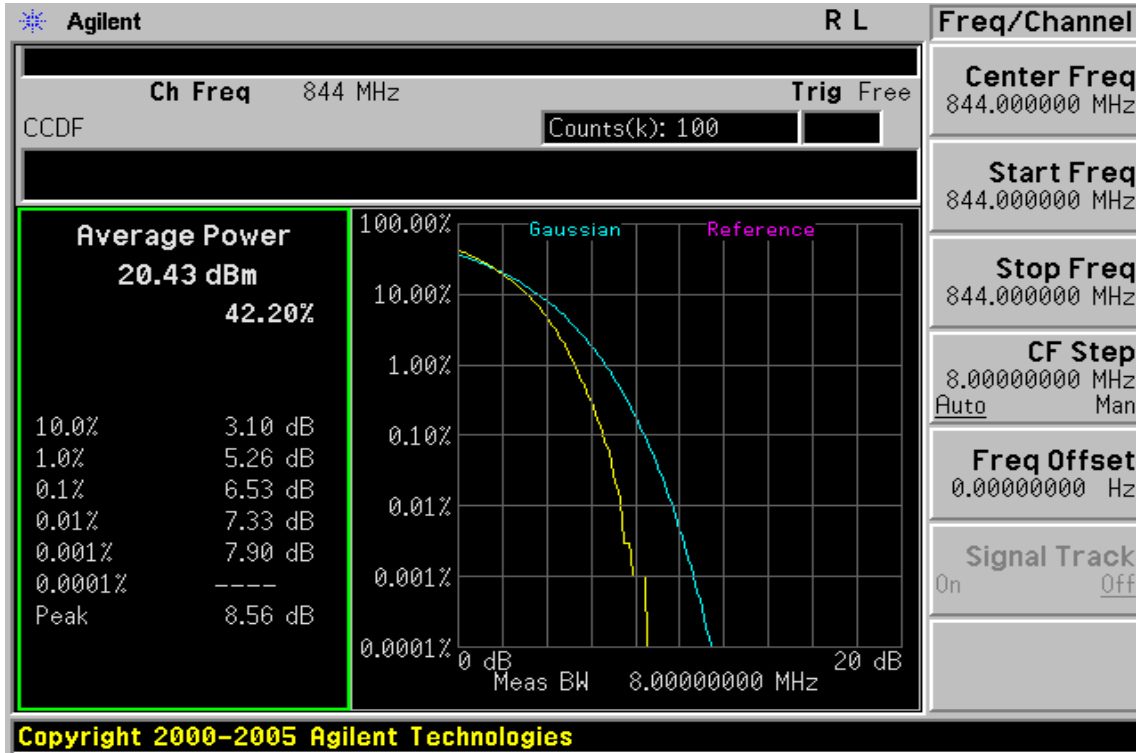

5MHz BW LTE-Band 7(16QAM Number: 25 Offset: 0) Channel Low

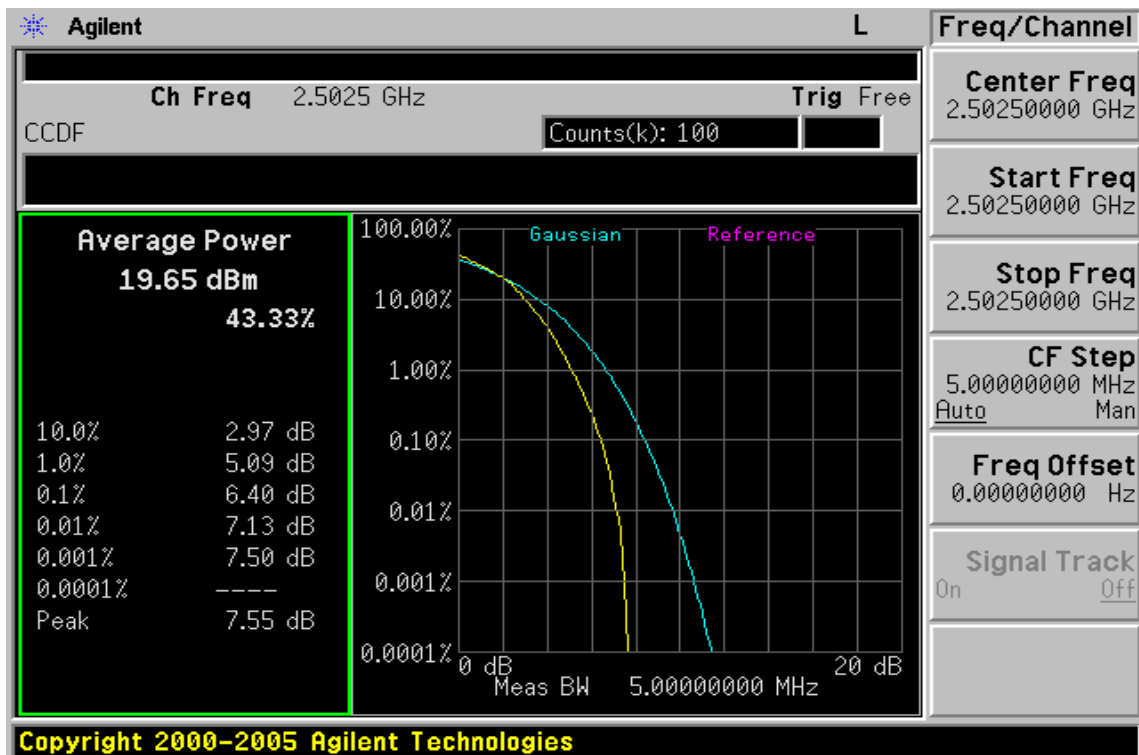

Unless otherwise stated the results shown in this test report refer only to the sample(s) tested and such sample(s) are retained for 90 days only.

除非另有說明，此報告結果僅對測試之樣品負責，同時此樣品僅保留90天。本報告未經本公司書面許可，不可部份複製。

This document is issued by the Company subject to its General Conditions of Service printed overleaf, available on request or accessible at www.sgs.com/terms_and_conditions.htm and, for electronic format documents, subject to Terms and Conditions for Electronic Documents at www.sgs.com/terms_e-document.htm. Attention is drawn to the limitation of liability, indemnification and jurisdiction issues defined therein. Any holder of this document is advised that information contained hereon reflects the Company's findings at the time of its intervention only and within the limits of Client's instructions, if any. The Company's sole responsibility is to its Client and this document does not exonerate parties to a transaction from exercising all their rights and obligations under the transaction documents. This document cannot be reproduced except in full, without prior written approval of the Company. Any unauthorized alteration, forgery or falsification of the content or appearance of this document is unlawful and offenders may be prosecuted to the fullest extent of the law.

SGS Taiwan Ltd.

No. 134, WuKungRoad, NewTaipeiIndustrialPark, WukuDistrict, NewTaipeiCity, Taiwan24803/新北市五股區新北產業園區五工路 134 號

台灣檢驗科技股份有限公司

t (886-2) 2299-3279

f (886-2) 2298-0488

www.tw.sgs.com

Member of SGS Group

5MHz BW LTE-Band 7(16QAM Number: 25 Offset: 0) Channel Mid



5MHz BW LTE-Band 7(16QAM Number: 25 Offset: 0) Channel High

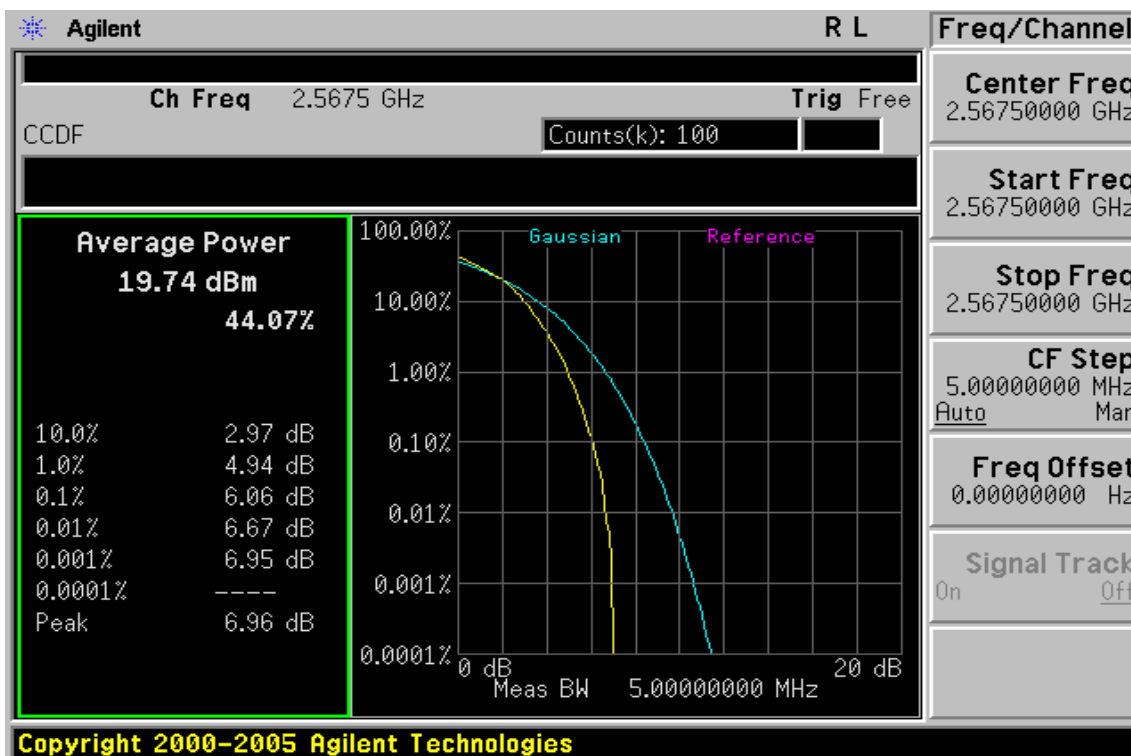

Unless otherwise stated the results shown in this test report refer only to the sample(s) tested and such sample(s) are retained for 90 days only.

除非另有說明，此報告結果僅對測試之樣品負責，同時此樣品僅保留90天。本報告未經本公司書面許可，不可部份複製。

This document is issued by the Company subject to its General Conditions of Service printed overleaf, available on request or accessible at www.sgs.com/terms_and_conditions.htm and, for electronic format documents, subject to Terms and Conditions for Electronic Documents at www.sgs.com/terms_e-document.htm. Attention is drawn to the limitation of liability, indemnification and jurisdiction issues defined therein. Any holder of this document is advised that information contained hereon reflects the Company's findings at the time of its intervention only and within the limits of Client's instructions, if any. The Company's sole responsibility is to its Client and this document does not exonerate parties to a transaction from exercising all their rights and obligations under the transaction documents. This document cannot be reproduced except in full, without prior written approval of the Company. Any unauthorized alteration, forgery or falsification of the content or appearance of this document is unlawful and offenders may be prosecuted to the fullest extent of the law.

SGS Taiwan Ltd.

No.134,WuKungRoad,NewTaipeiIndustrialPark,WukuDistrict,NewTaipeiCity,Taiwan24803/新北市五股區新北產業園區五工路 134 號

台灣檢驗科技股份有限公司

t (886-2) 2299-3279

f (886-2) 2298-0488

www.tw.sgs.com

Member of SGS Group

10MHz BW LTE-Band 7(16QAM Number: 50 Offset: 0) Channel Low

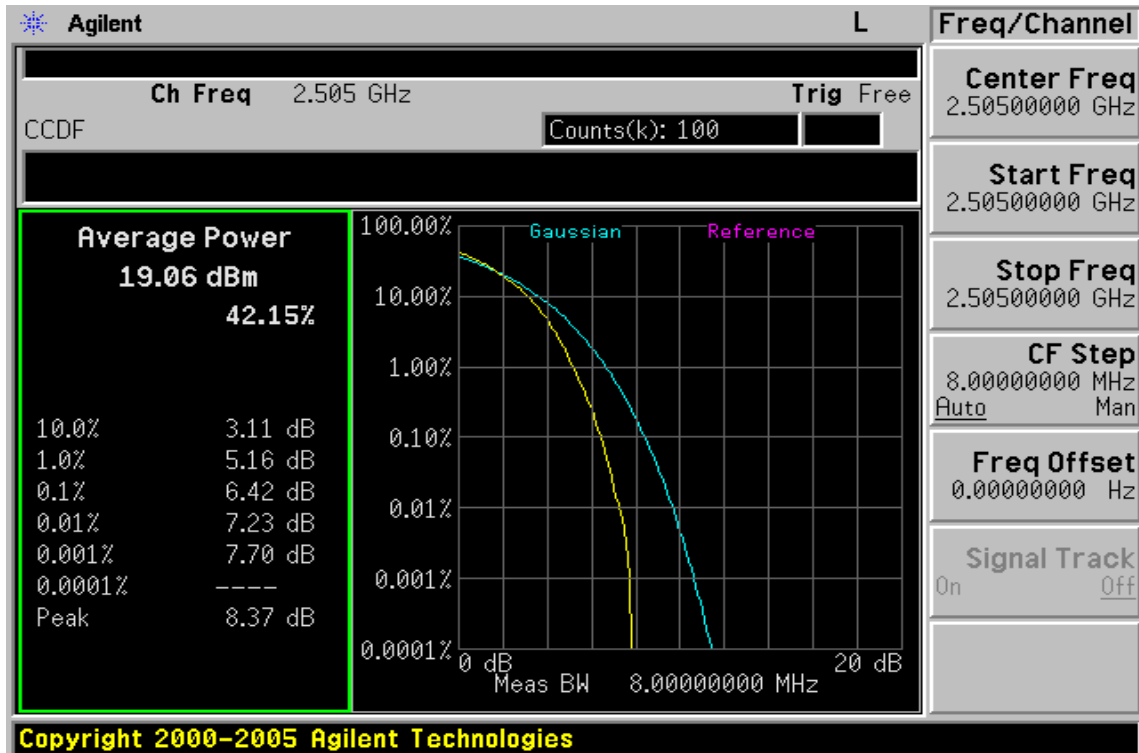

10MHz BW LTE-Band 7(16QAM Number: 50 Offset: 0) Channel Mid

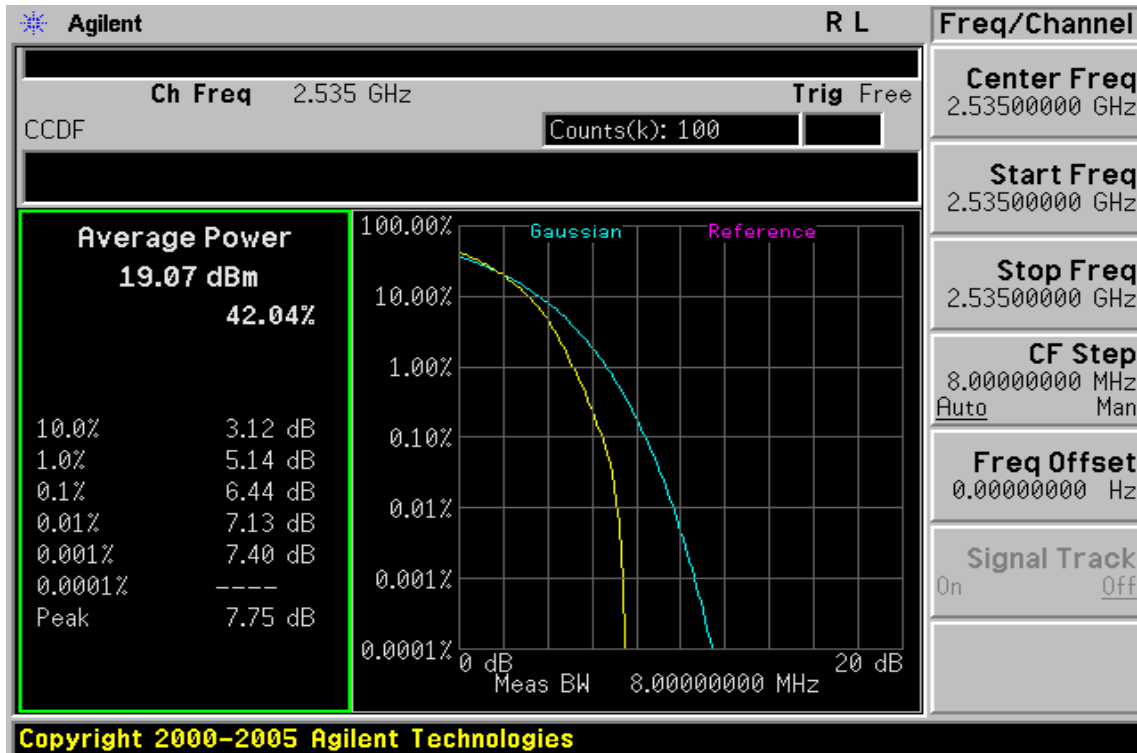

Unless otherwise stated the results shown in this test report refer only to the sample(s) tested and such sample(s) are retained for 90 days only.

除非另有說明，此報告結果僅對測試之樣品負責，同時此樣品僅保留90天。本報告未經本公司書面許可，不可部份複製。

This document is issued by the Company subject to its General Conditions of Service printed overleaf, available on request or accessible at www.sgs.com/terms_and_conditions.htm and, for electronic format documents, subject to Terms and Conditions for Electronic Documents at www.sgs.com/terms_e-document.htm. Attention is drawn to the limitation of liability, indemnification and jurisdiction issues defined therein. Any holder of this document is advised that information contained hereon reflects the Company's findings at the time of its intervention only and within the limits of Client's instructions, if any. The Company's sole responsibility is to its Client and this document does not exonerate parties to a transaction from exercising all their rights and obligations under the transaction documents. This document cannot be reproduced except in full, without prior written approval of the Company. Any unauthorized alteration, forgery or falsification of the content or appearance of this document is unlawful and offenders may be prosecuted to the fullest extent of the law.

SGS Taiwan Ltd.

No.134,WuKungRoad,NewTaipeiIndustrialPark,WukuDistrict,NewTaipeiCity,Taiwan24803/新北市五股區新北產業園區五工路 134 號

台灣檢驗科技股份有限公司

t (886-2) 2299-3279

f (886-2) 2298-0488

www.tw.sgs.com

Member of SGS Group

10MHz BW LTE-Band 7(16QAM Number: 50 Offset: 0) Channel High

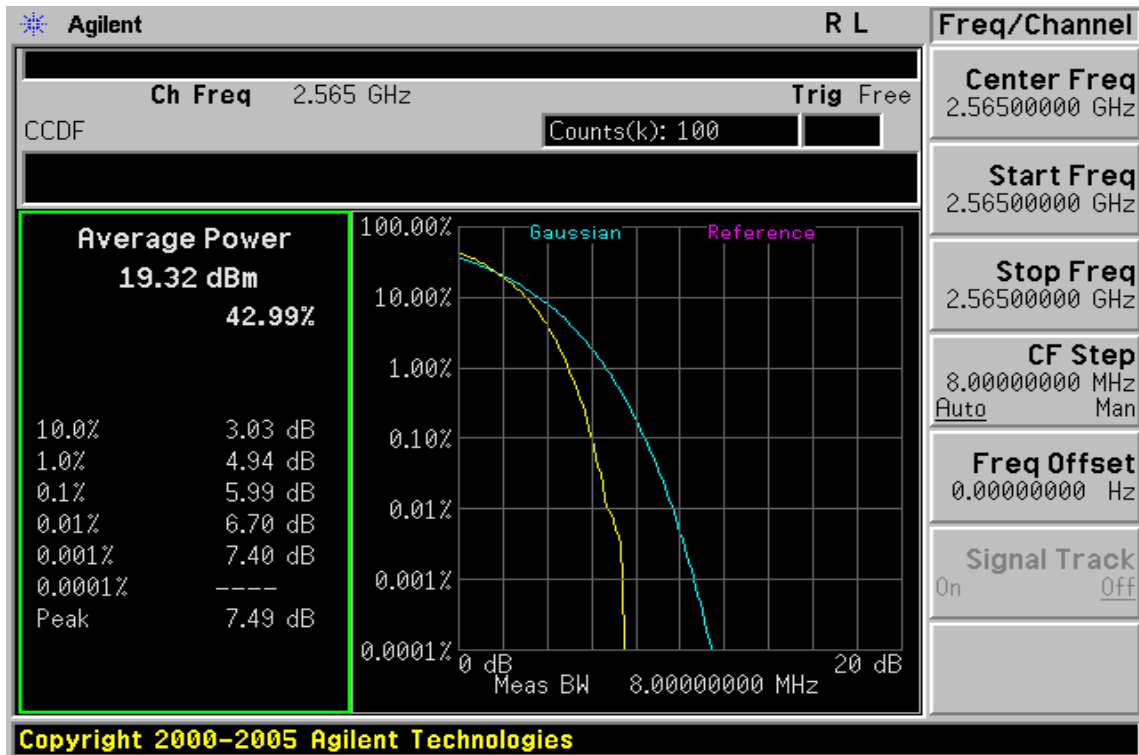

15MHz BW LTE-Band 7(16QAM Number: 75 Offset: 0) Channel Low

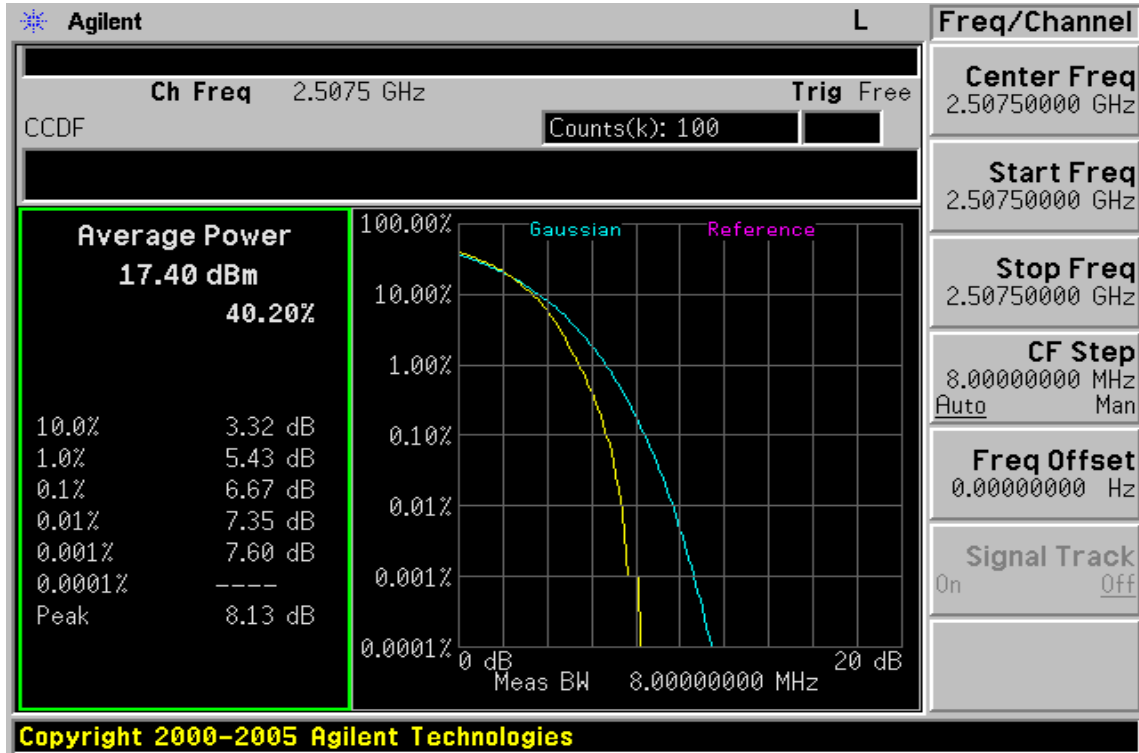

Unless otherwise stated the results shown in this test report refer only to the sample(s) tested and such sample(s) are retained for 90 days only.

除非另有說明，此報告結果僅對測試之樣品負責，同時此樣品僅保留90天。本報告未經本公司書面許可，不可部份複製。

This document is issued by the Company subject to its General Conditions of Service printed overleaf, available on request or accessible at www.sgs.com/terms_and_conditions.htm and, for electronic format documents, subject to Terms and Conditions for Electronic Documents at www.sgs.com/terms_e-document.htm. Attention is drawn to the limitation of liability, indemnification and jurisdiction issues defined therein. Any holder of this document is advised that information contained hereon reflects the Company's findings at the time of its intervention only and within the limits of Client's instructions, if any. The Company's sole responsibility is to its Client and this document does not exonerate parties to a transaction from exercising all their rights and obligations under the transaction documents. This document cannot be reproduced except in full, without prior written approval of the Company. Any unauthorized alteration, forgery or falsification of the content or appearance of this document is unlawful and offenders may be prosecuted to the fullest extent of the law.

SGS Taiwan Ltd.

No.134,WuKungRoad,NewTaipeiIndustrialPark,WukuDistrict,NewTaipeiCity,Taiwan24803/新北市五股區新北產業園區五工路 134 號

台灣檢驗科技股份有限公司

t (886-2) 2299-3279

f (886-2) 2298-0488

www.tw.sgs.com

Member of SGS Group

15MHz BW LTE-Band 7(16QAM Number: 75 Offset: 0) Channel Mid

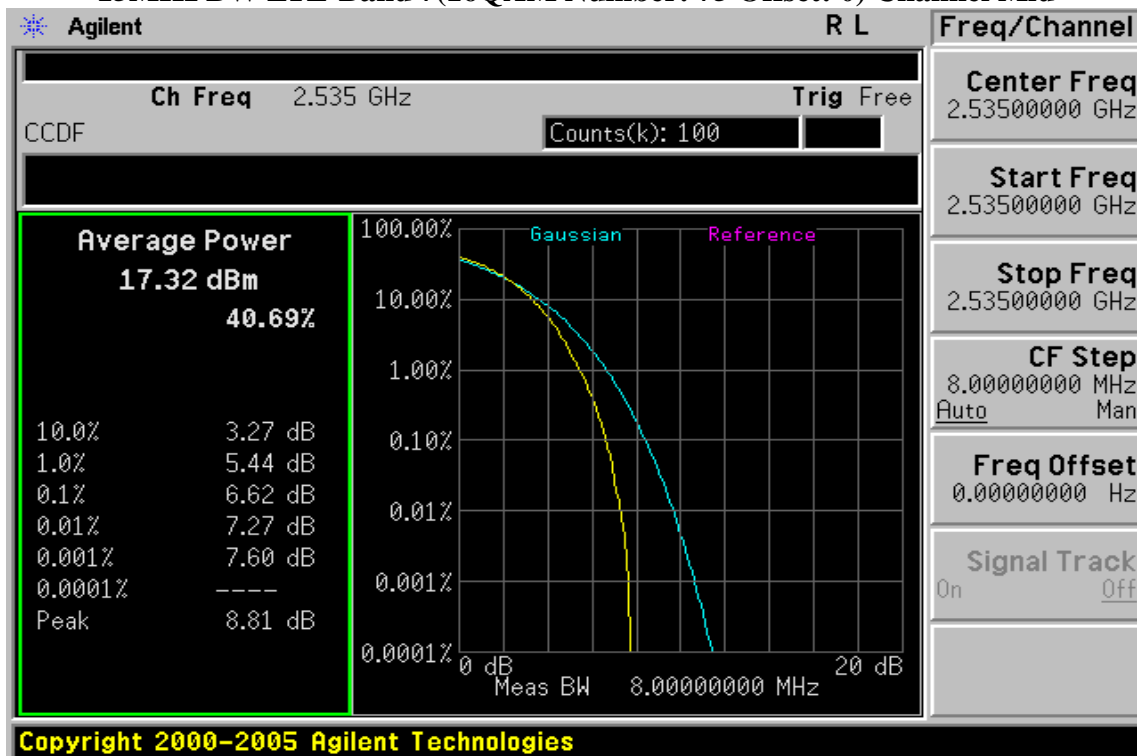

15MHz BW LTE-Band 7(16QAM Number: 75 Offset: 0) Channel High

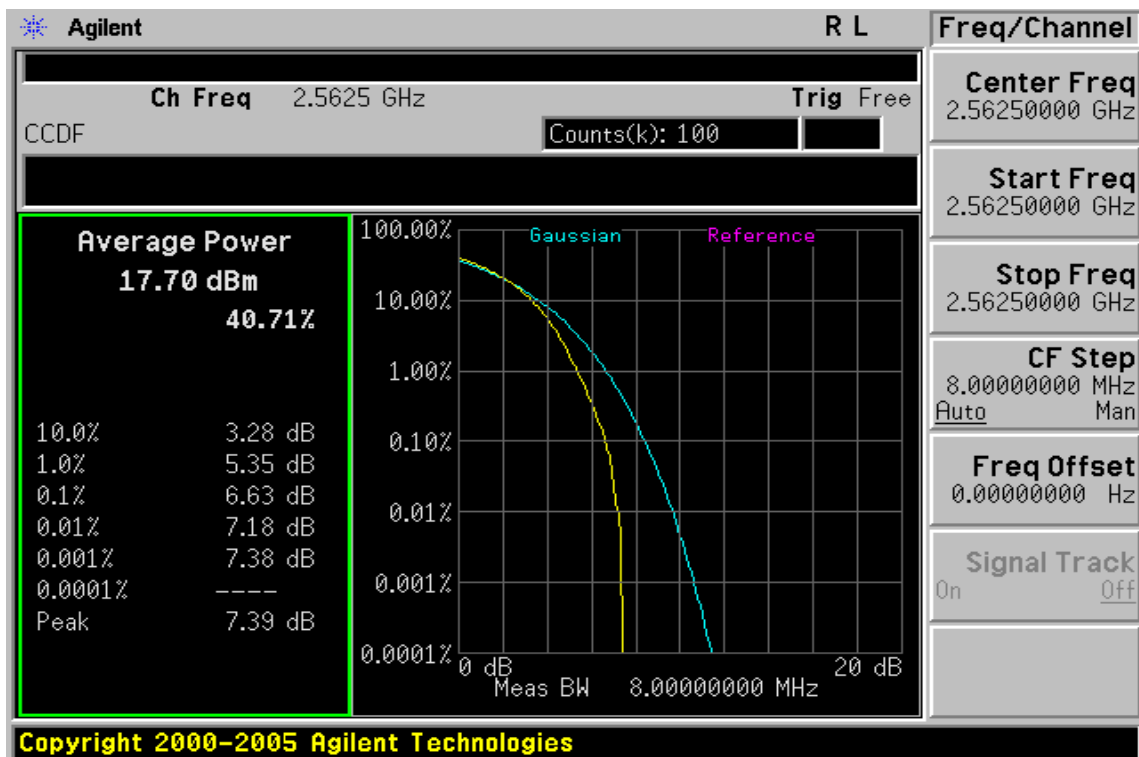

Unless otherwise stated the results shown in this test report refer only to the sample(s) tested and such sample(s) are retained for 90 days only.

除非另有說明，此報告結果僅對測試之樣品負責，同時此樣品僅保留90天。本報告未經本公司書面許可，不可部份複製。

This document is issued by the Company subject to its General Conditions of Service printed overleaf, available on request or accessible at www.sgs.com/terms_and_conditions.htm and, for electronic format documents, subject to Terms and Conditions for Electronic Documents at www.sgs.com/terms_e-document.htm. Attention is drawn to the limitation of liability, indemnification and jurisdiction issues defined therein. Any holder of this document is advised that information contained hereon reflects the Company's findings at the time of its intervention only and within the limits of Client's instructions, if any. The Company's sole responsibility is to its Client and this document does not exonerate parties to a transaction from exercising all their rights and obligations under the transaction documents. This document cannot be reproduced except in full, without prior written approval of the Company. Any unauthorized alteration, forgery or falsification of the content or appearance of this document is unlawful and offenders may be prosecuted to the fullest extent of the law.

SGS Taiwan Ltd.

No.134,WuKungRoad,NewTaipeiIndustrialPark,WukuDistrict,NewTaipeiCity,Taiwan24803/新北市五股區新北產業園區五工路 134 號

台灣檢驗科技股份有限公司

t (886-2) 2299-3279

f (886-2) 2298-0488

www.tw.sgs.com

Member of SGS Group

20MHz BW LTE-Band 7(16QAM Number: 100 Offset: 0) Channel Low

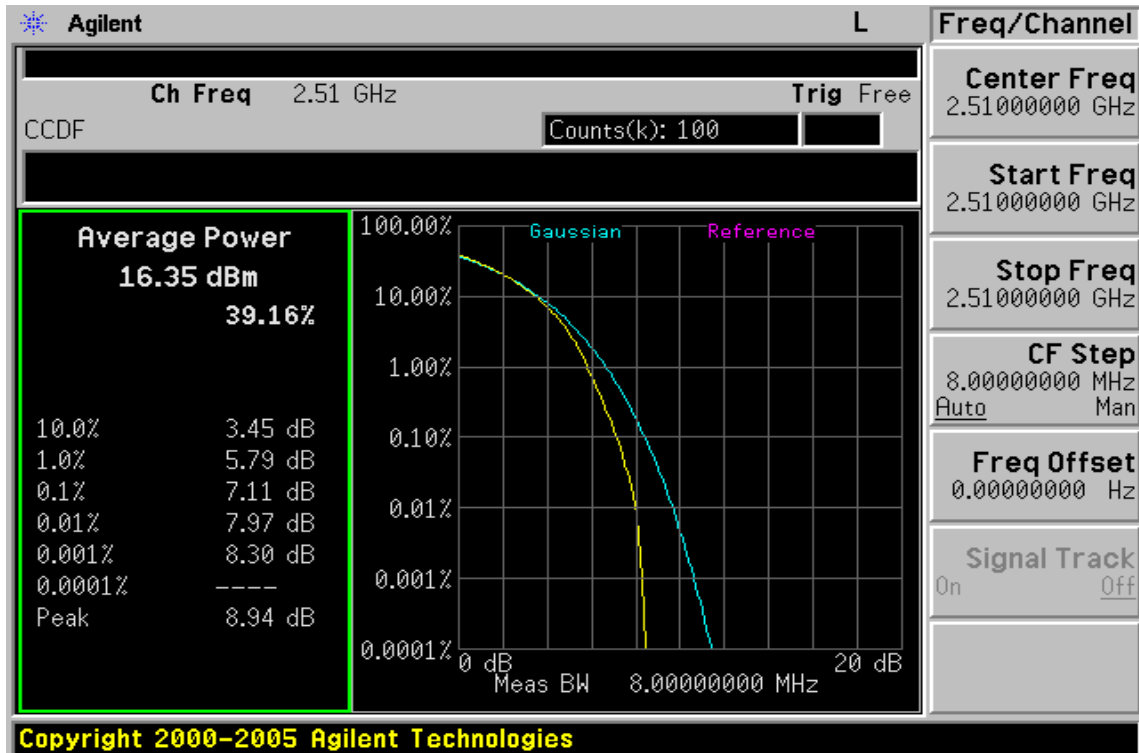

20MHz BW LTE-Band 7(16QAM Number: 100 Offset: 0) Channel Mid

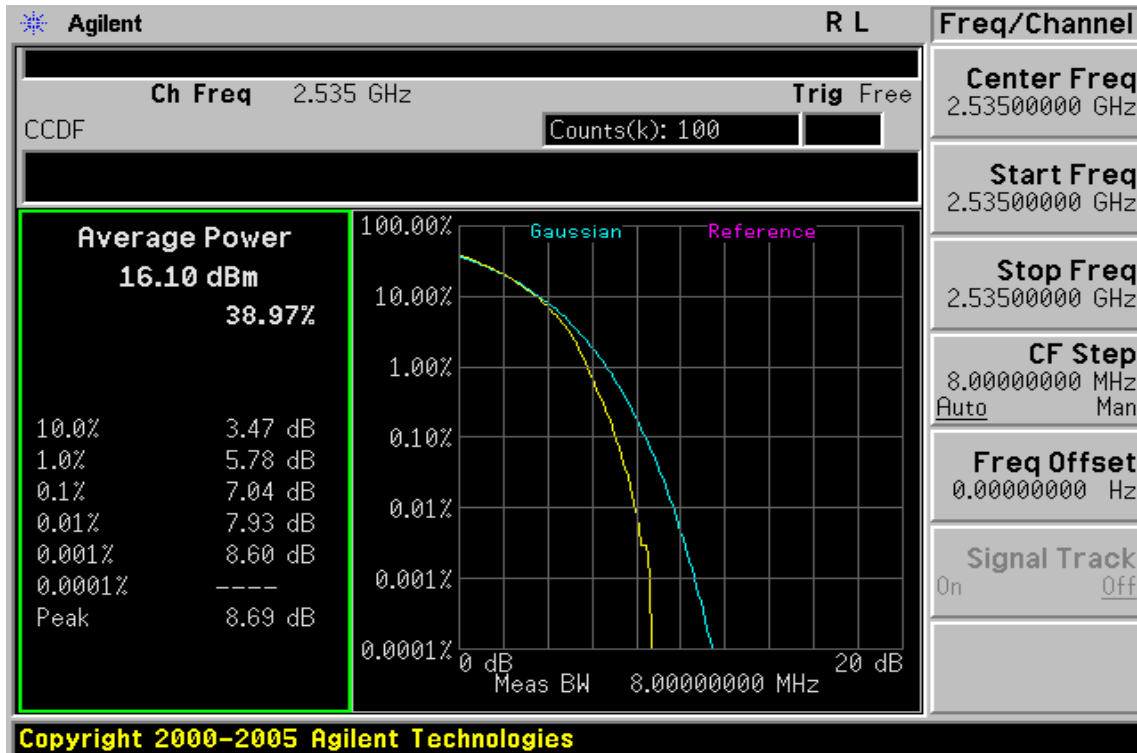

Unless otherwise stated the results shown in this test report refer only to the sample(s) tested and such sample(s) are retained for 90 days only.

除非另有說明，此報告結果僅對測試之樣品負責，同時此樣品僅保留90天。本報告未經本公司書面許可，不可部份複製。

This document is issued by the Company subject to its General Conditions of Service printed overleaf, available on request or accessible at www.sgs.com/terms_and_conditions.htm and, for electronic format documents, subject to Terms and Conditions for Electronic Documents at www.sgs.com/terms_e-document.htm. Attention is drawn to the limitation of liability, indemnification and jurisdiction issues defined therein. Any holder of this document is advised that information contained hereon reflects the Company's findings at the time of its intervention only and within the limits of Client's instructions, if any. The Company's sole responsibility is to its Client and this document does not exonerate parties to a transaction from exercising all their rights and obligations under the transaction documents. This document cannot be reproduced except in full, without prior written approval of the Company. Any unauthorized alteration, forgery or falsification of the content or appearance of this document is unlawful and offenders may be prosecuted to the fullest extent of the law.

SGS Taiwan Ltd.

No.134,WuKungRoad,NewTaipeiIndustrialPark,WukuDistrict,NewTaipeiCity,Taiwan24803/新北市五股區新北產業園區五工路 134 號

台灣檢驗科技股份有限公司

t (886-2) 2299-3279

f (886-2) 2298-0488

www.tw.sgs.com

Member of SGS Group

20MHz BW LTE-Band 7(16QAM Number: 100 Offset: 0) Channel High

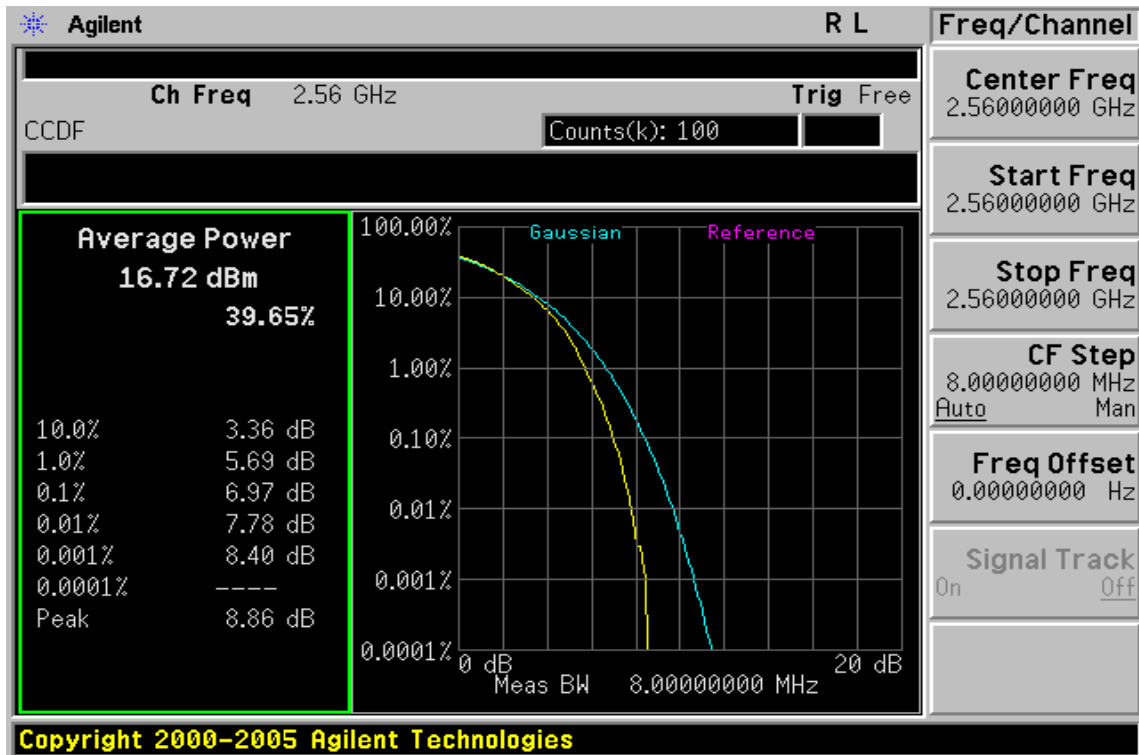

1.4MHz BW LTE-Band 12(16QAM Number: 6 Offset: 0) Channel Low

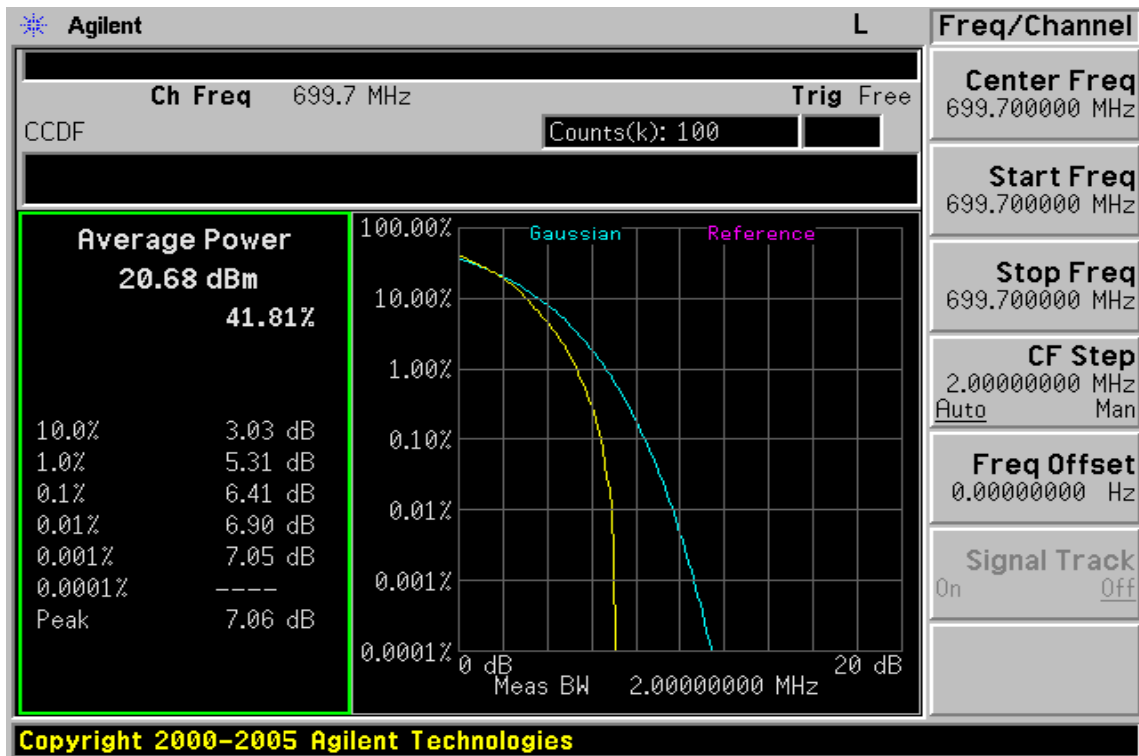

Unless otherwise stated the results shown in this test report refer only to the sample(s) tested and such sample(s) are retained for 90 days only.

除非另有說明，此報告結果僅對測試之樣品負責，同時此樣品僅保留90天。本報告未經本公司書面許可，不可部份複製。

This document is issued by the Company subject to its General Conditions of Service printed overleaf, available on request or accessible at www.sgs.com/terms_and_conditions.htm and, for electronic format documents, subject to Terms and Conditions for Electronic Documents at www.sgs.com/terms_e-document.htm. Attention is drawn to the limitation of liability, indemnification and jurisdiction issues defined therein. Any holder of this document is advised that information contained hereon reflects the Company's findings at the time of its intervention only and within the limits of Client's instructions, if any. The Company's sole responsibility is to its Client and this document does not exonerate parties to a transaction from exercising all their rights and obligations under the transaction documents. This document cannot be reproduced except in full, without prior written approval of the Company. Any unauthorized alteration, forgery or falsification of the content or appearance of this document is unlawful and offenders may be prosecuted to the fullest extent of the law.

SGS Taiwan Ltd.

No. 134, WuKungRoad, NewTaipeiIndustrialPark, WukuDistrict, NewTaipeiCity, Taiwan24803/新北市五股區新北產業園區五工路 134 號

台灣檢驗科技股份有限公司

t (886-2) 2299-3279

f (886-2) 2298-0488

www.tw.sgs.com

Member of SGS Group

1.4MHz BW LTE-Band 12(16QAM Number: 6 Offset: 0) Channel Mid

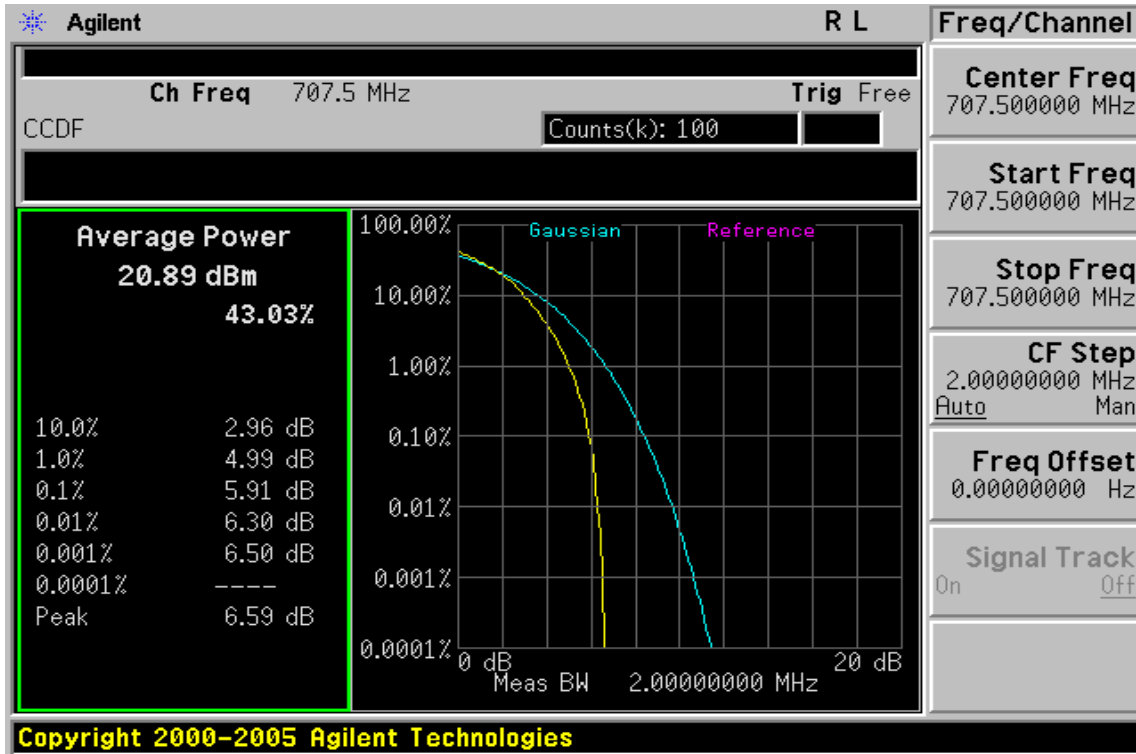

1.4MHz BW LTE-Band 12(16QAM Number: 6 Offset: 0) Channel High

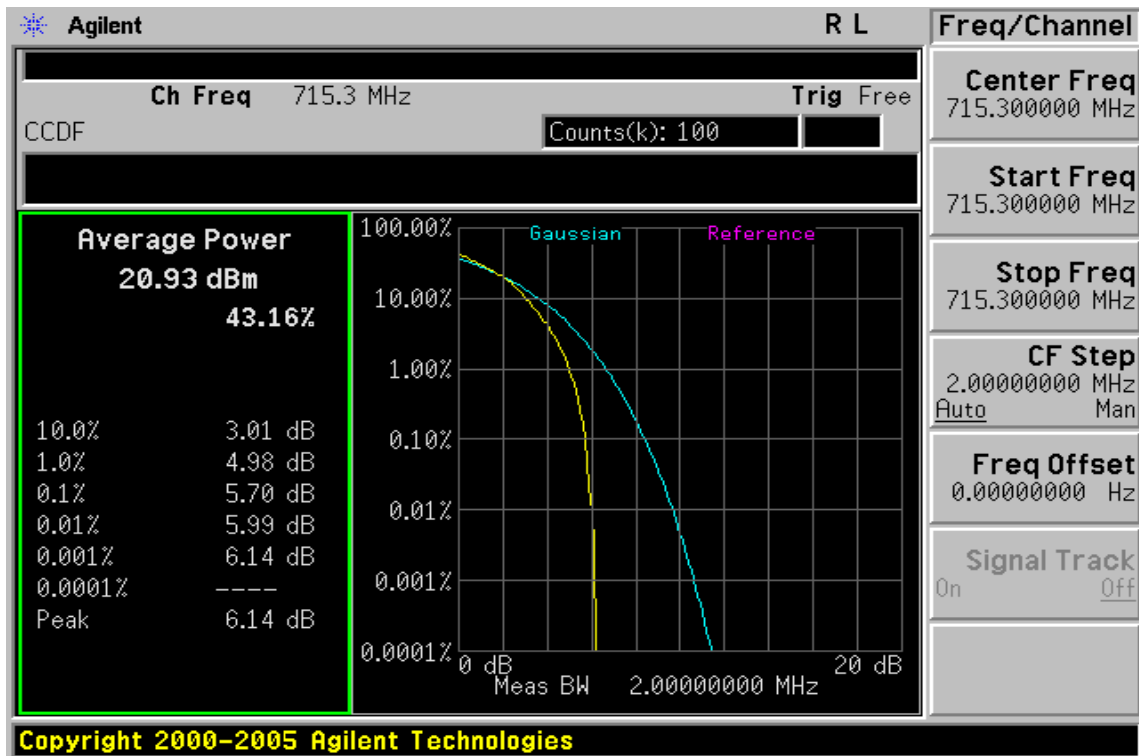

Unless otherwise stated the results shown in this test report refer only to the sample(s) tested and such sample(s) are retained for 90 days only.

除非另有說明，此報告結果僅對測試之樣品負責，同時此樣品僅保留90天。本報告未經本公司書面許可，不可部份複製。

This document is issued by the Company subject to its General Conditions of Service printed overleaf, available on request or accessible at www.sgs.com/terms_and_conditions.htm and, for electronic format documents, subject to Terms and Conditions for Electronic Documents at www.sgs.com/terms_e-document.htm. Attention is drawn to the limitation of liability, indemnification and jurisdiction issues defined therein. Any holder of this document is advised that information contained hereon reflects the Company's findings at the time of its intervention only and within the limits of Client's instructions, if any. The Company's sole responsibility is to its Client and this document does not exonerate parties to a transaction from exercising all their rights and obligations under the transaction documents. This document cannot be reproduced except in full, without prior written approval of the Company. Any unauthorized alteration, forgery or falsification of the content or appearance of this document is unlawful and offenders may be prosecuted to the fullest extent of the law.

SGS Taiwan Ltd.

No. 134, WuKungRoad, NewTaipeiIndustrialPark, WukuDistrict, NewTaipeiCity, Taiwan24803/新北市五股區新北產業園區五工路 134 號

台灣檢驗科技股份有限公司

t (886-2) 2299-3279

f (886-2) 2298-0488

www.tw.sgs.com

Member of SGS Group

3MHz BW LTE-Band 12(16QAM Number: 15 Offset: 0) Channel Low

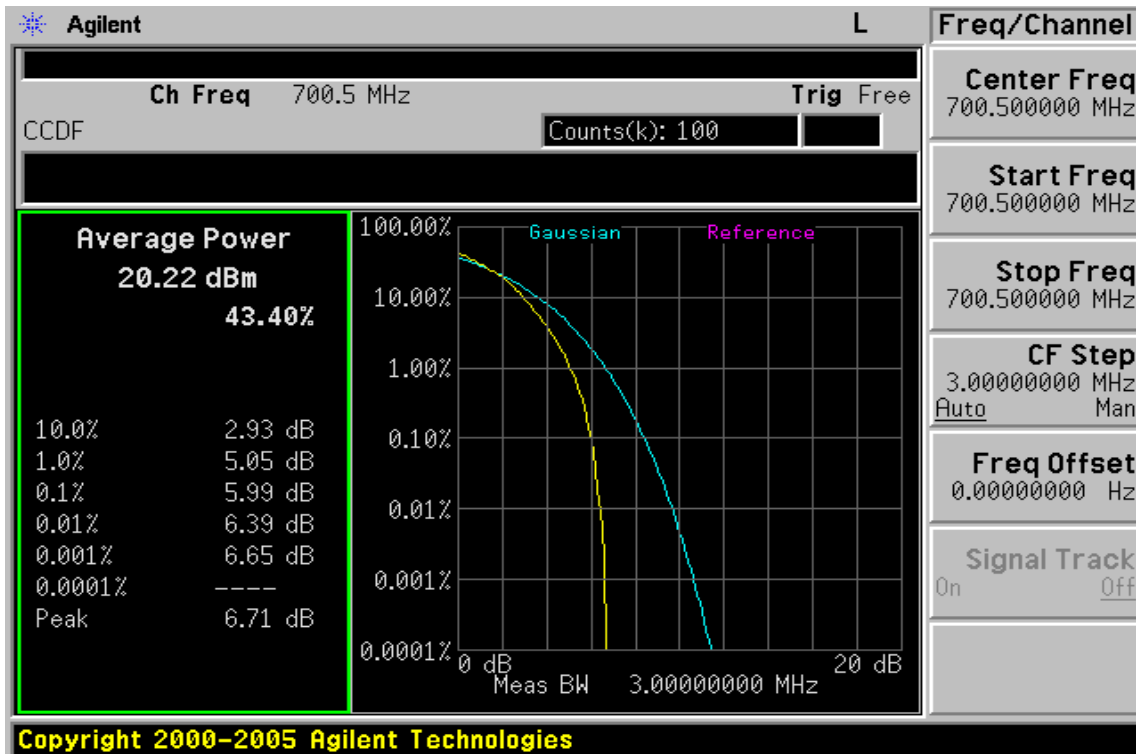

3MHz BW LTE-Band 12(16QAM Number: 15 Offset: 0) Channel Mid

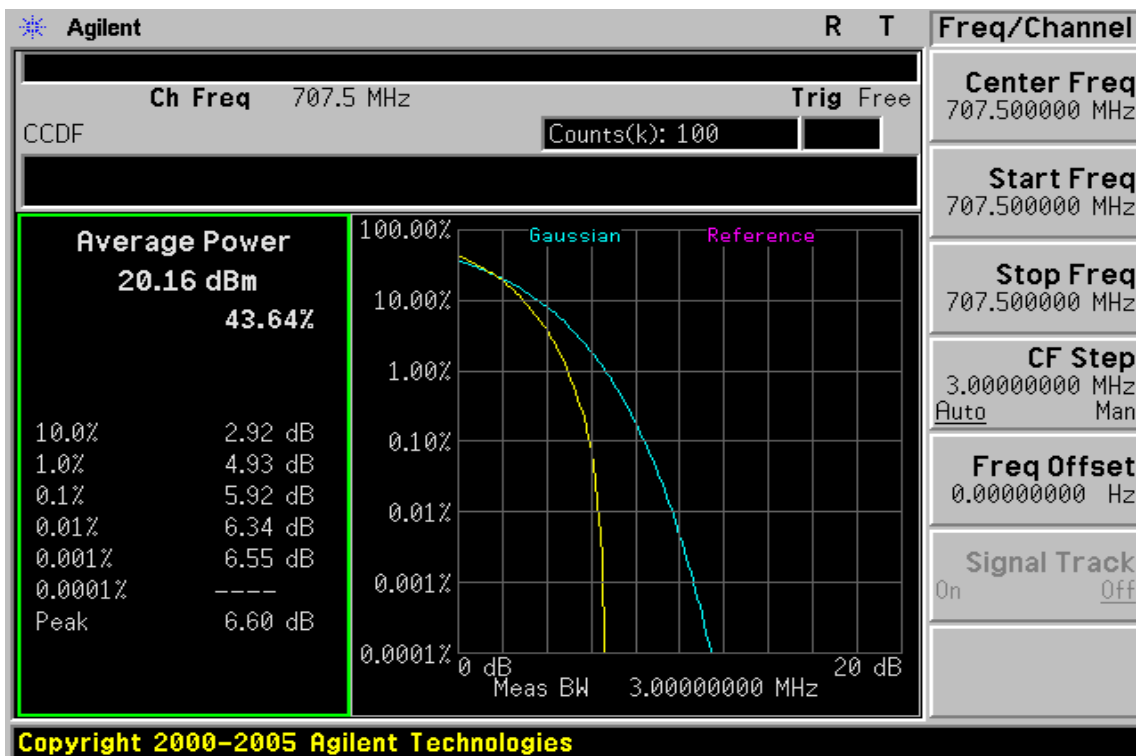

Unless otherwise stated the results shown in this test report refer only to the sample(s) tested and such sample(s) are retained for 90 days only.

除非另有說明，此報告結果僅對測試之樣品負責，同時此樣品僅保留90天。本報告未經本公司書面許可，不可部份複製。

This document is issued by the Company subject to its General Conditions of Service printed overleaf, available on request or accessible at www.sgs.com/terms_and_conditions.htm and, for electronic format documents, subject to Terms and Conditions for Electronic Documents at www.sgs.com/terms_e-document.htm. Attention is drawn to the limitation of liability, indemnification and jurisdiction issues defined therein. Any holder of this document is advised that information contained hereon reflects the Company's findings at the time of its intervention only and within the limits of Client's instructions, if any. The Company's sole responsibility is to its Client and this document does not exonerate parties to a transaction from exercising all their rights and obligations under the transaction documents. This document cannot be reproduced except in full, without prior written approval of the Company. Any unauthorized alteration, forgery or falsification of the content or appearance of this document is unlawful and offenders may be prosecuted to the fullest extent of the law.

SGS Taiwan Ltd.

No.134,WuKungRoad,NewTaipeiIndustrialPark,WukuDistrict,NewTaipeiCity,Taiwan24803/新北市五股區新北產業園區五工路 134 號

台灣檢驗科技股份有限公司

t (886-2) 2299-3279

f (886-2) 2298-0488

www.tw.sgs.com

Member of SGS Group

3MHz BW LTE-Band 12(16QAM Number: 15 Offset: 0) Channel High

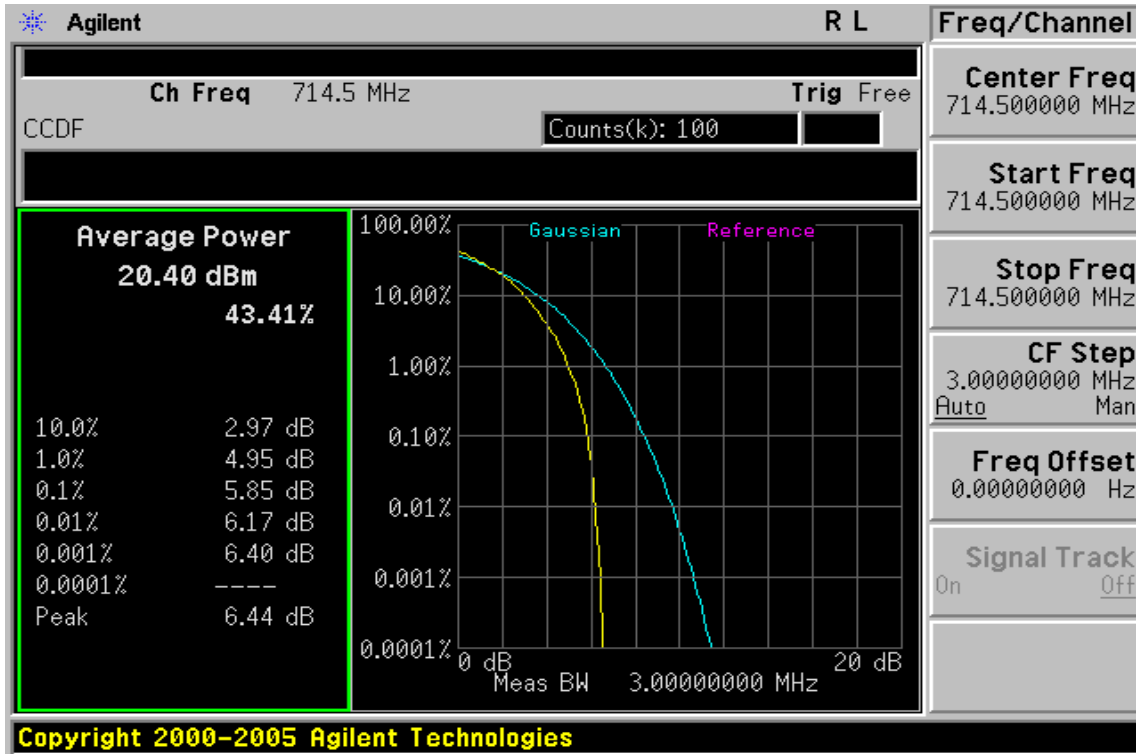

5MHz BW LTE-Band 12(16QAM Number: 25 Offset: 0) Channel Low

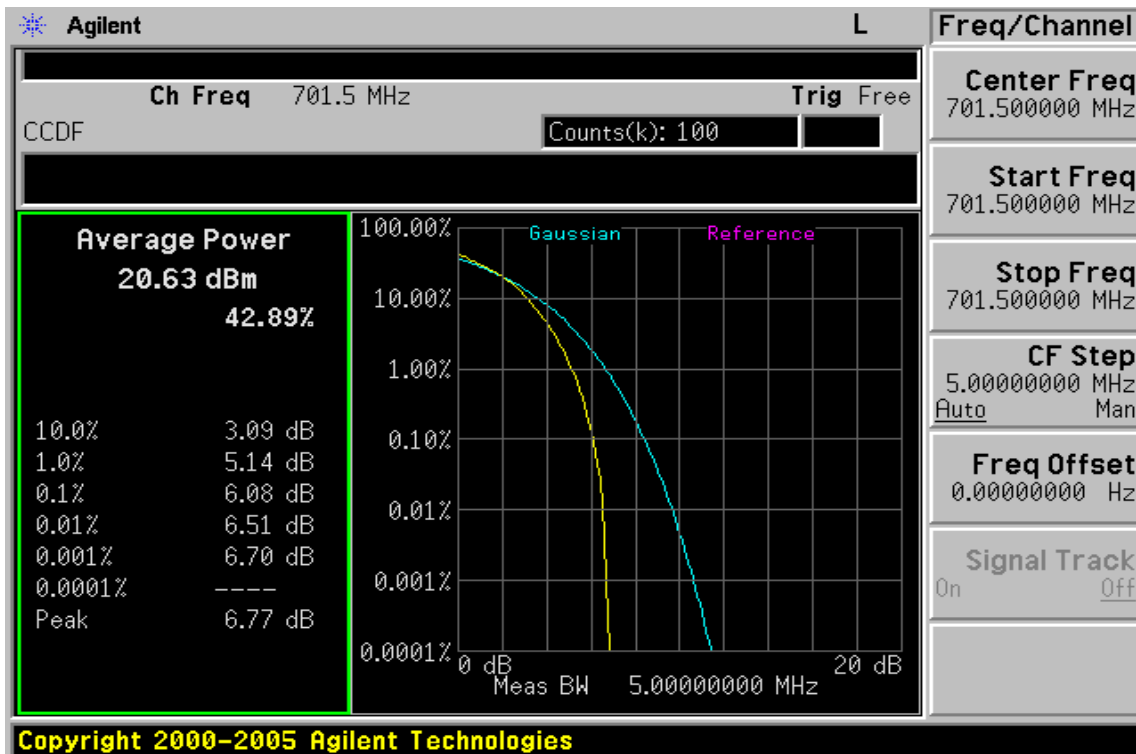

Unless otherwise stated the results shown in this test report refer only to the sample(s) tested and such sample(s) are retained for 90 days only.

除非另有說明，此報告結果僅對測試之樣品負責，同時此樣品僅保留90天。本報告未經本公司書面許可，不可部份複製。

This document is issued by the Company subject to its General Conditions of Service printed overleaf, available on request or accessible at www.sgs.com/terms_and_conditions.htm and, for electronic format documents, subject to Terms and Conditions for Electronic Documents at www.sgs.com/terms_e-document.htm. Attention is drawn to the limitation of liability, indemnification and jurisdiction issues defined therein. Any holder of this document is advised that information contained hereon reflects the Company's findings at the time of its intervention only and within the limits of Client's instructions, if any. The Company's sole responsibility is to its Client and this document does not exonerate parties to a transaction from exercising all their rights and obligations under the transaction documents. This document cannot be reproduced except in full, without prior written approval of the Company. Any unauthorized alteration, forgery or falsification of the content or appearance of this document is unlawful and offenders may be prosecuted to the fullest extent of the law.

SGS Taiwan Ltd.

No.134,WuKungRoad,NewTaipeiIndustrialPark,WukuDistrict,NewTaipeiCity,Taiwan24803/新北市五股區新北產業園區五工路 134 號

台灣檢驗科技股份有限公司

t (886-2) 2299-3279

f (886-2) 2298-0488

www.tw.sgs.com

Member of SGS Group

5MHz BW LTE-Band 12(16QAM Number: 25 Offset: 0) Channel Mid

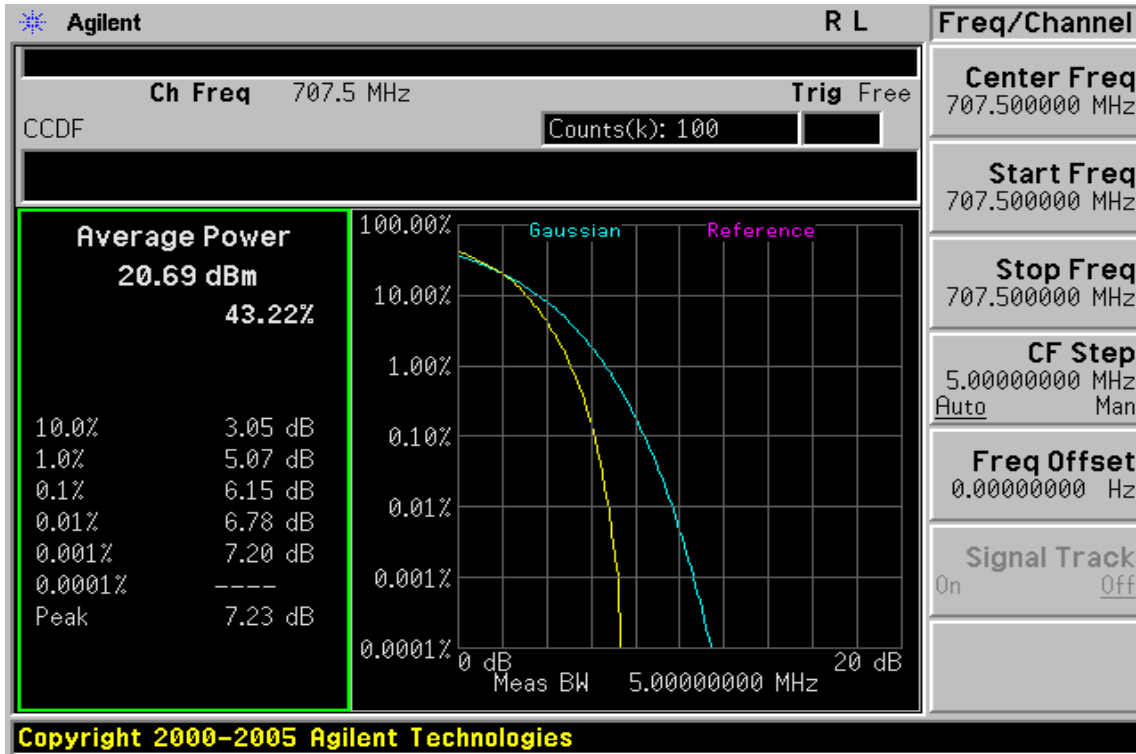

5MHz BW LTE-Band 12(16QAM Number: 25 Offset: 0) Channel High

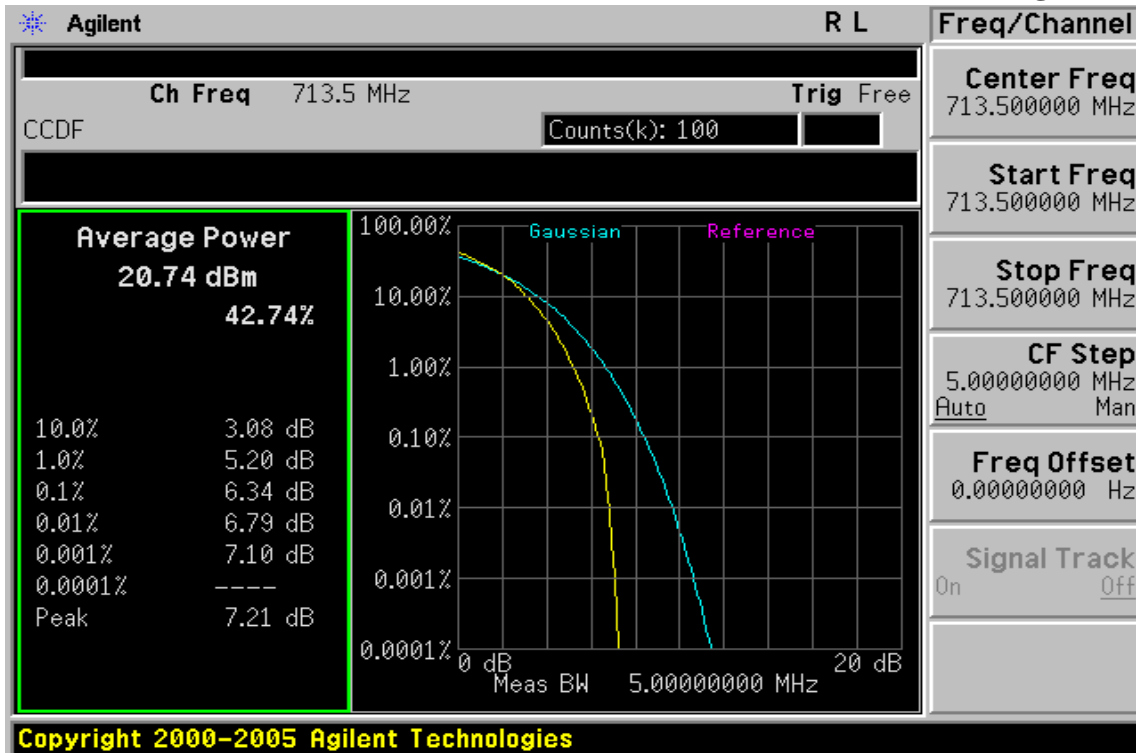

Unless otherwise stated the results shown in this test report refer only to the sample(s) tested and such sample(s) are retained for 90 days only.

除非另有說明，此報告結果僅對測試之樣品負責，同時此樣品僅保留90天。本報告未經本公司書面許可，不可部份複製。

This document is issued by the Company subject to its General Conditions of Service printed overleaf, available on request or accessible at www.sgs.com/terms_and_conditions.htm and, for electronic format documents, subject to Terms and Conditions for Electronic Documents at www.sgs.com/terms_e-document.htm. Attention is drawn to the limitation of liability, indemnification and jurisdiction issues defined therein. Any holder of this document is advised that information contained hereon reflects the Company's findings at the time of its intervention only and within the limits of Client's instructions, if any. The Company's sole responsibility is to its Client and this document does not exonerate parties to a transaction from exercising all their rights and obligations under the transaction documents. This document cannot be reproduced except in full, without prior written approval of the Company. Any unauthorized alteration, forgery or falsification of the content or appearance of this document is unlawful and offenders may be prosecuted to the fullest extent of the law.

SGS Taiwan Ltd.

No.134,WuKungRoad,NewTaipeiIndustrialPark,WukuDistrict,NewTaipeiCity,Taiwan24803/新北市五股區新北產業園區五工路 134 號

台灣檢驗科技股份有限公司

t (886-2) 2299-3279

f (886-2) 2298-0488

www.tw.sgs.com

Member of SGS Group

10MHz BW LTE-Band 12(16QAM Number: 50 Offset: 0) Channel Low

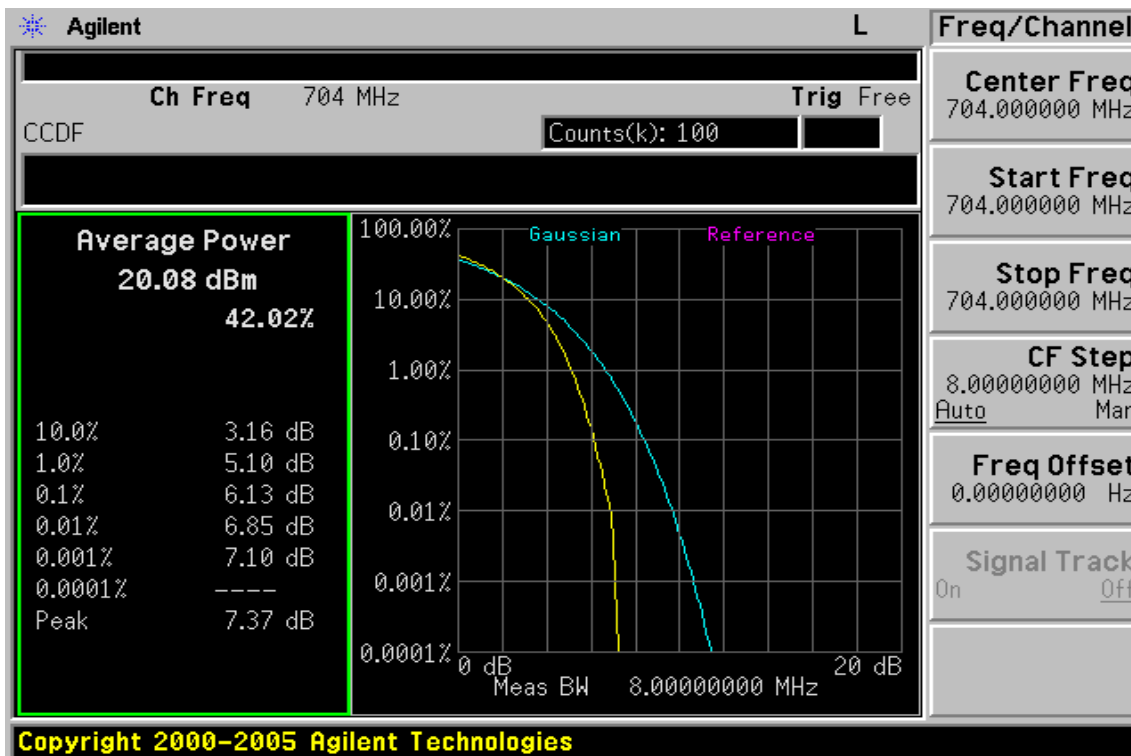

10MHz BW LTE-Band 12(16QAM Number: 50 Offset: 0) Channel Mid

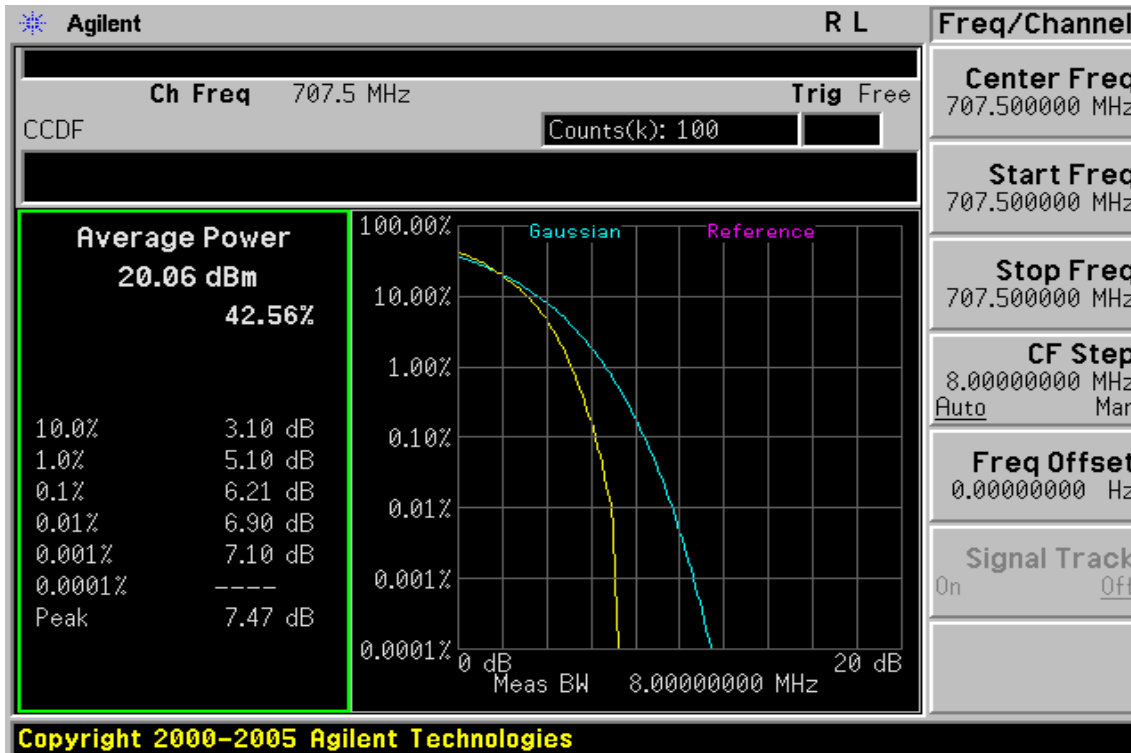

Unless otherwise stated the results shown in this test report refer only to the sample(s) tested and such sample(s) are retained for 90 days only.

除非另有說明，此報告結果僅對測試之樣品負責，同時此樣品僅保留90天。本報告未經本公司書面許可，不可部份複製。

This document is issued by the Company subject to its General Conditions of Service printed overleaf, available on request or accessible at www.sgs.com/terms_and_conditions.htm and, for electronic format documents, subject to Terms and Conditions for Electronic Documents at www.sgs.com/terms_e-document.htm. Attention is drawn to the limitation of liability, indemnification and jurisdiction issues defined therein. Any holder of this document is advised that information contained hereon reflects the Company's findings at the time of its intervention only and within the limits of Client's instructions, if any. The Company's sole responsibility is to its Client and this document does not exonerate parties to a transaction from exercising all their rights and obligations under the transaction documents. This document cannot be reproduced except in full, without prior written approval of the Company. Any unauthorized alteration, forgery or falsification of the content or appearance of this document is unlawful and offenders may be prosecuted to the fullest extent of the law.

SGS Taiwan Ltd.

No.134,WuKungRoad,NewTaipeiIndustrialPark,WukuDistrict,NewTaipeiCity,Taiwan24803/新北市五股區新北產業園區五工路 134 號

台灣檢驗科技股份有限公司

t (886-2) 2299-3279

f (886-2) 2298-0488

www.tw.sgs.com

Member of SGS Group

10MHz BW LTE-Band 12(16QAM Number: 50 Offset: 0) Channel High

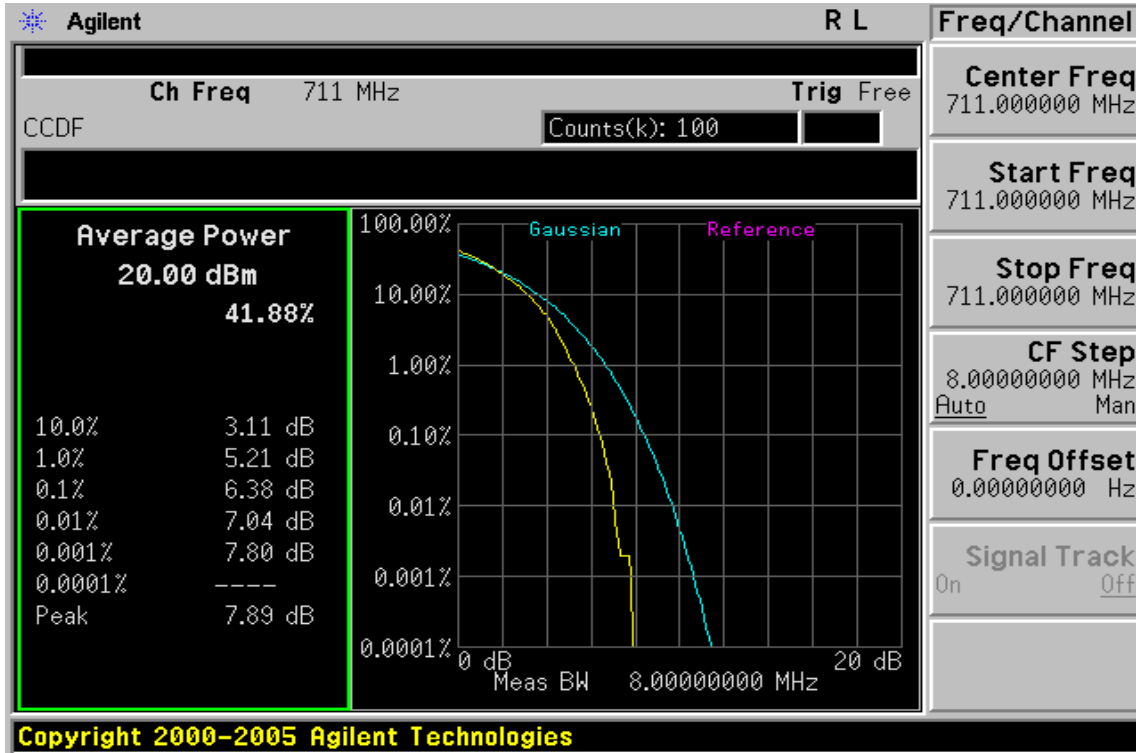

5MHz BW LTE-Band 13(16QAM Number: 25 Offset: 0) Channel Low

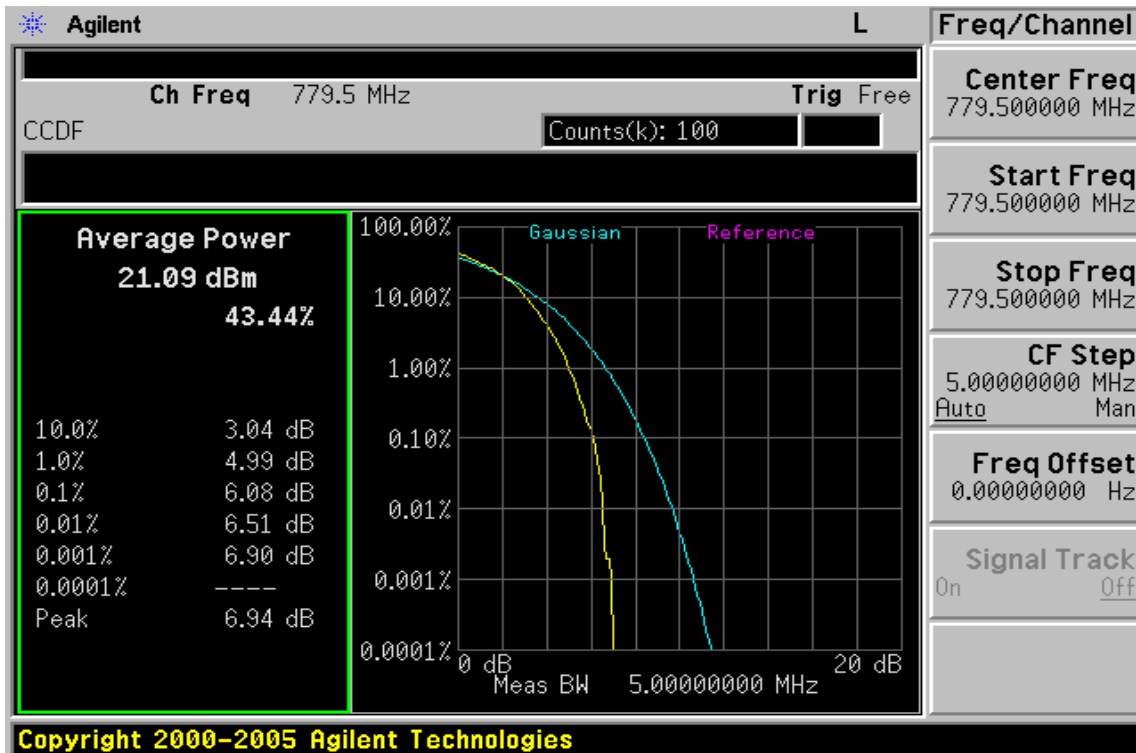

Unless otherwise stated the results shown in this test report refer only to the sample(s) tested and such sample(s) are retained for 90 days only.

除非另有說明，此報告結果僅對測試之樣品負責，同時此樣品僅保留90天。本報告未經本公司書面許可，不可部份複製。

This document is issued by the Company subject to its General Conditions of Service printed overleaf, available on request or accessible at www.sgs.com/terms_and_conditions.htm and, for electronic format documents, subject to Terms and Conditions for Electronic Documents at www.sgs.com/terms_e-document.htm. Attention is drawn to the limitation of liability, indemnification and jurisdiction issues defined therein. Any holder of this document is advised that information contained hereon reflects the Company's findings at the time of its intervention only and within the limits of Client's instructions, if any. The Company's sole responsibility is to its Client and this document does not exonerate parties to a transaction from exercising all their rights and obligations under the transaction documents. This document cannot be reproduced except in full, without prior written approval of the Company. Any unauthorized alteration, forgery or falsification of the content or appearance of this document is unlawful and offenders may be prosecuted to the fullest extent of the law.

5MHz BW LTE-Band 13(16QAM Number: 25 Offset: 0) Channel Mid

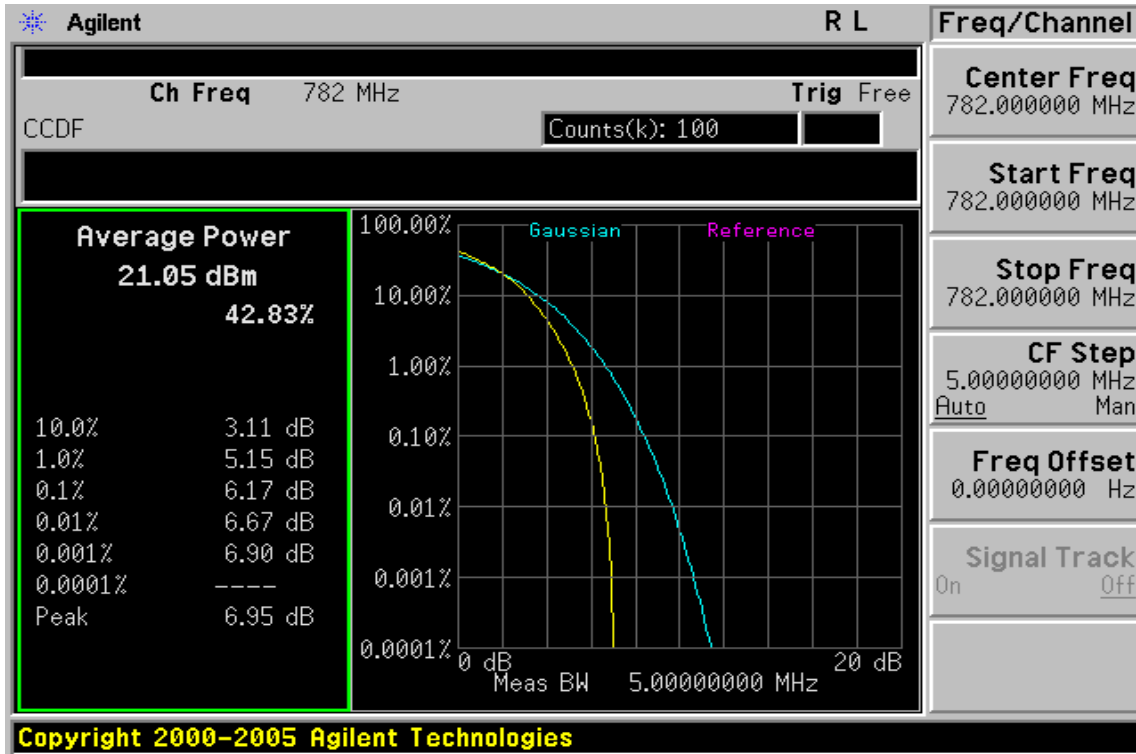

5MHz BW LTE-Band 13(16QAM Number: 25 Offset: 0) Channel High

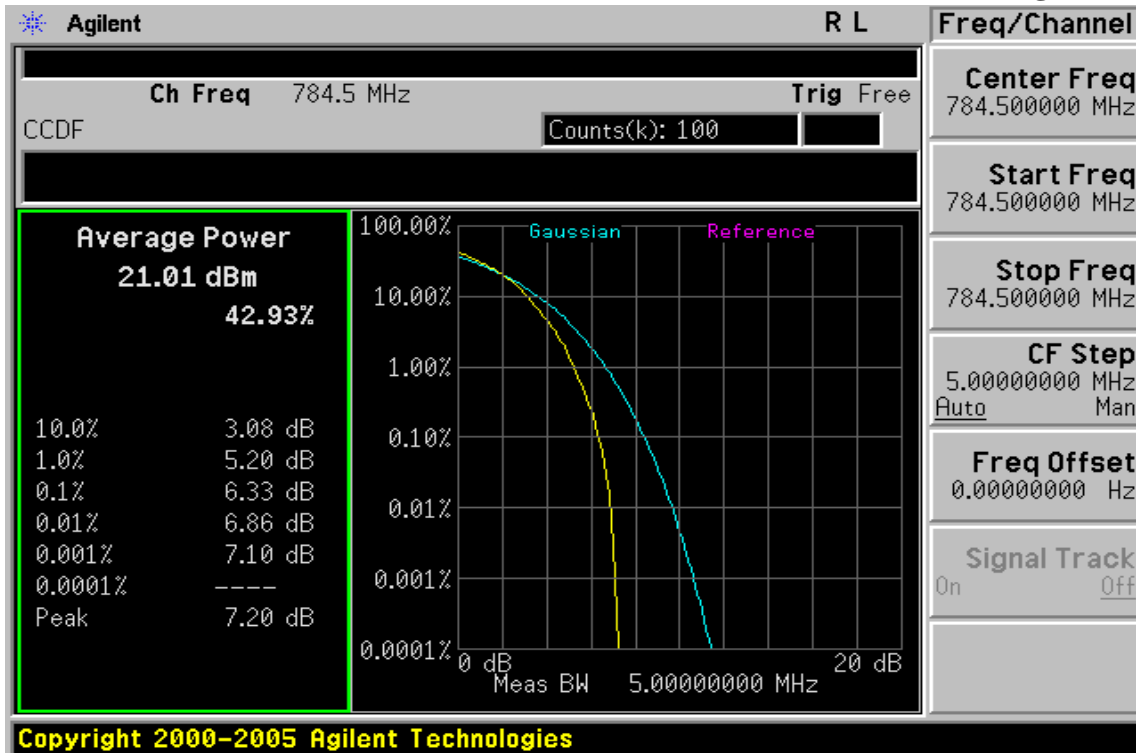

Unless otherwise stated the results shown in this test report refer only to the sample(s) tested and such sample(s) are retained for 90 days only.

除非另有說明，此報告結果僅對測試之樣品負責，同時此樣品僅保留90天。本報告未經本公司書面許可，不可部份複製。

This document is issued by the Company subject to its General Conditions of Service printed overleaf, available on request or accessible at www.sgs.com/terms_and_conditions.htm and, for electronic format documents, subject to Terms and Conditions for Electronic Documents at www.sgs.com/terms_e-document.htm. Attention is drawn to the limitation of liability, indemnification and jurisdiction issues defined therein. Any holder of this document is advised that information contained hereon reflects the Company's findings at the time of its intervention only and within the limits of Client's instructions, if any. The Company's sole responsibility is to its Client and this document does not exonerate parties to a transaction from exercising all their rights and obligations under the transaction documents. This document cannot be reproduced except in full, without prior written approval of the Company. Any unauthorized alteration, forgery or falsification of the content or appearance of this document is unlawful and offenders may be prosecuted to the fullest extent of the law.

SGS Taiwan Ltd.

No.134,WuKungRoad,NewTaipeiIndustrialPark,WukuDistrict,NewTaipeiCity,Taiwan24803/新北市五股區新北產業園區五工路 134 號

台灣檢驗科技股份有限公司

t (886-2) 2299-3279

f (886-2) 2298-0488

www.tw.sgs.com

Member of SGS Group

10MHz BW LTE-Band 13(16QAM Number: 50 Offset: 0) Channel Mid

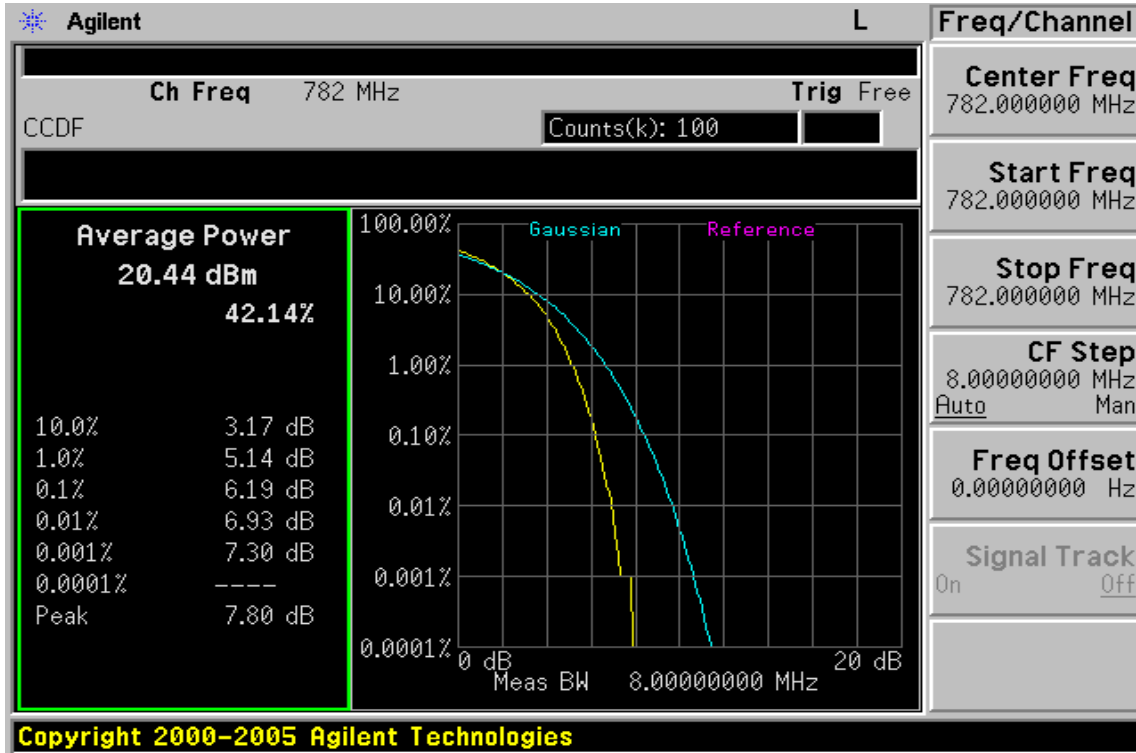

5MHz BW LTE-Band 17(16QAM Number: 25 Offset: 0) Channel Low

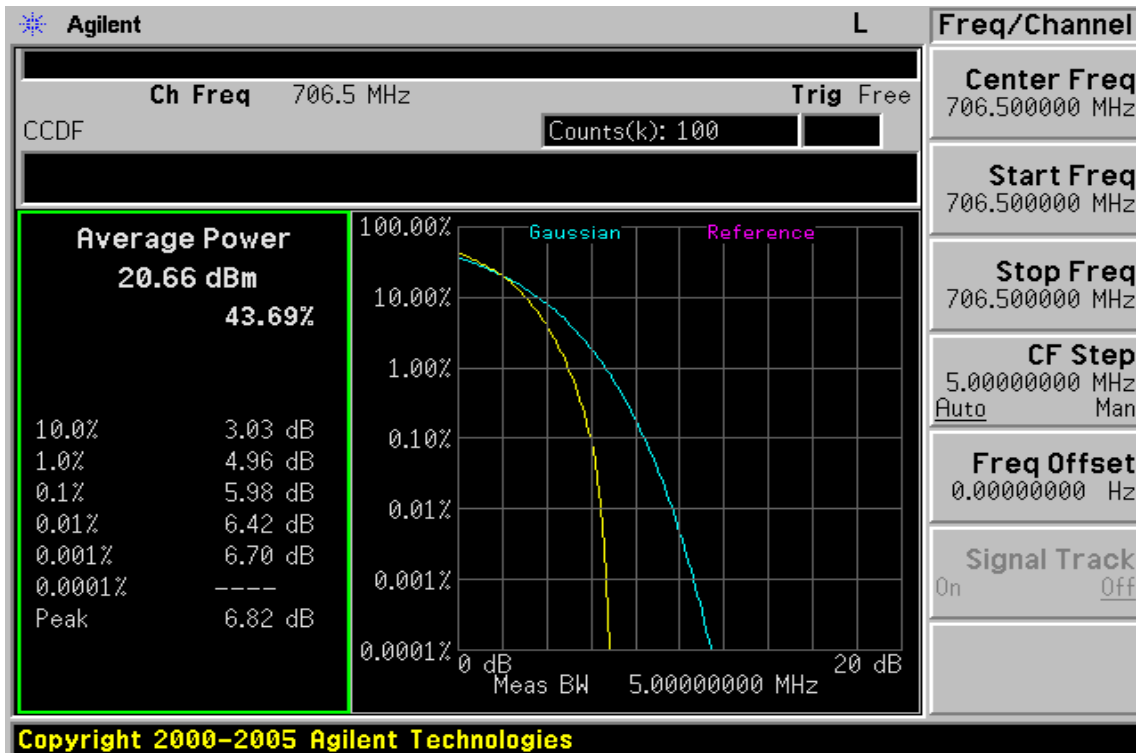

Unless otherwise stated the results shown in this test report refer only to the sample(s) tested and such sample(s) are retained for 90 days only.

除非另有說明，此報告結果僅對測試之樣品負責，同時此樣品僅保留90天。本報告未經本公司書面許可，不可部份複製。

This document is issued by the Company subject to its General Conditions of Service printed overleaf, available on request or accessible at www.sgs.com/terms_and_conditions.htm and, for electronic format documents, subject to Terms and Conditions for Electronic Documents at www.sgs.com/terms_e-document.htm. Attention is drawn to the limitation of liability, indemnification and jurisdiction issues defined therein. Any holder of this document is advised that information contained hereon reflects the Company's findings at the time of its intervention only and within the limits of Client's instructions, if any. The Company's sole responsibility is to its Client and this document does not exonerate parties to a transaction from exercising all their rights and obligations under the transaction documents. This document cannot be reproduced except in full, without prior written approval of the Company. Any unauthorized alteration, forgery or falsification of the content or appearance of this document is unlawful and offenders may be prosecuted to the fullest extent of the law.

SGS Taiwan Ltd.

No.134,WuKungRoad,NewTaipeiIndustrialPark,WukuDistrict,NewTaipeiCity,Taiwan24803/新北市五股區新北產業園區五工路 134 號

台灣檢驗科技股份有限公司

t (886-2) 2299-3279

f (886-2) 2298-0488

www.tw.sgs.com

Member of SGS Group

5MHz BW LTE-Band 17(16QAM Number: 25 Offset: 0) Channel Mid

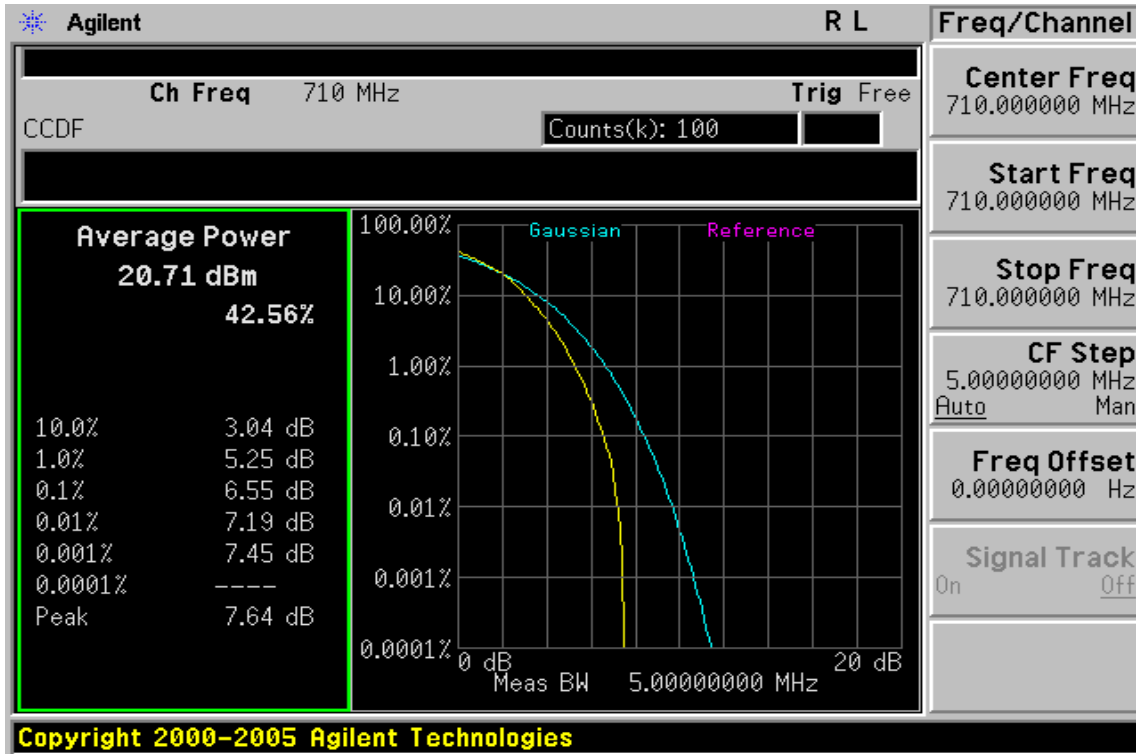

5MHz BW LTE-Band 17(16QAM Number: 25 Offset: 0) Channel High

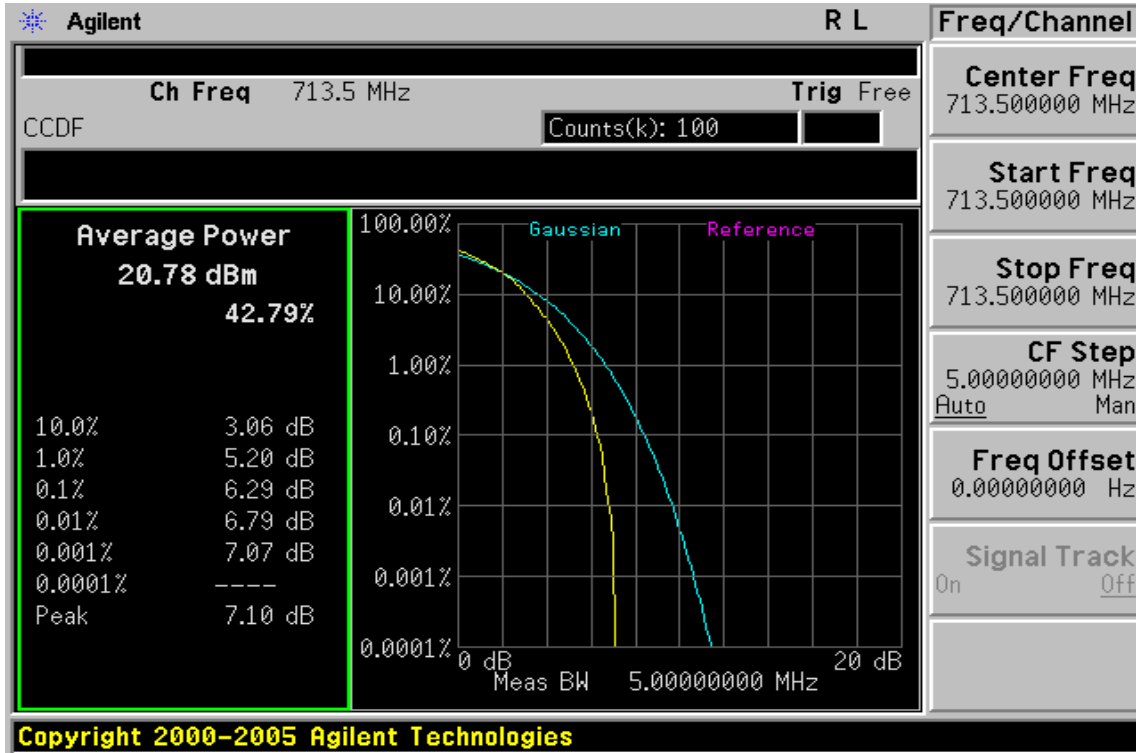

Unless otherwise stated the results shown in this test report refer only to the sample(s) tested and such sample(s) are retained for 90 days only.

除非另有說明，此報告結果僅對測試之樣品負責，同時此樣品僅保留90天。本報告未經本公司書面許可，不可部份複製。

This document is issued by the Company subject to its General Conditions of Service printed overleaf, available on request or accessible at www.sgs.com/terms_and_conditions.htm and, for electronic format documents, subject to Terms and Conditions for Electronic Documents at www.sgs.com/terms_e-document.htm. Attention is drawn to the limitation of liability, indemnification and jurisdiction issues defined therein. Any holder of this document is advised that information contained hereon reflects the Company's findings at the time of its intervention only and within the limits of Client's instructions, if any. The Company's sole responsibility is to its Client and this document does not exonerate parties to a transaction from exercising all their rights and obligations under the transaction documents. This document cannot be reproduced except in full, without prior written approval of the Company. Any unauthorized alteration, forgery or falsification of the content or appearance of this document is unlawful and offenders may be prosecuted to the fullest extent of the law.

SGS Taiwan Ltd.

No.134,WuKungRoad,NewTaipeiIndustrialPark,WukuDistrict,NewTaipeiCity,Taiwan24803/新北市五股區新北產業園區五工路 134 號

台灣檢驗科技股份有限公司

t (886-2) 2299-3279

f (886-2) 2298-0488

www.tw.sgs.com

Member of SGS Group

10MHz BW LTE-Band 17(16QAM Number: 25 Offset: 0) Channel Low

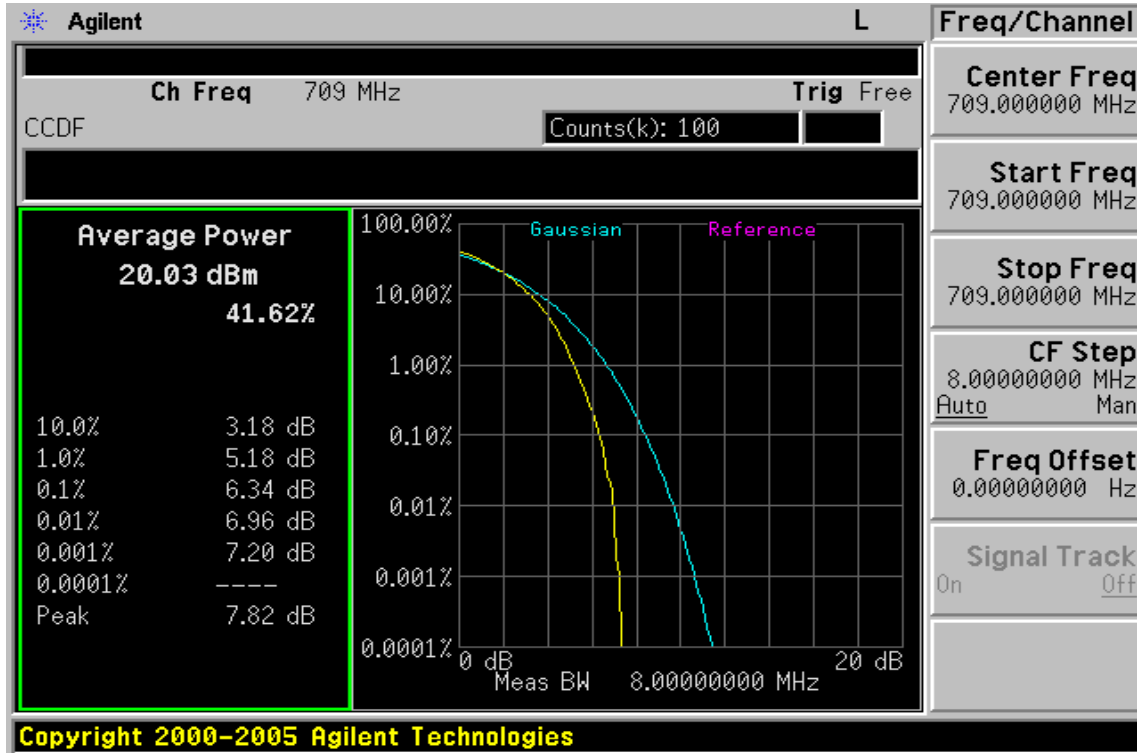

10MHz BW LTE-Band 17(16QAM Number: 50 Offset: 0) Channel Mid

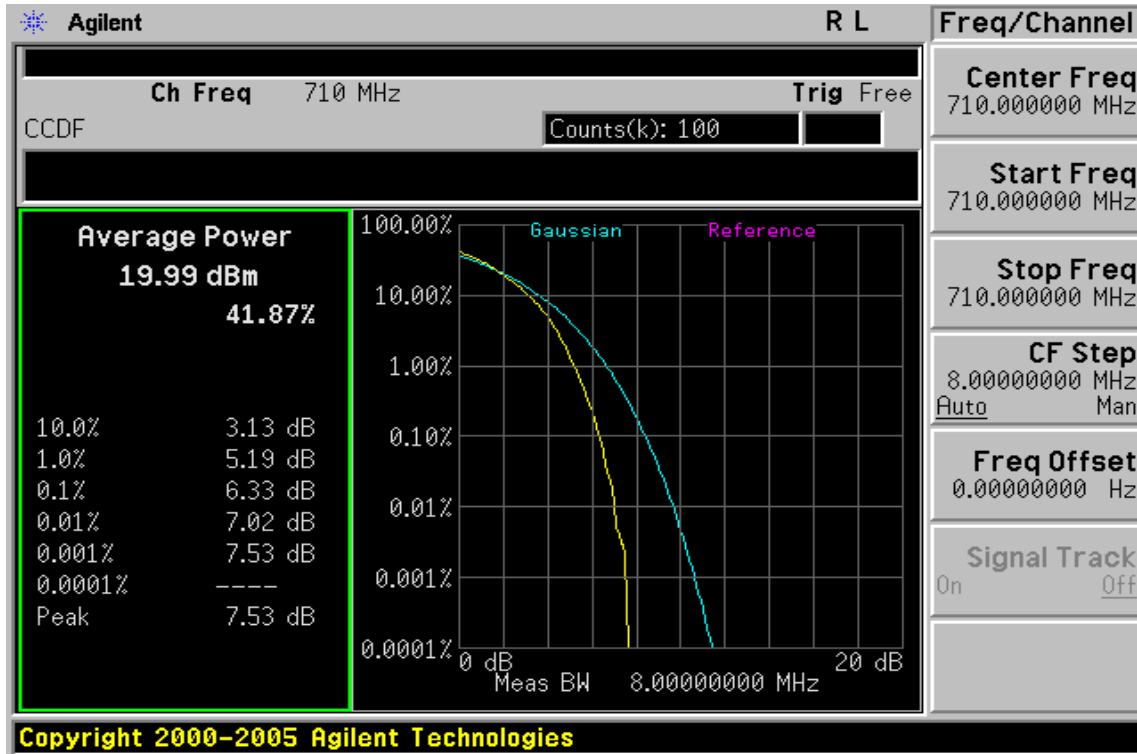

Unless otherwise stated the results shown in this test report refer only to the sample(s) tested and such sample(s) are retained for 90 days only.

除非另有說明，此報告結果僅對測試之樣品負責，同時此樣品僅保留90天。本報告未經本公司書面許可，不可部份複製。

This document is issued by the Company subject to its General Conditions of Service printed overleaf, available on request or accessible at www.sgs.com/terms_and_conditions.htm and, for electronic format documents, subject to Terms and Conditions for Electronic Documents at www.sgs.com/terms_e-document.htm. Attention is drawn to the limitation of liability, indemnification and jurisdiction issues defined therein. Any holder of this document is advised that information contained hereon reflects the Company's findings at the time of its intervention only and within the limits of Client's instructions, if any. The Company's sole responsibility is to its Client and this document does not exonerate parties to a transaction from exercising all their rights and obligations under the transaction documents. This document cannot be reproduced except in full, without prior written approval of the Company. Any unauthorized alteration, forgery or falsification of the content or appearance of this document is unlawful and offenders may be prosecuted to the fullest extent of the law.

SGS Taiwan Ltd.

No.134,WuKungRoad,NewTaipeiIndustrialPark,WukuDistrict,NewTaipeiCity,Taiwan24803/新北市五股區新北產業園區五工路 134 號

台灣檢驗科技股份有限公司

t (886-2) 2299-3279

f (886-2) 2298-0488

www.tw.sgs.com

Member of SGS Group

10MHz BW LTE-Band 17(16QAM Number: 50 Offset: 0) Channel High

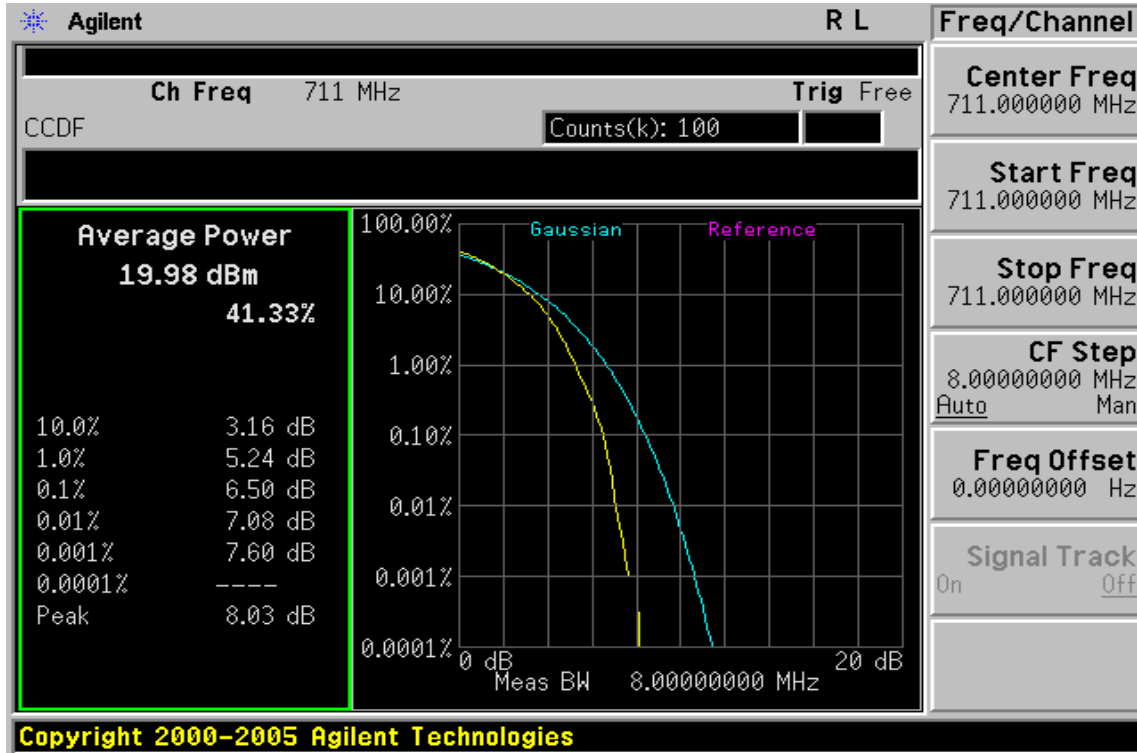

Unless otherwise stated the results shown in this test report refer only to the sample(s) tested and such sample(s) are retained for 90 days only.

除非另有說明，此報告結果僅對測試之樣品負責，同時此樣品僅保留90天。本報告未經本公司書面許可，不可部份複製。

This document is issued by the Company subject to its General Conditions of Service printed overleaf, available on request or accessible at www.sgs.com/terms_and_conditions.htm and, for electronic format documents, subject to Terms and Conditions for Electronic Documents at www.sgs.com/terms_e-document.htm. Attention is drawn to the limitation of liability, indemnification and jurisdiction issues defined therein. Any holder of this document is advised that information contained hereon reflects the Company's findings at the time of its intervention only and within the limits of Client's instructions, if any. The Company's sole responsibility is to its Client and this document does not exonerate parties to a transaction from exercising all their rights and obligations under the transaction documents. This document cannot be reproduced except in full, without prior written approval of the Company. Any unauthorized alteration, forgery or falsification of the content or appearance of this document is unlawful and offenders may be prosecuted to the fullest extent of the law.

SGS Taiwan Ltd.

No.134,WuKungRoad,NewTaipeiIndustrialPark,WukuDistrict,NewTaipeiCity,Taiwan24803/新北市五股區新北產業園區五工路 134 號

台灣檢驗科技股份有限公司

t (886-2) 2299-3279

f (886-2) 2298-0488

www.tw.sgs.com

Member of SGS Group