

# FCC SAR Test Report

APPLICANT : Sony Mobile Communications Inc.  
EQUIPMENT : Smart phone  
BRAND NAME : SONY  
TYPE NAME : PM-0861-BV  
FCC ID : PY7-PM0861  
STANDARD : FCC 47 CFR Part 2 (2.1093)  
ANSI/IEEE C95.1-1992  
IEEE 1528-2003

We, SPORTON INTERNATIONAL INC., would like to declare that the tested sample has been evaluated in accordance with the procedures and had been in compliance with the applicable technical standards.

The test results in this report apply exclusively to the tested model / sample. Without written approval of SPORTON INTERNATIONAL INC., the test report shall not be reproduced except in full.

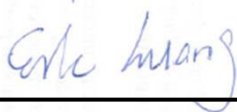

Reviewed by: Eric Huang / Deputy Manager



Approved by: Jones Tsai / Manager



## **SPORTON INTERNATIONAL INC.**

No.52, Hwa Ya 1st Rd., Hwa Ya Technology Park, Kwei-Shan District, Taoyuan City, Taiwan (R.O.C.)



Table of Contents

1. Statement of Compliance ..... 4
2. Administration Data ..... 5
3. Guidance Standard ..... 5
4. Equipment Under Test (EUT) ..... 6
4.1 General Information ..... 6
4.2 Device Serial Number ..... 6
4.3 Maximum Tune-up Limit ..... 7
4.4 General LTE SAR Test and Reporting Considerations ..... 8
5. RF Exposure Limits ..... 9
5.1 Uncontrolled Environment ..... 9
5.2 Controlled Environment ..... 9
6. Specific Absorption Rate (SAR) ..... 10
6.1 Introduction ..... 10
6.2 SAR Definition ..... 10
7. System Description and Setup ..... 11
8. Measurement Procedures ..... 12
8.1 Spatial Peak SAR Evaluation ..... 12
8.2 Power Reference Measurement ..... 13
8.3 Area Scan ..... 13
8.4 Zoom Scan ..... 14
8.5 Volume Scan Procedures ..... 14
8.6 Power Drift Monitoring ..... 14
9. Test Equipment List ..... 15
10. System Verification ..... 16
10.1 Tissue Verification ..... 16
10.2 System Performance Check Results ..... 18
11. RF Exposure Positions ..... 19
11.1 Ear and handset reference point ..... 19
11.2 Definition of the cheek position ..... 20
11.3 Definition of the tilt position ..... 21
11.4 Body Worn Accessory ..... 21
11.5 Wireless Router ..... 22
11.6 Extremity Exposure Configurations ..... 22
12. Conducted RF Output Power (Unit: dBm) ..... 23
13. Bluetooth Exclusions Applied ..... 37
14. Antenna Location ..... 38
15. SAR Test Results ..... 39
15.1 Head SAR ..... 40
15.2 Hotspot SAR ..... 42
15.3 Extremity SAR ..... 44
15.4 Body Worn Accessory SAR ..... 44
15.5 Repeated SAR Measurement ..... 46
16. Simultaneous Transmission Analysis ..... 47
16.1 Head Exposure Conditions ..... 48
16.2 Hotspot Exposure Conditions ..... 50
16.3 Body-Worn Accessory Exposure Conditions ..... 52
17. Uncertainty Assessment ..... 53
18. References ..... 56
Appendix A. Plots of System Performance Check
Appendix B. Plots of High SAR Measurement
Appendix C. DASY Calibration Certificate
Appendix D. Test Setup Photos



### Revision History

REPORT NO.	VERSION	DESCRIPTION	ISSUED DATE
FA4D3144	Rev. 01	Initial issue of report	Mar. 25, 2015



**1. Statement of Compliance**

The maximum results of Specific Absorption Rate (SAR) found during testing for **Sony Mobile Communications Inc., Smart phone, PM-0861-BV**, are as follows.

Equipment Class	Frequency Band	Highest 1g SAR(W/kg) Summary								Highest Simultaneous Transmission 1g SAR (W/kg)
		Head (Separation 0cm)		Body-worn (Separation 1.5cm)		Wireless Router (Separation 1cm)		Extremity (Separation 0mm)		
		Maximum power (dBm)	1g SAR (W/kg)	Maximum power (dBm)	1g SAR (W/kg)	Maximum power (dBm)	1g SAR (W/kg)	Maximum Power (dBm)	10g SAR (W/kg)	
PCE	GSM850(4Tx Slots)	29.00	0.21	29.00	0.43	29.00	0.50			1.20
	GSM1900(4Tx Slots)	25.00	0.11	25.00	0.25	25.00	1.00			
	WCDMA Band V	24.00	0.27	24.00	0.38	24.00	0.41			
	WCDMA Band II	22.50	0.17	22.50	0.36	22.50	<b>1.14</b>			
	LTE Band 5	24.00	0.16	24.00	0.31	24.00	0.38			
	LTE Band 7	22.50	0.25	22.50	<b>0.95</b>	19.00	0.97	22.50	<b>3.17</b>	
DTS	2.4GHz WLAN	17.00	0.94	17.00	0.12	17.00	0.26			1.20
NII	5.2GHz WLAN	14.00	0.53	14.00	0.08	14.00	0.20			1.20
	5.3GHz WLAN	14.00	0.63	14.00	0.09					
	5.5GHz WLAN	14.00	<b>0.95</b>	14.00	0.10					
	5.8GHz WLAN	14.00	0.74	14.00	0.11					
Date of Testing:		2015/01/16~2015/02/14								

Equipment Class	Frequency Band	Highest 10g SAR(W/kg) Summary								Highest Simultaneous Transmission 10g SAR (W/kg)
		Head (Separation 0cm)		Body-worn (Separation 1.5cm)		Wireless Router (Separation 1cm)		Extremity (Separation 0mm)		
		Maximum power (dBm)	10g SAR (W/kg)	Maximum power (dBm)	10g SAR (W/kg)	Maximum power (dBm)	10g SAR (W/kg)	Maximum Power (dBm)	10g SAR (W/kg)	
GSM	GSM850(4Tx Slots)	29.00	0.16	29.00	0.33	29.00	0.39			0.65
	GSM1900(4Tx Slots)	25.00	0.07	25.00	0.14	25.00	0.50			
WCDMA	Band V	24.00	0.20	24.00	0.29	24.00	0.29			0.65
	Band II	22.50	0.10	22.50	0.21	22.50	<b>0.58</b>			
LTE	Band 5	24.00	0.12	24.00	0.24	24.00	0.30			0.65
	Band 7	22.50	0.16	22.50	<b>0.45</b>	19.00	0.42	22.50	<b>3.17</b>	
WLAN	2.4GHz WLAN	17.00	<b>0.49</b>	17.00	0.07	17.00	0.13			0.65
	5.2GHz WLAN	14.00	0.17	14.00	0.02	14.00	0.07			0.58
	5.3GHz WLAN	14.00	0.19	14.00	0.03					
	5.5GHz WLAN	14.00	0.29	14.00	0.04					
	5.8GHz WLAN	14.00	0.23	14.00	0.04					
Date of Testing:		2015/01/16~2015/02/14								

This device is in compliance with Specific Absorption Rate (SAR) for general population/uncontrolled exposure limits (1.6 W/kg and 4.0W/kg) specified in FCC 47 CFR part 2 (2.1093) and ANSI/IEEE C95.1-1992, and had been tested in accordance with the measurement methods and procedures specified in IEEE 1528-2003.



## 2. Administration Data

Testing Laboratory	
Test Site	SPORTON INTERNATIONAL INC.
Test Site Location	No.52, Hwa Ya 1st Rd., Hwa Ya Technology Park, Kwei-Shan District, Taoyuan City, Taiwan (R.O.C.) TEL: +886-3-327-3456 FAX: +886-3-328-4978

Applicant	
Company Name	Sony Mobile Communications Inc.
Address	Nya Vattentornet, 22188 Lund, Sweden

Manufacturer	
Company Name	Arima Communications Corp.
Address	6F,No.866,Jhongjheng Rd., Jhonghe Dist., New Taipei City 23586, Taiwan

## 3. Guidance Standard

The Specific Absorption Rate (SAR) testing specification, method, and procedure for this device is in accordance with the following standards:

- FCC 47 CFR Part 2 (2.1093)
- ANSI/IEEE C95.1-1992
- IEEE 1528-2003
- FCC KDB 865664 D01 SAR Measurement 100 MHz to 6 GHz v01r03
- FCC KDB 865664 D02 SAR Reporting v01r01
- FCC KDB 447498 D01 General RF Exposure Guidance v05r02
- FCC KDB 648474 D04 SAR Evaluation Considerations for Wireless Handsets v01r02
- FCC KDB 248227 D01 SAR meas for 802 11abg v01r02
- FCC KDB 941225 D01 3G SAR Procedures v03
- FCC KDB 941225 D05 SAR for LTE Devices v02r03
- FCC KDB 941225 D06 Hotspot Mode SAR v02

## 4. Equipment Under Test (EUT)

### 4.1 General Information

The equipment under test is a smart phone supporting, GSM850/900/1800/1900, UMTS I / II / V / VIII, LTE Band 1 / 3 / 5 / 7 / 8 / 20, 802.11a/b/g/n, Bluetooth, FM Receiver, NFC and GPS features and below is details of information. For FCC, only wireless modes in US frequency bands are tested.

Product Feature & Specification	
Equipment Name	Smart phone
Brand Name	SONY
Type Name	PM-0861-BV
FCC ID	PY7-PM0861
Wireless Technology and Frequency Range	GSM850: 824.2 MHz ~ 848.8 MHz GSM1900: 1850.2 MHz ~ 1909.8 MHz WCDMA Band V: 826.4 MHz ~ 846.6 MHz WCDMA Band II: 1852.4 MHz ~ 1907.6 MHz LTE Band 5: 824.7 MHz ~ 848.3 MHz LTE Band 7: 2502.5 MHz ~ 2567.5 MHz WLAN 2.4GHz Band: 2412 MHz ~ 2462 MHz WLAN 5.2GHz Band: 5180 MHz ~ 5240 MHz WLAN 5.3GHz Band: 5260 MHz ~ 5320 MHz WLAN 5.5GHz Band: 5500 MHz ~ 5700 MHz WLAN 5.8GHz Band: 5745 MHz ~ 5825 MHz Bluetooth: 2402 MHz ~ 2480 MHz NFC : 13.56 MHz
Mode	<ul style="list-style-type: none"> <li>• GSM/GPRS/EGPRS</li> <li>• RMC/AMR 12.2Kbps</li> <li>• HSDPA</li> <li>• HSUPA</li> <li>• DC-HSDPA</li> <li>• LTE: QPSK, 16QAM</li> <li>• 802.11a/b/g/n HT20/HT40</li> <li>• Bluetooth v3.0+EDR · Bluetooth v4.0-LE</li> <li>• NFC:ASK</li> </ul>
HW Version	A
SW Version	27.1.A.1.11
GSM / (E)GPRS Transfer mode	Class B – EUT cannot support Packet Switched and Circuit Switched Network simultaneously but can automatically switch between Packet and Circuit Switched Network.
EUT Stage	Production Unit
<b>Remark:</b>	
<ol style="list-style-type: none"> <li>1. This device supported VoIP in EGPRS, WCDMA, LTE (e.g. 3rd party VoIP) and supports GRPS/EGPRS mode up to multi-slot class12.</li> <li>2. This device 2.4GHz WLAN supports Hotspot operation, and 2.4GHz / 5.2GHz WLAN supports WiFi Direct (Group Client / Group Owner), and 5.3GHz / 5.5GHz / 5.8GHz supports WiFi Direct (Group Client only).</li> <li>3. When hotspot mode is enabled, power reduction will be activated to limit the maximum power of LTE B7.</li> <li>4. The FCC ID PY7-PM0862 and FCC ID: PY7-PM0861 are similar device, in this report all the test case is referred to PY7-PM0862 and Spot checks for all the frequency band were performed to ensure that the SAR measurements for both devices are the same..</li> </ol>	

### 4.2 Device Serial Number

Sample	Serial Number	IMEI Code
GSM / UTMS SAR measurements	RS4C16D22145	004402453877304
LTE SAR measurements	RS4C16D21856	004402453877221
WLAN SAR measurements	RV4C13D10692	004402453631230
GSM / UTMS SAR measurements	RS4C16D22145	004402453877304
LTE SAR measurements	RS4C16D21856	004402453877221
BT/WLAN Conducted measurements	RV4C13D10724	004402453631198

**Note:** Several samples were used with identical hardware to support SAR testing. The manufacturer has confirmed that the device tested gave the same physical, mechanical and thermal characteristics and are within operational tolerances expected for production units.



**4.3 Maximum Tune-up Limit**

Mode	Burst Average Power (dBm)	
	GSM 850	GSM 1900
GSM (GMSK, 1 Tx slot)	33.00	30.00
GPRS/EDGE (GMSK, 1 Tx slot)	33.00	30.00
GPRS/EDGE (GMSK, 2 Tx slots)	31.00	27.00
GPRS/EDGE (GMSK, 3 Tx slots)	30.00	26.00
GPRS/EDGE (GMSK, 4 Tx slots)	29.00	25.00
EDGE (8PSK, 1 Tx slot)	29.50	26.50
EDGE (8PSK, 2 Tx slots)	28.50	25.50
EDGE (8PSK, 3 Tx slots)	27.50	24.50
EDGE (8PSK, 4 Tx slots)	26.50	23.50

Mode		Average Power (dBm)	
WCDMA	Band V	24.00	
	Band II	22.50	
LTE	Band 5	24.00	
	Band 7	Full power mode	22.50
		Reduced power mode	19.00
Bluetooth v3.0+EDR	1Mbps	7.00	
	2Mbps	5.00	
	3Mbps	5.00	
Bluetooth v4.0+LE		1.00	

Mode		Average Power (dBm)		
2.4GHz WLAN	802.11b	17.00		
	802.11g	15.00		
	802.11n-HT20	11.50		
	802.11n-HT40	11.50		
5GHz WLAN	802.11a	5.2GHz	14.00	
		5.3GHz	14.00	
		5.5GHz	14.00	
		5.8GHz	Ch149	10.00
	Other		14.00	
	802.11n-HT20	5.2GHz	11.50	
		5.3GHz	11.50	
		5.5GHz	11.50	
		5.8GHz	11.50	
	802.11n-HT40	5.2GHz	11.50	
		5.3GHz	Ch62	10.50
			Other	11.50
5.5GHz		11.50		
5.8GHz		Ch151	9.50	
		Other	11.50	

**<Target Power reduction applied for each wireless mode>**

Exposure Position / wireless mode	Hotspot <sup>(1)</sup>
LTE band 7	3.5 dB

**Remark:**

- (1): Reduced maximum limit applied by activation of Hotspot operation
- When hotspot mode is enabled, power reduction will be activated to limit the maximum power of B7.
- Power reduction is not applicable for GSM850/1900, UMTS B2/B5, LTE B5, WLAN and Bluetooth.



**4.4 General LTE SAR Test and Reporting Considerations**

Summarized necessary items addressed in KDB 941225 D05 v02r03																																														
FCC ID	PY7-PM0861																																													
Equipment Name	Smart phone																																													
Operating Frequency Range of each LTE transmission band	LTE Band 5: 824.7 MHz ~ 848.3 MHz LTE Band 7: 2502.5 MHz ~ 2567.5 MHz																																													
Channel Bandwidth	LTE Band 5: 1.4MHz, 3MHz, 5MHz, 10MHz LTE Band 7: 5MHz, 10MHz, 15MHz, 20MHz																																													
Release and Category	Rel8, cat4																																													
uplink modulations used	QPSK, and 16QAM																																													
LTE Voice / Data requirements	Data only																																													
LTE MPR permanently built-in by design	<p align="center"><b>Table 6.2.3-1: Maximum Power Reduction (MPR) for Power Class 3</b></p> <table border="1"> <thead> <tr> <th rowspan="2">Modulation</th> <th colspan="6">Channel bandwidth / Transmission bandwidth (RB)</th> <th rowspan="2">MPR (dB)</th> </tr> <tr> <th>1.4 MHz</th> <th>3.0 MHz</th> <th>5 MHz</th> <th>10 MHz</th> <th>15 MHz</th> <th>20 MHz</th> </tr> </thead> <tbody> <tr> <td>QPSK</td> <td>&gt; 5</td> <td>&gt; 4</td> <td>&gt; 8</td> <td>&gt; 12</td> <td>&gt; 16</td> <td>&gt; 18</td> <td>≤ 1</td> </tr> <tr> <td>16 QAM</td> <td>≤ 5</td> <td>≤ 4</td> <td>≤ 8</td> <td>≤ 12</td> <td>≤ 16</td> <td>≤ 18</td> <td>≤ 1</td> </tr> <tr> <td>16 QAM</td> <td>&gt; 5</td> <td>&gt; 4</td> <td>&gt; 8</td> <td>&gt; 12</td> <td>&gt; 16</td> <td>&gt; 18</td> <td>≤ 2</td> </tr> </tbody> </table>								Modulation	Channel bandwidth / Transmission bandwidth (RB)						MPR (dB)	1.4 MHz	3.0 MHz	5 MHz	10 MHz	15 MHz	20 MHz	QPSK	> 5	> 4	> 8	> 12	> 16	> 18	≤ 1	16 QAM	≤ 5	≤ 4	≤ 8	≤ 12	≤ 16	≤ 18	≤ 1	16 QAM	> 5	> 4	> 8	> 12	> 16	> 18	≤ 2
Modulation	Channel bandwidth / Transmission bandwidth (RB)						MPR (dB)																																							
	1.4 MHz	3.0 MHz	5 MHz	10 MHz	15 MHz	20 MHz																																								
QPSK	> 5	> 4	> 8	> 12	> 16	> 18	≤ 1																																							
16 QAM	≤ 5	≤ 4	≤ 8	≤ 12	≤ 16	≤ 18	≤ 1																																							
16 QAM	> 5	> 4	> 8	> 12	> 16	> 18	≤ 2																																							
LTE A-MPR	In the base station simulator configuration, Network Setting value is set to NS_01 to disable A-MPR during SAR testing and the LTE SAR tests was transmitting on all TTI frames (Maximum TTI)																																													
Spectrum plots for RB configuration	A properly configured base station simulator was used for the SAR and power measurement; therefore, spectrum plots for each RB allocation and offset configuration are not included in the SAR report.																																													
Power reduction applied to satisfy SAR compliance	Yes, When operating in hotspot mode that LTE band7 power reduction applied to satisfy SAR compliance.																																													
Transmission (H, M, L) channel numbers and frequencies in each LTE band																																														
LTE Band 5																																														
	Bandwidth 1.4 MHz		Bandwidth 3 MHz		Bandwidth 5 MHz		Bandwidth 10 MHz																																							
	Ch. #	Freq. (MHz)	Ch. #	Freq. (MHz)	Ch. #	Freq. (MHz)	Ch. #	Freq. (MHz)																																						
L	20407	824.7	20415	825.5	20425	826.5	20450	829																																						
M	20525	836.5	20525	836.5	20525	836.5	20525	836.5																																						
H	20643	848.3	20635	847.5	20625	846.5	20600	844																																						
LTE Band 7																																														
	Bandwidth 5 MHz		Bandwidth 10 MHz		Bandwidth 15 MHz		Bandwidth 20 MHz																																							
	Ch. #	Freq. (MHz)	Ch. #	Freq. (MHz)	Ch. #	Freq. (MHz)	Ch. #	Freq. (MHz)																																						
L	20775	2502.5	20800	2505	20825	2507.5	20850	2510																																						
M	21100	2535	21100	2535	21100	2535	21100	2535																																						
H	21425	2567.5	21400	2565	21375	2562.5	21350	2560																																						





**5. RF Exposure Limits**

**5.1 Uncontrolled Environment**

Uncontrolled Environments are defined as locations where there is the exposure of individuals who have no knowledge or control of their exposure. The general population/uncontrolled exposure limits are applicable to situations in which the general public may be exposed or in which persons who are exposed as a consequence of their employment may not be made fully aware of the potential for exposure or cannot exercise control over their exposure. Members of the general public would come under this category when exposure is not employment-related; for example, in the case of a wireless transmitter that exposes persons in its vicinity.

**5.2 Controlled Environment**

Controlled Environments are defined as locations where there is exposure that may be incurred by persons who are aware of the potential for exposure, (i.e. as a result of employment or occupation). In general, occupational/controlled exposure limits are applicable to situations in which persons are exposed as a consequence of their employment, who have been made fully aware of the potential for exposure and can exercise control over their exposure. The exposure category is also applicable when the exposure is of a transient nature due to incidental passage through a location where the exposure levels may be higher than the general population/uncontrolled limits, but the exposed person is fully aware of the potential for exposure and can exercise control over his or her exposure by leaving the area or by some other appropriate means.

**Limits for Occupational/Controlled Exposure (W/kg)**

Whole-Body	Partial-Body	Hands, Wrists, Feet and Ankles
0.4	8.0	20.0

**Limits for General Population/Uncontrolled Exposure (W/kg)**

Whole-Body	Partial-Body	Hands, Wrists, Feet and Ankles
0.08	1.6	4.0

1. Whole-Body SAR is averaged over the entire body, partial-body SAR is averaged over any 1gram of tissue defined as a tissue volume in the shape of a cube. SAR for hands, wrists, feet and ankles is averaged over any 10 grams of tissue defined as a tissue volume in the shape of a cube.

## **6. Specific Absorption Rate (SAR)**

### **6.1 Introduction**

SAR is related to the rate at which energy is absorbed per unit mass in an object exposed to a radio field. The SAR distribution in a biological body is complicated and is usually carried out by experimental techniques or numerical modeling. The standard recommends limits for two tiers of groups, occupational/controlled and general population/uncontrolled, based on a person's awareness and ability to exercise control over his or her exposure. In general, occupational/controlled exposure limits are higher than the limits for general population/uncontrolled.

### **6.2 SAR Definition**

The SAR definition is the time derivative (rate) of the incremental energy (dW) absorbed by (dissipated in) an incremental mass (dm) contained in a volume element (dv) of a given density ( $\rho$ ). The equation description is as below:

$$SAR = \frac{d}{dt} \left( \frac{dW}{dm} \right) = \frac{d}{dt} \left( \frac{dW}{\rho dv} \right)$$

SAR is expressed in units of Watts per kilogram (W/kg)

$$SAR = \frac{\sigma |E|^2}{\rho}$$

Where:  $\sigma$  is the conductivity of the tissue,  $\rho$  is the mass density of the tissue and E is the RMS electrical field strength.

## 7. System Description and Setup

The DASY system used for performing compliance tests consists of the following items:

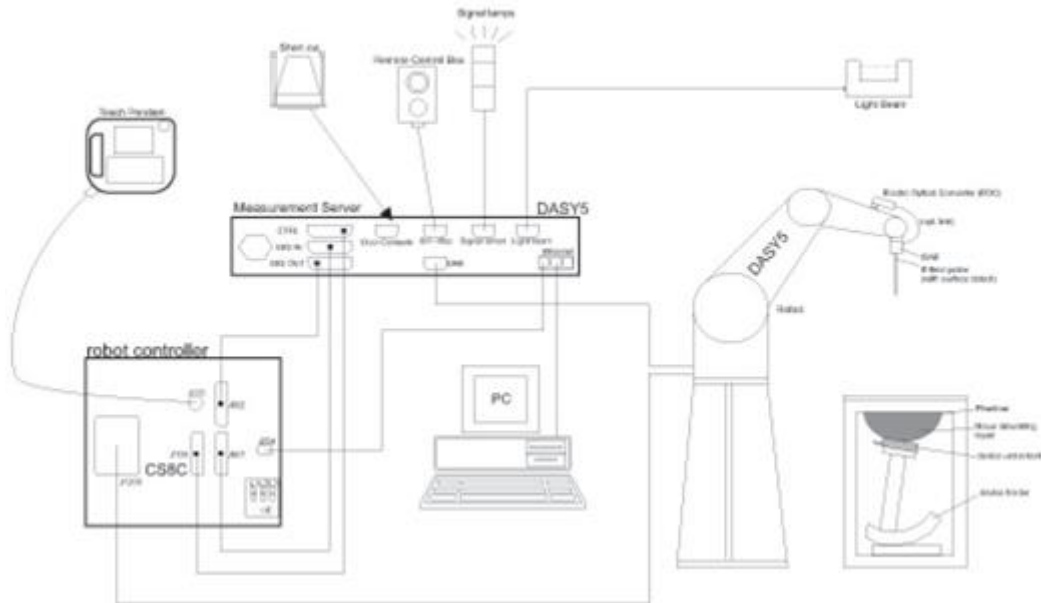

- A standard high precision 6-axis robot with controller, teach pendant and software. An arm extension for accommodating the data acquisition electronics (DAE).
- An isotropic Field probe optimized and calibrated for the targeted measurement.
- A data acquisition electronics (DAE) which performs the signal amplification, signal multiplexing, AD-conversion, offset measurements, mechanical surface detection, collision detection, etc. The unit is battery powered with standard or rechargeable batteries. The signal is optically transmitted to the EOC.
- The Electro-optical converter (EOC) performs the conversion from optical to electrical signals for the digital communication to the DAE. To use optical surface detection, a special version of the EOC is required. The EOC signal is transmitted to the measurement server.
- The function of the measurement server is to perform the time critical tasks such as signal filtering, control of the robot operation and fast movement interrupts.
- The Light Beam used is for probe alignment. This improves the (absolute) accuracy of the probe positioning.
- A computer running WinXP or Win7 and the DASY5 software.
- Remote control and teach pendant as well as additional circuitry for robot safety such as warning lamps, etc.
- The phantom, the device holder and other accessories according to the targeted measurement.

## **8. Measurement Procedures**

The measurement procedures are as follows:

### <Conducted power measurement>

- (a) For WWAN power measurement, use base station simulator to configure EUT WWAN transmission in conducted connection with RF cable, at maximum power in each supported wireless interface and frequency band.
- (b) Read the WWAN RF power level from the base station simulator.
- (c) For WLAN/BT power measurement, use engineering software to configure EUT WLAN/BT continuously transmission, at maximum RF power in each supported wireless interface and frequency band
- (d) Connect EUT RF port through RF cable to the power meter, and measure WLAN/BT output power

### <SAR measurement>

- (a) Use base station simulator to configure EUT WWAN transmission in radiated connection, and engineering software to configure EUT WLAN/BT continuously transmission, at maximum RF power, in the highest power channel.
- (b) Place the EUT in the positions as Appendix D demonstrates.
- (c) Set scan area, grid size and other setting on the DASY software.
- (d) Measure SAR results for the highest power channel on each testing position.
- (e) Find out the largest SAR result on these testing positions of each band
- (f) Measure SAR results for other channels in worst SAR testing position if the reported SAR of highest power channel is larger than 0.8 W/kg

According to the test standard, the recommended procedure for assessing the peak spatial-average SAR value consists of the following steps:

- (a) Power reference measurement
- (b) Area scan
- (c) Zoom scan
- (d) Power drift measurement

### **8.1 Spatial Peak SAR Evaluation**

The procedure for spatial peak SAR evaluation has been implemented according to the test standard. It can be conducted for 1g and 10g, as well as for user-specific masses. The DASY software includes all numerical procedures necessary to evaluate the spatial peak SAR value.

The base for the evaluation is a "cube" measurement. The measured volume must include the 1g and 10g cubes with the highest averaged SAR values. For that purpose, the center of the measured volume is aligned to the interpolated peak SAR value of a previously performed area scan.

The entire evaluation of the spatial peak values is performed within the post-processing engine (SEMCAD). The system always gives the maximum values for the 1g and 10g cubes. The algorithm to find the cube with highest averaged SAR is divided into the following stages:

- (a) Extraction of the measured data (grid and values) from the Zoom Scan
- (b) Calculation of the SAR value at every measurement point based on all stored data (A/D values and measurement parameters)
- (c) Generation of a high-resolution mesh within the measured volume
- (d) Interpolation of all measured values from the measurement grid to the high-resolution grid
- (e) Extrapolation of the entire 3-D field distribution to the phantom surface over the distance from sensor to surface
- (f) Calculation of the averaged SAR within masses of 1g and 10g

**8.2 Power Reference Measurement**

The Power Reference Measurement and Power Drift Measurements are for monitoring the power drift of the device under test in the batch process. The minimum distance of probe sensors to surface determines the closest measurement point to phantom surface. This distance cannot be smaller than the distance of sensor calibration points to probe tip as defined in the probe properties.

**8.3 Area Scan**

The area scan is used as a fast scan in two dimensions to find the area of high field values, before doing a fine measurement around the hot spot. The sophisticated interpolation routines implemented in DASY software can find the maximum found in the scanned area, within a range of the global maximum. The range (in dB0 is specified in the standards for compliance testing. For example, a 2 dB range is required in IEEE standard 1528 and IEC 62209 standards, whereby 3 dB is a requirement when compliance is assessed in accordance with the ARIB standard (Japan), if only one zoom scan follows the area scan, then only the absolute maximum will be taken as reference. For cases where multiple maximums are detected, the number of zoom scans has to be increased accordingly.

Area scan parameters extracted from FCC KDB 865664 D01v01r03 SAR measurement 100 MHz to 6 GHz.

	≤ 3 GHz	> 3 GHz
Maximum distance from closest measurement point (geometric center of probe sensors) to phantom surface	5 ± 1 mm	$\frac{1}{2} \cdot \delta \cdot \ln(2) \pm 0.5$ mm
Maximum probe angle from probe axis to phantom surface normal at the measurement location	30° ± 1°	20° ± 1°
Maximum area scan spatial resolution: $\Delta x_{Area}, \Delta y_{Area}$	≤ 2 GHz: ≤ 15 mm 2 – 3 GHz: ≤ 12 mm	3 – 4 GHz: ≤ 12 mm 4 – 6 GHz: ≤ 10 mm
	When the x or y dimension of the test device, in the measurement plane orientation, is smaller than the above, the measurement resolution must be ≤ the corresponding x or y dimension of the test device with at least one measurement point on the test device.	

### 8.4 Zoom Scan

Zoom scans are used assess the peak spatial SAR values within a cubic averaging volume containing 1 gram and 10 gram of simulated tissue. The zoom scan measures points (refer to table below) within a cube shoes base faces are centered on the maxima found in a preceding area scan job within the same procedure. When the measurement is done, the zoom scan evaluates the averaged SAR for 1 gram and 10 gram and displays these values next to the job's label.

Zoom scan parameters extracted from FCC KDB 865664 D01v01r03 SAR measurement 100 MHz to 6 GHz.

		≤ 3 GHz	> 3 GHz	
Maximum zoom scan spatial resolution: $\Delta x_{Zoom}, \Delta y_{Zoom}$		$\leq 2$ GHz: $\leq 8$ mm 2 – 3 GHz: $\leq 5$ mm*	3 – 4 GHz: $\leq 5$ mm* 4 – 6 GHz: $\leq 4$ mm*	
Maximum zoom scan spatial resolution, normal to phantom surface	uniform grid: $\Delta z_{Zoom}(n)$	$\leq 5$ mm	3 – 4 GHz: $\leq 4$ mm 4 – 5 GHz: $\leq 3$ mm 5 – 6 GHz: $\leq 2$ mm	
	graded grid	$\Delta z_{Zoom}(1)$ : between 1 <sup>st</sup> two points closest to phantom surface	$\leq 4$ mm	3 – 4 GHz: $\leq 3$ mm 4 – 5 GHz: $\leq 2.5$ mm 5 – 6 GHz: $\leq 2$ mm
		$\Delta z_{Zoom}(n>1)$ : between subsequent points	$\leq 1.5 \cdot \Delta z_{Zoom}(n-1)$	
Minimum zoom scan volume	x, y, z	$\geq 30$ mm	3 – 4 GHz: $\geq 28$ mm 4 – 5 GHz: $\geq 25$ mm 5 – 6 GHz: $\geq 22$ mm	
Note: $\delta$ is the penetration depth of a plane-wave at normal incidence to the tissue medium; see draft standard IEEE P1528-2011 for details. * When zoom scan is required and the <i>reported</i> SAR from the <i>area scan based 1-g SAR estimation</i> procedures of KDB 447498 is $\leq 1.4$ W/kg, $\leq 8$ mm, $\leq 7$ mm and $\leq 5$ mm zoom scan resolution may be applied, respectively, for 2 GHz to 3 GHz, 3 GHz to 4 GHz and 4 GHz to 6 GHz.				

### 8.5 Volume Scan Procedures

The volume scan is used for assess overlapping SAR distributions for antennas transmitting in different frequency bands. It is equivalent to an oversized zoom scan used in standalone measurements. The measurement volume will be used to enclose all the simultaneous transmitting antennas. For antennas transmitting simultaneously in different frequency bands, the volume scan is measured separately in each frequency band. In order to sum correctly to compute the 1g aggregate SAR, the EUT remain in the same test position for all measurements and all volume scan use the same spatial resolution and grid spacing. When all volume scan were completed, the software, SEMCAD postprocessor can combine and subsequently superpose these measurement data to calculating the multiband SAR.

### 8.6 Power Drift Monitoring

All SAR testing is under the EUT install full charged battery and transmit maximum output power. In DASYS measurement software, the power reference measurement and power drift measurement procedures are used for monitoring the power drift of EUT during SAR test. Both these procedures measure the field at a specified reference position before and after the SAR testing. The software will calculate the field difference in dB. If the power drifts more than 5%, the SAR will be retested.



**9. Test Equipment List**

Manufacturer	Name of Equipment	Type/Model	Serial Number	Calibration	
				Last Cal.	Due Date
SPEAG	835MHz System Validation Kit	D835V2	4d162	Nov. 19, 2014	Nov. 18, 2015
SPEAG	1900MHz System Validation Kit	D1900V2	5d182	Nov. 14, 2014	Nov. 13, 2015
SPEAG	2450MHz System Validation Kit	D2450V2	924	Nov. 19, 2014	Nov. 18, 2015
SPEAG	2600MHz System Validation Kit	D2600V2	1070	Nov. 19, 2014	Nov. 18, 2015
SPEAG	5GHz System Validation Kit	D5GHzV2	1006	Sep. 25, 2014	Sep. 24, 2015
SPEAG	Data Acquisition Electronics	DAE4	778	Aug. 21, 2014	Aug. 20, 2015
SPEAG	Data Acquisition Electronics	DAE3	577	Oct. 06, 2014	Oct. 05, 2015
SPEAG	Data Acquisition Electronics	DAE3	495	May. 19, 2014	May. 18, 2015
SPEAG	Data Acquisition Electronics	DAE4	1399	Nov. 13, 2014	Nov. 12, 2015
SPEAG	Dosimetric E-Field Probe	ES3DV3	3270	Sep. 26, 2014	Sep. 25, 2015
SPEAG	Dosimetric E-Field Probe	EX3DV4	3931	Sep. 25, 2014	Sep. 24, 2015
SPEAG	Dosimetric E-Field Probe	EX3DV4	3925	May. 22, 2014	May. 21, 2015
SPEAG	Dosimetric E-Field Probe	EX3DV4	3955	Nov. 21, 2014	Nov. 20, 2015
Wisewind	Thermometer	HTC-1	TM642	Oct. 21, 2014	Oct. 20, 2015
Wisewind	Thermometer	HTC-1	TM281	Oct. 21, 2014	Oct. 20, 2015
H.M.IRIS	Thermometer	TH-08	TM658	Oct. 21, 2014	Oct. 20, 2015
WonDer	Thermometer	WD-5015	TM225	Oct. 21, 2014	Oct. 20, 2015
Anritsu	Radio Communication Analyzer	MT8820C	6201074414	Feb. 11, 2014	Feb. 10, 2015
Anritsu	Radio Communication Analyzer	MT8820C	6201381760	May. 28, 2014	May. 27, 2015
Agilent	Wireless Communication Test Set	E5515C	MY50266977	May. 27, 2014	May. 26, 2015
SPEAG	Device Holder	N/A	N/A	NCR	NCR
R&S	Signal Generator	SMU200A	102502	Jul. 07, 2014	Jul. 06, 2015
SPEAG	Dielectric Probe Kit	DAKS-3.5	0004	Mar. 04, 2014	Mar. 03, 2015
SPEAG	Dielectric Probe Kit	DAK-3.5	1138	Nov. 18, 2014	Nov. 17, 2015
Agilent	ENA Network Analyzer	E5071C	MY46101588	May. 31, 2014	May. 30, 2015
Anritsu	Power Meter	ML2495A	1036004	Aug. 09, 2014	Aug. 08, 2015
Anritsu	Power Sensor	MA2411B	1027253	Aug. 11, 2014	Aug. 10, 2015
Anritsu	Power Meter	ML2495A	1349001	Dec. 03, 2014	Dec. 02, 2015
Anritsu	Power Sensor	MA2411B	1306099	Dec. 03, 2014	Dec. 02, 2015
R&S	Spectrum Analyzer	FSP 7	101131	Jul. 10, 2014	Jul. 09, 2015
R&S	Spectrum Analyzer	FSP 30	101329	Jun. 14, 2014	Jun. 13, 2015
Agilent	Dual Directional Coupler	778D	50422	Note1	
Woken	Attenuator 1	WK0602-XX	N/A	Note1	
PE	Attenuator 2	PE7005-10	N/A	Note1	
PE	Attenuator 3	PE7005- 3	N/A	Note1	
AR	Power Amplifier	5S1G4M2	0328767	Note1	
Mini-Circuits	Power Amplifier	ZVE-3W	162601250	Note1	
Mini-Circuits	Power Amplifier	ZHL-42W+	13440021344	Note1	

**General Note:**

1. Prior to system verification and validation, the path loss from the signal generator to the system check source and the power meter, which includes the amplifier, cable, attenuator and directional coupler, was measured by the network analyzer. The reading of the power meter was offset by the path loss difference between the path to the power meter and the path to the system check source to monitor the actual power level fed to the system check source.





**10. System Verification**

**10.1 Tissue Verification**

The following tissue formulations are provided for reference only as some of the parameters have not been thoroughly verified. The composition of ingredients may be modified accordingly to achieve the desired target tissue parameters required for routine SAR evaluation.

Frequency (MHz)	Water (%)	Sugar (%)	Cellulose (%)	Salt (%)	Preventol (%)	DGBE (%)	Conductivity (σ)	Permittivity (εr)
<b>For Head</b>								
750	41.1	57.0	0.2	1.4	0.2	0	0.89	41.9
835	40.3	57.9	0.2	1.4	0.2	0	0.90	41.5
900	40.3	57.9	0.2	1.4	0.2	0	0.97	41.5
1800, 1900, 2000	55.2	0	0	0.3	0	44.5	1.40	40.0
2450	55.0	0	0	0	0	45.0	1.80	39.2
2600	54.8	0	0	0.1	0	45.1	1.96	39.0
<b>For Body</b>								
750	51.7	47.2	0	0.9	0.1	0	0.96	55.5
835	50.8	48.2	0	0.9	0.1	0	0.97	55.2
900	50.8	48.2	0	0.9	0.1	0	1.05	55.0
1800, 1900, 2000	70.2	0	0	0.4	0	29.4	1.52	53.3
2450	68.6	0	0	0	0	31.4	1.95	52.7
2600	68.1	0	0	0.1	0	31.8	2.16	52.5

**Simulating Liquid for 5GHz, Manufactured by SPEAG**

Ingredients	(% by weight)
Water	64~78%
Mineral oil	11~18%
Emulsifiers	9~15%
Additives and Salt	2~3%





<Tissue Dielectric Parameter Check Results>

Frequency (MHz)	Tissue Type	Liquid Temp. (°C)	Conductivity (σ)	Permittivity (ε <sub>r</sub> )	Conductivity Target (σ)	Permittivity Target (ε <sub>r</sub> )	Delta (σ) (%)	Delta (ε <sub>r</sub> ) (%)	Limit (%)	Date
835	HSL	22.6	0.917	42.982	0.90	41.50	1.89	3.57	±5	2015/2/6
835	HSL	22.4	0.906	42.966	0.90	41.50	0.67	3.53	±5	2015/2/8
835	MSL	22.3	0.978	55.347	0.97	55.20	0.82	0.27	±5	2015/2/4
835	MSL	22.3	0.981	55.046	0.97	55.20	1.13	-0.28	±5	2015/2/7
1900	HSL	22.4	1.423	40.469	1.40	40.00	1.64	1.17	±5	2015/2/7
1900	MSL	22.4	1.549	53.703	1.52	53.30	1.91	0.76	±5	2015/1/30
1900	MSL	22.5	1.542	53.854	1.52	53.30	1.45	1.04	±5	2015/1/31
2450	HSL	22.7	1.862	38.858	1.80	39.20	3.44	-0.87	±5	2015/2/14
2450	MSL	22.7	2.015	51.798	1.95	52.70	3.33	-1.71	±5	2015/2/14
2600	HSL	22.4	2.050	38.055	1.96	39.00	4.59	-2.42	±5	2015/2/8
2600	MSL	22.5	2.234	52.385	2.16	52.50	3.43	-0.22	±5	2015/1/31
5200	HSL	22.3	4.811	35.433	4.66	36.00	3.24	-1.58	±5	2015/1/16
5200	MSL	22.6	5.293	47.772	5.30	49.00	-0.13	-2.51	±5	2015/1/19
5300	HSL	22.3	4.920	35.303	4.76	35.90	3.36	-1.66	±5	2015/1/16
5300	MSL	22.6	5.456	47.596	5.42	48.90	0.66	-2.67	±5	2015/1/19
5600	HSL	22.3	5.230	34.700	5.07	35.50	3.16	-2.25	±5	2015/1/16
5600	MSL	22.6	5.832	46.940	5.77	48.50	1.07	-3.22	±5	2015/1/19
5800	HSL	22.2	5.419	34.318	5.27	35.30	2.83	-2.78	±5	2015/1/18
5800	MSL	22.6	6.042	46.738	6.00	48.20	0.70	-3.03	±5	2015/1/19

**10.2 System Performance Check Results**

Comparing to the original SAR value provided by SPEAG, the verification data should be within its specification of 10 %. Below table shows the target SAR and measured SAR after normalized to 1W input power. The table below indicates the system performance check can meet the variation criterion and the plots can be referred to Appendix A of this report.

**<System Verification 1g SAR Results>**

Date	Frequency (MHz)	Tissue Type	Input Power (mW)	Dipole S/N	Probe S/N	DAE S/N	Measured 1g SAR (W/kg)	Targeted 1g SAR (W/kg)	Normalized 1g SAR (W/kg)	Deviation (%)
2015/2/6	835	HSL	250	D835V2-4d162	EX3DV4 - SN3955	DAE4 Sn1399	2.47	9.15	9.88	7.98
2015/2/8	835	HSL	250	D835V2-4d162	EX3DV4 - SN3955	DAE4 Sn1399	2.36	9.15	9.44	3.17
2015/2/4	835	MSL	250	D835V2-4d162	EX3DV4 - SN3955	DAE4 Sn1399	2.57	9.56	10.28	7.53
2015/2/7	835	MSL	250	D835V2-4d162	EX3DV4 - SN3955	DAE4 Sn1399	2.45	9.56	9.80	2.51
2015/2/7	1900	HSL	250	D1900V2-5d182	EX3DV4 - SN3955	DAE4 Sn1399	9.70	39.80	38.80	-2.51
2015/1/30	1900	MSL	250	D1900V2-5d182	ES3DV3 - SN3270	DAE4 Sn778	10.00	40.00	40.00	0.00
2015/1/31	1900	MSL	250	D1900V2-5d182	EX3DV4 - SN3955	DAE4 Sn1399	10.10	40.00	40.40	1.00
2015/2/14	2450	HSL	250	D2450V2-924	EX3DV4 - SN3931	DAE3 Sn577	13.10	51.90	52.40	0.96
2015/2/14	2450	MSL	250	D2450V2-924	EX3DV4 - SN3931	DAE3 Sn577	13.00	51.40	52.00	1.17
2015/2/8	2600	HSL	250	D2600V2-1070	EX3DV4 - SN3955	DAE4 Sn1399	15.00	56.90	60.00	5.45
2015/1/31	2600	MSL	250	D2600V2-1070	EX3DV4 - SN3955	DAE4 Sn1399	13.80	55.30	55.20	-0.18
2015/1/16	5200	HSL	100	D5GHzV2-1006	EX3DV4 - SN3925	DAE3 Sn495	8.40	81.10	84.00	3.58
2015/1/19	5200	MSL	100	D5GHzV2-1006	EX3DV4 - SN3925	DAE3 Sn495	7.46	77.50	74.60	-3.74
2015/1/16	5300	HSL	100	D5GHzV2-1006	EX3DV4 - SN3925	DAE3 Sn495	8.24	86.60	82.40	-4.85
2015/1/19	5300	MSL	100	D5GHzV2-1006	EX3DV4 - SN3925	DAE3 Sn495	7.91	80.00	79.10	-1.13
2015/1/16	5600	HSL	100	D5GHzV2-1006	EX3DV4 - SN3925	DAE3 Sn495	9.00	85.80	90.00	4.90
2015/1/19	5600	MSL	100	D5GHzV2-1006	EX3DV4 - SN3925	DAE3 Sn495	8.56	85.20	85.60	0.47
2015/1/18	5800	HSL	100	D5GHzV2-1006	EX3DV4 - SN3925	DAE3 Sn495	8.62	82.90	86.20	3.98
2015/1/19	5800	MSL	100	D5GHzV2-1006	EX3DV4 - SN3925	DAE3 Sn495	8.16	78.40	81.60	4.08

**<System Verification 10g SAR Results>**

Date	Frequency (MHz)	Tissue Type	Input Power (mW)	Dipole S/N	Probe S/N	DAE S/N	Measured 10g SAR (W/kg)	Targeted 10g SAR (W/kg)	Normalized 10g SAR (W/kg)	Deviation (%)
2015/1/31	2600	MSL	250	D2600V2-1070	EX3DV4 - SN3955	DAE4 Sn1399	6.10	24.50	24.40	-0.41

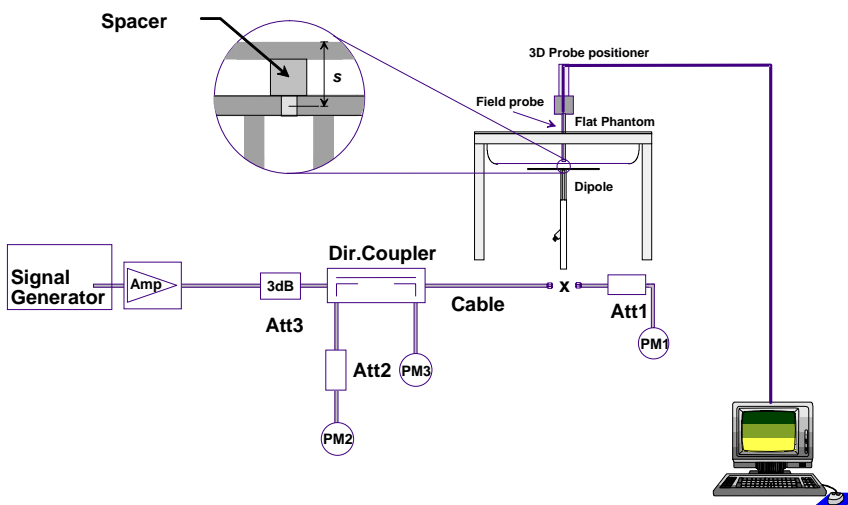

**Fig 8.3.1 System Performance Check Setup**



**Fig 8.3.2 Setup Photo**

## 11. RF Exposure Positions

### 11.1 Ear and handset reference point

Figure 9.1.1 shows the front, back, and side views of the SAM phantom. The center-of-mouth reference point is labeled "M," the left ear reference point (ERP) is marked "LE," and the right ERP is marked "RE." Each ERP is 15 mm along the B-M (back-mouth) line behind the entrance-to-ear-canal (EEC) point, as shown in Figure 9.1.2 The Reference Plane is defined as passing through the two ear reference points and point M. The line N-F (neck-front), also called the reference pivoting line, is normal to the Reference Plane and perpendicular to both a line passing through RE and LE and the B-M line (see Figure 9.1.3). Both N-F and B-M lines should be marked on the exterior of the phantom shell to facilitate handset positioning. Posterior to the N-F line the ear shape is a flat surface with 6 mm thickness at each ERP, and forward of the N-F line the ear is truncated, as illustrated in Figure 9.1.2. The ear truncation is introduced to preclude the ear lobe from interfering with handset tilt, which could lead to unstable positioning at the cheek.

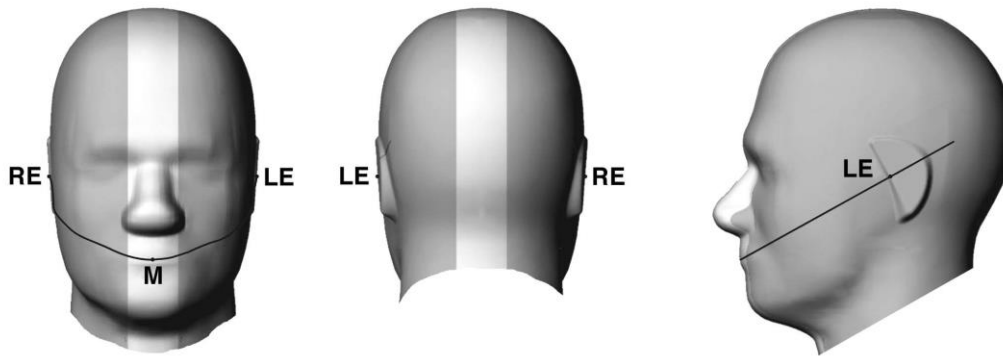

Fig 9.1.1 Front, back, and side views of SAM twin phantom

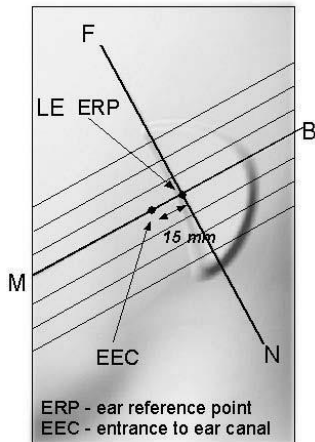

Fig 9.1.2 Close-up side view of phantom showing the ear region.

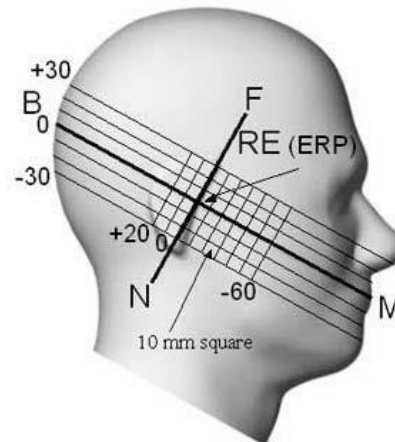
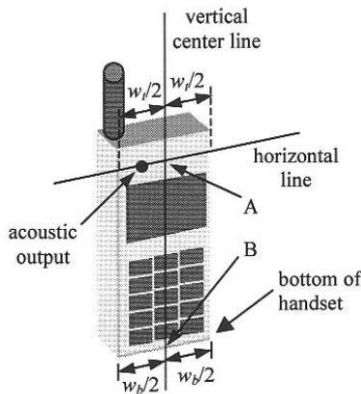

Fig 9.1.3 Side view of the phantom showing relevant markings and seven cross-sectional plane locations

**11.2 Definition of the cheek position**

1. Ready the handset for talk operation, if necessary. For example, for handsets with a cover piece (flip cover), open the cover. If the handset can transmit with the cover closed, both configurations must be tested.
2. Define two imaginary lines on the handset—the vertical centerline and the horizontal line. The vertical centerline passes through two points on the front side of the handset—the midpoint of the width  $w_t$  of the handset at the level of the acoustic output (point A in Figure 9.2.1 and Figure 9.2.2), and the midpoint of the width  $w_b$  of the bottom of the handset (point B). The horizontal line is perpendicular to the vertical centerline and passes through the center of the acoustic output (see Figure 9.2.1). The two lines intersect at point A. Note that for many handsets, point A coincides with the center of the acoustic output; however, the acoustic output may be located elsewhere on the horizontal line. Also note that the vertical centerline is not necessarily parallel to the front face of the handset (see Figure 9.2.2), especially for clamshell handsets, handsets with flip covers, and other irregularly-shaped handsets.
3. Position the handset close to the surface of the phantom such that point A is on the (virtual) extension of the line passing through points RE and LE on the phantom (see Figure 9.2.3), such that the plane defined by the vertical centerline and the horizontal line of the handset is approximately parallel to the sagittal plane of the phantom.
4. Translate the handset towards the phantom along the line passing through RE and LE until handset point A touches the pinna at the ERP.
5. While maintaining the handset in this plane, rotate it around the LE-RE line until the vertical centerline is in the plane normal to the plane containing B-M and N-F lines, i.e., the Reference Plane.
6. Rotate the handset around the vertical centerline until the handset (horizontal line) is parallel to the N-F line.
7. While maintaining the vertical centerline in the Reference Plane, keeping point A on the line passing through RE and LE, and maintaining the handset contact with the pinna, rotate the handset about the N-F line until any point on the handset is in contact with a phantom point below the pinna on the cheek. See Figure 9.2.3. The actual rotation angles should be documented in the test report.



**Fig 9.2.1 Handset vertical and horizontal reference lines—“fixed case”**

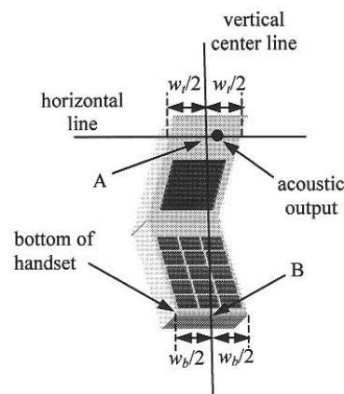

**Fig 9.2.2 Handset vertical and horizontal reference lines—“clam-shell case”**

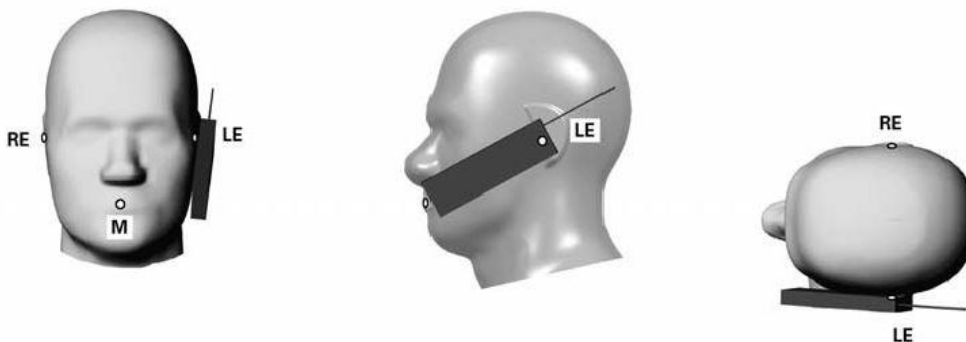

**Fig 9.2.3 cheek or touch position. The reference points for the right ear (RE), left ear (LE), and mouth (M), which establish the Reference Plane for handset positioning, are indicated.**

**11.3 Definition of the tilt position**

1. Ready the handset for talk operation, if necessary. For example, for handsets with a cover piece (flip cover), open the cover. If the handset can transmit with the cover closed, both configurations must be tested.
2. While maintaining the orientation of the handset, move the handset away from the pinna along the line passing through RE and LE far enough to allow a rotation of the handset away from the cheek by 15°.
3. Rotate the handset around the horizontal line by 15°.
4. While maintaining the orientation of the handset, move the handset towards the phantom on the line passing through RE and LE until any part of the handset touches the ear. The tilt position is obtained when the contact point is on the pinna. See Figure 9.3.1. If contact occurs at any location other than the pinna, e.g., the antenna at the back of the phantom head, the angle of the handset should be reduced. In this case, the tilt position is obtained if any point on the handset is in contact with the pinna and a second point

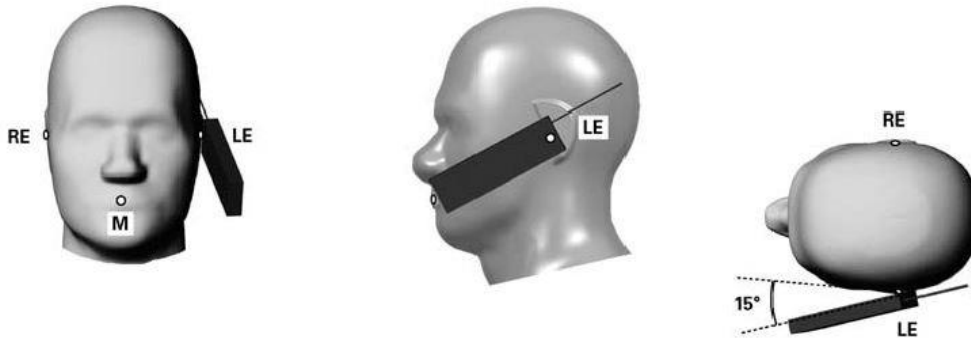
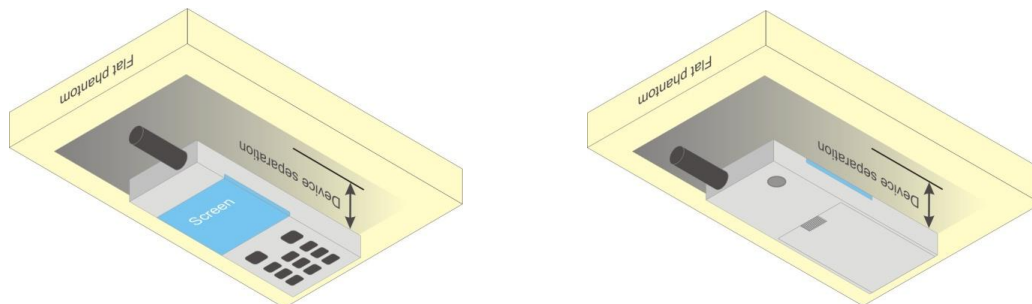

**Fig 9.3.1 Tilt position. The reference points for the right ear (RE), left ear (LE), and mouth (M), which define the Reference Plane for handset positioning, are indicated.**

**11.4 Body Worn Accessory**

Body-worn operating configurations are tested with the belt-clips and holsters attached to the device and positioned against a flat phantom in a normal use configuration (see Figure 9.4). Per KDB 648474 D04v01r02, body-worn accessory exposure is typically related to voice mode operations when handsets are carried in body-worn accessories. The body-worn accessory procedures in FCC KDB 447498 D01v05r02 should be used to test for body-worn accessory SAR compliance, without a headset connected to it. This enables the test results for such configuration to be compatible with that required for hotspot mode when the body-worn accessory test separation distance is greater than or equal to that required for hotspot mode, when applicable. When the reported SAR for body-worn accessory, measured without a headset connected to the handset is < 1.2 W/kg, the highest reported SAR configuration for that wireless mode and frequency band should be repeated for that body-worn accessory with a handset attached to the handset.

Accessories for body-worn operation configurations are divided into two categories: those that do not contain metallic components and those that do contain metallic components and those that do contain metallic components. When multiple accessories that do not contain metallic components are supplied with the device, the device is tested with only the accessory that dictates the closest spacing to the body. Then multiple accessories that contain metallic components are test with the device with each accessory. If multiple accessories share an identical metallic component (i.e. the same metallic belt-chip used with different holsters with no other metallic components) only the accessory that dictates the closest spacing to the body is tested.



**Fig 9.4 Body Worn Position**



### **11.5 Wireless Router**

Some battery-operated handsets have the capability to transmit and receive user through simultaneous transmission of WIFI simultaneously with a separate licensed transmitter. The FCC has provided guidance in FCC HDB Publication 941225 D06 v02 where SAR test considerations for handsets ( $L \times W \geq 9 \text{ cm} \times 5 \text{ cm}$ ) are based on a composite test separation distance of 10mm from the front, back and edges of the device containing transmitting antennas within 2.5cm of their edges, determined from general mixed use conditions for this type of devices. Since the hotspot SAR results may overlap with the body-worn accessory SAR requirements, the more conservative configurations can be considered, thus excluding some body-worn accessory SAR tests.

When the user enables the personal wireless router functions for the handset, actual operations include simultaneous transmission of both the WIFI transmitter and another licensed transmitter. Both transmitters often do not transmit at the same transmitting frequency and thus cannot be evaluated for SAR under actual use conditions due to the limitations of the SAR assessment probes. Therefore, SAR must be evaluated for each frequency transmission and mode separately and spatially summed with the WIFI transmitter according to FCC KDB Publication 447498 D01v05r02 publication procedures. The "Portable Hotspot" feature on the handset was NOT activated during SAR assessments, to ensure the SAR measurements were evaluated for a single transmission frequency RF signal at a time.

### **11.6 Extremity Exposure Configurations**

Devices that are designed or intended for use on extremities or mainly operated in extremity only exposure conditions; i.e., hands, wrists, feet and ankles, may require extremity SAR evaluation. When the device also operates in close proximity to the user's body, SAR compliance for the body is also required. The 1-g body and 10-g extremity SAR exclusion thresholds found in KDB Publication 447498 D01v05 should be applied to determine SAR test requirements.

For smart phones with a display diagonal dimension  $> 15.0 \text{ cm}$  or an overall diagonal dimension  $> 16.0 \text{ cm}$  that provide similar mobile web access and multimedia support found in mini-tablets or UMPC mini-tablets that support voice calls next to the ear, unless it is confirmed otherwise through KDB inquiries, the following phablet procedures should be applied to evaluate SAR compliance for each applicable wireless mode and frequency band. Devices marketed as phablets, regardless of form factors and operating characteristics must be tested as a phablet to determine SAR compliance. The normally required head and body-worn accessory SAR test procedures for handsets, including hotspot mode, must be applied. The UMPC mini-tablet procedures must also be applied to test the SAR of all surfaces and edges with an antenna located at  $\leq 25 \text{ mm}$  from that surface or edge, in direct contact with a flat phantom, for 10-g extremity SAR according to the body-equivalent tissue dielectric parameters in KDB 865664 to address interactive hand use exposure conditions.<sup>6</sup> The UMPC mini-tablet 1-g SAR at 5 mm is not required. When hotspot mode applies, 10-g extremity SAR is required only for the surfaces and edges with hotspot mode 1-g reported SAR  $> 1.2 \text{ W/kg}$ ; however, when power reduction applies to hotspot mode the measured SAR must be scaled to the maximum output power, including tolerance, allowed for phablet modes to compare with the 1.2 W/kg SAR test reduction threshold. The normal tablet procedures in KDB 616217 are required when the over diagonal dimension of the device is  $> 20.0 \text{ cm}$ . Hotspot mode SAR is not required when normal tablet procedures are applied. Extremity 10-g SAR is also not required for the front (top) surface of large form factor full size tablets. The more conservative tablet SAR results can be used to support the 10-g extremity SAR for phablet mode. The simultaneous transmission operating configurations applicable to voice and data transmissions for both phone and mini-tablet modes must be taken into consideration separately for 1-g and 10-g SAR to determine the simultaneous transmission SAR test exclusion and measurement requirements for the relevant wireless mode and exposure conditions





## 12. Conducted RF Output Power (Unit: dBm)

### <GSM Conducted Power>

**General Note:**

1. Per KDB 447498 D01v05r02, the maximum output power channel is used for SAR testing and for further SAR test reduction.
2. Per KDB 941225 D01v03, considering the possibility of e.g. 3rd party VoIP operation for Head and body-worn SAR test reduction for GSM and GPRS and EDGE modes is determined by the source-based time-averaged output power including tune-up tolerance. The mode with highest specified time-averaged output power should be tested for SAR compliance in the applicable exposure conditions. For modes with the same specified maximum output power and tolerance, the higher number time-slot configuration should be tested. Therefore, the EUT was set in GPRS (4Tx slots) for GSM850/GSM1900.
3. Per KDB 941225 D01v03, for Hotspot SAR test reduction for GPRS and EDGE modes is determined by the source-based time-averaged output power including tune-up tolerance, for modes with the same specified maximum output power and tolerance, the higher number time-slot configuration should be tested, therefore, the EUT was set in GPRS (4Tx slots) for GSM850/GSM1900.

Band GSM850	Burst Average Power (dBm)			Tune-up Limit (dBm)	Frame-Average Power (dBm)			Tune-up Limit (dBm)
	TX Channel	128	189		251	128	189	
Frequency (MHz)	824.2	836.4	848.8		824.2	836.4	848.8	
GSM (GMSK, 1 Tx slot)	32.62	32.59	32.61	33.00	23.62	23.59	23.61	24.00
GPRS (GMSK, 1 Tx slot)	32.63	32.60	32.62	33.00	23.63	23.60	23.62	24.00
GPRS (GMSK, 2 Tx slots)	30.67	30.58	30.64	31.00	24.67	24.58	24.64	25.00
GPRS (GMSK, 3 Tx slots)	29.49	29.38	29.42	30.00	25.23	25.12	25.16	25.74
GPRS (GMSK, 4 Tx slots)	28.66	28.53	28.52	29.00	25.66	25.53	25.52	26.00
EDGE (8PSK, 1 Tx slot)	28.96	28.79	28.69	29.50	19.96	19.79	19.69	20.50
EDGE (8PSK, 2 Tx slots)	28.49	28.42	28.30	28.50	22.49	22.42	22.30	22.50
EDGE (8PSK, 3 Tx slots)	27.14	26.95	26.88	27.50	22.88	22.69	22.62	23.24
EDGE (8PSK, 4 Tx slots)	25.94	25.76	25.60	26.50	22.94	22.76	22.60	23.50

Band GSM1900	Burst Average Power (dBm)			Tune-up Limit (dBm)	Frame-Average Power (dBm)			Tune-up Limit (dBm)
	TX Channel	512	661		810	512	661	
Frequency (MHz)	1850.2	1880	1909.8		1850.2	1880	1909.8	
GSM (GMSK, 1 Tx slot)	29.73	29.69	29.68	30.00	20.73	20.69	20.68	21.00
GPRS (GMSK, 1 Tx slot)	29.74	29.72	29.70	30.00	20.74	20.72	20.70	21.00
GPRS (GMSK, 2 Tx slots)	26.84	26.73	26.74	27.00	20.84	20.73	20.74	21.00
GPRS (GMSK, 3 Tx slots)	25.67	25.61	25.57	26.00	21.41	21.35	21.31	21.74
GPRS (GMSK, 4 Tx slots)	24.49	24.43	24.40	25.00	21.49	21.43	21.40	22.00
EDGE (8PSK, 1 Tx slot)	26.11	26.07	26.37	26.50	17.11	17.07	17.37	17.50
EDGE (8PSK, 2 Tx slots)	25.18	25.07	25.38	25.50	19.18	19.07	19.38	19.50
EDGE (8PSK, 3 Tx slots)	23.78	23.63	23.81	24.50	19.52	19.37	19.55	20.24
EDGE (8PSK, 4 Tx slots)	22.97	22.79	22.99	23.50	19.97	19.79	19.99	20.50

**<WCDMA Conducted Power>**

1. The following tests were conducted according to the test requirements outlines in 3GPP TS 34.121 specification.
2. The procedures in KDB 941225 D01 are applied for 3GPP Rel. 6 HSPA to configure the device in the required sub-test mode(s) to determine SAR test exclusion.
3. For DC-HSDPA, the device was configured according to the H-Set 12, Fixed Reference Channel (FRC) configuration in Table C.8.1.12 of 3GPP TS 34.121-1, with the primary and the secondary serving HS-DSCH Cell enabled during the power measurement.

A summary of these settings are illustrated below:

**HSDPA Setup Configuration:**

- a. The EUT was connected to Base Station Agilent E5515C referred to the Setup Configuration.
- b. The RF path losses were compensated into the measurements.
- c. A call was established between EUT and Base Station with following setting:
  - i. Set Gain Factors ( $\beta_c$  and  $\beta_d$ ) and parameters were set according to each
  - ii. Specific sub-test in the following table, C10.1.4, quoted from the TS 34.121
  - iii. Set RMC 12.2Kbps + HSDPA mode.
  - iv. Set Cell Power = -86 dBm
  - v. Set HS-DSCH Configuration Type to FRC (H-set 1, QPSK)
  - vi. Select HSDPA Uplink Parameters
  - vii. Set Delta ACK, Delta NACK and Delta CQI = 8
  - viii. Set Ack-Nack Repetition Factor to 3
  - ix. Set CQI Feedback Cycle (k) to 4 ms
  - x. Set CQI Repetition Factor to 2
  - xi. Power Ctrl Mode = All Up bits
- d. The transmitted maximum output power was recorded.

**Table C.10.1.4:  $\beta$  values for transmitter characteristics tests with HS-DPCCH**

Sub-test	$\beta_c$	$\beta_d$	$\beta_d$ (SF)	$\beta_c/\beta_d$	$\beta_{HS}$ (Note 1, Note 2)	CM (dB) (Note 3)	MPR (dB) (Note 3)
1	2/15	15/15	64	2/15	4/15	0.0	0.0
2	12/15 (Note 4)	15/15 (Note 4)	64	12/15 (Note 4)	24/15	1.0	0.0
3	15/15	8/15	64	15/8	30/15	1.5	0.5
4	15/15	4/15	64	15/4	30/15	1.5	0.5

Note 1:  $\Delta_{ACK}, \Delta_{NACK}$  and  $\Delta_{CQI} = 30/15$  with  $\beta_{HS} = 30/15 * \beta_c$ .

Note 2: For the HS-DPCCH power mask requirement test in clause 5.2C, 5.7A, and the Error Vector Magnitude (EVM) with HS-DPCCH test in clause 5.13.1A, and HSDPA EVM with phase discontinuity in clause 5.13.1AA,  $\Delta_{ACK}$  and  $\Delta_{NACK} = 30/15$  with  $\beta_{HS} = 30/15 * \beta_c$ , and  $\Delta_{CQI} = 24/15$  with  $\beta_{HS} = 24/15 * \beta_c$ .

Note 3: CM = 1 for  $\beta_c/\beta_d = 12/15, \beta_{HS}/\beta_c = 24/15$ . For all other combinations of DPCCH, DPDCCH and HS-DPCCH the MPR is based on the relative CM difference. This is applicable for only UEs that support HSDPA in release 6 and later releases.

Note 4: For subtest 2 the  $\beta_c/\beta_d$  ratio of 12/15 for the TFC during the measurement period (TF1, TF0) is achieved by setting the signalled gain factors for the reference TFC (TF1, TF1) to  $\beta_c = 11/15$  and  $\beta_d = 15/15$ .

**Setup Configuration**



**HSUPA Setup Configuration:**

- a. The EUT was connected to Base Station Agilent E5515C referred to the Setup Configuration.
- b. The RF path losses were compensated into the measurements.
- c. A call was established between EUT and Base Station with following setting \* :
  - i. Call Configs = 5.2B, 5.9B, 5.10B, and 5.13.2B with QPSK
  - ii. Set the Gain Factors ( $\beta_c$  and  $\beta_d$ ) and parameters (AG Index) were set according to each specific sub-test in the following table, C11.1.3, quoted from the TS 34.121
  - iii. Set Cell Power = -86 dBm
  - iv. Set Channel Type = 12.2k + HSPA
  - v. Set UE Target Power
  - vi. Power Ctrl Mode= Alternating bits
  - vii. Set and observe the E-TFCl
  - viii. Confirm that E-TFCl is equal to the target E-TFCl of 75 for sub-test 1, and other subtest's E-TFCl
- d. The transmitted maximum output power was recorded.

**Table C.11.1.3:  $\beta$  values for transmitter characteristics tests with HS-DPCCH and E-DCH**

Sub-test	$\beta_c$	$\beta_d$	$\beta_d$ (SF)	$\beta_c/\beta_d$	$\beta_{HS}$ (Note 1)	$\beta_{ec}$	$\beta_{ed}$ (Note 5) (Note 6)	$\beta_{ed}$ (SF)	$\beta_{ed}$ (Codes)	CM (dB) (Note 2)	MPR (dB) (Note 2)	AG Index (Note 6)	E-TFCl
1	11/15 (Note 3)	15/15 (Note 3)	64	11/15 (Note 3)	22/15	209/225	1309/225	4	1	1.0	0.0	20	75
2	6/15	15/15	64	6/15	12/15	12/15	94/75	4	1	3.0	2.0	12	67
3	15/15	9/15	64	15/9	30/15	30/15	$\beta_{ed1}$ : 47/15 $\beta_{ed2}$ : 47/15	4 4	2	2.0	1.0	15	92
4	2/15	15/15	64	2/15	4/15	2/15	56/75	4	1	3.0	2.0	17	71
5	15/15 (Note 4)	15/15 (Note 4)	64	15/15 (Note 4)	30/15	24/15	134/15	4	1	1.0	0.0	21	81

Note 1:  $\Delta_{ACK}, \Delta_{NACK}$  and  $\Delta_{CQI} = 30/15$  with  $\beta_{hs} = 30/15 * \beta_c$ .

Note 2: CM = 1 for  $\beta_c/\beta_d = 12/15, \beta_{hs}/\beta_c = 24/15$ . For all other combinations of DPDCH, DPCCH, HS-DPCCH, E-DPDCH and E-DPCCH the MPR is based on the relative CM difference.

Note 3: For subtest 1 the  $\beta_c/\beta_d$  ratio of 11/15 for the TFC during the measurement period (TF1, TF0) is achieved by setting the signalled gain factors for the reference TFC (TF1, TF1) to  $\beta_c = 10/15$  and  $\beta_d = 15/15$ .

Note 4: For subtest 5 the  $\beta_c/\beta_d$  ratio of 15/15 for the TFC during the measurement period (TF1, TF0) is achieved by setting the signalled gain factors for the reference TFC (TF1, TF1) to  $\beta_c = 14/15$  and  $\beta_d = 15/15$ .

Note 5: In case of testing by UE using E-DPDCH Physical Layer category 1, Sub-test 3 is omitted according to TS25.306 Table 5.1g.

Note 6:  $\beta_{ed}$  can not be set directly, it is set by Absolute Grant Value.

**Setup Configuration**

**DC-HSDPA 3GPP release 8 Setup Configuration:**

- a. The EUT was connected to Base Station Agilent E5515C referred to the Setup Configuration below
- b. The RF path losses were compensated into the measurements.
- c. A call was established between EUT and Base Station with following setting:
  - i. Set RMC 12.2Kbps + HSDPA mode.
  - ii. Set Cell Power = -25 dBm
  - iii. Set HS-DSCH Configuration Type to FRC (H-set 12, QPSK)
  - iv. Select HSDPA Uplink Parameters
  - v. Set Gain Factors ( $\beta_c$  and  $\beta_d$ ) and parameters were set according to each Specific sub-test in the following table, C10.1.4, quoted from the TS 34.121
    - a). Subtest 1:  $\beta_c/\beta_d=2/15$
    - b). Subtest 2:  $\beta_c/\beta_d=12/15$
    - c). Subtest 3:  $\beta_c/\beta_d=15/8$
    - d). Subtest 4:  $\beta_c/\beta_d=15/4$
  - vi. Set Delta ACK, Delta NACK and Delta CQI = 8
  - vii. Set Ack-Nack Repetition Factor to 3
  - viii. Set CQI Feedback Cycle (k) to 4 ms
  - ix. Set CQI Repetition Factor to 2
  - x. Power Ctrl Mode = All Up bits
- d. The transmitted maximum output power was recorded.

The following tests were conducted according to the test requirements outlines in 3GPP TS 34.121 specification. A summary of these settings are illustrated below:

**C.8.1.12 Fixed Reference Channel Definition H-Set 12**

**Table C.8.1.12: Fixed Reference Channel H-Set 12**

Parameter	Unit	Value
Nominal Avg. Inf. Bit Rate	kbps	60
Inter-TTI Distance	TTI's	1
Number of HARQ Processes	Processes	6
Information Bit Payload ( $N_{INF}$ )	Bits	120
Number Code Blocks	Blocks	1
Binary Channel Bits Per TTI	Bits	960
Total Available SML's in UE	SML's	19200
Number of SML's per HARQ Proc.	SML's	3200
Coding Rate		0.15
Number of Physical Channel Codes	Codes	1
Modulation		QPSK
Note 1: The RMC is intended to be used for DC-HSDPA mode and both cells shall transmit with identical parameters as listed in the table. Note 2: Maximum number of transmission is limited to 1, i.e., retransmission is not allowed. The redundancy and constellation version 0 shall be used.		

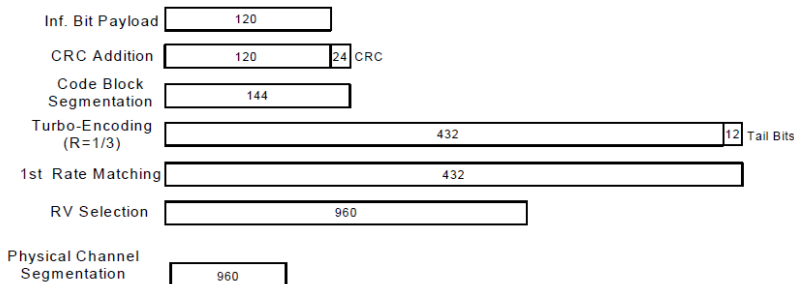

**Figure C.8.19: Coding rate for Fixed reference Channel H-Set 12 (QPSK)**

**Setup Configuration**



**<WCDMA Conducted Power>**

**General Note:**

1. Per KDB 941225 D01v03, SAR for Head / Hotspot / Body-worn exposure is measured using a 12.2 kbps RMC with TPC bits configured to all "1"s".
2. Per KDB 941225 D01v03, RMC 12.2kbps setting is used to evaluate SAR. If the maximum output power and tune-up tolerance specified for production units in HSDPA / HSUPA / DC-HSDPA is  $\leq \frac{1}{4}$  dB higher than RMC 12.2Kbps or when the highest reported SAR of the RMC12.2Kbps is scaled by the ratio of specified maximum output power and tune-up tolerance of HSDPA / HSUPA / DC-HSDPA to RMC12.2Kbps and the adjusted SAR is  $\leq 1.2$  W/kg, SAR measurement is not required for HSDPA / HSUPA / DC-HSDPA.

Band			WCDMA V			WCDMA II		
TX Channel			4132	4182	4233	9262	9400	9538
Frequency (MHz)			826.4	836.4	846.6	1852.4	1880	1907.6
MPR (dB)	3GPP Rel 99	AMR 12.2Kbps	23.96	23.98	23.95	22.49	22.44	22.47
	3GPP Rel 99	RMC 12.2Kbps	23.98	23.99	23.96	22.50	22.45	22.48
0	3GPP Rel 6	HSDPA Subtest-1	22.94	22.97	22.95	21.48	21.42	21.45
0	3GPP Rel 6	HSDPA Subtest-2	22.93	22.96	22.94	21.45	21.40	21.44
0.5	3GPP Rel 6	HSDPA Subtest-3	22.40	22.48	22.45	20.95	20.92	20.94
0.5	3GPP Rel 6	HSDPA Subtest-4	22.39	22.43	22.44	20.94	20.90	20.94
0	3GPP Rel 8	DC-HSDPA Subtest-1	22.77	22.89	22.85	21.40	21.36	21.35
0	3GPP Rel 8	DC-HSDPA Subtest-2	22.75	22.83	22.84	21.39	21.33	21.33
0.5	3GPP Rel 8	DC-HSDPA Subtest-3	22.28	22.35	22.34	20.88	20.80	20.85
0.5	3GPP Rel 8	DC-HSDPA Subtest-4	22.25	22.34	22.33	20.85	20.79	20.81
0	3GPP Rel 6	HSUPA Subtest-1	21.04	21.09	21.05	19.53	19.51	19.57
2	3GPP Rel 6	HSUPA Subtest-2	20.95	20.94	20.96	19.44	19.46	19.43
1	3GPP Rel 6	HSUPA Subtest-3	21.95	21.96	21.92	20.40	20.37	20.45
2	3GPP Rel 6	HSUPA Subtest-4	20.52	20.47	20.45	19.01	19.05	19.12
0	3GPP Rel 6	HSUPA Subtest-5	22.94	22.95	22.93	21.35	21.34	21.41



**<LTE Conducted Power>**

**General Note:**

1. Anritsu MT8820C base station simulator was used to setup the connection with EUT; the frequency band, channel bandwidth, RB allocation configuration, modulation type are set in the base station simulator to configure EUT transmitting at maximum power and at different configurations which are requested to be reported to FCC, for conducted power measurement and SAR testing.
2. Per KDB 941225 D05v02r03, when a properly configured base station simulator is used for the SAR and power measurements, spectrum plots for each RB allocation and offset configuration is not required.
3. Per KDB 941225 D05v02r03, start with the largest channel bandwidth and measure SAR for QPSK with 1 RB allocation, using the RB offset and required test channel combination with the highest maximum output power for RB offsets at the upper edge, middle and lower edge of each required test channel.
4. Per KDB 941225 D05v02r03, 50% RB allocation for QPSK SAR testing follows 1RB QPSK allocation procedure.
5. Per KDB 941225 D05v02r03, For QPSK with 100% RB allocation, SAR is not required when the highest maximum output power for 100 % RB allocation is less than the highest maximum output power in 50% and 1 RB allocations and the highest reported SAR for 1 RB and 50% RB allocation are  $\leq 0.8$  W/kg. Otherwise, SAR is measured for the highest output power channel; and if the reported SAR is  $> 1.45$  W/kg, the remaining required test channels must also be tested.
6. Per KDB 941225 D05v02r03, 16QAM output power for each RB allocation configuration is  $>$  not  $\frac{1}{2}$  dB higher than the same configuration in QPSK and the reported SAR for the QPSK configuration is  $\leq 1.45$  W/kg; Per KDB 941225 D05v02r03, 16QAM SAR testing is not required.
7. Per KDB 941225 D05v02r03, Smaller bandwidth output power for each RB allocation configuration is  $>$  not  $\frac{1}{2}$  dB higher than the same configuration in the largest supported bandwidth, and the reported SAR for the largest supported bandwidth is  $\leq 1.45$  W/kg; Per KDB 941225 D05v02r03, smaller bandwidth SAR testing is not required.



<LTE Band 5>

BW [MHz]	Modulation	RB Size	RB Offset	Power Low Ch. / Freq.	Power Middle Ch. / Freq.	Power High Ch. / Freq.	Tune up Limit (dBm)	MPR (dB)
Channel				20450	20525	20600		
Frequency (MHz)				829	836.5	844		
10	QPSK	1	0	23.53	23.73	23.56		
10	QPSK	1	24	23.52	23.57	23.51	24	0
10	QPSK	1	49	23.48	23.48	23.36		
10	QPSK	25	0	22.57	22.63	22.58		
10	QPSK	25	12	22.57	22.62	22.56	23	1
10	QPSK	25	24	22.54	22.62	22.52		
10	QPSK	50	0	22.59	22.62	22.55		
10	16QAM	1	0	22.92	22.92	22.93	23	1
10	16QAM	1	24	22.87	22.84	22.86		
10	16QAM	1	49	22.78	22.77	22.73		
10	16QAM	25	0	21.58	21.66	21.63	22	2
10	16QAM	25	12	21.60	21.67	21.60		
10	16QAM	25	24	21.62	21.67	21.56		
10	16QAM	50	0	21.61	21.66	21.59		
Channel				20425	20525	20625		
Frequency (MHz)				826.5	836.5	846.5		
5	QPSK	1	0	23.53	23.60	23.47		
5	QPSK	1	12	23.49	23.59	23.45	24	0
5	QPSK	1	24	23.49	23.52	23.31		
5	QPSK	12	0	22.63	22.70	22.58		
5	QPSK	12	6	22.62	22.68	22.52	23	1
5	QPSK	12	11	22.63	22.68	22.51		
5	QPSK	25	0	22.59	22.62	22.47		
5	16QAM	1	0	22.82	22.98	22.82	23	1
5	16QAM	1	12	22.81	22.96	22.80		
5	16QAM	1	24	22.78	22.89	22.65		
5	16QAM	12	0	21.65	21.76	21.62	22	2
5	16QAM	12	6	21.65	21.74	21.57		
5	16QAM	12	11	21.66	21.74	21.56		
5	16QAM	25	0	21.60	21.67	21.50		
Channel				20415	20525	20635		
Frequency (MHz)				825.5	836.5	847.5		
3	QPSK	1	0	23.49	23.56	23.42		
3	QPSK	1	7	23.46	23.51	23.39	24	0
3	QPSK	1	14	23.43	23.49	23.34		
3	QPSK	8	0	22.58	22.65	22.54		
3	QPSK	8	4	22.60	22.65	22.52	23	1
3	QPSK	8	7	22.59	22.64	22.50		
3	QPSK	15	0	22.59	22.65	22.51		
3	16QAM	1	0	22.77	22.97	22.78	23	1
3	16QAM	1	7	22.74	22.89	22.75		
3	16QAM	1	14	22.70	22.89	22.69		
3	16QAM	8	0	21.65	21.76	21.65	22	2
3	16QAM	8	4	21.67	21.76	21.63		
3	16QAM	8	7	21.66	21.75	21.59		
3	16QAM	15	0	21.62	21.71	21.56		



Channel				20407	20525	20643	Tune up Limit (dBm)	Target MPR (dB)
Frequency (MHz)				824.7	836.5	848.3		
1.4	QPSK	1	0	23.68	23.71	23.66	24	0
1.4	QPSK	1	2	23.67	23.68	23.64		
1.4	QPSK	1	5	23.59	23.64	23.60		
1.4	QPSK	3	0	23.58	23.64	23.52		
1.4	QPSK	3	1	23.63	23.62	23.60		
1.4	QPSK	3	2	23.62	23.61	23.60		
1.4	QPSK	6	0	22.69	22.78	22.66	23	1
1.4	16QAM	1	0	22.92	22.98	22.99	23	1
1.4	16QAM	1	2	22.85	22.92	22.92		
1.4	16QAM	1	5	22.84	22.88	22.86		
1.4	16QAM	3	0	22.78	22.93	22.73		
1.4	16QAM	3	1	22.73	22.87	22.67		
1.4	16QAM	3	2	22.72	22.86	22.65		
1.4	16QAM	6	0	21.85	21.94	21.78	22	2



<LTE Band 7 Hotspot inactive - full power mode>

BW [MHz]	Modulation	RB Size	RB Offset	Power Low Ch. / Freq.	Power Middle Ch. / Freq.	Power High Ch. / Freq.	Tune up Limit (dBm)	MPR (dB)
Channel				20850	21100	21350		
Frequency (MHz)				2510	2535	2560		
20	QPSK	1	0	22.32	22.27	22.33	22.5	0
20	QPSK	1	49	22.20	22.22	22.28		
20	QPSK	1	99	22.15	22.01	22.24		
20	QPSK	50	0	21.30	21.20	21.37	21.5	1
20	QPSK	50	24	21.26	21.19	21.35		
20	QPSK	50	49	21.21	21.10	21.33		
20	QPSK	100	0	21.27	21.16	21.33		
20	16QAM	1	0	21.49	21.48	21.50	21.5	1
20	16QAM	1	49	21.45	21.40	21.47		
20	16QAM	1	99	21.38	21.31	21.42		
20	16QAM	50	0	20.22	20.16	20.35	20.5	2
20	16QAM	50	24	20.24	20.08	20.34		
20	16QAM	50	49	20.28	20.18	20.38		
20	16QAM	100	0	20.24	20.13	20.34		
Channel				20825	21100	21375	Tune up Limit (dBm)	MPR (dB)
Frequency (MHz)				2507.5	2535	2562.5		
15	QPSK	1	0	22.25	22.18	22.28	22.5	0
15	QPSK	1	37	22.21	22.12	22.27		
15	QPSK	1	74	22.13	22.03	22.21		
15	QPSK	36	0	21.31	21.19	21.37	21.5	1
15	QPSK	36	18	21.30	21.15	21.35		
15	QPSK	36	37	21.24	21.10	21.32		
15	QPSK	75	0	21.28	21.15	21.34		
15	16QAM	1	0	21.50	21.47	21.49	21.5	1
15	16QAM	1	37	21.46	21.39	21.48		
15	16QAM	1	74	21.37	21.30	21.46		
15	16QAM	36	0	20.22	20.13	20.32	20.5	2
15	16QAM	36	18	20.27	20.08	20.37		
15	16QAM	36	37	20.29	20.16	20.38		
15	16QAM	75	0	20.26	20.11	20.35		
Channel				20800	21100	21400	Tune up Limit (dBm)	MPR (dB)
Frequency (MHz)				2505	2535	2565		
10	QPSK	1	0	22.19	22.09	22.22	22.5	0
10	QPSK	1	24	22.16	22.07	22.21		
10	QPSK	1	49	22.10	22.00	22.20		
10	QPSK	25	0	21.24	21.09	21.29	21.5	1
10	QPSK	25	12	21.20	21.08	21.28		
10	QPSK	25	24	21.16	21.04	21.27		
10	QPSK	50	0	21.25	21.08	21.32		
10	16QAM	1	0	21.44	21.40	21.50	21.5	1
10	16QAM	1	24	21.40	21.34	21.49		
10	16QAM	1	49	21.34	21.30	21.48		
10	16QAM	25	0	20.16	20.08	20.28	20.5	2
10	16QAM	25	12	20.18	20.03	20.29		
10	16QAM	25	24	20.23	20.07	20.30		
10	16QAM	50	0	20.22	20.06	20.33		



Channel				20775	21100	21425	Tune up Limit (dBm)	MPR (dB)
Frequency (MHz)				2502.5	2535	2567.5		
5	QPSK	1	0	22.14	21.99	22.21	22.5	0
5	QPSK	1	12	22.12	21.98	22.20		
5	QPSK	1	24	22.08	21.97	22.16		
5	QPSK	12	0	21.23	21.09	21.30	21.5	1
5	QPSK	12	6	21.21	21.07	21.29		
5	QPSK	12	11	21.20	21.06	21.31		
5	QPSK	25	0	21.18	21.04	21.27		
5	16QAM	1	0	21.38	21.31	21.50	21.5	1
5	16QAM	1	12	21.35	21.28	21.48		
5	16QAM	1	24	21.32	21.28	21.45		
5	16QAM	12	0	20.21	20.09	20.33	20.5	2
5	16QAM	12	6	20.20	20.07	20.32		
5	16QAM	12	11	20.22	20.06	20.34		
5	16QAM	25	0	20.16	20.02	20.28		





<LTE Band 7 Hotspot active - reduced power mode>

BW [MHz]	Modulation	RB Size	RB Offset	Power Low Ch. / Freq.	Power Middle Ch. / Freq.	Power High Ch. / Freq.	Tune up Limit (dBm)	MPR (dB)
Channel				20850	21100	21350		
Frequency (MHz)				2510	2535	2560		
20	QPSK	1	0	18.28	18.25	18.34	19	0
20	QPSK	1	49	18.19	18.18	18.26		
20	QPSK	1	99	18.10	18.00	18.32		
20	QPSK	50	0	18.27	18.15	18.33	19	0
20	QPSK	50	24	18.22	18.14	18.30		
20	QPSK	50	49	18.20	18.06	18.29		
20	QPSK	100	0	18.23	18.11	18.30		
20	16QAM	1	0	18.43	18.52	18.62	19	0
20	16QAM	1	49	18.53	18.34	18.62		
20	16QAM	1	99	18.61	18.62	18.68		
20	16QAM	50	0	18.20	18.15	18.32	19	0
20	16QAM	50	24	18.23	18.07	18.31		
20	16QAM	50	49	18.27	18.15	18.35		
20	16QAM	100	0	18.23	18.12	18.31		
Channel				20825	21100	21375	Tune up Limit (dBm)	MPR (dB)
Frequency (MHz)				2507.5	2535	2562.5		
15	QPSK	1	0	18.29	18.15	18.33	19	0
15	QPSK	1	37	18.22	18.10	18.29		
15	QPSK	1	74	18.19	18.02	18.29		
15	QPSK	36	0	18.28	18.13	18.29	19	0
15	QPSK	36	18	18.20	18.11	18.24		
15	QPSK	36	37	18.19	18.07	18.23		
15	QPSK	75	0	18.25	18.09	18.32		
15	16QAM	1	0	18.44	18.42	18.56	19	0
15	16QAM	1	37	18.53	18.34	18.61		
15	16QAM	1	74	18.51	18.47	18.63		
15	16QAM	36	0	18.20	18.11	18.30	19	0
15	16QAM	36	18	18.27	18.07	18.35		
15	16QAM	36	37	18.26	18.14	18.35		
15	16QAM	75	0	18.25	18.09	18.33		
Channel				20800	21100	21400	Tune up Limit (dBm)	MPR (dB)
Frequency (MHz)				2505	2535	2565		
10	QPSK	1	0	18.23	18.19	18.29	19	0
10	QPSK	1	24	18.17	18.07	18.24		
10	QPSK	1	49	18.18	17.99	18.22		
10	QPSK	25	0	18.22	18.05	18.27	19	0
10	QPSK	25	12	18.17	18.04	18.26		
10	QPSK	25	24	18.13	18.01	18.25		
10	QPSK	50	0	18.20	18.03	18.28		
10	16QAM	1	0	18.41	18.39	18.56	19	0
10	16QAM	1	24	18.49	18.31	18.48		
10	16QAM	1	49	18.50	18.43	18.58		
10	16QAM	25	0	18.14	18.04	18.27	19	0
10	16QAM	25	12	18.18	18.02	18.28		
10	16QAM	25	24	18.23	18.06	18.29		
10	16QAM	50	0	18.22	18.04	18.30		



Channel				20775	21100	21425	Tune up Limit (dBm)	MPR (dB)
Frequency (MHz)				2502.5	2535	2567.5		
5	QPSK	1	0	18.24	18.09	18.32	19	0
5	QPSK	1	12	18.17	17.99	18.25		
5	QPSK	1	24	18.12	17.98	18.18		
5	QPSK	12	0	18.23	18.08	18.31	19	0
5	QPSK	12	6	18.21	18.05	18.30		
5	QPSK	12	11	18.20	18.04	18.29		
5	QPSK	25	0	18.17	18.02	18.25		
5	16QAM	1	0	18.43	18.24	18.58	19	0
5	16QAM	1	12	18.49	18.31	18.59		
5	16QAM	1	24	18.44	18.34	18.53		
5	16QAM	12	0	18.22	18.09	18.33	19	0
5	16QAM	12	6	18.22	18.07	18.32		
5	16QAM	12	11	18.24	18.06	18.33		
5	16QAM	25	0	18.18	18.03	18.27		



**<WLAN Conducted Power>**

**General Note:**

1. For IEEE802.11a/b/g SAR testing, highest average RF output power channel for the lowest data rate for 802.11a/b were selected for SAR evaluation. 802.11g were not investigated since the average output powers over all channels and data rates were not more than 0.25 dB higher than the tested channel in the lowest data rate of 802.11a/b mode.
2. For IEEE802.11n, SAR testing can be conducted on channel with the highest output power when taking into consideration tune-up tolerance for same test configuration that was identified during SAR evaluations for IEEE802.11a/b/g (as applicable) provided bandwidth and test position are the same.
3. For IEEE802.11n with multiple channel BW configurations, highest channel BW configuration with highest output power limit shall be tested.
4. Testing of lower BW configurations is not required when the maximum average output of the default test channels in each lower BW configuration is less than 1/4dB higher than the default test channel in the highest BW configuration.

**<2.4GHz WLAN>**

WLAN 2.4GHz 802.11b Average Power (dBm)					
Power vs. Channel			Power vs. Data Rate		
Channel	Frequency (MHz)	Data Rate	2Mbps	5.5Mbps	11Mbps
		1Mbps			
CH 1	2412	16.63	16.86	16.86	16.65
CH 6	2437	16.70			
CH 11	2462	16.89			

WLAN 2.4GHz 802.11g Average Power (dBm)									
Power vs. Channel			Power vs. Data Rate						
Channel	Frequency (MHz)	Data Rate	9Mbps	12Mbps	18Mbps	24Mbps	36Mbps	48Mbps	54Mbps
		6Mbps							
CH 1	2412	13.45	14.94	14.82	14.77	14.95	14.68	14.85	14.92
CH 6	2437	14.87							
CH 11	2462	14.99							

WLAN 2.4GHz 802.11n-HT20 Average Power (dBm)									
Power vs. Channel			Power vs. MCS Index						
Channel	Frequency (MHz)	MCS Index	MCS1	MCS2	MCS3	MCS4	MCS5	MCS6	MCS7
		MCS0							
CH 1	2412	11.29	11.25	11.21	11.44	11.25	11.24	11.39	11.25
CH 6	2437	11.42							
CH 11	2462	11.48							

WLAN 2.4GHz 802.11n-HT40 Average Power (dBm)									
Power vs. Channel			Power vs. MCS Index						
Channel	Frequency (MHz)	MCS Index	MCS1	MCS2	MCS3	MCS4	MCS5	MCS6	MCS7
		MCS0							
CH 3	2422	11.25	11.01	11.02	11.06	11.10	11.16	11.14	11.06
CH 6	2437	11.19							
CH 9	2452	10.95							



<5GHz WLAN>

WLAN 5GHz 802.11a Average Power (dBm)									
Power vs. Channel			Power vs. Data Rate						
Channel	Frequency (MHz)	Data Rate 6Mbps	9Mbps	12Mbps	18Mbps	24Mbps	36Mbps	48Mbps	54Mbps
CH 36	5180	13.53	13.60	13.60	13.65	13.63	13.63	13.54	13.64
CH 40	5200	13.68							
CH 44	5220	13.79							
CH 48	5240	13.84							
CH 52	5260	13.58	13.57	13.57	13.70	13.62	13.62	13.69	13.79
CH 56	5280	13.61							
CH 60	5300	13.62							
CH 64	5320	13.94							
CH 100	5500	13.26	13.73	13.91	13.65	13.67	13.70	13.86	13.74
CH 104	5520	13.67							
CH 108	5540	13.71							
CH 112	5560	13.61							
CH 116	5580	13.64							
CH 132	5660	13.94							
CH 136	5680	13.43	13.59	13.54	13.55	13.61	13.70	13.72	13.76
CH 140	5700	13.66							
CH 149	5745	9.93							
CH 153	5765	13.83							
CH 157	5785	13.80							
CH 161	5805	13.78							
CH 165	5825	13.66							

WLAN 5GHz 802.11n-HT20 Average Power (dBm)									
Power vs. Channel			Power vs. MCS Index						
Channel	Frequency (MHz)	MCS Index MCS0	MCS1	MCS2	MCS3	MCS4	MCS5	MCS6	MCS7
CH 36	5180	11.45	11.37	11.37	11.37	11.32	11.23	11.18	11.17
CH 40	5200	11.13							
CH 44	5220	11.00							
CH 48	5240	11.30							
CH 52	5260	11.50	11.29	11.29	11.40	11.34	11.32	11.21	11.30
CH 56	5280	11.44							
CH 60	5300	11.48							
CH 64	5320	11.41							
CH 100	5500	11.39	11.18	11.47	11.33	11.24	11.21	11.21	11.32
CH 104	5520	11.03							
CH 108	5540	11.09							
CH 112	5560	11.49							
CH 116	5580	11.37							
CH 132	5660	11.33							
CH 136	5680	11.37	11.17	11.28	11.27	11.18	11.16	11.16	11.45
CH 140	5700	11.43							
CH 149	5745	11.44							
CH 153	5765	11.20							
CH 157	5785	11.47							
CH 161	5805	11.18							
CH 165	5825	11.43							

WLAN 5GHz 802.11n-HT40 Average Power (dBm)									
Power vs. Channel			Power vs. MCS Index						
Channel	Frequency (MHz)	MCS Index MCS0	MCS1	MCS2	MCS3	MCS4	MCS5	MCS6	MCS7
CH 38	5190	11.46	11.21	11.44	11.15	11.45	11.20	11.19	11.15
CH 46	5230	11.31							
CH 54	5270	11.49	11.48	11.25	11.41	11.34	11.37	11.33	11.21
CH 62	5310	10.33							
CH 102	5510	11.06	11.40	11.22	11.16	11.35	11.39	11.19	11.30
CH 110	5550	11.44							
CH 134	5670	11.45							
CH 151	5755	9.36	11.22	10.97	11.00	11.18	11.19	11.05	11.14
CH 159	5795	11.25							

### 13. Bluetooth Exclusions Applied

Mode Band	Average power(dBm)	
	Bluetooth v3.0+EDR	Bluetooth v4.0+LE
2.4GHz Bluetooth	7.0	1.0

**Note:**

- Per KDB 447498 D01v05r02, the 1-g and 10-g SAR test exclusion thresholds for 100 MHz to 6 GHz at *test separation distances* ≤ 50 mm are determined by:  

$$[(max. power of channel, including tune-up tolerance, mW)/(min. test separation distance, mm)] \cdot [\sqrt{f(GHz)}] \leq 3.0$$
for 1-g SAR and ≤ 7.5 for 10-g extremity SAR
  - f(GHz) is the RF channel transmit frequency in GHz
  - Power and distance are rounded to the nearest mW and mm before calculation
  - The result is rounded to one decimal place for comparison

Bluetooth Max Power (dBm)	Separation Distance (mm)	Frequency (GHz)	exclusion thresholds
7.0	< 5	2.48	1.57

**Note:**

Per KDB 447498 D01v05r02, when the minimum test separation distance is < 5 mm, a distance of 5 mm is applied to determine SAR test exclusion. The test exclusion threshold is 1.57 which is ≤ 3, SAR testing is not required.

### 14. Antenna Location

<Mobile Phone>

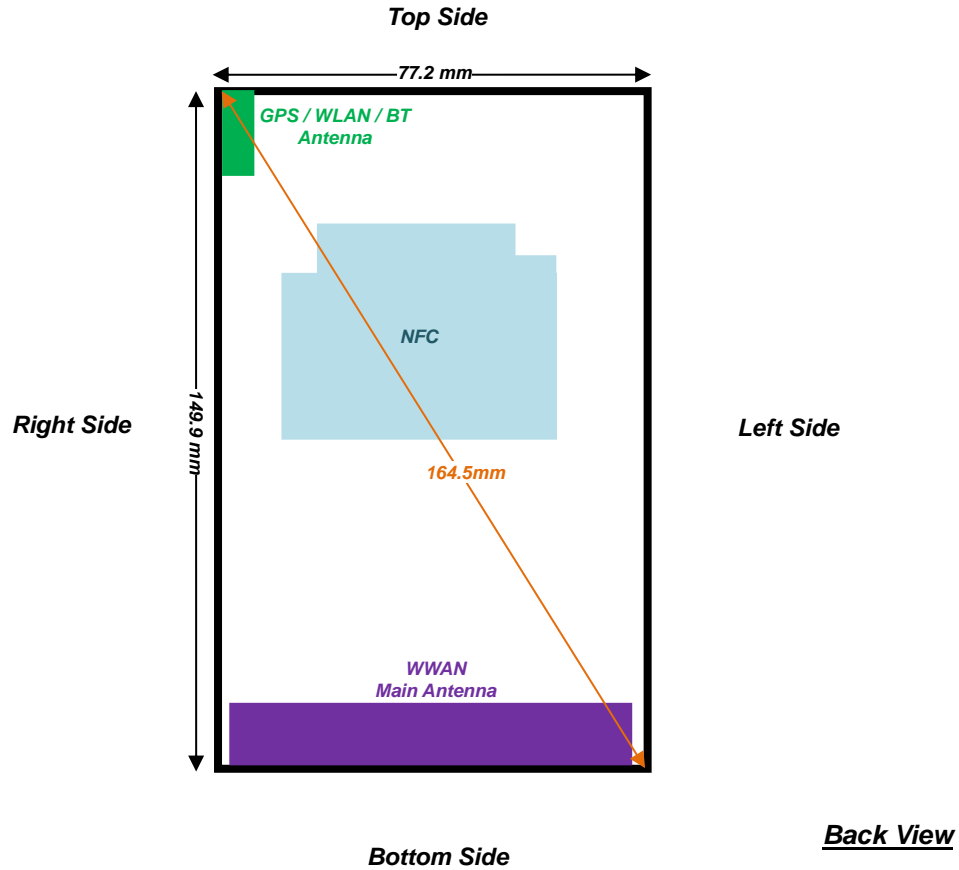

Distance of the Antenna to the EUT surface/edge						
Antennas	Back	Front	Top Side	Bottom Side	Right Side	Left Side
WWAN Main	≤ 25mm	≤ 25mm	> 25mm	≤ 25mm	≤ 25mm	≤ 25mm
BT&WLAN	≤ 25mm	≤ 25mm	≤ 25mm	> 25mm	≤ 25mm	> 25mm
Positions for SAR tests; Hotspot mode						
Antennas	Back	Front	Top Side	Bottom Side	Right Side	Left Side
WWAN Main	Yes	Yes	No	Yes	Yes	Yes
BT&WLAN	Yes	Yes	Yes	No	Yes	No

**General Note:**

- Referring to KDB 941225 D06 v02, when the overall device length and width are ≥ 9cm\*5cm, the test distance is 10 mm. SAR must be measured for all sides and surfaces with a transmitting antenna located within 25mm from that surface or edge.



## **15. SAR Test Results**

### **General Note:**

1. Per KDB 447498 D01v05r02, the reported SAR is the measured SAR value adjusted for maximum tune-up tolerance.
  - a. Tune-up scaling Factor = tune-up limit power (mW) / EUT RF power (mW), where tune-up limit is the maximum rated power among all production units.
  - b. For SAR testing of WLAN signal with non-100% duty cycle, the measured SAR is scaled-up by the duty cycle scaling factor which is equal to "1/(duty cycle)"
  - c. For WWAN: Reported SAR(W/kg)= Measured SAR(W/kg)\*Tune-up Scaling Factor
  - d. For WLAN: Reported SAR(W/kg)= Measured SAR(W/kg)\* Duty Cycle scaling factor \* Tune-up scaling factor
2. Per KDB 447498 D01v05r02, for each exposure position, testing of other required channels within the operating mode of a frequency band is not required when the *reported* 1-g or 10-g SAR for the mid-band or highest output power channel is:
  - $\leq 0.8$  W/kg or 2.0 W/kg, for 1-g or 10-g respectively, when the transmission band is  $\leq 100$  MHz
  - $\leq 0.6$  W/kg or 1.5 W/kg, for 1-g or 10-g respectively, when the transmission band is between 100 MHz and 200 MHz
  - $\leq 0.4$  W/kg or 1.0 W/kg, for 1-g or 10-g respectively, when the transmission band is  $\geq 200$  MHz
3. When hotspot mode is enabled, power reduction will be activated to limit the maximum power of LTE B7.
4. Per KDB 648474 D04v01r02, for smart phones with a display diagonal dimension  $> 15.0$  cm or an overall diagonal dimension  $> 16.0$  cm, when hotspot mode applies, 10-g extremity SAR is required only for the surfaces and edges with hotspot mode 1-g reported SAR  $> 1.2$  W/kg, however, when power reduction applies to hotspot mode the measured SAR must be scaled to the maximum output power, including tolerance, allowed for phablet modes to compare with the 1.2 W/kg SAR test reduction threshold, therefore the LTE B7 extremity SAR was performed..
5. Per KDB 648474 D04v01r02, the WLAN extremity SAR was not performed, since the WLAN hotspot SAR was  $< 1.2$  W/kg.
6. Per KDB 648474 D04v01r02, when the reported SAR for a body-worn accessory measured without a headset connected to the handset is  $\leq 1.2$  W/kg, SAR testing with a headset connected to the handset is not required.
7. Per KDB 941225 D01v03, considering the possibility of e.g. 3rd party VoIP operation for Head and body-worn SAR test reduction for GSM and GPRS and EDGE modes is determined by the source-based time-averaged output power including tune-up tolerance. The mode with highest specified time-averaged output power should be tested for SAR compliance in the applicable exposure conditions. For modes with the same specified maximum output power and tolerance, the higher number time-slot configuration should be tested. Therefore, the EUT was set in GPRS (4Tx slots) for GSM850/GSM1900.
8. Per KDB 941225 D01v03, for Hotspot SAR test reduction for GPRS and EDGE modes is determined by the source-based time-averaged output power including tune-up tolerance, for modes with the same specified maximum output power and tolerance, the higher number time-slot configuration should be tested, therefore, the EUT was set in GPRS (4Tx slots) for GSM850/GSM1900.
9. Per KDB 941225 D01v03, SAR for Head / Hotspot / Body-worn exposure is measured using a 12.2 kbps RMC with TPC bits configured to all "1's".
10. Per KDB 941225 D01v03, RMC 12.2kbps setting is used to evaluate SAR. If the maximum output power and tune-up tolerance specified for production units in HSDPA / HSUPA / DC-HSDPA is  $\leq \frac{1}{4}$  dB higher than RMC 12.2Kbps or when the highest reported SAR of the RMC12.2Kbps is scaled by the ratio of specified maximum output power and tune-up tolerance of HSDPA / HSUPA / DC-HSDPA to RMC12.2Kbps and the adjusted SAR is  $\leq 1.2$  W/kg, SAR measurement is not required for HSDPA / HSUPA / DC-HSDPA.
11. Per KDB 941225 D05v02r03, start with the largest channel bandwidth and measure SAR for QPSK with 1 RB allocation, using the RB offset and required test channel combination with the highest maximum output power for RB offsets at the upper edge, middle and lower edge of each required test channel.
12. Per KDB 941225 D05v02r03, 50% RB allocation for QPSK SAR testing follows 1RB QPSK allocation procedure.
13. Per KDB 941225 D05v02r03, For QPSK with 100% RB allocation, SAR is not required when the highest maximum output power for 100 % RB allocation is less than the highest maximum output power in 50% and 1 RB allocations and the highest reported SAR for 1 RB and 50% RB allocation are  $\leq 0.8$  W/kg. Otherwise, SAR is measured for the highest output power channel; and if the reported SAR is  $> 1.45$  W/kg, the remaining required test channels must also be tested.
14. Per KDB 941225 D05v02r03, 16QAM output power for each RB allocation configuration is  $>$  not  $\frac{1}{2}$  dB higher than the same configuration in QPSK and the reported SAR for the QPSK configuration is  $\leq 1.45$  W/kg; Per KDB 941225 D05v02r03, 16QAM SAR testing is not required.
15. Per KDB 941225 D05v02r03, Smaller bandwidth output power for each RB allocation configuration is  $>$  not  $\frac{1}{2}$  dB higher than the same configuration in the largest supported bandwidth, and the reported SAR for the largest supported bandwidth is  $\leq 1.45$  W/kg; Per KDB 941225 D05v02r03, smaller bandwidth SAR testing is not required.



15.1 Head SAR

<GSM SAR>

Plot No.	Band	Modulation	Mode	Test Position	Ch.	Freq. (MHz)	Average Power (dBm)	Tune-Up Limit (dBm)	Tune-up Scaling Factor	Power Drift (dB)	Measured 1g SAR (W/kg)	Reported 1g SAR (W/kg)	Measured 10g SAR (W/kg)	Reported 10g SAR (W/kg)
1	GSM850	GMSK	GPRS (4 Tx slots)	Right Cheek	128	824.2	28.66	29.00	1.081	0.04	0.195	<b>0.211</b>	0.150	<b>0.162</b>
	GSM850	GMSK	GPRS (4 Tx slots)	Right Tilted	128	824.2	28.66	29.00	1.081	0.06	0.103	0.111	0.081	0.088
	GSM850	GMSK	GPRS (4 Tx slots)	Left Cheek	128	824.2	28.66	29.00	1.081	0.09	0.158	0.171	0.122	0.132
	GSM850	GMSK	GPRS (4 Tx slots)	Left Tilted	128	824.2	28.66	29.00	1.081	0.04	0.096	0.104	0.075	0.081
	GSM1900	GMSK	GPRS (4 Tx slots)	Right Cheek	512	1850.2	24.49	25.00	1.125	-0.13	0.098	0.110	0.061	0.069
	GSM1900	GMSK	GPRS (4 Tx slots)	Right Tilted	512	1850.2	24.49	25.00	1.125	0.19	0.034	0.038	0.019	0.021
2	GSM1900	GMSK	GPRS (4 Tx slots)	Left Cheek	512	1850.2	24.49	25.00	1.125	-0.09	0.101	<b>0.114</b>	0.062	<b>0.070</b>
	GSM1900	GMSK	GPRS (4 Tx slots)	Left Tilted	512	1850.2	24.49	25.00	1.125	0.14	0.055	0.062	0.033	0.037

<WCDMA SAR>

Plot No.	Band	Modulation	Mode	Test Position	Ch.	Freq. (MHz)	Average Power (dBm)	Tune-Up Limit (dBm)	Tune-up Scaling Factor	Power Drift (dB)	Measured 1g SAR (W/kg)	Reported 1g SAR (W/kg)	Measured 10g SAR (W/kg)	Reported 10g SAR (W/kg)
3	WCDMA V	QPSK	RMC 12.2Kbps	Right Cheek	4182	836.4	23.99	24.00	1.002	0.1	0.267	<b>0.268</b>	0.202	<b>0.202</b>
	WCDMA V	QPSK	RMC 12.2Kbps	Right Tilted	4182	836.4	23.99	24.00	1.002	-0.01	0.124	0.124	0.097	0.097
	WCDMA V	QPSK	RMC 12.2Kbps	Left Cheek	4182	836.4	23.99	24.00	1.002	0.07	0.204	0.204	0.158	0.158
	WCDMA V	QPSK	RMC 12.2Kbps	Left Tilted	4182	836.4	23.99	24.00	1.002	0.06	0.122	0.122	0.095	0.095
4	WCDMA II	QPSK	RMC 12.2Kbps	Right Cheek	9262	1852.4	22.50	22.50	1.000	-0.15	0.166	<b>0.166</b>	0.103	<b>0.103</b>
	WCDMA II	QPSK	RMC 12.2Kbps	Right Tilted	9262	1852.4	22.50	22.50	1.000	0.12	0.054	0.054	0.031	0.031
	WCDMA II	QPSK	RMC 12.2Kbps	Left Cheek	9262	1852.4	22.50	22.50	1.000	-0.03	0.163	0.163	0.101	0.101
	WCDMA II	QPSK	RMC 12.2Kbps	Left Tilted	9262	1852.4	22.50	22.50	1.000	0.08	0.097	0.097	0.060	0.060

<LTE SAR>

Plot No.	Band	BW (MHz)	Modulation	RB Size	RB offset	Test Position	Ch.	Freq. (MHz)	Average Power (dBm)	Tune-Up Limit (dBm)	Tune-up Scaling Factor	Power Drift (dB)	Measured 1g SAR (W/kg)	Reported 1g SAR (W/kg)	Measured 10g SAR (W/kg)	Reported 10g SAR (W/kg)
5	LTE Band 5	10M	QPSK	1RB	0Offset	Right Cheek	20525	836.5	23.73	24.00	1.064	-0.04	0.152	<b>0.162</b>	0.116	<b>0.123</b>
	LTE Band 5	10M	QPSK	25RB	0Offset	Right Cheek	20525	836.5	22.63	23.00	1.089	0.04	0.121	0.132	0.093	0.101
	LTE Band 5	10M	QPSK	1RB	0Offset	Right Tilted	20525	836.5	23.73	24.00	1.064	-0.01	0.069	0.073	0.054	0.057
	LTE Band 5	10M	QPSK	25RB	0Offset	Right Tilted	20525	836.5	22.63	23.00	1.089	-0.02	0.055	0.060	0.044	0.048
	LTE Band 5	10M	QPSK	1RB	0Offset	Left Cheek	20525	836.5	23.73	24.00	1.064	0.08	0.102	0.109	0.080	0.085
	LTE Band 5	10M	QPSK	25RB	0Offset	Left Cheek	20525	836.5	22.63	23.00	1.089	0.19	0.083	0.090	0.065	0.071
	LTE Band 5	10M	QPSK	1RB	0Offset	Left Tilted	20525	836.5	23.73	24.00	1.064	-0.03	0.062	0.066	0.048	0.051
	LTE Band 5	10M	QPSK	25RB	0Offset	Left Tilted	20525	836.5	22.63	23.00	1.089	0.14	0.050	0.054	0.039	0.042
6	LTE Band 7	20M	QPSK	1RB	0Offset	Right Cheek	21350	2560	22.33	22.50	1.040	-0.13	0.172	0.179	0.091	0.095
	LTE Band 7	20M	QPSK	50RB	0Offset	Right Cheek	21350	2560	21.37	21.50	1.030	-0.01	0.132	0.136	0.069	0.071
	LTE Band 7	20M	QPSK	1RB	0Offset	Right Tilted	21350	2560	22.33	22.50	1.040	-0.19	0.098	0.102	0.050	0.052
	LTE Band 7	20M	QPSK	50RB	0Offset	Right Tilted	21350	2560	21.37	21.50	1.030	0.07	0.078	0.080	0.039	0.040
	LTE Band 7	20M	QPSK	1RB	0Offset	Left Cheek	21350	2560	22.33	22.50	1.040	0.09	0.241	<b>0.251</b>	0.149	<b>0.155</b>
	LTE Band 7	20M	QPSK	50RB	0Offset	Left Cheek	21350	2560	21.37	21.50	1.030	0.06	0.233	0.240	0.119	0.123
	LTE Band 7	20M	QPSK	1RB	0Offset	Left Tilted	21350	2560	22.33	22.50	1.040	0.01	0.095	0.099	0.047	0.049
	LTE Band 7	20M	QPSK	50RB	0Offset	Left Tilted	21350	2560	21.37	21.50	1.030	0	0.070	0.072	0.035	0.036





<WLAN SAR>

Plot No.	Band	Modulation	Mode	Test Position	Ch.	Freq. (MHz)	Average Power (dBm)	Tune-Up Limit (dBm)	Tune-up Scaling Factor	Duty Cycle %	Duty Cycle Scaling Factor	Power Drift (dB)	Measured 1g SAR (W/kg)	Reported 1g SAR (W/kg)	Measured 10g SAR (W/kg)	Reported 10g SAR (W/kg)
	WLAN2.4GHz	DBPSK	802.11b 1Mbps	Right Cheek	11	2462	16.89	17.00	1.025	98.14	1.019	0.05	0.488	0.510	0.243	0.254
	WLAN2.4GHz	DBPSK	802.11b 1Mbps	Right Tilted	11	2462	16.89	17.00	1.025	98.14	1.019	0.06	0.438	0.458	0.214	0.224
7	WLAN2.4GHz	DBPSK	802.11b 1Mbps	Left Cheek	11	2462	16.89	17.00	1.025	98.14	1.019	-0.01	0.904	0.944	0.466	0.487
	WLAN2.4GHz	DBPSK	802.11b 1Mbps	Left Cheek	1	2412	16.63	17.00	1.089	98.14	1.019	0.03	0.457	0.507	0.238	0.264
	WLAN2.4GHz	DBPSK	802.11b 1Mbps	Left Cheek	6	2437	16.70	17.00	1.071	98.14	1.019	0.05	0.693	0.756	0.363	0.396
	WLAN2.4GHz	OFDM	802.11n-HT40 MCS0	Left Cheek	3	2422	11.25	11.50	1.060	79.13	1.264	0.03	0.143	0.192	0.071	0.095
	WLAN2.4GHz	DBPSK	802.11b 1Mbps	Left Tilted	11	2462	16.89	17.00	1.025	98.14	1.019	0.07	0.834	0.871	0.382	0.399
	WLAN2.4GHz	DBPSK	802.11b 1Mbps	Left Tilted	1	2412	16.63	17.00	1.089	98.14	1.019	0.1	0.466	0.517	0.214	0.237
	WLAN2.4GHz	DBPSK	802.11b 1Mbps	Left Tilted	6	2437	16.70	17.00	1.071	98.14	1.019	0.08	0.669	0.730	0.308	0.336
	WLAN5GHz	OFDM	802.11a 6Mbps	Right Cheek	48	5240	13.84	14.00	1.037	89.10	1.122	0	0.145	0.169	0.043	0.050
	WLAN5GHz	OFDM	802.11a 6Mbps	Right Tilted	48	5240	13.84	14.00	1.037	89.10	1.122	0.02	0.135	0.157	0.040	0.047
8	WLAN5GHz	OFDM	802.11a 6Mbps	Left Cheek	48	5240	13.84	14.00	1.037	89.10	1.122	-0.11	0.456	0.531	0.146	0.170
	WLAN5GHz	OFDM	802.11a 6Mbps	Left Cheek	40	5200	13.68	14.00	1.076	89.10	1.122	-0.16	0.362	0.437	0.110	0.133
	WLAN5GHz	OFDM	802.11n-HT40 MCS0	Left Cheek	38	5190	11.46	11.50	1.010	79.27	1.262	-0.17	0.160	0.204	0.045	0.057
	WLAN5GHz	OFDM	802.11a 6Mbps	Left Tilted	48	5240	13.84	14.00	1.037	89.10	1.122	0.11	0.275	0.320	0.081	0.094
	WLAN5GHz	OFDM	802.11a 6Mbps	Right Cheek	64	5320	13.94	14.00	1.014	89.10	1.122	0.17	0.154	0.175	0.045	0.051
	WLAN5GHz	OFDM	802.11a 6Mbps	Right Tilted	64	5320	13.94	14.00	1.014	89.10	1.122	-0.01	0.109	0.124	0.034	0.039
9	WLAN5GHz	OFDM	802.11a 6Mbps	Left Cheek	64	5320	13.94	14.00	1.014	89.10	1.122	-0.03	0.555	0.631	0.169	0.192
	WLAN5GHz	OFDM	802.11a 6Mbps	Left Cheek	56	5280	13.61	14.00	1.094	89.10	1.122	0.19	0.479	0.588	0.150	0.184
	WLAN5GHz	OFDM	802.11n-HT40 MCS0	Left Cheek	54	5270	11.49	11.50	1.003	79.27	1.262	0.16	0.207	0.262	0.065	0.082
	WLAN5GHz	OFDM	802.11a 6Mbps	Left Tilted	64	5320	13.94	14.00	1.014	89.10	1.122	-0.03	0.215	0.245	0.073	0.083
	WLAN5GHz	OFDM	802.11a 6Mbps	Right Cheek	132	5660	13.94	14.00	1.014	89.10	1.122	0.05	0.364	0.414	0.088	0.100
	WLAN5GHz	OFDM	802.11a 6Mbps	Right Cheek	108	5540	13.71	14.00	1.069	89.10	1.122	0.07	0.213	0.255	0.057	0.068
	WLAN5GHz	OFDM	802.11a 6Mbps	Right Cheek	116	5580	13.64	14.00	1.086	89.10	1.122	0.05	0.226	0.275	0.059	0.072
	WLAN5GHz	OFDM	802.11a 6Mbps	Right Tilted	132	5660	13.94	14.00	1.014	89.10	1.122	0.06	0.332	0.378	0.074	0.084
10	WLAN5GHz	OFDM	802.11a 6Mbps	Left Cheek	132	5660	13.94	14.00	1.014	89.10	1.122	-0.18	0.837	0.952	0.256	0.291
	WLAN5GHz	OFDM	802.11a 6Mbps	Left Cheek	108	5540	13.71	14.00	1.069	89.10	1.122	-0.13	0.729	0.874	0.221	0.265
	WLAN5GHz	OFDM	802.11a 6Mbps	Left Cheek	116	5580	13.64	14.00	1.086	89.10	1.122	0	0.734	0.894	0.218	0.266
	WLAN5GHz	OFDM	802.11n-HT40 MCS0	Left Cheek	134	5670	11.45	11.50	1.012	79.27	1.262	-0.11	0.355	0.453	0.103	0.132
	WLAN5GHz	OFDM	802.11a 6Mbps	Left Tilted	132	5660	13.94	14.00	1.014	89.10	1.122	0.13	0.457	0.520	0.128	0.146
	WLAN5GHz	OFDM	802.11a 6Mbps	Left Tilted	108	5540	13.71	14.00	1.069	89.10	1.122	0.06	0.364	0.437	0.096	0.115
	WLAN5GHz	OFDM	802.11a 6Mbps	Left Tilted	116	5580	13.64	14.00	1.086	89.10	1.122	-0.01	0.395	0.481	0.104	0.127
	WLAN5GHz	OFDM	802.11a 6Mbps	Right Cheek	153	5765	13.83	14.00	1.040	89.10	1.122	0	0.469	0.547	0.142	0.166
	WLAN5GHz	OFDM	802.11a 6Mbps	Right Tilted	153	5765	13.83	14.00	1.040	89.10	1.122	0.06	0.443	0.517	0.130	0.152
11	WLAN5GHz	OFDM	802.11a 6Mbps	Left Cheek	153	5765	13.83	14.00	1.040	89.10	1.122	-0.05	0.632	0.737	0.199	0.232
	WLAN5GHz	OFDM	802.11a 6Mbps	Left Cheek	157	5785	13.80	14.00	1.047	89.10	1.122	-0.13	0.622	0.731	0.197	0.231
	WLAN5GHz	OFDM	802.11a 6Mbps	Left Cheek	161	5805	13.78	14.00	1.052	89.10	1.122	-0.17	0.575	0.679	0.183	0.216
	WLAN5GHz	OFDM	802.11n-HT40 MCS0	Left Cheek	159	5795	11.25	11.50	1.059	79.27	1.262	-0.03	0.252	0.337	0.077	0.103
	WLAN5GHz	OFDM	802.11a 6Mbps	Left Tilted	153	5765	13.83	14.00	1.040	89.10	1.122	0.1	0.415	0.484	0.109	0.127



**15.2 Hotspot SAR**

**<GSM SAR>**

Plot No.	Band	Modulation	Mode	Test Position	Gap (cm)	Ch.	Freq. (MHz)	Average Power (dBm)	Tune-Up Limit (dBm)	Tune-up Scaling Factor	Power Drift (dB)	Measured 1g SAR (W/kg)	Reported 1g SAR (W/kg)	Measured 10g SAR (W/kg)	Reported 10g SAR (W/kg)
	GSM850	GMSK	GPRS (4 Tx slots)	Front	1cm	128	824.2	28.66	29.00	1.081	0.05	0.267	0.289	0.207	0.224
12	GSM850	GMSK	GPRS (4 Tx slots)	Back	1cm	128	824.2	28.66	29.00	1.081	-0.09	0.465	0.503	0.358	0.387
	GSM850	GMSK	GPRS (4 Tx slots)	Left Side	1cm	128	824.2	28.66	29.00	1.081	-0.07	0.114	0.123	0.079	0.085
	GSM850	GMSK	GPRS (4 Tx slots)	Right Side	1cm	128	824.2	28.66	29.00	1.081	-0.07	0.251	0.271	0.174	0.188
	GSM850	GMSK	GPRS (4 Tx slots)	Bottom Side	1cm	128	824.2	28.66	29.00	1.081	-0.01	0.122	0.132	0.065	0.070
	GSM1900	GMSK	GPRS (4 Tx slots)	Front	1cm	512	1850.2	24.49	25.00	1.125	-0.02	0.338	0.380	0.183	0.206
	GSM1900	GMSK	GPRS (4 Tx slots)	Back	1cm	512	1850.2	24.49	25.00	1.125	0.01	0.508	0.571	0.267	0.300
	GSM1900	GMSK	GPRS (4 Tx slots)	Left Side	1cm	512	1850.2	24.49	25.00	1.125	0.17	0.087	0.098	0.051	0.057
	GSM1900	GMSK	GPRS (4 Tx slots)	Right Side	1cm	512	1850.2	24.49	25.00	1.125	0.1	0.063	0.071	0.037	0.042
13	GSM1900	GMSK	GPRS (4 Tx slots)	Bottom Side	1cm	512	1850.2	24.49	25.00	1.125	-0.06	0.885	0.995	0.444	0.499
	GSM1900	GMSK	GPRS (4 Tx slots)	Bottom Side	1cm	661	1880	24.43	25.00	1.140	-0.08	0.687	0.783	0.342	0.390
	GSM1900	GMSK	GPRS (4 Tx slots)	Bottom Side	1cm	810	1909.8	24.40	25.00	1.148	-0.1	0.584	0.671	0.290	0.333

**<WCDMA SAR>**

Plot No.	Band	Modulation	Mode	Test Position	Gap (cm)	Ch.	Freq. (MHz)	Average Power (dBm)	Tune-Up Limit (dBm)	Tune-up Scaling Factor	Power Drift (dB)	Measured 1g SAR (W/kg)	Reported 1g SAR (W/kg)	Measured 10g SAR (W/kg)	Reported 10g SAR (W/kg)
	WCDMA V	QPSK	RMC 12.2Kbps	Front	1cm	4182	836.4	23.99	24.00	1.002	0.01	0.280	0.281	0.218	0.219
	WCDMA V	QPSK	RMC 12.2Kbps	Back	1cm	4182	836.4	23.99	24.00	1.002	-0.04	0.382	0.383	0.221	0.222
	WCDMA V	QPSK	RMC 12.2Kbps	Left Side	1cm	4182	836.4	23.99	24.00	1.002	0	0.248	0.249	0.171	0.171
14	WCDMA V	QPSK	RMC 12.2Kbps	Right Side	1cm	4182	836.4	23.99	24.00	1.002	-0.03	0.413	0.414	0.287	0.288
	WCDMA V	QPSK	RMC 12.2Kbps	Bottom Side	1cm	4182	836.4	23.99	24.00	1.002	-0.1	0.149	0.149	0.080	0.080
	WCDMA II	QPSK	RMC 12.2Kbps	Front	1cm	9262	1852.4	22.50	22.50	1.000	-0.07	0.595	0.595	0.320	0.320
	WCDMA II	QPSK	RMC 12.2Kbps	Back	1cm	9262	1852.4	22.50	22.50	1.000	0.01	0.843	0.843	0.441	0.441
	WCDMA II	QPSK	RMC 12.2Kbps	Back	1cm	9400	1880	22.45	22.50	1.012	0.01	0.769	0.778	0.401	0.406
	WCDMA II	QPSK	RMC 12.2Kbps	Back	1cm	9538	1907.6	22.48	22.50	1.005	0.04	0.696	0.699	0.363	0.365
	WCDMA II	QPSK	RMC 12.2Kbps	Left Side	1cm	9262	1852.4	22.50	22.50	1.000	0.04	0.173	0.173	0.103	0.103
	WCDMA II	QPSK	RMC 12.2Kbps	Right Side	1cm	9262	1852.4	22.50	22.50	1.000	-0.13	0.126	0.126	0.076	0.076
15	WCDMA II	QPSK	RMC 12.2Kbps	Bottom Side	1cm	9262	1852.4	22.50	22.50	1.000	-0.01	1.140	1.140	0.581	0.581
	WCDMA II	QPSK	RMC 12.2Kbps	Bottom Side	1cm	9400	1880	22.45	22.50	1.012	-0.14	1.060	1.072	0.540	0.546
	WCDMA II	QPSK	RMC 12.2Kbps	Bottom Side	1cm	9538	1907.6	22.48	22.50	1.005	0.01	1.010	1.015	0.513	0.515



<LTE SAR>

Plot No.	Band	BW (MHz)	Modulation	RB Size	RB offset	Test Position	Gap (cm)	Power Reduction	Ch.	Freq. (MHz)	Average Power (dBm)	Tune-Up Limit (dBm)	Tune-up Scaling Factor	Power Drift (dB)	Measured 1g SAR (W/kg)	Reported 1g SAR (W/kg)	Measured 10g SAR (W/kg)	Reported 10g SAR (W/kg)
	LTE Band 5	10M	QPSK	1RB	0Offset	Front	1cm		20525	836.5	23.73	24.00	1.064	-0.04	0.211	0.225	0.166	0.177
	LTE Band 5	10M	QPSK	25RB	0Offset	Front	1cm		20525	836.5	22.63	23.00	1.089	0.01	0.184	0.200	0.144	0.157
16	LTE Band 5	10M	QPSK	1RB	0Offset	Back	1cm		20525	836.5	23.73	24.00	1.064	-0.04	0.360	0.383	0.278	0.296
	LTE Band 5	10M	QPSK	25RB	0Offset	Back	1cm		20525	836.5	22.63	23.00	1.089	-0.12	0.294	0.320	0.218	0.237
	LTE Band 5	10M	QPSK	1RB	0Offset	Left Side	1cm		20525	836.5	23.73	24.00	1.064	0	0.139	0.148	0.096	0.102
	LTE Band 5	10M	QPSK	25RB	0Offset	Left Side	1cm		20525	836.5	22.63	23.00	1.089	-0.03	0.112	0.122	0.077	0.084
	LTE Band 5	10M	QPSK	1RB	0Offset	Right Side	1cm		20525	836.5	23.73	24.00	1.064	-0.14	0.254	0.270	0.177	0.188
	LTE Band 5	10M	QPSK	25RB	0Offset	Right Side	1cm		20525	836.5	22.63	23.00	1.089	-0.03	0.198	0.216	0.137	0.149
	LTE Band 5	10M	QPSK	1RB	0Offset	Bottom Side	1cm		20525	836.5	23.73	24.00	1.064	-0.17	0.132	0.140	0.071	0.076
	LTE Band 5	10M	QPSK	25RB	0Offset	Bottom Side	1cm		20525	836.5	22.63	23.00	1.089	-0.12	0.109	0.119	0.059	0.064
	LTE Band 7	20M	QPSK	1RB	0offset	Front	1cm	ON	21350	2560	18.34	19.00	1.164	-0.11	0.222	0.258	0.103	0.120
	LTE Band 7	20M	QPSK	50RB	0offset	Front	1cm	ON	21350	2560	18.33	19.00	1.167	-0.02	0.228	0.266	0.104	0.121
	LTE Band 7	20M	QPSK	1RB	0offset	Back	1cm	ON	21350	2560	18.34	19.00	1.164	-0.05	0.777	0.905	0.347	0.404
	LTE Band 7	20M	QPSK	1RB	0offset	Back	1cm	ON	20850	2510	18.28	19.00	1.180	-0.05	0.617	0.728	0.281	0.332
	LTE Band 7	20M	QPSK	1RB	0offset	Back	1cm	ON	21100	2535	18.25	19.00	1.189	-0.06	0.609	0.724	0.275	0.327
	LTE Band 7	20M	QPSK	50RB	0offset	Back	1cm	ON	21350	2560	18.33	19.00	1.167	-0.05	0.797	0.930	0.355	0.414
	LTE Band 7	20M	QPSK	50RB	0offset	Back	1cm	ON	20850	2510	18.27	19.00	1.183	0.02	0.504	0.596	0.227	0.269
	LTE Band 7	20M	QPSK	50RB	0offset	Back	1cm	ON	21100	2535	18.15	19.00	1.216	-0.03	0.515	0.626	0.231	0.281
	LTE Band 7	20M	QPSK	100RB	0offset	Back	1cm	ON	21350	2560	18.30	19.00	1.175	-0.07	0.791	0.929	0.348	0.409
	LTE Band 7	20M	QPSK	1RB	0offset	Left Side	1cm	ON	21350	2560	18.34	19.00	1.164	0.11	0.135	0.157	0.069	0.080
	LTE Band 7	20M	QPSK	50RB	0offset	Left Side	1cm	ON	21350	2560	18.33	19.00	1.167	0.16	0.136	0.159	0.070	0.082
	LTE Band 7	20M	QPSK	1RB	0offset	Right Side	1cm	ON	21350	2560	18.34	19.00	1.164	0.14	0.055	0.064	0.028	0.033
	LTE Band 7	20M	QPSK	50RB	0offset	Right Side	1cm	ON	21350	2560	18.33	19.00	1.167	0.01	0.057	0.067	0.028	0.033
	LTE Band 7	20M	QPSK	1RB	0offset	Bottom Side	1cm	ON	21350	2560	18.34	19.00	1.164	-0.18	0.821	0.956	0.355	0.413
	LTE Band 7	20M	QPSK	1RB	0offset	Bottom Side	1cm	ON	20850	2510	18.28	19.00	1.180	-0.08	0.558	0.659	0.257	0.303
	LTE Band 7	20M	QPSK	1RB	0offset	Bottom Side	1cm	ON	21100	2535	18.25	19.00	1.189	-0.05	0.647	0.769	0.284	0.338
17	LTE Band 7	20M	QPSK	50RB	0offset	Bottom Side	1cm	ON	21350	2560	18.33	19.00	1.167	-0.05	0.830	0.968	0.362	0.422
	LTE Band 7	20M	QPSK	50RB	0offset	Bottom Side	1cm	ON	20850	2510	18.27	19.00	1.183	0.02	0.544	0.644	0.237	0.280
	LTE Band 7	20M	QPSK	50RB	0offset	Bottom Side	1cm	ON	21100	2535	18.15	19.00	1.216	0.04	0.559	0.680	0.245	0.298
	LTE Band 7	20M	QPSK	100RB	0offset	Bottom Side	1cm	ON	21350	2560	18.30	19.00	1.175	0.02	0.802	0.942	0.352	0.414

<WLAN SAR>

Plot No.	Band	Modulation	Mode	Test Position	Gap (cm)	Ch.	Freq. (MHz)	Average Power (dBm)	Tune-Up Limit (dBm)	Tune-up Scaling Factor	Duty Cycle %	Duty Cycle Scaling Factor	Power Drift (dB)	Measured 1g SAR (W/kg)	Reported 1g SAR (W/kg)	Measured 10g SAR (W/kg)	Reported 10g SAR (W/kg)
	WLAN2.4GHz	DBPSK	802.11b 1Mbps	Front	1cm	11	2462	16.89	17.00	1.025	98.14	1.019	0.02	0.186	0.194	0.104	0.109
18	WLAN2.4GHz	DBPSK	802.11b 1Mbps	Back	1cm	11	2462	16.89	17.00	1.025	98.14	1.019	-0.02	0.247	0.258	0.121	0.126
	WLAN2.4GHz	DBPSK	802.11b 1Mbps	Back	1cm	1	2412	16.63	17.00	1.089	98.14	1.019	0.06	0.130	0.144	0.056	0.062
	WLAN2.4GHz	DBPSK	802.11b 1Mbps	Back	1cm	6	2437	16.70	17.00	1.071	98.14	1.019	0.14	0.199	0.217	0.094	0.103
	WLAN2.4GHz	OFDM	802.11n-HT40 MCS0	Back	1cm	3	2422	11.25	11.50	1.060	79.13	1.264	0.14	0.045	0.060	0.019	0.025
	WLAN2.4GHz	DBPSK	802.11b 1Mbps	Right Side	1cm	11	2462	16.89	17.00	1.025	98.14	1.019	0.08	0.125	0.131	0.052	0.054
	WLAN2.4GHz	DBPSK	802.11b 1Mbps	Top Side	1cm	11	2462	16.89	17.00	1.025	98.14	1.019	0.17	0.174	0.182	0.091	0.095
	WLAN5GHz	OFDM	802.11a 6Mbps	Front	1cm	48	5240	13.84	14.00	1.037	89.10	1.122	-0.16	0.051	0.059	0.018	0.021
	WLAN5GHz	OFDM	802.11a 6Mbps	Back	1cm	48	5240	13.84	14.00	1.037	89.10	1.122	-0.01	0.166	0.193	0.043	0.050
19	WLAN5GHz	OFDM	802.11a 6Mbps	Right Side	1cm	48	5240	13.84	14.00	1.037	89.10	1.122	-0.02	0.170	0.198	0.062	0.072
	WLAN5GHz	OFDM	802.11a 6Mbps	Right Side	1cm	40	5240	13.68	14.00	1.076	89.10	1.122	-0.04	0.152	0.184	0.056	0.068
	WLAN5GHz	OFDM	802.11n-HT40 MCS0	Right Side	1cm	38	5190	11.46	11.50	1.010	79.27	1.262	0.13	0.064	0.082	0.022	0.028
	WLAN5GHz	OFDM	802.11a 6Mbps	Top Side	1cm	48	5240	13.84	14.00	1.037	89.10	1.122	0.06	0.074	0.086	0.025	0.029



**15.3 Extremity SAR**

**<LTE SAR>**

Plot No.	Band	BW (MHz)	Modulation	RB Size	RB offset	Test Position	Gap (cm)	Power Reduction	Ch.	Freq. (MHz)	Average Power (dBm)	Tune-Up Limit (dBm)	Tune-up Scaling Factor	Power Drift (dB)	Measured 1g SAR (W/kg)	Reported 1g SAR (W/kg)	Measured 10g SAR (W/kg)	Reported 10g SAR (W/kg)
20	LTE Band 7	20M	QPSK	1RB	0offset	Back	0cm	OFF	21350	2560	22.33	22.50	1.040	-0.12	8.100	8.423	3.050	<b>3.172</b>
	LTE Band 7	20M	QPSK	1RB	0offset	Back	0cm	OFF	20850	2510	22.32	22.50	1.042	-0.06	7.560	7.880	2.920	3.044
	LTE Band 7	20M	QPSK	1RB	0offset	Back	0cm	OFF	21100	2535	22.27	22.50	1.054	-0.01	7.110	7.497	2.810	2.963
	LTE Band 7	20M	QPSK	50RB	0offset	Back	0cm	OFF	21350	2560	21.37	21.50	1.030	0	6.600	6.801	2.470	2.545
	LTE Band 7	20M	QPSK	50RB	0offset	Back	0cm	OFF	20850	2510	21.30	21.50	1.047	-0.03	6.410	6.712	2.410	2.524
	LTE Band 7	20M	QPSK	50RB	0offset	Back	0cm	OFF	21100	2535	21.20	21.50	1.072	-0.02	5.830	6.247	2.270	2.432
	LTE Band 7	20M	QPSK	100RB	0offset	Back	0cm	OFF	21350	2560	21.33	21.50	1.040	-0.01	6.640	6.905	2.470	2.569
	LTE Band 7	20M	QPSK	1RB	0offset	Bottom Side	0cm	OFF	21350	2560	22.33	22.50	1.040	-0.14	7.050	7.331	2.590	2.693
	LTE Band 7	20M	QPSK	1RB	0offset	Bottom Side	0cm	OFF	20850	2510	22.32	22.50	1.042	-0.16	6.960	7.255	2.530	2.637
	LTE Band 7	20M	QPSK	1RB	0offset	Bottom Side	0cm	OFF	21100	2535	22.27	22.50	1.054	-0.05	6.990	7.370	2.550	2.689
	LTE Band 7	20M	QPSK	50RB	0offset	Bottom Side	0cm	OFF	21350	2560	21.37	21.50	1.030	-0.15	5.700	5.873	2.050	2.112
	LTE Band 7	20M	QPSK	50RB	0offset	Bottom Side	0cm	OFF	20850	2510	21.30	21.50	1.047	-0.04	5.540	5.801	2.020	2.115
	LTE Band 7	20M	QPSK	50RB	0offset	Bottom Side	0cm	OFF	21100	2535	21.20	21.50	1.072	-0.03	5.480	5.872	1.990	2.132
	LTE Band 7	20M	QPSK	100RB	0offset	Bottom Side	0cm	OFF	21350	2560	21.33	21.50	1.040	-0.09	5.720	5.948	2.060	2.142

**15.4 Body Worn Accessory SAR**

**<GSM SAR>**

Plot No.	Band	Modulation	Mode	Test Position	Gap (cm)	Ch.	Freq. (MHz)	Average Power (dBm)	Tune-Up Limit (dBm)	Tune-up Scaling Factor	Power Drift (dB)	Measured 1g SAR (W/kg)	Reported 1g SAR (W/kg)	Measured 10g SAR (W/kg)	Reported 10g SAR (W/kg)
	GSM850	GMSK	GPRS (4 Tx slots)	Front	1.5cm	128	824.2	28.66	29.00	1.081	0.02	0.239	0.258	0.187	0.202
21	GSM850	GMSK	GPRS (4 Tx slots)	Back	1.5cm	128	824.2	28.66	29.00	1.081	-0.07	0.398	<b>0.430</b>	0.309	<b>0.334</b>
	GSM1900	GMSK	GPRS (4 Tx slots)	Front	1.5cm	512	1850.2	24.49	25.00	1.125	-0.05	0.160	0.180	0.094	0.106
22	GSM1900	GMSK	GPRS (4 Tx slots)	Back	1.5cm	512	1850.2	24.49	25.00	1.125	0	0.223	<b>0.251</b>	0.127	<b>0.143</b>

**<WCDMA SAR>**

Plot No.	Band	Modulation	Mode	Test Position	Gap (cm)	Ch.	Freq. (MHz)	Average Power (dBm)	Tune-Up Limit (dBm)	Tune-up Scaling Factor	Power Drift (dB)	Measured 1g SAR (W/kg)	Reported 1g SAR (W/kg)	Measured 10g SAR (W/kg)	Reported 10g SAR (W/kg)
	WCDMA V	QPSK	RMC 12.2Kbps	Front	1.5cm	4182	836.4	23.99	24.00	1.002	-0.03	0.252	0.253	0.196	0.196
23	WCDMA V	QPSK	RMC 12.2Kbps	Back	1.5cm	4182	836.4	23.99	24.00	1.002	-0.02	0.377	<b>0.378</b>	0.292	<b>0.293</b>
	WCDMA II	QPSK	RMC 12.2Kbps	Front	1.5cm	9262	1852.4	22.50	22.50	1.000	0.01	0.276	0.276	0.161	0.161
24	WCDMA II	QPSK	RMC 12.2Kbps	Back	1.5cm	9262	1852.4	22.50	22.50	1.000	0	0.360	<b>0.360</b>	0.205	<b>0.205</b>



<LTE SAR>

Plot No.	Band	BW (MHz)	Modulation	RB Size	RB offset	Test Position	Gap (cm)	Ch.	Freq. (MHz)	Average Power (dBm)	Tune-Up Limit (dBm)	Tune-up Scaling Factor	Power Drift (dB)	Measured 1g SAR (W/kg)	Reported 1g SAR (W/kg)	Measured 10g SAR (W/kg)	Reported 10g SAR (W/kg)
	LTE Band 5	10M	QPSK	1RB	0Offset	Front	1.5cm	20525	836.5	23.73	24.00	1.064	-0.05	0.167	0.178	0.129	0.137
	LTE Band 5	10M	QPSK	25RB	0Offset	Front	1.5cm	20525	836.5	22.63	23.00	1.089	-0.13	0.109	0.119	0.084	0.091
25	LTE Band 5	10M	QPSK	1RB	0Offset	Back	1.5cm	20525	836.5	23.73	24.00	1.064	-0.01	0.290	0.309	0.224	0.238
	LTE Band 5	10M	QPSK	25RB	0Offset	Back	1.5cm	20525	836.5	22.63	23.00	1.089	-0.01	0.216	0.235	0.166	0.181
	LTE Band 7	20M	QPSK	1RB	0offset	Front	1.5cm	21350	2560	22.33	22.50	1.040	-0.01	0.269	0.280	0.134	0.139
	LTE Band 7	20M	QPSK	50RB	0offset	Front	1.5cm	21350	2560	21.37	21.50	1.030	0.02	0.220	0.227	0.110	0.113
26	LTE Band 7	20M	QPSK	1RB	0offset	Back	1.5cm	21350	2560	22.33	22.50	1.040	-0.18	0.913	0.949	0.430	0.447
	LTE Band 7	20M	QPSK	1RB	0offset	Back	1.5cm	20850	2510	22.32	22.50	1.042	0.08	0.563	0.587	0.271	0.282
	LTE Band 7	20M	QPSK	1RB	0offset	Back	1.5cm	21100	2535	22.27	22.50	1.054	0.08	0.586	0.618	0.296	0.312
	LTE Band 7	20M	QPSK	50RB	0offset	Back	1.5cm	21350	2560	21.37	21.50	1.030	0.13	0.729	0.751	0.345	0.355
	LTE Band 7	20M	QPSK	100RB	0offset	Back	1.5cm	21350	2560	21.33	21.50	1.040	-0.06	0.713	0.741	0.340	0.354

<WLAN SAR>

Plot No.	Band	Modulation	Mode	Test Position	Gap (cm)	Ch.	Freq. (MHz)	Average Power (dBm)	Tune-Up Limit (dBm)	Tune-up Scaling Factor	Duty Cycle %	Duty Cycle Scaling Factor	Power Drift (dB)	Measured 1g SAR (W/kg)	Reported 1g SAR (W/kg)	Measured 10g SAR (W/kg)	Reported 10g SAR (W/kg)
	WLAN2.4GHz	DBPSK	802.11b 1Mbps	Front	1.5cm	11	2462	16.89	17.00	1.025	98.14	1.019	0	0.113	0.118	0.059	0.062
27	WLAN2.4GHz	DBPSK	802.11b 1Mbps	Back	1.5cm	11	2462	16.89	17.00	1.025	98.14	1.019	0.03	0.119	0.124	0.063	0.066
	WLAN2.4GHz	DBPSK	802.11b 1Mbps	Back	1.5cm	1	2412	16.63	17.00	1.089	98.14	1.019	0.16	0.049	0.054	0.023	0.026
	WLAN2.4GHz	DBPSK	802.11b 1Mbps	Back	1.5cm	6	2437	16.70	17.00	1.071	98.14	1.019	0.13	0.088	0.096	0.043	0.047
	WLAN2.4GHz	OFDM	802.11n-HT40 MCS0	Back	1.5cm	3	2422	11.25	11.50	1.060	79.13	1.264	0.09	0.014	0.019	0.006	0.007
	WLAN5GHz	OFDM	802.11a 6Mbps	Front	1.5cm	48	5240	13.84	14.00	1.037	89.10	1.122	-0.02	0.031	0.036	0.011	0.013
28	WLAN5GHz	OFDM	802.11a 6Mbps	Back	1.5cm	48	5240	13.84	14.00	1.037	89.10	1.122	-0.07	0.068	0.079	0.020	0.023
	WLAN5GHz	OFDM	802.11a 6Mbps	Back	1.5cm	40	5200	13.68	14.00	1.076	89.10	1.122	0.07	0.057	0.069	0.016	0.019
	WLAN5GHz	OFDM	802.11n-HT40 MCS0	Back	1.5cm	38	5190	11.46	11.50	1.010	79.27	1.262	0.12	0.022	0.028	0.006	0.008
	WLAN5GHz	OFDM	802.11a 6Mbps	Front	1.5cm	64	5320	13.94	14.00	1.014	89.10	1.122	-0.01	0.035	0.040	0.013	0.015
29	WLAN5GHz	OFDM	802.11a 6Mbps	Back	1.5cm	64	5320	13.94	14.00	1.014	89.10	1.122	-0.12	0.076	0.086	0.024	0.027
	WLAN5GHz	OFDM	802.11a 6Mbps	Back	1.5cm	56	5280	13.61	14.00	1.094	89.10	1.122	-0.09	0.069	0.085	0.021	0.026
	WLAN5GHz	OFDM	802.11n-HT40 MCS0	Back	1.5cm	54	5270	11.49	11.50	1.003	79.27	1.262	-0.14	0.032	0.040	0.008	0.011
30	WLAN5GHz	OFDM	802.11a 6Mbps	Front	1.5cm	132	5660	13.94	14.00	1.014	89.10	1.122	0.1	0.089	0.101	0.034	0.039
	WLAN5GHz	OFDM	802.11a 6Mbps	Front	1.5cm	108	5540	13.71	14.00	1.069	89.10	1.122	0.13	0.023	0.028	0.008	0.009
	WLAN5GHz	OFDM	802.11a 6Mbps	Front	1.5cm	116	5580	13.64	14.00	1.086	89.10	1.122	-0.17	0.053	0.065	0.019	0.023
	WLAN5GHz	OFDM	802.11n-HT40 MCS0	Front	1.5cm	134	5670	11.45	11.50	1.012	79.27	1.262	-0.14	0.034	0.043	0.013	0.017
	WLAN5GHz	OFDM	802.11a 6Mbps	Back	1.5cm	132	5660	13.94	14.00	1.014	89.10	1.122	-0.16	0.044	0.050	0.016	0.018
	WLAN5GHz	OFDM	802.11a 6Mbps	Front	1.5cm	153	5765	13.83	14.00	1.040	89.10	1.122	-0.07	0.083	0.097	0.032	0.037
31	WLAN5GHz	OFDM	802.11a 6Mbps	Front	1.5cm	157	5785	13.80	14.00	1.047	89.10	1.122	-0.02	0.096	0.113	0.035	0.041
	WLAN5GHz	OFDM	802.11a 6Mbps	Front	1.5cm	161	5805	13.78	14.00	1.052	89.10	1.122	-0.06	0.072	0.085	0.028	0.033
	WLAN5GHz	OFDM	802.11n-HT40 MCS0	Front	1.5cm	159	5795	11.25	11.50	1.059	79.27	1.262	0.04	0.036	0.048	0.013	0.017
	WLAN5GHz	OFDM	802.11a 6Mbps	Back	1.5cm	153	5765	13.83	14.00	1.040	89.10	1.122	0.09	0.037	0.043	0.013	0.015



**15.5 Repeated SAR Measurement**

**General Note:**

1. Per KDB 865664 D01v01r03, for each frequency band, repeated SAR measurement is required only when the measured SAR is  $\geq 0.8W/kg$ .
2. Per KDB 865664 D01v01r03, if the ratio among the repeated measurement is  $\leq 1.2$  and the measured SAR  $< 1.45W/kg$ , only one repeated measurement is required.
3. Per KDB 865664 D01v01r03, if the extremity repeated SAR is necessary, the same procedures should be adapted for measurements according to extremity and occupational exposure limits by applying a factor of 2.5 for extremity exposure and a factor of 5 for occupational exposure to the corresponding SAR thresholds.
4. The ratio is the difference in percentage between original and repeated *measured SAR*.
5. All measurement SAR result is scaled-up to account for tune-up tolerance and is compliant.

**<1g Repeated SAR>**

No.	Band	Modulation	Mode	Test Position	Gap (cm)	Ch.	Freq. (MHz)	Average Power (dBm)	Tune-Up Limit (dBm)	Tune-up Scaling Factor	Duty Cycle %	Duty Cycle Scaling Factor	Power Drift (dB)	Measured 1g SAR (W/kg)	Ratio	Reported 1g SAR (W/kg)
1st	WLAN2.4GHz	DBPSK	802.11b 1Mbps	Left Cheek	-	11	2462	16.89	17.00	1.025	98.14	1.019	-0.01	0.904	-	0.944
2nd	WLAN2.4GHz	DBPSK	802.11b 1Mbps	Left Cheek	-	11	2462	16.89	17.00	1.025	98.14	1.019	0.02	0.889	1.02	0.929
1st	WLAN5GHz	OFDM	802.11a 6Mbps	Left Cheek	-	132	5660	13.94	14.00	1.014	89.10	1.122	-0.18	0.837	-	0.952
2nd	WLAN5GHz	OFDM	802.11a 6Mbps	Left Cheek	-	132	5660	13.94	14.00	1.014	89.10	1.122	-0.15	0.790	1.06	0.899
1st	WCDMA II	QPSK	RMC 12.2Kbps	Bottom Side	1cm	9262	1852.4	22.50	22.50	1.000	-	-	-0.01	1.140	-	1.140
2nd	WCDMA II	QPSK	RMC 12.2Kbps	Bottom Side	1cm	9262	1852.4	22.50	22.50	1.000	-	-	-0.17	1.130	1.01	1.130

No.	Band	BW (MHz)	Modulation	RB Size	RB offset	Test Position	Gap (cm)	Power Reduction	Ch.	Freq. (MHz)	Average Power (dBm)	Tune-Up Limit (dBm)	Tune-up Scaling Factor	Power Drift (dB)	Measured 1g SAR (W/kg)	Ratio	Reported 1g SAR (W/kg)
1st	LTE Band 7	20M	QPSK	1RB	0offset	Back	1.5cm	OFF	21350	2560	22.33	22.50	1.040	-0.18	0.913	-	0.949
2nd	LTE Band 7	20M	QPSK	1RB	0offset	Back	1.5cm	OFF	21350	2560	22.33	22.50	1.040	-0.02	0.901	1.01	0.937

**<10g Repeated SAR>**

No.	Band	BW (MHz)	Modulation	RB Size	RB offset	Test Position	Gap (cm)	Power Reduction	Ch.	Freq. (MHz)	Average Power (dBm)	Tune-Up Limit (dBm)	Tune-up Scaling Factor	Power Drift (dB)	Measured 10g SAR (W/kg)	Ratio	Reported 10g SAR (W/kg)
1st	LTE Band 7	20M	QPSK	1RB	0offset	Back	0cm	OFF	21350	2560	22.33	22.50	1.040	-0.12	3.050	-	3.172
2nd	LTE Band 7	20M	QPSK	1RB	0offset	Back	0cm	OFF	21350	2560	22.33	22.50	1.040	-0.07	3.010	1.01	3.130



**16. Simultaneous Transmission Analysis**

NO.	Simultaneous Transmission Configurations	Portable Phone				Note
		Head	Body-worn	Hotspot	Extremity	
1.	GSM(Voice) + WLAN2.4GHz(data)	Yes	Yes		Yes	
2.	WCDMA(Voice) + WLAN2.4GHz(data)	Yes	Yes		Yes	
3.	GSM(Voice) + Bluetooth(data)	Yes	Yes		Yes	
4.	WCDMA((Voice) + Bluetooth(data)	Yes	Yes		Yes	
5.	GSM(Voice) + WLAN5GHz(data)	Yes	Yes		Yes	
6.	WCDMA((Voice) + WLAN5GHz(data)	Yes	Yes		Yes	
7.	GPRS/EDGE(Data) + WLAN2.4GHz(data)	Yes	Yes	Yes	Yes	2.4GHz Hotspot
8.	WCDMA(Data) + WLAN2.4GHz(data)	Yes	Yes	Yes	Yes	2.4GHz Hotspot
9.	LTE(Data) + WLAN2.4GHz(data)	Yes	Yes	Yes	Yes	2.4GHz Hotspot
10.	GPRS/EDGE(Data) + Bluetooth(data)	Yes	Yes	Yes	Yes	Bluetooth Tethering
11.	WCDMA(Data) + Bluetooth(data)	Yes	Yes	Yes	Yes	Bluetooth Tethering
12.	LTE(Data) + Bluetooth(data)	Yes	Yes	Yes	Yes	Bluetooth Tethering
13.	GPRS/EDGE(data) + WLAN5GHz(data)	Yes	Yes	Yes	Yes	WiFi Direct (5.2GHz)
14.	WCDMA(data) + WLAN5GHz(data)	Yes	Yes	Yes	Yes	WiFi Direct (5.2GHz)
15.	LTE(data) + WLAN5GHz(data)	Yes	Yes	Yes	Yes	WiFi Direct (5.2GHz)

**General Note:**

- This device supported VoIP in EGPRS, WCDMA, LTE (e.g. 3rd party VoIP).
- This device 2.4GHz WLAN supports Hotspot operation, and 2.4GHz / 5.2GHz WLAN supports WiFi Direct (Group Client / Group Owner), and 5.3GHz / 5.5GHz / 5.8GHz supports WiFi Direct (Group Client only).
- The worst case WLAN reported SAR for each configuration was used for SAR summation, regardless of whether the WLAN channel has WiFi Direct and Hotspot capability. Therefore, the following summations represent the absolute worst cases for simultaneous transmission with WLAN.
- WLAN and Bluetooth share the same antenna, and cannot transmit simultaneously.
- EUT will choose either WLAN 2.4GHz or WLAN 5GHz according to the network signal condition; therefore, 2.4GHz WLAN and 5GHz WLAN will not operate simultaneously at any moment.
- The Scaled SAR summation is calculated based on the same configuration and test position.
- Per KDB 447498 D01v05r02, simultaneous transmission SAR is compliant if,
  - Scalar SAR summation < 1.6W/kg.
  - $SPLSR = (SAR1 + SAR2)^{1.5} / (\text{min. separation distance, mm})$ , and the peak separation distance is determined from the square root of  $[(x1-x2)^2 + (y1-y2)^2 + (z1-z2)^2]$ , where (x1, y1, z1) and (x2, y2, z2) are the coordinates of the extrapolated peak SAR locations in the zoom scan.
  - If  $SPLSR \leq 0.04$ , simultaneously transmission SAR measurement is not necessary.
  - Simultaneously transmission SAR measurement, and the reported multi-band SAR < 1.6W/kg.
- For simultaneous transmission analysis, Bluetooth SAR is estimated per KDB 447498 D01v05r02 based on the formula below.
  - $(\text{max. power of channel, including tune-up tolerance, mW}) / (\text{min. test separation distance, mm}) \cdot [\sqrt{f(\text{GHz})/x}] \text{ W/kg}$  for test separation distances  $\leq 50 \text{ mm}$ ; where  $x = 7.5$  for 1-g SAR, and  $x = 18.75$  for 10-g SAR.
  - When the minimum separation distance is < 5mm, the distance is used 5mm to determine SAR test exclusion.
  - 0.4 W/kg for 1-g SAR and 1.0 W/kg for 10-g SAR, when the test separation distances is > 50 mm.

Bluetooth Max Power	Exposure Position	Head	Hotspot	Body-worn
	Test separation	0 mm	10 mm	15 mm
7.0 dBm	Estimated 1g SAR (W/kg)	0.210 W/kg	0.105 W/kg	0.070 W/kg
	Estimated 10g SAR (W/kg)	0.084 W/kg	0.042 W/kg	0.028 W/kg



**16.1 Head Exposure Conditions**

WWAN Band		Exposure Position	1	2	3	4		1+2 Summed 1g SAR (W/kg)	1+3 Summed 1g SAR (W/kg)	1+2 Summed 1g SAR (W/kg)
			WWAN	2.4GHz WLAN	2.4GHz Bluetooth	5GHz WLAN				
			1g SAR (W/kg)	1g SAR (W/kg)	Estimated 1g SAR (W/kg)	Band	1g SAR (W/kg)			
GSM	GSM850	Right Cheek	0.211	0.510	0.210	5.8GHz WLAN	0.547	<b>0.72</b>	<b>0.42</b>	<b>0.76</b>
		Right Tilted	0.111	0.458	0.210	5.8GHz WLAN	0.517	<b>0.57</b>	<b>0.32</b>	<b>0.63</b>
		Left Cheek	0.171	0.944	0.210	5.5GHz WLAN	0.952	<b>1.12</b>	<b>0.38</b>	<b>1.12</b>
		Left Tilted	0.104	0.871	0.210	5.5GHz WLAN	0.520	<b>0.98</b>	<b>0.31</b>	<b>0.62</b>
	GSM1900	Right Cheek	0.110	0.510	0.210	5.8GHz WLAN	0.547	<b>0.62</b>	<b>0.32</b>	<b>0.66</b>
		Right Tilted	0.038	0.458	0.210	5.8GHz WLAN	0.517	<b>0.50</b>	<b>0.25</b>	<b>0.56</b>
		Left Cheek	0.114	0.944	0.210	5.5GHz WLAN	0.952	<b>1.06</b>	<b>0.32</b>	<b>1.07</b>
		Left Tilted	0.062	0.871	0.210	5.5GHz WLAN	0.520	<b>0.93</b>	<b>0.27</b>	<b>0.58</b>
WCDMA	Band V	Right Cheek	0.268	0.510	0.210	5.8GHz WLAN	0.547	<b>0.78</b>	<b>0.48</b>	<b>0.82</b>
		Right Tilted	0.124	0.458	0.210	5.8GHz WLAN	0.517	<b>0.58</b>	<b>0.33</b>	<b>0.64</b>
		Left Cheek	0.204	0.944	0.210	5.5GHz WLAN	0.952	<b>1.15</b>	<b>0.41</b>	<b>1.16</b>
		Left Tilted	0.122	0.871	0.210	5.5GHz WLAN	0.520	<b>0.99</b>	<b>0.33</b>	<b>0.64</b>
	Band II	Right Cheek	0.166	0.510	0.210	5.8GHz WLAN	0.547	<b>0.68</b>	<b>0.38</b>	<b>0.71</b>
		Right Tilted	0.054	0.458	0.210	5.8GHz WLAN	0.517	<b>0.51</b>	<b>0.26</b>	<b>0.57</b>
		Left Cheek	0.163	0.944	0.210	5.5GHz WLAN	0.952	<b>1.11</b>	<b>0.37</b>	<b>1.12</b>
		Left Tilted	0.097	0.871	0.210	5.5GHz WLAN	0.520	<b>0.97</b>	<b>0.31</b>	<b>0.62</b>
LTE	Band 5	Right Cheek	0.162	0.510	0.210	5.8GHz WLAN	0.547	<b>0.67</b>	<b>0.37</b>	<b>0.71</b>
		Right Tilted	0.073	0.458	0.210	5.8GHz WLAN	0.517	<b>0.53</b>	<b>0.28</b>	<b>0.59</b>
		Left Cheek	0.109	0.944	0.210	5.5GHz WLAN	0.952	<b>1.05</b>	<b>0.32</b>	<b>1.06</b>
		Left Tilted	0.066	0.871	0.210	5.5GHz WLAN	0.520	<b>0.94</b>	<b>0.28</b>	<b>0.59</b>
	Band 7	Right Cheek	0.179	0.510	0.210	5.8GHz WLAN	0.547	<b>0.69</b>	<b>0.39</b>	<b>0.73</b>
		Right Tilted	0.102	0.458	0.210	5.8GHz WLAN	0.517	<b>0.56</b>	<b>0.31</b>	<b>0.62</b>
		Left Cheek	0.251	0.944	0.210	5.5GHz WLAN	0.952	<b>1.20</b>	<b>0.46</b>	<b>1.20</b>
		Left Tilted	0.099	0.871	0.210	5.5GHz WLAN	0.520	<b>0.97</b>	<b>0.31</b>	<b>0.62</b>





WWAN Band		Exposure Position	1	2	3	4		1+2 Summed 10g SAR (W/kg)	1+3 Summed 10g SAR (W/kg)	1+4 Summed 10g SAR (W/kg)
			WWAN	2.4GHz WLAN	2.4GHz Bluetooth	5GHz WLAN				
			10g SAR (W/kg)	10g SAR (W/kg)	Estimated 10g SAR (W/kg)	Band	10g SAR (W/kg)			
GSM	GSM850	Right Cheek	0.162	0.254	0.084	5.8GHz WLAN	0.166	<b>0.42</b>	<b>0.25</b>	<b>0.33</b>
		Right Tilted	0.088	0.224	0.084	5.8GHz WLAN	0.152	<b>0.31</b>	<b>0.17</b>	<b>0.24</b>
		Left Cheek	0.132	0.487	0.084	5.5GHz WLAN	0.291	<b>0.62</b>	<b>0.22</b>	<b>0.42</b>
		Left Tilted	0.081	0.399	0.084	5.5GHz WLAN	0.146	<b>0.48</b>	<b>0.17</b>	<b>0.23</b>
	GSM1900	Right Cheek	0.069	0.254	0.084	5.8GHz WLAN	0.166	<b>0.32</b>	<b>0.15</b>	<b>0.24</b>
		Right Tilted	0.021	0.224	0.084	5.8GHz WLAN	0.152	<b>0.25</b>	<b>0.11</b>	<b>0.17</b>
		Left Cheek	0.070	0.487	0.084	5.5GHz WLAN	0.291	<b>0.56</b>	<b>0.15</b>	<b>0.36</b>
		Left Tilted	0.037	0.399	0.084	5.5GHz WLAN	0.146	<b>0.44</b>	<b>0.12</b>	<b>0.18</b>
WCDMA	Band V	Right Cheek	0.202	0.254	0.084	5.8GHz WLAN	0.166	<b>0.46</b>	<b>0.29</b>	<b>0.37</b>
		Right Tilted	0.097	0.224	0.084	5.8GHz WLAN	0.152	<b>0.32</b>	<b>0.18</b>	<b>0.25</b>
		Left Cheek	0.158	0.487	0.084	5.5GHz WLAN	0.291	<b>0.65</b>	<b>0.24</b>	<b>0.45</b>
		Left Tilted	0.095	0.399	0.084	5.5GHz WLAN	0.146	<b>0.49</b>	<b>0.18</b>	<b>0.24</b>
	Band II	Right Cheek	0.103	0.254	0.084	5.8GHz WLAN	0.166	<b>0.36</b>	<b>0.19</b>	<b>0.27</b>
		Right Tilted	0.031	0.224	0.084	5.8GHz WLAN	0.152	<b>0.26</b>	<b>0.12</b>	<b>0.18</b>
		Left Cheek	0.101	0.487	0.084	5.5GHz WLAN	0.291	<b>0.59</b>	<b>0.19</b>	<b>0.39</b>
		Left Tilted	0.060	0.399	0.084	5.5GHz WLAN	0.146	<b>0.46</b>	<b>0.14</b>	<b>0.21</b>
LTE	Band 5	Right Cheek	0.123	0.254	0.084	5.8GHz WLAN	0.166	<b>0.38</b>	<b>0.21</b>	<b>0.29</b>
		Right Tilted	0.057	0.224	0.084	5.8GHz WLAN	0.152	<b>0.28</b>	<b>0.14</b>	<b>0.21</b>
		Left Cheek	0.085	0.487	0.084	5.5GHz WLAN	0.291	<b>0.57</b>	<b>0.17</b>	<b>0.38</b>
		Left Tilted	0.051	0.399	0.084	5.5GHz WLAN	0.146	<b>0.45</b>	<b>0.14</b>	<b>0.20</b>
	Band 7	Right Cheek	0.095	0.254	0.084	5.8GHz WLAN	0.166	<b>0.35</b>	<b>0.18</b>	<b>0.26</b>
		Right Tilted	0.052	0.224	0.084	5.8GHz WLAN	0.152	<b>0.28</b>	<b>0.14</b>	<b>0.20</b>
		Left Cheek	0.155	0.487	0.084	5.5GHz WLAN	0.291	<b>0.64</b>	<b>0.24</b>	<b>0.45</b>
		Left Tilted	0.049	0.399	0.084	5.5GHz WLAN	0.146	<b>0.45</b>	<b>0.13</b>	<b>0.20</b>



**16.2 Hotspot Exposure Conditions**

WWAN Band	Exposure Position	1	2	3	4		1+2 Summed 1g SAR (W/kg)	1+3 Summed 1g SAR (W/kg)	1+4 Summed 1g SAR (W/kg)	
		WWAN	2.4GHz WLAN	2.4GHz Bluetooth	5GHz WLAN					
		1g SAR (W/kg)	1g SAR (W/kg)	Estimated SAR (W/kg)	Band	1g SAR (W/kg)				
GSM	GSM850	Front	0.289	0.194	0.105	5.2GHz WLAN	0.059	<b>0.48</b>	<b>0.39</b>	<b>0.35</b>
		Back	0.503	0.258	0.105	5.2GHz WLAN	0.193	<b>0.76</b>	<b>0.61</b>	<b>0.70</b>
		Left side	0.123					<b>0.12</b>	<b>0.12</b>	<b>0.12</b>
		Right side	0.271	0.131	0.105	5.2GHz WLAN	0.198	<b>0.40</b>	<b>0.38</b>	<b>0.47</b>
		Top side		0.183	0.105	5.2GHz WLAN	0.086	<b>0.18</b>	<b>0.11</b>	<b>0.09</b>
		Bottom side	0.132					<b>0.13</b>	<b>0.13</b>	<b>0.13</b>
	GSM1900	Front	0.380	0.194	0.105	5.2GHz WLAN	0.059	<b>0.57</b>	<b>0.49</b>	<b>0.44</b>
		Back	0.571	0.258	0.105	5.2GHz WLAN	0.193	<b>0.83</b>	<b>0.68</b>	<b>0.76</b>
		Left side	0.098					<b>0.10</b>	<b>0.10</b>	<b>0.10</b>
		Right side	0.071	0.131	0.105	5.2GHz WLAN	0.198	<b>0.20</b>	<b>0.18</b>	<b>0.27</b>
		Top side		0.183	0.105	5.2GHz WLAN	0.086	<b>0.18</b>	<b>0.11</b>	<b>0.09</b>
		Bottom side	0.995					<b>1.00</b>	<b>1.00</b>	<b>1.00</b>
WCDMA	Band V	Front	0.281	0.194	0.105	5.2GHz WLAN	0.059	<b>0.48</b>	<b>0.39</b>	<b>0.34</b>
		Back	0.383	0.258	0.105	5.2GHz WLAN	0.193	<b>0.64</b>	<b>0.49</b>	<b>0.58</b>
		Left side	0.249					<b>0.25</b>	<b>0.25</b>	<b>0.25</b>
		Right side	0.414	0.131	0.105	5.2GHz WLAN	0.198	<b>0.55</b>	<b>0.52</b>	<b>0.61</b>
		Top side		0.183	0.105	5.2GHz WLAN	0.086	<b>0.18</b>	<b>0.11</b>	<b>0.09</b>
		Bottom side	0.149					<b>0.15</b>	<b>0.15</b>	<b>0.15</b>
	Band II	Front	0.595	0.194	0.105	5.2GHz WLAN	0.059	<b>0.79</b>	<b>0.70</b>	<b>0.65</b>
		Back	0.843	0.258	0.105	5.2GHz WLAN	0.193	<b>1.10</b>	<b>0.95</b>	<b>1.04</b>
		Left side	0.173					<b>0.17</b>	<b>0.17</b>	<b>0.17</b>
		Right side	0.126	0.131	0.105	5.2GHz WLAN	0.198	<b>0.26</b>	<b>0.23</b>	<b>0.32</b>
		Top side		0.183	0.105	5.2GHz WLAN	0.086	<b>0.18</b>	<b>0.11</b>	<b>0.09</b>
		Bottom side	1.140					<b>1.14</b>	<b>1.14</b>	<b>1.14</b>
LTE	Band 5	Front	0.225	0.194	0.105	5.2GHz WLAN	0.059	<b>0.42</b>	<b>0.33</b>	<b>0.28</b>
		Back	0.383	0.258	0.105	5.2GHz WLAN	0.193	<b>0.64</b>	<b>0.49</b>	<b>0.58</b>
		Left side	0.148					<b>0.15</b>	<b>0.15</b>	<b>0.15</b>
		Right side	0.270	0.131	0.105	5.2GHz WLAN	0.198	<b>0.40</b>	<b>0.38</b>	<b>0.47</b>
		Top side		0.183	0.105	5.2GHz WLAN	0.086	<b>0.18</b>	<b>0.11</b>	<b>0.09</b>
		Bottom side	0.140					<b>0.14</b>	<b>0.14</b>	<b>0.14</b>
	Band 7	Front	0.266	0.194	0.105	5.2GHz WLAN	0.059	<b>0.46</b>	<b>0.37</b>	<b>0.33</b>
		Back	0.930	0.258	0.105	5.2GHz WLAN	0.193	<b>1.19</b>	<b>1.04</b>	<b>1.12</b>
		Left side	0.159					<b>0.16</b>	<b>0.16</b>	<b>0.16</b>
		Right side	0.067	0.131	0.105	5.2GHz WLAN	0.198	<b>0.20</b>	<b>0.17</b>	<b>0.27</b>
		Top side		0.183	0.105	5.2GHz WLAN	0.086	<b>0.18</b>	<b>0.11</b>	<b>0.09</b>
		Bottom side	0.968					<b>0.97</b>	<b>0.97</b>	<b>0.97</b>



WWAN Band		Exposure Position	1	2	3	4		1+2 Summed 10g SAR (W/kg)	1+3 Summed 10g SAR (W/kg)	1+4 Summed 10g SAR (W/kg)
			WWAN	2.4GHz WLAN	2.4GHz Bluetooth	5GHz WLAN				
			10g SAR (W/kg)	10g SAR (W/kg)	Estimated SAR (W/kg)	Band	10g SAR (W/kg)			
GSM	GSM850	Front	0.224	0.109	0.042	5.2GHz WLAN	0.021	<b>0.33</b>	<b>0.27</b>	<b>0.25</b>
		Back	0.387	0.126	0.042	5.2GHz WLAN	0.050	<b>0.51</b>	<b>0.43</b>	<b>0.44</b>
		Left side	0.085					<b>0.09</b>	<b>0.09</b>	<b>0.09</b>
		Right side	0.188	0.054	0.042	5.2GHz WLAN	0.072	<b>0.24</b>	<b>0.23</b>	<b>0.26</b>
		Top side		0.183	0.042	5.2GHz WLAN	0.029	<b>0.18</b>	<b>0.04</b>	<b>0.03</b>
		Bottom side	0.070					<b>0.07</b>	<b>0.07</b>	<b>0.07</b>
	GSM1900	Front	0.206	0.109	0.042	5.2GHz WLAN	0.021	<b>0.32</b>	<b>0.25</b>	<b>0.23</b>
		Back	0.300	0.126	0.042	5.2GHz WLAN	0.050	<b>0.43</b>	<b>0.34</b>	<b>0.35</b>
		Left side	0.057					<b>0.06</b>	<b>0.06</b>	<b>0.06</b>
		Right side	0.042	0.054	0.042	5.2GHz WLAN	0.072	<b>0.10</b>	<b>0.08</b>	<b>0.11</b>
		Top side		0.183	0.042	5.2GHz WLAN	0.029	<b>0.18</b>	<b>0.04</b>	<b>0.03</b>
		Bottom side	0.499					<b>0.50</b>	<b>0.50</b>	<b>0.50</b>
WCDMA	Band V	Front	0.219	0.109	0.042	5.2GHz WLAN	0.021	<b>0.33</b>	<b>0.26</b>	<b>0.24</b>
		Back	0.222	0.126	0.042	5.2GHz WLAN	0.050	<b>0.35</b>	<b>0.26</b>	<b>0.27</b>
		Left side	0.171					<b>0.17</b>	<b>0.17</b>	<b>0.17</b>
		Right side	0.288	0.054	0.042	5.2GHz WLAN	0.072	<b>0.34</b>	<b>0.33</b>	<b>0.36</b>
		Top side		0.183	0.042	5.2GHz WLAN	0.029	<b>0.18</b>	<b>0.04</b>	<b>0.03</b>
		Bottom side	0.080					<b>0.08</b>	<b>0.08</b>	<b>0.08</b>
	Band II	Front	0.320	0.109	0.042	5.2GHz WLAN	0.021	<b>0.43</b>	<b>0.36</b>	<b>0.34</b>
		Back	0.441	0.126	0.042	5.2GHz WLAN	0.050	<b>0.57</b>	<b>0.48</b>	<b>0.49</b>
		Left side	0.103					<b>0.10</b>	<b>0.10</b>	<b>0.10</b>
		Right side	0.076	0.054	0.042	5.2GHz WLAN	0.072	<b>0.13</b>	<b>0.12</b>	<b>0.15</b>
		Top side		0.183	0.042	5.2GHz WLAN	0.029	<b>0.18</b>	<b>0.04</b>	<b>0.03</b>
		Bottom side	0.581					<b>0.58</b>	<b>0.58</b>	<b>0.58</b>
LTE	Band 5	Front	0.177	0.109	0.042	5.2GHz WLAN	0.021	<b>0.29</b>	<b>0.22</b>	<b>0.20</b>
		Back	0.296	0.126	0.042	5.2GHz WLAN	0.050	<b>0.42</b>	<b>0.34</b>	<b>0.35</b>
		Left side	0.102					<b>0.10</b>	<b>0.10</b>	<b>0.10</b>
		Right side	0.188	0.054	0.042	5.2GHz WLAN	0.072	<b>0.24</b>	<b>0.23</b>	<b>0.26</b>
		Top side		0.183	0.042	5.2GHz WLAN	0.029	<b>0.18</b>	<b>0.04</b>	<b>0.03</b>
		Bottom side	0.076					<b>0.08</b>	<b>0.08</b>	<b>0.08</b>
	Band 7	Front	0.121	0.109	0.042	5.2GHz WLAN	0.021	<b>0.23</b>	<b>0.16</b>	<b>0.14</b>
		Back	0.414	0.126	0.042	5.2GHz WLAN	0.050	<b>0.54</b>	<b>0.46</b>	<b>0.46</b>
		Left side	0.082					<b>0.08</b>	<b>0.08</b>	<b>0.08</b>
		Right side	0.033	0.054	0.042	5.2GHz WLAN	0.072	<b>0.09</b>	<b>0.08</b>	<b>0.11</b>
		Top side		0.183	0.042	5.2GHz WLAN	0.029	<b>0.18</b>	<b>0.04</b>	<b>0.03</b>
		Bottom side	0.422					<b>0.42</b>	<b>0.42</b>	<b>0.42</b>



**16.3 Body-Worn Accessory Exposure Conditions**

WWAN Band		Exposure Position	1	2	3	4		1+2 Summed 1g SAR (W/kg)	1+3 Summed 1g SAR (W/kg)	1+4 Summed 1g SAR (W/kg)
			WWAN	2.4GHz WLAN	2.4GHz Bluetooth	5GHz WLAN				
			1g SAR (W/kg)	1g SAR (W/kg)	Estimated 1g SAR (W/kg)	Band	1g SAR (W/kg)			
GSM	GSM850	Front	0.258	0.118	0.070	5.8GHz WLAN	0.113	<b>0.38</b>	<b>0.33</b>	<b>0.37</b>
		Back	0.430	0.124	0.070	5.3GHz WLAN	0.086	<b>0.55</b>	<b>0.50</b>	<b>0.52</b>
	GSM1900	Front	0.180	0.118	0.070	5.8GHz WLAN	0.113	<b>0.30</b>	<b>0.25</b>	<b>0.29</b>
		Back	0.251	0.124	0.070	5.3GHz WLAN	0.086	<b>0.38</b>	<b>0.32</b>	<b>0.34</b>
WCDMA	Band V	Front	0.253	0.118	0.070	5.8GHz WLAN	0.113	<b>0.37</b>	<b>0.32</b>	<b>0.37</b>
		Back	0.378	0.124	0.070	5.3GHz WLAN	0.086	<b>0.50</b>	<b>0.45</b>	<b>0.46</b>
	Band II	Front	0.276	0.118	0.070	5.8GHz WLAN	0.113	<b>0.39</b>	<b>0.35</b>	<b>0.39</b>
		Back	0.360	0.124	0.070	5.3GHz WLAN	0.086	<b>0.48</b>	<b>0.43</b>	<b>0.45</b>
LTE	Band 5	Front	0.178	0.118	0.070	5.8GHz WLAN	0.113	<b>0.30</b>	<b>0.25</b>	<b>0.29</b>
		Back	0.309	0.124	0.070	5.3GHz WLAN	0.086	<b>0.43</b>	<b>0.38</b>	<b>0.40</b>
	Band 7	Front	0.280	0.118	0.070	5.8GHz WLAN	0.113	<b>0.40</b>	<b>0.35</b>	<b>0.39</b>
		Back	0.949	0.124	0.070	5.3GHz WLAN	0.086	<b>1.07</b>	<b>1.02</b>	<b>1.04</b>

WWAN Band		Exposure Position	1	2	3	4		1+2 Summed 10g SAR (W/kg)	1+3 Summed 10g SAR (W/kg)	1+4 Summed 10g SAR (W/kg)
			WWAN	2.4GHz WLAN	2.4GHz Bluetooth	5GHz WLAN				
			10g SAR (W/kg)	10g SAR (W/kg)	Estimated 10g SAR (W/kg)	Band	10g SAR (W/kg)			
GSM	GSM850	Front	0.202	0.062	0.028	5.8GHz WLAN	0.041	<b>0.26</b>	<b>0.23</b>	<b>0.24</b>
		Back	0.334	0.066	0.028	5.3GHz WLAN	0.027	<b>0.40</b>	<b>0.36</b>	<b>0.36</b>
	GSM1900	Front	0.106	0.062	0.028	5.8GHz WLAN	0.041	<b>0.17</b>	<b>0.13</b>	<b>0.15</b>
		Back	0.143	0.066	0.028	5.3GHz WLAN	0.027	<b>0.21</b>	<b>0.17</b>	<b>0.17</b>
WCDMA	Band V	Front	0.196	0.062	0.028	5.8GHz WLAN	0.041	<b>0.26</b>	<b>0.22</b>	<b>0.24</b>
		Back	0.293	0.066	0.028	5.3GHz WLAN	0.027	<b>0.36</b>	<b>0.32</b>	<b>0.32</b>
	Band II	Front	0.161	0.062	0.028	5.8GHz WLAN	0.041	<b>0.22</b>	<b>0.19</b>	<b>0.20</b>
		Back	0.205	0.066	0.028	5.3GHz WLAN	0.027	<b>0.27</b>	<b>0.23</b>	<b>0.23</b>
LTE	Band 5	Front	0.137	0.062	0.028	5.8GHz WLAN	0.041	<b>0.20</b>	<b>0.17</b>	<b>0.18</b>
		Back	0.238	0.066	0.028	5.3GHz WLAN	0.027	<b>0.30</b>	<b>0.27</b>	<b>0.27</b>
	Band 7	Front	0.139	0.062	0.028	5.8GHz WLAN	0.041	<b>0.20</b>	<b>0.17</b>	<b>0.18</b>
		Back	0.447	0.066	0.028	5.3GHz WLAN	0.027	<b>0.51</b>	<b>0.48</b>	<b>0.47</b>

**Test Engineer :** Angelo Chang, Ken Lin, Bevis Chang, Vic Yang, Tom Jiang, Galen Zhang, Kurt Liu, and Lawrence Chen

## 17. Uncertainty Assessment

The component of uncertainty may generally be categorized according to the methods used to evaluate them. The evaluation of uncertainty by the statistical analysis of a series of observations is termed a Type A evaluation of uncertainty. The evaluation of uncertainty by means other than the statistical analysis of a series of observation is termed a Type B evaluation of uncertainty. Each component of uncertainty, however evaluated, is represented by an estimated standard deviation, termed standard uncertainty, which is determined by the positive square root of the estimated variance.

A Type A evaluation of standard uncertainty may be based on any valid statistical method for treating data. This includes calculating the standard deviation of the mean of a series of independent observations; using the method of least squares to fit a curve to the data in order to estimate the parameter of the curve and their standard deviations; or carrying out an analysis of variance in order to identify and quantify random effects in certain kinds of measurement.

A type B evaluation of standard uncertainty is typically based on scientific judgment using all of the relevant information available. These may include previous measurement data, experience, and knowledge of the behavior and properties of relevant materials and instruments, manufacture’s specification, data provided in calibration reports and uncertainties assigned to reference data taken from handbooks. Broadly speaking, the uncertainty is either obtained from an outdoor source or obtained from an assumed distribution, such as the normal distribution, rectangular or triangular distributions indicated in table below.

Uncertainty Distributions	Normal	Rectangular	Triangular	U-Shape
Multi-plying Factor <sup>(a)</sup>	1/k <sup>(b)</sup>	1/√3	1/√6	1/√2

(a) standard uncertainty is determined as the product of the multiplying factor and the estimated range of variations in the measured quantity

(b)  $\kappa$  is the coverage factor

**Table 17.1. Standard Uncertainty for Assumed Distribution**

The combined standard uncertainty of the measurement result represents the estimated standard deviation of the result. It is obtained by combining the individual standard uncertainties of both Type A and Type B evaluation using the usual “root-sum-squares” (RSS) methods of combining standard deviations by taking the positive square root of the estimated variances.

Expanded uncertainty is a measure of uncertainty that defines an interval about the measurement result within which the measured value is confidently believed to lie. It is obtained by multiplying the combined standard uncertainty by a coverage factor. Typically, the coverage factor ranges from 2 to 3. Using a coverage factor allows the true value of a measured quantity to be specified with a defined probability within the specified uncertainty range. For purpose of this document, a coverage factor two is used, which corresponds to confidence interval of about 95 %. The DASY uncertainty Budget is shown in the following tables.



Error Description	Uncertainty Value (±%)	Probability Distribution	Divisor	Ci (1g)	Ci (10g)	Standard Uncertainty (1g)	Standard Uncertainty (10g)
<b>Measurement System</b>							
Probe Calibration	6.0	Normal	1	1	1	± 6.0 %	± 6.0 %
Axial Isotropy	4.7	Rectangular	√3	0.7	0.7	± 1.9 %	± 1.9 %
Hemispherical Isotropy	9.6	Rectangular	√3	0.7	0.7	± 3.9 %	± 3.9 %
Boundary Effects	1.0	Rectangular	√3	1	1	± 0.6 %	± 0.6 %
Linearity	4.7	Rectangular	√3	1	1	± 2.7 %	± 2.7 %
System Detection Limits	1.0	Rectangular	√3	1	1	± 0.6 %	± 0.6 %
Readout Electronics	0.3	Normal	1	1	1	± 0.3 %	± 0.3 %
Response Time	0.8	Rectangular	√3	1	1	± 0.5 %	± 0.5 %
Integration Time	2.6	Rectangular	√3	1	1	± 1.5 %	± 1.5 %
RF Ambient Noise	3.0	Rectangular	√3	1	1	± 1.7 %	± 1.7 %
RF Ambient Reflections	3.0	Rectangular	√3	1	1	± 1.7 %	± 1.7 %
Probe Positioner	0.4	Rectangular	√3	1	1	± 0.2 %	± 0.2 %
Probe Positioning	2.9	Rectangular	√3	1	1	± 1.7 %	± 1.7 %
Max. SAR Eval.	1.0	Rectangular	√3	1	1	± 0.6 %	± 0.6 %
<b>Test Sample Related</b>							
Device Positioning	2.9	Normal	1	1	1	± 2.9 %	± 2.9 %
Device Holder	3.6	Normal	1	1	1	± 3.6 %	± 3.6 %
Power Drift	5.0	Rectangular	√3	1	1	± 2.9 %	± 2.9 %
<b>Phantom and Setup</b>							
Phantom Uncertainty	4.0	Rectangular	√3	1	1	± 2.3 %	± 2.3 %
Liquid Conductivity (Target)	5.0	Rectangular	√3	0.64	0.43	± 1.8 %	± 1.2 %
Liquid Conductivity (Meas.)	2.5	Normal	1	0.64	0.43	± 1.6 %	± 1.1 %
Liquid Permittivity (Target)	5.0	Rectangular	√3	0.6	0.49	± 1.7 %	± 1.4 %
Liquid Permittivity (Meas.)	2.5	Normal	1	0.6	0.49	± 1.5 %	± 1.2 %
<b>Combined Standard Uncertainty</b>						± 11.0 %	± 10.8 %
<b>Coverage Factor for 95 %</b>						K=2	
<b>Expanded Uncertainty</b>						± 22.0 %	± 21.5 %

Table 17.2. Uncertainty Budget for frequency range 300 MHz to 3 GHz



Error Description	Uncertainty Value (±%)	Probability Distribution	Divisor	Ci (1g)	Ci (10g)	Standard Uncertainty (1g)	Standard Uncertainty (10g)
<b>Measurement System</b>							
Probe Calibration	6.55	Normal	1	1	1	± 6.55 %	± 6.55 %
Axial Isotropy	4.7	Rectangular	√3	0.7	0.7	± 1.9 %	± 1.9 %
Hemispherical Isotropy	9.6	Rectangular	√3	0.7	0.7	± 3.9 %	± 3.9 %
Boundary Effects	2.0	Rectangular	√3	1	1	± 1.2 %	± 1.2 %
Linearity	4.7	Rectangular	√3	1	1	± 2.7 %	± 2.7 %
System Detection Limits	1.0	Rectangular	√3	1	1	± 0.6 %	± 0.6 %
Readout Electronics	0.3	Normal	1	1	1	± 0.3 %	± 0.3 %
Response Time	0.8	Rectangular	√3	1	1	± 0.5 %	± 0.5 %
Integration Time	2.6	Rectangular	√3	1	1	± 1.5 %	± 1.5 %
RF Ambient Noise	3.0	Rectangular	√3	1	1	± 1.7 %	± 1.7 %
RF Ambient Reflections	3.0	Rectangular	√3	1	1	± 1.7 %	± 1.7 %
Probe Positioner	0.8	Rectangular	√3	1	1	± 0.5 %	± 0.5 %
Probe Positioning	9.9	Rectangular	√3	1	1	± 5.7 %	± 5.7 %
Max. SAR Eval.	4.0	Rectangular	√3	1	1	± 2.3 %	± 2.3 %
<b>Test Sample Related</b>							
Device Positioning	2.9	Normal	1	1	1	± 2.9 %	± 2.9 %
Device Holder	3.6	Normal	1	1	1	± 3.6 %	± 3.6 %
Power Drift	5.0	Rectangular	√3	1	1	± 2.9 %	± 2.9 %
<b>Phantom and Setup</b>							
Phantom Uncertainty	4.0	Rectangular	√3	1	1	± 2.3 %	± 2.3 %
Liquid Conductivity (Target)	5.0	Rectangular	√3	0.64	0.43	± 1.8 %	± 1.2 %
Liquid Conductivity (Meas.)	2.5	Normal	1	0.64	0.43	± 1.6 %	± 1.1 %
Liquid Permittivity (Target)	5.0	Rectangular	√3	0.6	0.49	± 1.7 %	± 1.4 %
Liquid Permittivity (Meas.)	2.5	Normal	1	0.6	0.49	± 1.5 %	± 1.2 %
<b>Combined Standard Uncertainty</b>						± 12.8 %	± 12.6 %
<b>Coverage Factor for 95 %</b>						K=2	
<b>Expanded Uncertainty</b>						± 25.6 %	± 25.2 %

Table 17.3. Uncertainty Budget for frequency range 3 GHz to 6 GHz



## **18. References**

- [1] FCC 47 CFR Part 2 "Frequency Allocations and Radio Treaty Matters; General Rules and Regulations"
- [2] ANSI/IEEE Std. C95.1-1992, "IEEE Standard for Safety Levels with Respect to Human Exposure to Radio Frequency Electromagnetic Fields, 3 kHz to 300 GHz", September 1992
- [3] IEEE Std. 1528-2003, "Recommended Practice for Determining the Peak Spatial-Average Specific Absorption Rate (SAR) in the Human Head from Wireless Communications Devices: Measurement Techniques", December 2003
- [4] SPEAG DASY System Handbook
- [5] FCC KDB 248227 D01 v01r02, "SAR Measurement Procedures for 802.11 a/b/g Transmitters", May 2007
- [6] FCC KDB 447498 D01 v05r02, "Mobile and Portable Device RF Exposure Procedures and Equipment Authorization Policies", Feb 2014
- [7] FCC KDB 648474 D04 v01r02, "SAR Evaluation Considerations for Wireless Handsets", Dec 2013.
- [8] FCC KDB 941225 D01 v03, "3G SAR MEAUREMENT PROCEDURES", Oct 2014
- [9] FCC KDB 941225 D05 v02r03, "SAR Evaluation Considerations for LTE Devices", Dec 2013
- [10] FCC KDB 941225 D06 v02, "SAR Evaluation Procedures for Portable Devices with Wireless Router Capabilities", Oct 2014.
- [11] FCC KDB 865664 D01 v01r03, "SAR Measurement Requirements for 100 MHz to 6 GHz", Feb 2014.
- [12] FCC KDB 865664 D02 v01r01, "RF Exposure Compliance Reporting and Documentation Considerations" May 2013.