



FCC/IC RF Test Report

APPLICANT : Sony Mobile Communications Inc.
EQUIPMENT : Smart phone
BRAND NAME : SONY
TYPE NAME : PM-0860-BV
FCC ID : PY7-PM0860
IC : 4170B-PM0860
STANDARD : 47 CFR Part 2, 22(H), 24(E), 27
IC RSS-130 issue 1
IC RSS-132 issue 3
IC RSS-133 issue 6
IC RSS-139 issue 2
IC RSS-199 issue 2
CLASSIFICATION : PCS Licensed Transmitter Held to Ear (PCE)

The product was received on Dec. 31, 2014 and completely tested on Jan. 30, 2015. We, SPORTON INTERNATIONAL INC., would like to declare that the tested sample has been evaluated in accordance with the test procedures given in ANSI / TIA / EIA-603-C-2004 and the testing has shown the tested sample to be in compliance with the applicable technical standards.

The test results in this report apply exclusively to the tested model / sample. Without written approval of SPORTON INTERNATIONAL INC., the test report shall not be reproduced except in full.

Reviewed by: Joseph Lin / Supervisor

Approved by: Jones Tsai / Manager



SPORTON INTERNATIONAL INC.

No. 52, Hwa Ya 1st Rd., Hwa Ya Technology Park, Kwei-Shan District, Tao Yuan City, Taiwan, R.O.C.



TABLE OF CONTENTS

REVISION HISTORY.....3
SUMMARY OF TEST RESULT4
1 GENERAL DESCRIPTION7
1.1 Applicant7
1.2 Manufacturer.....7
1.3 Product Feature of Equipment Under Test.....7
1.4 Product Specification subjective to this standard8
1.5 Modification of EUT9
1.6 Emission Designator10
1.7 Testing Location12
1.8 Applicable Standards.....12
2 TEST CONFIGURATION OF EQUIPMENT UNDER TEST13
2.1 Test Mode13
2.2 Support Unit used in test configuration and system16
2.3 Measurement Results Explanation Example.....16
3 CONDUCTED TEST ITEMS17
3.1 Measuring Instruments17
3.2 Test Setup17
3.3 Test Result of Conducted Test17
3.4 Conducted Output Power18
3.5 Peak-to-Average Ratio19
3.6 Occupied Bandwidth.....20
3.7 Conducted Band Edge21
3.8 Conducted Spurious Emission23
3.9 Frequency Stability24
4 RADIATED TEST ITEMS25
4.1 Measuring Instruments25
4.2 Test Setup25
4.3 Test Result of Radiated Test25
4.4 Effective Radiated Power and Effective Isotropic Radiated Power26
4.5 Radiated Spurious Emission28
5 LIST OF MEASURING EQUIPMENT29
6 UNCERTAINTY OF EVALUATION30
APPENDIX A. TEST RESULTS OF CONDUCTED TEST
APPENDIX B. TEST RESULTS OF RADIATED TEST



REVISION HISTORY

REPORT NO.	VERSION	DESCRIPTION	ISSUED DATE
FG4D3145B	Rev. 01	Initial issue of report	Mar. 25, 2015



SUMMARY OF TEST RESULT

Report Section	FCC Rule	IC Rule	Description	Limit	Result	Remark
3.4	§2.1046	RSS-130 (4.4) RSS-132 (5.4) RSS-133 (6.4) RSS-139 (6.4) RSS-199 (4.4)	Conducted Output Power	Reporting Only	PASS	-
3.5	§24.232(d)	RSS-130(4.4) RSS-132 (5.4) RSS-133 (6.4) RSS-139 (6.4)	Peak-to-Average Ratio	<13 dB	PASS	-
3.6	§2.1049 §22.917(b) §24.238(b) §27.53(h)(3) §27.53(m)(6)	RSS-GEN(6.6) RSS-132 (3.1) RSS-133 (3.1) RSS-130 (3.1) RSS-139 (3.1) RSS-199 (4.2)	Occupied Bandwidth	Reporting Only	PASS	-
3.7	§2.1051 §22.917(a) §24.238(a) §27.53(c)(2) §27.53(c)(4) §27.53(f) §27.53(g) §27.53(m)(4)	RSS-132 (5.5) RSS-133 (6.5.1) RSS-130(4.6) RSS-139 (6.5) RSS-199 (4.5)	Conducted Band Edge Measurement (Band 2) (Band 4) (Band 5) (Band 12) (Band 13) (Band 17) (Band 7)	< 43+10log10(P[Watts])	PASS	-



Report Section	FCC Rule	IC Rule	Description	Limit	Result	Remark
3.8	§2.1051 §22.917(a) §24.238(a) §27.53(c)(2) §27.53(f) §27.53(g)	RSS-132 (5.5) RSS-133 (6.5.1) RSS-130(4.6) RSS-139 (6.5)	Conducted Spurious Emission (Band 2) (Band 4) (Band 5) (Band 12) (Band 13) (Band 17)	< 43+10log ₁₀ (P[Watts])	PASS	-
	§2.1051 §27.53(m)(4)	RSS-199 (4.5)	Conducted Spurious Emission (Band 7)	< 55+10log ₁₀ (P[Watts])		
3.9	§2.1055 §22.355 §24.235 §27.54	RSS-GEN(6.11) RSS-132(5.3) RSS-133(6.3) RSS-130(4.3) RSS-139 (6.3) RSS-199 (4.3)	Frequency Stability Temperature & Voltage	< 2.5 ppm for Part 22 Within Authorized Band	PASS	-
4.4	§22.913(a)(2)	RSS-132(5.4) SRSP-503(5.1.3)	Effective Radiated Power (Band 5)	ERP < 7 Watt	PASS	-
	§27.50(b)(10) §27.50(c)(10)	N/A	Effective Radiated Power (Band 12) (Band 13) (Band 17)	ERP < 3 Watt		
	N/A	RSS-130(4.4)	Equivalent Isotropic Radiated Power (Band 12) (Band 13) (Band 17)	EIRP < 5 Watt		
	§24.232(c) §27.50(h)(2)	RSS-133 (6.4) SRSP-510(5.1.2) RSS-199 (4.4)	Equivalent Isotropic Radiated Power (Band 2)((Band 7)	EIRP < 2Watt		
	§27.50(d)(4)	RSS-139 (6.4) SRSP-513(5.1.2)	Equivalent Isotropic Radiated Power (Band 4)	EIRP < 1Watt		



Report Section	FCC Rule	IC Rule	Description	Limit	Result	Remark
4.5	§2.1053 §22.917(a) §24.238(a) §27.53(c)(2) §27.53(f) §27.53(g) §27.53(h)	RSS-132 (5.5) RSS-133 (6.5.1) RSS-130 (4.6) RSS-139 (6.5)	Radiated Spurious Emission (Band 2) (Band 4) (Band 5) (Band 12) (Band 13) (Band 17)	$< 43+10\log_{10}(P[\text{Watts}])$	PASS	Under limit 12.42 dB at 12504.000 MHz
	§2.1053 §27.53(m)(4)	RSS-199 (4.5)	Radiated Spurious Emission (Band 7)	$< 55+10\log_{10}(P[\text{Watts}])$		



1 General Description

1.1 Applicant

Sony Mobile Communications Inc.
Nya Vattentorget, 22188 Lund, Sweden

1.2 Manufacturer

Arima Communications Corp.
6F, No. 866, Jhongjheng Rd., Jhonghe Dist., New Taipei City 23586, Taiwan

1.3 Product Feature of Equipment Under Test

The Equipment Under Test (hereafter called: EUT) is smart phone supporting, GSM/WCDMA/LTE, Wi-Fi 2.4GHz 802.11b/g/n, Wi-Fi 5GHz 802.11a/n, Bluetooth with FM Receiver, GPS, and NFC features, and below is details of information.

Product Feature	
Equipment	Smart phone
Brand Name	SONY
Type Name	PM-0860-BV
FCC ID	PY7-PM0860
IC	4170B-PM0860
GSM Operating Band(s)	GSM 850/900/1800/1900MHz
GPRS / EGPRS Multi Slot Class	GPRS Class 12, EGPRS Class 12
WCDMA Operating Band(s)	FDD Band I / II / IV / V / VIII
WCDMA Rel. Version	Rel. 8
LTE Operating Band(s)	FDD Band II / IV / V / VII / XII / XIII / XVII
LTE Rel. Version	Rel. 8
Wi-Fi Specification	802.11a/b/g/n (HT20/HT40)
Bluetooth Version	v3.0+EDR / v4.0-LE
NFC Specification	ISO14443A / ISO14443B / Felica
Power Supply	Battery / AC Adapter / Car Charger

Remark: The above EUT's information was declared by manufacturer. Please refer to the specifications or user's manual for more detailed description.



1.4 Product Specification subjective to this standard

Product Specification subjective to this standard	
Tx Frequency	LTE Band 2 : 1850.7 MHz ~ 1909.3 MHz LTE Band 4 : 1710.7 MHz ~ 1754.3 MHz LTE Band 5 : 824.7 MHz ~ 848.3 MHz LTE Band 7 : 2502.5 MHz ~ 2567.5 MHz LTE Band 12 : 699 MHz ~ 716 MHz LTE Band 13 : 779.5 MHz ~ 784.5 MHz LTE Band 17 : 706.5 MHz ~ 713.5 MHz
Rx Frequency	LTE Band 2 : 1930.7 MHz ~ 1989.3 MHz LTE Band 4 : 2110.7 MHz ~ 2154.3 MHz LTE Band 5 : 869.7 MHz ~ 893.3 MHz LTE Band 7 : 2622.5MHz ~ 2687.5 MHz LTE Band 12 : 729 MHz ~ 746 MHz LTE Band 13 : 748.5 MHz ~ 753.5 MHz LTE Band 17 : 736.5 MHz ~ 743.5 MHz
Bandwidth	LTE Band 2 : 1.4MHz / 3MHz / 5MHz / 10MHz / 15MHz / 20MHz LTE Band 4 : 1.4MHz / 3MHz / 5MHz / 10MHz / 15MHz / 20MHz LTE Band 5 : 1.4MHz / 3MHz / 5MHz / 10MHz LTE Band 7 : 5MHz/ 10MHz / 15MHz / 20MHz LTE Band 12 : 1.4MHz / 3MHz / 5MHz / 10MHz LTE Band 13 : 5MHz / 10MHz LTE Band 17 : 5MHz / 10MHz
Maximum Output Power to Antenna	LTE Band 2 : 22.29 dBm LTE Band 4 : 22.87 dBm LTE Band 5 : 23.00 dBm LTE Band 7 : 22.49 dBm LTE Band 12 : 23.09 dBm LTE Band 13 : 23.00 dBm LTE Band 17 : 23.05 dBm
Type of Modulation	QPSK / 16QAM



EUT Information List				
IMEI	HW Version	SW Version	S/N	Performed Test Item
IMEI : 00440245908364	A	27.1.A.0.38	RV4C13D10888	Conducted Measurement Radiated Spurious Emission ERP /EIRP Test

Accessory List	
AC Adapter	Model No. : EP800
	Type No. : AC-0030-US
	S/N : 3113W46622783
Battery	Model No. : Ram
Earphone	Model No. : MH410c
	Type No. : AG-1103
	S/N : 1411204C00BC7D0
USB Cable	Model No. : EC450
	Type No. : AI-0700
	S/N : 143912D8330504A

Note:

1. Above EUT list and accessory list used are electrically identical per declared by manufacturer.
2. Above the accessories list are used to exercise the EUT during test.
3. For other wireless features of this EUT, test report will be issued separately.

1.5 Modification of EUT

No modifications are made to the EUT during all test items.



1.6 Emission Designator

LTE Band 2		QPSK			16QAM		
BW(MHz)	Emission Designator (99%OBW)	Frequency Tolerance (ppm)	Maximum EIRP(W)	Emission Designator (99%OBW)	Frequency Tolerance (ppm)	Maximum EIRP(W)	
1.4	1M10G7D	-	0.1119	1M10W7D	-	0.0977	
3	2M72G7D	-	0.1109	2M72W7D	-	0.0902	
5	4M51G7D	-	0.1038	4M52W7D	-	0.0849	
10	9M06G7D	0.0008	0.1112	9M04W7D	-	0.0873	
15	13M5G7D	-	0.1094	13M5W7D	-	0.0861	
20	18M6G7D	-	0.1180	18M6W7D	-	0.0841	
LTE Band 4		QPSK			16QAM		
BW(MHz)	Emission Designator (99%OBW)	Frequency Tolerance (ppm)	Maximum EIRP(W)	Emission Designator (99%OBW)	Frequency Tolerance (ppm)	Maximum EIRP(W)	
1.4	1M09G7D	-	0.1542	1M10W7D	-	0.1271	
3	2M72G7D	-	0.1535	2M72W7D	-	0.1271	
5	4M52G7D	-	0.1503	4M51W7D	-	0.1245	
10	9M08G7D	0.0010	0.1315	9M04W7D	-	0.1104	
15	13M5G7D	-	0.1459	13M5W7D	-	0.1219	
20	18M6G7D	-	0.1349	18M6W7D	-	0.1127	
LTE Band 5		QPSK			16QAM		
BW(MHz)	Emission Designator (99%OBW)	Frequency Tolerance (ppm)	Maximum ERP(W)	Emission Designator (99%OBW)	Frequency Tolerance (ppm)	Maximum ERP(W)	
1.4	1M10G7D	-	0.0422	1M10W7D	-	0.0361	
3	2M73G7D	-	0.0401	2M73W7D	-	0.0331	
5	4M50G7D	-	0.0422	4M51W7D	-	0.0364	
10	9M10G7D	0.0158	0.0400	9M06W7D	-	0.0458	
LTE Band 7		QPSK			16QAM		
BW(MHz)	Emission Designator (99%OBW)	Frequency Tolerance (ppm)	Maximum EIRP(W)	Emission Designator (99%OBW)	Frequency Tolerance (ppm)	Maximum EIRP(W)	
5	4M52G7D	-	0.1161	4M51W7D	-	0.0721	
10	9M06G7D	0.0103	0.0883	9M04W7D	-	0.0705	
15	13M5G7D	-	0.1059	13M5W7D	-	0.0706	
20	18M6G7D	-	0.1698	18M6W7D	-	0.1239	



LTE Band 12		QPSK			16QAM			
BW(MHz)	Emission Designator (99%OBW)	Frequency Tolerance (ppm)	Maximum ERP(W)	Maximum EIRP(W)	Emission Designator (99%OBW)	Frequency Tolerance (ppm)	Maximum ERP(W)	Maximum EIRP(W)
1.4	1M10G7D	-	0.0258	0.0424	1M10W7D	-	0.0226	0.0348
3	2M72G7D	-	0.0255	0.0418	2M72W7D	-	0.0218	0.0357
5	4M51G7D	-	0.0269	0.0441	4M51W7D	-	0.0229	0.0375
10	9M10G7D	0.0134	0.0272	0.0446	9M06W7D	-	0.0226	0.0371
LTE Band 13		QPSK			16QAM			
BW(MHz)	Emission Designator (99%OBW)	Frequency Tolerance (ppm)	Maximum ERP(W)	Maximum EIRP(W)	Emission Designator (99%OBW)	Frequency Tolerance (ppm)	Maximum ERP(W)	Maximum EIRP(W)
5	4M51G7D	-	0.0507	0.0832	4M51W7D	-	0.0513	0.0841
10	9M08G7D	0.0038	0.0481	0.0789	9M04W7D	-	0.0524	0.0859
LTE Band 17		QPSK			16QAM			
BW(MHz)	Emission Designator (99%OBW)	Frequency Tolerance (ppm)	Maximum ERP(W)	Maximum EIRP(W)	Emission Designator (99%OBW)	Frequency Tolerance (ppm)	Maximum ERP(W)	Maximum EIRP(W)
5	4M51G7D	-	0.0263	0.0432	4M51W7D	-	0.0225	0.0370
10	9M08G7D	0.0155	0.0259	0.0426	9M06W7D	-	0.0217	0.0356



1.7 Testing Location

Sporton Lab is accredited to ISO 17025 by Taiwan Accreditation Foundation (TAF code : 1190) and the FCC designation No. TW1022 under the FCC 2.948(e) by Mutual Recognition Agreement (MRA) in FCC Test.

Test Site	SPORTON INTERNATIONAL INC.		
Test Site Location	No. 52, Hwa Ya 1 st Rd., Hwa Ya Technology Park, Kwei-Shan District, Tao Yuan City, Taiwan, R.O.C. TEL: +886-3-327-3456 FAX: +886-3-328-4978		
Test Site No.	Sporton Site No.		IC Registration No.
	TH02-HY	03CH11-HY	4086H-2

1.8 Applicable Standards

According to the specifications of the manufacturer, the EUT must comply with the requirements of the following standards:

- ♦ 47 CFR Part 2, 22(H), 24(E), 27
- ♦ ANSI / TIA / EIA-603-C-2004
- ♦ FCC KDB 971168 D01 Power Meas. License Digital Systems v02r02
- ♦ IC RSS-130 Issue1
- ♦ IC RSS-132 Issue 3
- ♦ IC RSS-133 Issue 6
- ♦ IC RSS-139 Issue 2
- ♦ IC RSS-199 Issue 2
- ♦ IC RSS-Gen Issue 4
- ♦ NOTICE 2012-DRS0126

Remark:

1. All test items were verified and recorded according to the standards and without any deviation during the test.
2. This EUT has also been tested and complied with the requirements of FCC Part 15, Subpart B, recorded in a separate test report.
3. Per the section 2.2.3 of Notice of 2012-DRS0126, “ Receivers Excluded from Industry Canada Requirements”, only radiocommunication receivers operating in stand-alone mode within the band 30-960 MHz and scanner receivers are subject to Industry Canada requirements.



2 Test Configuration of Equipment Under Test

2.1 Test Mode

Antenna port conducted and radiated test items listed below are performed according to KDB 971168 D01 Power Meas. License Digital Systems v02r02 with maximum output power.

Radiated measurements are performed by rotating the EUT in three different orthogonal test planes to find the maximum emission.

Test Items	Band	Bandwidth (MHz)						Modulation		RB #			Test Channel		
		1.4	3	5	10	15	20	QPSK	16QAM	1	Half	Full	L	M	H
Max. Output Power	2	✓	✓	✓	✓	✓	✓	✓	✓	✓	✓	✓	✓	✓	✓
	4	✓	✓	✓	✓	✓	✓	✓	✓	✓	✓	✓	✓	✓	✓
	5	✓	✓	✓	✓	-	-	✓	✓	✓	✓	✓	✓	✓	✓
	7	-	-	✓	✓	✓	✓	✓	✓	✓	✓	✓	✓	✓	✓
	12	✓	✓	✓	✓	-	-	✓	✓	✓	✓	✓	✓	✓	✓
	13	-	-	✓	✓	-	-	✓	✓	✓	✓	✓	✓	✓	✓
	17	-	-	✓	✓	-	-	✓	✓	✓	✓	✓	✓	✓	✓
Peak-to-Average Ratio	2						✓	✓	✓	✓		✓	✓	✓	
	4						✓	✓	✓	✓		✓	✓	✓	
	5				✓	-	-	✓	✓	✓		✓	✓	✓	
	7	-	-				✓	✓	✓	✓		✓	✓	✓	
	12				✓	-	-	✓	✓	✓		✓	✓	✓	
	13	-	-		✓	-	-	✓	✓	✓		✓	✓	✓	
	17	-	-		✓	-	-	✓	✓	✓		✓	✓	✓	
26dB and 99% Bandwidth	2	✓	✓	✓	✓	✓	✓	✓	✓			✓	✓	✓	
	4	✓	✓	✓	✓	✓	✓	✓	✓			✓	✓	✓	
	5	✓	✓	✓	✓	-	-	✓	✓			✓	✓	✓	
	7	-	-	✓	✓	✓	✓	✓	✓			✓	✓	✓	
	12	✓	✓	✓	✓	-	-	✓	✓			✓	✓	✓	
	13	-	-	✓	✓	-	-	✓	✓			✓	✓	✓	
	17	-	-	✓	✓	-	-	✓	✓			✓	✓	✓	



Test Items	Band	Bandwidth (MHz)						Modulation		RB #			Test Channel		
		1.4	3	5	10	15	20	QPSK	16QAM	1	Half	Full	L	M	H
Conducted Band Edge	2	✓	✓	✓	✓	✓	✓	✓	✓	✓		✓	✓		✓
	4	✓	✓	✓	✓	✓	✓	✓	✓	✓		✓	✓		✓
	5	✓	✓	✓	✓	-	-	✓	✓	✓		✓	✓		✓
	7	-	-	✓	✓	✓	✓	✓	✓	✓		✓	✓		✓
	12	✓	✓	✓	✓	-	-	✓	✓	✓		✓	✓		✓
	13	-	-	✓	✓	-	-	✓	✓	✓		✓	✓		✓
	17	-	-	✓	✓	-	-	✓	✓	✓		✓	✓		✓
Conducted Spurious Emission	2	✓	✓	✓	✓	✓	✓	✓	✓	✓			✓	✓	✓
	4	✓	✓	✓	✓	✓	✓	✓	✓	✓			✓	✓	✓
	5	✓	✓	✓	✓	-	-	✓	✓	✓			✓	✓	✓
	7	-	-	✓	✓	✓	✓	✓	✓	✓			✓	✓	✓
	12	✓	✓	✓	✓	-	-	✓	✓	✓			✓	✓	✓
	13	-	-	✓	✓	-	-	✓	✓	✓			✓	✓	✓
	17	-	-	✓	✓	-	-	✓	✓	✓			✓	✓	✓
Frequency Stability	2				✓			✓				✓		✓	
	4				✓			✓				✓		✓	
	5				✓	-	-	✓				✓		✓	
	7	-	-	✓	✓			✓				✓		✓	
	12			✓	✓	-	-	✓				✓		✓	
	13	-	-	✓	✓	-	-	✓				✓		✓	
	17	-	-	✓	✓	-	-	✓				✓		✓	
E.R.P./E.I.R.P.	2	✓	✓	✓	✓	✓	✓	✓	✓	✓			✓	✓	✓
	4	✓	✓	✓	✓	✓	✓	✓	✓	✓			✓	✓	✓
	5	✓	✓	✓	✓	-	-	✓	✓	✓			✓	✓	✓
	7	-	-	✓	✓	✓	✓	✓	✓	✓			✓	✓	✓
	12	✓	✓	✓	✓	✓	✓	✓	✓	✓			✓	✓	✓
	13	-	-	✓	✓	✓	✓	✓	✓	✓			✓	✓	✓
	17	-	-	✓	✓	-	-	✓	✓	✓			✓	✓	✓



Test Items	Band	Bandwidth (MHz)						Modulation		RB #			Test Channel		
		1.4	3	5	10	15	20	QPSK	16QAM	1	Half	Full	L	M	H
Radiated Spurious Emission	2	v	v	v	v	v	v	v		v			v	v	v
	4	v	v	v	v	v	v	v		v			v	v	v
	5	v	v	v	v	-	-	v		v			v	v	v
	7	-	-	v	v	v	v	v		v			v	v	v
	12	v	v	v	v	-	-	v		v			v	v	v
	13	-	-	v	v	-	-	v		v			v	v	v
	17	-	-	v	v	-	-	v		v			v	v	v
Note	<ol style="list-style-type: none"> The mark “v “ means that this configuration is chosen for testing The mark “-“ means that this bandwidth is not supported. The device is investigated from 30MHz to 10 times of fundamental signal for radiated spurious emission test under different RB size/offset and modulations in exploratory test. Subsequently, only the worst case emissions are reported. 														



2.2 Support Unit used in test configuration and system

Item	Equipment	Trade Name	Model No.	FCC ID	Data Cable	Power Cord
1.	LTE Base Station	Anritsu	MT8820C	N/A	N/A	Unshielded, 1.8 m

2.3 Measurement Results Explanation Example

For all conducted test items:

The offset level is set in the spectrum analyzer to compensate the RF cable loss and attenuator factor between EUT conducted output port and spectrum analyzer. With the offset compensation, the spectrum analyzer reading level is exactly the EUT RF output level.

The spectrum analyzer offset is derived from RF cable loss and attenuator factor.

Offset = RF cable loss + attenuator factor.

Following shows an offset computation example with cable loss 4.2 dB and 10dB attenuator.

Example :

Offset(dB) = RF cable loss(dB) + attenuator factor(dB).

$$= 4.2 + 10 = 14.2 \text{ (dB)}$$

3 Conducted Test Items

3.1 Measuring Instruments

See list of measuring instruments of this test report.

3.2 Test Setup

3.2.1 Conducted Output Power

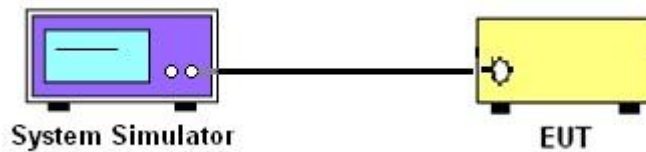

3.2.2 Peak-to-Average Ratio, Occupied Bandwidth ,Conducted Band-Edge and Conducted Spurious Emission

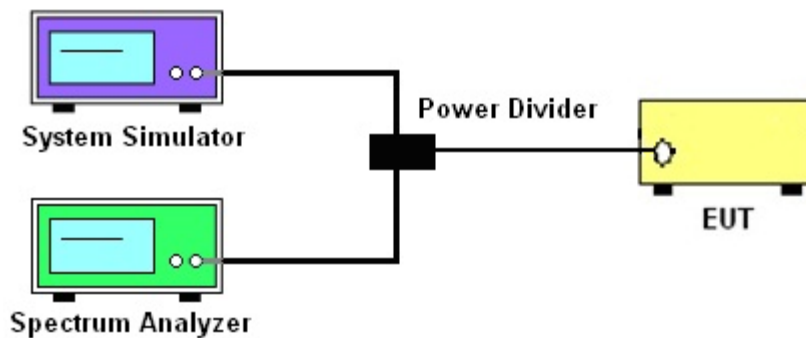

3.2.3 Frequency Stability

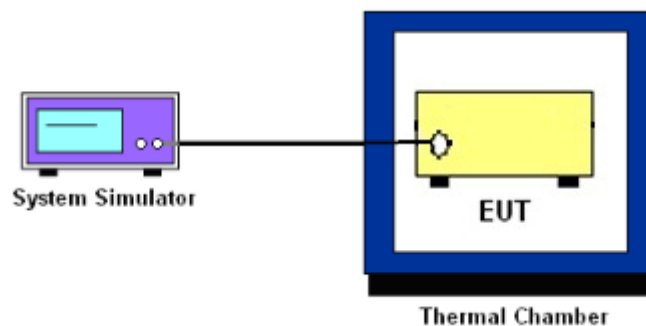

3.3 Test Result of Conducted Test

Please refer to Appendix A.



3.4 Conducted Output Power

3.4.1 Description of the Conducted Output Power Measurement

A system simulator was used to establish communication with the EUT. Its parameters were set to force the EUT transmitting at maximum output power. The measured power in the radio frequency on the transmitter output terminals shall be reported.

3.4.2 Test Procedures

1. The transmitter output port was connected to the system simulator.
2. Set EUT at maximum power through the system simulator.
3. Select lowest, middle, and highest channels for each band and different modulation.
4. Measure and record the power level from the system simulator.



3.5 Peak-to-Average Ratio

3.5.1 Description of the PAR Measurement

Power Complementary Cumulative Distribution Function (CCDF) curves provide a means for characterizing the power peaks of a digitally modulated signal on a statistical basis. A CCDF curve depicts the probability of the peak signal amplitude exceeding the average power level. Most contemporary measurement instrumentation include the capability to produce CCDF curves for an input signal provided that the instrument's resolution bandwidth can be set wide enough to accommodate the entire input signal bandwidth. In measuring transmissions in this band using an average power technique, the peak-to-average ratio (PAR) of the transmission may not exceed 13 dB.

3.5.2 Test Procedures

1. The testing follows FCC KDB 971168 v02r02 Section 5.7.1.
2. The EUT was connected to spectrum and system simulator via a power divider.
3. Set the CCDF (Complementary Cumulative Distribution Function) option in spectrum analyzer.
4. The highest RF powers were measured and recorded the maximum PAPR level associated with a probability of 0.1 %.
5. Record the deviation as Peak to Average Ratio.



3.6 Occupied Bandwidth

3.6.1 Description of Occupied Bandwidth Measurement

The occupied bandwidth is the width of a frequency band such that, below the lower and above the upper frequency limits, the mean powers emitted are each equal to a specified percentage 0.5% of the total mean transmitted power.

The 26 dB emission bandwidth is defined as the frequency range between two points, one above and one below the carrier frequency, at which the spectral density of the emission is attenuated 26 dB below the maximum in-band spectral density of the modulated signal. Spectral density (power per unit bandwidth) is to be measured with a detector of resolution bandwidth equal to approximately 1.0% of the emission bandwidth.

3.6.2 Test Procedures

1. The testing follows FCC KDB 971168 v02r02 Section 4.2.
2. The EUT was connected to spectrum analyzer and system simulator via a power divider.



3.7 Conducted Band Edge

3.7.1 Description of Conducted Band Edge Measurement

22.917(a) and RSS – 132

For operations in the 824 – 849 MHz band, the FCC limit is $43 + 10\log_{10}(P[\text{Watts}])$ dB below the transmitter power $P(\text{Watts})$ in a 100kHz bandwidth. However, in the 1MHz bands immediately outside and adjacent to the licensee's frequency block, a resolution bandwidth of at least one percent of the emission bandwidth of the fundamental emission of the transmitter may be employed.

24.238 (a) and RSS – 133

For operations in the 1850-1910 and 1930-1990 MHz band, the FCC limit is $43 + 10\log_{10}(P[\text{Watts}])$ dB below the transmitter power $P(\text{Watts})$ in a 1MHz bandwidth. However, in the 1 MHz bands immediately outside and adjacent to the frequency block a resolution bandwidth of at least one percent of the emission bandwidth of the fundamental emission of the transmitter may be employed.

27.53 (c) and RSS – 130

For operations in the 776-788 MHz band, the FCC limit is $43 + 10\log_{10}(P[\text{Watts}])$ dB below the transmitter power $P(\text{Watts})$ in a 100 kHz bandwidth. However, in the 100 kHz bands immediately outside and adjacent to the frequency block, a resolution bandwidth of at least 30 kHz may be employed. In addition, the power of any unwanted emissions in any 6.25 kHz bandwidth for all frequencies between 763-775 MHz and 793-806 MHz shall be attenuated below the transmitter power, P (dBW), by at least $65 + 10 \log_{10} p(\text{watts})$, dB, for mobile and portable equipment.

27.53 (g) and RSS – 130

For operations in the 698 -746 MHz band, the FCC limit is $43 + 10\log_{10}(P[\text{Watts}])$ dB below the transmitter power $P(\text{Watts})$ in a 100 kHz bandwidth. However, in the 100 kilohertz bands immediately outside and adjacent to a licensee's frequency block, a resolution bandwidth of at least 30 kHz may be employed.

27.53 (h) and RSS – 139

For operations in the 1710 – 1755 MHz band, the FCC limit is $43 + 10\log_{10}(P[\text{Watts}])$ dB below the transmitter power $P(\text{Watts})$ in a 1 MHz bandwidth. However, in the 1MHz bands immediately outside and adjacent to the licensee's frequency block, a resolution bandwidth of at least one percent of the emission bandwidth of the fundamental emission of the transmitter may be employed.



27.53(m)(4) and RSS-199

For mobile digital stations, the attenuation factor shall be not less than $40 + 10 \log (P)$ dB on all frequencies between the channel edge and 5 megahertz from the channel edge, $43 + 10 \log (P)$ dB on all frequencies between 5 megahertz and X megahertz from the channel edge, and $55 + 10 \log (P)$ dB on all frequencies more than X megahertz from the channel edge, where X is the greater of 6 megahertz or the actual emission bandwidth as defined in paragraph (m)(6) of this section. In addition, the attenuation factor shall not be less that $43 + 10 \log (P)$ dB on all frequencies between 2490.5 MHz and 2496 MHz and $55 + 10 \log (P)$ dB at or below 2490.5 MHz. Mobile Satellite Service licensees operating on frequencies below 2495 MHz may also submit a documented interference complaint against BRS licensees operating on channel BRS Channel 1 on the same terms and conditions as adjacent channel BRS or EBS licensees.

3.7.2 Test Procedures

1. The testing follows FCC KDB 971168 v02r02 Section 6.0.
2. The EUT was connected to spectrum analyzer and system simulator via a power divider.
3. The band edges of low and high channels for the highest RF powers were measured. Set RBW $\geq 1\%$ EBW in the 1MHz band immediately outside and adjacent to the band edge.
4. Set spectrum analyzer with RMS detector.
5. The RF fundamental frequency should be excluded against the limit line in the operating frequency band.
6. The limit line is derived from $43 + 10\log(P)$ dB below the transmitter power P(Watts)
 $= P(W) - [43 + 10\log(P)]$ (dB)
 $= [30 + 10\log(P)]$ (dBm) - $[43 + 10\log(P)]$ (dB)
 $= -13$ dBm.



3.8 Conducted Spurious Emission

3.8.1 Description of Conducted Spurious Emission Measurement

The power of any emission outside of the authorized operating frequency ranges must be lower than the transmitter power (P) by a factor of at least $43 + 10 \log (P)$ dB.

For Band 7:

The power of any emission outside of the authorized operating frequency ranges must be lower than the transmitter power (P) by a factor of at least $55 + 10 \log (P)$ dB.

It is measured by means of a calibrated spectrum analyzer and scanned from 30 MHz up to a frequency including its 10th harmonic.

3.8.2 Test Procedures

1. The testing follows FCC KDB 971168 v02r02 Section 6.0.
2. The EUT was connected to spectrum analyzer and system simulator via a power divider.
3. The RF output of EUT was connected to the spectrum analyzer by RF cable and attenuator. The path loss was compensated to the results for each measurement.
4. The middle channel for the highest RF power within the transmitting frequency was measured.
5. The conducted spurious emission for the whole frequency range was taken.
6. Make the measurement with the spectrum analyzer's RBW = 1MHz, VBW = 3MHz, taking the record of maximum spurious emission.
7. The RF fundamental frequency should be excluded against the limit line in the operating frequency band.
8. The limit line is derived from $43 + 10\log(P)$ dB below the transmitter power P(Watts)
= $P(W) - [43 + 10\log(P)]$ (dB)
= $[30 + 10\log(P)]$ (dBm) - $[43 + 10\log(P)]$ (dB)
= -13dBm.
9. For Band 7
The limit line is derived from $55 + 10\log(P)$ dB below the transmitter power P(Watts)



3.9 Frequency Stability

3.9.1 Description of Frequency Stability Measurement

The frequency stability shall be measured by variation of ambient temperature and variation of primary supply voltage to ensure that the fundamental emission stays within the authorized frequency block. The frequency stability of the transmitter shall be maintained within $\pm 0.00025\%$ ($\pm 2.5\text{ppm}$) of the center frequency.

3.9.2 Test Procedures for Temperature Variation

1. The EUT was set up in the thermal chamber and connected with the system simulator.
2. With power OFF, the temperature was decreased to -30°C and the EUT was stabilized before testing. Power was applied and the maximum change in frequency was recorded within one minute.
3. With power OFF, the temperature was raised in 10°C step up to 50°C . The EUT was stabilized at each step for at least half an hour. Power was applied and the maximum frequency change was recorded within one minute.

3.9.3 Test Procedures for Voltage Variation

1. The testing follows FCC KDB 971168 v02r02 Section 9.0.
2. The EUT was placed in a temperature chamber at $25\pm 5^{\circ}\text{C}$ and connected with the system simulator.
3. The power supply voltage to the EUT was varied from 85% to 115% of the nominal value measured at the input to the EUT.
4. The variation in frequency was measured for the worst case.

3.9.4 Test Procedures for Frequency Stability (IC)

1. The testing follows FCC KDB 971168 v02r02 Section 9.0.
2. The EUT was connected to spectrum analyzer and system simulator via a power divider.
3. The EUT was operated at the lowest and highest channel
4. Using $\text{RBW} = 1\%$ OBW and displaying line = -13dBm .
5. The frequency at these points shall be recorded as f_L and f_H respectively.
6. Calculate frequency stability within the 2500 – 2570MHz, 699 – 716MHz, 777 – 787MHz and 704 – 716 band.

4 Radiated Test Items

4.1 Measuring Instruments

See list of measuring instruments of this test report.

4.2 Test Setup

4.2.1 For radiated test from 30MHz to 1GHz

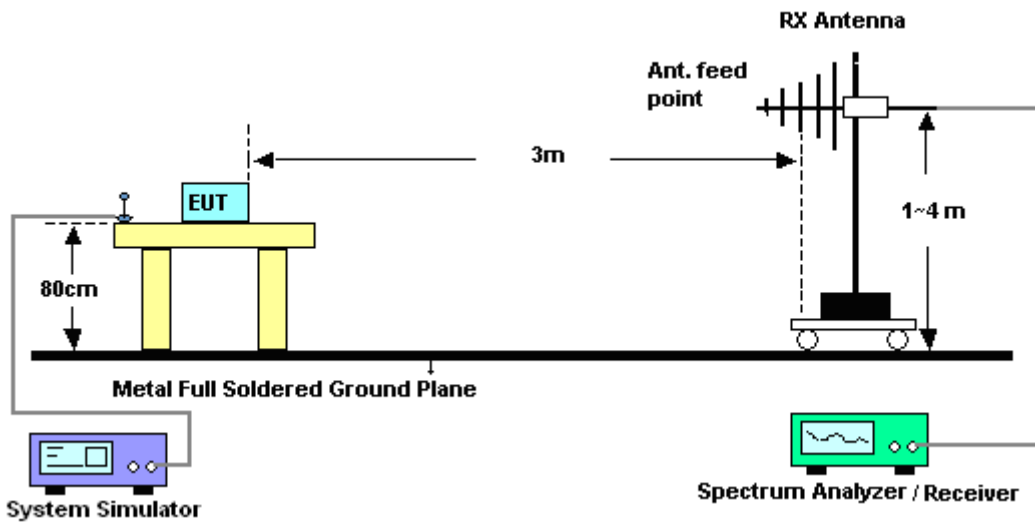

4.2.2 For radiated test above 1GHz

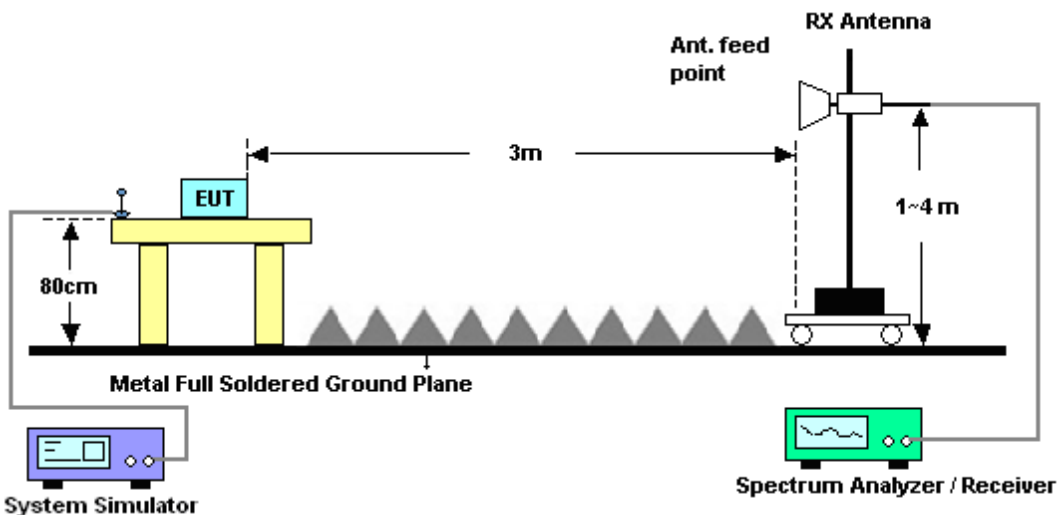

4.3 Test Result of Radiated Test

Please refer to Appendix B.



4.4 Effective Radiated Power and Effective Isotropic Radiated Power

4.4.1 Description of the ERP/EIRP Measurement

Effective radiated power output measurements by substitution method according to ANSI / TIA / EIA-603-C-2004, and the spectrum analyzer configuration follows KDB 971168 D01 Power Meas. License Digital Systems v02r02. Mobile and portable (hand-held) stations operating are limited to average ERP of 7 watts with LTE band 5 and 3 watts with LTE band 12 / 13 / 17.

Equivalent isotropic radiated power output measurements by substitution method according to ANSI / TIA / EIA-603-C-2004, and the spectrum analyzer configuration follows KDB 971168 D01 Power Meas. License Digital Systems v02r02. Mobile and portable (hand-held) stations operating are limited to average EIRP of 2 watts with LTE band 2 / 7 and 1 watt with LTE band 4.

4.4.2 Test Procedures

1. The testing follows FCC KDB 971168 v02r02 Section 5.2.1. (for CDMA/WCDMA), Section 5.2.2.2 (for GSM/GPRS/EDGE) and ANSI / TIA-603-C-2004 Section 2.2.17.
2. The EUT was placed on a non-conductive rotating platform 0.8 meters high in a semi-anechoic chamber. The radiated emission at the fundamental frequency was measured at 3 m with a test antenna and a spectrum analyzer with RMS detector.
3. During the measurement, the system simulator parameters were set to force the EUT transmitting at maximum output power. The maximum emission was recorded from analyzer power level (LVL) from the 360 degrees rotation of the turntable and the test antenna raised and lowered over a range from 1 to 4 meters in both horizontally and vertically polarized orientations.
4. Effective Isotropic Radiated Power (EIRP) was measured by substitution method according to TIA/EIA-603-C. The EUT was replaced by dipole antenna (substitution antenna) at same location, and then a known power from S.G. was applied into the dipole antenna through a Tx cable, and then recorded the maximum Analyzer reading through raised and lowered the test antenna. The correction factor (in dB) = S.G. - Tx Cable loss + Substitution antenna gain - Analyzer reading. Then the EUT's EIRP was calculated with the correction factor, $EIRP = LVL + \text{Correction factor}$ and $ERP = EIRP - 2.15$.



	LTE					
LTE BW	1.4M	3M	5M	10M	15M	20M
Span	3MHz	6MHz	10MHz	20MHz	30MHz	40MHz
RBW	30kHz	100kHz	100kHz	300kHz	300kHz	300kHz
VBW	100kHz	300kHz	300kHz	1MHz	1MHz	1MHz
Detector	RMS	RMS	RMS	RMS	RMS	RMS
Trace	Average	Average	Average	Average	Average	Average
Average Type	Power	Power	Power	Power	Power	Power
Sweep Count	100	100	100	100	100	100



4.5 Radiated Spurious Emission

4.5.1 Description of Radiated Spurious Emission

The radiated spurious emission was measured by substitution method according to ANSI / TIA / EIA-603-C-2004. The power of any emission outside of the authorized operating frequency ranges must be attenuated below the transmitter power (P) by a factor of at least $43 + 10 \log (P)$ dB.

For Band 7

The power of any emission outside of the authorized operating frequency ranges must be attenuated below the transmitter power (P) by a factor of at least $55 + 10 \log (P)$ dB.

For Band 12,13,17

For operations in the 746-758 MHz, 775-788 MHz, and 805-806 MHz bands, emissions in the band 1559-1610 MHz shall be limited to -70 dBW/MHz equivalent isotropically radiated power (EIRP) for wideband signals, and -80 dBW EIRP for discrete emissions of less than 700 Hz bandwidth.

The spectrum is scanned from 30 MHz up to a frequency including its 10th harmonic.

4.5.2 Test Procedures

1. The testing follows FCC KDB 971168 v02r02 Section 5.8 and ANSI / TIA-603-C-2004 Section 2.2.12.
2. The EUT was placed on a rotatable wooden table with 0.8 meter above ground.
3. The EUT was set 3 meters from the receiving antenna, which was mounted on the antenna tower.
4. The table was rotated 360 degrees to determine the position of the highest spurious emission.
5. The height of the receiving antenna is varied between one meter and four meters to search the maximum spurious emission for both horizontal and vertical polarizations.
6. Make the measurement with the spectrum analyzer's RBW = 1MHz, VBW = 3MHz, taking the record of maximum spurious emission.
7. A horn antenna was substituted in place of the EUT and was driven by a signal generator.
8. Tune the output power of signal generator to the same emission level with EUT maximum spurious emission.
9. Taking the record of output power at antenna port.
10. Repeat step 7 to step 8 for another polarization.
11. The RF fundamental frequency should be excluded against the limit line in the operating frequency band.

The limit line is derived from $43 + 10\log(P)$ dB below the transmitter power P(Watts)
 $= P(W) - [43 + 10\log(P)]$ (dB)
 $= [30 + 10\log(P)]$ (dBm) - $[43 + 10\log(P)]$ (dB)
 $= -13$ dBm.

For Band 7:

The limit line is derived from $55 + 10\log(P)$ dB below the transmitter power P(Watts)
EIRP (dBm) = S.G. Power – Tx Cable Loss + Tx Antenna Gain
ERP (dBm) = EIRP - 2.15



5 List of Measuring Equipment

Instrument	Manufacturer	Model No.	Serial No.	Characteristics	Calibration Date	Test Date	Due Date	Remark
LTE Base Station	Anritsu	MT8820C	6201026480	30MHz~2.7GHz SISO	Jan. 08, 2015	Jan. 12, 2015~Jan. 14, 2015	Jan. 07, 2016	Conducted (TH02-HY)
Spectrum Analyzer	Rohde & Schwarz	FSP40	100055	9kHz~40GHz	Jun. 09, 2014	Jan. 12, 2015~Jan. 14, 2015	Jun. 08, 2015	Conducted (TH02-HY)
Thermal Chamber	Ten Billion	TTH-D3SP	TBN-930701	N/A	Jul. 17, 2014	Jan. 12, 2015~Jan. 14, 2015	Jul. 16, 2015	Conducted (TH02-HY)
Hygrometer	Testo	608-H1	34897199	N/A	May 06, 2014	Jan. 12, 2015~Jan. 14, 2015	May 05, 2015	Conducted (TH02-HY)
RF cable	WOKEN	S05	S05-130708-038	N/A	Jan. 22, 2014	Jan. 12, 2015~Jan. 14, 2015	Jan. 21, 2015	Conducted (TH02-HY)
Preamplifier	Keysight	83017A	MY53270080	1GHz~26.5GHz	Nov. 20, 2014	Jan. 27, 2015~Jan. 30, 2015	Nov. 19, 2015	Radiation (03CH11-HY)
Amplifier	SONOMA	310N	187312	0.1MHz~1000MHz	Nov. 24, 2014	Jan. 27, 2015~Jan. 30, 2015	Nov. 23, 2015	Radiation (03CH11-HY)
Preamplifier	MITEQ	JS44-18004000-33-8P	1840917	18GHz ~ 40GHz	Jun. 09, 2014	Jan. 27, 2015~Jan. 30, 2015	Jun. 08, 2015	Radiation (03CH11-HY)
Bilog Antenna	TESEQ	CBL 6111D	35414	30MHz~1GHz	Oct. 24, 2014	Jan. 27, 2015~Jan. 30, 2015	Oct. 23, 2015	Radiation (03CH11-HY)
Double Ridged Guide Horn	SCHWARZBECK	BBHA 9120 D	9120D-1326	1GHz ~ 18GHz	Oct. 03, 2014	Jan. 27, 2015~Jan. 30, 2015	Oct. 02, 2015	Radiation (03CH11-HY)
Horn Antenna	SCHWARZBECK	BBHA 9170	BBHA9170584	18GHz- 40GHz	Nov. 03, 2014	Jan. 27, 2015~Jan. 30, 2015	Nov. 02, 2015	Radiation (03CH11-HY)
Spectrum Analyzer	Keysight	N9010A	MY54200486	N/A	Sep. 24, 2014	Jan. 27, 2015~Jan. 30, 2015	Sep. 23, 2015	Radiation (03CH11-HY)
EMI Test Receiver	Keysight	N9038A	MY54130085	20Hz ~ 26.5GHz	Nov. 05, 2014	Jan. 27, 2015~Jan. 30, 2015	Nov. 04, 2015	Radiation (03CH11-HY)
Controllor	EMEC	EM 1000	N/A	1m-4m	N/A	Jan. 27, 2015~Jan. 30, 2015	N/A	Radiation (03CH11-HY)
Turn Table	EMEC	TT 2000	N/A	0-360 degree	N/A	Jan. 27, 2015~Jan. 30, 2015	N/A	Radiation (03CH11-HY)
Antenna Mast	EMEC	AM-BS-450 0-B	N/A	N/A	N/A	Jan. 27, 2015~Jan. 30, 2015	N/A	Radiation (03CH11-HY)
Hygrometer	TECPEL	DTN-303B	TP140325	N/A	Nov. 19, 2014	Jan. 27, 2015~Jan. 30, 2015	Nov. 18, 2015	Radiation (03CH11-HY)
RF Cable	HUBER + SUHNER	SUCOFLEX 104	MY44614PE MY249674	25GHz~40GHz	Nov. 06, 2014	Jan. 27, 2015~Jan. 30, 2015	Nov. 05, 2015	Radiation (03CH11-HY)
RF Cable	HUBER + SUHNER	SUCOFLEX 104	MY44614PE MY249674MY	30MHz~1GHz	Nov. 06, 2014	Jan. 27, 2015~Jan. 30, 2015	Nov. 05, 2015	Radiation (03CH11-HY)
RF Cable	HUBER + SUHNER	SUCOFLEX 104	MY44614PE MY249674MY	1GHz~25GHz	Nov. 06, 2014	Jan. 27, 2015~Jan. 30, 2015	Nov. 05, 2015	Radiation (03CH11-HY)

Note: Test equipment calibration is traceable to the procedure of ISO17025.



6 Uncertainty of Evaluation

Uncertainty of Radiated Emission Measurement (30 MHz ~ 1000 MHz)

Measuring Uncertainty for a Level of Confidence of 95% ($U = 2Uc(y)$)	2.54
---	------



Appendix A. Test Results of Conducted Test

Conducted Output Power(Average power)

LTE Band 2 Maximum Average Power [dBm]						
BW [MHz]	RB Size	RB Offset	Mod	Lowest	Middle	Highest
1.4	1	0	QPSK	21.95	22.00	22.00
1.4	1	2		21.92	21.99	21.99
1.4	1	5		21.85	21.98	21.89
1.4	3	0		21.83	21.88	21.87
1.4	3	1		21.90	21.96	21.95
1.4	3	2		21.89	21.96	21.94
1.4	6	0		20.93	20.98	20.98
1.4	1	0	16-QAM	21.22	21.26	21.15
1.4	1	2		21.21	21.25	21.14
1.4	1	5		21.12	21.11	21.06
1.4	3	0		20.97	20.97	20.96
1.4	3	1		20.91	20.94	20.93
1.4	3	2		20.89	20.93	20.92
1.4	6	0		20.01	20.03	20.05
3	1	0	QPSK	21.87	21.93	21.96
3	1	7		21.82	21.92	21.95
3	1	14		21.76	21.87	21.86
3	8	0		20.95	21.00	21.02
3	8	4		20.95	20.99	21.00
3	8	7		20.92	20.99	20.99
3	15	0		20.93	21.01	21.04
3	1	0	16-QAM	21.16	21.16	21.14
3	1	7		21.15	21.15	21.13
3	1	14		21.05	21.11	21.04
3	8	0		20.01	20.03	20.06
3	8	4		19.99	20.02	20.04
3	8	7		19.97	20.02	20.01
3	15	0		19.93	20.00	20.01



LTE Band 2 Maximum Average Power [dBm]						
BW [MHz]	RB Size	RB Offset	Mod	Lowest	Middle	Highest
5	1	0	QPSK	21.90	21.97	21.99
5	1	12		21.89	21.96	21.98
5	1	24		21.80	21.88	21.88
5	12	0		20.99	21.05	21.08
5	12	6		20.96	21.02	21.04
5	12	11		20.96	21.03	21.04
5	25	0		20.91	21.00	21.03
5	1	0	16-QAM	21.19	21.20	21.19
5	1	12		21.18	21.19	21.18
5	1	24		21.07	21.11	21.05
5	12	0		19.98	20.03	20.06
5	12	6		19.97	20.01	20.03
5	12	11		19.96	20.02	20.02
5	25	0		19.90	19.98	20.00
10	1	0	QPSK	22.01	22.01	22.07
10	1	24		21.94	21.99	22.01
10	1	49		21.89	21.97	21.96
10	25	0		21.01	21.05	21.08
10	25	12		20.98	21.05	21.07
10	25	24		20.97	21.05	21.07
10	50	0		21.01	21.09	21.11
10	1	0	16-QAM	21.29	21.24	21.32
10	1	24		21.21	21.21	21.25
10	1	49		21.15	21.21	21.15
10	25	0		20.01	20.02	20.06
10	25	12		19.97	20.02	20.06
10	25	24		19.95	20.03	20.05
10	50	0		20.00	20.06	20.08



LTE Band 2 Maximum Average Power [dBm]						
BW [MHz]	RB Size	RB Offset	Mod	Lowest	Middle	Highest
15	1	0	QPSK	22.09	22.08	22.15
15	1	37		22.02	22.07	22.11
15	1	74		21.98	22.07	22.07
15	36	0		21.10	21.14	21.22
15	36	18		21.08	21.14	21.17
15	36	37		21.07	21.14	21.16
15	75	0		21.08	21.13	21.17
15	1	0	16-QAM	21.35	21.33	21.41
15	1	37		21.29	21.32	21.33
15	1	74		21.22	21.32	21.22
15	36	0		20.10	20.12	20.19
15	36	18		20.05	20.11	20.14
15	36	37		20.03	20.12	20.12
15	75	0		20.05	20.10	20.15
20	1	0	QPSK	22.24	22.25	22.29
20	1	49		22.13	22.19	22.22
20	1	99		22.17	22.23	22.19
20	50	0		21.26	21.31	21.35
20	50	24		21.19	21.28	21.30
20	50	49		21.20	21.27	21.26
20	100	0		21.21	21.28	21.30
20	1	0	16-QAM	21.46	21.48	21.49
20	1	49		21.39	21.47	21.48
20	1	99		21.37	21.41	21.39
20	50	0		20.25	20.28	20.32
20	50	24		20.18	20.24	20.27
20	50	49		20.19	20.24	20.23
20	100	0		20.17	20.24	20.26



LTE Band 4 Maximum Average Power [dBm]						
BW [MHz]	RB Size	RB Offset	Mod	Lowest	Middle	Highest
1.4	1	0	QPSK	22.51	22.59	22.60
1.4	1	2		22.50	22.58	22.59
1.4	1	5		22.40	22.47	22.50
1.4	3	0		22.40	22.58	22.48
1.4	3	1		22.46	22.53	22.55
1.4	3	2		22.46	22.52	22.56
1.4	6	0		21.49	21.58	21.58
1.4	1	0	16-QAM	21.78	21.82	21.88
1.4	1	2		21.77	21.81	21.86
1.4	1	5		21.67	21.69	21.73
1.4	3	0		21.52	21.57	21.60
1.4	3	1		21.48	21.53	21.55
1.4	3	2		21.48	21.50	21.54
1.4	6	0		20.55	20.63	20.65
3	1	0	QPSK	22.51	22.55	22.55
3	1	7		22.50	22.54	22.54
3	1	14		22.42	22.45	22.50
3	8	0		21.58	21.62	21.64
3	8	4		21.56	21.62	21.63
3	8	7		21.53	21.60	21.62
3	15	0		21.56	21.61	21.63
3	1	0	16-QAM	21.77	21.74	21.79
3	1	7		21.76	21.73	21.78
3	1	14		21.67	21.68	21.73
3	8	0		20.61	20.66	20.68
3	8	4		20.58	20.64	20.66
3	8	7		20.58	20.63	20.65
3	15	0		20.56	20.58	20.64



LTE Band 4 Maximum Average Power [dBm]						
BW [MHz]	RB Size	RB Offset	Mod	Lowest	Middle	Highest
5	1	0	QPSK	22.52	22.56	22.58
5	1	12		22.51	22.55	22.57
5	1	24		22.41	22.47	22.48
5	12	0		21.61	21.65	21.66
5	12	6		21.57	21.64	21.63
5	12	11		21.57	21.63	21.64
5	25	0		21.54	21.61	21.61
5	1	0	16-QAM	21.77	21.78	21.85
5	1	12		21.76	21.75	21.84
5	1	24		21.66	21.69	21.75
5	12	0		20.60	20.63	20.66
5	12	6		20.55	20.62	20.62
5	12	11		20.55	20.62	20.64
5	25	0		20.53	20.58	20.59
10	1	0	QPSK	22.63	22.64	22.62
10	1	24		22.59	22.61	22.58
10	1	49		22.50	22.54	22.53
10	25	0		21.61	21.68	21.62
10	25	12		21.59	21.66	21.61
10	25	24		21.60	21.64	21.61
10	50	0		21.62	21.70	21.65
10	1	0	16-QAM	21.91	21.85	21.88
10	1	24		21.87	21.84	21.85
10	1	49		21.77	21.79	21.80
10	25	0		20.61	20.66	20.61
10	25	12		20.57	20.64	20.60
10	25	24		20.58	20.61	20.60
10	50	0		20.60	20.68	20.63



LTE Band 4 Maximum Average Power [dBm]						
BW [MHz]	RB Size	RB Offset	Mod	Lowest	Middle	Highest
15	1	0	QPSK	22.68	22.70	22.68
15	1	37		22.62	22.66	22.62
15	1	74		22.60	22.60	22.58
15	36	0		21.70	21.76	21.72
15	36	18		21.69	21.74	21.70
15	36	37		21.67	21.70	21.67
15	75	0		21.67	21.73	21.67
15	1	0	16-QAM	21.95	21.92	21.92
15	1	37		21.87	21.91	21.90
15	1	74		21.83	21.85	21.83
15	36	0		20.68	20.74	20.70
15	36	18		20.66	20.71	20.66
15	36	37		20.64	20.67	20.66
15	75	0		20.63	20.70	20.66
20	1	0	QPSK	22.87	22.85	22.85
20	1	49		22.75	22.77	22.75
20	1	99		22.77	22.75	22.72
20	50	0		21.85	21.90	21.88
20	50	24		21.81	21.85	21.81
20	50	49		21.83	21.82	21.78
20	100	0		21.81	21.86	21.82
20	1	0	16-QAM	22.12	22.10	22.11
20	1	49		22.01	22.00	22.02
20	1	99		21.99	22.00	21.99
20	50	0		20.83	20.87	20.85
20	50	24		20.79	20.82	20.80
20	50	49		20.80	20.79	20.75
20	100	0		20.76	20.82	20.79



LTE Band 5 Maximum Average Power [dBm]						
BW [MHz]	RB Size	RB Offset	Mod	Lowest	Middle	Highest
1.4	1	0	QPSK	22.97	22.98	22.86
1.4	1	2		22.95	22.97	22.65
1.4	1	5		22.88	22.87	22.82
1.4	3	0		22.85	22.97	22.75
1.4	3	1		22.91	22.93	22.70
1.4	3	2		22.92	22.93	22.66
1.4	6	0		21.94	21.94	21.45
1.4	1	0	16-QAM	22.23	22.34	22.26
1.4	1	2		22.22	22.33	22.25
1.4	1	5		22.14	22.21	22.14
1.4	3	0		22.00	22.04	22.02
1.4	3	1		21.96	22.00	21.97
1.4	3	2		21.94	21.99	21.95
1.4	6	0		21.03	21.08	21.03
3	1	0	QPSK	22.93	22.92	22.94
3	1	7		22.92	22.91	22.93
3	1	14		22.82	22.85	22.80
3	8	0		22.02	21.99	21.98
3	8	4		21.97	21.99	21.99
3	8	7		21.96	21.98	21.97
3	15	0		21.99	21.95	21.98
3	1	0	16-QAM	22.24	22.30	22.25
3	1	7		22.23	22.29	22.24
3	1	14		22.14	22.22	22.14
3	8	0		21.07	21.09	21.09
3	8	4		21.04	21.08	21.06
3	8	7		21.02	21.09	21.07
3	15	0		21.01	21.02	21.03



LTE Band 5 Maximum Average Power [dBm]						
BW [MHz]	RB Size	RB Offset	Mod	Lowest	Middle	Highest
5	1	0	QPSK	22.89	22.91	22.91
5	1	12		22.84	22.90	22.90
5	1	24		22.83	22.83	22.79
5	12	0		21.97	21.98	22.00
5	12	6		21.92	21.97	21.98
5	12	11		21.94	21.98	21.97
5	25	0		21.90	21.89	21.93
5	1	0	16-QAM	22.17	22.29	22.26
5	1	12		22.15	22.28	22.25
5	1	24		22.16	22.19	22.12
5	12	0		21.00	21.01	21.05
5	12	6		20.95	21.02	21.03
5	12	11		20.96	21.03	21.02
5	25	0		20.92	20.97	20.97
10	1	0	QPSK	23.00	22.98	22.97
10	1	24		22.99	22.97	22.93
10	1	49		22.91	22.94	22.84
10	25	0		21.98	21.96	21.99
10	25	12		21.98	21.99	21.96
10	25	24		21.98	22.00	21.95
10	50	0		21.98	22.01	21.97
10	1	0	16-QAM	22.33	22.35	22.30
10	1	24		22.32	22.34	22.19
10	1	49		22.27	22.28	22.15
10	25	0		21.02	21.04	21.03
10	25	12		21.01	21.04	20.99
10	25	24		21.03	21.05	21.00
10	50	0		21.02	21.07	21.02



LTE Band 7 Maximum Average Power [dBm]						
BW [MHz]	RB Size	RB Offset	Mod	Lowest	Middle	Highest
5	1	0	QPSK	22.10	22.32	22.19
5	1	12		22.07	22.31	22.18
5	1	24		21.99	22.26	22.15
5	12	0		21.17	21.38	21.30
5	12	6		21.16	21.35	21.28
5	12	11		21.15	21.38	21.30
5	25	0		21.12	21.33	21.25
5	1	0	16-QAM	21.35	21.48	21.47
5	1	12		21.34	21.37	21.46
5	1	24		21.26	21.26	21.43
5	12	0		20.19	20.40	20.32
5	12	6		20.18	20.40	20.32
5	12	11		20.18	20.40	20.33
5	25	0		20.12	20.35	20.30
10	1	0	QPSK	22.17	22.41	22.28
10	1	24		22.15	22.40	22.27
10	1	49		22.13	22.40	22.27
10	25	0		21.22	21.41	21.32
10	25	12		21.19	21.42	21.33
10	25	24		21.21	21.45	21.35
10	50	0		21.23	21.46	21.38
10	1	0	16-QAM	21.44	21.49	21.46
10	1	24		21.43	21.38	21.37
10	1	49		21.42	21.24	21.27
10	25	0		20.22	20.44	20.33
10	25	12		20.20	20.44	20.35
10	25	24		20.21	20.46	20.36
10	50	0		20.23	20.45	20.40



LTE Band 7 Maximum Average Power [dBm]						
BW [MHz]	RB Size	RB Offset	Mod	Lowest	Middle	Highest
15	1	0	QPSK	22.41	22.46	22.45
15	1	37		22.38	22.40	22.44
15	1	74		22.34	22.38	22.43
15	36	0		21.43	21.45	21.46
15	36	18		21.43	21.36	21.34
15	36	37		21.46	21.20	21.25
15	75	0		21.43	21.15	21.12
15	1	0	16-QAM	21.49	21.49	21.45
15	1	37		21.34	21.36	21.34
15	1	74		21.29	21.25	21.24
15	36	0		20.44	20.45	20.43
15	36	18		20.43	20.36	20.34
15	36	37		20.47	20.22	20.26
15	75	0		20.44	20.16	20.12
20	1	0	QPSK	22.48	22.49	22.45
20	1	49		22.37	22.44	22.32
20	1	99		22.46	22.32	22.28
20	50	0		21.46	21.48	21.48
20	50	24		21.45	21.38	21.31
20	50	49		21.49	21.26	21.26
20	100	0		21.45	21.18	21.14
20	1	0	16-QAM	21.43	21.47	21.45
20	1	49		21.38	21.33	21.38
20	1	99		21.33	21.21	21.24
20	50	0		20.46	20.48	20.49
20	50	24		20.46	20.35	20.37
20	50	49		20.49	20.26	20.26
20	100	0		20.45	20.18	20.13



LTE Band 12 Maximum Average Power [dBm]						
BW [MHz]	RB Size	RB Offset	Mod	Lowest	Middle	Highest
1.4	1	0	QPSK	23.08	23.06	23.02
1.4	1	2		23.05	23.05	23.01
1.4	1	5		22.94	22.94	22.90
1.4	3	0		22.87	22.87	22.81
1.4	3	1		22.71	22.72	22.77
1.4	3	2		22.62	22.69	22.68
1.4	6	0		22.01	22.00	22.00
1.4	1	0	16-QAM	22.36	22.30	22.37
1.4	1	2		22.35	22.29	22.36
1.4	1	5		22.24	22.27	22.23
1.4	3	0		22.08	22.13	22.09
1.4	3	1		22.04	22.07	22.05
1.4	3	2		22.04	22.02	22.03
1.4	6	0		21.11	21.11	21.10
3	1	0	QPSK	22.98	23.01	22.96
3	1	7		22.97	23.00	22.95
3	1	14		22.94	22.89	22.88
3	8	0		22.06	22.06	22.02
3	8	4		22.04	22.06	22.05
3	8	7		22.05	22.05	22.03
3	15	0		22.03	22.05	22.02
3	1	0	16-QAM	22.28	22.36	22.32
3	1	7		22.27	22.35	22.31
3	1	14		22.26	22.25	22.23
3	8	0		21.14	21.13	21.11
3	8	4		21.13	21.14	21.11
3	8	7		21.13	21.13	21.10
3	15	0		21.06	21.07	21.05



LTE Band 12 Maximum Average Power [dBm]						
BW [MHz]	RB Size	RB Offset	Mod	Lowest	Middle	Highest
5	1	0	QPSK	23.01	23.01	22.94
5	1	12		23.00	23.00	22.93
5	1	24		22.95	22.92	22.84
5	12	0		22.03	22.05	21.98
5	12	6		22.05	22.05	21.96
5	12	11		22.07	22.04	21.98
5	25	0		22.00	21.99	21.93
5	1	0	16-QAM	22.32	22.35	22.27
5	1	12		22.31	22.34	22.26
5	1	24		22.30	22.25	22.19
5	12	0		21.06	21.09	21.01
5	12	6		21.08	21.09	20.99
5	12	11		21.08	21.07	21.01
5	25	0		21.01	21.00	20.94
10	1	0	QPSK	23.09	23.04	22.99
10	1	24		23.03	23.03	22.97
10	1	49		23.00	22.98	22.93
10	25	0		22.02	22.03	22.00
10	25	12		22.01	22.04	21.98
10	25	24		22.06	22.03	22.00
10	50	0		22.03	22.01	22.02
10	1	0	16-QAM	22.38	22.39	22.33
10	1	24		22.37	22.38	22.30
10	1	49		22.36	22.32	22.31
10	25	0		21.03	21.05	21.03
10	25	12		21.03	21.06	21.02
10	25	24		21.08	21.06	21.03
10	50	0		21.04	21.04	21.04



LTE Band 13 Maximum Average Power [dBm]						
BW [MHz]	RB Size	RB Offset	Mod	Lowest	Middle	Highest
5	1	0	QPSK	22.98	22.97	22.97
5	1	12		22.92	22.89	22.86
5	1	24		22.83	22.80	22.78
5	12	0		22.18	22.47	22.53
5	12	6		22.11	22.36	22.44
5	12	11		22.05	22.24	22.36
5	25	0		22.03	22.11	22.21
5	1	0	16-QAM	22.20	22.13	22.12
5	1	12		22.19	22.04	22.05
5	1	24		22.10	22.00	22.01
5	12	0		21.98	21.97	21.91
5	12	6		21.96	21.95	21.90
5	12	11		21.95	21.93	21.83
5	25	0		21.92	21.91	21.78
10	1	0	QPSK		23.00	
10	1	24			22.91	
10	1	49			22.85	
10	25	0			22.26	
10	25	12			22.14	
10	25	24			22.03	
10	50	0			22.00	
10	1	0	16-QAM		22.14	
10	1	24			22.09	
10	1	49			22.06	
10	25	0			21.95	
10	25	12			21.94	
10	25	24			21.91	
10	50	0			21.89	



LTE Band 17 Maximum Average Power [dBm]						
BW [MHz]	RB Size	RB Offset	Mod	Lowest	Middle	Highest
5	1	0	QPSK	23.04	23.03	22.96
5	1	12		23.02	23.02	22.95
5	1	24		23.01	22.90	22.85
5	12	0		22.12	22.09	22.02
5	12	6		22.11	22.05	22.00
5	12	11		22.13	22.04	22.02
5	25	0		22.07	22.01	21.97
5	1	0	16-QAM	22.47	22.36	22.32
5	1	12		22.46	22.35	22.31
5	1	24		22.35	22.23	22.20
5	12	0		21.16	21.12	21.05
5	12	6		21.15	21.08	21.03
5	12	11		21.16	21.08	21.06
5	25	0		21.08	21.03	20.98
10	1	0	QPSK	23.05	23.01	23.02
10	1	24		23.04	23.00	22.97
10	1	49		22.98	22.98	22.97
10	25	0		22.04	22.03	22.01
10	25	12		22.03	22.01	22.00
10	25	24		22.02	22.04	22.02
10	50	0		22.06	22.04	22.05
10	1	0	16-QAM	22.39	22.37	22.36
10	1	24		22.37	22.34	22.31
10	1	49		22.31	22.34	22.30
10	25	0		21.07	21.05	21.03
10	25	12		21.05	21.03	21.02
10	25	24		21.05	21.06	21.04
10	50	0		21.09	21.07	21.08



LTE Band 2

Peak-to-Average Ratio

Mode	LTE Band 2 / 20MHz				
Mod.	QPSK		16QAM		Limit: 13dB
RB Size	1RB	Full RB	1RB	Full RB	Result
Lowest CH	4.9	5.51	6.19	6.31	PASS
Middle CH	4.62	5.51	5.61	6.22	
Highest CH	4.58	5.54	5.8	6.22	



LTE Band 2 / 20MHz / QPSK

Lowest Channel / 1RB

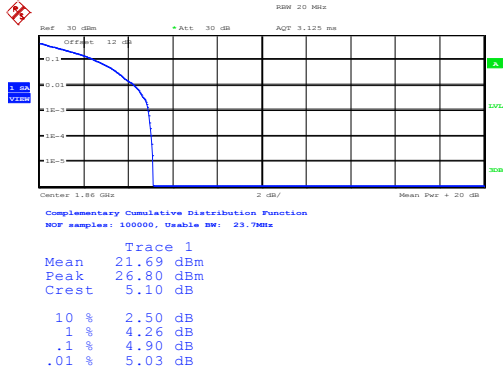

Date: 12.JAN.2015 16:41:32

Lowest Channel / Full RB

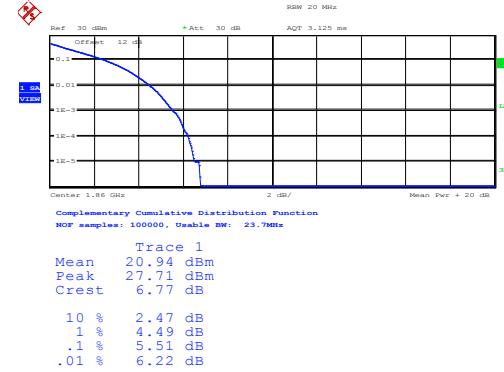

Date: 12.JAN.2015 16:41:47

Middle Channel / 1RB

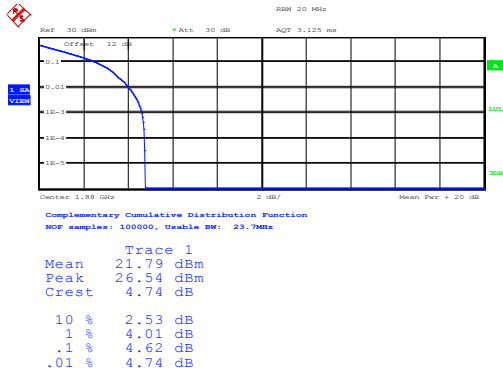

Date: 12.JAN.2015 16:42:10

Middle Channel / Full RB

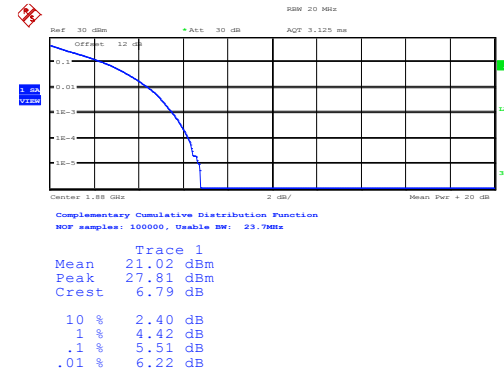

Date: 12.JAN.2015 16:42:32

Highest Channel / 1RB

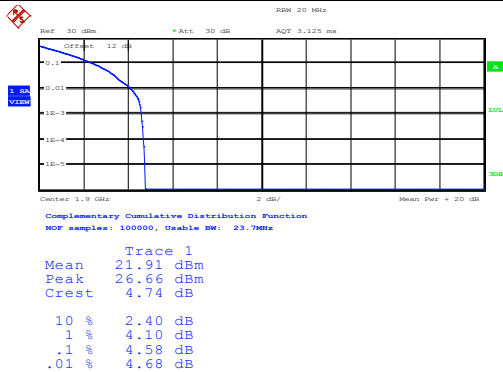

Date: 12.JAN.2015 16:42:49

Highest Channel / Full RB

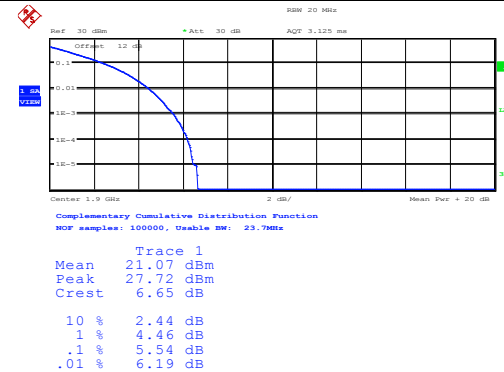

Date: 12.JAN.2015 16:43:09



LTE Band 2 / 20MHz / 16QAM

Lowest Channel / 1RB

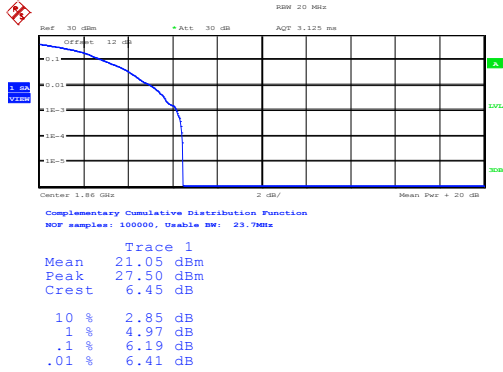

Date: 12.JAN.2015 16:37:56

Lowest Channel / Full RB

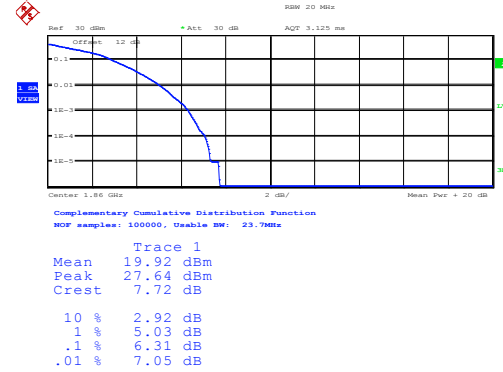

Date: 12.JAN.2015 16:38:37

Middle Channel / 1RB

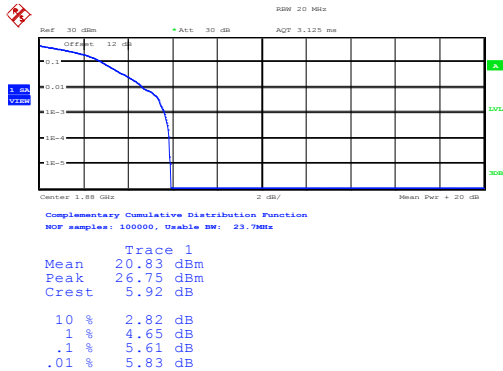

Date: 12.JAN.2015 16:39:31

Middle Channel / Full RB

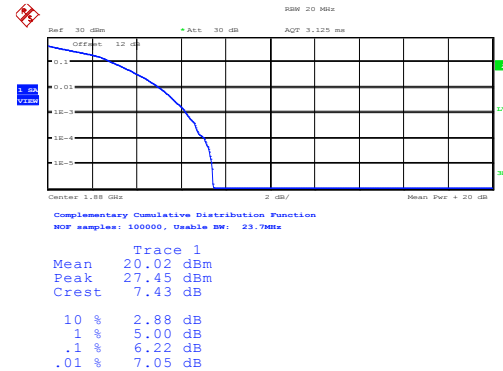

Date: 12.JAN.2015 16:40:26

Highest Channel / 1RB

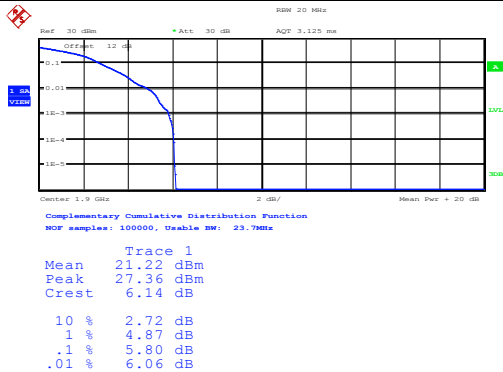

Date: 12.JAN.2015 16:40:49

Highest Channel / Full RB

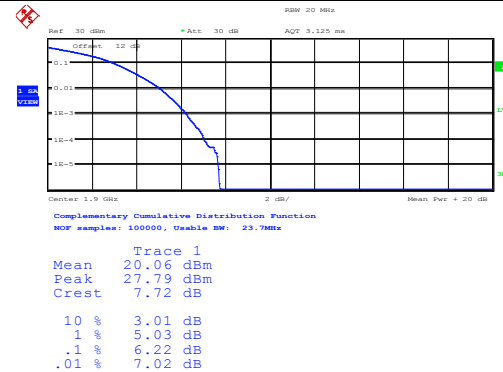

Date: 12.JAN.2015 16:41:14



26dB Bandwidth

Mode	LTE Band 2 : 26dB BW(MHz)											
	1.4MHz		3MHz		5MHz		10MHz		15MHz		20MHz	
BW	QPSK	16QAM	QPSK	16QAM	QPSK	16QAM	QPSK	16QAM	QPSK	16QAM	QPSK	16QAM
Lowest CH	1.26	1.27	3.01	3.01	5.06	5.03	10.06	10.06	14.73	14.79	21.08	21
Middle CH	1.26	1.27	3	3.02	5.01	5.02	10.08	10	14.82	14.7	21.12	21.08
Highest CH	1.26	1.27	3.01	3.02	4.95	4.94	10.08	10.02	14.85	14.82	21.16	21.2



LTE Band 2

Lowest Channel / 1.4MHz / QPSK

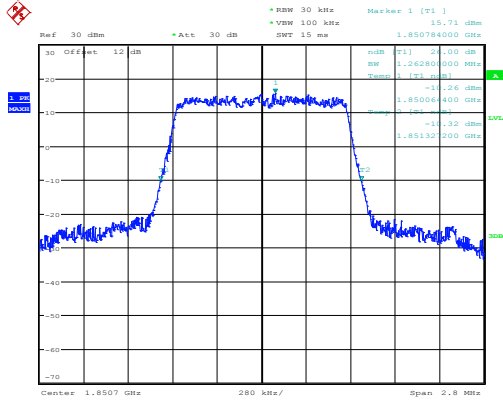

Lowest Channel / 1.4MHz / 16QAM

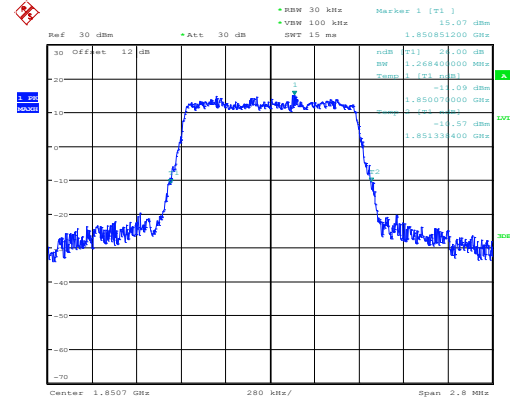

Middle Channel / 1.4MHz / QPSK

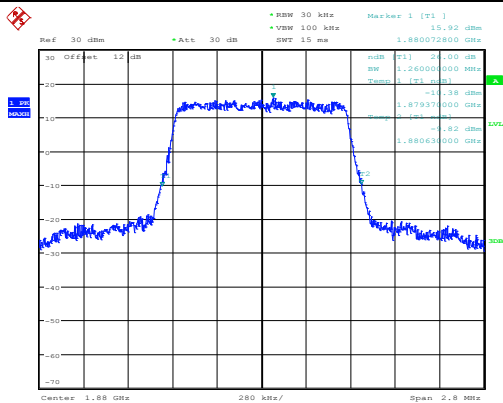

Middle Channel / 1.4MHz / 16QAM

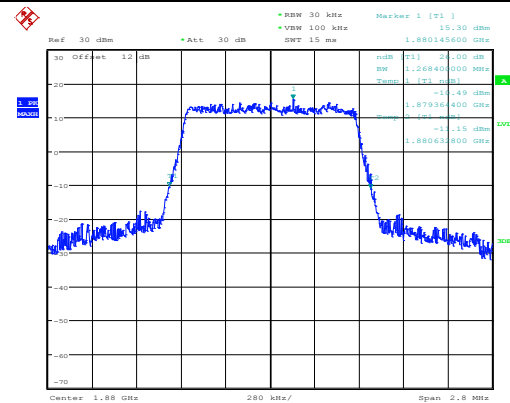

Highest Channel / 1.4MHz / QPSK

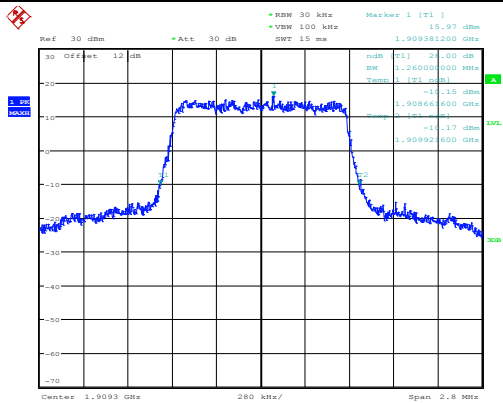

Highest Channel / 1.4MHz / 16QAM

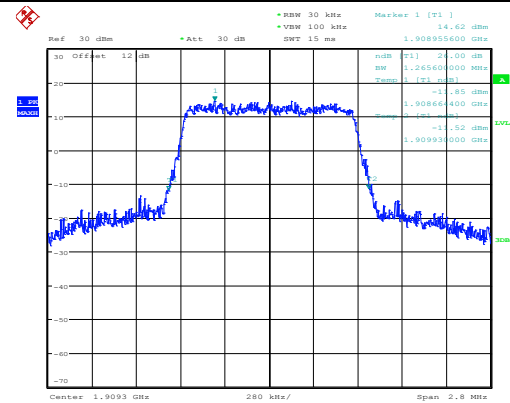



LTE Band 2

Lowest Channel / 3MHz / QPSK

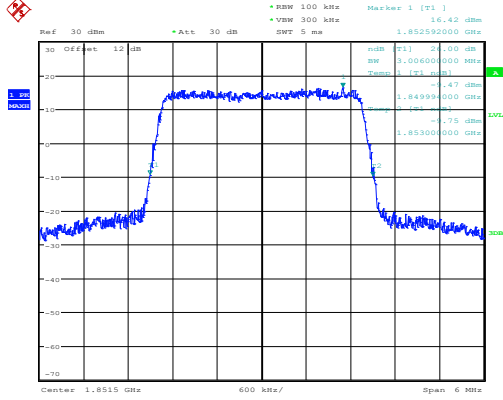

Date: 12.JAN.2015 14:03:17

Lowest Channel / 3MHz / 16QAM

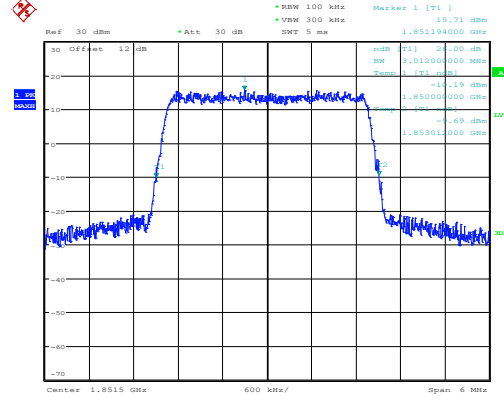

Date: 12.JAN.2015 14:03:29

Middle Channel / 3MHz / QPSK

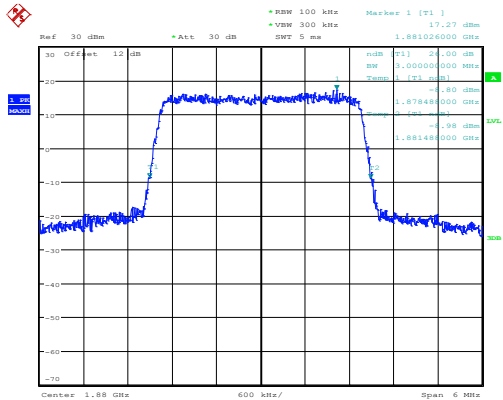

Date: 12.JAN.2015 14:12:00

Middle Channel / 3MHz / 16QAM

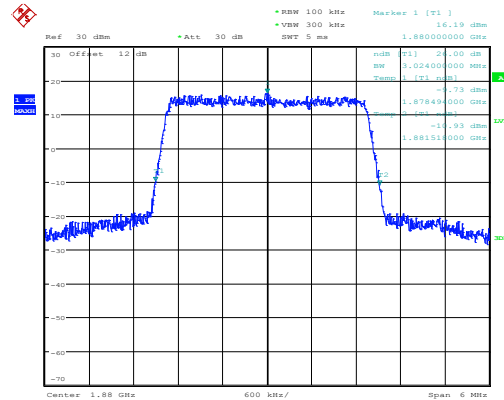

Date: 12.JAN.2015 14:12:14

Highest Channel / 3MHz / QPSK

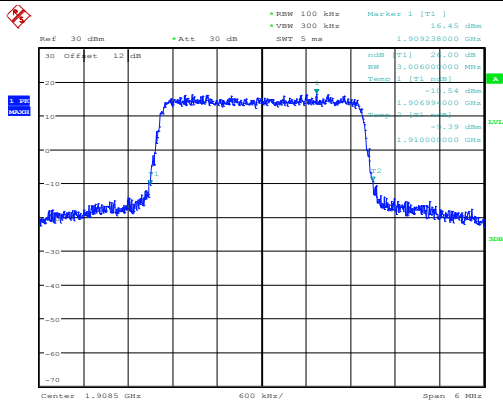

Date: 12.JAN.2015 14:15:22

Highest Channel / 3MHz / 16QAM

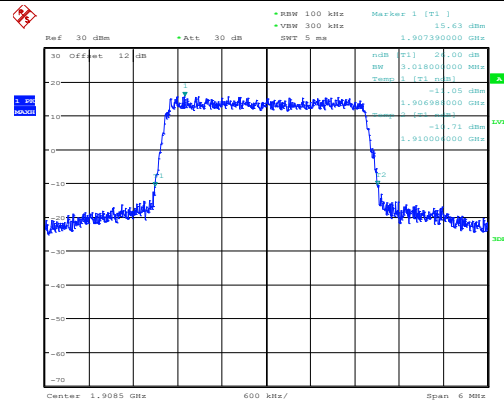

Date: 12.JAN.2015 14:15:35



LTE Band 2

Lowest Channel / 5MHz / QPSK

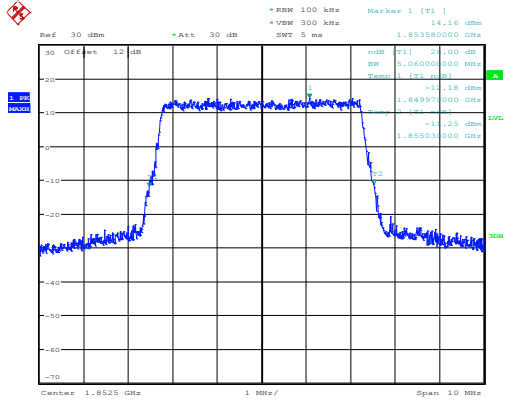

Date: 12.JAN.2015 14:23:15

Lowest Channel / 5MHz / 16QAM

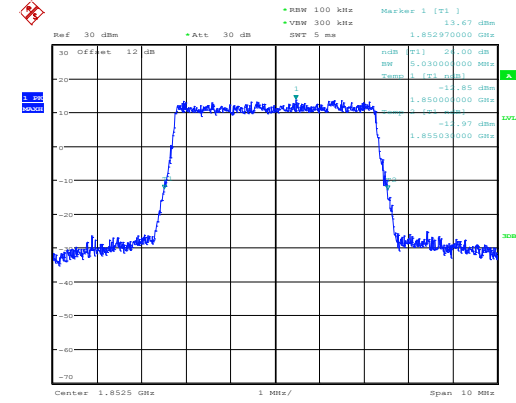

Date: 12.JAN.2015 14:23:28

Middle Channel / 5MHz / QPSK

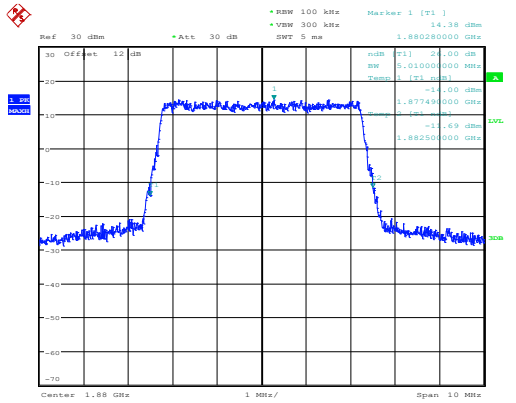

Date: 12.JAN.2015 14:31:04

Middle Channel / 5MHz / 16QAM

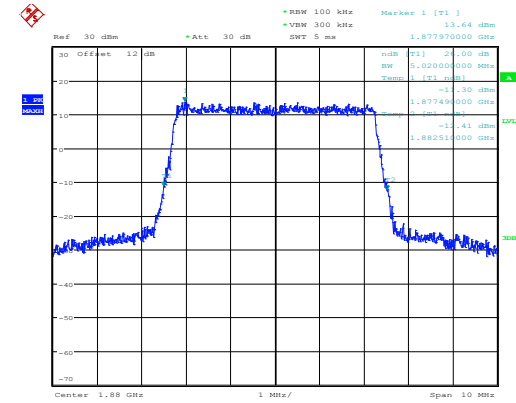

Date: 12.JAN.2015 14:31:17

Highest Channel / 5MHz / QPSK

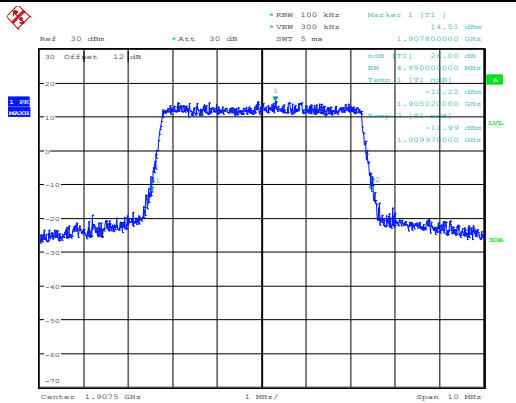

Date: 12.JAN.2015 14:34:11

Highest Channel / 5MHz / 16QAM

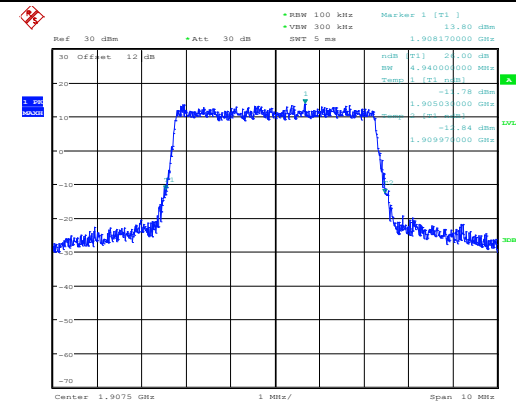

Date: 12.JAN.2015 14:34:24



LTE Band 2

Lowest Channel / 10MHz / QPSK

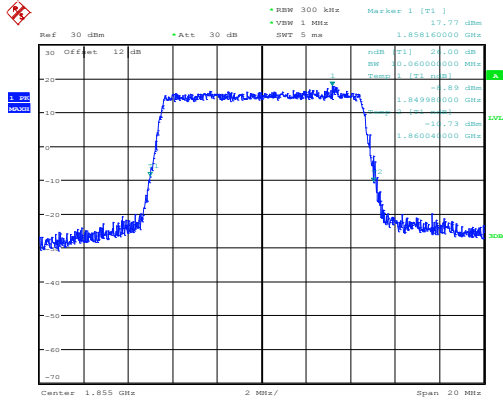

Date: 12.JAN.2015 14:44:20

Lowest Channel / 10MHz / 16QAM

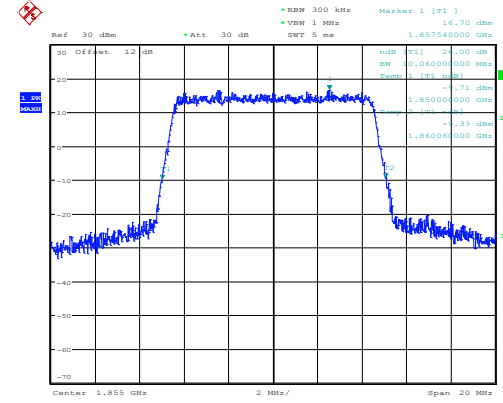

Date: 12.JAN.2015 14:44:33

Middle Channel / 10MHz / QPSK

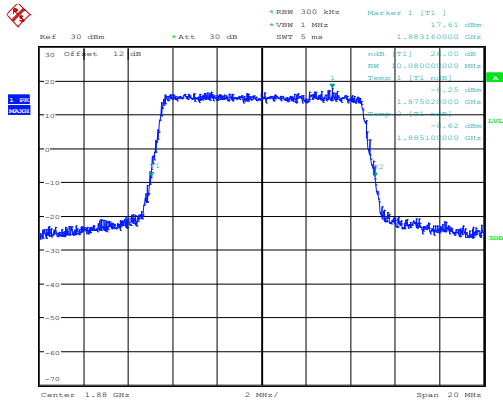

Date: 12.JAN.2015 14:52:06

Middle Channel / 10MHz / 16QAM

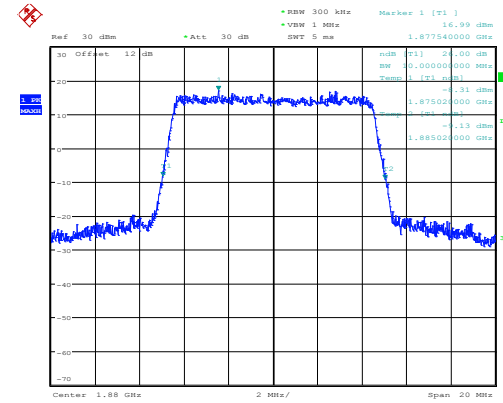

Date: 12.JAN.2015 14:52:19

Highest Channel / 10MHz / QPSK

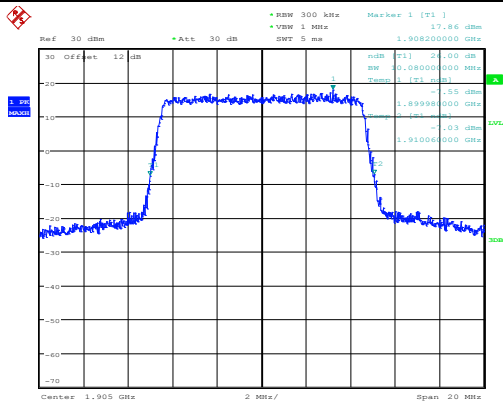

Date: 12.JAN.2015 14:55:13

Highest Channel / 10MHz / 16QAM

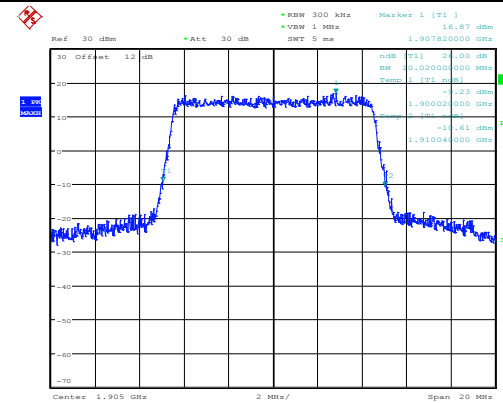

Date: 12.JAN.2015 14:55:26



LTE Band 2

Lowest Channel / 15MHz / QPSK

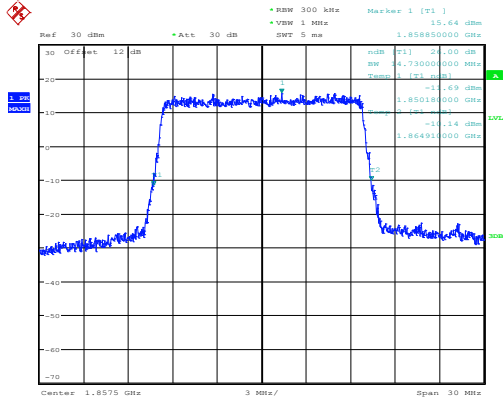

Date: 12.JAN.2015 15:05:04

Lowest Channel / 15MHz / 16QAM

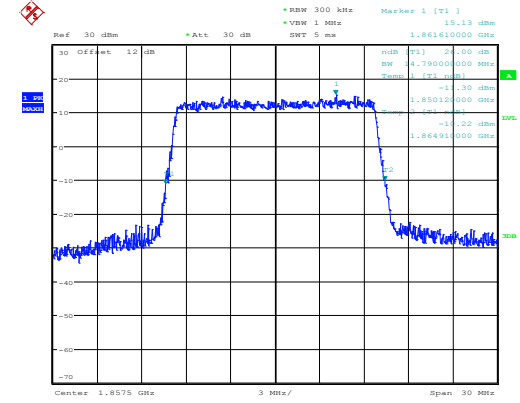

Date: 12.JAN.2015 15:05:16

Middle Channel / 15MHz / QPSK

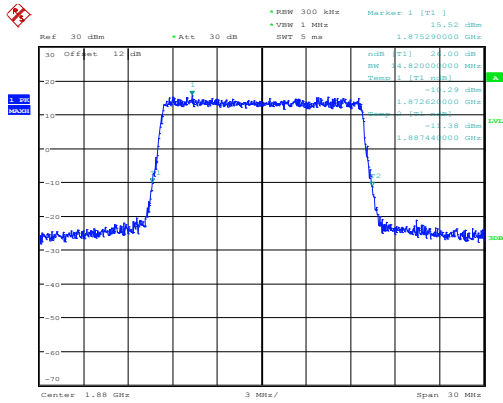

Date: 12.JAN.2015 15:12:50

Middle Channel / 15MHz / 16QAM

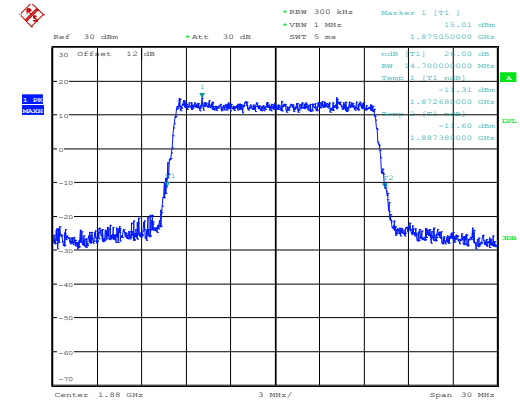

Date: 12.JAN.2015 15:13:03

Highest Channel / 15MHz / QPSK

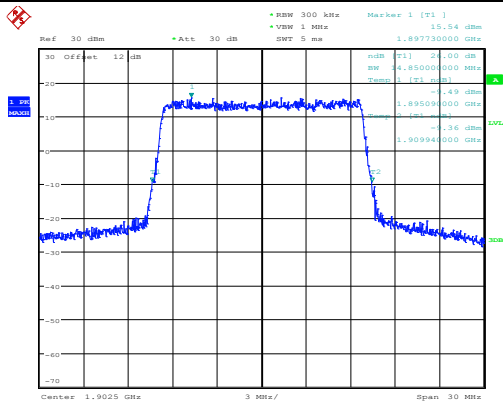

Date: 12.JAN.2015 15:15:57

Highest Channel / 15MHz / 16QAM

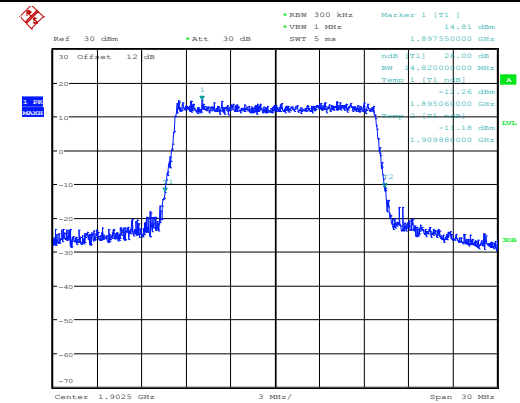

Date: 12.JAN.2015 15:16:10



LTE Band 2

Lowest Channel / 20MHz / QPSK

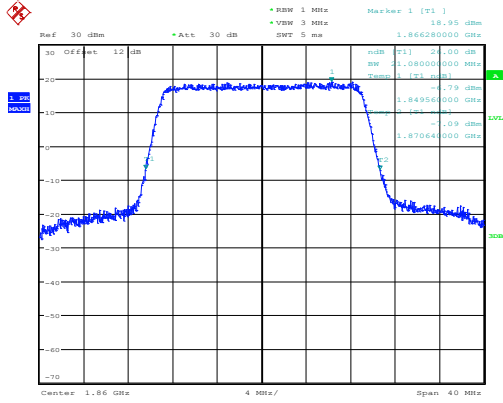

Date: 12.JAN.2015 15:23:51

Lowest Channel / 20MHz / 16QAM

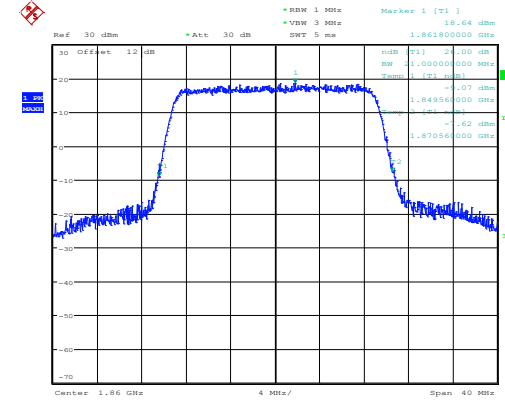

Date: 12.JAN.2015 15:24:04

Middle Channel / 20MHz / QPSK

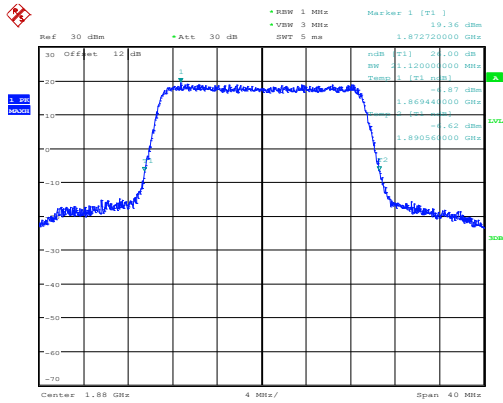

Date: 12.JAN.2015 15:31:37

Middle Channel / 20MHz / 16QAM

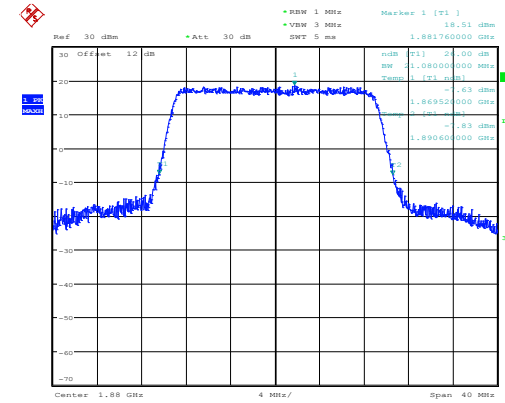

Date: 12.JAN.2015 15:31:50

Highest Channel / 20MHz / QPSK

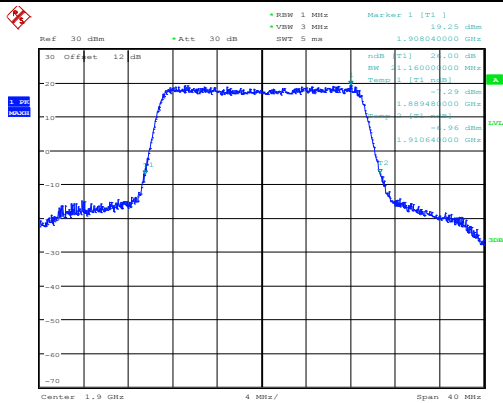

Date: 12.JAN.2015 15:34:44

Highest Channel / 20MHz / 16QAM

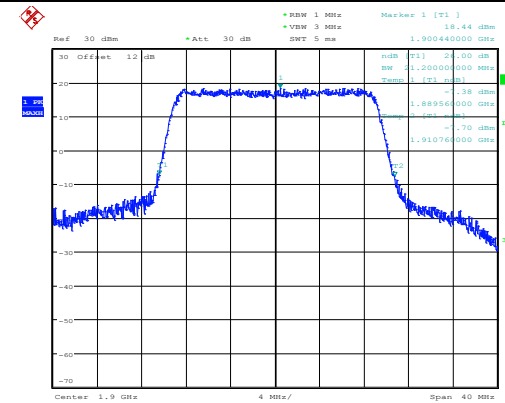

Date: 12.JAN.2015 15:34:57



Occupied Bandwidth

Mode	LTE Band 2 : 99%OBW(MHz)											
	1.4MHz		3MHz		5MHz		10MHz		15MHz		20MHz	
BW	QPSK	16QAM	QPSK	16QAM	QPSK	16QAM	QPSK	16QAM	QPSK	16QAM	QPSK	16QAM
Lowest CH	1.09	1.1	2.72	2.72	4.49	4.51	9.04	9.04	13.47	13.47	18.56	18.52
Middle CH	1.1	1.1	2.72	2.72	4.51	4.51	9.06	9.04	13.5	13.53	18.6	18.6
Highest CH	1.1	1.1	2.71	2.72	4.5	4.52	9.06	9.04	13.47	13.53	18.6	18.6



LTE Band 2

Lowest Channel / 1.4MHz / QPSK

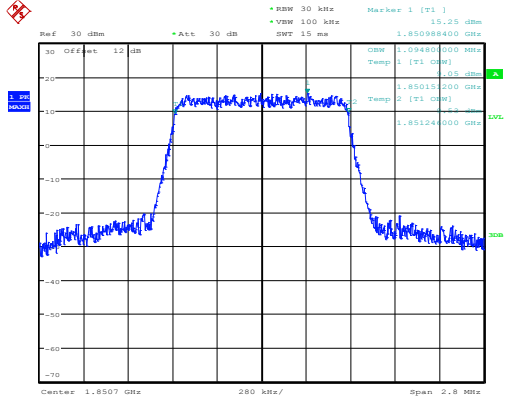

Date: 12.JAN.2015 16:04:28

Lowest Channel / 1.4MHz / 16QAM

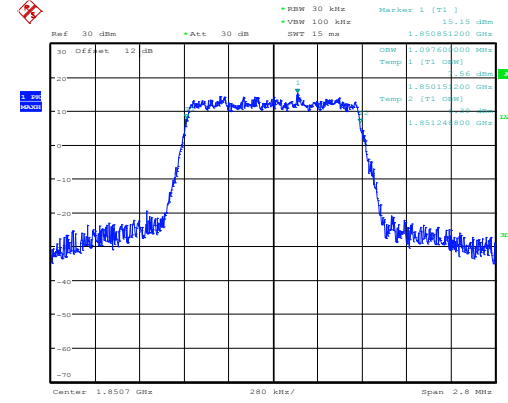

Date: 12.JAN.2015 16:04:39

Middle Channel / 1.4MHz / QPSK

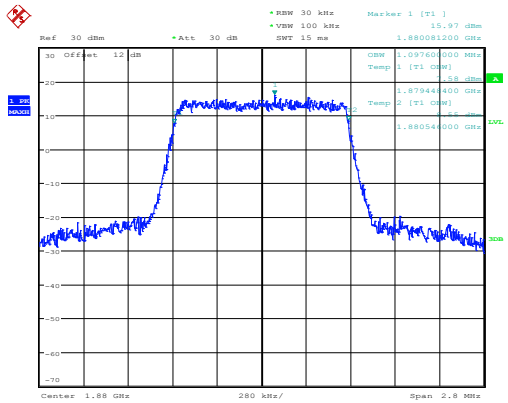

Date: 12.JAN.2015 16:12:15

Middle Channel / 1.4MHz / 16QAM

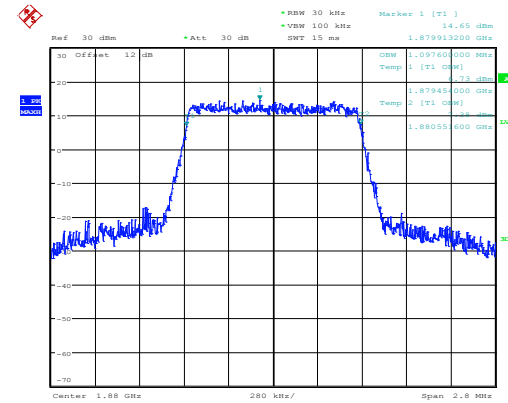

Date: 12.JAN.2015 16:12:25

Highest Channel / 1.4MHz / QPSK

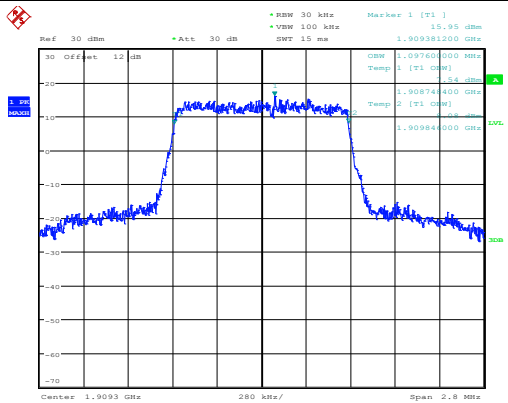

Date: 12.JAN.2015 16:15:23

Highest Channel / 1.4MHz / 16QAM

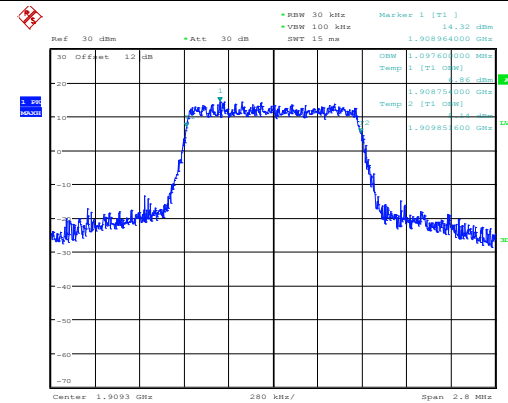

Date: 12.JAN.2015 16:15:34



LTE Band 2

Lowest Channel / 3MHz / QPSK

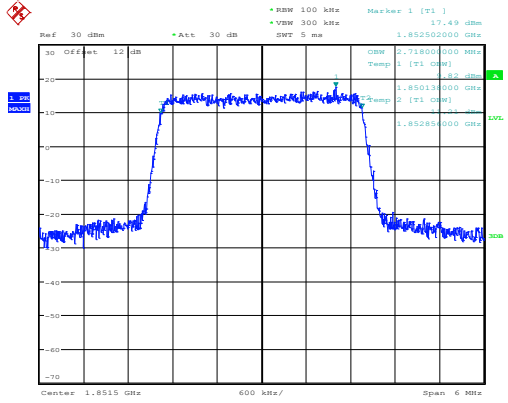

Date: 12.JAN.2015 14:02:53

Lowest Channel / 3MHz / 16QAM

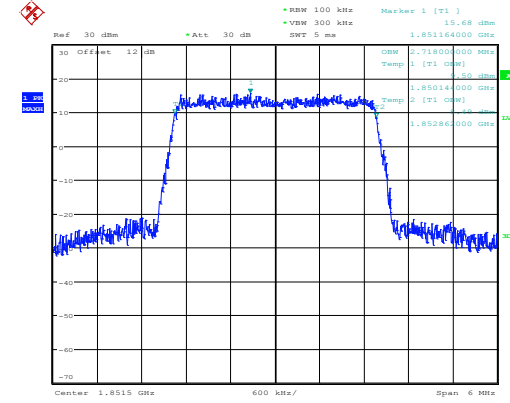

Date: 12.JAN.2015 14:03:04

Middle Channel / 3MHz / QPSK

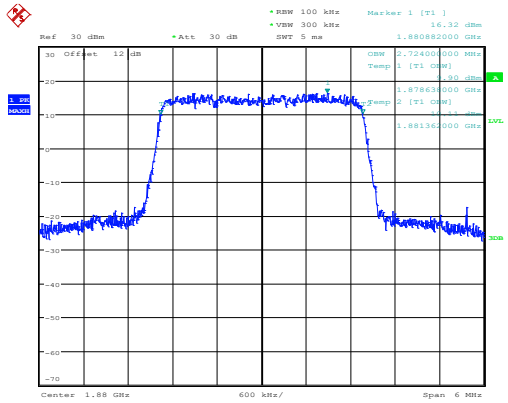

Date: 12.JAN.2015 14:11:34

Middle Channel / 3MHz / 16QAM

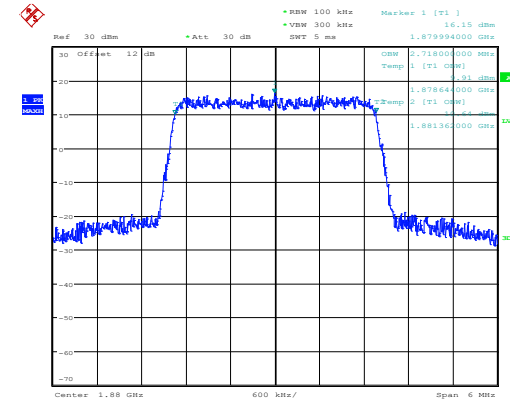

Date: 12.JAN.2015 14:11:46

Highest Channel / 3MHz / QPSK

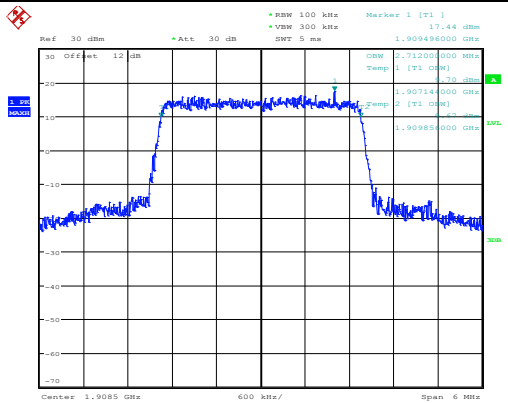

Date: 12.JAN.2015 14:14:56

Highest Channel / 3MHz / 16QAM

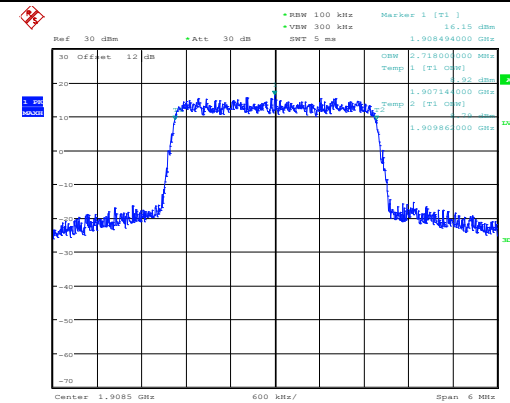

Date: 12.JAN.2015 14:15:08



LTE Band 2

Lowest Channel / 5MHz / QPSK

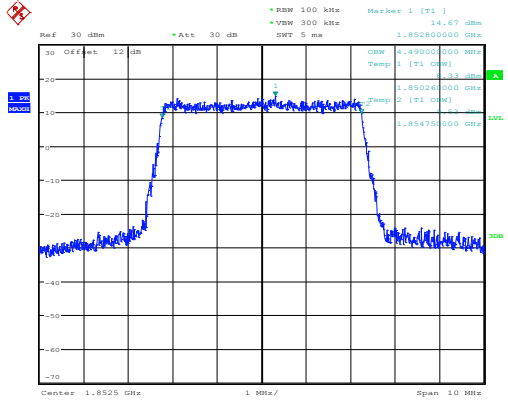

Date: 12.JAN.2015 14:22:52

Lowest Channel / 5MHz / 16QAM

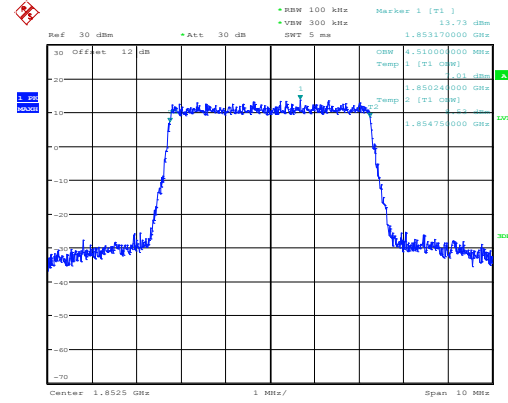

Date: 12.JAN.2015 14:23:02

Middle Channel / 5MHz / QPSK

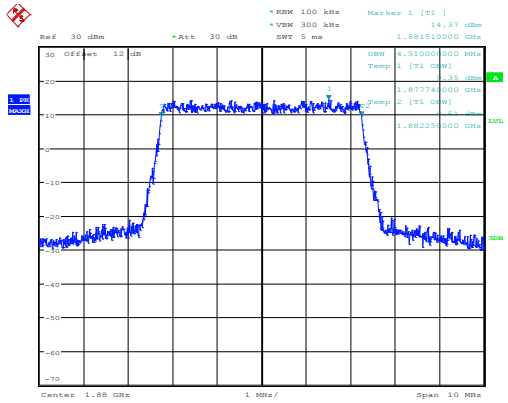

Date: 12.JAN.2015 14:30:41

Middle Channel / 5MHz / 16QAM

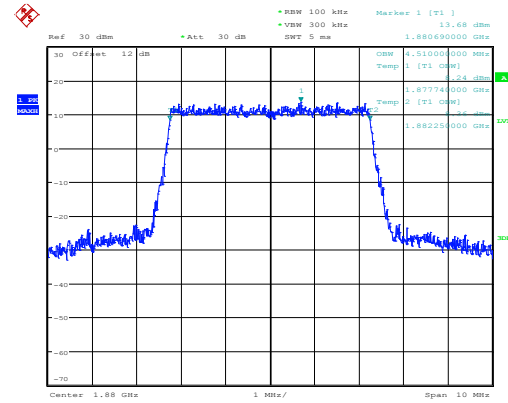

Date: 12.JAN.2015 14:30:51

Highest Channel / 5MHz / QPSK

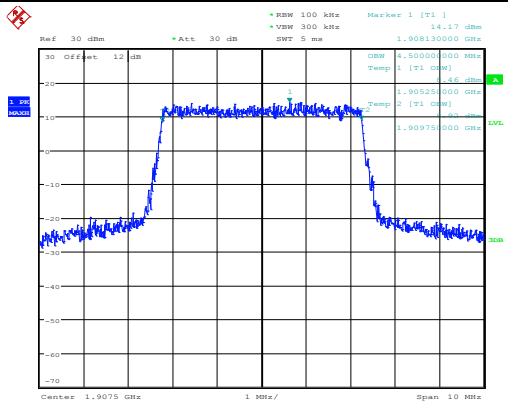

Date: 12.JAN.2015 14:33:48

Highest Channel / 5MHz / 16QAM

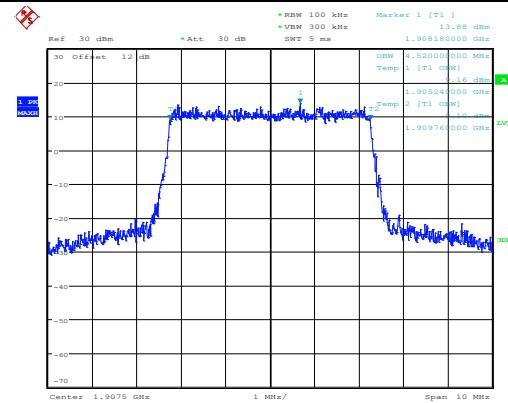

Date: 12.JAN.2015 14:33:58



LTE Band 2

Lowest Channel / 10MHz / QPSK

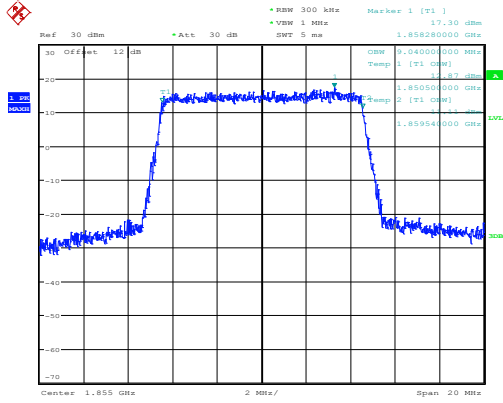

Lowest Channel / 10MHz / 16QAM

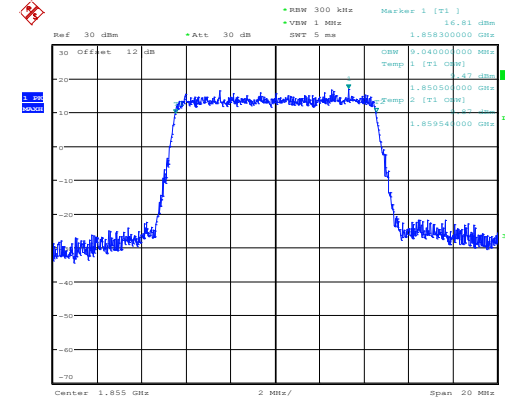

Middle Channel / 10MHz / QPSK

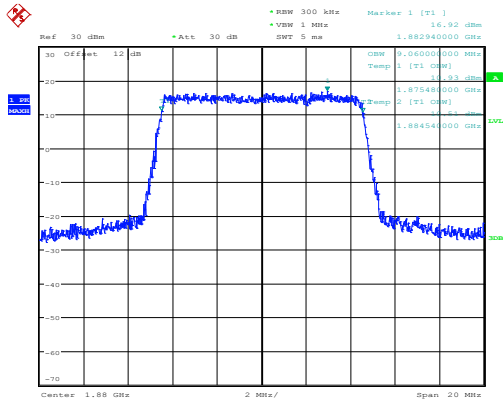

Middle Channel / 10MHz / 16QAM

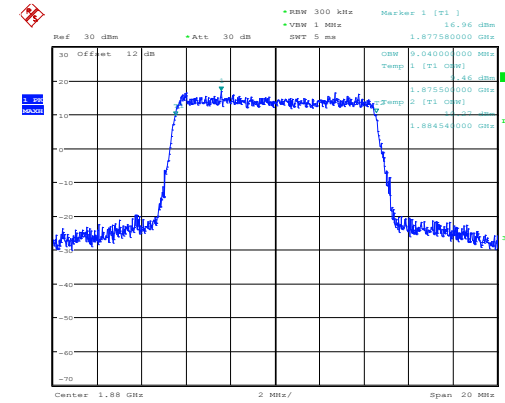

Highest Channel / 10MHz / QPSK

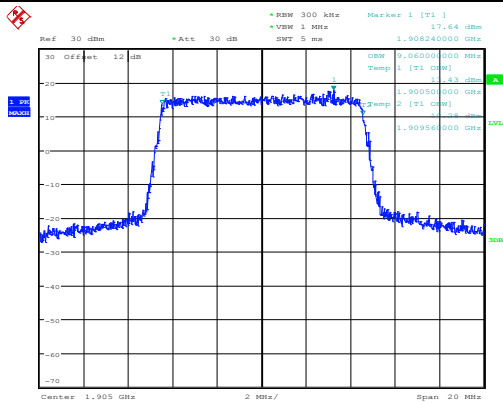

Highest Channel / 10MHz / 16QAM

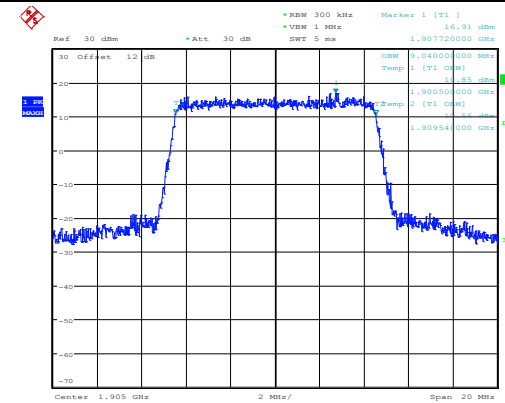



LTE Band 2

Lowest Channel / 15MHz / QPSK

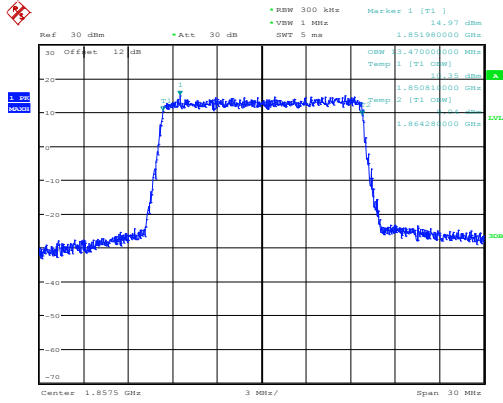

Date: 12.JAN.2015 16:02:20

Lowest Channel / 15MHz / 16QAM

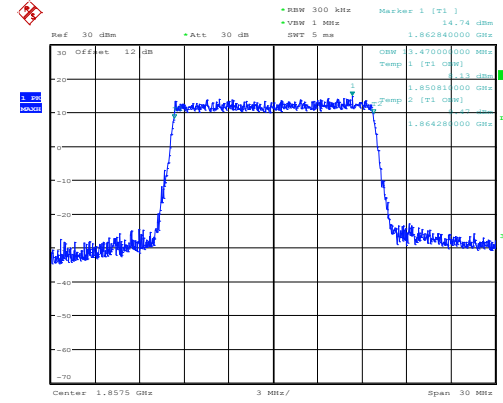

Date: 12.JAN.2015 15:04:50

Middle Channel / 15MHz / QPSK

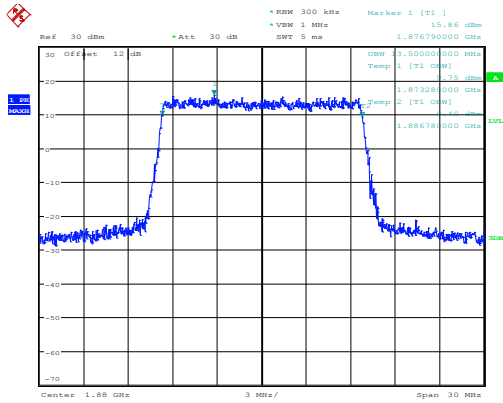

Date: 12.JAN.2015 15:12:27

Middle Channel / 15MHz / 16QAM

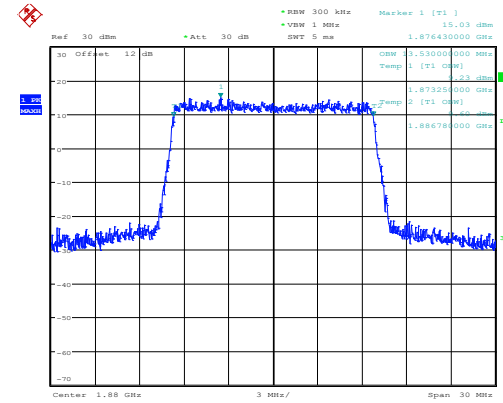

Date: 12.JAN.2015 15:12:37

Highest Channel / 15MHz / QPSK

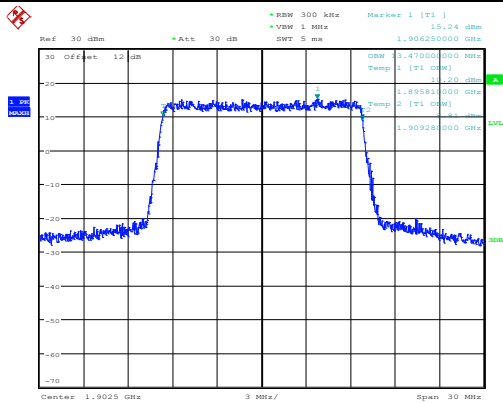

Date: 12.JAN.2015 15:15:34

Highest Channel / 15MHz / 16QAM

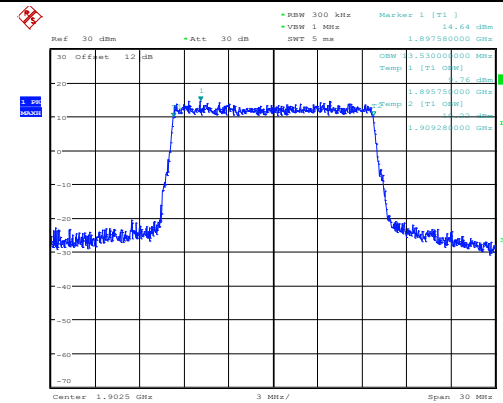

Date: 12.JAN.2015 15:15:44



LTE Band 2

Lowest Channel / 20MHz / QPSK

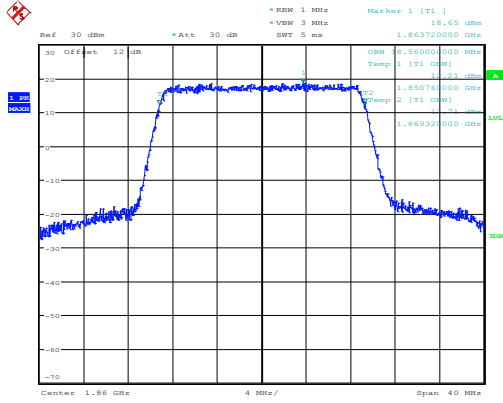

Date: 12.JAN.2015 15:23:27

Lowest Channel / 20MHz / 16QAM

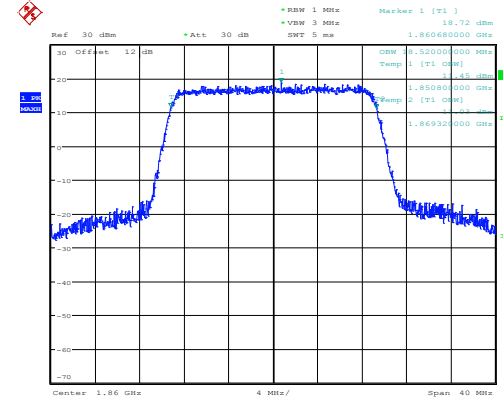

Date: 12.JAN.2015 15:23:38

Middle Channel / 20MHz / QPSK

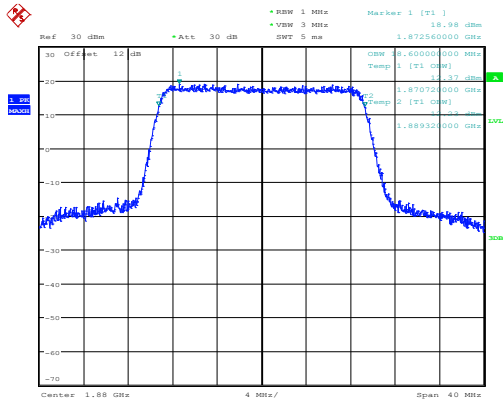

Date: 12.JAN.2015 15:31:14

Middle Channel / 20MHz / 16QAM

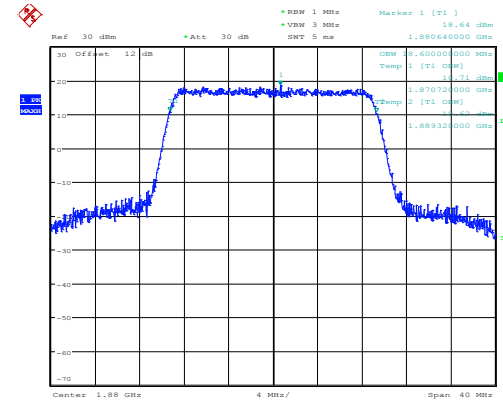

Date: 12.JAN.2015 15:31:24

Highest Channel / 20MHz / QPSK

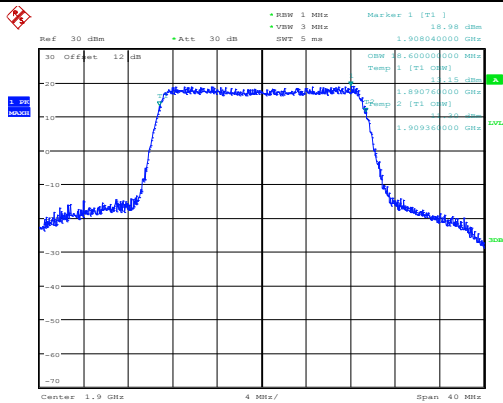

Date: 12.JAN.2015 15:34:21

Highest Channel / 20MHz / 16QAM

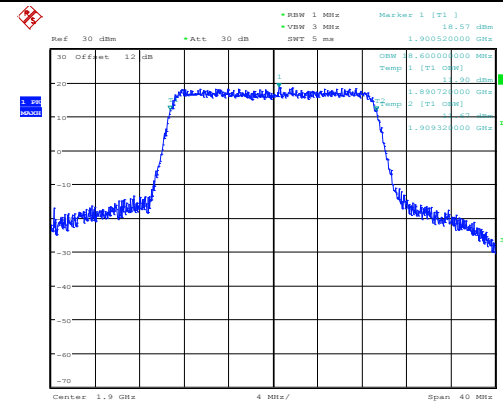

Date: 12.JAN.2015 15:34:31



Conducted Band Edge



LTE Band 2 / 1.4MHz / QPSK

Lowest Band Edge / 1RB

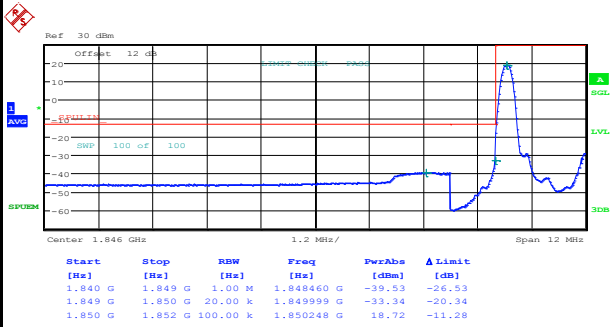

Date: 12.JAN.2015 16:06:14

Highest Band Edge / 1RB

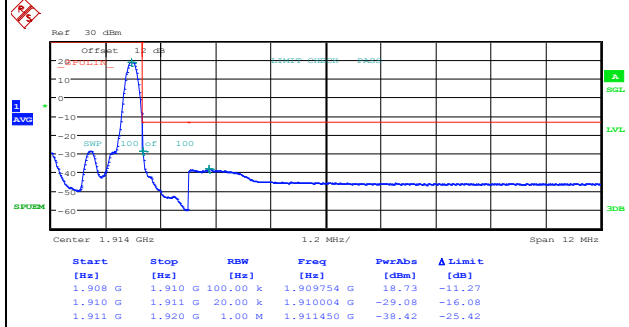

Date: 12.JAN.2015 16:18:16

Lowest Band Edge / Full RB

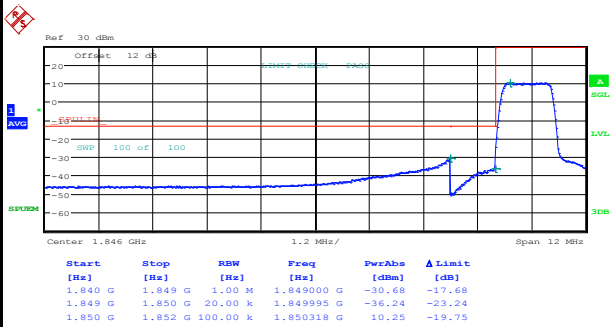

Date: 12.JAN.2015 16:08:34

Highest Band Edge / Full RB

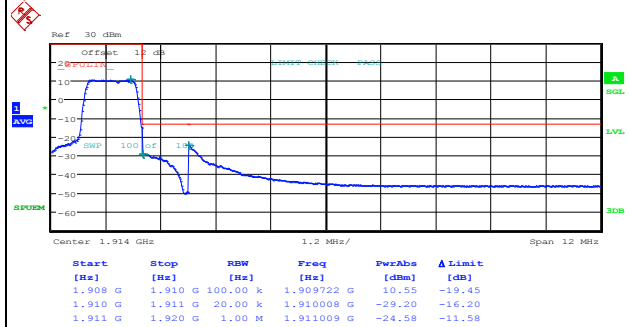

Date: 12.JAN.2015 16:20:40



LTE Band 2 / 1.4MHz / 16QAM

Lowest Band Edge / 1 RB

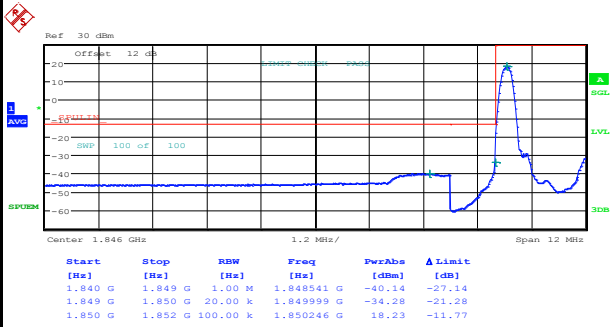

Date: 12.JAN.2015 16:07:25

Highest Band Edge / 1 RB

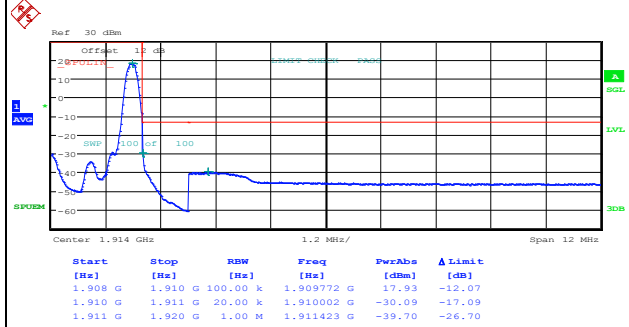

Date: 12.JAN.2015 16:19:30

Lowest Band Edge / Full RB

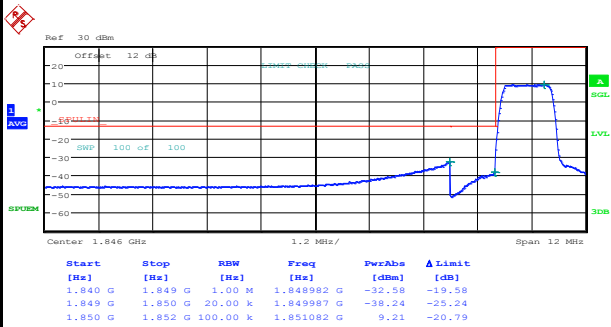

Date: 12.JAN.2015 16:09:44

Highest Band Edge / Full RB

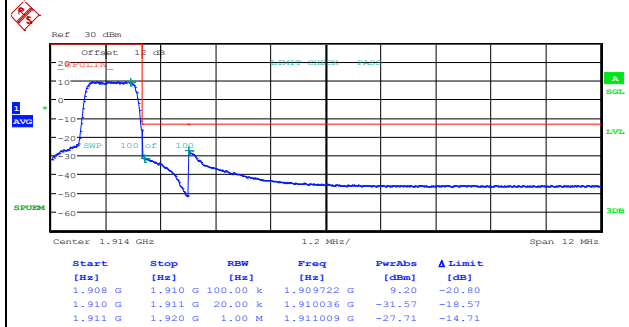

Date: 12.JAN.2015 16:21:53



LTE Band 2 / 3MHz / QPSK

Lowest Band Edge / 1RB

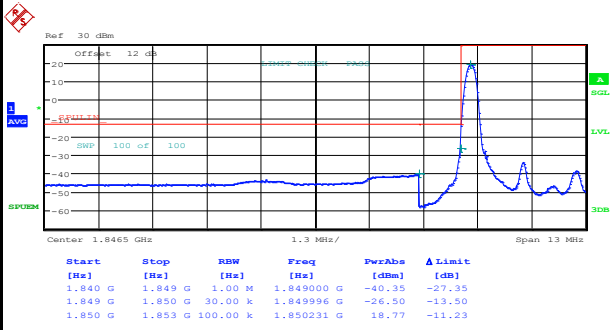

Date: 12.JAN.2015 14:04:39

Highest Band Edge / 1 RB

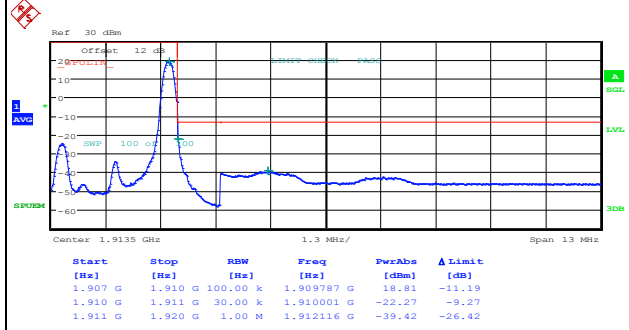

Date: 12.JAN.2015 14:16:47

Lowest Band Edge / Full RB

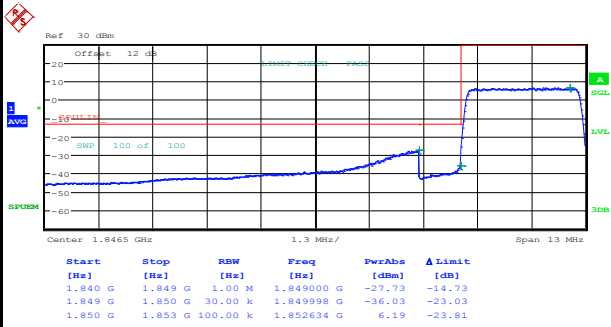

Date: 12.JAN.2015 14:06:59

Highest Band Edge / Full RB

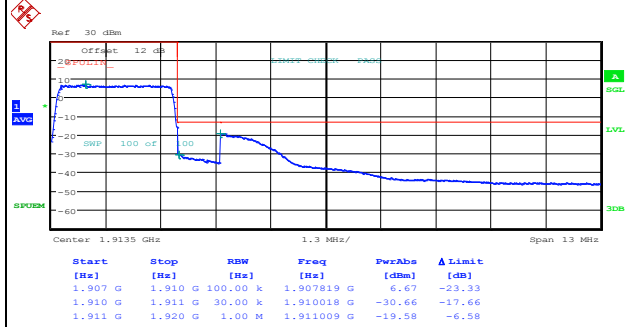

Date: 12.JAN.2015 14:19:07



LTE Band 2 / 3MHz / 16QAM

Lowest Band Edge / 1 RB

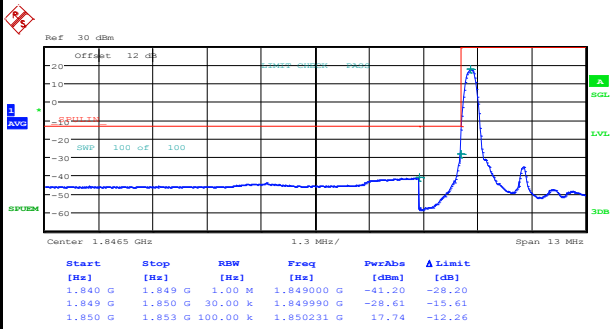

Date: 12.JAN.2015 14:05:49

Highest Band Edge / 1 RB

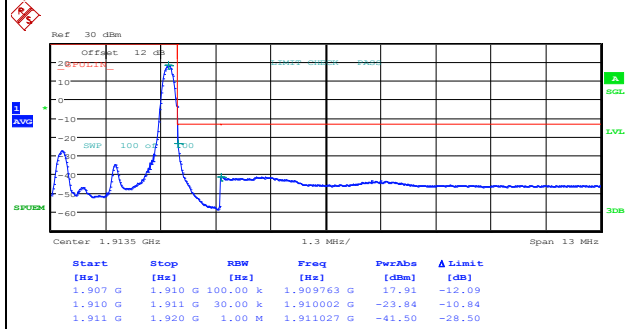

Date: 12.JAN.2015 14:17:57

Lowest Band Edge / Full RB

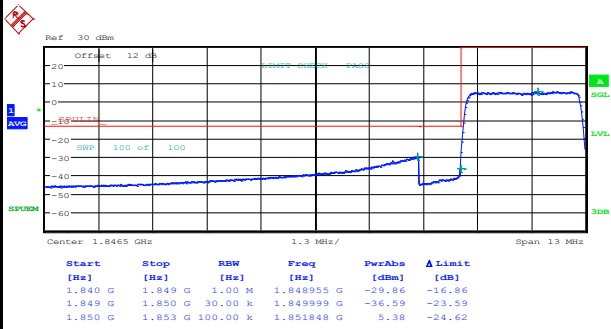

Date: 12.JAN.2015 14:08:09

Highest Band Edge / Full RB

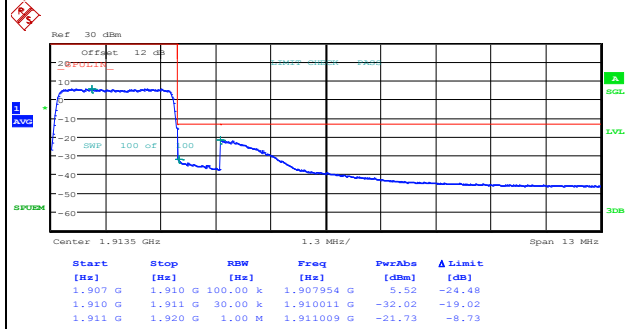

Date: 12.JAN.2015 14:20:16



LTE Band 2 / 5MHz / QPSK

Lowest Band Edge / 1 RB

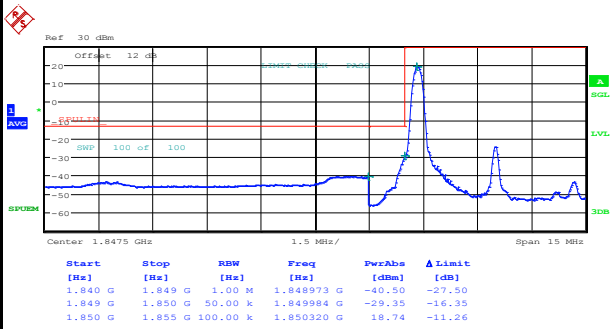

Date: 12.JAN.2015 14:24:38

Highest Band Edge / 1 RB

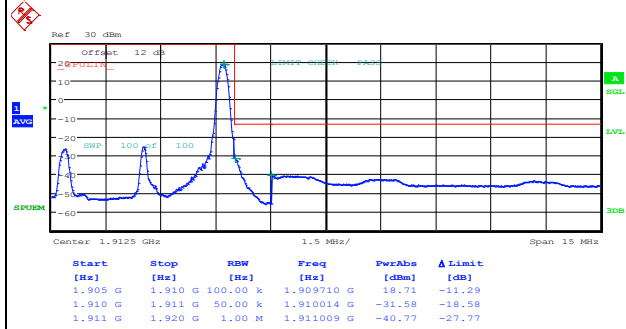

Date: 12.JAN.2015 14:35:34

Lowest Band Edge / Full RB

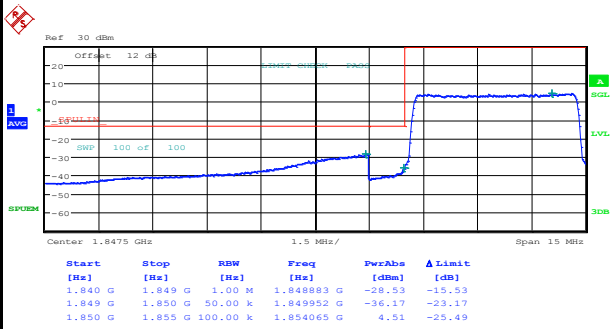

Date: 12.JAN.2015 14:26:58

Highest Band Edge / Full RB

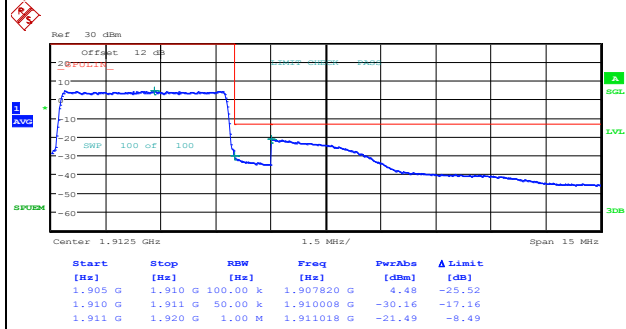

Date: 12.JAN.2015 14:37:53



LTE Band 2 / 5MHz / 16QAM

Lowest Band Edge / 1RB

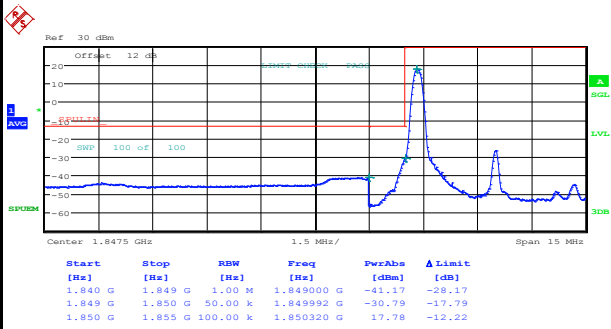

Date: 12.JAN.2015 14:25:48

Highest Band Edge / 1 RB

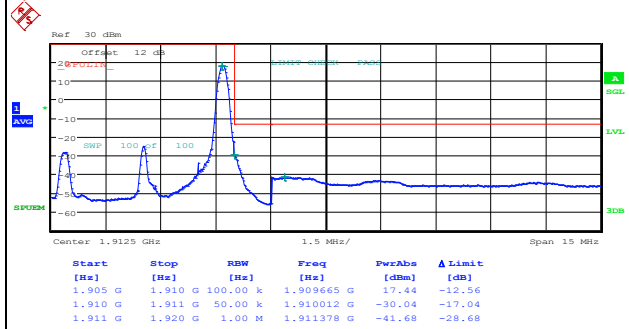

Date: 12.JAN.2015 14:36:44

Lowest Band Edge / Full RB

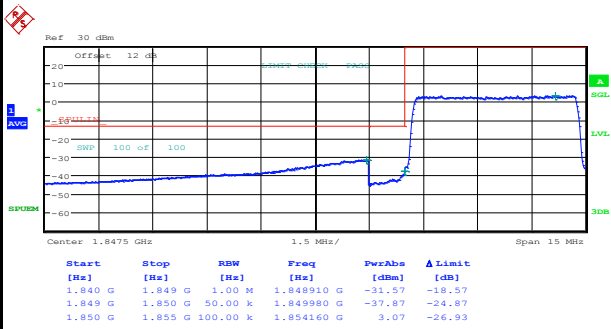

Date: 12.JAN.2015 14:28:10

Highest Band Edge / Full RB

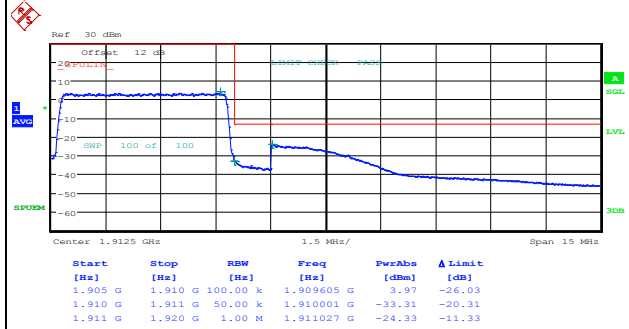

Date: 12.JAN.2015 14:39:03



LTE Band 2 / 10MHz / QPSK

Lowest Band Edge / 1 RB

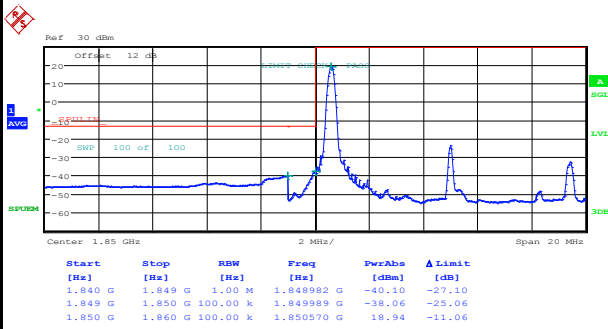

Date: 12.JAN.2015 14:45:42

Highest Band Edge / 1 RB

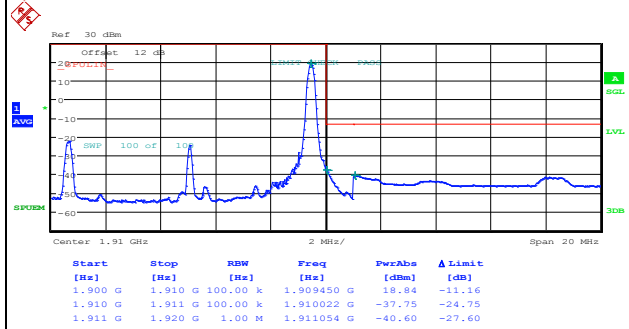

Date: 12.JAN.2015 14:56:35

Lowest Band Edge / Full RB

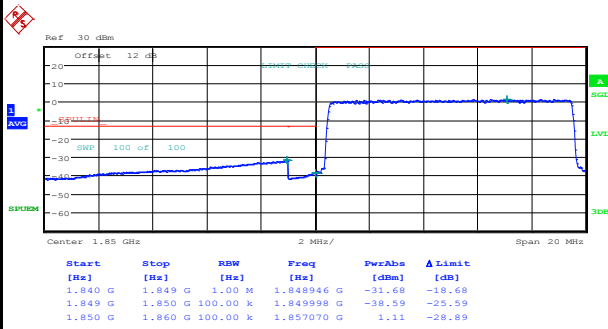

Date: 12.JAN.2015 14:48:02

Highest Band Edge / Full RB

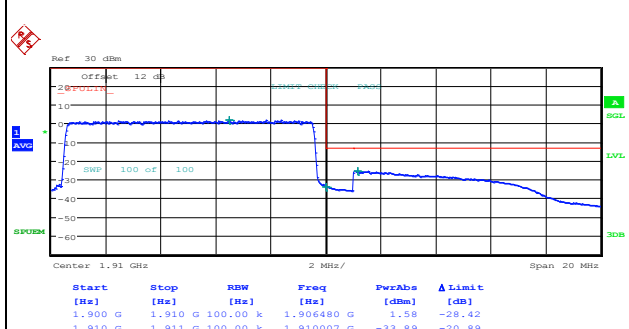

Date: 12.JAN.2015 14:58:55



LTE Band 2 / 10MHz / 16QAM

Lowest Band Edge / 1 RB

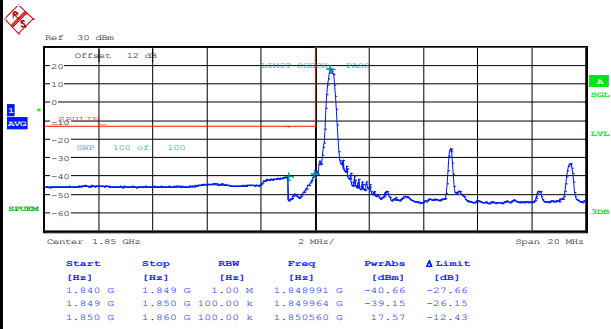

Date: 12.JAN.2015 14:46:52

Highest Band Edge / 1 RB

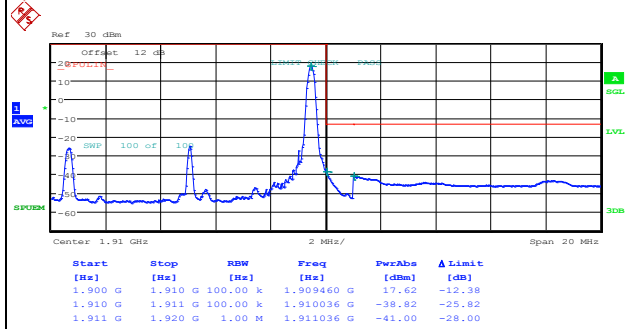

Date: 12.JAN.2015 14:57:46

Lowest Band Edge / Full RB

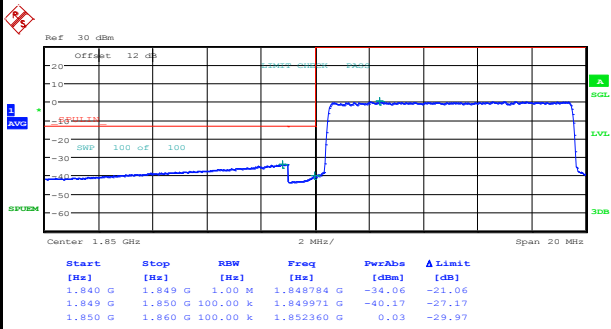

Date: 12.JAN.2015 14:49:12

Highest Band Edge / Full RB

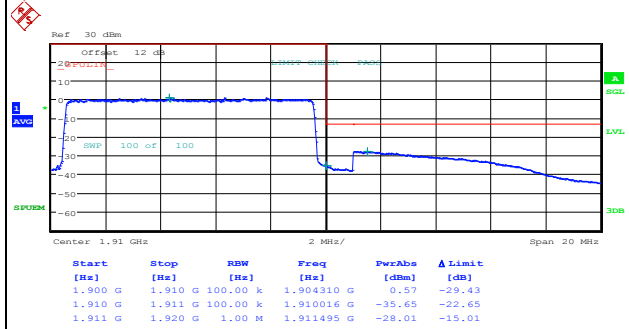

Date: 12.JAN.2015 15:00:05



LTE Band 2 / 15MHz / QPSK

Lowest Band Edge / 1 RB

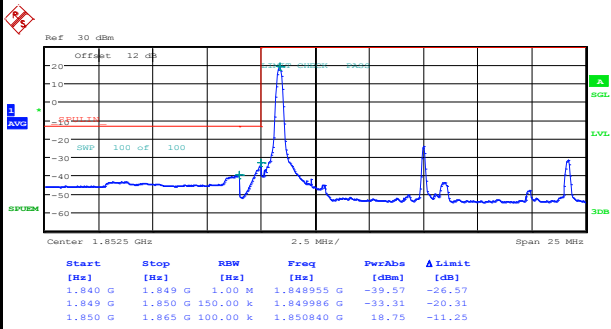

Date: 12.JAN.2015 16:03:21

Highest Band Edge / 1 RB

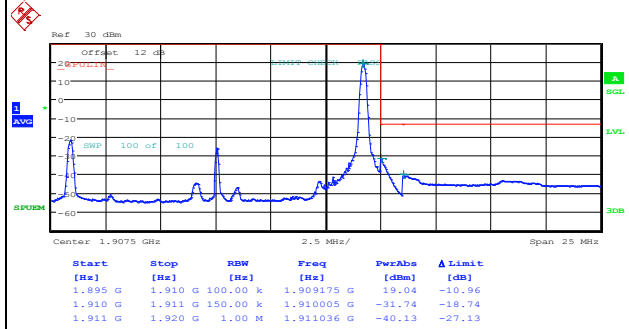

Date: 12.JAN.2015 15:17:19

Lowest Band Edge / Full RB

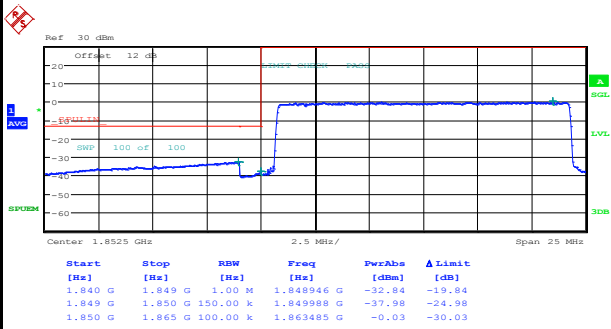

Date: 12.JAN.2015 15:08:45

Highest Band Edge / Full RB

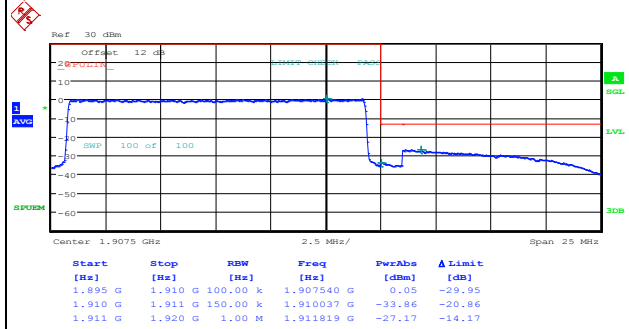

Date: 12.JAN.2015 15:19:39



LTE Band 2 / 15MHz / 16QAM

Lowest Band Edge / 1 RB

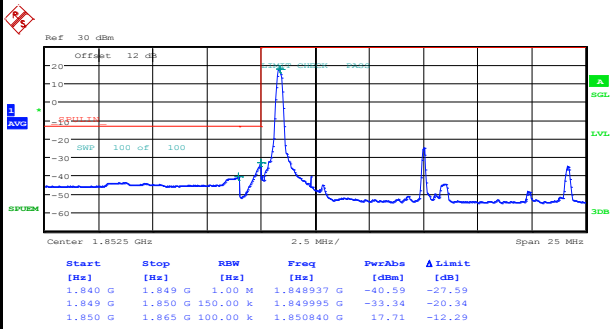

Date: 12.JAN.2015 15:07:35

Highest Band Edge / 1 RB

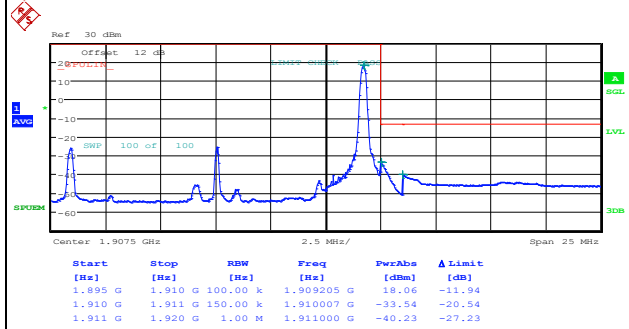

Date: 12.JAN.2015 15:18:29

Lowest Band Edge / Full RB

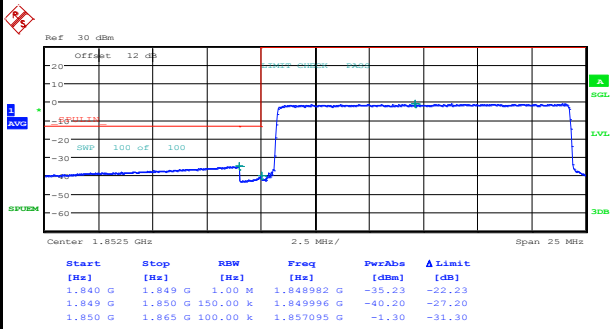

Date: 12.JAN.2015 15:09:55

Highest Band Edge / Full RB

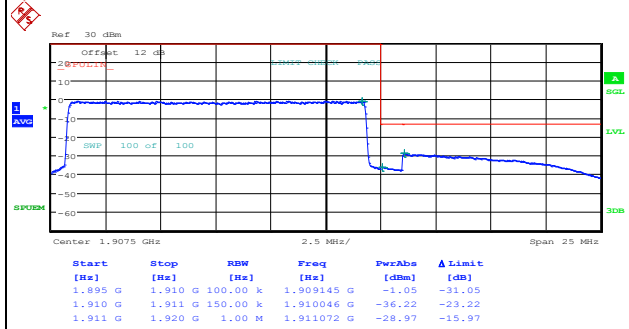

Date: 12.JAN.2015 15:20:50



LTE Band 2 / 20MHz / QPSK

Lowest Band Edge / 1 RB

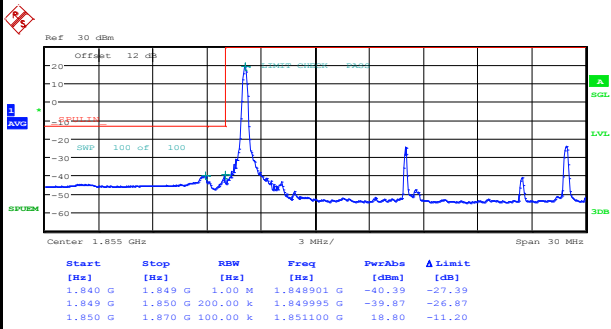

Date: 12.JAN.2015 15:25:13

Highest Band Edge / 1 RB

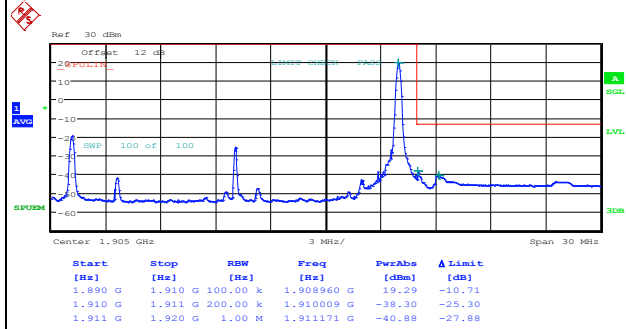

Date: 12.JAN.2015 15:36:06

Lowest Band Edge / Full RB

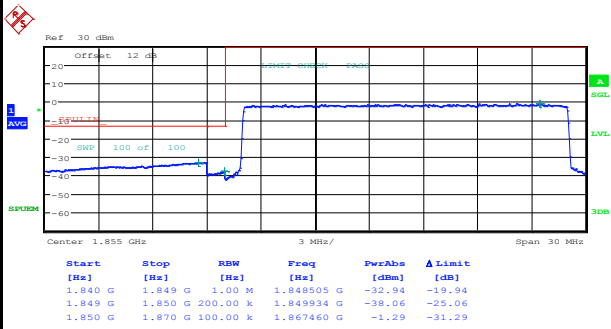

Date: 12.JAN.2015 15:27:33

Highest Band Edge / Full RB

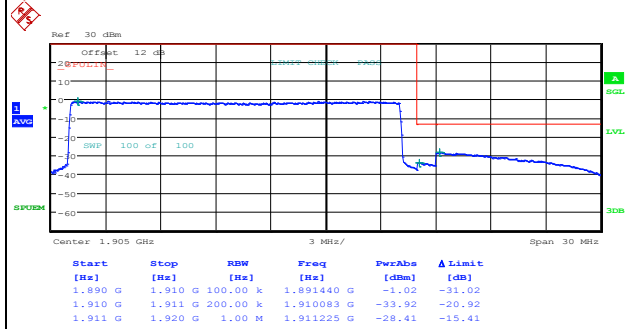

Date: 12.JAN.2015 15:38:26



LTE Band 2 / 20MHz / 16QAM

Lowest Band Edge / 1 RB

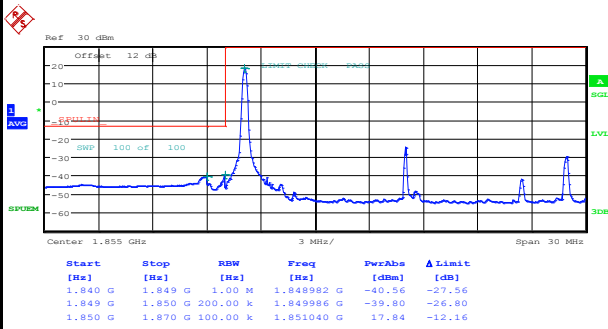

Date: 12.JAN.2015 15:26:23

Highest Band Edge / 1 RB

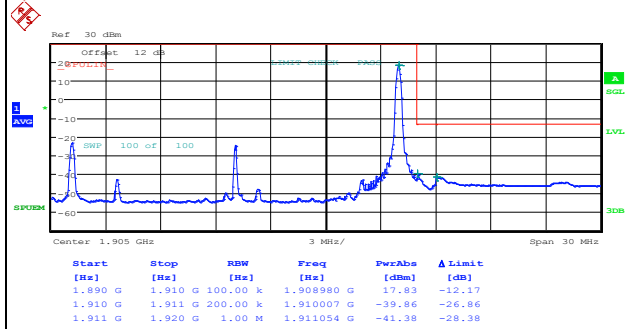

Date: 12.JAN.2015 15:37:16

Lowest Band Edge / Full RB

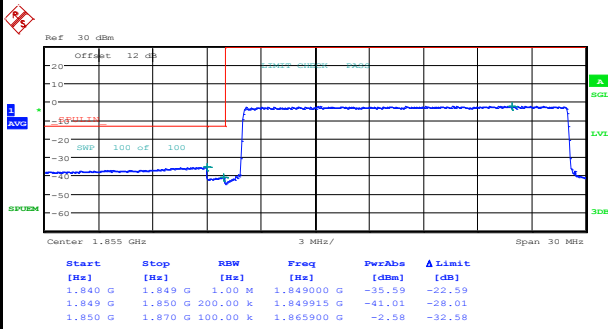

Date: 12.JAN.2015 15:28:43

Highest Band Edge / Full RB

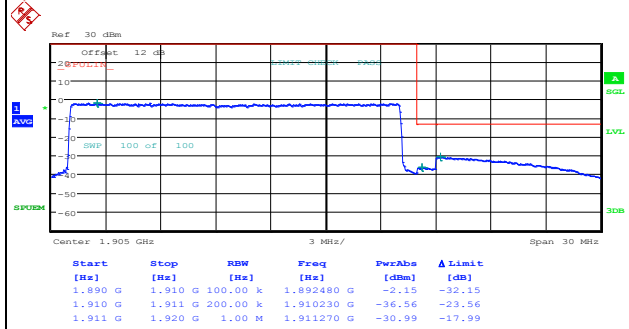

Date: 12.JAN.2015 15:39:36



Conducted Spurious Emission



LTE Band 2 / 1.4MHz

Lowest Channel / QPSK

Lowest Channel / 16QAM

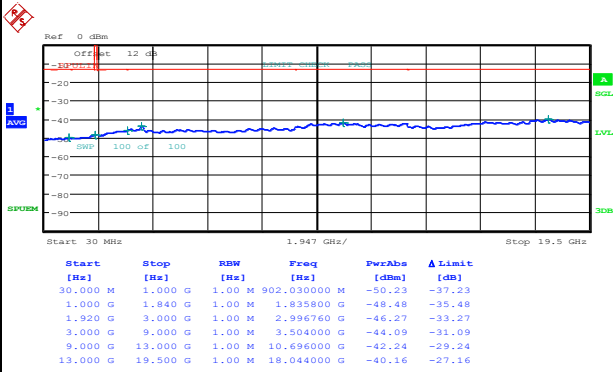

Date: 12.JAN.2015 16:10:53

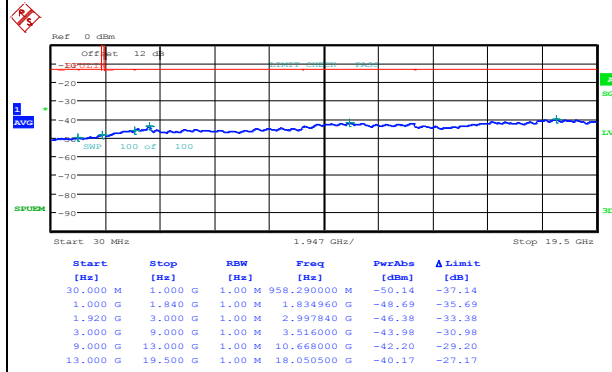

Date: 12.JAN.2015 16:12:04

Middle Channel / QPSK

Middle Channel / 16QAM

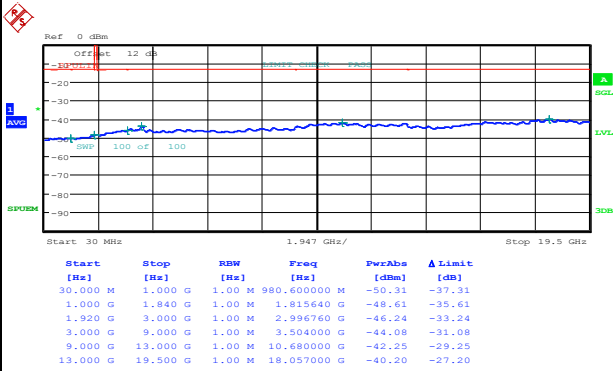

Date: 12.JAN.2015 16:14:00

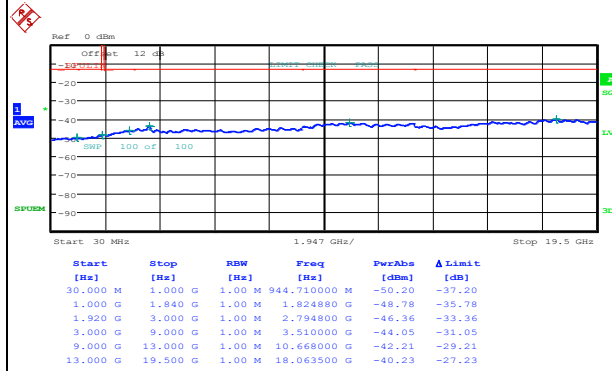

Date: 12.JAN.2015 16:15:12



LTE Band 2 / 1.4MHz

Highest Channel / QPSK

Highest Channel / 16QAM

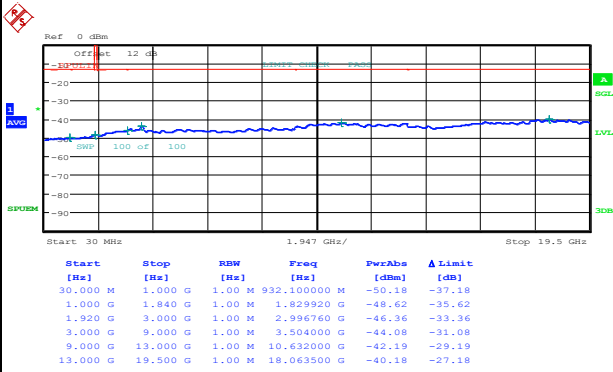

Date: 12.JAN.2015 16:23:03

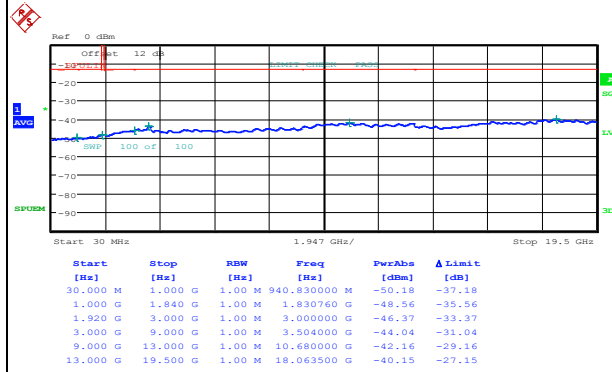

Date: 12.JAN.2015 16:24:13

LTE Band 2 / 3MHz

Lowest Channel / QPSK

Lowest Channel / 16QAM

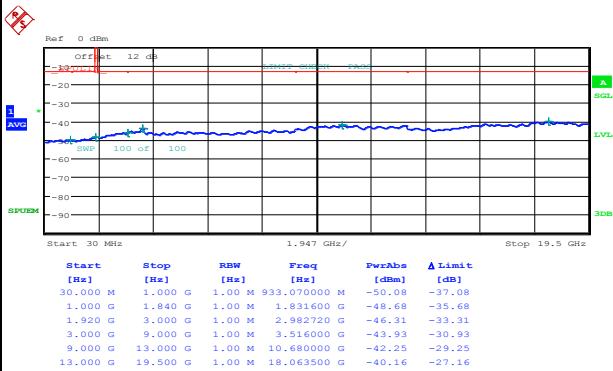

Date: 12.JAN.2015 14:09:19

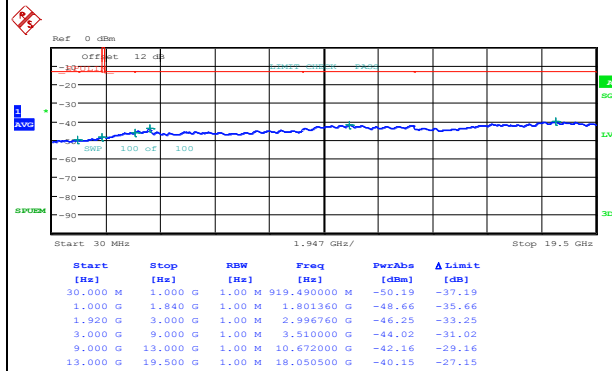

Date: 12.JAN.2015 14:11:20



LTE Band 2 / 3MHz

Middle Channel / QPSK

Middle Channel / 16QAM

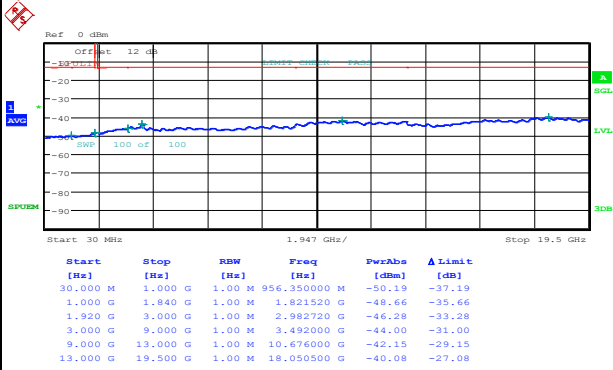

Date: 12.JAN.2015 14:13:25

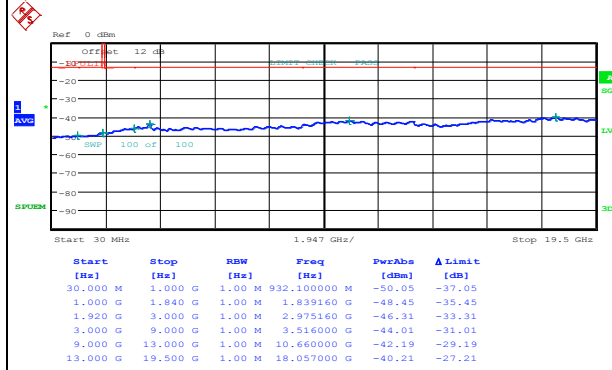

Date: 12.JAN.2015 14:14:37

Highest Channel / QPSK

Highest Channel / 16QAM

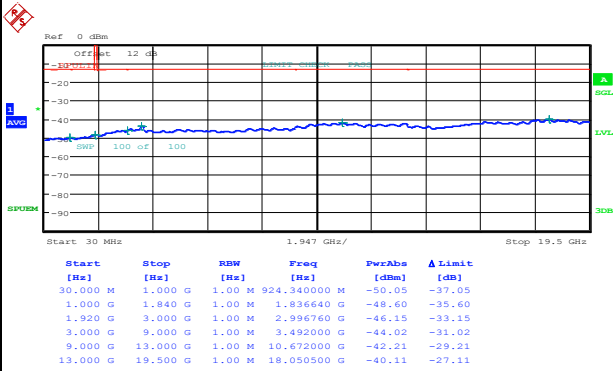

Date: 12.JAN.2015 14:21:26

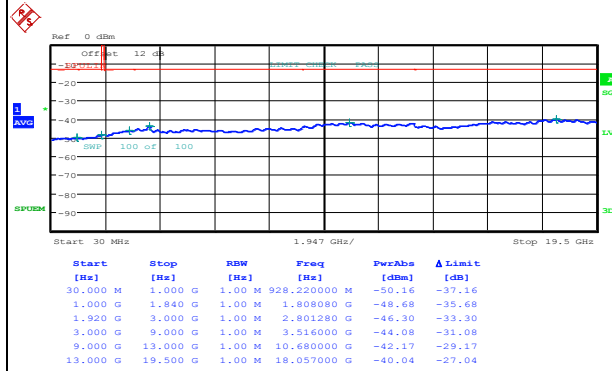

Date: 12.JAN.2015 14:22:37