



# FCC/IC RF Test Report

APPLICANT : Sony Mobile Communications Inc.  
EQUIPMENT : Smart phone  
BRAND NAME : SONY  
TYPE NAME : PM-0860-BV  
FCC ID : PY7-PM0860  
IC : 4170B-PM0860  
STANDARD : FCC 47 CFR Part 2, 22(H), 24(E), 27(L)  
IC RSS-132 issue 3, RSS-133 issue 6, and RSS-139 Issue 2  
CLASSIFICATION : PCS Licensed Transmitter Held to Ear (PCE)

The product was received on Dec. 31, 2014 and testing was completed on Feb. 16, 2015. We, SPORTON INTERNATIONAL INC., would like to declare that the tested sample has been evaluated in accordance with the test procedures given in ANSI / TIA / EIA-603-C-2004 and has been in compliance with the applicable technical standards.

The test results in this report apply exclusively to the tested model / sample. Without written approval of SPORTON INTERNATIONAL INC., the test report shall not be reproduced except in full.

Reviewed by: Joseph Lin / Supervisor

Approved by: Jones Tsai / Manager



## SPORTON INTERNATIONAL INC.

No. 52, Hwa Ya 1<sup>st</sup> Rd., Hwa Ya Technology Park, Kwei-Shan District, Tao Yuan City, Taiwan, R.O.C.



# TABLE OF CONTENTS

**REVISION HISTORY..... 3**

**SUMMARY OF TEST RESULT ..... 4**

**1 GENERAL DESCRIPTION ..... 5**

    1.1 Applicant..... 5

    1.2 Manufacturer ..... 5

    1.3 Product Feature of Equipment Under Test ..... 5

    1.4 Product Specification subjective to this standard ..... 6

    1.5 Modification of EUT ..... 7

    1.6 Maximum ERP/EIRP Power, Frequency Tolerance, and Emission Designator ..... 8

    1.7 Testing Location ..... 8

    1.8 Applicable Standards ..... 9

**2 TEST CONFIGURATION OF EQUIPMENT UNDER TEST ..... 10**

    2.1 Test Mode..... 10

    2.2 Connection Diagram of Test System ..... 12

    2.3 Support Unit used in test configuration ..... 12

    2.4 Measurement Results Explanation Example ..... 12

**3 TEST RESULT ..... 13**

    3.1 Conducted Output Power Measurement..... 13

    3.2 Peak-to-Average Ratio ..... 15

    3.3 Effective Radiated Power and Effective Isotropic Radiated Power Measurement ..... 31

    3.4 99% Occupied Bandwidth and 26dB Bandwidth Measurement..... 37

    3.5 Band Edge Measurement..... 61

    3.6 Conducted Spurious Emission Measurement ..... 69

    3.7 Field Strength of Spurious Radiation Measurement ..... 91

    3.8 Frequency Stability Measurement..... 114

**4 LIST OF MEASURING EQUIPMENT ..... 119**

**5 UNCERTAINTY OF EVALUATION ..... 120**



### REVISION HISTORY

REPORT NO.	VERSION	DESCRIPTION	ISSUED DATE
FG4D3145A	Rev. 01	Initial issue of report	Mar. 25, 2015



## SUMMARY OF TEST RESULT

Report Section	FCC Rule	IC Rule	Description	Limit	Result	Remark
3.1	§2.1046	RSS-132 (5.4) RSS-133 (6.4) RSS-139 (6.4)	Conducted Output Power	Reporting Only	PASS	-
3.2	§24.232(d)	RSS-132 (5.4) RSS-133 (6.4) RSS-139 (6.4)	Peak-to-Average Ratio	< 13 dB	PASS	-
3.3	§22.913(a)(2)	RSS-132(5.4) SRSP-503(5.1.3)	Effective Radiated Power	< 7 Watts	PASS	-
	§24.232(c)	RSS-133 (6.4) SRSP-510(5.1.2)	Equivalent Isotropic Radiated Power	< 2 Watts	PASS	-
	§27.50(d)(4)	RSS-139 (6.4) SRSP-513(5.1.2)	Equivalent Isotropic Radiated Power	< 1 Watts	PASS	-
3.4	§2.1049 §22.917(b) §24.238(b) §27.53(g)	RSS-GEN(6.6) RSS-133(6.5) RSS-139 (6.5)	Occupied Bandwidth	Reporting Only	PASS	-
3.5	§2.1051 §22.917(a) §24.238(a) §27.53(h)	RSS-132 (5.5) RSS-133 (6.5) RSS-139 (6.5)	Band Edge Measurement	< 43+10log10(P[Watts])	PASS	-
3.6	§2.1051 §22.917(a) §24.238(a) §27.53(h)	RSS-132 (5.5) RSS-133 (6.5) RSS-139 (6.5)	Conducted Emission	< 43+10log10(P[Watts])	PASS	-
3.7	§2.1053 §22.917(a) §24.238(a) §27.53(h)	RSS-132 (5.5) RSS-133 (6.5) RSS-139 (6.5)	Field Strength of Spurious Radiation	< 43+10log10(P[Watts])	PASS	Under limit 23.23 dB at 16656.000 MHz
3.8	§2.1055 §22.355	RSS-GEN(6.11) RSS-132 (5.3)	Frequency Stability for Temperature & Voltage	< 2.5 ppm for Part 22 Within Authorized Band	PASS	-
	§2.1055 §24.235	RSS-GEN(6.11) RSS-133 (6.3)				
	§27.54	RSS-139 (6.3)				



# 1 General Description

## 1.1 Applicant

**Sony Mobile Communications Inc.**  
Nya Vattentorget, 22188 Lund, Sweden

## 1.2 Manufacturer

**Arima Communications Corp.**  
6F, No. 866, Jhongjheng Rd., Jhonghe Dist., New Taipei City 23586, Taiwan

## 1.3 Product Feature of Equipment Under Test

The Equipment Under Test (hereafter called: EUT) is smart phone supporting, GSM/WCDMA/LTE, Wi-Fi 2.4GHz 802.11b/g/n, Wi-Fi 5GHz 802.11a/n, Bluetooth with FM Receiver, GPS, and NFC features, and below is details of information.

General Information of Equipment Under Test	
Equipment	Smart phone
Brand Name	SONY
Type Name	PM-0860-BV
FCC ID	PY7-PM0860
IC	4170B-PM0860
GSM Operating Band(s)	GSM 850/900/1800/1900MHz
GPRS / EGPRS Multi Slot Class	GPRS Class 12, EGPRS Class 12
WCDMA Operating Band(s)	FDD Band I / II / IV / V / VIII
WCDMA Rel. Version	Rel. 8
LTE Operating Band(s)	FDD Band II / IV / V / VII / XII / XIII / XVII
LTE Rel. Version	Rel. 8
Wi-Fi Specification	802.11a/b/g/n (HT20/HT40)
Bluetooth Version	v3.0+EDR / v4.0-LE
NFC Specification	ISO14443A / ISO14443B / Felica
Power Supply	Battery / AC Adapter / Car Charger

**Remark:** The above EUT's information was declared by manufacturer. Please refer to the specifications or user's manual for more detailed description.



1.4 Product Specification subjective to this standard

Product Specification subjective to this standard	
<b>Tx Frequency</b>	GSM850: 824.2 MHz ~ 848.8 MHz GSM1900: 1850.2 MHz ~ 1909.8MHz WCDMA Band V: 826.4 MHz ~ 846.6 MHz WCDMA Band IV : 1712.4 MHz ~ 1752.6 MHz WCDMA Band II: 1852.4 MHz ~ 1907.6 MHz
<b>Rx Frequency</b>	GSM850: 869.2 MHz ~ 893.8 MHz GSM1900: 1930.2 MHz ~ 1989.8 MHz WCDMA Band V: 871.4 MHz ~ 891.6 MHz WCDMA Band IV : 2112.4 MHz ~ 2152.6 MHz WCDMA Band II: 1932.4 MHz ~ 1987.6 MHz
<b>Maximum Output Power to Antenna</b>	GSM850 : 32.59 dBm GSM1900 : 29.50 dBm WCDMA Band V : 23.98 dBm WCDMA Band IV : 22.97 dBm WCDMA Band II : 22.49 dBm
<b>Antenna Type / Gain</b>	GSM850: Coupling type (LDS) Antenna / -6.60 dBi GSM1900: Coupling type (LDS) Antenna / -4.60 dBi WCDMA Band V: Coupling type (LDS) Antenna / -6.60 dBi WCDMA Band IV: Coupling type (LDS) Antenna / -4.20 dBi WCDMA Band II: Coupling type (LDS) Antenna / -4.60 dBi
<b>Type of Modulation</b>	GSM: GMSK GPRS: GMSK EDGE: GMSK / 8PSK WCDMA: QPSK (Uplink) HSDPA: 64QAM (Downlink) HSUPA: QPSK (Uplink)

EUT Information List				
IMEI	HW Version	SW Version	S/N	Performed Test Item
00440245908364	A	27.1.A.0.38	RV4C13D10888	Conducted Measurement Radiated Spurious Emission ERP /EIRP Test



Accessory List	
AC Adapter	Model No. : EP800
	Type No. : AC-0030-US
	S/N : 3113W46622783
Battery	Model No. : Ram
Earphone	Model No. : MH410c
	Type No. : AG-1103
	S/N : 1411204C00BC7D0
USB Cable	Model No. : EC450
	Type No. : AI-0700
	S/N : 143912D8330504A

**Note:**

1. Above EUT list and accessory list used are electrically identical per declared by manufacturer.
2. Above the accessories list are used to exercise the EUT during test.
3. For other wireless features of this EUT, test report will be issued separately.

### 1.5 Modification of EUT

No modifications are made to the EUT during all test items.



### 1.6 Maximum ERP/EIRP Power, Frequency Tolerance, and Emission Designator

FCC Rule	System	Type of Modulation	Maximum ERP/EIRP (W)	Frequency Tolerance (ppm)	Emission Designator
Part 22	GSM850 GSM	GMSK	0.5929	0.0407 ppm	247KGXW
Part 22	GSM850 EDGE class 8	8PSK	0.2153	0.0359 ppm	253KG7W
Part 22	WCDMA Band V RMC 12.2Kbps	QPSK	0.0560	0.0155 ppm	4M22F9W
Part 24	GSM1900 GSM	GMSK	0.6902	0.0170 ppm	245KGXW
Part 24	GSM1900 EDGE class 8	8PSK	0.2864	0.0186 ppm	254KG7W
Part 24	WCDMA Band II RMC 12.2Kbps	QPSK	0.1507	0.0101 ppm	4M22F9W
Part 27	WCDMA Band IV RMC 12.2Kbps	QPSK	0.1766	0.0098 ppm	4M22F9W

### 1.7 Testing Location

Sporton Lab is accredited to ISO 17025 by Taiwan Accreditation Foundation (TAF code : 1190) and the FCC designation No. TW1022 under the FCC 2.948(e) by Mutual Recognition Agreement (MRA) in FCC Test.

<b>Test Site</b>	SPORTON INTERNATIONAL INC.	
<b>Test Site Location</b>	No. 52, Hwa Ya 1 <sup>st</sup> Rd., Hwa Ya Technology Park, Kwei-Shan District, Tao Yuan City, Taiwan, R.O.C. TEL: +886-3-327-3456 FAX: +886-3-328-4978	
<b>Test Site No.</b>	<b>Sporton Site No.</b>	
	TH02-HY	

<b>Test Site</b>	SPORTON INTERNATIONAL INC.	
<b>Test Site Location</b>	No.58, Aly. 75, Ln. 564, Wenhua 3rd Rd. Kwei-Shan District, Tao Yuan City, Taiwan (R.O.C.) TEL: +886-3-327-0855	
<b>Test Site No.</b>	<b>Sporton Site No.</b>	<b>IC Registration No.</b>
	03CH11-HY	4086H-2





## 1.8 Applicable Standards

According to the specifications of the manufacturer, the EUT must comply with the requirements of the following standards:

- ♦ 47 CFR Part 2, 22(H), 24(E), 27(L)
- ♦ ANSI / TIA / EIA-603-C-2004
- ♦ FCC KDB 971168 D01 Power Meas. License Digital Systems v02r02
- ♦ IC RSS-132 Issue 3
- ♦ IC RSS-133 Issue 6
- ♦ IC RSS-139 Issue 2
- ♦ IC RSS-Gen Issue 4
- ♦ NOTICE 2012-DRS0126

### Remark:

1. All test items were verified and recorded according to the standards and without any deviation during the test.
2. This EUT has also been tested and complied with the requirements of FCC Part 15, Subpart B, recorded in a separate test report.
3. Per the section 2.2.3 of Notice of 2012-DRS0126, " Receivers Excluded from Industry Canada Requirements", only radiocommunication receivers operating in stand-alone mode within the band 30-960 MHz and scanner receivers are subject to Industry Canada requirements.



## 2 Test Configuration of Equipment Under Test

### 2.1 Test Mode

Antenna port conducted and radiated test items were performed according to KDB 971168 D01 Power Meas. License Digital Systems v02r02 with maximum output power.

Radiated measurements were performed with rotating EUT in different three orthogonal test planes to find the maximum emission.

Radiated emissions were investigated as following frequency range:

1. 30 MHz to 9000 MHz for GSM850 and WCDMA Band V.
2. 30 MHz to 18000 MHz for WCDMA Band IV
3. 30 MHz to 19000 MHz for GSM1900 and WCDMA Band II.

All modes and data rates and positions were investigated.

Test modes are chosen to be reported as the worst case configuration below:

Test Modes		
Band	Radiated TCs	Conducted TCs
GSM 850	<ul style="list-style-type: none"> <li>■ GSM Link</li> <li>■ EDGE class 8 Link</li> </ul>	<ul style="list-style-type: none"> <li>■ GSM Link</li> <li>■ EDGE class 8 Link</li> </ul>
GSM 1900	<ul style="list-style-type: none"> <li>■ GSM Link</li> <li>■ EDGE class 8 Link</li> </ul>	<ul style="list-style-type: none"> <li>■ GSM Link</li> <li>■ EDGE class 8 Link</li> </ul>
WCDMA Band V	<ul style="list-style-type: none"> <li>■ RMC 12.2Kbps Link</li> </ul>	<ul style="list-style-type: none"> <li>■ RMC 12.2Kbps Link</li> </ul>
WCDMA Band II	<ul style="list-style-type: none"> <li>■ RMC 12.2Kbps Link</li> </ul>	<ul style="list-style-type: none"> <li>■ RMC 12.2Kbps Link</li> </ul>
WCDMA Band IV	<ul style="list-style-type: none"> <li>■ RMC 12.2Kbps Link</li> </ul>	<ul style="list-style-type: none"> <li>■ RMC 12.2Kbps Link</li> </ul>

**Note:** The maximum power levels are chosen to test as the worst case configuration as follows:

GSM mode for GMSK modulation,

EDGE multi-slot class 8 mode for 8PSK modulation,

RMC 12.2Kbps mode for WCDMA band V, WCDMA band IV, and WCDMA band II,

only these modes were used for all tests.



Conducted Power Measurement Results:

Conducted Power (*Unit: dBm)						
Band	GSM850			GSM1900		
Channel	128	189	251	512	661	810
Frequency	824.2	836.4	848.8	1850.2	1880.0	1909.8
GSM	32.54	32.58	32.59	29.50	29.42	29.38
GPRS class 8	32.53	32.57	32.58	29.49	29.41	29.37
GPRS class 10	30.47	30.47	30.51	26.57	26.50	26.44
GPRS class 11	29.49	29.49	29.48	25.52	25.39	25.35
GPRS class 12	28.45	28.44	28.46	24.61	24.49	24.47
EGPRS class 8	29.20	29.31	29.09	26.04	26.02	26.13
EGPRS class 10	28.25	28.35	28.06	25.07	25.04	25.16
EGPRS class 11	27.27	27.36	27.10	24.48	24.46	24.49
EGPRS class 12	26.29	26.38	26.11	23.32	23.31	23.37

Conducted Power (*Unit: dBm)									
Band	WCDMA Band V			WCDMA Band II			WCDMA Band IV		
Channel	4132	4182	4233	9262	9400	9538	1312	1413	1513
Frequency	826.4	836.4	846.6	1852.4	1880	1907.6	1712.4	1732.6	1752.6
RMC 12.2K	23.92	23.98	23.93	22.45	22.39	22.49	22.86	22.95	22.97
HSDPA Subtest-1	22.97	22.97	22.93	21.46	21.31	21.45	21.85	22.00	22.00
HSDPA Subtest-2	22.96	22.95	22.91	21.44	21.34	21.49	21.84	21.98	21.99
HSDPA Subtest-3	22.49	22.49	22.48	20.98	20.94	20.98	21.46	21.48	21.50
HSDPA Subtest-4	22.46	22.47	22.47	20.97	20.91	20.97	21.46	21.48	21.49
HSUPA Subtest-1	21.01	21.03	21.01	19.56	19.54	19.59	20.05	20.01	20.06
HSUPA Subtest-2	20.98	20.97	20.95	19.42	19.36	19.48	19.85	19.98	19.93
HSUPA Subtest-3	21.94	21.96	21.95	20.43	20.38	20.48	20.92	20.96	20.95
HSUPA Subtest-4	20.50	20.53	20.46	19.06	18.96	19.11	19.55	19.61	19.54
HSUPA Subtest-5	22.88	22.97	22.88	21.37	21.27	21.41	21.84	21.92	21.86

## 2.2 Connection Diagram of Test System

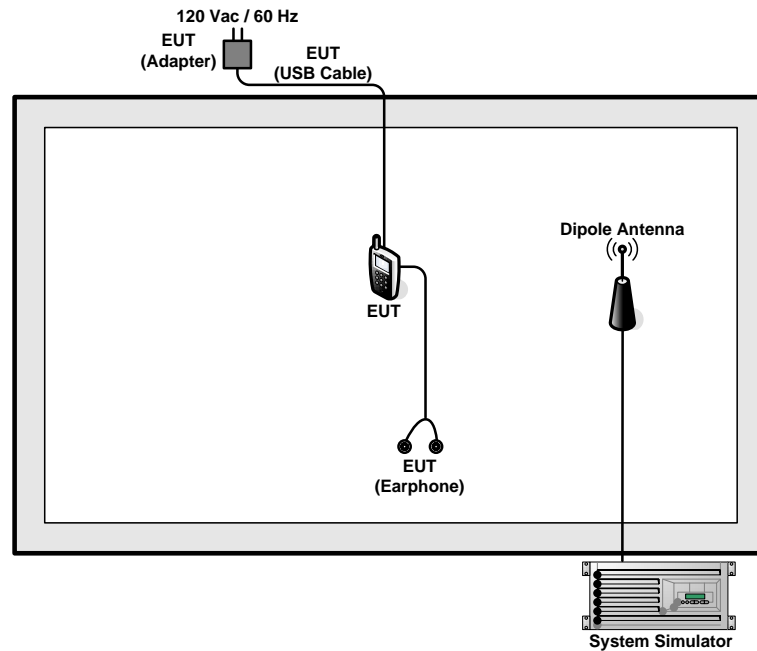

## 2.3 Support Unit used in test configuration

Item	Equipment	Trade Name	Model No.	FCC ID	Data Cable	Power Cord
1.	System Simulator	R&S	CMU 200	N/A	N/A	Unshielded, 1.8 m

## 2.4 Measurement Results Explanation Example

### For all conducted test items:

The offset level is set in the spectrum analyzer to compensate the RF cable loss and attenuator factor between RF conducted output port and spectrum analyzer. With the offset compensation, the spectrum analyzer reading level will be exactly the RF output level.

The spectrum analyzer offset is derived from RF cable loss and attenuator factor.

*Offset = RF cable loss + attenuator factor.*

The following shows an offset computation example with RF cable loss 4.2 dB and a 10dB attenuator.

Example :

$$\begin{aligned} \text{Offset(dB)} &= \text{RF cable loss(dB)} + \text{attenuator factor(dB)} \\ &= 4.2 + 10 = 14.2 \text{ (dB)} \end{aligned}$$

### 3 Test Result

#### 3.1 Conducted Output Power Measurement

##### 3.1.1 Description of the Conducted Output Power Measurement

A system simulator was used to establish communication with the EUT. Its parameters were set to enforce EUT transmitting at the maximum power. The measured power in the radio frequency on the transmitter output terminals shall be reported.

##### 3.1.2 Measuring Instruments

The measuring equipment is listed in the section 4 of this test report.

##### 3.1.3 Test Procedures

1. The transmitter output port was connected to the system simulator.
2. Set EUT at maximum power through system simulator.
3. Select lowest, middle, and highest channels for each band and different modulation.
4. Measure the maximum burst average power for GSM and maximum average power for other modulation signal.

##### 3.1.4 Test Setup

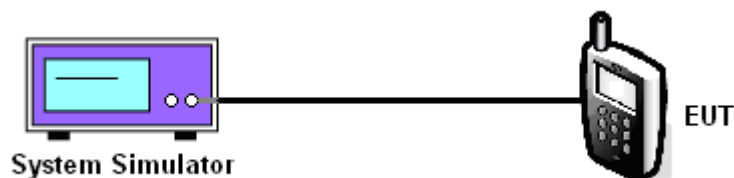

3.1.5 Test Result of Conducted Output Power

Cellular Band									
Modes	GSM850 (GSM)			GSM850 (EDGE class 8)			WCDMA Band V (RMC 12.2Kbps)		
Channel	128 (Low)	189 (Mid)	251 (High)	128 (Low)	189 (Mid)	251 (High)	4132 (Low)	4182 (Mid)	4233 (High)
Frequency (MHz)	824.2	836.4	848.8	824.2	836.4	848.8	826.4	836.4	846.6
Conducted Power (dBm)	32.54	32.58	32.59	29.20	29.31	29.09	23.92	23.98	23.93

PCS Band									
Modes	GSM1900 (GSM)			GSM1900 (EDGE class 8)			WCDMA Band II (RMC 12.2Kbps)		
Channel	512 (Low)	661 (Mid)	810 (High)	512 (Low)	661 (Mid)	810 (High)	9262 (Low)	9400 (Mid)	9538 (High)
Frequency (MHz)	1850.2	1880	1909.8	1850.2	1880	1909.8	1852.4	1880	1907.6
Conducted Power (dBm)	29.50	29.42	29.38	26.04	26.02	26.13	22.45	22.39	22.49

AWS Band			
Modes	WCDMA Band IV (RMC 12.2Kbps)		
Channel	1312(Low)	1413 (Mid)	1513 (High)
Frequency (MHz)	1712.4	1732.6	1752.6
Conducted Power (dBm)	22.86	22.95	22.97

Note: maximum burst average power for GSM, and maximum average power for WCDMA.

## 3.2 Peak-to-Average Ratio

### 3.2.1 Description of the PAR Measurement

The peak-to-average ratio (PAR) of the transmission may not exceed 13 dB.

### 3.2.2 Measuring Instruments

The measuring equipment is listed in the section 4 of this test report.

### 3.2.3 Test Procedures

1. The EUT was connected to spectrum analyzer and system simulator via a power divider.
2. Set EUT to transmit at maximum output power.
3. When the duty cycle is less than 98%, then signal gating will be implemented on the spectrum analyzer by triggering from the system simulator.
4. Set the CCDF (Complementary Cumulative Distribution Function) option of the spectrum analyzer.
5. Record the maximum PAPR level associated with a probability of 0.1%.

### 3.2.4 Test Setup

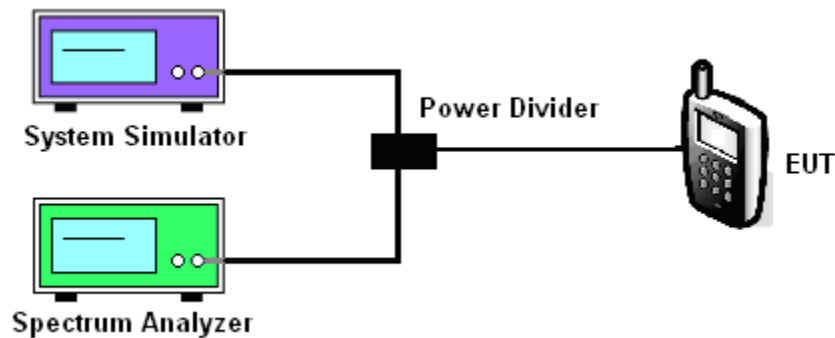

3.2.5 Test Result of Peak-to-Average Ratio

Cellular Band									
Modes	GSM850 (GSM)			GSM850 (EDGE class 8)			WCDMA Band V (RMC 12.2Kbps)		
Channel	128 (Low)	189 (Mid)	251 (High)	128 (Low)	189 (Mid)	251 (High)	4132 (Low)	4182 (Mid)	4233 (High)
Frequency (MHz)	824.2	836.4	848.8	824.2	836.4	848.8	826.4	836.4	846.6
Peak-to-Average Ratio (dB)	0.24	0.20	0.24	3.28	3.24	3.28	2.40	2.96	2.96

PCS Band									
Modes	GSM1900 (GSM)			GSM1900 (EDGE class 8)			WCDMA Band II (RMC 12.2Kbps)		
Channel	512 (Low)	661 (Mid)	810 (High)	512 (Low)	661 (Mid)	810 (High)	9262 (Low)	9400 (Mid)	9538 (High)
Frequency (MHz)	1850.2	1880	1909.8	1850.2	1880	1909.8	1852.4	1880	1907.6
Peak-to-Average Ratio (dB)	0.24	0.20	0.24	3.20	3.40	3.28	2.92	2.68	2.36

AWS Band			
Modes	WCDMA Band IV (RMC 12.2Kbps)		
Channel	1312(Low)	1413 (Mid)	1513 (High)
Frequency (MHz)	1712.4	1732.6	1752.6
Peak-to-Average Ratio (dB)	3.00	2.80	2.96





### 3.2.6 Test Result (Plots) of Peak-to-Average Ratio

Band :	GSM 850	Test Mode :	GSM Link (GMSK)
--------	---------	-------------	-----------------

#### Peak-to-Average Ratio on Channel 128 (824.2 MHz)

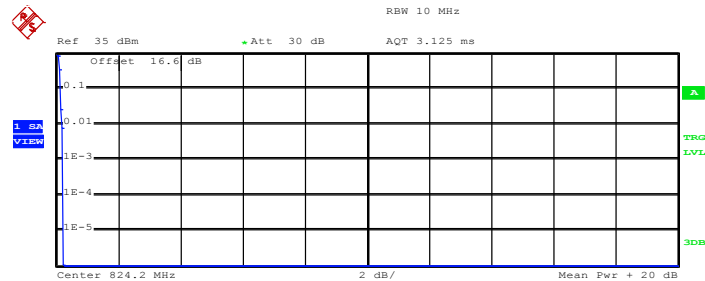

Complementary Cumulative Distribution Function (100000 samples)

Trace 1  
 Mean 31.93 dBm  
 Peak 32.15 dBm  
 Crest 0.22 dB

10 %	0.16 dB
1 %	0.20 dB
.1 %	0.24 dB
.01 %	0.24 dB

Date: 23.JAN.2015 19:56:37

#### Peak-to-Average Ratio on Channel 189 (836.4 MHz)

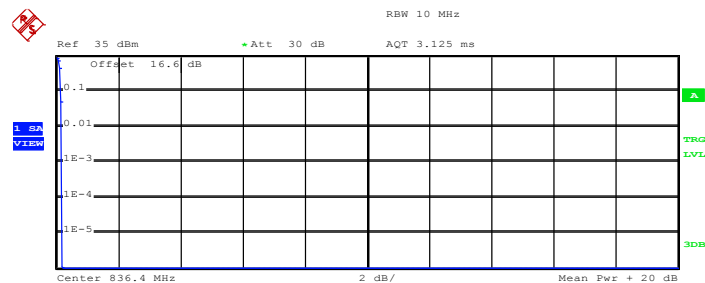

Complementary Cumulative Distribution Function (100000 samples)

Trace 1  
 Mean 32.26 dBm  
 Peak 32.43 dBm  
 Crest 0.16 dB

10 %	0.16 dB
1 %	0.20 dB
.1 %	0.20 dB
.01 %	0.20 dB

Date: 23.JAN.2015 19:56:50



Peak-to-Average Ratio on Channel 251 (848.8 MHz)

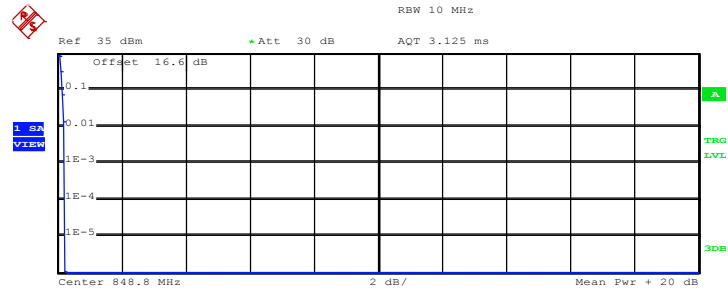

Complementary Cumulative Distribution Function (100000 samples)

Trace 1

Mean    32.08 dBm  
Peak    32.29 dBm  
Crest    0.21 dB

10 %    0.16 dB  
1 %    0.20 dB  
.1 %    0.24 dB  
.01 %    0.24 dB

Date: 23.JAN.2015 19:57:03



<b>Band :</b>	GSM 850	<b>Test Mode :</b>	EDGE class 8 Link (8PSK)
---------------	---------	--------------------	--------------------------

**Peak-to-Average Ratio on Channel 128 (824.2 MHz)**

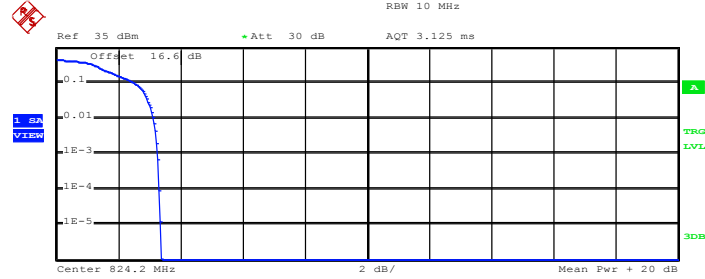

Complementary Cumulative Distribution Function (100000 samples)

Trace 1

Mean	26.74 dBm
Peak	30.10 dBm
Crest	3.36 dB
10 %	2.52 dB
1 %	3.12 dB
.1 %	3.28 dB
.01 %	3.32 dB

Date: 23.JAN.2015 20:10:00

**Peak-to-Average Ratio on Channel 189 (836.4 MHz)**

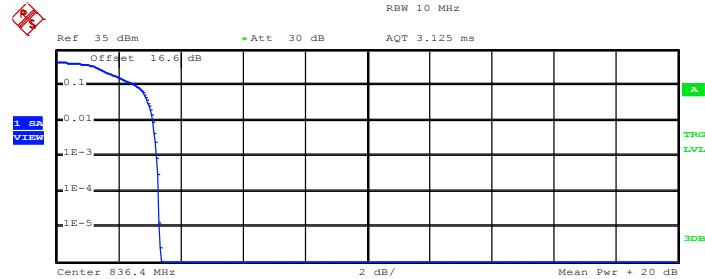

Complementary Cumulative Distribution Function (100000 samples)

Trace 1

Mean	27.30 dBm
Peak	30.67 dBm
Crest	3.36 dB
10 %	2.60 dB
1 %	3.12 dB
.1 %	3.24 dB
.01 %	3.32 dB

Date: 23.JAN.2015 20:10:13



Peak-to-Average Ratio on Channel 251 (848.8 MHz)

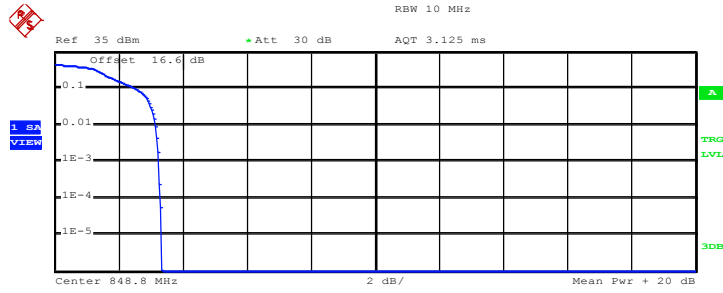

Complementary Cumulative Distribution Function (100000 samples)

Trace 1

Mean	27.39 dBm
Peak	30.74 dBm
Crest	3.35 dB
10 %	2.56 dB
1 %	3.16 dB
.1 %	3.28 dB
.01 %	3.32 dB

Date: 23.JAN.2015 20:10:26



<b>Band :</b>	GSM 1900	<b>Test Mode :</b>	GSM Link (GMSK)
---------------	----------	--------------------	-----------------

**Peak-to-Average Ratio on Channel 512 (1850.2 MHz)**

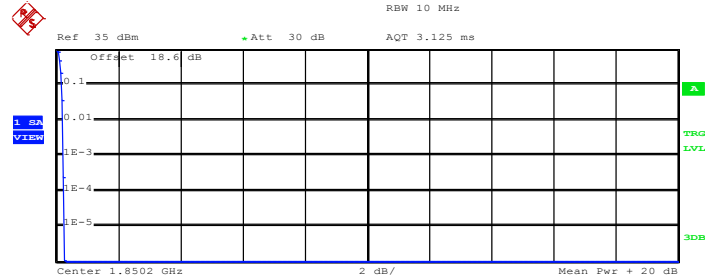

Complementary Cumulative Distribution Function (100000 samples)

Trace 1

Mean	28.98 dBm
Peak	29.25 dBm
Crest	0.28 dB
10 %	0.20 dB
1 %	0.24 dB
.1 %	0.24 dB
.01 %	0.28 dB

Date: 23.JAN.2015 20:19:01

**Peak-to-Average Ratio on Channel 661 (1880.0 MHz)**

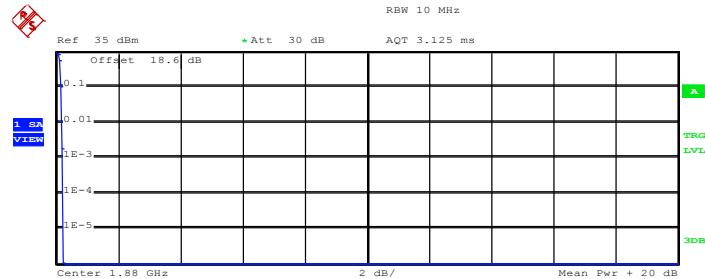

Complementary Cumulative Distribution Function (100000 samples)

Trace 1

Mean	29.79 dBm
Peak	30.03 dBm
Crest	0.24 dB
10 %	0.16 dB
1 %	0.20 dB
.1 %	0.20 dB
.01 %	0.24 dB

Date: 23.JAN.2015 20:19:12



Peak-to-Average Ratio on Channel 810 (1909.8 MHz)

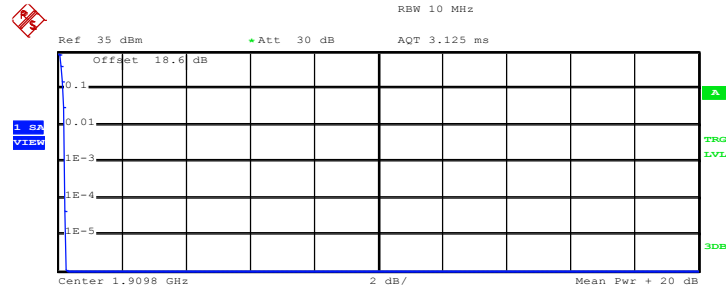

Complementary Cumulative Distribution Function (100000 samples)

Trace 1

Mean	28.83 dBm
Peak	29.11 dBm
Crest	0.28 dB
10 %	0.16 dB
1 %	0.24 dB
.1 %	0.24 dB
.01 %	0.24 dB

Date: 23.JAN.2015 20:19:24



<b>Band :</b>	GSM 1900	<b>Test Mode :</b>	EDGE class 8 Link (8PSK)
---------------	----------	--------------------	--------------------------

**Peak-to-Average Ratio on Channel 512 (1850.2 MHz)**

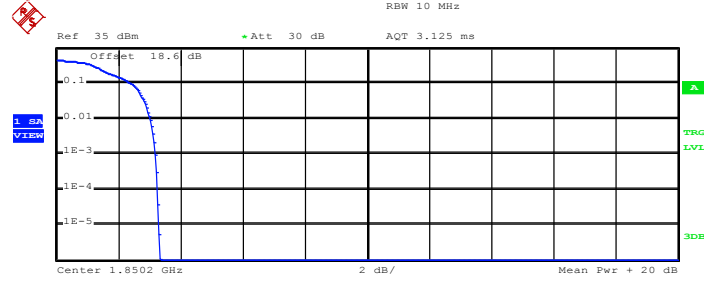

Complementary Cumulative Distribution Function (100000 samples)

Trace 1

Mean	25.58 dBm
Peak	28.90 dBm
Crest	3.32 dB
10 %	2.44 dB
1 %	3.04 dB
.1 %	3.20 dB
.01 %	3.28 dB

Date: 23.JAN.2015 20:29:10

**Peak-to-Average Ratio on Channel 661 (1880.0 MHz)**

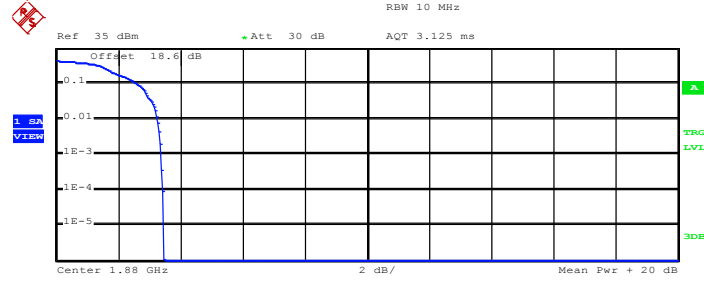

Complementary Cumulative Distribution Function (100000 samples)

Trace 1

Mean	26.80 dBm
Peak	30.24 dBm
Crest	3.45 dB
10 %	2.60 dB
1 %	3.28 dB
.1 %	3.40 dB
.01 %	3.44 dB

Date: 23.JAN.2015 20:29:24



Peak-to-Average Ratio on Channel 810 (1909.8 MHz)

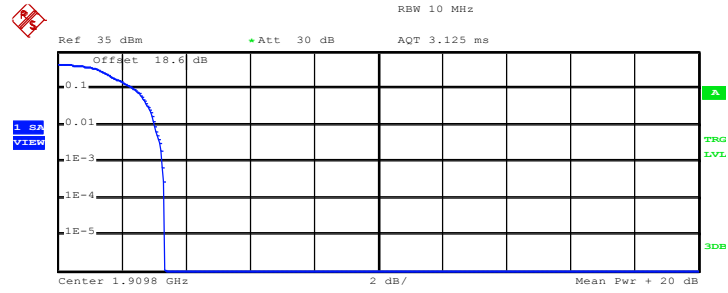

Complementary Cumulative Distribution Function (100000 samples)

Trace 1

Mean 25.56 dBm  
 Peak 28.90 dBm  
 Crest 3.34 dB

10 % 2.40 dB  
 1 % 3.04 dB  
 .1 % 3.28 dB  
 .01 % 3.36 dB

Date: 23.JAN.2015 20:29:37





<b>Band :</b>	WCDMA Band V	<b>Test Mode :</b>	RMC 12.2Kbps Link (QPSK)
---------------	--------------	--------------------	--------------------------

**Peak-to-Average Ratio on Channel 4132 (826.4 MHz)**

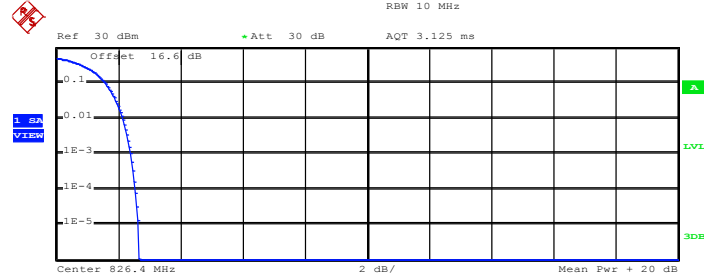

Complementary Cumulative Distribution Function (100000 samples)

Trace 1

Mean	23.49 dBm
Peak	26.16 dBm
Crest	2.67 dB
10 %	1.60 dB
1 %	2.16 dB
.1 %	2.40 dB
.01 %	2.56 dB

Date: 23.JAN.2015 20:46:47

**Peak-to-Average Ratio on Channel 4182 (836.4 MHz)**

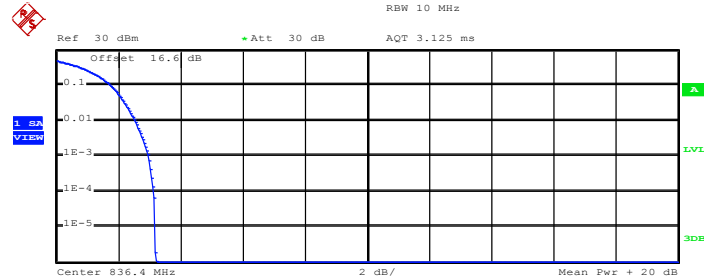

Complementary Cumulative Distribution Function (100000 samples)

Trace 1

Mean	23.46 dBm
Peak	26.65 dBm
Crest	3.19 dB
10 %	1.76 dB
1 %	2.56 dB
.1 %	2.96 dB
.01 %	3.16 dB

Date: 23.JAN.2015 20:46:58



Peak-to-Average Ratio on Channel 4233 (846.6 MHz)

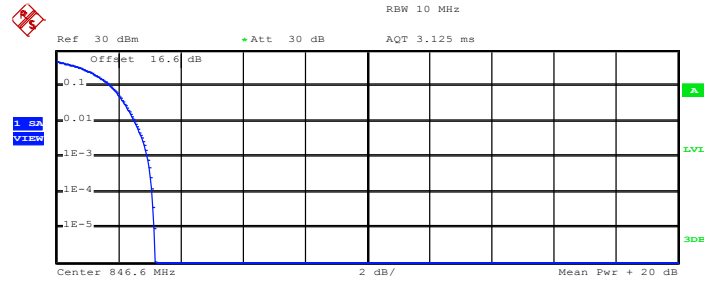

Complementary Cumulative Distribution Function (100000 samples)

Trace 1

Mean	23.41 dBm
Peak	26.58 dBm
Crest	3.17 dB
10 %	1.76 dB
1 %	2.52 dB
.1 %	2.96 dB
.01 %	3.08 dB

Date: 23.JAN.2015 20:47:08



<b>Band :</b>	WCDMA Band IV	<b>Test Mode :</b>	RMC 12.2Kbps Link (QPSK)
---------------	---------------	--------------------	--------------------------

**Peak-to-Average Ratio on Channel 1312 (1712.4 MHz)**

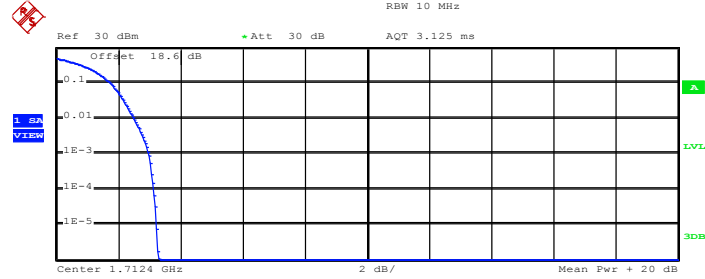

Complementary Cumulative Distribution Function (100000 samples)

Trace 1

Mean	22.73 dBm
Peak	26.02 dBm
Crest	3.29 dB
10 %	1.76 dB
1 %	2.52 dB
.1 %	3.00 dB
.01 %	3.16 dB

Date: 23.JAN.2015 21:04:04

**Peak-to-Average Ratio on Channel 1413 (1732.6 MHz)**

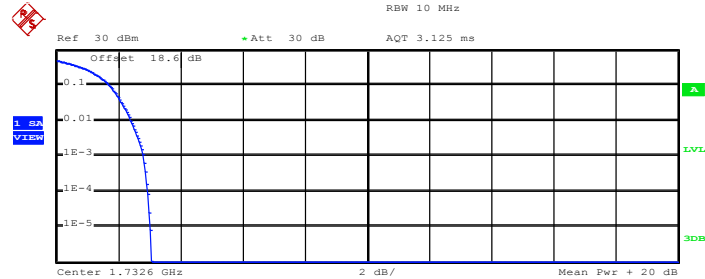

Complementary Cumulative Distribution Function (100000 samples)

Trace 1

Mean	23.25 dBm
Peak	26.30 dBm
Crest	3.05 dB
10 %	1.72 dB
1 %	2.40 dB
.1 %	2.80 dB
.01 %	2.96 dB

Date: 23.JAN.2015 21:04:15



Peak-to-Average Ratio on Channel 1513 (1752.6 MHz)

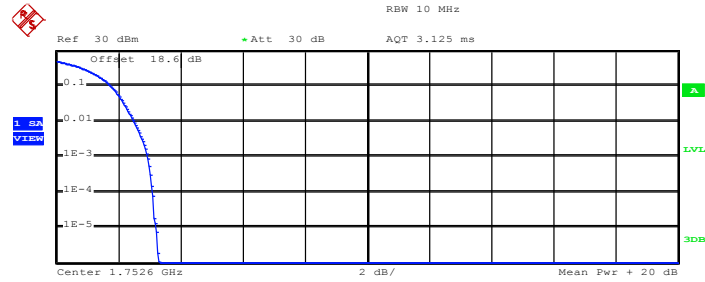

Complementary Cumulative Distribution Function (100000 samples)

Trace 1	
Mean	22.80 dBm
Peak	26.09 dBm
Crest	3.29 dB
10 %	1.76 dB
1 %	2.52 dB
.1 %	2.96 dB
.01 %	3.12 dB

Date: 23.JAN.2015 21:04:30



<b>Band :</b>	WCDMA Band II	<b>Test Mode :</b>	RMC 12.2Kbps Link (QPSK)
---------------	---------------	--------------------	--------------------------

**Peak-to-Average Ratio on Channel 9262 (1852.4 MHz)**

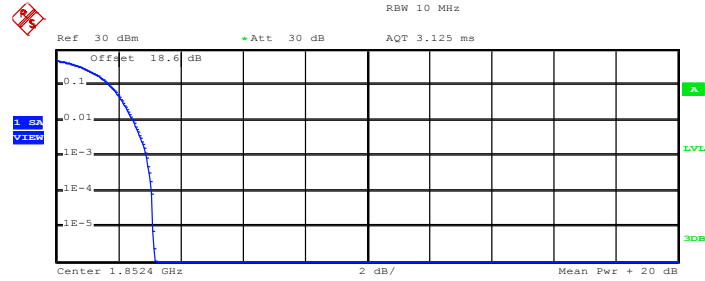

Complementary Cumulative Distribution Function (100000 samples)

Trace 1

Mean	21.93 dBm
Peak	25.10 dBm
Crest	3.17 dB
10 %	1.72 dB
1 %	2.48 dB
.1 %	2.92 dB
.01 %	3.08 dB

Date: 23.JAN.2015 20:55:40

**Peak-to-Average Ratio on Channel 9400 (1880.0 MHz)**

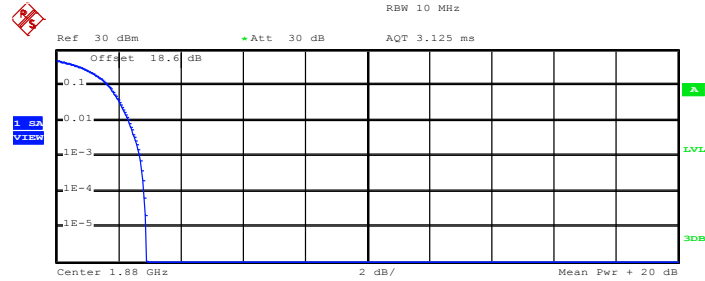

Complementary Cumulative Distribution Function (100000 samples)

Trace 1

Mean	22.70 dBm
Peak	25.60 dBm
Crest	2.89 dB
10 %	1.68 dB
1 %	2.36 dB
.1 %	2.68 dB
.01 %	2.84 dB

Date: 23.JAN.2015 20:55:50



Peak-to-Average Ratio on Channel 9538 (1907.6 MHz)

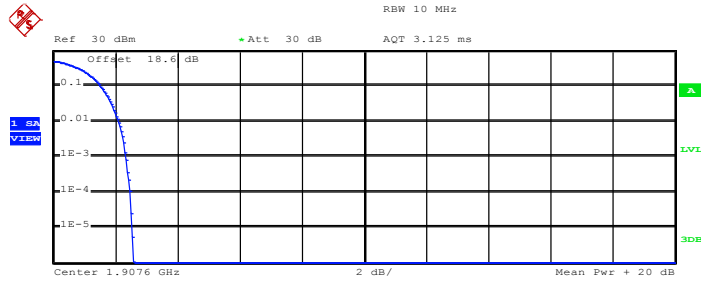

Complementary Cumulative Distribution Function (100000 samples)

Trace 1	
Mean	22.44 dBm
Peak	25.03 dBm
Crest	2.59 dB
10 %	1.52 dB
1 %	2.12 dB
.1 %	2.36 dB
.01 %	2.48 dB

Date: 23.JAN.2015 20:56:02



### 3.3 Effective Radiated Power and Effective Isotropic Radiated Power Measurement

#### 3.3.1 Description of the ERP/EIRP Measurement

The substitution method, in ANSI / TIA / EIA-603-C-2004, was used for ERP/EIRP measurement, and the spectrum analyzer configuration follows KDB 971168 D01 Power Meas. License Digital Systems v02r02. The ERP of mobile transmitters must not exceed 7 Watts (Cellular Band) and the EIRP of mobile transmitters are limited to 2 Watts (PCS Band) and 1 Watts (AWS Band).

#### 3.3.2 Measuring Instruments

The measuring equipment is listed in the section 4 of this test report.

#### 3.3.3 Test Procedures

1. The EUT was placed on a non-conductive rotating platform 0.8 meters high in a semi-anechoic chamber. The radiated emission at the fundamental frequency was measured at 3 m with a test antenna and a spectrum analyzer with RMS detector per section 5. of KDB 971168 D01.
2. During the measurement, the system simulator parameters were set to force the EUT transmitting at maximum output power. The maximum emission was recorded from analyzer power level (LVL) from the 360 degrees rotation of the turntable and the test antenna raised and lowered over a range from 1 to 4 meters in both horizontally and vertically polarized orientations.
3. Effective Isotropic Radiated Power (EIRP) was measured by substitution method according to TIA/EIA-603-C. The EUT was replaced by dipole antenna (substitution antenna) at the same location, and then a known power from S.G. was applied into the dipole antenna through a Tx cable, and then recorded the maximum Analyzer reading through raised and lowered the test antenna. The correction factor (in dB) = S.G. - Tx Cable loss + Substitution antenna gain - Analyzer reading. Then the EUT's EIRP was calculated with the correction factor,  $EIRP = LVL + \text{Correction factor}$  and  $ERP = EIRP - 2.15$ .

	GSM/GPRS/EDGE	WCDMA/HSPA
SPAN	500kHz	10MHz
RBW	10kHz	100kHz
VBW	30kHz	300kHz
Detector	RMS	RMS
Trace	Average	Average
Average Type	Power	Power
Sweep Count	100	100

### 3.3.4 Test Setup

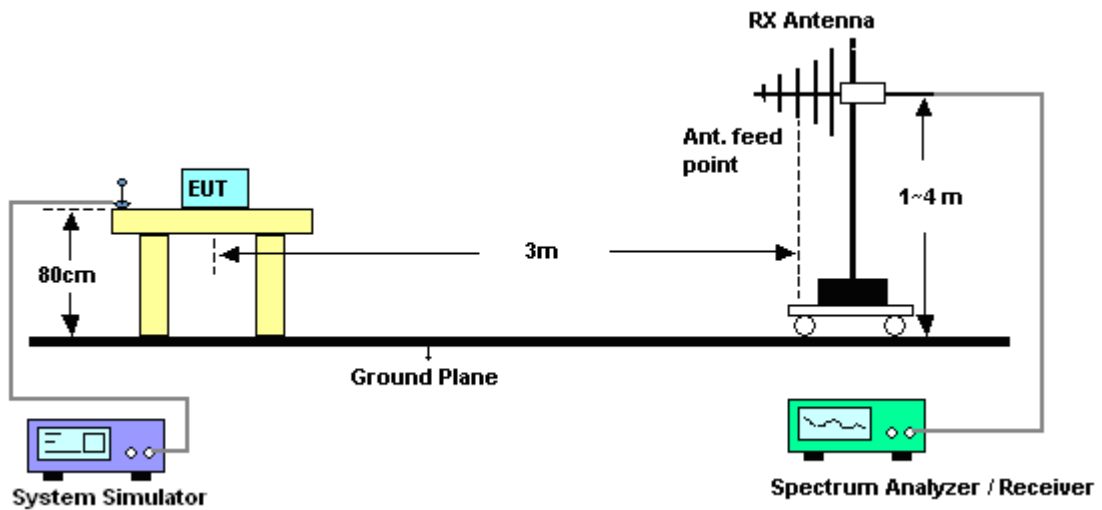





3.3.5 Test Result of ERP

GSM850 (GSM) Radiated Power ERP				
Horizontal Polarization				
Frequency (MHz)	LVL (dBm)	Correction Factor (dB)	ERP (dBm)	ERP (W)
824.2	-1.69	31.54	27.70	0.5888
836.4	-2.16	32.04	27.73	0.5929
848.8	-3.05	32.59	27.39	0.5483
Vertical Polarization				
Frequency (MHz)	LVL (dBm)	Correction Factor (dB)	ERP (dBm)	ERP (W)
824.2	-14.95	32.93	15.83	0.0383
836.4	-14.47	32.82	16.20	0.0417
848.8	-15.22	33.62	16.25	0.0422

\* ERP = LVL (dBm) + Correction Factor (dB) – 2.15

GSM850 (EDGE class 8) Radiated Power ERP				
Horizontal Polarization				
Frequency (MHz)	LVL (dBm)	Correction Factor (dB)	ERP (dBm)	ERP (W)
824.2	-7.18	31.54	22.21	0.1663
836.4	-7.08	32.04	22.81	0.1910
848.8	-7.11	32.59	23.33	0.2153
Vertical Polarization				
Frequency (MHz)	LVL (dBm)	Correction Factor (dB)	ERP (dBm)	ERP (W)
824.2	-20.40	32.93	10.38	0.0109
836.4	-19.51	32.82	11.16	0.0131
848.8	-19.68	33.62	11.79	0.0151

\* ERP = LVL (dBm) + Correction Factor (dB) – 2.15



WCDMA Band V (RMC 12.2Kbps) Radiated Power ERP				
Horizontal Polarization				
Frequency (MHz)	LVL (dBm)	Correction Factor (dB)	ERP (dBm)	ERP (W)
826.4	-12.50	31.44	16.79	0.0478
836.4	-12.85	32.04	17.04	0.0506
846.6	-13.00	32.63	17.48	0.0560
Vertical Polarization				
Frequency (MHz)	LVL (dBm)	Correction Factor (dB)	ERP (dBm)	ERP (W)
826.4	-22.70	32.78	7.93	0.0062
836.4	-22.31	32.82	8.36	0.0069
846.6	-22.55	33.4	8.70	0.0074

\* ERP = LVL (dBm) + Correction Factor (dB) – 2.15



3.3.6 Test Result of EIRP

GSM1900 (GSM) Radiated Power EIRP				
Horizontal Polarization				
Frequency (MHz)	LVL (dBm)	Correction Factor (dB)	EIRP (dBm)	EIRP (W)
1850.2	-17.26	45.34	28.08	0.6427
1880.0	-18.84	46.01	27.17	0.5212
1909.8	-19.19	45.81	26.62	0.4592
Vertical Polarization				
Frequency (MHz)	LVL (dBm)	Correction Factor (dB)	EIRP (dBm)	EIRP (W)
1850.2	-20.83	49.22	28.39	0.6902
1880.0	-22.74	50.42	27.68	0.5861
1909.8	-22.05	49.00	26.95	0.4955

\* EIRP = LVL (dBm) + Correction Factor (dB)

GSM1900 (EDGE class 8) Radiated Power EIRP				
Horizontal Polarization				
Frequency (MHz)	LVL (dBm)	Correction Factor (dB)	EIRP (dBm)	EIRP (W)
1850.2	-21.59	45.34	23.75	0.2371
1880.0	-23.03	46.01	22.98	0.1986
1909.8	-23.49	45.81	22.32	0.1706
Vertical Polarization				
Frequency (MHz)	LVL (dBm)	Correction Factor (dB)	EIRP (dBm)	EIRP (W)
1850.2	-24.65	49.22	24.57	0.2864
1880.0	-26.83	50.42	23.59	0.2286
1909.8	-27.34	49.00	21.66	0.1466

\* EIRP = LVL (dBm) + Correction Factor (dB)



WCDMA Band IV (RMC 12.2Kbps) Radiated Power EIRP				
Horizontal Polarization				
Frequency (MHz)	LVL (dBm)	Correction Factor (dB)	EIRP (dBm)	EIRP (W)
1712.4	-21.76	43.22	21.46	0.1400
1732.6	-21.64	43.49	21.85	0.1531
1752.6	-21.07	43.54	22.47	0.1766
Vertical Polarization				
Frequency (MHz)	LVL (dBm)	Correction Factor (dB)	EIRP (dBm)	EIRP (W)
1712.4	-25.91	46.53	20.62	0.1153
1732.6	-25.97	46.43	20.46	0.1112
1752.6	-27.11	48.05	20.94	0.1242

\* EIRP = LVL (dBm) + Correction Factor (dB)

WCDMA Band II (RMC 12.2Kbps) Radiated Power EIRP				
Horizontal Polarization				
Frequency (MHz)	LVL (dBm)	Correction Factor (dB)	EIRP (dBm)	EIRP (W)
1852.4	-23.59	45.37	21.78	0.1507
1880.0	-25.13	46.01	20.88	0.1225
1907.6	-25.67	45.87	20.20	0.1047
Vertical Polarization				
Frequency (MHz)	LVL (dBm)	Correction Factor (dB)	EIRP (dBm)	EIRP (W)
1852.4	-29.00	49.23	20.23	0.1054
1880.0	-31.15	50.42	19.27	0.0845
1907.6	-30.38	49.04	18.66	0.0735

\* EIRP = LVL (dBm) + Correction Factor (dB)

## 3.4 99% Occupied Bandwidth and 26dB Bandwidth Measurement

### 3.4.1 Description of 99% Occupied Bandwidth and 26dB Bandwidth Measurement

The 99% occupied bandwidth is the width of a frequency band such that, below the lower and above the upper frequency limits, the mean powers emitted are each equal to a specified percentage 0.5% of the total mean transmitted power.

The emission bandwidth is defined as the width of the signal between two points, located at the 2 sides of the carrier frequency, outside of which all emissions are attenuated at least 26 dB below the transmitter power.

### 3.4.2 Measuring Instruments

The measuring equipment is listed in the section 4 of this test report.

### 3.4.3 Test Procedures

1. The testing follows FCC KDB 971168 v02r02 Section 4.2.
2. The EUT was connected to the spectrum analyzer and system simulator via a power divider.
3. The RF output of the EUT was connected to the spectrum analyzer by RF cable and attenuator. The path loss was compensated to the results for each measurement.
4. The 99% occupied bandwidth were measured, set RBW= 1% of span, VBW= 3\*RBW, sample detector, trace maximum hold.
5. The 26dB bandwidth were measured, set RBW= 1% of EBW, VBW= 3\*RBW, peak detector, trace maximum hold.

### 3.4.4 Test Setup

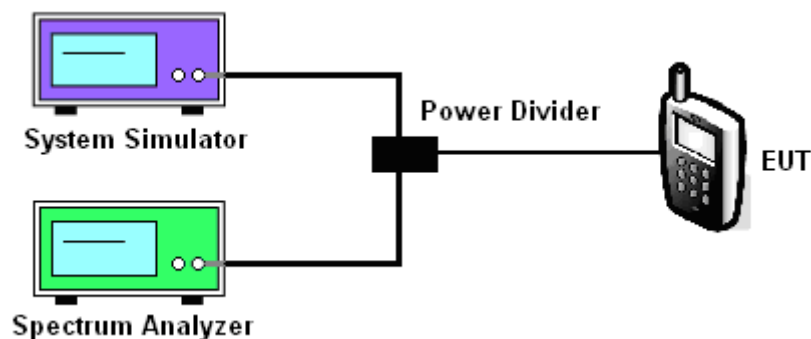



3.4.5 Test Result of Occupied Bandwidth and 26dB Bandwidth

Cellular Band						
Modes	GSM850 (GSM)			GSM850 (EDGE class 8)		
Channel	128 (Low)	189 (Mid)	251 (High)	128 (Low)	189 (Mid)	251 (High)
Frequency (MHz)	824.2	836.4	848.8	824.2	836.4	848.8
99% OBW (kHz)	245.00	245.00	247.00	251.00	251.00	253.00
26dB BW (kHz)	314.00	301.00	315.00	314.00	310.00	296.00

PCS Band						
Modes	GSM1900 (GSM)			GSM1900 (EDGE class 8)		
Channel	512 (Low)	661 (Mid)	810 (High)	512 (Low)	661 (Mid)	810 (High)
Frequency (MHz)	1850.2	1880	1909.8	1850.2	1880	1909.8
99% OBW (kHz)	244.00	245.00	245.00	253.00	254.00	251.00
26dB BW (kHz)	303.00	309.00	310.00	300.00	309.00	296.00

Cellular Band			
Modes	WCDMA Band V (RMC 12.2Kbps)		
Channel	4132 (Low)	4182 (Mid)	4233 (High)
Frequency (MHz)	826.4	836.4	846.6
99% OBW (MHz)	4.22	4.19	4.21
26dB BW (MHz)	4.86	4.84	4.86

AWS Band			
Modes	WCDMA Band IV (RMC 12.2Kbps)		
Channel	1312(Low)	1413 (Mid)	1513 (High)
Frequency (MHz)	1712.4	1732.6	1752.6
99% OBW (MHz)	4.20	4.22	4.21
26dB BW (MHz)	4.84	4.84	4.84



PCS Band			
Modes	WCDMA Band II (RMC 12.2Kbps)		
Channel	9262 (Low)	9400 (Mid)	9538 (High)
Frequency (MHz)	1852.4	1880	1907.6
99% OBW (MHz)	4.22	4.20	4.22
26dB BW (MHz)	4.85	4.87	4.89



3.4.6 Test Result (Plots) of Occupied Bandwidth and 26dB Bandwidth

Band :	GSM 850	Test Mode :	GSM Link (GMSK)
--------	---------	-------------	-----------------

99% Occupied Bandwidth Plot on Channel 128 (824.2 MHz)

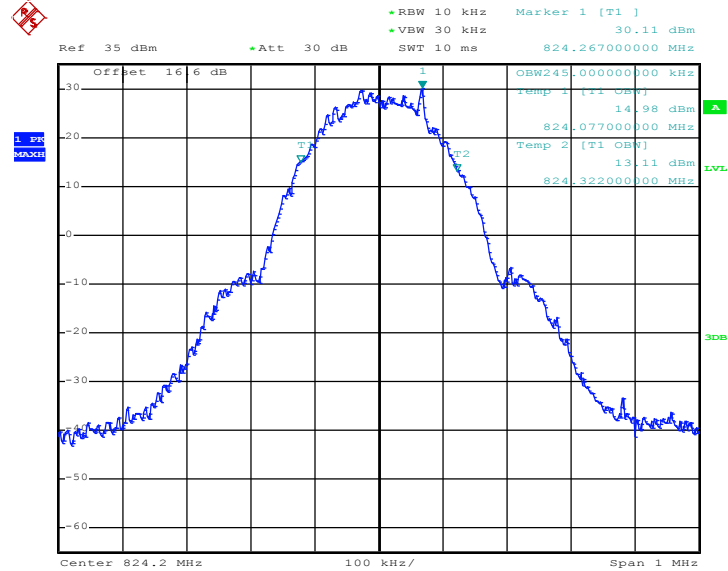

Date: 23.JAN.2015 19:51:18

26dB Bandwidth Plot on Channel 128 (824.2 MHz)

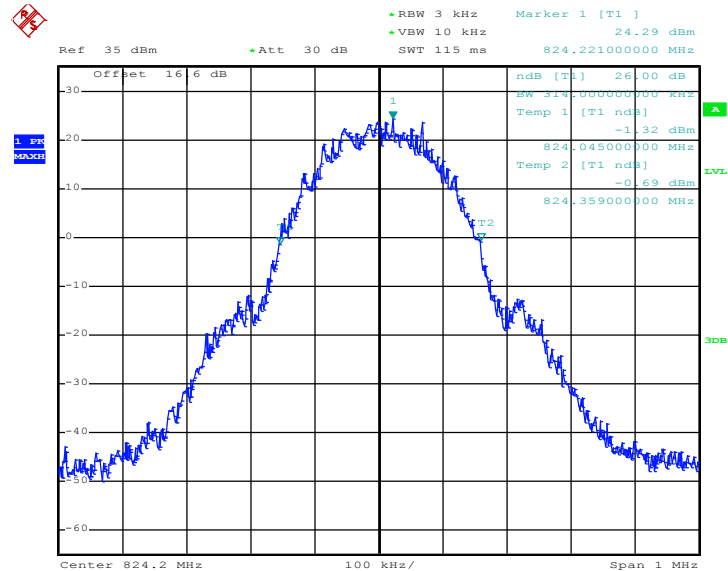

Date: 23.JAN.2015 19:49:03





99% Occupied Bandwidth Plot on Channel 189 (836.4 MHz)

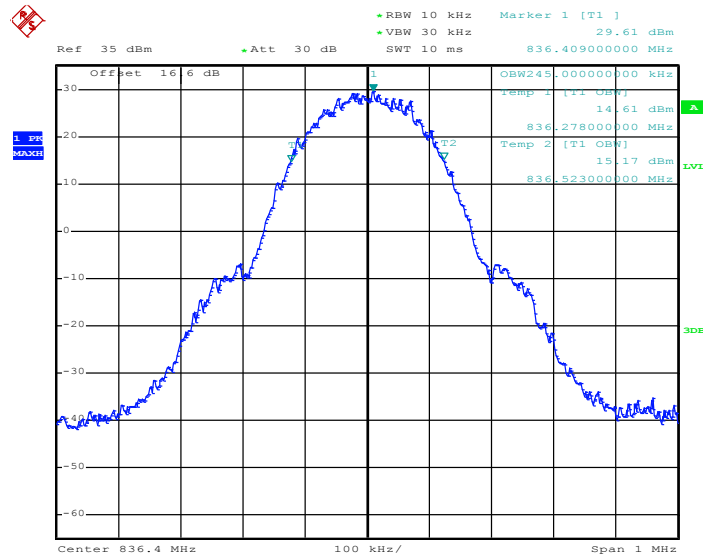

Date: 23.JAN.2015 19:51:46

26dB Bandwidth Plot on Channel 189 (836.4 MHz)

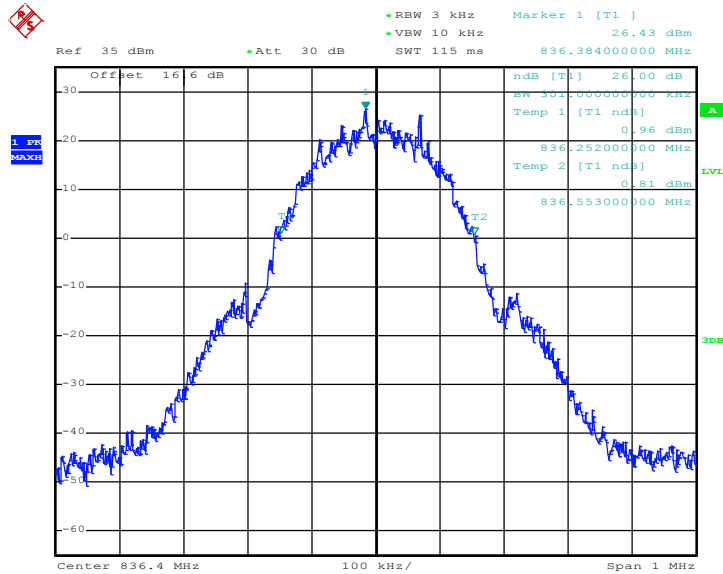

Date: 23.JAN.2015 19:49:31



99% Occupied Bandwidth Plot on Channel 251 (848.8 MHz)

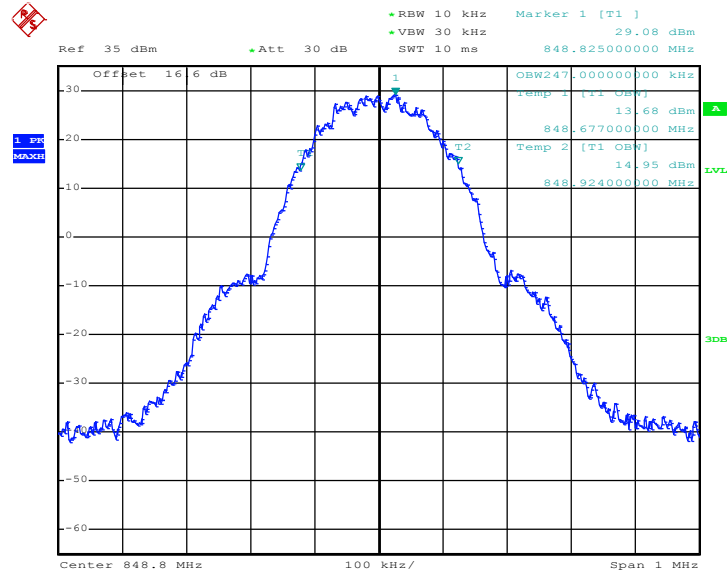

Date: 23.JAN.2015 19:52:14

26dB Bandwidth Plot on Channel 251 (848.8 MHz)

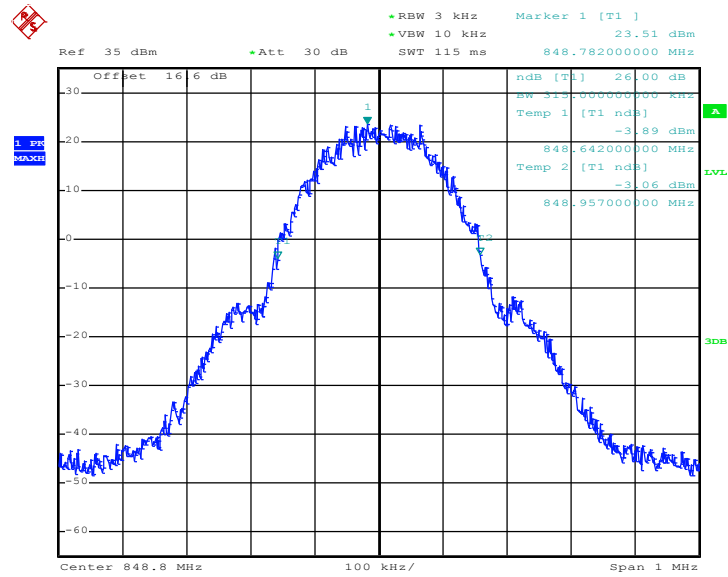

Date: 23.JAN.2015 19:49:59



<b>Band :</b>	GSM 850	<b>Test Mode :</b>	EDGE class 8 Link (8PSK)
---------------	---------	--------------------	--------------------------

99% Occupied Bandwidth Plot on Channel 128 (824.2 MHz)

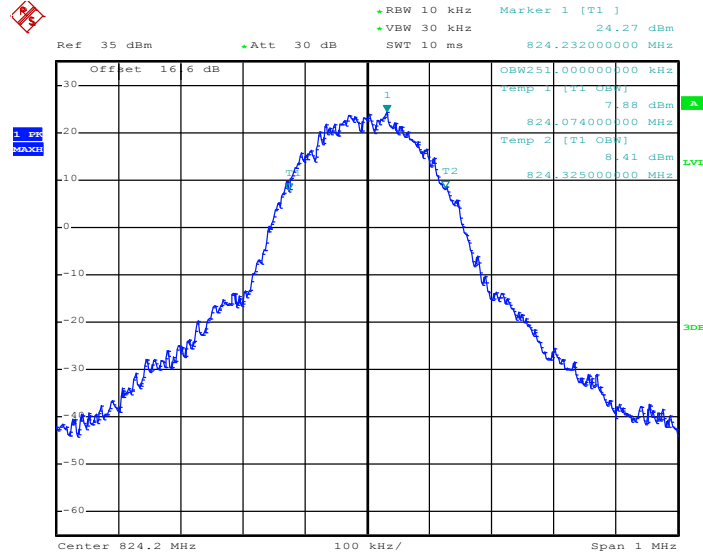

Date: 23.JAN.2015 20:03:49

26dB Bandwidth Plot on Channel 128 (824.2 MHz)

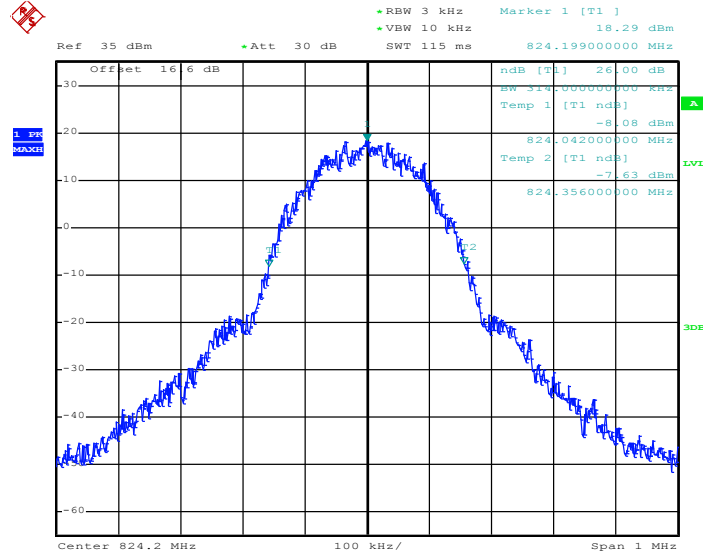

Date: 23.JAN.2015 20:01:59



99% Occupied Bandwidth Plot on Channel 189 (836.4 MHz)

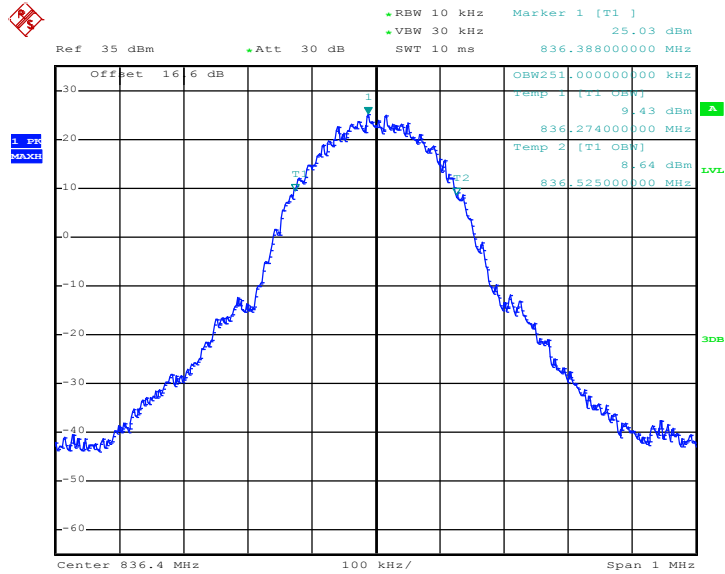

Date: 23.JAN.2015 20:04:21

26dB Bandwidth Plot on Channel 189 (836.4 MHz)

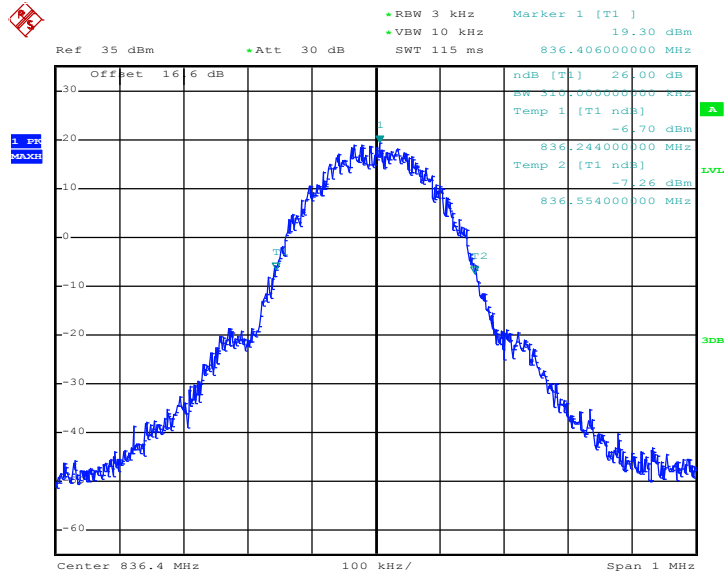

Date: 23.JAN.2015 20:02:36



99% Occupied Bandwidth Plot on Channel 251 (848.8 MHz)

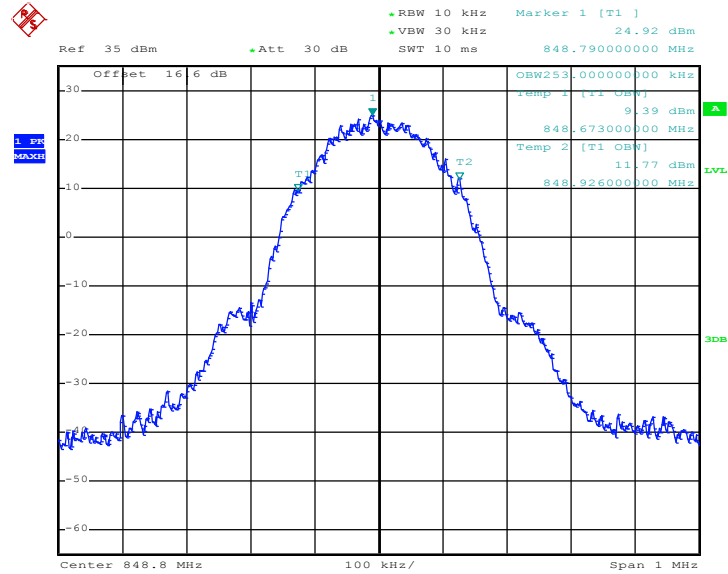

Date: 23.JAN.2015 20:04:50

26dB Bandwidth Plot on Channel 251 (848.8 MHz)

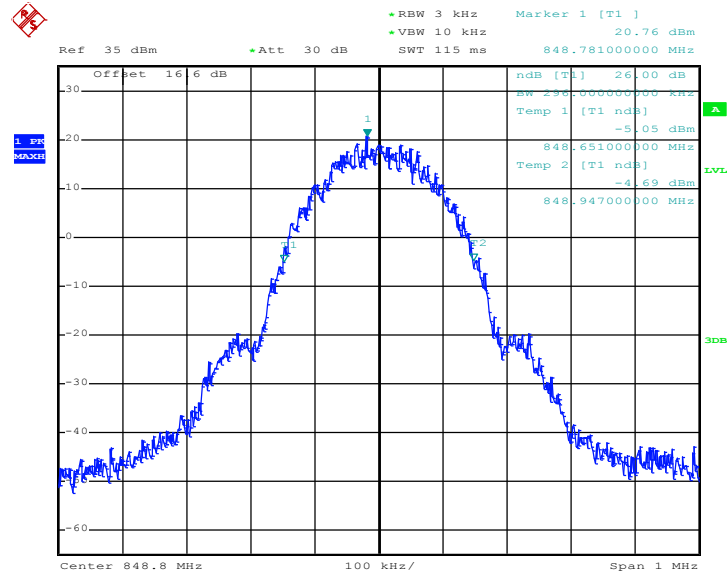

Date: 23.JAN.2015 20:03:14



<b>Band :</b>	GSM 1900	<b>Test Mode :</b>	GSM Link (GMSK)
---------------	----------	--------------------	-----------------

99% Occupied Bandwidth Plot on Channel 512 (1850.2 MHz)

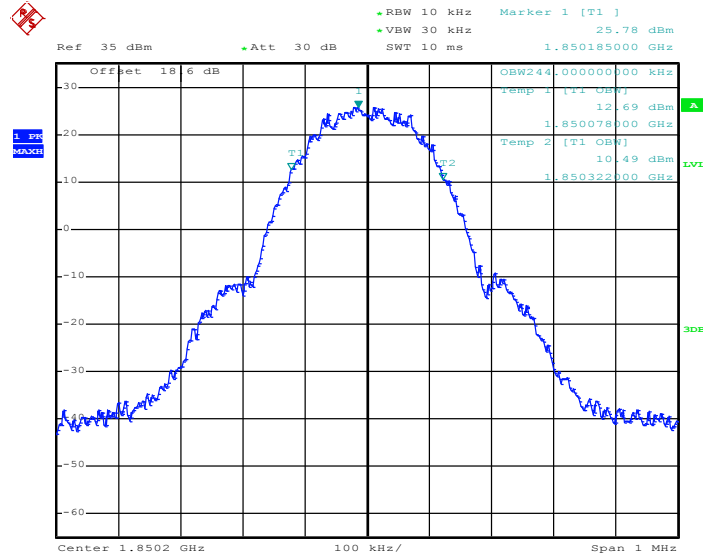

Date: 23.JAN.2015 20:13:59

26dB Bandwidth Plot on Channel 512 (1850.2 MHz)

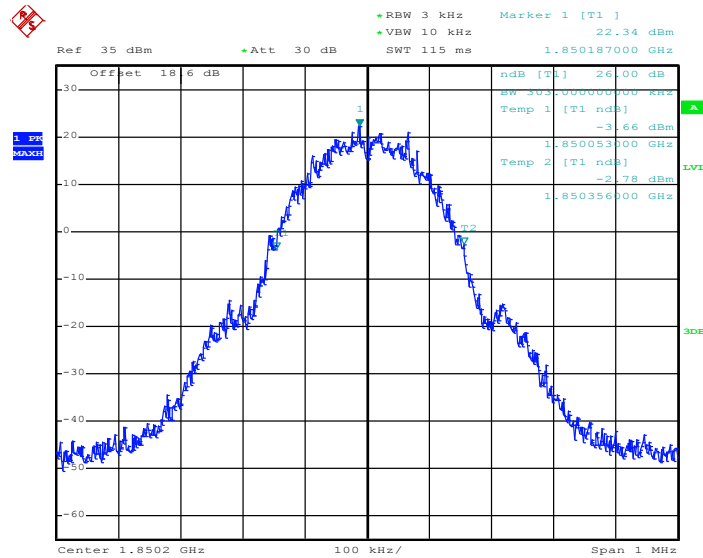

Date: 23.JAN.2015 20:12:32



99% Occupied Bandwidth Plot on Channel 661 (1880.0 MHz)

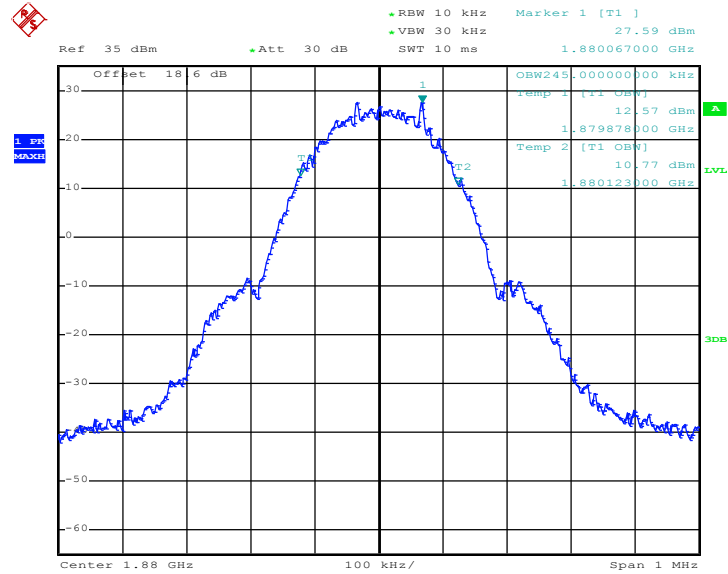

Date: 23.JAN.2015 20:14:27

26dB Bandwidth Plot on Channel 661 (1880.0 MHz)

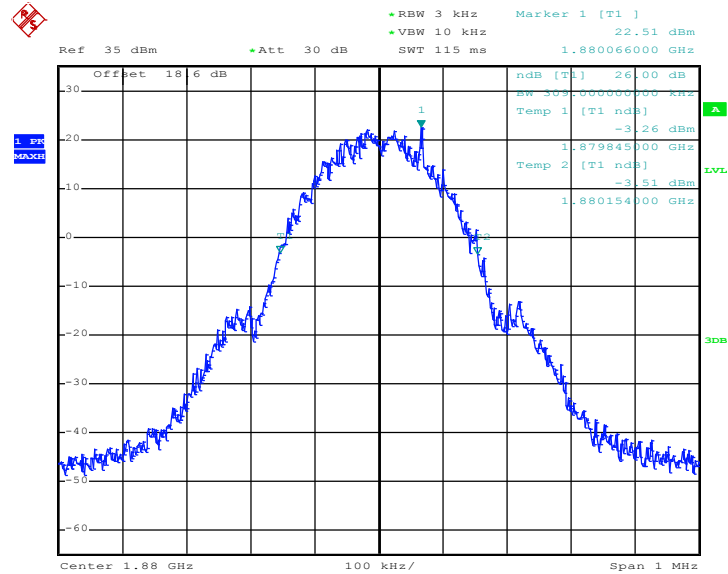

Date: 23.JAN.2015 20:13:00



99% Occupied Bandwidth Plot on Channel 810 (1909.8 MHz)

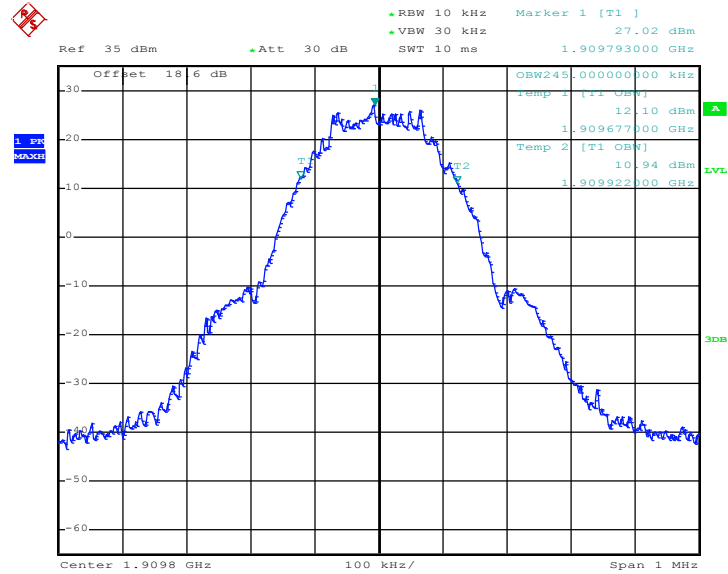

Date: 23.JAN.2015 20:14:55

26dB Bandwidth Plot on Channel 810 (1909.8 MHz)

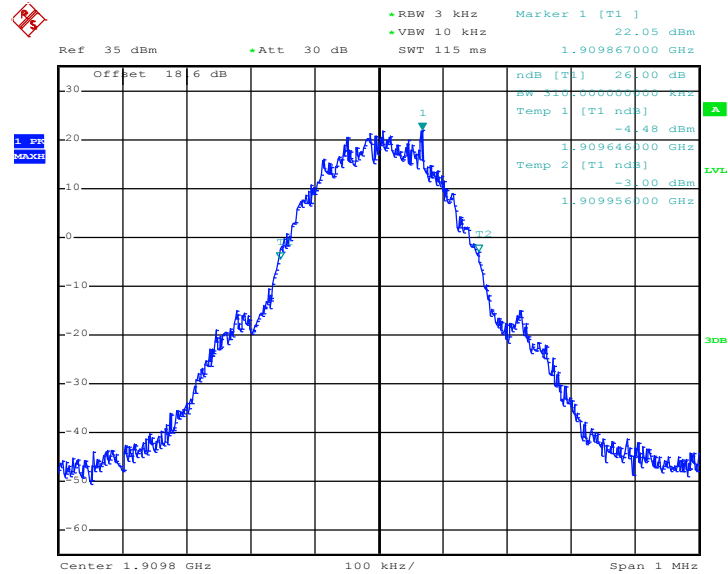

Date: 23.JAN.2015 20:13:28





<b>Band :</b>	GSM 1900	<b>Test Mode :</b>	EDGE class 8 Link (8PSK)
---------------	----------	--------------------	--------------------------

99% Occupied Bandwidth Plot on Channel 512 (1850.2 MHz)

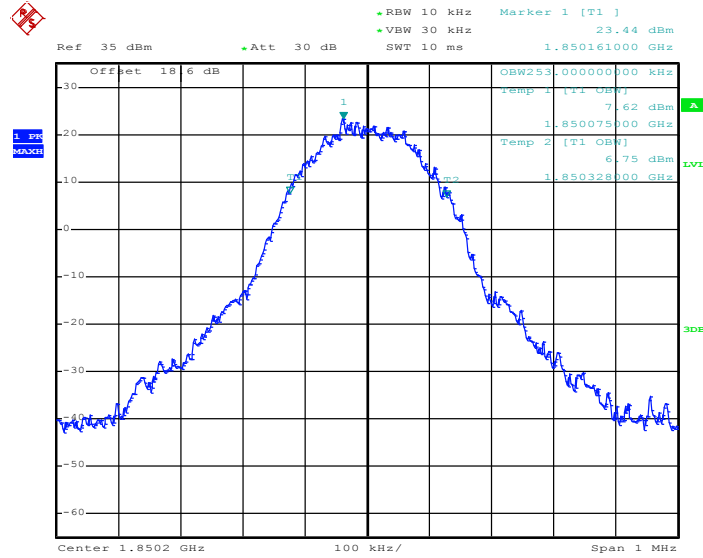

Date: 23.JAN.2015 20:23:15

26dB Bandwidth Plot on Channel 512 (1850.2 MHz)

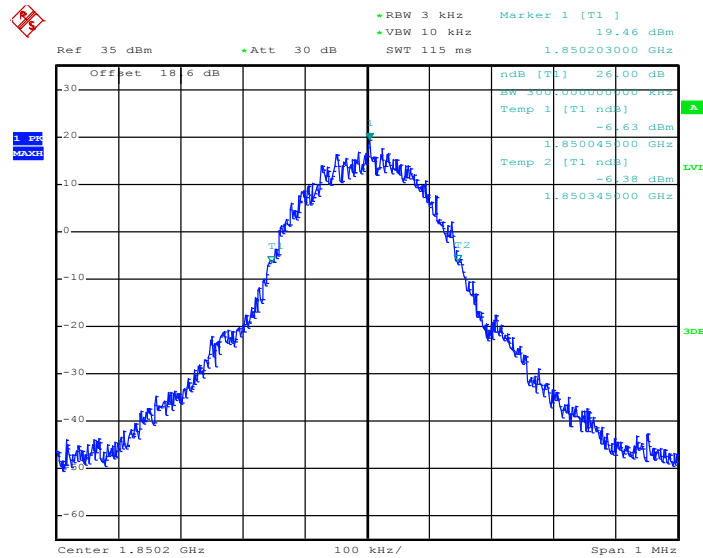

Date: 23.JAN.2015 20:21:39



99% Occupied Bandwidth Plot on Channel 661 (1880.0 MHz)

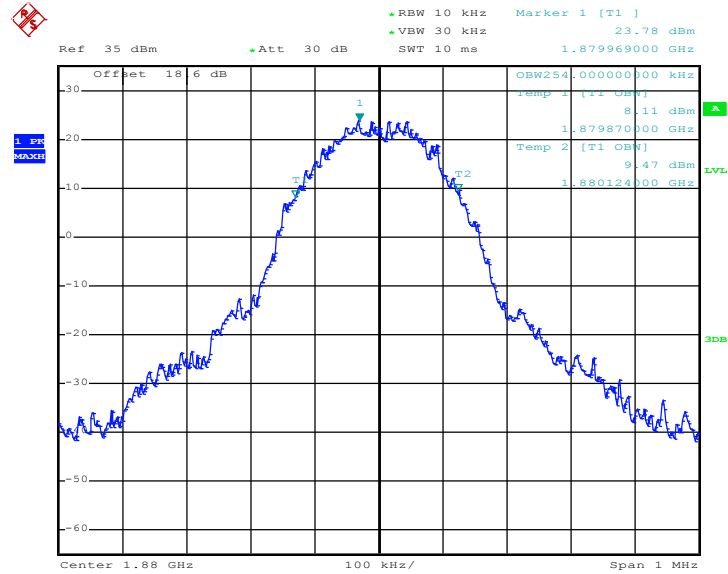

Date: 23.JAN.2015 20:23:47

26dB Bandwidth Plot on Channel 661 (1880.0 MHz)

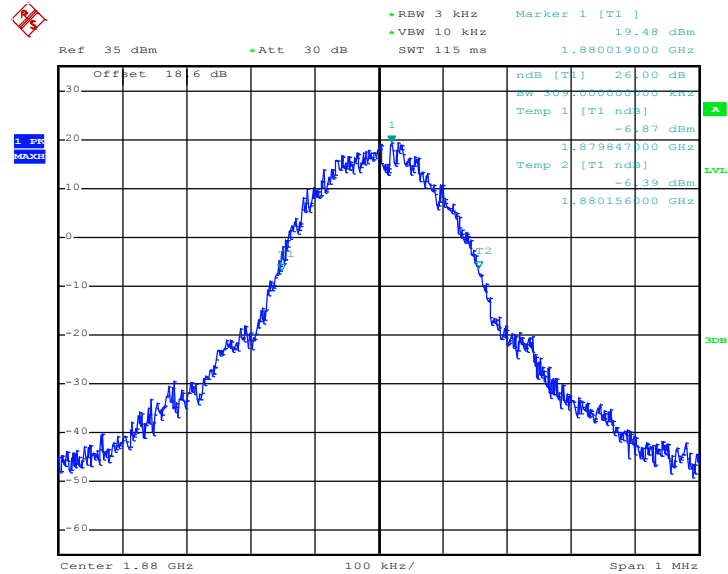

Date: 23.JAN.2015 20:22:10



99% Occupied Bandwidth Plot on Channel 810 (1909.8 MHz)

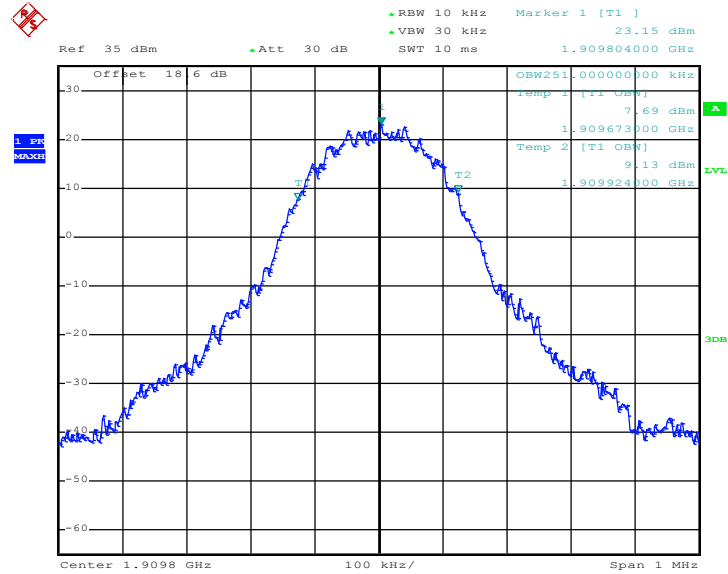

Date: 23.JAN.2015 20:24:16

26dB Bandwidth Plot on Channel 810 (1909.8 MHz)

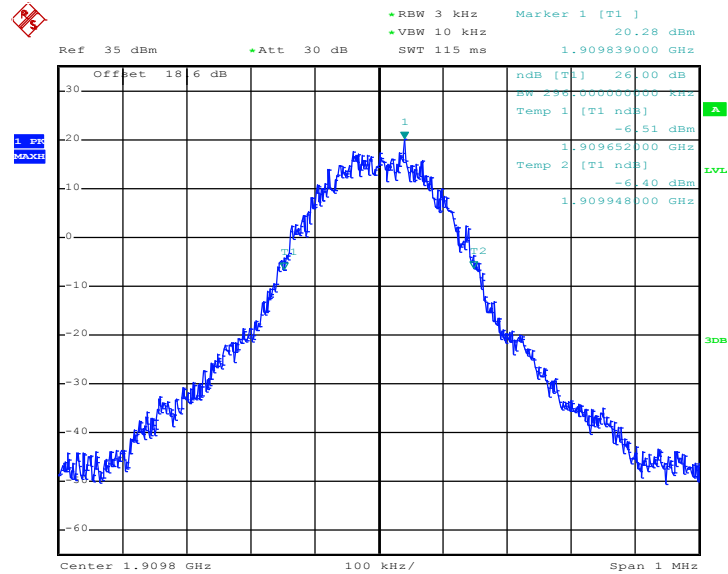

Date: 23.JAN.2015 20:22:41



<b>Band :</b>	WCDMA Band V	<b>Test Mode :</b>	RMC 12.2Kbps Link (QPSK)
---------------	--------------	--------------------	--------------------------

99% Occupied Bandwidth Plot on Channel 4132 (826.4 MHz)

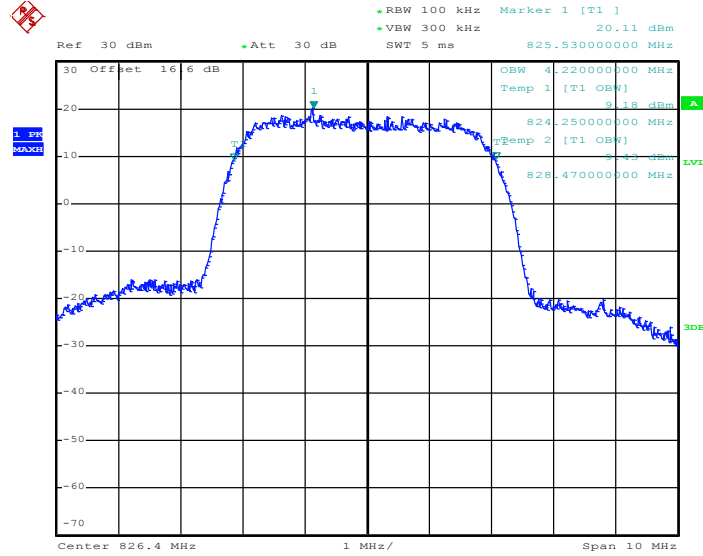

Date: 23.JAN.2015 20:41:21

26dB Bandwidth Plot on Channel 4132 (826.4 MHz)

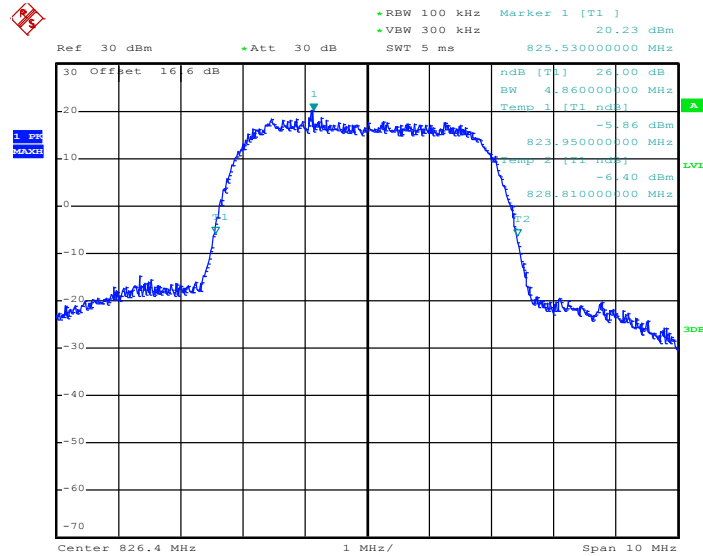

Date: 23.JAN.2015 20:39:43



99% Occupied Bandwidth Plot on Channel 4182 (836.4 MHz)

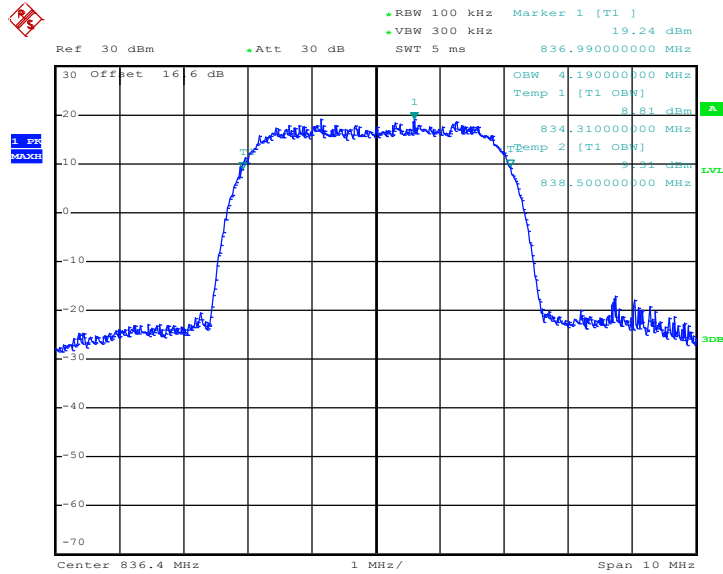

Date: 23.JAN.2015 20:41:51

26dB Bandwidth Plot on Channel 4182 (836.4 MHz)

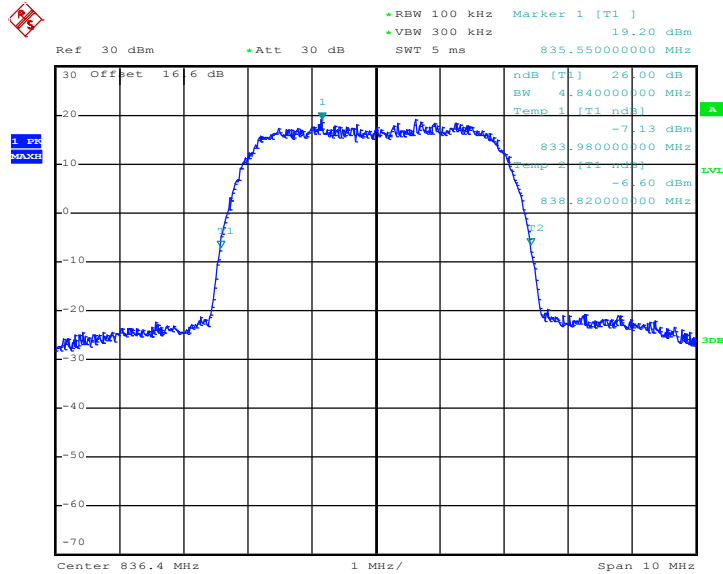

Date: 23.JAN.2015 20:40:13



99% Occupied Bandwidth Plot on Channel 4233 (846.6 MHz)

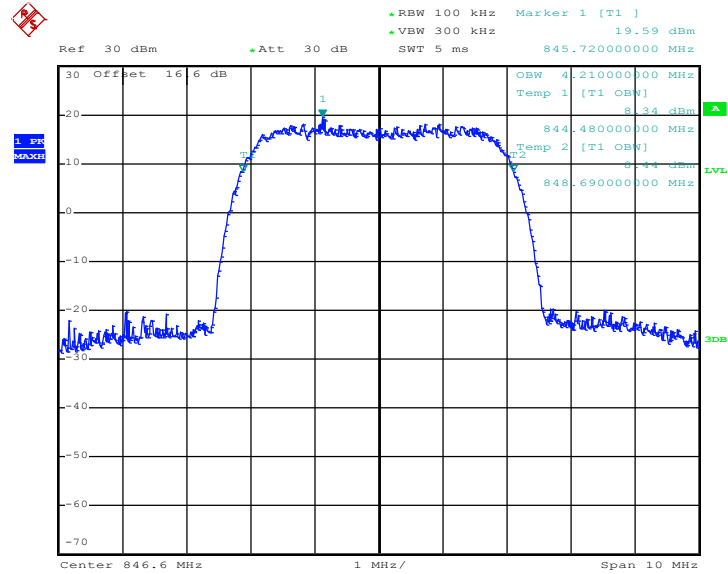

Date: 23.JAN.2015 20:42:20

26dB Bandwidth Plot on Channel 4233 (846.6 MHz)

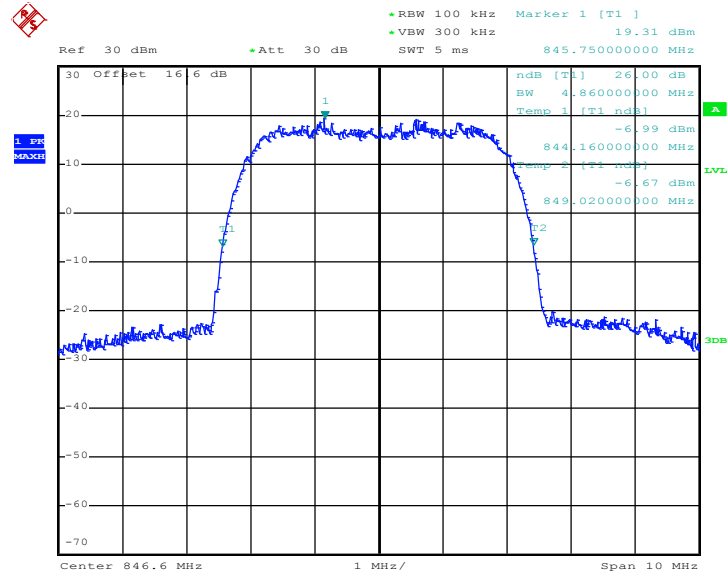

Date: 23.JAN.2015 20:40:42



<b>Band :</b>	WCDMA Band IV	<b>Test Mode :</b>	RMC 12.2Kbps Link (QPSK)
---------------	---------------	--------------------	--------------------------

99% Occupied Bandwidth Plot on Channel 1312 (1712.4 MHz)

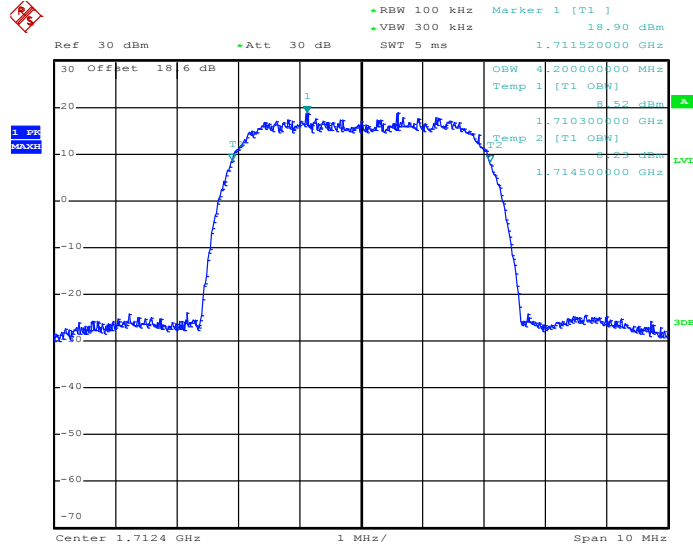

Date: 23.JAN.2015 20:58:51

26dB Bandwidth Plot on Channel 1312 (1712.4 MHz)

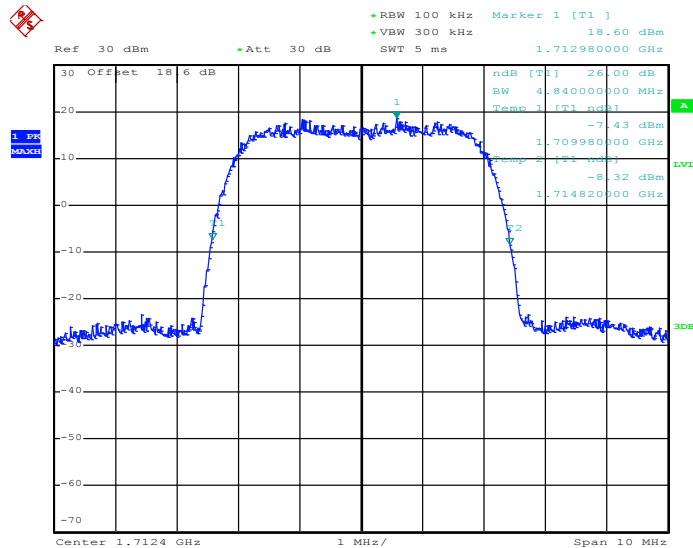

Date: 23.JAN.2015 20:57:15



99% Occupied Bandwidth Plot on Channel 1413 (1732.6 MHz)

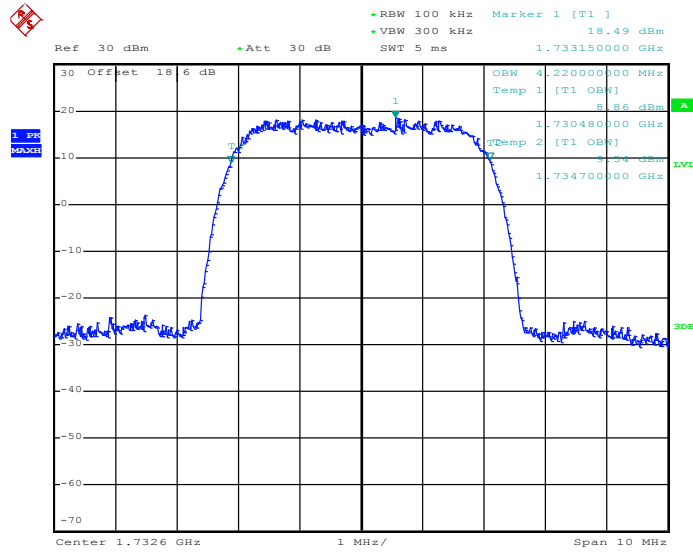

Date: 23.JAN.2015 20:59:20

26dB Bandwidth Plot on Channel 1413 (1732.6 MHz)

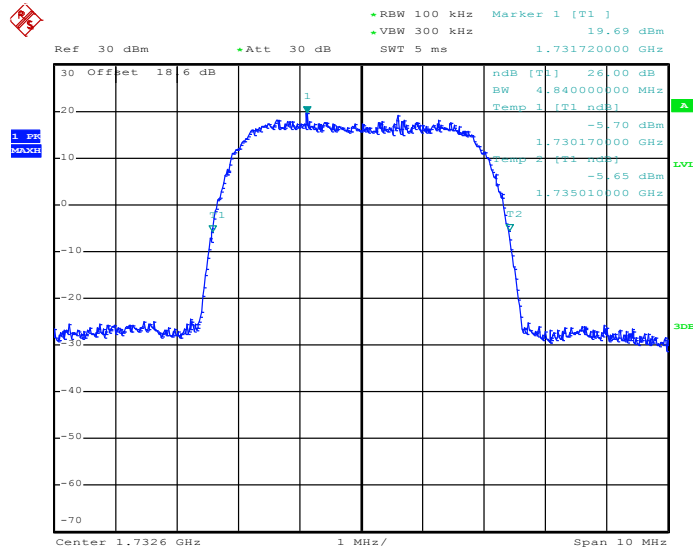

Date: 23.JAN.2015 20:57:48





### 99% Occupied Bandwidth Plot on Channel 1513 (1752.6 MHz)

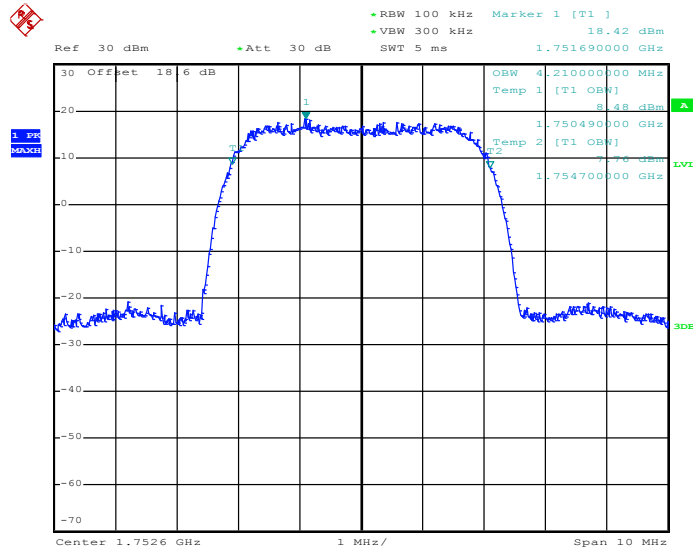

Date: 23.JAN.2015 20:59:49

### 26dB Bandwidth Plot on Channel 1513 (1752.6 MHz)

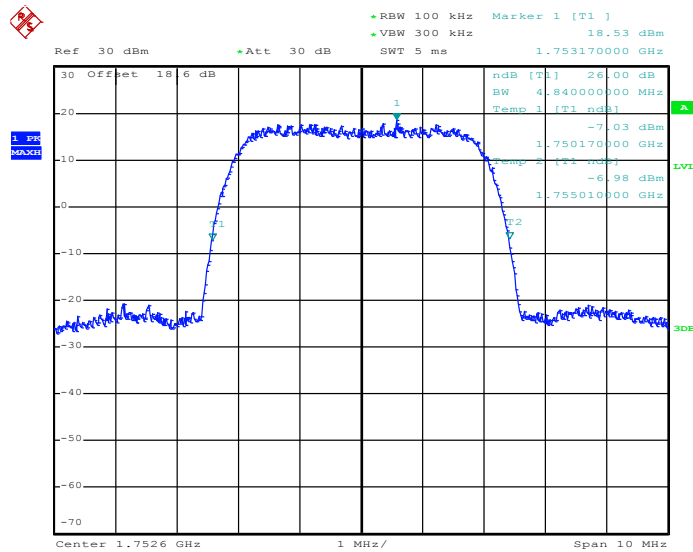

Date: 23.JAN.2015 20:58:17



<b>Band :</b>	WCDMA Band II	<b>Test Mode :</b>	RMC 12.2Kbps Link (QPSK)
---------------	---------------	--------------------	--------------------------

99% Occupied Bandwidth Plot on Channel 9262 (1852.4 MHz)

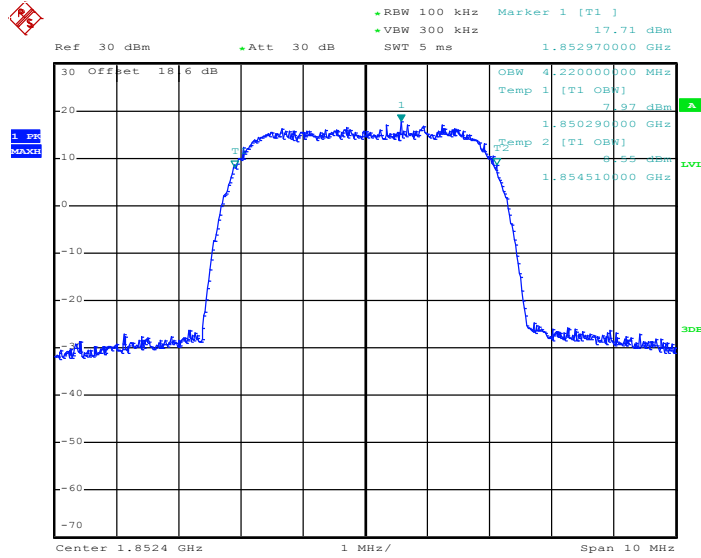

Date: 23.JAN.2015 20:50:16

26dB Bandwidth Plot on Channel 9262 (1852.4 MHz)

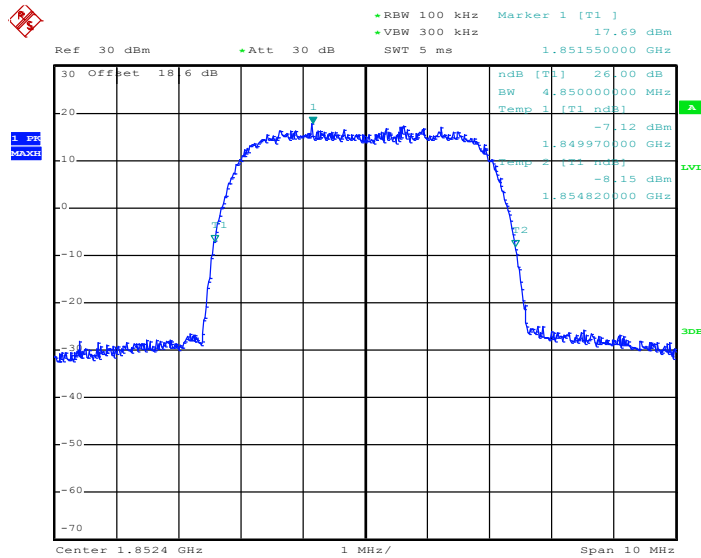

Date: 23.JAN.2015 20:48:41



99% Occupied Bandwidth Plot on Channel 9400 (1880.0 MHz)

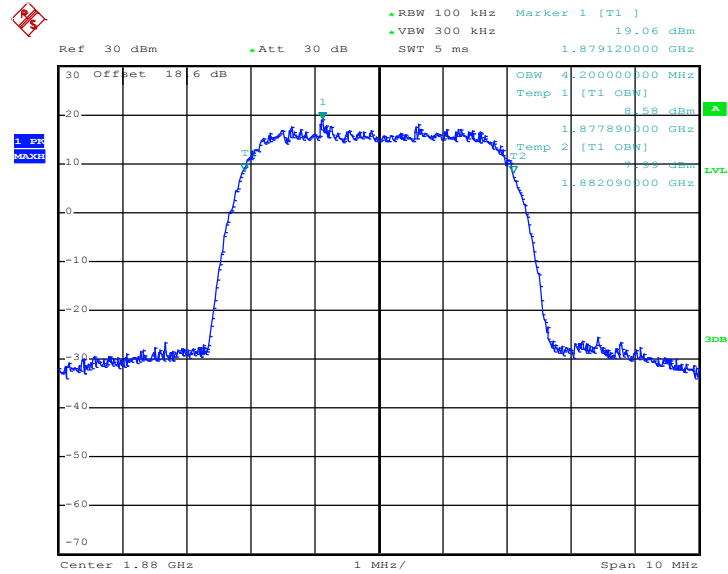

Date: 23.JAN.2015 20:50:45

26dB Bandwidth Plot on Channel 9400 (1880.0 MHz)

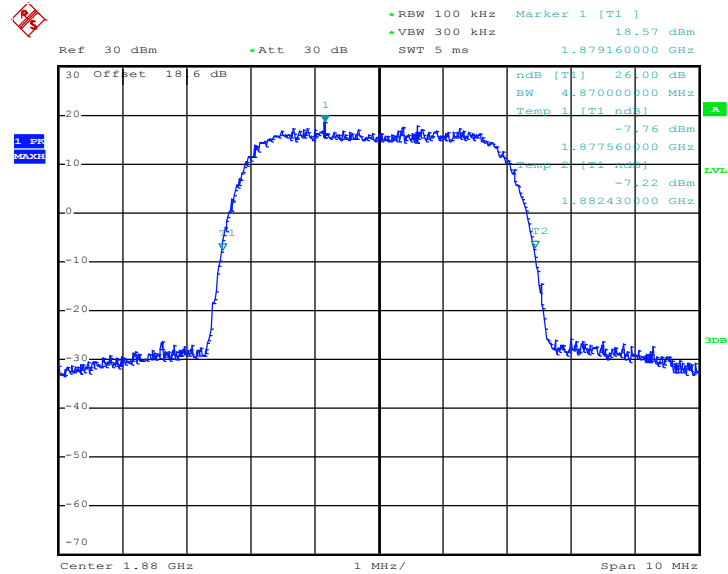

Date: 23.JAN.2015 20:49:11



99% Occupied Bandwidth Plot on Channel 9538 (1907.6 MHz)

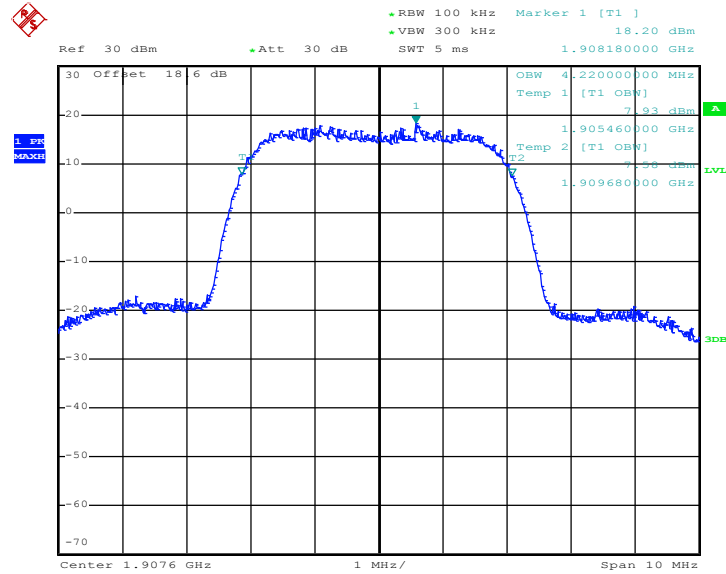

Date: 23.JAN.2015 20:51:13

26dB Bandwidth Plot on Channel 9538 (1907.6 MHz)

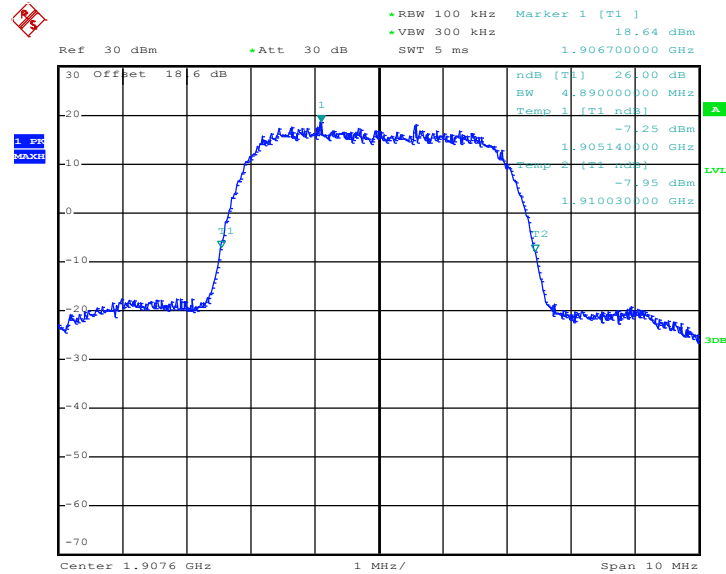

Date: 23.JAN.2015 20:49:41

## 3.5 Band Edge Measurement

### 3.5.1 Description of Band Edge Measurement

The power of any emission outside of the authorized operating frequency ranges must be lower than the transmitter power (P) by a factor of at least  $43 + 10 \log (P)$  dB.

### 3.5.2 Measuring Instruments

The measuring equipment is listed in the section 4 of this test report.

### 3.5.3 Test Procedures

1. The testing follows FCC KDB 971168 v02r02 Section 6.0.
2. The EUT was connected to the spectrum analyzer and system simulator via a power divider.
3. The RF output of EUT was connected to the spectrum analyzer by an RF cable and attenuator. The path loss was compensated to the results for each measurement.
4. The band edges of low and high channels for the highest RF powers were measured.
5. The RF fundamental frequency should be excluded against the limit line in the operating frequency band.
6. The limit line is derived from  $43 + 10\log(P)$  dB below the transmitter power P(Watts)  
 $= P(W) - [43 + 10\log(P)]$  (dB)  
 $= [30 + 10\log(P)]$  (dBm) -  $[43 + 10\log(P)]$  (dB)  
 $= -13\text{dBm}$ .

### 3.5.4 Test Setup

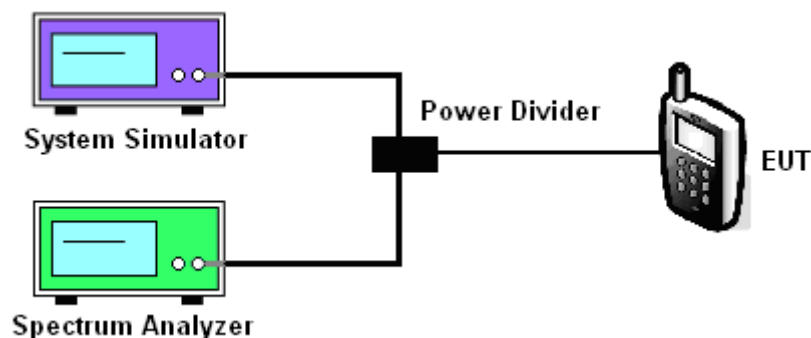



### 3.5.5 Test Result (Plots) of Conducted Band Edge

Band :	GSM850	Test Mode :	GSM Link (GMSK)
--------	--------	-------------	-----------------

#### Lower Band Edge Plot on Channel 128 (824.2 MHz)

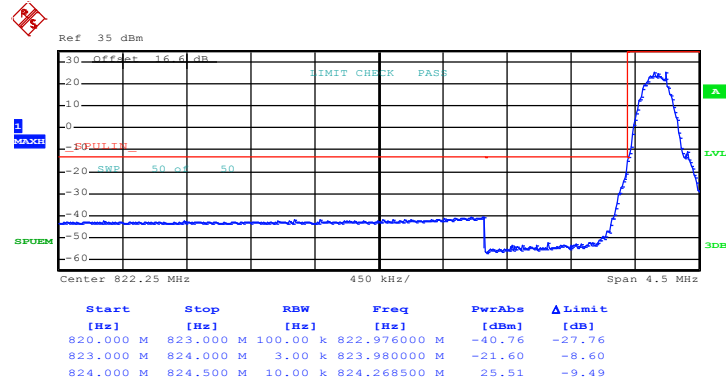

Date: 23.JAN.2015 19:53:30

#### Higher Band Edge Plot on Channel 251 (848.8 MHz)

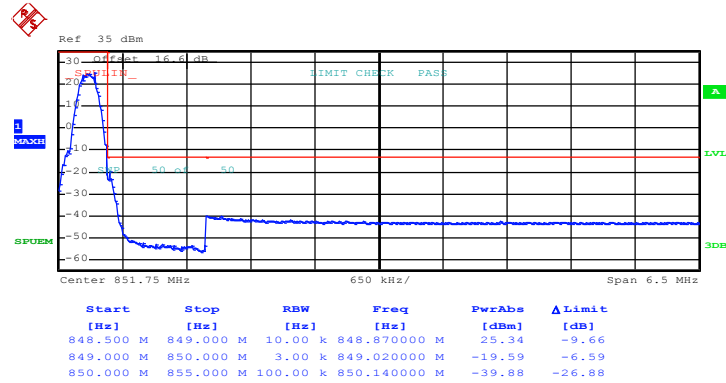

Date: 23.JAN.2015 19:54:42



Band :	GSM850	Test Mode :	EDGE class 8 Link (8PSK)
--------	--------	-------------	--------------------------

Lower Band Edge Plot on Channel 128 (824.2 MHz)

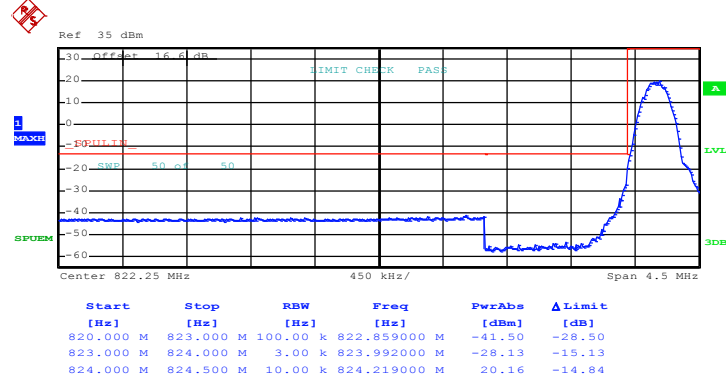

Date: 23.JAN.2015 20:06:04

Higher Band Edge Plot on Channel 251 (848.8 MHz)

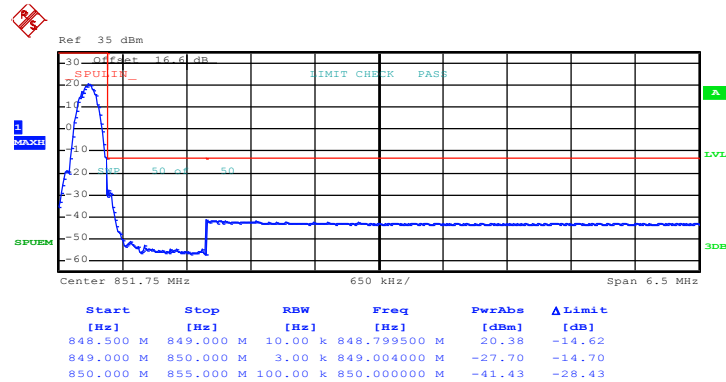

Date: 23.JAN.2015 20:07:17



Band : GSM1900	Test Mode : GSM Link (GMSK)
----------------	-----------------------------

Lower Band Edge Plot on Channel 512 (1850.2 MHz)

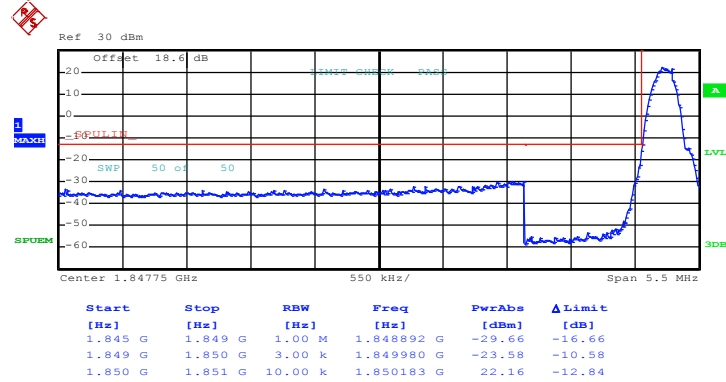

Date: 23.JAN.2015 20:16:09

Higher Band Edge Plot on Channel 810 (1909.8 MHz)

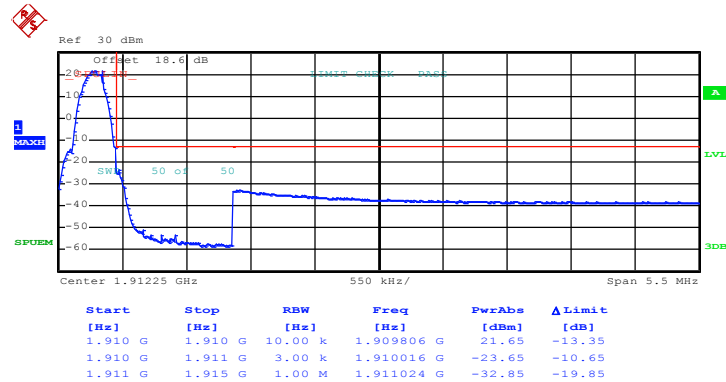

Date: 23.JAN.2015 20:17:21





Band : GSM1900	Test Mode : EDGE class 8 Link (8PSK)
----------------	--------------------------------------

Lower Band Edge Plot on Channel 512 (1850.2 MHz)

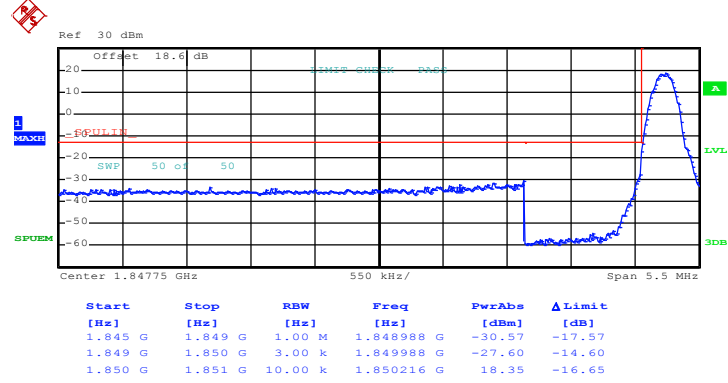

Date: 23.JAN.2015 20:25:35

Higher Band Edge Plot on Channel 810 (1909.8 MHz)

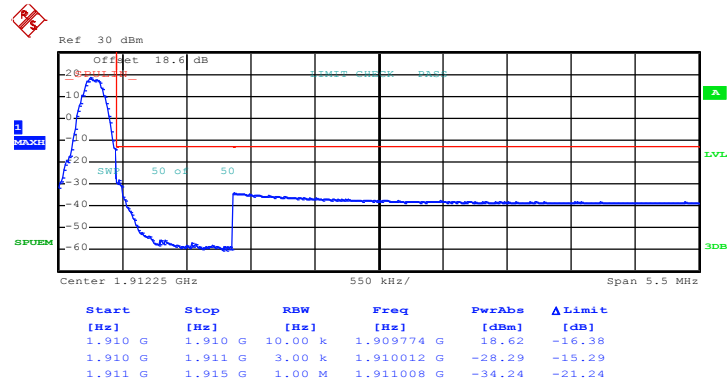

Date: 23.JAN.2015 20:26:50



Band : WCDMA Band V	Test Mode : RMC 12.2Kbps Link (QPSK)
---------------------	--------------------------------------

Lower Band Edge Plot on Channel 4132 (826.4 MHz)

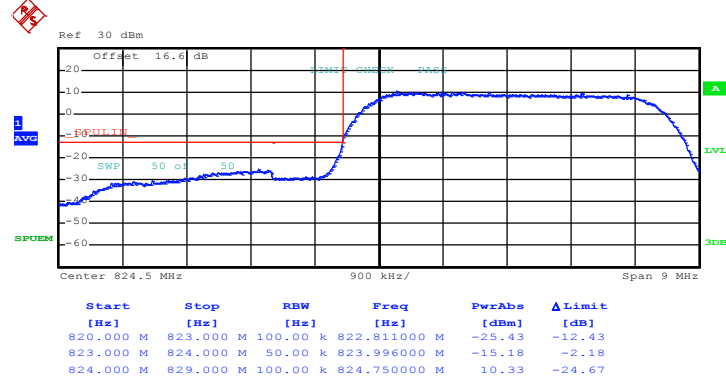

Date: 23.JAN.2015 20:43:40

Higher Band Edge Plot on Channel 4233 (846.6 MHz)

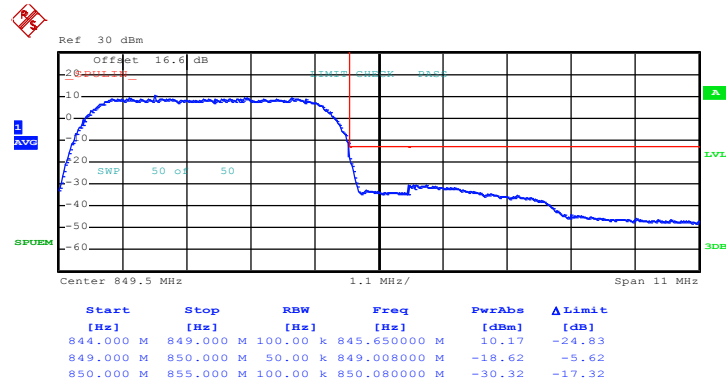

Date: 23.JAN.2015 20:44:57



<b>Band :</b> WCDMA Band IV	<b>Test Mode :</b> RMC 12.2Kbps Link (QPSK)
-----------------------------	---

Lower Band Edge Plot on Channel 1312 (1712.4 MHz)

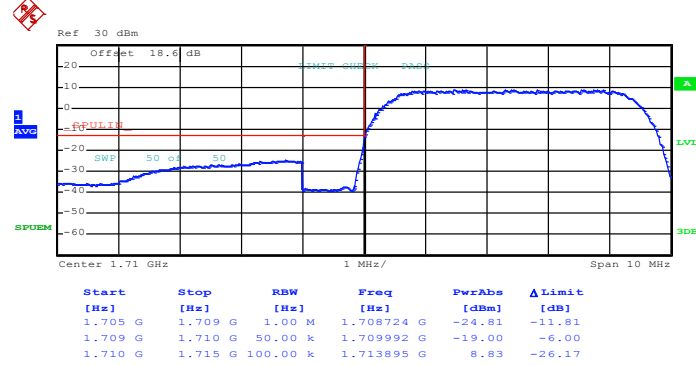

Date: 23.JAN.2015 21:01:04

Higher Band Edge Plot on Channel 1513 (1752.6 MHz)

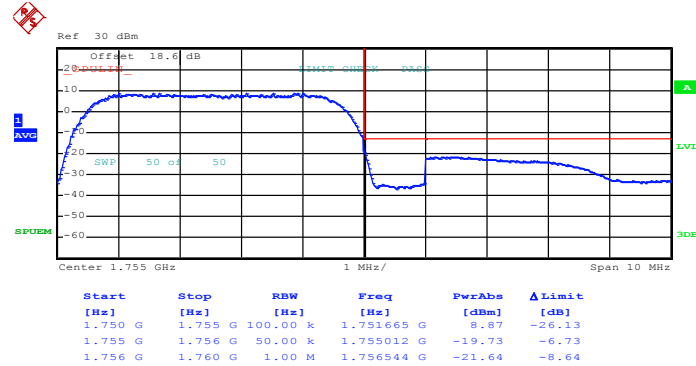

Date: 23.JAN.2015 21:02:21



Band : WCDMA Band II	Test Mode : RMC 12.2Kbps Link (QPSK)
----------------------	--------------------------------------

Lower Band Edge Plot on Channel 9262 (1852.4 MHz)

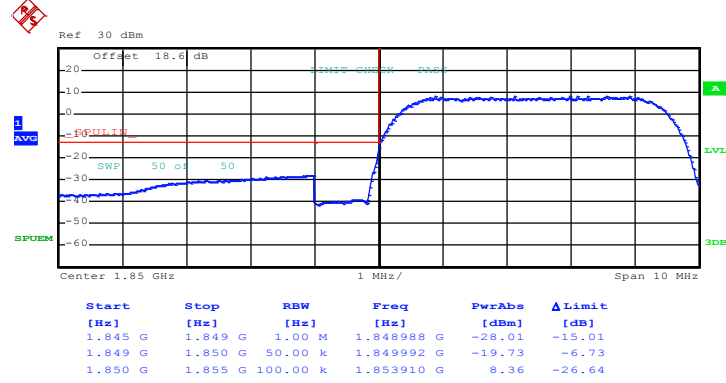

Date: 23.JAN.2015 20:52:30

Higher Band Edge Plot on Channel 9538 (1907.6 MHz)

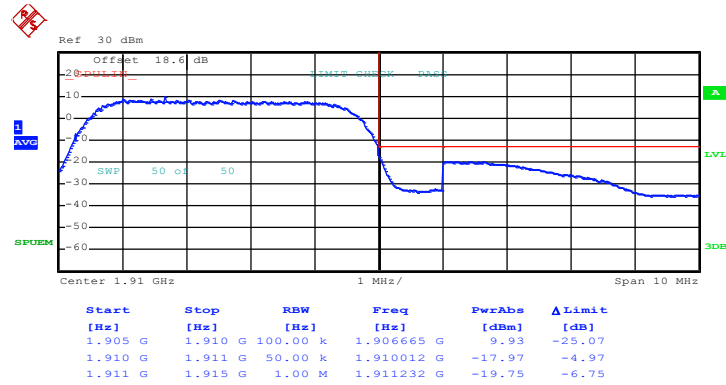

Date: 23.JAN.2015 20:53:45

### 3.6 Conducted Spurious Emission Measurement

#### 3.6.1 Description of Conducted Spurious Emission Measurement

The power of any emission outside of the authorized operating frequency ranges must be lower than the transmitter power (P) by a factor of at least  $43 + 10 \log (P)$  dB.

It is measured by means of a calibrated spectrum analyzer and scanned from 30 MHz up to a frequency including its 10<sup>th</sup> harmonic.

#### 3.6.2 Measuring Instruments

The measuring equipment is listed in the section 4 of this test report.

#### 3.6.3 Test Procedures

1. The testing follows FCC KDB 971168 v02r02 Section 6.0.
2. The EUT was connected to the spectrum analyzer and system simulator via a power divider.
3. The RF output of EUT was connected to the spectrum analyzer by an RF cable and attenuator. The path loss was compensated to the results for each measurement.
4. The middle channel for the highest RF power within the transmitting frequency was measured.
5. The conducted spurious emission for the whole frequency range was taken.
6. The RF fundamental frequency should be excluded against the limit line in the operating frequency band.
7. The limit line is derived from  $43 + 10\log(P)$  dB below the transmitter power P(Watts)
  - =  $P(W) - [43 + 10\log(P)]$  (dB)
  - =  $[30 + 10\log(P)]$  (dBm) -  $[43 + 10\log(P)]$  (dB)
  - = -13dBm.

#### 3.6.4 Test Setup

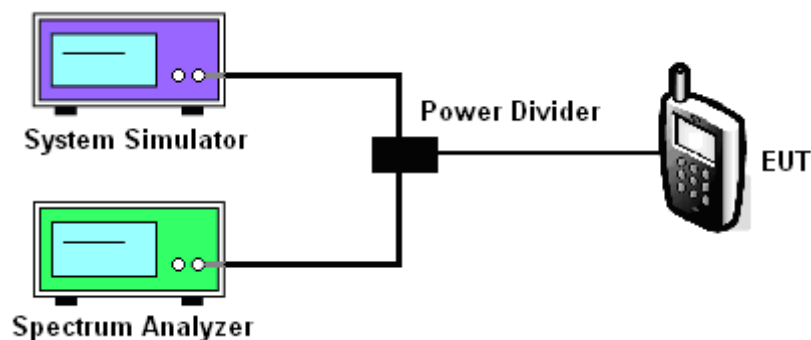



3.6.5 Test Result (Plots) of Conducted Spurious Emission

Band :	GSM850	Channel :	CH128
Test Mode :	GSM Link (GMSK)	Frequency :	824.2 MHz

Conducted Spurious Emission Plot between 30MHz ~ 9GHz

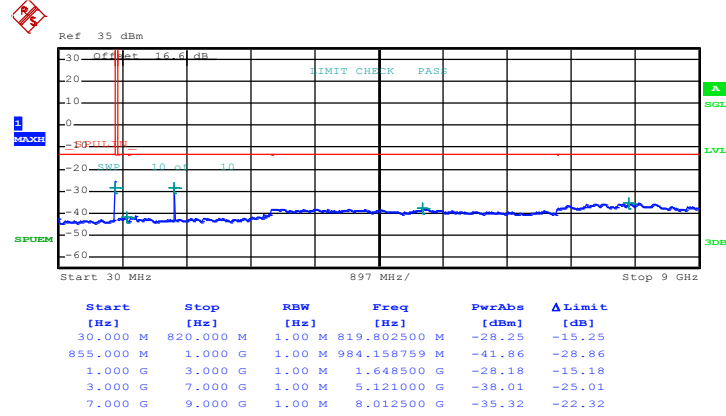

Date: 23.JAN.2015 19:55:28



<b>Band :</b>	GSM850	<b>Channel :</b>	CH189
<b>Test Mode :</b>	GSM Link (GMSK)	<b>Frequency :</b>	836.4 MHz

Conducted Spurious Emission Plot between 30MHz ~ 9GHz

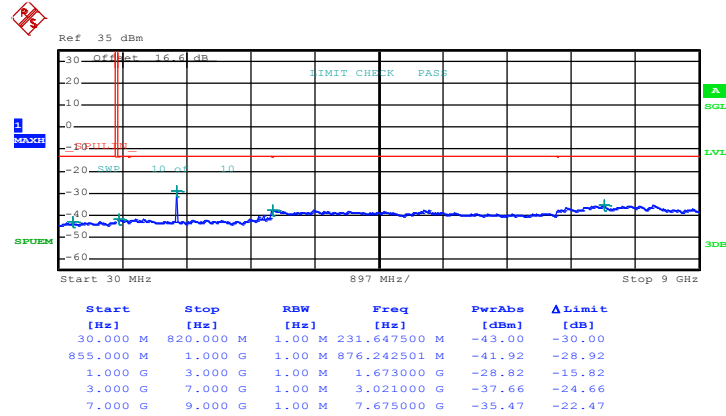

Date: 23.JAN.2015 19:55:53



<b>Band :</b>	GSM850	<b>Channel :</b>	CH251
<b>Test Mode :</b>	GSM Link (GMSK)	<b>Frequency :</b>	848.8 MHz

**Conducted Spurious Emission Plot between 30MHz ~ 9GHz**

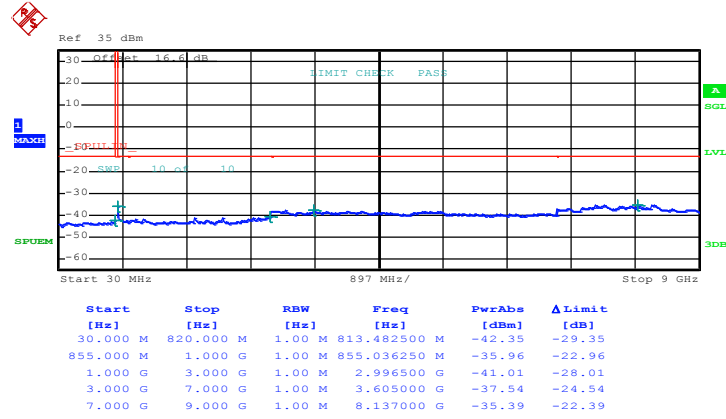

Date: 23.JAN.2015 19:56:18





<b>Band :</b>	GSM850	<b>Channel :</b>	CH128
<b>Test Mode :</b>	EDGE class 8 Link (8PSK)	<b>Frequency :</b>	824.2 MHz

Conducted Spurious Emission Plot between 30MHz ~ 9GHz

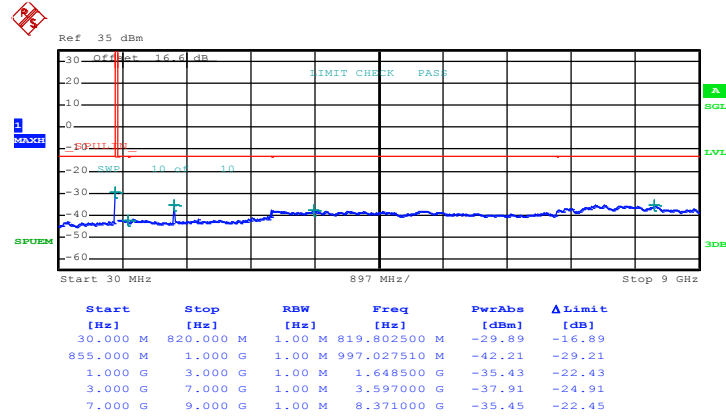

Date: 23.JAN.2015 20:07:47



<b>Band :</b>	GSM850	<b>Channel :</b>	CH189
<b>Test Mode :</b>	EDGE class 8 Link (8PSK)	<b>Frequency :</b>	836.4 MHz

Conducted Spurious Emission Plot between 30MHz ~ 9GHz

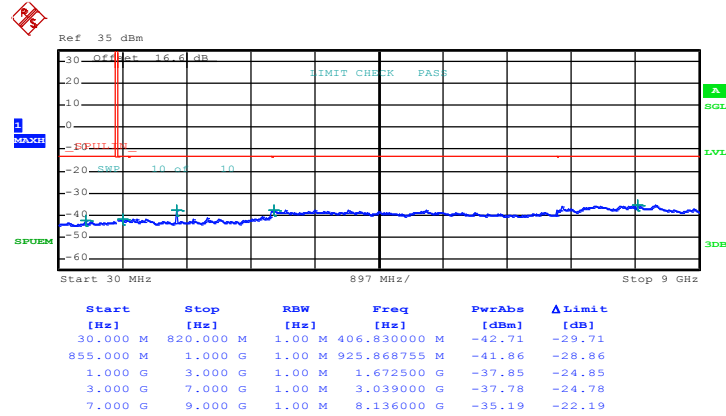

Date: 23.JAN.2015 20:08:15



<b>Band :</b>	GSM850	<b>Channel :</b>	CH251
<b>Test Mode :</b>	EDGE class 8 Link (8PSK)	<b>Frequency :</b>	848.8 MHz

Conducted Spurious Emission Plot between 30MHz ~ 9GHz

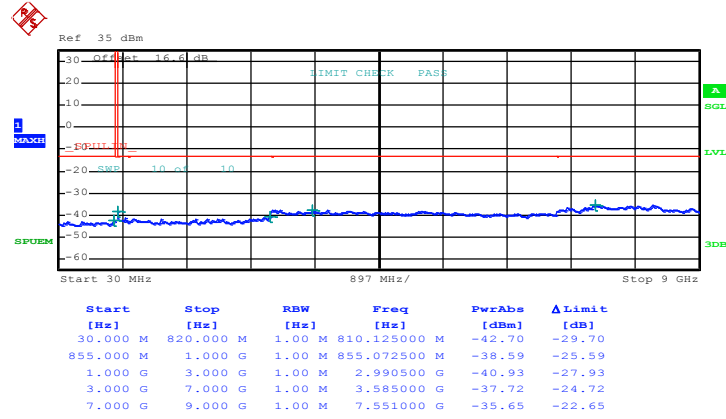

Date: 23.JAN.2015 20:08:42



<b>Band :</b>	GSM1900	<b>Channel :</b>	CH512
<b>Test Mode :</b>	GSM Link (GMSK)	<b>Frequency :</b>	1850.2 MHz

Conducted Spurious Emission Plot between 30MHz ~ 19.1GHz

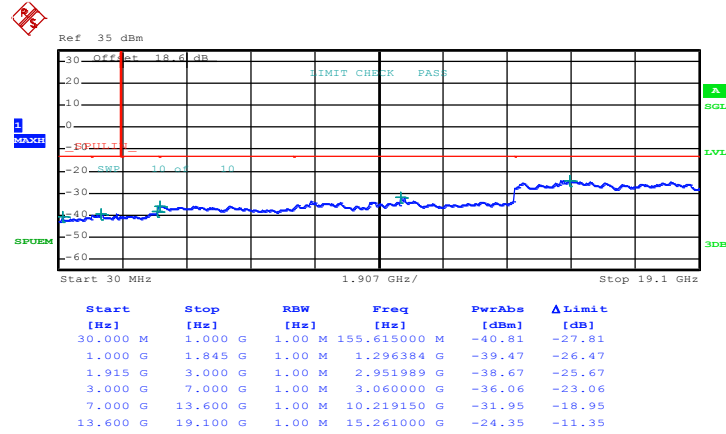

Date: 23.JAN.2015 20:17:52



<b>Band :</b>	GSM1900	<b>Channel :</b>	CH661
<b>Test Mode :</b>	GSM Link (GMSK)	<b>Frequency :</b>	1880.0 MHz

Conducted Spurious Emission Plot between 30MHz ~ 19.1GHz

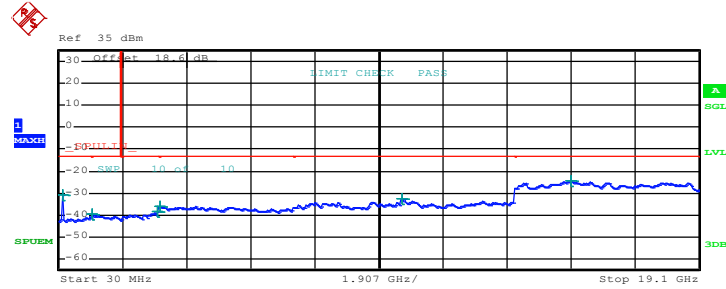

Start [Hz]	Stop [Hz]	RBW [Hz]	Freq [Hz]	PwrAbs [dBm]	Δ Limit [dB]
30.000 M	1.000 G	1.00 M	141.792500 M	-30.95	-17.95
1.000 G	1.845 G	1.00 M	1.029519 G	-39.83	-26.83
1.915 G	3.000 G	1.00 M	2.985081 G	-38.61	-25.61
3.000 G	7.000 G	1.00 M	3.036000 G	-36.01	-23.01
7.000 G	13.600 G	1.00 M	10.238950 G	-32.52	-19.52
13.600 G	19.100 G	1.00 M	15.298813 G	-24.38	-11.38

Date: 23.JAN.2015 20:18:17



<b>Band :</b>	GSM1900	<b>Channel :</b>	CH810
<b>Test Mode :</b>	GSM Link (GMSK)	<b>Frequency :</b>	1909.8 MHz

Conducted Spurious Emission Plot between 30MHz ~ 19.1GHz

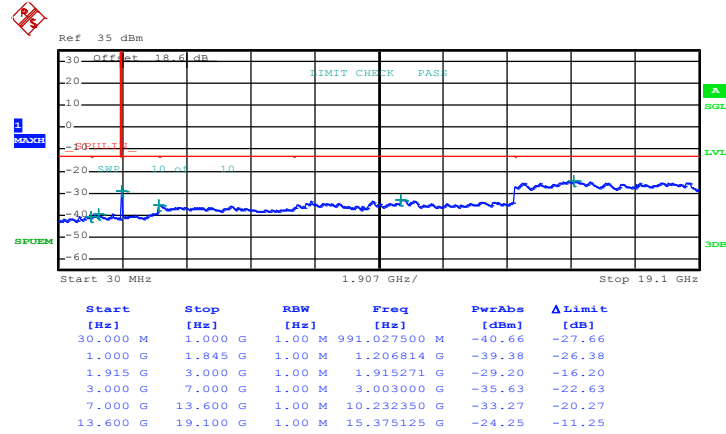

Date: 23.JAN.2015 20:18:42



<b>Band :</b>	GSM1900	<b>Channel :</b>	CH512
<b>Test Mode :</b>	EDGE class 8 Link (8PSK)	<b>Frequency :</b>	1850.2 MHz

Conducted Spurious Emission Plot between 30MHz ~ 19.1GHz

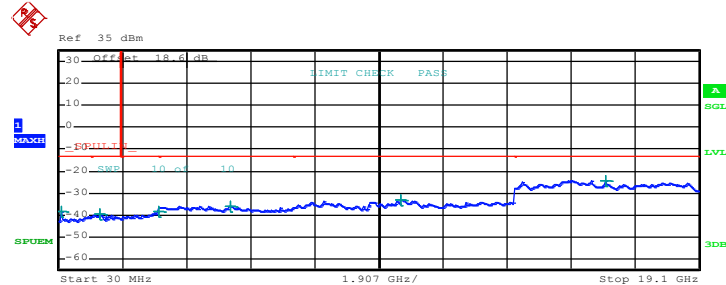

Start [Hz]	Stop [Hz]	RBW [Hz]	Freq [Hz]	PwrAbs [dBm]	Δ Limit [dB]
30.000 M	1.000 G	1.00 M	111.965000 M	-38.22	-25.22
1.000 G	1.845 G	1.00 M	1.256669 G	-39.69	-26.69
1.915 G	3.000 G	1.00 M	2.992405 G	-38.68	-25.68
3.000 G	7.000 G	1.00 M	5.127000 G	-35.88	-22.88
7.000 G	13.600 G	1.00 M	10.227400 G	-32.92	-19.92
13.600 G	19.100 G	1.00 M	16.303938 G	-24.08	-11.08

Date: 23.JAN.2015 20:28:00



<b>Band :</b>	GSM1900	<b>Channel :</b>	CH661
<b>Test Mode :</b>	EDGE class 8 Link (8PSK)	<b>Frequency :</b>	1880.0 MHz

Conducted Spurious Emission Plot between 30MHz ~ 19.1GHz

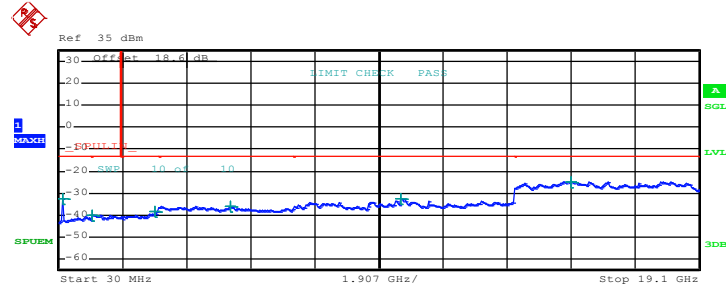

Start [Hz]	Stop [Hz]	RBW [Hz]	Freq [Hz]	PwrAbs [dBm]	Δ Limit [dB]
30.000 M	1.000 G	1.00 M	141.792500 M	-32.62	-19.62
1.000 G	1.845 G	1.00 M	1.038659 G	-39.96	-26.96
1.915 G	3.000 G	1.00 M	2.895569 G	-38.29	-25.29
3.000 G	7.000 G	1.00 M	5.1147000 G	-35.81	-22.81
7.000 G	13.600 G	1.00 M	10.216675 G	-32.60	-19.60
13.600 G	19.100 G	1.00 M	15.298125 G	-24.76	-11.76

Date: 23.JAN.2015 20:28:27





<b>Band :</b>	GSM1900	<b>Channel :</b>	CH810
<b>Test Mode :</b>	EDGE class 8 Link (8PSK)	<b>Frequency :</b>	1909.8 MHz

Conducted Spurious Emission Plot between 30MHz ~ 19.1GHz

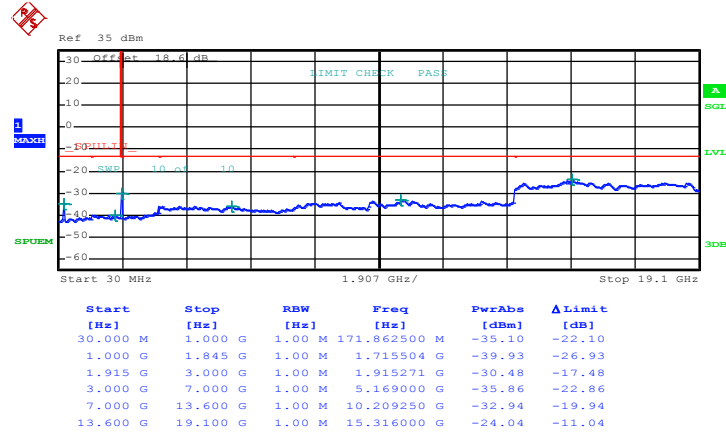

Date: 23.JAN.2015 20:28:53



<b>Band :</b>	WCDMA Band V	<b>Channel :</b>	CH4132
<b>Test Mode :</b>	RMC 12.2Kbps Link (QPSK)	<b>Frequency :</b>	826.4 MHz

Conducted Spurious Emission Plot between 30MHz ~ 9GHz

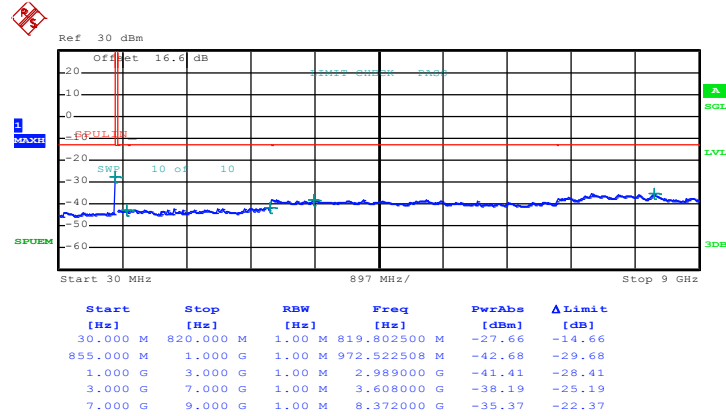

Date: 23.JAN.2015 20:45:33



Band :	WCDMA Band V	Channel :	CH4182
Test Mode :	RMC 12.2Kbps Link (QPSK)	Frequency :	836.4 MHz

Conducted Spurious Emission Plot between 30MHz ~ 9GHz

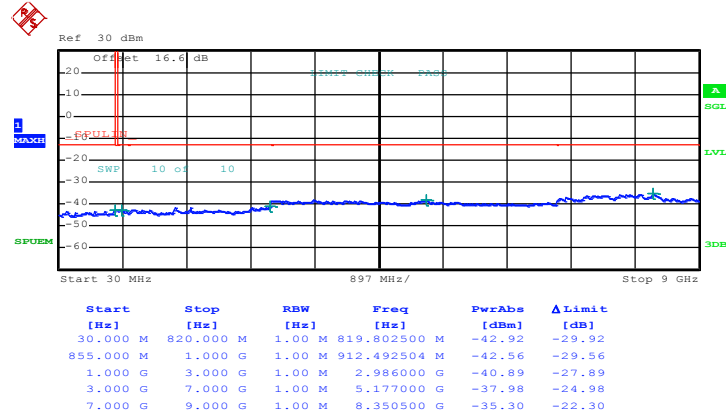

Date: 23.JAN.2015 20:46:01



Band :	WCDMA Band V	Channel :	CH4233
Test Mode :	RMC 12.2Kbps Link (QPSK)	Frequency :	846.6 MHz

Conducted Spurious Emission Plot between 30MHz ~ 9GHz

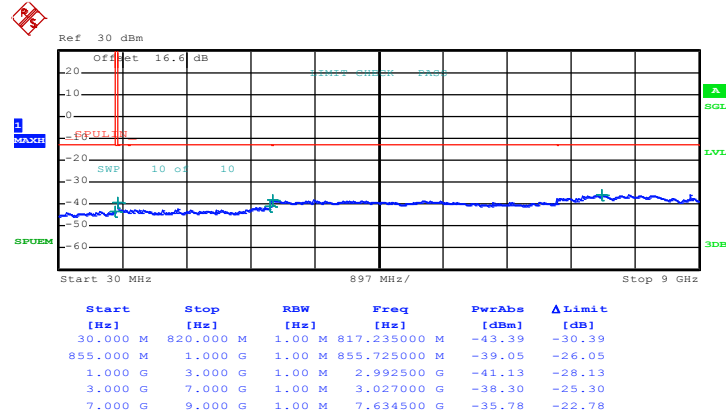

Date: 23.JAN.2015 20:46:27



<b>Band :</b>	WCDMA Band IV	<b>Channel :</b>	CH1312
<b>Test Mode :</b>	RMC 12.2Kbps Link (QPSK)	<b>Frequency :</b>	1712.4 MHz

**Conducted Spurious Emission Plot between 30MHz ~ 18GHz**

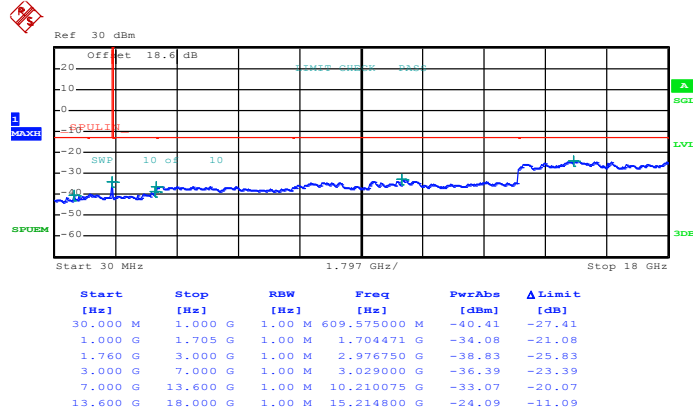

Date: 23.JAN.2015 21:02:52



<b>Band :</b>	WCDMA Band IV	<b>Channel :</b>	CH1413
<b>Test Mode :</b>	RMC 12.2Kbps Link (QPSK)	<b>Frequency :</b>	1732.6 MHz

**Conducted Spurious Emission Plot between 30MHz ~ 18GHz**

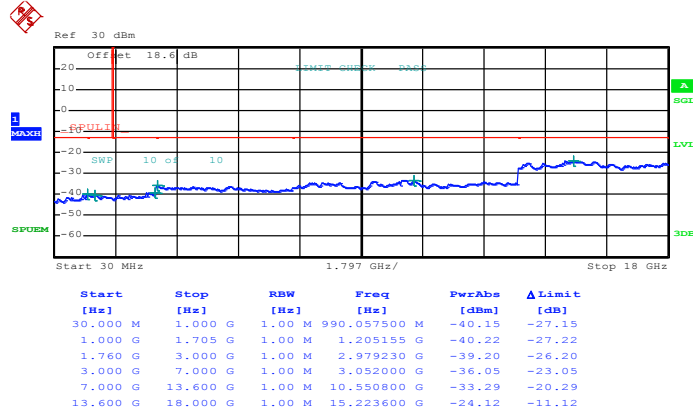

Date: 23.JAN.2015 21:03:19



<b>Band :</b>	WCDMA Band IV	<b>Channel :</b>	CH1513
<b>Test Mode :</b>	RMC 12.2Kbps Link (QPSK)	<b>Frequency :</b>	1752.6 MHz

**Conducted Spurious Emission Plot between 30MHz ~ 18GHz**

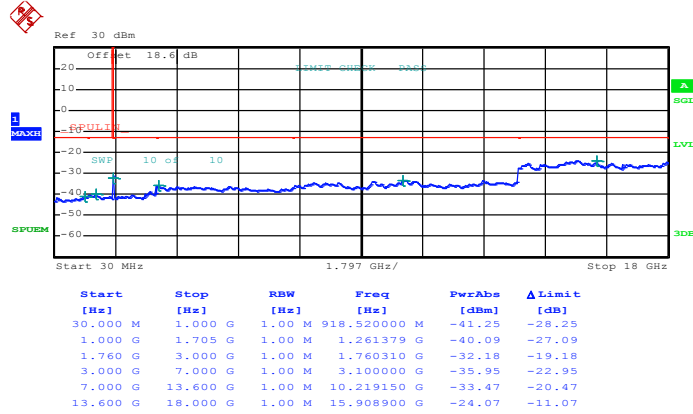

Date: 23.JAN.2015 21:03:46



Band :	WCDMA Band II	Channel :	CH9262
Test Mode :	RMC 12.2Kbps Link (QPSK)	Frequency :	1852.4 MHz

Conducted Spurious Emission Plot between 30MHz ~ 19.1GHz

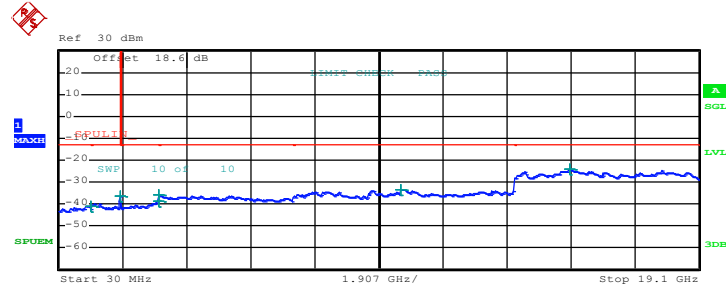

Date: 23.JAN.2015 20:54:30





<b>Band :</b>	WCDMA Band II	<b>Channel :</b>	CH9400
<b>Test Mode :</b>	RMC 12.2Kbps Link (QPSK)	<b>Frequency :</b>	1880.0 MHz

Conducted Spurious Emission Plot between 30MHz ~ 19.1GHz

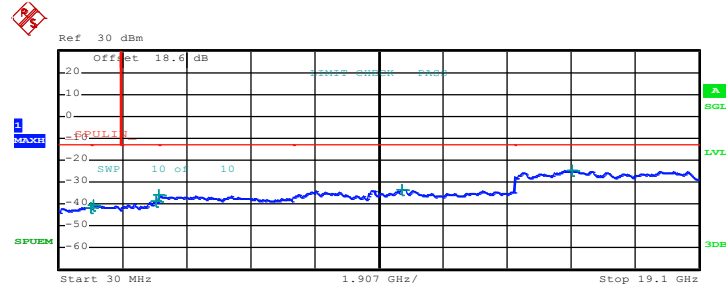

Start [Hz]	Stop [Hz]	RBW [Hz]	Freq [Hz]	PwrAbs [dBm]	Δ Limit [dB]
30.000 M	1.000 G	1.00 M	991.512500 M	-41.46	-28.46
1.000 G	1.845 G	1.00 M	1.059573 G	-40.26	-27.26
1.915 G	3.000 G	1.00 M	2.936256 G	-38.83	-25.83
3.000 G	7.000 G	1.00 M	3.003000 G	-36.03	-23.03
7.000 G	13.600 G	1.00 M	10.234000 G	-33.17	-20.17
13.600 G	19.100 G	1.00 M	15.341438 G	-24.61	-11.61

Date: 23.JAN.2015 20:54:56



<b>Band :</b>	WCDMA Band II	<b>Channel :</b>	CH9538
<b>Test Mode :</b>	RMC 12.2Kbps Link (QPSK)	<b>Frequency :</b>	1907.6 MHz

Conducted Spurious Emission Plot between 30MHz ~ 19.1GHz

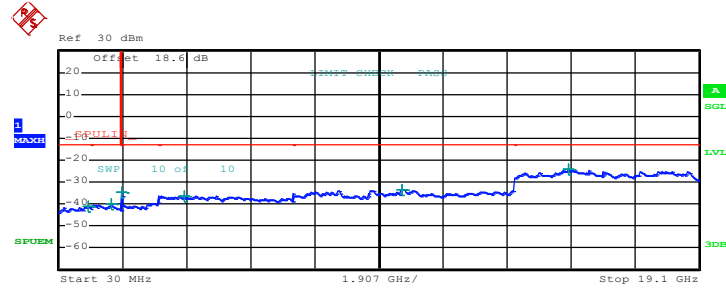

Start [Hz]	Stop [Hz]	RBW [Hz]	Freq [Hz]	PwrAbs [dBm]	Δ Limit [dB]
30.000 M	1.000 G	1.00 M	897.907500 M	-40.93	-27.93
1.000 G	1.845 G	1.00 M	1.590444 G	-40.10	-27.10
1.915 G	3.000 G	1.00 M	1.915542 G	-34.42	-21.42
3.000 G	7.000 G	1.00 M	3.785000 G	-36.41	-23.41
7.000 G	13.600 G	1.00 M	10.236475 G	-33.18	-20.18
13.600 G	19.100 G	1.00 M	15.206687 G	-24.35	-11.35

Date: 23.JAN.2015 20:55:24



### 3.7 Field Strength of Spurious Radiation Measurement

#### 3.7.1 Description of Field Strength of Spurious Radiated Measurement

The power of any emission outside of the authorized operating frequency ranges must be attenuated below the transmitter power (P) by a factor of at least  $43 + 10 \log (P)$  dB. The spectrum is scanned from 30 MHz up to a frequency including its 10th harmonic.

#### 3.7.2 Measuring Instruments

The measuring equipment is listed in the section 4 of this test report.

#### 3.7.3 Test Procedures

1. The testing follows FCC KDB 971168 v02r02 Section 5.8 and ANSI / TIA-603-C-2004 Section 2.2.12.
2. The EUT was placed on a rotatable wooden table 0.8 meters above the ground.
3. The EUT was set 3 meters from the receiving antenna, which was mounted on the antenna tower.
4. The table was rotated 360 degrees to determine the position of the highest spurious emission.
5. The height of the receiving antenna is varied between one meter and four meters to search for the maximum spurious emission for both horizontal and vertical polarizations.
6. Make the measurement with the spectrum analyzer's RBW = 1MHz, VBW = 3MHz, taking record of maximum spurious emission.
7. A horn antenna was substituted in place of the EUT and was driven by a signal generator.
8. Tune the output power of signal generator to the same emission level with EUT maximum spurious emission.
9. Taking the record of output power at antenna port.
10. Repeat step 7 to step 8 for another polarization.
11.  $EIRP \text{ (dBm)} = S.G. \text{ Power} - Tx \text{ Cable Loss} + Tx \text{ Antenna Gain}$
12.  $ERP \text{ (dBm)} = EIRP - 2.15$
13. The RF fundamental frequency should be excluded against the limit line in the operating frequency band.
14. The limit line is derived from  $43 + 10\log(P)$  dB below the transmitter power P(Watts)  
 $= P(W) - [43 + 10\log(P)] \text{ (dB)}$   
 $= [30 + 10\log(P)] \text{ (dBm)} - [43 + 10\log(P)] \text{ (dB)}$   
 $= -13dBm.$

### 3.7.4 Test Setup

For radiated emissions from 30MHz to 1GHz

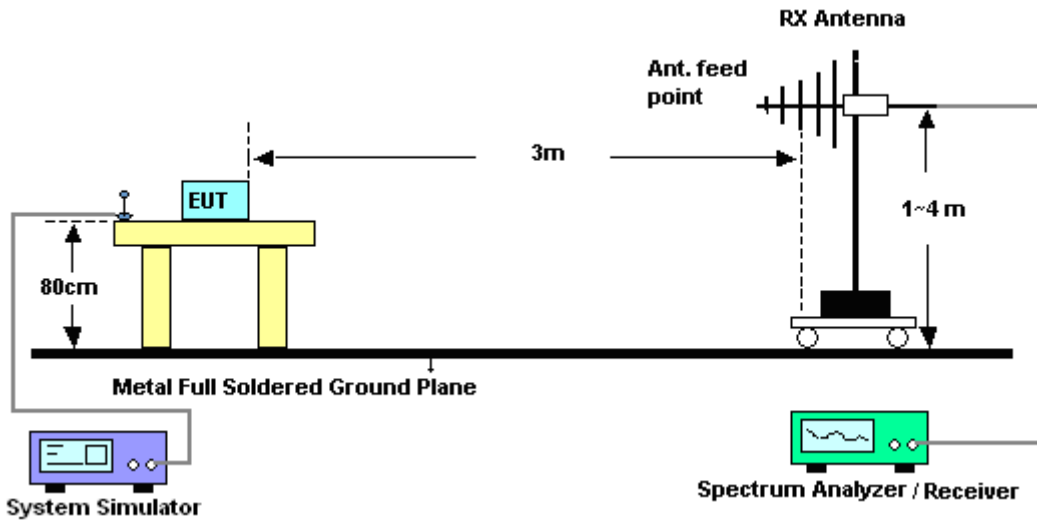

For radiated emissions above 1GHz

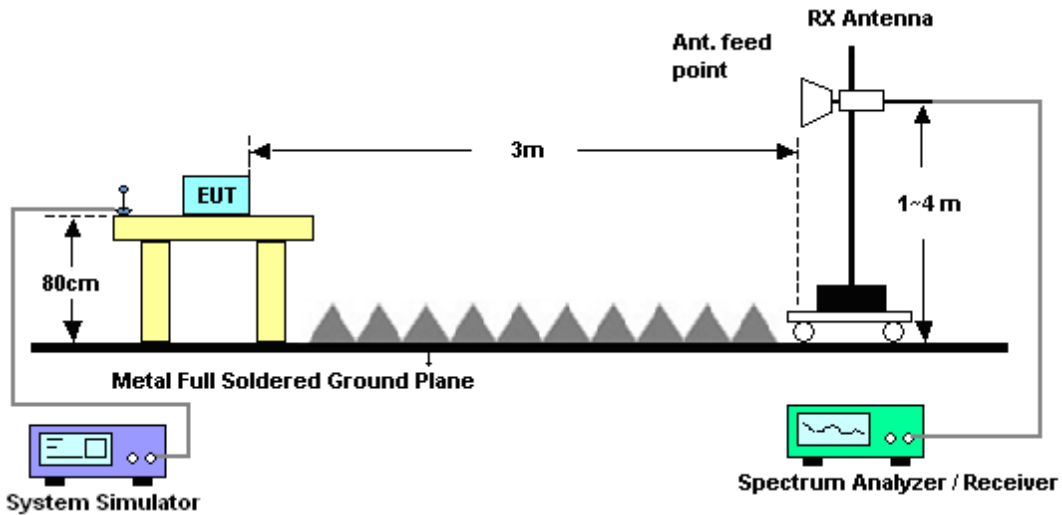



### 3.7.5 Test Result of Field Strength of Spurious Radiated

<Low Channel>

<b>Band :</b>	GSM850		<b>Temperature :</b>	23~24°C					
<b>Test Mode :</b>	GSM Link (GMSK)		<b>Relative Humidity :</b>	46~48%					
<b>Test Engineer :</b>	James Chiu and Derreck Chen		<b>Polarization :</b>	Horizontal					
<b>Remark :</b>	Spurious emissions within 30-1000MHz were found more than 20dB below limit line.								
Frequency ( MHz )	ERP ( dBm )	Limit ( dBm )	Over Limit ( dB )	SPA Reading ( dBm )	S.G. Power ( dBm )	TX Cable loss ( dB )	TX Antenna Gain ( dBi )	Polarization ( H/V )	Result
1650	-55.47	-13	-42.47	-60.61	-57.22	0.98	4.88	H	Pass
2476	-53.34	-13	-40.34	-64.01	-55.23	1.28	5.33	H	Pass
3301	-64.16	-13	-51.16	-77.05	-67.59	1.54	7.12	H	Pass

<b>Band :</b>	GSM850		<b>Temperature :</b>	23~24°C					
<b>Test Mode :</b>	GSM Link (GMSK)		<b>Relative Humidity :</b>	46~48%					
<b>Test Engineer :</b>	James Chiu and Derreck Chen		<b>Polarization :</b>	Vertical					
<b>Remark :</b>	Spurious emissions within 30-1000MHz were found more than 20dB below limit line.								
Frequency ( MHz )	ERP ( dBm )	Limit ( dBm )	Over Limit ( dB )	SPA Reading ( dBm )	S.G. Power ( dBm )	TX Cable loss ( dB )	TX Antenna Gain ( dBi )	Polarization ( H/V )	Result
1650	-59.64	-13	-46.64	-63.16	-61.39	0.98	4.88	V	Pass
2476	-48.99	-13	-35.99	-59.41	-50.88	1.28	5.33	V	Pass
3301	-63.65	-13	-50.65	-75.39	-67.08	1.54	7.12	V	Pass



<Middle Channel>

<b>Band :</b>	GSM850		<b>Temperature :</b>	23~24°C					
<b>Test Mode :</b>	GSM Link (GMSK)		<b>Relative Humidity :</b>	46~48%					
<b>Test Engineer :</b>	James Chiu and Derreck Chen		<b>Polarization :</b>	Horizontal					
<b>Remark :</b>	Spurious emissions within 30-1000MHz were found more than 20dB below limit line.								
Frequency ( MHz )	ERP ( dBm )	Limit ( dBm )	Over Limit ( dB )	SPA Reading ( dBm )	S.G. Power ( dBm )	TX Cable loss ( dB )	TX Antenna Gain ( dBi )	Polarization ( H/V )	Result
1672.8	-58.04	-13	-45.04	-62.3	-59.72	0.99	4.82	H	Pass
2509.2	-47.36	-13	-34.36	-56.97	-49.32	1.29	5.41	H	Pass
3345.6	-65.97	-13	-52.97	-77.79	-69.58	1.56	7.32	H	Pass

<b>Band :</b>	GSM850		<b>Temperature :</b>	23~24°C					
<b>Test Mode :</b>	GSM Link (GMSK)		<b>Relative Humidity :</b>	46~48%					
<b>Test Engineer :</b>	James Chiu and Derreck Chen		<b>Polarization :</b>	Vertical					
<b>Remark :</b>	Spurious emissions within 30-1000MHz were found more than 20dB below limit line.								
Frequency ( MHz )	ERP ( dBm )	Limit ( dBm )	Over Limit ( dB )	SPA Reading ( dBm )	S.G. Power ( dBm )	TX Cable loss ( dB )	TX Antenna Gain ( dBi )	Polarization ( H/V )	Result
1672.8	-58.25	-13	-45.25	-60.95	-59.93	0.99	4.82	V	Pass
2509.2	-49.87	-13	-36.87	-59.24	-51.83	1.29	5.41	V	Pass
3345.6	-66.57	-13	-53.57	-77.82	-70.18	1.56	7.32	V	Pass



<High Channel>

<b>Band :</b>	GSM850		<b>Temperature :</b>	23~24°C					
<b>Test Mode :</b>	GSM Link (GMSK)		<b>Relative Humidity :</b>	46~48%					
<b>Test Engineer :</b>	James Chiu and Derreck Chen		<b>Polarization :</b>	Horizontal					
<b>Remark :</b>	Spurious emissions within 30-1000MHz were found more than 20dB below limit line.								
Frequency ( MHz )	ERP ( dBm )	Limit ( dBm )	Over Limit ( dB )	SPA Reading ( dBm )	S.G. Power ( dBm )	TX Cable loss ( dB )	TX Antenna Gain ( dBi )	Polarization ( H/V )	Result
1698	-58.51	-13	-45.51	-63.43	-60.11	1.00	4.75	H	Pass
2548	-54.07	-13	-41.07	-63.74	-56.05	1.31	5.44	H	Pass
3395	-64.20	-13	-51.20	-77.8	-68.02	1.57	7.54	H	Pass

<b>Band :</b>	GSM850		<b>Temperature :</b>	23~24°C					
<b>Test Mode :</b>	GSM Link (GMSK)		<b>Relative Humidity :</b>	46~48%					
<b>Test Engineer :</b>	James Chiu and Derreck Chen		<b>Polarization :</b>	Vertical					
<b>Remark :</b>	Spurious emissions within 30-1000MHz were found more than 20dB below limit line.								
Frequency ( MHz )	ERP ( dBm )	Limit ( dBm )	Over Limit ( dB )	SPA Reading ( dBm )	S.G. Power ( dBm )	TX Cable loss ( dB )	TX Antenna Gain ( dBi )	Polarization ( H/V )	Result
1698	-59.51	-13	-46.51	-63.34	-61.11	1.00	4.75	V	Pass
2548	-49.35	-13	-36.35	-60.16	-51.33	1.31	5.44	V	Pass
3395	-62.92	-13	-49.92	-77	-66.74	1.57	7.54	V	Pass



<Low Channel>

<b>Band :</b>	GSM850		<b>Temperature :</b>	23~24°C					
<b>Test Mode :</b>	EDGE class 8 Link (8PSK)		<b>Relative Humidity :</b>	46~48%					
<b>Test Engineer :</b>	James Chiu and Derreck Chen		<b>Polarization :</b>	Horizontal					
<b>Remark :</b>	Spurious emissions within 30-1000MHz were found more than 20dB below limit line.								
Frequency ( MHz )	ERP ( dBm )	Limit ( dBm )	Over Limit ( dB )	SPA Reading ( dBm )	S.G. Power ( dBm )	TX Cable loss ( dB )	TX Antenna Gain ( dBi )	Polarization ( H/V )	Result
1648	-61.82	-13	-48.82	-66.25	-63.58	0.98	4.89	H	Pass
2472	-57.44	-13	-44.44	-66.48	-59.32	1.28	5.32	H	Pass
3296	-62.88	-13	-49.88	-75.38	-66.29	1.54	7.10	H	Pass

<b>Band :</b>	GSM850		<b>Temperature :</b>	23~24°C					
<b>Test Mode :</b>	EDGE class 8 Link (8PSK)		<b>Relative Humidity :</b>	46~48%					
<b>Test Engineer :</b>	James Chiu and Derreck Chen		<b>Polarization :</b>	Vertical					
<b>Remark :</b>	Spurious emissions within 30-1000MHz were found more than 20dB below limit line.								
Frequency ( MHz )	ERP ( dBm )	Limit ( dBm )	Over Limit ( dB )	SPA Reading ( dBm )	S.G. Power ( dBm )	TX Cable loss ( dB )	TX Antenna Gain ( dBi )	Polarization ( H/V )	Result
1648	-58.82	-13	-45.82	-61.37	-60.58	0.98	4.89	V	Pass
2472	-51.53	-13	-38.53	-61.26	-53.41	1.28	5.32	V	Pass
3296	-62.87	-13	-49.87	-74.37	-66.28	1.54	7.10	V	Pass





<Middle Channel>

<b>Band :</b>	GSM850		<b>Temperature :</b>	23~24°C					
<b>Test Mode :</b>	EDGE class 8 Link (8PSK)		<b>Relative Humidity :</b>	46~48%					
<b>Test Engineer :</b>	James Chiu and Derreck Chen		<b>Polarization :</b>	Horizontal					
<b>Remark :</b>	Spurious emissions within 30-1000MHz were found more than 20dB below limit line.								
Frequency ( MHz )	ERP ( dBm )	Limit ( dBm )	Over Limit ( dB )	SPA Reading ( dBm )	S.G. Power ( dBm )	TX Cable loss ( dB )	TX Antenna Gain ( dBi )	Polarization ( H/V )	Result
1672	-59.85	-13	-46.85	-64.12	-61.53	0.99	4.82	H	Pass
2509	-53.00	-13	-40.00	-62.42	-54.96	1.29	5.41	H	Pass
3345	-63.97	-13	-50.97	-75.99	-67.58	1.56	7.32	H	Pass

<b>Band :</b>	GSM850		<b>Temperature :</b>	23~24°C					
<b>Test Mode :</b>	EDGE class 8 Link (8PSK)		<b>Relative Humidity :</b>	46~48%					
<b>Test Engineer :</b>	James Chiu and Derreck Chen		<b>Polarization :</b>	Vertical					
<b>Remark :</b>	Spurious emissions within 30-1000MHz were found more than 20dB below limit line.								
Frequency ( MHz )	ERP ( dBm )	Limit ( dBm )	Over Limit ( dB )	SPA Reading ( dBm )	S.G. Power ( dBm )	TX Cable loss ( dB )	TX Antenna Gain ( dBi )	Polarization ( H/V )	Result
1672	-58.01	-13	-45.01	-60.6	-59.69	0.99	4.82	V	Pass
2509	-50.89	-13	-37.89	-61.08	-52.85	1.29	5.41	V	Pass
3345	-61.35	-13	-48.35	-71.98	-64.96	1.56	7.32	V	Pass



<High Channel>

<b>Band :</b>	GSM850		<b>Temperature :</b>	23~24°C					
<b>Test Mode :</b>	EDGE class 8 Link (8PSK)		<b>Relative Humidity :</b>	46~48%					
<b>Test Engineer :</b>	James Chiu and Derreck Chen		<b>Polarization :</b>	Horizontal					
<b>Remark :</b>	Spurious emissions within 30-1000MHz were found more than 20dB below limit line.								
Frequency ( MHz )	ERP ( dBm )	Limit ( dBm )	Over Limit ( dB )	SPA Reading ( dBm )	S.G. Power ( dBm )	TX Cable loss ( dB )	TX Antenna Gain ( dBi )	Polarization ( H/V )	Result
1696	-63.36	-13	-50.36	-67.46	-64.96	1.00	4.75	H	Pass
2546	-58.90	-13	-45.90	-68.43	-60.88	1.31	5.44	H	Pass
3395	-63.80	-13	-50.80	-75.91	-67.62	1.57	7.54	H	Pass

<b>Band :</b>	GSM850		<b>Temperature :</b>	23~24°C					
<b>Test Mode :</b>	EDGE class 8 Link (8PSK)		<b>Relative Humidity :</b>	46~48%					
<b>Test Engineer :</b>	James Chiu and Derreck Chen		<b>Polarization :</b>	Vertical					
<b>Remark :</b>	Spurious emissions within 30-1000MHz were found more than 20dB below limit line.								
Frequency ( MHz )	ERP ( dBm )	Limit ( dBm )	Over Limit ( dB )	SPA Reading ( dBm )	S.G. Power ( dBm )	TX Cable loss ( dB )	TX Antenna Gain ( dBi )	Polarization ( H/V )	Result
1696	-56.43	-13	-43.43	-59.92	-58.03	1.00	4.75	V	Pass
2546	-48.36	-13	-35.36	-57.92	-52.49	1.31	5.44	V	Pass
3395	-62.34	-13	-49.34	-74.23	-68.31	1.57	7.54	V	Pass



<Low Channel>

<b>Band :</b>	GSM1900		<b>Temperature :</b>	23~24°C					
<b>Test Mode :</b>	GSM Link (GMSK)		<b>Relative Humidity :</b>	46~48%					
<b>Test Engineer :</b>	James Chiu and Derreck Chen		<b>Polarization :</b>	Horizontal					
<b>Remark :</b>	Spurious emissions within 30-1000MHz were found more than 20dB below limit line.								
Frequency ( MHz )	EIRP ( dBm )	Limit ( dBm )	Over Limit ( dB )	SPA Reading ( dBm )	S.G. Power ( dBm )	TX Cable loss ( dB )	TX Antenna Gain ( dBi )	Polarization ( H/V )	Result
3704	-53.08	-13	-40.08	-57.68	-59.66	1.67	8.24	H	Pass
5556	-45.11	-13	-32.11	-65.51	-52.18	2.66	9.72	H	Pass
7404	-41.87	-13	-28.87	-67.38	-51.02	2.46	11.61	H	Pass
9256	-45.46	-13	-32.46	-74.52	-55.52	2.54	12.60	H	Pass
11104	-48.29	-13	-35.29	-78.51	-58.06	2.69	12.46	H	Pass
12956	-39.84	-13	-26.84	-77.51	-49.87	2.92	12.95	H	Pass
14804	-44.78	-13	-31.78	-79.91	-54.63	3.52	13.36	H	Pass
16656	-36.23	-13	-23.23	-77.26	-44.69	3.93	12.39	H	Pass

<b>Band :</b>	GSM1900		<b>Temperature :</b>	23~24°C					
<b>Test Mode :</b>	GSM Link (GMSK)		<b>Relative Humidity :</b>	46~48%					
<b>Test Engineer :</b>	James Chiu and Derreck Chen		<b>Polarization :</b>	Vertical					
<b>Remark :</b>	Spurious emissions within 30-1000MHz were found more than 20dB below limit line.								
Frequency ( MHz )	EIRP ( dBm )	Limit ( dBm )	Over Limit ( dB )	SPA Reading ( dBm )	S.G. Power ( dBm )	TX Cable loss ( dB )	TX Antenna Gain ( dBi )	Polarization ( H/V )	Result
3704	-52.97	-13	-39.97	-67.61	-59.55	1.67	8.24	V	Pass
5556	-50.06	-13	-37.06	-68.95	-57.13	2.66	9.72	V	Pass
7404	-44.51	-13	-31.51	-69.06	-53.66	2.46	11.61	V	Pass
9256	-52.40	-13	-39.40	-78.58	-62.46	2.54	12.60	V	Pass
11104	-47.29	-13	-34.29	-76.03	-57.06	2.69	12.46	V	Pass
12956	-41.29	-13	-28.29	-74.94	-51.32	2.92	12.95	V	Pass
14804	-44.26	-13	-31.26	-80.24	-54.11	3.52	13.36	V	Pass
16656	-38.65	-13	-25.65	-77.32	-47.11	3.93	12.39	V	Pass



<Middle Channel>

<b>Band :</b>	GSM1900		<b>Temperature :</b>	23~24°C					
<b>Test Mode :</b>	GSM Link (GMSK)		<b>Relative Humidity :</b>	46~48%					
<b>Test Engineer :</b>	James Chiu and Derreck Chen		<b>Polarization :</b>	Horizontal					
<b>Remark :</b>	Spurious emissions within 30-1000MHz were found more than 20dB below limit line.								
Frequency ( MHz )	EIRP ( dBm )	Limit ( dBm )	Over Limit ( dB )	SPA Reading ( dBm )	S.G. Power ( dBm )	TX Cable loss ( dB )	TX Antenna Gain ( dBi )	Polarization ( H/V )	Result
3762	-41.59	-13	-28.59	-56.37	-48.22	1.69	8.31	H	Pass
5644	-40.61	-13	-27.61	-60.52	-47.66	2.71	9.76	H	Pass
7524	-42.16	-13	-29.16	-67.23	-51.55	2.42	11.81	H	Pass
9404	-45.39	-13	-32.39	-74.71	-55.36	2.57	12.54	H	Pass
11284	-46.78	-13	-33.78	-77.28	-56.48	2.68	12.39	H	Pass
13164	-38.77	-13	-25.77	-76.59	-49.03	2.97	13.23	H	Pass
15045	-43.36	-13	-30.36	-79.39	-53.41	3.62	13.66	H	Pass
16926	-38.07	-13	-25.07	-78.67	-46.89	3.89	12.71	H	Pass

<b>Band :</b>	GSM1900		<b>Temperature :</b>	23~24°C					
<b>Test Mode :</b>	GSM Link (GMSK)		<b>Relative Humidity :</b>	46~48%					
<b>Test Engineer :</b>	James Chiu and Derreck Chen		<b>Polarization :</b>	Vertical					
<b>Remark :</b>	Spurious emissions within 30-1000MHz were found more than 20dB below limit line.								
Frequency ( MHz )	EIRP ( dBm )	Limit ( dBm )	Over Limit ( dB )	SPA Reading ( dBm )	S.G. Power ( dBm )	TX Cable loss ( dB )	TX Antenna Gain ( dBi )	Polarization ( H/V )	Result
3762	-49.78	-13	-36.78	-64.3	-56.41	1.69	8.31	V	Pass
5644	-51.62	-13	-38.62	-70.31	-58.67	2.71	9.76	V	Pass
7524	-45.05	-13	-32.05	-69.27	-54.44	2.42	11.81	V	Pass
9404	-52.14	-13	-39.14	-78.11	-62.11	2.57	12.54	V	Pass
11284	-43.41	-13	-30.41	-72.59	-53.11	2.68	12.39	V	Pass
13164	-38.87	-13	-25.87	-73.66	-49.13	2.97	13.23	V	Pass
15045	-44.05	-13	-31.05	-80.18	-54.1	3.62	13.66	V	Pass
16926	-39.40	-13	-26.40	-79.06	-48.22	3.89	12.71	V	Pass



<High Channel>

<b>Band :</b>	GSM1900		<b>Temperature :</b>	23~24°C					
<b>Test Mode :</b>	GSM Link (GMSK)		<b>Relative Humidity :</b>	46~48%					
<b>Test Engineer :</b>	James Chiu and Derreck Chen		<b>Polarization :</b>	Horizontal					
<b>Remark :</b>	Spurious emissions within 30-1000MHz were found more than 20dB below limit line.								
Frequency ( MHz )	EIRP ( dBm )	Limit ( dBm )	Over Limit ( dB )	SPA Reading ( dBm )	S.G. Power ( dBm )	TX Cable loss ( dB )	TX Antenna Gain ( dBi )	Polarization ( H/V )	Result
3822	-40.45	-13	-27.45	-55.34	-47.13	1.71	8.39	H	Pass
5732	-43.15	-13	-30.15	-63.62	-50.18	2.76	9.79	H	Pass
7644	-43.72	-13	-30.72	-68.58	-53.22	2.38	11.89	H	Pass
9552	-45.15	-13	-32.15	-74.36	-55.02	2.60	12.47	H	Pass
11464	-46.45	-13	-33.45	-76.88	-56.08	2.68	12.31	H	Pass
13372	-40.01	-13	-27.01	-77.71	-50.51	3.02	13.52	H	Pass
15282	-40.38	-13	-27.38	-78.27	-50.66	3.72	13.99	H	Pass

<b>Band :</b>	GSM1900		<b>Temperature :</b>	23~24°C					
<b>Test Mode :</b>	GSM Link (GMSK)		<b>Relative Humidity :</b>	46~48%					
<b>Test Engineer :</b>	James Chiu and Derreck Chen		<b>Polarization :</b>	Vertical					
<b>Remark :</b>	Spurious emissions within 30-1000MHz were found more than 20dB below limit line.								
Frequency ( MHz )	EIRP ( dBm )	Limit ( dBm )	Over Limit ( dB )	SPA Reading ( dBm )	S.G. Power ( dBm )	TX Cable loss ( dB )	TX Antenna Gain ( dBi )	Polarization ( H/V )	Result
3822	-48.34	-13	-35.34	-62.66	-55.02	1.71	8.39	V	Pass
5732	-49.71	-13	-36.71	-68.8	-56.74	2.76	9.79	V	Pass
7644	-44.61	-13	-31.61	-68.73	-54.11	2.38	11.89	V	Pass
9552	-47.38	-13	-34.38	-73.72	-57.25	2.60	12.47	V	Pass
11464	-43.05	-13	-30.05	-72.52	-52.68	2.68	12.31	V	Pass
13372	-38.72	-13	-25.72	-74.44	-49.22	3.02	13.52	V	Pass
15282	-42.74	-13	-29.74	-79.23	-53.02	3.72	13.99	V	Pass



<Low Channel>

<b>Band :</b>	GSM1900		<b>Temperature :</b>	23~24°C					
<b>Test Mode :</b>	EDGE class 8 Link (8PSK)		<b>Relative Humidity :</b>	46~48%					
<b>Test Engineer :</b>	James Chiu and Derreck Chen		<b>Polarization :</b>	Horizontal					
<b>Remark :</b>	Spurious emissions within 30-1000MHz were found more than 20dB below limit line.								
Frequency ( MHz )	EIRP ( dBm )	Limit ( dBm )	Over Limit ( dB )	SPA Reading ( dBm )	S.G. Power ( dBm )	TX Cable loss ( dB )	TX Antenna Gain ( dBi )	Polarization ( H/V )	Result
3702	-54.45	-13	-41.45	-69.22	-61.02	1.67	8.24	H	Pass
5556	-53.96	-13	-40.96	-74.34	-61.03	2.66	9.72	H	Pass
7404	-52.51	-13	-39.51	-78.21	-61.66	2.46	11.61	H	Pass

<b>Band :</b>	GSM1900		<b>Temperature :</b>	23~24°C					
<b>Test Mode :</b>	EDGE class 8 Link (8PSK)		<b>Relative Humidity :</b>	46~48%					
<b>Test Engineer :</b>	James Chiu and Derreck Chen		<b>Polarization :</b>	Vertical					
<b>Remark :</b>	Spurious emissions within 30-1000MHz were found more than 20dB below limit line.								
Frequency ( MHz )	EIRP ( dBm )	Limit ( dBm )	Over Limit ( dB )	SPA Reading ( dBm )	S.G. Power ( dBm )	TX Cable loss ( dB )	TX Antenna Gain ( dBi )	Polarization ( H/V )	Result
3702	-60.48	-13	-47.48	-74.92	-67.05	1.67	8.24	V	Pass
5556	-53.81	-13	-40.81	-72.51	-60.88	2.66	9.72	V	Pass
7404	-54.07	-13	-41.07	-78.46	-63.22	2.46	11.61	V	Pass



<Middle Channel>

<b>Band :</b>	GSM1900		<b>Temperature :</b>	23~24°C					
<b>Test Mode :</b>	EDGE class 8 Link (8PSK)		<b>Relative Humidity :</b>	46~48%					
<b>Test Engineer :</b>	James Chiu and Derreck Chen		<b>Polarization :</b>	Horizontal					
<b>Remark :</b>	Spurious emissions within 30-1000MHz were found more than 20dB below limit line.								
Frequency ( MHz )	EIRP ( dBm )	Limit ( dBm )	Over Limit ( dB )	SPA Reading ( dBm )	S.G. Power ( dBm )	TX Cable loss ( dB )	TX Antenna Gain ( dBi )	Polarization ( H/V )	Result
3762	-51.06	-13	-38.06	-65.95	-57.69	1.69	8.31	H	Pass
5644	-52.63	-13	-39.63	-72.78	-59.68	2.71	9.76	H	Pass
7524	-51.96	-13	-38.96	-77.14	-61.35	2.42	11.81	H	Pass

<b>Band :</b>	GSM1900		<b>Temperature :</b>	23~24°C					
<b>Test Mode :</b>	EDGE class 8 Link (8PSK)		<b>Relative Humidity :</b>	46~48%					
<b>Test Engineer :</b>	James Chiu and Derreck Chen		<b>Polarization :</b>	Vertical					
<b>Remark :</b>	Spurious emissions within 30-1000MHz were found more than 20dB below limit line.								
Frequency ( MHz )	EIRP ( dBm )	Limit ( dBm )	Over Limit ( dB )	SPA Reading ( dBm )	S.G. Power ( dBm )	TX Cable loss ( dB )	TX Antenna Gain ( dBi )	Polarization ( H/V )	Result
3762	-60.39	-13	-47.39	-74.84	-67.02	1.69	8.31	V	Pass
5644	-60.30	-13	-47.30	-78.77	-67.35	2.71	9.76	V	Pass
7520	-51.03	-13	-38.03	-75.21	-60.42	2.42	11.81	V	Pass



<High Channel>

<b>Band :</b>	GSM1900		<b>Temperature :</b>	23~24°C					
<b>Test Mode :</b>	EDGE class 8 Link (8PSK)		<b>Relative Humidity :</b>	46~48%					
<b>Test Engineer :</b>	James Chiu and Derreck Chen		<b>Polarization :</b>	Horizontal					
<b>Remark :</b>	Spurious emissions within 30-1000MHz were found more than 20dB below limit line.								
Frequency ( MHz )	EIRP ( dBm )	Limit ( dBm )	Over Limit ( dB )	SPA Reading ( dBm )	S.G. Power ( dBm )	TX Cable loss ( dB )	TX Antenna Gain ( dBi )	Polarization ( H/V )	Result
3822	-46.54	-13	-33.54	-61.56	-53.22	1.71	8.39	H	Pass
5732	-53.19	-13	-40.19	-73.34	-60.22	2.76	9.79	H	Pass
7644	-51.98	-13	-38.98	-76.72	-61.48	2.38	11.89	H	Pass

<b>Band :</b>	GSM1900		<b>Temperature :</b>	23~24°C					
<b>Test Mode :</b>	EDGE class 8 Link (8PSK)		<b>Relative Humidity :</b>	46~48%					
<b>Test Engineer :</b>	James Chiu and Derreck Chen		<b>Polarization :</b>	Vertical					
<b>Remark :</b>	Spurious emissions within 30-1000MHz were found more than 20dB below limit line.								
Frequency ( MHz )	EIRP ( dBm )	Limit ( dBm )	Over Limit ( dB )	SPA Reading ( dBm )	S.G. Power ( dBm )	TX Cable loss ( dB )	TX Antenna Gain ( dBi )	Polarization ( H/V )	Result
3822	-58.33	-13	-45.33	-72.49	-65.01	1.71	8.39	V	Pass
5732	-58.73	-13	-45.73	-77.77	-65.76	2.76	9.79	V	Pass
7644	-51.55	-13	-38.55	-75.61	-61.05	2.38	11.89	V	Pass





<Low Channel>

<b>Band :</b>	WCDMA Band V		<b>Temperature :</b>	23~24°C					
<b>Test Mode :</b>	RMC 12.2Kbps Link (QPSK)		<b>Relative Humidity :</b>	46~48%					
<b>Test Engineer :</b>	James Chiu and Derreck Chen		<b>Polarization :</b>	Horizontal					
<b>Remark :</b>	Spurious emissions within 30-1000MHz were found more than 20dB below limit line.								
Frequency ( MHz )	ERP ( dBm )	Limit ( dBm )	Over Limit ( dB )	SPA Reading ( dBm )	S.G. Power ( dBm )	TX Cable loss ( dB )	TX Antenna Gain ( dBi )	Polarization ( H/V )	Result
1651	-66.14	-13	-53.14	-74.44	-67.89	0.98	4.88	H	Pass
2479	-63.49	-13	-50.49	-73.27	-65.39	1.28	5.34	H	Pass
3298	-65.37	-13	-52.37	77.87	-68.79	1.54	7.11	H	Pass

<b>Band :</b>	WCDMA Band V		<b>Temperature :</b>	23~24°C					
<b>Test Mode :</b>	RMC 12.2Kbps Link (QPSK)		<b>Relative Humidity :</b>	46~48%					
<b>Test Engineer :</b>	James Chiu and Derreck Chen		<b>Polarization :</b>	Vertical					
<b>Remark :</b>	Spurious emissions within 30-1000MHz were found more than 20dB below limit line.								
Frequency ( MHz )	ERP ( dBm )	Limit ( dBm )	Over Limit ( dB )	SPA Reading ( dBm )	S.G. Power ( dBm )	TX Cable loss ( dB )	TX Antenna Gain ( dBi )	Polarization ( H/V )	Result
1651	-64.13	-13	-51.13	-67.49	-65.88	0.98	4.88	V	Pass
2479	-61.22	-13	-48.22	-71.58	-63.12	1.28	5.34	V	Pass
3298	-66.29	-13	-53.29	-77.97	-69.71	1.54	7.11	V	Pass



<Middle Channel>

<b>Band :</b>	WCDMA Band V	<b>Temperature :</b>	23~24°C						
<b>Test Mode :</b>	RMC 12.2Kbps Link (QPSK)	<b>Relative Humidity :</b>	46~48%						
<b>Test Engineer :</b>	James Chiu and Derreck Chen	<b>Polarization :</b>	Horizontal						
<b>Remark :</b>	Spurious emissions within 30-1000MHz were found more than 20dB below limit line.								
Frequency ( MHz )	ERP ( dBm )	Limit ( dBm )	Over Limit ( dB )	SPA Reading ( dBm )	S.G. Power ( dBm )	TX Cable loss ( dB )	TX Antenna Gain ( dBi )	Polarization ( H/V )	Result
1674	-65.08	-13	-52.08	-69.66	-66.75	0.99	4.81	H	Pass
2512	-64.16	-13	-51.16	-73.75	-66.13	1.29	5.41	H	Pass
3345	-65.50	-13	-52.50	-77.76	-69.11	1.56	7.32	H	Pass

<b>Band :</b>	WCDMA Band V	<b>Temperature :</b>	23~24°C						
<b>Test Mode :</b>	RMC 12.2Kbps Link (QPSK)	<b>Relative Humidity :</b>	46~48%						
<b>Test Engineer :</b>	James Chiu and Derreck Chen	<b>Polarization :</b>	Vertical						
<b>Remark :</b>	Spurious emissions within 30-1000MHz were found more than 20dB below limit line.								
Frequency ( MHz )	ERP ( dBm )	Limit ( dBm )	Over Limit ( dB )	SPA Reading ( dBm )	S.G. Power ( dBm )	TX Cable loss ( dB )	TX Antenna Gain ( dBi )	Polarization ( H/V )	Result
1674	-63.44	-13	-50.44	-66.76	-65.11	0.99	4.81	V	Pass
2509	-61.26	-13	-48.26	-71.91	-63.22	1.29	5.41	V	Pass
3346	-65.73	-13	-52.73	-77.21	-69.35	1.56	7.32	V	Pass



<High Channel>

<b>Band :</b>	WCDMA Band V	<b>Temperature :</b>	23~24°C						
<b>Test Mode :</b>	RMC 12.2Kbps Link (QPSK)	<b>Relative Humidity :</b>	46~48%						
<b>Test Engineer :</b>	James Chiu and Derreck Chen	<b>Polarization :</b>	Horizontal						
<b>Remark :</b>	Spurious emissions within 30-1000MHz were found more than 20dB below limit line.								
Frequency ( MHz )	ERP ( dBm )	Limit ( dBm )	Over Limit ( dB )	SPA Reading ( dBm )	S.G. Power ( dBm )	TX Cable loss ( dB )	TX Antenna Gain ( dBi )	Polarization ( H/V )	Result
1696	-68.01	-13	-55.01	-72.9	-69.61	1.00	4.75	H	Pass
2539	-61.58	-13	-48.58	-71.53	-63.56	1.30	5.43	H	Pass
3395	-65.07	-13	-52.07	-77.71	-68.89	1.57	7.54	H	Pass

<b>Band :</b>	WCDMA Band V	<b>Temperature :</b>	23~24°C						
<b>Test Mode :</b>	RMC 12.2Kbps Link (QPSK)	<b>Relative Humidity :</b>	46~48%						
<b>Test Engineer :</b>	James Chiu and Derreck Chen	<b>Polarization :</b>	Vertical						
<b>Remark :</b>	Spurious emissions within 30-1000MHz were found more than 20dB below limit line.								
Frequency ( MHz )	ERP ( dBm )	Limit ( dBm )	Over Limit ( dB )	SPA Reading ( dBm )	S.G. Power ( dBm )	TX Cable loss ( dB )	TX Antenna Gain ( dBi )	Polarization ( H/V )	Result
1696	-65.56	-13	-52.56	-69.55	-67.16	1.00	4.75	V	Pass
2542	-60.16	-13	-47.16	-70.65	-62.14	1.30	5.43	V	Pass
3395	-65.39	-13	-52.39	-77.26	-69.21	1.57	7.54	V	Pass



<Low Channel>

<b>Band :</b>	WCDMA Band IV		<b>Temperature :</b>	23~24°C					
<b>Test Mode :</b>	RMC 12.2Kbps Link (QPSK)		<b>Relative Humidity :</b>	46~48%					
<b>Test Engineer :</b>	James Chiu and Derreck Chen		<b>Polarization :</b>	Horizontal					
<b>Remark :</b>	Spurious emissions within 30-1000MHz were found more than 20dB below limit line.								
Frequency ( MHz )	EIRP ( dBm )	Limit ( dBm )	Over Limit ( dB )	SPA Reading ( dBm )	S.G. Power ( dBm )	TX Cable loss ( dB )	TX Antenna Gain ( dBi )	Polarization ( H/V )	Result
3427	-62.13	-13	-49.13	-74.87	-68.23	1.58	7.68	H	Pass
5142	-53.77	-13	-40.77	-73.22	-61.05	2.42	9.70	H	Pass
6850	-41.05	-13	-28.05	-64.44	-49.03	2.64	10.62	H	Pass

<b>Band :</b>	WCDMA Band IV		<b>Temperature :</b>	23~24°C					
<b>Test Mode :</b>	RMC 12.2Kbps Link (QPSK)		<b>Relative Humidity :</b>	46~48%					
<b>Test Engineer :</b>	James Chiu and Derreck Chen		<b>Polarization :</b>	Vertical					
<b>Remark :</b>	Spurious emissions within 30-1000MHz were found more than 20dB below limit line.								
Frequency ( MHz )	EIRP ( dBm )	Limit ( dBm )	Over Limit ( dB )	SPA Reading ( dBm )	S.G. Power ( dBm )	TX Cable loss ( dB )	TX Antenna Gain ( dBi )	Polarization ( H/V )	Result
3427	-64.12	-13	-51.12	-76.83	-70.22	1.58	7.68	V	Pass
5142	-59.91	-13	-46.91	-78.15	-67.19	2.42	9.70	V	Pass
6850	-47.13	-13	-34.13	-70.04	-55.11	2.64	10.62	V	Pass



<Middle Channel>

<b>Band :</b>	WCDMA Band IV	<b>Temperature :</b>	23~24°C						
<b>Test Mode :</b>	RMC 12.2Kbps Link (QPSK)	<b>Relative Humidity :</b>	46~48%						
<b>Test Engineer :</b>	James Chiu and Derreck Chen	<b>Polarization :</b>	Horizontal						
<b>Remark :</b>	Spurious emissions within 30-1000MHz were found more than 20dB below limit line.								
Frequency ( MHz )	EIRP ( dBm )	Limit ( dBm )	Over Limit ( dB )	SPA Reading ( dBm )	S.G. Power ( dBm )	TX Cable loss ( dB )	TX Antenna Gain ( dBi )	Polarization ( H/V )	Result
3462	-60.21	-13	-47.21	-73.65	-66.45	1.59	7.83	H	Pass
5198	-51.06	-13	-38.06	-70.51	-58.31	2.45	9.70	H	Pass
6927	-42.76	-13	-29.76	-66.23	-50.86	2.61	10.71	H	Pass

<b>Band :</b>	WCDMA Band IV	<b>Temperature :</b>	23~24°C						
<b>Test Mode :</b>	RMC 12.2Kbps Link (QPSK)	<b>Relative Humidity :</b>	46~48%						
<b>Test Engineer :</b>	James Chiu and Derreck Chen	<b>Polarization :</b>	Vertical						
<b>Remark :</b>	Spurious emissions within 30-1000MHz were found more than 20dB below limit line.								
Frequency ( MHz )	EIRP ( dBm )	Limit ( dBm )	Over Limit ( dB )	SPA Reading ( dBm )	S.G. Power ( dBm )	TX Cable loss ( dB )	TX Antenna Gain ( dBi )	Polarization ( H/V )	Result
3462	-63.40	-13	-50.40	-76.63	-69.64	1.59	7.83	V	Pass
5198	-57.08	-13	-44.08	-75.68	-64.33	2.45	9.70	V	Pass
6934	-46.95	-13	-33.95	-70.29	-55.06	2.61	10.72	V	Pass



<High Channel>

<b>Band :</b>	WCDMA Band IV	<b>Temperature :</b>	23~24°C						
<b>Test Mode :</b>	RMC 12.2Kbps Link (QPSK)	<b>Relative Humidity :</b>	46~48%						
<b>Test Engineer :</b>	James Chiu and Derreck Chen	<b>Polarization :</b>	Horizontal						
<b>Remark :</b>	Spurious emissions within 30-1000MHz were found more than 20dB below limit line.								
Frequency ( MHz )	EIRP ( dBm )	Limit ( dBm )	Over Limit ( dB )	SPA Reading ( dBm )	S.G. Power ( dBm )	TX Cable loss ( dB )	TX Antenna Gain ( dBi )	Polarization ( H/V )	Result
3504	-62.49	-13	-49.49	-76.09	-68.89	1.61	8.00	H	Pass
5254	-51.89	-13	-38.89	-71.13	-59.11	2.48	9.70	H	Pass
7011	-47.24	-13	-34.24	-71.17	-55.48	2.59	10.82	H	Pass

<b>Band :</b>	WCDMA Band IV	<b>Temperature :</b>	23~24°C						
<b>Test Mode :</b>	RMC 12.2Kbps Link (QPSK)	<b>Relative Humidity :</b>	46~48%						
<b>Test Engineer :</b>	James Chiu and Derreck Chen	<b>Polarization :</b>	Vertical						
<b>Remark :</b>	Spurious emissions within 30-1000MHz were found more than 20dB below limit line.								
Frequency ( MHz )	EIRP ( dBm )	Limit ( dBm )	Over Limit ( dB )	SPA Reading ( dBm )	S.G. Power ( dBm )	TX Cable loss ( dB )	TX Antenna Gain ( dBi )	Polarization ( H/V )	Result
3504	-62.91	-13	-49.91	-76.83	-69.31	1.61	8.00	V	Pass
5254	-57.55	-13	-44.55	-76.36	-64.77	2.48	9.70	V	Pass
7011	-49.75	-13	-36.75	-73.3	-57.99	2.59	10.82	V	Pass



<Low Channel>

<b>Band :</b>	WCDMA Band II		<b>Temperature :</b>	23~24°C					
<b>Test Mode :</b>	RMC 12.2Kbps Link (QPSK)		<b>Relative Humidity :</b>	46~48%					
<b>Test Engineer :</b>	James Chiu and Derreck Chen		<b>Polarization :</b>	Horizontal					
<b>Remark :</b>	Spurious emissions within 30-1000MHz were found more than 20dB below limit line.								
Frequency ( MHz )	EIRP ( dBm )	Limit ( dBm )	Over Limit ( dB )	SPA Reading ( dBm )	S.G. Power ( dBm )	TX Cable loss ( dB )	TX Antenna Gain ( dBi )	Polarization ( H/V )	Result
3708	-60.39	-13	-47.39	-74.91	-66.97	1.67	8.25	H	Pass
5560	-50.19	-13	-37.19	-70.33	-57.25	2.66	9.72	H	Pass
7416	-51.30	-13	-38.30	-76.84	-60.48	2.46	11.63	H	Pass
12964	-41.63	-13	-28.63	-79.3	-51.67	2.92	12.96	H	Pass

<b>Band :</b>	WCDMA Band II		<b>Temperature :</b>	23~24°C					
<b>Test Mode :</b>	RMC 12.2Kbps Link (QPSK)		<b>Relative Humidity :</b>	46~48%					
<b>Test Engineer :</b>	James Chiu and Derreck Chen		<b>Polarization :</b>	Vertical					
<b>Remark :</b>	Spurious emissions within 30-1000MHz were found more than 20dB below limit line.								
Frequency ( MHz )	EIRP ( dBm )	Limit ( dBm )	Over Limit ( dB )	SPA Reading ( dBm )	S.G. Power ( dBm )	TX Cable loss ( dB )	TX Antenna Gain ( dBi )	Polarization ( H/V )	Result
3708	-63.73	-13	-50.73	-78.14	-70.31	1.67	8.25	V	Pass
5560	-56.56	-13	-43.56	-75.22	-63.62	2.66	9.72	V	Pass
7416	-55.01	-13	-42.01	-79.27	-64.19	2.46	11.63	V	Pass
12964	-47.07	-13	-34.07	-80.69	-57.11	2.92	12.96	V	Pass



<Middle Channel>

<b>Band :</b>	WCDMA Band II		<b>Temperature :</b>	23~24°C					
<b>Test Mode :</b>	RMC 12.2Kbps Link (QPSK)		<b>Relative Humidity :</b>	46~48%					
<b>Test Engineer :</b>	James Chiu and Derreck Chen		<b>Polarization :</b>	Horizontal					
<b>Remark :</b>	Spurious emissions within 30-1000MHz were found more than 20dB below limit line.								
Frequency ( MHz )	EIRP ( dBm )	Limit ( dBm )	Over Limit ( dB )	SPA Reading ( dBm )	S.G. Power ( dBm )	TX Cable loss ( dB )	TX Antenna Gain ( dBi )	Polarization ( H/V )	Result
3764	-61.18	-13	-48.18	-75.9	-67.81	1.69	8.32	H	Pass
5644	-51.69	-13	-38.69	-71.6	-58.74	2.71	9.76	H	Pass
7528	-54.17	-13	-41.17	-79.14	-63.57	2.42	11.82	H	Pass

<b>Band :</b>	WCDMA Band II		<b>Temperature :</b>	23~24°C					
<b>Test Mode :</b>	RMC 12.2Kbps Link (QPSK)		<b>Relative Humidity :</b>	46~48%					
<b>Test Engineer :</b>	James Chiu and Derreck Chen		<b>Polarization :</b>	Vertical					
<b>Remark :</b>	Spurious emissions within 30-1000MHz were found more than 20dB below limit line.								
Frequency ( MHz )	EIRP ( dBm )	Limit ( dBm )	Over Limit ( dB )	SPA Reading ( dBm )	S.G. Power ( dBm )	TX Cable loss ( dB )	TX Antenna Gain ( dBi )	Polarization ( H/V )	Result
3764	-63.73	-13	-50.73	-78.01	-70.36	1.69	8.32	V	Pass
5644	-58.73	-13	-45.73	-77.15	-65.78	2.71	9.76	V	Pass
7528	-55.23	-13	-42.23	-79.34	-64.63	2.42	11.82	V	Pass





<High Channel>

<b>Band :</b>	WCDMA Band II	<b>Temperature :</b>	23~24°C						
<b>Test Mode :</b>	RMC 12.2Kbps Link (QPSK)	<b>Relative Humidity :</b>	46~48%						
<b>Test Engineer :</b>	James Chiu and Derreck Chen	<b>Polarization :</b>	Horizontal						
<b>Remark :</b>	Spurious emissions within 30-1000MHz were found more than 20dB below limit line.								
Frequency ( MHz )	EIRP ( dBm )	Limit ( dBm )	Over Limit ( dB )	SPA Reading ( dBm )	S.G. Power ( dBm )	TX Cable loss ( dB )	TX Antenna Gain ( dBi )	Polarization ( H/V )	Result
3816	-60.56	-13	-47.56	-75.35	-67.24	1.70	8.38	H	Pass
5728	-50.08	-13	-37.08	-70.22	-57.11	2.76	9.79	H	Pass
7632	-54.33	-13	-41.33	-79.08	-63.82	2.39	11.88	H	Pass

<b>Band :</b>	WCDMA Band II	<b>Temperature :</b>	23~24°C						
<b>Test Mode :</b>	RMC 12.2Kbps Link (QPSK)	<b>Relative Humidity :</b>	46~48%						
<b>Test Engineer :</b>	James Chiu and Derreck Chen	<b>Polarization :</b>	Vertical						
<b>Remark :</b>	Spurious emissions within 30-1000MHz were found more than 20dB below limit line.								
Frequency ( MHz )	EIRP ( dBm )	Limit ( dBm )	Over Limit ( dB )	SPA Reading ( dBm )	S.G. Power ( dBm )	TX Cable loss ( dB )	TX Antenna Gain ( dBi )	Polarization ( H/V )	Result
3816	-64.05	-13	-51.05	-78.16	-70.73	1.70	8.38	V	Pass
5728	-56.08	-13	-43.08	-75.07	-63.11	2.76	9.79	V	Pass
7632	-55.65	-13	-42.65	-79.65	-65.14	2.39	11.88	V	Pass



### 3.8 Frequency Stability Measurement

#### 3.8.1 Description of Frequency Stability Measurement

The frequency stability shall be measured by variation of ambient temperature and variation of primary supply voltage to ensure that the fundamental emission stays within the authorized frequency block. The frequency stability of the transmitter shall be maintained within  $\pm 0.00025\%$  ( $\pm 2.5\text{ppm}$ ) of the center frequency.

#### 3.8.2 Measuring Instruments

The measuring equipment is listed in the section 4 of this test report.

#### 3.8.3 Test Procedures for Temperature Variation

1. The testing follows FCC KDB 971168 v02r02 Section 9.0.
2. The EUT was set up in the thermal chamber and connected with the system simulator.
3. With power OFF, the temperature was decreased to  $-30^{\circ}\text{C}$  and the EUT was stabilized before testing. Power was applied and the maximum change in frequency was recorded within one minute.
4. With power OFF, the temperature was raised in  $10^{\circ}\text{C}$  steps up to  $50^{\circ}\text{C}$ . The EUT was stabilized at each step for at least half an hour. Power was applied and the maximum frequency change was recorded within one minute.

#### 3.8.4 Test Procedures for Voltage Variation

1. The testing follows FCC KDB 971168 v02r02 Section 9.0.
2. The EUT was placed in a temperature chamber at  $25\pm 5^{\circ}\text{C}$  and connected with the system simulator.
3. The power supply voltage to the EUT was varied from BEP to 115% of the nominal value measured at the input to the EUT.
4. The variation in frequency was measured for the worst case.

### 3.8.5 Test Setup

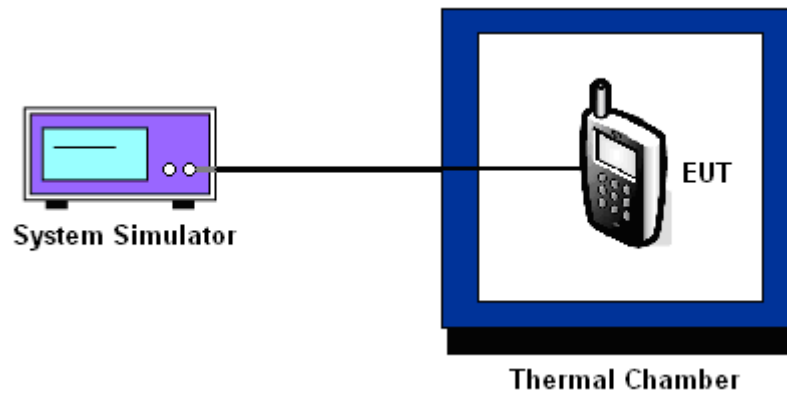

### 3.8.6 Test Result of Temperature Variation

Band :	GSM 850	Channel :	189
Limit (ppm) :	2.5	Frequency :	836.4 MHz

Temperature (°C)	GSM	EDGE class 8	Result
	Deviation (ppm)	Deviation (ppm)	
50	0.0407	0.0072	PASS
40	0.0335	0.0048	
30	0.0048	0.0012	
20(Ref.)	0.0000	0.0000	
10	0.0012	0.0323	
0	0.0036	0.0323	
-10	0.0024	0.0299	
-20	0.0012	0.0359	
-30	0.0048	0.0287	



<b>Band :</b>	GSM 1900	<b>Channel :</b>	661
<b>Limit (ppm) :</b>	within authorized band	<b>Frequency :</b>	1880.0 MHz

Temperature (°C)	GSM	EDGE class 8	Result
	Deviation (ppm)	Deviation (ppm)	
50	0.0170	0.0021	PASS
40	0.0154	0.0032	
30	0.0016	0.0016	
20(Ref.)	0.0000	0.0000	
10	0.0011	0.0149	
0	0.0000	0.0176	
-10	0.0005	0.0149	
-20	0.0000	0.0186	
-30	0.0032	0.0165	

**Note:** The frequency fundamental emissions stay within the authorized frequency block based on the frequency deviation measured is small.

<b>Band :</b>	WCDMA Band V	<b>Channel :</b>	4182
<b>Limit (ppm) :</b>	2.5	<b>Frequency :</b>	836.4 MHz

Temperature (°C)	RMC 12.2Kbps	Result
	Deviation (ppm)	
50	0.0012	PASS
40	0.0155	
30	0.0000	
20(Ref.)	0.0000	
10	0.0120	
0	0.0012	
-10	0.0012	
-20	0.0155	
-30	0.0132	



<b>Band :</b>	WCDMA Band IV	<b>Channel :</b>	1413
<b>Limit (ppm) :</b>	within authorized band	<b>Frequency :</b>	1732.6 MHz

Temperature (°C)	RMC 12.2Kbps	Result
	Deviation (ppm)	
50	0.0087	PASS
40	0.0092	
30	0.0098	
20(Ref.)	0.0000	
10	0.0081	
0	0.0098	
-10	0.0081	
-20	0.0075	
-30	0.0081	

**Note:** The frequency fundamental emissions stay within the authorized frequency block based on the frequency deviation measured is small.

<b>Band :</b>	WCDMA Band II	<b>Channel :</b>	9400
<b>Limit (ppm) :</b>	within authorized band	<b>Frequency :</b>	1880.0 MHz

Temperature (°C)	RMC 12.2Kbps	Result
	Deviation (ppm)	
50	0.0085	PASS
40	0.0080	
30	0.0085	
20(Ref.)	0.0000	
10	0.0080	
0	0.0005	
-10	0.0101	
-20	0.0085	
-30	0.0011	

**Note:** The frequency fundamental emissions stay within the authorized frequency block based on the frequency deviation measured is small.



3.8.7 Test Result of Voltage Variation

Band & Channel	Mode	Voltage (Volt)	Deviation (ppm)	Limit (ppm)	Result
GSM 850 CH189	GSM	4.10	0.0012	2.5	PASS
		3.70	0.0395		
		BEP	0.0036		
	EDGE class 8	4.10	0.0323		
		3.70	0.0036		
		BEP	0.0012		
GSM 1900 CH661	GSM	4.10	0.0016	(Note 3.)	
		3.70	0.0165		
		BEP	0.0000		
	EDGE class 8	4.10	0.0160		
		3.70	0.0149		
		BEP	0.0016		
WCDMA Band V CH4182	RMC 12.2Kbps	4.10	0.0155	2.5	
		3.70	0.0143		
		BEP	0.0024		
WCDMA Band IV CH1413	RMC 12.2Kbps	4.10	0.0075	(Note 3.)	
		3.70	0.0081		
		BEP	0.0098		
WCDMA Band II CH9400	RMC 12.2Kbps	4.10	0.0090	(Note 3.)	
		3.70	0.0005		
		BEP	0.0074		

Note:

1. Normal Voltage = 3.70V.
2. Battery End Point (BEP) = 3.50 V.
3. The frequency fundamental emissions stay within the authorized frequency block based on the frequency deviation measured is small.



## 4 List of Measuring Equipment

Instrument	Manufacturer	Model No.	Serial No.	Characteristics	Calibration Date	Test Date	Due Date	Remark
System Simulator	Rohde & Schwarz	CMU200	117995	N/A	Jul. 29, 2014	Jan. 23, 2015 ~ Feb. 05, 2015	Jul. 28, 2015	Conducted (TH02-HY)
Spectrum Analyzer	Rohde & Schwarz	FSP30	101329	9kHz~30GHz	Jun. 14, 2014	Jan. 23, 2015 ~ Feb. 05, 2015	Jun. 13, 2015	Conducted (TH02-HY)
Temperature Chamber	ESPEC	SU-641	92013721	-30 ~70	Dec. 01, 2014	Jan. 23, 2015 ~ Feb. 05, 2015	Nov. 30, 2015	Conducted (TH02-HY)
Hygrometer	Testo	608-H1	34893241	N/A	May. 06, 2014	Jan. 23, 2015 ~ Feb. 05, 2015	May. 05, 2015	Conducted (TH02-HY)
RF cable	WOKEN	S05	S05-130708-2 2	N/A	Jan. 21, 2015	Jan. 23, 2015 ~ Feb. 05, 2015	Jan. 20, 2016	Conducted (TH02-HY)
Preamplifier	Keysight	83017A	MY53270080	1GHz~26.5GHz	Nov. 20, 2014	Jan. 29, 2015 ~ Feb. 16, 2015	Nov. 19, 2015	Radiation (03CH11-HY)
Amplifier	SONOMA	310N	187312	0.1MHz~1000MHz	Nov. 24, 2014	Jan. 29, 2015 ~ Feb. 16, 2015	Nov. 23, 2015	Radiation (03CH11-HY)
Preamplifier	MITEQ	JS44-18004 000-33-8P	1840917	18GHz ~ 40GHz	Jun. 09, 2014	Jan. 29, 2015 ~ Feb. 16, 2015	Jun. 08, 2015	Radiation (03CH11-HY)
Bilog Antenna	TESEQ	CBL 6111D	35414	30MHz~1GHz	Oct. 24, 2014	Jan. 29, 2015 ~ Feb. 16, 2015	Oct. 23, 2015	Radiation (03CH11-HY)
Double Ridged Guide Horn	SCHWARZBECK	BBHA 9120 D	9120D-1326	1GHz ~ 18GHz	Oct. 03, 2014	Jan. 29, 2015 ~ Feb. 16, 2015	Oct. 02, 2015	Radiation (03CH11-HY)
Horn Antenna	SCHWARZBECK	BBHA 9170	BBHA917058 4	18GHz- 40GHz	Nov. 03, 2014	Jan. 29, 2015 ~ Feb. 16, 2015	Nov. 02, 2015	Radiation (03CH11-HY)
Spectrum Analyzer	Keysight	N9010A	MY54200486	N/A	Sep. 24, 2014	Jan. 29, 2015 ~ Feb. 16, 2015	Sep. 23, 2015	Radiation (03CH11-HY)
EMI Test Receiver	Keysight	N9038A	MY54130085	20Hz ~ 26.5GHz	Nov. 05, 2014	Jan. 29, 2015 ~ Feb. 16, 2015	Nov. 04, 2015	Radiation (03CH11-HY)
Controller	EMEC	EM 1000	N/A	1m-4m	N/A	Jan. 29, 2015 ~ Feb. 16, 2015	N/A	Radiation (03CH11-HY)
Turn Table	EMEC	TT 2000	N/A	0-360 degree	N/A	Jan. 29, 2015 ~ Feb. 16, 2015	N/A	Radiation (03CH11-HY)
Antenna Mast	EMEC	AM-BS-450 0-B	N/A	N/A	N/A	Jan. 29, 2015 ~ Feb. 16, 2015	N/A	Radiation (03CH11-HY)
Hygrometer	TECPEL	DTN-303B	TP140325	N/A	Nov. 19, 2014	Jan. 29, 2015 ~ Feb. 16, 2015	Nov. 18, 2015	Radiation (03CH11-HY)
RF Cable	HUBER + SUHNER	SUCOFLEX 104	MY44614PE MY249674	25GHz~40GHz	Nov. 06, 2014	Jan. 29, 2015 ~ Feb. 16, 2015	Nov. 05, 2015	Radiation (03CH11-HY)
RF Cable	HUBER + SUHNER	SUCOFLEX 104	MY44614PE MY249674MY	30MHz~1GHz	Nov. 06, 2014	Jan. 29, 2015 ~ Feb. 16, 2015	Nov. 05, 2015	Radiation (03CH11-HY)
RF Cable	HUBER + SUHNER	SUCOFLEX 104	MY44614PE MY249674MY	1GHz~25GHz	Nov. 06, 2014	Jan. 29, 2015 ~ Feb. 16, 2015	Nov. 05, 2015	Radiation (03CH11-HY)

**Note:** Test equipment calibration is traceable to the procedure of ISO17025.



## 5 Uncertainty of Evaluation

### Uncertainty of Radiated Emission Measurement (30 MHz ~ 1000 MHz)

Measuring Uncertainty for a Level of Confidence of 95% ( $U = 2Uc(y)$ )	4.90
---	------