



TEST REPORT

No. I15Z40385-SRD07

for

Sony Mobile Communications Inc.

GSM/WCDMA/LTE Mobile Phone

FCC ID: PY7-PM0817

with

Hardware Version: A

Software Version: 23.0.F.0.56

Issued Date: 2015-04-21

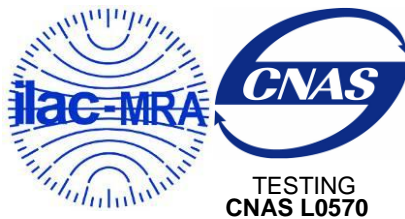

Note:

The test results in this test report relate only to the devices specified in this report. This report shall not be reproduced except in full without the written approval of CTTL.

Test Laboratory:

CTTL, Telecommunication Technology Labs, Academy of Telecommunication Research, MIIT

No. 52, Huayuan North Road, Haidian District, Beijing, P. R. China 100191.

Tel:+86(0)10-62304633-2512, Fax:+86(0)10-62304633-2504

Email: ctl_terminals@catr.cn, website: www.chinattl.com



CONTENTS

1. BTEST LABORATORY	3
1.1. 8BTESTING LOCATION	3
1.2. 9BTESTING ENVIRONMENT.....	3
1.3. 10BPROJECT DATA	3
1.4. 11BSIGNATURE	3
2. BCLIENT INFORMATION	4
2.1. 12BAPPLICANT INFORMATION	4
2.2. 13BMANUFACTURER INFORMATION.....	4
3. BEQUIPMENT UNDER TEST (EUT) AND ANCILLARY EQUIPMENT (AE)	5
3.1. 14BABOUT EUT	5
3.2. 15BINTERNAL IDENTIFICATION OF EUT USED DURING THE TEST	5
3.3. 16BINTERNAL IDENTIFICATION OF AE USED DURING THE TEST.....	5
3.4. 17BGENERAL DESCRIPTION.....	6
3.5. 18BEUT SET-UPS	6
4. BREFERENCE DOCUMENTS	6
4.1. 19BDOCUMENTS SUPPLIED BY THE APPLICANT	6
4.2. 20BREGULATIONS AND STANDARDS.....	6
5. BLABORATORY ENVIRONMENT	7
6. BSUMMARY OF TEST RESULTS.....	8
6.1. 21BSUMMARY OF TEST RESULTS.....	8
6.2. 22BTERMS USED IN THE SUMMARY OF TEST RESULTS	9
6.3. 23BSTATEMENTS.....	9
7. BTEST EQUIPMENTS UTILIZED	10
ANNEX A: MEASUREMENT RESULTS.....	11
24BA.1. ELECTRIC FIELD STRENGTH OF FUNDAMENTAL AND OUTSIDE THE ALLOCATED BANDS	11
25BA.2. ELECTRIC FIELD RADIATED EMISSIONS (< 30MHZ)	13
26BA.3. ELECTRIC FIELD RADIATED EMISSIONS (≥30MHZ)	15
27BA.4. FREQUENCY TOLERANCE	17
28BA.5. 20DB BANDWIDTH.....	18
29BA.6. CONDUCTED EMISSION	19
FINAL RESULT.....	21
ANNEX C: TEST LAYOUT	23

1. Test Laboratory

1.1. Testing Location

Company Name: CTTL Beijing, Telecommunication Metrology Center of MIIT
Address: No 52, Huayuanbei Road, Haidian District, Beijing, P.R.China
Postal Code: 100191
Telephone: +86-10-62304633-2678
Fax: +86-10-62304633-2504

1.2. Testing Environment

Ambient Temperature: 15 ~ 25 °C
Relative Humidity: 30 ~ 60 %
Air pressure 860 ~ 1060 mbar

1.3. Project Data

Receipt of Sample: Jul. 08th, 2014
Testing Start Date: Jul. 16th, 2014
Testing End Date: Jul. 26th, 2014

1.4. Signature

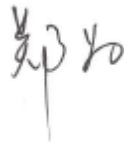

Zheng Wei
(Prepared this test report)

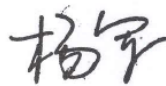

Yang Jun
(Reviewed this test report)

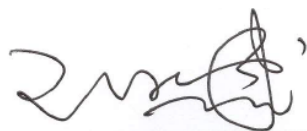

Wang Hongbo
Deputy Director of the laboratory
(Approved this test report)



2. Client Information

2.1. Applicant Information

Company Name: Sony Mobile Communications (China) Co. Ltd
Address /Post: Sony Mobile R&D Center, No. 16, Guangshun South Street,
Chaoyang District
City: Beijing
Postal Code: 100102
Country: China
Contact Person: Ma, Gang
Telephone: +86-10-58656312
Fax: +86-10-58659049

2.2. Manufacturer Information

Company Name: Sony Mobile Communications Inc.
Address /Post: 1-8-15 Konan, Minato-ku, Tokyo, 108-0075, Japan
City: Tokyo
Postal Code: 108-0075
Country: Japan

3. Equipment Under Test (EUT) and Ancillary Equipment (AE)

3.1. About EUT

Description:	GSM/WCDMA /LTE mobile phone
FCC ID	PY7-PM0817
With NFC Function:	Yes
Frequency:	13.56 MHz
Antenna:	Internal
Operation Voltage:	3.6VDC to 4.2VDC (nominal: 3.8VDC)
Operation Temperature:	-20°C to +55°C

Note1: Photographs of EUT are shown in ANNEX B of this test report. For component list, please refer to documents of the manufacturer.

3.2. Internal Identification of EUT Used during the Test

Mobile phone identification

EUT ID*	IMEI	HW Version	SW Version
EUT	004402452522083	A	23.0.F.0.56

*EUT ID: is used to identify the test sample in the lab internally.

3.3. Internal Identification of AE Used during the Test

AE ID*	Description	SN	Reversion
AE1	Travel Charger	/	/
AE2	USB Cable	134912A21208328	AP1.0
AE3	Type A CARD	/	/

AE1

Model	EP880
Type	AC-0400-EU
Manufacturer	SALCOMP
Length of cable	98.5 cm (length of USB cable)

AE2

Commercial name	EC803
Type	AI-0404
Manufacturer	Sony Mobile
Length of cable	100 cm

AE3

Type	/
Manufacturer	Gemalto

*AE ID: is used to identify the test sample in the lab internally.

3.4. General Description

This is a product supporting GSM/UMTS/LTE with 2.4G/5G technologies.

Manuals and specifications of the EUT were provided to fulfil the test.

Samples undergoing test were selected by the client.

Manufacturer's declaration: NFC work does not depend on other access methods, such as WLAN, GPRS, etc.

3.5. EUT Set-ups

EUT Set-up No.	Combination of EUT and AE	Remarks
Set. NFC01	EUT1 + AE1 + AE2 + AE3	--
Set. NFC02	EUT1	--
Set. NFC03	EUT1 + AE3	

The Transmit State of NFC: the NFC function is on. The EUT will transmit the NFC data and command continuously during the test.

The Transmit State of without modulation: The EUT will transmit the CW signal at the operating frequency.

4. Reference Documents

4.1. Documents Supplied by the Applicant

EUT feature information is supplied by the applicant or manufacturer, which is the basis of testing.

4.2. Regulations and Standards

The following documents listed in this section are referred for testing.

Reference	Title	Version
CFR 47 Part 2	Part 2 — Frequency Allocations and Radio Treaty Matters; General Rules and Regulations.	2012
CFR 47 Part 15	Part 15 — Radio Frequency Devices. Subpart C — Intentional Radiators. § 15.35 Measurement detector functions and bandwidths. § 15.207 Conducted limits. § 15.209 Radiated emission limits, general requirements. § 15.215 Additional provisions to the general radiated emission limitations. § 15.225 Operation within the band 13.110–14.010 MHz.	2012
ANSI C63.4	American National Standard for Methods of Measurement of Radio-Noise Emissions from Low-Voltage Electrical and Electronic Equipment in the Range of 9 kHz to 40 GHz.	2009

5. LABORATORY ENVIRONMENT

Semi-anechoic chamber SAC-1 (23 meters×17meters×10meters) did not exceed following limits along the EMC testing:

Temperature	Min. = 15 °C, Max. = 35 °C
Relative humidity	Min. = 15 %, Max. = 75 %
Shielding effectiveness	0.014MHz - 1MHz, >60dB; 1MHz - 1000MHz, >90dB.
Electrical insulation	> 2 MΩ
Ground system resistance	< 4Ω
Normalised site attenuation (NSA)	< ± 4 dB, 3m/10m distance, from 30 to 1000 MHz
Site voltage standing-wave ratio (S_{VSWR})	Between 0 and 6 dB, from 1GHz to 18GHz
Uniformity of field strength	Between 0 and 6 dB, from 80 to 3000 MHz

Fully-Anechoic Chamber FAC-3 (8.6m×6.1m×3.85m) did not exceed following limits along the testing:

Temperature	Min. = 15 °C, Max. = 25 °C
Relative humidity	Min. = 30 %, Max. = 60 %
Shielding effectiveness	> 110 dB
Electrical insulation	> 2 MΩ
Ground system resistance	< 1 Ω
Site voltage standing-wave ratio (S_{VSWR})	Between 0 and 6 dB, from 1 to 18GHz
Uniformity of field strength	Between 0 and 6 dB, from 80 to 4000 MHz

Conducted Chamber did not exceed following limits along the testing:

Temperature	Min. = 15 °C, Max. = 25 °C
Relative humidity	Min. = 30 %, Max. = 60 %
Shielding effectiveness	> 110 dB
Electrical insulation	> 2 MΩ
Ground system resistance	< 0.5 Ω

Control Room did not exceed following limits along the testing:

Temperature	Min. = 15 °C, Max. = 25 °C
Relative humidity	Min. =30 %, Max. = 60 %
Shielding effectiveness	> 110 dB
Electrical insulation	> 2 MΩ
Ground system resistance	< 0.5 Ω

6. SUMMARY OF TEST RESULTS

6.1. Summary of Test Results

No	Test Cases	Clause in Regulation	Section in This Report	Verdict
1	Electric Field Strength of Fundamental Emissions	CFR 47 § 15.225(a)	A.1	P(Set. NFC03)
2	Electric Field Strength of Outside the Allocated Bands	CFR 47 § 15.225(b) CFR 47 § 15.225(c)		P(Set. NFC03)
3	Electric Field Radiated Emissions	CFR 47 § 15.209	A.2	P(Set. NFC01)
		CFR 47 § 15.225(d)	A.3	P(Set. NFC01)
4	Frequency Tolerance	CFR 47 § 15.225(e)	A.4	P(Set. NFC02)
5	20dB Bandwidth	CFR 47 § 15.215(c)	A.5	P(Set. NFC02, 03)
6	Conducted Emissions	CFR 47 § 15.207	A.6	P(Set. NFC01)
The measurement is carried out according to ANSI C63.4. See ANNEX A for details.				

Test Conditions:

For this report, all the test cases listed above were tested under normal Temperature, Voltage, Humidity, and Air Pressure. The specific conditions are as following:

Temperature	T min	-20 °C
	T nom	25 °C
	T max	55 °C
Voltage	V min	3.6 V
	V nom	3.8 V
	V max	4.2 V
Humidity	H nom	44%
Air Pressure	A nom	1010 mbar

6.2. Terms Used in the Summary of Test Results

Terms Used in Condition Column:

T nom	Normal Temperature
T min	Low Temperature
T max	High Temperature
V nom	Normal Voltage
V min	Low Voltage
V max	High voltage
H nom	Norm Humidity
A nom	Norm Air Pressure

Terms Used in Verdict Column:

P	Pass, The EUT complies with the essential requirements in the standard.
NP	Not Perform, The test was not performed by CTTL
NA	Not Applicable, The test was not applicable
F	Fail, The EUT does not comply with the essential requirements in the standard

Abbreviations:

AC	Alternating Current
AFH	Adaptive Frequency Hopping
BW	Band Width
E.I.R.P.	equivalent isotropical radiated power
ISM	Industrial, Scientific and Medical
RF	Radio Frequency
Tx	Transmitter

6.3. Statements

The test cases listed in Section 6.1 of this report for the EUT specified in Section 3 were performed by CTTL according to the reference documents in Section 4.

The EUT meets all applicable requirements of the regulations and standards in Section 4.2.

This report only deals with the NFC function among the features described in section 3.

This model is a variant product which FCC ID is PY7-PM0808; all the test result has been derived from test report of PY7-PM0808.

7. Test Equipments Utilized

NO.	NAME	TYPE	SERIES NUMBER	PRODUCER	CAL. DUE DATE	CAL. INTERVAL
1.	Thermal Chamber	PL-2G	343074	ESPEC	2015-05-12	1 Year
2.	Spectrum Analyzer	RSA3408A	B 010277	Tektronix	2015-05-27	1 Year
3.	H-field Antenna	HFH2-Z2	829324/0007	R&S	2015-07-02	1 Year
4.	EMI Antenna	VULB 9163	9163-235	Schwarzbeck	2014-09-28	3 Years
5.	Test Receiver	ESCI	100344	R&S	2015-03-03	1 Year
6.	EMI Antenna	3117	00119024	ETS-Lindgren	2016-01-20	3 Years
7.	EMI Antenna	9117	167	Schwarzbeck	2015-07-06	
8.	EMI Antenna	3117	00058889	ETS-Lindgren	2014-12-20	3 Years
9.	Signal Generator	N5183A	MY49060052	Agilent	2015-03-02	1 Year
10.	Power Amplifier	5S1G4	0341863	AR	/	1 Year
11.	Universal Radio Communication Tester	CMW500	143008	R&S	2014-12-09	1 Year
12.	Universal Radio Communication Tester	CMW500	116588	R&S	2014-10-27	1 Year
13.	Universal Radio Communication Tester	E5515C	MY48363198	Agilent	2015-07-06	1 Year
14.	Spectrum Analyzer	E4440A	MY48250642	Agilent	2015-02-27	1 Year
15.	LISN	ESH2-Z5	829991/012	R&S	2015-04-14	1 Year
16.	Climatic chamber	SH-641	92014694	ESPEC	2015-11-27	1 Year

ANNEX A: MEASUREMENT RESULTS

A.1. Electric Field Strength of Fundamental and Outside the Allocated bands

A.1.1. Reference

See Clause 13.5, Clause 13.4, Clause 8, and Annex E of ANSI C63.4-2009 specifically.
See Clause 4, Clause 5, and Clause 6 of ANSI C63.4-2009 generally.

A.1.2. Measurement Methods

The transmitter carrier output levels (E-Field) from the EUT are measured in a semi-anechoic chamber. The EUT is placed on a non-conductive stand of 80cm high, and at a measurement distance of 3m from the receiving antenna. The center of the receiving loop antenna is 1.0 meter above the ground. The E-field is measured with a shielded loop antenna connected to a measurement receiver. Detected E-field was maximized by rotating the EUT through 360° and adjusting the receiving antenna polarizations. The maximization processes were repeated with the EUT positioned respectively in its three orthogonal axes. The measurements were performed with the peak detector and if required, the quasi-peak detector.

The measurement bandwidth is:

Frequency of Emission (MHz)	RBW/VBW
12.56-14.56	10/30 kHz

The E-field measured at 3m is calculated as:

$$\text{E-field (dB}\mu\text{V/m)} = \text{Rx (dB}\mu\text{V)} + \text{Cable Loss (dB)} + \text{AF@3m (dB/m)}$$

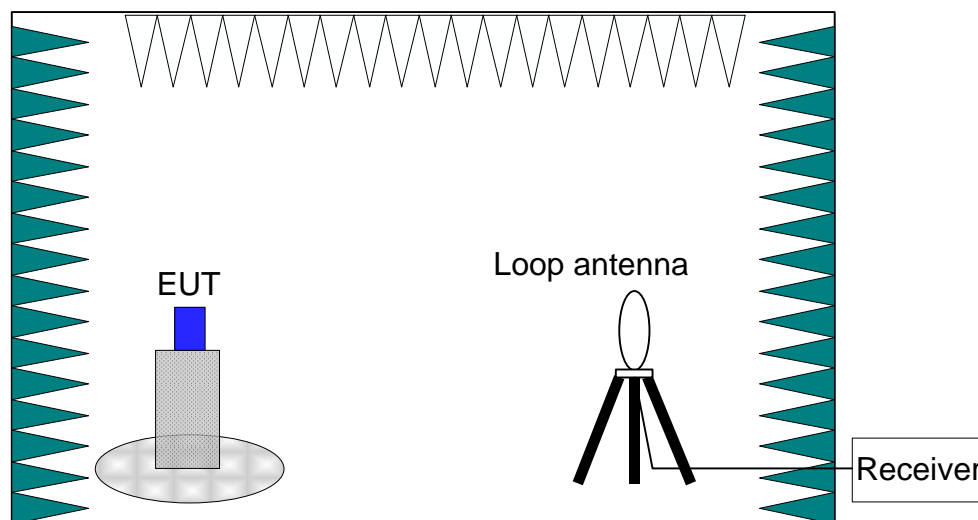

A.1.3. EUT Operating Mode and Test Conditions

The measurement of EUT is carried out under the transmit state of NFC (See 3.5).

The EUT is powered by a travel adapter.

During the measurements, the ambient temperature of the electromagnetic anechoic chamber is

in the range of 15 ~ 25 °C.

A.1.4. Limits

Frequency Range (MHz)	E-field Strength Limit @ 30 m (μV/m)	E-field Strength Limit @ 3 m (dBμV/m)
13.560 ± 0.007	+15,848	124
13.410 to 13.553 13.567 to 13.710	+334	90
13.110 to 13.410 13.710 to 14.010	+106	81

Note: Where the limits have been defined at one distance, and a signal level measured at another, the limits have been extrapolated using the following formula:

$$\text{Extrapolation(dB)} = 40\log_{10}(\text{Measurement Distance}/\text{Specification Distance})$$

A.1.5. Measurement Results

Measurement results of normal conditions see Figure A-1 for different set-ups of EUT. The result displayed take into account applicable antenna factors and cable losses.

Conclusions: Set. NFC03, **PASS**.

RE_FCC_NFC Main Frequency_13.110MHz-14.010MHz

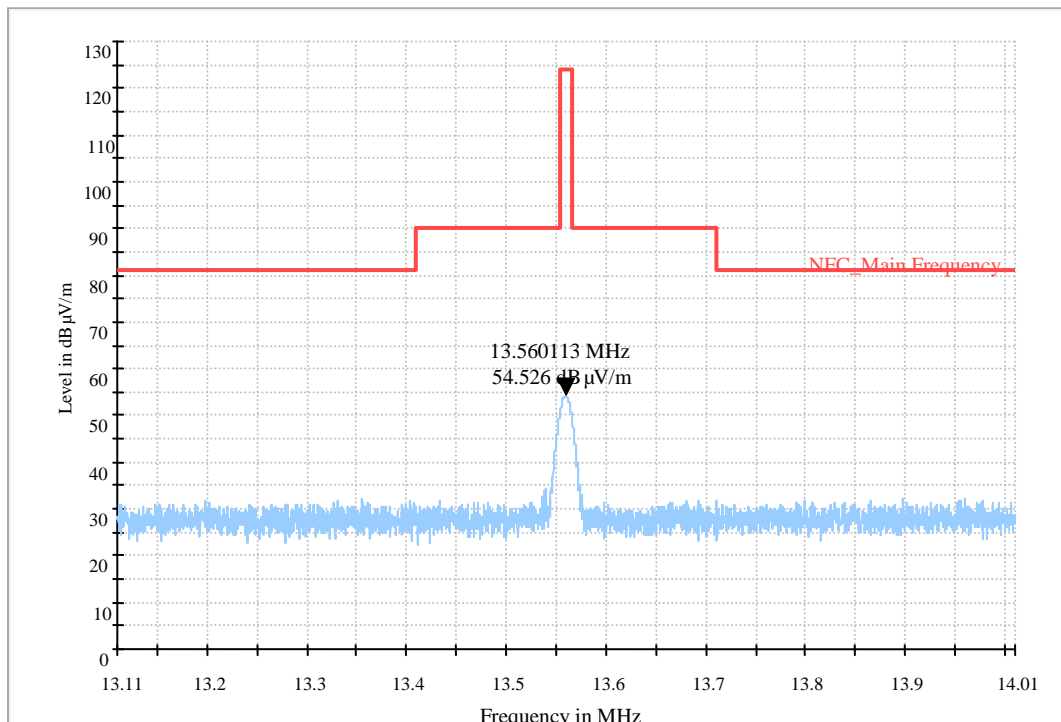

Figure A-1: Set. NFC03

A.1.6. Measurement Uncertainty

Measurement uncertainty: $U = 4.0$ dB, $k=2$.

A.2. Electric Field Radiated Emissions (< 30MHz)

A.2.1. Reference

See Clause 13.4, Clause 8 and Annex E of ANSI C63.4-2009 specifically.
See Clause 4, Clause 5, and Clause 6 of ANSI C63.4-2009 generally.

A.2.2. Measurement Methods

The transmitter carrier output levels (E-Field) from the EUT are measured in a semi-anechoic chamber. The EUT is placed on a non-conductive stand of 80cm high, and at a measurement distance of 3m from the receiving antenna. The center of the receiving loop antenna is 1.0 meter above the ground. The E-field is measured with a shielded loop antenna connected to a measurement receiver. Detected E-field was maximized by rotating the EUT through 360° and adjusting the receiving antenna polarizations. The maximization processes were repeated with the EUT positioned respectively in its three orthogonal axes. The measurements were performed with the peak detector and if required, the quasi-peak detector.

The measurement bandwidth is:

Frequency of Emission (MHz)	RBW/VBW
0.009-0.15	100/300 Hz
0.15-30	10/30 kHz

The E-field measured at 3m is calculated as:

$$\text{E-field (dB}\mu\text{V/m)} = \text{Rx (dB}\mu\text{V)} + \text{Cable Loss (dB)} + \text{AF@3m (dB/m)}$$

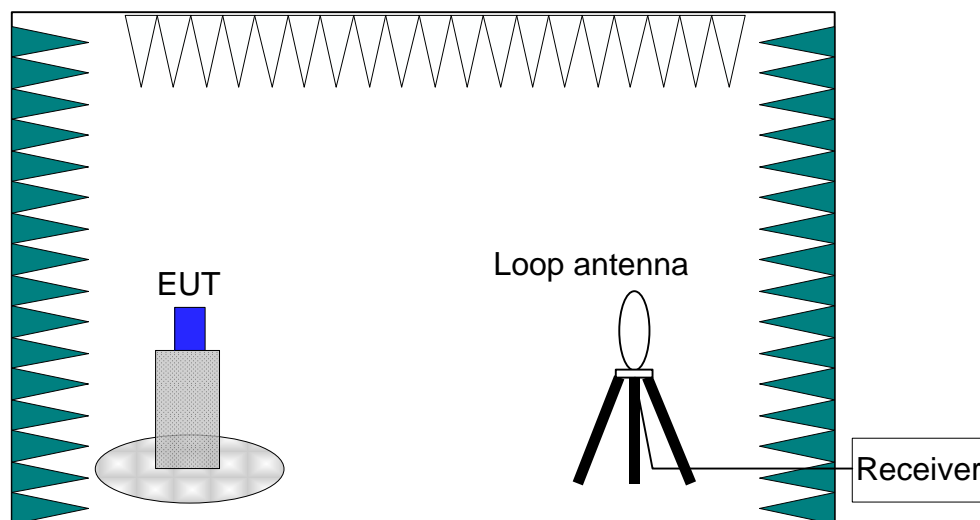

A.2.3. EUT Operating Mode and Test Conditions

The measurement of EUT is carried out under the transmit state of NFC (See 3.5).

The EUT is powered by a travel adapter.

During the measurements, the ambient temperature of the electromagnetic anechoic chamber is

in the range of 15 ~ 25 °C.

A.2.4. Limits

Frequency Range (MHz)	E-field Strength Limit @ 30m (mV/m)	E-field Strength Limit @ 3m (dBµV/m)
0.009-0.490	2400/F(kHz)	129-94
0.490-1.705	24000/F(kHz)	74-63
1.705-30	30	70

Note: Where the limits have been defined at one distance, and a signal level measured at another, the limits have been extrapolated using the following formula:

$$\text{Extrapolation(dB)} = 40\log_{10}(\text{Measurement Distance}/\text{Specification Distance})$$

A.2.5. Measurement Results

Measurement results of normal conditions see Figure A-2 for different set-ups of EUT. The result displayed take into account applicable antenna factors and cable losses.

Conclusions: Set. NFC01, **PASS**.

RE_FCC_NFC_9k-30MHz

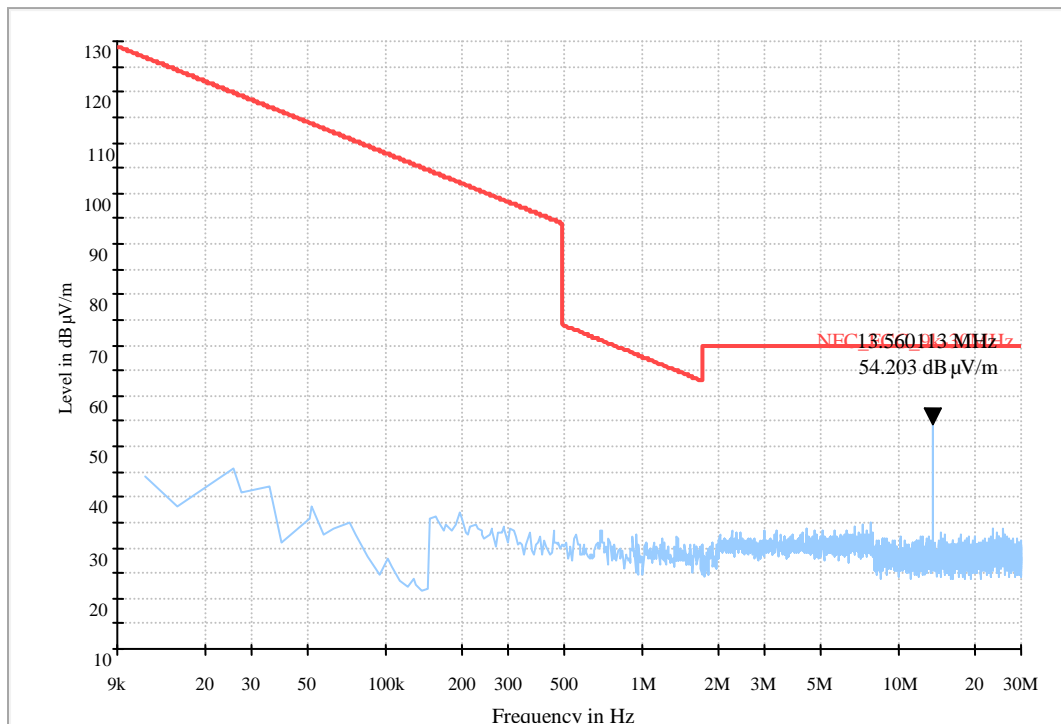

Figure A-2: Set. NFC01

A.2.6. Measurement Uncertainty

Measurement uncertainty: $U = 4.0$ dB, $k=2$.

A.3. Electric Field Radiated Emissions ($\geq 30\text{MHz}$)

A.3.1. Reference

See Clause 13.4, Clause 8, and Annex E of ANSI C63.4-2009 specifically.
See Clause 4, Clause 5, and Clause 6 of ANSI C63.4-2009 generally.

A.3.2. Measurement Methods

The electric field radiated emissions from the EUT are measured in a semi-anechoic chamber. The EUT is placed on a non-conductive stand of 80cm high, and at a measurement distance of 10m from the receiving antenna. The receiving antennas connected to a measurement receiver comply with Clause 15 of ANSI C63.2-1996 and Clause 4.1.5 of ANSI C63.4-2009. In order to search for maximum field strength emitted from the EUT, the receiving antenna can be moved between the height of 1.0 m to 4.0 m. Detected E-field was maximized at each frequency by rotating the EUT through 360° and adjusting the receiving antenna positions for both vertical and horizontal antenna polarizations. The maximization processes were repeated with the EUT positioned respectively in its three orthogonal axes. The measurements were performed with the peak detector and if required, the quasi-peak detector.

The measurement bandwidth is:

Frequency of Emission (MHz)	RBW/VBW
30-1000	120kHz

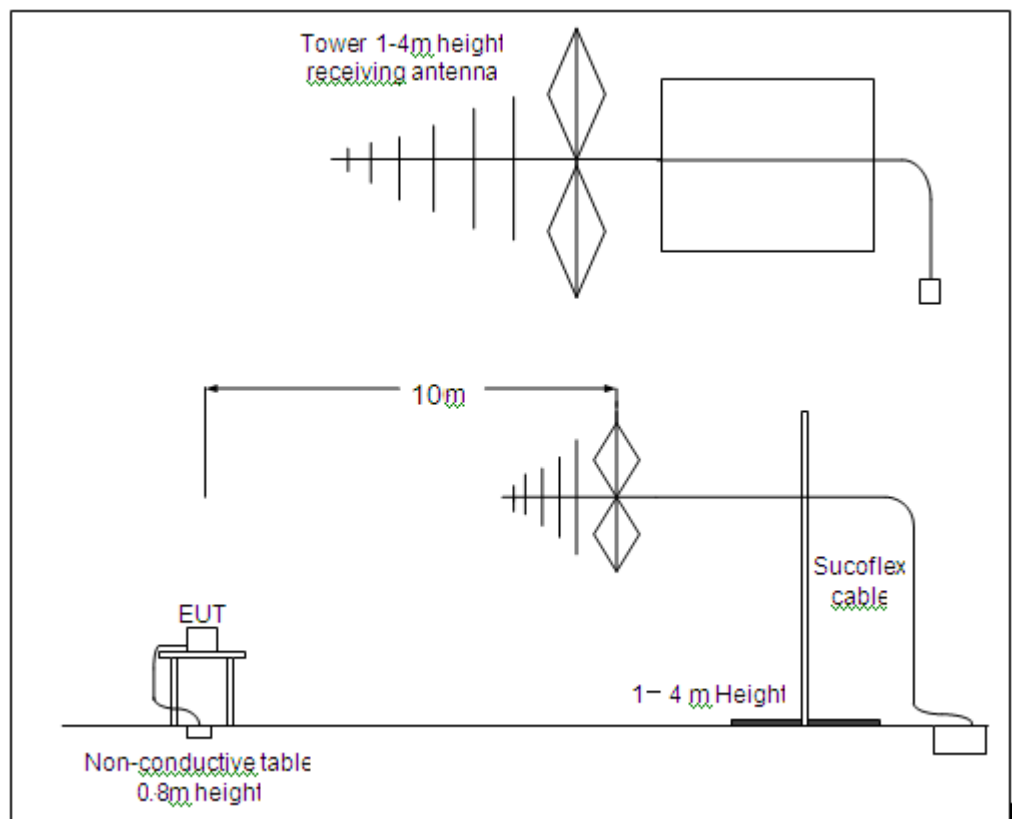

A.3.3. EUT Operating Mode and Test Conditions

The measurement of EUT is carried out under the transmit state of NFC (See 3.5).

EUT1 had been connected to a travel adapter.

During the measurements, the ambient temperature of the electromagnetic anechoic chamber is in the range of 15 ~ 25 °C.

A.3.4. Limits

Frequency Range (MHz)	E-field Strength Limit @ 3m (mV/m)	E-field Strength Limit @ 3m (dB μ V/m)	E-field Strength Limit @ 10m (dB μ V/m)
30-88	100	40	30
88-216	150	43.5	33.5
216-960	200	46	36
960-1000	500	54	44

A.3.5. Measurement Results

Measurement results of normal conditions see Figure A-3 for different set-ups of EUT. The result displayed take into account applicable antenna factors and cable losses.

Conclusions: Set. NFC01, **PASS**.

A.3.6. Measurement Uncertainty

Measurement uncertainty: $U = 3.9$ dB, $k=2$

Normal RE_30M-1GHz_3m

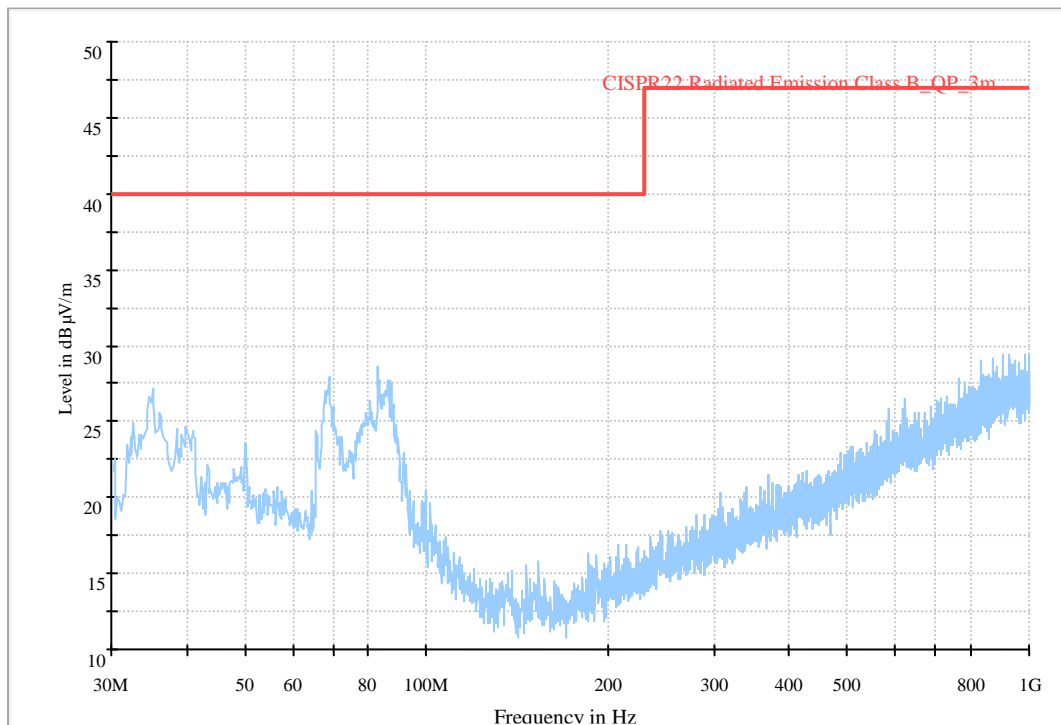

Figure A-3: Set. NFC01

Figure A-4:

A.4. Frequency Tolerance

A.4.1. Reference

See Clause 13.6 of ANSI C63.4-2009 specifically.

See Clause 4, Clause 5, and Clause 6 of ANSI C63.4-2009 generally.

A.4.2. Measurement Methods

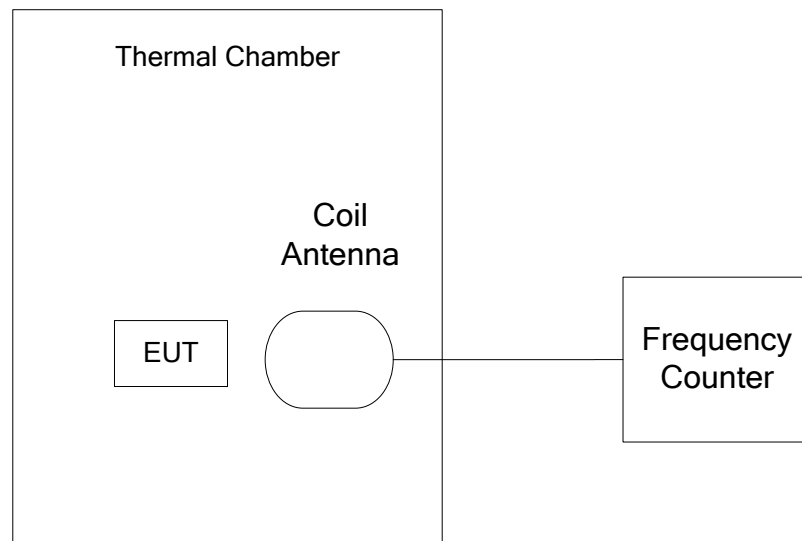

The transmitter output signal was picked up by coil antenna connected to the frequency counter. The center frequency was measured with 30Hz RBW and 1kHz span.

During the test, the EUT was placed in a thermal chamber until thermal balance and lasting appropriate time.

A.4.3. EUT Operating Mode and Test Conditions

The measurement of EUT is carried out under the transmit state of without modulation (See 3.5).

EUT1 had been not connected to a travel adapter.

Operation Temperature: T min, T nom, and T max with V nom.

Operation Voltage: V min and V max with T nom.

A.4.4. Test Layouts

See A.4.2.

A.4.5. Limits

The frequency tolerance of the carrier signal shall be maintained within +/- 0.01% of the operating frequency.

A.4.6. Measurement Results

Measurement results see Table A-1 for different test conditions.

Conclusions: Set. NFC02, **PASS**.

Table A-1: Frequency Stability VS Temperature and Voltage

Temperature	Voltage	Frequency Error (MHz)			
		Startup	2 Min Later	5 Min Later	10 Min Later
T min	V nom	13.559671	13.559684	13.559658	13.55959
T max	V nom	13.559771	13.559682	13.559687	13.559673
T nom	V nom	13.559784	13.559682	13.559673	13.559687
T nom	V min	13.559623	13.559686	13.559681	13.559687
T nom	V max	13.559379	13.559683	13.559673	13.559681

Temperature	Voltage	Frequency Error (%)			
		Startup	2 Min Later	5 Min Later	10 Min Later
T min	V nom	-0.002	-0.002	-0.002	-0.002
T max	V nom	-0.002	-0.002	-0.002	-0.002
T nom	V nom	-0.002	-0.002	-0.002	-0.002
T nom	V min	-0.002	-0.002	-0.002	-0.002
T nom	V max	-0.004	-0.002	-0.002	-0.002

A.4.7. Measurement Uncertainty

Measurement uncertainty: $U = 77 \text{ Hz}$, $k=2$

A.5. 20dB Bandwidth

A.5.1. Reference

See Clause 13.7 of ANSI C63.4-2009 specifically.

See Clause 4, Clause 5, and Clause 6 of ANSI C63.4-2009 generally.

A.5.2. Measurement Methods

The transmitter output signal was picked up by coil antenna to the spectrum analyzer.

The transmitter output signal was picked up by coil antenna connected to the spectrum analyzer.

The bandwidth of the center frequency was measured with 140Hz RBW, 420Hz VBW and 14kHz span.

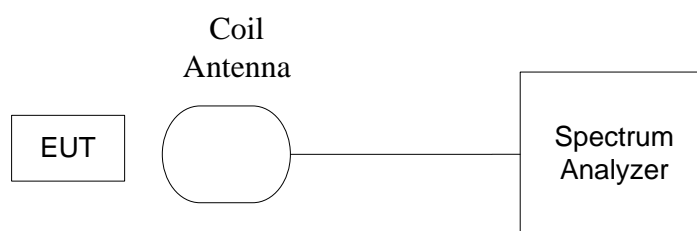

A.5.3. EUT Operating Mode and Test Conditions

The measurement of EUT is carried out under the transmit state of NFC and without modulation (See 3.5).

EUT had been not connected to a travel adapter..

During the measurements, the ambient temperature is in the range of 15 ~ 25 °C.

A.5.4. Test Layouts

See A.5.2.

A.5.5. Limits

The 20dB bandwidth shall be less than 80% of the permitted frequency band. For 13.56 MHz NFC, the permitted frequency band is 14kHz, so the limit is 11.2 kHz.

A.5.6. Measurement Results

Measurement results see Figure A-4.

Conclusions: Set. NFC02 and NFC03, **PASS**.

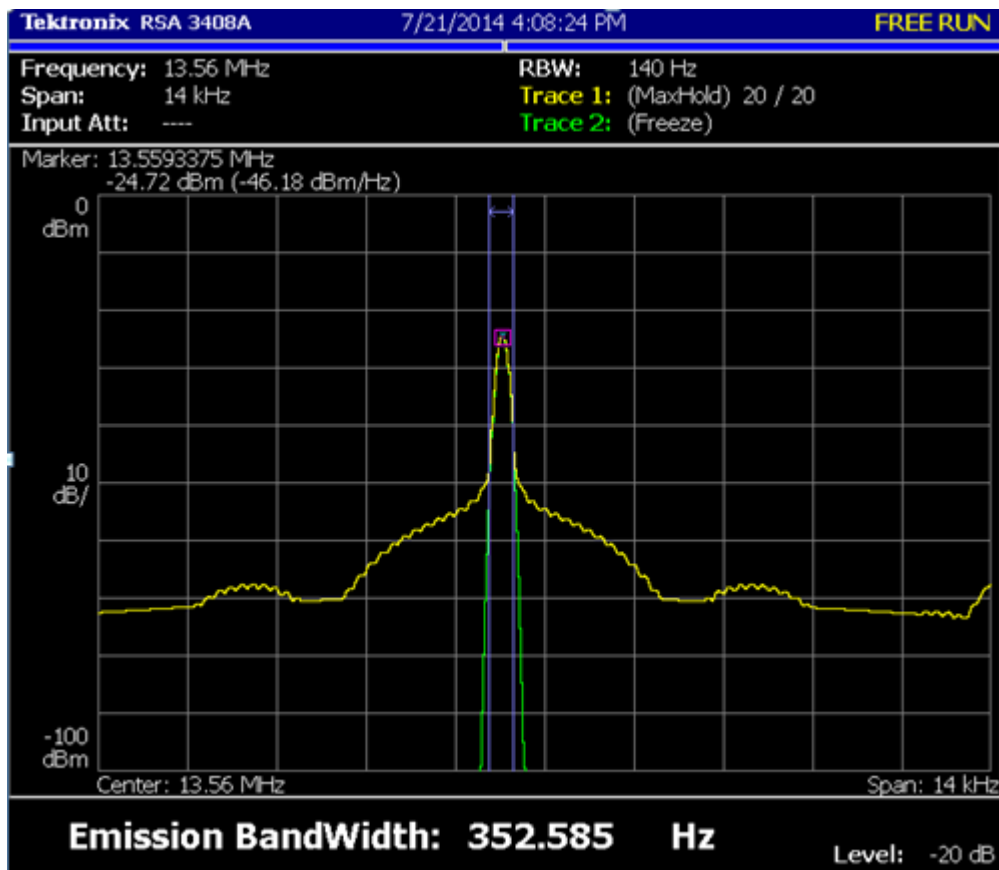

Figure A-5: Test result of EUT1 at test set. NFC02

A.5.7. Measurement Uncertainty

Measurement uncertainty: $U = 77 \text{ Hz}$, $k=2$

A.6. Conducted emission

A.6.1. Reference

See Clause 13.3 and Clause 7 of ANSI C63.4-2009 specifically.

See Clause 4, Clause 5, and Clause 6 of ANSI C63.4-2009 generally.

A.6.2. Measurement Methods

The conducted emissions from the AC port of the EUT are measured in a shielding room. The EUT is connected to a Line Impedance Stabilization Network (LISN). An overview sweep with peak detection was performed. The measurements were performed with a quasi-peak detector and if required, an average detector.

The conducted emission measurements were made with the following detector of the test receiver: Quasi-Peak / Average Detector.

The measurement bandwidth is:

Frequency of Emission (MHz)	RBW/VBW
0.15-30	9kHz

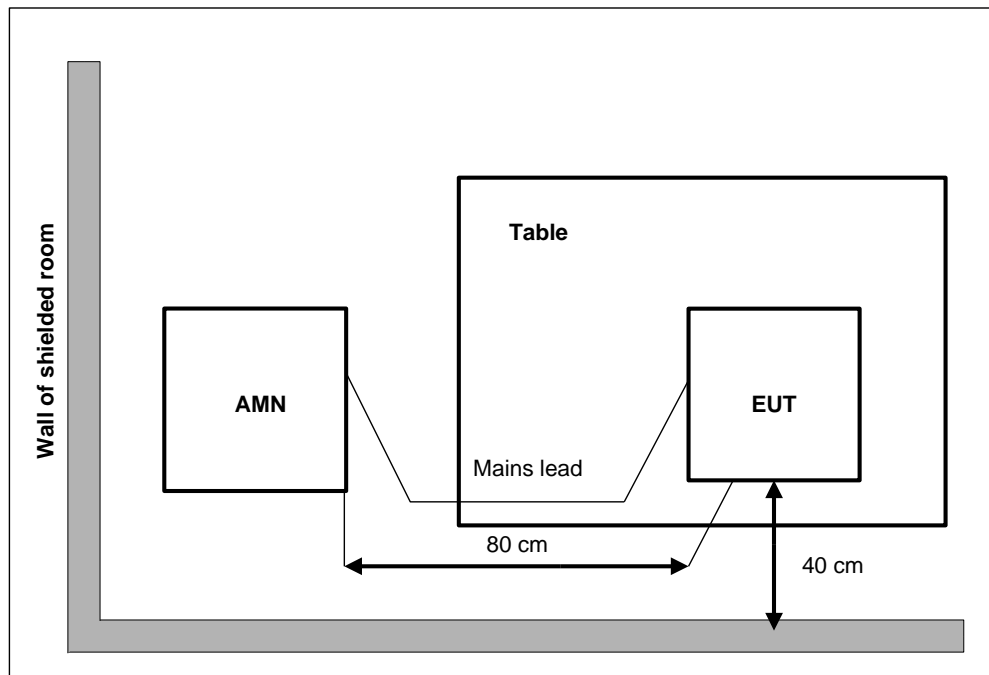

A.6.3. EUT Operating Mode and Test Conditions

The measurement of EUT is carried out under the transmit state of NFC (See 3.5).

The EUT is powered by a travel adapter.

During the measurements, the ambient temperature is in the range of 15 ~ 25 °C.

A.6.4. Limits

Frequency range (MHz)	Quasi-peak Limit (dB μ V)	Average Limit (dB μ V)
0.15 to 0.5	66 to 56	56 to 46
0.5 to 5	56	46
5 to 30	60	50

A.6.5. Measurement Results

Measurement results see Figure A-5.

Conclusions: Set. NFC01, **PASS**.

Note: The measurement result at 13.56MHz is the fundamental emission of NFC signal.

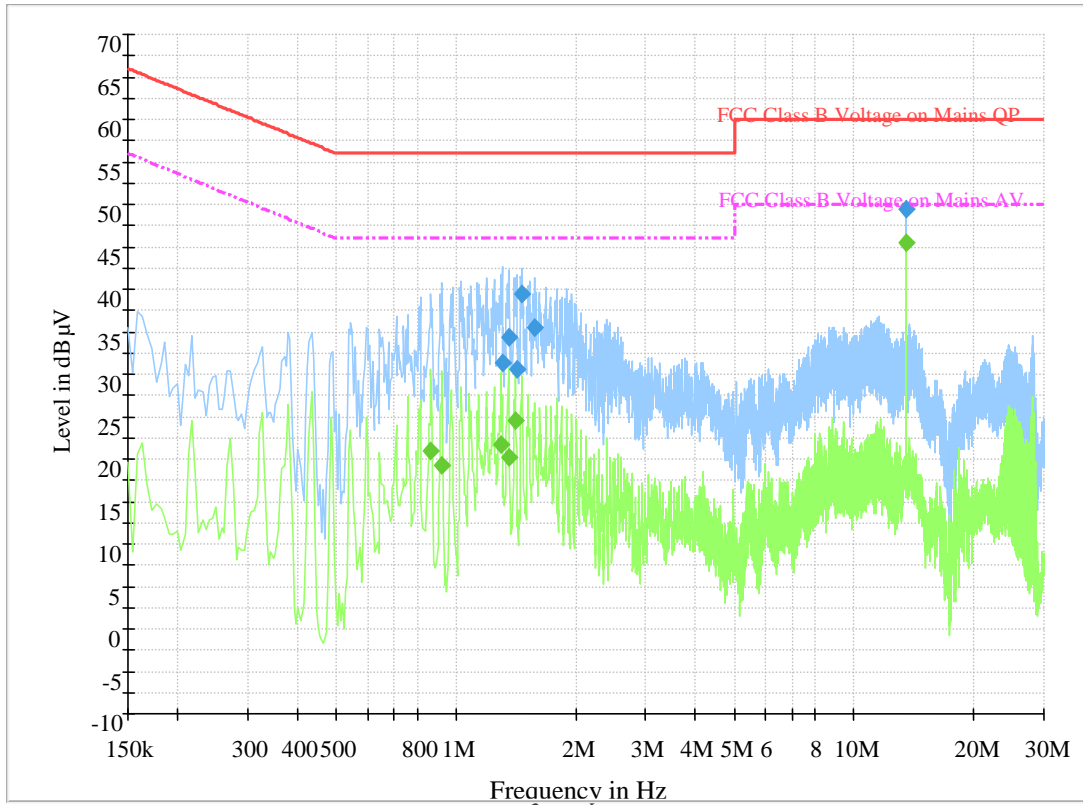

Final Result 1

Frequency	QuasiPeak	PE	Line	Corr.	Margin	Limit
1.306500	31.2	GND	L1	9.7	24.8	56.0
1.356000	34.4	GND	L1	9.7	21.6	56.0
1.419000	30.5	GND	L1	9.7	25.5	56.0
1.468500	39.4	GND	L1	9.7	16.6	56.0
1.576500	35.5	GND	L1	9.7	20.5	56.0
13.560000	49.3	GND	L1	9.5	10.7	60.0

Final Result 2

Frequency	Average	PE	Line	Corr.	Margin	Limit
0.865500	20.9	GND	L1	9.8	25.1	46.0
0.924000	19.3	GND	L1	9.7	26.7	46.0
1.297500	21.7	GND	L1	9.7	24.3	46.0
1.356000	20.1	GND	L1	9.7	25.9	46.0
1.410000	24.5	GND	L1	9.7	21.5	46.0
13.560000	45.5	GND	L1	9.5	4.5	50.0

Figure A-6: Test result of EUT1 at test set. NFC01

A.6.6. Measurement Uncertainty

Measurement uncertainty: $U = 3.2$ dB, $k=2$

ANNEX C: TEST LAYOUT

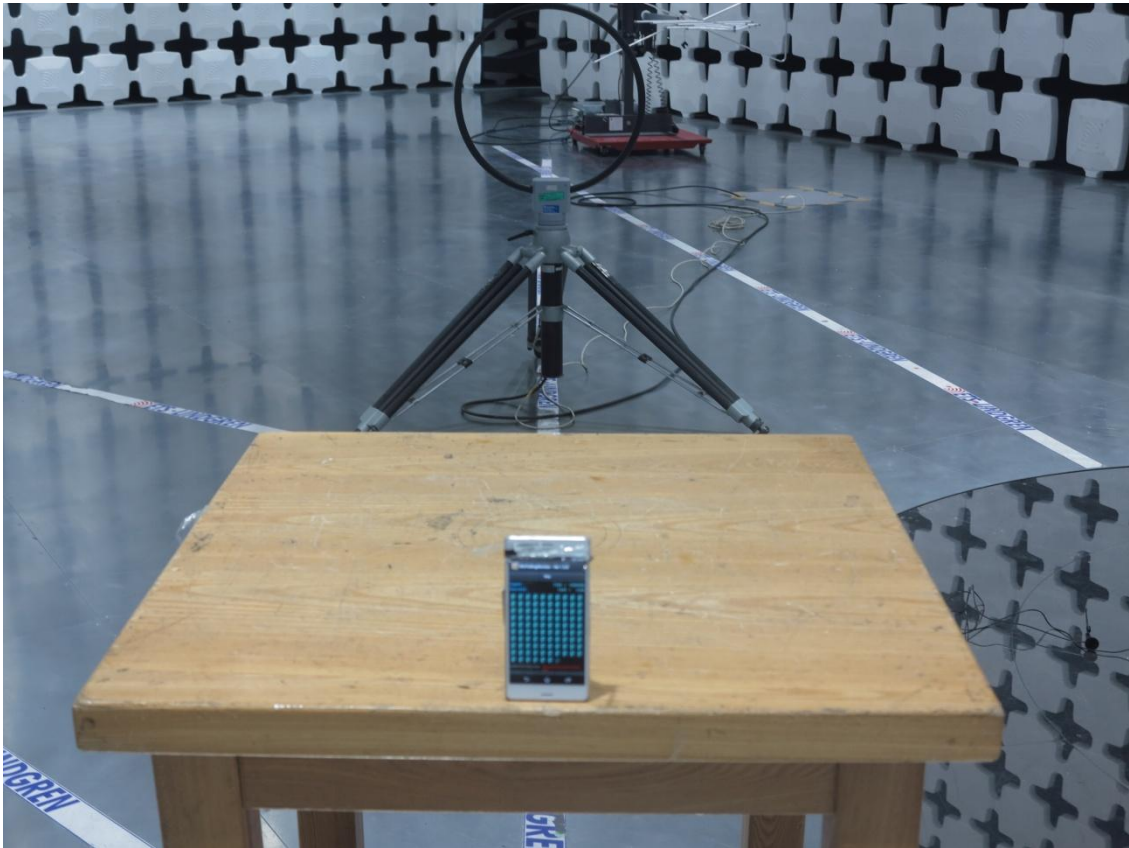

Picture C-1: Field Strength Measurements (Below 30MHz)

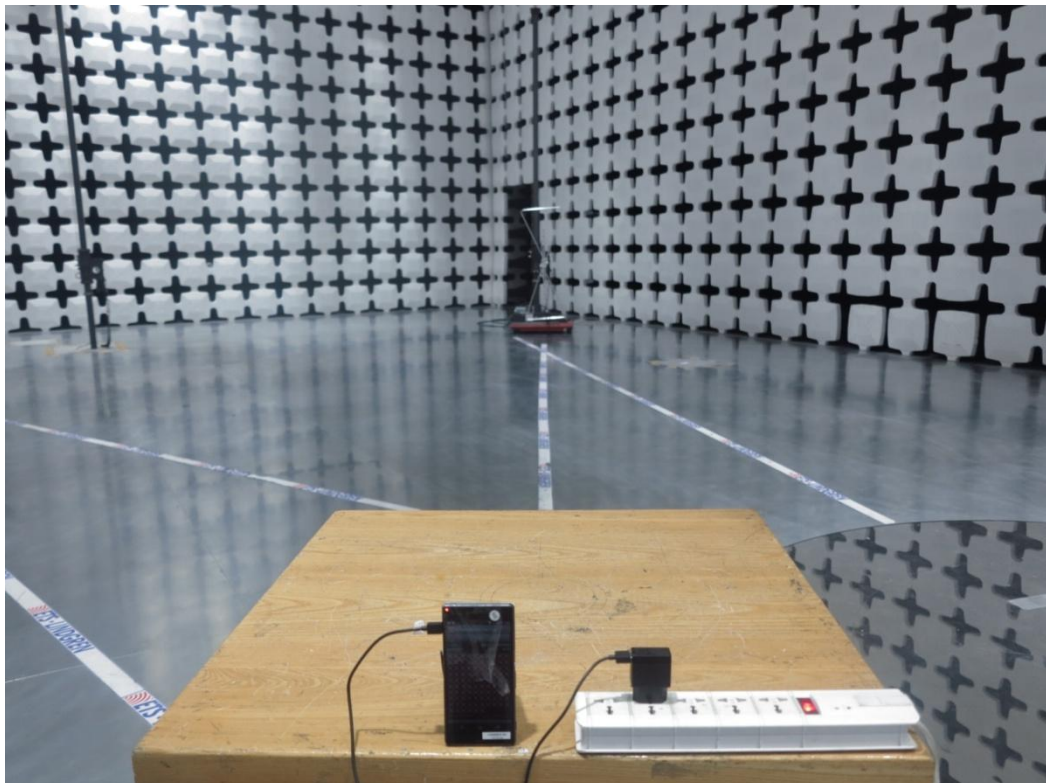

Picture C-2: Field Strength Measurements (Above 30MHz)

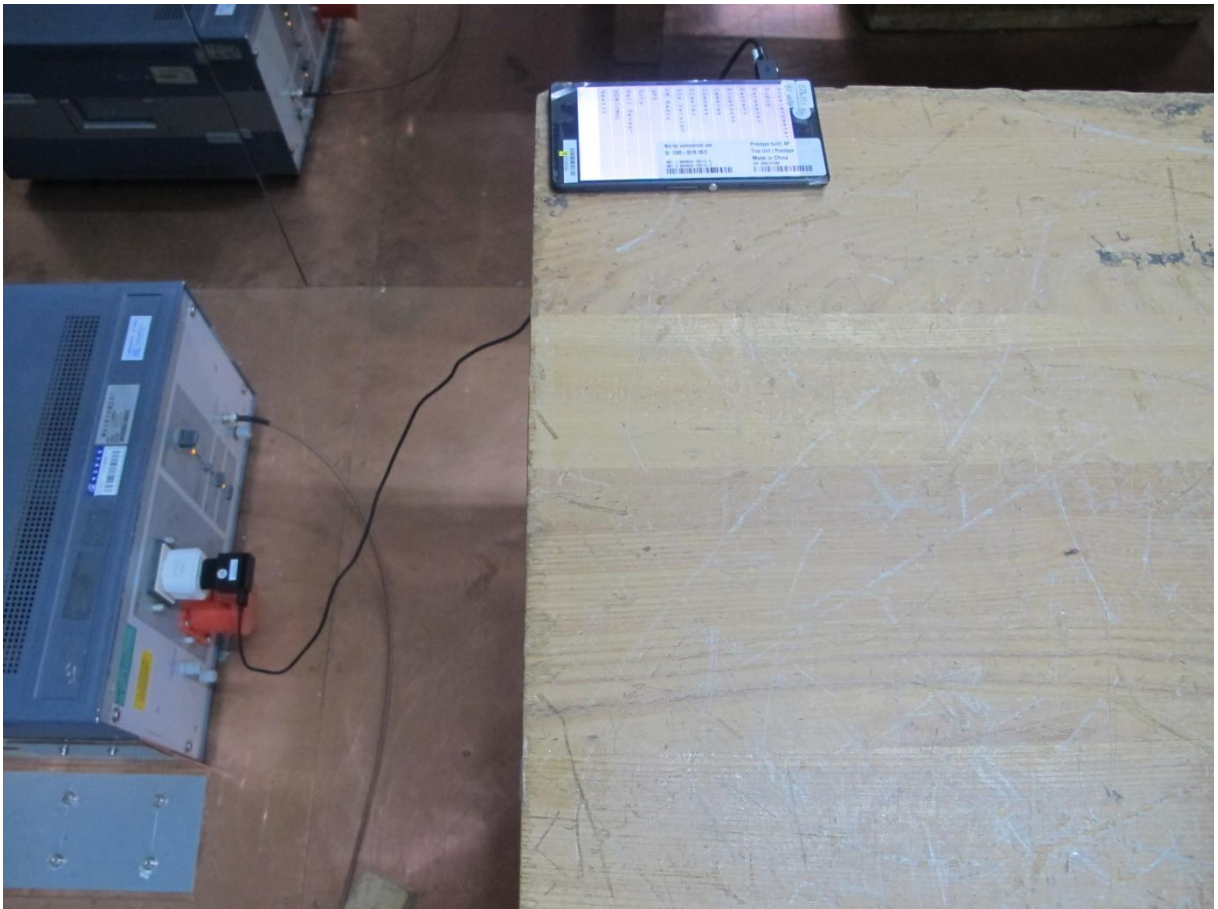

Picture C-3: Conducted Emissions Measurements

*****END OF REPORT*****