



**FCC PART 15  
TEST REPORT  
No. I15Z40385-SRD03**

**for**

**Sony Mobile Communications Inc.**

**GSM/WCDMA/LTE Mobile Phone**

**FCC ID: PY7-PM0817**

**with**

**Hardware Version: A**

**Software Version: 23.0.F.0.56**

**Issued Date: 2015-04-21**

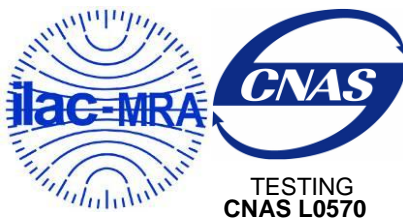

**Note:**

The test results in this test report relate only to the devices specified in this report. This report shall not be reproduced except in full without the written approval of CTTL.

**Test Laboratory:**

CTTL, Telecommunication Technology Labs, Academy of Telecommunication Research, MIIT

No. 52, Huayuan North Road, Haidian District, Beijing, P. R. China 100191.

Tel:+86(0)10-62304633-2512, Fax:+86(0)10-62304633-2504

Email: [ctl\\_terminals@catr.cn](mailto:ctl_terminals@catr.cn), website: [www.chinattl.com](http://www.chinattl.com)



## **CONTENTS**

<b>1.</b>	<b>TEST LATORATORY</b> .....	<b>3</b>
1.1.	TESTING LOCATION .....	3
1.2.	PROJECT DATA .....	3
1.3.	SIGNATURE .....	3
<b>2.</b>	<b>CLIENT INFORMATION</b> .....	<b>4</b>
<b>2.1.</b>	<b>APPLICANT INFORMATION</b> .....	<b>4</b>
<b>2.2.</b>	<b>MANUFACTURER INFORMATION</b> .....	<b>4</b>
<b>3.</b>	<b>EQUIPMENT UNDER TEST (EUT) AND ANCILLARY EQUIPMENT(AE)</b> .....	<b>5</b>
3.1.	ABOUT EUT .....	5
3.2.	INTERNAL IDENTIFICATION OF EUT USED DURING THE TEST .....	5
3.3.	GENERAL DESCRIPTION .....	5
<b>4.</b>	<b>REFERENCE DOCUMENTS</b> .....	<b>6</b>
4.1.	DOCUMENTS SUPPLIED BY APPLICANT .....	6
4.2.	REFERENCE DOCUMENTS FOR TESTING.....	6
<b>5.</b>	<b>LABORATORY ENVIRONMENT</b> .....	<b>6</b>
<b>6.</b>	<b>SUMMARY OF TEST RESULTS</b> .....	<b>6</b>
6.1.	SUMMARY OF TEST RESULTS.....	6
6.2.	STATEMENTS.....	6
<b>7.</b>	<b>TEST EQUIPMENTS UTILIZED</b> .....	<b>7</b>
	<b>ANNEX A: MEASUREMENT RESULTS</b> .....	<b>8</b>
A.1.	MEASUREMENT METHOD .....	8
A.2.	CHANNEL MOVE TIME AND CHANNEL CLOSING TRANSMISSION TIME .....	10
A.3.	NON-OCCUPANCY PERIOD .....	15
A3.1	ASSOCIATED TEST.....	15
	<b>ANNEX B: PHOTOGRAPHS OF THE TEST SET-UP</b> .....	<b>16</b>

## 1. TEST LATORATORY

### 1.1. Testing Location

Company Name: CTTL Beijing, Telecommunication Metrology Center of MIIT  
Address: No 52 Hua Yuanbei Road, Haidian District, Beijing, P.R.China  
Postal Code: 100191  
Telephone: +86-10-62304633-2054  
Fax: +86-10-62304633-2504

### 1.2. Project data

Testing Start Date: 2014-08-01  
Testing End Date: 2014-08-07

### 1.3. Signature

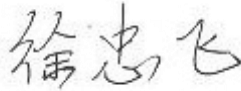

---

Xu Zhongfei  
(Prepared this test report)

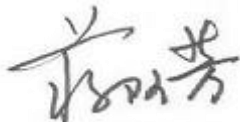

---

Jiang Afang  
(Reviewed this test report)



---

Xiao Li  
Deputy Director of the laboratory  
(Approved this test report)



## **2. CLIENT INFORMATION**

### **2.1. Applicant Information**

Company Name: Sony Mobile Communications (China) Co. Ltd  
Address /Post: Sony Mobile R&D Center, No. 16, Guangshun South Street,  
Chaoyang District  
City: Beijing  
Postal Code: 100102  
Country: China  
Contact Person: Ma, Gang  
Telephone: +86-10-58656312  
Fax: +86-10-58659049

### **2.2. Manufacturer Information**

Company Name: Sony Mobile Communications Inc.  
Address /Post: 1-8-15 Konan, Minato-ku, Tokyo, 108-0075, Japan  
City: Tokyo  
Postal Code: 108-0075  
Country: Japan

### **3. EQUIPMENT UNDER TEST (EUT) AND ANCILLARY**

#### **EQUIPMENT(AE)**

##### **3.1. About EUT**

Description	GSM, GPRS, EDGE,WCDMA FDD, HSDPA, HSUPA,LTE FDD Bluetooth (EDR and BLE), ANT+, WLAN NFC, FM, GPS mobile phone
Model name	PY7-PM0817
WLAN Frequency Range	ISM Band: -5250MHz~5350MHz -5470MHz~5725MHz
Type of modulation	OFDM
Number of Channels	15
Antenna	Integral Antenna
Extreme vol. Limits	3.6VDC to 4.2VDC (nominal: 3.8VDC)
Device Type (DFS)	Client without radar detection(only support client mode)
TPC mechanism	Not support

Note1: Photographs of EUT are shown in ANNEX C of this test report. Components list, please refer to documents of the manufacturer; it is also included in the original test record of Telecommunication Metrology Center of MIIT of People's Republic of China.

##### **3.2. Internal Identification of EUT used during the test**

<b>EUT ID*</b>	<b>IMEI</b>	<b>HW Version</b>	<b>SW Version</b>
EUT1	004402452521085	A	23.0.F.0.56

\*EUT ID: is used to identify the test sample in the lab internally.

##### **3.3. General Description**

The Equipment Under Test (EUT) is a model of GSM/WCDMA/LTE Mobile Phone with integrated antenna and embedded battery.

The EUT supports GSM, WCDMA FDD and LTE FDD. It supports GPRS service with multi-slots class 33 and EGPRS service with multi-slots class 33. The HSDPA (Cat 24) and HSUPA (Cat 6) features are also supported.

It has MP3, camera, USB memory, FM radio, GPS receiver, NFC, Bluetooth (EDR, BLE), ANT+, WLAN (802.11 a/ac/b/g/n) and Wi-Fi hotspot functions.

It consists of normal options: USB cable and travel charger.

Manual and specifications of the EUT were provided to fulfil the test.

Samples undergoing test were selected by the client.



#### 4. REFERENCE DOCUMENTS

##### 4.1. Documents supplied by applicant

EUT feature information is supplied by the applicant or manufacturer, which is the basis of testing.

##### 4.2. Reference Documents for testing

The following documents listed in this section are referred for testing.

FCC Part15	Title 47 of the Code of Federal Regulations; Chapter I Part 15 - Radio frequency devices Subpart E – UNII Devices	Oct, 2012
FCC 06-96	Revision of Parts 2 and 15 of the Commission’s Rules to Permit Unlicensed National Information Infrastructure (U-NII) devices in the 5 GHz band	2006

#### 5. LABORATORY ENVIRONMENT

Measurement is performed in shielding room.

#### 6. SUMMARY OF TEST RESULTS

##### 6.1. Summary of Test Results

SUMMARY OF MEASUREMENT RESULTS	Sub-clause of Part15E	Verdict
Channel move time and channel closing transmission time	15.407 (h)(2)(iii)	P
Non-Occupancy Period	15.407 (h)(2) (iv)	P

Please refer to **ANNEX A** for detail.

Terms used in Verdict column

P	Pass, The EUT complies with the essential requirements in the standard.
NM	Not measured, The test was not measured by CTTL
NA	Not Applicable, The test was not applicable
F	Fail, The EUT does not comply with the essential requirements in the standard

##### 6.2. Statements

CTTL has evaluated the test cases requested by the client/manufacturer as listed in section 6.1 of this report for the EUT specified in section 3 according to the standards or reference documents listed in section 4.1.

This report only deal with the UNII DFS functions among the features described in section 3, and The EUT met all requirements of the reference documents.

The end user is not available to get and modify the parameters of the detected Radar Waveforms in this product.

This model is a variant product which FCC ID is PY7-PM0808; all the test result has been derived from test report of PY7-PM0808.



Test Conditions

T nom	Normal Temperature
T min	Low Temperature
T max	High Temperature
V nom	Normal Voltage
V min	Low Voltage
V max	High Voltage
H nom	Norm Humidity
A nom	Norm Air Pressure

For this report, all the test case listed above is tested under Normal Temperature and Normal Voltage, and also under norm humidity, the specific conditions as following:

Temperature	T nom	26°C
Voltage	V nom	3.8V(By battery)
Humidity	H nom	44%
Air Pressure	A nom	1010hPa

## 7. TEST EQUIPMENTS UTILIZED

### Conducted test system

No.	Equipment	Model	Serial Number	Manufacturer	Calibration Date	Calibration Due Date
1	Vector Signal Analyzer	FSQ40	200089	Rohde & Schwarz	2014-07-19	2015-07-19
2	Vector Signal General	SMU200A	103752	Rohde & Schwarz	2014-07-19	2015-07-19
3	Shielding Room	S81	/	ETS-Lindgren	/	/

## ANNEX A: MEASUREMENT RESULTS

### A.1. Measurement Method

#### A.1.1. Conducted Measurements

The below figure shows the DFS setup, where the EUT is a RLAN device operating in slave mode, without Radar Interference Detection function. This setup also contains a device operating in master mode. The radar test signals are injected into the master device. The EUT (slave device) is associated with the master device. WLAN traffic is generated by streaming the mpeg file from the master to the slave in full monitor video mode using the media player.

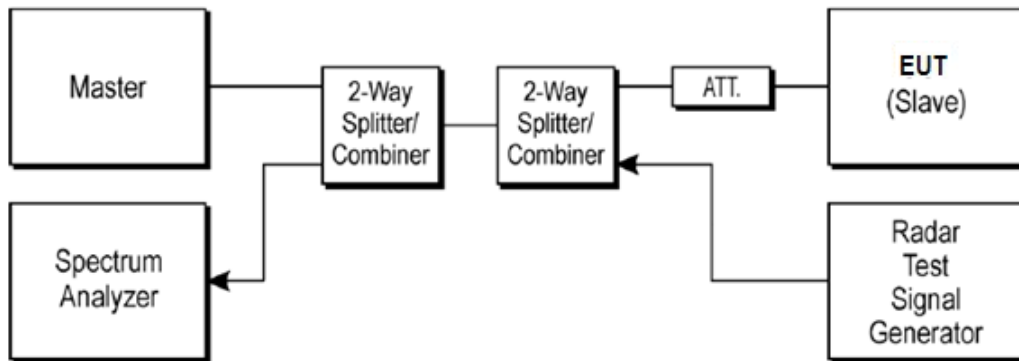

Note:

- 1) All Measurements are performed with the EUT's narrowest channel bandwidth.
- 2) The master device information is as follows  
Vendor: Cisco  
Model: AIR-AP1252AG-A-K9  
FCC ID: LDK102061, 1DK102062
- 3) The software of radar signal generator (R&S SMU200A) is completely designed based on FCC-06-96A1/NTIA requirement.

#### A.1.2. Parameters of DFS test signal

1). Interference threshold values, master or client incorporation in service monitoring. For device power less than 23dBm (E.I.R.P.), the threshold level is -62 dBm at the antenna port after correction for antenna gain and procedural adjustments.

Because of conducted measurement performed, the calibration power from radar signal generator to antenna port of DFS test equipment is -62 dBm.

Maximum Transmit Power	Value
> 200 mW	-64 dBm
< 200 mW	-62 dBm



## 2). DFS requirement values

The required values are as the following table.

Parameter	Value
Non-occupancy	> 1800 s
Channel Availability Check Time	60 s
Channel Move Time	10 s
Channel Closing Transmission Time	200 ms + 60 ms
U-NII Detection Bandwidth	Minimum 80% of the 99% transmission power bandwidth

As the EUT is IP based system, the MPEG video file from NTIA website is used to steam to EUT via the Master device.

**A.1.3. Measurement Uncertainty**

Item	Measurement Uncertainty
Time	0.70 ms
Power	0.75 dBm

## A.2. Channel move time and channel closing transmission time

### Measurement Limit:

Test Items	Limit
channel closing transmission time	< 200 ms + 60 ms
Channel move time	< 10 s

### Measurement Results:

HT20 Frequency Band: 5250MHz ~ 5350MHz

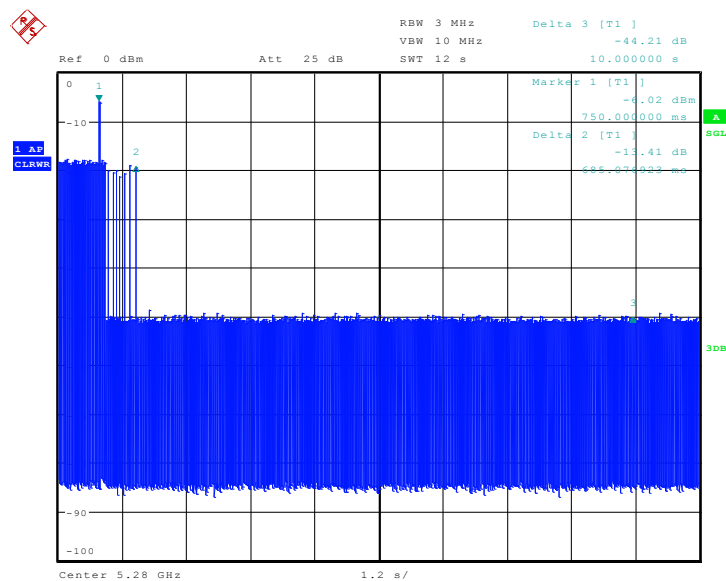

Date: 6.AUG.2014 20:33:57

The channel move time is as the figure. It shows the time of the radar and the client pulses. The figure shows that the client stops transmission within 10 seconds, and no transmissions occur after 10 seconds later of the radar burst signal.

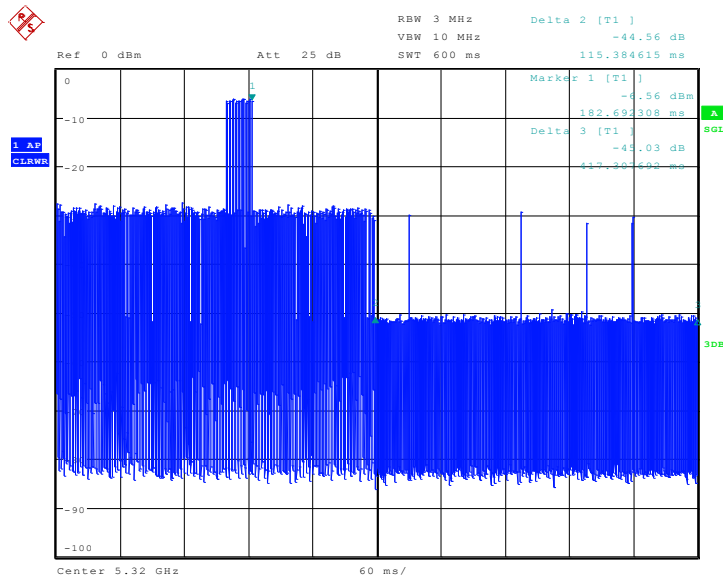

Date: 6.AUG.2014 20:36:19

The closing transmission time is as the figure, and the result is 115.38ms

**Conclusion: PASS**

### HT40 Frequency Band: 5250MHz ~ 5350MHz

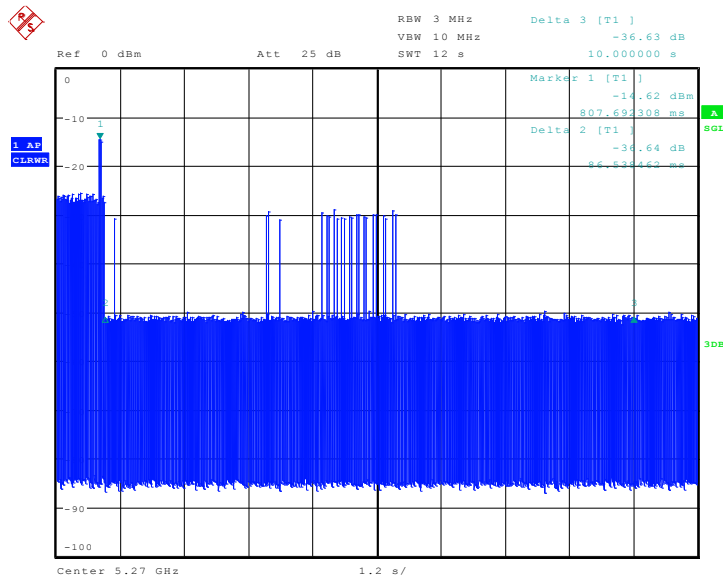

Date: 6.AUG.2014 20:48:09

The channel move time is as the figure. It shows the time of the radar and the client pulses. The figure shows that the client stops transmission within 10 seconds, and no transmissions occur after 10 seconds later of the radar burst signal.

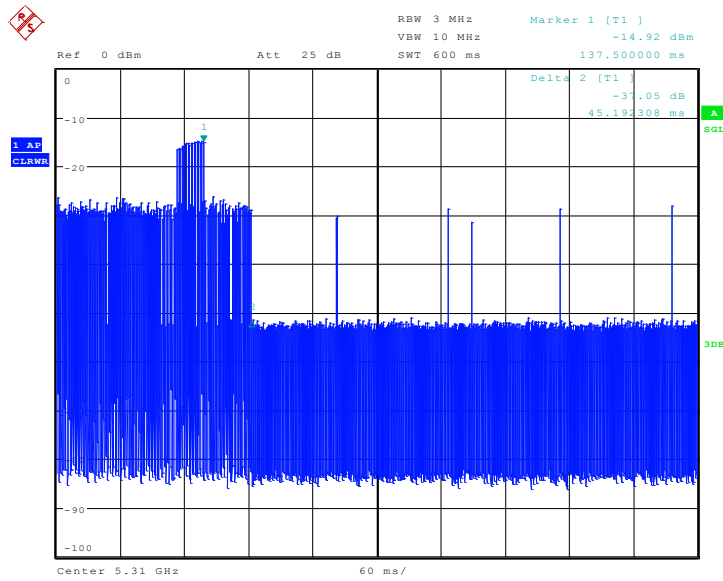

Date: 6.AUG.2014 20:40:13

The closing transmission time is as the figure, and the result is 137.50ms

**Conclusion: PASS**

### HT20 Frequency Band 5470MHz ~ 5725MHz

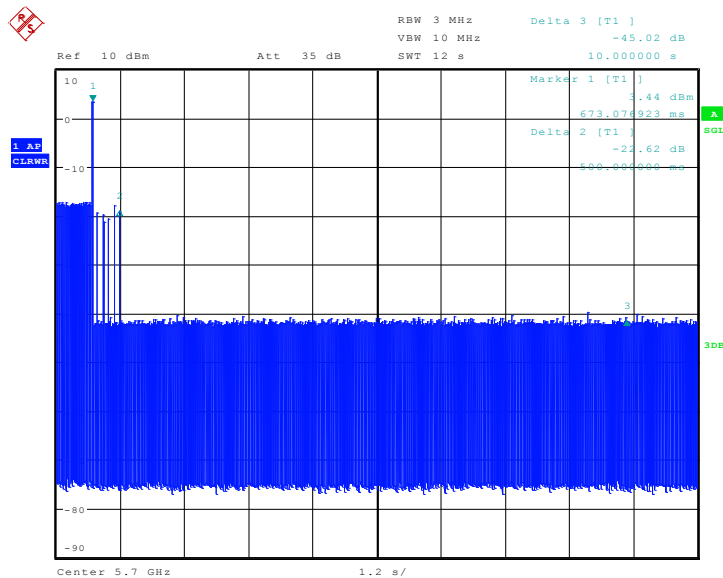

Date: 6.AUG.2014 20:16:35

The channel move time is as the figure. It shows the time of the radar and the client pulses. The figure shows that the client stops transmission within 10 seconds, and no transmissions occur after 10 seconds later of the radar burst signal.

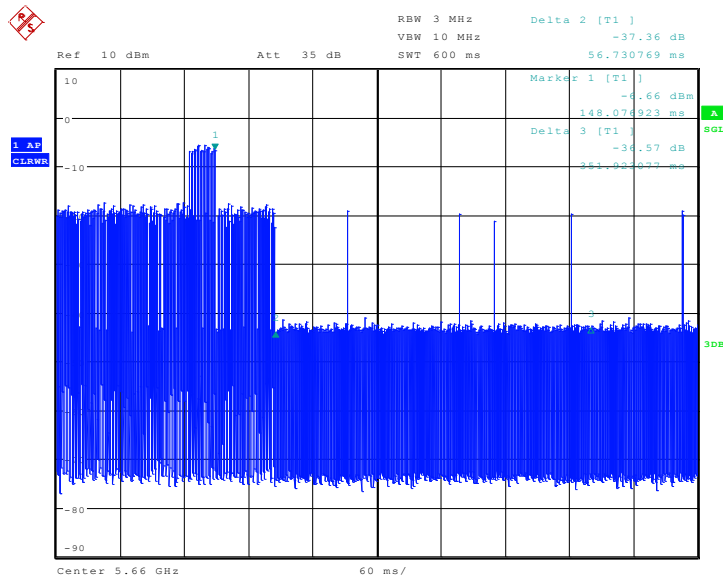

Date: 6.AUG.2014 20:20:06

The closing transmission time is as the figure, and the result is 56.73ms

**Conclusion: PASS**

### HT40 Frequency Band 5470MHz ~ 5725MHz

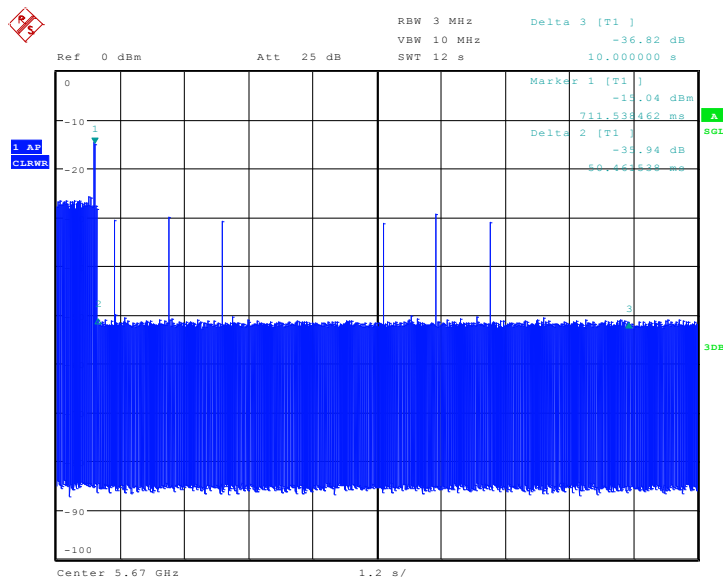

Date: 6.AUG.2014 20:30:43

The channel move time is as the figure. It shows the time of the radar and the client pulses. The figure shows that the client stops transmission within 10 seconds, and no transmissions occur after 10 seconds later of the radar burst signal.

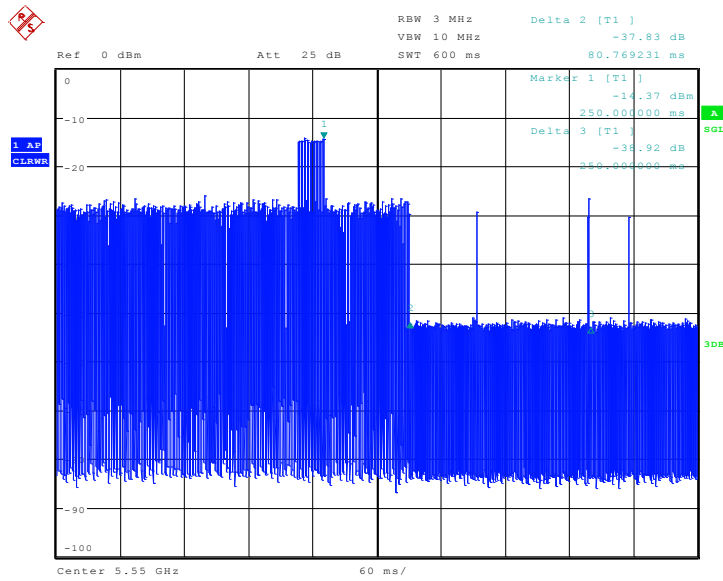

Date: 6.AUG.2014 20:23:00

The closing transmission time is as the figure, and the result is 80.77ms

**Conclusion: PASS**

### A.3. Non-Occupancy Period

#### Measurement Limit:

Test Items	Limit
Non-Occupancy Period	> 1800 s

#### A3.1 Associated test

Associate the master and client, transmit specified stream between the master and client; monitor the analyzer on the operating frequency to make sure no beacons have been transmitted for 1800 seconds.

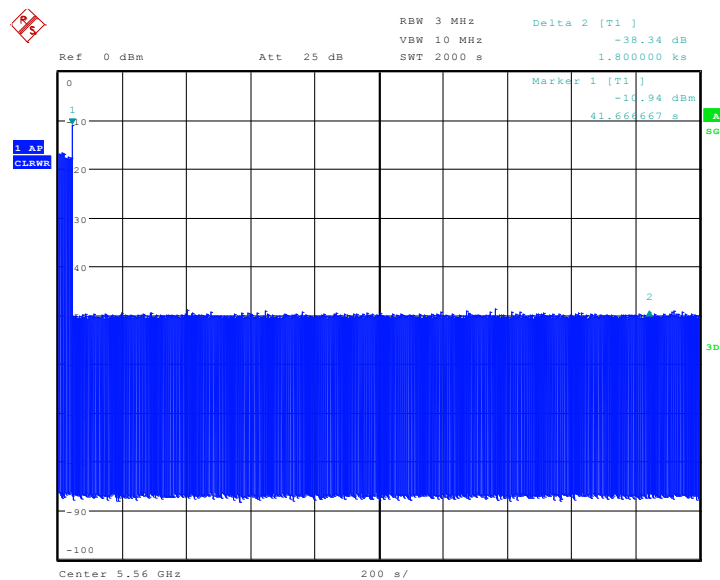

Date: 7.AUG.2014 09:05:54

The figure above shows that the client does not transmit any emission within 1800 seconds after getting the order of “stop transmits” from the DFS master (access point).

**Conclusion: PASS**

## ANNEX B: PHOTOGRAPHS OF THE TEST SET-UP

### Layout of Conducted Test



\*\*\* END OF REPORT BODY \*\*\*