



**FCC CFR47 PART 22 SUBPART H
FCC CFR47 PART 24 SUBPART E
FCC CFR47 PART 27 SUBPART L**

CERTIFICATION TEST REPORT

**FOR
GSM/WCDMA/LTE + BLUETOOTH, DTS/UNII a/b/g/n/ac, ANT+ and NFC**

FCC ID: PY7-PM0793

**REPORT NUMBER: 15J20116-E1 Revision A
ISSUE DATE: APRIL 15, 2015**

**Prepared for
SONY MOBILE COMMUNICATIONS, INC.
1-8-15 KONAN, MINATO-KU
TOKYO, 108-0075 JAPAN**

**Prepared by
UL VERIFICATION SERVICES INC.
47173 BENICIA STREET
FREMONT, CA 94538, U.S.A.
TEL: (510) 771-1000
FAX: (510) 661-0888**



NVLAP LAB CODE 200065-0

Revision History

Rev.	Date	Revisions	Revised By
-	04/01/15	Initial Issue	CHOON OOI
		Revised Section 10.2 and 11.2 Rule Parts	
A	04/15/15	Removed 11.1 Peak reference section Updated Company Address	CHOON OOI

TABLE OF CONTENTS

1. ATTESTATION OF TEST RESULTS 5

2. TEST METHODOLOGY 6

3. FACILITIES AND ACCREDITATION 6

4. CALIBRATION AND UNCERTAINTY 7

 4.1. *MEASURING INSTRUMENT CALIBRATION 7*

 4.2. *SAMPLE CALCULATION 7*

 4.3. *MEASUREMENT UNCERTAINTY 7*

5. EQUIPMENT UNDER TEST 8

 5.1. *DESCRIPTION OF EUT 8*

 5.2. *MAXIMUM OUTPUT POWER 8*

 5.3. *MAXIMUM OUTPUT POWER (LTE) 9*

 5.4. *DESCRIPTION OF AVAILABLE ANTENNAS 10*

 5.5. *DESCRIPTION OF TEST SETUP 11*

6. TEST AND MEASUREMENT EQUIPMENT 14

7. Summary Table 15

8. RF POWER OUTPUT VERIFICATION 16

 8.1. *GSM/GPRS/EDGE 16*

 8.1.1. *GSM OUTPUT POWER RESULT 17*

 8.2. *UMTS REL 99 19*

 8.2.1. *UMTS REL 99 OUTPUT POWER RESULT 19*

 8.3. *UMTS HSDPA 20*

 8.3.1. *UMTS HSDPA OUTPUT POWER RESULT 20*

 8.4. *UMTS HSUPA 21*

 8.4.1. *UMTS HSUPA OUTPUT POWER RESULT 22*

 8.5. *LTE OUTPUT VERIFICATION 23*

 8.5.1. *LTE OUTPUT RESULT 23*

9. PEAK TO AVERAGE RATIO 24

 9.1. *CONDUCTED PEAK TO AVERAGE RESULT 24*

10. LIMITS AND CONDUCTED RESULTS 27

 10.1. *OCCUPIED BANDWIDTH 27*

 10.1.1. *OCCUPIED BANDWIDTH RESULTS 28*

 10.1.2. *LTE OCCUPIED BANDWIDTH RESULTS 29*

10.1.3.	OCCUPIED BANDWIDTH PLOTS	30
10.2.	<i>BAND EDGE EMISSIONS</i>	33
10.2.1.	BAND EDGE PLOTS	34
10.3.	<i>OUT OF BAND EMISSIONS</i>	41
10.3.1.	OUT OF BAND EMISSIONS RESULT	42
10.3.2.	OUT OF BAND EMISSIONS PLOTS.....	44
10.4.	<i>FREQUENCY STABILITY</i>	47
10.4.1.	FREQUENCY STABILITY RESULTS.....	48
11.	RADIATED TEST RESULTS	51
11.1.	<i>RADIATED POWER (ERP & EIRP)</i>	51
11.1.1.	ERP/EIRP Results.....	52
11.1.2.	LTE ERP/EIRP Results	53
11.1.3.	ERP/EIRP PLOTS.....	54
11.2.	<i>FIELD STRENGTH OF SPURIOUS RADIATION</i>	64
11.2.1.	SPURIOUS RADIATION PLOTS.....	66
12.	SETUP PHOTOS	76

1. ATTESTATION OF TEST RESULTS

COMPANY NAME: SONY MOBILE COMMUNICATIONS, INC.
EUT DESCRIPTION: GSM/WCDMA/LTE + BLUETOOTH, DTS/UNII a/b/g/n/ac, ANT+ and NFC
SERIAL NUMBER: 162834-7 (RF Radiated), 159236-0 (RF Conducted)
DATE TESTED: MARCH 9-27, 2015

APPLICABLE STANDARDS	
STANDARD	TEST RESULTS
FCC PART 22H, 24E and 27L	PASS

UL Verification Services Inc. tested the above equipment in accordance with the requirements set forth in the above standards. All indications of Pass/Fail in this report are opinions expressed by UL Verification Services Inc. based on interpretations and/or observations of test results. Measurement Uncertainties were not taken into account and are published for informational purposes only. The test results show that the equipment tested is capable of demonstrating compliance with the requirements as documented in this report.

Note: The results documented in this report apply only to the tested sample, under the conditions and modes of operation as described herein. This document may not be altered or revised in any way unless done so by UL Verification Services Inc. and all revisions are duly noted in the revisions section. Any alteration of this document not carried out by UL Verification Services Inc. will constitute fraud and shall nullify the document. This report must not be used by the client to claim product certification, approval, or endorsement by NVLAP, NIST, any agency of the Federal Government, or any agency of any government.

Approved & Released For
UL Verification Services Inc. By:

Tested By:



CHOON OOI
CONSUMER TECHNOLOGY DIVISION
WISE PROJECT LEAD
UL Verification Services Inc.

STEVEN TRAN
CONSUMER TECHNOLOGY DIVISION
WISE LAB ENGINEER
UL Verification Services Inc.

2. TEST METHODOLOGY

The tests documented in this report were performed in accordance with TIA-603-C, FCC CFR 47 Part 22, FCC CFR Part 24, and FCC CFR 47 Part 27.

3. FACILITIES AND ACCREDITATION

The test sites and measurement facilities used to collect data are located at 47173 and 47266 Benicia Street, Fremont, California, USA. Line conducted emissions are measured only at the 47173 address. The following table identifies which facilities were utilized for radiated emission measurements documented in this report. Specific facilities are also identified in the test results sections.

47173 Benicia Street	47266 Benicia Street
<input checked="" type="checkbox"/> Chamber A(IC: 2324B-1)	<input type="checkbox"/> Chamber D(IC: 2324B-4)
<input type="checkbox"/> Chamber B(IC: 2324B-2)	<input type="checkbox"/> Chamber E(IC: 2324B-5)
<input checked="" type="checkbox"/> Chamber C(IC: 2324B-3)	<input type="checkbox"/> Chamber F(IC: 2324B-6)
	<input checked="" type="checkbox"/> Chamber G(IC: 2324B-7)
	<input type="checkbox"/> Chamber H(IC: 2324B-8)

UL Verification Services Inc. is accredited by NVLAP, Laboratory Code 200065-0. The full scope of accreditation can be viewed at <http://ts.nist.gov/standards/scopes/2000650.htm>.

4. CALIBRATION AND UNCERTAINTY

4.1. MEASURING INSTRUMENT CALIBRATION

The measuring equipment utilized to perform the tests documented in this report has been calibrated in accordance with the manufacturer's recommendations, and is traceable to recognized national standards

4.2. SAMPLE CALCULATION

Where relevant, the following sample calculation is provided:

$$\text{EIRP} = \text{PSA reading with EUT worst orientation (dBm)} + \text{Path loss (dB)} - \text{cable loss (between the SG and substitution antenna)} + \text{Substitution Antenna Factor (dBi)}$$

$$\text{ERP} = \text{PSA reading with EUT worst orientation (dBm)} + \text{Path loss (dB)} - \text{cable loss (between the SG and substitution antenna)}$$

(Path loss = Signal generator output – PSA reading with substitution antenna)

4.3. MEASUREMENT UNCERTAINTY

Where relevant, the following measurement uncertainty levels have been estimated for tests performed on the apparatus:

PARAMETER	UNCERTAINTY
Conducted Disturbance, 0.15 to 30 MHz	3.52 dB
Radiated Disturbance, 30 to 1000 MHz	4.94 dB
Radiated Disturbance, 1GHz to 40GHz	4.94 dB

Uncertainty figures are valid to a confidence level of 95%.

5. EQUIPMENT UNDER TEST

5.1. DESCRIPTION OF EUT

This EUT is a GSM/WCDMA/LTE + BLUETOOTH, DTS/UNII a/b/g/n/ac , ANT+ and NFC.

5.2. MAXIMUM OUTPUT POWER

The transmitter has a maximum peak conducted and radiated ERP / EIRP output powers as follows:

FCC Part 22/24						
Band	Frequency Range(MHz)	Modulation	Conducted		Radiated	
			AVG(dBm)	AVG(mW)	AVG(dBm)	AVG(mW)
GSM850	824~849	GMSK	32.6	1819.70		
	824~849	GPRS	32.6	1819.70	28.10	645.8
	824~849	EGPRS	26.5	446.68	23.60	229.14
GSM1900	1850~1910	GMSK	29.9	977.24		
	1850~1910	GPRS	29.9	977.24	29.09	811.78
	1850~1910	EGPRS	25.3	338.84	22.75	188.52
Band 5	824~849	REL99	24.8	302.00	20.00	100.02
	824~849	HSDPA	23.2	208.93	19.40	87.12
	824~849	HSUPA	23.2	208.93		

5.3. MAXIMUM OUTPUT POWER (LTE)

The transmitter has a maximum peak conducted and radiated ERP/EIRP output powers as follows:

FCC Part 27							
Band	Frequency Range(MHz)	BandWidth (MHz)	Modulation	Conducted		Radiated	
				AVG(dBm)	AVG(mW)	AVG(dBm)	AVG(mW)
LTE17	704~716	10MHz	QPSK	23.1	204.17	15.90	38.90
			16QAM	22.5	177.83	15.00	31.62
		5MHz	QPSK	23.2	208.93	16.28	42.46
			16QAM	22.1	162.18	15.40	34.67

5.4. DESCRIPTION OF AVAILABLE ANTENNAS

Frequency (MHz)	Peak Gain (dBi)
GSM850, 824~849MHz	-4.2
GSM1900, 1850~1910MHz	-2.1
Band 5, 824~849MHz	-4.2
LTE17, 704~716MHz	-8.9

The radio utilizes a PIFA antenna for the [List the bands supported] with a maximum peak gain as follow:

5.5. DESCRIPTION OF TEST SETUP

SUPPORT EQUIPMENT

N/A

I/O CABLES (CONDUCTED SETUP)

I/O Cable List						
Cable No	Port	# of identical ports	Connector Type	Cable Type	Cable Length (m)	Remarks
1	RF Out	1	Spectrum Analyzer	Shielded	None	NA
2	Antenna Port	1	EUT	Shielded	0.1m	NA
3	RF In/Out	1	Communication Test Set	Shielded	1m	NA

I/O CABLES (RADIATED SETUP)

I/O CABLE LIST						
Cable No.	Port	# of Identical Ports	Connector Type	Cable Type	Cable Length	Remarks
1	USB	1	AC Adapter	Un-shielded	1.2m	No
2	Jack	1	Headset	Shielded	1m	No
3	RF In/out	1	Communication Test Set	Un-shielded	2m	Yes

TEST SETUP

The EUT is continuously communicated to the call box during the tests.

SETUP DIAGRAM FOR TESTS (CONDUCTED TEST SETUP)

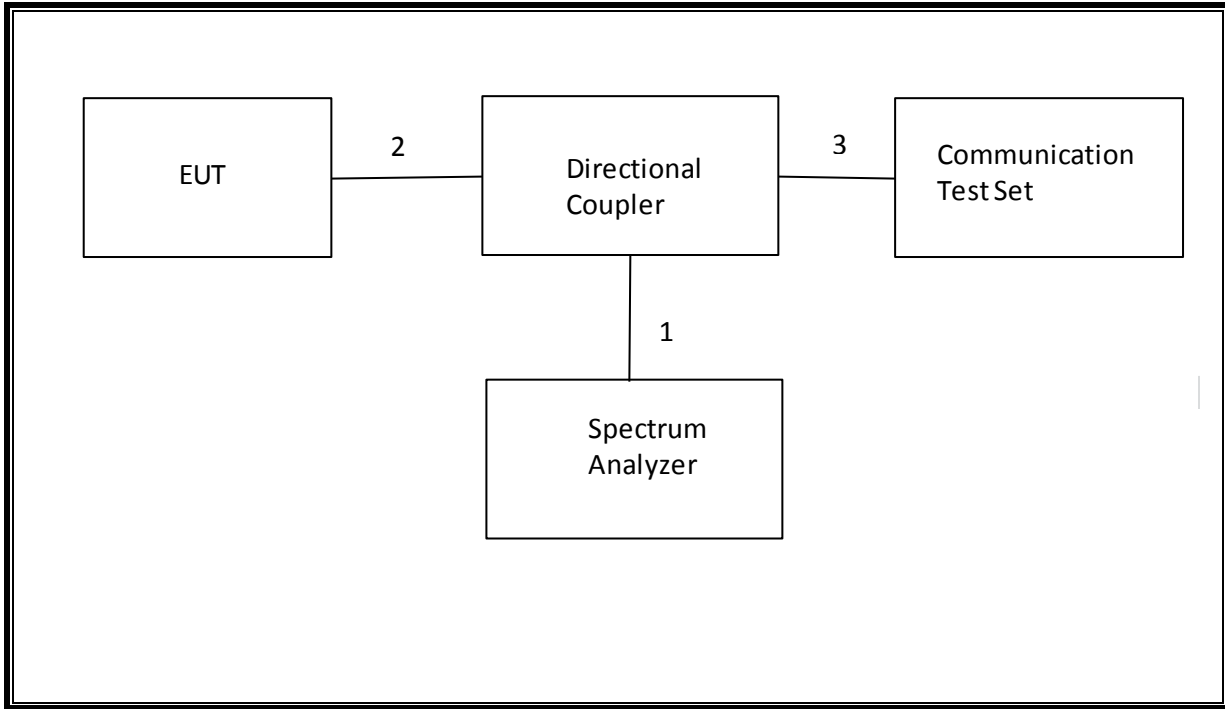

SETUP DIAGRAM FOR TESTS (RADIATED TEST SETUP)

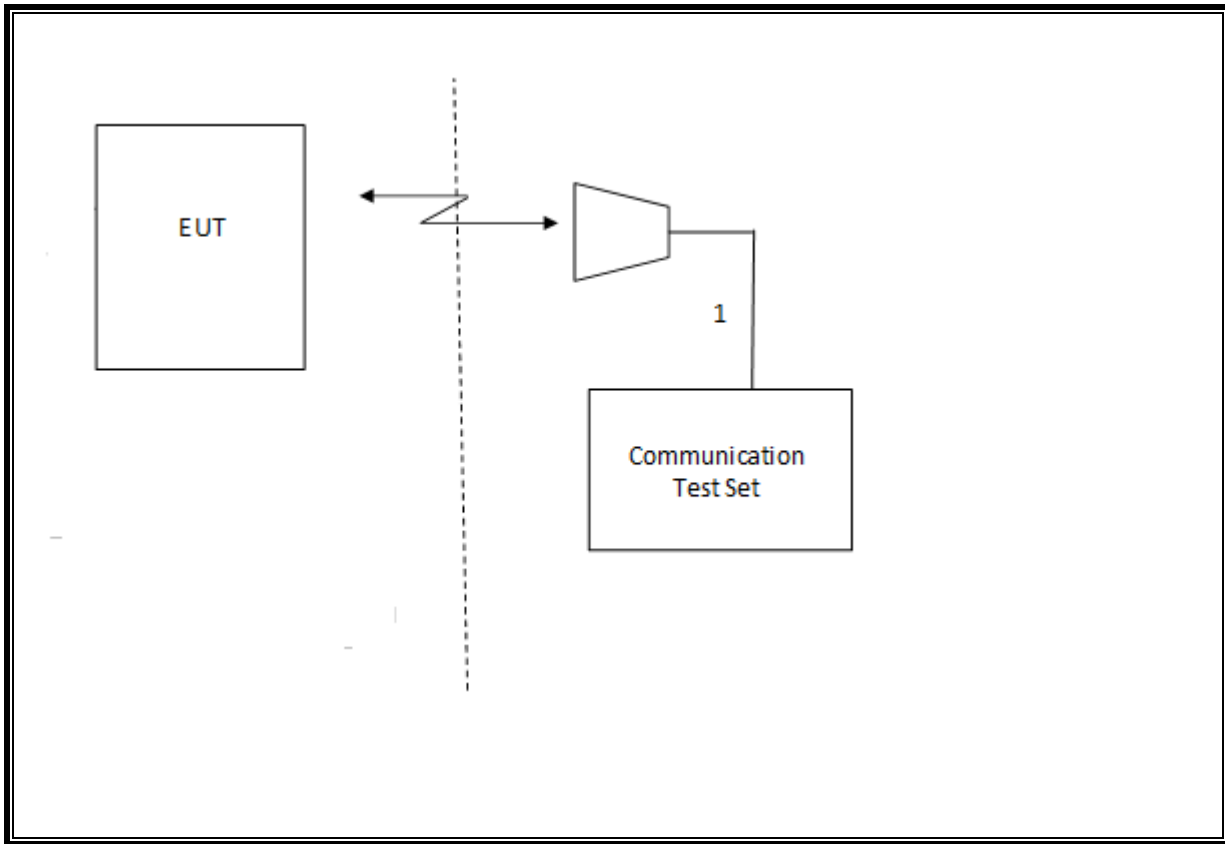

6. TEST AND MEASUREMENT EQUIPMENT

The following test and measurement equipment was utilized for the tests documented in this report:

TEST EQUIPMENT LIST				
Description	Manufacturer	Model	Asset	Cal Due
Spectrum Analyzer, 44 GHz	Agilent / HP	E4446A	C01179	05/01/15
Antenna, Bilog, 2 GHz	Sunol Sciences	JB1	C01011	04/22/15
Antenna, Horn, 18 GHz	EMCO	3115	C00783	10/25/15
Antenna, Horn, 18 GHz	EMCO	3115	C00784	10/25/15
Highpass Filter, 2.7 GHz	Micro-Tronics	HPM13194	N02687	CNR
Highpass Filter, 1.5 GHz	Micro-Tronics	HPM13193	N02688	CNR
Temperature / Humidity Chamber	Thermotron	SE 600-10-10	C00930	05/11/15
Communications Test Set	R&S	CMW500	T159	07/02/15
DC power supply, 8 V @ 3 A or 15 V	Agilent / HP	E3610A	None	CNR
Vector signal generator, 6 GHz	Agilent / HP	E4438C	None	06/18/15
Directional Coupler	RF-Lambda	RFDC5M06G15	None	CNR
Antenna, Horn, 26.5 GHz	ARA	MWH-1826/B	C00589	12/17/15

7. Summary Table

FCC Part Section	RSS Section(s)	Test Description	Test Limit	Test Condition	Test Result	Note
2.1049	N/A	Occupied Band width (99%)	N/A	Conducted	Pass	8.98 MHz
22.917(a) 24.238(a) 27.53(g) 90.691	RSS-132(4.5.1) RSS-133(6.5.1) RSS-139(6.5.1)	Band Edge / Conducted Spurious Emission	-13dBm		Pass	-23.4 dBm
2.1046	N/A	Conducted output power	N/A		Pass	32.6 dBm
22.355 24.235 27.54 90.213	RSS-132(4.3) RSS-133(6.3) RSS-139(6.3) RSS-199(4.3)	Frequency Stability	2.5PPM		Pass	0.012 PPM
22.913(a)(2)	RSS-132(4.4)	Effective Radiated Power	38 dBm	Radiated	Pass	28.1 dBm
27.50(c)(10)	N/A		34.77 dBm		Pass	16.2 dBm
24.232(c) 27.50(h)(2)	RSS-133(6.4) RSS-199(4.4)	Equivalent Isotropic Radiated Power	33dBm		Pass	29.1 dBm
22.917(a) 24.238(a) 27.53(g)	RSS-132(4.5.1) RSS-133(6.5.1) RSS-139(6.5.1)	Radiated Spurious Emission	-13dBm		Pass	-34.4 dBm

8. RF POWER OUTPUT VERIFICATION

8.1. GSM/GPRS/EDGE

Function: Menu select > GSM Mobile Station > GSM 850/900/1800/1900
Press Connection control to choose the different menus
Press RESET > choose all to reset all settings
Connection Press Signal Off to turn off the signal and change settings
Network Support > GSM+GPRS or GSM+EGPRS
Main Service > Packet Data
Service selection > Test Mode A – Auto Slot Config. off
MS Signal Press Slot Config bottom on the right twice to select and change the number of time slots and power setting
 > Slot configuration > Uplink/Gamma
 > 33 dBm for GPRS 850/900
 > 30 dBm for GPRS1800/1900
BS Signal Enter the same channel number for TCH channel (test channel) and BCCH channel
Frequency Offset > + 0 Hz
Mode > BCCH and TCH
BCCH Level > -85 dBm (May need to adjust if link is not stable)
BCCH Channel > choose desire test channel [Enter the same channel number for TCH channel (test channel) and BCCH channel]
Channel Type > Off
P0> 4 dB
Slot Config > Unchanged (if already set under MS Signal)
TCH > choose desired test channel
Hopping > Off
Main Timeslot > 3 (Default)
Network Coding Scheme > CS4 (GPRS) and MCS5 ~ MCS9 (EGPRS)
 Bit Stream > 2E9-1PSR Bit Pattern
AF/RF Enter appropriate offsets for Ext. Att. Output and Ext. Att. Input
Connection Press Signal On to turn on the signal and change settings

8.1.1. GSM OUTPUT POWER RESULT

Mode	Coding Scheme	Time Slots	Ch No.	Freq. (MHz)	Burst Pwr (dBm)
GSM (Voice)	CS1	1	128	824.2	32.6
			190	836.6	32.6
			251	848.8	32.3
GPRS (GMSK)	CS1	1	128	824.2	32.6
			190	836.6	32.6
			251	848.8	32.3
		2	128	824.2	31.4
			190	836.6	31.5
			251	848.8	31.5
		3	128	824.2	29.6
			190	836.6	29.6
			251	848.8	29.6
		4	128	824.2	29.2
			190	836.6	29.2
			251	848.8	29.2
EGPRS (8PSK)	MCS5	1	128	824.2	26.5
			190	836.6	26.5
			251	848.8	26.5
		2	128	824.2	25.8
			190	836.6	25.8
			251	848.8	25.8
		3	128	824.2	23.2
			190	836.6	23.2
			251	848.8	23.1
		4	128	824.2	22.4
			190	836.6	22.4
			251	848.8	22.3

Mode	Coding Scheme	Time Slots	Ch No.	Freq. (MHz)	Burst Pwr (dBm)
GSM (Voice)	CS1	1	512	1850.2	29.7
			661	1880.0	29.9
			810	1909.8	29.7
GPRS (GMSK)	CS1	1	512	1850.2	29.7
			661	1880.0	29.9
			810	1909.8	29.7
		2	512	1850.2	28.8
			661	1880.0	28.7
			810	1909.8	28.7
		3	512	1850.2	26.7
			661	1880.0	27.0
			810	1909.8	27.0
		4	512	1850.2	25.3
			661	1880.0	25.6
			810	1909.8	25.8
EGPRS (8PSK)	MCS5	1	512	1850.2	25.0
			661	1880.0	25.2
			810	1909.8	25.3
		2	512	1850.2	23.8
			661	1880.0	24.0
			810	1909.8	24.1
		3	512	1850.2	21.8
			661	1880.0	22.0
			810	1909.8	22.1
		4	512	1850.2	20.5
			661	1880.0	20.6
			810	1909.8	20.8

8.2. UMTS REL 99

TEST PROCEDURE

The following summary of these settings are illustrated below:

	Mode	Rel99
	Subtest	-
WCDMA General Settings	Loopback Mode	Test Mode 1
	Rel99 RMC	12.2kbps RMC
	HSDPA FRC	Not Applicable
	HSUPA Test	Not Applicable
	Power Control Algorithm	Algorithm2
	β_c	Not Applicable
	β_d	Not Applicable
	β_{ec}	Not Applicable
	β_c/β_d	8/15
	β_{hs}	Not Applicable
β_{ed}	Not Applicable	

8.2.1. UMTS REL 99 OUTPUT POWER RESULT

Band	Mode	UL Ch No.	Freq. (MHz)	MPR	Avg Pwr (dBm)
W-CDMA Band V	Rel 99 (RMC, 12.2 kbps)	4132	826.4	0	24.8
		4183	836.6	0	24.8
		4233	846.6	0	24.7

8.3. UMTS HSDPA

The following 4 Sub-tests were completed according to Release 5 procedures in section 5.2 of 3GPP TS34.121. A summary of these settings are illustrated below:

	Mode	Rel5 HSDPA			
	Subtest	1	2	3	4
WCDMA General Settings	Loopback Mode	Test Mode 1			
	Rel99 RMC	12.2kbps RMC			
	HSDPA FRC	H-Set1			
	Power Control Algorithm	Algorithm 2			
	β_c	2/15	12/15	15/15	15/15
	β_d	15/15	15/15	8/15	4/15
	Bd (SF)	64			
	β_c/β_d	2/15	12/15	15/8	15/4
	β_{hs}	4/15	24/15	30/15	30/15
	MPR (dB)	0	0	0.5	0.5
HSDPA Specific Settings	D_{ACK}	8			
	D_{NAK}	8			
	DCQI	8			
	Ack-Nack repetition factor	3			
	CQI Feedback (Table 5.2B.4)	4ms			
	CQI Repetition Factor (Table 5.2B.4)	2			
	$A_{hs} = \beta_{hs}/\beta_c$	30/15			

8.3.1. UMTS HSDPA OUTPUT POWER RESULT

Band	Mode	UL Ch No.	Freq. (MHz)	MPR	Avg Pwr (dBm)
W-CDMA Band V	Subtest 1	4132	826.4	0	23.2
		4183	836.6	0	23.2
		4233	846.6	0	23.2
	Subtest 2	4132	826.4	0	23.2
		4183	836.6	0	23.2
		4233	846.6	0	23.2
	Subtest 3	4132	826.4	0.5	22.7
		4183	836.6	0.5	22.7
		4233	846.6	0.5	22.7
	Subtest 4	4132	826.4	0.5	22.7
		4183	836.6	0.5	22.7
		4233	846.6	0.5	22.7

8.4. UMTS HSUPA

TEST PROCEDURE

The following summary of these settings are illustrated below: (ETSI TS 134.121-1 Table C.11.1)

	Mode	Rel6 HSUPA	Rel6 HSUPA	Rel6 HSUPA	Rel6 HSUPA	Rel6 HSUPA
	Subtest	1	2	3	4	5
WCDMA General Settings	Loopback Mode	Test Mode 1				
	P-CPICH (dB)	-10				
	P-CCPCH (dB)	-12				
	SCH (dB)	-12				
	PICH(dB)	-15				
	DPCH (dB)	-9				
	HS-SCCH_1 (dB)	-8				
	HS-PDSCH (dB)	-3				
	Rel99 RMC	12.2kbps RMC				
	HSDPA FRC	H-Set1				
	HSUPA Test	HSUPA Loopback				
	Power Control Algorithm	Algorithm2				
	Bc	11/15	6/15	15/15	2/15	15/15
	Bd	15/15	15/15	9/15	15/15	15/15
	Bec	209/225	12/15	30/15	2/15	5/15
	β_c/β_d	11/15	6/15	15/9	2/15	15/15
Bhs	22/15	12/15	30/15	4/15	30/15	
β_{ed} (note1)	1309/225	94/75	47/15 47/15	56/75	134/15	
MPR	0	2	1	2	0	
HSDPA Specific Settings	DACK	8				
	DNAK	8				
	DCQI	8				
	Ack-Nack repetition factor	3				
	CQI Feedback (Table 5.2B.4)	4ms				
	CQI Repetition Factor (Table 5.2B.4)	2				
	$A_{hs} = \beta_{hs}/\beta_c$	30/15				
HSUPA Specific Settings	D E-DPCCH	6	8	8	5	7
	DHARQ	0	0	0	0	0
	AG Index	20	12	15	17	21
	Reference E-TFCIs	5	5	2	5	5
	ETFCI (from 34.121 Table C.11.1.3)	75	67	92	71	81
	Associated Max UL Data Rate kbps	242.1	174.9	482.8	205.8	308.9
	Reference E_TFCIs	E-TFCI 11 E-TFCI PO 4 E-TFCI 67 E-TFCI PO 18 E-TFCI 71 E-TFCI PO 23 E-TFCI 75 E-TFCI PO 26 E-TFCI 81 E-TFCI PO 27		E-TFCI 11 E-TFCI PO 4 E-TFCI 92 E-TFCI PO 18		E-TFCI 11 E-TFCI PO 4 E-TFCI 67 E-TFCI PO 18 E-TFCI 71 E-TFCI PO 23 E-TFCI 75 E-TFCI PO 26 E-TFCI 81 E-TFCI PO 27

Note1: β_{ed} cannot be set directly, it is set by Absolute Grant Value.

8.4.1. UMTS HSUPA OUTPUT POWER RESULT

Band	Mode	UL Ch No.	Freq. (MHz)	MPR	Avg Pwr (dBm)
W-CDMA Band V	Subtest 1	4132	826.4	0	23.2
		4183	836.6	0	23.2
		4233	846.6	0	22.6
	Subtest 2	4132	826.4	2	21.6
		4183	836.6	2	21.6
		4233	846.6	2	21.6
	Subtest 3	4132	826.4	1	21.5
		4183	836.6	1	21.5
		4233	846.6	1	21.6
	Subtest 4	4132	826.4	2	21.6
		4183	836.6	2	21.6
		4233	846.6	2	21.6
	Subtest 5	4132	826.4	0	23.2
		4183	836.6	0	23.3
		4233	846.6	0	22.6

8.5. LTE OUTPUT VERIFICATION

8.5.1. LTE OUTPUT RESULT

Band	BW (MHz)	Mode	RB Allocation	RB offset	Target MPR	Avg Pwr (dBm)
						23790
						710 MHz
LTE Band 17	10	QPSK	1	0	0	23.1
			1	25	0	22.9
			1	49	0	22.8
			25	0	1	21.9
			25	12	1	22.0
			25	25	1	21.8
			50	0	1	22.0
		16QAM	1	0	1	22.3
			1	25	1	22.5
			1	49	1	22.1
			25	0	2	21.0
			25	12	2	21.1
			25	25	2	20.9
			50	0	2	21.0
Band	BW (MHz)	Mode	RB Allocation	RB offset	Target MPR	Avg Pwr (dBm)
						23790
						710 MHz
LTE Band 17	5	QPSK	1	0	0	23.1
			1	12	0	23.2
			1	24	0	22.9
			12	0	1	21.9
			12	7	1	22.0
			12	13	1	21.9
			25	0	1	22.0
		16QAM	1	0	1	22.0
			1	12	1	22.1
			1	24	1	22.1
			12	0	2	21.0
			12	7	2	20.9
			12	13	2	21.0
			25	0	2	21.1

9. PEAK TO AVERAGE RATIO

Test Procedure

Per KDB 971168 D01 Power Meas License Digital Systems v02r02

Test Spec

In addition, when the transmitter power is measured in terms of average value, the peak-to-average ratio of the power shall not exceed 13 dB.

9.1. CONDUCTED PEAK TO AVERAGE RESULT

LTE Band 17

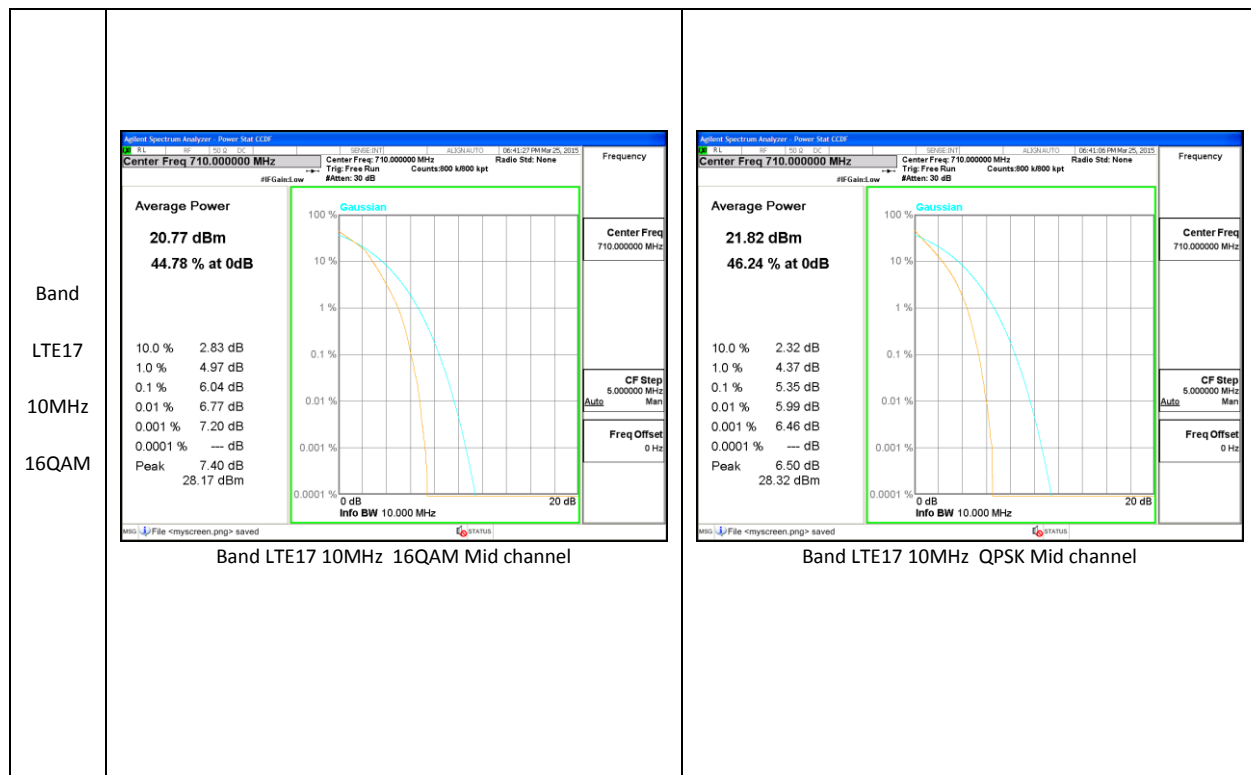

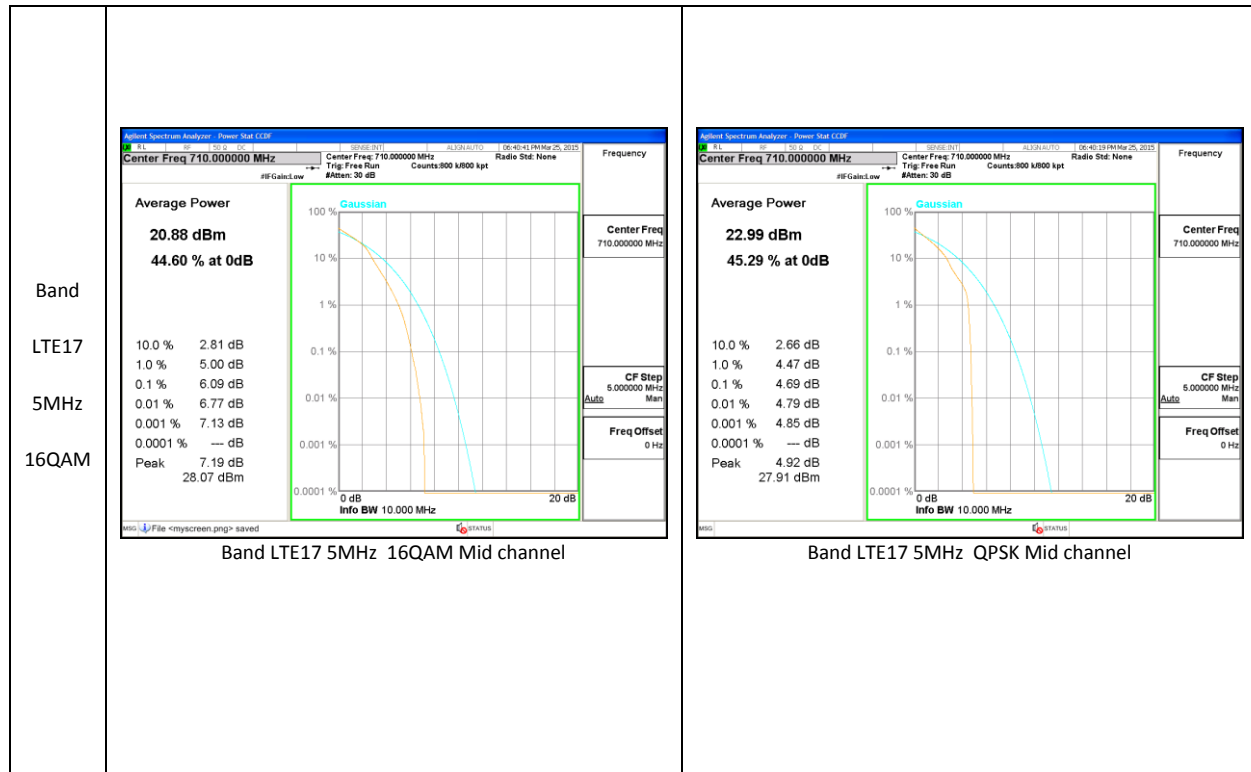

WCDMA

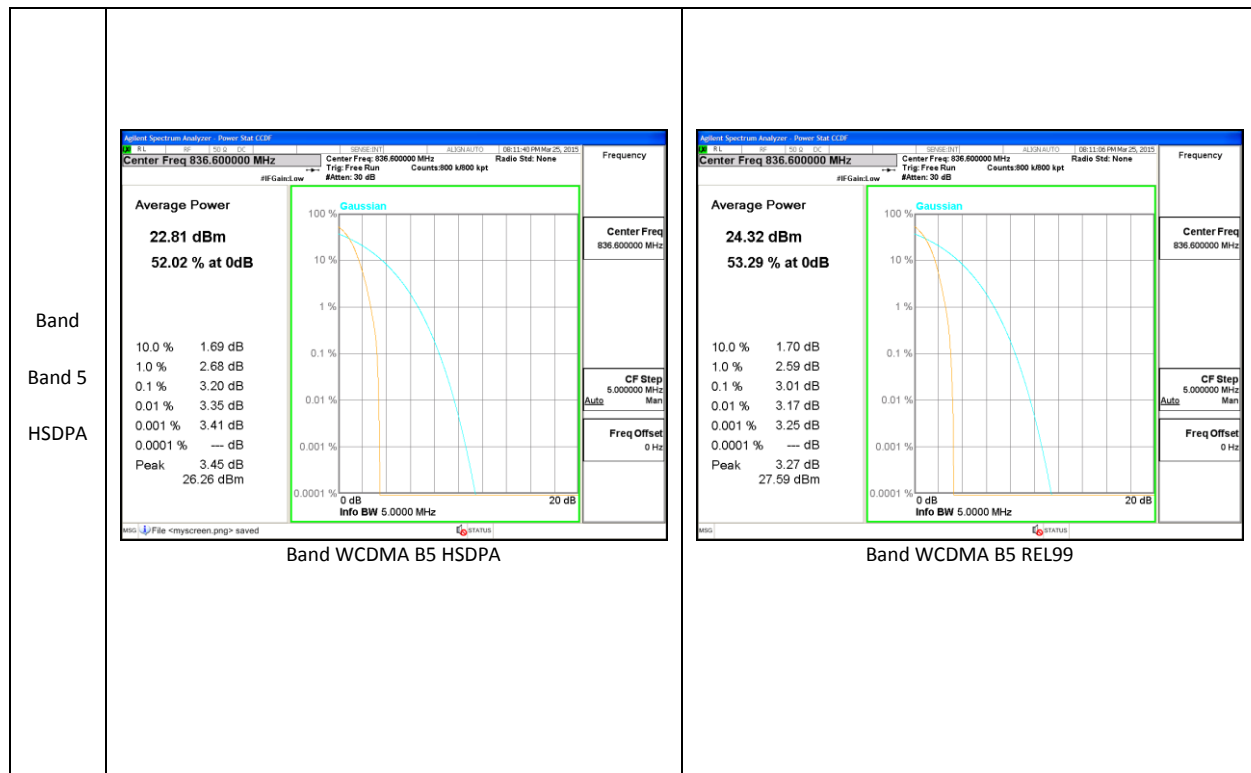

GSM

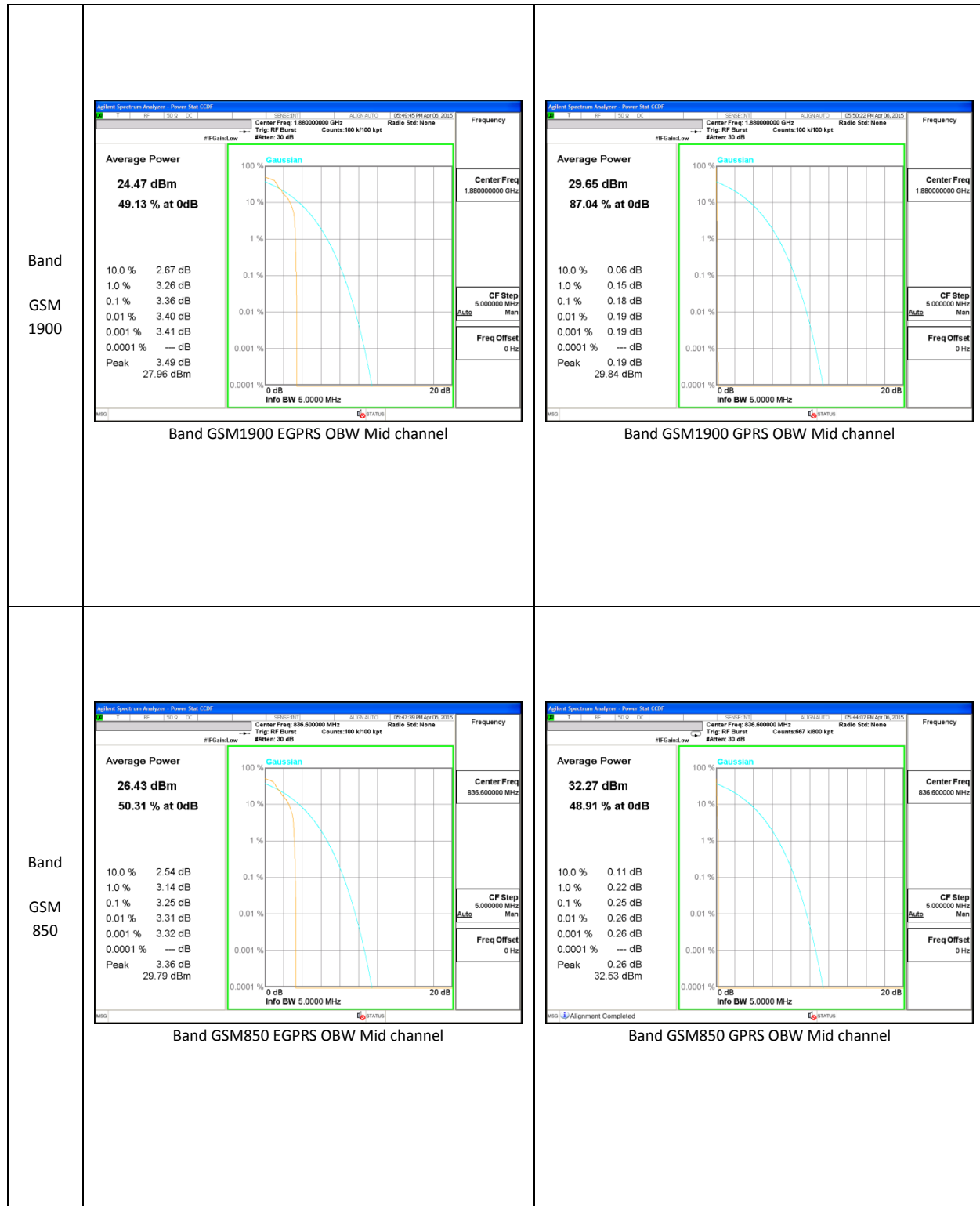

10. LIMITS AND CONDUCTED RESULTS

10.1. OCCUPIED BANDWIDTH

RULE PART(S)

FCC: §2.1049

LIMITS

For reporting purposes only

TEST PROCEDURE

The transmitter output was connected to a calibrated coaxial cable and coupler, the other end of which was connected to a spectrum analyzer. The occupied bandwidth was measured with the spectrum analyzer at the low, middle and high channel in each band. The -26dB bandwidth was also measured and recorded.

(KDB 971168 D01 Power Meas License Digital Systems v02r02)

MODES TESTED

GSM, WCDMA, and LTE

10.1.1. OCCUPIED BANDWIDTH RESULTS

Band	Mode	Channel	f (MHz)	99% BW (kHz)	-26dB BW (kHz)
GSM850	GPRS	128	824.2	245.7	317.7
		190	836.6	242.5	316.6
		251	848.8	246.8	314.7
	EGPRS	128	824.2	252.3	320.9
		190	836.6	243.1	312.3
		251	848.8	249.6	308.8
GSM1900	GPRS	512	1850.2	243.7	313.3
		661	1880	245.9	319.2
		810	1909.8	246.6	320.6
	EGPRS	512	1850.2	249.8	316.5
		661	1880	239.4	311.8
		810	1909.8	240.7	310.7

Band	Mode	Channel	f (MHz)	99% BW (MHz)	-26dB BW (MHz)
Band 5	REL99	4132	826.4	4.1321	4.686
		4183	836.6	4.1301	4.673
		4233	846.6	4.1341	4.660
	HSDPA	4132	826.4	4.2960	4.842
		4183	836.6	4.1478	4.678
		4233	846.6	4.1297	4.663

10.1.2. LTE OCCUPIED BANDWIDTH RESULTS

Band	BW(MHz)	Mode	RB/RB Size	f (MHz)	99% BW (MHz)	-26dB BW(MHz)
LTE17	10	QPSK	50/0	709	8.980	9.797
			50/0	710	8.970	9.771
			50/0	711	8.976	9.803
		16QAM	50/0	709	8.961	9.820
			50/0	710	8.961	9.753
			50/0	711	8.984	9.753
	5	QPSK	25/0	706.5	4.496	4.951
			25/0	710	4.488	4.930
			25/0	713.5	4.500	4.937
		16QAM	25/0	706.5	4.491	4.938
			25/0	710	4.482	4.916
			25/0	713.5	4.497	4.969

10.1.3. OCCUPIED BANDWIDTH PLOTS

LTE Band 17

<p>Band LTE17 10MHz 16QAM</p>	 <p>Band LTE17 10MHz OBW 16QAM Mid Channel FRB.gif</p>	 <p>Band LTE17 10MHz OBW QPSK Mid Channel FRB.gif</p>
<p>Band LTE17 5MHz 16QAM</p>	 <p>Band LTE17 5MHz OBW 16QAM Mid Channel FRB.gif</p>	 <p>Band LTE17 5MHz OBW QPSK Mid Channel FRB.gif</p>

WCDMA



GSM



10.2. BAND EDGE EMISSIONS

RULE PART(S)

FCC: §22.359, §24.238, §27.53 and §90.691

LIMITS

The power of any emission outside of the authorized operating frequency ranges must be attenuated below the transmitting power (P) by a factor of at least $43 + 10 \log(P)$ dB.

Part 27: (m)(4) For mobile station, the attenuation factor shall be not less than $43+10\log(P)$ dB at the channel edge and $(55+10\log(P))$ dB at 5.5MHz from the channel edges.

Part 90:

(a)(1) For any frequency removed from the EA licensee's frequency block by up to and including 37.5 kHz, the power of any emission shall be attenuated below the transmitter power (P) in watts by at least $116 \log_{10}(f/6.1)$ decibels or $50 + 10 \log_{10}(P)$ decibels or 80 decibels, whichever is the lesser attenuation, where f is the frequency removed from the center of the outer channel in the block in kilohertz and where f is greater than 12.5 kHz.

(a)(2) For any frequency removed from the EA licensee's frequency block greater than 37.5 kHz, the power of any emission shall be attenuated below the transmitter power (P) in watts by at least $43 + 10\log_{10}(P)$ decibels or 80 decibels, whichever is the lesser attenuation, where f is the frequency removed from the center of the outer channel in the block in kilohertz and where f is greater than 37.5 kHz. {NOTE: Use 100 kHz reference bandwidth.}

TEST PROCEDURE

Per KDB 971168 D01 Power Meas License Digital Systems v02r02

The transmitter output was connected to an Agilent 8960 or a CMW500 Test Set and configured to operate at maximum power. The band edge emissions were measured at the required operating frequencies in each band on the Spectrum Analyzer.

MODES TESTED

GSM, WCDMA, and LTE

RESULTS

10.2.1. BAND EDGE PLOTS

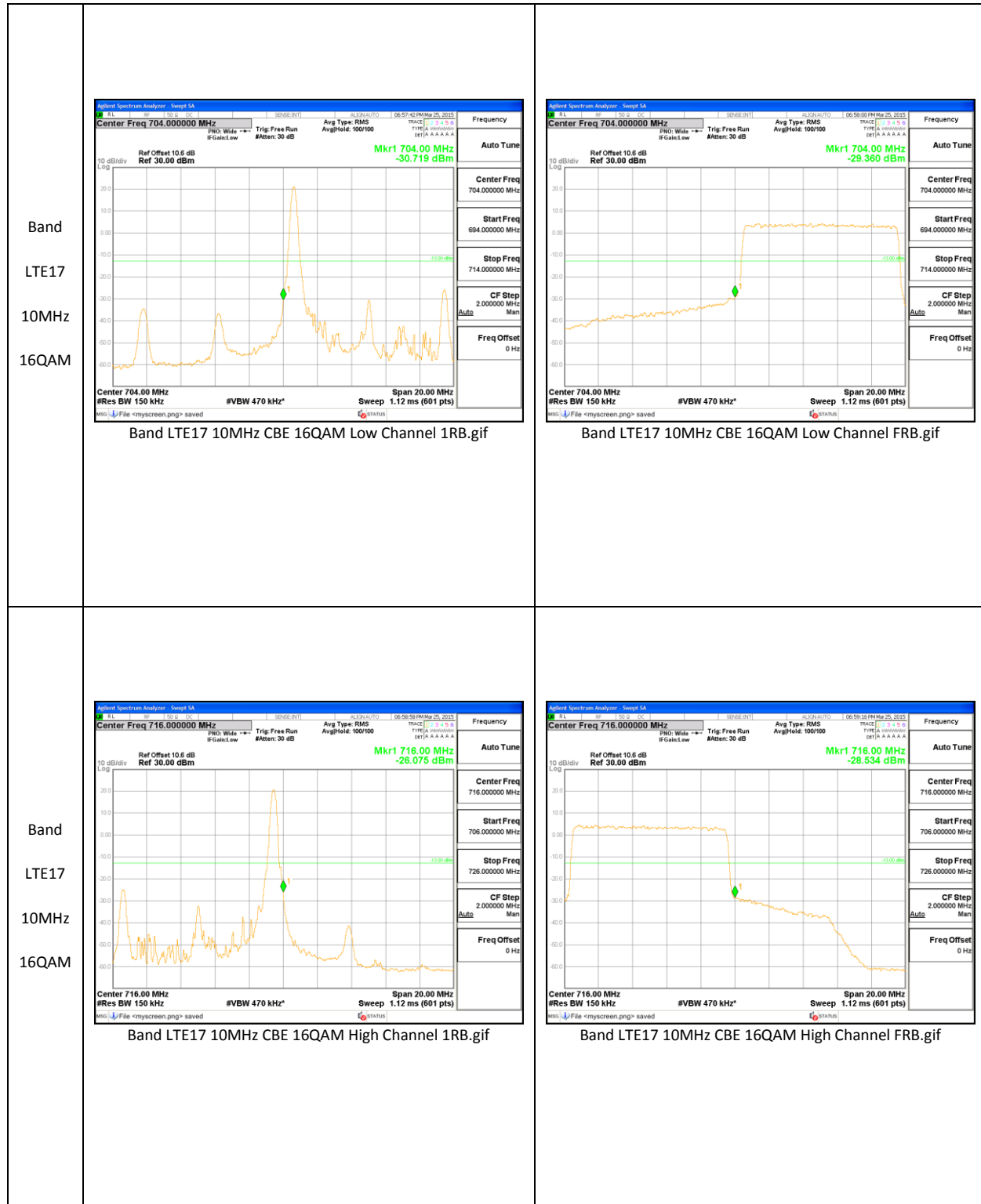

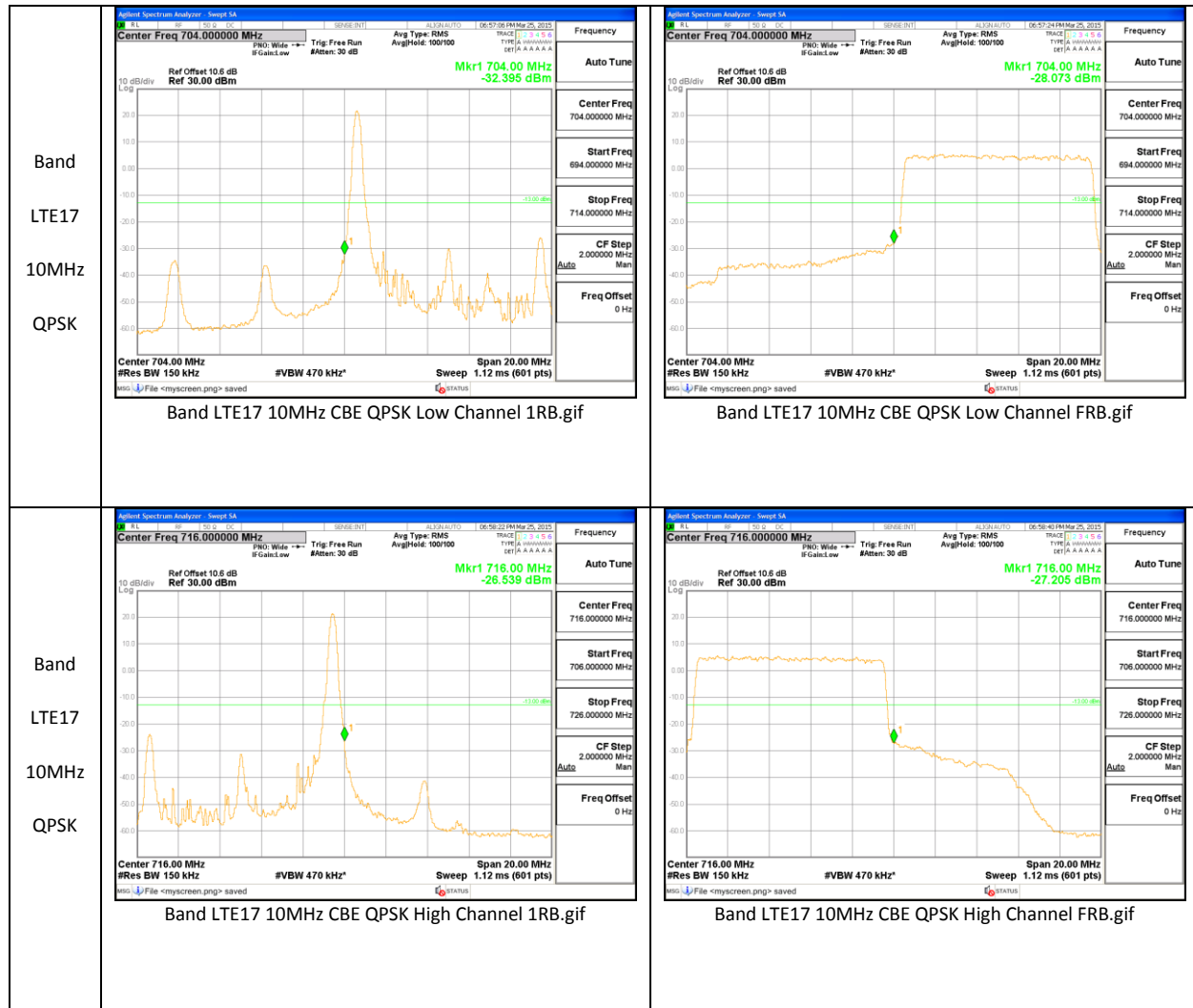

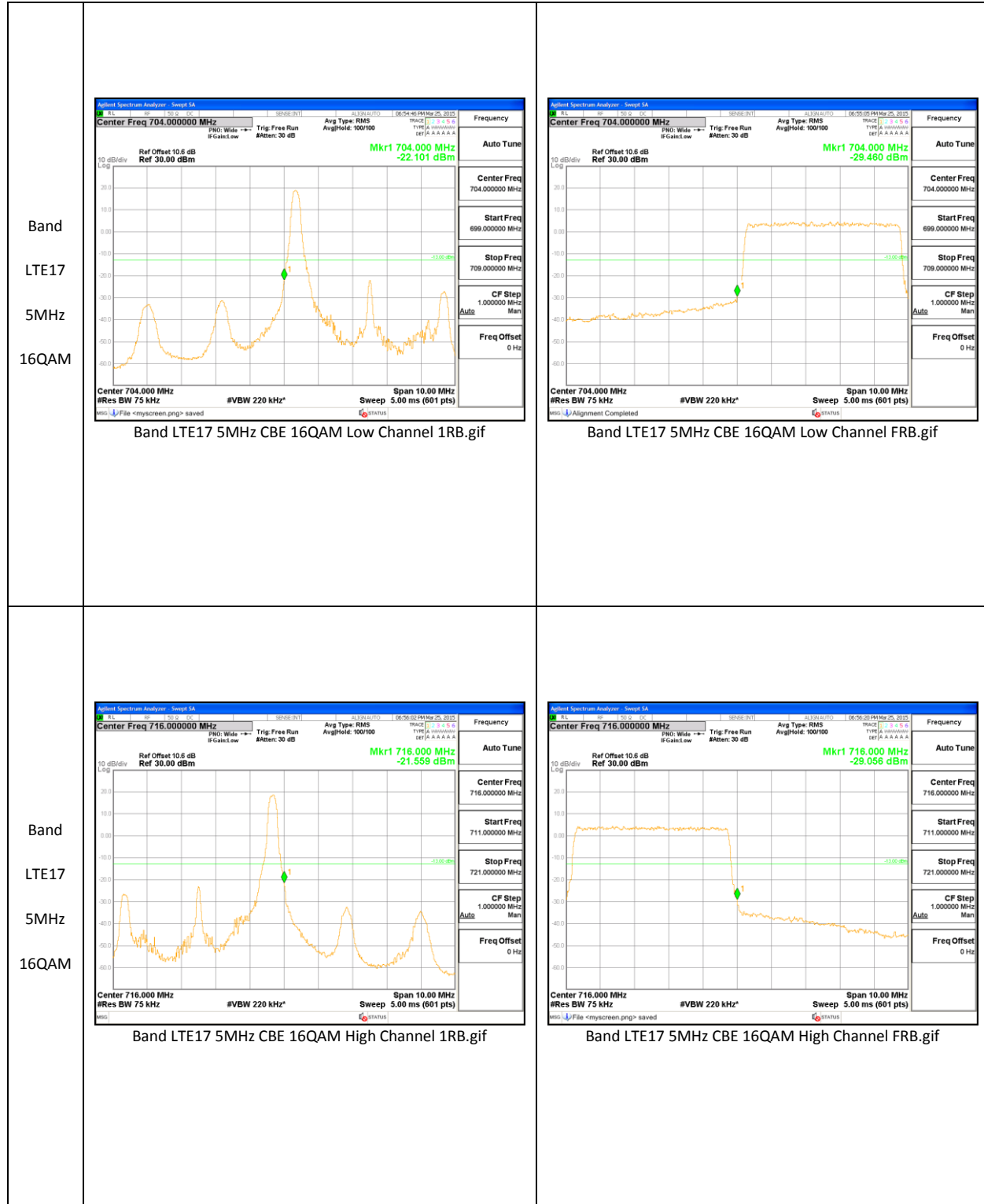

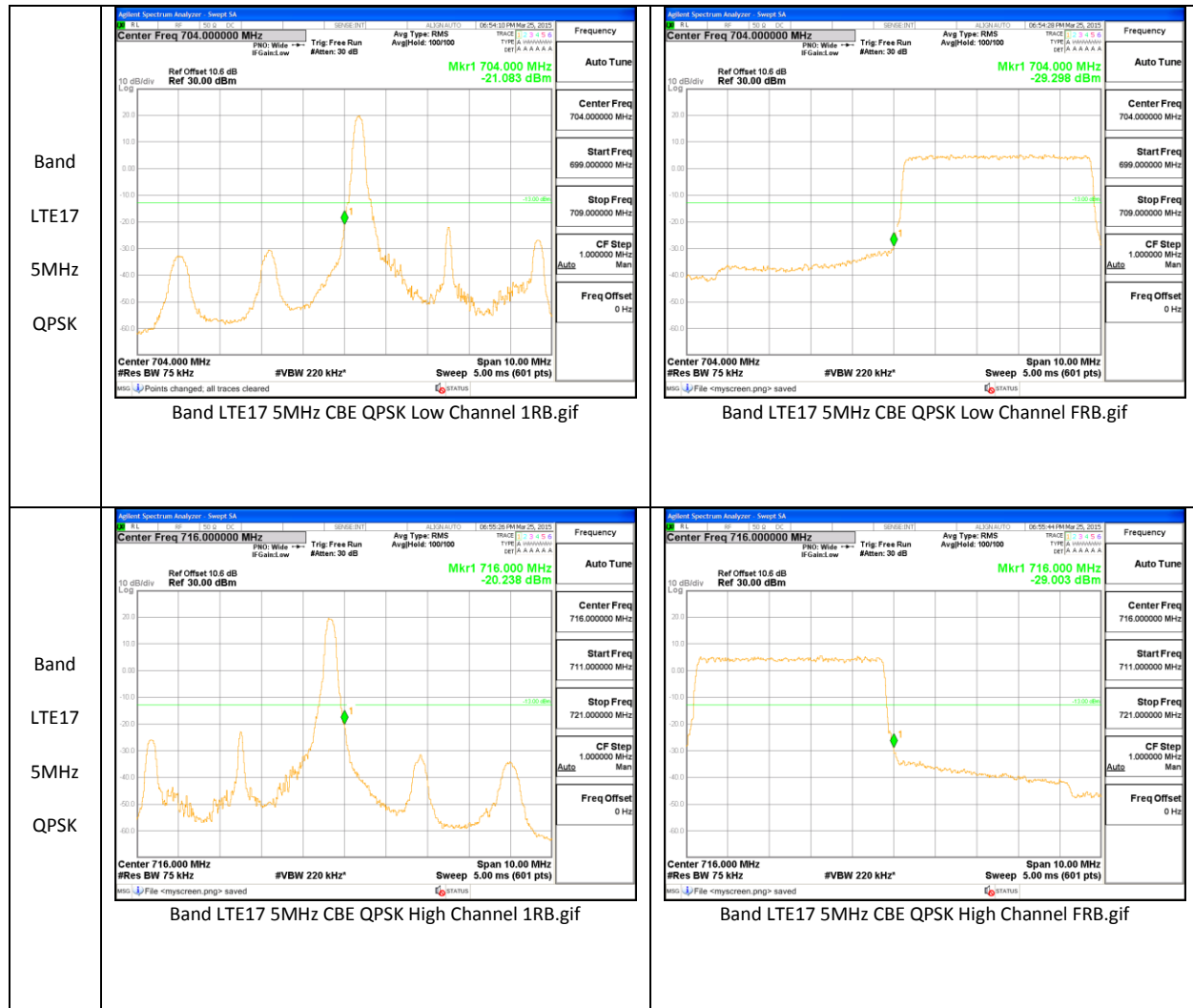

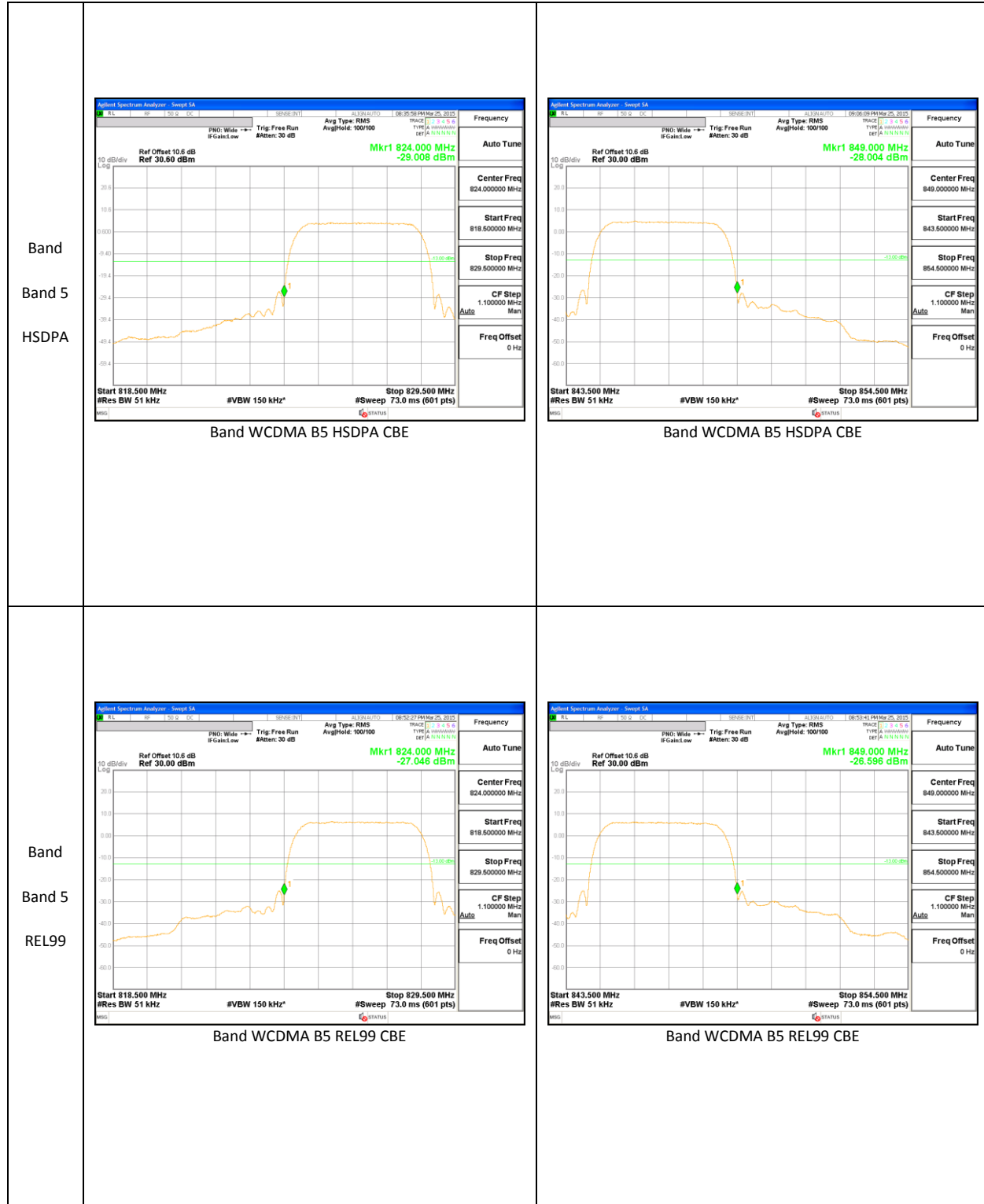

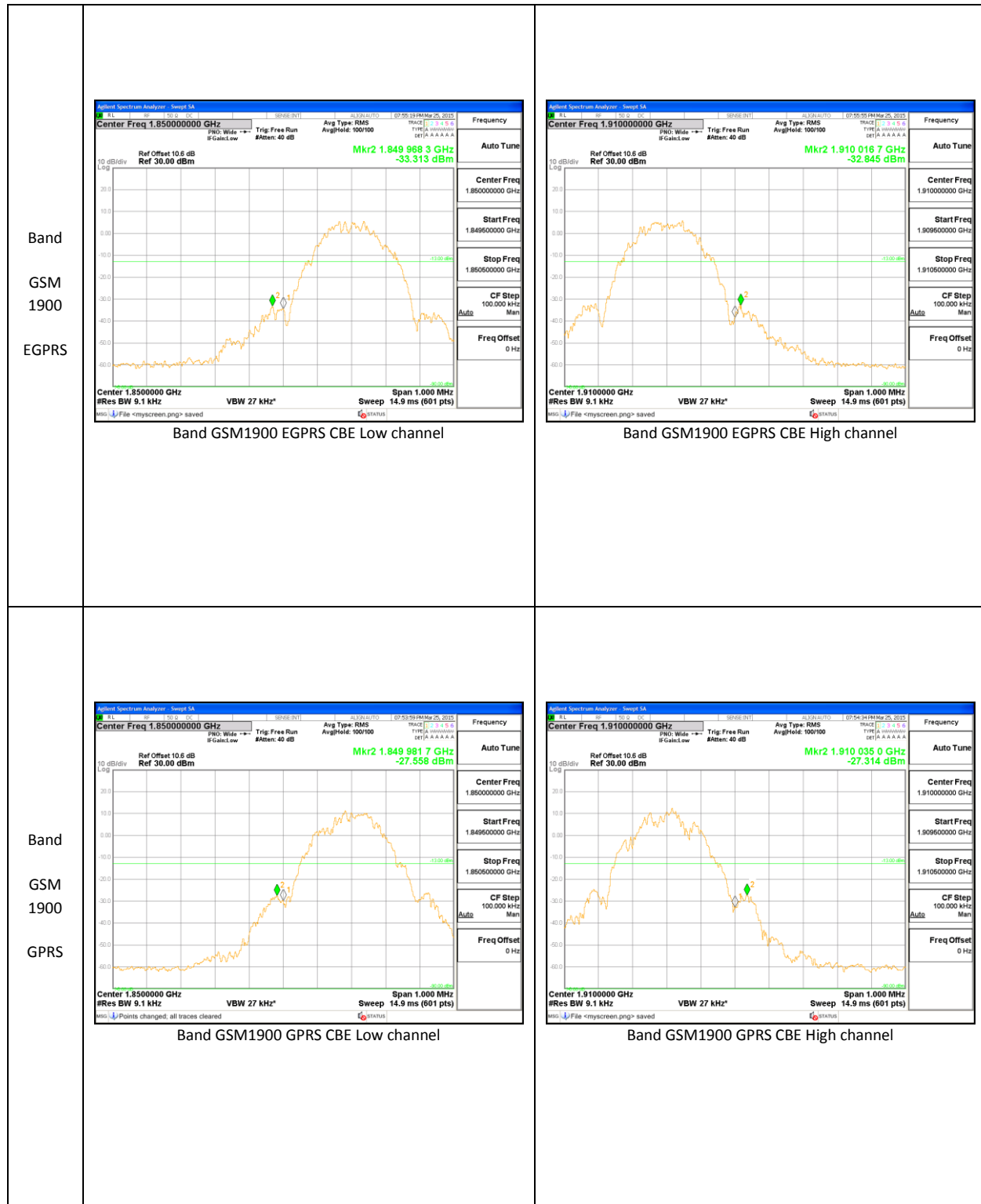

Note: GSM reading need add 9dB DCCF factor due to duty cycle is 12.5% during test.

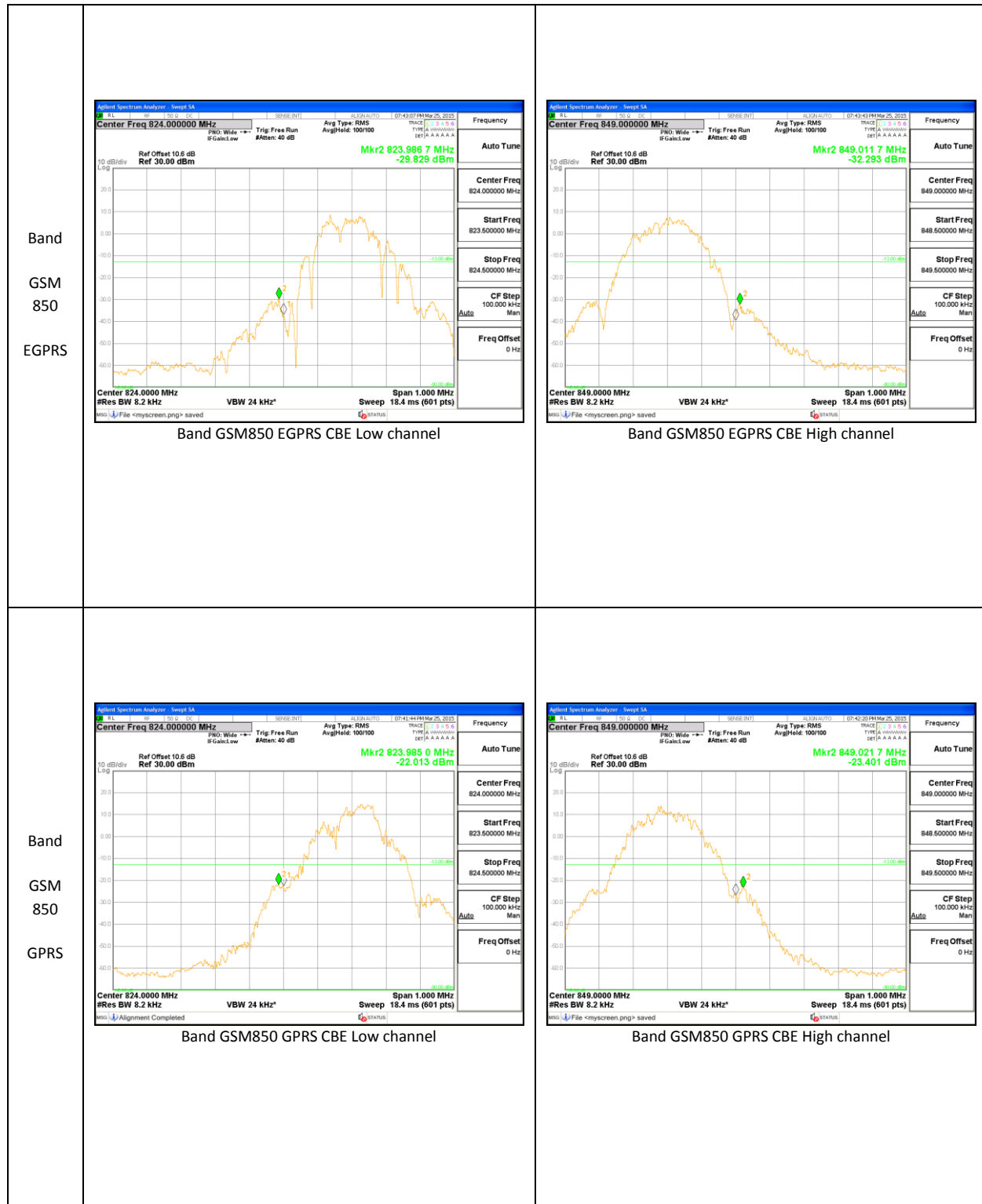

Note: GSM reading need add 9dB DCCF factor due to duty cycle is 12.5% during test.

10.3. OUT OF BAND EMISSIONS

RULE PART(S)

FCC: §2.1051, §22H, §24E, §27.53(g)

LIMITS

The power of any emission outside of the authorized operating frequency ranges must be attenuated below the transmitting power (P) by a factor of at least $43 + 10 \log (P)$ dB.

Part 27.53 (g) For operations in the 600 MHz band and the 698-746 MHz band, the power of any emission outside a licensee's frequency band(s) of operation shall be attenuated below the transmitter power (P) within the licensed band(s) of operation, measured in watts, by at least $43 + 10 \log (P)$ dB. Compliance with this provision is based on the use of measurement instrumentation employing a resolution bandwidth of 100 kilohertz or greater. However, in the 100 kilohertz bands immediately outside and adjacent to a licensee's frequency block, a resolution bandwidth of at least 30 kHz may be employed.

TEST PROCEDURE

Per KDB 971168 D01 Power Meas License Digital Systems v02r02

The RF output of the transmitter was connected to a spectrum analyzer through a calibrated coaxial cable. Sufficient scans were taken to show the out-of-band Emissions, if any, up to 10th harmonic. Multiple sweeps were recorded in maximum hold mode using a peak detector to ensure that the worst-case emissions were caught.

MODES TESTED

GSM, WCDMA, and LTE

RESULTS

10.3.1. OUT OF BAND EMISSIONS RESULT

Band	BW (MHz)	Mode	f (MHz)	Spur (dBm)	Spec (dBm)	Delta (dB)
LTE17	10	QPSK	709	-31.60	-13	-18.60
			710	-30.50	-13	-17.50
			711	-30.14	-13	-17.14
		16QAM	709	-31.29	-13	-18.29
			710	-31.00	-13	-18.00
			711	-29.68	-13	-16.68
	5	QPSK	706.5	-33.80	-13	-20.80
			710	-31.19	-13	-18.19
			713.5	-31.09	-13	-18.09
		16QAM	706.5	-34.17	-13	-21.17
			710	-27.30	-13	-14.30
			713.5	-34.40	-13	-21.40

Band	Mode	f (MHz)	Spur (dBm)	Spec (dBm)	Delta (dB)
GSM850	GPRS	824.2	-24.734	-13	-11.734
		836.6	-24.231	-13	-11.231
		848.8	-24.261	-13	-11.261
	EGPRS	824.2	-24.635	-13	-11.635
		836.6	-23.576	-13	-10.576
		848.8	-23.751	-13	-10.751
GSM1900	GPRS	1850.2	-24.713	-13	-11.713
		1880	-23.378	-13	-10.378
		1909.8	-24.332	-13	-11.332
	EGPRS	1850.2	-24.226	-13	-11.226
		1880	-24.355	-13	-11.355
		1909.8	-24.248	-13	-11.248
WCDMA Band 5	REL99	826.4	-36.77	-13	-23.77
		836.6	-36.93	-13	-23.93
		846.6	-36.91	-13	-23.91
	HSDPA	826.4	-36.11	-13	-23.11
		836.6	-36.00	-13	-23.00
		846.6	-36.46	-13	-23.46

10.3.2. OUT OF BAND EMISSIONS PLOTS

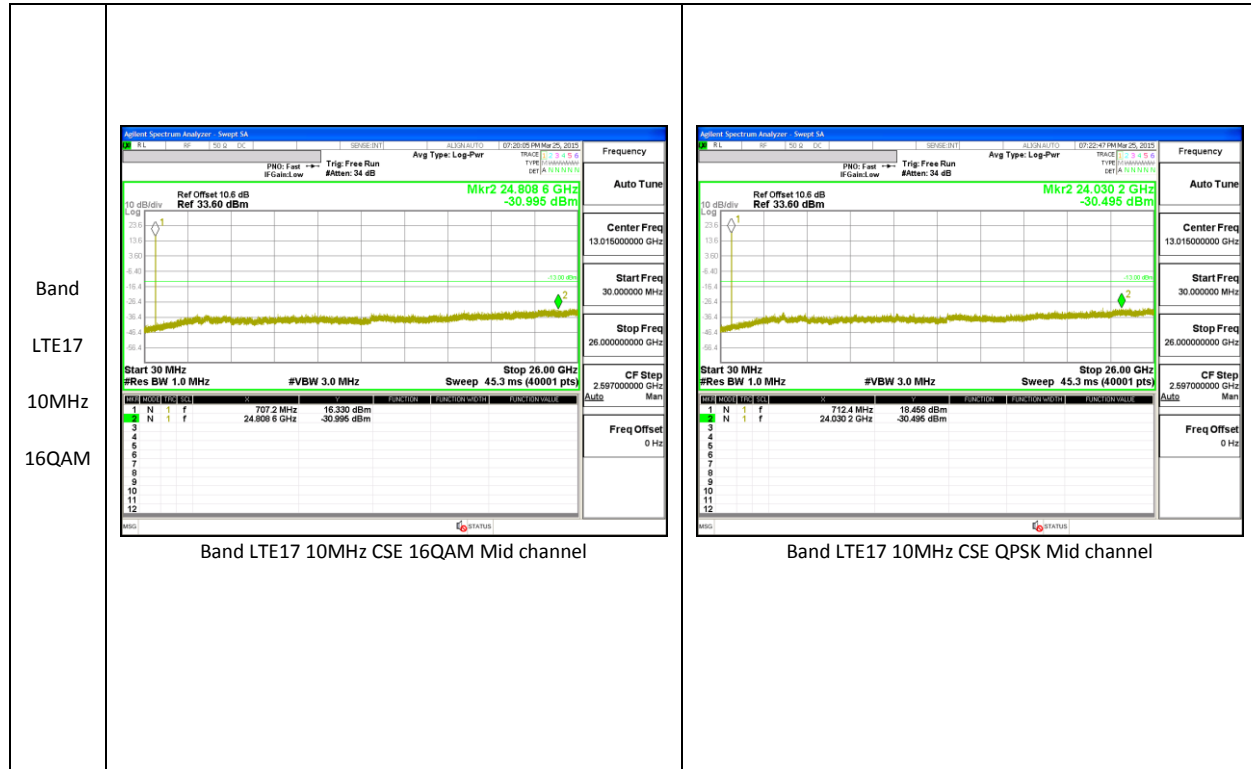

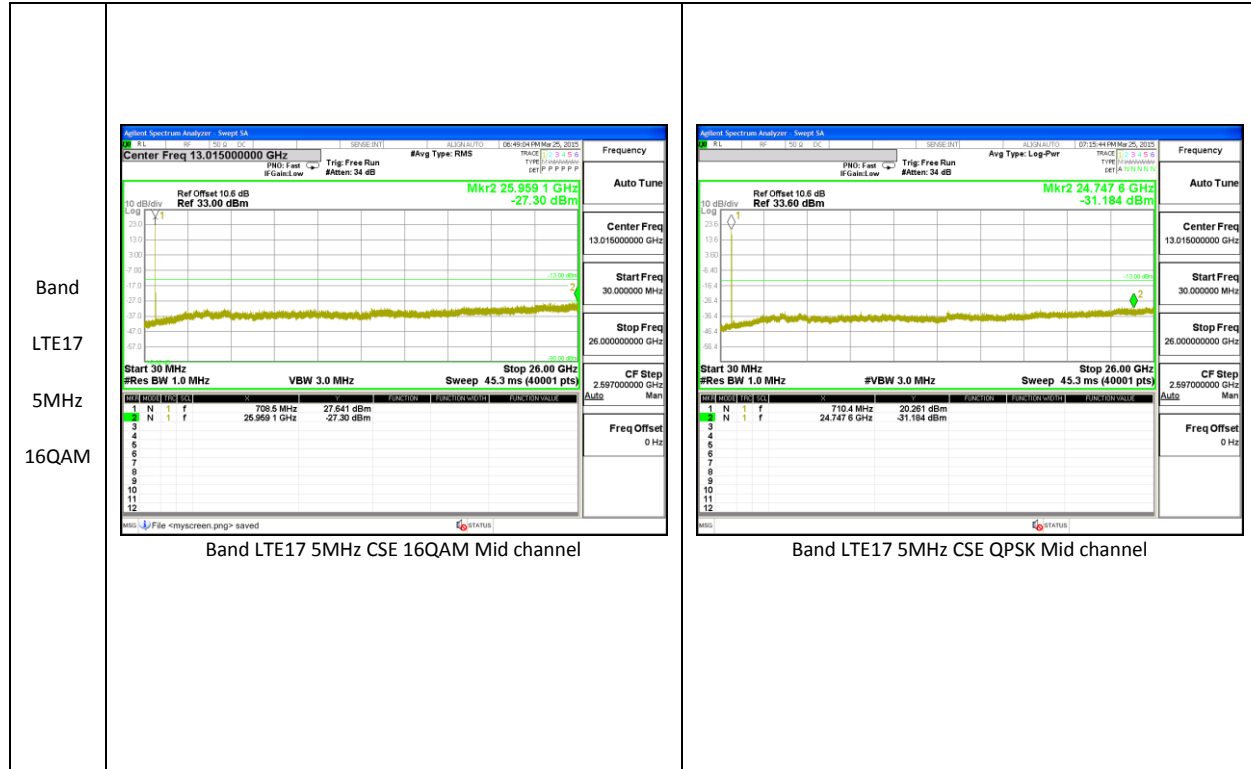

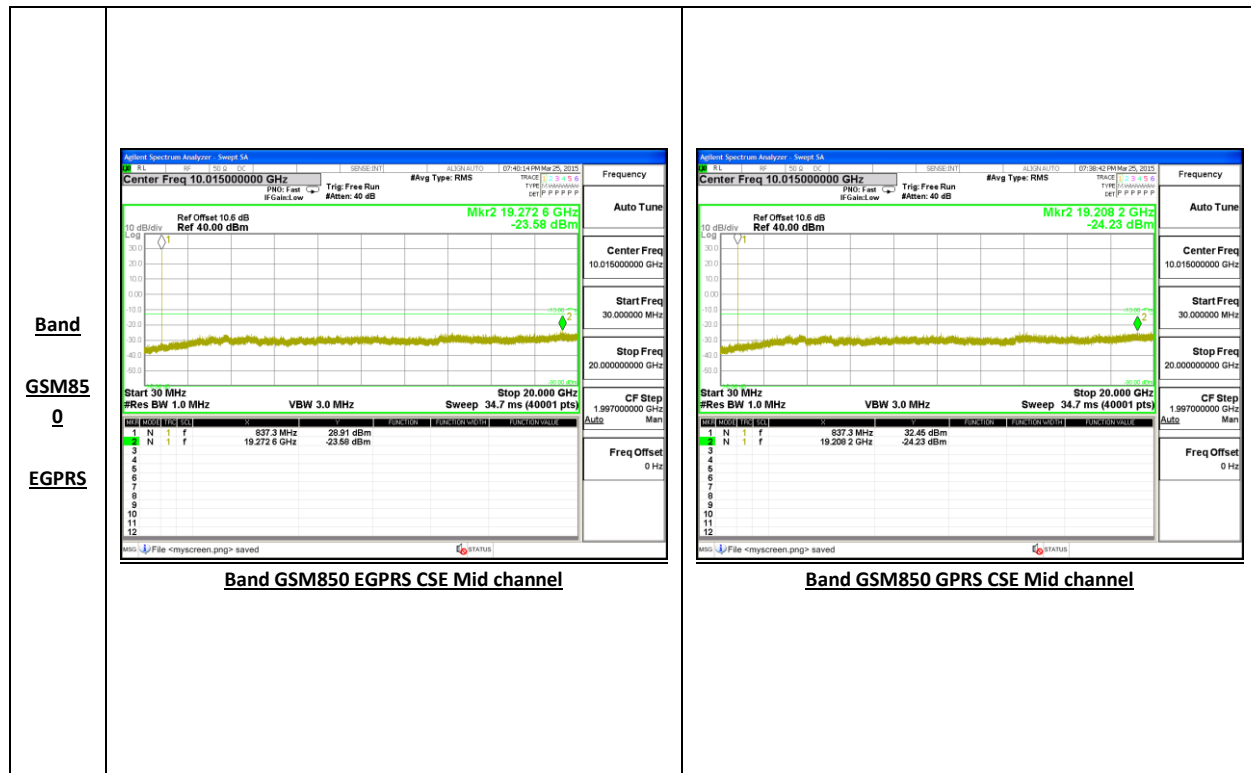

10.4. FREQUENCY STABILITY

RULE PART(S)

FCC: §2.1055, §22.355, §24.235, §27.54 and §90.213

LIMITS

§22.355 - The carrier frequency shall not depart from the reference frequency in excess of ± 2.5 ppm for mobile stations.

§24.235 - The frequency stability shall be sufficient to ensure that the fundamental emission stays within the authorized frequency block.

§27.54 - The frequency stability shall be sufficient to ensure that the fundamental emissions stay within the authorized bands of operation.

§90.213 - The carrier frequency shall not depart from the reference frequency in excess of ± 2.5 ppm for mobile stations.

TEST PROCEDURE

Per KDB 971168 D01 Power Meas License Digital Systems v02r02

MODES TESTED

GSM and LTE

RESULTS

See the following pages.

10.4.1. FREQUENCY STABILITY RESULTS

GSM 850, Frequency 836.6 MHz– MID CHANNEL

Reference Frequency: PCS Mid Channel 836.6 MHz @ 20°C				
Limit: to stay +- 2.5 ppm = 2091.500 Hz				
Power Supply (Vdc)	Environment Temperature (°C)	Frequency Deviation Measured with Time Elapse		
		(MHz)	Delta (ppm)	Limit (ppm)
3.80	50	836.600018	0.002	2.5
3.80	40	836.600018	0.003	2.5
3.80	30	836.600015	0.006	2.5
3.80	20	836.600020	0	2.5
3.80	10	836.600030	-0.012	2.5
3.80	0	836.600017	0.003	2.5
3.80	-10	836.600017	0.003	2.5
3.80	-20	836.600016	0.005	2.5
3.80	-30	836.600021	-0.001	2.5

Reference Frequency: PCS Mid Channel 836.6 MHz @ 20°C				
Limit: to stay +- 2.5 ppm = 2091.500 Hz				
Power Supply (Vdc)	Environment Temperature (°C)	Frequency Deviation Measured with Time Elapse		
		(MHz)	Delta (ppm)	Limit (ppm)
3.80	20	836.600020	0	2.5
4.37	20	836.6000235	-0.004	2.5
3.23	20	836.6000227	-0.003	2.5

GSM 1800, Frequency 1880MHz– MID CHANNEL

Reference Frequency: PCS Mid Channel 1880 MHz @ 20°C Limit: to stay +/- 2.5 ppm = 4700.000 Hz				
Power Supply (Vdc)	Environment Temperature (°C)	Frequency Deviation Measured with Time Elapse		
		(MHz)	Delta (ppm)	Limit (ppm)
3.80	50	1880.000024	0.009	2.5
3.80	40	1880.000019	0.011	2.5
3.80	30	1880.000038	0.001	2.5
3.80	20	1880.000040	0	2.5
3.80	10	1880.000025	0.008	2.5
3.80	0	1880.000023	0.009	2.5
3.80	-10	1880.000031	0.005	2.5
3.80	-20	1880.000027	0.007	2.5
3.80	-30	1880.000031	0.005	2.5

Reference Frequency: PCS Mid Channel 1880 MHz @ 20°C Limit: to stay +/- 2.5 ppm = 4700.000 Hz				
Power Supply (Vdc)	Environment Temperature (°C)	Frequency Deviation Measured with Time Elapse		
		(MHz)	Delta (ppm)	Limit (ppm)
3.80	20	1880.000040	0	2.5
4.37	20	1880.000036	0.002	2.5
3.23	20	1880.000042	-0.001	2.5

LTE17, Frequency: 710 MHz- MID CHANNEL

Reference Frequency: PCS Mid Channel 710 MHz @ 20°C				
Limit: to stay +/- 2.5 ppm = 1775.000 Hz				
Power Supply (Vdc)	Environment Temperature (°C)	Frequency Deviation Measured with Time Elapse		
		(MHz)	Delta (ppm)	Limit (ppm)
3.80	50	709.999999	0.005	2.5
3.80	40	709.999999	0.004	2.5
3.80	30	709.999998	0.005	2.5
3.80	20	710.000002	0	2.5
3.80	10	710.000001	0.002	2.5
3.80	0	710.000001	0.002	2.5
3.80	-10	710.000001	0.002	2.5
3.80	-20	710.000002	0.001	2.5
3.80	-30	709.999999	0.005	2.5

Reference Frequency: PCS Mid Channel 710 MHz @ 20°C				
Limit: to stay +/- 2.5 ppm = 1775.000 Hz				
Power Supply (Vdc)	Environment Temperature (°C)	Frequency Deviation Measured with Time Elapse		
		(MHz)	Delta (ppm)	Limit (ppm)
3.80	20	710.000002	0	2.5
4.37	20	710.0000015	0.001	2.5
3.23	20	710.0000012	0.002	2.5

11. RADIATED TEST RESULTS

11.1. RADIATED POWER (ERP & EIRP)

RULE PART(S)

FCC: §2.1046, §22.913, §24.232, and §27

LIMITS

22.913(a) - The ERP of mobile transmitters and auxiliary test transmitters must not exceed 7 Watts.

24.232(c) - Mobile/portable stations are limited to 2 watts e.i.r.p. peak power and the equipment must employ means to limit the power to the minimum necessary for successful communications.

27.50(c) - (10) Portable stations (hand-held devices) are limited to 3 watts ERP; (LTE B17)

TEST PROCEDURE

ANSI / TIA / EIA 603C Clause 2.2.17; PSA setting reference to 971168 D01 v02r02

For average power measurement with a PSA:

a) Set span to at least 1.5 times the OBW; b) Set RBW = 1-5% of the OBW, not to exceed 1 MHz; c) Set VBW $\geq 3 \times$ RBW; d) Set number of points in sweep $\geq 2 \times$ span / RBW; e) Sweep time = auto-couple; f) Detector = RMS (power averaging); g) Use free run trigger If burst duty cycle ≥ 98 ; h) Use trigger to capture bursts If burst duty cycle < 98 ; i) Trace average at least 100 traces in power averaging (*i.e.*, RMS) mode. j) Compute the power by integrating the spectrum across the OBW of the signal using the instrument's band power measurement function.

MODES TESTED

GSM, WCDMA and LTE

TEST RESULTS

11.1.1. ERP/EIRP Results

Band	Mode	Channel	f(MHz)	ERP / EIRP	
				dBm	mW
Band 5	REL99	4132	826.4	20.001	100.02
		4183	836.6	19.101	81.3
		4233	846.6	17.681	58.63
	HSDPA	4132	826.4	19.401	87.12
		4183	836.6	18.301	67.62
		4233	846.6	16.901	48.99

Band	Mode	Channel	f(MHz)	ERP / EIRP	
				dBm	mW
GSM1900	GPRS	512	1850.2	28.0574	639.35
		661	1880	29.0944	811.78
		810	1909.8	29.0536	804.19
	EGPRS	512	1850.2	21.8574	153.37
		661	1880	22.6694	184.9
		810	1909.8	22.7536	188.52

Band	Mode	Channel	f(MHz)	ERP / EIRP	
				dBm	mW
GSM850	GPRS	128	824.2	28.101	645.8
		190	836.6	27.321	539.63
		251	848.8	26.301	426.68
	EGPRS	128	824.2	23.601	229.14
		190	836.6	22.701	186.25
		251	848.8	21.931	155.99

11.1.2. LTE ERP/EIRP Results

Band	BW (MHz)	Mode	RB/RB Size	f (MHz)	ERP / EIRP	
					dBm	mW
LTE17	10	QPSK	1/0	709	15.3	33.88
			1/0	710	15.7	37.15
			1/0	711	15.9	38.9
		16QAM	1/0	709	14.5	28.18
			1/0	710	14.7	29.51
			1/0	711	15	31.62
	5	QPSK	1/0	706.5	15.57	36.06
			1/0	710	15.87	38.64
			1/0	713.5	16.28	42.46
		16QAM	1/0	706.5	14.8	30.2
			1/0	710	14.95	31.26
			1/0	713.5	15.4	34.67

11.1.3. ERP/EIRP PLOTS

LTE Band 17

Band LTE17 10MHz 16QAM	High Frequency Substitution Measurement UL Verification Services, Inc.																																																																																																	
	Company:		Sony																																																																																															
	Project #:		15J20116																																																																																															
	Date:		3/26/2015																																																																																															
	Test Engineer:		R.Z																																																																																															
	Configuration:		EUT , AC Adapter/Headset																																																																																															
	Location:		Chamber G																																																																																															
	Mode:		LTE_16QAM Band 17 Fundamentals, 10MHz Bandwidth																																																																																															
	Test Equipment:		Receiving: Hybrid T899, and Chamber G SMA Cables Substitution: Dipole T273, 6ft SMA Cable																																																																																															
	<table border="1"> <thead> <tr> <th>f MHz</th> <th>SG reading (dBm)</th> <th>Ant. Pol. (H/V)</th> <th>Cable Loss (dB)</th> <th>Antenna Gain (dBd)</th> <th>ERP (dBm)</th> <th>Limit (dBm)</th> <th>Delta (dB)</th> <th>Notes</th> </tr> </thead> <tbody> <tr> <td colspan="9">Low Ch</td> </tr> <tr> <td>709.00</td> <td>10.40</td> <td>V</td> <td>0.9</td> <td>0.0</td> <td>9.50</td> <td>34.8</td> <td>-25.3</td> <td></td> </tr> <tr> <td>709.00</td> <td>15.40</td> <td>H</td> <td>0.9</td> <td>0.0</td> <td>14.50</td> <td>34.8</td> <td>-20.3</td> <td></td> </tr> <tr> <td colspan="9">Mid Ch</td> </tr> <tr> <td>710.00</td> <td>8.90</td> <td>V</td> <td>0.9</td> <td>0.0</td> <td>8.00</td> <td>34.8</td> <td>-26.8</td> <td></td> </tr> <tr> <td>710.00</td> <td>15.60</td> <td>H</td> <td>0.9</td> <td>0.0</td> <td>14.70</td> <td>34.8</td> <td>-20.1</td> <td></td> </tr> <tr> <td colspan="9">High Ch</td> </tr> <tr> <td>711.00</td> <td>8.70</td> <td>V</td> <td>0.9</td> <td>0.0</td> <td>7.80</td> <td>34.8</td> <td>-27.0</td> <td></td> </tr> <tr> <td>711.00</td> <td>15.90</td> <td>H</td> <td>0.9</td> <td>0.0</td> <td>15.00</td> <td>34.8</td> <td>-19.8</td> <td></td> </tr> </tbody> </table>									f MHz	SG reading (dBm)	Ant. Pol. (H/V)	Cable Loss (dB)	Antenna Gain (dBd)	ERP (dBm)	Limit (dBm)	Delta (dB)	Notes	Low Ch									709.00	10.40	V	0.9	0.0	9.50	34.8	-25.3		709.00	15.40	H	0.9	0.0	14.50	34.8	-20.3		Mid Ch									710.00	8.90	V	0.9	0.0	8.00	34.8	-26.8		710.00	15.60	H	0.9	0.0	14.70	34.8	-20.1		High Ch									711.00	8.70	V	0.9	0.0	7.80	34.8	-27.0		711.00	15.90	H	0.9	0.0	15.00	34.8	-19.8
f MHz	SG reading (dBm)	Ant. Pol. (H/V)	Cable Loss (dB)	Antenna Gain (dBd)	ERP (dBm)	Limit (dBm)	Delta (dB)	Notes																																																																																										
Low Ch																																																																																																		
709.00	10.40	V	0.9	0.0	9.50	34.8	-25.3																																																																																											
709.00	15.40	H	0.9	0.0	14.50	34.8	-20.3																																																																																											
Mid Ch																																																																																																		
710.00	8.90	V	0.9	0.0	8.00	34.8	-26.8																																																																																											
710.00	15.60	H	0.9	0.0	14.70	34.8	-20.1																																																																																											
High Ch																																																																																																		
711.00	8.70	V	0.9	0.0	7.80	34.8	-27.0																																																																																											
711.00	15.90	H	0.9	0.0	15.00	34.8	-19.8																																																																																											

Band LTE17 10MHz QPSK	High Frequency Substitution Measurement UL Verification Services, Inc.								
	Company: Sony Project #: 15J20116 Date: 3/26/2015 Test Engineer: R.Z Configuration: EUT , AC Adapter/Headset Location: Chamber G Mode: LTE_QPSK Band 17 Fundamentals, 10MHz Bandwidth								
	Test Equipment: Receiving: Hybrid T899, and Chamber G SMA Cables Substitution: Dipole T273, 6ft SMA Cable								
	f	SG reading	Ant. Pol.	Cable Loss	Antenna Gain	ERP	Limit	Delta	Notes
	MHz	(dBm)	(H/V)	(dB)	(dBd)	(dBm)	(dBm)	(dB)	
	Low Ch								
	709.00	11.27	V	0.9	0.0	10.37	34.8	-24.4	
	709.00	16.20	H	0.9	0.0	15.30	34.8	-19.5	
	Mid Ch								
	710.00	10.00	V	0.9	0.0	9.10	34.8	-25.7	
710.00	16.60	H	0.9	0.0	15.70	34.8	-19.1		
High Ch									
711.00	9.60	V	0.9	0.0	8.70	34.8	-26.1		
711.00	16.80	H	0.9	0.0	15.90	34.8	-18.9		

Band LTE17 5MHz 16QAM	High Frequency Substitution Measurement UL Verification Services, Inc.																																																																																																	
	Company:		Sony																																																																																															
	Project #:		15J20116																																																																																															
	Date:		3/26/2015																																																																																															
	Test Engineer:		R.Z																																																																																															
	Configuration:		EUT , AC Adapter/Headset																																																																																															
	Location:		Chamber G																																																																																															
	Mode:		LTE_16QAM Band 17 Fundamentals, 5MHz Bandwidth																																																																																															
	Test Equipment:		Receiving: Hybrid T899, and Chamber G SMA Cables Substitution: Dipole T273, 6ft SMA Cable																																																																																															
	<table border="1"> <thead> <tr> <th>f MHz</th> <th>SG reading (dBm)</th> <th>Ant. Pol. (H/V)</th> <th>Cable Loss (dB)</th> <th>Antenna Gain (dBd)</th> <th>ERP (dBm)</th> <th>Limit (dBm)</th> <th>Delta (dB)</th> <th>Notes</th> </tr> </thead> <tbody> <tr> <td colspan="9">Low Ch</td> </tr> <tr> <td>706.50</td> <td>9.80</td> <td>V</td> <td>0.9</td> <td>0.0</td> <td>8.90</td> <td>34.8</td> <td>-25.9</td> <td></td> </tr> <tr> <td>706.50</td> <td>15.70</td> <td>H</td> <td>0.9</td> <td>0.0</td> <td>14.80</td> <td>34.8</td> <td>-20.0</td> <td></td> </tr> <tr> <td colspan="9">Mid Ch</td> </tr> <tr> <td>710.00</td> <td>8.80</td> <td>V</td> <td>0.9</td> <td>0.0</td> <td>7.90</td> <td>34.8</td> <td>-26.9</td> <td></td> </tr> <tr> <td>710.00</td> <td>15.85</td> <td>H</td> <td>0.9</td> <td>0.0</td> <td>14.95</td> <td>34.8</td> <td>-19.8</td> <td></td> </tr> <tr> <td colspan="9">High Ch</td> </tr> <tr> <td>713.50</td> <td>9.10</td> <td>V</td> <td>0.9</td> <td>0.0</td> <td>8.20</td> <td>34.8</td> <td>-26.6</td> <td></td> </tr> <tr> <td>713.50</td> <td>16.30</td> <td>H</td> <td>0.9</td> <td>0.0</td> <td>15.40</td> <td>34.8</td> <td>-19.4</td> <td></td> </tr> </tbody> </table>									f MHz	SG reading (dBm)	Ant. Pol. (H/V)	Cable Loss (dB)	Antenna Gain (dBd)	ERP (dBm)	Limit (dBm)	Delta (dB)	Notes	Low Ch									706.50	9.80	V	0.9	0.0	8.90	34.8	-25.9		706.50	15.70	H	0.9	0.0	14.80	34.8	-20.0		Mid Ch									710.00	8.80	V	0.9	0.0	7.90	34.8	-26.9		710.00	15.85	H	0.9	0.0	14.95	34.8	-19.8		High Ch									713.50	9.10	V	0.9	0.0	8.20	34.8	-26.6		713.50	16.30	H	0.9	0.0	15.40	34.8	-19.4
f MHz	SG reading (dBm)	Ant. Pol. (H/V)	Cable Loss (dB)	Antenna Gain (dBd)	ERP (dBm)	Limit (dBm)	Delta (dB)	Notes																																																																																										
Low Ch																																																																																																		
706.50	9.80	V	0.9	0.0	8.90	34.8	-25.9																																																																																											
706.50	15.70	H	0.9	0.0	14.80	34.8	-20.0																																																																																											
Mid Ch																																																																																																		
710.00	8.80	V	0.9	0.0	7.90	34.8	-26.9																																																																																											
710.00	15.85	H	0.9	0.0	14.95	34.8	-19.8																																																																																											
High Ch																																																																																																		
713.50	9.10	V	0.9	0.0	8.20	34.8	-26.6																																																																																											
713.50	16.30	H	0.9	0.0	15.40	34.8	-19.4																																																																																											

Band LTE17 5MHz QPSK	High Frequency Substitution Measurement UL Verification Services, Inc.																																																																																																	
	Company:		Sony																																																																																															
	Project #:		15J20116																																																																																															
	Date:		3/26/2015																																																																																															
	Test Engineer:		R.Z																																																																																															
	Configuration:		EUT , AC Adapter/Headset																																																																																															
	Location:		Chamber G																																																																																															
	Mode:		LTE_QPSK Band 17 Fundamentals, 5MHz Bandwidth																																																																																															
	Test Equipment:		Receiving: Hybrid T899, and Chamber G SMA Cables Substitution: Dipole T273, 6ft SMA Cable																																																																																															
	<table border="1"> <thead> <tr> <th>f MHz</th> <th>SG reading (dBm)</th> <th>Ant. Pol. (H/V)</th> <th>Cable Loss (dB)</th> <th>Antenna Gain (dBd)</th> <th>ERP (dBm)</th> <th>Limit (dBm)</th> <th>Delta (dB)</th> <th>Notes</th> </tr> </thead> <tbody> <tr> <td colspan="9">Low Ch</td> </tr> <tr> <td>706.50</td> <td>10.90</td> <td>V</td> <td>0.9</td> <td>0.0</td> <td>10.00</td> <td>34.8</td> <td>-24.8</td> <td></td> </tr> <tr> <td>706.50</td> <td>16.47</td> <td>H</td> <td>0.9</td> <td>0.0</td> <td>15.57</td> <td>34.8</td> <td>-19.2</td> <td></td> </tr> <tr> <td colspan="9">Mid Ch</td> </tr> <tr> <td>710.00</td> <td>9.90</td> <td>V</td> <td>0.9</td> <td>0.0</td> <td>9.00</td> <td>34.8</td> <td>-25.8</td> <td></td> </tr> <tr> <td>710.00</td> <td>16.77</td> <td>H</td> <td>0.9</td> <td>0.0</td> <td>15.87</td> <td>34.8</td> <td>-18.9</td> <td></td> </tr> <tr> <td colspan="9">High Ch</td> </tr> <tr> <td>713.50</td> <td>10.00</td> <td>V</td> <td>0.9</td> <td>0.0</td> <td>9.10</td> <td>34.8</td> <td>-25.7</td> <td></td> </tr> <tr> <td>713.50</td> <td>17.18</td> <td>H</td> <td>0.9</td> <td>0.0</td> <td>16.28</td> <td>34.8</td> <td>-18.5</td> <td></td> </tr> </tbody> </table>									f MHz	SG reading (dBm)	Ant. Pol. (H/V)	Cable Loss (dB)	Antenna Gain (dBd)	ERP (dBm)	Limit (dBm)	Delta (dB)	Notes	Low Ch									706.50	10.90	V	0.9	0.0	10.00	34.8	-24.8		706.50	16.47	H	0.9	0.0	15.57	34.8	-19.2		Mid Ch									710.00	9.90	V	0.9	0.0	9.00	34.8	-25.8		710.00	16.77	H	0.9	0.0	15.87	34.8	-18.9		High Ch									713.50	10.00	V	0.9	0.0	9.10	34.8	-25.7		713.50	17.18	H	0.9	0.0	16.28	34.8	-18.5
f MHz	SG reading (dBm)	Ant. Pol. (H/V)	Cable Loss (dB)	Antenna Gain (dBd)	ERP (dBm)	Limit (dBm)	Delta (dB)	Notes																																																																																										
Low Ch																																																																																																		
706.50	10.90	V	0.9	0.0	10.00	34.8	-24.8																																																																																											
706.50	16.47	H	0.9	0.0	15.57	34.8	-19.2																																																																																											
Mid Ch																																																																																																		
710.00	9.90	V	0.9	0.0	9.00	34.8	-25.8																																																																																											
710.00	16.77	H	0.9	0.0	15.87	34.8	-18.9																																																																																											
High Ch																																																																																																		
713.50	10.00	V	0.9	0.0	9.10	34.8	-25.7																																																																																											
713.50	17.18	H	0.9	0.0	16.28	34.8	-18.5																																																																																											

WCDMA

Band Band 5 HSDPA	High Frequency Substitution Measurement UL Verification Services, Inc. Chamber A																																																																																																
	Company:		Sony																																																																																														
	Project #:		15J20116																																																																																														
	Date:		03/17/15																																																																																														
	Test Engineer:		K. Kedida																																																																																														
	Configuration:		X-pos EUT only																																																																																														
	Mode:		HSDPA B5 FUND																																																																																														
	Test Equipment:																																																																																																
	Receiving: Sunol T130, and 3m Chamber A N-type Cable																																																																																																
	Substitution: Dipole T273, 4ft SMA Cable Warehouse.																																																																																																
<table border="1"> <thead> <tr> <th>f MHz</th> <th>SG reading (dBm)</th> <th>Ant. Pol. (H/V)</th> <th>Cable Loss (dB)</th> <th>Antenna Gain (dBd)</th> <th>ERP (dBm)</th> <th>Limit (dBm)</th> <th>Margin (dB)</th> <th>Notes</th> </tr> </thead> <tbody> <tr> <td colspan="9">Low Ch</td> </tr> <tr> <td>826.40</td> <td>12.00</td> <td>V</td> <td>0.9</td> <td>0.0</td> <td>11.10</td> <td>38.5</td> <td>-27.3</td> <td></td> </tr> <tr> <td>826.40</td> <td>20.30</td> <td>H</td> <td>0.9</td> <td>0.0</td> <td>19.40</td> <td>38.5</td> <td>-19.0</td> <td></td> </tr> <tr> <td colspan="9">Mid Ch</td> </tr> <tr> <td>836.60</td> <td>11.90</td> <td>V</td> <td>0.9</td> <td>0.0</td> <td>11.00</td> <td>38.5</td> <td>-27.4</td> <td></td> </tr> <tr> <td>836.60</td> <td>19.20</td> <td>H</td> <td>0.9</td> <td>0.0</td> <td>18.30</td> <td>38.5</td> <td>-20.1</td> <td></td> </tr> <tr> <td colspan="9">High Ch</td> </tr> <tr> <td>846.60</td> <td>11.77</td> <td>V</td> <td>0.9</td> <td>0.0</td> <td>10.87</td> <td>38.5</td> <td>-27.6</td> <td></td> </tr> <tr> <td>846.60</td> <td>17.80</td> <td>H</td> <td>0.9</td> <td>0.0</td> <td>16.90</td> <td>38.5</td> <td>-21.5</td> <td></td> </tr> </tbody> </table>								f MHz	SG reading (dBm)	Ant. Pol. (H/V)	Cable Loss (dB)	Antenna Gain (dBd)	ERP (dBm)	Limit (dBm)	Margin (dB)	Notes	Low Ch									826.40	12.00	V	0.9	0.0	11.10	38.5	-27.3		826.40	20.30	H	0.9	0.0	19.40	38.5	-19.0		Mid Ch									836.60	11.90	V	0.9	0.0	11.00	38.5	-27.4		836.60	19.20	H	0.9	0.0	18.30	38.5	-20.1		High Ch									846.60	11.77	V	0.9	0.0	10.87	38.5	-27.6		846.60	17.80	H	0.9	0.0	16.90	38.5	-21.5	
f MHz	SG reading (dBm)	Ant. Pol. (H/V)	Cable Loss (dB)	Antenna Gain (dBd)	ERP (dBm)	Limit (dBm)	Margin (dB)	Notes																																																																																									
Low Ch																																																																																																	
826.40	12.00	V	0.9	0.0	11.10	38.5	-27.3																																																																																										
826.40	20.30	H	0.9	0.0	19.40	38.5	-19.0																																																																																										
Mid Ch																																																																																																	
836.60	11.90	V	0.9	0.0	11.00	38.5	-27.4																																																																																										
836.60	19.20	H	0.9	0.0	18.30	38.5	-20.1																																																																																										
High Ch																																																																																																	
846.60	11.77	V	0.9	0.0	10.87	38.5	-27.6																																																																																										
846.60	17.80	H	0.9	0.0	16.90	38.5	-21.5																																																																																										
Rev. 3.17.11																																																																																																	
Note: For Band 13/17 ERP limit is 34.77dBm; For Band 26 limit is 50dBm																																																																																																	

High Frequency Substitution Measurement									
UL Verification Services, Inc. Chamber A									
Company: Sony									
Project #: 15J20116									
Date: 03/17/15									
Test Engineer: K.Kedida									
Configuration: X-pos EUT only									
Mode: REL99 B5 FUND									
Test Equipment:									
Receiving: Sunol T130, and 3m Chamber A N-type Cable									
Substitution: Dipole T273, 4ft SMA Cable Warehouse.									
Band									
Band 5									
REL99									
f	SG reading	Ant. Pol.	Cable Loss	Antenna Gain	ERP	Limit	Margin	Notes	
MHz	(dBm)	(H/V)	(dB)	(dBd)	(dBm)	(dBm)	(dB)		
Low Ch									
826.40	13.10	V	0.9	0.0	12.20	38.5	-26.2		
826.40	20.90	H	0.9	0.0	20.00	38.5	-18.4		
Mid Ch									
836.60	12.73	V	0.9	0.0	11.83	38.5	-26.6		
836.60	20.00	H	0.9	0.0	19.10	38.5	-19.3		
High Ch									
846.60	11.28	V	0.9	0.0	10.38	38.5	-28.1		
846.60	18.58	H	0.9	0.0	17.68	38.5	-20.8		
Rev. 3.17.11									
Note: For Band 13/17 ERP limit is 34.77dBm; For Band 26 limit is 50dBm									

GSM

High Frequency Substitution Measurement UL Verification Services, Inc. Chamber A								
Company: Sony Project #: 15J20116 Date: 3/17/2015 Test Engineer: K.Kedida Configuration: X-pos EUT only Mode: EGPRS 1900								
Test Equipment:								
Receiving: Horn T136, and Chamber A SMA Cables								
Substitution: Horn T59 Substitution, T1096 SMA Cable Warehouse								
f MHz	SG reading (dBm)	Ant. Pol. (H/V)	Cable Loss (dB)	Antenna Gain (dBi)	EIRP (dBm)	Limit (dBm)	Margin (dB)	Notes
Low Ch								
1850.20	13.60	V	0.9	8.5	21.26	33.0	-11.7	
1850.20	14.20	H	0.9	8.5	21.86	33.0	-11.1	
Mid Ch								
1880.00	13.50	V	0.9	8.5	21.15	33.0	-11.9	
1880.00	15.02	H	0.9	8.5	22.67	33.0	-10.3	
High Ch								
1909.80	13.90	V	0.9	8.5	21.59	33.0	-11.4	
1909.80	15.06	H	0.9	8.5	22.75	33.0	-10.2	
Rev. 3.17.11								
Note: For Band 4 EIRP limit is 30dBm								

Band
GSM
1900
EGPRS

Band GSM 1900 GPRS	High Frequency Substitution Measurement UL Verification Services, Inc. Chamber A								
	Company: Sony Project #: 15J20116 Date: 3/17/2015 Test Engineer: K.Kedida Configuration: X-pos EUT only Mode: GPRS 1900								
	Test Equipment:								
	Receiving: Horn T136, and Chamber A SMA Cables								
	Substitution: Horn T59 Substitution, T1096 SMA Cable Warehouse								
	f MHz	SG reading (dBm)	Ant. Pol. (H/V)	Cable Loss (dB)	Antenna Gain (dBi)	EIRP (dBm)	Limit (dBm)	Margin (dB)	Notes
	Low Ch								
	1850.20	20.10	V	0.9	8.5	27.76	33.0	-5.2	
	1850.20	20.40	H	0.9	8.5	28.06	33.0	-4.9	
	Mid Ch								
1880.00	19.77	V	0.9	8.5	27.42	33.0	-5.6		
1880.00	21.45	H	0.9	8.5	29.09	33.0	-3.9		
High Ch									
1909.80	20.28	V	0.9	8.5	27.97	33.0	-5.0		
1909.80	21.36	H	0.9	8.5	29.05	33.0	-3.9		
Rev. 3.17.11 Note: For Band 4 EIRP limit is 30dBm									

Band GSM 850 EGPRS	High Frequency Substitution Measurement UL Verification Services, Inc. Chamber C																																																																																																
	Company: Sony																																																																																																
	Project #: 15120030																																																																																																
	Date: 03/05/15																																																																																																
	Test Engineer: Charles Vergonio																																																																																																
	Configuration: EUT Y-position																																																																																																
	Mode: EGPRS850																																																																																																
	Test Equipment:																																																																																																
	Receiving: Hybrid T185, and Chamber C N-type Cable																																																																																																
	Substitution: Dipole T273, 8ft SMA Cable Warehouse.																																																																																																
<table border="1"> <thead> <tr> <th>f MHz</th> <th>SG reading (dBm)</th> <th>Ant. Pol. (H/V)</th> <th>Cable Loss (dB)</th> <th>Antenna Gain (dBd)</th> <th>ERP (dBm)</th> <th>Limit (dBm)</th> <th>Margin (dB)</th> <th>Notes</th> </tr> </thead> <tbody> <tr> <td colspan="9">Low Ch</td> </tr> <tr> <td>824.20</td> <td>15.80</td> <td>V</td> <td>0.9</td> <td>0.0</td> <td>14.90</td> <td>38.5</td> <td>-23.5</td> <td></td> </tr> <tr> <td>824.20</td> <td>24.50</td> <td>H</td> <td>0.9</td> <td>0.0</td> <td>23.60</td> <td>38.5</td> <td>-14.8</td> <td></td> </tr> <tr> <td colspan="9">Mid Ch</td> </tr> <tr> <td>836.60</td> <td>16.70</td> <td>V</td> <td>0.9</td> <td>0.0</td> <td>15.80</td> <td>38.5</td> <td>-22.6</td> <td></td> </tr> <tr> <td>836.60</td> <td>23.60</td> <td>H</td> <td>0.9</td> <td>0.0</td> <td>22.70</td> <td>38.5</td> <td>-15.7</td> <td></td> </tr> <tr> <td colspan="9">High Ch</td> </tr> <tr> <td>848.80</td> <td>14.90</td> <td>V</td> <td>0.9</td> <td>0.0</td> <td>14.00</td> <td>38.5</td> <td>-24.4</td> <td></td> </tr> <tr> <td>848.80</td> <td>22.83</td> <td>H</td> <td>0.9</td> <td>0.0</td> <td>21.93</td> <td>38.5</td> <td>-16.5</td> <td></td> </tr> </tbody> </table>								f MHz	SG reading (dBm)	Ant. Pol. (H/V)	Cable Loss (dB)	Antenna Gain (dBd)	ERP (dBm)	Limit (dBm)	Margin (dB)	Notes	Low Ch									824.20	15.80	V	0.9	0.0	14.90	38.5	-23.5		824.20	24.50	H	0.9	0.0	23.60	38.5	-14.8		Mid Ch									836.60	16.70	V	0.9	0.0	15.80	38.5	-22.6		836.60	23.60	H	0.9	0.0	22.70	38.5	-15.7		High Ch									848.80	14.90	V	0.9	0.0	14.00	38.5	-24.4		848.80	22.83	H	0.9	0.0	21.93	38.5	-16.5	
f MHz	SG reading (dBm)	Ant. Pol. (H/V)	Cable Loss (dB)	Antenna Gain (dBd)	ERP (dBm)	Limit (dBm)	Margin (dB)	Notes																																																																																									
Low Ch																																																																																																	
824.20	15.80	V	0.9	0.0	14.90	38.5	-23.5																																																																																										
824.20	24.50	H	0.9	0.0	23.60	38.5	-14.8																																																																																										
Mid Ch																																																																																																	
836.60	16.70	V	0.9	0.0	15.80	38.5	-22.6																																																																																										
836.60	23.60	H	0.9	0.0	22.70	38.5	-15.7																																																																																										
High Ch																																																																																																	
848.80	14.90	V	0.9	0.0	14.00	38.5	-24.4																																																																																										
848.80	22.83	H	0.9	0.0	21.93	38.5	-16.5																																																																																										
Rev. 3.17.11																																																																																																	
Note: For Band 13/17 ERP limit is 34.77dBm; For Band 26 limit is 50dBm																																																																																																	

High Frequency Substitution Measurement UL Verification Services, Inc. Chamber C									
Band GSM 850 GPRS		Company:		Sony					
		Project #:		15I20030					
		Date:		03/05/15					
		Test Engineer:		Charles Vergonio					
		Configuration:		EUT Y-position					
Mode:		GPRS850							
		Test Equipment:							
		Receiving: Hybrid T185, and Chamber C N-type Cable							
		Substitution: Dipole T273, 8ft SMA Cable Warehouse.							
f MHz	SG reading (dBm)	Ant. Pol. (H/V)	Cable Loss (dB)	Antenna Gain (dBd)	ERP (dBm)	Limit (dBm)	Margin (dB)	Notes	
Low Ch									
824.20	21.10	V	0.9	0.0	20.20	38.5	-18.2		
824.20	29.00	H	0.9	0.0	28.10	38.5	-10.3		
Mid Ch									
836.60	21.90	V	0.9	0.0	21.00	38.5	-17.4		
836.60	28.22	H	0.9	0.0	27.32	38.5	-11.1		
High Ch									
848.80	20.25	V	0.9	0.0	19.35	38.5	-19.1		
848.80	27.20	H	0.9	0.0	26.30	38.5	-12.1		
Rev. 3.17.11									
Note: For Band 13/17 ERP limit is 34.77dBm; For Band 26 limit is 50dBm									

11.2. FIELD STRENGTH OF SPURIOUS RADIATION

RULE PART(S)

FCC: §2.1053, §22H, §24E, §27.53(g)

LIMIT

The power of any emission outside of the authorized operating frequency ranges must be attenuated below the transmitting power (P) by a factor of at least $43 + 10 \log (P)$ dB.

Part 27.53 (g) For operations in the 600 MHz band and the 698-746 MHz band, the power of any emission outside a licensee's frequency band(s) of operation shall be attenuated below the transmitter power (P) within the licensed band(s) of operation, measured in watts, by at least $43 + 10 \log (P)$ dB. Compliance with this provision is based on the use of measurement instrumentation employing a resolution bandwidth of 100 kilohertz or greater. However, in the 100 kilohertz bands immediately outside and adjacent to a licensee's frequency block, a resolution bandwidth of at least 30 kHz may be employed.

TEST PROCEDURE

For Cellular equipment - Compliance with these rules is based on the use of measurement instrumentation employing a resolution bandwidth of 100 kHz or greater. In the 1 MHz bands immediately outside and adjacent to the frequency block a resolution bandwidth of at least one percent of the emission bandwidth of the fundamental emission of the transmitter may be employed. A narrower resolution bandwidth is permitted in all cases to improve measurement accuracy provided the measured power is integrated over the full required measurement bandwidth (i.e. 100 kHz or 1 percent of emission bandwidth, as specified). The emission bandwidth is defined as the width of the signal between two points, one below the carrier center frequency and one above the carrier center frequency, outside of which all emissions are attenuated at least 26 dB below the transmitter power.

For PCS equipment - Compliance with these rules is based on the use of measurement instrumentation employing a resolution bandwidth of 1 MHz or greater. However, in the 1 MHz bands immediately outside and adjacent to the frequency block a resolution bandwidth of at least one percent of the emission bandwidth of the fundamental emission of the transmitter may be employed. A narrower resolution bandwidth is permitted in all cases to improve measurement accuracy provided the measured power is integrated over the full required measurement bandwidth (i.e. 1 MHz or 1 percent of emission bandwidth, as specified). The emission bandwidth is defined as the width of the signal between two points, one below the carrier center frequency and one above the carrier center frequency, outside of which all emissions are attenuated at least 26 dB below the transmitter power.

MODES TESTED

GSM, WCDMA, and LTE

RESULTS

11.2.1. SPURIOUS RADIATION PLOTS

LTE Band 17

UL Verification Services, Inc. Above 1GHz High Frequency Substitution Measurement									
Company:		Sony							
Project #:		15J20116							
Date:		3/26/2015							
Test Engineer:		R.Z							
Configuration:		EUT , AC Adapter/Headset							
Location:		Chamber G							
Mode:		LTE_16QAM Band 17 Harmonics, 10MHz Bandwidth							
f MHz	SG reading (dBm)	Ant. Pol. (H/V)	Distance (m)	Preamp (dB)	Filter (dB)	EIRP (dBm)	Limit (dBm)	Delta (dB)	Notes
Low Ch, 709									
1418.00	-24.7	V	3.0	37.4	1.0	-61.0	-13.0	-48.0	
2127.00	-0.3	V	3.0	36.6	1.0	-35.9	-13.0	-22.9	
2836.00	-21.9	V	3.0	36.4	1.0	-57.3	-13.0	-44.3	
10MHz									
1418.00	-26.3	H	3.0	37.4	1.0	-62.7	-13.0	-49.7	
2127.00	-0.5	H	3.0	36.6	1.0	-36.0	-13.0	-23.0	
2836.00	-20.1	H	3.0	36.4	1.0	-55.5	-13.0	-42.5	
16QAM									
Mid Ch, 710									
1420.00	-25.2	V	3.0	37.3	1.0	-61.5	-13.0	-48.5	
2130.00	-4.3	V	3.0	36.6	1.0	-39.8	-13.0	-26.8	
2840.00	-20.6	V	3.0	36.4	1.0	-56.0	-13.0	-43.0	
1420.00	-26.4	H	3.0	37.3	1.0	-62.8	-13.0	-49.8	
2130.00	1.2	H	3.0	36.6	1.0	-34.4	-13.0	-21.4	
2840.00	-21.5	H	3.0	36.4	1.0	-56.8	-13.0	-43.8	
High Ch, 711									
1422.00	-24.1	V	3.0	37.3	1.0	-60.4	-13.0	-47.4	
2133.00	-2.1	V	3.0	36.6	1.0	-37.7	-13.0	-24.7	
2844.00	-21.6	V	3.0	36.4	1.0	-57.0	-13.0	-44.0	
1422.00	-26.8	H	3.0	37.3	1.0	-63.1	-13.0	-50.1	
2133.00	-1.9	H	3.0	36.6	1.0	-37.4	-13.0	-24.4	
2844.00	-22.8	H	3.0	36.4	1.0	-58.2	-13.0	-45.2	

UL Verification Services, Inc. Above 1GHz High Frequency Substitution Measurement										
Company:		Sony								
Project #:		15J20116								
Date:		3/26/2015								
Test Engineer:		R.Z								
Configuration:		EUT , AC Adapter/Headset								
Location:		Chamber G								
Mode:		LTE_QPSK Band 17 Harmonics, 10MHz Bandwidth								
	f MHz	SG reading (dBm)	Ant. Pol. (H/V)	Distance (m)	Preamp (dB)	Filter (dB)	EIRP (dBm)	Limit (dBm)	Delta (dB)	Notes
Band	Low Ch, 709									
	1418.00	-24.5	V	3.0	37.4	1.0	-60.9	-13.0	-47.9	
	2127.00	-3.1	V	3.0	36.6	1.0	-38.6	-13.0	-25.6	
LTE17	2836.00	-15.9	V	3.0	36.4	1.0	-51.3	-13.0	-38.3	
	1418.00	-28.0	H	3.0	37.4	1.0	-64.3	-13.0	-51.3	
	2127.00	-0.4	H	3.0	36.6	1.0	-36.0	-13.0	-23.0	
10MHz	2836.00	-22.4	H	3.0	36.4	1.0	-57.8	-13.0	-44.8	
QPSK	Mid Ch, 710									
	1420.00	-25.0	V	3.0	37.3	1.0	-61.3	-13.0	-48.3	
	2130.00	-2.9	V	3.0	36.6	1.0	-38.4	-13.0	-25.4	
	2840.00	-21.4	V	3.0	36.4	1.0	-56.8	-13.0	-43.8	
	1420.00	-26.4	H	3.0	37.3	1.0	-62.8	-13.0	-49.8	
	2130.00	1.1	H	3.0	36.6	1.0	-34.5	-13.0	-21.5	
	2840.00	-22.8	H	3.0	36.4	1.0	-58.1	-13.0	-45.1	
	High Ch, 711									
	1422.00	-23.9	V	3.0	37.3	1.0	-60.2	-13.0	-47.2	
	2133.00	-1.3	V	3.0	36.6	1.0	-36.9	-13.0	-23.9	
	2844.00	-20.1	V	3.0	36.4	1.0	-55.5	-13.0	-42.5	
	1422.00	-26.7	H	3.0	37.3	1.0	-63.0	-13.0	-50.0	
	2133.00	-0.8	H	3.0	36.6	1.0	-36.4	-13.0	-23.4	
	2844.00	-22.6	H	3.0	36.4	1.0	-58.0	-13.0	-45.0	

UL Verification Services, Inc. Above 1GHz High Frequency Substitution Measurement										
Company:		Sony								
Project #:		15J20116								
Date:		3/26/2015								
Test Engineer:		R.Z								
Configuration:		EUT , AC Adapter/Headset								
Location:		Chamber G								
Mode:		LTE_16QAM Band 17 Harmonics, 5MHz Bandwidth								
	f MHz	SG reading (dBm)	Ant. Pol. (H/V)	Distance (m)	Preamp (dB)	Filter (dB)	EIRP (dBm)	Limit (dBm)	Delta (dB)	Notes
Band	Low Ch, 706.5									
	1413.00	-24.0	V	3.0	37.4	1.0	-60.4	-13.0	-47.4	
	2119.50	-5.6	V	3.0	36.6	1.0	-41.2	-13.0	-28.2	
LTE17	2826.00	-21.0	V	3.0	36.4	1.0	-56.4	-13.0	-43.4	
	1413.00	-27.8	H	3.0	37.4	1.0	-64.1	-13.0	-51.1	
	2119.50	-5.5	H	3.0	36.6	1.0	-41.1	-13.0	-28.1	
5MHz	2826.00	-21.9	H	3.0	36.4	1.0	-57.3	-13.0	-44.3	
	Mid Ch, 710									
16QAM	1420.00	-25.7	V	3.0	37.3	1.0	-62.0	-13.0	-49.0	
	2130.00	-9.0	V	3.0	36.6	1.0	-44.6	-13.0	-31.6	
	2840.00	-16.4	V	3.0	36.4	1.0	-51.8	-13.0	-38.8	
	1420.00	-26.2	H	3.0	37.3	1.0	-62.5	-13.0	-49.5	
	2130.00	1.1	H	3.0	36.6	1.0	-34.5	-13.0	-21.5	
	2840.00	-22.0	H	3.0	36.4	1.0	-57.3	-13.0	-44.3	
High Ch, 713.5										
	1427.00	-24.8	V	3.0	37.3	1.0	-61.1	-13.0	-48.1	
	2140.50	1.0	V	3.0	36.6	1.0	-34.6	-13.0	-21.6	
	2854.00	-21.9	V	3.0	36.4	1.0	-57.2	-13.0	-44.2	
	1427.00	-25.1	H	3.0	37.3	1.0	-61.4	-13.0	-48.4	
	2140.50	-2.1	H	3.0	36.6	1.0	-37.6	-13.0	-24.6	
	2854.00	-21.5	H	3.0	36.4	1.0	-56.9	-13.0	-43.9	

UL Verification Services, Inc. Above 1GHz High Frequency Substitution Measurement										
Company:		Sony								
Project #:		15J20116								
Date:		3/26/2015								
Test Engineer:		R.Z								
Configuration:		EUT , AC Adapter/Headset								
Location:		Chamber G								
Mode:		LTE_QPSK Band 17 Harmonics, 5MHz Bandwidth								
	f MHz	SG reading (dBm)	Ant. Pol. (H/V)	Distance (m)	Preamp (dB)	Filter (dB)	EIRP (dBm)	Limit (dBm)	Delta (dB)	Notes
	Low Ch, 706.5									
Band	1413.00	-24.9	V	3.0	37.4	1.0	-61.3	-13.0	-48.3	
	2119.50	-7.0	V	3.0	36.6	1.0	-42.6	-13.0	-29.6	
LTE17	2826.00	-20.2	V	3.0	36.4	1.0	-55.6	-13.0	-42.6	
	1413.00	-27.8	H	3.0	37.4	1.0	-64.1	-13.0	-51.1	
	2119.50	-4.5	H	3.0	36.6	1.0	-40.1	-13.0	-27.1	
5MHz	2826.00	-21.5	H	3.0	36.4	1.0	-56.9	-13.0	-43.9	
	Mid Ch, 710									
	1420.00	-24.6	V	3.0	37.3	1.0	-60.9	-13.0	-47.9	
QPSK	2130.00	-7.8	V	3.0	36.6	1.0	-43.4	-13.0	-30.4	
	2840.00	-20.4	V	3.0	36.4	1.0	-55.8	-13.0	-42.8	
	1420.00	-24.7	H	3.0	37.3	1.0	-61.1	-13.0	-48.1	
	2130.00	0.5	H	3.0	36.6	1.0	-35.1	-13.0	-22.1	
	2840.00	-21.5	H	3.0	36.4	1.0	-56.8	-13.0	-43.8	
	High Ch, 713.5									
	1427.00	-24.3	V	3.0	37.3	1.0	-60.7	-13.0	-47.7	
	2140.50	-3.7	V	3.0	36.6	1.0	-39.3	-13.0	-26.3	
	2854.00	-20.9	V	3.0	36.4	1.0	-56.2	-13.0	-43.2	
	1427.00	-26.6	H	3.0	37.3	1.0	-62.9	-13.0	-49.9	
	2140.50	0.0	H	3.0	36.6	1.0	-35.5	-13.0	-22.5	
	2854.00	-21.9	H	3.0	36.4	1.0	-57.3	-13.0	-44.3	

WCDMA

UL Verification Services, Inc. Above 1GHz High Frequency Substitution Measurement									
Company:		Sony							
Project #:		15J20116							
Date:		3/26/2015							
Test Engineer:		R.Z							
Configuration:		EUT , AC Adapter/Headset							
Location:		Chamber G							
Mode:		HSDPA Band 5 Harmonics							
f MHz	SG reading (dBm)	Ant. Pol. (H/V)	Distance (m)	Preamp (dB)	Filter (dB)	EIRP (dBm)	Limit (dBm)	Delta (dB)	Notes
Low Ch, 826.4									
Band	1652.80	-25.0	V	3.0	37.0	1.0	-61.0	-13.0	-48.0
	2479.20	-20.5	V	3.0	36.4	1.0	-55.9	-13.0	-42.9
	3305.60	-20.2	V	3.0	36.1	1.0	-55.4	-13.0	-42.4
Band 5	1652.80	-24.1	H	3.0	37.0	1.0	-60.2	-13.0	-47.2
	2479.20	-20.3	H	3.0	36.4	1.0	-55.7	-13.0	-42.7
	3305.60	-18.4	H	3.0	36.1	1.0	-53.6	-13.0	-40.6
HSDPA	Mid Ch, 836.6								
	1673.20	-25.6	V	3.0	37.0	1.0	-61.6	-13.0	-48.6
	2509.80	-19.6	V	3.0	36.4	1.0	-55.0	-13.0	-42.0
	3346.40	-19.9	V	3.0	36.1	1.0	-55.1	-13.0	-42.1
	1673.20	-27.0	H	3.0	37.0	1.0	-63.0	-13.0	-50.0
	2509.80	-20.9	H	3.0	36.4	1.0	-56.3	-13.0	-43.3
	3346.40	-19.3	H	3.0	36.1	1.0	-54.4	-13.0	-41.4
	High Ch, 846.6								
	1693.20	-23.5	V	3.0	37.0	1.0	-59.5	-13.0	-46.5
	2539.80	-20.5	V	3.0	36.4	1.0	-55.9	-13.0	-42.9
	3386.40	-20.1	V	3.0	36.1	1.0	-55.2	-13.0	-42.2
	1693.20	-23.9	H	3.0	37.0	1.0	-59.9	-13.0	-46.9
	2539.80	-17.3	H	3.0	36.4	1.0	-52.7	-13.0	-39.7
	3386.40	-19.9	H	3.0	36.1	1.0	-55.0	-13.0	-42.0

UL Verification Services, Inc. Above 1GHz High Frequency Substitution Measurement									
Company:		Sony							
Project #:		15J20116							
Date:		3/26/2015							
Test Engineer:		R.Z							
Configuration:		EUT , AC Adapter/Headset							
Location:		Chamber G							
Mode:		Rel99 Band 5 Harmonics							
f MHz	SG reading (dBm)	Ant. Pol. (H/V)	Distance (m)	Preamp (dB)	Filter (dB)	EIRP (dBm)	Limit (dBm)	Delta (dB)	Notes
Low Ch, 826.4									
1652.80	-22.9	V	3.0	37.0	1.0	-58.9	-13.0	-45.9	
2479.20	-19.6	V	3.0	36.4	1.0	-55.0	-13.0	-42.0	
3305.60	-19.3	V	3.0	36.1	1.0	-54.4	-13.0	-41.4	
Band 5									
1652.80	-24.1	H	3.0	37.0	1.0	-60.1	-13.0	-47.1	
2479.20	-20.5	H	3.0	36.4	1.0	-55.9	-13.0	-42.9	
3305.60	-20.0	H	3.0	36.1	1.0	-55.2	-13.0	-42.2	
REL99									
Mid Ch, 836.6									
1673.20	-21.1	V	3.0	37.0	1.0	-57.1	-13.0	-44.1	
2509.80	-14.8	V	3.0	36.4	1.0	-50.2	-13.0	-37.2	
3346.40	-20.3	V	3.0	36.1	1.0	-55.5	-13.0	-42.5	
1673.20	-23.1	H	3.0	37.0	1.0	-59.1	-13.0	-46.1	
2509.80	-11.9	H	3.0	36.4	1.0	-47.3	-13.0	-34.3	
3346.40	-20.5	H	3.0	36.1	1.0	-55.7	-13.0	-42.7	
High Ch, 846.6									
1693.20	-21.2	V	3.0	37.0	1.0	-57.2	-13.0	-44.2	
2539.80	-18.6	V	3.0	36.4	1.0	-54.0	-13.0	-41.0	
3386.40	-20.1	V	3.0	36.1	1.0	-55.2	-13.0	-42.2	
1693.20	-23.1	H	3.0	37.0	1.0	-59.1	-13.0	-46.1	
2539.80	-14.3	H	3.0	36.4	1.0	-49.7	-13.0	-36.7	
3386.40	-19.9	H	3.0	36.1	1.0	-55.0	-13.0	-42.0	

GSM

UL Verification Services, Inc. Above 1GHz High Frequency Substitution Measurement									
Company:		Sony							
Project #:		15J20116							
Date:		3/26/2015							
Test Engineer:		R.Z							
Configuration:		EUT , AC Adapter/Headset							
Location:		Chamber G							
Mode:		EGPRS 1900 MHz Harmonics							
f MHz	SG reading (dBm)	Ant. Pol. (H/V)	Distance (m)	Preamp (dB)	Filter (dB)	EIRP (dBm)	Limit (dBm)	Delta (dB)	Notes
Low Ch, 1850.2									
Band	3700.40	-18.0	V	3.0	35.9	1.0	-52.8	-13.0	-39.8
	5550.60	-15.0	V	3.0	35.5	1.0	-49.5	-13.0	-36.5
	7400.80	-13.5	V	3.0	35.7	1.0	-48.2	-13.0	-35.2
GSM	3700.40	-16.7	H	3.0	35.9	1.0	-51.5	-13.0	-38.5
	5550.60	-13.9	H	3.0	35.5	1.0	-48.4	-13.0	-35.4
1900	7400.80	-11.5	H	3.0	35.7	1.0	-46.3	-13.0	-33.3
Mid Ch, 1880									
EGPRS	3760.00	-17.9	V	3.0	35.8	1.0	-52.7	-13.0	-39.7
	5640.00	-15.2	V	3.0	35.5	1.0	-49.7	-13.0	-36.7
	7520.00	-14.2	V	3.0	35.7	1.0	-48.9	-13.0	-35.9
	3760.00	-17.9	H	3.0	35.8	1.0	-52.7	-13.0	-39.7
	5640.00	-14.8	H	3.0	35.5	1.0	-49.3	-13.0	-36.3
	7520.00	-12.3	H	3.0	35.7	1.0	-47.0	-13.0	-34.0
High Ch, 1909.8									
	3819.60	-17.5	V	3.0	35.8	1.0	-52.3	-13.0	-39.3
	5729.40	-15.1	V	3.0	35.5	1.0	-49.6	-13.0	-36.6
	7639.20	-13.5	V	3.0	35.8	1.0	-48.3	-13.0	-35.3
	3819.60	-15.8	H	3.0	35.8	1.0	-50.5	-13.0	-37.5
	5729.40	-13.8	H	3.0	35.5	1.0	-48.3	-13.0	-35.3
	7639.20	-11.9	H	3.0	35.8	1.0	-46.6	-13.0	-33.6

UL Verification Services, Inc. Above 1GHz High Frequency Substitution Measurement										
Company:		Sony								
Project #:		15J20116								
Date:		3/26/2015								
Test Engineer:		R.Z								
Configuration:		EUT , AC Adapter/Headset								
Location:		Chamber G								
Mode:		GPRS 1900 MHz Harmonics								
	f MHz	SG reading (dBm)	Ant. Pol. (H/V)	Distance (m)	Preamp (dB)	Filter (dB)	EIRP (dBm)	Limit (dBm)	Delta (dB)	Notes
	Low Ch, 1850.2									
Band	3700.40	-17.8	V	3.0	35.9	1.0	-52.6	-13.0	-39.6	
	5550.60	-14.9	V	3.0	35.5	1.0	-49.4	-13.0	-36.4	
	7400.80	-13.2	V	3.0	35.7	1.0	-47.9	-13.0	-34.9	
GSM	3700.40	-16.5	H	3.0	35.9	1.0	-51.3	-13.0	-38.3	
	5550.60	-13.5	H	3.0	35.5	1.0	-48.0	-13.0	-35.0	
	7400.80	-11.2	H	3.0	35.7	1.0	-46.0	-13.0	-33.0	
1900	Mid Ch, 1880									
	3760.00	-17.6	V	3.0	35.8	1.0	-52.4	-13.0	-39.4	
	5640.00	-14.6	V	3.0	35.5	1.0	-49.1	-13.0	-36.1	
GPRS	7520.00	-14.0	V	3.0	35.7	1.0	-48.7	-13.0	-35.7	
	3760.00	-17.7	H	3.0	35.8	1.0	-52.5	-13.0	-39.5	
	5640.00	-14.4	H	3.0	35.5	1.0	-48.9	-13.0	-35.9	
	7520.00	-12.1	H	3.0	35.7	1.0	-46.8	-13.0	-33.8	
	High Ch, 1909.8									
	3819.60	-17.3	V	3.0	35.8	1.0	-52.1	-13.0	-39.1	
	5729.40	-14.9	V	3.0	35.5	1.0	-49.4	-13.0	-36.4	
	7639.20	-13.1	V	3.0	35.8	1.0	-47.9	-13.0	-34.9	
	3819.60	-15.1	H	3.0	35.8	1.0	-49.8	-13.0	-36.8	
	5729.40	-13.2	H	3.0	35.5	1.0	-47.7	-13.0	-34.7	
	7639.20	-11.7	H	3.0	35.8	1.0	-46.4	-13.0	-33.4	

UL Verification Services, Inc. Above 1GHz High Frequency Substitution Measurement										
Company:		Sony								
Project #:		15J20116								
Date:		3/26/2015								
Test Engineer:		R.Z								
Configuration:		EUT , AC Adapter/Headset								
Location:		Chamber G								
Mode:		EGPRS 850 MHz Harmonics								
	f MHz	SG reading (dBm)	Ant. Pol. (H/V)	Distance (m)	Preamp (dB)	Filter (dB)	EIRP (dBm)	Limit (dBm)	Delta (dB)	Notes
	Low Ch, 824.2									
Band	1648.40	-25.1	V	3.0	37.0	1.0	-61.1	-13.0	-48.1	
	2472.60	-12.0	V	3.0	36.4	1.0	-47.5	-13.0	-34.5	
	3296.80	-20.1	V	3.0	36.2	1.0	-55.2	-13.0	-42.2	
GSM	1648.40	-25.5	H	3.0	37.0	1.0	-61.5	-13.0	-48.5	
	2472.60	-10.8	H	3.0	36.4	1.0	-46.2	-13.0	-33.2	
	3296.80	-20.2	H	3.0	36.2	1.0	-55.3	-13.0	-42.3	
850	Mid Ch, 836.6									
	1673.20	-21.9	V	3.0	37.0	1.0	-57.9	-13.0	-44.9	
	2509.80	-15.6	V	3.0	36.4	1.0	-51.0	-13.0	-38.0	
EGPRS	3346.40	-19.9	V	3.0	36.1	1.0	-55.1	-13.0	-42.1	
	1673.20	-20.2	H	3.0	37.0	1.0	-56.2	-13.0	-43.2	
	2509.80	-18.2	H	3.0	36.4	1.0	-53.6	-13.0	-40.6	
	3346.40	-20.4	H	3.0	36.1	1.0	-55.5	-13.0	-42.5	
	High Ch, 848.8									
	1697.60	-14.5	V	3.0	37.0	1.0	-50.5	-13.0	-37.5	
	2546.40	-11.8	V	3.0	36.4	1.0	-47.2	-13.0	-34.2	
	3395.20	-20.2	V	3.0	36.1	1.0	-55.3	-13.0	-42.3	
	1697.60	-22.5	H	3.0	37.0	1.0	-58.5	-13.0	-45.5	
	2546.40	-8.9	H	3.0	36.4	1.0	-44.3	-13.0	-31.3	
	3395.20	-20.7	H	3.0	36.1	1.0	-55.8	-13.0	-42.8	

UL Verification Services, Inc. Above 1GHz High Frequency Substitution Measurement										
Company:		Sony								
Project #:		15J20116								
Date:		3/26/2015								
Test Engineer:		R.Z								
Configuration:		EUT , AC Adapter/Headset								
Location:		Chamber G								
Mode:		GPRS 850 MHz Harmonics								
	f MHz	SG reading (dBm)	Ant. Pol. (H/V)	Distance (m)	Preamp (dB)	Filter (dB)	EIRP (dBm)	Limit (dBm)	Delta (dB)	Notes
	Low Ch, 824.2									
Band	1648.40	-22.4	V	3.0	37.0	1.0	-58.5	-13.0	-45.5	
	2472.60	-10.3	V	3.0	36.4	1.0	-45.8	-13.0	-32.8	
	3296.80	-20.7	V	3.0	36.2	1.0	-55.8	-13.0	-42.8	
GSM 850	1648.40	-16.9	H	3.0	37.0	1.0	-52.9	-13.0	-39.9	
	2472.60	-7.2	H	3.0	36.4	1.0	-42.6	-13.0	-29.6	
	3296.80	-20.4	H	3.0	36.2	1.0	-55.5	-13.0	-42.5	
	Mid Ch, 836.6									
GPRS	1673.20	-14.8	V	3.0	37.0	1.0	-50.8	-13.0	-37.8	
	2509.80	-10.3	V	3.0	36.4	1.0	-45.7	-13.0	-32.7	
	3346.40	-19.9	V	3.0	36.1	1.0	-55.1	-13.0	-42.1	
	1673.20	-14.4	H	3.0	37.0	1.0	-50.4	-13.0	-37.4	
	2509.80	-11.1	H	3.0	36.4	1.0	-46.5	-13.0	-33.5	
	High Ch, 848.8									
	1697.60	-13.0	V	3.0	37.0	1.0	-48.9	-13.0	-35.9	
	2546.40	-11.9	V	3.0	36.4	1.0	-47.3	-13.0	-34.3	
	3395.20	-20.1	V	3.0	36.1	1.0	-55.2	-13.0	-42.2	
	1697.60	-15.2	H	3.0	37.0	1.0	-51.2	-13.0	-38.2	
	2546.40	-12.5	H	3.0	36.4	1.0	-47.9	-13.0	-34.9	
	3395.20	-19.9	H	3.0	36.1	1.0	-55.0	-13.0	-42.0	