

FCC SAR Test Report

APPLICANT : Sony Mobile Communications Inc
EQUIPMENT : PDA Phone
BRAND NAME : Sony
TYPE NAME : PM-0787-BV
FCC ID : PY7-PM0787
STANDARD : FCC 47 CFR Part 2 (2.1093)
ANSI/IEEE C95.1-1992
IEEE 1528-2003

We, SPORTON INTERNATIONAL INC., would like to declare that the tested sample has been evaluated in accordance with the procedures and had been in compliance with the applicable technical standards.

The test results in this report apply exclusively to the tested model / sample. Without written approval of SPORTON INTERNATIONAL INC., the test report shall not be reproduced except in full.

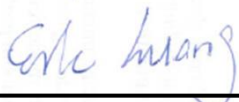

Reviewed by: Eric Huang / Deputy Manager



Approved by: Jones Tsai / Manager



SPORTON INTERNATIONAL INC.

No.52, Hwa Ya 1st Rd., Hwa Ya Technology Park, Kwei-Shan District, Taoyuan City, Taiwan (R.O.C.)



Table of Contents

1. Statement of Compliance 4
2. Administration Data 5
3. Guidance Standard 5
4. Equipment Under Test (EUT) 6
4.1 General Information 6
4.2 Device Serial Number 7
4.3 Maximum Tune-up Limit 7
4.4 General LTE SAR Test and Reporting Considerations 9
5. RF Exposure Limits 10
5.1 Uncontrolled Environment 10
5.2 Controlled Environment 10
6. Specific Absorption Rate (SAR) 11
6.1 Introduction 11
6.2 SAR Definition 11
7. System Description and Setup 12
8. Measurement Procedures 13
8.1 Spatial Peak SAR Evaluation 13
8.2 Power Reference Measurement 14
8.3 Area Scan 14
8.4 Zoom Scan 15
8.5 Volume Scan Procedures 15
8.6 Power Drift Monitoring 15
9. Test Equipment List 16
10. System Verification 17
10.1 Tissue Verification 17
10.2 System Performance Check Results 19
11. RF Exposure Positions 20
11.1 Ear and handset reference point 20
11.2 Definition of the cheek position 21
11.3 Definition of the tilt position 22
11.4 Body Worn Accessory 23
11.5 Wireless Router 23
12. Conducted RF Output Power (Unit: dBm) 24
13. Antenna Location 39
14. SAR Test Results 40
14.1 Head SAR 41
14.2 Hotspot SAR 43
14.3 Body Worn Accessory SAR 45
14.4 Repeated SAR Measurement 46
15. Simultaneous Transmission Analysis 47
15.1 Head Exposure Conditions 48
15.2 Hotspot Exposure Conditions 52
15.3 Body-Worn Accessory Exposure Conditions 56
15.4 SPLSR Evaluation and Analysis 58
16. Uncertainty Assessment 60
17. References 63
Appendix A. Plots of System Performance Check
Appendix B. Plots of High SAR Measurement
Appendix C. DASy Calibration Certificate
Appendix D. Test Setup Photos



Revision History

| REPORT NO. | VERSION | DESCRIPTION | ISSUED DATE |
|------------|---------|-------------------------|---------------|
| FA4D0472 | Rev. 01 | Initial issue of report | Mar. 30, 2015 |
| | | | |
| | | | |
| | | | |
| | | | |
| | | | |
| | | | |
| | | | |
| | | | |
| | | | |
| | | | |
| | | | |
| | | | |
| | | | |
| | | | |
| | | | |



1. Statement of Compliance

The maximum results of Specific Absorption Rate (SAR) found during testing for **Sony Mobile Communications Inc, PDA Phone**, are as follows.

| Equipment Class | Frequency Band | Highest SAR Summary | | | | | | Simultaneous Transmission 1g SAR (W/kg) |
|------------------|--------------------|-----------------------|---------------|-----------------------------|---------------|-----------------------------------|---------------|---|
| | | Head (Separation 0mm) | | Body-worn (Separation 15mm) | | Wireless Router (Separation 10mm) | | |
| | | Maximum power(dBm) | 1g SAR (W/kg) | Maximum power(dBm) | 1g SAR (W/kg) | Maximum power(dBm) | 1g SAR (W/kg) | |
| PCE | GSM850(4Tx Slots) | 28.00 | 0.75 | 28.00 | 0.79 | 28.00 | 0.86 | 1.56 |
| | GSM1900(4Tx Slots) | 28.00 | 1.02 | 28.00 | 0.65 | 28.00 | 1.20 | |
| | WCDMA Band V | 25.00 | 0.66 | 25.00 | 0.85 | 25.00 | 0.89 | |
| | WCDMA Band II | 24.00 | 0.74 | 24.00 | 0.63 | 24.00 | 1.13 | |
| | LTE Band 5 | 25.00 | 0.54 | 25.00 | 0.68 | 25.00 | 0.70 | |
| | LTE Band 7 | 23.00 | 1.20 | 23.00 | 0.47 | 23.00 | 1.00 | |
| DTS | 2.4GHz WLAN | 18.00 | 0.51 | 18.00 | 0.34 | 18.00 | 0.87 | 1.56 |
| NII | 5.2GHz WLAN | 14.00 | 0.25 | 14.00 | 0.08 | 14.00 | 0.16 | 1.34 |
| | 5.3GHz WLAN | 14.00 | 0.25 | 14.00 | 0.07 | | | |
| | 5.5GHz WLAN | 14.00 | 0.24 | 14.00 | 0.04 | | | |
| | 5.8GHz WLAN | 14.00 | 0.38 | 14.00 | 0.05 | 14.00 | 0.08 | |
| DSS | Bluetooth | 11.00 | 0.01 | | | | | 1.47 |
| Date of Testing: | | 2014/12/23-2014/03/05 | | | | | | |

| Equipment Class | Frequency Band | Highest SAR Summary | | | | | | Simultaneous Transmission 10g SAR (W/kg) |
|------------------|--------------------|-----------------------|----------------|-----------------------------|----------------|-----------------------------------|----------------|--|
| | | Head (Separation 0mm) | | Body-worn (Separation 15mm) | | Wireless Router (Separation 10mm) | | |
| | | Maximum Power(dBm) | 10g SAR (W/kg) | Maximum power(dBm) | 10g SAR (W/kg) | Maximum power(dBm) | 10g SAR (W/kg) | |
| GSM | GSM850(4Tx Slots) | 28.00 | 0.58 | 28.00 | 0.60 | 28.00 | 0.66 | 1.10 |
| | GSM1900(4Tx Slots) | 28.00 | 0.60 | 28.00 | 0.40 | 28.00 | 0.71 | |
| WCDMA | Band V | 25.00 | 0.51 | 25.00 | 0.65 | 25.00 | 0.69 | |
| | Band II | 24.00 | 0.45 | 24.00 | 0.40 | 24.00 | 0.67 | |
| LTE | Band 5 | 25.00 | 0.42 | 25.00 | 0.52 | 25.00 | 0.55 | |
| | Band 7 | 23.00 | 0.62 | 23.00 | 0.26 | 23.00 | 0.53 | |
| WLAN | 2.4GHz WLAN | 18.00 | 0.23 | 18.00 | 0.17 | 18.00 | 0.38 | 1.10 |
| | 5.2GHz WLAN | 14.00 | 0.07 | 14.00 | 0.03 | 14.00 | 0.05 | 0.74 |
| | 5.3GHz WLAN | 14.00 | 0.08 | 14.00 | 0.03 | | | |
| | 5.5GHz WLAN | 14.00 | 0.07 | 14.00 | 0.02 | | | |
| | 5.8GHz WLAN | 14.00 | 0.12 | 14.00 | 0.02 | 14.00 | 0.02 | |
| Bluetooth | 2.4GHz Band | 11.00 | < 0.01 | | | | | 0.82 |
| Date of Testing: | | 2014/12/23-2014/03/05 | | | | | | |

This device is in compliance with Specific Absorption Rate (SAR) for general population/uncontrolled exposure limits (1.6 W/kg) specified in FCC 47 CFR part 2 (2.1093) and ANSI/IEEE C95.1-1992, and had been tested in accordance with the measurement methods and procedures specified in IEEE 1528-2003.



2. Administration Data

| Testing Laboratory | |
|--------------------|--|
| Test Site | SPORTON INTERNATIONAL INC. |
| Test Site Location | No.52, Hwa Ya 1st Rd., Hwa Ya Technology Park, Kwei-Shan District, Taoyuan City, Taiwan (R.O.C.) TEL: +886-3-327-3456 FAX: +886-3-328-4978 |

| Applicant | |
|--------------|------------------------------------|
| Company Name | Sony Mobile Communications Inc |
| Address | Nya Vattentornet 22188 Lund/Sweden |

| Manufacturer | |
|--------------|------------------------------------|
| Company Name | Sony Mobile Communications Inc |
| Address | Nya Vattentornet 22188 Lund/Sweden |

3. Guidance Standard

The Specific Absorption Rate (SAR) testing specification, method, and procedure for this device is in accordance with the following standards:

- FCC 47 CFR Part 2 (2.1093)
- ANSI/IEEE C95.1-1992
- IEEE 1528-2003
- FCC KDB 865664 D01 SAR Measurement 100 MHz to 6 GHz v01r03
- FCC KDB 865664 D02 SAR Reporting v01r01
- FCC KDB 447498 D01 General RF Exposure Guidance v05r02
- FCC KDB 648474 D04 SAR Evaluation Considerations for Wireless Handsets v01r02
- FCC KDB 248227 D01 SAR meas for 802 11abg v01r02
- FCC KDB 941225 D01 3G SAR Procedures v03
- FCC KDB 941225 D05 SAR for LTE Devices v02r03
- FCC KDB 941225 D06 Hotspot Mode SAR v02



4. Equipment Under Test (EUT)

4.1 General Information

The equipment under test is a smart phone supporting, GSM850/900/1800/1900, UMTS I / II / V / VIII, LTE Band 1 / 3 / 5 / 7 / 8 / 28 / 40, 802.11 a/b/g/n, Bluetooth, FM Receiver, NFC, ANT+ and GPS features, and below is details of information. For FCC only wireless modes in US frequency bands are tested.

| Product Feature & Specification | |
|---|---|
| Equipment Name | PDA Phone |
| Brand Name | Sony |
| Type Name | PM-0787-BV |
| FCC ID | PY7-PM0787 |
| Wireless Technology and Frequency Range | GSM850: 824.2 MHz ~ 848.8 MHz GSM1900: 1850.2 MHz ~ 1909.8 MHz WCDMA Band V: 826.4 MHz ~ 846.6 MHz WCDMA Band II: 1852.4 MHz ~ 1907.6 MHz LTE Band 5: 824.7 MHz ~ 848.3 MHz LTE Band 7: 2502.5 MHz ~ 2567.5 MHz WLAN 2.4GHz Band: 2412 MHz ~ 2462 MHz WLAN 5.2GHz Band: 5180 MHz ~ 5240 MHz WLAN 5.3GHz Band: 5260 MHz ~ 5320 MHz WLAN 5.5GHz Band: 5500 MHz ~ 5700 MHz WLAN 5.8GHz Band: 5745 MHz ~ 5825 MHz Bluetooth: 2402 MHz ~ 2480 MHz NFC: 13.56 MHz |
| Mode | <ul style="list-style-type: none"> • GSM/GPRS/EGPRS • RMC/AMR 12.2Kbps • HSDPA • HSUPA • DC-HSDPA • LTE: QPSK, 16QAM • 802.11a/b/g/n HT20/HT40 • Bluetooth v3.0+EDR · Bluetooth v4.0-LE • NFC: ASK • ANT+ |
| HW Version | AP |
| SW Version | 26.1.B.1.23 |
| GSM / (E)GPRS Dual Transfer mode | Class A – EUT can support Packet Switched and Circuit Switched Network simultaneously. |
| EUT Stage | Identical Prototype |
| Remark: | |
| <ol style="list-style-type: none"> 1. This device 2.4GHz supports Hotspot and 5.2GHz / 5.8GHz WLAN supports WiFi Direct (GC/GO) operation, and 5.3GHz / 5.5GHz WLAN supports WiFi Direct (GC only). 2. This device supported VoIP in EGPRS, WCDMA, LTE (e.g. 3rd party VoIP) and 802.11n-HT40 is not supported in 2.4GHz WLAN. 3. WLAN operation in 5600 MHz ~ 5650 MHz is notched. 4. The FCC ID PY7-PM0787 and FCC ID: PY7-PM0782 are similar device, in this report all the test case is referred to PY7-PM0782 and spot checks for all the frequency band were performed to ensure that the SAR measurements for both devices are the same. | |

4.2 Device Serial Number

| Sample | Serial Number | IMEI Code |
|-----------------------------|---------------|-----------------|
| GSM SAR measurements | YT9110HS7R | 004402454018411 |
| UMTS SAR measurements | YT9110HSAN | 004402454018361 |
| LTE SAR measurements | YT9110HS64 | 004402454018288 |
| BT SAR measurements | YT910ZRWBX | 004402453307021 |
| WLAN SAR measurements | YT910ZRWDA | 004402453307252 |
| GSM Conducted measurements | YT9110HS7R | 004402454018411 |
| UMTS Conducted measurements | YT9110HSAN | 004402454018361 |
| LTE Conducted measurements | YT9110HS64 | 004402454018288 |
| WLAN Conducted measurements | YT910ZRWDA | 004402453307252 |
| BT Conducted measurements | YT910ZRWBX | 004402453307021 |

Note: Several samples were used with identical hardware to support SAR testing. The manufacturer has confirmed that the device tested gave the same physical, mechanical and thermal characteristics and are within operational tolerances expected for production units.

4.3 Maximum Tune-up Limit

| Mode | Burst average power(dBm) | | |
|-------------------------|--------------------------|----------|-------|
| | GSM 850 | GSM 1900 | |
| GSM (GMSK, 1 Tx slot) | 34.00 | 31.00 | |
| GPRS (GMSK, 1 Tx slot) | 34.00 | 31.00 | |
| GPRS (GMSK, 2 Tx slots) | 30.00 | 30.00 | |
| GPRS (GMSK, 3 Tx slots) | 29.00 | 29.00 | |
| GPRS (GMSK, 4 Tx slots) | 28.00 | 28.00 | |
| EDGE (8PSK, 1 Tx slot) | 27.00 | 26.00 | |
| EDGE (8PSK, 2 Tx slots) | 26.00 | 26.00 | |
| EDGE (8PSK, 3 Tx slots) | 26.00 | 26.00 | |
| EDGE (8PSK, 4 Tx slots) | 25.00 | 25.00 | |
| DTM 5 (2Tx slots) | GSM (GMSK, 1 Tx slot) | 30.00 | 30.00 |
| | GPRS (GMSK, 1 Tx slot) | 30.00 | 30.00 |
| DTM 9 (2Tx slots) | GSM (GMSK, 1 Tx slot) | 30.00 | 30.00 |
| | GPRS (GMSK, 1 Tx slot) | 30.00 | 30.00 |
| DTM 11 (3Tx slots) | GSM (GMSK, 1 Tx slot) | 29.00 | 29.00 |
| | GPRS (GMSK, 2 Tx slots) | 29.00 | 29.00 |
| DTM 5 (2Tx slots) | GSM (GMSK, 1 Tx slot) | 30.00 | 30.00 |
| | EDGE (8PSK, 1 Tx slot) | 26.00 | 26.00 |
| DTM 9 (2Tx slots) | GSM (GMSK, 1 Tx slot) | 30.00 | 30.00 |
| | EDGE (8PSK, 1 Tx slot) | 26.00 | 26.00 |
| DTM 11 (3Tx slots) | GSM (GMSK, 1 Tx slot) | 29.00 | 29.00 |
| | EDGE (8PSK, 2 Tx slots) | 26.00 | 26.00 |



| Mode | | Average Power (dBm) | |
|--------------------|--------------|---------------------|-------|
| WCDMA | Band V | 25.00 | |
| | Band II | 24.00 | |
| LTE | Band 5 | 25.00 | |
| | Band 7 | 23.00 | |
| 2.4GHz WLAN | 802.11b | 18.00 | |
| | 802.11g | 15.00 | |
| | 802.11n-HT20 | 13.00 | |
| 5GHz WLAN | 802.11a | 14.00 | |
| | 802.11n-HT20 | 12.50 | |
| | 802.11n-HT40 | 5.2GHz | 12.00 |
| | | 5.3GHz | 12.00 |
| | | 5.5GHz | 11.00 |
| | | 5.8GHz | 11.00 |
| Bluetooth v3.0+EDR | Low | 10.00 | |
| | Middle | 11.00 | |
| | High | 10.00 | |
| Bluetooth v4.0+LE | | 3.00 | |



4.4 General LTE SAR Test and Reporting Considerations

| Summarized necessary items addressed in KDB 941225 D05 v02r03 | | | | | | | | | | | | | | | | | | | | | | | | | | | | | | | | | | | | | | | | | | | | | | |
|---|---|-------------|------------------|-------------|------------------|-------------|------------------|-------------|------------|---|--|--|--|--|--|----------|---------|---------|-------|--------|--------|--------|------|-----|-----|-----|------|------|------|-----|--------|-----|-----|-----|------|------|------|-----|--------|-----|-----|-----|------|------|------|-----|
| FCC ID | PY7-PM0787 | | | | | | | | | | | | | | | | | | | | | | | | | | | | | | | | | | | | | | | | | | | | | |
| Equipment Name | PDA Phone | | | | | | | | | | | | | | | | | | | | | | | | | | | | | | | | | | | | | | | | | | | | | |
| Operating Frequency Range of each LTE transmission band | LTE Band 5: 824.7 MHz ~ 848.3 MHz LTE Band 7: 2502.5 MHz ~ 2567.5 MHz | | | | | | | | | | | | | | | | | | | | | | | | | | | | | | | | | | | | | | | | | | | | | |
| Channel Bandwidth | LTE Band 5: 1.4MHz, 3MHz, 5MHz, 10MHz LTE Band 7: 5MHz, 10MHz, 15MHz, 20MHz | | | | | | | | | | | | | | | | | | | | | | | | | | | | | | | | | | | | | | | | | | | | | |
| Release and Category | Rel10, Cat4 | | | | | | | | | | | | | | | | | | | | | | | | | | | | | | | | | | | | | | | | | | | | | |
| Uplink modulations used | QPSK, and 16QAM | | | | | | | | | | | | | | | | | | | | | | | | | | | | | | | | | | | | | | | | | | | | | |
| LTE Voice / Data requirements | Data only | | | | | | | | | | | | | | | | | | | | | | | | | | | | | | | | | | | | | | | | | | | | | |
| LTE MPR permanently built-in by design | <p style="text-align: center;">Table 6.2.3-1: Maximum Power Reduction (MPR) for Power Class 3</p> <table border="1" style="width: 100%; border-collapse: collapse;"> <thead> <tr> <th rowspan="2">Modulation</th> <th colspan="6">Channel bandwidth / Transmission bandwidth (RB)</th> <th rowspan="2">MPR (dB)</th> </tr> <tr> <th>1.4 MHz</th> <th>3.0 MHz</th> <th>5 MHz</th> <th>10 MHz</th> <th>15 MHz</th> <th>20 MHz</th> </tr> </thead> <tbody> <tr> <td>QPSK</td> <td>> 5</td> <td>> 4</td> <td>> 8</td> <td>> 12</td> <td>> 16</td> <td>> 18</td> <td>≤ 1</td> </tr> <tr> <td>16 QAM</td> <td>≤ 5</td> <td>≤ 4</td> <td>≤ 8</td> <td>≤ 12</td> <td>≤ 16</td> <td>≤ 18</td> <td>≤ 1</td> </tr> <tr> <td>16 QAM</td> <td>> 5</td> <td>> 4</td> <td>> 8</td> <td>> 12</td> <td>> 16</td> <td>> 18</td> <td>≤ 2</td> </tr> </tbody> </table> | | | | | | | | Modulation | Channel bandwidth / Transmission bandwidth (RB) | | | | | | MPR (dB) | 1.4 MHz | 3.0 MHz | 5 MHz | 10 MHz | 15 MHz | 20 MHz | QPSK | > 5 | > 4 | > 8 | > 12 | > 16 | > 18 | ≤ 1 | 16 QAM | ≤ 5 | ≤ 4 | ≤ 8 | ≤ 12 | ≤ 16 | ≤ 18 | ≤ 1 | 16 QAM | > 5 | > 4 | > 8 | > 12 | > 16 | > 18 | ≤ 2 |
| Modulation | Channel bandwidth / Transmission bandwidth (RB) | | | | | | MPR (dB) | | | | | | | | | | | | | | | | | | | | | | | | | | | | | | | | | | | | | | | |
| | 1.4 MHz | 3.0 MHz | 5 MHz | 10 MHz | 15 MHz | 20 MHz | | | | | | | | | | | | | | | | | | | | | | | | | | | | | | | | | | | | | | | | |
| QPSK | > 5 | > 4 | > 8 | > 12 | > 16 | > 18 | ≤ 1 | | | | | | | | | | | | | | | | | | | | | | | | | | | | | | | | | | | | | | | |
| 16 QAM | ≤ 5 | ≤ 4 | ≤ 8 | ≤ 12 | ≤ 16 | ≤ 18 | ≤ 1 | | | | | | | | | | | | | | | | | | | | | | | | | | | | | | | | | | | | | | | |
| 16 QAM | > 5 | > 4 | > 8 | > 12 | > 16 | > 18 | ≤ 2 | | | | | | | | | | | | | | | | | | | | | | | | | | | | | | | | | | | | | | | |
| LTE A-MPR | In the base station simulator configuration, Network Setting value is set to NS_01 to disable A-MPR during SAR testing and the LTE SAR tests was transmitting on all TTI frames (Maximum TTI) | | | | | | | | | | | | | | | | | | | | | | | | | | | | | | | | | | | | | | | | | | | | | |
| Spectrum plots for RB configuration | A properly configured base station simulator was used for the SAR and power measurement; therefore, spectrum plots for each RB allocation and offset configuration are not included in the SAR report. | | | | | | | | | | | | | | | | | | | | | | | | | | | | | | | | | | | | | | | | | | | | | |
| Transmission (H, M, L) channel numbers and frequencies in each LTE band | | | | | | | | | | | | | | | | | | | | | | | | | | | | | | | | | | | | | | | | | | | | | | |
| LTE Band 5 | | | | | | | | | | | | | | | | | | | | | | | | | | | | | | | | | | | | | | | | | | | | | | |
| | Bandwidth 1.4 MHz | | Bandwidth 3 MHz | | Bandwidth 5 MHz | | Bandwidth 10 MHz | | | | | | | | | | | | | | | | | | | | | | | | | | | | | | | | | | | | | | | |
| | Ch. # | Freq. (MHz) | Ch. # | Freq. (MHz) | Ch. # | Freq. (MHz) | Ch. # | Freq. (MHz) | | | | | | | | | | | | | | | | | | | | | | | | | | | | | | | | | | | | | | |
| L | 20407 | 824.7 | 20415 | 825.5 | 20425 | 826.5 | 20450 | 829 | | | | | | | | | | | | | | | | | | | | | | | | | | | | | | | | | | | | | | |
| M | 20525 | 836.5 | 20525 | 836.5 | 20525 | 836.5 | 20525 | 836.5 | | | | | | | | | | | | | | | | | | | | | | | | | | | | | | | | | | | | | | |
| H | 20643 | 848.3 | 20635 | 847.5 | 20625 | 846.5 | 20600 | 844 | | | | | | | | | | | | | | | | | | | | | | | | | | | | | | | | | | | | | | |
| LTE Band 7 | | | | | | | | | | | | | | | | | | | | | | | | | | | | | | | | | | | | | | | | | | | | | | |
| | Bandwidth 5 MHz | | Bandwidth 10 MHz | | Bandwidth 15 MHz | | Bandwidth 20 MHz | | | | | | | | | | | | | | | | | | | | | | | | | | | | | | | | | | | | | | | |
| | Ch. # | Freq. (MHz) | Ch. # | Freq. (MHz) | Ch. # | Freq. (MHz) | Ch. # | Freq. (MHz) | | | | | | | | | | | | | | | | | | | | | | | | | | | | | | | | | | | | | | |
| L | 20775 | 2502.5 | 20800 | 2505 | 20825 | 2507.5 | 20850 | 2510 | | | | | | | | | | | | | | | | | | | | | | | | | | | | | | | | | | | | | | |
| M | 21100 | 2535 | 21100 | 2535 | 21100 | 2535 | 21100 | 2535 | | | | | | | | | | | | | | | | | | | | | | | | | | | | | | | | | | | | | | |
| H | 21425 | 2567.5 | 21400 | 2565 | 21375 | 2562.5 | 21350 | 2560 | | | | | | | | | | | | | | | | | | | | | | | | | | | | | | | | | | | | | | |



5. RF Exposure Limits

5.1 Uncontrolled Environment

Uncontrolled Environments are defined as locations where there is the exposure of individuals who have no knowledge or control of their exposure. The general population/uncontrolled exposure limits are applicable to situations in which the general public may be exposed or in which persons who are exposed as a consequence of their employment may not be made fully aware of the potential for exposure or cannot exercise control over their exposure. Members of the general public would come under this category when exposure is not employment-related; for example, in the case of a wireless transmitter that exposes persons in its vicinity.

5.2 Controlled Environment

Controlled Environments are defined as locations where there is exposure that may be incurred by persons who are aware of the potential for exposure, (i.e. as a result of employment or occupation). In general, occupational/controlled exposure limits are applicable to situations in which persons are exposed as a consequence of their employment, who have been made fully aware of the potential for exposure and can exercise control over their exposure. The exposure category is also applicable when the exposure is of a transient nature due to incidental passage through a location where the exposure levels may be higher than the general population/uncontrolled limits, but the exposed person is fully aware of the potential for exposure and can exercise control over his or her exposure by leaving the area or by some other appropriate means.

Limits for Occupational/Controlled Exposure (W/kg)

Table with 3 columns: Whole-Body, Partial-Body, Hands, Wrists, Feet and Ankles. Values: 0.4, 8.0, 20.0

Limits for General Population/Uncontrolled Exposure (W/kg)

Table with 3 columns: Whole-Body, Partial-Body, Hands, Wrists, Feet and Ankles. Values: 0.08, 1.6, 4.0

- 1. Whole-Body SAR is averaged over the entire body, partial-body SAR is averaged over any 1gram of tissue defined as a tissue volume in the shape of a cube. SAR for hands, wrists, feet and ankles is averaged over any 10 grams of tissue defined as a tissue volume in the shape of a cube.

6. Specific Absorption Rate (SAR)

6.1 Introduction

SAR is related to the rate at which energy is absorbed per unit mass in an object exposed to a radio field. The SAR distribution in a biological body is complicated and is usually carried out by experimental techniques or numerical modeling. The standard recommends limits for two tiers of groups, occupational/controlled and general population/uncontrolled, based on a person's awareness and ability to exercise control over his or her exposure. In general, occupational/controlled exposure limits are higher than the limits for general population/uncontrolled.

6.2 SAR Definition

The SAR definition is the time derivative (rate) of the incremental energy (dW) absorbed by (dissipated in) an incremental mass (dm) contained in a volume element (dv) of a given density (ρ). The equation description is as below:

$$SAR = \frac{d}{dt} \left(\frac{dW}{dm} \right) = \frac{d}{dt} \left(\frac{dW}{\rho dv} \right)$$

SAR is expressed in units of Watts per kilogram (W/kg)

$$SAR = \frac{\sigma |E|^2}{\rho}$$

Where: σ is the conductivity of the tissue, ρ is the mass density of the tissue and E is the RMS electrical field strength.

7. System Description and Setup

The DASY system used for performing compliance tests consists of the following items:

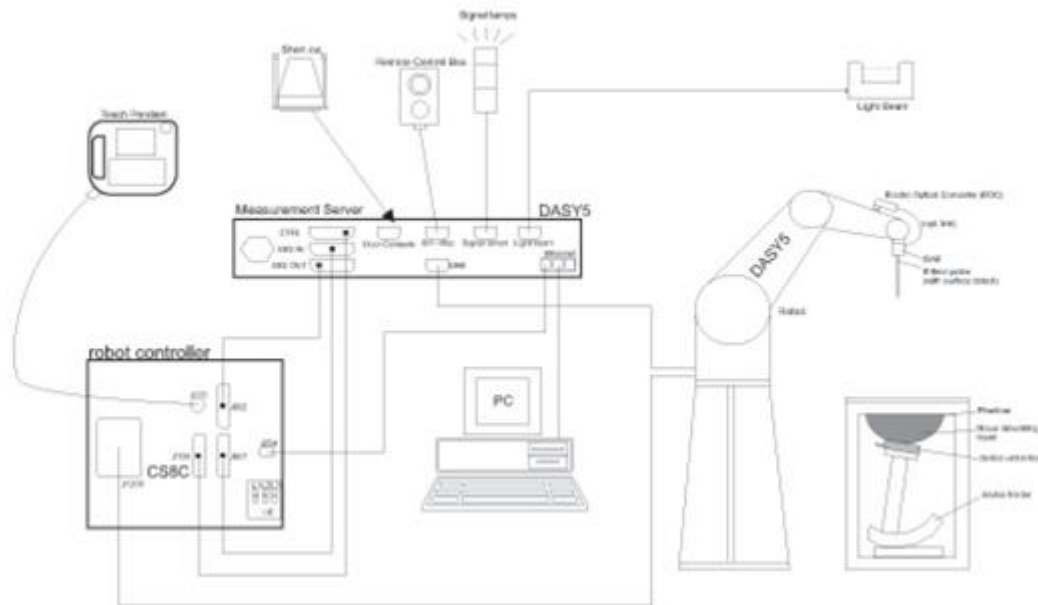

- A standard high precision 6-axis robot with controller, teach pendant and software. An arm extension for accommodating the data acquisition electronics (DAE).
- An isotropic Field probe optimized and calibrated for the targeted measurement.
- A data acquisition electronics (DAE) which performs the signal amplification, signal multiplexing, AD-conversion, offset measurements, mechanical surface detection, collision detection, etc. The unit is battery powered with standard or rechargeable batteries. The signal is optically transmitted to the EOC.
- The Electro-optical converter (EOC) performs the conversion from optical to electrical signals for the digital communication to the DAE. To use optical surface detection, a special version of the EOC is required. The EOC signal is transmitted to the measurement server.
- The function of the measurement server is to perform the time critical tasks such as signal filtering, control of the robot operation and fast movement interrupts.
- The Light Beam used is for probe alignment. This improves the (absolute) accuracy of the probe positioning.
- A computer running WinXP or Win7 and the DASY5 software.
- Remote control and teach pendant as well as additional circuitry for robot safety such as warning lamps, etc.
- The phantom, the device holder and other accessories according to the targeted measurement.

8. Measurement Procedures

The measurement procedures are as follows:

<Conducted power measurement>

- (a) For WWAN power measurement, use base station simulator to configure EUT WWAN transmission in conducted connection with RF cable, at maximum power in each supported wireless interface and frequency band.
- (b) Read the WWAN RF power level from the base station simulator.
- (c) For WLAN/BT power measurement, use engineering software to configure EUT WLAN/BT continuously transmission, at maximum RF power in each supported wireless interface and frequency band
- (d) Connect EUT RF port through RF cable to the power meter, and measure WLAN/BT output power

<SAR measurement>

- (a) Use base station simulator to configure EUT WWAN transmission in radiated connection, and engineering software to configure EUT WLAN/BT continuously transmission, at maximum RF power, in the highest power channel.
- (b) Place the EUT in the positions as Appendix D demonstrates.
- (c) Set scan area, grid size and other setting on the DASY software.
- (d) Measure SAR results for the highest power channel on each testing position.
- (e) Find out the largest SAR result on these testing positions of each band
- (f) Measure SAR results for other channels in worst SAR testing position if the reported SAR of highest power channel is larger than 0.8 W/kg

According to the test standard, the recommended procedure for assessing the peak spatial-average SAR value consists of the following steps:

- (a) Power reference measurement
- (b) Area scan
- (c) Zoom scan
- (d) Power drift measurement

8.1 Spatial Peak SAR Evaluation

The procedure for spatial peak SAR evaluation has been implemented according to the test standard. It can be conducted for 1g and 10g, as well as for user-specific masses. The DASY software includes all numerical procedures necessary to evaluate the spatial peak SAR value.

The base for the evaluation is a "cube" measurement. The measured volume must include the 1g and 10g cubes with the highest averaged SAR values. For that purpose, the center of the measured volume is aligned to the interpolated peak SAR value of a previously performed area scan.

The entire evaluation of the spatial peak values is performed within the post-processing engine (SEMCAD). The system always gives the maximum values for the 1g and 10g cubes. The algorithm to find the cube with highest averaged SAR is divided into the following stages:

- (a) Extraction of the measured data (grid and values) from the Zoom Scan
- (b) Calculation of the SAR value at every measurement point based on all stored data (A/D values and measurement parameters)
- (c) Generation of a high-resolution mesh within the measured volume
- (d) Interpolation of all measured values from the measurement grid to the high-resolution grid
- (e) Extrapolation of the entire 3-D field distribution to the phantom surface over the distance from sensor to surface
- (f) Calculation of the averaged SAR within masses of 1g and 10g

8.2 Power Reference Measurement

The Power Reference Measurement and Power Drift Measurements are for monitoring the power drift of the device under test in the batch process. The minimum distance of probe sensors to surface determines the closest measurement point to phantom surface. This distance cannot be smaller than the distance of sensor calibration points to probe tip as defined in the probe properties.

8.3 Area Scan

The area scan is used as a fast scan in two dimensions to find the area of high field values, before doing a fine measurement around the hot spot. The sophisticated interpolation routines implemented in DASY software can find the maximum found in the scanned area, within a range of the global maximum. The range (in dB0 is specified in the standards for compliance testing. For example, a 2 dB range is required in IEEE standard 1528 and IEC 62209 standards, whereby 3 dB is a requirement when compliance is assessed in accordance with the ARIB standard (Japan), if only one zoom scan follows the area scan, then only the absolute maximum will be taken as reference. For cases where multiple maximums are detected, the number of zoom scans has to be increased accordingly.

Area scan parameters extracted from FCC KDB 865664 D01v01r03 SAR measurement 100 MHz to 6 GHz.

| | ≤ 3 GHz | > 3 GHz |
|--|---|--|
| Maximum distance from closest measurement point (geometric center of probe sensors) to phantom surface | 5 ± 1 mm | $\frac{1}{2} \cdot \delta \cdot \ln(2) \pm 0.5$ mm |
| Maximum probe angle from probe axis to phantom surface normal at the measurement location | 30° ± 1° | 20° ± 1° |
| Maximum area scan spatial resolution: $\Delta x_{Area}, \Delta y_{Area}$ | ≤ 2 GHz: ≤ 15 mm 2 – 3 GHz: ≤ 12 mm | 3 – 4 GHz: ≤ 12 mm 4 – 6 GHz: ≤ 10 mm |
| | When the x or y dimension of the test device, in the measurement plane orientation, is smaller than the above, the measurement resolution must be ≤ the corresponding x or y dimension of the test device with at least one measurement point on the test device. | |

8.4 Zoom Scan

Zoom scans are used assess the peak spatial SAR values within a cubic averaging volume containing 1 gram and 10 gram of simulated tissue. The zoom scan measures points (refer to table below) within a cube shoes base faces are centered on the maxima found in a preceding area scan job within the same procedure. When the measurement is done, the zoom scan evaluates the averaged SAR for 1 gram and 10 gram and displays these values next to the job's label.

Zoom scan parameters extracted from FCC KDB 865664 D01v01r03 SAR measurement 100 MHz to 6 GHz.

| | | ≤ 3 GHz | > 3 GHz | |
|--|------------------------------------|--|---|--|
| Maximum zoom scan spatial resolution: $\Delta x_{Zoom}, \Delta y_{Zoom}$ | | ≤ 2 GHz: ≤ 8 mm 2 – 3 GHz: ≤ 5 mm* | 3 – 4 GHz: ≤ 5 mm* 4 – 6 GHz: ≤ 4 mm* | |
| Maximum zoom scan spatial resolution, normal to phantom surface | uniform grid: $\Delta z_{Zoom}(n)$ | ≤ 5 mm | 3 – 4 GHz: ≤ 4 mm 4 – 5 GHz: ≤ 3 mm 5 – 6 GHz: ≤ 2 mm | |
| | graded grid | $\Delta z_{Zoom}(1)$: between 1 st two points closest to phantom surface | ≤ 4 mm | 3 – 4 GHz: ≤ 3 mm 4 – 5 GHz: ≤ 2.5 mm 5 – 6 GHz: ≤ 2 mm |
| | | $\Delta z_{Zoom}(n>1)$: between subsequent points | $\leq 1.5 \cdot \Delta z_{Zoom}(n-1)$ | |
| Minimum zoom scan volume | x, y, z | ≥ 30 mm | 3 – 4 GHz: ≥ 28 mm 4 – 5 GHz: ≥ 25 mm 5 – 6 GHz: ≥ 22 mm | |
| Note: δ is the penetration depth of a plane-wave at normal incidence to the tissue medium; see draft standard IEEE P1528-2011 for details. * When zoom scan is required and the <i>reported</i> SAR from the <i>area scan based 1-g SAR estimation</i> procedures of KDB 447498 is ≤ 1.4 W/kg, ≤ 8 mm, ≤ 7 mm and ≤ 5 mm zoom scan resolution may be applied, respectively, for 2 GHz to 3 GHz, 3 GHz to 4 GHz and 4 GHz to 6 GHz. | | | | |

8.5 Volume Scan Procedures

The volume scan is used for assess overlapping SAR distributions for antennas transmitting in different frequency bands. It is equivalent to an oversized zoom scan used in standalone measurements. The measurement volume will be used to enclose all the simultaneous transmitting antennas. For antennas transmitting simultaneously in different frequency bands, the volume scan is measured separately in each frequency band. In order to sum correctly to compute the 1g aggregate SAR, the EUT remain in the same test position for all measurements and all volume scan use the same spatial resolution and grid spacing. When all volume scan were completed, the software, SEMCAD postprocessor can combine and subsequently superpose these measurement data to calculating the multiband SAR.

8.6 Power Drift Monitoring

All SAR testing is under the EUT install full charged battery and transmit maximum output power. In DASy measurement software, the power reference measurement and power drift measurement procedures are used for monitoring the power drift of EUT during SAR test. Both these procedures measure the field at a specified reference position before and after the SAR testing. The software will calculate the field difference in dB. If the power drifts more than 5%, the SAR will be retested.



9. Test Equipment List

| Manufacturer | Name of Equipment | Type/Model | Serial Number | Calibration | |
|---------------|---------------------------------|------------|---------------|---------------|---------------|
| | | | | Last Cal. | Due Date |
| SPEAG | 835MHz System Validation Kit | D835V2 | 4d162 | Nov. 19, 2014 | Nov. 18, 2015 |
| SPEAG | 1900MHz System Validation Kit | D1900V2 | 5d182 | Nov. 14, 2014 | Nov. 13, 2015 |
| SPEAG | 2450MHz System Validation Kit | D2450V2 | 924 | Nov. 19, 2014 | Nov. 18, 2015 |
| SPEAG | 2600MHz System Validation Kit | D2600V2 | 1070 | Nov. 19, 2014 | Nov. 18, 2015 |
| SPEAG | 5GHz System Validation Kit | D5GHzV2 | 1006 | Sep. 25, 2014 | Sep. 24, 2015 |
| SPEAG | Data Acquisition Electronics | DAE4 | 778 | Aug. 21, 2014 | Aug. 20, 2015 |
| SPEAG | Data Acquisition Electronics | DAE4 | 1388 | Sep. 24, 2014 | Sep. 23, 2015 |
| SPEAG | Data Acquisition Electronics | DAE3 | 577 | Oct. 06, 2014 | Oct. 05, 2015 |
| SPEAG | Data Acquisition Electronics | DAE4 | 1279 | Jul. 23, 2014 | Jul. 22, 2015 |
| SPEAG | Data Acquisition Electronics | DAE3 | 495 | May. 19, 2014 | May. 18, 2015 |
| SPEAG | Data Acquisition Electronics | DAE4 | 1399 | Nov. 13, 2014 | Nov. 12, 2015 |
| SPEAG | Dosimetric E-Field Probe | ES3DV3 | 3270 | Sep. 26, 2014 | Sep. 25, 2015 |
| SPEAG | Dosimetric E-Field Probe | EX3DV4 | 3697 | Sep. 29, 2014 | Sep. 28, 2015 |
| SPEAG | Dosimetric E-Field Probe | EX3DV4 | 3931 | Sep. 25, 2014 | Sep. 24, 2015 |
| SPEAG | Dosimetric E-Field Probe | EX3DV4 | 3954 | Nov. 21, 2014 | Nov. 20, 2015 |
| SPEAG | Dosimetric E-Field Probe | EX3DV4 | 3925 | May. 22, 2014 | May. 21, 2015 |
| SPEAG | Dosimetric E-Field Probe | EX3DV4 | 3955 | Nov. 21, 2014 | Nov. 20, 2015 |
| Wisewind | Thermometer | ETP-101 | TM560 | Oct. 21, 2014 | Oct. 20, 2015 |
| Wisewind | Thermometer | ETP-101 | TM685 | Oct. 21, 2014 | Oct. 20, 2015 |
| Wisewind | Thermometer | HTC-1 | TM642 | Oct. 21, 2014 | Oct. 20, 2015 |
| Wisewind | Thermometer | HTC-1 | TM281 | Oct. 21, 2014 | Oct. 20, 2015 |
| H.M.IRIS | Thermometer | TH-08 | TM658 | Oct. 21, 2014 | Oct. 20, 2015 |
| WonDer | Thermometer | WD-5015 | TM225 | Oct. 21, 2014 | Oct. 20, 2015 |
| Anritsu | Radio Communication Analyzer | MT8820C | 6201381760 | May. 28, 2014 | May. 27, 2015 |
| Anritsu | Radio Communication Analyzer | MT8820C | 6201341952 | Dec. 11, 2014 | Dec. 10, 2015 |
| Agilent | Wireless Communication Test Set | E5515C | MY50266977 | May. 27, 2014 | May. 26, 2015 |
| Anritsu | BT Base Station | MT8852B | 1350002 | Dec. 12, 2014 | Dec. 11, 2015 |
| SPEAG | Device Holder | N/A | N/A | NCR | NCR |
| R&S | Signal Generator | SMU200A | 102502 | Jul. 07, 2014 | Jul. 06, 2015 |
| SPEAG | Dielectric Probe Kit | DAK-3.5 | 1138 | Nov. 18, 2014 | Nov. 17, 2015 |
| Agilent | ENA Network Analyzer | E5071C | MY46101588 | May. 31, 2014 | May. 30, 2015 |
| Anritsu | Power Meter | ML2495A | 1036004 | Aug. 09, 2014 | Aug. 08, 2015 |
| Anritsu | Power Sensor | MA2411B | 1027253 | Aug. 11, 2014 | Aug. 10, 2015 |
| R&S | Spectrum Analyzer | FSP 7 | 101131 | Jul. 10, 2014 | Jul. 09, 2015 |
| Agilent | Dual Directional Coupler | 778D | 50422 | | Note1 |
| Woken | Attenuator 1 | WK0602-XX | N/A | | Note1 |
| PE | Attenuator 2 | PE7005-10 | N/A | | Note1 |
| PE | Attenuator 3 | PE7005- 3 | N/A | | Note1 |
| AR | Power Amplifier | 5S1G4M2 | 0328767 | | Note1 |
| Mini-Circuits | Power Amplifier | ZVE-3W | 162601250 | | Note1 |
| Mini-Circuits | Power Amplifier | ZHL-42W+ | 13440021344 | | Note1 |

General Note:

1. Prior to system verification and validation, the path loss from the signal generator to the system check source and the power meter, which includes the amplifier, cable, attenuator and directional coupler, was measured by the network analyzer. The reading of the power meter was offset by the path loss difference between the path to the power meter and the path to the system check source to monitor the actual power level fed to the system check source.



10. System Verification

10.1 Tissue Verification

The following tissue formulations are provided for reference only as some of the parameters have not been thoroughly verified. The composition of ingredients may be modified accordingly to achieve the desired target tissue parameters required for routine SAR evaluation.

| Frequency (MHz) | Water (%) | Sugar (%) | Cellulose (%) | Salt (%) | Preventol (%) | DGBE (%) | Conductivity (σ) | Permittivity (ϵ_r) |
|------------------|-----------|-----------|---------------|----------|---------------|----------|---------------------------|-------------------------------|
| For Head | | | | | | | | |
| 750 | 41.1 | 57.0 | 0.2 | 1.4 | 0.2 | 0 | 0.89 | 41.9 |
| 835 | 40.3 | 57.9 | 0.2 | 1.4 | 0.2 | 0 | 0.90 | 41.5 |
| 900 | 40.3 | 57.9 | 0.2 | 1.4 | 0.2 | 0 | 0.97 | 41.5 |
| 1800, 1900, 2000 | 55.2 | 0 | 0 | 0.3 | 0 | 44.5 | 1.40 | 40.0 |
| 2450 | 55.0 | 0 | 0 | 0 | 0 | 45.0 | 1.80 | 39.2 |
| 2600 | 54.8 | 0 | 0 | 0.1 | 0 | 45.1 | 1.96 | 39.0 |
| For Body | | | | | | | | |
| 750 | 51.7 | 47.2 | 0 | 0.9 | 0.1 | 0 | 0.96 | 55.5 |
| 835 | 50.8 | 48.2 | 0 | 0.9 | 0.1 | 0 | 0.97 | 55.2 |
| 900 | 50.8 | 48.2 | 0 | 0.9 | 0.1 | 0 | 1.05 | 55.0 |
| 1800, 1900, 2000 | 70.2 | 0 | 0 | 0.4 | 0 | 29.4 | 1.52 | 53.3 |
| 2450 | 68.6 | 0 | 0 | 0 | 0 | 31.4 | 1.95 | 52.7 |
| 2600 | 68.1 | 0 | 0 | 0.1 | 0 | 31.8 | 2.16 | 52.5 |

Simulating Liquid for 5GHz, Manufactured by SPEAG

| Ingredients | (% by weight) |
|--------------------|---------------|
| Water | 64~78% |
| Mineral oil | 11~18% |
| Emulsifiers | 9~15% |
| Additives and Salt | 2~3% |



<Tissue Dielectric Parameter Check Results>

| Frequency (MHz) | Tissue Type | Liquid Temp. (°C) | Conductivity (σ) | Permittivity (ε _r) | Conductivity Target (σ) | Permittivity Target (ε _r) | Delta (σ) (%) | Delta (ε _r) (%) | Limit (%) | Date |
|-----------------|-------------|-------------------|------------------|--------------------------------|-------------------------|---------------------------------------|---------------|-----------------------------|-----------|------------|
| 835 | HSL | 22.5 | 0.881 | 42.165 | 0.90 | 41.50 | -2.11 | 1.60 | ±5 | 2015/2/11 |
| 835 | HSL | 22.3 | 0.925 | 43.289 | 0.90 | 41.50 | 2.78 | 4.31 | ±5 | 2015/2/13 |
| 835 | HSL | 22.4 | 0.929 | 43.117 | 0.90 | 41.50 | 3.22 | 3.90 | ±5 | 2015/2/15 |
| 835 | MSL | 22.5 | 0.981 | 54.961 | 0.97 | 55.20 | 1.13 | -0.43 | ±5 | 2015/2/13 |
| 835 | MSL | 22.4 | 0.972 | 54.215 | 0.97 | 55.20 | 0.21 | -1.78 | ±5 | 2015/2/14 |
| 1900 | HSL | 22.3 | 1.432 | 39.040 | 1.40 | 40.00 | 2.29 | -2.40 | ±5 | 2015/2/8 |
| 1900 | MSL | 22.6 | 1.532 | 52.506 | 1.52 | 53.30 | 0.79 | -1.49 | ±5 | 2015/2/5 |
| 1900 | MSL | 22.5 | 1.535 | 52.471 | 1.52 | 53.30 | 0.99 | -1.56 | ±5 | 2015/2/9 |
| 2450 | HSL | 22.4 | 1.840 | 38.700 | 1.80 | 39.20 | 2.22 | -1.28 | ±5 | 2014/12/23 |
| 2450 | HSL | 22.4 | 1.840 | 38.600 | 1.80 | 39.20 | 2.22 | -1.53 | ±5 | 2014/12/31 |
| 2450 | MSL | 22.4 | 1.984 | 51.263 | 1.95 | 52.70 | 1.74 | -2.73 | ±5 | 2015/2/16 |
| 2600 | HSL | 22.5 | 2.042 | 37.341 | 1.96 | 39.00 | 4.18 | -4.25 | ±5 | 2015/2/25 |
| 2600 | MSL | 22.2 | 2.227 | 52.208 | 2.16 | 52.50 | 3.10 | -0.56 | ±5 | 2015/2/24 |
| 5200 | HSL | 22.4 | 4.812 | 35.445 | 4.66 | 36.00 | 3.26 | -1.54 | ±5 | 2015/2/16 |
| 5200 | MSL | 22.4 | 5.240 | 47.500 | 5.30 | 49.00 | -1.13 | -3.06 | ±5 | 2014/12/26 |
| 5200 | MSL | 22.4 | 5.432 | 47.957 | 5.30 | 49.00 | 2.49 | -2.13 | ±5 | 2015/3/5 |
| 5300 | HSL | 22.4 | 4.920 | 35.315 | 4.76 | 35.90 | 3.36 | -1.63 | ±5 | 2015/2/16 |
| 5300 | MSL | 22.4 | 5.380 | 47.200 | 5.42 | 48.90 | -0.74 | -3.48 | ±5 | 2014/12/26 |
| 5600 | HSL | 22.4 | 5.231 | 34.710 | 5.07 | 35.50 | 3.18 | -2.23 | ±5 | 2015/2/16 |
| 5600 | MSL | 22.4 | 5.770 | 46.800 | 5.77 | 48.50 | 0.00 | -3.51 | ±5 | 2014/12/26 |
| 5800 | HSL | 22.5 | 5.390 | 34.400 | 5.27 | 35.30 | 2.28 | -2.55 | ±5 | 2014/12/25 |
| 5800 | MSL | 22.4 | 6.130 | 46.500 | 6.00 | 48.20 | 2.17 | -3.53 | ±5 | 2014/12/26 |
| 5800 | MSL | 22.4 | 6.251 | 46.901 | 6.00 | 48.20 | 4.18 | -2.70 | ±5 | 2015/3/5 |

10.2 System Performance Check Results

Comparing to the original SAR value provided by SPEAG, the verification data should be within its specification of 10 %. Below table shows the target SAR and measured SAR after normalized to 1W input power. The table below indicates the system performance check can meet the variation criterion and the plots can be referred to Appendix A of this report.

| Date | Frequency (MHz) | Tissue Type | Input Power (mW) | Dipole S/N | Probe S/N | DAE S/N | Measured 1g SAR (W/kg) | Targeted 1g SAR (W/kg) | Normalized 1g SAR (W/kg) | Deviation (%) |
|------------|-----------------|-------------|------------------|---------------|-----------------|-------------|------------------------|------------------------|--------------------------|---------------|
| 2015/2/11 | 835 | HSL | 250 | D835V2-4d162 | EX3DV4 - SN3955 | DAE4 Sn1399 | 2.25 | 9.15 | 9.00 | -1.64 |
| 2015/2/13 | 835 | HSL | 250 | D835V2-4d162 | EX3DV4 - SN3697 | DAE4 Sn1388 | 2.24 | 9.15 | 8.96 | -2.08 |
| 2015/2/15 | 835 | HSL | 250 | D835V2-4d162 | EX3DV4 - SN3931 | DAE3 Sn577 | 2.40 | 9.15 | 9.60 | 4.92 |
| 2015/2/13 | 835 | MSL | 250 | D835V2-4d162 | EX3DV4 - SN3697 | DAE4 Sn1388 | 2.47 | 9.56 | 9.88 | 3.35 |
| 2015/2/14 | 835 | MSL | 250 | D835V2-4d162 | EX3DV4 - SN3954 | DAE4 Sn1279 | 2.33 | 9.56 | 9.32 | -2.51 |
| 2015/2/8 | 1900 | HSL | 250 | D1900V2-5d182 | EX3DV4 - SN3925 | DAE3 Sn495 | 10.40 | 39.80 | 41.60 | 4.52 |
| 2015/2/5 | 1900 | MSL | 250 | D1900V2-5d182 | EX3DV4 - SN3925 | DAE3 Sn495 | 9.71 | 40.00 | 38.84 | -2.90 |
| 2015/2/9 | 1900 | MSL | 250 | D1900V2-5d182 | EX3DV4 - SN3925 | DAE3 Sn495 | 9.73 | 40.00 | 38.92 | -2.70 |
| 2014/12/23 | 2450 | HSL | 250 | D2450V2-924 | ES3DV3 - SN3270 | DAE4 Sn778 | 13.90 | 51.90 | 55.60 | 7.13 |
| 2014/12/31 | 2450 | HSL | 250 | D2450V2-924 | ES3DV3 - SN3270 | DAE4 Sn778 | 13.20 | 51.90 | 52.80 | 1.73 |
| 2015/2/16 | 2450 | MSL | 250 | D2450V2-924 | EX3DV4 - SN3955 | DAE4 Sn1399 | 12.10 | 51.40 | 48.40 | -5.84 |
| 2015/2/25 | 2600 | HSL | 250 | D2600V2-1070 | EX3DV4 - SN3954 | DAE4 Sn1279 | 14.60 | 56.90 | 58.40 | 2.64 |
| 2015/2/24 | 2600 | MSL | 250 | D2600V2-1070 | EX3DV4 - SN3954 | DAE4 Sn1279 | 14.00 | 55.30 | 56.00 | 1.27 |
| 2015/2/16 | 5200 | HSL | 100 | D5GHzV2-1006 | EX3DV4 - SN3955 | DAE4 Sn1399 | 8.32 | 81.10 | 83.20 | 2.59 |
| 2014/12/26 | 5200 | MSL | 100 | D5GHzV2-1006 | EX3DV4 - SN3925 | DAE3 Sn495 | 7.79 | 77.50 | 77.90 | 0.52 |
| 2015/3/5 | 5200 | MSL | 100 | D5GHzV2-1006 | EX3DV4 - SN3925 | DAE3 Sn495 | 7.83 | 77.50 | 78.30 | 1.03 |
| 2015/2/16 | 5300 | HSL | 100 | D5GHzV2-1006 | EX3DV4 - SN3955 | DAE4 Sn1399 | 8.87 | 86.60 | 88.70 | 2.42 |
| 2014/12/26 | 5300 | MSL | 100 | D5GHzV2-1006 | EX3DV4 - SN3925 | DAE3 Sn495 | 7.97 | 80.00 | 79.70 | -0.37 |
| 2015/2/16 | 5600 | HSL | 100 | D5GHzV2-1006 | EX3DV4 - SN3955 | DAE4 Sn1399 | 9.21 | 85.80 | 92.10 | 7.34 |
| 2014/12/26 | 5600 | MSL | 100 | D5GHzV2-1006 | EX3DV4 - SN3925 | DAE3 Sn495 | 8.32 | 85.20 | 83.20 | -2.35 |
| 2014/12/25 | 5800 | HSL | 100 | D5GHzV2-1006 | EX3DV4 - SN3925 | DAE3 Sn495 | 8.75 | 82.90 | 87.50 | 5.55 |
| 2014/12/26 | 5800 | MSL | 100 | D5GHzV2-1006 | EX3DV4 - SN3925 | DAE3 Sn495 | 8.40 | 78.40 | 84.00 | 7.14 |
| 2015/3/5 | 5800 | MSL | 100 | D5GHzV2-1006 | EX3DV4 - SN3925 | DAE3 Sn495 | 7.77 | 78.40 | 77.70 | -0.89 |

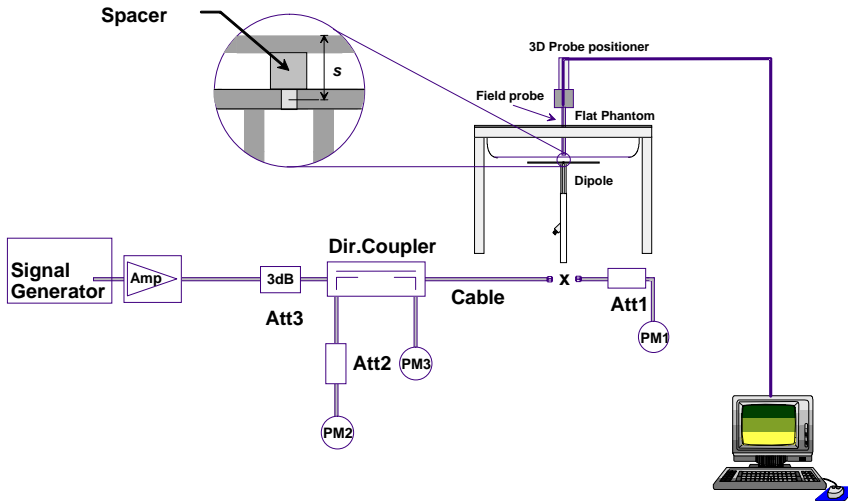

Fig 8.3.1 System Performance Check Setup



Fig 8.3.2 Setup Photo

11. RF Exposure Positions

11.1 Ear and handset reference point

Figure 9.1.1 shows the front, back, and side views of the SAM phantom. The center-of-mouth reference point is labeled “M,” the left ear reference point (ERP) is marked “LE,” and the right ERP is marked “RE.” Each ERP is 15 mm along the B-M (back-mouth) line behind the entrance-to-ear-canal (EEC) point, as shown in Figure 9.1.2 The Reference Plane is defined as passing through the two ear reference points and point M. The line N-F (neck-front), also called the reference pivoting line, is normal to the Reference Plane and perpendicular to both a line passing through RE and LE and the B-M line (see Figure 9.1.3). Both N-F and B-M lines should be marked on the exterior of the phantom shell to facilitate handset positioning. Posterior to the N-F line the ear shape is a flat surface with 6 mm thickness at each ERP, and forward of the N-F line the ear is truncated, as illustrated in Figure 9.1.2. The ear truncation is introduced to preclude the ear lobe from interfering with handset tilt, which could lead to unstable positioning at the cheek.

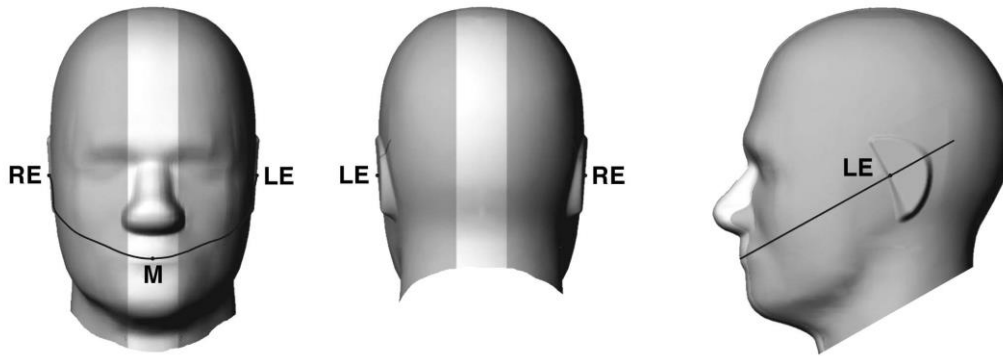

Fig 9.1.1 Front, back, and side views of SAM twin phantom

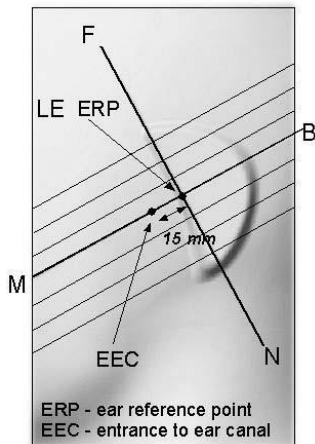

Fig 9.1.2 Close-up side view of phantom showing the ear region.

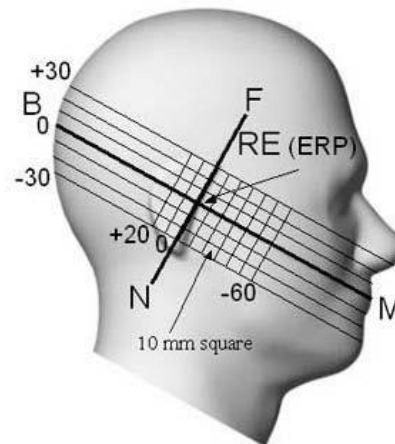

Fig 9.1.3 Side view of the phantom showing relevant markings and seven cross-sectional plane locations

11.2 Definition of the cheek position

1. Ready the handset for talk operation, if necessary. For example, for handsets with a cover piece (flip cover), open the cover. If the handset can transmit with the cover closed, both configurations must be tested.
2. Define two imaginary lines on the handset—the vertical centerline and the horizontal line. The vertical centerline passes through two points on the front side of the handset—the midpoint of the width w_t of the handset at the level of the acoustic output (point A in Figure 9.2.1 and Figure 9.2.2), and the midpoint of the width w_b of the bottom of the handset (point B). The horizontal line is perpendicular to the vertical centerline and passes through the center of the acoustic output (see Figure 9.2.1). The two lines intersect at point A. Note that for many handsets, point A coincides with the center of the acoustic output; however, the acoustic output may be located elsewhere on the horizontal line. Also note that the vertical centerline is not necessarily parallel to the front face of the handset (see Figure 9.2.2), especially for clamshell handsets, handsets with flip covers, and other irregularly-shaped handsets.
3. Position the handset close to the surface of the phantom such that point A is on the (virtual) extension of the line passing through points RE and LE on the phantom (see Figure 9.2.3), such that the plane defined by the vertical centerline and the horizontal line of the handset is approximately parallel to the sagittal plane of the phantom.
4. Translate the handset towards the phantom along the line passing through RE and LE until handset point A touches the pinna at the ERP.
5. While maintaining the handset in this plane, rotate it around the LE-RE line until the vertical centerline is in the plane normal to the plane containing B-M and N-F lines, i.e., the Reference Plane.
6. Rotate the handset around the vertical centerline until the handset (horizontal line) is parallel to the N-F line.
7. While maintaining the vertical centerline in the Reference Plane, keeping point A on the line passing through RE and LE, and maintaining the handset contact with the pinna, rotate the handset about the N-F line until any point on the handset is in contact with a phantom point below the pinna on the cheek. See Figure 9.2.3. The actual rotation angles should be documented in the test report.

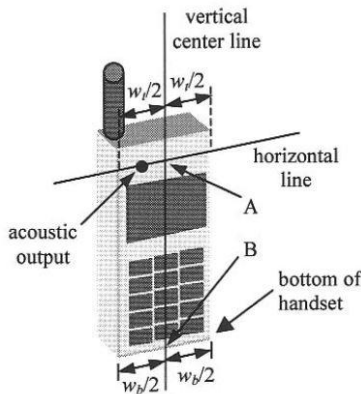

Fig 9.2.1 Handset vertical and horizontal reference lines—“fixed case”

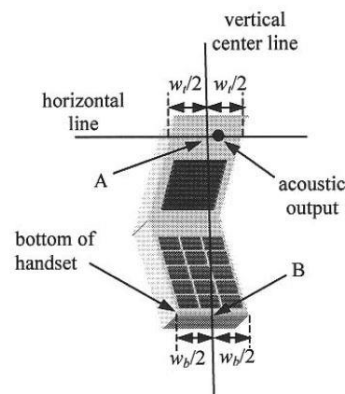

Fig 9.2.2 Handset vertical and horizontal reference lines—“clam-shell case”

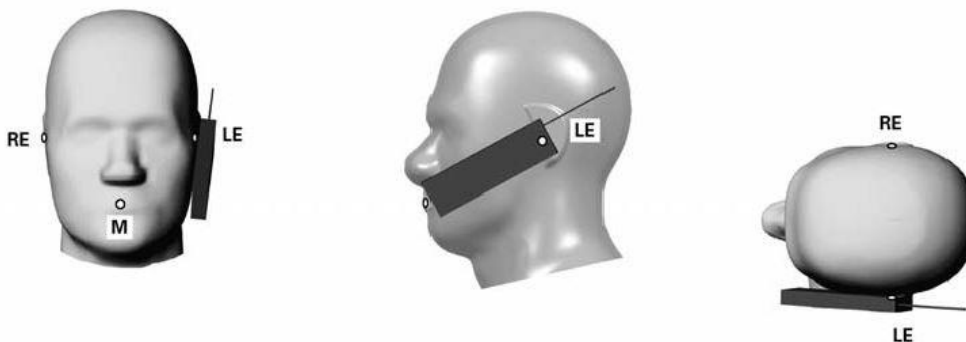

Fig 9.2.3 cheek or touch position. The reference points for the right ear (RE), left ear (LE), and mouth (M), which establish the Reference Plane for handset positioning, are indicated.

11.3 Definition of the tilt position

1. Ready the handset for talk operation, if necessary. For example, for handsets with a cover piece (flip cover), open the cover. If the handset can transmit with the cover closed, both configurations must be tested.
2. While maintaining the orientation of the handset, move the handset away from the pinna along the line passing through RE and LE far enough to allow a rotation of the handset away from the cheek by 15°.
3. Rotate the handset around the horizontal line by 15°.
4. While maintaining the orientation of the handset, move the handset towards the phantom on the line passing through RE and LE until any part of the handset touches the ear. The tilt position is obtained when the contact point is on the pinna. See Figure 9.3.1. If contact occurs at any location other than the pinna, e.g., the antenna at the back of the phantom head, the angle of the handset should be reduced. In this case, the tilt position is obtained if any point on the handset is in contact with the pinna and a second point

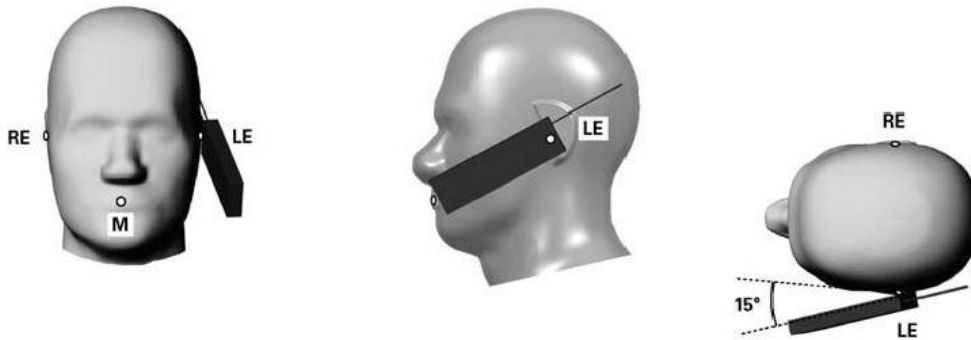

Fig 9.3.1 Tilt position. The reference points for the right ear (RE), left ear (LE), and mouth (M), which define the Reference Plane for handset positioning, are indicated.

11.4 Body Worn Accessory

Body-worn operating configurations are tested with the belt-clips and holsters attached to the device and positioned against a flat phantom in a normal use configuration (see Figure 9.4). Per KDB 648474 D04v01r02, body-worn accessory exposure is typically related to voice mode operations when handsets are carried in body-worn accessories. The body-worn accessory procedures in FCC KDB 447498 D01v05r02 should be used to test for body-worn accessory SAR compliance, without a headset connected to it. This enables the test results for such configuration to be compatible with that required for hotspot mode when the body-worn accessory test separation distance is greater than or equal to that required for hotspot mode, when applicable. When the reported SAR for body-worn accessory, measured without a headset connected to the handset is < 1.2 W/kg, the highest reported SAR configuration for that wireless mode and frequency band should be repeated for that body-worn accessory with a headset attached to the handset.

Accessories for body-worn operation configurations are divided into two categories: those that do not contain metallic components and those that do contain metallic components. When multiple accessories that do not contain metallic components are supplied with the device, the device is tested with only the accessory that dictates the closest spacing to the body. Then multiple accessories that contain metallic components are test with the device with each accessory. If multiple accessories share an identical metallic component (i.e. the same metallic belt-chip used with different holsters with no other metallic components) only the accessory that dictates the closest spacing to the body is tested.

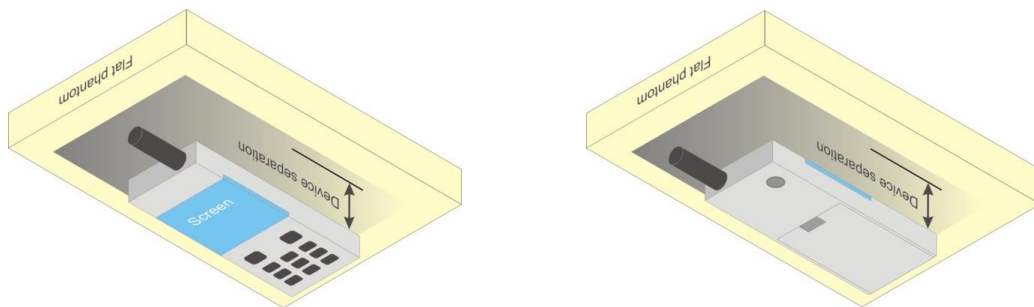

Fig 9.4 Body Worn Position

11.5 Wireless Router

Some battery-operated handsets have the capability to transmit and receive user through simultaneous transmission of WIFI simultaneously with a separate licensed transmitter. The FCC has provided guidance in FCC HDB Publication 941225 D06 v02 where SAR test considerations for handsets (L x W ≥ 9 cm x 5 cm) are based on a composite test separation distance of 10mm from the front, back and edges of the device containing transmitting antennas within 2.5cm of their edges, determined from general mixed use conditions for this type of devices. Since the hotspot SAR results may overlap with the body-worn accessory SAR requirements, the more conservative configurations can be considered, thus excluding some body-worn accessory SAR tests.

When the user enables the personal wireless router functions for the handset, actual operations include simultaneous transmission of both the WIFI transmitter and another licensed transmitter. Both transmitters often do not transmit at the same transmitting frequency and thus cannot be evaluated for SAR under actual use conditions due to the limitations of the SAR assessment probes. Therefore, SAR must be evaluated for each frequency transmission and mode separately and spatially summed with the WIFI transmitter according to FCC KDB Publication 447498 D01v05r02 publication procedures. The "Portable Hotspot" feature on the handset was NOT activated during SAR assessments, to ensure the SAR measurements were evaluated for a single transmission frequency RF signal at a time.



12. Conducted RF Output Power (Unit: dBm)

<GSM Conducted Power>

General Note:

- For DTM multi-slot class mode, the device was linked with base station simulator (Agilent E5515C) and transmit maximum power on maximum number of TX slots, i.e. one CS timeslot, and additional PS timeslots (1 for DTM class 5 and 9, 2 for DTM class 11) in one TDMA frame.
- Agilent E5515C was used to setup the device operated under DTM mode for power measurement and SAR testing. For conducted power, the power of the burst for voice and the power of the bursts for data was reported separately in the table above, and the frame-average power is derived below to determine SAR testing.

$$DTM \text{ frame average power (dBm)} = 10 * \log [\sum (\text{power of each slot, in mW}) / 8]$$
- Per KDB 447498 D01v05r02, the maximum output power channel is used for SAR testing and for further SAR test reduction.
- Per KDB 941225 D01v03, considering the possibility of e.g. 3rd party VoIP operation for Head and body-worn SAR test reduction for GSM and GPRS and EDGE modes is determined by the source-based time-averaged output power including tune-up tolerance. The mode with highest specified time-averaged output power should be tested for SAR compliance in the applicable exposure conditions. For modes with the same specified maximum output power and tolerance, the higher number time-slot configuration should be tested. Therefore, the EUT was set in GPRS (4Tx slots) for GSM850/GSM1900.
- Per KDB 941225 D01v03, for Hotspot SAR test reduction for GPRS and EDGE modes is determined by the source-based time-averaged output power including tune-up tolerance, for modes with the same specified maximum output power and tolerance, the higher number time-slot configuration should be tested, therefore, the EUT was set in GPRS (4Tx slots) for GSM850/GSM1900.

| Band GSM850 | | Burst Average Power (dBm) | | | Tune-up Limit (dBm) | Frame-Average Power (dBm) | | | Tune-up Limit (dBm) |
|-------------------------|-------------------------|---------------------------|-------|-------|---------------------|---------------------------|-------|-------|---------------------|
| TX Channel | | 128 | 189 | 251 | | 128 | 189 | 251 | |
| Frequency (MHz) | | 824.2 | 836.4 | 848.8 | | 824.2 | 836.4 | 848.8 | |
| GSM (GMSK, 1 Tx slot) | | 33.45 | 33.41 | 33.58 | 34.00 | 24.45 | 24.41 | 24.58 | 25.00 |
| GPRS (GMSK, 1 Tx slot) | | 33.50 | 33.48 | 33.66 | 34.00 | 24.50 | 24.48 | 24.66 | 25.00 |
| GPRS (GMSK, 2 Tx slots) | | 28.56 | 28.66 | 28.52 | 30.00 | 22.56 | 22.66 | 22.52 | 24.00 |
| GPRS (GMSK, 3 Tx slots) | | 27.42 | 27.21 | 27.43 | 29.00 | 23.16 | 22.95 | 23.17 | 24.74 |
| GPRS (GMSK, 4 Tx slots) | | 27.64 | 27.50 | 27.73 | 28.00 | 24.64 | 24.50 | 24.73 | 25.00 |
| EDGE (8PSK, 1 Tx slot) | | 26.61 | 26.64 | 26.72 | 27.00 | 17.61 | 17.64 | 17.72 | 18.00 |
| EDGE (8PSK, 2 Tx slots) | | 25.67 | 25.70 | 25.82 | 26.00 | 19.67 | 19.70 | 19.82 | 20.00 |
| EDGE (8PSK, 3 Tx slots) | | 25.32 | 25.30 | 25.35 | 26.00 | 21.06 | 21.04 | 21.09 | 21.74 |
| EDGE (8PSK, 4 Tx slots) | | 24.58 | 24.34 | 24.70 | 25.00 | 21.58 | 21.34 | 21.70 | 22.00 |
| DTM 5 (2Tx slots) | GSM (GMSK, 1 Tx slot) | 28.51 | 28.61 | 28.45 | 30.00 | 22.46 | 22.55 | 22.41 | 23.98 |
| | GPRS (GMSK, 1 Tx slot) | 28.46 | 28.53 | 28.41 | 30.00 | | | | |
| DTM 9 (2Tx slots) | GSM (GMSK, 1 Tx slot) | 28.49 | 28.57 | 28.43 | 30.00 | 22.44 | 22.52 | 22.39 | 23.98 |
| | GPRS (GMSK, 1 Tx slot) | 28.43 | 28.51 | 28.39 | 30.00 | | | | |
| DTM 11 (3Tx slots) | GSM (GMSK, 1 Tx slot) | 27.41 | 27.20 | 27.38 | 29.00 | 23.11 | 22.91 | 23.11 | 24.74 |
| | GPRS (GMSK, 2 Tx slots) | 27.35 | 27.16 | 27.36 | 29.00 | | | | |
| DTM 5 (2Tx slots) | GSM (GMSK, 1 Tx slot) | 28.47 | 28.51 | 28.41 | 30.00 | 21.25 | 21.29 | 21.25 | 22.42 |
| | EDGE (8PSK, 1 Tx slot) | 25.61 | 25.66 | 25.73 | 26.00 | | | | |
| DTM 9 (2Tx slots) | GSM (GMSK, 1 Tx slot) | 28.45 | 28.50 | 28.43 | 30.00 | 21.24 | 21.30 | 21.26 | 22.42 |
| | EDGE (8PSK, 1 Tx slot) | 25.63 | 25.69 | 25.70 | 26.00 | | | | |
| DTM 11 (3Tx slots) | GSM (GMSK, 1 Tx slot) | 27.40 | 27.20 | 27.36 | 29.00 | 21.86 | 21.76 | 21.85 | 22.98 |
| | EDGE (8PSK, 2 Tx slots) | 25.30 | 25.28 | 25.31 | 26.00 | | | | |



| Band GSM1900 | | Burst Average Power (dBm) | | | Tune-up Limit (dBm) | Frame-Average Power (dBm) | | | Tune-up Limit (dBm) |
|-------------------------|-------------------------|---------------------------|-------|--------|---------------------|---------------------------|--------|-------|---------------------|
| TX Channel | | 512 | 661 | 810 | | 512 | 661 | 810 | |
| Frequency (MHz) | | 1850.2 | 1880 | 1909.8 | 1850.2 | 1880 | 1909.8 | | |
| GSM (GMSK, 1 Tx slot) | | 30.52 | 30.61 | 30.85 | 31.00 | 21.52 | 21.61 | 21.85 | 22.00 |
| GPRS (GMSK, 1 Tx slot) | | 30.58 | 30.67 | 30.99 | 31.00 | 21.58 | 21.67 | 21.99 | 22.00 |
| GPRS (GMSK, 2 Tx slots) | | 28.37 | 28.44 | 28.47 | 30.00 | 22.37 | 22.44 | 22.47 | 24.00 |
| GPRS (GMSK, 3 Tx slots) | | 28.97 | 28.91 | 28.89 | 29.00 | 24.71 | 24.65 | 24.63 | 24.74 |
| GPRS (GMSK, 4 Tx slots) | | 27.94 | 27.95 | 27.98 | 28.00 | 24.94 | 24.95 | 24.98 | 25.00 |
| EDGE (8PSK, 1 Tx slot) | | 25.76 | 25.73 | 25.75 | 26.00 | 16.76 | 16.73 | 16.75 | 17.00 |
| EDGE (8PSK, 2 Tx slots) | | 25.64 | 25.62 | 25.66 | 26.00 | 19.64 | 19.62 | 19.66 | 20.00 |
| EDGE (8PSK, 3 Tx slots) | | 25.00 | 24.93 | 24.92 | 26.00 | 20.74 | 20.67 | 20.66 | 21.74 |
| EDGE (8PSK, 4 Tx slots) | | 24.61 | 24.58 | 24.52 | 25.00 | 21.61 | 21.58 | 21.52 | 22.00 |
| DTM 5 (2Tx slots) | GSM (GMSK, 1 Tx slot) | 28.35 | 28.40 | 28.45 | 30.00 | 22.31 | 22.36 | 22.42 | 23.98 |
| | GPRS (GMSK, 1 Tx slot) | 28.32 | 28.37 | 28.43 | 30.00 | | | | |
| DTM 9 (2Tx slots) | GSM (GMSK, 1 Tx slot) | 28.34 | 28.38 | 28.43 | 30.00 | 22.30 | 22.34 | 22.39 | 23.98 |
| | GPRS (GMSK, 1 Tx slot) | 28.30 | 28.35 | 28.40 | 30.00 | | | | |
| DTM 11 (3Tx slots) | GSM (GMSK, 1 Tx slot) | 28.97 | 28.90 | 28.87 | 29.00 | 24.67 | 24.63 | 24.60 | 24.74 |
| | GPRS (GMSK, 2 Tx slots) | 28.91 | 28.88 | 28.85 | 29.00 | | | | |
| DTM 5 (2Tx slots) | GSM (GMSK, 1 Tx slot) | 28.95 | 28.88 | 28.85 | 30.00 | 21.58 | 21.52 | 21.50 | 22.42 |
| | EDGE (8PSK, 1 Tx slot) | 25.63 | 25.60 | 25.61 | 26.00 | | | | |
| DTM 9 (2Tx slots) | GSM (GMSK, 1 Tx slot) | 28.93 | 28.87 | 28.85 | 30.00 | 21.56 | 21.51 | 21.50 | 22.42 |
| | EDGE (8PSK, 1 Tx slot) | 25.61 | 25.59 | 25.60 | 26.00 | | | | |
| DTM 11 (3Tx slots) | GSM (GMSK, 1 Tx slot) | 28.95 | 28.88 | 28.85 | 29.00 | 22.48 | 22.40 | 22.38 | 22.98 |
| | EDGE (8PSK, 2 Tx slots) | 24.98 | 24.90 | 24.90 | 26.00 | | | | |

<WCDMA Conducted Power>

1. The following tests were conducted according to the test requirements outlines in 3GPP TS 34.121 specification.
2. The procedures in KDB 941225 D01 are applied for 3GPP Rel. 6 HSPA to configure the device in the required sub-test mode(s) to determine SAR test exclusion.
3. For DC-HSDPA, the device was configured according to the H-Set 12, Fixed Reference Channel (FRC) configuration in Table C.8.1.12 of 3GPP TS 34.121-1, with the primary and the secondary serving HS-DSCH Cell enabled during the power measurement.

A summary of these settings are illustrated below:

HSDPA Setup Configuration:

- a. The EUT was connected to Base Station Agilent E5515C referred to the Setup Configuration.
- b. The RF path losses were compensated into the measurements.
- c. A call was established between EUT and Base Station with following setting:
 - i. Set Gain Factors (β_c and β_d) and parameters were set according to each
 - ii. Specific sub-test in the following table, C10.1.4, quoted from the TS 34.121
 - iii. Set RMC 12.2Kbps + HSDPA mode.
 - iv. Set Cell Power = -86 dBm
 - v. Set HS-DSCH Configuration Type to FRC (H-set 1, QPSK)
 - vi. Select HSDPA Uplink Parameters
 - vii. Set Delta ACK, Delta NACK and Delta CQI = 8
 - viii. Set Ack-Nack Repetition Factor to 3
 - ix. Set CQI Feedback Cycle (k) to 4 ms
 - x. Set CQI Repetition Factor to 2
 - xi. Power Ctrl Mode = All Up bits
- d. The transmitted maximum output power was recorded.

Table C.10.1.4: β values for transmitter characteristics tests with HS-DPCCH

| Sub-test | β_c | β_d | β_d (SF) | β_c/β_d | β_{HS} (Note 1, Note 2) | CM (dB) (Note 3) | MPR (dB) (Note 3) |
|----------|-------------------|-------------------|-------------------|-------------------|-------------------------------------|---------------------|----------------------|
| 1 | 2/15 | 15/15 | 64 | 2/15 | 4/15 | 0.0 | 0.0 |
| 2 | 12/15 (Note 4) | 15/15 (Note 4) | 64 | 12/15 (Note 4) | 24/15 | 1.0 | 0.0 |
| 3 | 15/15 | 8/15 | 64 | 15/8 | 30/15 | 1.5 | 0.5 |
| 4 | 15/15 | 4/15 | 64 | 15/4 | 30/15 | 1.5 | 0.5 |

Note 1: $\Delta_{ACK}, \Delta_{NACK}$ and $\Delta_{CQI} = 30/15$ with $\beta_{HS} = 30/15 * \beta_c$.

Note 2: For the HS-DPCCH power mask requirement test in clause 5.2C, 5.7A, and the Error Vector Magnitude (EVM) with HS-DPCCH test in clause 5.13.1A, and HSDPA EVM with phase discontinuity in clause 5.13.1AA, Δ_{ACK} and $\Delta_{NACK} = 30/15$ with $\beta_{HS} = 30/15 * \beta_c$, and $\Delta_{CQI} = 24/15$ with $\beta_{HS} = 24/15 * \beta_c$.

Note 3: CM = 1 for $\beta_c/\beta_d = 12/15, \beta_{HS}/\beta_c = 24/15$. For all other combinations of DPCCH, DPDCCH and HS-DPCCH the MPR is based on the relative CM difference. This is applicable for only UEs that support HSDPA in release 6 and later releases.

Note 4: For subtest 2 the β_c/β_d ratio of 12/15 for the TFC during the measurement period (TF1, TF0) is achieved by setting the signalled gain factors for the reference TFC (TF1, TF1) to $\beta_c = 11/15$ and $\beta_d = 15/15$.

Setup Configuration

HSUPA Setup Configuration:

- a. The EUT was connected to Base Station Agilent E5515C referred to the Setup Configuration.
- b. The RF path losses were compensated into the measurements.
- c. A call was established between EUT and Base Station with following setting * :
 - i. Call Configs = 5.2B, 5.9B, 5.10B, and 5.13.2B with QPSK
 - ii. Set the Gain Factors (β_c and β_d) and parameters (AG Index) were set according to each specific sub-test in the following table, C11.1.3, quoted from the TS 34.121
 - iii. Set Cell Power = -86 dBm
 - iv. Set Channel Type = 12.2k + HSPA
 - v. Set UE Target Power
 - vi. Power Ctrl Mode= Alternating bits
 - vii. Set and observe the E-TFCl
 - viii. Confirm that E-TFCl is equal to the target E-TFCl of 75 for sub-test 1, and other subtest's E-TFCl
- d. The transmitted maximum output power was recorded.

Table C.11.1.3: β values for transmitter characteristics tests with HS-DPCCH and E-DCH

| Sub-test | β_c | β_d | β_d (SF) | β_c/β_d | β_{HS} (Note 1) | β_{ec} | β_{ed} (Note 5) (Note 6) | β_{ed} (SF) | β_{ed} (Codes) | CM (dB) (Note 2) | MPR (dB) (Note 2) | AG Index (Note 6) | E-TFCl |
|----------|----------------|----------------|----------------|-------------------|-----------------------|--------------|--|-------------------|----------------------|------------------|-------------------|-------------------|--------|
| 1 | 11/15 (Note 3) | 15/15 (Note 3) | 64 | 11/15 (Note 3) | 22/15 | 209/25 | 1309/225 | 4 | 1 | 1.0 | 0.0 | 20 | 75 |
| 2 | 6/15 | 15/15 | 64 | 6/15 | 12/15 | 12/15 | 94/75 | 4 | 1 | 3.0 | 2.0 | 12 | 67 |
| 3 | 15/15 | 9/15 | 64 | 15/9 | 30/15 | 30/15 | $\beta_{ed1}: 47/15$ $\beta_{ed2}: 47/15$ | 4 4 | 2 | 2.0 | 1.0 | 15 | 92 |
| 4 | 2/15 | 15/15 | 64 | 2/15 | 4/15 | 2/15 | 56/75 | 4 | 1 | 3.0 | 2.0 | 17 | 71 |
| 5 | 15/15 (Note 4) | 15/15 (Note 4) | 64 | 15/15 (Note 4) | 30/15 | 24/15 | 134/15 | 4 | 1 | 1.0 | 0.0 | 21 | 81 |

Note 1: $\Delta_{ACK}, \Delta_{NACK}$ and $\Delta_{CQI} = 30/15$ with $\beta_{hs} = 30/15 * \beta_c$.

Note 2: CM = 1 for $\beta_c/\beta_d = 12/15$, $\beta_{hs}/\beta_c = 24/15$. For all other combinations of DPDCH, DPCCH, HS- DPCCH, E-DPDCH and E-DPCCH the MPR is based on the relative CM difference.

Note 3: For subtest 1 the β_c/β_d ratio of 11/15 for the TFC during the measurement period (TF1, TF0) is achieved by setting the signalled gain factors for the reference TFC (TF1, TF1) to $\beta_c = 10/15$ and $\beta_d = 15/15$.

Note 4: For subtest 5 the β_c/β_d ratio of 15/15 for the TFC during the measurement period (TF1, TF0) is achieved by setting the signalled gain factors for the reference TFC (TF1, TF1) to $\beta_c = 14/15$ and $\beta_d = 15/15$.

Note 5: In case of testing by UE using E-DPDCH Physical Layer category 1, Sub-test 3 is omitted according to TS25.306 Table 5.1g.

Note 6: β_{ed} can not be set directly, it is set by Absolute Grant Value.

Setup Configuration

DC-HSDPA 3GPP release 8 Setup Configuration:

- a. The EUT was connected to Base Station Agilent E5515C referred to the Setup Configuration below
- b. The RF path losses were compensated into the measurements.
- c. A call was established between EUT and Base Station with following setting:
 - i. Set RMC 12.2Kbps + HSDPA mode.
 - ii. Set Cell Power = -25 dBm
 - iii. Set HS-DSCH Configuration Type to FRC (H-set 12, QPSK)
 - iv. Select HSDPA Uplink Parameters
 - v. Set Gain Factors (β_c and β_d) and parameters were set according to each Specific sub-test in the following table, C10.1.4, quoted from the TS 34.121
 - a). Subtest 1: $\beta_c/\beta_d=2/15$
 - b). Subtest 2: $\beta_c/\beta_d=12/15$
 - c). Subtest 3: $\beta_c/\beta_d=15/8$
 - d). Subtest 4: $\beta_c/\beta_d=15/4$
 - vi. Set Delta ACK, Delta NACK and Delta CQI = 8
 - vii. Set Ack-Nack Repetition Factor to 3
 - viii. Set CQI Feedback Cycle (k) to 4 ms
 - ix. Set CQI Repetition Factor to 2
 - x. Power Ctrl Mode = All Up bits
- d. The transmitted maximum output power was recorded.

The following tests were conducted according to the test requirements outlines in 3GPP TS 34.121 specification. A summary of these settings are illustrated below:

C.8.1.12 Fixed Reference Channel Definition H-Set 12

Table C.8.1.12: Fixed Reference Channel H-Set 12

| Parameter | Unit | Value |
|--|-----------|-------|
| Nominal Avg. Inf. Bit Rate | kbps | 60 |
| Inter-TTI Distance | TTI's | 1 |
| Number of HARQ Processes | Processes | 6 |
| Information Bit Payload (N_{INF}) | Bits | 120 |
| Number Code Blocks | Blocks | 1 |
| Binary Channel Bits Per TTI | Bits | 960 |
| Total Available SML's in UE | SML's | 19200 |
| Number of SML's per HARQ Proc. | SML's | 3200 |
| Coding Rate | | 0.15 |
| Number of Physical Channel Codes | Codes | 1 |
| Modulation | | QPSK |
| Note 1: The RMC is intended to be used for DC-HSDPA mode and both cells shall transmit with identical parameters as listed in the table. Note 2: Maximum number of transmission is limited to 1, i.e., retransmission is not allowed. The redundancy and constellation version 0 shall be used. | | |

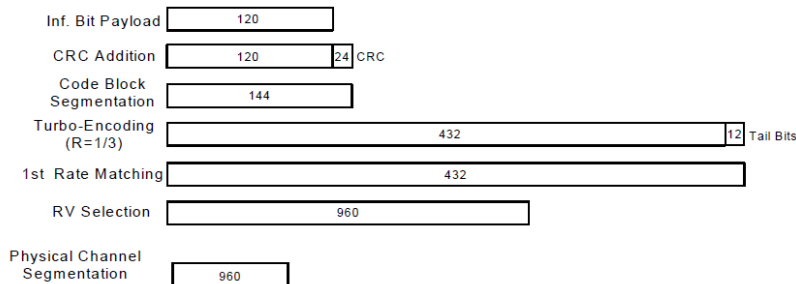

Figure C.8.19: Coding rate for Fixed reference Channel H-Set 12 (QPSK)

Setup Configuration



<WCDMA Conducted Power>

General Note:

1. Per KDB 941225 D01v03, SAR for Head / Hotspot / Body-worn exposure is measured using a 12.2 kbps RMC with TPC bits configured to all "1's".
2. Per KDB 941225 D01v03, RMC 12.2kbps setting is used to evaluate SAR. If the maximum output power and tune-up tolerance specified for production units in HSDPA / HSUPA / DC-HSDPA is $\leq \frac{1}{4}$ dB higher than RMC 12.2Kbps or when the highest reported SAR of the RMC12.2Kbps is scaled by the ratio of specified maximum output power and tune-up tolerance of HSDPA / HSUPA / DC-HSDPA to RMC12.2Kbps and the adjusted SAR is ≤ 1.2 W/kg, SAR measurement is not required for HSDPA / HSUPA / DC-HSDPA.

| Band | | | WCDMA V | | | WCDMA II | | |
|-----------------|-------------|--------------------|---------|-------|-------|----------|-------|--------|
| TX Channel | | | 4132 | 4182 | 4233 | 9262 | 9400 | 9538 |
| Rx Channel | | | 4357 | 4407 | 4458 | 9662 | 9800 | 9938 |
| Frequency (MHz) | | | 826.4 | 836.4 | 846.6 | 1852.4 | 1880 | 1907.6 |
| 3GPP MPR (dB) | 3GPP Rel 99 | AMR 12.2Kbps | 24.40 | 24.56 | 24.39 | 23.81 | 23.90 | 23.80 |
| | 3GPP Rel 99 | RMC 12.2Kbps | 24.55 | 24.61 | 24.53 | 23.91 | 23.92 | 23.85 |
| 0 | 3GPP Rel 6 | HSDPA Subtest-1 | 23.31 | 23.38 | 23.28 | 22.96 | 22.95 | 22.94 |
| 0 | 3GPP Rel 6 | HSDPA Subtest-2 | 23.63 | 23.48 | 23.53 | 22.96 | 22.93 | 22.94 |
| 0.5 | 3GPP Rel 6 | HSDPA Subtest-3 | 22.92 | 22.96 | 22.94 | 22.43 | 22.40 | 22.43 |
| 0.5 | 3GPP Rel 6 | HSDPA Subtest-4 | 22.92 | 22.99 | 22.87 | 22.47 | 22.38 | 22.45 |
| 0 | 3GPP Rel 8 | DC-HSDPA Subtest-1 | 23.21 | 23.33 | 23.19 | 22.88 | 22.87 | 22.88 |
| 0 | 3GPP Rel 8 | DC-HSDPA Subtest-2 | 23.63 | 23.45 | 23.48 | 22.95 | 22.84 | 22.91 |
| 0.5 | 3GPP Rel 8 | DC-HSDPA Subtest-3 | 22.87 | 22.86 | 22.85 | 22.40 | 22.38 | 22.33 |
| 0.5 | 3GPP Rel 8 | DC-HSDPA Subtest-4 | 22.83 | 22.90 | 22.80 | 22.38 | 22.30 | 22.36 |
| 0 | 3GPP Rel 6 | HSUPA Subtest-1 | 23.20 | 23.25 | 23.20 | 22.88 | 22.40 | 22.86 |
| 2 | 3GPP Rel 6 | HSUPA Subtest-2 | 22.67 | 22.63 | 22.46 | 21.60 | 21.82 | 21.56 |
| 1 | 3GPP Rel 6 | HSUPA Subtest-3 | 22.30 | 22.48 | 22.20 | 21.80 | 21.40 | 21.90 |
| 2 | 3GPP Rel 6 | HSUPA Subtest-4 | 22.98 | 22.93 | 22.90 | 21.80 | 21.92 | 21.95 |
| 0 | 3GPP Rel 6 | HSUPA Subtest-5 | 23.81 | 23.90 | 23.90 | 23.12 | 23.05 | 23.20 |



<LTE Conducted Power>

General Note:

1. Anritsu MT8820C base station simulator was used to setup the connection with EUT; the frequency band, channel bandwidth, RB allocation configuration, modulation type are set in the base station simulator to configure EUT transmitting at maximum power and at different configurations which are requested to be reported to FCC, for conducted power measurement and SAR testing.
2. Per KDB 941225 D05v02r03, when a properly configured base station simulator is used for the SAR and power measurements, spectrum plots for each RB allocation and offset configuration is not required.
3. Per KDB 941225 D05v02r03, start with the largest channel bandwidth and measure SAR for QPSK with 1 RB allocation, using the RB offset and required test channel combination with the highest maximum output power for RB offsets at the upper edge, middle and lower edge of each required test channel.
4. Per KDB 941225 D05v02r03, 50% RB allocation for QPSK SAR testing follows 1RB QPSK allocation procedure.
5. Per KDB 941225 D05v02r03, For QPSK with 100% RB allocation, SAR is not required when the highest maximum output power for 100 % RB allocation is less than the highest maximum output power in 50% and 1 RB allocations and the highest reported SAR for 1 RB and 50% RB allocation are ≤ 0.8 W/kg. Otherwise, SAR is measured for the highest output power channel; and if the reported SAR is > 1.45 W/kg, the remaining required test channels must also be tested.
6. Per KDB 941225 D05v02r03, 16QAM output power for each RB allocation configuration is $>$ not $\frac{1}{2}$ dB higher than the same configuration in QPSK and the reported SAR for the QPSK configuration is ≤ 1.45 W/kg; Per KDB 941225 D05v02r03, 16QAM SAR testing is not required.
7. Per KDB 941225 D05v02r03, Smaller bandwidth output power for each RB allocation configuration is $>$ not $\frac{1}{2}$ dB higher than the same configuration in the largest supported bandwidth, and the reported SAR for the largest supported bandwidth is ≤ 1.45 W/kg; Per KDB 941225 D05v02r03, smaller bandwidth SAR testing is not required.



<LTE Band 5>

| BW [MHz] | Modulation | RB Size | RB Offset | Power Low Ch. / Freq. | Power Middle Ch. / Freq. | Power High Ch. / Freq. | Tune up Limit (dBm) | MPR (dB) |
|-----------------|------------|---------|-----------|-----------------------|--------------------------|------------------------|---------------------|----------|
| Channel | | | | 20450 | 20525 | 20600 | | |
| Frequency (MHz) | | | | 829 | 836.5 | 844 | | |
| 10 | QPSK | 1 | 0 | 24.63 | 24.69 | 24.42 | 25 | 0 |
| 10 | QPSK | 1 | 24 | 24.68 | 24.45 | 24.41 | | |
| 10 | QPSK | 1 | 49 | 24.34 | 24.41 | 24.30 | | |
| 10 | QPSK | 25 | 0 | 23.45 | 23.47 | 23.36 | 24 | 1 |
| 10 | QPSK | 25 | 12 | 23.43 | 23.30 | 23.33 | | |
| 10 | QPSK | 25 | 24 | 23.29 | 23.20 | 23.33 | | |
| 10 | QPSK | 50 | 0 | 23.35 | 23.36 | 23.32 | | |
| 10 | 16QAM | 1 | 0 | 23.98 | 23.80 | 23.58 | 24 | 1 |
| 10 | 16QAM | 1 | 24 | 23.57 | 23.54 | 23.89 | | |
| 10 | 16QAM | 1 | 49 | 23.52 | 23.61 | 23.84 | | |
| 10 | 16QAM | 25 | 0 | 22.43 | 22.67 | 22.35 | 23 | 2 |
| 10 | 16QAM | 25 | 12 | 22.42 | 22.61 | 22.38 | | |
| 10 | 16QAM | 25 | 24 | 22.50 | 22.18 | 22.37 | | |
| 10 | 16QAM | 50 | 0 | 22.37 | 22.20 | 22.28 | | |
| Channel | | | | 20425 | 20525 | 20625 | | |
| Frequency (MHz) | | | | 826.5 | 836.5 | 846.5 | | |
| 5 | QPSK | 1 | 0 | 24.43 | 24.40 | 24.42 | 25 | 0 |
| 5 | QPSK | 1 | 12 | 24.42 | 24.39 | 24.41 | | |
| 5 | QPSK | 1 | 24 | 24.36 | 23.99 | 24.08 | | |
| 5 | QPSK | 12 | 0 | 23.38 | 23.24 | 23.37 | 24 | 1 |
| 5 | QPSK | 12 | 6 | 23.27 | 23.23 | 23.32 | | |
| 5 | QPSK | 12 | 11 | 23.29 | 23.15 | 23.21 | | |
| 5 | QPSK | 25 | 0 | 23.33 | 23.26 | 23.31 | | |
| 5 | 16QAM | 1 | 0 | 23.46 | 23.61 | 23.77 | 24 | 1 |
| 5 | 16QAM | 1 | 12 | 23.34 | 23.45 | 23.18 | | |
| 5 | 16QAM | 1 | 24 | 23.02 | 23.46 | 23.16 | | |
| 5 | 16QAM | 12 | 0 | 22.28 | 22.28 | 22.24 | 23 | 2 |
| 5 | 16QAM | 12 | 6 | 22.21 | 22.29 | 22.32 | | |
| 5 | 16QAM | 12 | 11 | 22.31 | 22.20 | 22.30 | | |
| 5 | 16QAM | 25 | 0 | 22.35 | 22.49 | 22.40 | | |
| Channel | | | | 20415 | 20525 | 20635 | | |
| Frequency (MHz) | | | | 825.5 | 836.5 | 847.5 | | |
| 3 | QPSK | 1 | 0 | 24.43 | 24.61 | 24.37 | 25 | 0 |
| 3 | QPSK | 1 | 7 | 24.34 | 24.60 | 24.24 | | |
| 3 | QPSK | 1 | 14 | 24.27 | 24.18 | 23.94 | | |
| 3 | QPSK | 8 | 0 | 23.37 | 23.26 | 23.24 | 24 | 1 |
| 3 | QPSK | 8 | 4 | 23.18 | 23.20 | 23.16 | | |
| 3 | QPSK | 8 | 7 | 23.19 | 23.15 | 23.05 | | |
| 3 | QPSK | 15 | 0 | 23.28 | 23.26 | 23.17 | | |
| 3 | 16QAM | 1 | 0 | 23.91 | 23.90 | 23.51 | 24 | 1 |
| 3 | 16QAM | 1 | 7 | 23.99 | 23.96 | 23.48 | | |
| 3 | 16QAM | 1 | 14 | 23.89 | 23.88 | 23.58 | | |
| 3 | 16QAM | 8 | 0 | 22.63 | 22.57 | 22.40 | 23 | 2 |
| 3 | 16QAM | 8 | 4 | 22.43 | 22.50 | 22.22 | | |
| 3 | 16QAM | 8 | 7 | 22.27 | 22.33 | 22.20 | | |
| 3 | 16QAM | 15 | 0 | 22.31 | 22.26 | 22.00 | | |



| Channel | | | | 20407 | 20525 | 20643 | Tune up Limit (dBm) | Target MPR (dB) |
|-----------------|-------|---|---|-------|-------|-------|------------------------|--------------------|
| Frequency (MHz) | | | | 824.7 | 836.5 | 848.3 | | |
| 1.4 | QPSK | 1 | 0 | 24.56 | 24.27 | 24.20 | 25 | 0 |
| 1.4 | QPSK | 1 | 2 | 24.55 | 24.20 | 23.91 | | |
| 1.4 | QPSK | 1 | 5 | 24.30 | 24.10 | 23.87 | | |
| 1.4 | QPSK | 3 | 0 | 24.39 | 24.21 | 24.17 | | |
| 1.4 | QPSK | 3 | 1 | 24.44 | 24.25 | 24.13 | | |
| 1.4 | QPSK | 3 | 2 | 24.43 | 24.26 | 24.19 | | |
| 1.4 | QPSK | 6 | 0 | 23.36 | 23.14 | 23.12 | 24 | 1 |
| 1.4 | 16QAM | 1 | 0 | 23.52 | 23.20 | 23.29 | 24 | 1 |
| 1.4 | 16QAM | 1 | 2 | 23.89 | 23.26 | 23.56 | | |
| 1.4 | 16QAM | 1 | 5 | 23.48 | 23.31 | 23.69 | | |
| 1.4 | 16QAM | 3 | 0 | 23.42 | 23.26 | 23.73 | | |
| 1.4 | 16QAM | 3 | 1 | 23.41 | 23.42 | 23.84 | | |
| 1.4 | 16QAM | 3 | 2 | 23.52 | 23.55 | 23.59 | | |
| 1.4 | 16QAM | 6 | 0 | 22.38 | 21.94 | 21.87 | 23 | 2 |



<LTE Band 7>

| BW [MHz] | Modulation | RB Size | RB Offset | Power Low Ch. / Freq. | Power Middle Ch. / Freq. | Power High Ch. / Freq. | Tune up Limit (dBm) | MPR (dB) |
|-----------------|------------|---------|-----------|-----------------------|--------------------------|------------------------|---------------------|----------|
| Channel | | | | 20850 | 21100 | 21350 | | |
| Frequency (MHz) | | | | 2510 | 2535 | 2560 | | |
| 20 | QPSK | 1 | 0 | 22.99 | 22.94 | 22.80 | 23 | 0 |
| 20 | QPSK | 1 | 49 | 22.55 | 22.39 | 22.11 | | |
| 20 | QPSK | 1 | 99 | 22.54 | 22.30 | 22.15 | | |
| 20 | QPSK | 50 | 0 | 21.46 | 21.39 | 21.23 | 22 | 1 |
| 20 | QPSK | 50 | 24 | 21.32 | 21.30 | 21.15 | | |
| 20 | QPSK | 50 | 49 | 21.29 | 21.29 | 21.14 | | |
| 20 | QPSK | 100 | 0 | 21.34 | 21.30 | 21.17 | | |
| 20 | 16QAM | 1 | 0 | 21.74 | 21.72 | 21.53 | 22 | 1 |
| 20 | 16QAM | 1 | 49 | 21.58 | 21.48 | 21.56 | | |
| 20 | 16QAM | 1 | 99 | 21.51 | 21.55 | 21.43 | | |
| 20 | 16QAM | 50 | 0 | 20.40 | 20.37 | 20.32 | 21 | 2 |
| 20 | 16QAM | 50 | 24 | 20.38 | 20.39 | 20.25 | | |
| 20 | 16QAM | 50 | 49 | 20.35 | 20.29 | 20.25 | | |
| 20 | 16QAM | 100 | 0 | 20.48 | 20.32 | 20.22 | | |
| Channel | | | | 20825 | 21100 | 21375 | Tune up Limit (dBm) | MPR (dB) |
| Frequency (MHz) | | | | 2507.5 | 2535 | 2562.5 | | |
| 15 | QPSK | 1 | 0 | 22.49 | 22.28 | 22.21 | 23 | 0 |
| 15 | QPSK | 1 | 37 | 22.22 | 22.12 | 22.04 | | |
| 15 | QPSK | 1 | 74 | 22.11 | 22.07 | 22.16 | | |
| 15 | QPSK | 36 | 0 | 21.24 | 21.20 | 21.15 | 22 | 1 |
| 15 | QPSK | 36 | 18 | 21.17 | 21.07 | 21.04 | | |
| 15 | QPSK | 36 | 37 | 21.08 | 21.06 | 21.09 | | |
| 15 | QPSK | 75 | 0 | 21.21 | 21.14 | 21.08 | | |
| 15 | 16QAM | 1 | 0 | 21.64 | 21.57 | 21.41 | 22 | 1 |
| 15 | 16QAM | 1 | 37 | 21.34 | 21.40 | 21.35 | | |
| 15 | 16QAM | 1 | 74 | 21.36 | 21.36 | 21.33 | | |
| 15 | 16QAM | 36 | 0 | 20.14 | 20.13 | 20.17 | 21 | 2 |
| 15 | 16QAM | 36 | 18 | 20.02 | 19.98 | 20.09 | | |
| 15 | 16QAM | 36 | 37 | 20.01 | 19.87 | 20.15 | | |
| 15 | 16QAM | 75 | 0 | 20.13 | 20.06 | 20.12 | | |
| Channel | | | | 20800 | 21100 | 21400 | Tune up Limit (dBm) | MPR (dB) |
| Frequency (MHz) | | | | 2505 | 2535 | 2565 | | |
| 10 | QPSK | 1 | 0 | 22.39 | 22.15 | 22.12 | 23 | 0 |
| 10 | QPSK | 1 | 24 | 22.33 | 21.96 | 22.35 | | |
| 10 | QPSK | 1 | 49 | 22.08 | 22.01 | 22.18 | | |
| 10 | QPSK | 25 | 0 | 21.31 | 21.13 | 21.11 | 22 | 1 |
| 10 | QPSK | 25 | 12 | 21.17 | 21.13 | 21.16 | | |
| 10 | QPSK | 25 | 24 | 21.21 | 21.10 | 21.10 | | |
| 10 | QPSK | 50 | 0 | 21.18 | 21.07 | 21.11 | | |
| 10 | 16QAM | 1 | 0 | 21.70 | 21.47 | 21.36 | 22 | 1 |
| 10 | 16QAM | 1 | 24 | 21.78 | 21.16 | 21.36 | | |
| 10 | 16QAM | 1 | 49 | 21.22 | 21.12 | 21.41 | | |
| 10 | 16QAM | 25 | 0 | 20.25 | 20.33 | 20.10 | 21 | 2 |
| 10 | 16QAM | 25 | 12 | 20.20 | 20.11 | 20.17 | | |
| 10 | 16QAM | 25 | 24 | 20.15 | 20.06 | 20.11 | | |
| 10 | 16QAM | 50 | 0 | 20.12 | 20.13 | 20.15 | | |



| Channel | | | | 20775 | 21100 | 21425 | Tune up Limit (dBm) | MPR (dB) |
|-----------------|-------|----|----|--------|-------|--------|------------------------|-------------|
| Frequency (MHz) | | | | 2502.5 | 2535 | 2567.5 | | |
| 5 | QPSK | 1 | 0 | 22.26 | 22.31 | 22.28 | 23 | 0 |
| 5 | QPSK | 1 | 12 | 22.22 | 22.30 | 22.27 | | |
| 5 | QPSK | 1 | 24 | 22.25 | 22.25 | 22.04 | | |
| 5 | QPSK | 12 | 0 | 21.28 | 21.12 | 21.12 | 22 | 1 |
| 5 | QPSK | 12 | 6 | 21.18 | 21.12 | 21.13 | | |
| 5 | QPSK | 12 | 11 | 21.19 | 21.11 | 21.07 | | |
| 5 | QPSK | 25 | 0 | 21.22 | 21.07 | 21.09 | | |
| 5 | 16QAM | 1 | 0 | 21.27 | 21.26 | 20.99 | 22 | 1 |
| 5 | 16QAM | 1 | 12 | 21.67 | 21.55 | 21.44 | | |
| 5 | 16QAM | 1 | 24 | 21.26 | 21.64 | 21.38 | | |
| 5 | 16QAM | 12 | 0 | 20.06 | 20.06 | 20.12 | 21 | 2 |
| 5 | 16QAM | 12 | 6 | 20.10 | 20.09 | 19.94 | | |
| 5 | 16QAM | 12 | 11 | 20.21 | 20.12 | 19.88 | | |
| 5 | 16QAM | 25 | 0 | 20.30 | 20.16 | 20.22 | | |



<WLAN Conducted Power>

General Note:

1. For 2.4GHz WLAN SAR testing, highest average RF output power channel for the lowest data rate for 802.11b were selected for SAR evaluation. 802.11g/n HT20 were not investigated since the average output powers over all channels and data rates were not more than 0.25 dB higher than the tested channel in the lowest data rate of 802.11b mode.
2. For 5 GHz WLAN SAR testing, highest average RF output power channel for the lowest data rate for 802.11a were selected for SAR evaluation. 802.11n HT20/HT40 modes were not investigated since the average output powers over all channels and data rates were not more than 0.25 dB higher than the tested channel in the lowest data rate of 802.11a mode.

<2.4GHz WLAN>

| WLAN 2.4GHz 802.11b Average Power (dBm) | | | | | |
|---|-----------------|-----------|---------------------|---------|--------|
| Power vs. Channel | | | Power vs. Data Rate | | |
| Channel | Frequency (MHz) | Data Rate | 2Mbps | 5.5Mbps | 11Mbps |
| | | 1Mbps | | | |
| CH 1 | 2412 | 17.91 | 17.96 | 17.92 | 17.95 |
| CH 6 | 2437 | 17.98 | | | |
| CH 11 | 2462 | 17.97 | | | |

| WLAN 2.4GHz 802.11g Average Power (dBm) | | | | | | | | | |
|---|-----------------|-----------|---------------------|--------|--------|--------|--------|--------|--------|
| Power vs. Channel | | | Power vs. Data Rate | | | | | | |
| Channel | Frequency (MHz) | Data Rate | 9Mbps | 12Mbps | 18Mbps | 24Mbps | 36Mbps | 48Mbps | 54Mbps |
| | | 6Mbps | | | | | | | |
| CH 1 | 2412 | 14.89 | 14.89 | 14.90 | 14.92 | 14.92 | 14.89 | 14.87 | 14.91 |
| CH 6 | 2437 | 14.72 | | | | | | | |
| CH 11 | 2462 | 14.93 | | | | | | | |

| WLAN 2.4GHz 802.11n-HT20 Average Power (dBm) | | | | | | | | | |
|--|-----------------|-----------|---------------------|-------|-------|-------|-------|-------|-------|
| Power vs. Channel | | | Power vs. MCS Index | | | | | | |
| Channel | Frequency (MHz) | MCS Index | MCS1 | MCS2 | MCS3 | MCS4 | MCS5 | MCS6 | MCS7 |
| | | MCS0 | | | | | | | |
| CH 1 | 2412 | 12.97 | 12.96 | 12.95 | 12.95 | 12.94 | 12.96 | 12.95 | 12.97 |
| CH 6 | 2437 | 13.00 | | | | | | | |
| CH 11 | 2462 | 12.86 | | | | | | | |



<5GHz WLAN>

| WLAN 5GHz 802.11a Average Power (dBm) | | | | | | | | | |
|---------------------------------------|-----------------|-----------|---------------------|--------|--------|--------|--------|--------|--------|
| Power vs. Channel | | | Power vs. Data Rate | | | | | | |
| Channel | Frequency (MHz) | Data Rate | 9Mbps | 12Mbps | 18Mbps | 24Mbps | 36Mbps | 48Mbps | 54Mbps |
| | | 6Mbps | | | | | | | |
| CH 36 | 5180 | 13.90 | 13.52 | 13.48 | 13.58 | 13.61 | 13.76 | 13.71 | 13.76 |
| CH 40 | 5200 | 13.78 | | | | | | | |
| CH 44 | 5220 | 13.87 | | | | | | | |
| CH 48 | 5240 | 13.85 | | | | | | | |
| CH 52 | 5260 | 13.73 | 13.82 | 13.81 | 13.82 | 13.84 | 13.89 | 13.87 | 13.88 |
| CH 56 | 5280 | 13.71 | | | | | | | |
| CH 60 | 5300 | 13.89 | | | | | | | |
| CH 64 | 5320 | 13.63 | | | | | | | |
| CH 100 | 5500 | 13.65 | 13.06 | 13.11 | 13.13 | 13.18 | 13.29 | 13.13 | 13.29 |
| CH 104 | 5520 | 13.61 | | | | | | | |
| CH 108 | 5540 | 13.59 | | | | | | | |
| CH 112 | 5560 | 13.52 | | | | | | | |
| CH 116 | 5580 | 13.60 | | | | | | | |
| CH 132 | 5660 | 13.46 | | | | | | | |
| CH 136 | 5680 | 13.42 | | | | | | | |
| CH 140 | 5700 | 13.70 | 13.63 | 13.65 | 13.67 | 13.68 | 13.78 | 13.72 | 13.74 |
| CH 149 | 5745 | 13.98 | | | | | | | |
| CH 153 | 5765 | 13.74 | | | | | | | |
| CH 157 | 5785 | 13.80 | | | | | | | |
| CH 161 | 5805 | 13.77 | | | | | | | |
| CH 165 | 5825 | 13.93 | | | | | | | |



| WLAN 5GHz 802.11a Average Power (dBm) | | | | | | | | | |
|---------------------------------------|-----------------|-----------|---------------------|--------|--------|--------|--------|--------|--------|
| Power vs. Channel | | | Power vs. MCS Index | | | | | | |
| Channel | Frequency (MHz) | Data Rate | 9Mbps | 12Mbps | 18Mbps | 24Mbps | 36Mbps | 48Mbps | 54Mbps |
| | | 6Mbps | | | | | | | |
| CH 36 | 5180 | 12.47 | 12.40 | 12.34 | 12.32 | 12.44 | 12.47 | 12.41 | 12.42 |
| CH 40 | 5200 | 12.29 | | | | | | | |
| CH 44 | 5220 | 12.31 | | | | | | | |
| CH 48 | 5240 | 12.22 | | | | | | | |
| CH 52 | 5260 | 12.33 | 12.35 | 12.31 | 12.28 | 12.44 | 12.43 | 12.25 | 12.37 |
| CH 56 | 5280 | 12.31 | | | | | | | |
| CH 60 | 5300 | 12.43 | | | | | | | |
| CH 64 | 5320 | 12.46 | | | | | | | |
| CH 100 | 5500 | 12.44 | | | | | | | |
| CH 104 | 5520 | 12.34 | 12.32 | 12.30 | 12.27 | 12.35 | 12.38 | 12.31 | 12.39 |
| CH 108 | 5540 | 12.31 | | | | | | | |
| CH 112 | 5560 | 12.29 | | | | | | | |
| CH 116 | 5580 | 12.39 | | | | | | | |
| CH 132 | 5660 | 12.18 | | | | | | | |
| CH 136 | 5680 | 12.21 | | | | | | | |
| CH 140 | 5700 | 12.29 | | | | | | | |
| CH 149 | 5745 | 12.42 | 12.11 | 12.07 | 12.15 | 12.17 | 12.26 | 12.23 | 12.21 |
| CH 153 | 5765 | 12.23 | | | | | | | |
| CH 157 | 5785 | 12.17 | | | | | | | |
| CH 161 | 5805 | 12.14 | | | | | | | |
| CH 165 | 5825 | 12.35 | | | | | | | |

| WLAN 5GHz 802.11n-HT40 Average Power (dBm) | | | | | | | | | |
|--|-----------------|-----------|---------------------|-------|-------|-------|-------|-------|-------|
| Power vs. Channel | | | Power vs. MCS Index | | | | | | |
| Channel | Frequency (MHz) | MCS Index | MCS1 | MCS2 | MCS3 | MCS4 | MCS5 | MCS6 | MCS7 |
| | | MCS0 | | | | | | | |
| CH 38 | 5190 | 11.56 | 11.57 | 11.84 | 11.79 | 11.85 | 11.84 | 11.81 | 11.82 |
| CH 46 | 5230 | 11.87 | | | | | | | |
| CH 54 | 5270 | 11.94 | 11.81 | 11.91 | 11.88 | 11.90 | 11.93 | 11.92 | 11.93 |
| CH 62 | 5310 | 11.85 | | | | | | | |
| CH 102 | 5510 | 10.95 | 10.65 | 10.78 | 10.68 | 10.89 | 10.75 | 10.95 | 10.91 |
| CH 110 | 5550 | 10.78 | | | | | | | |
| CH 134 | 5670 | 10.99 | | | | | | | |
| CH 151 | 5755 | 10.98 | 10.63 | 10.83 | 10.70 | 10.82 | 10.81 | 10.91 | 10.95 |
| CH 159 | 5795 | 10.97 | | | | | | | |



<2.4GHz Bluetooth>

General Note:

1. For 2.4GHz Bluetooth Head SAR testing was selected 1Mbps, due to its highest average power.
2. The duty factor is selected theoretical 83.3% perform Bluetooth SAR testing.
3. Base on the maximum tune-up limit of Bluetooth (rounded to the nearest mW) and the minimum separation distance, the Hotspot and Body-worn Bluetooth SAR were not required; $[(13/10)*\sqrt{2.480}]=2.05 < 3$, $[(13/15)*\sqrt{2.480}]=1.36 < 3$, Per KDB 447498 D01v05r02.

| Mode | Channel | Frequency (MHz) | Average power (dBm) | | |
|---------------|---------|-----------------|---------------------|-------|-------|
| | | | 1Mbps | 2Mbps | 3Mbps |
| v3.0 with EDR | CH 00 | 2402 | 9.90 | 7.82 | 7.74 |
| | CH 39 | 2441 | 10.86 | 8.83 | 8.81 |
| | CH 78 | 2480 | 8.88 | 6.79 | 6.78 |

| Mode | Channel | Frequency (MHz) | Average power (dBm) |
|--------------|---------|-----------------|---------------------|
| | | | GFSK |
| v4.0 with LE | CH 00 | 2402 | 1.74 |
| | CH 19 | 2440 | 2.79 |
| | CH 39 | 2480 | 1.32 |

13. Antenna Location

<Mobile Phone>

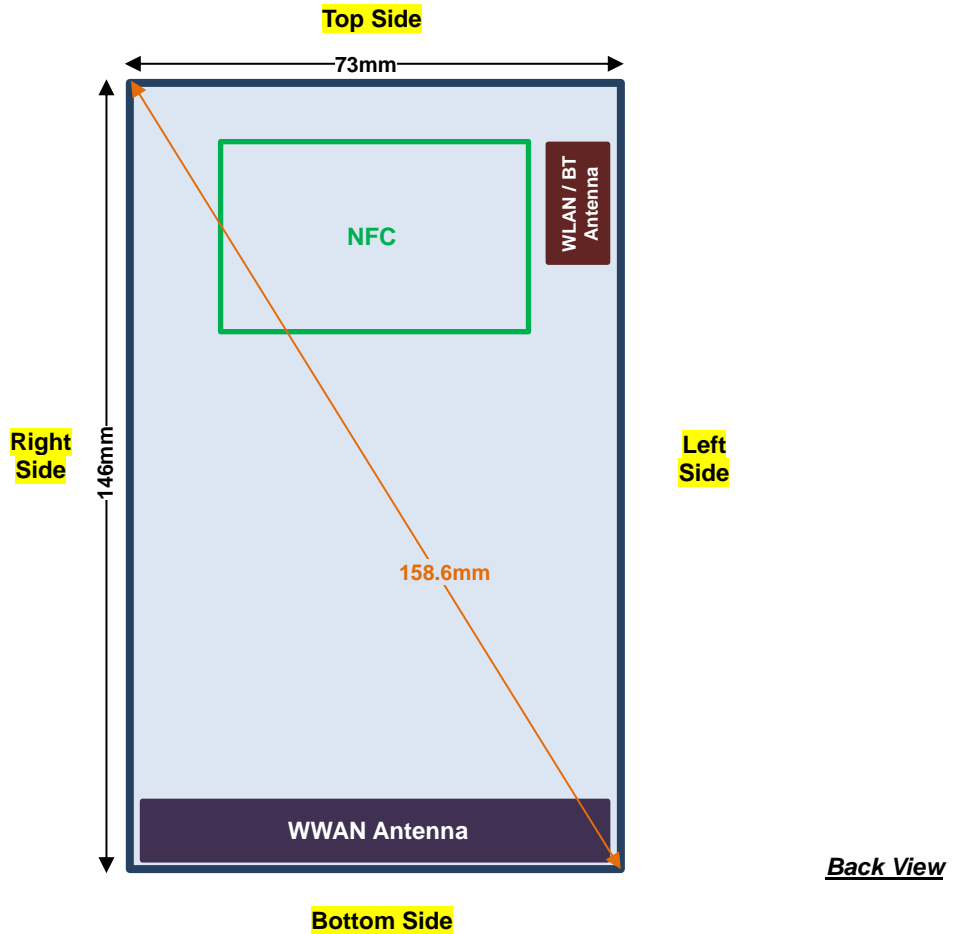

| Distance of the Antenna to the EUT surface/edge | | | | | | |
|---|--------|--------|----------|-------------|------------|-----------|
| Antennas | Back | Front | Top Side | Bottom Side | Right Side | Left Side |
| WWAN Main | ≤ 25mm | ≤ 25mm | > 25mm | ≤ 25mm | ≤ 25mm | ≤ 25mm |
| BT&WLAN | ≤ 25mm | ≤ 25mm | ≤ 25mm | > 25mm | > 25mm | ≤ 25mm |

| Positions for SAR tests; Hotspot mode | | | | | | |
|---------------------------------------|------|-------|----------|-------------|------------|-----------|
| Antennas | Back | Front | Top Side | Bottom Side | Right Side | Left Side |
| WWAN Main | Yes | Yes | No | Yes | Yes | Yes |
| BT&WLAN | Yes | Yes | Yes | No | No | Yes |

General Note:

Referring to KDB 941225 D06 v02, when the overall device length and width are ≥ 9cm*5cm, the test distance is 10 mm. SAR must be measured for all sides and surfaces with a transmitting antenna located within 25mm from that surface or edge.



14. SAR Test Results

General Note:

1. Per KDB 447498 D01v05r02, the reported SAR is the measured SAR value adjusted for maximum tune-up tolerance.
 - a. Tune-up scaling Factor = tune-up limit power (mW) / EUT RF power (mW), where tune-up limit is the maximum rated power among all production units.
 - b. For SAR testing of WLAN signal with non-100% duty cycle, the measured SAR is scaled-up by the duty cycle scaling factor which is equal to "1/(duty cycle)"
 - c. For WWAN: Reported SAR(W/kg)= Measured SAR(W/kg)*Tune-up Scaling Factor
 - d. For WLAN: Reported SAR(W/kg)= Measured SAR(W/kg)* Duty Cycle scaling factor * Tune-up scaling factor
2. Per KDB 447498 D01v05r02, for each exposure position, testing of other required channels within the operating mode of a frequency band is not required when the *reported* 1-g or 10-g SAR for the mid-band or highest output power channel is:
 - ≤ 0.8 W/kg or 2.0 W/kg, for 1-g or 10-g respectively, when the transmission band is ≤ 100 MHz
 - ≤ 0.6 W/kg or 1.5 W/kg, for 1-g or 10-g respectively, when the transmission band is between 100 MHz and 200 MHz
 - ≤ 0.4 W/kg or 1.0 W/kg, for 1-g or 10-g respectively, when the transmission band is ≥ 200 MHz
3. Per KDB 941225 D01v03, considering the possibility of e.g. 3rd party VoIP operation for Head and body-worn SAR test reduction for GSM and GPRS and EDGE modes is determined by the source-based time-averaged output power including tune-up tolerance. The mode with highest specified time-averaged output power should be tested for SAR compliance in the applicable exposure conditions. For modes with the same specified maximum output power and tolerance, the higher number time-slot configuration should be tested. Therefore, the EUT was set in GPRS (4Tx slots) for GSM850/GSM1900.
4. Per KDB 941225 D01v03, for Hotspot SAR test reduction for GPRS and EDGE modes is determined by the source-based time-averaged output power including tune-up tolerance, for modes with the same specified maximum output power and tolerance, the higher number time-slot configuration should be tested, therefore, the EUT was set in GPRS (4Tx slots) for GSM850/GSM1900.
5. Per KDB 941225 D01v03, SAR for Head / Hotspot / Body-worn exposure is measured using a 12.2 kbps RMC with TPC bits configured to all "1's".
6. Per KDB 941225 D01v03, RMC 12.2kbps setting is used to evaluate SAR. If the maximum output power and tune-up tolerance specified for production units in HSDPA / HSUPA / DC-HSDPA is $\leq \frac{1}{4}$ dB higher than RMC 12.2Kbps or when the highest reported SAR of the RMC12.2Kbps is scaled by the ratio of specified maximum output power and tune-up tolerance of HSDPA / HSUPA / DC-HSDPA to RMC12.2Kbps and the adjusted SAR is ≤ 1.2 W/kg, SAR measurement is not required for HSDPA / HSUPA / DC-HSDPA.
7. Per KDB 941225 D05v02r03, start with the largest channel bandwidth and measure SAR for QPSK with 1 RB allocation, using the RB offset and required test channel combination with the highest maximum output power for RB offsets at the upper edge, middle and lower edge of each required test channel.
8. Per KDB 941225 D05v02r03, 50% RB allocation for QPSK SAR testing follows 1RB QPSK allocation procedure.
9. Per KDB 941225 D05v02r03, For QPSK with 100% RB allocation, SAR is not required when the highest maximum output power for 100 % RB allocation is less than the highest maximum output power in 50% and 1 RB allocations and the highest reported SAR for 1 RB and 50% RB allocation are ≤ 0.8 W/kg. Otherwise, SAR is measured for the highest output power channel; and if the reported SAR is > 1.45 W/kg, the remaining required test channels must also be tested.
10. Per KDB 941225 D05v02r03, 16QAM output power for each RB allocation configuration is $> \text{not } \frac{1}{2}$ dB higher than the same configuration in QPSK and the reported SAR for the QPSK configuration is ≤ 1.45 W/kg; Per KDB 941225 D05v02r03, 16QAM SAR testing is not required.
11. Per KDB 941225 D05v02r03, Smaller bandwidth output power for each RB allocation configuration is $> \text{not } \frac{1}{2}$ dB higher than the same configuration in the largest supported bandwidth, and the reported SAR for the largest supported bandwidth is ≤ 1.45 W/kg; Per KDB 941225 D05v02r03, smaller bandwidth SAR testing is not required.
12. Per KDB 648474 D04v01r02, when the reported SAR for a body-worn accessory measured without a headset connected to the handset is ≤ 1.2 W/kg, SAR testing with a headset connected to the handset is not required.
13. During SAR testing the WLAN transmission was verified using a spectrum analyzer.



14.1 Head SAR

<GSM SAR>

| Plot No. | Band | Modulation | Mode | Test Position | Ch. | Freq. (MHz) | Average Power (dBm) | Tune-Up Limit (dBm) | Tune-up Scaling Factor | Power Drift (dB) | Measured 1g SAR (W/kg) | Reported 1g SAR (W/kg) | Measured 10g SAR (W/kg) | Reported 10g SAR (W/kg) |
|----------|---------|------------|-------------------|---------------|-----|-------------|---------------------|---------------------|------------------------|------------------|------------------------|------------------------|-------------------------|-------------------------|
| 01 | GSM850 | GMSK | GPRS (4 Tx slots) | Right Cheek | 251 | 848.8 | 27.73 | 28.00 | 1.064 | -0.02 | 0.709 | 0.754 | 0.548 | 0.583 |
| | GSM850 | GMSK | GPRS (4 Tx slots) | Right Tilted | 251 | 848.8 | 27.73 | 28.00 | 1.064 | -0.04 | 0.383 | 0.408 | 0.299 | 0.318 |
| | GSM850 | GMSK | GPRS (4 Tx slots) | Left Cheek | 251 | 848.8 | 27.73 | 28.00 | 1.064 | -0.03 | 0.698 | 0.743 | 0.541 | 0.576 |
| | GSM850 | GMSK | GPRS (4 Tx slots) | Left Tilted | 251 | 848.8 | 27.73 | 28.00 | 1.064 | 0.11 | 0.383 | 0.408 | 0.278 | 0.296 |
| | GSM1900 | GMSK | GPRS (4 Tx slots) | Right Cheek | 810 | 1909.8 | 27.98 | 28.00 | 1.005 | -0.12 | 0.507 | 0.509 | 0.318 | 0.319 |
| | GSM1900 | GMSK | GPRS (4 Tx slots) | Right Tilted | 810 | 1909.8 | 27.98 | 28.00 | 1.005 | -0.02 | 0.281 | 0.282 | 0.162 | 0.163 |
| 02 | GSM1900 | GMSK | GPRS (4 Tx slots) | Left Cheek | 810 | 1909.8 | 27.98 | 28.00 | 1.005 | 0.03 | 1.010 | 1.015 | 0.596 | 0.599 |
| | GSM1900 | GMSK | GPRS (4 Tx slots) | Left Cheek | 512 | 1850.2 | 27.94 | 28.00 | 1.014 | 0 | 0.996 | 1.010 | 0.590 | 0.598 |
| | GSM1900 | GMSK | GPRS (4 Tx slots) | Left Cheek | 661 | 1880 | 27.95 | 28.00 | 1.012 | -0.02 | 0.966 | 0.977 | 0.589 | 0.596 |
| | GSM1900 | GMSK | GPRS (4 Tx slots) | Left Tilted | 810 | 1909.8 | 27.98 | 28.00 | 1.005 | -0.04 | 0.237 | 0.238 | 0.143 | 0.144 |

<WCDMA SAR>

| Plot No. | Band | Modulation | Mode | Test Position | Ch. | Freq. (MHz) | Average Power (dBm) | Tune-Up Limit (dBm) | Tune-up Scaling Factor | Power Drift (dB) | Measured 1g SAR (W/kg) | Reported 1g SAR (W/kg) | Measured 10g SAR (W/kg) | Reported 10g SAR (W/kg) |
|----------|----------|------------|--------------|---------------|------|-------------|---------------------|---------------------|------------------------|------------------|------------------------|------------------------|-------------------------|-------------------------|
| 03 | WCDMA V | QPSK | RMC 12.2Kbps | Right Cheek | 4182 | 836.4 | 24.61 | 25.00 | 1.094 | -0.06 | 0.600 | 0.656 | 0.466 | 0.510 |
| | WCDMA V | QPSK | RMC 12.2Kbps | Right Tilted | 4182 | 836.4 | 24.61 | 25.00 | 1.094 | 0.11 | 0.338 | 0.370 | 0.265 | 0.290 |
| | WCDMA V | QPSK | RMC 12.2Kbps | Left Cheek | 4182 | 836.4 | 24.61 | 25.00 | 1.094 | -0.05 | 0.564 | 0.617 | 0.435 | 0.476 |
| | WCDMA V | QPSK | RMC 12.2Kbps | Left Tilted | 4182 | 836.4 | 24.61 | 25.00 | 1.094 | 0.08 | 0.317 | 0.347 | 0.243 | 0.266 |
| | WCDMA II | QPSK | RMC 12.2Kbps | Right Cheek | 9400 | 1880 | 23.92 | 24.00 | 1.019 | 0.06 | 0.496 | 0.505 | 0.311 | 0.317 |
| | WCDMA II | QPSK | RMC 12.2Kbps | Right Tilted | 9400 | 1880 | 23.92 | 24.00 | 1.019 | -0.04 | 0.222 | 0.226 | 0.129 | 0.131 |
| 04 | WCDMA II | QPSK | RMC 12.2Kbps | Left Cheek | 9400 | 1880 | 23.92 | 24.00 | 1.019 | 0.01 | 0.730 | 0.744 | 0.443 | 0.451 |
| | WCDMA II | QPSK | RMC 12.2Kbps | Left Tilted | 9400 | 1880 | 23.92 | 24.00 | 1.019 | 0.01 | 0.191 | 0.195 | 0.117 | 0.119 |

<LTE SAR>

| Plot No. | Band | BW (MHz) | Modulation | RB Size | RB offset | Test Position | Ch. | Freq. (MHz) | Average Power (dBm) | Tune-Up Limit (dBm) | Tune-up Scaling Factor | Power Drift (dB) | Measured 1g SAR (W/kg) | Reported 1g SAR (W/kg) | Measured 10g SAR (W/kg) | Reported 10g SAR (W/kg) |
|----------|------------|----------|------------|---------|-----------|---------------|-------|-------------|---------------------|---------------------|------------------------|------------------|------------------------|------------------------|-------------------------|-------------------------|
| 05 | LTE Band 5 | 10M | QPSK | 1RB | 0offset | Right Cheek | 20525 | 836.5 | 24.69 | 25.00 | 1.074 | 0.03 | 0.498 | 0.535 | 0.394 | 0.423 |
| | LTE Band 5 | 10M | QPSK | 25RB | 0offset | Right Cheek | 20525 | 836.5 | 23.47 | 24.00 | 1.130 | -0.04 | 0.409 | 0.462 | 0.319 | 0.360 |
| | LTE Band 5 | 10M | QPSK | 1RB | 0offset | Right Tilted | 20525 | 836.5 | 24.69 | 25.00 | 1.074 | -0.12 | 0.292 | 0.314 | 0.225 | 0.242 |
| | LTE Band 5 | 10M | QPSK | 25RB | 0offset | Right Tilted | 20525 | 836.5 | 23.47 | 24.00 | 1.130 | -0.07 | 0.226 | 0.255 | 0.172 | 0.194 |
| | LTE Band 5 | 10M | QPSK | 1RB | 0offset | Left Cheek | 20525 | 836.5 | 24.69 | 25.00 | 1.074 | -0.12 | 0.493 | 0.529 | 0.381 | 0.409 |
| | LTE Band 5 | 10M | QPSK | 25RB | 0offset | Left Cheek | 20525 | 836.5 | 23.47 | 24.00 | 1.130 | -0.07 | 0.387 | 0.437 | 0.297 | 0.336 |
| | LTE Band 5 | 10M | QPSK | 1RB | 0offset | Left Tilted | 20525 | 836.5 | 24.69 | 25.00 | 1.074 | 0.07 | 0.274 | 0.294 | 0.212 | 0.228 |
| | LTE Band 5 | 10M | QPSK | 25RB | 0offset | Left Tilted | 20525 | 836.5 | 23.47 | 24.00 | 1.130 | 0.03 | 0.213 | 0.241 | 0.166 | 0.188 |
| | LTE Band 7 | 20M | QPSK | 1RB | 0offset | Right Cheek | 20850 | 2510 | 22.99 | 23.00 | 1.002 | -0.11 | 0.527 | 0.528 | 0.300 | 0.301 |
| | LTE Band 7 | 20M | QPSK | 50RB | 0offset | Right Cheek | 20850 | 2510 | 21.46 | 22.00 | 1.132 | 0.11 | 0.420 | 0.476 | 0.234 | 0.265 |
| | LTE Band 7 | 20M | QPSK | 1RB | 0offset | Right Tilted | 20850 | 2510 | 22.99 | 23.00 | 1.002 | -0.04 | 0.266 | 0.267 | 0.136 | 0.136 |
| | LTE Band 7 | 20M | QPSK | 50RB | 0offset | Right Tilted | 20850 | 2510 | 21.46 | 22.00 | 1.132 | 0.13 | 0.203 | 0.230 | 0.102 | 0.116 |
| | LTE Band 7 | 20M | QPSK | 1RB | 0offset | Left Cheek | 20850 | 2510 | 22.99 | 23.00 | 1.002 | -0.14 | 1.150 | 1.153 | 0.599 | 0.600 |
| 06 | LTE Band 7 | 20M | QPSK | 1RB | 0offset | Left Cheek | 21100 | 2535 | 22.94 | 23.00 | 1.014 | 0.11 | 1.180 | 1.196 | 0.614 | 0.623 |
| | LTE Band 7 | 20M | QPSK | 1RB | 0offset | Left Cheek | 21350 | 2560 | 22.80 | 23.00 | 1.047 | 0.1 | 1.140 | 1.194 | 0.576 | 0.603 |
| | LTE Band 7 | 20M | QPSK | 50RB | 0offset | Left Cheek | 20850 | 2510 | 21.46 | 22.00 | 1.132 | 0.05 | 0.863 | 0.977 | 0.450 | 0.510 |
| | LTE Band 7 | 20M | QPSK | 50RB | 0offset | Left Cheek | 21100 | 2535 | 21.39 | 22.00 | 1.151 | 0.09 | 0.762 | 0.877 | 0.395 | 0.455 |
| | LTE Band 7 | 20M | QPSK | 50RB | 0offset | Left Cheek | 21350 | 2560 | 21.23 | 22.00 | 1.194 | 0.09 | 0.807 | 0.964 | 0.416 | 0.497 |
| | LTE Band 7 | 20M | QPSK | 100RB | 0offset | Left Cheek | 20850 | 2510 | 21.34 | 22.00 | 1.164 | 0.07 | 0.747 | 0.870 | 0.391 | 0.455 |
| | LTE Band 7 | 20M | QPSK | 1RB | 0offset | Left Tilted | 20850 | 2510 | 22.99 | 23.00 | 1.002 | 0.1 | 0.155 | 0.155 | 0.081 | 0.081 |
| | LTE Band 7 | 20M | QPSK | 50RB | 0offset | Left Tilted | 20850 | 2510 | 21.46 | 22.00 | 1.132 | -0.19 | 0.114 | 0.129 | 0.060 | 0.068 |



<WLAN SAR>

| Plot No. | Band | Modulation | Mode | Test Position | Ch. | Freq. (MHz) | Average Power (dBm) | Tune-Up Limit (dBm) | Tune-up Scaling Factor | Duty Cycle % | Duty Cycle Scaling Factor | Power Drift (dB) | Measured 1g SAR (W/kg) | Reported 1g SAR (W/kg) | Measured 10g SAR (W/kg) | Reported 10g SAR (W/kg) |
|----------|------------|------------|---------------|---------------|-----|-------------|---------------------|---------------------|------------------------|--------------|---------------------------|------------------|------------------------|------------------------|-------------------------|-------------------------|
| 07 | WLAN2.4GHz | DBPSK | 802.11b 1Mbps | Right Cheek | 6 | 2437 | 17.98 | 18.00 | 1.005 | 97.63 | 1.024 | 0.05 | 0.498 | 0.512 | 0.226 | 0.232 |
| | WLAN2.4GHz | DBPSK | 802.11b 1Mbps | Right Tilted | 6 | 2437 | 17.98 | 18.00 | 1.005 | 97.63 | 1.024 | 0.041 | 0.250 | 0.257 | 0.116 | 0.119 |
| | WLAN2.4GHz | DBPSK | 802.11b 1Mbps | Left Cheek | 6 | 2437 | 17.98 | 18.00 | 1.005 | 97.63 | 1.024 | 0.166 | 0.167 | 0.172 | 0.079 | 0.081 |
| | WLAN2.4GHz | DBPSK | 802.11b 1Mbps | Left Tilted | 6 | 2437 | 17.98 | 18.00 | 1.005 | 97.63 | 1.024 | 0.125 | 0.123 | 0.127 | 0.060 | 0.062 |
| 08 | WLAN5GHz | OFDM | 802.11a 6Mbps | Right Cheek | 36 | 5180 | 13.90 | 14.00 | 1.023 | 87.26 | 1.146 | -0.03 | 0.209 | 0.245 | 0.061 | 0.072 |
| | WLAN5GHz | OFDM | 802.11a 6Mbps | Right Tilted | 36 | 5180 | 13.90 | 14.00 | 1.023 | 87.26 | 1.146 | -0.02 | 0.097 | 0.114 | 0.030 | 0.035 |
| | WLAN5GHz | OFDM | 802.11a 6Mbps | Left Cheek | 36 | 5180 | 13.90 | 14.00 | 1.023 | 87.26 | 1.146 | -0.06 | 0.056 | 0.066 | 0.019 | 0.022 |
| | WLAN5GHz | OFDM | 802.11a 6Mbps | Left Tilted | 36 | 5180 | 13.90 | 14.00 | 1.023 | 87.26 | 1.146 | 0.09 | 0.034 | 0.040 | 0.009 | 0.010 |
| 09 | WLAN5GHz | OFDM | 802.11a 6Mbps | Right Cheek | 60 | 5300 | 13.89 | 14.00 | 1.025 | 87.26 | 1.146 | -0.16 | 0.216 | 0.254 | 0.067 | 0.079 |
| | WLAN5GHz | OFDM | 802.11a 6Mbps | Right Tilted | 60 | 5300 | 13.89 | 14.00 | 1.025 | 87.26 | 1.146 | -0.16 | 0.102 | 0.120 | 0.033 | 0.039 |
| | WLAN5GHz | OFDM | 802.11a 6Mbps | Left Cheek | 60 | 5300 | 13.89 | 14.00 | 1.025 | 87.26 | 1.146 | 0.03 | 0.091 | 0.107 | 0.031 | 0.036 |
| | WLAN5GHz | OFDM | 802.11a 6Mbps | Left Tilted | 60 | 5300 | 13.89 | 14.00 | 1.025 | 87.26 | 1.146 | 0.09 | 0.055 | 0.065 | 0.019 | 0.022 |
| 10 | WLAN5GHz | OFDM | 802.11a 6Mbps | Right Cheek | 140 | 5700 | 13.70 | 14.00 | 1.072 | 87.26 | 1.146 | 0.04 | 0.196 | 0.241 | 0.055 | 0.068 |
| | WLAN5GHz | OFDM | 802.11a 6Mbps | Right Tilted | 140 | 5700 | 13.70 | 14.00 | 1.072 | 87.26 | 1.146 | 0.06 | 0.144 | 0.177 | 0.050 | 0.061 |
| | WLAN5GHz | OFDM | 802.11a 6Mbps | Left Cheek | 140 | 5700 | 13.70 | 14.00 | 1.072 | 87.26 | 1.146 | 0.05 | 0.120 | 0.147 | 0.042 | 0.052 |
| | WLAN5GHz | OFDM | 802.11a 6Mbps | Left Tilted | 140 | 5700 | 13.70 | 14.00 | 1.072 | 87.26 | 1.146 | 0.1 | 0.062 | 0.076 | 0.022 | 0.027 |
| 11 | WLAN5GHz | OFDM | 802.11a 6Mbps | Right Cheek | 149 | 5745 | 13.98 | 14.00 | 1.004 | 87.26 | 1.146 | 0.092 | 0.332 | 0.382 | 0.100 | 0.115 |
| | WLAN5GHz | OFDM | 802.11a 6Mbps | Right Tilted | 149 | 5745 | 13.98 | 14.00 | 1.004 | 87.26 | 1.146 | 0.163 | 0.093 | 0.107 | 0.034 | 0.039 |
| | WLAN5GHz | OFDM | 802.11a 6Mbps | Left Cheek | 149 | 5745 | 13.98 | 14.00 | 1.004 | 87.26 | 1.146 | 0.096 | 0.070 | 0.081 | 0.024 | 0.028 |
| | WLAN5GHz | OFDM | 802.11a 6Mbps | Left Tilted | 149 | 5745 | 13.98 | 14.00 | 1.004 | 87.26 | 1.146 | 0.162 | 0.042 | 0.048 | 0.014 | 0.016 |

<Bluetooth SAR>

| Plot No. | Band | Modulation | Mode | Test Position | Ch. | Freq. (MHz) | Average Power (dBm) | Tune-Up Limit (dBm) | Tune-up Scaling Factor | Power Drift (dB) | Measured 1g SAR (W/kg) | Reported 1g SAR (W/kg) | Measured 10g SAR (W/kg) | Reported 10g SAR (W/kg) |
|----------|-----------|------------|-------|---------------|-----|-------------|---------------------|---------------------|------------------------|------------------|------------------------|------------------------|-------------------------|-------------------------|
| 12 | Bluetooth | GFSK | 1Mbps | Right Cheek | 39 | 2441 | 10.86 | 11.00 | 1.033 | -0.055 | 0.011 | 0.011 | 0.003 | 0.003 |
| | Bluetooth | GFSK | 1Mbps | Right Tilted | 39 | 2441 | 10.86 | 11.00 | 1.033 | 0.01 | 0.004 | 0.004 | 0.001 | 0.001 |
| | Bluetooth | GFSK | 1Mbps | Left Cheek | 39 | 2441 | 10.86 | 11.00 | 1.033 | 0.029 | 0.004 | 0.004 | 0.001 | 0.001 |
| | Bluetooth | GFSK | 1Mbps | Left Tilted | 39 | 2441 | 10.86 | 11.00 | 1.033 | 0.07 | 0.002 | 0.002 | 0.001 | 0.001 |



14.2 Hotspot SAR

<GSM SAR>

| Plot No. | Band | Modulation | Mode | Test Position | Gap (cm) | Ch. | Freq. (MHz) | Average Power (dBm) | Tune-Up Limit (dBm) | Tune-up Scaling Factor | Power Drift (dB) | Measured 1g SAR (W/kg) | Reported 1g SAR (W/kg) | Measured 10g SAR (W/kg) | Reported 10g SAR (W/kg) |
|----------|---------|------------|-------------------|---------------|----------|-----|-------------|---------------------|---------------------|------------------------|------------------|------------------------|------------------------|-------------------------|-------------------------|
| | GSM850 | GMSK | GPRS (4 Tx slots) | Front | 1cm | 251 | 848.8 | 27.73 | 28.00 | 1.064 | -0.04 | 0.794 | 0.845 | 0.617 | 0.657 |
| | GSM850 | GMSK | GPRS (4 Tx slots) | Front | 1cm | 128 | 824.2 | 27.64 | 28.00 | 1.086 | -0.01 | 0.715 | 0.777 | 0.548 | 0.595 |
| 13 | GSM850 | GMSK | GPRS (4 Tx slots) | Front | 1cm | 189 | 836.4 | 27.50 | 28.00 | 1.122 | -0.05 | 0.762 | 0.855 | 0.591 | 0.663 |
| | GSM850 | GMSK | GPRS (4 Tx slots) | Back | 1cm | 251 | 848.8 | 27.73 | 28.00 | 1.064 | -0.05 | 0.650 | 0.692 | 0.445 | 0.474 |
| | GSM850 | GMSK | GPRS (4 Tx slots) | Left Side | 1cm | 251 | 848.8 | 27.73 | 28.00 | 1.064 | 0.01 | 0.674 | 0.717 | 0.467 | 0.497 |
| | GSM850 | GMSK | GPRS (4 Tx slots) | Right Side | 1cm | 251 | 848.8 | 27.73 | 28.00 | 1.064 | 0.02 | 0.614 | 0.653 | 0.431 | 0.459 |
| | GSM850 | GMSK | GPRS (4 Tx slots) | Bottom Side | 1cm | 251 | 848.8 | 27.73 | 28.00 | 1.064 | 0.07 | 0.181 | 0.193 | 0.102 | 0.109 |
| | GSM1900 | GMSK | GPRS (4 Tx slots) | Front | 1cm | 810 | 1909.8 | 27.98 | 28.00 | 1.005 | 0 | 0.843 | 0.847 | 0.492 | 0.494 |
| | GSM1900 | GMSK | GPRS (4 Tx slots) | Front | 1cm | 512 | 1850.2 | 27.94 | 28.00 | 1.014 | -0.09 | 0.984 | 0.998 | 0.567 | 0.575 |
| | GSM1900 | GMSK | GPRS (4 Tx slots) | Front | 1cm | 661 | 1880 | 27.95 | 28.00 | 1.012 | -0.02 | 0.842 | 0.852 | 0.504 | 0.510 |
| | GSM1900 | GMSK | GPRS (4 Tx slots) | Back | 1cm | 810 | 1909.8 | 27.98 | 28.00 | 1.005 | -0.01 | 1.190 | 1.195 | 0.689 | 0.692 |
| 14 | GSM1900 | GMSK | GPRS (4 Tx slots) | Back | 1cm | 512 | 1850.2 | 27.94 | 28.00 | 1.014 | -0.1 | 1.180 | 1.196 | 0.703 | 0.713 |
| | GSM1900 | GMSK | GPRS (4 Tx slots) | Back | 1cm | 661 | 1880 | 27.95 | 28.00 | 1.012 | -0.04 | 1.080 | 1.093 | 0.646 | 0.653 |
| | GSM1900 | GMSK | GPRS (4 Tx slots) | Left Side | 1cm | 810 | 1909.8 | 27.98 | 28.00 | 1.005 | -0.1 | 0.555 | 0.558 | 0.331 | 0.333 |
| | GSM1900 | GMSK | GPRS (4 Tx slots) | Right Side | 1cm | 810 | 1909.8 | 27.98 | 28.00 | 1.005 | 0 | 0.071 | 0.071 | 0.043 | 0.043 |
| | GSM1900 | GMSK | GPRS (4 Tx slots) | Bottom Side | 1cm | 810 | 1909.8 | 27.98 | 28.00 | 1.005 | 0 | 0.324 | 0.325 | 0.192 | 0.193 |

<WCDMA SAR>

| Plot No. | Band | Modulation | Mode | Test Position | Gap (cm) | Ch. | Freq. (MHz) | Average Power (dBm) | Tune-Up Limit (dBm) | Tune-up Scaling Factor | Power Drift (dB) | Measured 1g SAR (W/kg) | Reported 1g SAR (W/kg) | Measured 10g SAR (W/kg) | Reported 10g SAR (W/kg) |
|----------|----------|------------|--------------|---------------|----------|------|-------------|---------------------|---------------------|------------------------|------------------|------------------------|------------------------|-------------------------|-------------------------|
| | WCDMA V | QPSK | RMC 12.2Kbps | Front | 1cm | 4182 | 836.4 | 24.61 | 25.00 | 1.094 | 0.1 | 0.794 | 0.869 | 0.614 | 0.672 |
| | WCDMA V | QPSK | RMC 12.2Kbps | Front | 1cm | 4132 | 826.4 | 24.55 | 25.00 | 1.109 | -0.07 | 0.800 | 0.887 | 0.624 | 0.692 |
| | WCDMA V | QPSK | RMC 12.2Kbps | Front | 1cm | 4233 | 846.6 | 24.53 | 25.00 | 1.114 | 0.02 | 0.724 | 0.807 | 0.561 | 0.625 |
| | WCDMA V | QPSK | RMC 12.2Kbps | Back | 1cm | 4182 | 836.4 | 24.61 | 25.00 | 1.094 | 0.02 | 0.802 | 0.877 | 0.624 | 0.683 |
| 15 | WCDMA V | QPSK | RMC 12.2Kbps | Back | 1cm | 4132 | 826.4 | 24.55 | 25.00 | 1.109 | 0 | 0.803 | 0.891 | 0.626 | 0.694 |
| | WCDMA V | QPSK | RMC 12.2Kbps | Back | 1cm | 4233 | 846.6 | 24.53 | 25.00 | 1.114 | -0.06 | 0.744 | 0.829 | 0.576 | 0.642 |
| | WCDMA V | QPSK | RMC 12.2Kbps | Left Side | 1cm | 4182 | 836.4 | 24.61 | 25.00 | 1.094 | -0.1 | 0.743 | 0.813 | 0.520 | 0.569 |
| | WCDMA V | QPSK | RMC 12.2Kbps | Left Side | 1cm | 4132 | 826.4 | 24.55 | 25.00 | 1.109 | 0.01 | 0.764 | 0.847 | 0.537 | 0.596 |
| | WCDMA V | QPSK | RMC 12.2Kbps | Left Side | 1cm | 4233 | 846.6 | 24.53 | 25.00 | 1.114 | -0.04 | 0.645 | 0.719 | 0.448 | 0.499 |
| | WCDMA V | QPSK | RMC 12.2Kbps | Right Side | 1cm | 4182 | 836.4 | 24.61 | 25.00 | 1.094 | -0.02 | 0.760 | 0.831 | 0.530 | 0.580 |
| | WCDMA V | QPSK | RMC 12.2Kbps | Right Side | 1cm | 4132 | 826.4 | 24.55 | 25.00 | 1.109 | -0.01 | 0.744 | 0.825 | 0.519 | 0.576 |
| | WCDMA V | QPSK | RMC 12.2Kbps | Right Side | 1cm | 4233 | 846.6 | 24.53 | 25.00 | 1.114 | 0.01 | 0.690 | 0.769 | 0.479 | 0.534 |
| | WCDMA V | QPSK | RMC 12.2Kbps | Bottom Side | 1cm | 4182 | 836.4 | 24.61 | 25.00 | 1.094 | -0.07 | 0.153 | 0.167 | 0.089 | 0.097 |
| | WCDMA II | QPSK | RMC 12.2Kbps | Front | 1cm | 9400 | 1880 | 23.92 | 24.00 | 1.019 | -0.04 | 0.838 | 0.854 | 0.494 | 0.503 |
| | WCDMA II | QPSK | RMC 12.2Kbps | Front | 1cm | 9262 | 1852.4 | 23.91 | 24.00 | 1.021 | 0 | 0.933 | 0.953 | 0.551 | 0.563 |
| | WCDMA II | QPSK | RMC 12.2Kbps | Front | 1cm | 9538 | 1907.6 | 23.85 | 24.00 | 1.035 | -0.04 | 0.788 | 0.816 | 0.465 | 0.481 |
| | WCDMA II | QPSK | RMC 12.2Kbps | Back | 1cm | 9400 | 1880 | 23.92 | 24.00 | 1.019 | -0.09 | 1.070 | 1.090 | 0.614 | 0.625 |
| 16 | WCDMA II | QPSK | RMC 12.2Kbps | Back | 1cm | 9262 | 1852.4 | 23.91 | 24.00 | 1.021 | -0.1 | 1.110 | 1.133 | 0.652 | 0.666 |
| | WCDMA II | QPSK | RMC 12.2Kbps | Back | 1cm | 9538 | 1907.6 | 23.85 | 24.00 | 1.035 | -0.14 | 1.090 | 1.128 | 0.623 | 0.645 |
| | WCDMA II | QPSK | RMC 12.2Kbps | Left Side | 1cm | 9400 | 1880 | 23.92 | 24.00 | 1.019 | -0.06 | 0.482 | 0.491 | 0.289 | 0.294 |
| | WCDMA II | QPSK | RMC 12.2Kbps | Right Side | 1cm | 9400 | 1880 | 23.92 | 24.00 | 1.019 | 0 | 0.093 | 0.095 | 0.057 | 0.058 |
| | WCDMA II | QPSK | RMC 12.2Kbps | Bottom Side | 1cm | 9400 | 1880 | 23.92 | 24.00 | 1.019 | 0.06 | 0.240 | 0.244 | 0.146 | 0.149 |



<LTE SAR>

| Plot No. | Band | BW (MHz) | Modulation | RB Size | RB offset | Test Position | Gap (cm) | Ch. | Freq. (MHz) | Average Power (dBm) | Tune-Up Limit (dBm) | Tune-up Scaling Factor | Power Drift (dB) | Measured 1g SAR (W/kg) | Reported 1g SAR (W/kg) | Measured 10g SAR (W/kg) | Reported 10g SAR (W/kg) |
|----------|------------|----------|------------|---------|-----------|---------------|----------|-------|-------------|---------------------|---------------------|------------------------|------------------|------------------------|------------------------|-------------------------|-------------------------|
| 17 | LTE Band 5 | 10M | QPSK | 1RB | 0offset | Front | 1cm | 20525 | 836.5 | 24.69 | 25.00 | 1.074 | -0.02 | 0.655 | 0.703 | 0.509 | 0.547 |
| | LTE Band 5 | 10M | QPSK | 25RB | 0offset | Front | 1cm | 20525 | 836.5 | 23.47 | 24.00 | 1.130 | -0.02 | 0.509 | 0.575 | 0.395 | 0.446 |
| | LTE Band 5 | 10M | QPSK | 1RB | 0offset | Back | 1cm | 20525 | 836.5 | 24.69 | 25.00 | 1.074 | -0.17 | 0.610 | 0.655 | 0.469 | 0.504 |
| | LTE Band 5 | 10M | QPSK | 25RB | 0offset | Back | 1cm | 20525 | 836.5 | 23.47 | 24.00 | 1.130 | -0.02 | 0.411 | 0.464 | 0.271 | 0.306 |
| | LTE Band 5 | 10M | QPSK | 1RB | 0offset | Left Side | 1cm | 20525 | 836.5 | 24.69 | 25.00 | 1.074 | 0.02 | 0.530 | 0.569 | 0.371 | 0.398 |
| | LTE Band 5 | 10M | QPSK | 25RB | 0offset | Left Side | 1cm | 20525 | 836.5 | 23.47 | 24.00 | 1.130 | -0.13 | 0.420 | 0.475 | 0.292 | 0.330 |
| | LTE Band 5 | 10M | QPSK | 1RB | 0offset | Right Side | 1cm | 20525 | 836.5 | 24.69 | 25.00 | 1.074 | -0.06 | 0.573 | 0.615 | 0.396 | 0.425 |
| | LTE Band 5 | 10M | QPSK | 25RB | 0offset | Right Side | 1cm | 20525 | 836.5 | 23.47 | 24.00 | 1.130 | 0.01 | 0.449 | 0.507 | 0.311 | 0.351 |
| | LTE Band 5 | 10M | QPSK | 1RB | 0offset | Bottom Side | 1cm | 20525 | 836.5 | 24.69 | 25.00 | 1.074 | -0.14 | 0.142 | 0.153 | 0.086 | 0.092 |
| | LTE Band 5 | 10M | QPSK | 25RB | 0offset | Bottom Side | 1cm | 20525 | 836.5 | 23.47 | 24.00 | 1.130 | 0.01 | 0.118 | 0.133 | 0.070 | 0.079 |
| | LTE Band 7 | 20M | QPSK | 1RB | 0offset | Front | 1cm | 20850 | 2510 | 22.99 | 23.00 | 1.002 | 0.09 | 0.741 | 0.743 | 0.400 | 0.401 |
| | LTE Band 7 | 20M | QPSK | 50RB | 0offset | Front | 1cm | 20850 | 2510 | 21.46 | 22.00 | 1.132 | -0.03 | 0.580 | 0.657 | 0.314 | 0.356 |
| | LTE Band 7 | 20M | QPSK | 1RB | 0offset | Back | 1cm | 20850 | 2510 | 22.99 | 23.00 | 1.002 | -0.14 | 0.900 | 0.902 | 0.474 | 0.475 |
| | LTE Band 7 | 20M | QPSK | 1RB | 0offset | Back | 1cm | 21100 | 2535 | 22.94 | 23.00 | 1.014 | 0.04 | 0.939 | 0.952 | 0.495 | 0.502 |
| 18 | LTE Band 7 | 20M | QPSK | 1RB | 0offset | Back | 1cm | 21350 | 2560 | 22.80 | 23.00 | 1.047 | -0.12 | 0.957 | 1.002 | 0.506 | 0.530 |
| | LTE Band 7 | 20M | QPSK | 50RB | 0offset | Back | 1cm | 20850 | 2510 | 21.46 | 22.00 | 1.132 | -0.12 | 0.683 | 0.773 | 0.367 | 0.416 |
| | LTE Band 7 | 20M | QPSK | 100RB | 0offset | Back | 1cm | 20850 | 2510 | 21.34 | 22.00 | 1.164 | -0.03 | 0.676 | 0.787 | 0.356 | 0.414 |
| | LTE Band 7 | 20M | QPSK | 1RB | 0offset | Left Side | 1cm | 20850 | 2510 | 22.99 | 23.00 | 1.002 | -0.18 | 0.692 | 0.694 | 0.351 | 0.352 |
| | LTE Band 7 | 20M | QPSK | 50RB | 0offset | Left Side | 1cm | 20850 | 2510 | 21.46 | 22.00 | 1.132 | -0.04 | 0.498 | 0.564 | 0.259 | 0.293 |
| | LTE Band 7 | 20M | QPSK | 1RB | 0offset | Right Side | 1cm | 20850 | 2510 | 22.99 | 23.00 | 1.002 | -0.18 | 0.058 | 0.058 | 0.032 | 0.032 |
| | LTE Band 7 | 20M | QPSK | 50RB | 0offset | Right Side | 1cm | 20850 | 2510 | 21.46 | 22.00 | 1.132 | 0.05 | 0.044 | 0.050 | 0.025 | 0.028 |
| | LTE Band 7 | 20M | QPSK | 1RB | 0offset | Bottom Side | 1cm | 20850 | 2510 | 22.99 | 23.00 | 1.002 | -0.17 | 0.746 | 0.748 | 0.344 | 0.345 |
| | LTE Band 7 | 20M | QPSK | 50RB | 0offset | Bottom Side | 1cm | 20850 | 2510 | 21.46 | 22.00 | 1.132 | -0.14 | 0.563 | 0.638 | 0.262 | 0.297 |

<WLAN SAR>

| Plot No. | Band | Mode | Mode | Test Position | Gap (cm) | Ch. | Freq. (MHz) | Average Power (dBm) | Tune-Up Limit (dBm) | Tune-up Scaling Factor | Duty Cycle % | Duty Cycle Scaling Factor | Power Drift (dB) | Measured 1g SAR (W/kg) | Reported 1g SAR (W/kg) | Measured 10g SAR (W/kg) | Reported 10g SAR (W/kg) |
|----------|------------|-------|---------------|---------------|----------|-----|-------------|---------------------|---------------------|------------------------|--------------|---------------------------|------------------|------------------------|------------------------|-------------------------|-------------------------|
| | WLAN2.4GHz | DBPSK | 802.11b 1Mbps | Front | 1cm | 6 | 2437 | 17.98 | 18.00 | 1.005 | 97.63 | 1.024 | 0.04 | 0.133 | 0.137 | 0.066 | 0.068 |
| 19 | WLAN2.4GHz | DBPSK | 802.11b 1Mbps | Back | 1cm | 6 | 2437 | 17.98 | 18.00 | 1.005 | 97.63 | 1.024 | -0.01 | 0.841 | 0.865 | 0.373 | 0.384 |
| | WLAN2.4GHz | DBPSK | 802.11b 1Mbps | Back | 1cm | 1 | 2412 | 17.91 | 18.00 | 1.020 | 97.63 | 1.024 | -0.02 | 0.460 | 0.480 | 0.203 | 0.212 |
| | WLAN2.4GHz | DBPSK | 802.11b 1Mbps | Back | 1cm | 11 | 2462 | 17.97 | 18.00 | 1.006 | 97.63 | 1.024 | -0.02 | 0.700 | 0.721 | 0.305 | 0.314 |
| | WLAN2.4GHz | DBPSK | 802.11b 1Mbps | Left Side | 1cm | 6 | 2437 | 17.98 | 18.00 | 1.005 | 97.63 | 1.024 | -0.02 | 0.535 | 0.550 | 0.250 | 0.257 |
| | WLAN2.4GHz | DBPSK | 802.11b 1Mbps | Top Side | 1cm | 6 | 2437 | 17.98 | 18.00 | 1.005 | 97.63 | 1.024 | 0.04 | 0.050 | 0.051 | 0.025 | 0.026 |
| 20 | WLAN5GHz | OFDM | 802.11a 6Mbps | Front | 1cm | 36 | 5180 | 13.90 | 14.00 | 1.023 | 87.26 | 1.146 | 0.08 | 0.140 | 0.164 | 0.041 | 0.048 |
| | WLAN5GHz | OFDM | 802.11a 6Mbps | Back | 1cm | 36 | 5180 | 13.90 | 14.00 | 1.023 | 87.26 | 1.146 | 0.04 | 0.070 | 0.082 | 0.020 | 0.023 |
| | WLAN5GHz | OFDM | 802.11a 6Mbps | Left Side | 1cm | 36 | 5180 | 13.90 | 14.00 | 1.023 | 87.26 | 1.146 | -0.04 | 0.030 | 0.035 | 0.009 | 0.010 |
| | WLAN5GHz | OFDM | 802.11a 6Mbps | Top Side | 1cm | 36 | 5180 | 13.90 | 14.00 | 1.023 | 87.26 | 1.146 | -0.06 | 0.000 | 0.001 | 0.000 | 0.000 |
| | WLAN5GHz | OFDM | 802.11a 6Mbps | Front | 1cm | 149 | 5745 | 13.98 | 14.00 | 1.004 | 87.26 | 1.146 | -0.07 | 0.024 | 0.028 | 0.004 | 0.005 |
| 21 | WLAN5GHz | OFDM | 802.11a 6Mbps | Back | 1cm | 149 | 5745 | 13.98 | 14.00 | 1.004 | 87.26 | 1.146 | 0.07 | 0.072 | 0.083 | 0.021 | 0.024 |
| | WLAN5GHz | OFDM | 802.11a 6Mbps | Left Side | 1cm | 149 | 5745 | 13.98 | 14.00 | 1.004 | 87.26 | 1.146 | -0.08 | 0.013 | 0.015 | 0.003 | 0.003 |
| | WLAN5GHz | OFDM | 802.11a 6Mbps | Top Side | 1cm | 149 | 5745 | 13.98 | 14.00 | 1.004 | 87.26 | 1.146 | -0.01 | 0.006 | 0.007 | 0.001 | 0.002 |

14.3 Body Worn Accessory SAR

<GSM SAR>

| Plot No. | Band | Modulation | Mode | Test Position | Gap (cm) | Ch. | Freq. (MHz) | Average Power (dBm) | Tune-Up Limit (dBm) | Tune-up Scaling Factor | Power Drift (dB) | Measured 1g SAR (W/kg) | Reported 1g SAR (W/kg) | Measured 10g SAR (W/kg) | Reported 10g SAR (W/kg) |
|----------|---------|------------|-------------------|---------------|----------|-----|-------------|---------------------|---------------------|------------------------|------------------|------------------------|------------------------|-------------------------|-------------------------|
| 22 | GSM850 | GMSK | GPRS (4 Tx slots) | Front | 1.5cm | 251 | 848.8 | 27.73 | 28.00 | 1.064 | -0.01 | 0.741 | 0.789 | 0.568 | 0.604 |
| | GSM850 | GMSK | GPRS (4 Tx slots) | Back | 1.5cm | 251 | 848.8 | 27.73 | 28.00 | 1.064 | 0 | 0.692 | 0.736 | 0.532 | 0.566 |
| 23 | GSM1900 | GMSK | GPRS (4 Tx slots) | Front | 1.5cm | 810 | 1909.8 | 27.98 | 28.00 | 1.005 | 0 | 0.489 | 0.491 | 0.314 | 0.315 |
| | GSM1900 | GMSK | GPRS (4 Tx slots) | Back | 1.5cm | 810 | 1909.8 | 27.98 | 28.00 | 1.005 | -0.01 | 0.642 | 0.645 | 0.402 | 0.404 |

<WCDMA SAR>

| Plot No. | Band | Modulation | Mode | Test Position | Gap (cm) | Ch. | Freq. (MHz) | Average Power (dBm) | Tune-Up Limit (dBm) | Tune-up Scaling Factor | Power Drift (dB) | Measured 1g SAR (W/kg) | Reported 1g SAR (W/kg) | Measured 10g SAR (W/kg) | Reported 10g SAR (W/kg) |
|----------|----------|------------|--------------|---------------|----------|------|-------------|---------------------|---------------------|------------------------|------------------|------------------------|------------------------|-------------------------|-------------------------|
| 24 | WCDMA V | QPSK | RMC 12.2Kbps | Front | 1.5cm | 4182 | 836.4 | 24.61 | 25.00 | 1.094 | 0 | 0.744 | 0.814 | 0.574 | 0.628 |
| | WCDMA V | QPSK | RMC 12.2Kbps | Front | 1.5cm | 4132 | 826.4 | 24.55 | 25.00 | 1.109 | -0.07 | 0.762 | 0.845 | 0.582 | 0.646 |
| | WCDMA V | QPSK | RMC 12.2Kbps | Front | 1.5cm | 4233 | 846.6 | 24.53 | 25.00 | 1.114 | -0.02 | 0.670 | 0.747 | 0.516 | 0.575 |
| | WCDMA V | QPSK | RMC 12.2Kbps | Back | 1.5cm | 4182 | 836.4 | 24.61 | 25.00 | 1.094 | -0.03 | 0.753 | 0.824 | 0.578 | 0.632 |
| | WCDMA V | QPSK | RMC 12.2Kbps | Back | 1.5cm | 4132 | 826.4 | 24.55 | 25.00 | 1.109 | 0.02 | 0.754 | 0.836 | 0.580 | 0.643 |
| | WCDMA V | QPSK | RMC 12.2Kbps | Back | 1.5cm | 4233 | 846.6 | 24.53 | 25.00 | 1.114 | -0.02 | 0.702 | 0.782 | 0.537 | 0.598 |
| | WCDMA II | QPSK | RMC 12.2Kbps | Front | 1.5cm | 9400 | 1880 | 23.92 | 24.00 | 1.019 | -0.01 | 0.474 | 0.483 | 0.305 | 0.311 |
| 25 | WCDMA II | QPSK | RMC 12.2Kbps | Back | 1.5cm | 9400 | 1880 | 23.92 | 24.00 | 1.019 | -0.01 | 0.621 | 0.633 | 0.389 | 0.396 |

<LTE SAR>

| Plot No. | Band | BW (MHz) | Modulation | RB Size | RB offset | Test Position | Gap (cm) | Ch. | Freq. (MHz) | Average Power (dBm) | Tune-Up Limit (dBm) | Tune-up Scaling Factor | Power Drift (dB) | Measured 1g SAR (W/kg) | Reported 1g SAR (W/kg) | Measured 10g SAR (W/kg) | Reported 10g SAR (W/kg) |
|----------|------------|----------|------------|---------|-----------|---------------|----------|-------|-------------|---------------------|---------------------|------------------------|------------------|------------------------|------------------------|-------------------------|-------------------------|
| 26 | LTE Band 5 | 10M | QPSK | 1RB | 0offset | Front | 1.5cm | 20525 | 836.5 | 24.69 | 25.00 | 1.074 | -0.03 | 0.634 | 0.681 | 0.485 | 0.521 |
| | LTE Band 5 | 10M | QPSK | 25RB | 0offset | Front | 1.5cm | 20525 | 836.5 | 23.47 | 24.00 | 1.130 | -0.06 | 0.482 | 0.545 | 0.370 | 0.418 |
| | LTE Band 5 | 10M | QPSK | 1RB | 0offset | Back | 1.5cm | 20525 | 836.5 | 24.69 | 25.00 | 1.074 | -0.11 | 0.566 | 0.608 | 0.435 | 0.467 |
| | LTE Band 5 | 10M | QPSK | 25RB | 0offset | Back | 1.5cm | 20525 | 836.5 | 23.47 | 24.00 | 1.130 | -0.01 | 0.443 | 0.500 | 0.340 | 0.384 |
| 27 | LTE Band 7 | 20M | QPSK | 1RB | 0offset | Front | 1.5cm | 20850 | 2510 | 22.99 | 23.00 | 1.002 | 0.03 | 0.472 | 0.473 | 0.262 | 0.263 |
| | LTE Band 7 | 20M | QPSK | 50RB | 0offset | Front | 1.5cm | 20850 | 2510 | 21.46 | 22.00 | 1.132 | -0.05 | 0.349 | 0.395 | 0.194 | 0.220 |
| | LTE Band 7 | 20M | QPSK | 1RB | 0offset | Back | 1.5cm | 20850 | 2510 | 22.99 | 23.00 | 1.002 | 0.05 | 0.434 | 0.435 | 0.242 | 0.243 |
| | LTE Band 7 | 20M | QPSK | 50RB | 0offset | Back | 1.5cm | 20850 | 2510 | 21.46 | 22.00 | 1.132 | -0.04 | 0.346 | 0.392 | 0.187 | 0.212 |

<WLAN SAR>

| Plot No. | Band | Modulation | Mode | Test Position | Gap (cm) | Ch. | Freq. (MHz) | Average Power (dBm) | Tune-Up Limit (dBm) | Tune-up Scaling Factor | Duty Cycle % | Duty Cycle Scaling Factor | Power Drift (dB) | Measured 1g SAR (W/kg) | Reported 1g SAR (W/kg) | Measured 10g SAR (W/kg) | Reported 10g SAR (W/kg) |
|----------|------------|------------|---------------|---------------|----------|-----|-------------|---------------------|---------------------|------------------------|--------------|---------------------------|------------------|------------------------|------------------------|-------------------------|-------------------------|
| 28 | WLAN2.4GHz | DBPSK | 802.11b 1Mbps | Front | 1.5cm | 6 | 2437 | 17.98 | 18.00 | 1.005 | 97.63 | 1.024 | 0.05 | 0.072 | 0.074 | 0.037 | 0.038 |
| | WLAN2.4GHz | DBPSK | 802.11b 1Mbps | Back | 1.5cm | 6 | 2437 | 17.98 | 18.00 | 1.005 | 97.63 | 1.024 | -0.03 | 0.333 | 0.343 | 0.162 | 0.167 |
| 29 | WLAN5GHz | OFDM | 802.11a 6Mbps | Front | 1.5cm | 36 | 5180 | 13.90 | 14.00 | 1.023 | 87.26 | 1.146 | 0.047 | 0.071 | 0.083 | 0.025 | 0.029 |
| | WLAN5GHz | OFDM | 802.11a 6Mbps | Back | 1.5cm | 36 | 5180 | 13.90 | 14.00 | 1.023 | 87.26 | 1.146 | -0.013 | 0.045 | 0.053 | 0.016 | 0.019 |
| 30 | WLAN5GHz | OFDM | 802.11a 6Mbps | Front | 1.5cm | 60 | 5300 | 13.89 | 14.00 | 1.025 | 87.26 | 1.146 | 0.04 | 0.060 | 0.070 | 0.022 | 0.026 |
| | WLAN5GHz | OFDM | 802.11a 6Mbps | Back | 1.5cm | 60 | 5300 | 13.89 | 14.00 | 1.025 | 87.26 | 1.146 | -0.078 | 0.050 | 0.059 | 0.016 | 0.019 |
| 31 | WLAN5GHz | OFDM | 802.11a 6Mbps | Front | 1.5cm | 140 | 5700 | 13.70 | 14.00 | 1.072 | 87.26 | 1.146 | 0.184 | 0.024 | 0.029 | 0.009 | 0.011 |
| | WLAN5GHz | OFDM | 802.11a 6Mbps | Back | 1.5cm | 140 | 5700 | 13.70 | 14.00 | 1.072 | 87.26 | 1.146 | 0.028 | 0.035 | 0.043 | 0.014 | 0.017 |
| 32 | WLAN5GHz | OFDM | 802.11a 6Mbps | Front | 1.5cm | 149 | 5745 | 13.98 | 14.00 | 1.004 | 87.26 | 1.146 | 0.031 | 0.013 | 0.015 | 0.002 | 0.002 |
| | WLAN5GHz | OFDM | 802.11a 6Mbps | Back | 1.5cm | 149 | 5745 | 13.98 | 14.00 | 1.004 | 87.26 | 1.146 | -0.098 | 0.041 | 0.047 | 0.014 | 0.016 |

14.4 Repeated SAR Measurement

| No. | Band | BW (MHz) | Modulation | RB Size | RB offset | Mode | Test Position | Gap (cm) | Ch. | Freq. (MHz) | Average Power (dBm) | Tune-Up Limit (dBm) | Tune-up Scaling Factor | Duty Cycle % | Duty Cycle Scaling Factor | Power Drift (dB) | Measured 1g SAR (W/kg) | Ratio | Reported 1g SAR (W/kg) |
|-----|------------|----------|------------|---------|-----------|-------------------|---------------|----------|-------|-------------|---------------------|---------------------|------------------------|--------------|---------------------------|------------------|------------------------|-------|------------------------|
| 1st | GSM1900 | - | - | - | - | GPRS (4 Tx slots) | Left Cheek | - | 810 | 1909.8 | 27.98 | 28.00 | 1.005 | - | - | 0.03 | 1.010 | - | 1.015 |
| 2nd | GSM1900 | - | - | - | - | GPRS (4 Tx slots) | Left Cheek | - | 810 | 1909.8 | 27.98 | 28.00 | 1.005 | - | - | 0.02 | 0.956 | 1.06 | 0.960 |
| 1st | GSM1900 | - | - | - | - | GPRS (4 Tx slots) | Back | 1cm | 810 | 1909.8 | 27.98 | 28.00 | 1.005 | - | - | -0.01 | 1.190 | - | 1.195 |
| 2nd | GSM1900 | - | - | - | - | GPRS (4 Tx slots) | Back | 1cm | 810 | 1909.8 | 27.98 | 28.00 | 1.005 | - | - | -0.04 | 1.120 | 1.06 | 1.125 |
| 1st | WCDMA V | - | - | - | - | RMC 12.2Kbps | Back | 1cm | 4132 | 826.4 | 24.55 | 25.00 | 1.109 | - | - | 0 | 0.803 | - | 0.891 |
| 2nd | WCDMA V | - | - | - | - | RMC 12.2Kbps | Back | 1cm | 4132 | 826.4 | 24.55 | 25.00 | 1.109 | - | - | 0.02 | 0.794 | 1.01 | 0.881 |
| 1st | LTE Band 7 | 20M | QPSK | 1RB | 0offset | - | Left Cheek | - | 21100 | 2535 | 22.94 | 23.00 | 1.014 | - | - | 0.11 | 1.180 | - | 1.196 |
| 2nd | LTE Band 7 | 20M | QPSK | 1RB | 0offset | - | Left Cheek | - | 21100 | 2535 | 22.94 | 23.00 | 1.014 | - | - | -0.16 | 1.010 | 1.17 | 1.024 |
| 1st | LTE Band 7 | 20M | QPSK | 1RB | 0offset | - | Back | 1cm | 21350 | 2560 | 22.80 | 23.00 | 1.047 | - | - | -0.12 | 0.957 | - | 1.002 |
| 2nd | LTE Band 7 | 20M | QPSK | 1RB | 0offset | - | Back | 1cm | 21350 | 2560 | 22.80 | 23.00 | 1.047 | - | - | 0.05 | 0.952 | 1.01 | 0.997 |
| 1st | WLAN2.4GHz | - | - | - | - | 802.11b 1Mbps | Back | 1cm | 6 | 2437 | 17.98 | 18.00 | 1.005 | 97.63 | 1.024 | -0.01 | 0.841 | - | 0.865 |
| 2nd | WLAN2.4GHz | - | - | - | - | 802.11b 1Mbps | Back | 1cm | 6 | 2437 | 17.98 | 18.00 | 1.005 | 97.63 | 1.024 | 0.01 | 0.825 | 1.02 | 0.849 |

General Note:

1. Per KDB 865664 D01v01r03, for each frequency band, repeated SAR measurement is required only when the measured SAR is $\geq 0.8W/kg$
2. Per KDB 865664 D01v01r03, if the ratio among the repeated measurement is ≤ 1.2 and the measured SAR $< 1.45W/kg$, only one repeated measurement is required.
3. The ratio is the difference in percentage between original and repeated *measured SAR*.
4. All measurement SAR result is scaled-up to account for tune-up tolerance and is compliant.

15. Simultaneous Transmission Analysis

| NO. | Simultaneous Transmission Configurations | Portable Handset | | | Note |
|-----|--|------------------|-----------|---------|---------------------|
| | | Head | Body-worn | Hotspot | |
| 1. | GSM(Voice) + WLAN2.4GHz(data) | Yes | Yes | | |
| 2. | WCDMA(Voice) + WLAN2.4GHz(data) | Yes | Yes | | |
| 3. | GSM(Voice) + Bluetooth(data) | Yes | Yes | | |
| 4. | WCDMA((Voice) + Bluetooth(data) | Yes | Yes | | |
| 5. | GSM(Voice) + WLAN5GHz(data) | Yes | Yes | | |
| 6. | WCDMA((Voice) + WLAN5GHz(data) | Yes | Yes | | |
| 7. | GPRS/EDGE(Data) + WLAN2.4GHz(data) | Yes | Yes | Yes | 2.4GHz Hotspot |
| 8. | WCDMA(Data) + WLAN2.4GHz(data) | Yes | Yes | Yes | 2.4GHz Hotspot |
| 9. | LTE(Data) + WLAN2.4GHz(data) | Yes | Yes | Yes | 2.4GHz Hotspot |
| 10. | GPRS/EDGE(Data) + Bluetooth(data) | Yes | Yes | Yes | Bluetooth Tethering |
| 11. | WCDMA(Data) + Bluetooth(data) | Yes | Yes | Yes | Bluetooth Tethering |
| 12. | LTE(Data) + Bluetooth(data) | Yes | Yes | Yes | Bluetooth Tethering |
| 13. | GPRS/EDGE(data) + WLAN5GHz(data) | Yes | Yes | Yes | WiFi Direct |
| 14. | WCDMA(data) + WLAN5GHz(data) | Yes | Yes | Yes | WiFi Direct |
| 15. | LTE(data) + WLAN5GHz(data) | Yes | Yes | Yes | WiFi Direct |

General Note:

- This device supported VoIP in EGPRS, WCDMA, LTE (e.g. 3rd party VoIP).
- This device 2.4GHz supports Hotspot and 5.2GHz / 5.8GHz WLAN supports WiFi Direct (GC/GO) operation, and 5.3GHz / 5.5GHz WLAN supports WiFi Direct (GC only).
- WLAN and Bluetooth share the same antenna, and cannot transmit simultaneously.
- EUT will choose either WLAN 2.4GHz or WLAN 5GHz according to the network signal condition; therefore, 2.4GHz WLAN and 5GHz WLAN will not operate simultaneously at any moment.
- The worst case 5 GHz WLAN reported SAR for each configuration was used for SAR summation. Therefore, the following summations represent the absolute worst cases for simultaneous transmission with 5 GHz WLAN.
- The Scaled SAR summation is calculated based on the same configuration and test position.
- Per KDB 447498 D01v05r02, simultaneous transmission SAR is compliant if,
 - Scalar SAR summation < 1.6W/kg.
 - $SPLSR = (SAR1 + SAR2)^{1.5} / (\text{min. separation distance, mm})$, and the peak separation distance is determined from the square root of $[(x1-x2)^2 + (y1-y2)^2 + (z1-z2)^2]$, where (x1, y1, z1) and (x2, y2, z2) are the coordinates of the extrapolated peak SAR locations in the zoom scan.
 - If $SPLSR \leq 0.04$, simultaneously transmission SAR measurement is not necessary.
 - Simultaneously transmission SAR measurement, and the reported multi-band SAR < 1.6W/kg.
 - The SPLSR calculated results please refer to section 15.4.
- For simultaneous transmission analysis, Bluetooth SAR is estimated per KDB 447498 D01v05r02 based on the formula below.
 - $(\text{max. power of channel, including tune-up tolerance, mW}) / (\text{min. test separation distance, mm}) \cdot [\sqrt{f(\text{GHz})} / x] \text{ W/kg}$ for test separation distances $\leq 50 \text{ mm}$; where $x = 7.5$ for 1-g SAR, and $x = 18.75$ for 10-g SAR.
 - When the minimum separation distance is < 5mm, the distance is used 5mm to determine SAR test exclusion.
 - 0.4 W/kg for 1-g SAR and 1.0 W/kg for 10-g SAR, when the test separation distances is > 50 mm.

| Bluetooth Max Power | Exposure Position | Hotspot | Body-worn |
|---------------------|--------------------------|------------|------------|
| | Test separation | 10 mm | 15 mm |
| 11 dBm | Estimated 1g SAR (W/kg) | 0.273 W/kg | 0.182 W/kg |
| | Estimated 10g SAR (W/kg) | 0.109 W/kg | 0.073 W/kg |



15.1 Head Exposure Conditions

| WWAN Band | | Exposure Position | 1 | 2 | 3 | 1+2 Summed 1g SAR (W/kg) | 1+3 Summed 1g SAR (W/kg) | SPLSR | Case No |
|-----------|---------|-------------------|--------------------------|------------------------------------|---|-----------------------------------|-----------------------------------|-------|---------|
| | | | WWAN 1g SAR (W/kg) | 2.4GHz WLAN 1g SAR (W/kg) | 2.4GHz Bluetooth 1g SAR (W/kg) | | | | |
| GSM | GSM850 | Right Cheek | 0.754 | 0.512 | 0.011 | 1.27 | 0.77 | | |
| | | Right Tilted | 0.408 | 0.257 | 0.004 | 0.67 | 0.41 | | |
| | | Left Cheek | 0.743 | 0.172 | 0.004 | 0.92 | 0.75 | | |
| | | Left Tilted | 0.408 | 0.127 | 0.002 | 0.54 | 0.41 | | |
| | GSM1900 | Right Cheek | 0.509 | 0.512 | 0.011 | 1.02 | 0.52 | | |
| | | Right Tilted | 0.282 | 0.257 | 0.004 | 0.54 | 0.29 | | |
| | | Left Cheek | 1.015 | 0.172 | 0.004 | 1.19 | 1.02 | | |
| | | Left Tilted | 0.238 | 0.127 | 0.002 | 0.37 | 0.24 | | |
| WCDMA | Band V | Right Cheek | 0.656 | 0.512 | 0.011 | 1.17 | 0.67 | | |
| | | Right Tilted | 0.370 | 0.257 | 0.004 | 0.63 | 0.37 | | |
| | | Left Cheek | 0.617 | 0.172 | 0.004 | 0.79 | 0.62 | | |
| | | Left Tilted | 0.347 | 0.127 | 0.002 | 0.47 | 0.35 | | |
| | Band II | Right Cheek | 0.505 | 0.512 | 0.011 | 1.02 | 0.52 | | |
| | | Right Tilted | 0.226 | 0.257 | 0.004 | 0.48 | 0.23 | | |
| | | Left Cheek | 0.744 | 0.172 | 0.004 | 0.92 | 0.75 | | |
| | | Left Tilted | 0.195 | 0.127 | 0.002 | 0.32 | 0.20 | | |
| LTE | Band 5 | Right Cheek | 0.535 | 0.512 | 0.011 | 1.05 | 0.55 | | |
| | | Right Tilted | 0.314 | 0.257 | 0.004 | 0.57 | 0.32 | | |
| | | Left Cheek | 0.529 | 0.172 | 0.004 | 0.70 | 0.53 | | |
| | | Left Tilted | 0.294 | 0.127 | 0.002 | 0.42 | 0.30 | | |
| | Band 7 | Right Cheek | 0.528 | 0.512 | 0.011 | 1.04 | 0.54 | | |
| | | Right Tilted | 0.267 | 0.257 | 0.004 | 0.52 | 0.27 | | |
| | | Left Cheek | 1.196 | 0.172 | 0.004 | 1.37 | 1.20 | | |
| | | Left Tilted | 0.155 | 0.127 | 0.002 | 0.28 | 0.16 | | |



| WWAN Band | | Exposure Position | 1 | 2 | | 1+2 Summed 1g SAR (W/kg) | SPLSR | Case No |
|-----------|---------|-------------------|------------------|-----------|------------------|-----------------------------------|-------|---------|
| | | | WWAN | 5GHz WLAN | | | | |
| | | | 1g SAR (W/kg) | Band | 1g SAR (W/kg) | | | |
| GSM | GSM850 | Right Cheek | 0.754 | 5.8GHz | 0.382 | 1.14 | | |
| | | Right Tilted | 0.408 | 5.5GHz | 0.177 | 0.59 | | |
| | | Left Cheek | 0.743 | 5.5GHz | 0.147 | 0.89 | | |
| | | Left Tilted | 0.408 | 5.5GHz | 0.076 | 0.48 | | |
| | GSM1900 | Right Cheek | 0.509 | 5.8GHz | 0.382 | 0.89 | | |
| | | Right Tilted | 0.282 | 5.5GHz | 0.177 | 0.46 | | |
| | | Left Cheek | 1.015 | 5.5GHz | 0.147 | 1.16 | | |
| | | Left Tilted | 0.238 | 5.5GHz | 0.076 | 0.31 | | |
| WCDMA | Band V | Right Cheek | 0.656 | 5.8GHz | 0.382 | 1.04 | | |
| | | Right Tilted | 0.370 | 5.5GHz | 0.177 | 0.55 | | |
| | | Left Cheek | 0.617 | 5.5GHz | 0.147 | 0.76 | | |
| | | Left Tilted | 0.347 | 5.5GHz | 0.076 | 0.42 | | |
| | Band II | Right Cheek | 0.505 | 5.8GHz | 0.382 | 0.89 | | |
| | | Right Tilted | 0.226 | 5.5GHz | 0.177 | 0.40 | | |
| | | Left Cheek | 0.744 | 5.5GHz | 0.147 | 0.89 | | |
| | | Left Tilted | 0.195 | 5.5GHz | 0.076 | 0.27 | | |
| LTE | Band 5 | Right Cheek | 0.535 | 5.8GHz | 0.382 | 0.92 | | |
| | | Right Tilted | 0.314 | 5.5GHz | 0.177 | 0.49 | | |
| | | Left Cheek | 0.529 | 5.5GHz | 0.147 | 0.68 | | |
| | | Left Tilted | 0.294 | 5.5GHz | 0.076 | 0.37 | | |
| | Band 7 | Right Cheek | 0.528 | 5.8GHz | 0.382 | 0.91 | | |
| | | Right Tilted | 0.267 | 5.5GHz | 0.177 | 0.44 | | |
| | | Left Cheek | 1.196 | 5.5GHz | 0.147 | 1.34 | | |
| | | Left Tilted | 0.155 | 5.5GHz | 0.076 | 0.23 | | |



| WWAN Band | | Exposure Position | 1 | 2 | 3 | 1+2 Summed 10g SAR (W/kg) | 1+3 Summed 10g SAR (W/kg) | SPLSR | Case No |
|-----------|---------|-------------------|---------------------------|-------------------------------------|--|------------------------------------|------------------------------------|-------|---------|
| | | | WWAN 10g SAR (W/kg) | 2.4GHz WLAN 10g SAR (W/kg) | 2.4GHz Bluetooth 10g SAR (W/kg) | | | | |
| GSM | GSM850 | Right Cheek | 0.583 | 0.232 | 0.003 | 0.82 | 0.59 | | |
| | | Right Tilted | 0.318 | 0.119 | 0.001 | 0.44 | 0.32 | | |
| | | Left Cheek | 0.576 | 0.081 | 0.001 | 0.66 | 0.58 | | |
| | | Left Tilted | 0.296 | 0.062 | 0.001 | 0.36 | 0.30 | | |
| | GSM1900 | Right Cheek | 0.319 | 0.232 | 0.003 | 0.55 | 0.32 | | |
| | | Right Tilted | 0.163 | 0.119 | 0.001 | 0.28 | 0.16 | | |
| | | Left Cheek | 0.599 | 0.081 | 0.001 | 0.68 | 0.60 | | |
| | | Left Tilted | 0.144 | 0.062 | 0.001 | 0.21 | 0.15 | | |
| WCDMA | Band V | Right Cheek | 0.510 | 0.232 | 0.003 | 0.74 | 0.51 | | |
| | | Right Tilted | 0.290 | 0.119 | 0.001 | 0.41 | 0.29 | | |
| | | Left Cheek | 0.476 | 0.081 | 0.001 | 0.56 | 0.48 | | |
| | | Left Tilted | 0.266 | 0.062 | 0.001 | 0.33 | 0.27 | | |
| | Band II | Right Cheek | 0.317 | 0.232 | 0.003 | 0.55 | 0.32 | | |
| | | Right Tilted | 0.131 | 0.119 | 0.001 | 0.25 | 0.13 | | |
| | | Left Cheek | 0.451 | 0.081 | 0.001 | 0.53 | 0.45 | | |
| | | Left Tilted | 0.119 | 0.062 | 0.001 | 0.18 | 0.12 | | |
| LTE | Band 5 | Right Cheek | 0.423 | 0.232 | 0.003 | 0.66 | 0.43 | | |
| | | Right Tilted | 0.242 | 0.119 | 0.001 | 0.36 | 0.24 | | |
| | | Left Cheek | 0.409 | 0.081 | 0.001 | 0.49 | 0.41 | | |
| | | Left Tilted | 0.228 | 0.062 | 0.001 | 0.29 | 0.23 | | |
| | Band 7 | Right Cheek | 0.301 | 0.232 | 0.003 | 0.53 | 0.30 | | |
| | | Right Tilted | 0.136 | 0.119 | 0.001 | 0.26 | 0.14 | | |
| | | Left Cheek | 0.623 | 0.081 | 0.001 | 0.70 | 0.62 | | |
| | | Left Tilted | 0.081 | 0.062 | 0.001 | 0.14 | 0.08 | | |



| WWAN Band | | Exposure Position | 1 | 2 | | 1+2 Summed 10g SAR (W/kg) | SPLSR | Case No |
|-----------|---------|-------------------|-------------------|-----------|-------------------|------------------------------------|-------|---------|
| | | | WWAN | 5GHz WLAN | | | | |
| | | | 10g SAR (W/kg) | Band | 10g SAR (W/kg) | | | |
| GSM | GSM850 | Right Cheek | 0.583 | 5.8GHz | 0.115 | 0.70 | | |
| | | Right Tilted | 0.318 | 5.5GHz | 0.061 | 0.38 | | |
| | | Left Cheek | 0.576 | 5.5GHz | 0.052 | 0.63 | | |
| | | Left Tilted | 0.296 | 5.5GHz | 0.027 | 0.32 | | |
| | GSM1900 | Right Cheek | 0.319 | 5.8GHz | 0.115 | 0.43 | | |
| | | Right Tilted | 0.163 | 5.5GHz | 0.061 | 0.22 | | |
| | | Left Cheek | 0.599 | 5.5GHz | 0.052 | 0.65 | | |
| | | Left Tilted | 0.144 | 5.5GHz | 0.027 | 0.17 | | |
| WCDMA | Band V | Right Cheek | 0.510 | 5.8GHz | 0.115 | 0.63 | | |
| | | Right Tilted | 0.290 | 5.5GHz | 0.061 | 0.35 | | |
| | | Left Cheek | 0.476 | 5.5GHz | 0.052 | 0.53 | | |
| | | Left Tilted | 0.266 | 5.5GHz | 0.027 | 0.29 | | |
| | Band II | Right Cheek | 0.317 | 5.8GHz | 0.115 | 0.43 | | |
| | | Right Tilted | 0.131 | 5.5GHz | 0.061 | 0.19 | | |
| | | Left Cheek | 0.451 | 5.5GHz | 0.052 | 0.50 | | |
| | | Left Tilted | 0.119 | 5.5GHz | 0.027 | 0.15 | | |
| LTE | Band 5 | Right Cheek | 0.423 | 5.8GHz | 0.115 | 0.54 | | |
| | | Right Tilted | 0.242 | 5.5GHz | 0.061 | 0.30 | | |
| | | Left Cheek | 0.409 | 5.5GHz | 0.052 | 0.46 | | |
| | | Left Tilted | 0.228 | 5.5GHz | 0.027 | 0.26 | | |
| | Band 7 | Right Cheek | 0.301 | 5.8GHz | 0.115 | 0.42 | | |
| | | Right Tilted | 0.136 | 5.5GHz | 0.061 | 0.20 | | |
| | | Left Cheek | 0.623 | 5.5GHz | 0.052 | 0.68 | | |
| | | Left Tilted | 0.081 | 5.5GHz | 0.027 | 0.11 | | |



15.2 Hotspot Exposure Conditions

| WWAN Band | Exposure Position | 1 | 2 | 3 | 1+2 Summed 1g SAR (W/kg) | 1+3 Summed 1g SAR (W/kg) | SPLSR | Case No | |
|-------------|-------------------|-----------------------|------------------------------|---|--------------------------|--------------------------|-------|---------|--------|
| | | WWAN 1g SAR (W/kg) | 2.4GHz WLAN 1g SAR (W/kg) | 2.4GHz Bluetooth Estimated 1g SAR (W/kg) | | | | | |
| GSM | GSM850 | Front | 0.855 | 0.137 | 0.273 | 0.99 | 1.13 | | |
| | | Back | 0.692 | 0.865 | 0.273 | 1.56 | 0.97 | | |
| | | Left side | 0.717 | 0.550 | 0.273 | 1.27 | 0.99 | | |
| | | Right side | 0.653 | | | 0.65 | 0.65 | | |
| | | Top side | | 0.051 | 0.273 | 0.05 | 0.27 | | |
| | Bottom side | 0.193 | | | 0.19 | 0.19 | | | |
| | GSM1900 | Front | 0.998 | 0.137 | 0.273 | 1.14 | 1.27 | | |
| | | Back | 1.196 | 0.865 | 0.273 | 2.06 | 1.47 | 0.03 | Case 1 |
| | | Left side | 0.558 | 0.550 | 0.273 | 1.11 | 0.83 | | |
| | | Right side | 0.071 | | | 0.07 | 0.07 | | |
| Top side | | | 0.051 | 0.273 | 0.05 | 0.27 | | | |
| Bottom side | 0.325 | | | 0.33 | 0.33 | | | | |
| WCDMA | Band V | Front | 0.887 | 0.137 | 0.273 | 1.02 | 1.16 | | |
| | | Back | 0.891 | 0.865 | 0.273 | 1.76 | 1.16 | 0.03 | Case 2 |
| | | Left side | 0.847 | 0.550 | 0.273 | 1.40 | 1.12 | | |
| | | Right side | 0.831 | | | 0.83 | 0.83 | | |
| | | Top side | | 0.051 | 0.273 | 0.05 | 0.27 | | |
| | Bottom side | 0.167 | | | 0.17 | 0.17 | | | |
| | Band II | Front | 0.953 | 0.137 | 0.273 | 1.09 | 1.23 | | |
| | | Back | 1.133 | 0.865 | 0.273 | 2.00 | 1.41 | 0.03 | Case 3 |
| | | Left side | 0.491 | 0.550 | 0.273 | 1.04 | 0.76 | | |
| | | Right side | 0.095 | | | 0.10 | 0.10 | | |
| Top side | | | 0.051 | 0.273 | 0.05 | 0.27 | | | |
| Bottom side | 0.244 | | | 0.24 | 0.24 | | | | |
| LTE | Band 5 | Front | 0.703 | 0.137 | 0.273 | 0.84 | 0.98 | | |
| | | Back | 0.655 | 0.865 | 0.273 | 1.52 | 0.93 | | |
| | | Left side | 0.569 | 0.550 | 0.273 | 1.12 | 0.84 | | |
| | | Right side | 0.615 | | | 0.62 | 0.62 | | |
| | | Top side | | 0.051 | 0.273 | 0.05 | 0.27 | | |
| | Bottom side | 0.153 | | | 0.15 | 0.15 | | | |
| | Band 7 | Front | 0.743 | 0.137 | 0.273 | 0.88 | 1.02 | | |
| | | Back | 1.002 | 0.865 | 0.273 | 1.87 | 1.28 | 0.02 | Case 4 |
| | | Left side | 0.694 | 0.550 | 0.273 | 1.24 | 0.97 | | |
| | | Right side | 0.058 | | | 0.06 | 0.06 | | |
| Top side | | | 0.051 | 0.273 | 0.05 | 0.27 | | | |
| Bottom side | 0.748 | | | 0.75 | 0.75 | | | | |



| WWAN Band | | Exposure Position | 1 | 2 | | 1+2 Summed 1g SAR (W/kg) | SPLSR | Case No |
|-----------|---------|-------------------|------------------|-----------|------------------|-----------------------------------|-------|---------|
| | | | WWAN | 5GHz WLAN | | | | |
| | | | 1g SAR (W/kg) | Band | 1g SAR (W/kg) | | | |
| GSM | GSM850 | Front | 0.855 | 5.2GHz | 0.164 | 1.02 | | |
| | | Back | 0.692 | 5.8GHz | 0.083 | 0.78 | | |
| | | Left side | 0.717 | 5.2GHz | 0.035 | 0.75 | | |
| | | Right side | 0.653 | | | 0.65 | | |
| | | Top side | | 5.8GHz | 0.007 | 0.01 | | |
| | | Bottom side | 0.193 | | | 0.19 | | |
| | GSM1900 | Front | 0.998 | 5.2GHz | 0.164 | 1.16 | | |
| | | Back | 1.196 | 5.8GHz | 0.083 | 1.28 | | |
| | | Left side | 0.558 | 5.2GHz | 0.035 | 0.59 | | |
| | | Right side | 0.071 | | | 0.07 | | |
| | | Top side | | 5.8GHz | 0.007 | 0.01 | | |
| | | Bottom side | 0.325 | | | 0.33 | | |
| WCDMA | Band V | Front | 0.887 | 5.2GHz | 0.164 | 1.05 | | |
| | | Back | 0.891 | 5.8GHz | 0.083 | 0.97 | | |
| | | Left side | 0.847 | 5.2GHz | 0.035 | 0.88 | | |
| | | Right side | 0.831 | | | 0.83 | | |
| | | Top side | | 5.8GHz | 0.007 | 0.01 | | |
| | | Bottom side | 0.167 | | | 0.17 | | |
| | Band II | Front | 0.953 | 5.2GHz | 0.164 | 1.12 | | |
| | | Back | 1.133 | 5.8GHz | 0.083 | 1.22 | | |
| | | Left side | 0.491 | 5.2GHz | 0.035 | 0.53 | | |
| | | Right side | 0.095 | | | 0.10 | | |
| | | Top side | | 5.8GHz | 0.007 | 0.01 | | |
| | | Bottom side | 0.244 | | | 0.24 | | |
| LTE | Band 5 | Front | 0.703 | 5.2GHz | 0.164 | 0.87 | | |
| | | Back | 0.655 | 5.8GHz | 0.083 | 0.74 | | |
| | | Left side | 0.569 | 5.2GHz | 0.035 | 0.60 | | |
| | | Right side | 0.615 | | | 0.62 | | |
| | | Top side | | 5.8GHz | 0.007 | 0.01 | | |
| | | Bottom side | 0.153 | | | 0.15 | | |
| | Band 7 | Front | 0.743 | 5.2GHz | 0.164 | 0.91 | | |
| | | Back | 1.002 | 5.8GHz | 0.083 | 1.09 | | |
| | | Left side | 0.694 | 5.2GHz | 0.035 | 0.73 | | |
| | | Right side | 0.058 | | | 0.06 | | |
| | | Top side | | 5.8GHz | 0.007 | 0.01 | | |
| | | Bottom side | 0.748 | | | 0.75 | | |



| WWAN Band | | Exposure Position | 1 | 2 | 3 | 1+2 Summed 10g SAR (W/kg) | 1+3 Summed 10g SAR (W/kg) | SPLSR | Case No |
|-----------|---------|-------------------|---------------------------|-------------------------------------|---|------------------------------------|------------------------------------|-------|---------|
| | | | WWAN 10g SAR (W/kg) | 2.4GHz WLAN 10g SAR (W/kg) | 2.4GHz Bluetooth Estimated 10g SAR (W/kg) | | | | |
| GSM | GSM850 | Front | 0.663 | 0.068 | 0.109 | 0.73 | 0.77 | | |
| | | Back | 0.474 | 0.384 | 0.109 | 0.86 | 0.58 | | |
| | | Left side | 0.497 | 0.257 | 0.109 | 0.75 | 0.61 | | |
| | | Right side | 0.459 | | | 0.46 | 0.46 | | |
| | | Top side | | 0.026 | 0.109 | 0.03 | 0.11 | | |
| | | Bottom side | 0.109 | | | 0.11 | 0.11 | | |
| | GSM1900 | Front | 0.575 | 0.068 | 0.109 | 0.64 | 0.68 | | |
| | | Back | 0.713 | 0.384 | 0.109 | 1.10 | 0.82 | | |
| | | Left side | 0.333 | 0.257 | 0.109 | 0.59 | 0.44 | | |
| | | Right side | 0.043 | | | 0.04 | 0.04 | | |
| | | Top side | | 0.026 | 0.109 | 0.03 | 0.11 | | |
| | | Bottom side | 0.193 | | | 0.19 | 0.19 | | |
| WCDMA | Band V | Front | 0.692 | 0.068 | 0.109 | 0.76 | 0.80 | | |
| | | Back | 0.694 | 0.384 | 0.109 | 1.08 | 0.80 | | |
| | | Left side | 0.596 | 0.257 | 0.109 | 0.85 | 0.71 | | |
| | | Right side | 0.580 | | | 0.58 | 0.58 | | |
| | | Top side | | 0.026 | 0.109 | 0.03 | 0.11 | | |
| | | Bottom side | 0.097 | | | 0.10 | 0.10 | | |
| | Band II | Front | 0.563 | 0.068 | 0.109 | 0.63 | 0.67 | | |
| | | Back | 0.666 | 0.384 | 0.109 | 1.05 | 0.78 | | |
| | | Left side | 0.294 | 0.257 | 0.109 | 0.55 | 0.40 | | |
| | | Right side | 0.058 | | | 0.06 | 0.06 | | |
| | | Top side | | 0.026 | 0.109 | 0.03 | 0.11 | | |
| | | Bottom side | 0.149 | | | 0.15 | 0.15 | | |
| LTE | Band 5 | Front | 0.547 | 0.068 | 0.109 | 0.62 | 0.66 | | |
| | | Back | 0.504 | 0.384 | 0.109 | 0.89 | 0.61 | | |
| | | Left side | 0.398 | 0.257 | 0.109 | 0.66 | 0.51 | | |
| | | Right side | 0.425 | | | 0.43 | 0.43 | | |
| | | Top side | | 0.026 | 0.109 | 0.03 | 0.11 | | |
| | | Bottom side | 0.092 | | | 0.09 | 0.09 | | |
| | Band 7 | Front | 0.401 | 0.068 | 0.109 | 0.47 | 0.51 | | |
| | | Back | 0.530 | 0.384 | 0.109 | 0.91 | 0.64 | | |
| | | Left side | 0.352 | 0.257 | 0.109 | 0.61 | 0.46 | | |
| | | Right side | 0.032 | | | 0.03 | 0.03 | | |
| | | Top side | | 0.026 | 0.109 | 0.03 | 0.11 | | |
| | | Bottom side | 0.345 | | | 0.35 | 0.35 | | |



| WWAN Band | | Exposure Position | 1 | 2 | | 1+2 Summed 10g SAR (W/kg) | SPLSR | Case No |
|-----------|---------|-------------------|-------------------|-----------|-------------------|------------------------------------|-------|---------|
| | | | WWAN | 5GHz WLAN | | | | |
| | | | 10g SAR (W/kg) | Band | 10g SAR (W/kg) | | | |
| GSM | GSM850 | Front | 0.663 | 5.2GHz | 0.048 | 0.71 | | |
| | | Back | 0.474 | 5.8GHz | 0.024 | 0.50 | | |
| | | Left side | 0.497 | 5.2GHz | 0.010 | 0.51 | | |
| | | Right side | 0.459 | | | 0.46 | | |
| | | Top side | | 5.8GHz | 0.002 | 0.00 | | |
| | | Bottom side | 0.109 | | | 0.11 | | |
| | GSM1900 | Front | 0.575 | 5.2GHz | 0.048 | 0.62 | | |
| | | Back | 0.713 | 5.8GHz | 0.024 | 0.74 | | |
| | | Left side | 0.333 | 5.2GHz | 0.010 | 0.34 | | |
| | | Right side | 0.043 | | | 0.04 | | |
| | | Top side | | 5.8GHz | 0.002 | 0.00 | | |
| | | Bottom side | 0.193 | | | 0.19 | | |
| WCDMA | Band V | Front | 0.692 | 5.2GHz | 0.048 | 0.74 | | |
| | | Back | 0.694 | 5.8GHz | 0.024 | 0.72 | | |
| | | Left side | 0.596 | 5.2GHz | 0.010 | 0.61 | | |
| | | Right side | 0.580 | | | 0.58 | | |
| | | Top side | | 5.8GHz | 0.002 | 0.00 | | |
| | | Bottom side | 0.097 | | | 0.10 | | |
| | Band II | Front | 0.563 | 5.2GHz | 0.048 | 0.61 | | |
| | | Back | 0.666 | 5.8GHz | 0.024 | 0.69 | | |
| | | Left side | 0.294 | 5.2GHz | 0.010 | 0.30 | | |
| | | Right side | 0.058 | | | 0.06 | | |
| | | Top side | | 5.8GHz | 0.002 | 0.00 | | |
| | | Bottom side | 0.149 | | | 0.15 | | |
| LTE | Band 5 | Front | 0.547 | 5.2GHz | 0.048 | 0.60 | | |
| | | Back | 0.504 | 5.8GHz | 0.024 | 0.53 | | |
| | | Left side | 0.398 | 5.2GHz | 0.010 | 0.41 | | |
| | | Right side | 0.425 | | | 0.43 | | |
| | | Top side | | 5.8GHz | 0.002 | 0.00 | | |
| | | Bottom side | 0.092 | | | 0.09 | | |
| | Band 7 | Front | 0.401 | 5.2GHz | 0.048 | 0.45 | | |
| | | Back | 0.530 | 5.8GHz | 0.024 | 0.55 | | |
| | | Left side | 0.352 | 5.2GHz | 0.010 | 0.36 | | |
| | | Right side | 0.032 | | | 0.03 | | |
| | | Top side | | 5.8GHz | 0.002 | 0.00 | | |
| | | Bottom side | 0.345 | | | 0.35 | | |



15.3 Body-Worn Accessory Exposure Conditions

| WWAN Band | Exposure Position | 1 | 2 | 3 | 1+2 Summed 1g SAR (W/kg) | 1+3 Summed 1g SAR (W/kg) | SPLSR | Case No |
|-----------|-------------------|---------------|---------------|-------------------------|--------------------------|--------------------------|-------|---------|
| | | WWAN | 2.4GHz WLAN | 2.4GHz Bluetooth | | | | |
| | | 1g SAR (W/kg) | 1g SAR (W/kg) | Estimated 1g SAR (W/kg) | | | | |
| GSM | GSM850 | Front | 0.789 | 0.074 | 0.182 | 0.86 | 0.97 | |
| | | Back | 0.736 | 0.343 | 0.182 | 1.08 | 0.92 | |
| | GSM1900 | Front | 0.491 | 0.074 | 0.182 | 0.57 | 0.67 | |
| | | Back | 0.645 | 0.343 | 0.182 | 0.99 | 0.83 | |
| WCDMA | Band V | Front | 0.845 | 0.074 | 0.182 | 0.92 | 1.03 | |
| | | Back | 0.836 | 0.343 | 0.182 | 1.18 | 1.02 | |
| | Band II | Front | 0.483 | 0.074 | 0.182 | 0.56 | 0.67 | |
| | | Back | 0.633 | 0.343 | 0.182 | 0.98 | 0.82 | |
| LTE | Band 5 | Front | 0.681 | 0.074 | 0.182 | 0.76 | 0.86 | |
| | | Back | 0.608 | 0.343 | 0.182 | 0.95 | 0.79 | |
| | Band 7 | Front | 0.473 | 0.074 | 0.182 | 0.55 | 0.66 | |
| | | Back | 0.435 | 0.343 | 0.182 | 0.78 | 0.62 | |

| WWAN Band | Exposure Position | 1 | 2 | | 1+2 Summed 1g SAR (W/kg) | SPLSR | Case No |
|-----------|-------------------|---------------|-----------|---------------|--------------------------|-------|---------|
| | | WWAN | 5GHz WLAN | | | | |
| | | 1g SAR (W/kg) | Band | 1g SAR (W/kg) | | | |
| GSM | GSM850 | Front | 0.789 | 5.2GHz | 0.083 | 0.87 | |
| | | Back | 0.736 | 5.3GHz | 0.059 | 0.80 | |
| | GSM1900 | Front | 0.491 | 5.2GHz | 0.083 | 0.57 | |
| | | Back | 0.645 | 5.3GHz | 0.059 | 0.70 | |
| WCDMA | Band V | Front | 0.845 | 5.2GHz | 0.083 | 0.93 | |
| | | Back | 0.836 | 5.3GHz | 0.059 | 0.90 | |
| | Band II | Front | 0.483 | 5.2GHz | 0.083 | 0.57 | |
| | | Back | 0.633 | 5.3GHz | 0.059 | 0.69 | |
| LTE | Band 5 | Front | 0.681 | 5.2GHz | 0.083 | 0.76 | |
| | | Back | 0.608 | 5.3GHz | 0.059 | 0.67 | |
| | Band 7 | Front | 0.473 | 5.2GHz | 0.083 | 0.56 | |
| | | Back | 0.435 | 5.3GHz | 0.059 | 0.49 | |

| WWAN Band | Exposure Position | 1 | 2 | 3 | 1+2 Summed 10g SAR (W/kg) | 1+3 Summed 10g SAR (W/kg) | SPLSR | Case No |
|-----------|-------------------|----------------|----------------|--------------------------|---------------------------|---------------------------|-------|---------|
| | | WWAN | 2.4GHz WLAN | 2.4GHz Bluetooth | | | | |
| | | 10g SAR (W/kg) | 10g SAR (W/kg) | Estimated 10g SAR (W/kg) | | | | |
| GSM | GSM850 | Front | 0.604 | 0.038 | 0.073 | 0.64 | 0.68 | |
| | | Back | 0.566 | 0.167 | 0.073 | 0.73 | 0.64 | |
| | GSM1900 | Front | 0.315 | 0.038 | 0.073 | 0.35 | 0.39 | |
| | | Back | 0.404 | 0.167 | 0.073 | 0.57 | 0.48 | |
| WCDMA | Band V | Front | 0.646 | 0.038 | 0.073 | 0.68 | 0.72 | |
| | | Back | 0.643 | 0.167 | 0.073 | 0.81 | 0.72 | |
| | Band II | Front | 0.311 | 0.038 | 0.073 | 0.35 | 0.38 | |
| | | Back | 0.396 | 0.167 | 0.073 | 0.56 | 0.47 | |
| LTE | Band 5 | Front | 0.521 | 0.038 | 0.073 | 0.56 | 0.59 | |
| | | Back | 0.467 | 0.167 | 0.073 | 0.63 | 0.54 | |
| | Band 7 | Front | 0.263 | 0.038 | 0.073 | 0.30 | 0.34 | |
| | | Back | 0.243 | 0.167 | 0.073 | 0.41 | 0.32 | |



| WWAN Band | | Exposure Position | 1 | 2 | | 1+2 Summed 10g SAR (W/kg) | SPLSR | Case No |
|-----------|---------|-------------------|-------------------|-----------|------------------|------------------------------------|-------|---------|
| | | | WWAN | 5GHz WLAN | | | | |
| | | | 10g SAR (W/kg) | Band | 10gSAR (W/kg) | | | |
| GSM | GSM850 | Front | 0.604 | 5.2GHz | 0.029 | 0.63 | | |
| | | Back | 0.566 | 5.3GHz | 0.019 | 0.59 | | |
| | GSM1900 | Front | 0.315 | 5.2GHz | 0.029 | 0.34 | | |
| | | Back | 0.404 | 5.3GHz | 0.019 | 0.42 | | |
| WCDMA | Band V | Front | 0.646 | 5.2GHz | 0.029 | 0.68 | | |
| | | Back | 0.643 | 5.3GHz | 0.019 | 0.66 | | |
| | Band II | Front | 0.311 | 5.2GHz | 0.029 | 0.34 | | |
| | | Back | 0.396 | 5.3GHz | 0.019 | 0.42 | | |
| LTE | Band 5 | Front | 0.521 | 5.2GHz | 0.029 | 0.55 | | |
| | | Back | 0.467 | 5.3GHz | 0.019 | 0.49 | | |
| | Band 7 | Front | 0.263 | 5.2GHz | 0.029 | 0.29 | | |
| | | Back | 0.243 | 5.3GHz | 0.019 | 0.26 | | |

15.4 SPLSR Evaluation and Analysis

General Note:

- SPLSR = $(SAR_1 + SAR_2)^{1.5} / (\text{min. separation distance, mm})$. If $SPLSR \leq 0.04$, simultaneously transmission SAR measurement is not necessary

| Case 1 | Band | Position | SAR (W/kg) | Gap (cm) | SAR peak location (m) | | | 3D distance (mm) | Summed SAR (W/kg) | SPLSR Results | Simultaneous SAR |
|--------|-------------|----------|------------|----------|-----------------------|---------|--------|------------------|-------------------|---------------|------------------|
| | GSM1900 | | | | X | Y | Z | | | | |
| | 2.4GHz WLAN | Back | 0.865 | 1cm | 0.0146 | 0.0492 | -0.204 | 102.2 | 2.06 | 0.03 | Not required |
| | GSM1900 | | 1.196 | 1cm | 0.005 | -0.0525 | -0.205 | | | | |

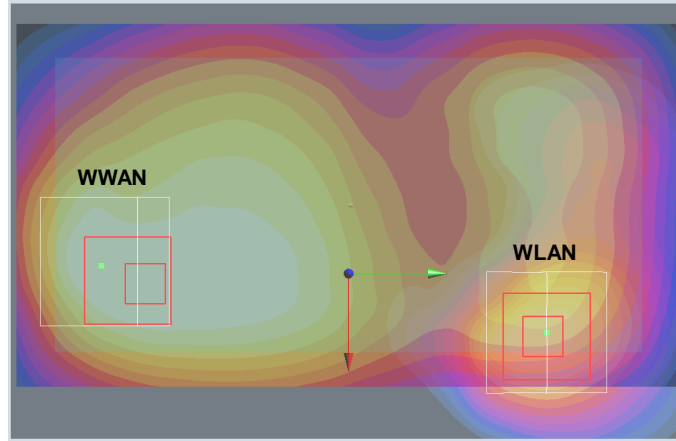

| Case 2 | Band | Position | SAR (W/kg) | Gap (cm) | SAR peak location (m) | | | 3D distance (mm) | Summed SAR (W/kg) | SPLSR Results | Simultaneous SAR |
|--------|-------------|----------|------------|----------|-----------------------|---------|--------|------------------|-------------------|---------------|------------------|
| | WCDMA V | | | | X | Y | Z | | | | |
| | 2.4GHz WLAN | Back | 0.865 | 1cm | 0.0146 | 0.0492 | -0.204 | 70.4 | 1.76 | 0.03 | Not required |
| | WCDMA V | | 0.891 | 1cm | -0.0285 | -0.0065 | -0.205 | | | | |

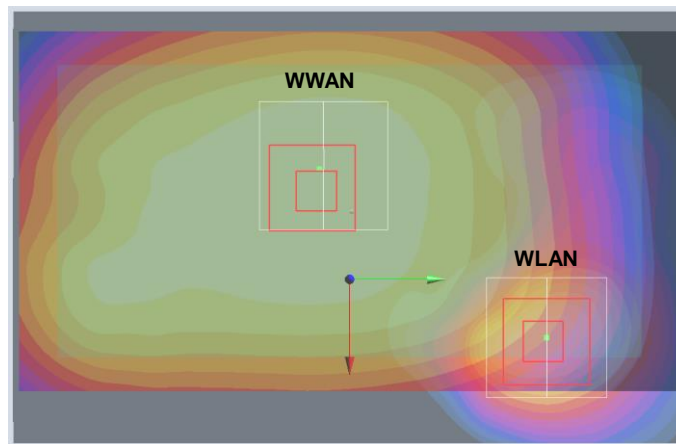

| Case 3 | Band | Position | SAR (W/kg) | Gap (cm) | SAR peak location (m) | | | 3D distance (mm) | Summed SAR (W/kg) | SPLSR Results | Simultaneous SAR |
|--------|-------------|----------|------------|----------|-----------------------|--------|--------|------------------|-------------------|---------------|------------------|
| | WCDMA II | | | | X | Y | Z | | | | |
| | 2.4GHz WLAN | Back | 0.865 | 1cm | 0.0146 | 0.0492 | -0.204 | 102.2 | 2.00 | 0.03 | Not required |

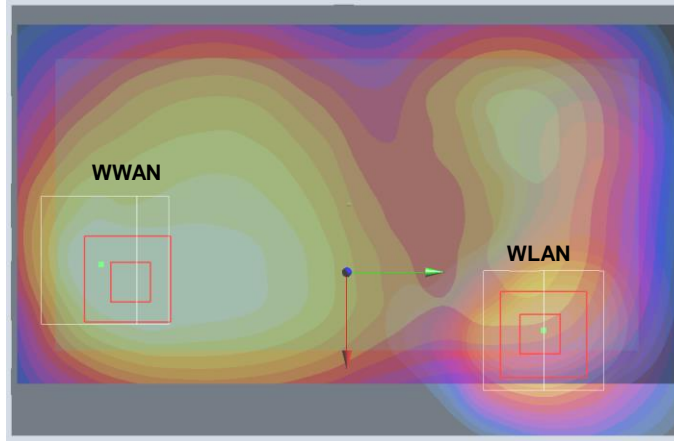

| Case 4 | Band | Position | SAR (W/kg) | Gap (cm) | SAR peak location (m) | | | 3D distance (mm) | Summed SAR (W/kg) | SPLSR Results | Simultaneous SAR |
|--------|-------------|----------|------------|----------|-----------------------|--------|--------|------------------|-------------------|---------------|------------------|
| | LTE Band 7 | | | | X | Y | Z | | | | |
| | 2.4GHz WLAN | Back | 0.865 | 1cm | 0.0146 | 0.0492 | -0.204 | 107.2 | 1.87 | 0.02 | Not required |

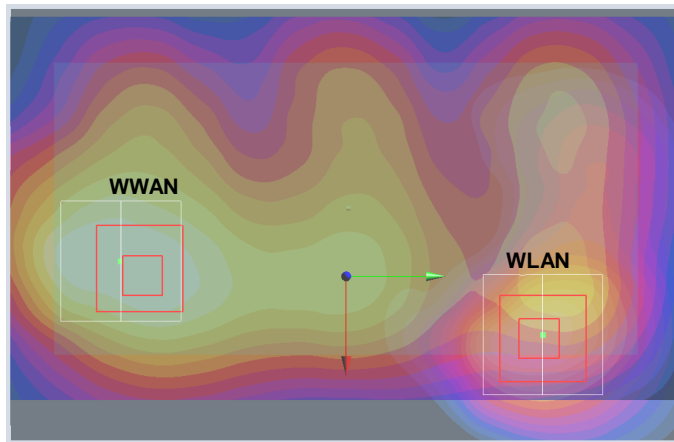

Test Engineer : Ken Li, Tommy Chen, Frank Wu, Domo Hsiao, Jerry Hu, Lawrence Chen, Poa Pan, Mood Huang, Vic Yang and Kurt Liu

16. Uncertainty Assessment

The component of uncertainty may generally be categorized according to the methods used to evaluate them. The evaluation of uncertainty by the statistical analysis of a series of observations is termed a Type A evaluation of uncertainty. The evaluation of uncertainty by means other than the statistical analysis of a series of observation is termed a Type B evaluation of uncertainty. Each component of uncertainty, however evaluated, is represented by an estimated standard deviation, termed standard uncertainty, which is determined by the positive square root of the estimated variance.

A Type A evaluation of standard uncertainty may be based on any valid statistical method for treating data. This includes calculating the standard deviation of the mean of a series of independent observations; using the method of least squares to fit a curve to the data in order to estimate the parameter of the curve and their standard deviations; or carrying out an analysis of variance in order to identify and quantify random effects in certain kinds of measurement.

A type B evaluation of standard uncertainty is typically based on scientific judgment using all of the relevant information available. These may include previous measurement data, experience, and knowledge of the behavior and properties of relevant materials and instruments, manufacture’s specification, data provided in calibration reports and uncertainties assigned to reference data taken from handbooks. Broadly speaking, the uncertainty is either obtained from an outdoor source or obtained from an assumed distribution, such as the normal distribution, rectangular or triangular distributions indicated in table below.

| Uncertainty Distributions | Normal | Rectangular | Triangular | U-Shape |
|------------------------------------|--------------------|-------------|------------|---------|
| Multi-plying Factor ^(a) | 1/k ^(b) | 1/√3 | 1/√6 | 1/√2 |

(a) standard uncertainty is determined as the product of the multiplying factor and the estimated range of variations in the measured quantity

(b) κ is the coverage factor

Table 16.1. Standard Uncertainty for Assumed Distribution

The combined standard uncertainty of the measurement result represents the estimated standard deviation of the result. It is obtained by combining the individual standard uncertainties of both Type A and Type B evaluation using the usual “root-sum-squares” (RSS) methods of combining standard deviations by taking the positive square root of the estimated variances.

Expanded uncertainty is a measure of uncertainty that defines an interval about the measurement result within which the measured value is confidently believed to lie. It is obtained by multiplying the combined standard uncertainty by a coverage factor. Typically, the coverage factor ranges from 2 to 3. Using a coverage factor allows the true value of a measured quantity to be specified with a defined probability within the specified uncertainty range. For purpose of this document, a coverage factor two is used, which corresponds to confidence interval of about 95 %. The DASY uncertainty Budget is shown in the following tables.



| Error Description | Uncertainty Value (±%) | Probability Distribution | Divisor | Ci (1g) | Ci (10g) | Standard Uncertainty (1g) | Standard Uncertainty (10g) |
|--------------------------------------|------------------------|--------------------------|---------|---------|----------|---------------------------|----------------------------|
| Measurement System | | | | | | | |
| Probe Calibration | 6.0 | Normal | 1 | 1 | 1 | ± 6.0 % | ± 6.0 % |
| Axial Isotropy | 4.7 | Rectangular | √3 | 0.7 | 0.7 | ± 1.9 % | ± 1.9 % |
| Hemispherical Isotropy | 9.6 | Rectangular | √3 | 0.7 | 0.7 | ± 3.9 % | ± 3.9 % |
| Boundary Effects | 1.0 | Rectangular | √3 | 1 | 1 | ± 0.6 % | ± 0.6 % |
| Linearity | 4.7 | Rectangular | √3 | 1 | 1 | ± 2.7 % | ± 2.7 % |
| System Detection Limits | 1.0 | Rectangular | √3 | 1 | 1 | ± 0.6 % | ± 0.6 % |
| Readout Electronics | 0.3 | Normal | 1 | 1 | 1 | ± 0.3 % | ± 0.3 % |
| Response Time | 0.8 | Rectangular | √3 | 1 | 1 | ± 0.5 % | ± 0.5 % |
| Integration Time | 2.6 | Rectangular | √3 | 1 | 1 | ± 1.5 % | ± 1.5 % |
| RF Ambient Noise | 3.0 | Rectangular | √3 | 1 | 1 | ± 1.7 % | ± 1.7 % |
| RF Ambient Reflections | 3.0 | Rectangular | √3 | 1 | 1 | ± 1.7 % | ± 1.7 % |
| Probe Positioner | 0.4 | Rectangular | √3 | 1 | 1 | ± 0.2 % | ± 0.2 % |
| Probe Positioning | 2.9 | Rectangular | √3 | 1 | 1 | ± 1.7 % | ± 1.7 % |
| Max. SAR Eval. | 1.0 | Rectangular | √3 | 1 | 1 | ± 0.6 % | ± 0.6 % |
| Test Sample Related | | | | | | | |
| Device Positioning | 2.9 | Normal | 1 | 1 | 1 | ± 2.9 % | ± 2.9 % |
| Device Holder | 3.6 | Normal | 1 | 1 | 1 | ± 3.6 % | ± 3.6 % |
| Power Drift | 5.0 | Rectangular | √3 | 1 | 1 | ± 2.9 % | ± 2.9 % |
| Phantom and Setup | | | | | | | |
| Phantom Uncertainty | 4.0 | Rectangular | √3 | 1 | 1 | ± 2.3 % | ± 2.3 % |
| Liquid Conductivity (Target) | 5.0 | Rectangular | √3 | 0.64 | 0.43 | ± 1.8 % | ± 1.2 % |
| Liquid Conductivity (Meas.) | 2.5 | Normal | 1 | 0.64 | 0.43 | ± 1.6 % | ± 1.1 % |
| Liquid Permittivity (Target) | 5.0 | Rectangular | √3 | 0.6 | 0.49 | ± 1.7 % | ± 1.4 % |
| Liquid Permittivity (Meas.) | 2.5 | Normal | 1 | 0.6 | 0.49 | ± 1.5 % | ± 1.2 % |
| Combined Standard Uncertainty | | | | | | ± 11.0 % | ± 10.8 % |
| Coverage Factor for 95 % | | | | | | K=2 | |
| Expanded Uncertainty | | | | | | ± 22.0 % | ± 21.5 % |

Table 16.2. Uncertainty Budget for frequency range 300 MHz to 3 GHz



| Error Description | Uncertainty Value (±%) | Probability Distribution | Divisor | Ci (1g) | Ci (10g) | Standard Uncertainty (1g) | Standard Uncertainty (10g) |
|--------------------------------------|------------------------|--------------------------|---------|---------|----------|---------------------------|----------------------------|
| Measurement System | | | | | | | |
| Probe Calibration | 6.55 | Normal | 1 | 1 | 1 | ± 6.55 % | ± 6.55 % |
| Axial Isotropy | 4.7 | Rectangular | √3 | 0.7 | 0.7 | ± 1.9 % | ± 1.9 % |
| Hemispherical Isotropy | 9.6 | Rectangular | √3 | 0.7 | 0.7 | ± 3.9 % | ± 3.9 % |
| Boundary Effects | 2.0 | Rectangular | √3 | 1 | 1 | ± 1.2 % | ± 1.2 % |
| Linearity | 4.7 | Rectangular | √3 | 1 | 1 | ± 2.7 % | ± 2.7 % |
| System Detection Limits | 1.0 | Rectangular | √3 | 1 | 1 | ± 0.6 % | ± 0.6 % |
| Readout Electronics | 0.3 | Normal | 1 | 1 | 1 | ± 0.3 % | ± 0.3 % |
| Response Time | 0.8 | Rectangular | √3 | 1 | 1 | ± 0.5 % | ± 0.5 % |
| Integration Time | 2.6 | Rectangular | √3 | 1 | 1 | ± 1.5 % | ± 1.5 % |
| RF Ambient Noise | 3.0 | Rectangular | √3 | 1 | 1 | ± 1.7 % | ± 1.7 % |
| RF Ambient Reflections | 3.0 | Rectangular | √3 | 1 | 1 | ± 1.7 % | ± 1.7 % |
| Probe Positioner | 0.8 | Rectangular | √3 | 1 | 1 | ± 0.5 % | ± 0.5 % |
| Probe Positioning | 9.9 | Rectangular | √3 | 1 | 1 | ± 5.7 % | ± 5.7 % |
| Max. SAR Eval. | 4.0 | Rectangular | √3 | 1 | 1 | ± 2.3 % | ± 2.3 % |
| Test Sample Related | | | | | | | |
| Device Positioning | 2.9 | Normal | 1 | 1 | 1 | ± 2.9 % | ± 2.9 % |
| Device Holder | 3.6 | Normal | 1 | 1 | 1 | ± 3.6 % | ± 3.6 % |
| Power Drift | 5.0 | Rectangular | √3 | 1 | 1 | ± 2.9 % | ± 2.9 % |
| Phantom and Setup | | | | | | | |
| Phantom Uncertainty | 4.0 | Rectangular | √3 | 1 | 1 | ± 2.3 % | ± 2.3 % |
| Liquid Conductivity (Target) | 5.0 | Rectangular | √3 | 0.64 | 0.43 | ± 1.8 % | ± 1.2 % |
| Liquid Conductivity (Meas.) | 2.5 | Normal | 1 | 0.64 | 0.43 | ± 1.6 % | ± 1.1 % |
| Liquid Permittivity (Target) | 5.0 | Rectangular | √3 | 0.6 | 0.49 | ± 1.7 % | ± 1.4 % |
| Liquid Permittivity (Meas.) | 2.5 | Normal | 1 | 0.6 | 0.49 | ± 1.5 % | ± 1.2 % |
| Combined Standard Uncertainty | | | | | | ± 12.8 % | ± 12.6 % |
| Coverage Factor for 95 % | | | | | | K=2 | |
| Expanded Uncertainty | | | | | | ± 25.6 % | ± 25.2 % |

Table 16.3. Uncertainty Budget for frequency range 3 GHz to 6 GHz



17. References

- [1] FCC 47 CFR Part 2 "Frequency Allocations and Radio Treaty Matters; General Rules and Regulations"
- [2] ANSI/IEEE Std. C95.1-1992, "IEEE Standard for Safety Levels with Respect to Human Exposure to Radio Frequency Electromagnetic Fields, 3 kHz to 300 GHz", September 1992
- [3] IEEE Std. 1528-2003, "Recommended Practice for Determining the Peak Spatial-Average Specific Absorption Rate (SAR) in the Human Head from Wireless Communications Devices: Measurement Techniques", December 2003
- [4] SPEAG DASY System Handbook
- [5] FCC KDB 248227 D01 v01r02, "SAR Measurement Procedures for 802.11 a/b/g Transmitters", May 2007
- [6] FCC KDB 447498 D01 v05r02, "Mobile and Portable Device RF Exposure Procedures and Equipment Authorization Policies", Feb 2014
- [7] FCC KDB 648474 D04 v01r02, "SAR Evaluation Considerations for Wireless Handsets", Dec 2013.
- [8] FCC KDB 941225 D01 v03, "3G SAR MEAUREMENT PROCEDURES", Oct 2014
- [9] FCC KDB 941225 D05 v02r03, "SAR Evaluation Considerations for LTE Devices", Dec 2013
- [10] FCC KDB 941225 D06 v02, "SAR Evaluation Procedures for Portable Devices with Wireless Router Capabilities", Oct 2014.
- [11] FCC KDB 865664 D01 v01r03, "SAR Measurement Requirements for 100 MHz to 6 GHz", Feb 2014.
- [12] FCC KDB 865664 D02 v01r01, "RF Exposure Compliance Reporting and Documentation Considerations" May 2013.