



FCC RF Test Report

APPLICANT : Sony Mobile Communications Inc
EQUIPMENT : PDA Phone
BRAND NAME : Sony
TYPE NAME : PM-0780-BV
FCC ID : PY7-PM0780
STANDARD : FCC Part 15 Subpart C §15.247
CLASSIFICATION : (DTS) Digital Transmission System

The product was received on Dec. 03, 2014 and testing was completed on Jan. 07, 2015. We, SPORTON INTERNATIONAL INC., would like to declare that the tested sample has been evaluated in accordance with the test procedures and the testing has shown the tested sample to be in compliance with the applicable technical standards.

The test results in this report apply exclusively to the tested model / sample. Without written approval of SPORTON INTERNATIONAL INC., the test report shall not be reproduced except in full.

Reviewed by: Joseph Lin / Supervisor

Approved by: Jones Tsai / Manager



SPORTON INTERNATIONAL INC.

No. 52, Hwa Ya 1st Rd., Hwa Ya Technology Park, Kwei-Shan Hsiang, Tao Yuan Hsien, Taiwan, R.O.C.



TABLE OF CONTENTS

SREVISION HISTORY 3

SUMMARY OF TEST RESULT 4

1 GENERAL DESCRIPTION..... 5

1.1 Applicant 5

1.2 Manufacturer 5

1.3 Product Feature of Equipment Under Test..... 5

1.4 Product Specification subjective to this standard 6

1.5 Modification of EUT 7

1.6 Test Location 7

1.7 Applicable Standards..... 7

2 TEST CONFIGURATION OF EQUIPMENT UNDER TEST..... 8

2.1 Descriptions of Test Mode 8

2.2 Test Mode 8

2.3 Connection Diagram of Test System 9

2.4 Support Unit used in test configuration and system 10

2.5 EUT Operation Test Setup 10

2.6 Measurement Results Explanation Example..... 10

3 TEST RESULT 11

3.1 6dB Bandwidth Measurement 11

3.2 Peak Output Power Measurement 14

3.3 Power Spectral Density Measurement 16

3.4 Conducted Band Edges and Spurious Emission Measurement 21

3.5 Radiated Band Edges and Spurious Emission Measurement 29

3.6 AC Conducted Emission Measurement..... 33

3.7 Antenna Requirements 37

4 LIST OF MEASURING EQUIPMENT..... 38

5 UNCERTAINTY OF EVALUATION..... 40

APPENDIX A. TEST RESULT OF RADIATED EMISSION



SREVISION HISTORY

| REPORT NO. | VERSION | DESCRIPTION | ISSUED DATE |
|------------|---------|-------------------------|---------------|
| FR4D0327B | Rev. 01 | Initial issue of report | Mar. 02, 2015 |
| | | | |
| | | | |
| | | | |
| | | | |
| | | | |
| | | | |
| | | | |
| | | | |
| | | | |
| | | | |
| | | | |
| | | | |
| | | | |
| | | | |



SUMMARY OF TEST RESULT

| Report Section | FCC Rule | Description | Limit | Result | Remark |
|----------------|--------------------|--|-----------------------|--------|--|
| 3.1 | 15.247(a)(2) | 6dB Bandwidth | $\geq 0.5\text{MHz}$ | Pass | - |
| 3.2 | 15.247(b)(1) | Peak Output Power | $\leq 30\text{dBm}$ | Pass | - |
| 3.3 | 15.247(e) | Power Spectral Density | $\leq 8\text{dBm}$ | Pass | - |
| 3.4 | 15.247(d) | Conducted Band Edges and Spurious Emission | $\leq 20\text{dBc}$ | Pass | - |
| 3.5 | 15.247(d) | Radiated Band Edges and Spurious Emission | 15.209(a) & 15.247(d) | Pass | Under limit 11.90 dB at 2496.160 MHz |
| 3.6 | 15.207 | AC Conducted Emission | 15.207(a) | Pass | Under limit 15.80 dB at 3.446 MHz |
| 3.7 | 15.203 & 15.247(b) | Antenna Requirement | N/A | Pass | - |



1 General Description

1.1 Applicant

Sony Mobile Communications Inc
Nya Vattentorget 22188 Lund/Sweden

1.2 Manufacturer

Sony Mobile Communications Inc
Nya Vattentorget 22188 Lund/Sweden

1.3 Product Feature of Equipment Under Test

The Equipment Under Test (hereafter called: EUT) is PDA Phone supporting, GSM / WCDMA / LTE, Wi-Fi 2.4GHz 802.11b/g/n, 5GHz 802.11a/n, Bluetooth with FM Receiver, GPS, ANT+, and NFC features, and below is details of information

| Product Feature | |
|--------------------------------------|---|
| Equipment | PDA Phone |
| Brand Name | Sony |
| Type Name | PM-0780-BV |
| FCC ID | PY7-PM0780 |
| GSM Operating Band(s) | GSM 850/900/1800/1900MHz |
| GPRS / EGPRS Multi Slot Class | GPRS Class 33 , EGPRS Class 33 |
| WCDMA Operating Band(s) | FDD Band I / II / V / VIII |
| WCDMA Rel. Version | Rel. 8 |
| LTE Operating Band(s) | FDD Band I / II / III / V / VII / VIII / XX |
| LTE Rel. Version | Rel. 10 |
| Wi-Fi Specification | 802.11b/g/n HT20 802.11a/n HT20/HT40 |
| Bluetooth Version | v3.0 + EDR / v4.0 - LE |
| NFC Specification | ISO14443A / ISO14443B / Felica / ISO15693 |
| ANT+ | ANT+ |
| Power Supply | Battery / AC Adapter / Car Charger |

Remark: The above EUT's information was declared by manufacturer. Please refer to the specifications or user's manual for more detailed description.



1.4 Product Specification subjective to this standard

| Product Specification subjective to this standard | |
|---|--|
| Tx/Rx Frequency Range | 2402 MHz ~ 2480 MHz |
| Number of Channels | 40 |
| Carrier Frequency of Each Channel | 40 Channel(37 hopping + 3 advertising channel) |
| Maximum Output Power to Antenna | 3.44 dBm (0.0022 W) |
| Antenna Type | PIFA Antenna type with gain 0.06 dBi |
| Type of Modulation | Bluetooth LE : GFSK |

| EUT Information List | | | | |
|------------------------|------------|-------------|------------|----------------------------|
| IMEI | HW Version | SW Version | S/N | Performed Test Item |
| IMEI : 004402453307021 | AP | 26.1.A.0.79 | YT910ZRX3D | RF conducted measurement |
| IMEI : 004402453307021 | | | YT910ZRX3D | Radiated Spurious Emission |
| IMEI : 004402453306957 | | | YT910ZRWBG | Conducted Emission |

| Accessory List | |
|-------------------|---|
| AC Adapter | Model No. : EP800 |
| | Type No. : CAA-0002016-US |
| | S/N : 3112W49108087 (For Conducted Emission) 3112W49107935 (For Radiated Spurious Emission) |
| Battery | Model No. : Bellis |
| Earphone | Model No. : MH410c |
| | Type No. : AG-1100 |
| | S/N : 12431A1B0011582 (For Conducted Emission) 12431A1E00118A8 (For Radiated Spurious Emission) |
| USB Cable | Model No. : EC450 |
| | Type No. : AI-0700 |
| | S/N : 142412D8250297C (For Conducted Emission) 113912D0171324C (For Radiated Spurious Emission) |

Note:

1. Above EUT list and accessory list used are electrically identical per declared by manufacturer.
2. Above the accessories list are used to exercise the EUT during test.
3. For other wireless features of this EUT, test report will be issued separately.



1.5 Modification of EUT

No modifications are made to the EUT during all test items.

1.6 Test Location

Sporton Lab is accredited to ISO 17025 by Taiwan Accreditation Foundation (TAF code : 1190) and the FCC designation No. TW1022 under the FCC 2.948(e) by Mutual Recognition Agreement (MRA) in FCC Test.

| | | | |
|---------------------------|--|---------|-----------|
| Test Site | SPORTON INTERNATIONAL INC. | | |
| Test Site Location | No. 52, Hwa Ya 1 st Rd., Hwa Ya Technology Park, Kwei-Shan Hsiang, Tao Yuan Hsien, Taiwan, R.O.C. TEL: +886-3-3273456 / FAX: +886-3-3284978 | | |
| Test Site No. | Sporton Site No. | | |
| | TH02-HY | CO05-HY | 03CH07-HY |

Note: The test site complies with ANSI C63.4 2009 requirement.

1.7 Applicable Standards

According to the specifications of the manufacturer, the EUT must comply with the requirements of the following standards:

- ♦ FCC Part 15 Subpart C §15.247
- ♦ FCC KDB Publication No. 558074 D01 DTS Meas. Guidance v03r02
- ♦ ANSI C63.10-2013

Remark:

1. All test items were verified and recorded according to the standards and without any deviation during the test.
2. FCC permits the use of the 1.5 meter table as an alternative in C63.10-2013 through inquiry tracking number 961829.
3. This EUT has also been tested and complied with the requirements of FCC Part 15, Subpart B, recorded in a separate test report.



2 Test Configuration of Equipment Under Test

2.1 Descriptions of Test Mode

The RF output power was recorded in the following table:

| Channel | Frequency | Bluetooth 4.0 – LE RF Output Power | |
|---------|-----------|------------------------------------|--|
| | | Data Rate / Modulation | |
| | | GFSK | |
| | | 1Mbps | |
| Ch00 | 2402MHz | 2.57 dBm | |
| Ch19 | 2440MHz | 3.44 dBm | |
| Ch39 | 2480MHz | 2.17 dBm | |

a. The EUT has been associated with peripherals and configuration operated in a manner tended to maximize its emission characteristics in a typical application. Frequency range investigated: conduction (150 kHz to 30 MHz), radiation (9 kHz to the 10th harmonic of the highest fundamental frequency or to 40 GHz, whichever is lower). Pre-scanned tests, X, Y, Z in three orthogonal panels to determine the final configuration (X plane as worst plane) from all possible combinations.

b. AC power line Conducted Emission was tested under maximum output power.

2.2 Test Mode

The following summary table is showing all test modes to demonstrate in compliance with the standard.

| Summary table of Test Cases | |
|-----------------------------|--|
| Test Item | Data Rate / Modulation |
| | Bluetooth 4.0 – LE / GFSK |
| Conducted TCs | Mode 1: Bluetooth Tx CH00_2402 MHz_1Mbps Mode 2: Bluetooth Tx CH19_2440 MHz_1Mbps Mode 3: Bluetooth Tx CH39_2480 MHz_1Mbps |
| Radiated TCs | Mode 1: Bluetooth Tx CH00_2402 MHz_1Mbps Mode 2: Bluetooth Tx CH19_2440 MHz_1Mbps Mode 3: Bluetooth Tx CH39_2480 MHz_1Mbps |
| AC Conducted Emission | Mode 1: GSM1900 Idle + Bluetooth Link + WLAN Link + Earphone + Battery + USB Cable (Charging from Adapter) + MP3 |

2.3 Connection Diagram of Test System

<Bluetooth 4.0 – LE Tx Mode>



<AC Conducted Emission Mode>

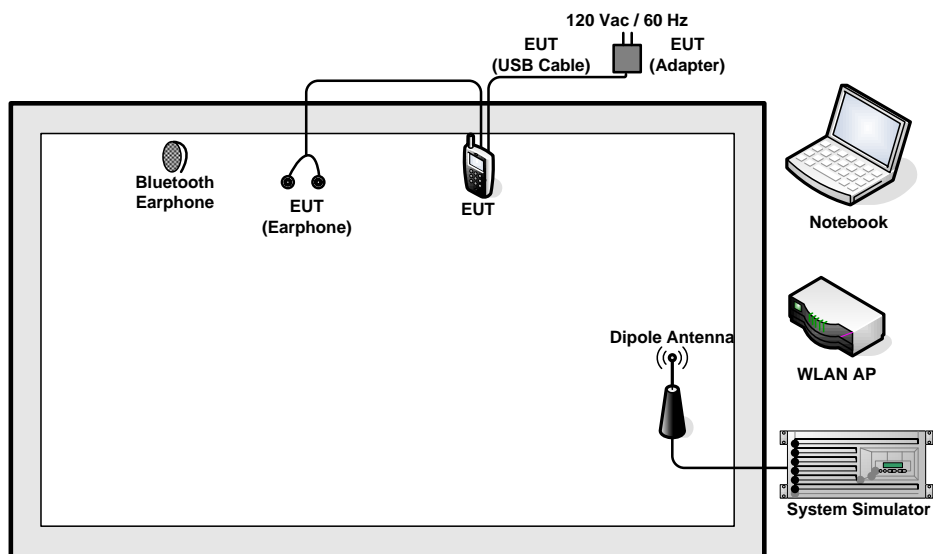



2.4 Support Unit used in test configuration and system

| Item | Equipment | Trade Name | Model Name | FCC ID | Data Cable | Power Cord |
|------|--------------------|------------|----------------|--|-------------------|--|
| 1. | System Simulator | Anritsu | MT8820C | N/A | N/A | Unshielded, 1.8 m |
| 2. | WLAN AP | D-Link | DIR-865L | KA2IR865LA1 | N/A | Unshielded, 1.8 m |
| 3. | Bluetooth Earphone | Sony | SBH20 | PY7-RD0010 | Unshielded, 0.75m | N/A |
| 4. | Notebook | DELL | Latitude E6320 | FCC DoC/ Contains FCC ID: QDS-BRCM1054 | N/A | AC I/P: Unshielded, 1.2 m DC O/P: Shielded, 1.8 m |
| 5. | SD Card | SanDisk | MicroSD HC | FCC DoC | N/A | N/A |

2.5 EUT Operation Test Setup

For Bluetooth test items, an engineering test program was provided and enabled to make EUT transmitting and receiving signals.

2.6 Measurement Results Explanation Example

For all conducted test items:

The offset level is set in the spectrum analyzer to compensate the RF cable loss and attenuator factor between EUT conducted output port and spectrum analyzer. With the offset compensation, the spectrum analyzer reading level is exactly the EUT RF output level.

Example :

The spectrum analyzer offset is derived from RF cable loss and attenuator factor.

Offset = RF cable loss + attenuator factor.

Following shows an offset computation example with cable loss 4.2 dB and 10dB attenuator.

$$\begin{aligned}
 \text{Offset(dB)} &= \text{RF cable loss(dB)} + \text{attenuator factor(dB)}. \\
 &= 4.2 + 10 = 14.2 \text{ (dB)}
 \end{aligned}$$

3 Test Result

3.1 6dB Bandwidth Measurement

3.1.1 Limit of 6dB Bandwidth

The minimum 6 dB bandwidth shall be at least 500 kHz.

3.1.2 Measuring Instruments

The measuring equipment is listed in the section 4 of this test report.

3.1.3 Test Procedures

1. The testing follows FCC KDB Publication No. 558074 D01 DTS Meas. Guidance v03r02.
2. The RF output of EUT was connected to the spectrum analyzer by RF cable and attenuator. The path loss was compensated to the results for each measurement.
3. Set to the maximum power setting and enable the EUT transmit continuously.
4. Make the measurement with the spectrum analyzer's resolution bandwidth (RBW) = 100 kHz. Set the Video bandwidth (VBW) = 300 kHz. In order to make an accurate measurement. The 6 dB bandwidth must be greater than 500 kHz.
5. Measure and record the results in the test report.

3.1.4 Test Setup

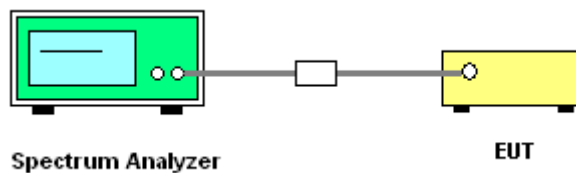



3.1.5 Test Result of 6dB Bandwidth

| | | | |
|-----------------|--------------------|---------------------|---------|
| Test Mode : | Bluetooth 4.0 - LE | Temperature : | 22~25°C |
| Test Engineer : | Osolemio Chang | Relative Humidity : | 51~55% |

| Channel | Frequency (MHz) | 6dB Bandwidth (MHz) | 6dB Bandwidth Min. Limit (MHz) | Pass/Fail |
|---------|-----------------|---------------------|--------------------------------|-----------|
| 00 | 2402 | 0.672 | 0.5 | Pass |
| 19 | 2440 | 0.672 | 0.5 | Pass |
| 39 | 2480 | 0.672 | 0.5 | Pass |

6 dB Bandwidth Plot on Channel 00

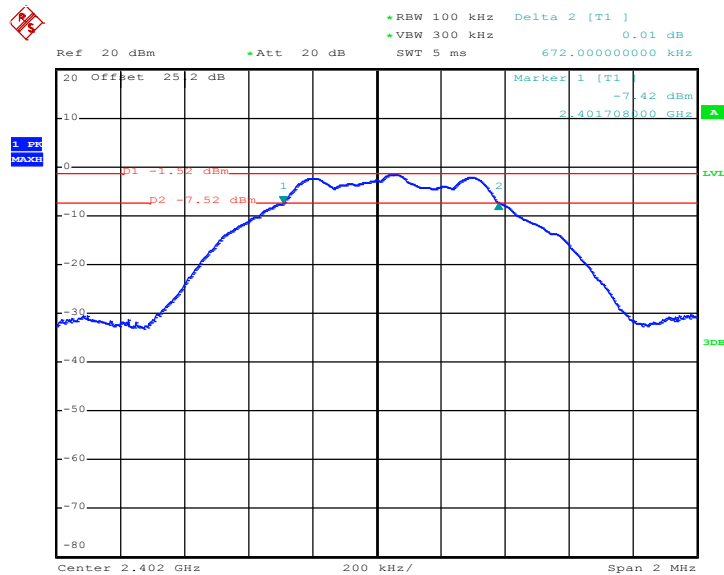

Note: The total loss is 25.2 dB of the RF cable and attenuator, and has been compensated to the spectrum analyzer offset.



6 dB Bandwidth Plot on Channel 19

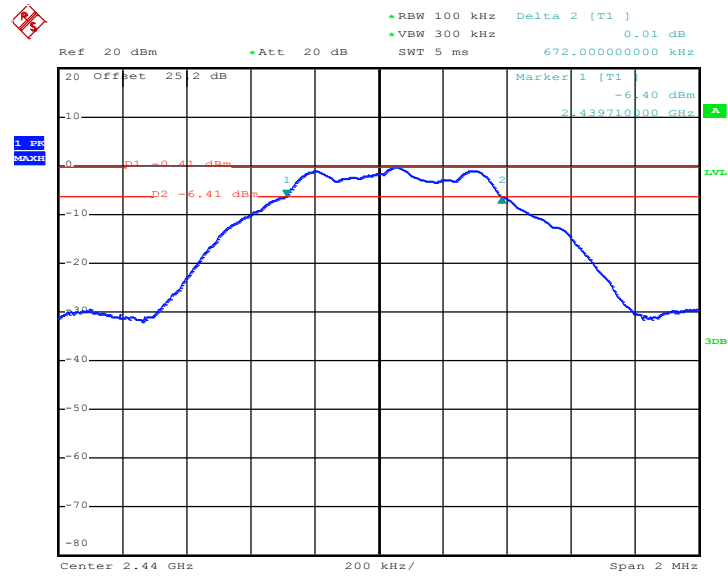

6 dB Bandwidth Plot on Channel 39

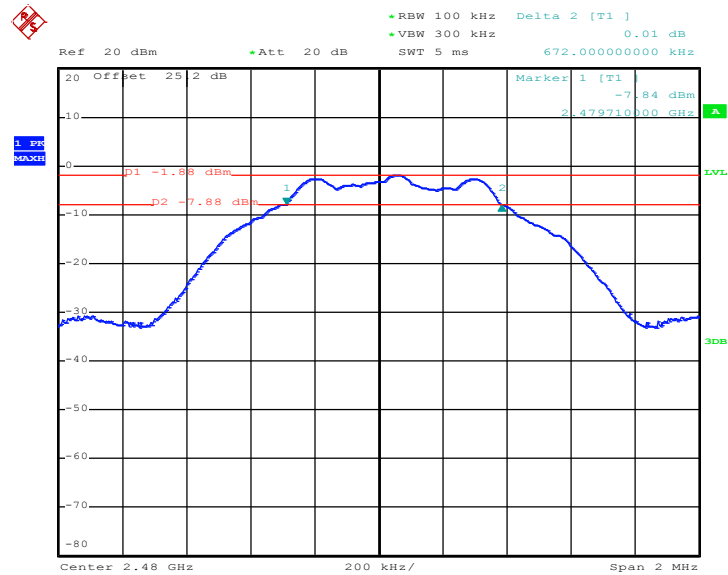

3.2 Peak Output Power Measurement

3.2.1 Limit of Peak Output Power

For systems using digital modulation in the 2400-2483.5MHz, the limit for peak output power is 30dBm. If transmitting antenna of directional gain greater than 6dBi is used, the peak output power from the intentional radiator shall be reduced below the above stated value by the amount in dB that the directional gain of the antenna exceeds 6 dBi. In case of point-to-point operation, the limit has to be reduced by 1dB for every 3dB that the directional gain of the antenna exceeds 6dBi.

3.2.2 Measuring Instruments

The measuring equipment is listed in the section 4 of this test report.

3.2.3 Test Procedures

1. The testing follows the Measurement Procedure of FCC KDB No. 558074 DTS D01 Meas. Guidance v03r02.
2. The RF output of EUT was connected to the power meter by RF cable and attenuator. The path loss was compensated to the results for each measurement.
3. Set to the maximum power setting and enable the EUT transmit continuously.
4. Measure the conducted output power and record the results in the test report.

3.2.4 Test Setup

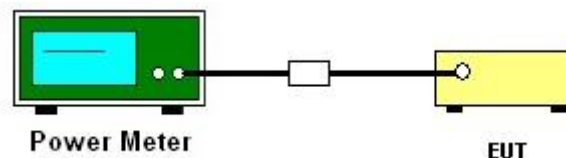



3.2.5 Test Result of Peak Output Power

| | | | |
|-----------------|--------------------|---------------------|---------|
| Test Mode : | Bluetooth 4.0 - LE | Temperature : | 22~25°C |
| Test Engineer : | Osolemio Chang | Relative Humidity : | 51~55% |

| Channel | Frequency (MHz) | RF Power (dBm) | | |
|---------|-----------------|----------------|-------------------|-----------|
| | | GFSK | Max. Limits (dBm) | Pass/Fail |
| | | 1 Mbps | | |
| 00 | 2402 | 2.570 | 30.00 | Pass |
| 19 | 2440 | 3.440 | 30.00 | Pass |
| 39 | 2480 | 2.170 | 30.00 | Pass |

3.3 Power Spectral Density Measurement

3.3.1 Limit of Power Spectral Density

The peak power spectral density shall not be greater than 8dBm in any 3kHz band at any time interval of continuous transmission.

3.3.2 Measuring Instruments

The measuring equipment is listed in the section 4 of this test report.

3.3.3 Test Procedures

1. The testing follows Measurement Procedure 10.2 Method PKPSD of FCC KDB Publication No. 558074 D01 DTS Meas. Guidance v03r02.
2. The RF output of EUT was connected to the spectrum analyzer by RF cable and attenuator. The path loss was compensated to the results for each measurement.
3. Set to the maximum power setting and enable the EUT transmit continuously.
4. Make the measurement with the spectrum analyzer's resolution bandwidth (RBW) = 3 kHz. Video bandwidth VBW = 10 kHz In order to make an accurate measurement, set the span to 1.5 times DTS Channel Bandwidth. (6dB BW)
5. Detector = peak, Sweep time = auto couple, Trace mode = max hold, Allow trace to fully stabilize. Use the peak marker function to determine the maximum power level.
6. Measure and record the results in the test report.
7. The Measured power density (dBm)/ 100kHz is a reference level and used as 20dBc down limit line for Conducted Band Edges and Conducted Spurious Emission.

3.3.4 Test Setup

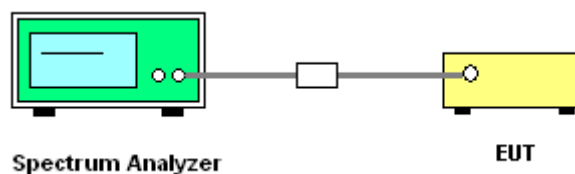



3.3.5 Test Result of Power Spectral Density

| | | | |
|-----------------|--------------------|---------------------|---------|
| Test Mode : | Bluetooth 4.0 - LE | Temperature : | 22~25°C |
| Test Engineer : | Osolemio Chang | Relative Humidity : | 51~55% |

| Channel | Frequency (MHz) | Power Density | | Max. Limits (dBm/3kHz) | Pass/Fail |
|---------|-----------------|------------------|----------------|------------------------|-----------|
| | | PSD/100kHz (dBm) | PSD/3kHz (dBm) | | |
| 00 | 2402 | -1.560 | -16.760 | 8 | Pass |
| 19 | 2440 | -0.420 | -15.660 | 8 | Pass |
| 39 | 2480 | -1.900 | -17.110 | 8 | Pass |

Note:

1. The total loss is 25.2 dB of the RF cable and attenuator, and has been compensated to the spectrum analyzer offset.
2. Measured power density (dBm) has offset with cable loss.
3. The Measured power density (dBm)/ 100kHz is reference level and used as 20dBc down for Conducted Band Edges and Conducted Spurious Emission limit line.

3.3.6 Test Result of Power Spectral Density Plots (100kHz)

PSD 100kHz Plot on Channel 00

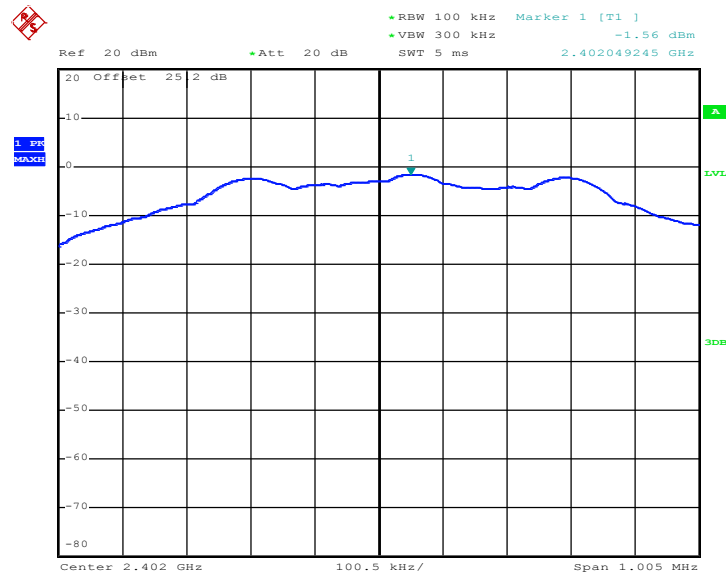



PSD 100kHz Plot on Channel 19

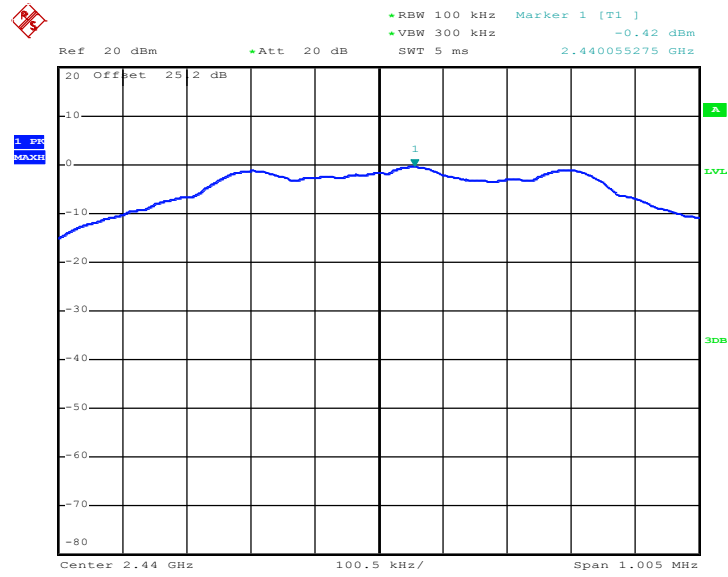

PSD 100kHz Plot on Channel 39

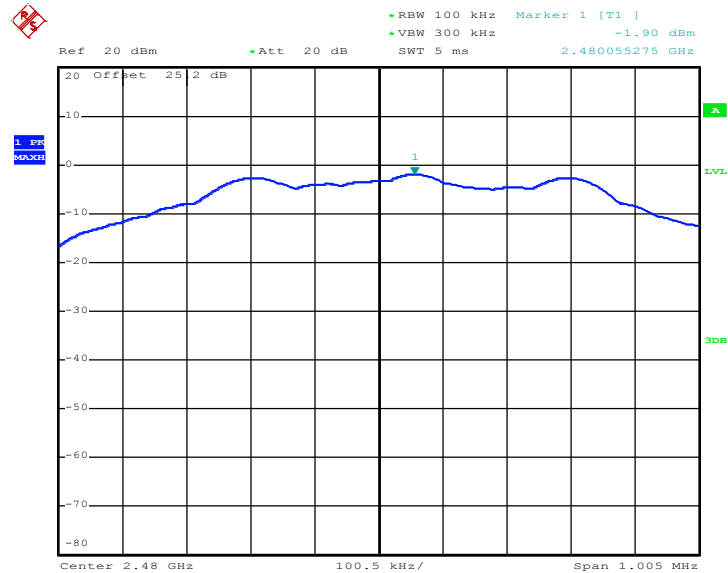



3.3.7 Test Result of Power Spectral Density Plots (3kHz)

PSD 3kHz Plot on Channel 00

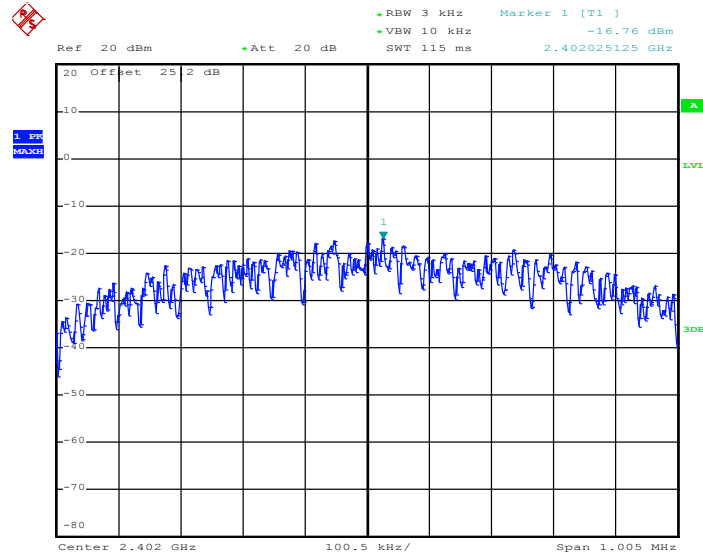

PSD 3kHz Plot on Channel 19

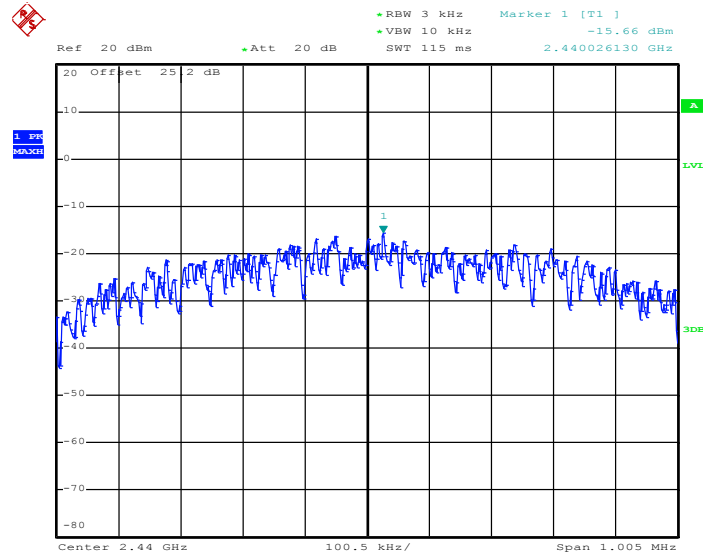



PSD 3kHz Plot on Channel 39

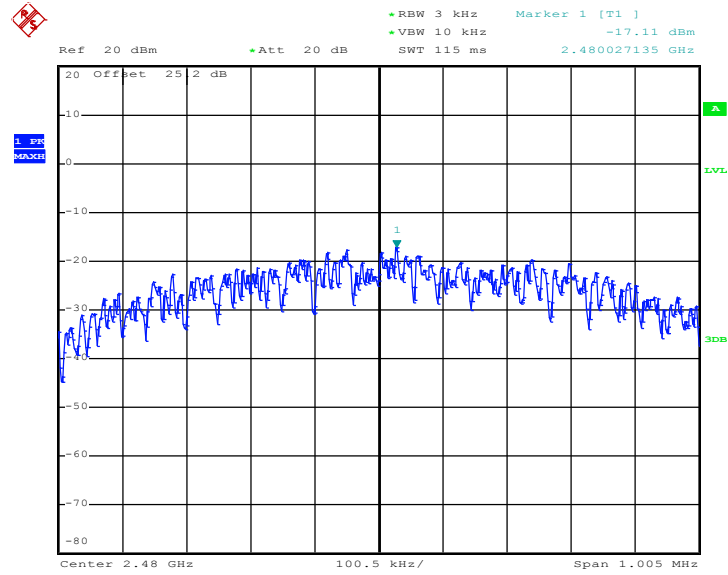

3.4 Conducted Band Edges and Spurious Emission Measurement

3.4.1 Limit of Conducted Band Edges and Spurious Emission

All harmonics/spurious must be at least 20 dB down from the highest emission level within the authorized band.

3.4.2 Measuring Instruments

The measuring equipment is listed in the section 4 of this test report.

3.4.3 Test Procedure

1. The testing follows FCC KDB Publication No. 558074 D01 DTS Meas. Guidance v03r02.
2. The RF output of EUT was connected to the spectrum analyzer by RF cable and attenuator. The path loss was compensated to the results for each measurement.
3. Set to the maximum power setting and enable the EUT transmit continuously.
4. Set RBW = 100 kHz, VBW=300 kHz, Peak Detector. Unwanted Emissions measured in any 100 kHz bandwidth outside of the authorized frequency band shall be attenuated by at least 20 dB relative to the maximum in-band peak PSD level in 100 kHz when maximum peak conducted output power procedure is used. If the transmitter complies with the conducted power limits based on the use of RMS averaging over a time interval, the attenuation required under this paragraph shall be 30 dB instead of 20 dB per 15.247(d).
5. Measure and record the results in the test report.
6. The RF fundamental frequency should be excluded against the limit line in the operating frequency band.

3.4.4 Test Setup

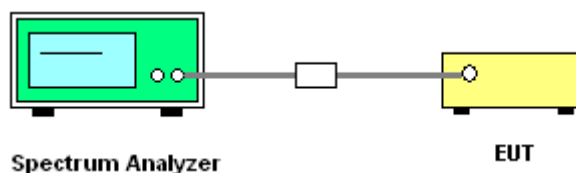



3.4.5 Test Result of Conducted Band Edges

| | | | |
|----------------|--------------------|---------------------|----------------|
| Test Mode : | Bluetooth 4.0 - LE | Temperature : | 22~25°C |
| Test Channel : | 00 and 39 | Relative Humidity : | 51~55% |
| | | Test Engineer : | Osolemio Chang |

Low Band Edge Plot on Channel 00

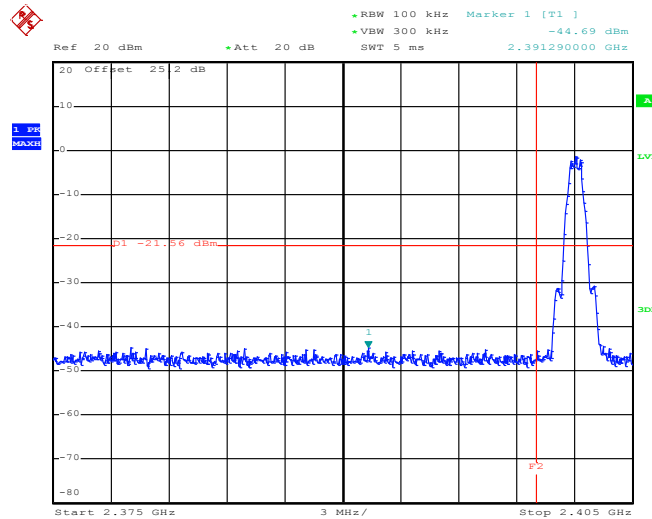

High Band Edge Plot on Channel 39

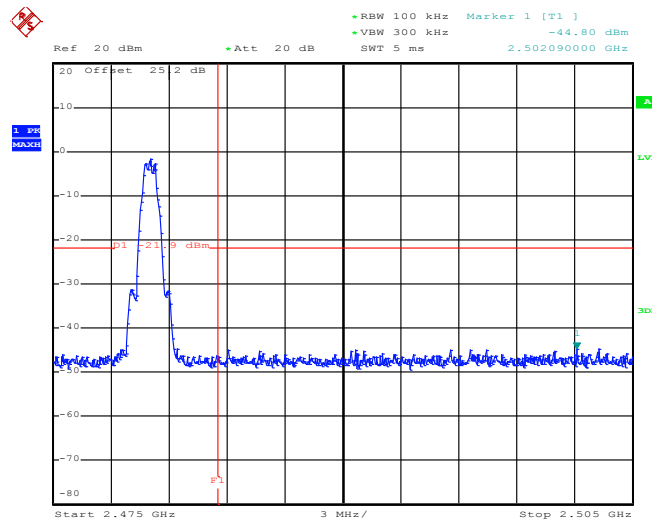

3.4.6 Test Result of Conducted Spurious Emission

| | | | |
|----------------|--------------------|---------------------|----------------|
| Test Mode : | Bluetooth 4.0 - LE | Temperature : | 22~25°C |
| Test Channel : | 00 | Relative Humidity : | 51~55% |
| | | Test Engineer : | Osolemio Chang |

Conducted Spurious Emission Plot on Bluetooth LE 1Mbps GFSK Channel 00

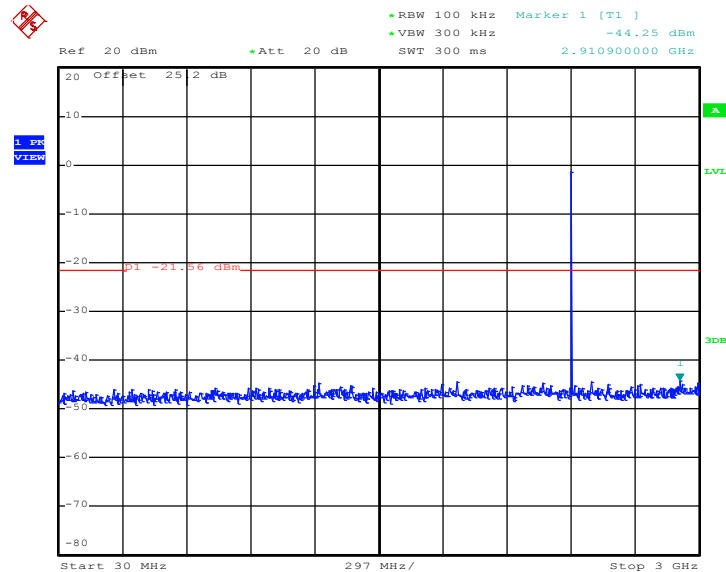

Note:

1. The total loss is 25.2 dB of the RF cable and attenuator, and has been compensated to the spectrum analyzer offset.
2. The RF fundamental frequency should be excluded against the limit line in the operating frequency band.

**Conducted Spurious Emission Plot on Bluetooth LE 1Mbps
GFSK Channel 00**

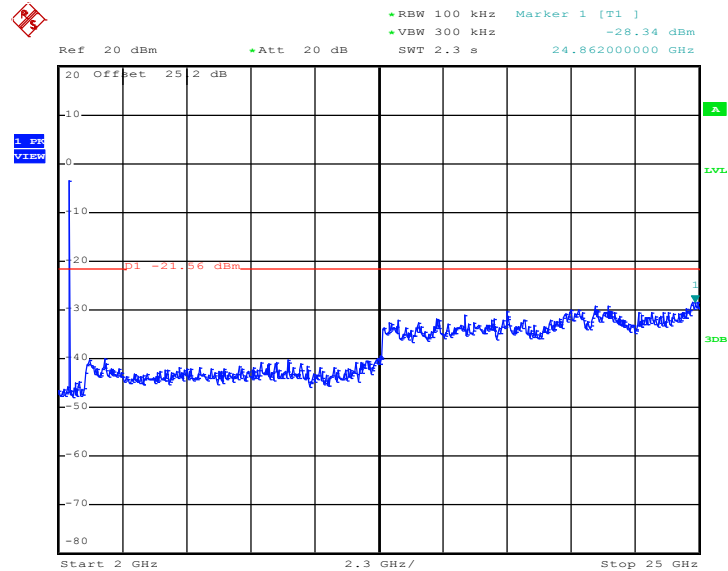

Note:

1. The total loss is 25.2 of the RF cable and attenuator, and has been compensated to the spectrum analyzer offset.
2. The RF fundamental frequency should be excluded against the limit line in the operating frequency band.



| | | | |
|----------------|--------------------|---------------------|----------------|
| Test Mode : | Bluetooth 4.0 - LE | Temperature : | 22~25°C |
| Test Channel : | 19 | Relative Humidity : | 51~55% |
| | | Test Engineer : | Osolemio Chang |

**Conducted Spurious Emission Plot on Bluetooth LE 1Mbps
GFSK Channel 19**

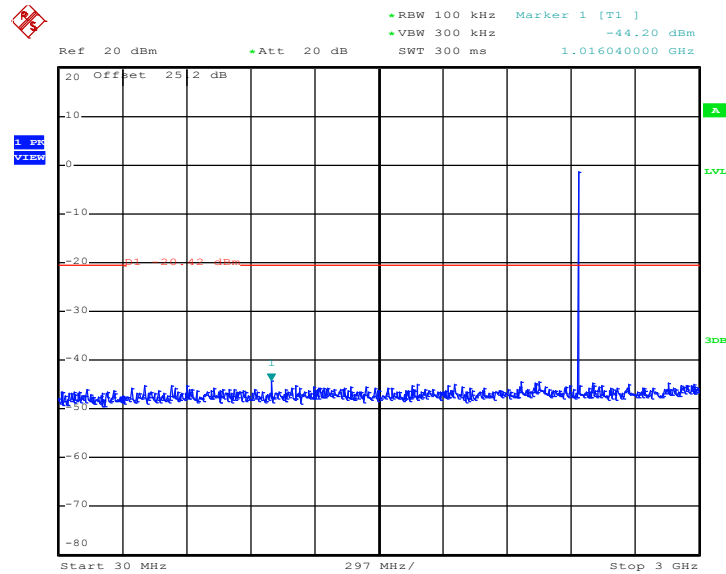

Note:

1. The total loss is 25.2 of the RF cable and attenuator, and has been compensated to the spectrum analyzer offset.
2. The RF fundamental frequency should be excluded against the limit line in the operating frequency band.



Conducted Spurious Emission Plot on Bluetooth LE 1Mbps GFSK Channel 19

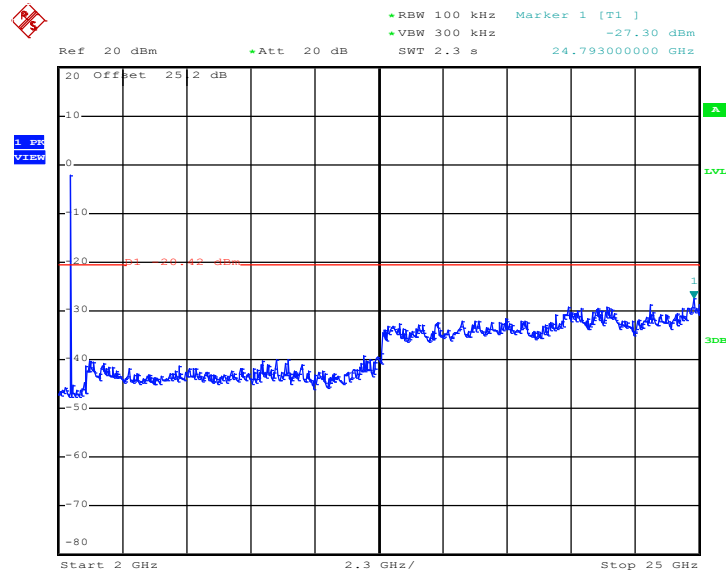

Note:

- 1. The total loss is 25.2 of the RF cable and attenuator, and has been compensated to the spectrum analyzer offset.
- 2. The RF fundamental frequency should be excluded against the limit line in the operating frequency band.



| | | | |
|----------------|--------------------|---------------------|----------------|
| Test Mode : | Bluetooth 4.0 - LE | Temperature : | 22~25°C |
| Test Channel : | 39 | Relative Humidity : | 51~55% |
| | | Test Engineer : | Osolemio Chang |

**Conducted Spurious Emission Plot on Bluetooth LE 1Mbps
GFSK Channel 39**

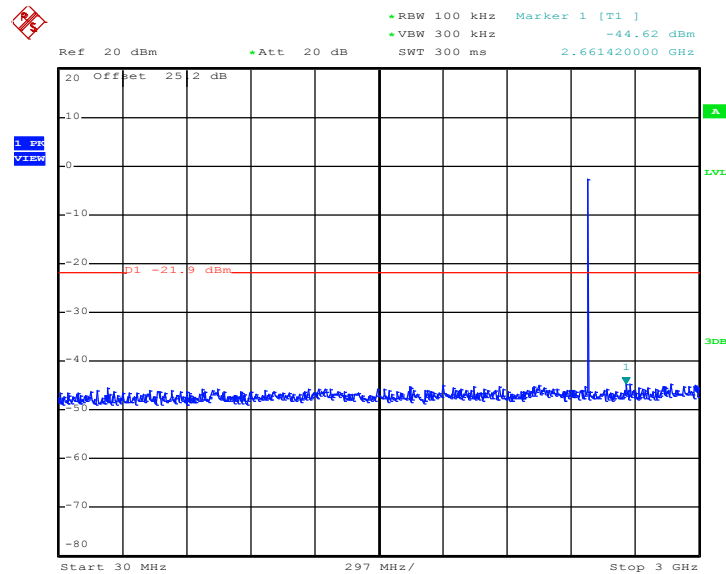

Note:

1. The total loss is 25.2 of the RF cable and attenuator, and has been compensated to the spectrum analyzer offset.
2. The RF fundamental frequency should be excluded against the limit line in the operating frequency band.

**Conducted Spurious Emission Plot on Bluetooth LE 1Mbps
GFSK Channel 39**

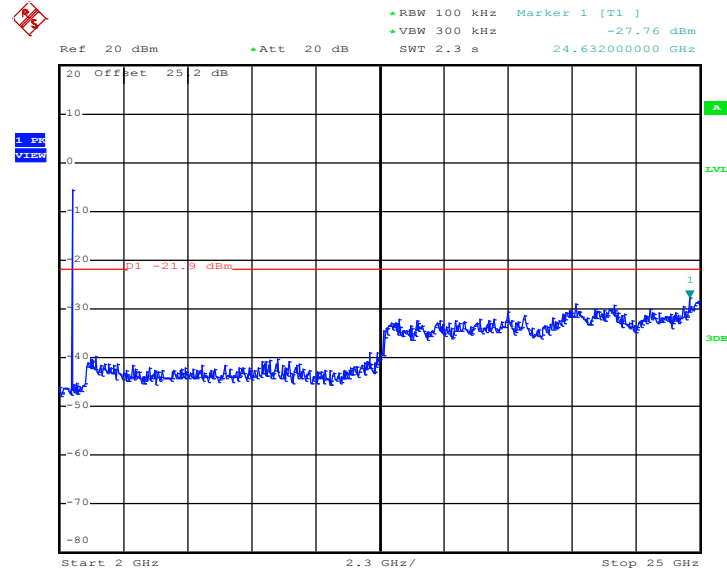

Note:

1. The total loss is 25.2 of the RF cable and attenuator, and has been compensated to the spectrum analyzer offset.
2. The RF fundamental frequency should be excluded against the limit line in the operating frequency band.



3.5 Radiated Band Edges and Spurious Emission Measurement

3.5.1 Limit of Radiated Band Edges and Spurious Emission

In any 100 kHz bandwidth outside the intentional radiator frequency band, all harmonics/spurious must be at least 20 dB below the highest emission level within the authorized band. If the output power of this device was measured by spectrum analyzer, the attenuation under this paragraph shall be 30 dB instead of 20 dB. In addition, radiated emissions which fall in the restricted bands must also comply with the FCC section 15.209 limits as below.

| Frequency (MHz) | Field Strength (microvolts/meter) | Measurement Distance (meters) |
|-----------------|-----------------------------------|-------------------------------|
| 0.009 – 0.490 | 2400/F(kHz) | 300 |
| 0.490 – 1.705 | 24000/F(kHz) | 30 |
| 1.705 – 30.0 | 30 | 30 |
| 30 – 88 | 100 | 3 |
| 88 – 216 | 150 | 3 |
| 216 - 960 | 200 | 3 |
| Above 960 | 500 | 3 |

3.5.2 Measuring Instruments

The measuring equipment is listed in the section 4 of this test report.



3.5.3 Test Procedures

1. The testing follows FCC KDB Publication No. 558074 D01 DTS Meas. Guidance v03r02.
2. The EUT was arranged to its worst case and then tune the antenna tower (from 1 m to 4 m) and turntable (from 0 degree to 360 degrees) to find the maximum reading. A pre-amp and a high pass filter are used for the test in order to get better signal level.
3. The EUT was placed on a turntable with 1.5 meter above ground.
4. The EUT was set 3 meters from the interference receiving antenna, which was mounted on the top of a variable height antenna tower.
5. Corrected Reading: Antenna Factor + Cable Loss + Read Level - Preamp Factor = Level
6. For measurement below 1GHz, if the emission level of the EUT measured by the peak detector is 3 dB lower than the applicable limit, the peak emission level will be reported. Otherwise, the emission measurement will be repeated using the quasi-peak detector and reported.
7. Use the following spectrum analyzer settings:
 - (1) Span shall wide enough to fully capture the emission being measured;
 - (2) Set RBW=100 kHz for $f < 1$ GHz; $VBW \geq RBW$; Sweep = auto; Detector function = peak; Trace = max hold;
 - (3) Set RBW = 1 MHz, VBW= 3MHz for $f \geq 1$ GHz for peak measurement.

For average measurement:

 - $VBW = 10$ Hz, when duty cycle is no less than 98 percent.
 - $VBW \geq 1/T$, when duty cycle is less than 98 percent where T is the minimum transmission duration over which the transmitter is on and is transmitting at its maximum power control level for the tested mode of operation.

| Band | Duty Cycle(%) | T(μs) | 1/T(kHz) | VBW Setting |
|--------------------|---------------|--------|----------|-------------|
| Bluetooth 4.0 - LE | 62.78 | 306.70 | 3.26 | 10kHz |

3.5.4 Test Setup

For radiated emissions below 30MHz

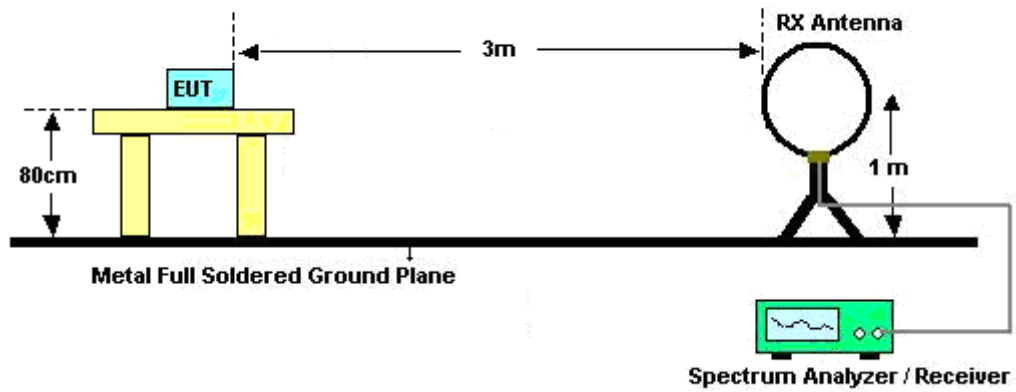

For radiated emissions from 30MHz to 1GHz

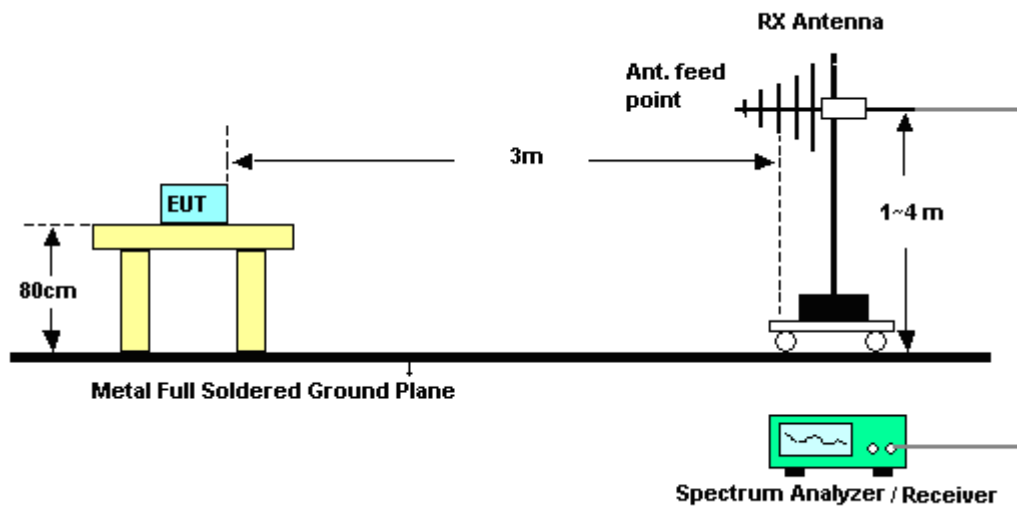

For radiated emissions above 1GHz

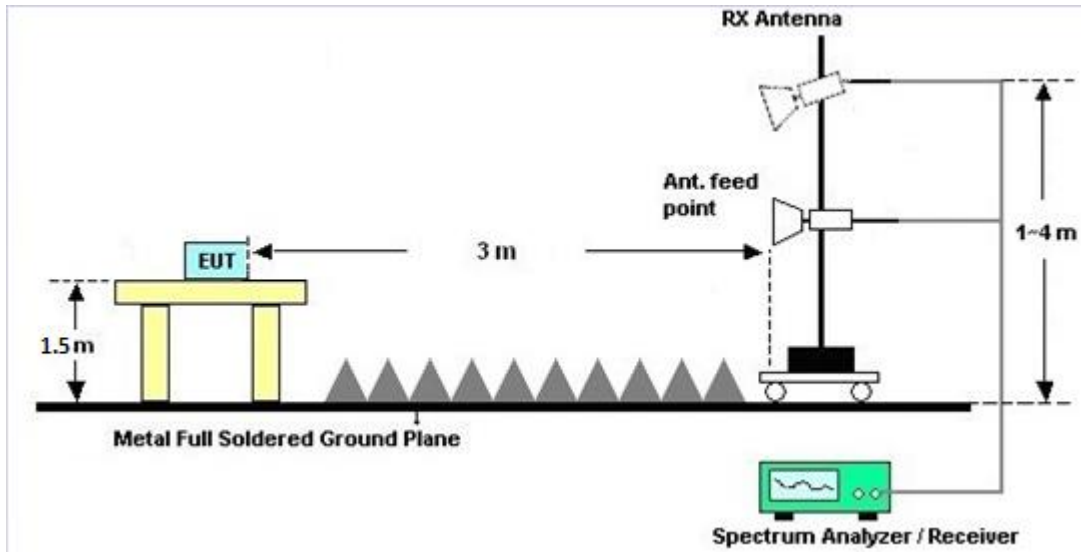

3.5.5 Test Results of Radiated Spurious Emissions (9 kHz ~ 30 MHz)

The low frequency, which started from 9 kHz to 30MHz, was pre-scanned and the result which was 20dB lower than the limit line per 15.31(o) was not reported.

3.5.6 Test Result

Please refer to appendix A as below.



3.6 AC Conducted Emission Measurement

3.6.1 Limit of AC Conducted Emission

For equipment that is designed to be connected to the public utility (AC) power line, the radio frequency voltage that is conducted back onto the AC power line on any frequency or frequencies within the band 150 kHz to 30 MHz shall not exceed the limits in the following table.

| Frequency of emission (MHz) | Conducted limit (dBµV) | |
|-----------------------------|------------------------|-----------|
| | Quasi-peak | Average |
| 0.15-0.5 | 66 to 56* | 56 to 46* |
| 0.5-5 | 56 | 46 |
| 5-30 | 60 | 50 |

*Decreases with the logarithm of the frequency.

3.6.2 Measuring Instruments

The measuring equipment is listed in the section 4 of this test report.

3.6.3 Test Procedures

1. The EUT was placed 0.4 meter from the conducting wall of the shielding room was kept at least 80 centimeters from any other grounded conducting surface.
2. Connect EUT to the power mains through a line impedance stabilization network (LISN).
3. All the support units are connecting to the other LISN.
4. The LISN provides 50 ohm coupling impedance for the measuring instrument.
5. The FCC states that a 50 ohm, 50 microhenry LISN should be used.
6. Both sides of AC line were checked for maximum conducted interference.
7. The frequency range from 150 kHz to 30 MHz was searched.
8. Set the test-receiver system to Peak Detect Function and specified bandwidth with Maximum Hold Mode.

3.6.4 Test Setup

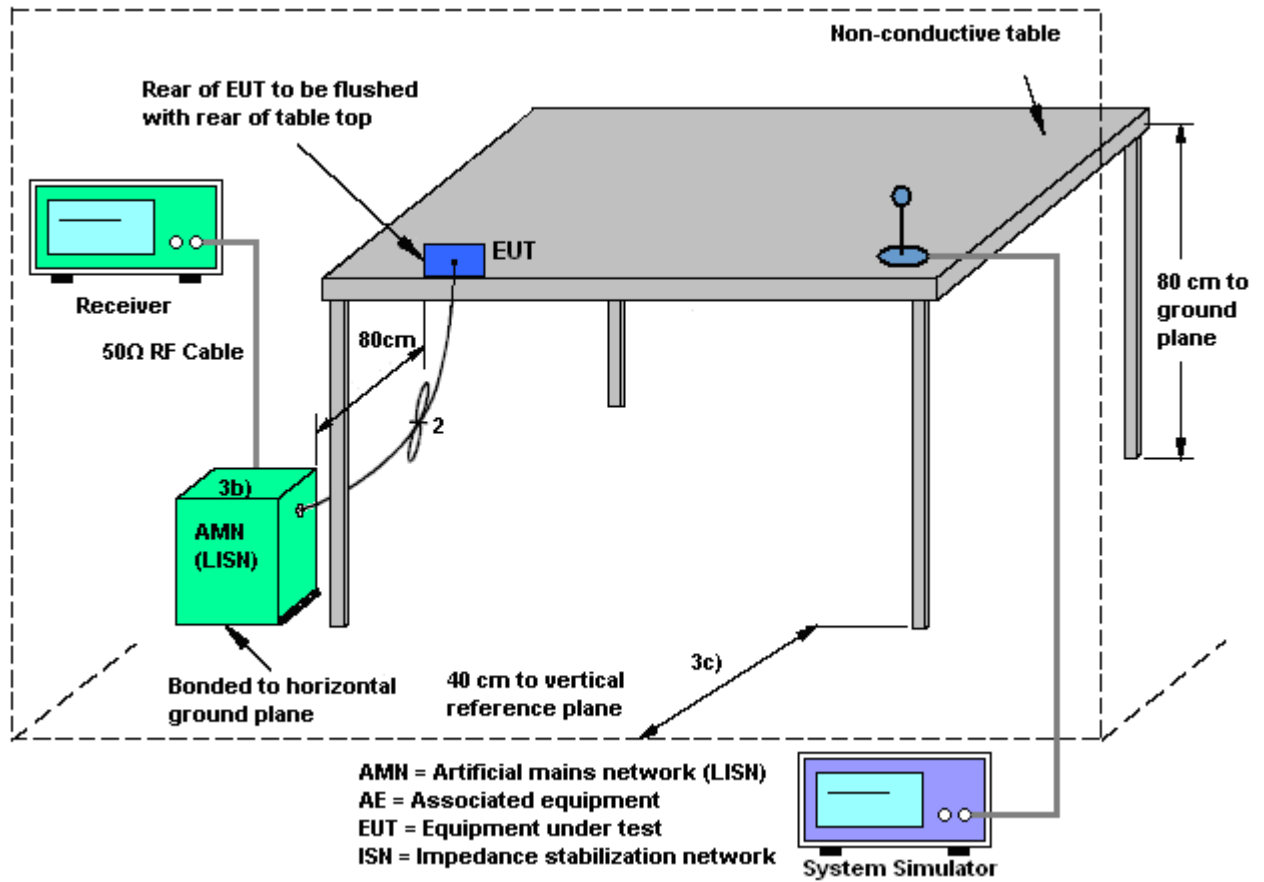



3.6.5 Test Result of AC Conducted Emission

| | | | |
|-----------------|--|---------------------|---------|
| Test Mode : | Mode 1 | Temperature : | 20~22°C |
| Test Engineer : | Kai-Chun Chu | Relative Humidity : | 46~48% |
| Test Voltage : | 120Vac / 60Hz | Phase : | Line |
| Function Type : | GSM1900 Idle + Bluetooth Link + WLAN Link + Earphone + Battery + USB Cable (Charging from Adapter) + MP3 | | |

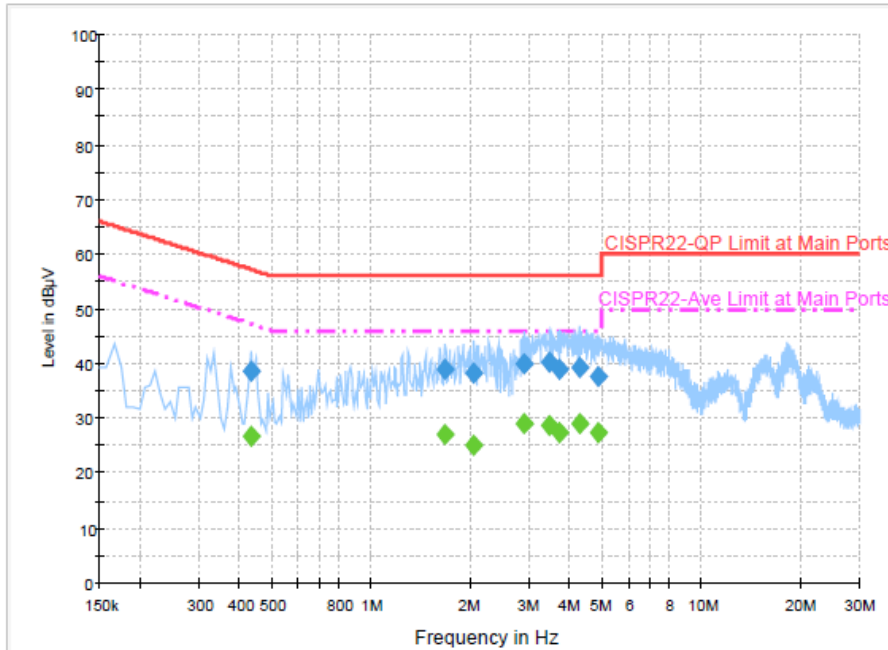

Final Result : Quasi-Peak

| Frequency (MHz) | Quasi-Peak (dBµV) | Filter | Line | Corr. (dB) | Margin (dB) | Limit (dBµV) |
|-----------------|-------------------|--------|------|------------|-------------|--------------|
| 0.430000 | 38.6 | Off | L1 | 19.5 | 18.7 | 57.3 |
| 1.670000 | 39.1 | Off | L1 | 19.6 | 16.9 | 56.0 |
| 2.046000 | 38.4 | Off | L1 | 19.4 | 17.6 | 56.0 |
| 2.910000 | 39.8 | Off | L1 | 19.6 | 16.2 | 56.0 |
| 3.446000 | 40.2 | Off | L1 | 19.6 | 15.8 | 56.0 |
| 3.718000 | 39.1 | Off | L1 | 19.7 | 16.9 | 56.0 |
| 4.246000 | 39.3 | Off | L1 | 19.6 | 16.7 | 56.0 |
| 4.846000 | 37.6 | Off | L1 | 19.7 | 18.4 | 56.0 |

Final Result : Average

| Frequency (MHz) | Average (dBµV) | Filter | Line | Corr. (dB) | Margin (dB) | Limit (dBµV) |
|-----------------|----------------|--------|------|------------|-------------|--------------|
| 0.430000 | 26.8 | Off | L1 | 19.5 | 20.5 | 47.3 |
| 1.670000 | 27.2 | Off | L1 | 19.6 | 18.8 | 46.0 |
| 2.046000 | 25.1 | Off | L1 | 19.4 | 20.9 | 46.0 |
| 2.910000 | 29.0 | Off | L1 | 19.6 | 17.0 | 46.0 |
| 3.446000 | 28.6 | Off | L1 | 19.6 | 17.4 | 46.0 |
| 3.718000 | 27.5 | Off | L1 | 19.7 | 18.5 | 46.0 |
| 4.246000 | 29.1 | Off | L1 | 19.6 | 16.9 | 46.0 |
| 4.846000 | 27.3 | Off | L1 | 19.7 | 18.7 | 46.0 |

| | | | |
|------------------------|--|----------------------------|---------|
| Test Mode : | Mode 1 | Temperature : | 20~22°C |
| Test Engineer : | Kai-Chun Chu | Relative Humidity : | 46~48% |
| Test Voltage : | 120Vac / 60Hz | Phase : | Neutral |
| Function Type : | GSM1900 Idle + Bluetooth Link + WLAN Link + Earphone + Battery + USB Cable (Charging from Adapter) + MP3 | | |

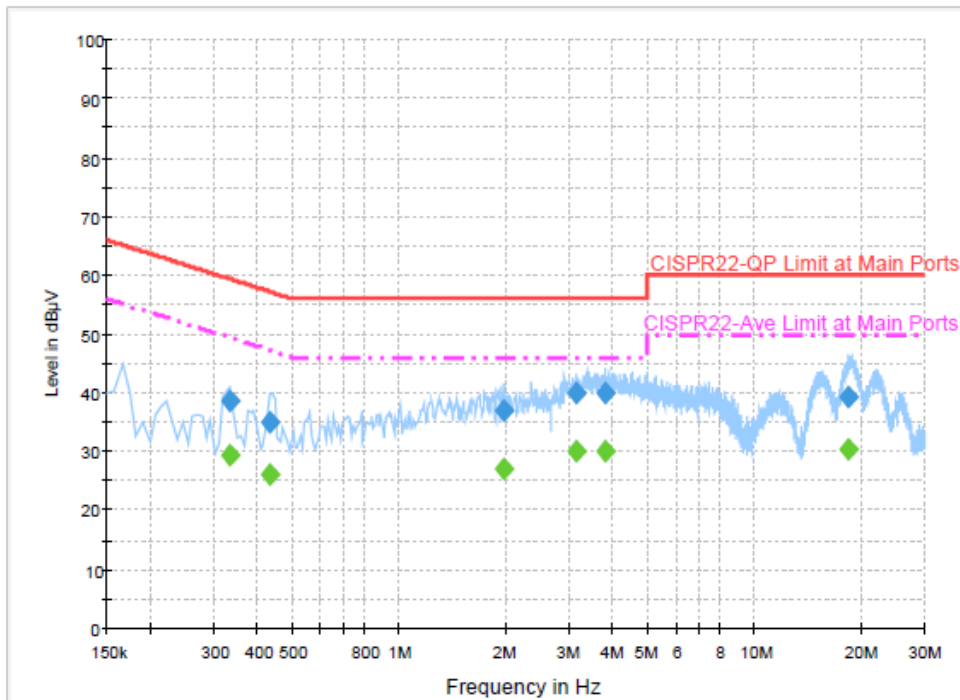

Final Result : Quasi-Peak

| Frequency (MHz) | Quasi-Peak (dBµV) | Filter | Line | Corr. (dB) | Margin (dB) | Limit (dBµV) |
|-----------------|-------------------|--------|------|------------|-------------|--------------|
| 0.334000 | 38.6 | Off | N | 19.4 | 20.8 | 59.4 |
| 0.430000 | 35.0 | Off | N | 19.5 | 22.3 | 57.3 |
| 1.958000 | 36.9 | Off | N | 19.6 | 19.1 | 56.0 |
| 3.134000 | 40.0 | Off | N | 19.6 | 16.0 | 56.0 |
| 3.806000 | 40.0 | Off | N | 19.6 | 16.0 | 56.0 |
| 18.382000 | 39.3 | Off | N | 20.0 | 20.7 | 60.0 |

Final Result : Average

| Frequency (MHz) | Average (dBµV) | Filter | Line | Corr. (dB) | Margin (dB) | Limit (dBµV) |
|-----------------|----------------|--------|------|------------|-------------|--------------|
| 0.334000 | 29.3 | Off | N | 19.4 | 20.1 | 49.4 |
| 0.430000 | 26.2 | Off | N | 19.5 | 21.1 | 47.3 |
| 1.958000 | 27.1 | Off | N | 19.6 | 18.9 | 46.0 |
| 3.134000 | 30.1 | Off | N | 19.6 | 15.9 | 46.0 |
| 3.806000 | 30.1 | Off | N | 19.6 | 15.9 | 46.0 |
| 18.382000 | 30.5 | Off | N | 20.0 | 19.5 | 50.0 |



3.7 Antenna Requirements

3.7.1 Standard Applicable

If directional gain of transmitting antennas is greater than 6dBi, the power shall be reduced by the same level in dB comparing to gain minus 6dBi. The use of a permanently attached antenna or of an antenna that uses a unique coupling to the intentional radiator shall be considered sufficient to comply with the FCC rule.

3.7.2 Antenna Anti-Replacement Construction

An embedded-in antenna design is used.

3.7.3 Antenna Gain

The antenna peak gain of EUT is less than 6 dBi. Therefore, it is not necessary to reduce maximum peak output power limit.



4 List of Measuring Equipment

| Instrument | Manufacturer | Model No. | Serial No. | Characteristics | Calibration Date | Test Date | Due Date | Remark |
|---------------------------|-----------------|------------------------|----------------|--------------------|------------------|-------------------------------|---------------|-----------------------|
| BT Base Station | Rohde & Schwarz | CBT32 | 100519 | N/A | Jun. 25, 2014 | Dec. 23, 2014 ~ Dec. 31, 2014 | Jun. 24, 2015 | Conducted (TH02-HY) |
| Power Meter | Agilent | E4416A | GB41292344 | 300MHz~40GHz | Jan. 28, 2014 | Dec. 23, 2014 ~ Dec. 31, 2014 | Jan. 27, 2015 | Conducted (TH02-HY) |
| Power Sensor | Agilent | E9327A | US40441548 | 300MHz~40GHz | Jan. 28, 2014 | Dec. 23, 2014 ~ Dec. 31, 2014 | Jan. 27, 2015 | Conducted (TH02-HY) |
| Spectrum Analyzer | Rohde & Schwarz | FSP40 | 100055 | 9kHz~40GHz | Jun. 09, 2014 | Dec. 23, 2014 ~ Dec. 31, 2014 | Jun. 08, 2015 | Conducted (TH02-HY) |
| Hygrometer | Testo | 608-H1 | 34897199 | N/A | May. 06, 2014 | Dec. 23, 2014 ~ Dec. 31, 2014 | May. 05, 2015 | Conducted (TH02-HY) |
| RF cable | WOKEN | S05 | S05-130708-038 | N/A | Jan. 22, 2014 | Dec. 23, 2014 ~ Dec. 31, 2014 | Jan. 21, 2015 | Conducted (TH02-HY) |
| Preamplifier | COM-POWER | PA-103A | 161241 | 10MHz-1000MHz | Mar. 17, 2014 | Jan. 04, 2015 ~ Jan. 07, 2015 | Mar. 16, 2015 | Radiation (03CH07-HY) |
| Preamplifier | Agilent | 8449B | 3008A02362 | 1GHz~ 26.5GHz | Oct. 21, 2014 | Jan. 04, 2015 ~ Jan. 07, 2015 | Oct. 20, 2015 | Radiation (03CH07-HY) |
| Preamplifier | MITEQ | AMF-7D-00101800-30-10P | 159075 | 1GHz ~ 18GHz | Apr. 21, 2014 | Jan. 04, 2015 ~ Jan. 07, 2015 | Apr. 20, 2015 | Radiation (03CH07-HY) |
| Preamplifier | MITEQ | JS44-18004000-33-8P | 1840917 | 18GHz ~ 40GHz | Jun. 09, 2014 | Jan. 04, 2015 ~ Jan. 07, 2015 | Jun. 08, 2015 | Radiation (03CH07-HY) |
| Bilog Antenna | Schaffner | CBL6111C | 2726 | 30MHz ~ 1GHz | Sep. 27, 2014 | Jan. 04, 2015 ~ Jan. 07, 2015 | Sep. 26, 2015 | Radiation (03CH07-HY) |
| Double Ridge Horn Antenna | ESCO | 3117 | 00075962 | 1GHz ~ 18GHz | Aug. 19, 2014 | Jan. 04, 2015 ~ Jan. 07, 2015 | Aug. 18, 2015 | Radiation (03CH07-HY) |
| Loop Antenna | Rohde & Schwarz | HFH2-Z2 | 100315 | 9 kHz~30 MHz | Jul. 28, 2014 | Jan. 04, 2015 ~ Jan. 07, 2015 | Jul. 27, 2015 | Radiation (03CH07-HY) |
| Horn Antenna | SCHWARZBECK | BBHA 9170 | BBHA9170584 | 18GHz- 40GHz | Nov. 03, 2014 | Jan. 04, 2015 ~ Jan. 07, 2015 | Nov. 02, 2015 | Radiation (03CH07-HY) |
| EMI Test Receiver | Rohde & Schwarz | ESCI 7 | 100724 | 9kHz~7GHz | Aug. 30, 2014 | Jan. 04, 2015 ~ Jan. 07, 2015 | Aug. 29, 2015 | Radiation (03CH07-HY) |
| Signal Analyzer | Rohde & Schwarz | FSV 30 | 101749 | 10Hz~30GHz | Feb. 10, 2014 | Jan. 04, 2015 ~ Jan. 07, 2015 | Feb. 09, 2015 | Radiation (03CH07-HY) |
| Controller | ChainTek | Chaintek 3000 | N/A | Control Turn table | N/A | Jan. 04, 2015 ~ Jan. 07, 2015 | N/A | Radiation (03CH07-HY) |
| Controller | Max-Full | MF7802 | MF780208368 | Control Ant Mast | N/A | Jan. 04, 2015 ~ Jan. 07, 2015 | N/A | Radiation (03CH07-HY) |
| Turn Table | ChainTek | Chaintek 3000 | N/A | 0~360 degree | N/A | Jan. 04, 2015 ~ Jan. 07, 2015 | N/A | Radiation (03CH07-HY) |
| Antenna Mast | Max-Full | MFA520BS | N/A | 1m~4m | N/A | Jan. 04, 2015 ~ Jan. 07, 2015 | N/A | Radiation (03CH07-HY) |
| Hygrometer | Testo | 608-H1 | 34897197 | N/A | May. 06, 2014 | Jan. 04, 2015 ~ Jan. 07, 2015 | May. 05, 2015 | Radiation (03CH07-HY) |
| RF Cable | HUBER + SUHNER | SUCOFLEX 104 | MY84209521 | 1GHz~40GHz | Dec. 04, 2014 | Jan. 04, 2015 ~ Jan. 07, 2015 | Dec. 03, 2015 | Radiation (03CH07-HY) |
| RF Cable | HUBER + SUHNER | SUCOFLEX 104 | MY84209521 | 9KHz~1GHz | Dec. 04, 2014 | Jan. 04, 2015 ~ Jan. 07, 2015 | Dec. 03, 2015 | Radiation (03CH07-HY) |



| Instrument | Manufacturer | Model No. | Serial No. | Characteristics | Calibration Date | Test Date | Due Date | Remark |
|-------------------|-----------------|--|------------------------|-----------------|------------------|----------------------------------|---------------|--------------------------|
| Notch Filter | Wainwright | WRCGV24 00/2483-23 90/2493-35/ 10SS | SN4 | 2.4G | Oct. 01, 2014 | Jan. 04, 2015 ~ Jan. 07, 2015 | Sep. 30, 2015 | Radiation (03CH07-HY) |
| Filter | Wainwright | WLKS1200- 8SS | SN3 | 1.2G Low Pass | Oct. 01, 2014 | Jan. 04, 2015 ~ Jan. 07, 2015 | Sep. 30, 2015 | Radiation (03CH07-HY) |
| Filter | Microwave | H3G018G1 | SN477220 | 3.0G High Pass | Oct. 01, 2014 | Jan. 04, 2015 ~ Jan. 07, 2015 | Sep. 30, 2015 | Radiation (03CH07-HY) |
| Test Software | Audix | E3 | Version 6.2009-8-24 | N/A | N/A | Jan. 04, 2015 ~ Jan. 07, 2015 | N/A | Radiation (03CH07-HY) |
| EMI Test Receiver | Rohde & Schwarz | ESCS 30 | 100356 | 9kHz – 2.75GHz | Dec. 01, 2014 | Dec. 09, 2014 | Nov. 30, 2015 | Conduction (CO05-HY) |
| Two-LISN | Rohde & Schwarz | ENV216 | 100080 | 9kHz-30MHz | Dec. 02, 2014 | Dec. 09, 2014 | Dec. 01, 2015 | Conduction (CO05-HY) |
| AC Power Source | ChainTek | APC-1000 W | N/A | N/A | N/A | Dec. 09, 2014 | N/A | Conduction (CO05-HY) |
| Hygrometer | Testo | 608-H1 | 34913912 | N/A | Apr. 23, 2014 | Dec. 09, 2014 | Apr. 22, 2015 | Conduction (CO05-HY) |
| LF Cable | Shuner | RG-402 | N/A | N/A | Oct. 07, 2014 | Dec. 09, 2014 | Oct. 06, 2015 | Conduction (CO05-HY) |
| Test Software | N/A | EMC32 | 8.40.0 | N/A | N/A | Dec. 09, 2014 | N/A | Conduction (CO05-HY) |

Note: Test equipment calibration is traceable to the procedure of ISO17025.



5 Uncertainty of Evaluation

Uncertainty of Conducted Emission Measurement (150 kHz ~ 30 MHz)

| | |
|---|------|
| Measuring Uncertainty for a Level of Confidence of 95% ($U = 2Uc(y)$) | 2.26 |
|---|------|

Uncertainty of Radiated Emission Measurement (30 MHz ~ 1000 MHz)

| | |
|---|------|
| Measuring Uncertainty for a Level of Confidence of 95% ($U = 2Uc(y)$) | 4.50 |
|---|------|



Appendix A. Radiated Spurious Emission

| | | | |
|-----------------|------------|---------------------|---------|
| Test Engineer : | Donny Tang | Temperature : | 22~25°C |
| | | Relative Humidity : | 42~45% |

15C 2.4GHz 2400~2483.5MHz

BLE (Band Edge @ 3m)

| BLE | Note | Frequency | Level | Over | Limit | Read | Antenna | Cable | Preamp | Ant | Table | Peak | Pol. | |
|-------------------------|------|-----------|------------|--------|--------|----------|----------|--------|--------|--------|---------|---------|---------|---|
| | | (MHz) | (dBμV/m) | (dB) | Limit | Level | Factor | Loss | Factor | Pos | Pos | Avg. | | |
| | | | | | Line | (dBμV) | (dB/m) | (dB) | (dB) | (cm) | (deg) | (P/A) | (H/V) | |
| BLE CH 00 2402MHz | | 2323.32 | 50.93 | -23.07 | 74 | 52.05 | 27.05 | 5.89 | 34.06 | 204 | 354 | P | H | |
| | | 2368.86 | 41.79 | -12.21 | 54 | 42.63 | 27.19 | 6.01 | 34.04 | 204 | 354 | A | H | |
| | * | 2402.34 | 85.64 | - | - | 86.44 | 27.23 | 6.01 | 34.04 | 204 | 354 | P | H | |
| | * | 2402.09 | 84.64 | - | - | 85.44 | 27.23 | 6.01 | 34.04 | 204 | 354 | A | H | |
| | | | | | | | | | | | | | H | |
| | | | | | | | | | | | | | | H |
| | | | 2348.97 | 50.67 | -23.33 | 74 | 51.67 | 27.1 | 5.95 | 34.05 | 118 | 27 | P | V |
| | | | 2383.8 | 41.52 | -12.48 | 54 | 42.36 | 27.19 | 6.01 | 34.04 | 118 | 27 | A | V |
| | * | | 2402.34 | 83.2 | - | - | 84 | 27.23 | 6.01 | 34.04 | 118 | 27 | P | V |
| | * | | 2402.09 | 82.57 | - | - | 83.37 | 27.23 | 6.01 | 34.04 | 118 | 27 | A | V |
| | | | | | | | | | | | | | | V |
| | | | | | | | | | | | | | V | |
| BLE CH 19 2440MHz | | 2351.85 | 50.74 | -23.26 | 74 | 51.7 | 27.14 | 5.95 | 34.05 | 100 | 335 | P | H | |
| | | 2364.27 | 41.63 | -12.37 | 54 | 42.52 | 27.14 | 6.01 | 34.04 | 100 | 335 | A | H | |
| | * | 2440.08 | 85.21 | - | - | 85.83 | 27.37 | 6.04 | 34.03 | 100 | 335 | P | H | |
| | * | 2440.08 | 84.25 | - | - | 84.87 | 27.37 | 6.04 | 34.03 | 100 | 335 | A | H | |
| | | | 2491.36 | 51.51 | -22.49 | 74 | 51.93 | 27.5 | 6.09 | 34.01 | 100 | 335 | P | H |
| | | | 2490.92 | 42.05 | -11.95 | 54 | 42.47 | 27.5 | 6.09 | 34.01 | 100 | 335 | A | H |
| | | | 2388.48 | 50.96 | -23.04 | 74 | 51.76 | 27.23 | 6.01 | 34.04 | 110 | 26 | P | V |
| | | | 2388.84 | 41.63 | -12.37 | 54 | 42.43 | 27.23 | 6.01 | 34.04 | 110 | 26 | A | V |
| | * | | 2440.33 | 83.77 | - | - | 84.39 | 27.37 | 6.04 | 34.03 | 110 | 26 | P | V |
| | * | | 2440.08 | 82.68 | - | - | 83.3 | 27.37 | 6.04 | 34.03 | 110 | 26 | A | V |
| | | | 2486.96 | 50.55 | -23.45 | 74 | 51.01 | 27.46 | 6.09 | 34.01 | 110 | 26 | P | V |
| | | 2496.16 | 42.1 | -11.9 | 54 | 42.51 | 27.5 | 6.09 | 34 | 110 | 26 | A | V | |



| | | | | | | | | | | | | | |
|----------------------------------|---|---------|-------|--------|----|-------|-------|------|-------|-----|----|---|---|
| BLE CH 39 2480MHz | * | 2479.83 | 86.41 | - | - | 86.89 | 27.46 | 6.07 | 34.01 | 123 | 13 | P | H |
| | * | 2479.99 | 85.66 | - | - | 86.14 | 27.46 | 6.07 | 34.01 | 123 | 13 | A | H |
| | | 2490.44 | 51.41 | -22.59 | 74 | 51.83 | 27.5 | 6.09 | 34.01 | 123 | 13 | P | H |
| | | 2498 | 41.88 | -12.12 | 54 | 42.29 | 27.5 | 6.09 | 34 | 123 | 13 | A | H |
| | | | | | | | | | | | | | H |
| | | | | | | | | | | | | | H |
| | * | 2479.83 | 80.58 | - | - | 81.06 | 27.46 | 6.07 | 34.01 | 100 | 31 | P | V |
| | * | 2479.99 | 80.14 | - | - | 80.62 | 27.46 | 6.07 | 34.01 | 100 | 31 | A | V |
| | | 2496.24 | 50.92 | -23.08 | 74 | 51.33 | 27.5 | 6.09 | 34 | 100 | 31 | P | V |
| | | 2489.8 | 41.73 | -12.27 | 54 | 42.15 | 27.5 | 6.09 | 34.01 | 100 | 31 | A | V |
| | | | | | | | | | | | | | V |
| | | | | | | | | | | | | | V |
| Remark | <ol style="list-style-type: none"> 1. No other spurious found. 2. All results are PASS against Peak and Average limit line. | | | | | | | | | | | | |



15C 2.4GHz 2400~2483.5MHz
BLE (Harmonic @ 3m)

| BLE | Note | Frequency | Level | Over | Limit | Read | Antenna | Cable | Preamp | Ant | Table | Peak | Pol. |
|-------------------------|---|-----------|------------|--------|------------|----------|----------|--------|--------|--------|---------|---------|---------|
| | | (MHz) | (dBµV/m) | (dB) | (dBµV/m) | (dBµV) | (dB/m) | (dB) | (dB) | (cm) | (deg) | (P/A) | (H/V) |
| BLE CH 00 2402MHz | | 4806 | 31.64 | -42.36 | 74 | 50.33 | 31.3 | 8.65 | 58.64 | 100 | 0 | P | H |
| | | | | | | | | | | | | | H |
| | | | | | | | | | | | | | H |
| | | | | | | | | | | | | | H |
| | | | | | | | | | | | | | V |
| | | | | | | | | | | | | | V |
| | | | | | | | | | | | | | V |
| BLE CH 19 2440MHz | | 4878 | 31.17 | -42.83 | 74 | 49.59 | 31.41 | 8.69 | 58.52 | 100 | 0 | P | H |
| | | 7320 | 36.68 | -37.32 | 74 | 48.16 | 36.32 | 10.39 | 58.19 | 100 | 0 | P | H |
| | | | | | | | | | | | | | H |
| | | | | | | | | | | | | | H |
| | | | | | | | | | | | | | V |
| | | | | | | | | | | | | | V |
| | | | | | | | | | | | | | V |
| BLE CH 39 2480MHz | | 4962 | 32.49 | -41.51 | 74 | 50.48 | 31.54 | 8.83 | 58.36 | 100 | 0 | P | H |
| | | 7440 | 36.61 | -37.39 | 74 | 47.91 | 36.59 | 10.52 | 58.41 | 100 | 0 | P | H |
| | | | | | | | | | | | | | H |
| | | | | | | | | | | | | | H |
| | | | | | | | | | | | | | V |
| | | | | | | | | | | | | | V |
| | | | | | | | | | | | | | V |
| Remark | 1. No other spurious found. 2. All results are PASS against Peak and Average limit line. | | | | | | | | | | | | |



15C Emission below 1GHz

2.4GHz BLE (LF)

| BLE | Note | Frequency | Level | Over | Limit | Read | Antenna | Cable | Preamp | Ant | Table | Peak | Pol. | |
|---------------------|--|-----------|------------|--------|------------|----------|----------|--------|--------|--------|---------|---------|---------|---|
| | | (MHz) | (dBμV/m) | (dB) | (dBμV/m) | (dBμV) | (dB/m) | (dB) | (dB) | (cm) | (deg) | (P/A) | (H/V) | |
| 2.4GHz BLE LF | | 31.62 | 18 | -22 | 40 | 31.97 | 17.19 | 0.67 | 31.83 | 100 | 55 | P | H | |
| | | 142.05 | 20.23 | -23.27 | 43.5 | 40.07 | 10.48 | 1.46 | 31.78 | | | P | H | |
| | | 231.96 | 17.25 | -28.75 | 46 | 37.49 | 9.74 | 1.79 | 31.77 | | | P | H | |
| | | 400.1 | 23.59 | -22.41 | 46 | 37.36 | 15.71 | 2.32 | 31.8 | | | P | H | |
| | | 504.4 | 17.6 | -28.4 | 46 | 29.52 | 17.34 | 2.64 | 31.9 | | | P | H | |
| | | 786.5 | 21.81 | -24.19 | 46 | 30.7 | 19.7 | 3.35 | 31.94 | | | P | H | |
| | | | | | | | | | | | | | | H |
| | | | | | | | | | | | | | | H |
| | | | | | | | | | | | | | | H |
| | | | | | | | | | | | | | | H |
| | | | | | | | | | | | | | | H |
| | | | | | | | | | | | | | | H |
| | | | 50.52 | 17.64 | -22.36 | 40 | 40.88 | 7.52 | 1.04 | 31.8 | 117 | 82 | P | V |
| | | | 113.97 | 17.8 | -25.7 | 43.5 | 37 | 11.3 | 1.28 | 31.78 | | | P | V |
| | | | 225.21 | 17.27 | -28.73 | 46 | 38.53 | 8.73 | 1.79 | 31.78 | | | P | V |
| | | | 490.4 | 18.64 | -27.36 | 46 | 30.58 | 17.3 | 2.64 | 31.88 | | | P | V |
| | | | 673.8 | 20.13 | -25.87 | 46 | 30.25 | 18.9 | 3.02 | 32.04 | | | P | V |
| | | | 822.2 | 22.25 | -23.75 | 46 | 30.56 | 20.1 | 3.4 | 31.81 | | | P | V |
| | | | | | | | | | | | | | | V |
| | | | | | | | | | | | | | | V |
| | | | | | | | | | | | | | V | |
| | | | | | | | | | | | | | V | |
| | | | | | | | | | | | | | V | |
| | | | | | | | | | | | | | V | |
| Remark | 1. No other spurious found. 2. All results are PASS against limit line. | | | | | | | | | | | | | |



Note symbol

| | |
|-----|--|
| * | Fundamental Frequency which can be ignored. However, the level of any unwanted emissions shall not exceed the level of the fundamental frequency per 15.209(c). |
| ! | Test result is over limit line. |
| P/A | Peak or Average |
| H/V | Horizontal or Vertical |



A calculation example for radiated spurious emission is shown as below:

| WIFI | Note | Frequency | Level | Over | Limit | Read | Antenna | Cable | Preamp | Ant | Table | Peak | Pol. |
|---------|------|-----------|------------|--------|------------|----------|----------|--------|--------|--------|---------|-------|-------|
| Ant. | | | | Limit | Line | Level | Factor | Loss | Factor | Pos | Pos | Avg. | |
| 1+2 | | (MHz) | (dBμV/m) | (dB) | (dBμV/m) | (dBμV) | (dB/m) | (dB) | (dB) | (cm) | (deg) | (P/A) | (H/V) |
| 802.11b | | 2390 | 55.45 | -18.55 | 74 | 54.51 | 32.22 | 4.58 | 35.86 | 103 | 308 | P | H |
| CH 01 | | | | | | | | | | | | | |
| 2412MHz | | 2390 | 43.54 | -10.46 | 54 | 42.6 | 32.22 | 4.58 | 35.86 | 103 | 308 | A | H |

- Level(dBμV/m) =
Antenna Factor(dB/m) + Cable Loss(dB) + Read Level(dBμV) - Preamp Factor(dB)
- Over Limit(dB) = Level(dBμV/m) – Limit Line(dBμV/m)

For Peak Limit @ 2390MHz:

- Level(dBμV/m)
= Antenna Factor(dB/m) + Cable Loss(dB) + Read Level(dBμV) - Preamp Factor(dB)
= 32.22(dB/m) + 4.58(dB) + 54.51(dBμV) – 35.86 (dB)
= 55.45 (dBμV/m)
- Over Limit(dB)
= Level(dBμV/m) – Limit Line(dBμV/m)
= 55.45(dBμV/m) – 74(dBμV/m)
= -18.55(dB)

For Average Limit @ 2390MHz:

- Level(dBμV/m)
= Antenna Factor(dB/m) + Cable Loss(dB) + Read Level(dBμV) - Preamp Factor(dB)
= 32.22(dB/m) + 4.58(dB) + 42.6(dBμV) – 35.86 (dB)
= 43.54 (dBμV/m)
- Over Limit(dB)
= Level(dBμV/m) – Limit Line(dBμV/m)
= 43.54(dBμV/m) – 54(dBμV/m)
= -10.46(dB)

Both peak and average measured complies with the limit line, so test result is “PASS”.