



# FCC/IC RF Test Report

**APPLICANT** : Sony Mobile Communications Inc  
**EQUIPMENT** : PDA Phone  
**BRAND NAME** : Sony  
**TYPE NAME** : PM-0785-BV  
**FCC ID** : PY7-PM0785  
**IC** : 4170B-PM0785  
**STANDARD** : 47 CFR Part 2, 22(H), 24(E), 27  
IC RSS-130 issue 1  
IC RSS-132 issue 3  
IC RSS-133 issue 6  
IC RSS-139 issue 2  
IC RSS-199 issue 2  
**CLASSIFICATION** : PCS Licensed Transmitter Held to Ear (PCE)

The product was received on Dec. 04, 2015 and completely tested on Feb. 26, 2015. We, SPORTON INTERNATIONAL INC., would like to declare that the tested sample has been evaluated in accordance with the test procedures given in ANSI / TIA / EIA-603-C-2004 and the testing has shown the tested sample to be in compliance with the applicable technical standards.

The test results in this report apply exclusively to the tested model / sample. Without written approval of SPORTON INTERNATIONAL INC., the test report shall not be reproduced except in full.



Reviewed by: Joseph Lin / Supervisor

Approved by: Jones Tsai / Manager



**SPORTON INTERNATIONAL INC.**

**No. 52, Hwa Ya 1<sup>st</sup> Rd., Hwa Ya Technology Park, Kwei-Shan District, Tao Yuan City, Taiwan, R.O.C.**



TABLE OF CONTENTS

REVISION HISTORY..... 5
SUMMARY OF TEST RESULT ..... 6
1 GENERAL DESCRIPTION ..... 8
1.1 Applicant ..... 8
1.2 Manufacturer ..... 8
1.3 Product Feature of Equipment Under Test..... 8
1.4 Details of Tested Sample (EUT) Information..... 9
1.5 Modification of EUT ..... 10
1.6 Emission Designator ..... 11
1.7 Testing Location ..... 12
1.8 Applicable Standards..... 13
2 TEST CONFIGURATION OF EQUIPMENT UNDER TEST ..... 14
2.1 Test Mode ..... 14
2.2 Connection Diagram of Test System ..... 16
2.3 Support Unit used in test configuration and system ..... 16
2.4 Measurement Results Explanation Example..... 16
3 CONDUCTED TEST ITEMS ..... 17
3.1 Measuring Instruments ..... 17
3.2 Test Setup ..... 17
3.3 Test Result of Conducted Test ..... 18
3.4 Conducted Output Power ..... 18
3.5 Peak-to-Average Ratio ..... 19
3.6 Occupied Bandwidth ..... 20
3.7 Conducted Band Edge ..... 21
3.8 Conducted Spurious Emission ..... 22
3.9 Frequency Stability ..... 23
4 RADIATED TEST ITEMS ..... 24
4.1 Measuring Instruments ..... 24
4.2 Test Setup ..... 24
4.3 Test Result of Radiated Test ..... 25
4.4 Effective Radiated Power and Effective Isotropic Radiated Power ..... 25
4.5 Radiated Spurious Emission ..... 27
5 LIST OF MEASURING EQUIPMENT ..... 29
6 UNCERTAINTY OF EVALUATION ..... 31

APPENDIX A. TEST RESULTS OF CONDUCTED TEST



**APPENDIX B. TEST RESULTS OF RADIATED TEST**





**SUMMARY OF TEST RESULT**

Report Section	FCC Rule	IC Rule	Description	Limit	Result	Remark
3.4	§2.1046	RSS-Gen(4.8) RSS-130(4.4) RSS-132 (5.4) RSS-133 (6.4) RSS-139 (6.4) RSS-199 (4.4)	Conducted Output Power	Reporting Only	PASS	-
3.5	N/A	RSS-130(4.4) RSS-139 (6.4)	Peak-to-Average Ratio	<13 dB	PASS	-
3.6	§2.1049 §27.53(h)(3)	RSS-GEN(4.6.1) RSS-139 (3.1) RSS-130 (3.1)	Occupied Bandwidth	Reporting Only	PASS	-
3.7	§2.1051 §27.53(c)(2) §27.53(c)(4) §27.53(f) §27.53(g)	RSS-GEN(4.9) RSS-130(4.6) RSS-139 (6.5)	Conducted Band Edge Measurement (Band 4) (Band 12) (Band 13) (Band 17)	< 43+10log10(P[Watts])	PASS	-
3.8	§2.1051 §27.53(c)(2) §27.53(f) §27.53(g)	RSS-GEN(4.9) RSS-130(4.6) RSS-139 (6.5)	Conducted Spurious Emission (Band 4) (Band 12) (Band 13) (Band 17)	< 43+10log10(P[Watts])	PASS	-
3.9	§2.1055 §27.54	RSS-GEN(4.7) RSS-130(4.3) RSS-139 (6.3)	Frequency Stability Temperature & Voltage	Within Authorized Band	PASS	-



Report Section	FCC Rule	IC Rule	Description	Limit	Result	Remark
4.4	§27.50(b)(10) §27.50(c)(10)	N/A	Effective Radiated Power (Band 12) (Band 13) (Band 17)	ERP < 3 Watt	PASS	-
	N/A	RSS-130(4.4)	Equivalent Isotropic Radiated Power (Band 12) (Band 13) (Band 17)	EIRP < 5 Watt		
	§27.50(d)(4)	RSS-139 (6.4) SRSP-513(5.1.2)	Equivalent Isotropic Radiated Power (Band 4)	EIRP < 1Watt		
4.5	§2.1053 §22.917(a) §24.238(a) §27.53(c)(2) §27.53(f) §27.53(g) §27.53(h)	RSS-GEN(4.9) RSS-132 (5.5) RSS-133 (6.5.1) RSS-130(4.6) RSS-139 (6.5)	Radiated Spurious Emission (Band 2) (Band 4) (Band 5) (Band 12) (Band 13) (Band 17)	< 43+10log <sub>10</sub> (P[Watts])	PASS	Under limit 7.84 dB at 7698.000 MHz
	§2.1053 §27.53(m)(4)	RSS-GEN(4.9) RSS-199 (4.5)	Radiated Spurious Emission (Band 7)	< 55+10log <sub>10</sub> (P[Watts])		



# 1 General Description

## 1.1 Applicant

**Sony Mobile Communications Inc**  
Nya Vattentorget 22188 Lund/Sweden

## 1.2 Manufacturer

**Sony Mobile Communications Inc**  
Nya Vattentorget 22188 Lund/Sweden

## 1.3 Product Feature of Equipment Under Test

The Equipment Under Test (hereafter called: EUT) is PDA Phone supporting, GSM / WCDMA / LTE, Wi-Fi 2.4GHz 802.11b/g/n, Wi-Fi 5GHz 802.11a/n, Bluetooth with FM Receiver, GPS, ANT+, and NFC features, and below is details of information.

Product Feature	
<b>Equipment</b>	PDA Phone
<b>Brand Name</b>	Sony
<b>Model Name</b>	PM-0785-BV
<b>FCC ID</b>	PY7-PM0785
<b>IC</b>	4170B-PM0785
<b>GSM Operating Band(s)</b>	GSM 850/900/1800/1900MHz
<b>GPRS / EGPRS Multi Slot Class</b>	GPRS Class 33, EGPRS Class 33
<b>WCDMA Operating Band(s)</b>	FDD Band I / II / IV / V / VIII
<b>WCDMA Rel. Version</b>	Rel. 8
<b>LTE Operating Band(s)</b>	FDD Band II / IV / V / VII / XII / XIII / XVII / XXVIII
<b>LTE Rel. Version</b>	Rel. 10
<b>Wi-Fi Specification</b>	802.11b/g/n HT20 802.11a/n HT20/HT40
<b>Bluetooth Version</b>	v3.0 + EDR / v4.0 - LE
<b>NFC Specification</b>	ISO14443A / ISO14443B / Felica / ISO15693
<b>ANT+</b>	ANT+
<b>Power Supply</b>	Battery / AC Adapter / Car Charger

**Remark:** The above EUT's information was declared by manufacturer. Please refer to the specifications or user's manual for more detailed description.





### 1.4 Details of Tested Sample (EUT) Information

Product Specification subjective to this standard	
<b>Tx Frequency</b>	LTE Band 2 : 1850.7 MHz ~ 1909.3 MHz LTE Band 4 : 1710.7 MHz ~ 1754.3 MHz LTE Band 5 : 824.7 MHz ~ 848.3 MHz LTE Band 7 : 2502.5 MHz ~ 2567.5 MHz LTE Band 12 : 698.7 MHz ~ 715.3 MHz LTE Band 13 : 779.5 MHz ~ 784.5 MHz LTE Band 17 : 706.5 MHz ~ 713.5 MHz
<b>Rx Frequency</b>	LTE Band 2 : 1930.7 MHz ~ 1989.3 MHz LTE Band 4 : 2110.7 MHz ~ 2154.3 MHz LTE Band 5 : 869.7 MHz ~ 893.3 MHz LTE Band 7 : 2622.5MHz ~ 2687.5 MHz LTE Band 12 : 729.7 MHz ~ 745.3 MHz LTE Band 13 : 748.5 MHz ~ 753.5 MHz LTE Band 17 : 736.5 MHz ~ 743.5 MHz
<b>Bandwidth</b>	LTE Band 2 : 1.4MHz / 3MHz / 5MHz / 10MHz / 15MHz / 20MHz LTE Band 4 : 1.4MHz / 3MHz / 5MHz / 10MHz / 15MHz / 20MHz LTE Band 5 : 1.4MHz / 3MHz / 5MHz / 10MHz LTE Band 7 : 5MHz / 10MHz / 15MHz / 20MHz LTE Band 12 : 1.4MHz / 3MHz / 5MHz / 10MHz LTE Band 13 : 5MHz / 10MHz LTE Band 17 : 5MHz / 10MHz
<b>Maximum Output Power to Antenna</b>	LTE Band 2 : 23.75 dBm LTE Band 4 : 23.70 dBm LTE Band 5 : 24.22 dBm LTE Band 7 : 22.74 dBm LTE Band 12 : 24.97 dBm LTE Band 13 : 23.97 dBm LTE Band 17 : 23.94 dBm
<b>Type of Modulation</b>	QPSK / 16QAM

EUT Information List				
IMEI	HW Version	SW Version	S/N	Performed Test Item
004402454111331	AP	26.1.A.0.66	YT9110K9N9	Conducted Measurement Radiated Spurious Emission ERP/EIRP Test



Accessory List	
AC Adapter	Model No. : EP800
	Type No. : AC-0030-US
	S/N : 3114W44203166 (For Radiated Emission)
Battery	Model No. : Bellis
Earphone	Model No. : MH410c
	Type No. : AG-1100
	S/N : 12431A1A00118E8 (For Radiated Emission)
USB Cable	Model No. : EC450
	Type No. : AI-0700
	S/N : 142412DF3337518 (For Radiated Emission)

**Note:**

1. Above EUT list and accessory list used are electrically identical per declared by manufacturer.
2. Above the accessories list are used to exercise the EUT during test.
3. For other wireless features of this EUT, test report will be issued separately.

### 1.5 Modification of EUT

No modifications are made to the EUT during all test items.



### 1.6 Emission Designator

LTE Band 4		QPSK			16QAM			
BW(MHz)	Emission Designator (99%OBW)	Frequency Tolerance (ppm)	Maximum EIRP(W)		Emission Designator (99%OBW)	Frequency Tolerance (ppm)	Maximum EIRP(W)	
1.4	1M10G7D	-	0.2213		1M10W7D	-	0.1995	
3	2M73G7D	-	0.2328		2M72W7D	-	0.1854	
5	4M51G7D	-	0.2213		4M51W7D	-	0.1774	
10	9M10G7D	0.0074	0.2296		9M08W7D	-	0.1941	
15	13M5G7D	-	0.1991		13M5W7D	-	0.1567	
20	18M6G7D	-	0.1879		18M6W7D	-	0.1556	
LTE Band 12		QPSK			16QAM			
BW(MHz)	Emission Designator (99%OBW)	Frequency Tolerance (ppm)	Maximum ERP/EIRP(W)		Emission Designator (99%OBW)	Frequency Tolerance (ppm)	Maximum ERP/EIRP(W)	
			ERP	EIRP			ERP	EIRP
1.4	1M10G7D	-	0.0570	0.0935	1M10W7D	-	0.0422	0.0692
3	2M73G7D	-	0.0573	0.0940	2M73W7D	-	0.0472	0.0774
5	4M51G7D	-	0.0586	0.0962	4M52W7D	-	0.0520	0.0853
10	9M10G7D	0.0110	0.0560	0.0918	9M10W7D	-	0.0466	0.0764
LTE Band 13		QPSK			16QAM			
BW(MHz)	Emission Designator (99%OBW)	Frequency Tolerance (ppm)	Maximum ERP/EIRP(W)		Emission Designator (99%OBW)	Frequency Tolerance (ppm)	Maximum ERP/EIRP(W)	
			ERP	EIRP			ERP	EIRP
5	4M52G7D	-	0.1493	0.2449	4M50W7D	-	0.1368	0.2244
10	9M08G7D	0.0152	0.1538	0.2523	9M04W7D	-	0.1259	0.2065
LTE Band 17		QPSK			16QAM			
BW(MHz)	Emission Designator (99%OBW)	Frequency Tolerance (ppm)	Maximum ERP/EIRP(W)		Emission Designator (99%OBW)	Frequency Tolerance (ppm)	Maximum ERP/EIRP(W)	
			ERP	EIRP			ERP	EIRP
5	4M51G7D	-	0.0525	0.0861	4M52W7D	-	0.0474	0.0778
10	9M16G7D	0.0107	0.0561	0.0920	9M12W7D	-	0.0493	0.0809



### 1.7 Testing Location

Sporton Lab is accredited to ISO 17025 by Taiwan Accreditation Foundation (TAF code : 1190) and the FCC designation No. TW1022 under the FCC 2.948(e) by Mutual Recognition Agreement (MRA) in FCC Test.

<b>Test Site</b>	SPORTON INTERNATIONAL INC.	
<b>Test Site Location</b>	No. 52, Hwa Ya 1 <sup>st</sup> Rd., Hwa Ya Technology Park, Kwei-Shan District, Tao Yuan City, Taiwan, R.O.C. TEL: +886-3-327-3456 FAX: +886-3-328-4978	
<b>Test Site No.</b>	<b>Sporton Site No.</b>	
	TH02-HY	

<b>Test Site</b>	SPORTON INTERNATIONAL INC.	
<b>Test Site Location</b>	No.58, Aly. 75, Ln. 564, Wenhua 3rd Rd. Kwei-Shan District, Tao Yuan City, Taiwan, R.O.C. TEL: +886-3-327-0855	
<b>Test Site No.</b>	<b>Sporton Site No.</b>	<b>IC Registration No.</b>
	03CH10-HY	4086H-1



## 1.8 Applicable Standards

According to the specifications of the manufacturer, the EUT must comply with the requirements of the following standards:

- ♦ 47 CFR Part 2, 22(H), 24(E), 27
- ♦ ANSI / TIA / EIA-603-C-2004
- ♦ FCC KDB 971168 D01 Power Meas. License Digital Systems v02r02
- ♦ IC RSS-130 Issue1
- ♦ IC RSS-132 Issue 3
- ♦ IC RSS-133 Issue 6
- ♦ IC RSS-139 Issue 2
- ♦ IC RSS-199 Issue 2
- ♦ IC RSS-Gen Issue 4
- ♦ NOTICE 2012-DRS0126

### Remark:

1. All test items were verified and recorded according to the standards and without any deviation during the test.
2. This EUT has also been tested and complied with the requirements of FCC Part 15, Subpart B, recorded in a separate test report.
3. Per the section 2.2.3 of Notice of 2012-DRS0126, “ Receivers Excluded from Industry Canada Requirements”, only radiocommunication receivers operating in stand-alone mode within the band 30-960 MHz and scanner receivers are subject to Industry Canada requirements.



## 2 Test Configuration of Equipment Under Test

### 2.1 Test Mode

Antenna port conducted and radiated test items listed below are performed according to KDB 971168 D01 Power Meas. License Digital Systems v02r02 with maximum output power.

Radiated measurements are performed by rotating the EUT in three different orthogonal test planes to find the maximum emission.

Test Items	Band	Bandwidth (MHz)						Modulation		RB #			Test Channel		
		1.4	3	5	10	15	20	QPSK	16QAM	1	Half	Full	L	M	H
Max. Output Power	2	✓	✓	✓	✓	✓	✓	✓	✓	✓	✓	✓	✓	✓	✓
	4	✓	✓	✓	✓	✓	✓	✓	✓	✓	✓	✓	✓	✓	✓
	5	✓	✓	✓	✓	-	-	✓	✓	✓	✓	✓	✓	✓	✓
	7	-	-	✓	✓	✓	✓	✓	✓	✓	✓	✓	✓	✓	✓
	12	✓	✓	✓	✓	-	-	✓	✓	✓	✓	✓	✓	✓	✓
	13	-	-	✓	✓	-	-	✓	✓	✓	✓	✓	✓	✓	✓
	17	-	-	✓	✓	-	-	✓	✓	✓	✓	✓	✓	✓	✓
Peak-to-Average Ratio	4						✓	✓	✓	✓		✓	✓	✓	✓
	12				✓	-	-	✓	✓	✓		✓	✓	✓	✓
	13	-	-		✓	-	-	✓	✓	✓		✓	✓	✓	✓
	17	-	-		✓	-	-	✓	✓	✓		✓	✓	✓	✓
26dB and 99% Bandwidth	4	✓	✓	✓	✓	✓	✓	✓	✓			✓	✓	✓	✓
	12	✓	✓	✓	✓	-	-	✓	✓			✓	✓	✓	✓
	13	-	-	✓	✓	-	-	✓	✓			✓	✓	✓	✓
	17	-	-	✓	✓	-	-	✓	✓			✓	✓	✓	✓
Conducted Band Edge	4	✓	✓	✓	✓	✓	✓	✓	✓	✓		✓			✓
	12	✓	✓	✓	✓	-	-	✓	✓	✓		✓	✓		✓
	13	-	-	✓	✓	-	-	✓	✓	✓		✓	✓		✓
	17	-	-	✓	✓	-	-	✓	✓	✓		✓	✓		✓
Conducted Spurious Emission	4	✓	✓	✓	✓	✓	✓	✓	✓	✓			✓	✓	✓
	12	✓	✓	✓	✓	-	-	✓	✓	✓			✓	✓	✓
	13	-	-	✓	✓	-	-	✓	✓	✓			✓	✓	✓
	17	-	-	✓	✓	-	-	✓	✓	✓			✓	✓	✓



Test Items	Band	Bandwidth (MHz)						Modulation		RB #			Test Channel		
		1.4	3	5	10	15	20	QPSK	16QAM	1	Half	Full	L	M	H
Frequency Stability	4				√			√				√		√	
	12	√			√	-	-	√				√		√	
	13	-	-	√	√	-	-	√				√		√	
	17	-	-	√	√	-	-	√				√		√	
E.R.P/ E.I.R.P.	4	√	√	√	√	√	√	√	√	√			√	√	√
	12	√	√	√	√	-	-	√	√	√			√	√	√
	13	-	-	√	√	-	-	√	√	√			√	√	√
	17	-	-	√	√	-	-	√	√	√			√	√	√
Radiated Spurious Emission	2				√			√		√			√	√	√
	4	√	√	√	√	√	√	√		√			√	√	√
	5			√		-	-	√		√			√	√	√
	7	-	-	√				√		√			√	√	√
	12	√	√	√	√	-	-	√		√			√	√	√
	13	-	-	√	√	-	-	√		√			√	√	√
	17	-	-	√	√	-	-	√		√			√	√	√
Note	<p>1. The mark "√" means that this configuration is chosen for testing</p> <p>2. The mark "-" means that this bandwidth is not supported.</p> <p>3. The device is investigated from 30MHz to 10 times of fundamental signal for radiated spurious emission test under different RB size/offset and modulations in exploratory test. Subsequently, only the worst case emissions are reported.</p>														

## 2.2 Connection Diagram of Test System

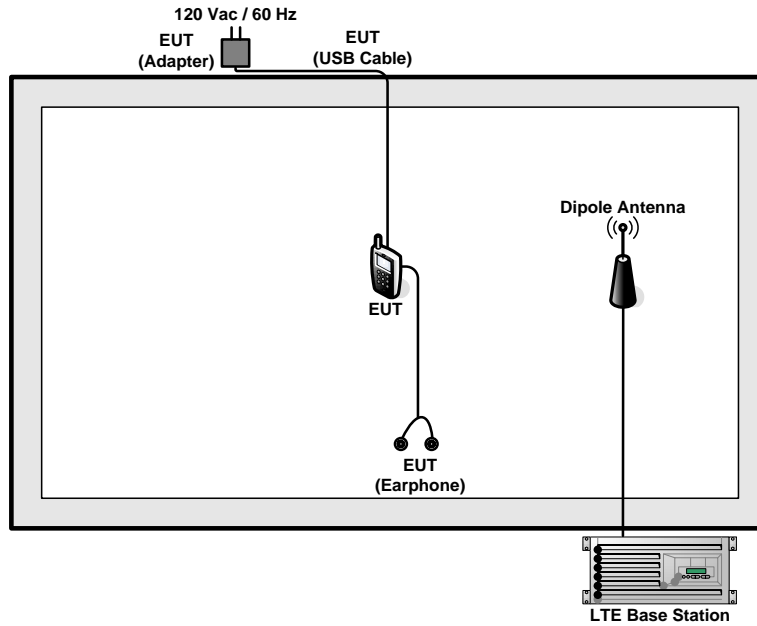

## 2.3 Support Unit used in test configuration and system

Item	Equipment	Trade Name	Model No.	FCC ID	Data Cable	Power Cord
1.	LTE Base Station	Anritsu	MT8820C	N/A	N/A	Unshielded, 1.8 m

## 2.4 Measurement Results Explanation Example

For all conducted test items:

The offset level is set in the spectrum analyzer to compensate the RF cable loss and attenuator factor between EUT conducted output port and spectrum analyzer. With the offset compensation, the spectrum analyzer reading level is exactly the EUT RF output level.

The spectrum analyzer offset is derived from RF cable loss and attenuator factor.

*Offset = RF cable loss + attenuator factor.*

Following shows an offset computation example with cable loss 4.2 dB and 10dB attenuator.

Example :

$$\begin{aligned} \text{Offset}(dB) &= \text{RF cable loss}(dB) + \text{attenuator factor}(dB). \\ &= 4.2 + 10 = 14.2 \text{ (dB)} \end{aligned}$$



### 3 Conducted Test Items

#### 3.1 Measuring Instruments

See list of measuring instruments of this test report.

#### 3.2 Test Setup

##### 3.2.1 Conducted Output Power

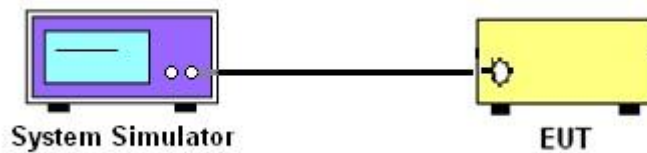

##### 3.2.2 Peak-to-Average Ratio, Occupied Bandwidth ,Conducted Band-Edge and Conducted Spurious Emission



##### 3.2.3 Frequency Stability

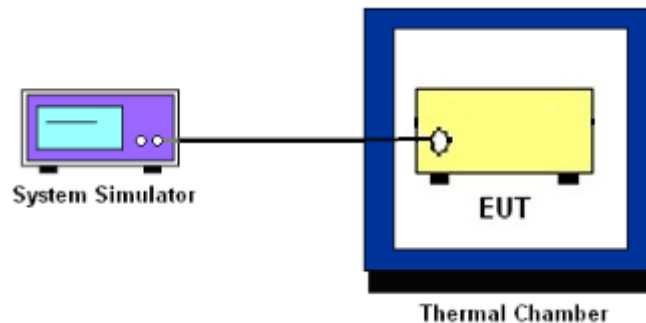



### **3.3 Test Result of Conducted Test**

Please refer to Appendix A.

### **3.4 Conducted Output Power**

#### **3.4.1 Description of the Conducted Output Power Measurement**

A system simulator was used to establish communication with the EUT. Its parameters were set to force the EUT transmitting at maximum output power. The measured power in the radio frequency on the transmitter output terminals shall be reported.

#### **3.4.2 Test Procedures**

1. The transmitter output port was connected to the system simulator.
2. Set EUT at maximum power through the system simulator.
3. Select lowest, middle, and highest channels for each band and different modulation.
4. Measure and record the power level from the system simulator.



## **3.5 Peak-to-Average Ratio**

### **3.5.1 Description of the PAR Measurement**

Power Complementary Cumulative Distribution Function (CCDF) curves provide a means for characterizing the power peaks of a digitally modulated signal on a statistical basis. A CCDF curve depicts the probability of the peak signal amplitude exceeding the average power level. Most contemporary measurement instrumentation include the capability to produce CCDF curves for an input signal provided that the instrument's resolution bandwidth can be set wide enough to accommodate the entire input signal bandwidth. In measuring transmissions in this band using an average power technique, the peak-to-average ratio (PAR) of the transmission may not exceed 13 dB.

### **3.5.2 Test Procedures**

1. The testing follows FCC KDB 971168 v02r02 Section 5.7.1.
2. The EUT was connected to spectrum and system simulator via a power divider.
3. Set the CCDF (Complementary Cumulative Distribution Function) option in spectrum analyzer.
4. The highest RF powers were measured and recorded the maximum PAPR level associated with a probability of 0.1 %.
5. Record the deviation as Peak to Average Ratio.



## **3.6 Occupied Bandwidth**

### **3.6.1 Description of Occupied Bandwidth Measurement**

The occupied bandwidth is the width of a frequency band such that, below the lower and above the upper frequency limits, the mean powers emitted are each equal to a specified percentage 0.5% of the total mean transmitted power.

The 26 dB emission bandwidth is defined as the frequency range between two points, one above and one below the carrier frequency, at which the spectral density of the emission is attenuated 26 dB below the maximum in-band spectral density of the modulated signal. Spectral density (power per unit bandwidth) is to be measured with a detector of resolution bandwidth equal to approximately 1.0% of the emission bandwidth.

### **3.6.2 Test Procedures**

1. The testing follows FCC KDB 971168 v02r02 Section 4.2.
2. The EUT was connected to spectrum analyzer and system simulator via a power divider.



### 3.7 Conducted Band Edge

#### 3.7.1 Description of Conducted Band Edge Measurement

27.53 (c) and RSS – 130 for Band 13

For operations in the 776-788 MHz band, the FCC limit is  $43 + 10\log_{10}(P[\text{Watts}])$  dB below the transmitter power P(Watts) in a 100 kHz bandwidth. However, in the 100 kHz bands immediately outside and adjacent to the frequency block, a resolution bandwidth of at least 30 kHz may be employed. In addition, the power of any unwanted emissions in any 6.25 kHz bandwidth for all frequencies between 763-775 MHz and 793-806 MHz shall be attenuated below the transmitter power, P (dBW), by at least  $65 + 10 \log_{10} p(\text{watts})$ , dB, for mobile and portable equipment.

27.53 (g) and RSS – 130 for Band 12,17

For operations in the 698 -746 MHz band, the FCC limit is  $43 + 10\log_{10}(P[\text{Watts}])$  dB below the transmitter power P(Watts) in a 100 kHz bandwidth. However, in the 100 kilohertz bands immediately outside and adjacent to a licensee's frequency block, a resolution bandwidth of at least 30 kHz may be employed.

27.53 (h) and RSS – 139 for Band 4

For operations in the 1710 – 1755 MHz band, the FCC limit is  $43 + 10\log_{10}(P[\text{Watts}])$  dB below the transmitter power P(Watts) in a 1 MHz bandwidth. However, in the 1MHz bands immediately outside and adjacent to the licensee's frequency block, a resolution bandwidth of at least one percent of the emission bandwidth of the fundamental emission of the transmitter may be employed.

#### 3.7.2 Test Procedures

1. The testing follows FCC KDB 971168 v02r02 Section 6.0.
2. The EUT was connected to spectrum analyzer and system simulator via a power divider.
3. The band edges of low and high channels for the highest RF powers were measured. Set RBW  $\geq 1\%$  EBW in the 1MHz band immediately outside and adjacent to the band edge.
4. Set spectrum analyzer with RMS detector.
5. The RF fundamental frequency should be excluded against the limit line in the operating frequency band.
6. The limit line is derived from  $43 + 10\log(P)$ dB below the transmitter power P(Watts)  
 $= P(W) - [43 + 10\log(P)]$  (dB)  
 $= [30 + 10\log(P)]$  (dBm) -  $[43 + 10\log(P)]$  (dB)  
 $= -13\text{dBm}$ .



### 3.8 Conducted Spurious Emission

#### 3.8.1 Description of Conducted Spurious Emission Measurement

The power of any emission outside of the authorized operating frequency ranges must be lower than the transmitter power (P) by a factor of at least  $43 + 10 \log (P)$  dB.

It is measured by means of a calibrated spectrum analyzer and scanned from 30 MHz up to a frequency including its 10<sup>th</sup> harmonic.

#### 3.8.2 Test Procedures

1. The testing follows FCC KDB 971168 v02r02 Section 6.0.
2. The EUT was connected to spectrum analyzer and system simulator via a power divider.
3. The RF output of EUT was connected to the spectrum analyzer by RF cable and attenuator. The path loss was compensated to the results for each measurement.
4. The middle channel for the highest RF power within the transmitting frequency was measured.
5. The conducted spurious emission for the whole frequency range was taken.
6. Make the measurement with the spectrum analyzer's RBW = 1MHz, VBW = 3MHz, taking the record of maximum spurious emission.
7. The RF fundamental frequency should be excluded against the limit line in the operating frequency band.
8. The limit line is derived from  $43 + 10\log(P)$ dB below the transmitter power P(Watts)  
=  $P(W) - [43 + 10\log(P)]$  (dB)  
=  $[30 + 10\log(P)]$  (dBm) -  $[43 + 10\log(P)]$  (dB)  
= -13dBm.



### **3.9 Frequency Stability**

#### **3.9.1 Description of Frequency Stability Measurement**

The frequency stability shall be measured by variation of ambient temperature and variation of primary supply voltage to ensure that the fundamental emission stays within the authorized frequency block. The frequency stability of the transmitter shall be maintained within  $\pm 0.00025\%$  ( $\pm 2.5\text{ppm}$ ) of the center frequency.

#### **3.9.2 Test Procedures for Temperature Variation**

1. The EUT was set up in the thermal chamber and connected with the system simulator.
2. With power OFF, the temperature was decreased to  $-30^{\circ}\text{C}$  and the EUT was stabilized before testing. Power was applied and the maximum change in frequency was recorded within one minute.
3. With power OFF, the temperature was raised in  $10^{\circ}\text{C}$  step up to  $50^{\circ}\text{C}$ . The EUT was stabilized at each step for at least half an hour. Power was applied and the maximum frequency change was recorded within one minute.

#### **3.9.3 Test Procedures for Voltage Variation**

1. The testing follows FCC KDB 971168 v02r02 Section 9.0.
2. The EUT was placed in a temperature chamber at  $25\pm 5^{\circ}\text{C}$  and connected with the system simulator.
3. The power supply voltage to the EUT was varied from 85% to 115% of the nominal value measured at the input to the EUT.
4. The variation in frequency was measured for the worst case.

#### **3.9.4 Test Procedures for Frequency Stability (IC)**

1. The testing follows FCC KDB 971168 v02r02 Section 9.0.
2. The EUT was connected to spectrum analyzer and system simulator via a power divider.
3. The EUT was operated at the lowest and highest channel
4. Using  $\text{RBW} = 1\% \text{ OBW}$  and displaying line =  $-13\text{dBm}$ .
5. The frequency at these points shall be recorded as  $f_L$  and  $f_H$  respectively.
6. Calculate frequency stability within the  $698.7 \sim 715.3 \text{ MHz}$ ,  $779.5 \sim 784.5 \text{ MHz}$ , and  $706.5 \sim 713.5 \text{ MHz}$

## 4 Radiated Test Items

### 4.1 Measuring Instruments

See list of measuring instruments of this test report.

### 4.2 Test Setup

#### 4.2.1 For radiated test from 30MHz to 1GHz

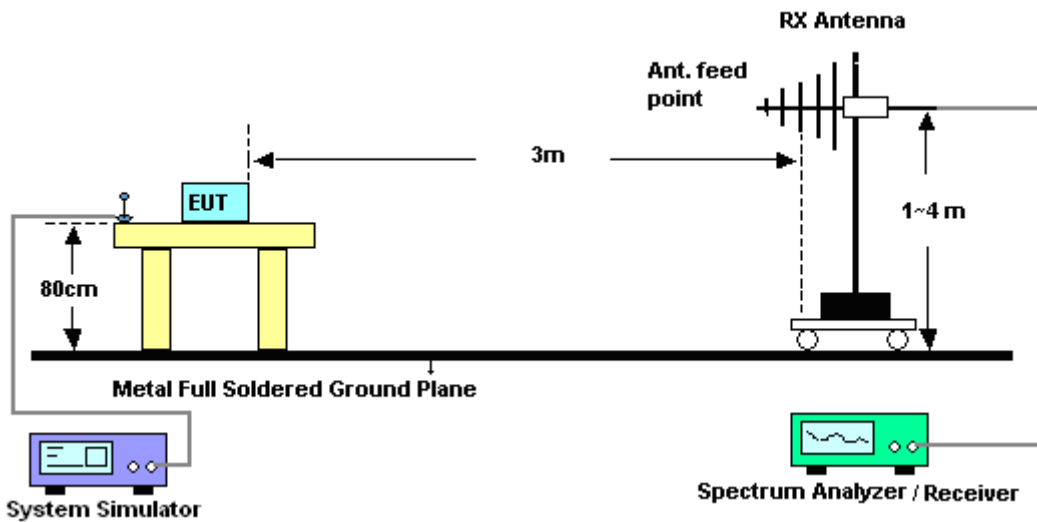

#### 4.2.2 For radiated test above 1GHz

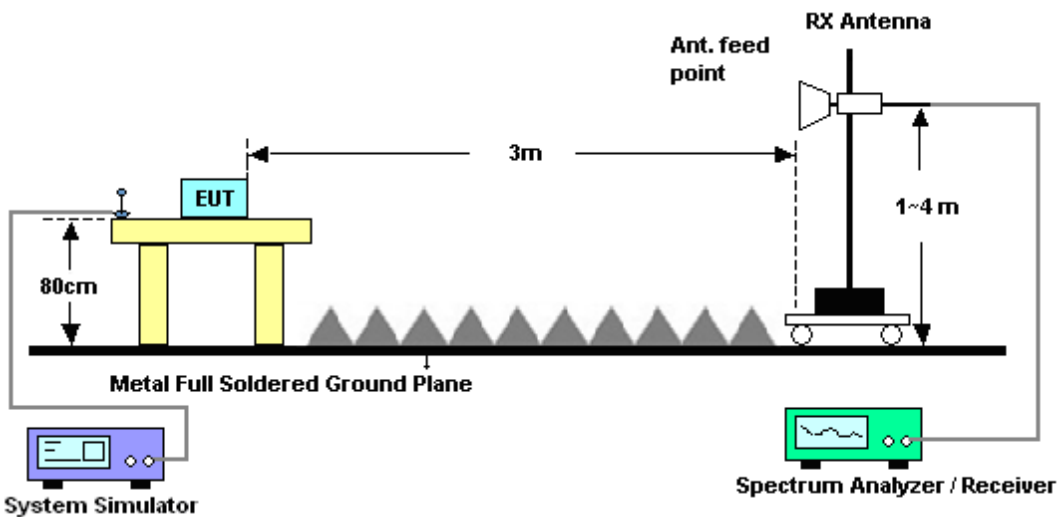





### 4.3 Test Result of Radiated Test

Please refer to Appendix B.

### 4.4 Effective Radiated Power and Effective Isotropic Radiated Power

#### 4.4.1 Description of the ERP/EIRP Measurement

Effective radiated power output measurements by substitution method according to ANSI / TIA / EIA-603-C-2004, and the spectrum analyzer configuration follows KDB 971168 D01 Power Meas. License Digital Systems v02r02. Mobile and portable (hand-held) stations operating are limited to average 3 watts with LTE band 12 / 13 / 17.

Equivalent isotropic radiated power output measurements by substitution method according to ANSI / TIA / EIA-603-C-2004, and the spectrum analyzer configuration follows KDB 971168 D01 Power Meas. License Digital Systems v02r02. Mobile and portable (hand-held) stations operating are limited to average 1 watt with LTE band 4.

#### 4.4.2 Test Procedures

1. The testing follows FCC KDB 971168 v02r02 Section 5.2.1. (for CDMA/WCDMA), Section 5.2.2.2 (for GSM/GPRS/EDGE) and ANSI / TIA-603-C-2004 Section 2.2.17.
2. The EUT was placed on a non-conductive rotating platform 0.8 meters high in a semi-anechoic chamber. The radiated emission at the fundamental frequency was measured at 3 m with a test antenna and a spectrum analyzer with RMS detector.
3. During the measurement, the system simulator parameters were set to force the EUT transmitting at maximum output power. The maximum emission was recorded from analyzer power level (LVL) from the 360 degrees rotation of the turntable and the test antenna raised and lowered over a range from 1 to 4 meters in both horizontally and vertically polarized orientations.
4. Effective Isotropic Radiated Power (EIRP) was measured by substitution method according to TIA/EIA-603-C. The EUT was replaced by dipole antenna (substitution antenna) at same location, and then a known power from S.G. was applied into the dipole antenna through a Tx cable, and then recorded the maximum Analyzer reading through raised and lowered the test antenna. The correction factor (in dB) = S.G. - Tx Cable loss + Substitution antenna gain - Analyzer reading. Then the EUT's EIRP was calculated with the correction factor,  $EIRP = LVL + \text{Correction factor}$  and  $ERP = EIRP - 2.15$ .



	LTE					
LTE BW	1.4M	3M	5M	10M	15M	20M
Span	3MHz	6MHz	10MHz	20MHz	30MHz	40MHz
RBW	30kHz	100kHz	100kHz	300kHz	300kHz	300kHz
VBW	100kHz	300kHz	300kHz	1MHz	1MHz	1MHz
Detector	RMS	RMS	RMS	RMS	RMS	RMS
Trace	Average	Average	Average	Average	Average	Average
Average Type	Power	Power	Power	Power	Power	Power
Sweep Count	100	100	100	100	100	100



## 4.5 Radiated Spurious Emission

### 4.5.1 Description of Radiated Spurious Emission

The radiated spurious emission was measured by substitution method according to ANSI / TIA / EIA-603-C-2004. The power of any emission outside of the authorized operating frequency ranges must be attenuated below the transmitter power (P) by a factor of at least  $43 + 10 \log (P)$  dB.

For Band 7

The power of any emission outside of the authorized operating frequency ranges must be attenuated below the transmitter power (P) by a factor of at least  $55 + 10 \log (P)$  dB.

For LTE Band 12,13,17

For operations in the 746-758 MHz, 775-788 MHz, and 805-806 MHz bands, emissions in the band 1559-1610 MHz shall be limited to  $-70$  dBW/MHz equivalent isotropically radiated power (EIRP) for wideband signals, and  $-80$  dBW EIRP for discrete emissions of less than 700 Hz bandwidth.

The spectrum is scanned from 30 MHz up to a frequency including its 10th harmonic.

### 4.5.2 Test Procedures

1. The testing follows FCC KDB 971168 v02r02 Section 5.8 and ANSI / TIA-603-C-2004 Section 2.2.12.
2. The EUT was placed on a rotatable wooden table with 0.8 meter above ground.
3. The EUT was set 3 meters from the receiving antenna, which was mounted on the antenna tower.
4. The table was rotated 360 degrees to determine the position of the highest spurious emission.
5. The height of the receiving antenna is varied between one meter and four meters to search the maximum spurious emission for both horizontal and vertical polarizations.
6. Make the measurement with the spectrum analyzer's RBW = 1MHz, VBW = 3MHz, taking the record of maximum spurious emission.
7. A horn antenna was substituted in place of the EUT and was driven by a signal generator.
8. Tune the output power of signal generator to the same emission level with EUT maximum spurious emission.
9. Taking the record of output power at antenna port.
10. Repeat step 7 to step 8 for another polarization.
11. The RF fundamental frequency should be excluded against the limit line in the operating frequency band.

The limit line is derived from  $43 + 10\log(P)$ dB below the transmitter power P(Watts)  
 $= P(W) - [43 + 10\log(P)]$  (dB)  
 $= [30 + 10\log(P)]$  (dBm) -  $[43 + 10\log(P)]$  (dB)  
 $= -13$ dBm.

For Band 7:

The limit line is derived from  $55 + 10\log(P)$ dB below the transmitter power P(Watts)



12.  $EIRP \text{ (dBm)} = S.G. \text{ Power} - Tx \text{ Cable Loss} + Tx \text{ Antenna Gain}$
13.  $ERP \text{ (dBm)} = EIRP - 2.15$



## 5 List of Measuring Equipment

Instrument	Manufacturer	Model No.	Serial No.	Characteristics	Calibration Date	Test Date	Due Date	Remark
Spectrum Analyzer	Rohde & Schwarz	FSP40	100055	9kHz~40GHz	Jun. 09, 2014	Jan. 27, 2015~ Feb. 02, 2015	Jun. 08, 2015	Conducted (TH02-HY)
Thermal Chamber	Ten Billion	TTH-D3SP	TBN-930701	N/A	Jul. 17, 2014	Jan. 27, 2015~ Feb. 02, 2015	Jul. 16, 2015	Conducted (TH02-HY)
LTE Base Station	Anritsu	MT8820C	6201026480	30MHz~2.7GHz SISO	Jan. 07, 2014	Jan. 27, 2015~ Feb. 02, 2015	Jan. 06, 2015	Conducted (TH02-HY)
Hygrometer	Testo	608-H1	34897199	N/A	May 06, 2014	Jan. 27, 2015~ Feb. 02, 2015	May 05, 2015	Conducted (TH02-HY)
RF cable	WOKEN	S05	S05-130708-038	N/A	Jan. 21, 2015	Jan. 21, 2015~ Feb. 02, 2015	Jan. 20, 2016	Conducted (TH02-HY)
Preamplifier	Keysight	83017A	MY53270078	1GHz~26.5GHz	Nov. 20, 2014	Feb. 03, 2015~ Feb. 26, 2015	Nov. 19, 2015	Radiation (03CH10-HY)
Amplifier	SONOMA	310N	187311	0.1MHz~1000MHz	Nov. 24, 2014	Feb. 03, 2015~ Feb. 26, 2015	Nov. 23, 2015	Radiation (03CH10-HY)
Preamplifier	MITEQ	JS44-18004000-33-8P	1840917	18GHz ~ 40GHz	Jun. 09, 2014	Feb. 03, 2015~ Feb. 26, 2015	Jun. 08, 2015	Radiation (03CH10-HY)
Bilog Antenna	TESEQ	CBL 6111D	35413	30MHz~1GHz	Oct. 24, 2014	Feb. 03, 2015~ Feb. 26, 2015	Oct. 23, 2015	Radiation (03CH10-HY)
Double Ridged Guide Horn	SCHWARZBECK	BBHA 9120 D	9120D-1325	1GHz ~ 18GHz	Oct. 03, 2014	Feb. 03, 2015~ Feb. 26, 2015	Oct. 02, 2015	Radiation (03CH10-HY)
Horn Antenna	SCHWARZBECK	BBHA 9170	BBHA9170584	18GHz- 40GHz	Nov. 03, 2014	Feb. 03, 2015~ Feb. 26, 2015	Nov. 02, 2015	Radiation (03CH10-HY)
Spectrum Analyzer	Keysight	N9010A	MY54200485	10Hz ~ 44GHZ	Oct. 14, 2014	Feb. 03, 2015~ Feb. 26, 2015	Oct. 13, 2015	Radiation (03CH10-HY)
EMI Test Receiver	Keysight	N9038A	MY54130085	20Hz ~ 26.5GHz	Nov. 05, 2014	Feb. 03, 2015~ Feb. 26, 2015	Nov. 04, 2015	Radiation (03CH10-HY)
Controllor	EMEC	EM 1000	N/A	Control Turn table & Ant Mast	N/A	Feb. 03, 2015~ Feb. 26, 2015	N/A	Radiation (03CH10-HY)
Turn Table	EMEC	TT 2200	N/A	0-360 degree	N/A	Feb. 03, 2015~ Feb. 26, 2015	N/A	Radiation (03CH10-HY)
Antenna Mast	EMEC	AM-BS-450 0-B	N/A	1~4m	N/A	Feb. 03, 2015~ Feb. 26, 2015	N/A	Radiation (03CH10-HY)
Hygrometer	TECPEL	DTM-303B	TP140320	N/A	Nov. 17, 2014	Feb. 03, 2015~ Feb. 26, 2015	Nov. 16, 2015	Radiation (03CH10-HY)
RF Cable	HUBER + SUHNER	SUCOFLEX 104	MY24956/4 MY24952/4MY	25GHz~40GHz	Nov. 06, 2014	Feb. 03, 2015~ Feb. 26, 2015	Nov. 05, 2015	Radiation (03CH10-HY)
RF Cable	HUBER + SUHNER	SUCOFLEX 104	MY24956/4 MY24952/4MY	30MHz~1GHz	Nov. 06, 2014	Feb. 03, 2015~ Feb. 26, 2015	Nov. 05, 2015	Radiation (03CH10-HY)
RF Cable	HUBER + SUHNER	SUCOFLEX 104	MY249564 MY249524MY	1GHz~25GHz	Nov. 06, 2014	Feb. 03, 2015~ Feb. 26, 2015	Nov. 05, 2015	Radiation (03CH10-HY)
Notch Filter	Wainwright	WRCG 824/849/814	SN35	850	Oct. 01, 2014	Feb. 03, 2015~ Feb. 26, 2015	Sep. 30, 2015	Radiation (03CH10-HY)
Notch Filter	Wainwright	WRCT1850/1910-40/8S	SN21	1900	Oct. 01, 2014	Feb. 03, 2015~ Feb. 26, 2015	Sep. 30, 2015	Radiation (03CH10-HY)



BAND4 、Band12 13 17?

Instrument	Manufacturer	Model No.	Serial No.	Characteristics	Calibration Date	Test Date	Due Date	Remark
Notch Filter	Wainwright	WRCT2500/ 2570-10/40-	SN1 R	LTE Band7	Oct. 01, 2014	Feb. 03, 2015~ Feb. 26, 2015	Sep. 30, 2015	Radiation (03CH10-HY)
Notch Filter	Wainwright	WRCT700/9 15-20/40-8S	SN1	700-915	Oct. 01, 2014	Feb. 03, 2015~ Feb. 26, 2015	Sep. 30, 2015	Radiation (03CH10-HY)
Filter	Microwave Circuits	H1G013G1	SN477215	1GHz HPF	Oct. 01, 2014	Feb. 03, 2015~ Feb. 26, 2015	Sep. 30, 2015	Radiation (03CH10-HY)
Filter	Wainwright Instruments	WLKS1200- 8SS	SN3	1.2GHz LPF	Oct. 01, 2014	Feb. 03, 2015~ Feb. 26, 2015	Sep. 30, 2015	Radiation (03CH10-HY)
Filter	Microwave Circuits	H3G018G1	SN477220	3GHz HPF	Oct. 01, 2014	Feb. 03, 2015~ Feb. 26, 2015	Sep. 30, 2015	Radiation (03CH10-HY)
Test Software	Audix	E3	Version 6.2009-8-24	N/A	N/A	Feb. 03, 2015~ Feb. 26, 2015	N/A	Radiation (03CH10-HY)



## 6 Uncertainty of Evaluation

### Uncertainty of Radiated Emission Measurement (30 MHz ~ 1000 MHz)

Measuring Uncertainty for a Level of Confidence of 95% ( $U = 2Uc(y)$ )	2.54
---	------

### Uncertainty of Radiated Emission Measurement (1 GHz ~ 40 GHz)

Measuring Uncertainty for a Level of Confidence of 95% ( $U = 2Uc(y)$ )	4.72
---	------



## Appendix A. Test Results of Conducted Test

### Conducted Output Power(Average power)

LTE Band 2 Maximum Average Power [dBm]						
BW [MHz]	RB Size	RB Offset	Mod	Lowest	Middle	Highest
1.4	1	0	QPSK	23.53	23.67	23.70
1.4	1	2		23.45	23.57	23.46
1.4	1	5		23.52	23.42	23.44
1.4	3	0		23.39	23.63	23.63
1.4	3	1		23.42	23.66	23.69
1.4	3	2		23.43	23.56	23.59
1.4	6	0		22.50	22.60	22.50
1.4	1	0	16-QAM	22.46	22.80	22.23
1.4	1	2		22.40	22.79	22.12
1.4	1	5		22.30	22.67	22.11
1.4	3	0		22.20	22.67	22.09
1.4	3	1		22.13	22.57	22.01
1.4	3	2		22.08	22.42	22.05
1.4	6	0		20.93	21.42	21.39
3	1	0	QPSK	23.53	23.74	23.75
3	1	7		23.52	23.72	23.74
3	1	14		23.47	23.71	23.70
3	8	0		22.61	22.69	22.62
3	8	4		22.64	22.71	22.69
3	8	7		22.60	22.72	22.75
3	15	0		22.57	22.72	22.60
3	1	0	16-QAM	22.44	22.88	22.31
3	1	7		22.31	22.73	22.26
3	1	14		22.21	22.60	22.22
3	8	0		21.82	21.99	21.71
3	8	4		21.55	21.61	21.65
3	8	7		21.51	21.80	21.80
3	15	0		21.72	21.84	21.81





LTE Band 2 Maximum Average Power [dBm]						
BW [MHz]	RB Size	RB Offset	Mod	Lowest	Middle	Highest
5	1	0	QPSK	23.44	23.48	23.66
5	1	12		23.43	23.47	23.65
5	1	24		23.37	23.45	23.57
5	12	0		22.57	22.60	22.54
5	12	6		22.57	22.61	22.54
5	12	11		22.58	22.67	22.62
5	25	0		22.55	22.61	22.64
5	1	0	16-QAM	22.46	22.84	22.42
5	1	12		22.38	22.83	22.41
5	1	24		22.25	22.70	22.24
5	12	0		21.56	21.68	21.62
5	12	6		21.52	21.61	21.63
5	12	11		21.59	21.58	21.56
5	25	0		21.69	21.88	21.57
10	1	0	QPSK	23.68	23.74	23.75
10	1	24		23.67	23.72	23.74
10	1	49		23.52	23.40	23.52
10	25	0		22.58	22.61	22.54
10	25	12		22.66	22.71	22.53
10	25	24		22.55	22.57	22.48
10	50	0		22.61	22.67	22.52
10	1	0	16-QAM	22.37	22.71	22.47
10	1	24		22.15	22.47	22.46
10	1	49		22.03	22.23	22.25
10	25	0		21.49	21.79	21.70
10	25	12		21.46	21.61	21.44
10	25	24		21.63	21.60	21.58
10	50	0		21.55	21.66	21.52



LTE Band 2 Maximum Average Power [dBm]						
BW [MHz]	RB Size	RB Offset	Mod	Lowest	Middle	Highest
15	1	0	QPSK	23.63	23.65	23.73
15	1	37		23.55	23.53	23.44
15	1	74		23.43	23.49	23.44
15	36	0		22.61	22.66	22.59
15	36	18		22.56	22.59	22.44
15	36	37		22.49	22.56	22.44
15	75	0		22.59	22.59	22.58
15	1	0	16-QAM	22.91	22.99	22.80
15	1	37		22.78	22.89	22.77
15	1	74		22.77	22.82	22.73
15	36	0		21.38	21.60	21.57
15	36	18		21.35	21.54	21.51
15	36	37		21.24	21.54	21.50
15	75	0		21.49	21.60	21.56
20	1	0	QPSK	23.72	23.74	23.74
20	1	49		23.71	23.51	23.72
20	1	99		23.38	23.43	23.70
20	50	0		22.75	22.67	22.74
20	50	24		22.55	22.63	22.53
20	50	49		22.56	22.65	22.41
20	100	0		22.60	22.62	22.55
20	1	0	16-QAM	22.99	22.92	22.94
20	1	49		22.92	22.81	22.88
20	1	99		22.71	22.73	22.75
20	50	0		21.70	21.55	21.66
20	50	24		21.61	21.61	21.51
20	50	49		21.48	21.62	21.49
20	100	0		21.60	21.60	21.52



LTE Band 4 Maximum Average Power [dBm]						
BW [MHz]	RB Size	RB Offset	Mod	Lowest	Middle	Highest
1.4	1	0	QPSK	23.44	23.59	23.51
1.4	1	2		23.36	23.29	23.50
1.4	1	5		23.16	23.22	23.17
1.4	3	0		23.33	23.37	23.26
1.4	3	1		23.43	23.58	23.40
1.4	3	2		23.35	23.26	23.38
1.4	6	0		22.31	22.38	22.32
1.4	1	0	16-QAM	22.33	22.87	22.83
1.4	1	2		22.22	22.20	22.72
1.4	1	5		22.16	22.86	22.62
1.4	3	0		22.17	22.05	22.46
1.4	3	1		21.89	22.20	22.26
1.4	3	2		22.07	22.40	22.22
1.4	6	0		21.23	21.25	21.13
3	1	0	QPSK	23.39	23.31	23.45
3	1	7		23.34	23.29	23.44
3	1	14		23.03	23.15	23.28
3	8	0		22.26	22.38	22.30
3	8	4		22.28	22.33	22.31
3	8	7		22.19	22.31	22.30
3	15	0		22.28	22.32	22.36
3	1	0	16-QAM	22.69	22.50	22.23
3	1	7		22.06	22.44	22.19
3	1	14		22.15	22.49	22.02
3	8	0		21.49	21.37	21.31
3	8	4		21.47	21.42	21.45
3	8	7		21.18	21.31	21.41
3	15	0		21.22	21.48	21.57



LTE Band 4 Maximum Average Power [dBm]						
BW [MHz]	RB Size	RB Offset	Mod	Lowest	Middle	Highest
5	1	0	QPSK	23.18	23.30	23.36
5	1	12		23.17	23.29	23.35
5	1	24		23.04	23.19	23.06
5	12	0		22.30	22.34	22.33
5	12	6		22.31	22.42	22.18
5	12	11		22.25	22.38	22.23
5	25	0		22.28	22.33	22.24
5	1	0	16-QAM	22.06	22.69	22.31
5	1	12		21.91	22.59	22.28
5	1	24		21.90	22.35	22.20
5	12	0		21.23	21.41	21.31
5	12	6		21.28	21.44	21.26
5	12	11		21.31	21.36	21.24
5	25	0		21.43	21.59	21.19
10	1	0	QPSK	23.47	23.48	23.53
10	1	24		23.31	23.47	23.52
10	1	49		23.18	23.22	23.38
10	25	0		22.31	22.38	22.43
10	25	12		22.26	22.32	22.37
10	25	24		22.24	22.37	22.20
10	50	0		22.30	22.35	22.41
10	1	0	16-QAM	22.84	22.70	22.62
10	1	24		22.57	22.41	22.55
10	1	49		22.51	21.92	22.48
10	25	0		21.46	21.58	21.53
10	25	12		21.22	21.53	21.25
10	25	24		21.13	21.45	21.27
10	50	0		21.32	21.25	21.38



LTE Band 4 Maximum Average Power [dBm]						
BW [MHz]	RB Size	RB Offset	Mod	Lowest	Middle	Highest
15	1	0	QPSK	22.49	23.41	23.39
15	1	37		22.25	23.26	23.24
15	1	74		22.28	23.12	23.18
15	36	0		22.41	22.42	22.46
15	36	18		22.28	22.39	22.37
15	36	37		22.32	22.30	22.38
15	75	0		22.32	22.41	22.39
15	1	0	16-QAM	22.20	22.95	22.10
15	1	37		22.17	22.90	22.03
15	1	74		22.10	22.84	21.90
15	36	0		21.20	21.46	21.32
15	36	18		21.09	21.45	21.25
15	36	37		21.12	21.44	21.25
15	75	0		21.44	21.37	21.45
20	1	0	QPSK	23.70	23.56	23.53
20	1	49		23.69	23.48	23.49
20	1	99		23.33	23.37	23.31
20	50	0		22.43	22.53	22.51
20	50	24		22.29	22.45	22.46
20	50	49		22.25	22.41	22.34
20	100	0		22.30	22.50	22.38
20	1	0	16-QAM	22.10	22.83	22.80
20	1	49		22.01	22.67	22.68
20	1	99		22.05	22.57	22.55
20	50	0		21.47	21.47	21.47
20	50	24		21.34	21.43	21.41
20	50	49		21.31	21.36	21.30
20	100	0		21.44	21.56	21.53



LTE Band 5 Maximum Average Power [dBm]						
BW [MHz]	RB Size	RB Offset	Mod	Lowest	Middle	Highest
1.4	1	0	QPSK	24.16	24.12	24.12
1.4	1	2		24.13	24.11	24.02
1.4	1	5		24.09	24.05	24.00
1.4	3	0		24.03	24.03	24.10
1.4	3	1		23.98	24.04	24.11
1.4	3	2		24.07	24.05	24.05
1.4	6	0		23.00	23.08	23.18
1.4	1	0	16-QAM	23.89	23.78	23.77
1.4	1	2		23.69	23.77	23.66
1.4	1	5		23.53	23.66	23.52
1.4	3	0		23.71	23.73	23.65
1.4	3	1		23.62	23.60	23.67
1.4	3	2		23.78	23.70	23.55
1.4	6	0		22.60	22.86	22.50
3	1	0	QPSK	24.15	23.96	24.16
3	1	7		24.13	23.93	24.15
3	1	14		23.74	23.66	24.14
3	8	0		23.81	23.81	23.97
3	8	4		23.84	23.95	23.82
3	8	7		23.88	23.89	23.66
3	15	0		23.83	23.81	23.71
3	1	0	16-QAM	23.65	23.72	23.57
3	1	7		23.51	23.62	23.40
3	1	14		23.40	23.56	23.38
3	8	0		22.93	22.72	22.84
3	8	4		22.88	22.85	22.75
3	8	7		22.77	22.62	22.67
3	15	0		22.65	22.53	22.58



LTE Band 5 Maximum Average Power [dBm]						
BW [MHz]	RB Size	RB Offset	Mod	Lowest	Middle	Highest
5	1	0	QPSK	24.22	24.02	24.14
5	1	12		24.21	24.01	24.13
5	1	24		23.76	23.61	23.45
5	12	0		23.84	23.85	23.72
5	12	6		23.83	23.88	23.68
5	12	11		24.00	23.78	23.51
5	25	0		23.86	23.87	23.51
5	1	0	16-QAM	23.34	23.66	23.57
5	1	12		23.20	23.53	23.40
5	1	24		23.17	23.48	23.32
5	12	0		23.00	22.86	22.79
5	12	6		22.91	22.88	22.84
5	12	11		22.81	22.70	22.85
5	25	0		22.70	22.91	22.71
10	1	0	QPSK	23.91	24.00	24.12
10	1	24		23.90	23.98	24.11
10	1	49		23.79	23.89	23.76
10	25	0		23.53	23.85	23.95
10	25	12		23.54	23.84	23.92
10	25	24		23.45	23.89	23.85
10	50	0		23.52	23.91	23.90
10	1	0	16-QAM	23.36	23.64	23.60
10	1	24		23.23	23.57	23.55
10	1	49		23.17	23.48	23.42
10	25	0		23.00	22.97	22.82
10	25	12		22.92	22.96	22.70
10	25	24		22.80	22.99	22.45
10	50	0		22.70	22.86	22.39



LTE Band 7 Maximum Average Power [dBm]						
BW [MHz]	RB Size	RB Offset	Mod	Lowest	Middle	Highest
5	1	0	QPSK	22.46	22.70	22.74
5	1	12		22.45	22.67	22.63
5	1	24		22.08	22.23	22.44
5	12	0		21.51	21.49	21.58
5	12	6		21.49	21.44	21.50
5	12	11		21.45	21.42	21.58
5	25	0		21.44	21.48	21.64
5	1	0	16-QAM	21.68	21.69	21.95
5	1	12		21.63	21.68	21.94
5	1	24		21.59	21.56	21.81
5	12	0		20.42	20.48	20.69
5	12	6		20.33	20.45	20.61
5	12	11		20.31	20.50	20.71
5	25	0		20.40	20.87	20.77
10	1	0	QPSK	22.70	22.70	22.69
10	1	24		22.68	22.68	22.68
10	1	49		22.49	22.62	22.55
10	25	0		21.51	21.57	21.58
10	25	12		21.48	21.47	21.65
10	25	24		21.41	21.44	21.61
10	50	0		21.53	21.52	21.60
10	1	0	16-QAM	21.32	22.00	21.55
10	1	24		21.29	21.99	21.27
10	1	49		21.18	21.82	21.38
10	25	0		20.57	20.70	20.73
10	25	12		20.34	20.73	20.79
10	25	24		20.33	20.73	20.86
10	50	0		20.28	20.40	20.48





LTE Band 7 Maximum Average Power [dBm]						
BW [MHz]	RB Size	RB Offset	Mod	Lowest	Middle	Highest
15	1	0	QPSK	22.57	22.71	22.69
15	1	37		22.33	22.67	22.58
15	1	74		22.23	22.50	22.66
15	36	0		21.56	21.57	21.54
15	36	18		21.43	21.47	21.56
15	36	37		21.41	21.46	21.62
15	75	0		21.42	21.55	21.51
15	1	0	16-QAM	21.37	21.83	21.96
15	1	37		21.36	21.69	21.78
15	1	74		21.04	21.73	21.63
15	36	0		20.28	20.42	20.67
15	36	18		20.25	20.52	20.59
15	36	37		20.16	20.52	20.60
15	75	0		20.39	20.52	20.64
20	1	0	QPSK	22.70	22.74	22.74
20	1	49		22.57	22.70	22.73
20	1	99		22.47	22.66	22.54
20	50	0		21.53	21.61	21.59
20	50	24		21.46	21.49	21.68
20	50	49		21.35	21.44	21.66
20	100	0		21.51	21.50	21.62
20	1	0	16-QAM	21.90	21.83	21.50
20	1	49		21.59	21.71	21.49
20	1	99		21.70	21.78	21.35
20	50	0		20.47	20.67	20.71
20	50	24		20.41	20.55	20.70
20	50	49		20.42	20.50	20.71
20	100	0		20.44	20.54	20.65



LTE Band 12 Maximum Average Power [dBm]						
BW [MHz]	RB Size	RB Offset	Mod	Lowest	Middle	Highest
1.4	1	0	QPSK	24.91	24.97	24.94
1.4	1	2		24.86	24.93	24.81
1.4	1	5		24.76	24.58	24.93
1.4	3	0		24.61	24.91	24.85
1.4	3	1		24.55	24.85	24.84
1.4	3	2		24.48	24.77	24.85
1.4	6	0		23.98	23.80	23.90
1.4	1	0	16-QAM	23.77	23.64	23.85
1.4	1	2		23.70	23.52	23.70
1.4	1	5		23.60	23.46	23.62
1.4	3	0		23.56	23.61	23.54
1.4	3	1		23.40	23.53	23.41
1.4	3	2		23.38	23.34	23.35
1.4	6	0		22.82	22.95	22.92
3	1	0	QPSK	24.17	24.24	23.96
3	1	7		23.95	24.23	23.87
3	1	14		23.88	23.70	23.86
3	8	0		23.97	23.83	23.84
3	8	4		23.87	23.89	23.94
3	8	7		23.95	23.86	23.75
3	15	0		23.95	23.85	23.85
3	1	0	16-QAM	23.61	23.55	23.74
3	1	7		23.57	23.41	23.66
3	1	14		23.39	23.36	23.58
3	8	0		22.96	22.82	22.90
3	8	4		22.81	22.79	22.86
3	8	7		22.74	22.60	22.73
3	15	0		22.78	22.54	22.69



LTE Band 12 Maximum Average Power [dBm]						
BW [MHz]	RB Size	RB Offset	Mod	Lowest	Middle	Highest
5	1	0	QPSK	23.84	23.85	23.85
5	1	12		23.79	23.84	23.84
5	1	24		23.53	23.53	23.53
5	12	0		23.81	23.81	23.81
5	12	6		23.78	23.78	23.78
5	12	11		23.80	23.80	23.80
5	25	0		23.74	23.74	23.74
5	1	0	16-QAM	23.58	23.88	23.88
5	1	12		23.28	23.72	23.78
5	1	24		23.09	23.69	23.69
5	12	0		22.83	22.83	22.83
5	12	6		22.86	22.86	22.86
5	12	11		22.86	22.86	22.86
5	25	0		22.92	22.92	22.92
10	1	0	QPSK	23.94	24.04	24.22
10	1	24		23.92	23.92	24.08
10	1	49		23.89	23.90	23.95
10	25	0		23.74	23.93	23.95
10	25	12		23.52	23.84	23.82
10	25	24		23.44	23.86	23.70
10	50	0		23.38	23.73	23.60
10	1	0	16-QAM	22.88	23.50	23.55
10	1	24		22.74	23.47	23.39
10	1	49		22.67	23.38	23.21
10	25	0		22.40	22.94	22.92
10	25	12		22.20	22.98	22.80
10	25	24		22.16	22.97	22.70
10	50	0		22.08	22.90	22.68



LTE Band 13 Maximum Average Power [dBm]						
BW [MHz]	RB Size	RB Offset	Mod	Lowest	Middle	Highest
5	1	0	QPSK	23.85	23.88	23.97
5	1	12		23.84	23.87	23.96
5	1	24		23.53	23.52	23.72
5	12	0		23.81	23.71	23.69
5	12	6		23.78	23.86	23.86
5	12	11		23.80	23.69	23.85
5	25	0		23.74	23.82	23.64
5	1	0	16-QAM	23.58	23.62	23.37
5	1	12		23.48	23.59	23.23
5	1	24		23.39	23.41	23.12
5	12	0		22.83	22.79	22.81
5	12	6		22.86	22.75	22.83
5	12	11		22.86	22.80	22.83
5	25	0		22.92	22.94	22.99
10	1	0	QPSK	-	23.94	-
10	1	24		-	23.74	-
10	1	49		-	23.73	-
10	25	0		-	23.75	-
10	25	12		-	23.81	-
10	25	24		-	23.74	-
10	50	0		-	23.82	-
10	1	0	16-QAM	-	23.74	-
10	1	24		-	23.69	-
10	1	49		-	23.50	-
10	25	0		-	22.82	-
10	25	12		-	22.85	-
10	25	24		-	22.78	-
10	50	0		-	22.78	-



LTE Band 17 Maximum Average Power [dBm]						
BW [MHz]	RB Size	RB Offset	Mod	Lowest	Middle	Highest
5	1	0	QPSK	23.94	23.88	23.82
5	1	12		23.93	23.83	23.81
5	1	24		23.33	23.52	23.81
5	12	0		23.65	23.61	23.58
5	12	6		23.67	23.52	23.49
5	12	11		23.69	23.56	23.76
5	25	0		23.55	23.52	23.58
5	1	0	16-QAM	23.37	23.46	23.57
5	1	12		23.28	23.40	23.43
5	1	24		23.11	23.39	23.39
5	12	0		22.54	22.69	22.61
5	12	6		22.67	22.60	22.63
5	12	11		22.68	22.58	22.72
5	25	0		22.61	22.75	22.73
10	1	0	QPSK	23.92	23.87	23.77
10	1	24		23.91	23.77	23.61
10	1	49		23.66	23.79	23.58
10	25	0		23.74	23.79	23.57
10	25	12		23.80	23.63	23.57
10	25	24		23.61	23.65	23.58
10	50	0		23.77	23.80	23.71
10	1	0	16-QAM	22.83	23.72	23.34
10	1	24		22.75	23.69	23.26
10	1	49		22.64	23.59	23.06
10	25	0		22.72	22.90	22.82
10	25	12		22.78	22.64	22.63
10	25	24		22.78	22.67	22.64
10	50	0		22.69	22.75	22.64



## LTE Band 4

### Peak-to-Average Ratio

Mode	LTE Band 4 / 20MHz				
Mod.	QPSK		16QAM		Limit: 13dB
RB Size	1RB	Full RB	1RB	Full RB	Result
Lowest CH	4.26	5.22	5.45	6.06	<b>PASS</b>
Middle CH	4.20	5.26	5.19	6.03	
Highest CH	4.20	5.19	5.35	5.99	



LTE Band 4 / 20MHz / QPSK

Lowest Channel / 1RB

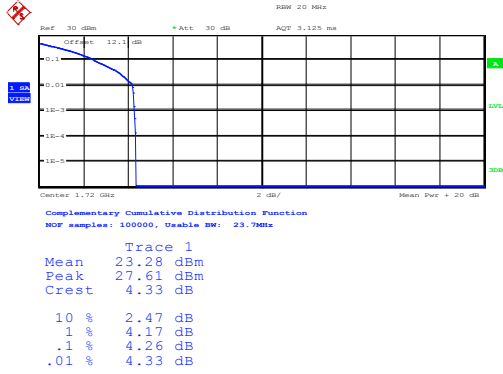

Date: 27.JAN.2015 21:16:02

Lowest Channel / Full RB

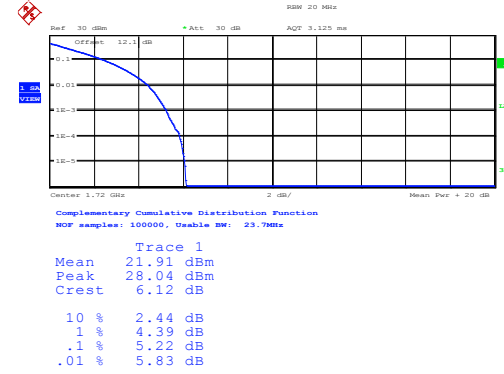

Date: 27.JAN.2015 21:16:18

Middle Channel / 1RB

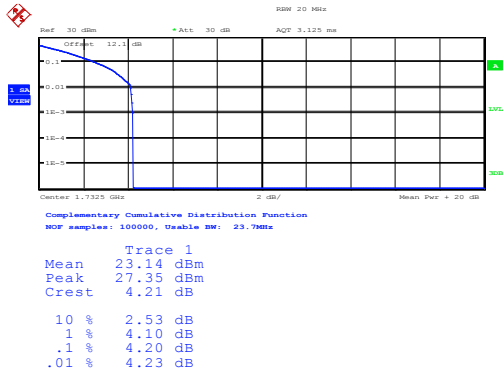

Date: 27.JAN.2015 21:16:32

Middle Channel / Full RB

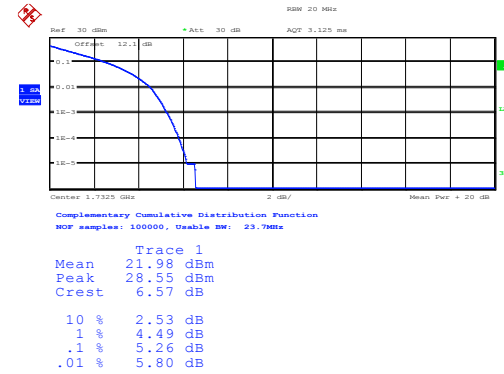

Date: 27.JAN.2015 21:16:46

Highest Channel / 1RB

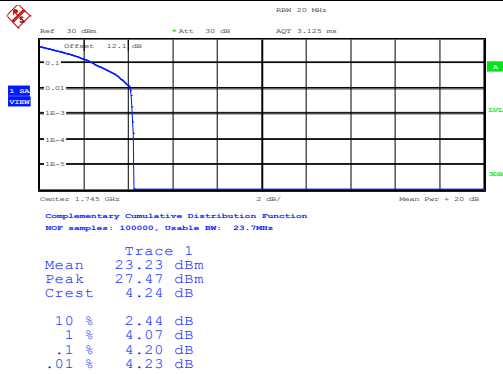

Date: 27.JAN.2015 21:17:02

Highest Channel / Full RB

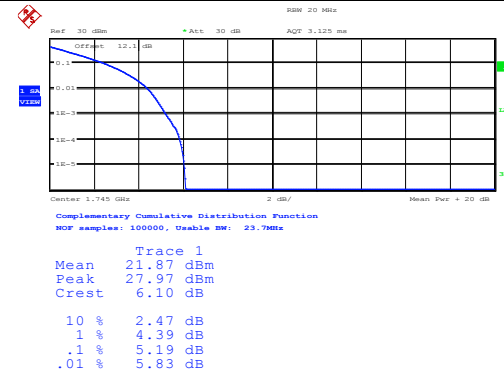

Date: 27.JAN.2015 21:17:15



LTE Band 4 / 20MHz / 16QAM

Lowest Channel / 1RB

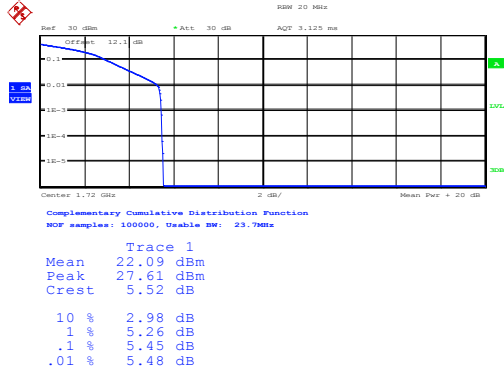

Date: 27.JAN.2015 21:10:15

Lowest Channel / Full RB

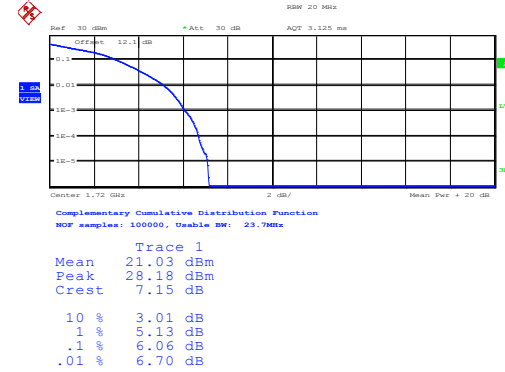

Date: 27.JAN.2015 21:14:58

Middle Channel / 1RB

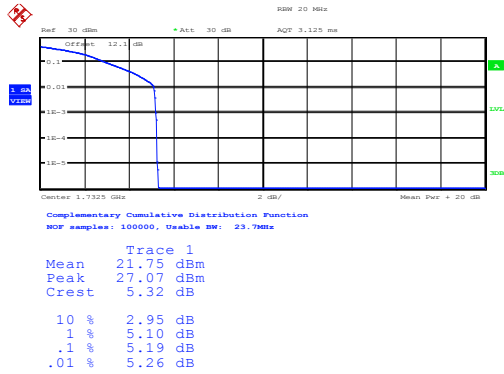

Date: 27.JAN.2015 21:15:10

Middle Channel / Full RB

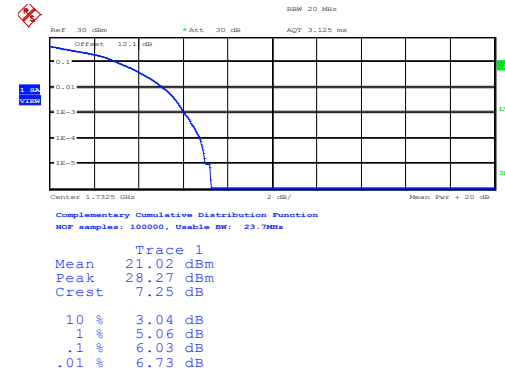

Date: 27.JAN.2015 21:15:23

Highest Channel / 1RB

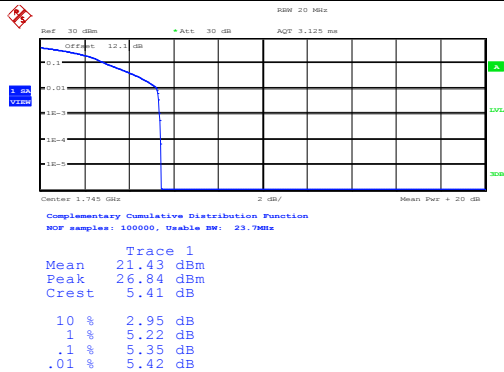

Date: 27.JAN.2015 21:15:34

Highest Channel / Full RB

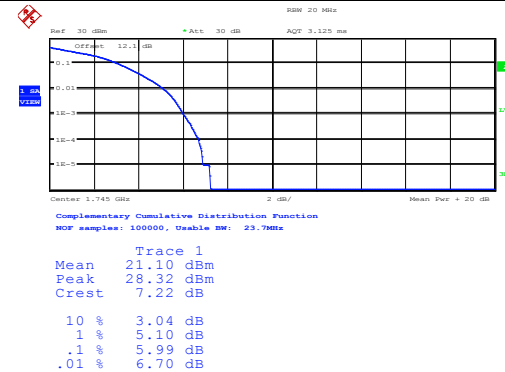

Date: 27.JAN.2015 21:15:49





**26dB Bandwidth**

Mode	LTE Band 4 : 26dB BW(MHz)											
	1.4MHz		3MHz		5MHz		10MHz		15MHz		20MHz	
BW												
Mod.	QPSK	16QAM	QPSK	16QAM	QPSK	16QAM	QPSK	16QAM	QPSK	16QAM	QPSK	16QAM
Lowest CH	1.28	1.28	3.01	3.04	4.93	4.96	10.04	10.00	14.73	14.67	20.88	20.92
Middle CH	1.28	1.30	3.01	3.02	4.95	5.00	10.08	10.06	14.73	14.73	21.04	21.00
Highest CH	1.28	1.29	3.04	3.04	4.99	4.91	10.12	10.04	14.76	14.67	20.96	20.88





LTE Band 4

Lowest Channel / 3MHz / QPSK

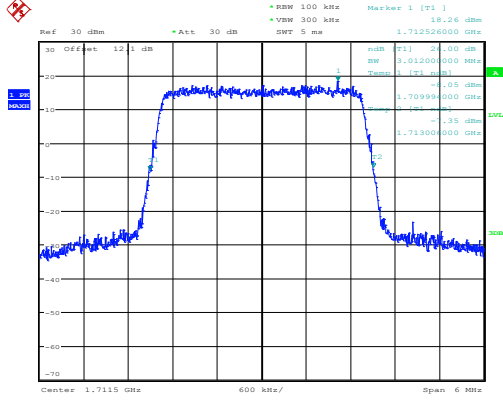

Date: 27.JAN.2015 19:17:47

Lowest Channel / 3MHz / 16QAM

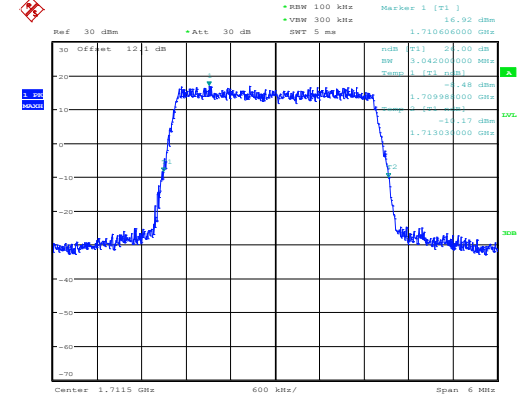

Date: 27.JAN.2015 19:18:00

Middle Channel / 3MHz / QPSK

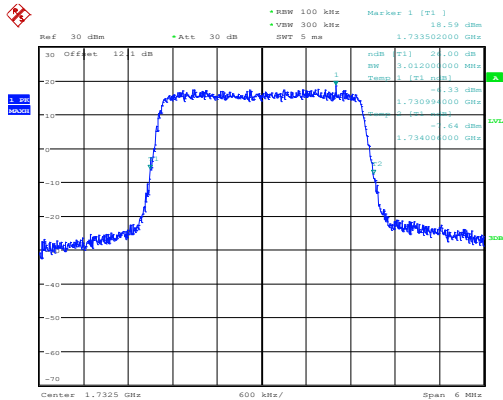

Date: 27.JAN.2015 19:25:34

Middle Channel / 3MHz / 16QAM

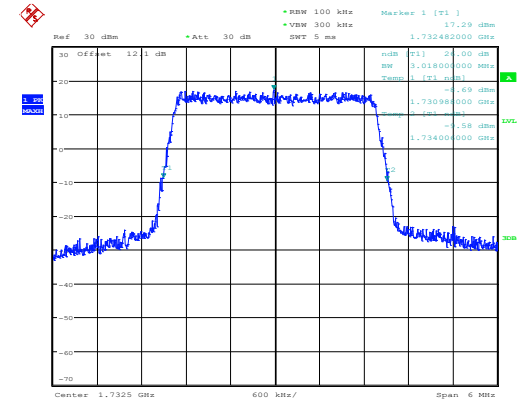

Date: 27.JAN.2015 19:25:47

Highest Channel / 3MHz / QPSK

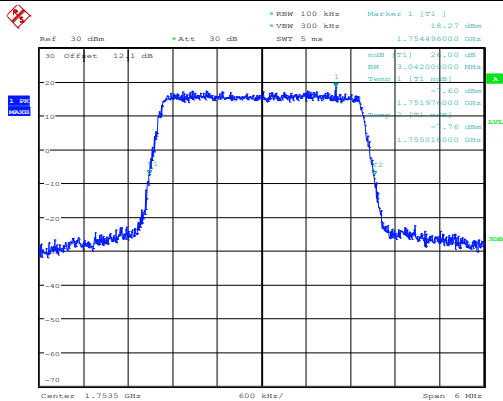

Date: 27.JAN.2015 19:28:41

Highest Channel / 3MHz / 16QAM

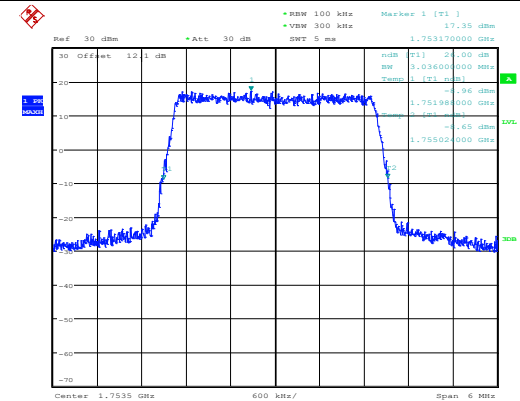

Date: 27.JAN.2015 19:28:54



LTE Band 4

Lowest Channel / 5MHz / QPSK

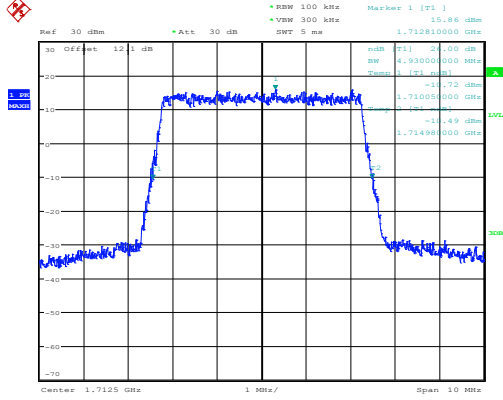

Date: 27.JAN.2015 19:36:32

Lowest Channel / 5MHz / 16QAM

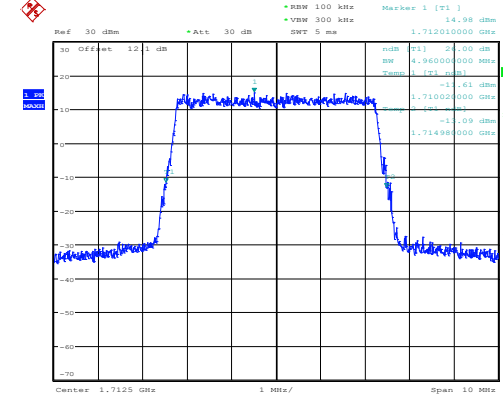

Date: 27.JAN.2015 19:36:45

Middle Channel / 5MHz / QPSK

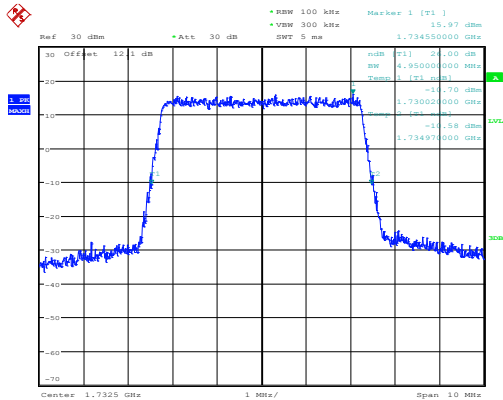

Date: 27.JAN.2015 19:44:19

Middle Channel / 5MHz / 16QAM

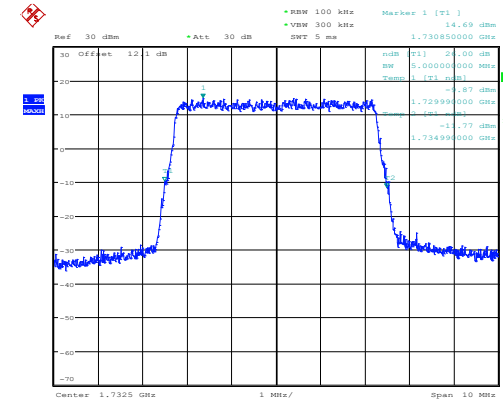

Date: 27.JAN.2015 19:44:32

Highest Channel / 5MHz / QPSK

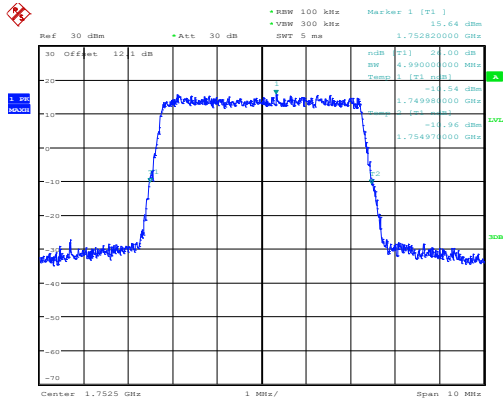

Date: 27.JAN.2015 19:47:27

Highest Channel / 5MHz / 16QAM

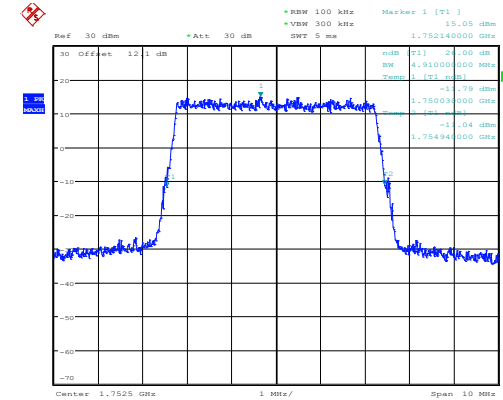

Date: 27.JAN.2015 19:47:39



LTE Band 4

Lowest Channel / 10MHz / QPSK

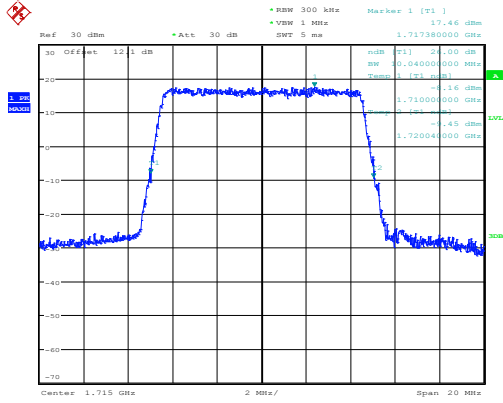

Date: 27.JAN.2015 19:55:30

Lowest Channel / 10MHz / 16QAM

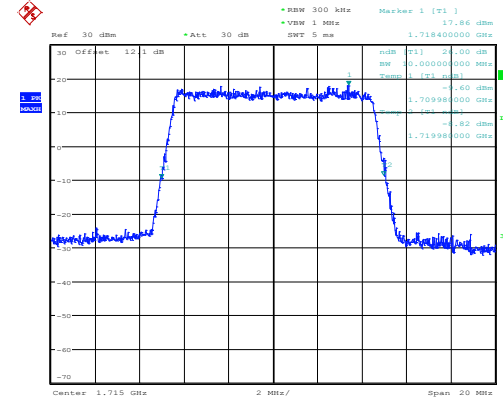

Date: 27.JAN.2015 19:55:43

Middle Channel / 10MHz / QPSK

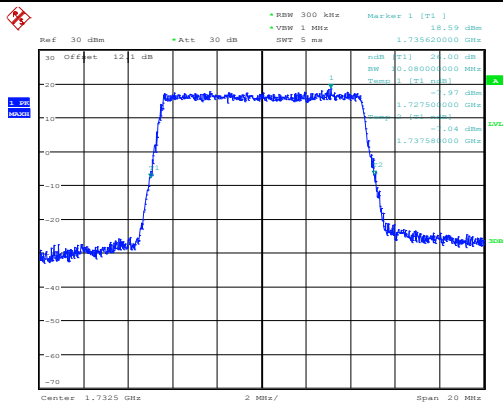

Date: 27.JAN.2015 20:03:17

Middle Channel / 10MHz / 16QAM

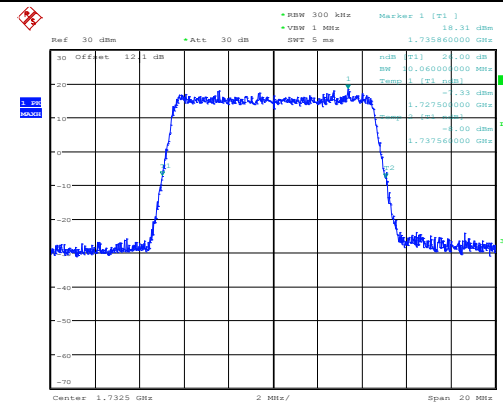

Date: 27.JAN.2015 20:03:30

Highest Channel / 10MHz / QPSK

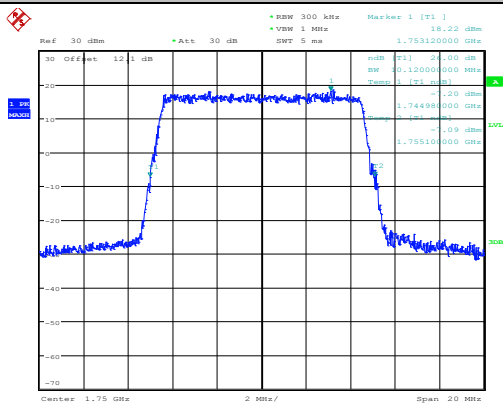

Date: 27.JAN.2015 20:06:24

Highest Channel / 10MHz / 16QAM

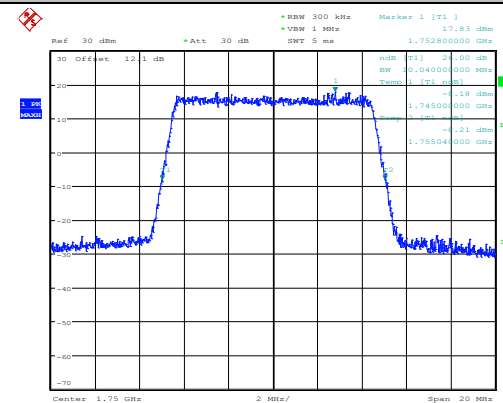

Date: 27.JAN.2015 20:06:37



LTE Band 4

Lowest Channel / 15MHz / QPSK

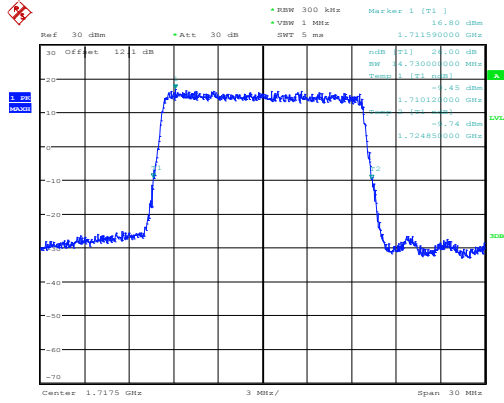

Date: 27.JAN.2015 20:14:15

Lowest Channel / 15MHz / 16QAM

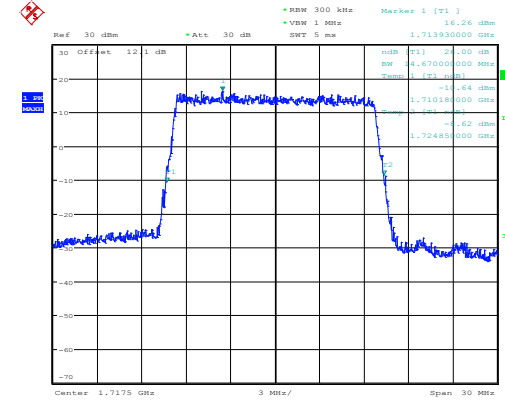

Date: 27.JAN.2015 20:14:28

Middle Channel / 15MHz / QPSK

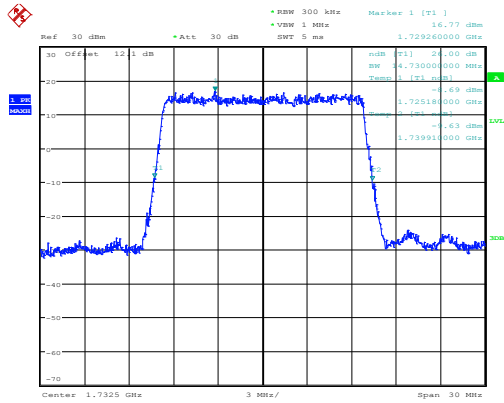

Date: 27.JAN.2015 20:22:02

Middle Channel / 15MHz / 16QAM

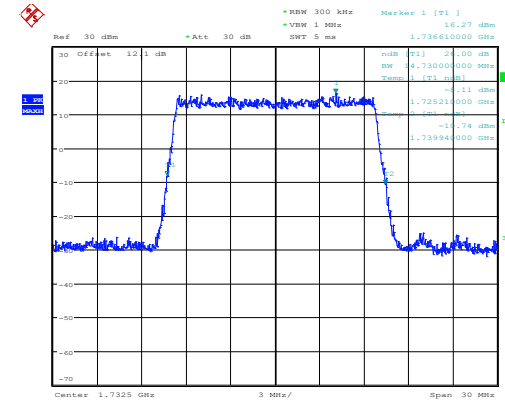

Date: 27.JAN.2015 20:22:15

Highest Channel / 15MHz / QPSK

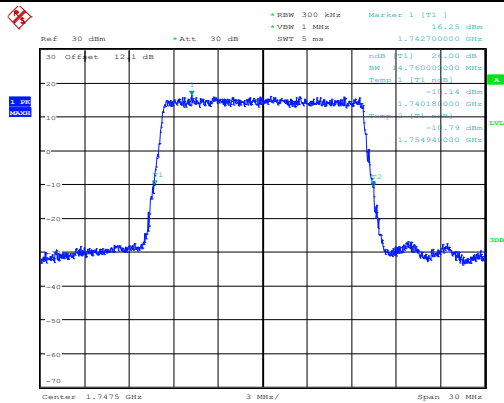

Date: 27.JAN.2015 20:25:10

Highest Channel / 15MHz / 16QAM

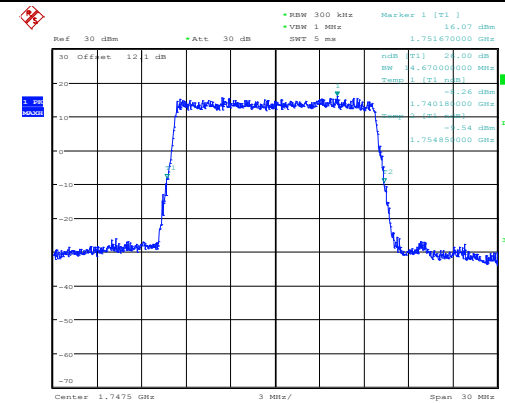

Date: 27.JAN.2015 20:25:22



LTE Band 4

Lowest Channel / 20MHz / QPSK

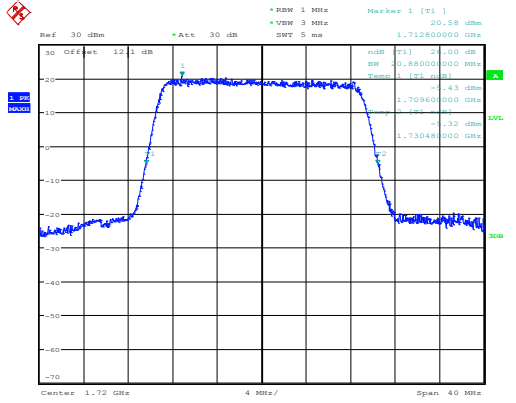

Date: 27.JAN.2015 20:33:01

Lowest Channel / 20MHz / 16QAM

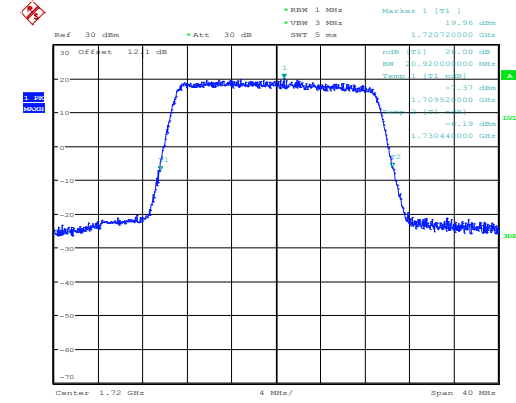

Date: 27.JAN.2015 20:33:14

Middle Channel / 20MHz / QPSK

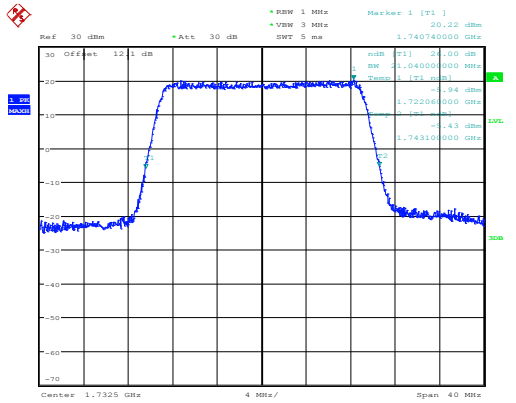

Date: 27.JAN.2015 20:40:47

Middle Channel / 20MHz / 16QAM

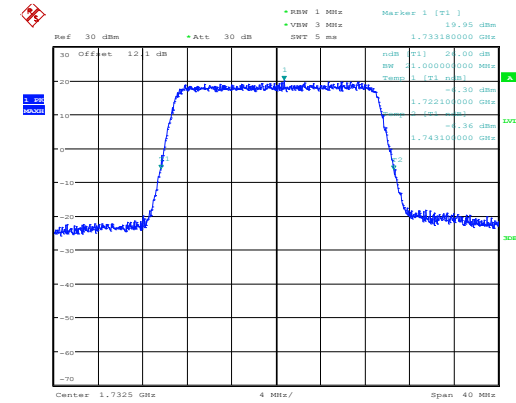

Date: 27.JAN.2015 20:41:00

Highest Channel / 20MHz / QPSK

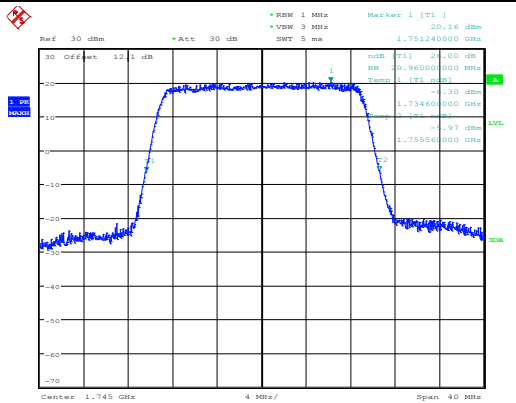

Date: 27.JAN.2015 20:43:54

Highest Channel / 20MHz / 16QAM

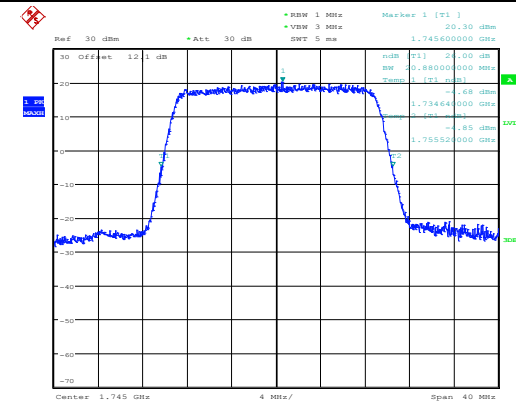

Date: 27.JAN.2015 20:44:07



### Occupied Bandwidth

Mode	LTE Band 4 : 99%OBW(MHz)											
	1.4MHz		3MHz		5MHz		10MHz		15MHz		20MHz	
BW												
Mod.	QPSK	16QAM	QPSK	16QAM	QPSK	16QAM	QPSK	16QAM	QPSK	16QAM	QPSK	16QAM
Lowest CH	1.10	1.10	2.71	2.71	4.50	4.50	9.06	9.04	13.47	13.50	18.48	18.48
Middle CH	1.10	1.10	2.72	2.72	4.50	4.51	9.10	9.08	13.50	13.53	18.56	18.60
Highest CH	1.10	1.10	2.73	2.72	4.51	4.50	9.06	9.06	13.44	13.50	18.48	18.48





LTE Band 4

Lowest Channel / 1.4MHz / QPSK

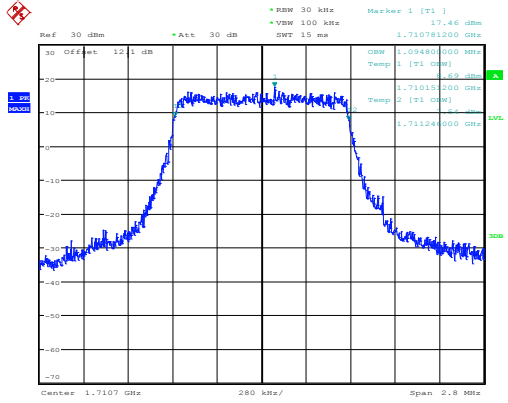

Date: 27.JAN.2015 20:51:22

Lowest Channel / 1.4MHz / 16QAM

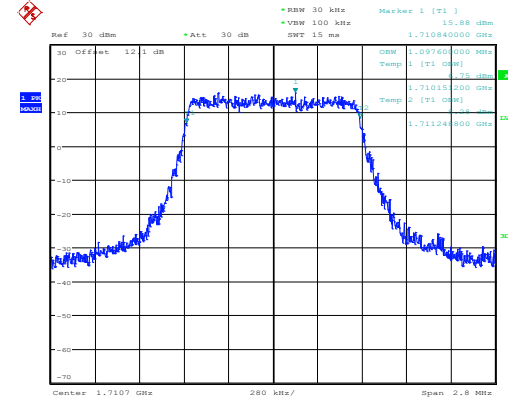

Date: 27.JAN.2015 20:51:33

Middle Channel / 1.4MHz / QPSK

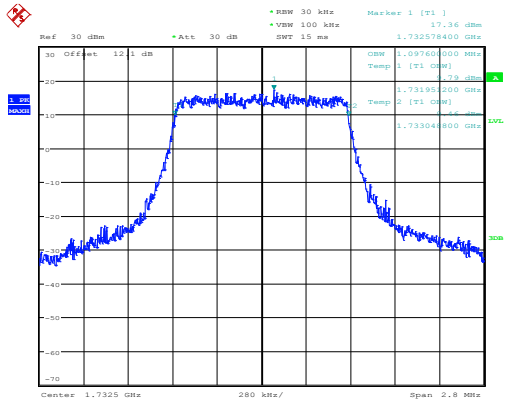

Date: 27.JAN.2015 20:59:08

Middle Channel / 1.4MHz / 16QAM

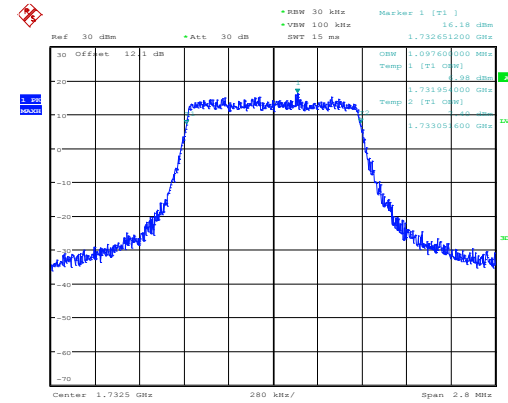

Date: 27.JAN.2015 20:59:19

Highest Channel / 1.4MHz / QPSK

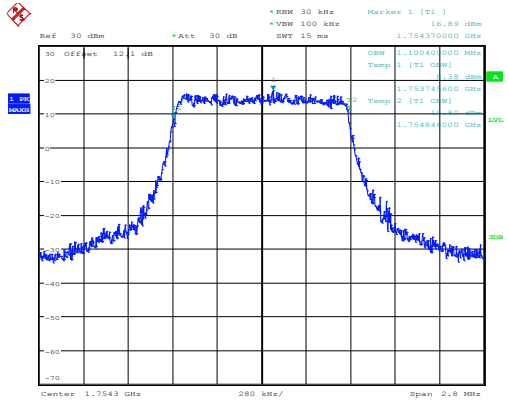

Date: 27.JAN.2015 21:02:15

Highest Channel / 1.4MHz / 16QAM

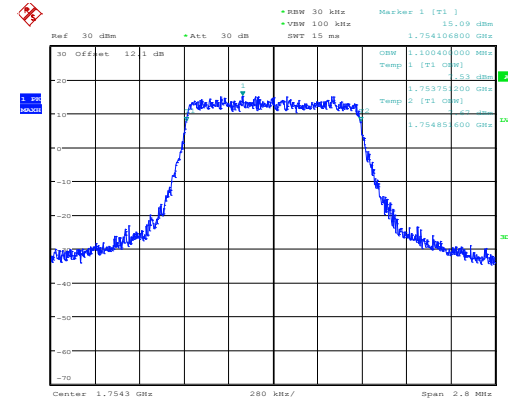

Date: 27.JAN.2015 21:02:26



LTE Band 4

Lowest Channel / 3MHz / QPSK

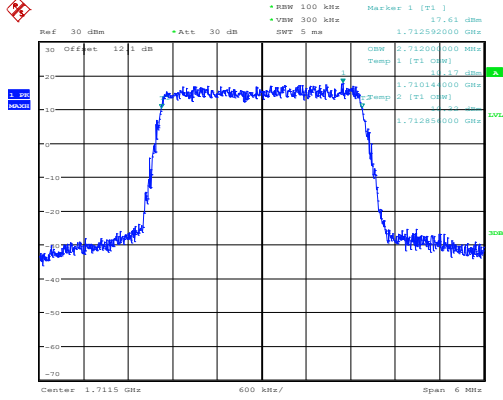

Lowest Channel / 3MHz / 16QAM

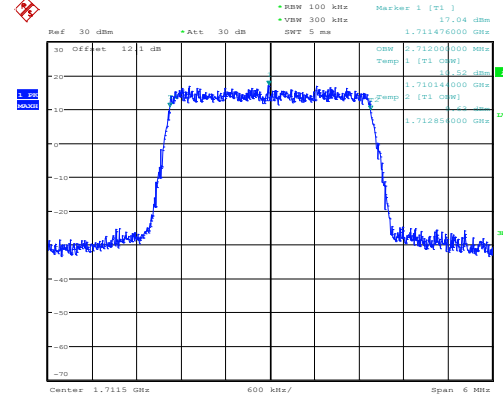

Middle Channel / 3MHz / QPSK

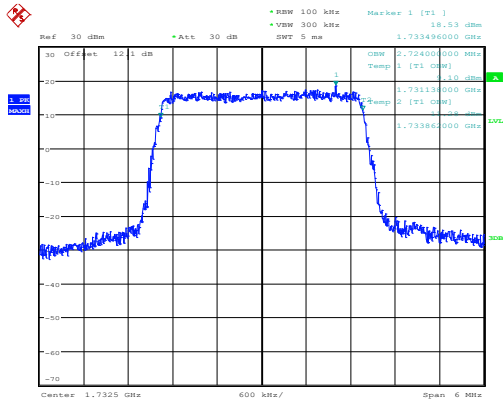

Middle Channel / 3MHz / 16QAM

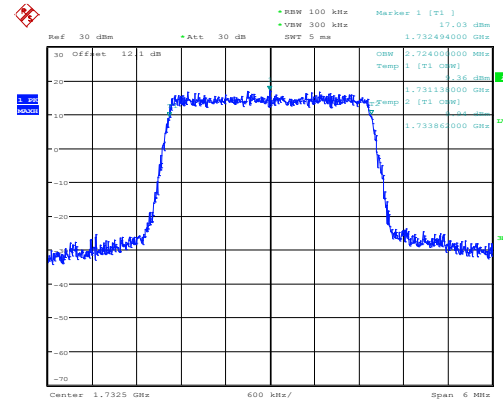

Highest Channel / 3MHz / QPSK

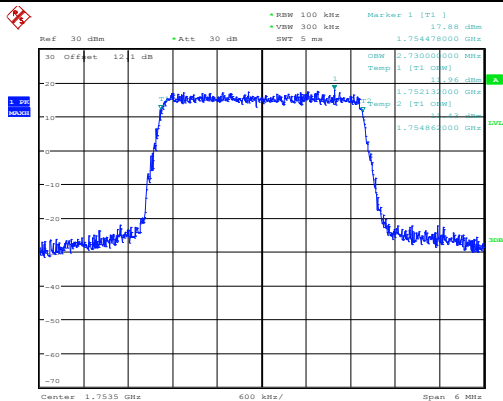

Highest Channel / 3MHz / 16QAM

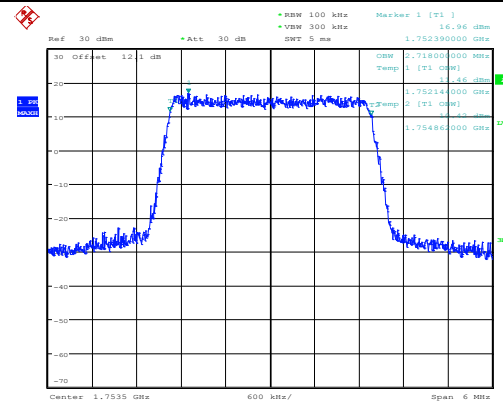



LTE Band 4

Lowest Channel / 5MHz / QPSK

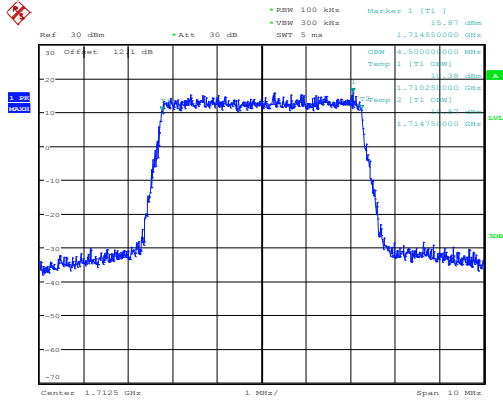

Date: 27.JAN.2015 19:36:09

Lowest Channel / 5MHz / 16QAM

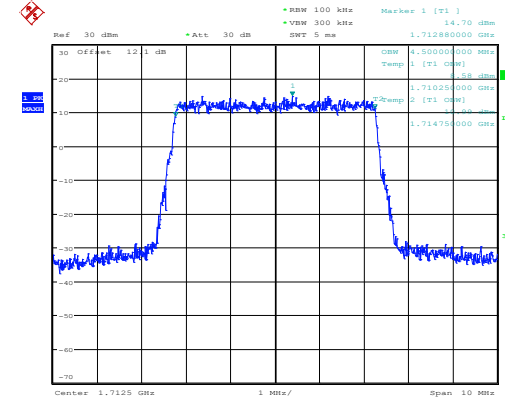

Date: 27.JAN.2015 19:36:20

Middle Channel / 5MHz / QPSK

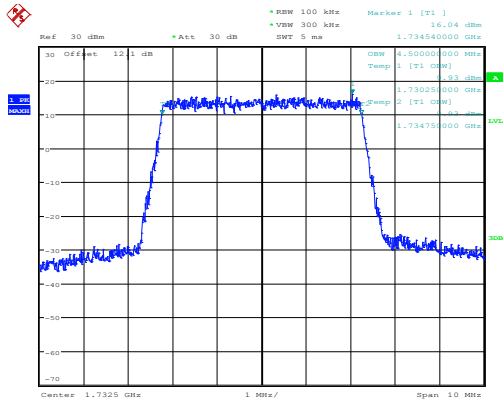

Date: 27.JAN.2015 19:43:56

Middle Channel / 5MHz / 16QAM

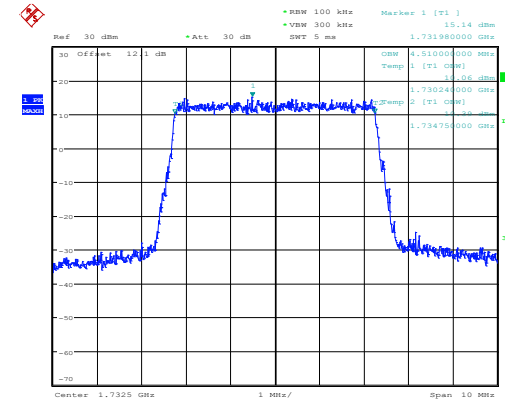

Date: 27.JAN.2015 19:44:06

Highest Channel / 5MHz / QPSK

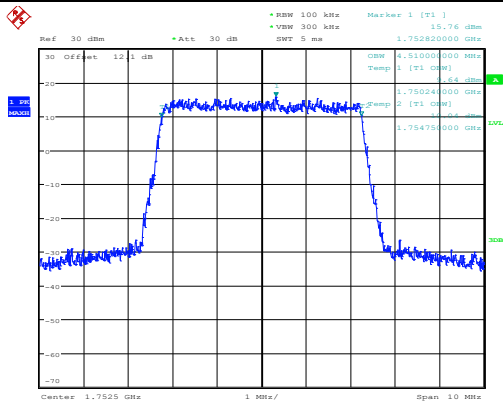

Date: 27.JAN.2015 19:47:03

Highest Channel / 5MHz / 16QAM

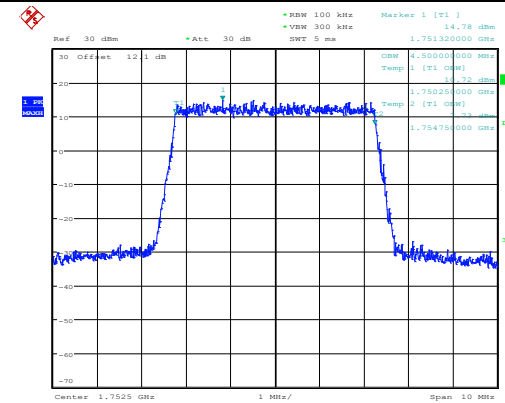

Date: 27.JAN.2015 19:47:14



LTE Band 4

Lowest Channel / 10MHz / QPSK

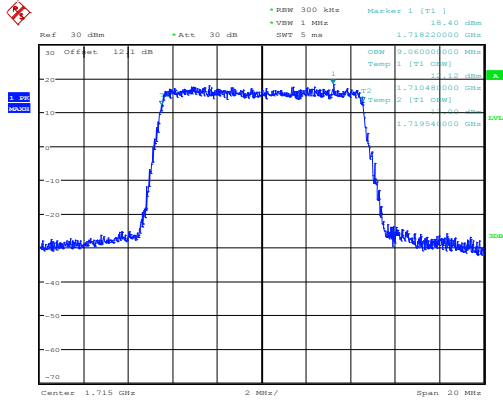

Lowest Channel / 10MHz / 16QAM

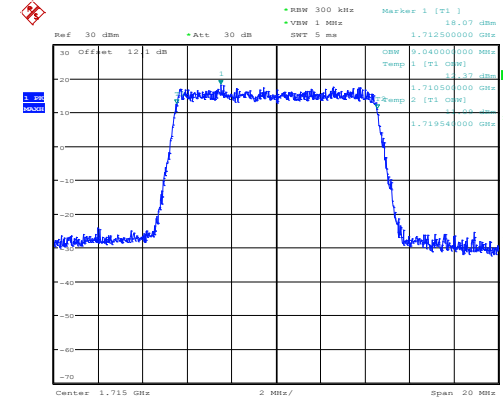

Middle Channel / 10MHz / QPSK

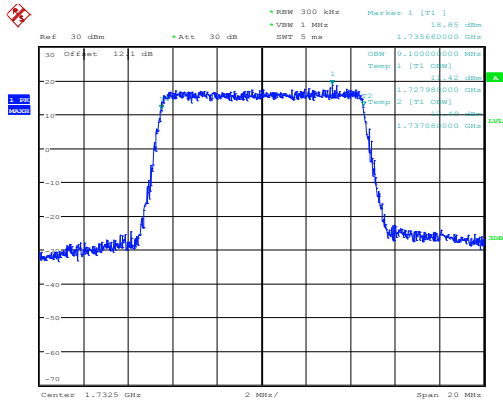

Middle Channel / 10MHz / 16QAM

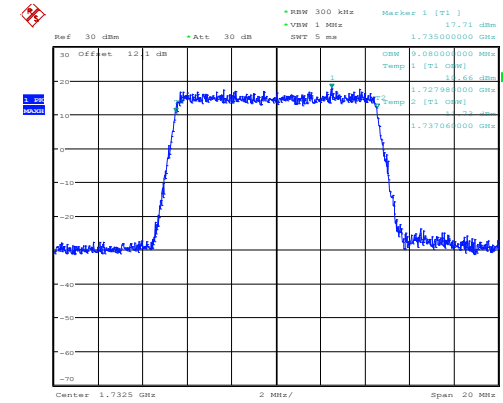

Highest Channel / 10MHz / QPSK

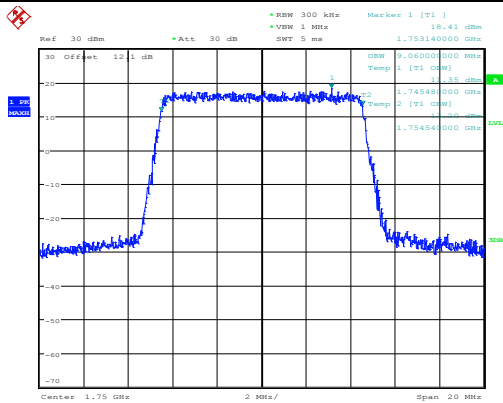

Highest Channel / 10MHz / 16QAM

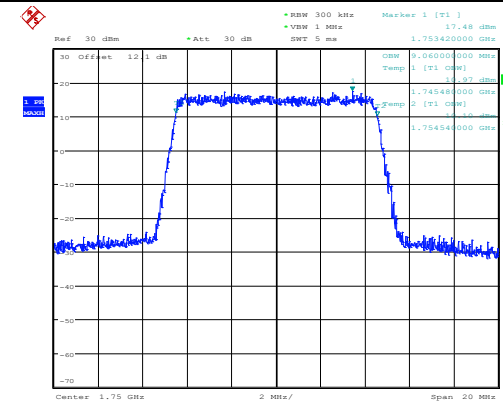



LTE Band 4

Lowest Channel / 15MHz / QPSK

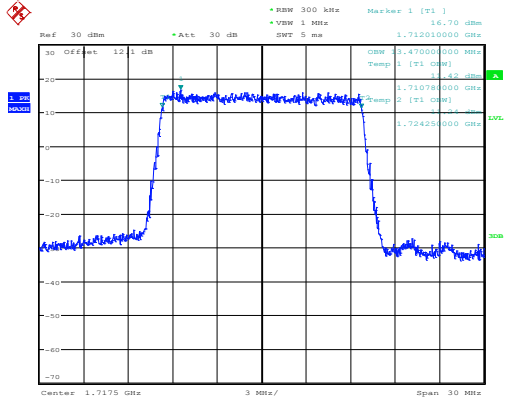

Date: 27.JAN.2015 20:13:52

Lowest Channel / 15MHz / 16QAM

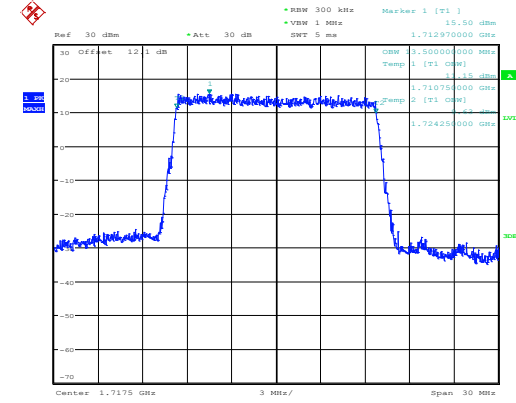

Date: 27.JAN.2015 20:14:03

Middle Channel / 15MHz / QPSK

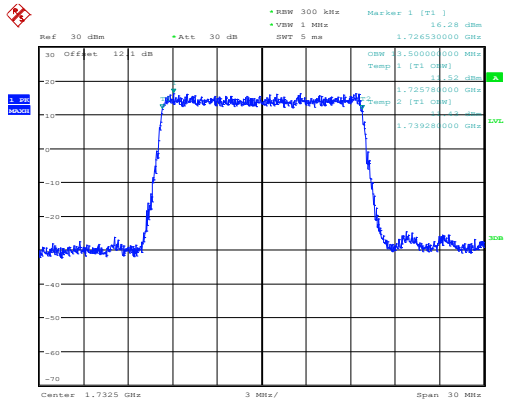

Date: 27.JAN.2015 20:21:39

Middle Channel / 15MHz / 16QAM

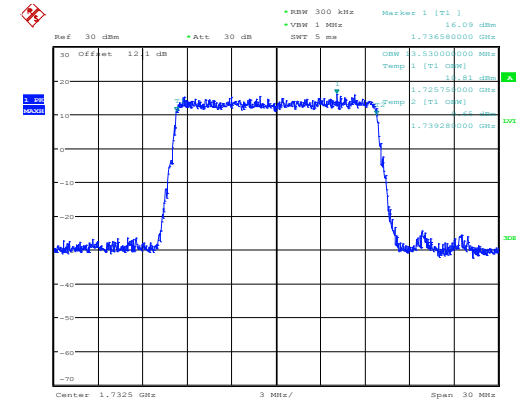

Date: 27.JAN.2015 20:21:50

Highest Channel / 15MHz / QPSK

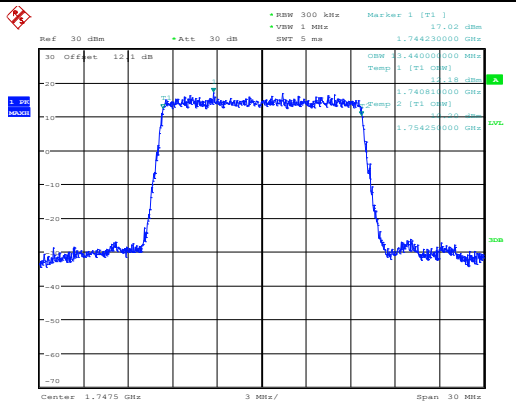

Date: 27.JAN.2015 20:24:46

Highest Channel / 15MHz / 16QAM

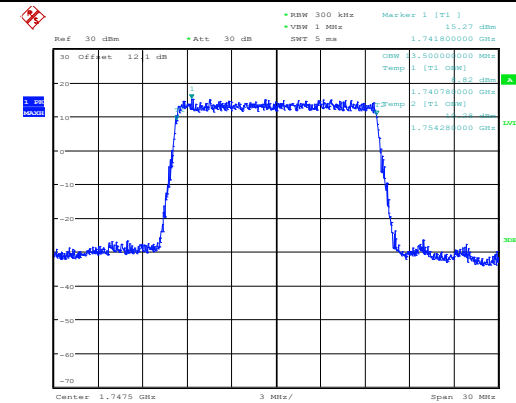

Date: 27.JAN.2015 20:24:57



LTE Band 4

Lowest Channel / 20MHz / QPSK

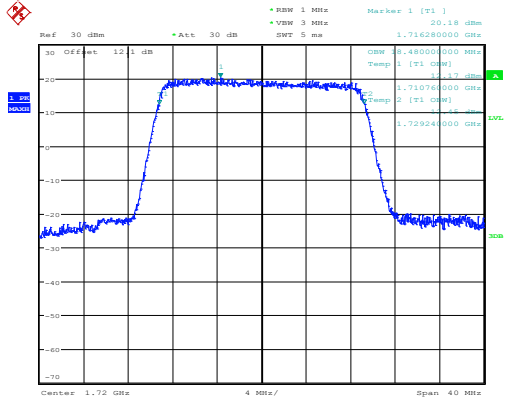

Date: 27.JAN.2015 20:32:37

Lowest Channel / 20MHz / 16QAM

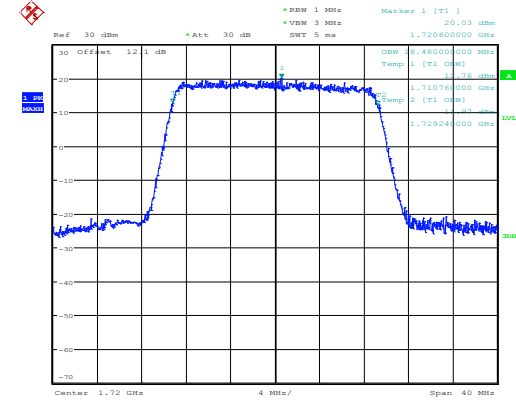

Date: 27.JAN.2015 20:32:48

Middle Channel / 20MHz / QPSK

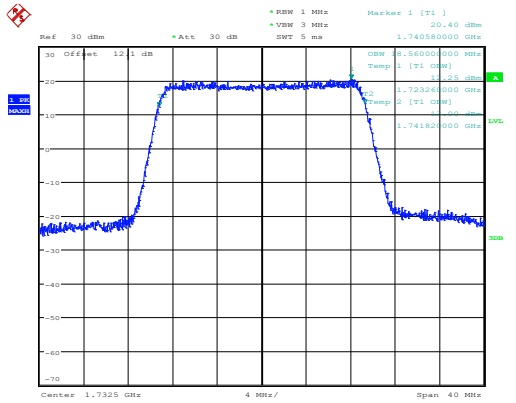

Date: 27.JAN.2015 20:40:24

Middle Channel / 20MHz / 16QAM

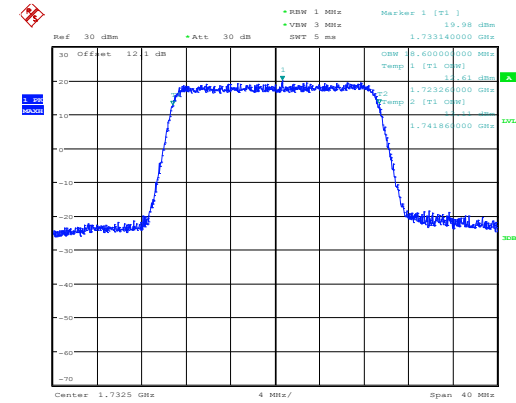

Date: 27.JAN.2015 20:40:34

Highest Channel / 20MHz / QPSK

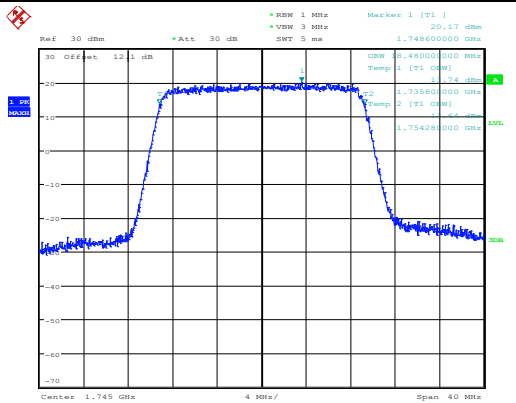

Date: 27.JAN.2015 20:43:31

Highest Channel / 20MHz / 16QAM

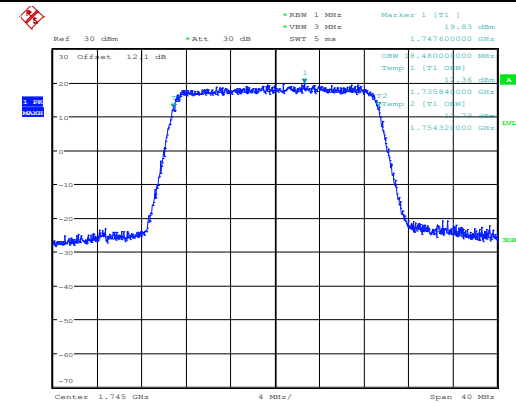

Date: 27.JAN.2015 20:43:42



# Conducted Band Edge

## LTE Band 4 / 1.4MHz / QPSK

### Lowest Band Edge / 1RB

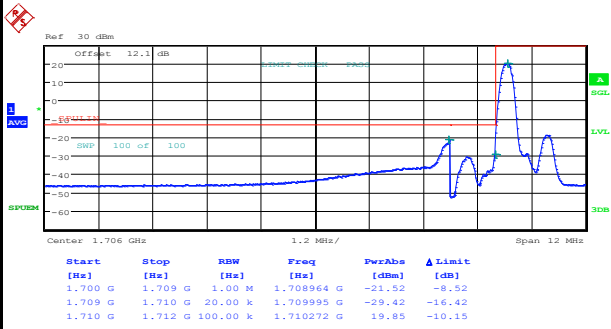

Date: 27.JAN.2015 20:53:08

### Highest Band Edge / 1RB

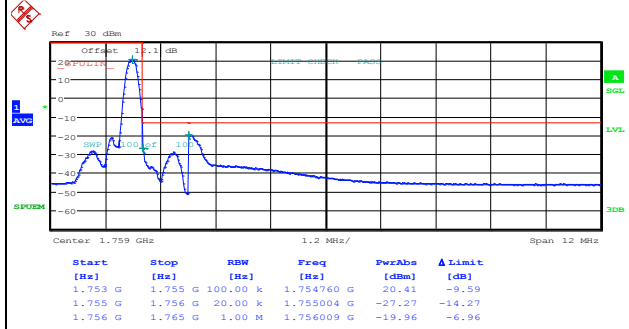

Date: 27.JAN.2015 21:04:02

### Lowest Band Edge / Full RB

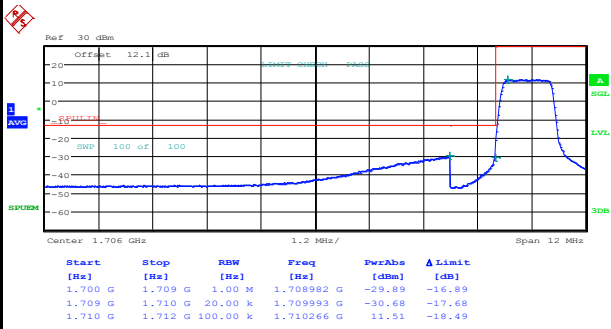

Date: 27.JAN.2015 20:55:28

### Highest Band Edge / Full RB

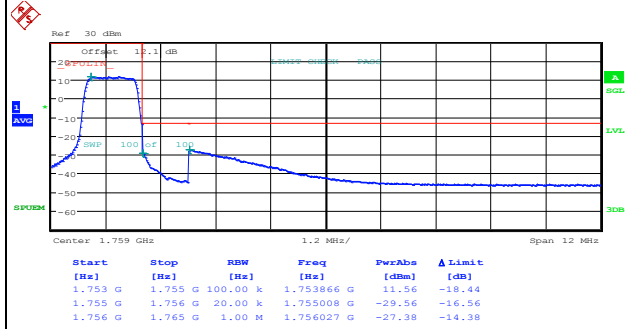

Date: 27.JAN.2015 21:06:22



LTE Band 4 / 1.4MHz / 16QAM

Lowest Band Edge / 1 RB

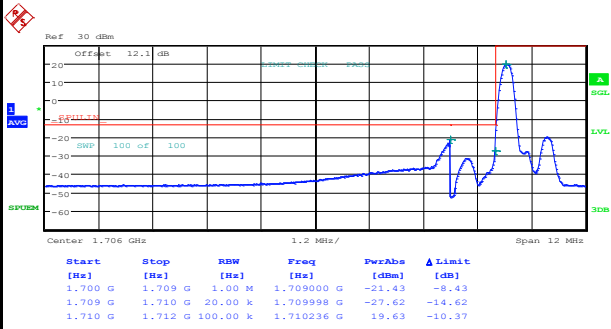

Date: 27.JAN.2015 20:54:18

Highest Band Edge / 1 RB

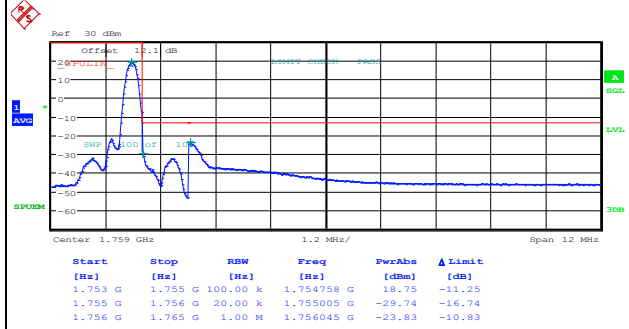

Date: 27.JAN.2015 21:05:12

Lowest Band Edge / Full RB

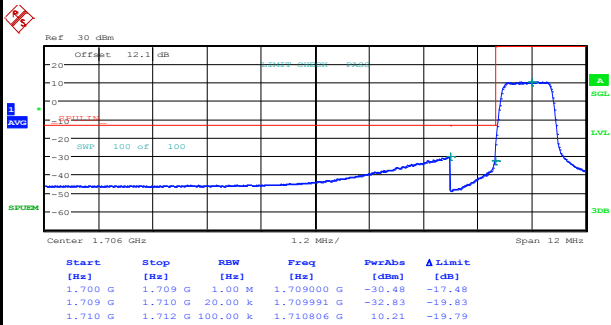

Date: 27.JAN.2015 20:56:37

Highest Band Edge / Full RB

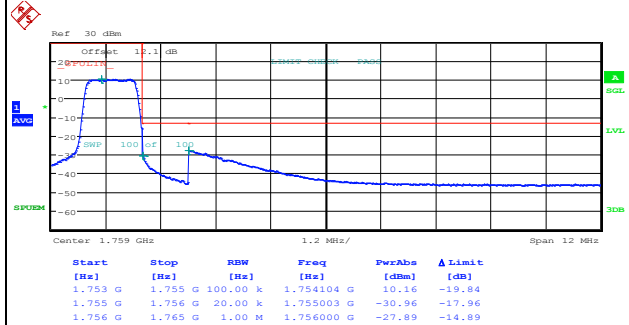

Date: 27.JAN.2015 21:07:32





LTE Band 4 / 3MHz / QPSK

Lowest Band Edge / 1RB

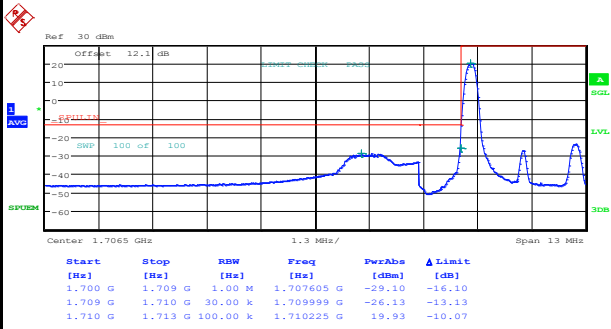

Date: 27.JAN.2015 19:19:10

Highest Band Edge / 1 RB

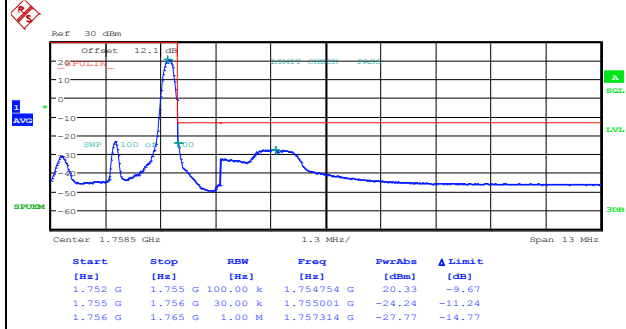

Date: 27.JAN.2015 19:30:04

Lowest Band Edge / Full RB

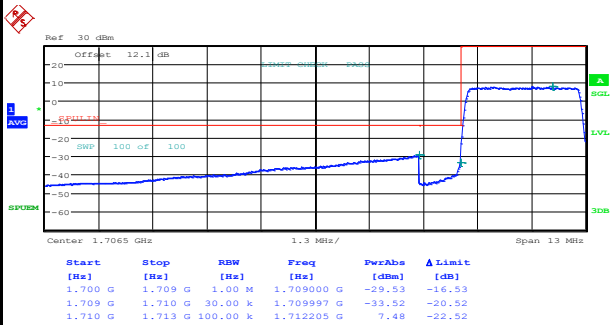

Date: 27.JAN.2015 19:21:30

Highest Band Edge / Full RB

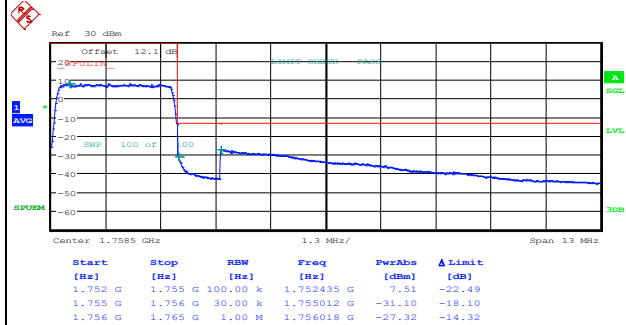

Date: 27.JAN.2015 19:32:24



LTE Band 4 / 3MHz / 16QAM

Lowest Band Edge / 1 RB

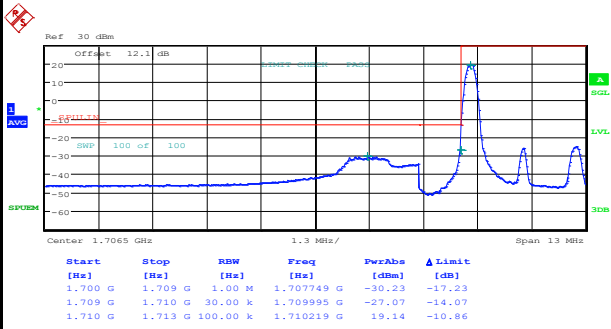

Date: 27.JAN.2015 19:20:20

Highest Band Edge / 1 RB

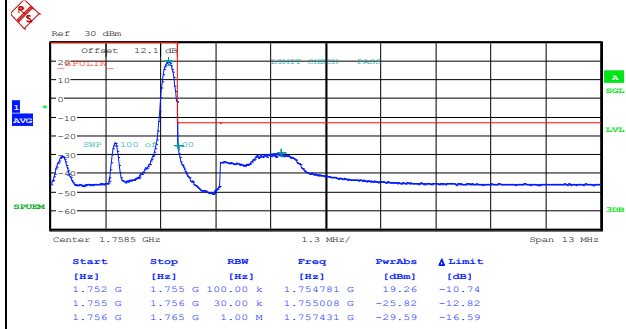

Date: 27.JAN.2015 19:31:14

Lowest Band Edge / Full RB

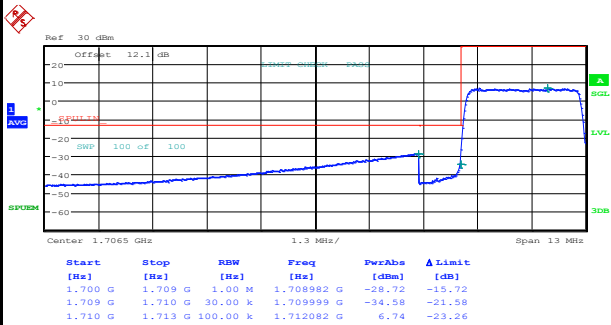

Date: 27.JAN.2015 19:22:40

Highest Band Edge / Full RB

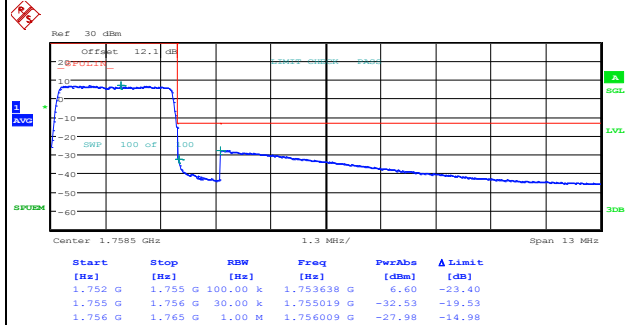

Date: 27.JAN.2015 19:33:34



LTE Band 4 / 5MHz / QPSK

Lowest Band Edge / 1 RB

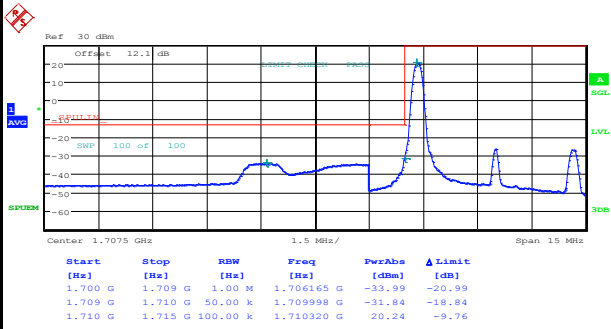

Date: 27.JAN.2015 19:37:55

Highest Band Edge / 1 RB

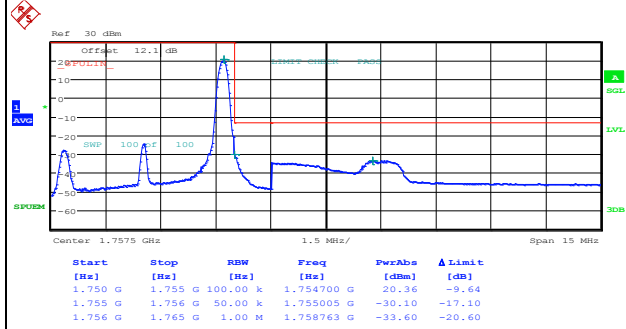

Date: 27.JAN.2015 19:48:49

Lowest Band Edge / Full RB

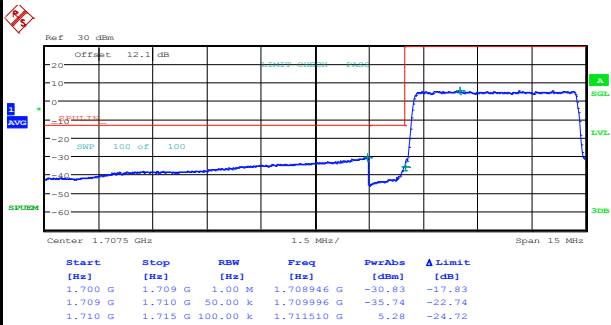

Date: 27.JAN.2015 19:40:15

Highest Band Edge / Full RB

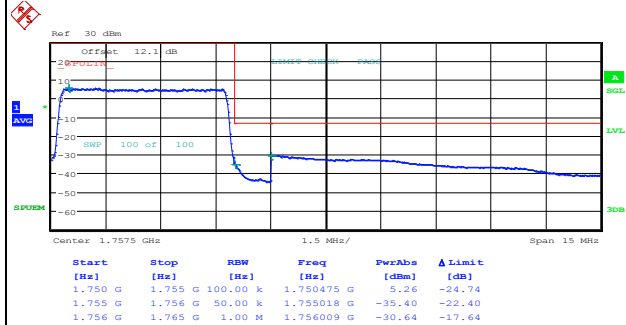

Date: 27.JAN.2015 19:51:21



LTE Band 4 / 5MHz / 16QAM

Lowest Band Edge / 1RB

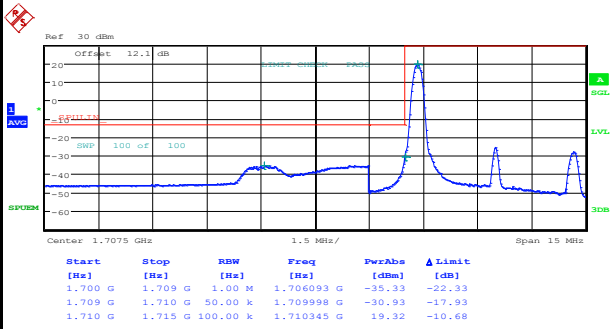

Date: 27.JAN.2015 19:39:05

Highest Band Edge / 1 RB

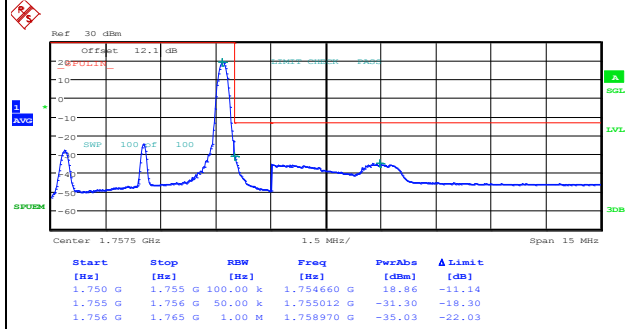

Date: 27.JAN.2015 19:50:02

Lowest Band Edge / Full RB

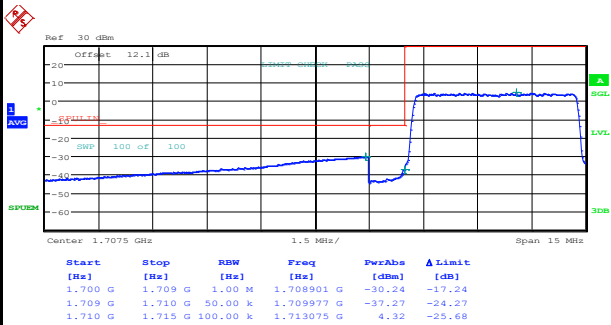

Date: 27.JAN.2015 19:41:25

Highest Band Edge / Full RB

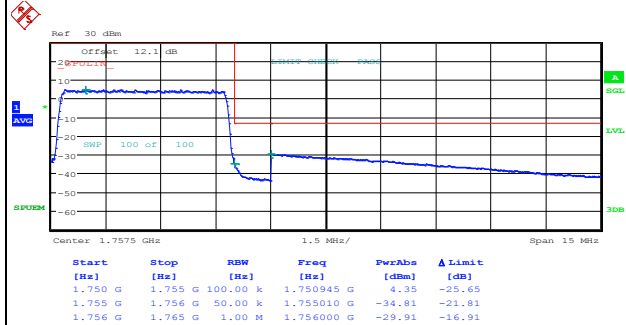

Date: 27.JAN.2015 19:52:31



LTE Band 4 / 10MHz / QPSK

Lowest Band Edge / 1 RB

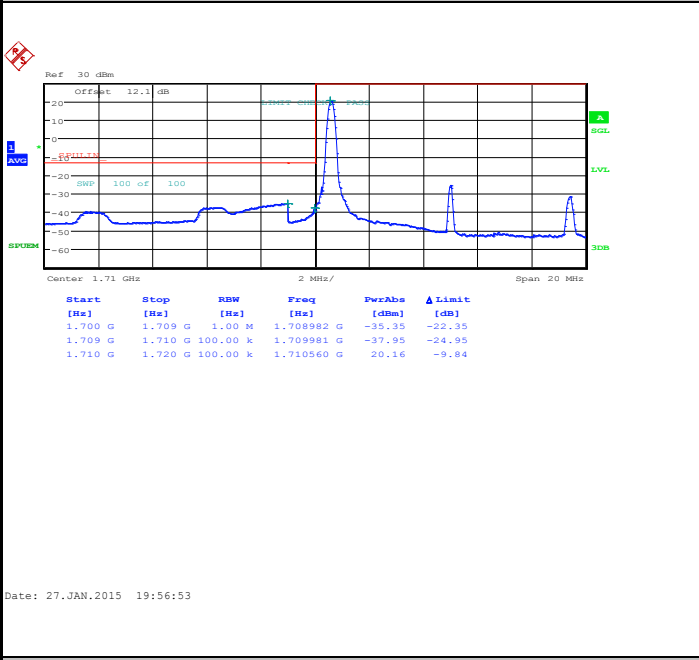

Highest Band Edge / 1 RB

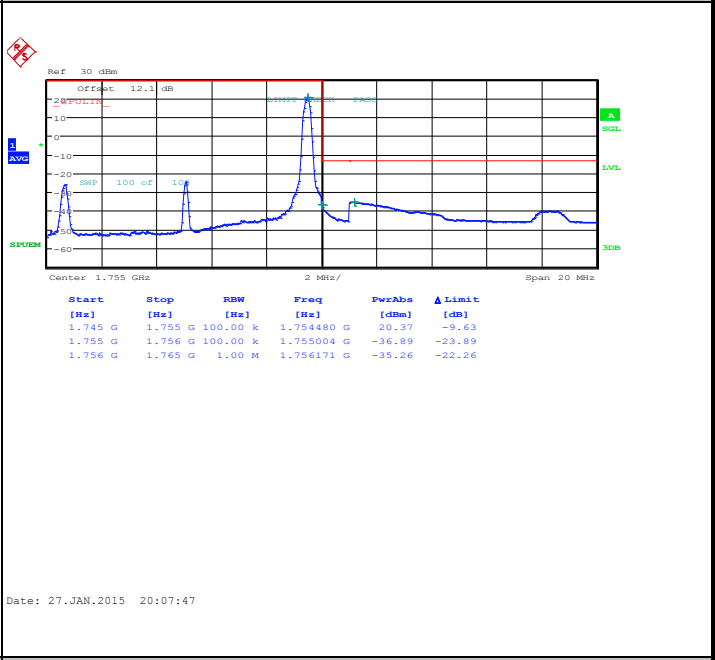

Lowest Band Edge / Full RB

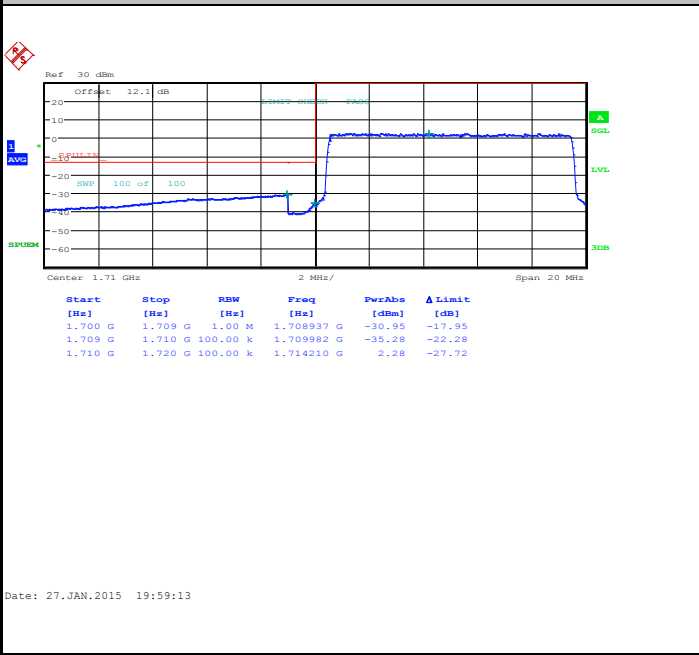

Highest Band Edge / Full RB

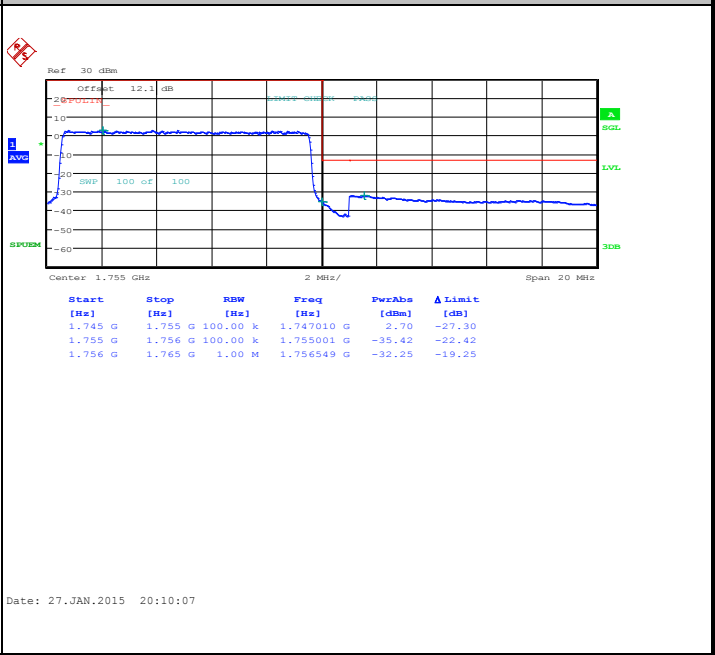



LTE Band 4 / 10MHz / 16QAM

Lowest Band Edge / 1 RB

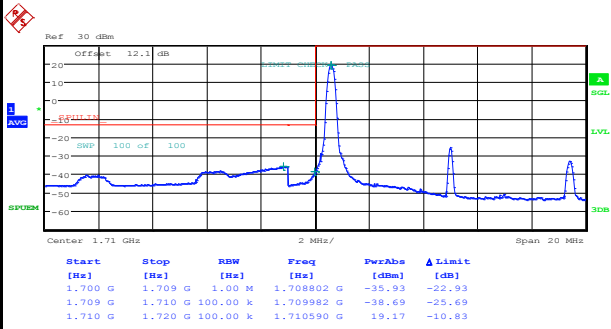

Date: 27.JAN.2015 19:58:03

Highest Band Edge / 1 RB

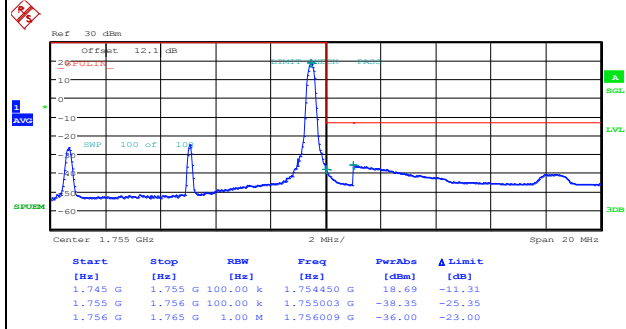

Date: 27.JAN.2015 20:08:57

Lowest Band Edge / Full RB

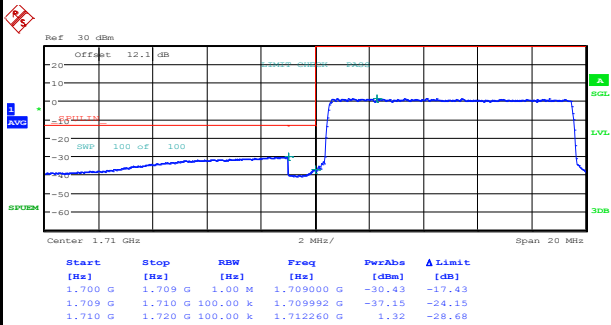

Date: 27.JAN.2015 20:00:23

Highest Band Edge / Full RB

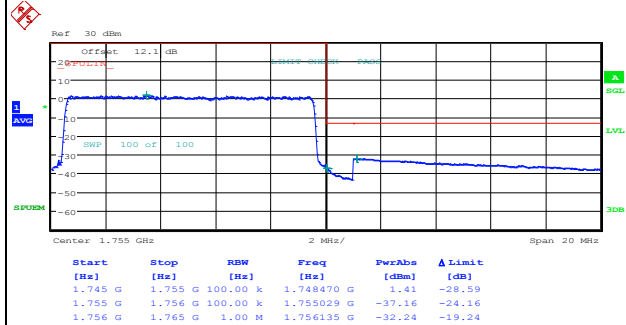

Date: 27.JAN.2015 20:11:17



LTE Band 4 / 15MHz / QPSK

Lowest Band Edge / 1 RB

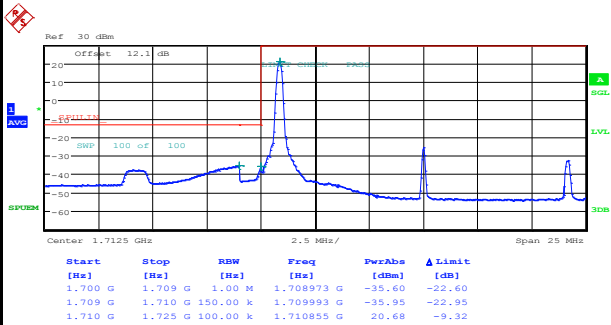

Date: 27.JAN.2015 20:15:38

Highest Band Edge / 1 RB

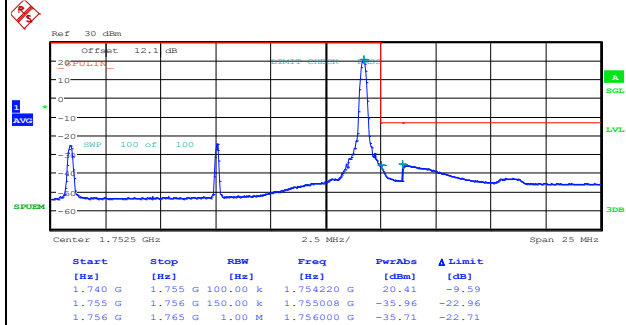

Date: 27.JAN.2015 20:26:32

Lowest Band Edge / Full RB

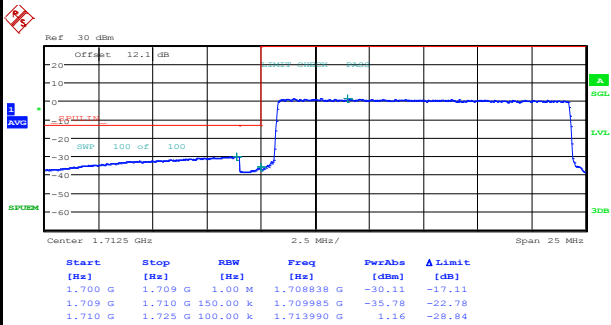

Date: 27.JAN.2015 20:17:58

Highest Band Edge / Full RB

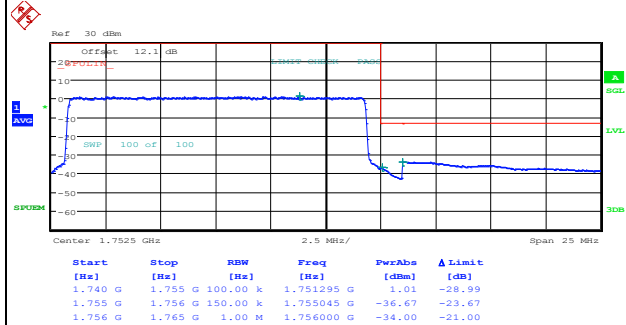

Date: 27.JAN.2015 20:28:51



LTE Band 4 / 15MHz / 16QAM

Lowest Band Edge / 1 RB

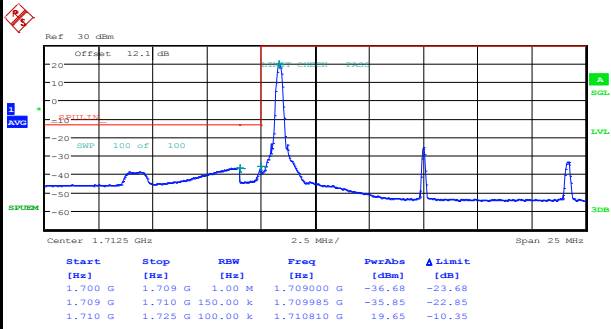

Date: 27.JAN.2015 20:16:48

Highest Band Edge / 1 RB

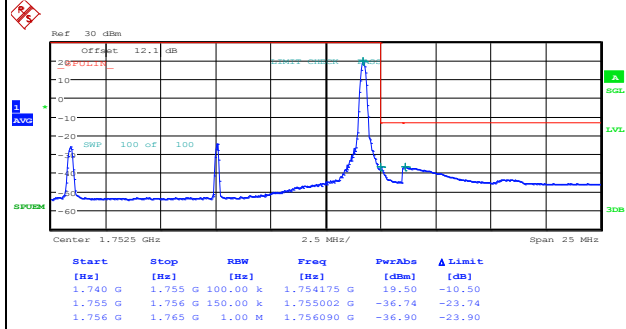

Date: 27.JAN.2015 20:27:42

Lowest Band Edge / Full RB

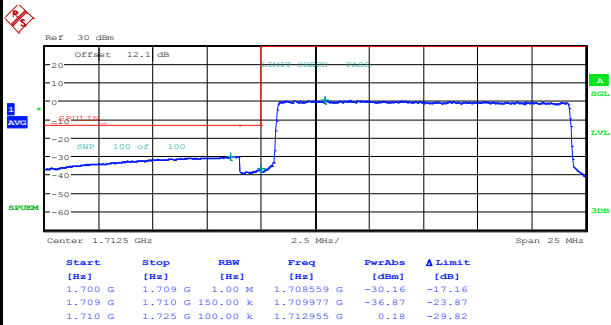

Date: 27.JAN.2015 20:19:07

Highest Band Edge / Full RB

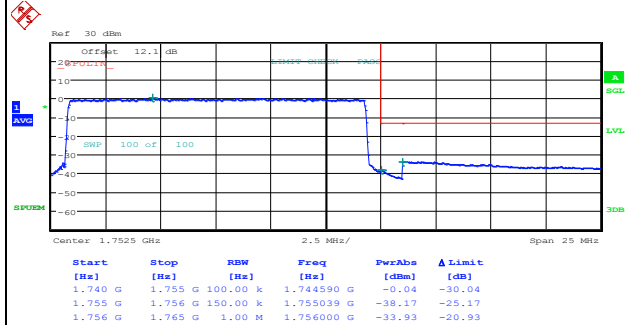

Date: 27.JAN.2015 20:30:02





LTE Band 4 / 20MHz / QPSK

Lowest Band Edge / 1 RB

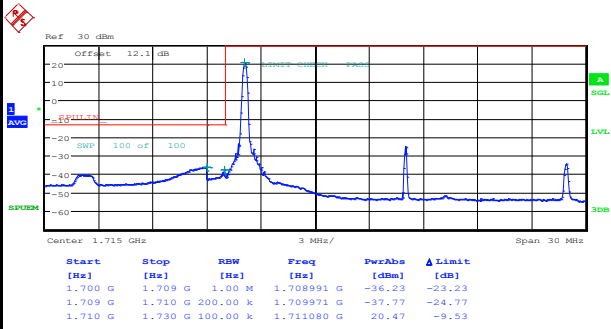

Date: 27.JAN.2015 20:34:23

Highest Band Edge / 1 RB

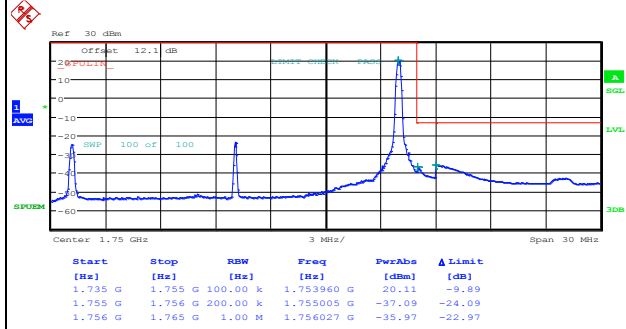

Date: 27.JAN.2015 20:45:17

Lowest Band Edge / Full RB

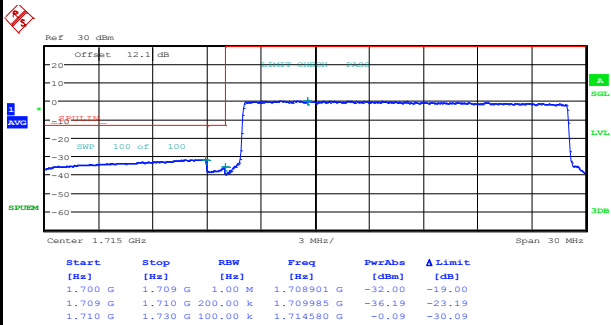

Date: 27.JAN.2015 20:36:43

Highest Band Edge / Full RB

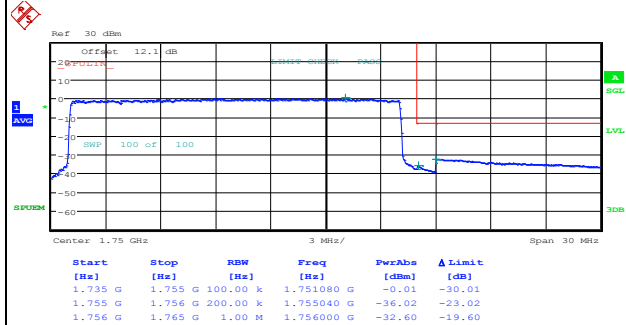

Date: 27.JAN.2015 20:47:37



LTE Band 4 / 20MHz / 16QAM

Lowest Band Edge / 1 RB

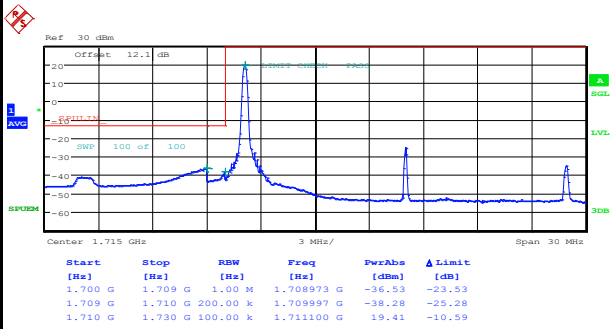

Date: 27.JAN.2015 20:35:33

Highest Band Edge / 1 RB

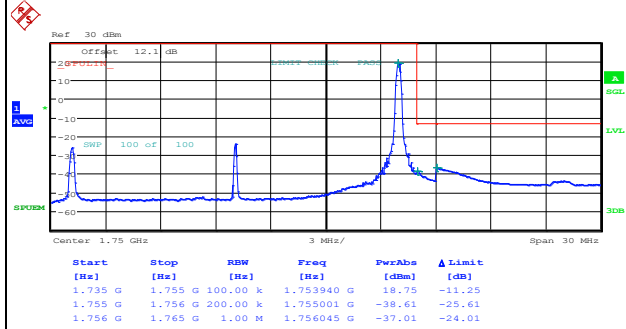

Date: 27.JAN.2015 20:46:27

Lowest Band Edge / Full RB

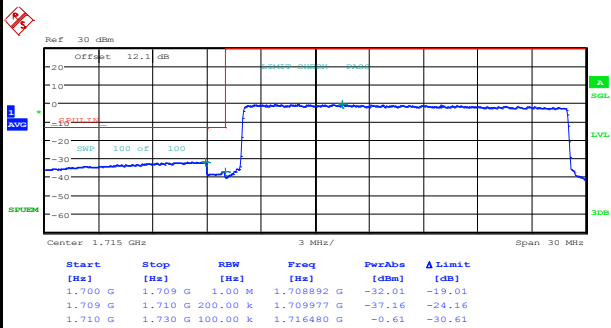

Date: 27.JAN.2015 20:37:53

Highest Band Edge / Full RB

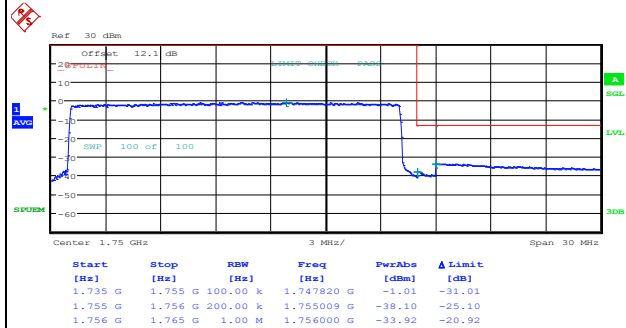

Date: 27.JAN.2015 20:48:47



# Conducted Spurious Emission

## LTE Band 4 / 1.4MHz

### Lowest Channel / QPSK

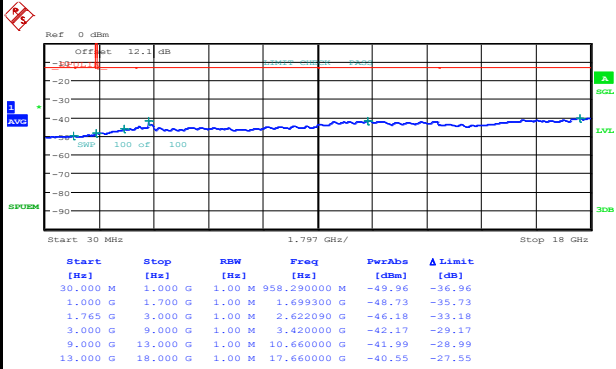

Date: 27.JAN.2015 20:57:47

### Lowest Channel / 16QAM

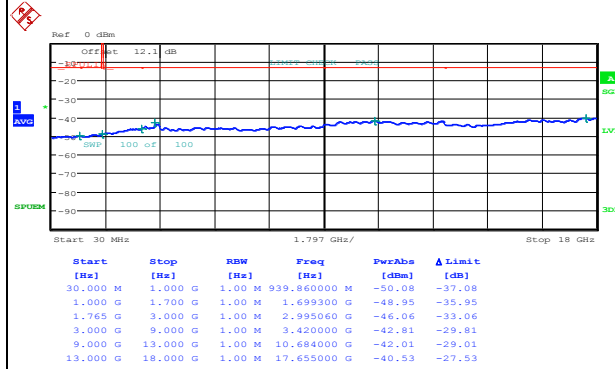

Date: 27.JAN.2015 20:58:57

### Middle Channel / QPSK

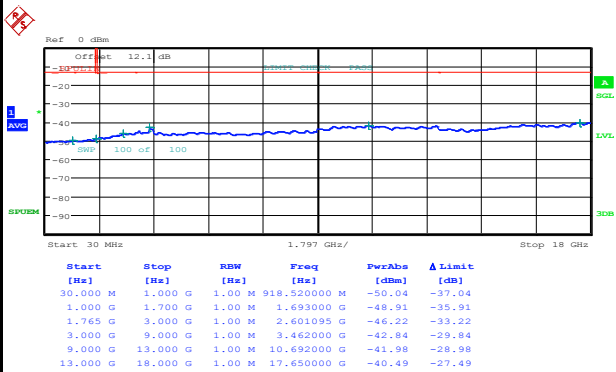

Date: 27.JAN.2015 21:00:54

### Middle Channel / 16QAM

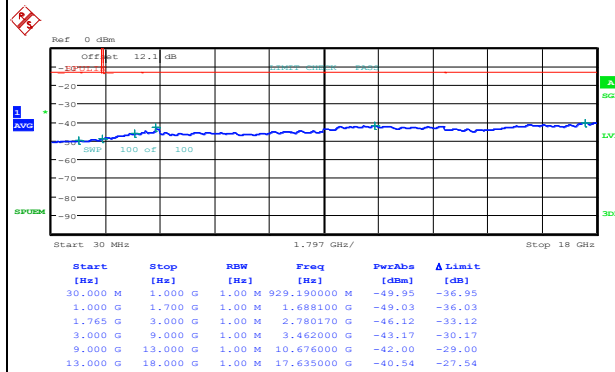

Date: 27.JAN.2015 21:02:04



LTE Band 4 / 1.4MHz

Highest Channel / QPSK

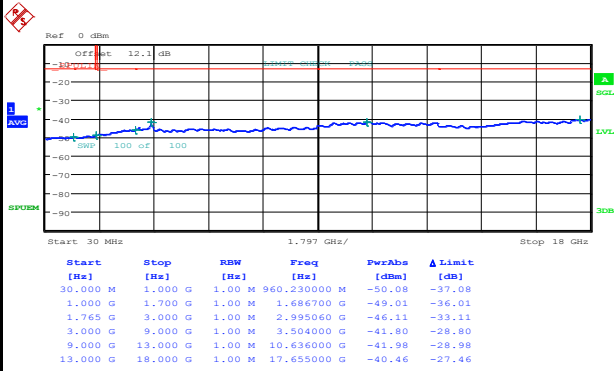

Date: 27.JAN.2015 21:08:42

Highest Channel / 16QAM

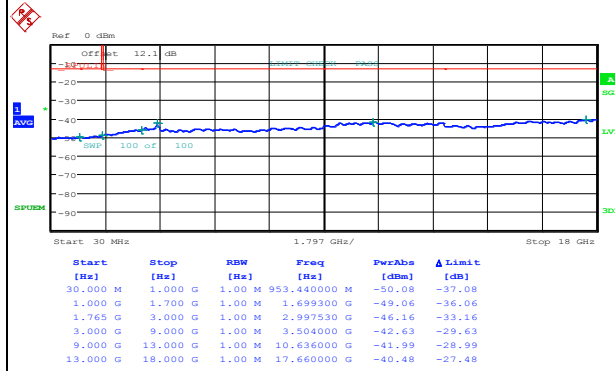

Date: 27.JAN.2015 21:09:52

LTE Band 4 / 3MHz

Lowest Channel / QPSK

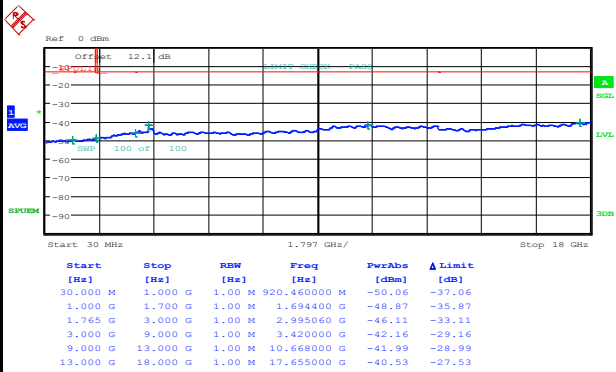

Date: 27.JAN.2015 19:23:50

Lowest Channel / 16QAM

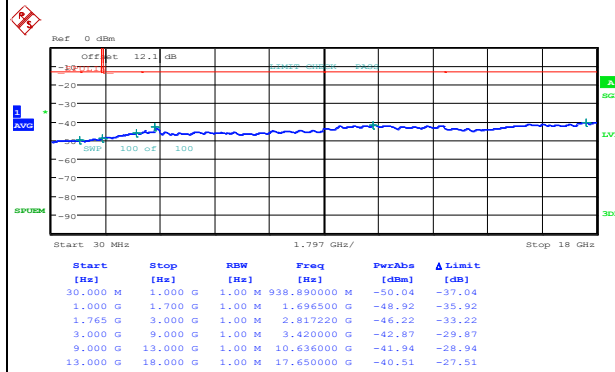

Date: 27.JAN.2015 19:25:00



LTE Band 4 / 3MHz

Middle Channel / QPSK

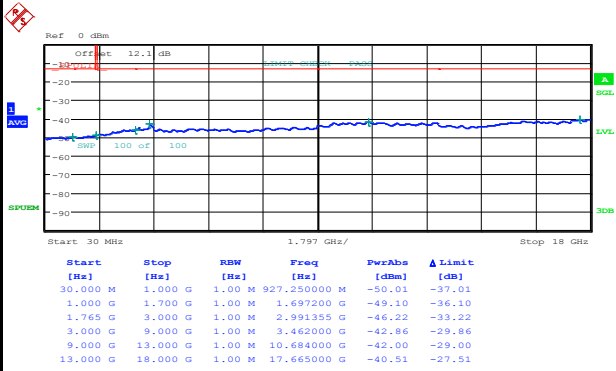

Date: 27.JAN.2015 19:26:57

Middle Channel / 16QAM

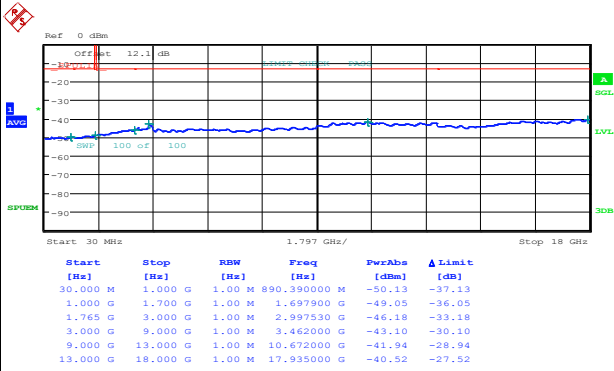

Date: 27.JAN.2015 19:28:07

Highest Channel / QPSK

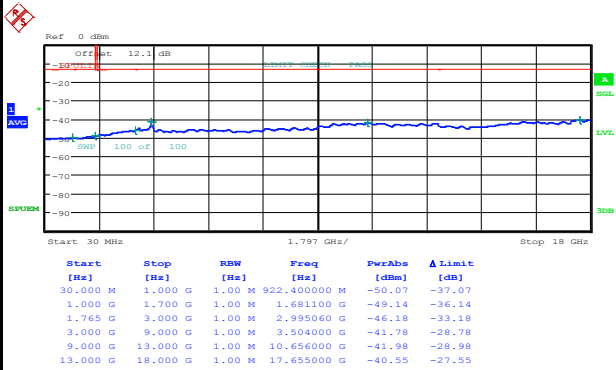

Date: 27.JAN.2015 19:34:44

Highest Channel / 16QAM

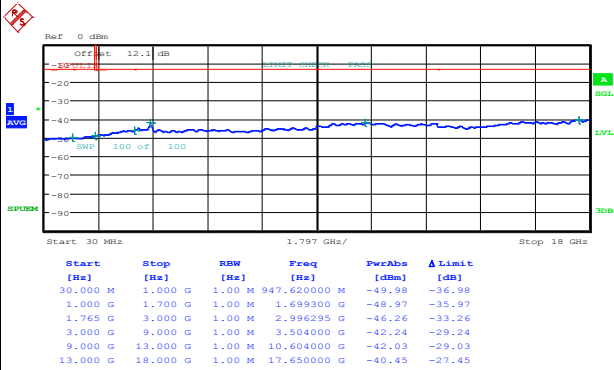

Date: 27.JAN.2015 19:35:54



LTE Band 4 / 5MHz

Lowest Channel / QPSK

Lowest Channel / 16QAM

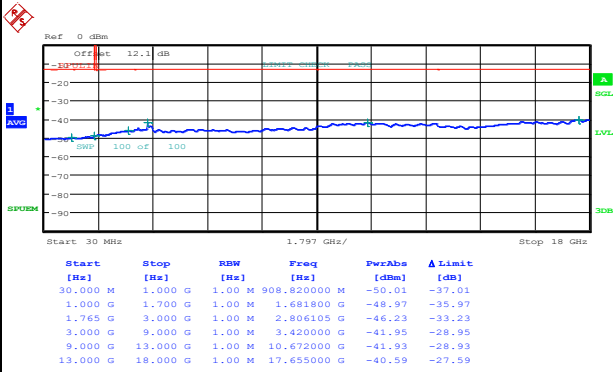

Date: 27.JAN.2015 19:42:35



Date: 27.JAN.2015 19:43:45

Middle Channel / QPSK

Middle Channel / 16QAM

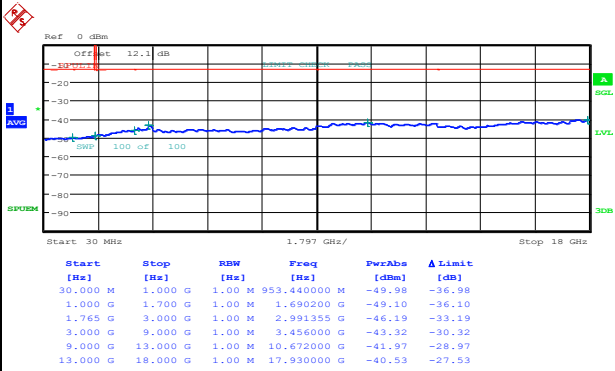

Date: 27.JAN.2015 19:45:42

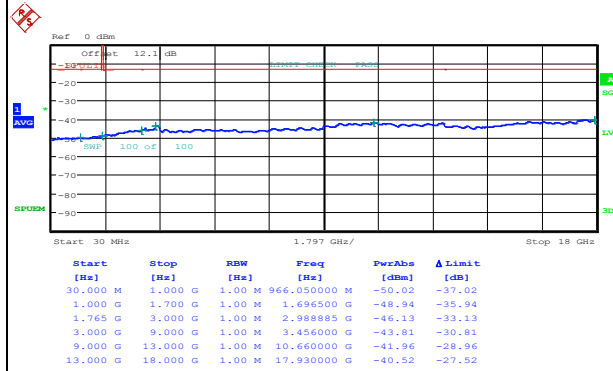

Date: 27.JAN.2015 19:46:52



LTE Band 4 / 5MHz

Highest Channel / QPSK

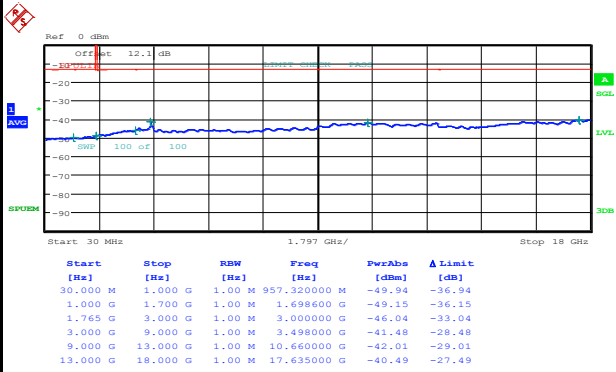

Date: 27.JAN.2015 19:53:41

Highest Channel / 16QAM



Date: 27.JAN.2015 19:54:51

LTE Band 4 / 10MHz

Lowest Channel / QPSK

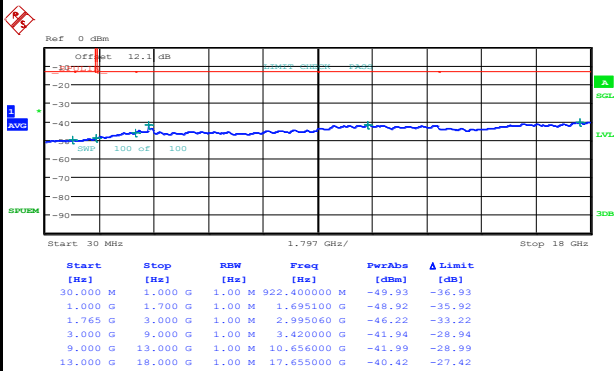

Date: 27.JAN.2015 20:01:33

Lowest Channel / 16QAM

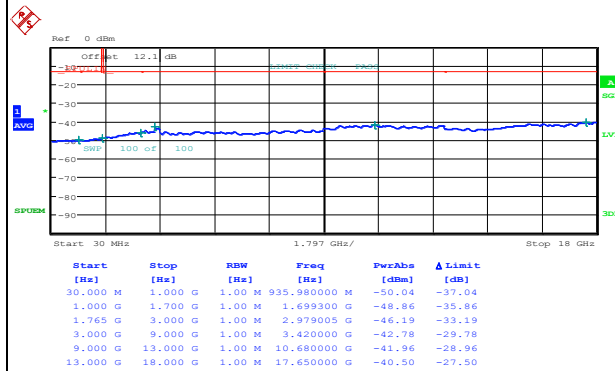

Date: 27.JAN.2015 20:02:43



LTE Band 4 / 10MHz

Middle Channel / QPSK

Middle Channel / 16QAM

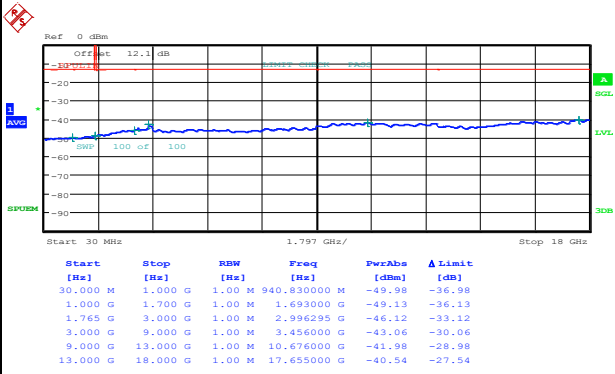

Date: 27.JAN.2015 20:04:40

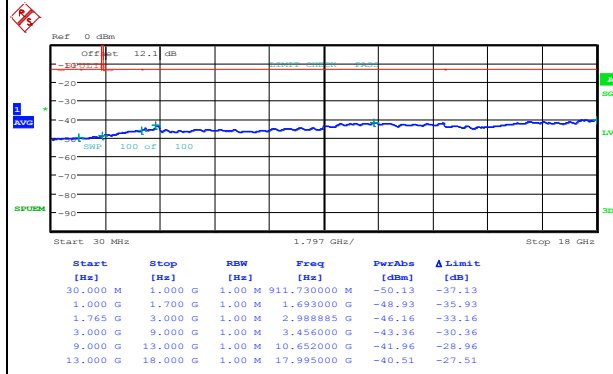

Date: 27.JAN.2015 20:05:50

Highest Channel / QPSK

Highest Channel / 16QAM

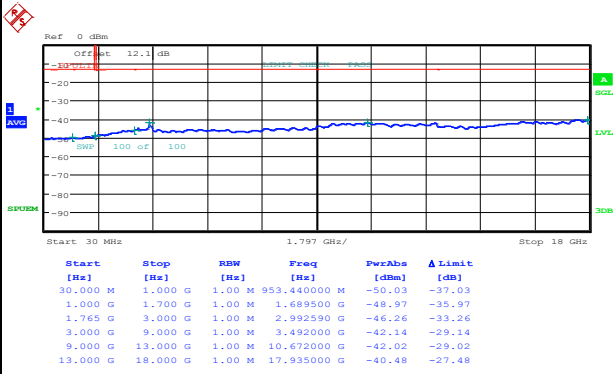

Date: 27.JAN.2015 20:12:27

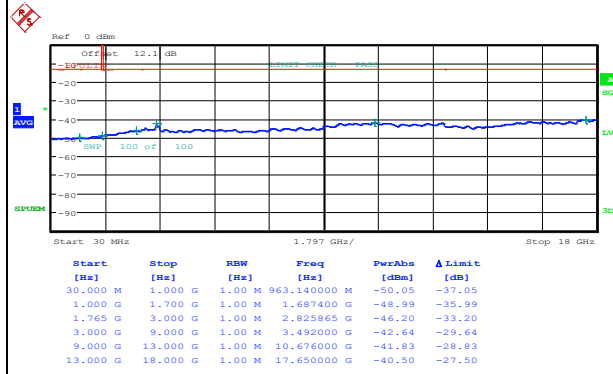

Date: 27.JAN.2015 20:13:37