



FCC RF Test Report

APPLICANT : Sony Mobile Communications Inc
EQUIPMENT : PDA Phone
BRAND NAME : Sony
TYPE NAME : PM-0780-BV
FCC ID : PY7-PM0780
STANDARD : FCC Part 15 Subpart E §15.407
CLASSIFICATION : (NII) Unlicensed National Information Infrastructure

The product was received on Dec. 03, 2014 and testing was completed on Jan. 15, 2015. We, SPORTON INTERNATIONAL INC., would like to declare that the tested sample has been evaluated in accordance with the test procedures and has been in compliance with the applicable technical standards.

The test results in this report apply exclusively to the tested model / sample. Without written approval of SPORTON INTERNATIONAL INC., the test report shall not be reproduced except in full.

Reviewed by: Joseph Lin / Supervisor

Approved by: Jones Tsai / Manager



SPORTON INTERNATIONAL INC.

No. 52, Hwa Ya 1st Rd., Hwa Ya Technology Park, Kwei-Shan District, Tao Yuan City, Taiwan, R.O.C.



TABLE OF CONTENTS

SUMMARY OF TEST RESULT 4

1 GENERAL DESCRIPTION 5

1.1 Applicant 5

1.2 Manufacturer 5

1.3 Feature of Equipment Under Test 5

1.4 Product Specification of Equipment Under Test 6

1.5 Modification of EUT 7

1.6 Testing Location 8

1.7 Applicable Standards 8

2 TEST CONFIGURATION OF EQUIPMENT UNDER TEST 9

2.1 Carrier Frequency Channel 10

2.2 Pre-Scanned RF Power 11

2.3 Test Mode 12

2.4 Connection Diagram of Test System 14

2.5 Support Unit used in test configuration and system 15

2.6 EUT Operation Test Setup 15

2.7 Measurement Results Explanation Example 15

3 TEST RESULT 16

3.1 26dB & 99% Occupied Bandwidth Measurement 16

3.2 Maximum Conducted Output Power Measurement 19

3.3 Power Spectral Density Measurement 22

3.4 Unwanted Radiated Emission Measurement 25

3.5 AC Conducted Emission Measurement 31

3.6 Frequency Stability Measurement 36

3.7 Automatically Discontinue Transmission 37

3.8 Antenna Requirements 38

4 LIST OF MEASURING EQUIPMENTS 39

5 UNCERTAINTY OF EVALUATION 41

APPENDIX A. CONDUCTED TEST RESULTS

APPENDIX B. RADIATED TEST RESULTS



SUMMARY OF TEST RESULT

Report Section	FCC Rule	Description	Limit	Result	Remark
3.1	2.1049 15.403(i)	26dB & 99% Bandwidth	-	Pass	-
3.2	15.407(a)	Maximum Conducted Output Power	≤ 24 dBm (depend on band)	Pass	-
3.3	15.407(a)	Power Spectral Density	≤ 11 dBm (depend on band)	Pass	-
3.4	15.407(b)	Unwanted Emissions	≤ -17, -27 dBm (depend on band)&15.209(a)	Pass	Under limit 3.02 dB at 5148.950 MHz
3.5	15.207	AC Conducted Emission	15.207(a)	Pass	Under limit 15.60 dB at 3.358 MHz
3.6	15.407(g)	Frequency Stability	Within Operation Band	Pass	-
3.7	15.407(c)	Automatically Discontinue Transmission	Discontinue Transmission	Pass	-
3.8	15.203 & 15.407(a)	Antenna Requirement	N/A	Pass	-



1 General Description

1.1 Applicant

Sony Mobile Communications Inc
Nya Vattentorget 22188 Lund/Sweden

1.2 Manufacturer

Sony Mobile Communications Inc
Nya Vattentorget 22188 Lund/Sweden

1.3 Feature of Equipment Under Test

The Equipment Under Test (hereafter called: EUT) is PDA Phone supporting, GSM / WCDMA / LTE, Wi-Fi 2.4GHz 802.11b/g/n, 5GHz 802.11a/n, Bluetooth with FM Receiver, GPS, ANT+, and NFC features, and below is details of information

Product Feature	
Equipment	PDA Phone
Brand Name	Sony
Type Name	PM-0780-BV
FCC ID	PY7-PM0780
GSM Operating Band(s)	GSM 850/900/1800/1900MHz
GPRS / EGPRS Multi Slot Class	GPRS Class 33, EGPRS Class 33
WCDMA Operating Band(s)	FDD Band I / II / V / VIII
WCDMA Rel. Version	Rel. 8
LTE Operating Band(s)	FDD Band I / II / III / V / VII / VIII / XX
LTE Rel. Version	Rel. 10
Wi-Fi Specification	802.11b/g/n HT20 802.11a/n HT20/HT40
Bluetooth Version	v3.0 + EDR / v4.0 - LE
NFC Specification	ISO14443A / ISO14443B / Felica / ISO15693
ANT+	ANT+
Power Supply	Battery / AC Adapter / Car Charger

Remark: The above EUT's information was declared by manufacturer. Please refer to the specifications or user's manual for more detailed description.



1.4 Product Specification of Equipment Under Test

Product Specification subjective to this standard	
Tx/Rx Frequency Range	5180 MHz ~ 5240 MHz 5260 MHz ~ 5320 MHz 5500 MHz ~ 5580 MHz 5660 MHz ~ 5700 MHz
Maximum Output Power to Antenna	<5180 MHz ~ 5240 MHz> 802.11a : 13.90 dBm / 0.0245 W 802.11n HT20 : 12.47 dBm / 0.0177 W 802.11n HT40 : 11.87 dBm / 0.0154 W <5260 MHz ~ 5320 MHz> 802.11a : 13.89 dBm / 0.0245 W 802.11n HT20 : 12.46 dBm / 0.0176 W 802.11n HT40 : 11.94 dBm / 0.0156 W <5500 MHz ~ 5580 MHz and 5660 MHz ~ 5700 MHz > 802.11a : 13.70 dBm / 0.0234 W 802.11n HT20 : 12.44 dBm / 0.0175 W 802.11n HT40 : 10.99 dBm / 0.0126 W
99% Occupied Bandwidth	802.11a : 19.20 MHz 802.11n HT20 : 19.30 MHz 802.11n HT40 : 36.60 MHz
Antenna Type & Gain	<5180 MHz ~ 5240 MHz> PIFA Antenna with gain 1.31 dBi <5260 MHz ~ 5320 MHz> PIFA Antenna with gain 1.87 dBi <5500 MHz ~ 5580 MHz and 5660 MHz ~ 5700 MHz> PIFA Antenna with gain 1.88 dBi
Type of Modulation	OFDM (BPSK / QPSK / 16QAM / 64QAM)



EUT Information List				
IMEI	HW Version	SW Version	S/N	Performed Test Item
IMEI : 004402453275632	AP	26.1.A.0.79	YT910ZRWBX	RF conducted measurement
IMEI : 004402453275632			YT910ZRWBX	Radiated Spurious Emission
IMEI : 004402453306957			YT910ZRWBG	Conducted Emission

Accessory List	
AC Adapter	Model No. : EP800
	Type No. : CAA-0002016-US
	S/N : 3112W49108087 (For Conducted Emission) 3112W49107935 (For Radiated Spurious Emission)
Battery	Model No. : Bellis
Earphone	Model No. : MH410c
	Type No. : AG-1100
	S/N : 12431A1B0011582 (For Conducted Emission) 12431A1E00118A8 (For Radiated Spurious Emission)
USB Cable	Model No. : EC450
	Type No. : AI-0700
	S/N : 142412D8250297C (For Conducted Emission) 113912D0171324C (For Radiated Spurious Emission)

Note:

1. Above EUT list and accessory list used are electrically identical per declared by manufacturer.
2. Above the accessories list are used to exercise the EUT during test.
3. For other wireless features of this EUT, test report will be issued separately.

1.5 Modification of EUT

No modifications are made to the EUT during all test items.



1.6 Testing Location

Sporton Lab is accredited to ISO 17025 by Taiwan Accreditation Foundation (TAF code : 1190) and the FCC designation No. TW1022 under the FCC 2.948(e) by Mutual Recognition Agreement (MRA) in FCC Test.

Test Site	SPORTON INTERNATIONAL INC.	
Test Site Location	No. 52, Hwa Ya 1 st Rd., Hwa Ya Technology Park, Kwei-Shan District, Tao Yuan City, Taiwan, R.O.C. TEL: +886-3-327-3456 FAX: +886-3-328-4978	
Test Site No.	Sporton Site No.	
	TH02-HY	CO05-HY

Test Site	SPORTON INTERNATIONAL INC.	
Test Site Location	No.58, Aly. 75, Ln. 564, Wenhua 3rd Rd. Guishan District, Taoyuan City, Taiwan (R.O.C.) TEL: +886-3-327-0855	
Test Site No.	Sporton Site No.	
	03CH11-HY	

Note: The test site complies with ANSI C63.4 2009 requirement.

1.7 Applicable Standards

According to the specifications of the manufacturer, the EUT must comply with the requirements of the following standards:

- ♦ FCC Part 15 Subpart E
- ♦ FCC KDB 789033 D02 General UNII Test Procedures New Rules v01
- ♦ FCC KDB 644545 D03 Guidance for IEEE 802 11ac New Rules v01
- ♦ ANSI C63.10-2013

Remark:

1. All test items were verified and recorded according to the standards and without any deviation during the test.
2. FCC permits the use of the 1.5 meter table as an alternative in C63.10-2013 through inquiry tracking number 961829.
3. This EUT has also been tested and complied with the requirements of FCC Part 15, Subpart B, recorded in a separate test report.



2 Test Configuration of Equipment Under Test

The EUT has been associated with peripherals and configuration operated in a manner tended to maximize its emission characteristics in a typical application. Frequency range investigated: conducted emission (150 kHz to 30 MHz) and radiated emission (9 kHz to the 10th harmonic of the highest fundamental frequency or to 40 GHz, whichever is lower). For radiated measurement, pre-scanned in three orthogonal panels, X, Y, Z. The worst cases (X plane) were recorded in this report.

The final configuration from all the combinations and the worst-case data rates were investigated by measuring the maximum power across all the data rates and modulation modes under section 2.2.

Based on the worst configuration found above, the RF power setting is set individually to meet FCC compliance limit for the final conducted and radiated tests shown in section 2.3.



2.1 Carrier Frequency Channel

Frequency Band	Channel	Freq. (MHz)	Channel	Freq. (MHz)
5150-5250 MHz Band 1 (U-NII-1)	36	5180	44	5220
	38	5190	46	5230
	40	5200	48	5240

Frequency Band	Channel	Freq. (MHz)	Channel	Freq. (MHz)
5250-5350 MHz Band 2 (U-NII-2A)	52	5260	60	5300
	54	5270	62	5310
	56	5280	64	5320

Frequency Band	Channel	Freq. (MHz)	Channel	Freq. (MHz)
5470-5600 MHz and 5650-5725 MHz Band 3 (U-NII-2C)	100	5500	116	5580
	102	5510	132	5660
	104	5520	134	5670
	108	5540	136	5680
	110	5550	140	5700
	112	5560		

Frequency Band	Channel	Freq. (MHz)	Channel	Freq. (MHz)
Straddle Channel	144	5720	142	5710

Note: The above Frequency and Channel in boldface were 802.11n HT40.



2.2 Pre-Scanned RF Power

Preliminary tests were performed in different data rate and data rate associated with the highest power were chosen for full test in the following tables.

5GHz 802.11a mode								
Data Rate (MHz)	6M bps	9M bps	12M bps	18M bps	24M bps	36M bps	48M bps	54M bps
Average Power (dBm)	13.90	13.52	13.48	13.58	13.61	13.76	13.71	13.76

5GHz 802.11n HT20 mode								
Data Rate (MHz)	MCS0	MCS1	MCS2	MCS3	MCS4	MCS5	MCS6	MCS7
Average Power (dBm)	12.47	12.40	12.34	12.32	12.44	12.47	12.41	12.42

5GHz 802.11n HT40 mode								
Data Rate (MHz)	MCS0	MCS1	MCS2	MCS3	MCS4	MCS5	MCS6	MCS7
Average Power (dBm)	11.94	11.81	11.91	11.88	11.90	11.93	11.92	11.93



2.3 Test Mode

Final test mode of conducted test items and radiated spurious emissions are considering the modulation and worse data rates from the power table described in section 2.2.

Modulation	Data Rate
802.11a	6 Mbps
802.11n HT20	MCS0
802.11n HT40	MCS0

AC Conducted Emission	Mode 1 : GSM1900 Idle + Bluetooth Link + WLAN (5GHz) Link + Earphone + Battery + MP3 + USB Cable (Charging from Adapter)
------------------------------	--



Ch. #		Band I : 5150-5250 MHz	Band II : 5250-5350 MHz	Band III : 5470-5725MHz
		802.11a	802.11a	802.11a
L	Low	36	52	100
M	Middle	44	60	116
H	High	48	64	140
Straddle		-	-	144

Ch. #		Band I : 5150-5250 MHz	Band II : 5250-5350 MHz	Band III : 5470-5725MHz
		802.11n HT20	802.11n HT20	802.11n HT20
L	Low	36	52	100
M	Middle	44	60	116
H	High	48	64	140
Straddle		-	-	144

Ch. #		Band I : 5150-5250 MHz	Band II : 5250-5350 MHz	Band III : 5470-5725MHz
		802.11n HT40	802.11n HT40	802.11n HT40
L	Low	38	54	102
M	Middle	-	-	110
H	High	46	62	134
Straddle		-	-	142

2.4 Connection Diagram of Test System

<WLAN Tx Mode>

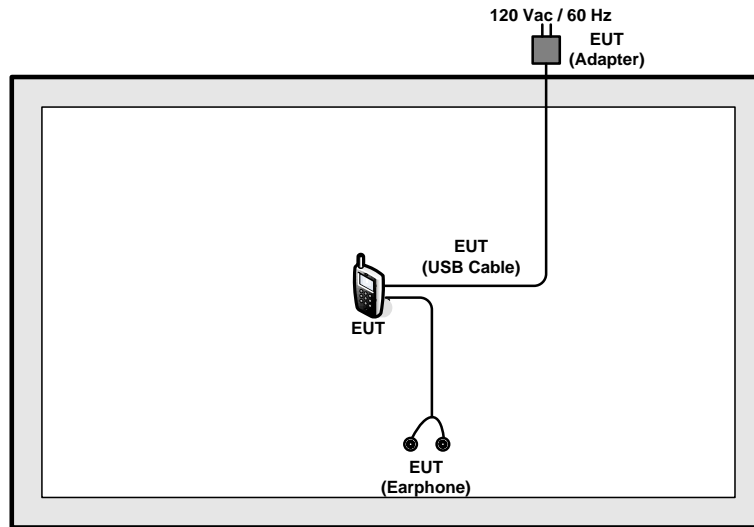

<AC Conducted Emission Mode>

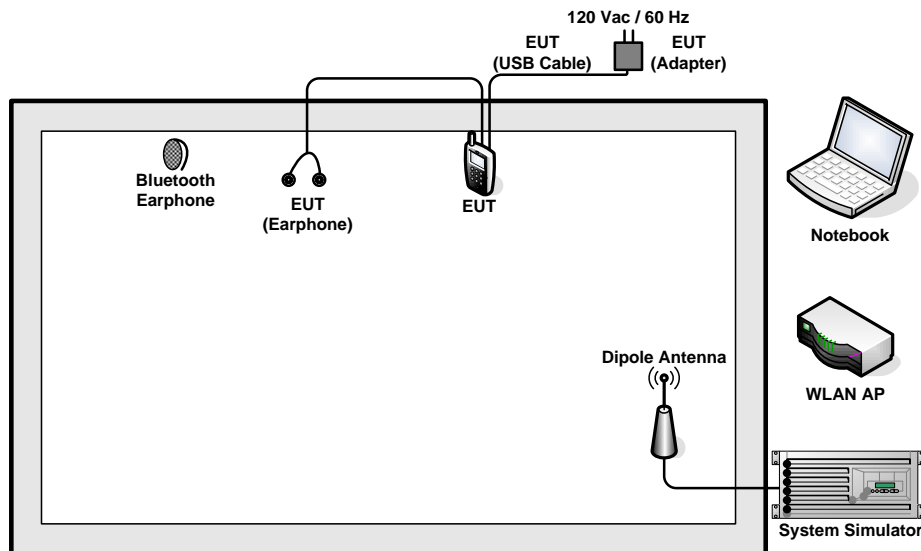



2.5 Support Unit used in test configuration and system

Item	Equipment	Trade Name	Model Name	FCC ID	Data Cable	Power Cord
1.	System Simulator	Anritsu	MT8820C	N/A	N/A	Unshielded, 1.8 m
2.	WLAN AP	D-Link	DIR-865L	KA2IR865LA1	N/A	Unshielded, 1.8 m
3.	Notebook	DELL	Latitude E6320	FCC DoC/ Contains FCC ID: QDS-BRCM1054	N/A	AC I/P: Unshielded, 1.2 m DC O/P: Shielded, 1.8 m
4.	Bluetooth Earphone	Sony	SBH20	PY7-RD0010	Unshielded, 0.75m	N/A
5.	SD Card	SanDisk	MicroSD HC	FCC DoC	N/A	N/A

2.6 EUT Operation Test Setup

For WLAN function, programmed RF utility, “QRCT” installed in the notebook make the EUT provide functions like channel selection and power level for continuous transmitting and receiving signals.

2.7 Measurement Results Explanation Example

For all conducted test items:

The offset level is set in the spectrum analyzer to compensate the RF cable loss and attenuator factor between EUT conducted output port and spectrum analyzer. With the offset compensation, the spectrum analyzer reading level is exactly the EUT RF output level.

Example :

The spectrum analyzer offset is derived from RF cable loss and attenuator factor.

Offset = RF cable loss + attenuator factor.

Following shows an offset computation example with cable loss 4.2 dB and 10dB attenuator.

$$\begin{aligned}
 \text{Offset(dB)} &= \text{RF cable loss(dB)} + \text{attenuator factor(dB)}. \\
 &= 4.2 + 10 = 14.2 \text{ (dB)}
 \end{aligned}$$



3 Test Result

3.1 26dB & 99% Occupied Bandwidth Measurement

3.1.1 Description of 26dB & 99% Occupied Bandwidth

This section is for reporting purpose only.

There is no restriction limits for bandwidth.

For Straddle Channel, U-NII procedures and limits were applied for operations in the frequency band in accordance with FCC KDB 644545 D03.

3.1.2 Measuring Instruments

The measuring equipment is listed in the section 4 of this test report.

3.1.3 Test Procedures

1. The testing follows FCC KDB 789033 D02 General UNII Test Procedures New Rules v01.
Section C) Emission bandwidth
2. Set RBW = approximately 1% of the emission bandwidth.
3. Set the VBW > RBW.
4. Detector = Peak.
5. Trace mode = max hold
6. Measure the maximum width of the emission that is 26 dB down from the peak of the emission.
Compare this with the RBW setting of the analyzer. Readjust RBW and repeat measurement as needed until the RBW/EBW ratio is approximately 1%.
7. For 99% Bandwidth Measurement, the spectrum analyzer's resolution bandwidth (RBW) is set 1MHz and set the Video bandwidth (VBW) $\geq 3 * RBW$.
8. Measure and record the results in the test report.

3.1.4 Test Setup

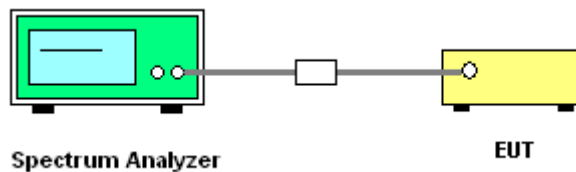



3.1.5 Test Result of 26dB & 99% Occupied Bandwidth Plots

Please refer to Appendix A.

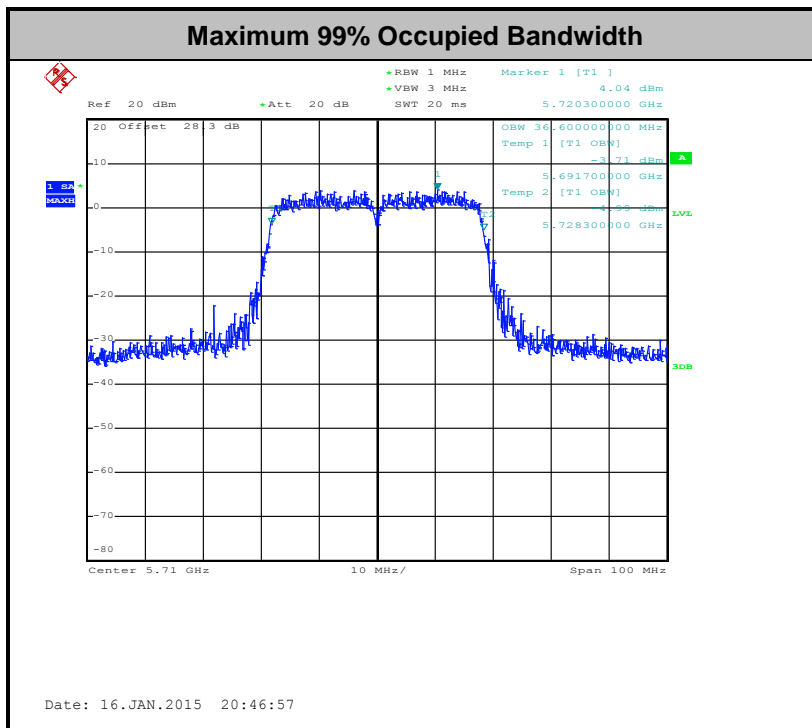
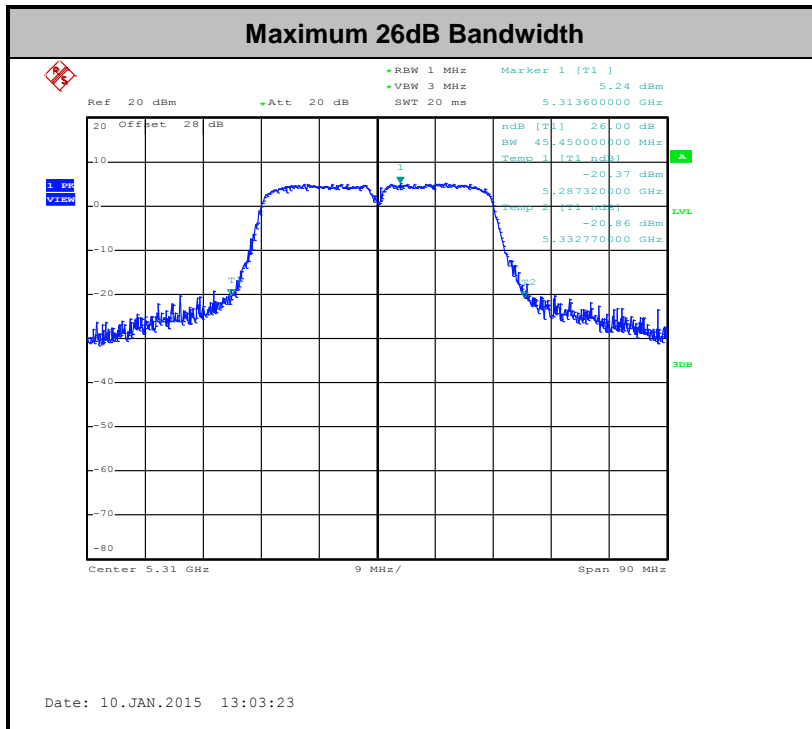

Note : The occupied channel bandwidth is maintained within the band of operation for all of the modulations.



3.2 Maximum Conducted Output Power Measurement

3.2.1 Limit of Maximum Conducted Output Power

<FCC 14-30 CFR 15.407>

For mobile and portable client devices in the 5.15–5.25 GHz band, the maximum conducted output power over the frequency band of operation shall not exceed 250 mW.

For the 5.25–5.35 GHz and 5.47–5.725 GHz bands, the maximum conducted output power over the frequency bands of operation shall not exceed the lesser of 250 mW or 11 dBm 10 log B, where B is the 26 dB emission bandwidth in megahertz.

For Straddle Channel, U-NII procedures and limits were applied for operations in the frequency band in accordance with FCC KDB 644545 D03.

If transmitting antennas of directional gain greater than 6 dBi are used, the peak output power shall be reduced by the amount in dB that the directional gain of the antenna exceeds 6 dBi.

Note that U-NII-2 band, devices with a maximum e.i.r.p. greater than 500 mW shall implement TPC in order to have the capability to operate at least 6 dB below the maximum permitted e.i.r.p. of 1 W.

3.2.2 Measuring Instruments

The measuring equipment is listed in the section 4 of this test report.

3.2.3 Test Procedures

The testing follows Method PM of FCC KDB 789033 D02 General UNII Test Procedures New Rules v01.

Method PM (Measurement using an RF average power meter):

1. Measurement is performed using a wideband RF power meter.
2. The EUT is configured to transmit continuously with a consistent duty cycle at its maximum power control level.
3. Measure the average power of the transmitter, and the average power is corrected with duty factor, $10 \log(1/x)$, where x is the duty cycle.

For straddle channel, the testing follows Method SA-3 (RMS detection with max hold) of FCC KDB 789033 D02 General UNII Test Procedures New Rules v01.

Compute power by integrating the spectrum across the 99% occupied bandwidth of the signal using the instrument's band power measurement function.

3.2.4 Test Setup

For normal channel:

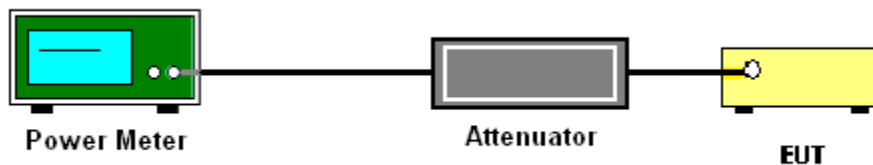

For straddle channel:

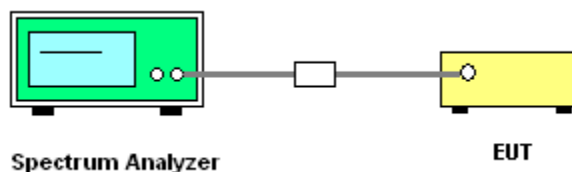



3.2.5 Test Result of Maximum Conducted Output Power

Please refer to Appendix A.

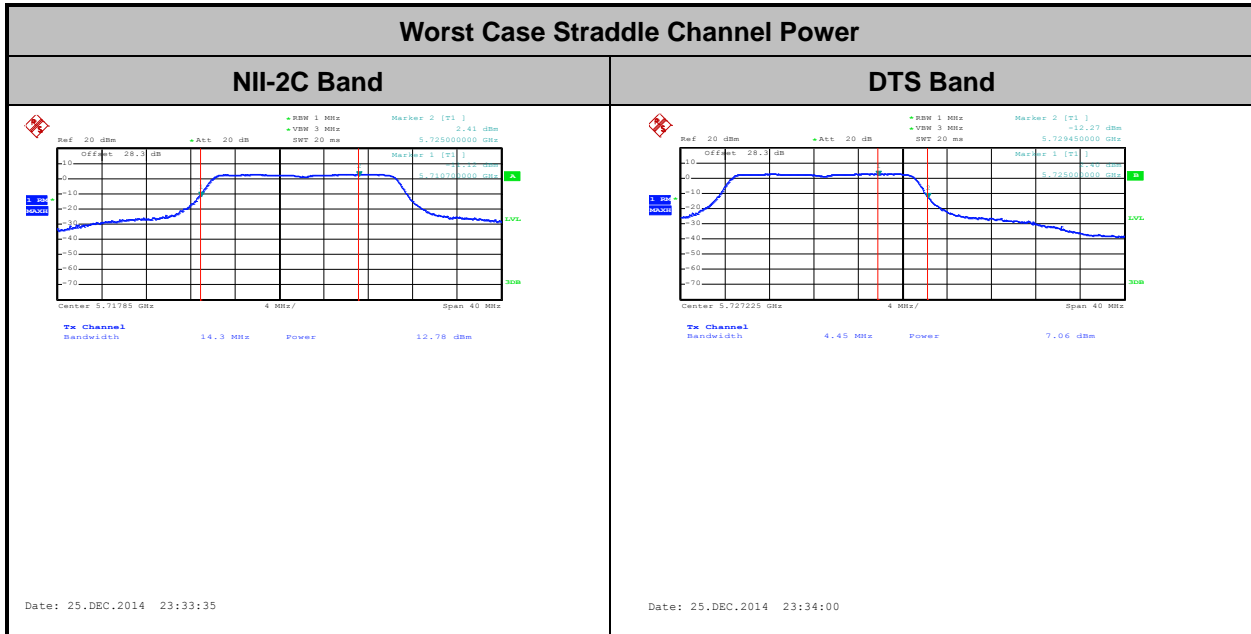



3.3 Power Spectral Density Measurement

3.3.1 Limit of Power Spectral Density

<FCC 14-30 CFR 15.407>

For mobile and portable client devices in the 5.15–5.25 GHz band, the maximum power spectral density shall not exceed 11dBm in any 1 megahertz band.

For the 5.25–5.35 GHz and 5.47–5.725 GHz bands, the maximum power spectral density shall not exceed 11 dBm in any 1 megahertz band.

For Straddle Channel, U-NII procedures and limits were applied for operations in the frequency band in accordance with FCC KDB 644545 D03.

If transmitting antennas of directional gain greater than 6 dBi are used, the peak output power shall be reduced by the amount in dB that the directional gain of the antenna exceeds 6 dBi.

3.3.2 Measuring Instruments

The measuring equipment is listed in the section 4 of this test report.

3.3.3 Test Procedures

The testing follows FCC KDB 789033 D02 General UNII Test Procedures New Rules v01.
Section F) Maximum power spectral density.

Method SA-2

(trace averaging across on and off times of the EUT transmissions, followed by duty cycle correction).

1. The testing follows Method SA-2 of FCC KDB 789033 D02 General UNII Test Procedures New Rules v01.
 - Measure the duty cycle.
 - Set span to encompass the entire emission bandwidth (EBW) of the signal.
 - Set RBW = 1 MHz.
 - Set VBW \geq 3 MHz.
 - Number of points in sweep \geq 2 Span / RBW.
 - Sweep time = auto.
 - Detector = RMS
 - Trace average at least 100 traces in power averaging mode.
 - Add $10 \log(1/x)$, where x is the duty cycle, to the measured power in order to compute the average power during the actual transmission times. For example, add $10 \log(1/0.25) = 6$ dB if the duty cycle is 25 percent.
2. The RF output of EUT was connected to the spectrum analyzer by a low loss cable.
3. Each plot has already offset with cable loss, and attenuator loss. Measure the PPSD and record it.

3.3.4 Test Setup

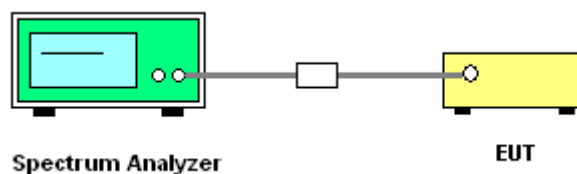



3.3.5 Test Result of Power Spectral Density

Please refer to Appendix A.

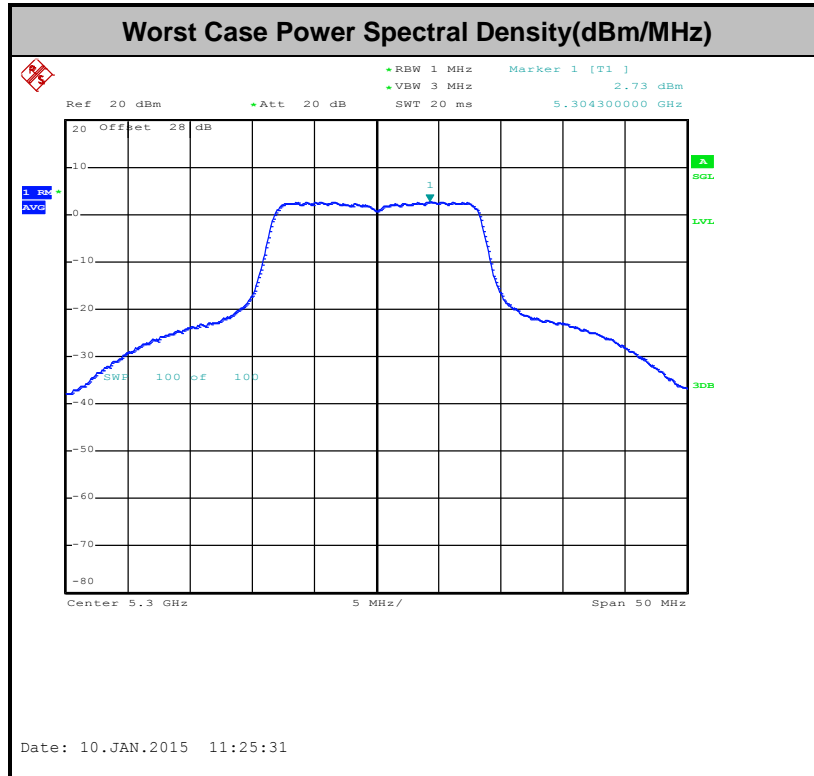

Note: Average Power Density (dB) = Measured value+ Duty Factor



3.4 Unwanted Radiated Emission Measurement

This section as specified in FCC Part 15.407(b) is to measure unwanted emissions through radiated measurement for band edge spurious emissions and out of band emissions measurement. The unwanted emissions shall comply with 15.407(b)(1) to (6), and restricted bands per FCC Part15.205.

3.4.1 Limit of Unwanted Emissions

(1) For transmitters operating in the 5150-5250 MHz band: all emissions outside of the 5150-5350 MHz band shall not exceed an EIRP of -27dBm/MHz.

For transmitters operating in the 5250-5350 MHz band: all emissions outside of the 5150-5350 MHz band shall not exceed an EIRP of -27 dBm/MHz. Devices operating in the 5250-5350 MHz band that generate emissions in the 5150-5250 MHz band must meet all applicable technical requirements for operation in the 5150-5250 MHz band (including indoor use) or alternatively meet an out-of-band emission EIRP limit of -27 dBm/MHz in the 5150-5250 MHz band.

For transmitters operating in the 5470-5600 MHz and 5650-5725MHz band: all emissions outside of the 5470-5600 MHz and 5650-5725MHz band shall not exceed an EIRP of -27 dBm/MHz.

(2) Unwanted spurious emissions fallen in restricted bands per FCC Part15.205 shall comply with the general field strength limits set forth in § 15.209 as below table,

Frequency (MHz)	Field Strength (microvolts/meter)	Measurement Distance (meters)
0.009 – 0.490	2400/F(kHz)	300
0.490 – 1.705	24000/F(kHz)	30
1.705 – 30.0	30	30
30 – 88	100	3
88 – 216	150	3
216 - 960	200	3
Above 960	500	3

Note: The following formula is used to convert the EIRP to field strength.

$$E = \frac{1000000\sqrt{30P}}{3} \mu\text{V/m, where P is the eirp (Watts)}$$

EIRP (dBm)	Field Strength at 3m (dBμV/m)
-17	78.3
- 27	68.3

(3) KDB789033 v01 G)2)c) As specified in 15.407(b), emissions above 1000 MHz that are outside of



the restricted bands are subject to a peak emission limit of -27 dBm/MHz (or -17 dBm/MHz as specified in 15.407(b)(4)). However, an out-of-band emission that complies with both the average and peak limits of 15.209 is not required to satisfy the -27 dBm/MHz or -17 dBm/MHz peak emission limit.

3.4.2 Measuring Instruments

The measuring equipment is listed in the section 4 of this test report.



3.4.3 Test Procedures

1. The testing follows FCC KDB 789033 D02 General UNII Test Procedures New Rules v01. Section G) Unwanted emissions measurement.

(1) Procedure for Unwanted Emissions Measurements Below 1000MHz

- RBW = 120 kHz
- VBW = 300 kHz
- Detector = Peak
- Trace mode = max hold

(2) Procedure for Peak Unwanted Emissions Measurements Above 1000 MHz

- RBW = 1 MHz
- VBW ≥ 3 MHz
- Detector = Peak
- Sweep time = auto
- Trace mode = max hold

(3) Procedures for Average Unwanted Emissions Measurements Above 1000MHz

- RBW = 1 MHz
- VBW = 10 Hz, when duty cycle is no less than 98 percent.
- $VBW \geq 1/T$, when duty cycle is less than 98 percent where T is the minimum transmission duration over which the transmitter is on and is transmitting at its maximum power control level for the tested mode of operation.

Band	Duty Cycle(%)	T(μs)	1/T(kHz)	VBW Setting
802.11a	87.26	1370.00	0.73	1kHz
802.11n HT20	87.07	1280.00	0.78	1kHz
802.11n HT40	76.43	642.00	1.56	3kHz

- The EUT was placed on a turntable with 0.8 meter for frequency below 1GHz and 1.5 meter for frequency above 1GHz respectively above ground.
- The EUT was set 3 meters from the interference receiving antenna which was mounted on the top of a variable height antenna tower.
- The antenna is a broadband antenna and its height is adjusted between one meter and four meters above ground to find the maximum value of the field strength for both horizontal polarization and vertical polarization of the antenna.
- For each suspected emission, the EUT was arranged to its worst case and then adjust the antenna tower (from 1 m to 4 m) and turntable (from 0 degree to 360 degrees) to find the maximum reading.

6. For testing below 1GHz, if the emission level of the EUT in peak mode was 3 dB lower than the limit specified, then peak values of EUT will be reported, otherwise, the emissions will be repeated one by one using the CISPR quasi-peak method and reported.
7. For testing above 1GHz, the emission level of the EUT in peak mode was 20dB lower than average limit (that means the emission level in average mode also complies with the limit in average mode), then peak values of EUT will be reported, otherwise, the emissions will be measured in average mode again and reported.

3.4.4 Test Setup

For radiated emissions below 30MHz

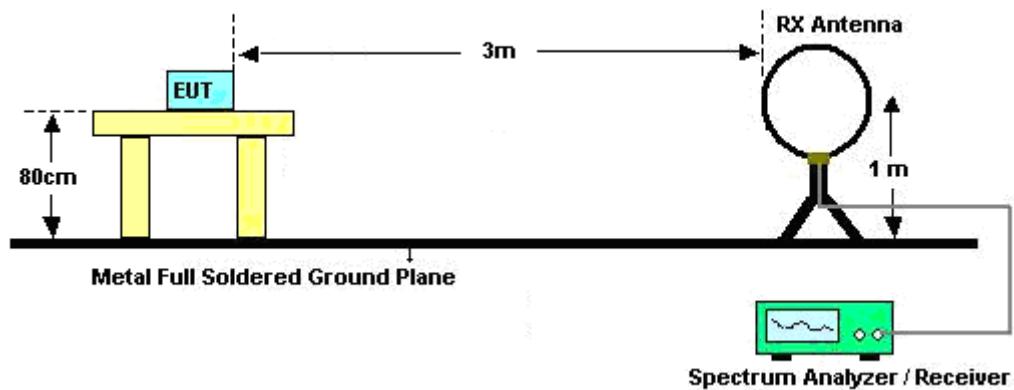

For radiated emissions from 30MHz to 1GHz

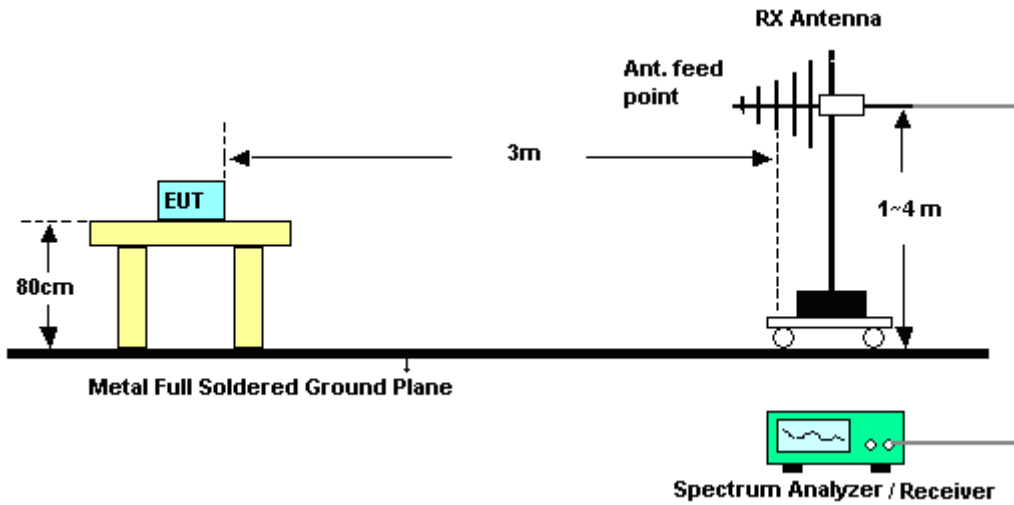

For radiated emissions above 1GHz

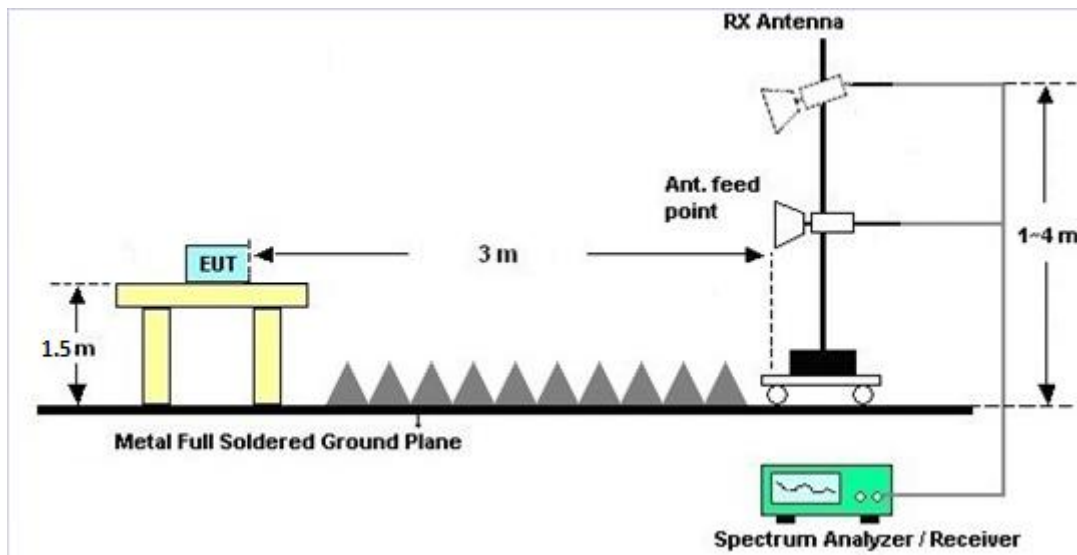

3.4.5 Test Results of Radiated Emissions (9 kHz ~ 30 MHz)

The low frequency, which started from 9 kHz to 30MHz, was pre-scanned and the result which was 20dB lower than the limit line per 15.31(o) was not reported.



3.4.6 Test Result of Radiated Band Edges

Please refer to Appendix B.

3.4.7 Test Result of Unwanted Radiated Emission (30MHz ~ 10th Harmonic)

Please refer to Appendix B.



3.5 AC Conducted Emission Measurement

3.5.1 Limit of AC Conducted Emission

For equipment that is designed to be connected to the public utility (AC) power line, the radio frequency voltage that is conducted back onto the AC power line on any frequency or frequencies within the band 150 kHz to 30 MHz shall not exceed the limits in the following table.

Frequency of emission (MHz)	Conducted limit (dB μ V)	
	Quasi-peak	Average
0.15-0.5	66 to 56*	56 to 46*
0.5-5	56	46
5-30	60	50

*Decreases with the logarithm of the frequency.

3.5.2 Measuring Instruments

The measuring equipment is listed in the section 4 of this test report.

3.5.3 Test Procedures

1. The EUT was placed 0.4 meter from the conducting wall of the shielding room was kept at least 80 centimeters from any other grounded conducting surface.
2. Connect EUT to the power mains through a line impedance stabilization network (LISN).
3. All the support units are connecting to the other LISN.
4. The LISN provides 50 ohm coupling impedance for the measuring instrument.
5. The FCC states that a 50 ohm, 50 microhenry LISN should be used.
6. Both sides of AC line were checked for maximum conducted interference.
7. The frequency range from 150 kHz to 30 MHz was searched.
8. Set the test-receiver system to Peak Detect Function and specified bandwidth with Maximum Hold Mode.

3.5.4 Test Setup

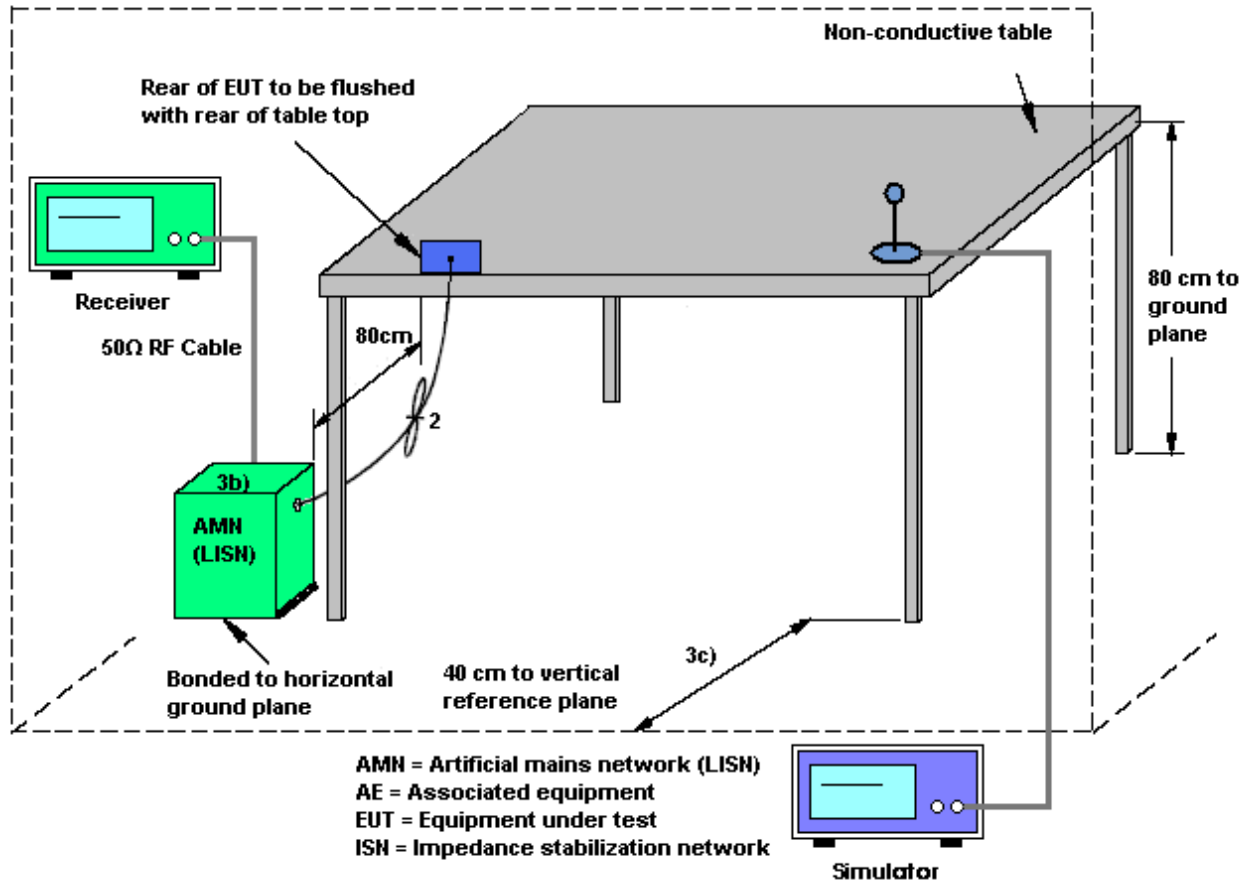



3.5.5 Test Result of AC Conducted Emission

Test Mode :	Mode 1	Temperature :	20~22°C
Test Engineer :	Kai-Chun Chu	Relative Humidity :	46~48%
Test Voltage :	120Vac / 60Hz	Phase :	Line
Function Type :	GSM1900 Idle + Bluetooth Link + WLAN (5GHz) Link + Earphone + Battery + MP3 + USB Cable (Charging from Adapter)		

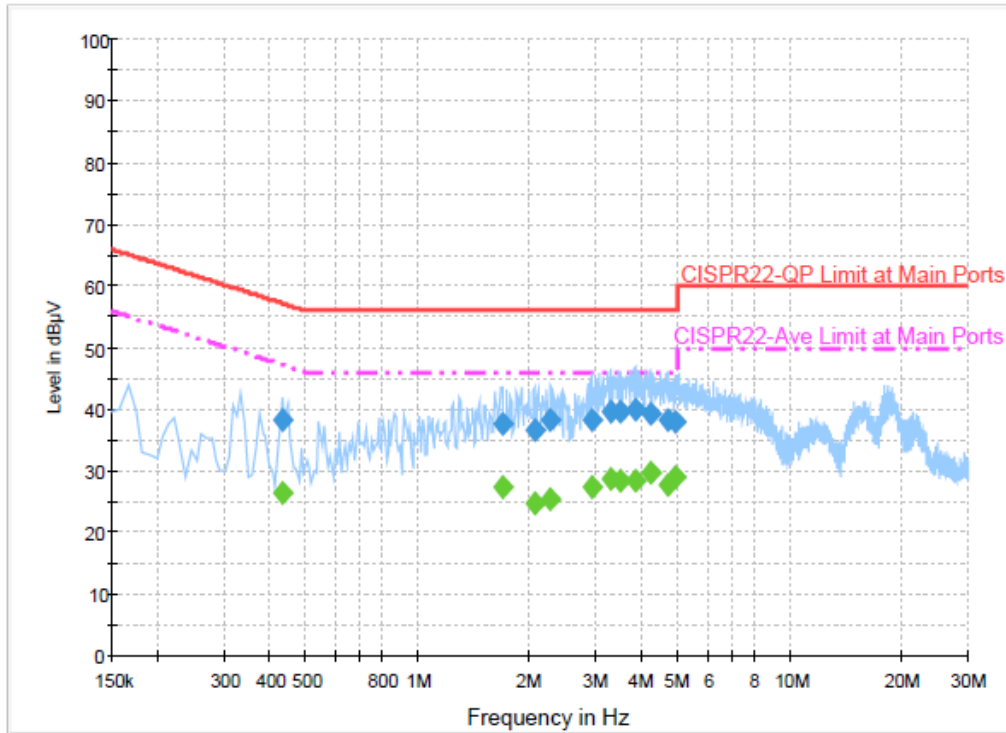

Final Result : QuasiPeak

Frequency (MHz)	QuasiPeak (dBµV)	Filter	Line	Corr. (dB)	Margin (dB)	Limit (dBµV)
0.430000	38.4	Off	L1	19.5	18.9	57.3
1.678000	37.5	Off	L1	19.6	18.5	56.0
2.054000	36.7	Off	L1	19.4	19.3	56.0
2.270000	38.2	Off	L1	19.4	17.8	56.0
2.918000	38.4	Off	L1	19.6	17.6	56.0
3.278000	39.7	Off	L1	19.6	16.3	56.0
3.510000	39.6	Off	L1	19.6	16.4	56.0
3.822000	39.9	Off	L1	19.6	16.1	56.0
4.198000	39.3	Off	L1	19.6	16.7	56.0
4.686000	38.3	Off	L1	19.7	17.7	56.0
4.926000	38.1	Off	L1	19.7	17.9	56.0



Test Mode :	Mode 1	Temperature :	20~22°C
Test Engineer :	Kai-Chun Chu	Relative Humidity :	46~48%
Test Voltage :	120Vac / 60Hz	Phase :	Line
Function Type :	GSM1900 Idle + Bluetooth Link + WLAN (5GHz) Link + Earphone + Battery + MP3 + USB Cable (Charging from Adapter)		

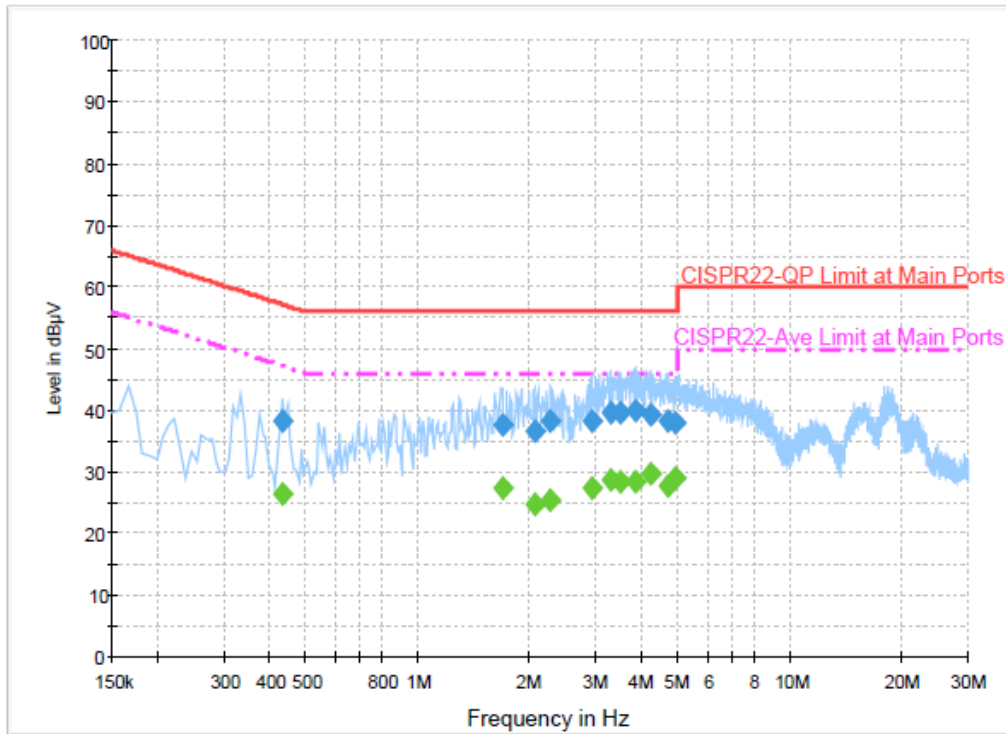

Final Result : Average

Frequency (MHz)	Average (dBµV)	Filter	Line	Corr. (dB)	Margin (dB)	Limit (dBµV)
0.430000	26.3	Off	L1	19.5	21.0	47.3
1.678000	27.3	Off	L1	19.6	18.7	46.0
2.054000	24.7	Off	L1	19.4	21.3	46.0
2.270000	25.5	Off	L1	19.4	20.5	46.0
2.918000	27.5	Off	L1	19.6	18.5	46.0
3.278000	28.6	Off	L1	19.6	17.4	46.0
3.510000	28.4	Off	L1	19.6	17.6	46.0
3.822000	28.3	Off	L1	19.6	17.7	46.0
4.198000	29.7	Off	L1	19.6	16.3	46.0
4.686000	27.8	Off	L1	19.7	18.2	46.0



Test Mode :	Mode 1	Temperature :	20~22°C
Test Engineer :	Kai-Chun Chu	Relative Humidity :	46~48%
Test Voltage :	120Vac / 60Hz	Phase :	Neutral
Function Type :	GSM1900 Idle + Bluetooth Link + WLAN (5GHz) Link + Earphone + Battery + MP3 + USB Cable (Charging from Adapter)		

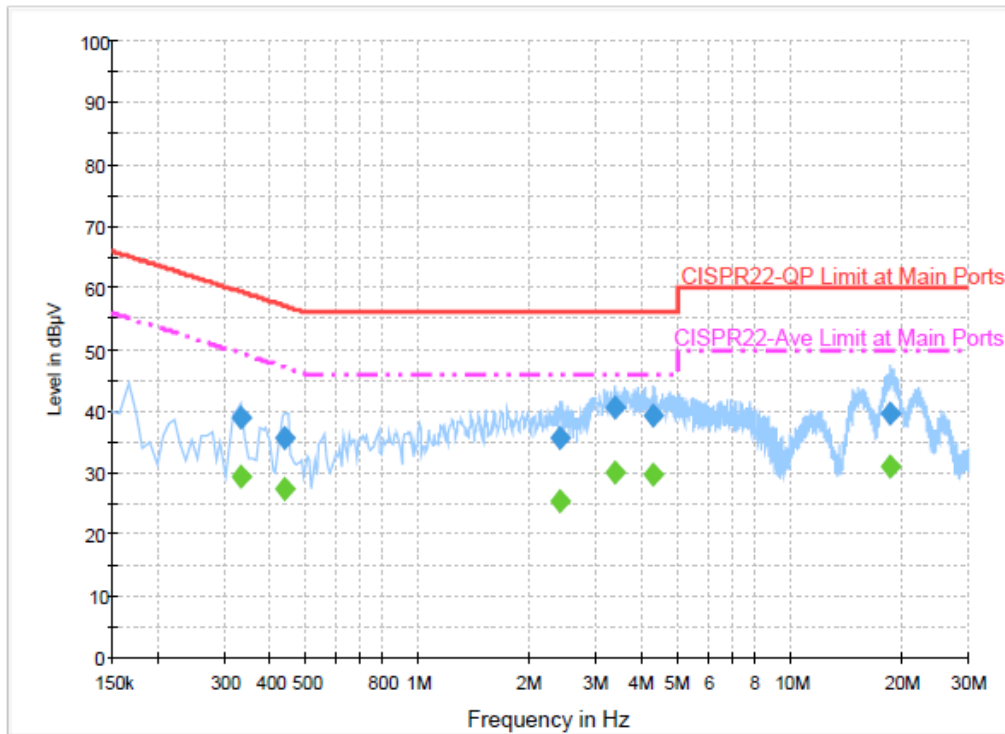

Final Result : QuasiPeak

Frequency (MHz)	QuasiPeak (dBµV)	Filter	Line	Corr. (dB)	Margin (dB)	Limit (dBµV)
0.334000	38.8	Off	N	19.4	20.6	59.4
0.438000	35.5	Off	N	19.5	21.6	57.1
2.398000	35.5	Off	N	19.5	20.5	56.0
3.358000	40.4	Off	N	19.6	15.6	56.0
4.254000	39.3	Off	N	19.6	16.7	56.0
18.614000	39.5	Off	N	20.0	20.5	60.0

Final Result : Average

Frequency (MHz)	Average (dBµV)	Filter	Line	Corr. (dB)	Margin (dB)	Limit (dBµV)
0.334000	29.3	Off	N	19.4	20.1	49.4
0.438000	27.4	Off	N	19.5	19.7	47.1
2.398000	25.6	Off	N	19.5	20.4	46.0
3.358000	30.2	Off	N	19.6	15.8	46.0
4.254000	29.8	Off	N	19.6	16.2	46.0
18.614000	30.9	Off	N	20.0	19.1	50.0

3.6 Frequency Stability Measurement

3.6.1 Limit of Frequency Stability

Manufacturers of U-NII devices are responsible for ensuring frequency stability such that an emission is maintained within the band of operation under all conditions of normal operation as specified in the user's manual.

3.6.2 Measuring Instruments

The measuring equipment is listed in the section 4 of this test report.

3.6.3 Test Procedures

1. To ensure emission at the band edge is maintained within the authorized band, those values shall be measured by radiation emissions at upper and lower frequency points, and finally compensated by frequency deviation as procedures below.
2. The EUT was operated at the maximum output power, and connected to the spectrum analyzer, which is set to maximum hold function and peak detector. The peak value of the power envelope was measured and noted. The upper and lower frequency points were respectively measured relatively 10dB lower than the measured peak value.
3. The frequency deviation was calculated by adding the upper frequency point and the lower frequency point divided by two. Those detailed values of frequency deviation are provided in table below.

3.6.4 Test Setup

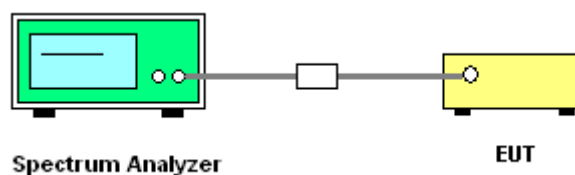

3.6.5 Test Result of Frequency Stability

Please refer to Appendix A.



3.7 Automatically Discontinue Transmission

3.7.1 Limit of Automatically Discontinue Transmission

The device shall automatically discontinue transmission in case of either absence of information to transmit or operational failure. These provisions are not intended to preclude the transmission of control or signaling information or the use of repetitive codes used by certain digital technologies to complete frame or burst intervals. Applicants shall include in their application for equipment authorization to describe how this requirement is met.

3.7.2 Measuring Instruments

The measuring equipment is listed in the section 4 of this test report.

3.7.3 Test Result of Automatically Discontinue Transmission

While the EUT is not transmitting any information, the EUT can automatically discontinue transmission and become standby mode for power saving. The EUT can detect the controlling signal of ACK message transmitting from remote device and verify whether it shall resend or discontinue transmission.



3.8 Antenna Requirements

3.8.1 Standard Applicable

According to FCC 47 CFR Section 15.407(a)(1)(2) ,if transmitting antenna directional gain is greater than 6 dBi, both the peak transmit power and the peak power spectral density shall be reduced by the amount in dB that the directional gain of the antenna exceeds 6 dBi.

3.8.2 Antenna Anti-Replacement Construction

An embedded-in antenna design is used.

3.8.3 Antenna Gain

The antenna gain is less than 6 dBi. Therefore, it is not necessary to reduce maximum peak output power limit.



4 List of Measuring Equipments

Instrument	Manufacturer	Model No.	Serial No.	Characteristics	Calibration Date	Test Date	Due Date	Remark
Power Meter	Agilent	E4416A	GB41292344	300MHz~40GHz	Jan. 28, 2014	Dec. 25, 2014 ~ Jan. 15, 2015	Jan. 27, 2015	Conducted (TH02-HY)
Power Sensor	Agilent	E9327A	US40441548	300MHz~40GHz	Jan. 28, 2014	Dec. 25, 2014 ~ Jan. 15, 2015	Jan. 27, 2015	Conducted (TH02-HY)
Spectrum Analyzer	Rohde & Schwarz	FSP40	100055	9kHz~40GHz	Jun. 09, 2014	Dec. 25, 2014 ~ Jan. 15, 2015	Jun. 08, 2015	Conducted (TH02-HY)
Hygrometer	Testo	608-H1	34897199	N/A	May. 06, 2014	Dec. 25, 2014 ~ Jan. 15, 2015	May. 05, 2015	Conducted (TH02-HY)
RF cable	WOKEN	S05	S05-130708-038	N/A	Jan. 22, 2014	Dec. 25, 2014 ~ Jan. 15, 2015	Jan. 21, 2015	Conducted (TH02-HY)
EMI Test Receiver	Rohde & Schwarz	ESCS 30	100356	9kHz – 2.75GHz	Dec. 01, 2014	Dec. 09, 2014	Nov. 30, 2015	Conduction (CO05-HY)
Two-LISN	Rohde & Schwarz	ENV216	100080	9kHz~30MHz	Dec. 02, 2014	Dec. 09, 2014	Dec. 01, 2015	Conduction (CO05-HY)
AC Power Source	ChainTek	APC-1000W	N/A	N/A	N/A	Dec. 09, 2014	N/A	Conduction (CO05-HY)
Hygrometer	Testo	608-H1	34913912	N/A	Apr. 23, 2014	Dec. 09, 2014	Apr. 22, 2015	Conduction (CO05-HY)
LF Cable	Shuner	RG-402	N/A	N/A	Oct. 07, 2014	Dec. 09, 2014	Oct. 06, 2015	Conduction (CO05-HY)
Test Software	N/A	EMC32	8.40.0	N/A	N/A	Dec. 09, 2014	N/A	Conduction (CO05-HY)



Instrument	Manufacturer	Model No.	Serial No.	Characteristics	Calibration Date	Test Date	Due Date	Remark
EMI Test Receiver	Keysight	N9038A	MY54130085	20Hz ~ 26.5GHz	Nov. 05, 2014	Jan. 07, 2015 ~ Jan. 09, 2015	Nov. 04, 2015	Radiation (03CH11-HY)
Spectrum Analyzer	Keysight	N9010A	MY54200486	10Hz ~ 44GHZ	Sep. 24, 2014	Jan. 07, 2015 ~ Jan. 09, 2015	Sep. 23, 2015	Radiation (03CH11-HY)
Loop Antenna	R&S	HFH2-Z2	100315	9 kHz~30 MHz	Jul. 28, 2014	Jan. 07, 2015 ~ Jan. 09, 2015	Jul. 27, 2015	Radiation (03CH11-HY)
Bilog Antenna	TESEQ	CBL 6111D	35414	30MHz~1GHz	Oct. 24, 2014	Jan. 07, 2015 ~ Jan. 09, 2015	Oct. 23, 2015	Radiation (03CH11-HY)
Double Ridged Guide Horn Antenna	SCHWARZBECK	BBHA 9120 D	9120D-1326	1GHz ~ 18GHz	Oct. 03, 2014	Jan. 07, 2015 ~ Jan. 09, 2015	Oct. 02, 2015	Radiation (03CH11-HY)
Horn Antenna	SCHWARZBECK	BBHA 9170	BBHA9170584	18GHz- 40GHz	Nov. 03, 2014	Jan. 07, 2015 ~ Jan. 09, 2015	Nov. 02, 2015	Radiation (03CH11-HY)
Amplifier	SONOMA	310N	187312	0.1MHz~1000M Hz	Nov. 24, 2014	Jan. 07, 2015 ~ Jan. 09, 2015	Nov. 23, 2015	Radiation (03CH11-HY)
Preamplifier	Keysight	83017A	MY53270080	1GHz~26.5GHz	Nov. 20, 2014	Jan. 07, 2015 ~ Jan. 09, 2015	Nov. 19, 2015	Radiation (03CH11-HY)
Preamplifier	MITEQ	AMF-7D-00101800-30-10P	1902247	1GHz~18GHz	Nov. 25, 2014	Jan. 07, 2015 ~ Jan. 09, 2015	Nov. 24, 2015	Radiation (03CH11-HY)
Preamplifier	MITEQ	JS44-18004000-33-8P	1840917	18GHz ~ 40GHz	Jun. 09, 2014	Jan. 07, 2015 ~ Jan. 09, 2015	Jun. 08, 2015	Radiation (03CH11-HY)
Antenna Mast	EMEC	AM-BS-4500-B	N/A	N/A	N/A	Jan. 07, 2015 ~ Jan. 09, 2015	N/A	Radiation (03CH11-HY)
Turn Table	EMEC	TT 2000	N/A	0-360 degree	N/A	Jan. 07, 2015 ~ Jan. 09, 2015	N/A	Radiation (03CH11-HY)
Controller	EMEC	EM 1000	N/A	1m-4m	N/A	Jan. 07, 2015 ~ Jan. 09, 2015	N/A	Radiation (03CH11-HY)
RF Cable	HUBER + SUHNER	SUCOFLEX 104	MY84209521	9KHz~1GHz	Dec. 04, 2014	Jan. 07, 2015 ~ Jan. 09, 2015	Dec. 03, 2015	Radiation (03CH11-HY)
RF Cable	HUBER + SUHNER	SUCOFLEX 104	MY44614PE MY249674M Y249714	30MHz~1GHz	Nov. 06, 2014	Jan. 07, 2015 ~ Jan. 09, 2015	Nov. 05, 2015	Radiation (03CH11-HY)
RF Cable	HUBER + SUHNER	SUCOFLEX 104	MY44614PE MY249674M Y249714	1GHz~25GHz	Nov. 06, 2014	Jan. 07, 2015 ~ Jan. 09, 2015	Nov. 05, 2015	Radiation (03CH11-HY)
RF Cable	HUBER + SUHNER	SUCOFLEX 104	MY44614PE MY249674 MY249714	25GHz~40GHz	Nov. 06, 2014	Jan. 07, 2015 ~ Jan. 09, 2015	Nov. 05, 2015	Radiation (03CH11-HY)
Hygrometer	TECPEL	DTN-303B	TP140325	N/A	Nov. 19, 2014	Jan. 07, 2015 ~ Jan. 09, 2015	Nov. 05, 2015	Radiation (03CH11-HY)
Filter	Wainwright	WLKS4500-8SS	SN19	4.5G Low Pass	Oct. 01, 2014	Jan. 07, 2015 ~ Jan. 09, 2015	Sep. 30, 2015	Radiation (03CH11-HY)
Filter	Microwave Circuits	H07G18G3	282388	7G High Pass	Oct. 01, 2014	Jan. 07, 2015 ~ Jan. 09, 2015	Sep. 30, 2015	Radiation (03CH11-HY)
Test Software	Audix	E3	Version 6.2009-8-24	N/A	N/A	Jan. 07, 2015 ~ Jan. 09, 2015	N/A	Radiation (03CH11-HY)



5 Uncertainty of Evaluation

Uncertainty of Conducted Emission Measurement (150kHz ~ 30MHz)

Measuring Uncertainty for a Level of Confidence of 95% ($U = 2Uc(y)$)	2.26
---	------

Uncertainty of Radiated Emission Measurement (30 MHz ~ 1000 MHz)

Measuring Uncertainty for a Level of Confidence of 95% ($U = 2Uc(y)$)	4.90
---	------



Appendix A. Conducted test results

Test Engineer:	Bill Kuo	Temperature:	21~25	°C
Test Date:	2014/12/25 ~ 2015/1/15	Relative Humidity:	51~54	%

TEST RESULTS DATA
26dB and 99% OBW

Band I										
Mod.	Data Rate	NTX	CH.	Freq. (MHz)	99% Bandwidth (MHz)	26 dB Bandwidth (MHz)	IC 99% Bandwidth Power Limit (dBm)	IC 99% Bandwidth EIRP Limit (dBm)		
11a	6Mbps	1	36	5180	18.65	34.40	-	22.71		
11a	6Mbps	1	44	5220	18.70	34.80	-	22.72		
11a	6Mbps	1	48	5240	18.70	31.65	-	22.72		
HT20	MCS0	1	36	5180	18.95	24.10	-	22.78		
HT20	MCS0	1	44	5220	19.05	24.50	-	22.80		
HT20	MCS0	1	48	5240	18.95	24.95	-	22.78		
HT40	MCS0	1	38	5190	36.50	44.64	-	23.01		
HT40	MCS0	1	46	5230	36.60	45.36	-	23.01		

TEST RESULTS DATA
Average Power Table

FCC Band I										
Mod.	Data Rate	NTX	CH.	Freq. (MHz)	Duty Factor (dB)	Average Conducted Power (dBm)	FCC Conducted Power Limit (dBm)	DG (dBi)		Pass/Fail
11a	6Mbps	1	36	5180	0.59	13.90	24.00	1.31		Pass
11a	6Mbps	1	44	5220	0.59	13.87	24.00	1.31		Pass
11a	6Mbps	1	48	5240	0.59	13.85	24.00	1.31		Pass
HT20	MCS0	1	36	5180	0.60	12.47	24.00	1.31		Pass
HT20	MCS0	1	44	5220	0.60	12.31	24.00	1.31		Pass
HT20	MCS0	1	48	5240	0.60	12.22	24.00	1.31		Pass
HT40	MCS0	1	38	5190	1.17	11.56	24.00	1.31		Pass
HT40	MCS0	1	46	5230	1.17	11.87	24.00	1.31		Pass

TEST RESULTS DATA
Power Spectral Density

FCC Band I										
Mod.	Data Rate	NTX	CH.	Freq. (MHz)	Duty Factor (dB)	Average Power Density (dBm/MHz)	Average PSD Limit (dBm/MHz)	DG (dBi)	-	Pass/Fail
11a	6Mbps	1	36	5180	0.59	3.14	11.00	1.31		Pass
11a	6Mbps	1	44	5220	0.59	2.95	11.00	1.31		Pass
11a	6Mbps	1	48	5240	0.59	2.85	11.00	1.31		Pass
HT20	MCS0	1	36	5180	0.60	0.27	11.00	1.31		Pass
HT20	MCS0	1	44	5220	0.60	0.41	11.00	1.31		Pass
HT20	MCS0	1	48	5240	0.60	0.43	11.00	1.31		Pass
HT40	MCS0	1	38	5190	1.17	-3.52	11.00	1.31		Pass
HT40	MCS0	1	46	5230	1.17	-2.75	11.00	1.31		Pass

TEST RESULTS DATA
26dB and 99% OBW

Band II										
Mod.	Data Rate	NTX	CH.	Freq. (MHz)	99% Bandwidth (MHz)	26 dB Bandwidth (MHz)	IC 99% Bandwidth Power Limit (dBm)	IC 99% Bandwidth EIRP Limit (dBm)	FCC 26dB Bandwidth Power Limit (dBm)	Note
11a	6Mbps	1	52	5260	18.85	33.55	23.75	29.75	23.98	
11a	6Mbps	1	60	5300	19.2	36.1	23.83	29.83	23.98	
11a	6Mbps	1	64	5320	18.7	31.35	23.72	29.72	23.98	
HT20	MCS0	1	52	5260	19.1	24.55	23.81	29.81	23.98	
HT20	MCS0	1	60	5300	19.3	25.5	23.86	29.86	23.98	
HT20	MCS0	1	64	5320	18.95	25.65	23.78	29.78	23.98	
HT40	MCS0	1	54	5270	36.5	44.73	23.98	30.00	23.98	
HT40	MCS0	1	62	5310	36.6	45.45	23.98	30.00	23.98	

TEST RESULTS DATA
Average Power Table

FCC Band II										
Mod.	Data Rate	NTX	CH.	Freq. (MHz)	Duty Factor (dB)	Average Conducted Power (dBm)	FCC Conducted Power Limit (dBm)	DG (dBi)		Pass/Fail
11a	6Mbps	1	52	5260	0.59	13.73	23.98	1.87		Pass
11a	6Mbps	1	60	5300	0.59	13.89	23.98	1.87		Pass
11a	6Mbps	1	64	5320	0.59	13.63	23.98	1.87		Pass
HT20	MCS0	1	52	5260	0.60	12.33	23.98	1.87		Pass
HT20	MCS0	1	60	5300	0.60	12.43	23.98	1.87		Pass
HT20	MCS0	1	64	5320	0.60	12.46	23.98	1.87		Pass
HT40	MCS0	1	54	5270	1.17	11.94	23.98	1.87		Pass
HT40	MCS0	1	62	5310	1.17	11.85	23.98	1.87		Pass

TEST RESULTS DATA
Power Spectral Density

Band II										
Mod.	Data Rate	NTX	CH.	Freq. (MHz)	Duty Factor (dB)	Average Power Density (dBm/MHz)	Average PSD Limit (dBm/MHz)	DG (dBi)		Pass/Fail
11a	6Mbps	1	52	5260	0.59	3.11	11.00	1.87		Pass
11a	6Mbps	1	60	5300	0.59	3.32	11.00	1.87		Pass
11a	6Mbps	1	64	5320	0.59	2.72	11.00	1.87		Pass
HT20	MCS0	1	52	5260	0.60	0.60	11.00	1.87		Pass
HT20	MCS0	1	60	5300	0.60	0.43	11.00	1.87		Pass
HT20	MCS0	1	64	5320	0.60	0.65	11.00	1.87		Pass
HT40	MCS0	1	54	5270	1.17	-2.77	11.00	1.87		Pass
HT40	MCS0	1	62	5310	1.17	-3.12	11.00	1.87		Pass

TEST RESULTS DATA
26dB and 99% OBW

Band III										
Mod.	Data Rate	NTX	CH.	Freq. (MHz)	99% Bandwidth (MHz)	26 dB Bandwidth (MHz)	IC 99% Bandwidth Power Limit (dBm)	IC 99% Bandwidth EIRP Limit (dBm)	FCC 26dB Bandwidth Power Limit (dBm)	Note
11a	6Mbps	1	100	5500	18.45	26.15	23.66	29.66	23.98	
11a	6Mbps	1	116	5580	18.3	28.05	23.62	29.62	23.98	
11a	6Mbps	1	140	5700	18.55	27.25	23.68	29.68	23.98	
HT20	MCS0	1	100	5500	19	24.35	23.79	29.79	23.98	
HT20	MCS0	1	116	5580	19	24.65	23.79	29.79	23.98	
HT20	MCS0	1	140	5700	19.05	25.3	23.80	29.80	23.98	
HT40	MCS0	1	102	5510	36.5	45	23.98	30.00	23.98	
HT40	MCS0	1	110	5550	36.6	44.91	23.98	30.00	23.98	
HT40	MCS0	1	134	5670	36.6	45.36	23.98	30.00	23.98	

TEST RESULTS DATA
Average Power Table

FCC Band III										
Mod.	Data Rate	NTX	CH.	Freq. (MHz)	Duty Factor (dB)	Average Conducted Power (dBm)	FCC Conducted Power Limit (dBm)	DG (dBi)		Pass/Fail
11a	6Mbps	1	100	5500	0.59	13.65	23.98	1.88		Pass
11a	6Mbps	1	116	5580	0.59	13.60	23.98	1.88		Pass
11a	6Mbps	1	140	5700	0.59	13.70	23.98	1.88		Pass
HT20	MCS0	1	100	5500	0.60	12.44	23.98	1.88		Pass
HT20	MCS0	1	116	5580	0.60	12.39	23.98	1.88		Pass
HT20	MCS0	1	140	5700	0.60	12.29	23.98	1.88		Pass
HT40	MCS0	1	102	5510	1.17	10.95	23.98	1.88		Pass
HT40	MCS0	1	110	5550	1.17	10.78	23.98	1.88		Pass
HT40	MCS0	1	134	5670	1.17	10.99	23.98	1.88		Pass

TEST RESULTS DATA
Power Spectral Density

Band III										
Mod.	Data Rate	NTX	CH.	Freq. (MHz)	Duty Factor (dB)	Average Power Density (dBm/MHz)	Average PSD Limit (dBm/MHz)	DG (dBi)		Pass/Fail
11a	6Mbps	1	100	5500	0.59	1.43	11.00	1.88		Pass
11a	6Mbps	1	116	5580	0.59	1.74	11.00	1.88		Pass
11a	6Mbps	1	140	5700	0.59	1.50	11.00	1.88		Pass
HT20	MCS0	1	100	5500	0.60	0.63	11.00	1.88		Pass
HT20	MCS0	1	116	5580	0.60	0.06	11.00	1.88		Pass
HT20	MCS0	1	140	5700	0.60	0.17	11.00	1.88		Pass
HT40	MCS0	1	102	5510	1.17	-3.94	11.00	1.88		Pass
HT40	MCS0	1	110	5550	1.17	-3.18	11.00	1.88		Pass
HT40	MCS0	1	134	5670	1.17	-2.80	11.00	1.88		Pass

TEST RESULTS DATA
26dB and 99% OBW

Straddle Channel										
Mod.	Data Rate	NTX	CH.	Freq. (MHz)	99% Bandwidth (MHz)	26 dB Bandwidth (MHz)	IC 99% Bandwidth Power Limit (dBm)	IC 99% Bandwidth EIRP Limit (dBm)	FCC 26dB Bandwidth Power Limit (dBm)	Note
11a	6Mbps	1	144	5720	18.75	29.80	-	-	-	
				NII-2C	14.3	21.1	22.55	28.55	23.98	
				NII-3	4.45	8.7	23.48	29.48	-	
HT20	MCS0	1	144	5720	19.15	24.50	-	-	-	
				NII-2C	14.6	17.25	22.64	28.64	23.37	
				NII-3	4.55	7.25	23.58	29.58	-	
HT40	MCS0	1	142	5710	36.60	45.18	-	-	-	
				NII-2C	33.3	37.41	23.98	30.00	23.98	
				NII-3	3.3	7.77	22.19	28.19	-	

TEST RESULTS DATA
Average Power Table

FCC Straddle Channel										
Mod.	Data Rate	NTX	CH.	Freq. (MHz)	Duty Factor (dB)	Average Conducted Power (dBm)	FCC Conducted Power Limit (dBm)	DG (dBi)		Pass/Fail
11a	6Mbps	1	144	5720	0.59	13.81	-	1.88		Pass
				NII-2C	0.59	12.78	23.98	1.88	Pass	
				NII-3	0.59	7.06	30.00	1.88	Pass	
HT20	MCS0	1	144	5720	0.60	12.46	-	1.88		Pass
				NII-2C	0.60	11.33	23.37	1.88	Pass	
				NII-3	0.60	6.07	30.00	1.88	Pass	
HT40	MCS0	1	142	5710	1.17	10.87	-	1.88		Pass
				NII-2C	1.17	10.54	23.98	1.88	Pass	
				NII-3	1.17	-0.50	30.00	1.88	Pass	

TEST RESULTS DATA
Power Spectral Density

Straddle Channel										
Mod.	Data Rate	NTX	CH.	Freq. (MHz)	Duty Factor (dB)	Average Power Density (dBm/MHz)	Average PSD Limit (dBm/MHz)	DG (dBi)		Pass/Fail
11a	6Mbps	1	144	NII-2C	0.59	2.04	11.00	1.88		Pass
				NII-3	0.59	2.04	30.00	1.88		Pass
HT20	MCS0	1	144	NII-2C	0.60	-0.05	11.00	1.88		Pass
				NII-3	0.60	-0.05	30.00	1.88		Pass
HT40	MCS0	1	142	NII-2C	1.17	-2.74	11.00	1.88		Pass
				NII-3	1.17	-2.74	30.00	1.88		Pass

TEST RESULTS DATA
Frequency Stability

Band I										
Mod.	Data Rate	NTX	CH.	Freq. (MHz)	Center Frequency (MHz)	Frequency Deviation (MHz)	Frequency Stability (ppm)	Temperature (°C)	Voltage (V)	Note
11a	6Mbps	1	36	5180	5180.050	0.050	9.65	20	3.2	
11a	6Mbps	1	36	5180	5180.050	0.050	9.65	20	4.2	
11a	6Mbps	1	36	5180	5180.050	0.050	9.65	20	3.7	
11a	6Mbps	1	36	5180	5180.100	0.100	19.31	-30	3.7	
11a	6Mbps	1	36	5180	5180.100	0.100	19.31	50	3.7	

Band II										
Mod.	Data Rate	NTX	CH.	Freq. (MHz)	Center Frequency (MHz)	Frequency Deviation (MHz)	Frequency Stability (ppm)	Temperature (°C)	Voltage (V)	Note
11a	6Mbps	1	64	5320	5320.100	0.100	18.80	20	3.2	
11a	6Mbps	1	64	5320	5320.100	0.100	18.80	20	4.2	
11a	6Mbps	1	64	5320	5320.100	0.100	18.80	20	3.7	
11a	6Mbps	1	64	5320	5320.100	0.100	18.80	-30	3.7	
11a	6Mbps	1	64	5320	5320.075	0.075	14.10	50	3.7	

Band III										
Mod.	Data Rate	NTX	CH.	Freq. (MHz)	Center Frequency (MHz)	Frequency Deviation (MHz)	Frequency Stability (ppm)	Temperature (°C)	Voltage (V)	Note
11a	6Mbps	1	100	5500	5500.050	0.050	9.09	20	3.2	
11a	6Mbps	1	100	5500	5500.050	0.050	9.09	20	4.2	
11a	6Mbps	1	100	5500	5500.050	0.050	9.09	20	3.7	
11a	6Mbps	1	100	5500	5500.100	0.100	18.18	-30	3.7	
11a	6Mbps	1	100	5500	5500.100	0.100	18.18	50	3.7	



Appendix B. Radiated Spurious Emission

15E Band 1 - 5150~5250MHz

WIFI 802.11a (Band Edge @ 3m)

WIFI	Note	Frequency	Level	Over	Limit	Read	Antenna	Cable	Preamp	Ant	Table	Peak	Pol.	
Ant.				Limit	Line	Level	Factor	Loss	Factor	Pos	Pos	Avg.		
1		(MHz)	(dBμV/m)	(dB)	(dBμV/m)	(dBμV)	(dB/m)	(dB)	(dB)	(cm)	(deg)	(P/A)	(H/V)	
802.11a CH 36 5180MHz		5148.2	59.97	-14.03	74	52.84	31.72	8.95	33.54	131	97	P	H	
		5148.95	50.98	-3.02	54	43.85	31.72	8.95	33.54	131	97	A	H	
	*	5182	103.76	-	-	96.58	31.75	8.97	33.54	131	97	P	H	
	*	5182	97.59	-	-	90.41	31.75	8.97	33.54	131	97	A	H	
													H	
														H
			5146.4	57.97	-16.03	74	50.84	31.72	8.95	33.54	102	92	P	V
			5149.85	48.58	-5.42	54	41.45	31.72	8.95	33.54	102	92	A	V
	*		5179	101.69	-	-	94.51	31.75	8.97	33.54	102	92	P	V
	*		5179	94.39	-	-	87.21	31.75	8.97	33.54	102	92	A	V
														V
														V
802.11a CH 44 5220MHz		5103.65	49.36	-24.64	74	42.29	31.68	8.92	33.53	143	97	P	H	
		5114.3	39.6	-14.4	54	32.52	31.69	8.92	33.53	143	97	A	H	
	*	5223	105.71	-	-	98.5	31.77	8.98	33.54	143	97	P	H	
	*	5223	98.07	-	-	90.86	31.77	8.98	33.54	143	97	A	H	
			5448.23	47.14	-26.86	74	39.51	31.96	9.22	33.55	143	97	P	H
			5416.88	39.08	-14.92	54	31.53	31.93	9.17	33.55	143	97	A	H
			5017.7	48.44	-25.56	74	41.5	31.61	8.86	33.53	100	102	P	V
			5084.15	39.64	-14.36	54	32.58	31.67	8.92	33.53	100	102	A	V
	*		5218	102.56	-	-	95.35	31.77	8.98	33.54	100	102	P	V
	*		5218	95.34	-	-	88.13	31.77	8.98	33.54	100	102	A	V
			5353.3	48.36	-25.64	74	40.94	31.88	9.08	33.54	100	102	P	V
			5457.69	38.95	-15.05	54	31.32	31.96	9.22	33.55	100	102	A	V



802.11a CH 48 5240MHz		5108.75	49.74	-24.26	74	42.66	31.69	8.92	33.53	154	66	P	H
		5039.9	39.67	-14.33	54	32.7	31.64	8.86	33.53	154	66	A	H
	*	5238	106.04	-	-	98.81	31.79	8.98	33.54	154	66	P	H
	*	5238	98.78	-	-	91.55	31.79	8.98	33.54	154	66	A	H
		5427.55	47.83	-26.17	74	40.28	31.93	9.17	33.55	154	66	P	H
		5434.92	39.28	-14.72	54	31.71	31.95	9.17	33.55	154	66	A	H
		5001.2	49.12	-24.88	74	42.22	31.6	8.83	33.53	100	103	P	V
		5038.4	39.5	-14.5	54	32.53	31.64	8.86	33.53	100	103	A	V
	*	5238	101.36	-	-	94.13	31.79	8.98	33.54	100	103	P	V
	*	5238	94.9	-	-	87.67	31.79	8.98	33.54	100	103	A	V
		5427.55	47.86	-26.14	74	40.31	31.93	9.17	33.55	100	103	P	V
		5428.65	39.02	-14.98	54	31.45	31.95	9.17	33.55	100	103	A	V
Remark	1. No other spurious found. 2. All results are PASS against Peak and Average limit line.												



15E band 1 5150~5250MHz
WIFI 802.11a (Harmonic @ 3m)

WIFI	Note	Frequency	Level	Over	Limit	Read	Antenna	Cable	Preamp	Ant	Table	Peak	Pol.
Ant.				Limit	Line	Level	Factor	Loss	Factor	Pos	Pos	Avg.	
1		(MHz)	(dBμV/m)	(dB)	(dBμV/m)	(dBμV)	(dB/m)	(dB)	(dB)	(cm)	(deg)	(P/A)	(H/V)
802.11a CH 36 5180MHz		10360	42.79	-31.21	74	23.9	39.94	13.09	34.14	100	0	P	H
		15540	47.05	-26.95	74	27.95	38.33	16.55	35.78	100	0	P	H
													H
													H
		10360	42.29	-31.71	74	23.4	39.94	13.09	34.14	100	0	P	V
		15540	46.26	-27.74	74	27.16	38.33	16.55	35.78	100	0	P	V
													V
													V
802.11a CH 44 5220MHz		10440	42.18	-31.82	74	23.19	40.02	13.11	34.14	100	0	P	H
		15660	45.65	-28.35	74	26.8	38.09	16.56	35.8	100	0	P	H
													H
													H
		10440	42.56	-31.44	74	23.57	40.02	13.11	34.14	100	0	P	V
		15660	46.46	-27.54	74	27.61	38.09	16.56	35.8	100	0	P	V
													V
													V
802.11a CH 48 5240MHz		10480	42.73	-31.27	74	23.68	40.08	13.11	34.14	100	0	P	H
		15720	45.43	-28.57	74	26.71	37.95	16.57	35.8	100	0	P	H
													H
													H
		10480	41.75	-32.25	74	22.7	40.08	13.11	34.14	100	0	P	V
		15720	46.58	-27.42	74	27.86	37.95	16.57	35.8	100	0	P	V
													V
													V
Remark	1. No other spurious found. 2. All results are PASS against Peak and Average limit line.												



15E band 1 5150~5250MHz
WIFI 802.11n HT20(Band Edge @ 3m)

WIFI	Note	Frequency	Level	Over	Limit	Read	Antenna	Cable	Preamp	Ant	Table	Peak	Pol.	
Ant.				Limit	Line	Level	Factor	Loss	Factor	Pos	Pos	Avg.		
1		(MHz)	(dBμV/m)	(dB)	(dBμV/m)	(dBμV)	(dB/m)	(dB)	(dB)	(cm)	(deg)	(P/A)	(H/V)	
802.11n HT20 CH 36 5180MHz		5149.55	58.41	-15.59	74	51.28	31.72	8.95	33.54	137	93	P	H	
		5149.7	48.78	-5.22	54	41.65	31.72	8.95	33.54	137	93	A	H	
	*	5182	104.07	-	-	96.89	31.75	8.97	33.54	137	93	P	H	
	*	5182	96.89	-	-	89.71	31.75	8.97	33.54	137	93	A	H	
													H	
														H
			5141.75	57.29	-16.71	74	50.16	31.72	8.95	33.54	100	91	P	V
			5148.8	45.03	-8.97	54	37.9	31.72	8.95	33.54	100	91	A	V
		*	5182	101.3	-	-	94.12	31.75	8.97	33.54	100	91	P	V
		*	5182	93.89	-	-	86.71	31.75	8.97	33.54	100	91	A	V
														V
														V
802.11n HT20 CH 44 5220MHz		5011.4	49.43	-24.57	74	42.49	31.61	8.86	33.53	144	92	P	H	
		5123	39.8	-14.2	54	32.68	31.71	8.95	33.54	144	92	A	H	
		* 5222	104.62	-	-	97.41	31.77	8.98	33.54	144	92	P	H	
		* 5222	98.3	-	-	91.09	31.77	8.98	33.54	144	92	A	H	
			5457.8	48.93	-25.07	74	41.3	31.96	9.22	33.55	144	92	P	H
			5411.38	39.55	-14.45	54	32.01	31.92	9.17	33.55	144	92	A	H
			5069.45	48.68	-25.32	74	41.67	31.65	8.89	33.53	108	104	P	V
			5121.95	39.65	-14.35	54	32.55	31.69	8.95	33.54	108	104	A	V
		*	5222	100.32	-	-	93.11	31.77	8.98	33.54	108	104	P	V
		*	5222	93.91	-	-	86.7	31.77	8.98	33.54	108	104	A	V
			5423.81	48.55	-25.45	74	41	31.93	9.17	33.55	108	104	P	V
			5420.4	39.31	-14.69	54	31.76	31.93	9.17	33.55	108	104	A	V



802.11n HT20 CH 48 5240MHz		5082.65	48.75	-25.25	74	41.69	31.67	8.92	33.53	136	93	P	H
		5107.1	39.53	-14.47	54	32.45	31.69	8.92	33.53	136	93	A	H
	*	5240	104.35	-	-	97.12	31.79	8.98	33.54	136	93	P	H
	*	5240	96.44	-	-	89.21	31.79	8.98	33.54	136	93	A	H
		5444.38	47.36	-26.64	74	39.74	31.95	9.22	33.55	136	93	P	H
		5426.45	39.05	-14.95	54	31.5	31.93	9.17	33.55	136	93	A	H
		5048.6	49.13	-24.87	74	42.13	31.64	8.89	33.53	162	319	P	V
		5074.7	39.5	-14.5	54	32.47	31.67	8.89	33.53	162	319	A	V
	*	5240	98.43	-	-	91.2	31.79	8.98	33.54	162	319	P	V
	*	5240	90.69	-	-	83.46	31.79	8.98	33.54	162	319	A	V
		5443.94	48.17	-25.83	74	40.55	31.95	9.22	33.55	162	319	P	V
		5454.5	39.03	-14.97	54	31.4	31.96	9.22	33.55	162	319	A	V
Remark	1. No other spurious found. 2. All results are PASS against Peak and Average limit line.												



15E band 1 5150~5250MHz

WIFI 802.11n HT20 (Harmonic @ 3m)

WIFI	Note	Frequency	Level	Over	Limit	Read	Antenna	Cable	Preamp	Ant	Table	Peak	Pol.
Ant.				Limit	Line	Level	Factor	Loss	Factor	Pos	Pos	Avg.	
1		(MHz)	(dBμV/m)	(dB)	(dBμV/m)	(dBμV)	(dB/m)	(dB)	(dB)	(cm)	(deg)	(P/A)	(H/V)
802.11n HT20 CH 36 5180MHz		10360	41.94	-32.06	74	23.05	39.94	13.09	34.14	100	0	P	H
		15540	46.73	-27.27	74	27.63	38.33	16.55	35.78	100	0	P	H
													H
													H
		10360	41.68	-32.32	74	22.79	39.94	13.09	34.14	100	0	P	V
		15540	46.47	-27.53	74	27.37	38.33	16.55	35.78	100	0	P	V
													V
802.11n HT20 CH 44 5220MHz		10440	41.82	-32.18	74	22.83	40.02	13.11	34.14	100	0	P	H
		15660	46.99	-27.01	74	28.14	38.09	16.56	35.8	100	0	P	H
													H
													H
		10440	41.94	-32.06	74	22.95	40.02	13.11	34.14	100	0	P	V
		15660	46.53	-27.47	74	27.68	38.09	16.56	35.8	100	0	P	V
													V
802.11n HT20 CH 48 5240MHz		10480	41.29	-32.71	74	22.24	40.08	13.11	34.14	100	0	P	H
		15720	46.11	-27.89	74	27.39	37.95	16.57	35.8	100	0	P	H
													H
													H
		10480	41.82	-32.18	74	22.77	40.08	13.11	34.14	100	0	P	V
		15720	45.66	-28.34	74	26.94	37.95	16.57	35.8	100	0	P	V
													V
Remark	1. No other spurious found. 2. All results are PASS against Peak and Average limit line.												



15E band 1 5150~5250MHz
WIFI 802.11n HT40 (Band Edge @ 3m)

WIFI	Note	Frequency	Level	Over	Limit	Read	Antenna	Cable	Preamp	Ant	Table	Peak	Pol.
Ant.				Limit	Line	Level	Factor	Loss	Factor	Pos	Pos	Avg.	
1		(MHz)	(dBμV/m)	(dB)	(dBμV/m)	(dBμV)	(dB/m)	(dB)	(dB)	(cm)	(deg)	(P/A)	(H/V)
802.11n HT40 CH 38 5190MHz		5148.35	61.06	-12.94	74	53.93	31.72	8.95	33.54	133	92	P	H
		5149.4	50.07	-3.93	54	42.94	31.72	8.95	33.54	133	92	A	H
	*	5188	98.51	-	-	91.33	31.75	8.97	33.54	133	92	P	H
	*	5188	92.29	-	-	85.11	31.75	8.97	33.54	133	92	A	H
		5380.14	47.43	-26.57	74	39.94	31.91	9.13	33.55	133	92	P	H
		5453.95	39.34	-14.66	54	31.71	31.96	9.22	33.55	133	92	A	H
		5149.25	55.56	-18.44	74	48.43	31.72	8.95	33.54	100	105	P	V
		5150	48.41	-5.59	54	41.28	31.72	8.95	33.54	100	105	A	V
	*	5192	95.71	-	-	88.52	31.76	8.97	33.54	100	105	P	V
	*	5192	88.58	-	-	81.39	31.76	8.97	33.54	100	105	A	V
		5354.18	48.03	-25.97	74	40.61	31.88	9.08	33.54	100	105	P	V
		5451.31	39.22	-14.78	54	31.59	31.96	9.22	33.55	100	105	A	V
802.11n HT40 CH 46 5230MHz		5149.7	48.82	-25.18	74	41.69	31.72	8.95	33.54	142	89	P	H
		5127.2	40.66	-13.34	54	33.54	31.71	8.95	33.54	142	89	A	H
	*	5228	101.06	-	-	93.83	31.79	8.98	33.54	142	89	P	H
	*	5228	93.73	-	-	86.5	31.79	8.98	33.54	142	89	A	H
		5436.02	47.33	-26.67	74	39.76	31.95	9.17	33.55	142	89	P	H
		5444.05	39.5	-14.5	54	31.88	31.95	9.22	33.55	142	89	A	H
		5000.15	48.76	-25.24	74	41.86	31.6	8.83	33.53	100	99	P	V
		5113.1	40.02	-13.98	54	32.94	31.69	8.92	33.53	100	99	A	V
	*	5232	96.31	-	-	89.08	31.79	8.98	33.54	100	99	P	V
	*	5232	90.56	-	-	83.33	31.79	8.98	33.54	100	99	A	V
		5451.97	47.44	-26.56	74	39.81	31.96	9.22	33.55	100	99	P	V
		5408.85	39.56	-14.44	54	32.02	31.92	9.17	33.55	100	99	A	V
Remark	1. No other spurious found. 2. All results are PASS against Peak and Average limit line.												



15E band 1 5150~5250MHz

WIFI 802.11n HT40 (Harmonic @ 3m)

WIFI	Note	Frequency	Level	Over	Limit	Read	Antenna	Cable	Preamp	Ant	Table	Peak	Pol.
Ant.				Limit	Line	Level	Factor	Loss	Factor	Pos	Pos	Avg.	
1		(MHz)	(dBμV/m)	(dB)	(dBμV/m)	(dBμV)	(dB/m)	(dB)	(dB)	(cm)	(deg)	(P/A)	(H/V)
802.11n HT40 CH 38 5190MHz		10380	41.74	-32.26	74	22.83	39.96	13.09	34.14	100	0	P	H
		15570	46.93	-27.07	74	27.91	38.26	16.55	35.79	100	0	P	H
													H
													H
		10380	41.45	-32.55	74	22.54	39.96	13.09	34.14	100	0	P	V
		15570	46.04	-27.96	74	27.02	38.26	16.55	35.79	100	0	P	V
													V
802.11n HT40 CH 46 5230MHz		10460	42.35	-31.65	74	23.34	40.04	13.11	34.14	100	0	P	H
		15690	46.22	-27.78	74	27.44	38.02	16.56	35.8	100	0	P	H
													H
													H
		10460	42.47	-31.53	74	23.46	40.04	13.11	34.14	100	0	P	V
		15690	45.52	-28.48	74	26.74	38.02	16.56	35.8	100	0	P	V
													V
Remark	1. No other spurious found. 2. All results are PASS against Peak and Average limit line.												



15E Band 2 - 5250~5350MHz

WIFI 802.11a (Band Edge @ 3m)

WIFI	Note	Frequency	Level	Over	Limit	Read	Antenna	Cable	Preamp	Ant	Table	Peak	Pol.
Ant.				Limit	Line	Level	Factor	Loss	Factor	Pos	Pos	Avg.	
1		(MHz)	(dBμV/m)	(dB)	(dBμV/m)	(dBμV)	(dB/m)	(dB)	(dB)	(cm)	(deg)	(P/A)	(H/V)
802.11a CH 52 5260MHz		5121.35	48.66	-25.34	74	41.59	31.69	8.92	33.54	140	90	P	H
		5030.3	39.6	-14.4	54	32.64	31.63	8.86	33.53	140	90	A	H
	*	5262	104.05	-	-	96.79	31.81	8.99	33.54	140	90	P	H
	*	5262	97.79	-	-	90.53	31.81	8.99	33.54	140	90	A	H
		5420.29	47.62	-26.38	74	40.07	31.93	9.17	33.55	140	90	P	H
		5452.96	39.21	-14.79	54	31.58	31.96	9.22	33.55	140	90	A	H
		5096.15	49.12	-24.88	74	42.05	31.68	8.92	33.53	100	100	P	V
		5082.65	39.47	-14.53	54	32.41	31.67	8.92	33.53	100	100	A	V
	*	5262	102.48	-	-	95.22	31.81	8.99	33.54	100	100	P	V
	*	5262	95.16	-	-	87.9	31.81	8.99	33.54	100	100	A	V
		5443.72	47.67	-26.33	74	40.05	31.95	9.22	33.55	100	100	P	V
		5459.01	39.04	-14.96	54	31.41	31.96	9.22	33.55	100	100	A	V
802.11a CH 60 5300MHz		5064.65	48.44	-25.56	74	41.43	31.65	8.89	33.53	140	93	P	H
		5117.9	39.53	-14.47	54	32.45	31.69	8.92	33.53	140	93	A	H
	*	5299	105.61	-	-	98.27	31.84	9.04	33.54	140	93	P	H
	*	5299	98.74	-	-	91.4	31.84	9.04	33.54	140	93	A	H
		5352.64	53.04	-20.96	74	45.62	31.88	9.08	33.54	140	93	P	H
		5352.09	46.02	-7.98	54	38.6	31.88	9.08	33.54	140	93	A	H
		5105.15	49.3	-24.7	74	42.23	31.68	8.92	33.53	105	105	P	V
		5111.9	39.52	-14.48	54	32.44	31.69	8.92	33.53	105	105	A	V
	*	5302	101.12	-	-	93.78	31.84	9.04	33.54	105	105	P	V
	*	5302	94.31	-	-	86.97	31.84	9.04	33.54	105	105	A	V
		5354.84	52.88	-21.12	74	45.46	31.88	9.08	33.54	105	105	P	V
		5352.53	43.25	-10.75	54	35.83	31.88	9.08	33.54	105	105	A	V



802.11a CH 64 5320MHz	*	5318	104.89	-	-	97.54	31.85	9.04	33.54	148	69	P	H
	*	5318	98.1	-	-	90.75	31.85	9.04	33.54	148	69	A	H
		5354.07	61.7	-12.3	74	54.28	31.88	9.08	33.54	148	69	P	H
		5350.88	50.8	-3.2	54	43.38	31.88	9.08	33.54	148	69	A	H
													H
													H
	*	5318	100.6	-	-	93.25	31.85	9.04	33.54	100	99	P	V
	*	5318	93.14	-	-	85.79	31.85	9.04	33.54	100	99	A	V
		5350.66	56.62	-17.38	74	49.2	31.88	9.08	33.54	100	99	P	V
		5350.55	45.22	-8.78	54	37.8	31.88	9.08	33.54	100	99	A	V
													V
													V
Remark	1. No other spurious found. 2. All results are PASS against Peak and Average limit line.												



15E band 2 5250~5350MHz
WIFI 802.11a (Harmonic @ 3m)

WIFI	Note	Frequency	Level	Over	Limit	Read	Antenna	Cable	Preamp	Ant	Table	Peak	Pol.
Ant.				Limit	Line	Level	Factor	Loss	Factor	Pos	Pos	Avg.	
1		(MHz)	(dBµV/m)	(dB)	(dBµV/m)	(dBµV)	(dB/m)	(dB)	(dB)	(cm)	(deg)	(P/A)	(H/V)
802.11a CH 52 5260MHz		10520	41.87	-32.13	74	22.76	40.11	13.14	34.14	100	0	P	H
		15780	45.96	-28.04	74	27.35	37.85	16.57	35.81	100	0	P	H
													H
													H
		10520	42.5	-31.5	74	23.39	40.11	13.14	34.14	100	0	P	V
		15780	45.13	-28.87	74	26.52	37.85	16.57	35.81	100	0	P	V
													V
													V
802.11a CH 60 5300MHz		10600	42.02	-31.98	74	22.84	40.16	13.2	34.18	100	0	P	H
		15900	45.18	-28.82	74	26.81	37.61	16.58	35.82	100	0	P	H
													H
													H
		10600	41.77	-32.23	74	22.59	40.16	13.2	34.18	100	0	P	V
		15900	46.64	-27.36	74	28.27	37.61	16.58	35.82	100	0	P	V
													V
													V
802.11a CH 64 5320MHz		10640	41.4	-32.6	74	22.2	40.18	13.23	34.21	100	0	P	H
		15960	45.76	-28.24	74	27.53	37.47	16.59	35.83	100	0	P	H
													H
													H
		10640	41.71	-32.29	74	22.51	40.18	13.23	34.21	100	0	P	V
		15960	45.1	-28.9	74	26.87	37.47	16.59	35.83	100	0	P	V
													V
													V
Remark	1. No other spurious found. 2. All results are PASS against Peak and Average limit line.												



15E band 2 5250~5350MHz
WIFI 802.11n HT20 (Band Edge @ 3m)

WIFI	Note	Frequency	Level	Over	Limit	Read	Antenna	Cable	Preamp	Ant	Table	Peak	Pol.
Ant.				Limit	Line	Level	Factor	Loss	Factor	Pos	Pos	Avg.	
1		(MHz)	(dBμV/m)	(dB)	(dBμV/m)	(dBμV)	(dB/m)	(dB)	(dB)	(cm)	(deg)	(P/A)	(H/V)
802.11n HT20 CH 52 5260MHz		5129.45	48.63	-25.37	74	41.51	31.71	8.95	33.54	140	93	P	H
		5064.95	39.51	-14.49	54	32.5	31.65	8.89	33.53	140	93	A	H
	*	5260	103.22	-	-	95.96	31.81	8.99	33.54	140	93	P	H
	*	5260	96.38	-	-	89.12	31.81	8.99	33.54	140	93	A	H
		5441.08	48.06	-25.94	74	40.49	31.95	9.17	33.55	140	93	P	H
		5459.12	39.06	-14.94	54	31.43	31.96	9.22	33.55	140	93	A	H
		5141.45	48.72	-25.28	74	41.59	31.72	8.95	33.54	161	269	P	V
		5074.1	39.47	-14.53	54	32.44	31.67	8.89	33.53	161	269	A	V
	*	5260	98.32	-	-	91.06	31.81	8.99	33.54	161	269	P	V
	*	5260	91.66	-	-	84.4	31.81	8.99	33.54	161	269	A	V
		5439.32	47.36	-26.64	74	39.79	31.95	9.17	33.55	161	269	P	V
		5448.23	39.04	-14.96	54	31.41	31.96	9.22	33.55	161	269	A	V
802.11n HT20 CH 60 5300MHz		5064.5	49.31	-24.69	74	42.3	31.65	8.89	33.53	152	98	P	H
		5065.25	40.63	-13.37	54	33.62	31.65	8.89	33.53	152	98	A	H
	*	5300	105.46	-	-	98.12	31.84	9.04	33.54	152	98	P	H
	*	5300	98.58	-	-	91.24	31.84	9.04	33.54	152	98	A	H
		5353.63	53.57	-20.43	74	46.15	31.88	9.08	33.54	152	98	P	H
		5351.76	46.67	-7.33	54	39.25	31.88	9.08	33.54	152	98	A	H
		5106.65	49.91	-24.09	74	42.83	31.69	8.92	33.53	159	268	P	V
		5104.85	40.52	-13.48	54	33.45	31.68	8.92	33.53	159	268	A	V
	*	5300	99.92	-	-	92.58	31.84	9.04	33.54	159	268	P	V
	*	5300	94.45	-	-	87.11	31.84	9.04	33.54	159	268	A	V
		5350.99	51.47	-22.53	74	44.05	31.88	9.08	33.54	159	268	P	V
		5351.87	43.73	-10.27	54	36.31	31.88	9.08	33.54	159	268	A	V



802.11n HT20 CH 64 5320MHz	*	5320	103.08	-	-	95.73	31.85	9.04	33.54	133	91	P	H
	*	5320	100.95	-	-	93.6	31.85	9.04	33.54	133	91	A	H
		5353.63	57.77	-16.23	74	50.35	31.88	9.08	33.54	133	91	P	H
		5350	48.17	-5.83	54	40.75	31.88	9.08	33.54	133	91	A	H
													H
													H
	*	5320	97.27	-	-	89.92	31.85	9.04	33.54	152	276	P	V
	*	5320	90.29	-	-	82.94	31.85	9.04	33.54	152	276	A	V
		5357.48	55.27	-18.73	74	47.85	31.88	9.08	33.54	152	276	P	V
		5350	43.12	-10.88	54	35.7	31.88	9.08	33.54	152	276	A	V
													V
													V
Remark	1. No other spurious found. 2. All results are PASS against Peak and Average limit line.												



15E band 2 5250~5350MHz

WIFI 802.11n HT20 (Harmonic @ 3m)

WIFI	Note	Frequency	Level	Over	Limit	Read	Antenna	Cable	Preamp	Ant	Table	Peak	Pol.
Ant.				Limit	Line	Level	Factor	Loss	Factor	Pos	Pos	Avg.	
1		(MHz)	(dBμV/m)	(dB)	(dBμV/m)	(dBμV)	(dB/m)	(dB)	(dB)	(cm)	(deg)	(P/A)	(H/V)
802.11n HT20 CH 52 5260MHz		10520	41.46	-32.54	74	22.35	40.11	13.14	34.14	100	0	P	H
		15780	46.86	-27.14	74	28.25	37.85	16.57	35.81	100	0	P	H
													H
													H
		10520	41.93	-32.07	74	22.82	40.11	13.14	34.14	100	0	P	V
		15780	45.98	-28.02	74	27.37	37.85	16.57	35.81	100	0	P	V
													V
802.11n HT20 CH 60 5300MHz		10600	41.94	-32.06	74	22.76	40.16	13.2	34.18	100	0	P	H
		15900	45.29	-28.71	74	26.92	37.61	16.58	35.82	100	0	P	H
													H
													H
		10600	40.98	-33.02	74	21.8	40.16	13.2	34.18	100	0	P	V
		15900	45.28	-28.72	74	26.91	37.61	16.58	35.82	100	0	P	V
													V
802.11n HT20 CH 64 5320MHz		10640	42.77	-31.23	74	23.57	40.18	13.23	34.21	100	0	P	H
		15960	46.04	-27.96	74	27.81	37.47	16.59	35.83	100	0	P	H
													H
													H
		10640	41.28	-32.72	74	22.08	40.18	13.23	34.21	100	0	P	V
		15960	45.17	-28.83	74	26.94	37.47	16.59	35.83	100	0	P	V
													V
Remark	1. No other spurious found. 2. All results are PASS against Peak and Average limit line.												



15E band 2 5250~5350MHz
WIFI 802.11n HT40 (Band Edge @ 3m)

WIFI	Note	Frequency	Level	Over	Limit	Read	Antenna	Cable	Preamp	Ant	Table	Peak	Pol.
Ant.				Limit	Line	Level	Factor	Loss	Factor	Pos	Pos	Avg.	
1		(MHz)	(dBμV/m)	(dB)	(dBμV/m)	(dBμV)	(dB/m)	(dB)	(dB)	(cm)	(deg)	(P/A)	(H/V)
802.11n HT40 CH 54 5270MHz		5062.4	49.13	-24.87	74	42.12	31.65	8.89	33.53	133	91	P	H
		5122.4	40.02	-13.98	54	32.92	31.69	8.95	33.54	133	91	A	H
	*	5272	101.23	-	-	93.97	31.81	8.99	33.54	133	91	P	H
	*	5272	93.91	-	-	86.65	31.81	8.99	33.54	133	91	A	H
		5352.09	50.24	-23.76	74	42.82	31.88	9.08	33.54	133	91	P	H
		5350.11	40.91	-13.09	54	33.49	31.88	9.08	33.54	133	91	A	H
		5123.3	48.99	-25.01	74	41.87	31.71	8.95	33.54	100	100	P	V
		5036.6	39.96	-14.04	54	33	31.63	8.86	33.53	100	100	A	V
	*	5272	96.7	-	-	89.44	31.81	8.99	33.54	100	100	P	V
	*	5272	89.71	-	-	82.45	31.81	8.99	33.54	100	100	A	V
		5457.25	48.03	-25.97	74	40.4	31.96	9.22	33.55	100	100	P	V
		5372.99	39.88	-14.12	54	32.4	31.89	9.13	33.54	100	100	A	V
802.11n HT40 CH 62 5310MHz		5007.8	49.29	-24.71	74	42.35	31.61	8.86	33.53	141	90	P	H
		5145.35	40.7	-13.3	54	33.57	31.72	8.95	33.54	141	90	A	H
	*	5308	98.31	-	-	90.97	31.84	9.04	33.54	141	90	P	H
	*	5308	92.06	-	-	84.72	31.84	9.04	33.54	141	90	A	H
		5352.97	59.81	-14.19	74	52.39	31.88	9.08	33.54	141	90	P	H
		5350.33	49.66	-4.34	54	42.24	31.88	9.08	33.54	141	90	A	H
		5073.2	49.59	-24.41	74	42.56	31.67	8.89	33.53	160	269	P	V
		5044.1	40.32	-13.68	54	33.32	31.64	8.89	33.53	160	269	A	V
	*	5310	96.26	-	-	88.91	31.85	9.04	33.54	160	269	P	V
	*	5310	89.84	-	-	82.49	31.85	9.04	33.54	160	269	A	V
		5353.19	58.74	-15.26	74	51.32	31.88	9.08	33.54	160	269	P	V
		5350.11	49.58	-4.42	54	42.16	31.88	9.08	33.54	160	269	A	V
Remark	1. No other spurious found. 2. All results are PASS against Peak and Average limit line.												



15E band 2 5250~5350MHz

WIFI 802.11n HT40 (Harmonic @ 3m)

WIFI	Note	Frequency	Level	Over	Limit	Read	Antenna	Cable	Preamp	Ant	Table	Peak	Pol.
Ant.				Limit	Line	Level	Factor	Loss	Factor	Pos	Pos	Avg.	
1		(MHz)	(dBμV/m)	(dB)	(dBμV/m)	(dBμV)	(dB/m)	(dB)	(dB)	(cm)	(deg)	(P/A)	(H/V)
802.11n HT40 CH 54 5270MHz		10540	41.72	-32.28	74	22.61	40.12	13.14	34.15	100	0	P	H
		15810	46.09	-27.91	74	27.55	37.78	15.57	35.81	100	0	P	H
													H
													H
		10540	42.4	-31.6	74	23.29	40.12	13.14	34.15	100	0	P	V
		15810	45.79	-28.21	74	27.25	37.78	15.57	35.81	100	0	P	V
													V
802.11n HT40 CH 62 5310MHz		10620	41.85	-32.15	74	22.67	40.17	13.2	34.19	100	0	P	H
		15930	46.28	-27.72	74	27.98	37.54	16.58	35.82	100	0	P	H
													H
													H
		10620	41.28	-32.72	74	22.1	40.17	13.2	34.19	100	0	P	V
		15930	45.36	-28.64	74	27.06	37.54	16.58	35.82	100	0	P	V
													V
Remark	1. No other spurious found. 2. All results are PASS against Peak and Average limit line.												



15E Band 3 - 5470~5725MHz

WIFI 802.11a (Band Edge @ 3m)

WIFI	Note	Frequency	Level	Over	Limit	Read	Antenna	Cable	Preamp	Ant	Table	Peak	Pol.	
Ant.				Limit	Line	Level	Factor	Loss	Factor	Pos	Pos	Avg.		
1		(MHz)	(dBμV/m)	(dB)	(dBμV/m)	(dBμV)	(dB/m)	(dB)	(dB)	(cm)	(deg)	(P/A)	(H/V)	
802.11a CH 100 5500MHz		5469.52	57.94	-16.06	74	50.3	31.97	9.22	33.55	155	70	P	H	
		5469.68	46.16	-7.84	54	38.52	31.97	9.22	33.55	155	70	A	H	
	*	5498	101.33	-	-	93.62	32	9.26	33.55	155	70	P	H	
	*	5498	94.4	-	-	86.69	32	9.26	33.55	155	70	A	H	
													H	
													H	
			5467.92	57.01	-16.99	74	49.37	31.97	9.22	33.55	103	88	P	V
			5469.84	45.21	-8.79	54	37.57	31.97	9.22	33.55	103	88	A	V
	*		5498	98.2	-	-	90.49	32	9.26	33.55	103	88	P	V
	*		5498	91.43	-	-	83.72	32	9.26	33.55	103	88	A	V
													V	
													V	
802.11a CH 116 5580MHz		5424.4	47.14	-26.86	74	39.59	31.93	9.17	33.55	140	63	P	H	
		5458.64	39.28	-14.72	54	31.65	31.96	9.22	33.55	140	63	A	H	
	*	5582	100.68	-	-	92.83	32.12	9.32	33.59	140	63	P	H	
	*	5582	94.11	-	-	86.26	32.12	9.32	33.59	140	63	A	H	
			5732.12	48.48	-25.52	74	40.38	32.31	9.44	33.65	140	63	P	H
			5750.52	39.68	-14.32	54	31.55	32.34	9.44	33.65	140	63	A	H
			5412.24	47.4	-26.6	74	39.85	31.93	9.17	33.55	100	88	P	V
			5468.88	39.12	-14.88	54	31.48	31.97	9.22	33.55	100	88	A	V
	*		5578	96.68	-	-	88.85	32.1	9.32	33.59	100	88	P	V
	*		5578	89.58	-	-	81.75	32.1	9.32	33.59	100	88	A	V
			5760.52	48.39	-25.61	74	40.24	32.36	9.44	33.65	100	88	P	V
			5758.68	39.71	-14.29	54	31.56	32.36	9.44	33.65	100	88	A	V



802.11a CH 140 5700MHz	*	5698	100.87	-	-	92.84	32.27	9.39	33.63	162	65	P	H
	*	5698	92.97	-	-	84.94	32.27	9.39	33.63	162	65	A	H
		5726.12	58.91	-15.09	74	50.8	32.31	9.44	33.64	162	65	P	H
		5725.24	46.67	-7.33	54	38.56	32.31	9.44	33.64	162	65	A	H
													H
													H
	*	5698	93.56	-	-	85.53	32.27	9.39	33.63	110	103	P	V
	*	5698	87.33	-	-	79.3	32.27	9.39	33.63	110	103	A	V
		5725	52.08	-21.92	74	43.97	32.31	9.44	33.64	110	103	P	V
		5725.08	42.56	-11.44	54	34.45	32.31	9.44	33.64	110	103	A	V
													V
													V
Remark	1. No other spurious found. 2. All results are PASS against Peak and Average limit line.												



15E band 3 - 5470~5725MHz

WIFI 802.11a (Harmonic @ 3m)

WIFI	Note	Frequency	Level	Over	Limit	Read	Antenna	Cable	Preamp	Ant	Table	Peak	Pol.
Ant.				Limit	Line	Level	Factor	Loss	Factor	Pos	Pos	Avg.	
1		(MHz)	(dBµV/m)	(dB)	(dBµV/m)	(dBµV)	(dB/m)	(dB)	(dB)	(cm)	(deg)	(P/A)	(H/V)
802.11a CH 100 5500MHz		11000	39.85	-34.15	74	20.36	40.4	13.48	34.39	100	0	P	H
		16500	46.5	-27.5	74	26.6	39	16.81	35.91	100	0	P	H
													H
													H
		11000	39.93	-34.07	74	20.44	40.4	13.48	34.39	100	0	P	V
		16500	47.27	-26.73	74	27.37	39	16.81	35.91	100	0	P	V
													V
													V
802.11a CH 116 5580MHz		11160	35.89	-38.11	74	16.47	40.27	13.64	34.49	100	0	P	H
		16740	47.84	-26.16	74	27.06	39.92	16.8	35.94	100	0	P	H
													H
													H
		11160	37.14	-36.86	74	17.72	40.27	13.64	34.49	100	0	P	V
		16740	48.06	-25.94	74	27.28	39.92	16.8	35.94	100	0	P	V
													V
													V
802.11a CH 140 5700MHz		11400	36.11	-37.89	74	16.82	40.08	13.87	34.66	100	0	P	H
		17100	49.72	-24.28	74	27.72	41.12	16.85	35.97	100	0	P	H
													H
													H
		11400	37.25	-36.75	74	17.96	40.08	13.87	34.66	100	0	P	V
		17100	48.9	-25.1	74	26.9	41.12	16.85	35.97	100	0	P	V
													V
													V
Remark	1. No other spurious found. 2. All results are PASS against Peak and Average limit line.												



15E band 3 - 5470~5725MHz

WIFI 802.11n HT20 (Band Edge @ 3m)

WIFI	Note	Frequency	Level	Over	Limit	Read	Antenna	Cable	Preamp	Ant	Table	Peak	Pol.	
Ant.				Limit	Line	Level	Factor	Loss	Factor	Pos	Pos	Avg.		
1		(MHz)	(dBμV/m)	(dB)	(dBμV/m)	(dBμV)	(dB/m)	(dB)	(dB)	(cm)	(deg)	(P/A)	(H/V)	
802.11n HT20 CH 100 5500MHz		5448.24	50.21	-23.79	74	42.58	31.96	9.22	33.55	150	68	P	H	
		5448.24	42.32	-11.68	54	34.69	31.96	9.22	33.55	150	68	A	H	
	*	5500	98.5	-	-	90.79	32	9.26	33.55	150	68	P	H	
	*	5500	92.24	-	-	84.53	32	9.26	33.55	150	68	A	H	
													H	
													H	
			5448.08	48.43	-25.57	74	40.8	31.96	9.22	33.55	170	279	P	V
			5448.24	40.25	-13.75	54	32.62	31.96	9.22	33.55	170	279	A	V
		*	5500	94.96	-	-	87.25	32	9.26	33.55	170	279	P	V
		*	5500	87.67	-	-	79.96	32	9.26	33.55	170	279	A	V
													V	
													V	
802.11n HT20 CH 116 5580MHz		5465.04	48.82	-25.18	74	41.18	31.97	9.22	33.55	155	68	P	H	
		5466.32	39.19	-14.81	54	31.55	31.97	9.22	33.55	155	68	A	H	
	*	5580	99.37	-	-	91.54	32.1	9.32	33.59	155	68	P	H	
	*	5580	92.31	-	-	84.48	32.1	9.32	33.59	155	68	A	H	
			5732.92	48.72	-25.28	74	40.62	32.31	9.44	33.65	155	68	P	H
			5756.12	39.73	-14.27	54	31.58	32.36	9.44	33.65	155	68	A	H
			5394.8	47.32	-26.68	74	39.82	31.92	9.13	33.55	153	309	P	V
			5463.76	38.98	-15.02	54	31.34	31.97	9.22	33.55	153	309	A	V
		*	5580	94.39	-	-	86.56	32.1	9.32	33.59	153	309	P	V
		*	5580	87.29	-	-	79.46	32.1	9.32	33.59	153	309	A	V
		5753.96	48.09	-25.91	74	39.94	32.36	9.44	33.65	153	309	P	V	
		5751.56	39.67	-14.33	54	31.52	32.36	9.44	33.65	153	309	A	V	



802.11n HT20 CH 140 5700MHz	*	5700	98.38	-	-	90.35	32.27	9.39	33.63	156	68	P	H
	*	5700	91.92	-	-	83.89	32.27	9.39	33.63	156	68	A	H
		5725.24	57.16	-16.84	74	49.05	32.31	9.44	33.64	156	68	P	H
		5725	47.2	-6.8	54	39.09	32.31	9.44	33.64	156	68	A	H
													H
													H
	*	5700	92.74	-	-	84.71	32.27	9.39	33.63	160	272	P	V
	*	5700	85.96	-	-	77.93	32.27	9.39	33.63	160	272	A	V
		5726.2	52.73	-21.27	74	44.62	32.31	9.44	33.64	160	272	P	V
		5725	42.2	-11.8	54	34.09	32.31	9.44	33.64	160	272	A	V
													V
													V
Remark	1. No other spurious found. 2. All results are PASS against Peak and Average limit line.												



15E band 3 - 5470~5725MHz

WIFI 802.11n HT20 (Harmonic @ 3m)

WIFI	Note	Frequency	Level	Over	Limit	Read	Antenna	Cable	Preamp	Ant	Table	Peak	Pol.
Ant.				Limit	Line	Level	Factor	Loss	Factor	Pos	Pos	Avg.	
1		(MHz)	(dBµV/m)	(dB)	(dBµV/m)	(dBµV)	(dB/m)	(dB)	(dB)	(cm)	(deg)	(P/A)	(H/V)
802.11n HT20 CH 100 5500MHz		11000	39.55	-34.45	74	20.06	40.4	13.48	34.39	100	0	P	H
		16500	47.08	-26.92	74	27.18	39	16.81	35.91	100	0	P	H
													H
													H
		11000	39.43	-34.57	74	19.94	40.4	13.48	34.39	100	0	P	V
		16500	47.24	-26.76	74	27.34	39	16.81	35.91	100	0	P	V
													V
802.11n HT20 CH 116 5580MHz		11160	36.07	-37.93	74	16.65	40.27	13.64	34.49	100	0	P	H
		16740	48.72	-25.28	74	27.94	39.92	16.8	35.94	100	0	P	H
													H
													H
		11160	36.85	-37.15	74	17.43	40.27	13.64	34.49	100	0	P	V
		16740	48.84	-25.16	74	28.06	39.92	16.8	35.94	100	0	P	V
													V
802.11n HT20 CH 140 5700MHz		11400	36.79	-37.21	74	17.5	40.08	13.87	34.66	100	0	P	H
		17100	48.98	-25.02	74	26.98	41.12	16.85	35.97	100	0	P	H
													H
													H
		11400	37.72	-36.28	74	18.43	40.08	13.87	34.66	100	0	P	V
		17100	49.64	-24.36	74	27.64	41.12	16.85	35.97	100	0	P	V
													V
Remark	1. No other spurious found. 2. All results are PASS against Peak and Average limit line.												



15E band 3 - 5470~5725MHz

WIFI 802.11n HT40 (Band Edge @ 3m)

WIFI	Note	Frequency	Level	Over	Limit	Read	Antenna	Cable	Preamp	Ant	Table	Peak	Pol.
Ant.				Limit	Line	Level	Factor	Loss	Factor	Pos	Pos	Avg.	
1		(MHz)	(dBμV/m)	(dB)	(dBμV/m)	(dBμV)	(dB/m)	(dB)	(dB)	(cm)	(deg)	(P/A)	(H/V)
802.11n HT40 CH 102 5510MHz		5469.2	60.56	-13.44	74	52.92	31.97	9.22	33.55	153	74	P	H
		5468.56	50.92	-3.08	54	43.28	31.97	9.22	33.55	153	74	A	H
	*	5512	98.34	-	-	90.64	32	9.26	33.56	153	74	P	H
	*	5512	90.89	-	-	83.19	32	9.26	33.56	153	74	A	H
		5737.16	48.29	-25.71	74	40.16	32.34	9.44	33.65	153	74	P	H
		5760.12	40.55	-13.45	54	32.4	32.36	9.44	33.65	153	74	A	H
		5468.24	60.11	-13.89	74	52.47	31.97	9.22	33.55	167	311	P	V
		5470	48.59	-5.41	54	40.95	31.97	9.22	33.55	167	311	A	V
	*	5510	93.05	-	-	85.35	32	9.26	33.56	167	311	P	V
	*	5510	86.03	-	-	78.33	32	9.26	33.56	167	311	A	V
		5731.16	48.57	-25.43	74	40.47	32.31	9.44	33.65	167	311	P	V
		5764.36	40.34	-13.66	54	32.14	32.36	9.49	33.65	167	311	A	V
802.11n HT40 CH 110 5550MHz		5418	48.29	-25.71	74	40.74	31.93	9.17	33.55	131	63	P	H
		5446.8	40.53	-13.47	54	32.9	31.96	9.22	33.55	131	63	A	H
	*	5550	96.24	-	-	88.45	32.07	9.29	33.57	131	63	P	H
	*	5550	88.86	-	-	81.07	32.07	9.29	33.57	131	63	A	H
		5756.76	49.02	-24.98	74	40.87	32.36	9.44	33.65	131	63	P	H
		5753.8	40.23	-13.77	54	32.08	32.36	9.44	33.65	131	63	A	H
		5469.84	48.92	-25.08	74	41.28	31.97	9.22	33.55	150	308	P	V
		5447.76	40.02	-13.98	54	32.39	31.96	9.22	33.55	150	308	A	V
	*	5550	92.41	-	-	84.62	32.07	9.29	33.57	150	308	P	V
	*	5550	86.06	-	-	78.27	32.07	9.29	33.57	150	308	A	V
		5729.48	48.86	-25.14	74	40.75	32.31	9.44	33.64	150	308	P	V
		5728.76	40.46	-13.54	54	32.35	32.31	9.44	33.64	150	308	A	V



802.11n HT40 CH 134 5670MHz		5373.68	48.28	-25.72	74	40.81	31.89	9.13	33.55	151	67	P	H
		5453.68	40.37	-13.63	54	32.74	31.96	9.22	33.55	151	67	A	H
	*	5670	97.03	-	-	89.06	32.24	9.35	33.62	151	67	P	H
	*	5670	90.57	-	-	82.6	32.24	9.35	33.62	151	67	A	H
		5725.32	51.45	-22.55	74	43.34	32.31	9.44	33.64	151	67	P	H
		5725.48	42.39	-11.61	54	34.28	32.31	9.44	33.64	151	67	A	H
		5419.12	48.84	-25.16	74	41.29	31.93	9.17	33.55	158	307	P	V
		5466.32	39.67	-14.33	54	32.03	31.97	9.22	33.55	158	307	A	V
	*	5670	91.17	-	-	83.2	32.24	9.35	33.62	158	307	P	V
	*	5670	84.44	-	-	76.47	32.24	9.35	33.62	158	307	A	V
		5754.28	48.12	-25.88	74	39.97	32.36	9.44	33.65	158	307	P	V
		5725.4	40.57	-13.43	54	32.46	32.31	9.44	33.64	158	307	A	V
Remark	1. No other spurious found. 2. All results are PASS against Peak and Average limit line.												



15E band 3 - 5470~5725MHz

WIFI 802.11n HT40 (Harmonic @ 3m)

WIFI	Note	Frequency	Level	Over	Limit	Read	Antenna	Cable	Preamp	Ant	Table	Peak	Pol.
Ant.				Limit	Line	Level	Factor	Loss	Factor	Pos	Pos	Avg.	
1		(MHz)	(dBμV/m)	(dB)	(dBμV/m)	(dBμV)	(dB/m)	(dB)	(dB)	(cm)	(deg)	(P/A)	(H/V)
802.11n HT40 CH 102 5510MHz		11020	39.54	-34.46	74	20.08	40.39	13.48	34.41	100	0	P	H
		16530	47.62	-26.38	74	27.59	39.13	16.81	35.91	100	0	P	H
													H
													H
		11020	39.89	-34.11	74	20.43	40.39	13.48	34.41	100	0	P	V
		16530	47.24	-26.76	74	27.21	39.13	16.81	35.91	100	0	P	V
													V
802.11n HT40 CH 110 5550MHz		11100	39.58	-34.42	74	20.16	40.32	13.56	34.46	100	0	P	H
		16650	47.93	-26.07	74	27.47	39.59	16.8	35.93	100	0	P	H
													H
													H
		11100	39.68	-34.32	74	20.26	40.32	13.56	34.46	100	0	P	V
		16650	47.9	-26.1	74	27.44	39.59	16.8	35.93	100	0	P	V
													V
802.11n HT40 CH 134 5670MHz		11340	35.55	-38.45	74	16.24	40.13	13.79	34.61	100	0	P	H
		17010	48.7	-25.3	74	26.93	40.94	16.8	35.97	100	0	P	H
													H
													H
		11340	35.79	-38.21	74	16.48	40.13	13.79	34.61	100	0	P	V
		17010	48.37	-25.63	74	26.6	40.94	16.8	35.97	100	0	P	V
													V
Remark	1. No other spurious found. 2. All results are PASS against Peak and Average limit line.												



15E Band 3 - Straddle Channel

WIFI 802.11a (Band Edge @ 3m)

WIFI	Note	Frequency	Level	Over	Limit	Read	Antenna	Cable	Preamp	Ant	Table	Peak	Pol.
Ant.				Limit	Line	Level	Factor	Loss	Factor	Pos	Pos	Avg.	
1		(MHz)	(dBµV/m)	(dB)	(dBµV/m)	(dBµV)	(dB/m)	(dB)	(dB)	(cm)	(deg)	(P/A)	(H/V)
802.11a CH 144 5720MHz	*	5723	107.14	-	-	99.03	32.31	9.44	33.64	125	66	P	H
	*	5723	97.28	-	-	89.17	32.31	9.44	33.64	125	66	A	H
													H
													H
													H
													H
	*	5728	103.4	-	-	95.29	32.31	9.44	33.64	100	105	P	V
	*	5728	94.32	-	-	86.21	32.31	9.44	33.64	100	105	A	V
													V
													V
													V
Remark	1. No other spurious found. 2. All results are PASS against Peak and Average limit line.												



15E band 3 - Straddle Channel

WIFI 802.11a (Harmonic @ 3m)

WIFI	Note	Frequency	Level	Over	Limit	Read	Antenna	Cable	Preamp	Ant	Table	Peak	Pol.
Ant.				Limit	Line	Level	Factor	Loss	Factor	Pos	Pos	Avg.	
1		(MHz)	(dBμV/m)	(dB)	(dBμV/m)	(dBμV)	(dB/m)	(dB)	(dB)	(cm)	(deg)	(P/A)	(H/V)
802.11a CH 144 5720MHz		11440	40.58	-33.42	74	21.3	40.05	13.91	34.68	150	0	P	H
		17160	50.96	-23.04	74	28.77	41.27	16.9	35.98	150	0	P	H
													H
													H
		11440	40.82	-33.18	74	21.54	40.05	13.91	34.68	150	0	P	V
		17160	49.98	-24.02	74	27.79	41.27	16.9	35.98	150	0	P	V
													V
													V
Remark	1. No other spurious found. 2. All results are PASS against Peak and Average limit line.												



**15E band 3 - Straddle Channel
WIFI 802.11n HT20 (Band Edge @ 3m)**

WIFI	Note	Frequency	Level	Over	Limit	Read	Antenna	Cable	Preamp	Ant	Table	Peak	Pol.
Ant.				Limit	Line	Level	Factor	Loss	Factor	Pos	Pos	Avg.	
1		(MHz)	(dBμV/m)	(dB)	(dBμV/m)	(dBμV)	(dB/m)	(dB)	(dB)	(cm)	(deg)	(P/A)	(H/V)
802.11n HT20 CH 144 5720MHz	*	5716	100.78	-	-	92.74	32.29	9.39	33.64	131	60	P	H
	*	5716	91.49	-	-	83.45	32.29	9.39	33.64	131	60	A	H
													H
													H
													H
													H
	*	5723	97.44	-	-	89.33	32.31	9.44	33.64	100	92	P	V
	*	5723	88.61	-	-	80.5	32.31	9.44	33.64	100	92	A	V
													V
													V
Remark	1. No other spurious found. 2. All results are PASS against Peak and Average limit line.												



**15E band 3 - Straddle Channel
WIFI 802.11n HT20 (Harmonic @ 3m)**

WIFI	Note	Frequency	Level	Over	Limit	Read	Antenna	Cable	Preamp	Ant	Table	Peak	Pol.
Ant.				Limit	Line	Level	Factor	Loss	Factor	Pos	Pos	Avg.	
1		(MHz)	(dBμV/m)	(dB)	(dBμV/m)	(dBμV)	(dB/m)	(dB)	(dB)	(cm)	(deg)	(P/A)	(H/V)
802.11n HT20 CH 144 5720MHz		11440	43.68	-30.32	74	24.4	40.05	13.91	34.68	150	0	P	H
		17160	50.87	-23.13	74	28.68	41.27	16.9	35.98	150	0	P	H
													H
													H
		11440	43.1	-30.9	74	23.82	40.05	13.91	34.68	150	0	P	V
		17160	50.59	-23.41	74	28.4	41.27	16.9	35.98	150	0	P	V
													V
													V
Remark	1. No other spurious found. 2. All results are PASS against Peak and Average limit line.												



**15E band 3 - Straddle Channel
WIFI 802.11n HT40 (Band Edge @ 3m)**

WIFI	Note	Frequency	Level	Over	Limit	Read	Antenna	Cable	Preamp	Ant	Table	Peak	Pol.
Ant.				Limit	Line	Level	Factor	Loss	Factor	Pos	Pos	Avg.	
1		(MHz)	(dBμV/m)	(dB)	(dBμV/m)	(dBμV)	(dB/m)	(dB)	(dB)	(cm)	(deg)	(P/A)	(H/V)
802.11n HT40 CH 142 5710MHz	*	5710	92.7	-	-	84.66	32.29	9.39	33.64	100	79	P	H
	*	5710	85.45	-	-	77.41	32.29	9.39	33.64	100	79	A	H
													H
													H
													H
													H
	*	5710	93.87	-	-	85.83	32.29	9.39	33.64	366	100	P	V
	*	5710	87.21	-	-	79.17	32.29	9.39	33.64	366	100	A	V
													V
													V
Remark	1. No other spurious found. 2. All results are PASS against Peak and Average limit line.												



**15E band 3 - Straddle Channel
WIFI 802.11n HT40 (Harmonic @ 3m)**

WIFI	Note	Frequency	Level	Over	Limit	Read	Antenna	Cable	Preamp	Ant	Table	Peak	Pol.
Ant.				Limit	Line	Level	Factor	Loss	Factor	Pos	Pos	Avg.	
1		(MHz)	(dBμV/m)	(dB)	(dBμV/m)	(dBμV)	(dB/m)	(dB)	(dB)	(cm)	(deg)	(P/A)	(H/V)
802.11n HT40 CH 142 5710MHz		11420	46.91	-27.09	74	27.65	40.07	13.87	34.68	150	0	P	H
		17130	50.41	-23.59	74	28.32	41.19	16.88	35.98	150	0	P	H
													H
													H
		11420	46.84	-27.16	74	27.58	40.07	13.87	34.68	150	0	P	V
		17130	50.98	-23.02	74	28.89	41.19	16.88	35.98	150	0	P	V
													V
													V
Remark	1. No other spurious found. 2. All results are PASS against Peak and Average limit line.												



15E Emission below 1GHz

WIFI 802.11n HT20 (LF @ 3m)

WIFI	Note	Frequency	Level	Over	Limit	Read	Antenna	Cable	Preamp	Ant	Table	Peak	Pol.	
Ant.				Limit	Line	Level	Factor	Loss	Factor	Pos	Pos	Avg.		
1		(MHz)	(dBμV/m)	(dB)	(dBμV/m)	(dBμV)	(dB/m)	(dB)	(dB)	(cm)	(deg)	(P/A)	(H/V)	
802.11n HT20 LF		47.28	17.67	-22.33	40	39.68	8.76	1.04	31.81	142	221	P	H	
		113.97	15.83	-27.67	43.5	35.03	11.3	1.28	31.78			P	H	
		226.56	16.11	-29.89	46	37.14	8.95	1.79	31.77			P	H	
		344.1	14.82	-31.18	46	30.47	13.96	2.17	31.78			P	H	
		552	19.95	-26.05	46	30.49	18.66	2.77	31.97			P	H	
		772.5	21.01	-24.99	46	29.91	19.7	3.35	31.95			P	H	
														H
														H
														H
														H
														H
														H
			31.62	17.58	-22.42	40	31.55	17.19	0.67	31.83	220	35	P	V
			113.97	16.59	-26.91	43.5	35.79	11.3	1.28	31.78			P	V
			199.83	20.28	-23.22	43.5	41.82	8.6	1.64	31.78			P	V
			488.3	18.34	-27.66	46	30.3	17.28	2.64	31.88			P	V
			622	20.18	-25.82	46	30.26	19	2.96	32.04			P	V
			754.3	21.69	-24.31	46	30.66	19.76	3.25	31.98			P	V
														V
														V
													V	
													V	
													V	
Remark	1. No other spurious found. 2. All results are PASS against limit line.													



15E Emission below 1GHz

WIFI 802.11n HT40 (LF @ 3m)

WIFI	Note	Frequency	Level	Over	Limit	Read	Antenna	Cable	Preamp	Ant	Table	Peak	Pol.	
Ant.				Limit	Line	Level	Factor	Loss	Factor	Pos	Pos	Avg.		
1		(MHz)	(dBμV/m)	(dB)	(dBμV/m)	(dBμV)	(dB/m)	(dB)	(dB)	(cm)	(deg)	(P/A)	(H/V)	
802.11n HT40 LF		64.02	13.25	-26.75	40	39.1	4.9	1.04	31.79			P	H	
		114.24	16.17	-27.33	43.5	35.37	11.3	1.28	31.78			P	H	
		169.05	21.07	-22.43	43.5	42.35	8.86	1.64	31.78	100	114	P	H	
		356.7	14.41	-31.59	46	29.48	14.54	2.17	31.78			P	H	
		550.6	19.22	-26.78	46	29.73	18.69	2.77	31.97			P	H	
		730.5	21.64	-24.36	46	30.59	19.8	3.25	32			P	H	
													H	
													H	
													H	
													H	
													H	
													H	
			51.87	21.02	-18.98	40	44.73	7.05	1.04	31.8	151	125	P	V
			135.84	14.93	-28.57	43.5	34.15	11.1	1.46	31.78			P	V
			220.62	17.65	-28.35	46	39.29	8.35	1.79	31.78			P	V
			475	17.7	-28.3	46	29.95	17.05	2.57	31.87			P	V
			590.5	19.71	-26.29	46	30.35	18.5	2.89	32.03			P	V
			774.6	22.06	-23.94	46	30.96	19.7	3.35	31.95			P	V
														V
														V
													V	
													V	
													V	
Remark	1. No other spurious found. 2. All results are PASS against limit line.													



Note symbol

*	Fundamental Frequency which can be ignored. However, the level of any unwanted emissions shall not exceed the level of the fundamental frequency per 15.209(c).
!	Test result is over limit line.
P/A	Peak or Average
H/V	Horizontal or Vertical



A calculation example for radiated spurious emission is shown as below:

WIFI	Note	Frequency	Level	Over	Limit	Read	Antenna	Cable	Preamp	Ant	Table	Peak	Pol.
Ant.				Limit	Line	Level	Factor	Loss	Factor	Pos	Pos	Avg.	
1		(MHz)	(dBμV/m)	(dB)	(dBμV/m)	(dBμV)	(dB/m)	(dB)	(dB)	(cm)	(deg)	(P/A)	(H/V)
802.11b		2390	55.45	-18.55	74	54.51	32.22	4.58	35.86	103	308	P	H
CH 01													
2412MHz		2390	43.54	-10.46	54	42.6	32.22	4.58	35.86	103	308	A	H

- Level(dBμV/m) =
Antenna Factor(dB/m) + Cable Loss(dB) + Read Level(dBμV) - Preamp Factor(dB)
- Over Limit(dB) = Level(dBμV/m) – Limit Line(dBμV/m)

For Peak Limit @ 2390MHz:

- Level(dBμV/m)
= Antenna Factor(dB/m) + Cable Loss(dB) + Read Level(dBμV) - Preamp Factor(dB)
= 32.22(dB/m) + 4.58(dB) + 54.51(dBμV) – 35.86 (dB)
= 55.45 (dBμV/m)
- Over Limit(dB)
= Level(dBμV/m) – Limit Line(dBμV/m)
= 55.45(dBμV/m) – 74(dBμV/m)
= -18.55(dB)

For Average Limit @ 2390MHz:

- Level(dBμV/m)
= Antenna Factor(dB/m) + Cable Loss(dB) + Read Level(dBμV) - Preamp Factor(dB)
= 32.22(dB/m) + 4.58(dB) + 42.6(dBμV) – 35.86 (dB)
= 43.54 (dBμV/m)
- Over Limit(dB)
= Level(dBμV/m) – Limit Line(dBμV/m)
= 43.54(dBμV/m) – 54(dBμV/m)
= -10.46(dB)

Both peak and average measured complies with the limit line, so test result is “PASS”.