

FCC SAR Test Report

APPLICANT : Sony Mobile Communications Inc
EQUIPMENT : PDA Phone
BRAND NAME : Sony
TYPE NAME : PM-0780-BV
FCC ID : PY7-PM0780
STANDARD : FCC 47 CFR Part 2 (2.1093)
ANSI/IEEE C95.1-1992
IEEE 1528-2003

We, SPORTON INTERNATIONAL INC., would like to declare that the tested sample has been evaluated in accordance with the procedures and had been in compliance with the applicable technical standards.

The test results in this report apply exclusively to the tested model / sample. Without written approval of SPORTON INTERNATIONAL INC., the test report shall not be reproduced except in full.

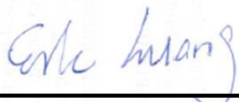

Reviewed by: Eric Huang / Deputy Manager



Approved by: Jones Tsai / Manager



SPORTON INTERNATIONAL INC.

No.52, Hwa Ya 1st Rd., Hwa Ya Technology Park, Kwei-Shan District, Taoyuan City, Taiwan (R.O.C.)



Table of Contents

1. Statement of Compliance 4
2. Administration Data 5
3. Guidance Standard 5
4. Equipment Under Test (EUT) 6
4.1 General Information 6
4.2 Device Serial Number 7
4.3 Maximum Tune-up Limit 7
4.4 General LTE SAR Test and Reporting Considerations 9
5. RF Exposure Limits 10
5.1 Uncontrolled Environment 10
5.2 Controlled Environment 10
6. Specific Absorption Rate (SAR) 11
6.1 Introduction 11
6.2 SAR Definition 11
7. System Description and Setup 12
8. Measurement Procedures 13
8.1 Spatial Peak SAR Evaluation 13
8.2 Power Reference Measurement 14
8.3 Area Scan 14
8.4 Zoom Scan 15
8.5 Volume Scan Procedures 15
8.6 Power Drift Monitoring 15
9. Test Equipment List 16
10. System Verification 17
10.1 Tissue Verification 17
10.2 System Performance Check Results 19
11. RF Exposure Positions 20
11.1 Ear and handset reference point 20
11.2 Definition of the cheek position 21
11.3 Definition of the tilt position 22
11.4 Body Worn Accessory 23
11.5 Wireless Router 23
12. Conducted RF Output Power (Unit: dBm) 24
13. Antenna Location 40
14. SAR Test Results 41
14.1 Head SAR 42
14.2 Hotspot SAR 44
14.3 Body Worn Accessory SAR 46
14.4 Repeated SAR Measurement 47
15. Simultaneous Transmission Analysis 48
15.1 Head Exposure Conditions 49
15.2 Hotspot Exposure Conditions 53
15.3 Body-Worn Accessory Exposure Conditions 57
15.4 SPLSR Evaluation and Analysis 59
16. Uncertainty Assessment 62
17. References 65
Appendix A. Plots of System Performance Check
Appendix B. Plots of High SAR Measurement
Appendix C. DASy Calibration Certificate
Appendix D. Test Setup Photos



Revision History

REPORT NO.	VERSION	DESCRIPTION	ISSUED DATE
FA4D0327	Rev. 01	Initial issue of report	Feb. 25, 2015
FA4D0327	Rev. 02	Revised the UMTS B2 and LTE B2 Hotspot SAR results on page4 and section14.2	Mar. 23, 2015
FA4D0327	Rev. 03	Revised the GSM1900, UMTS B2 and LTE B5 conducted power on section12 and also added "SN" / "IMEI code" on page7.	Mar. 24, 2015



1. Statement of Compliance

The maximum results of Specific Absorption Rate (SAR) found during testing for **Sony Mobile Communications Inc, PDA Phone**, are as follows.

Equipment Class	Frequency Band	Highest SAR Summary						Simultaneous Transmission 1g SAR (W/kg)
		Head (Separation 0mm)		Body-worn (Separation 15mm)		Wireless Router (Separation 10mm)		
		Maximum Power (dBm)	1g SAR (W/kg)	Maximum Power (dBm)	1g SAR (W/kg)	Maximum Power (dBm)	1g SAR (W/kg)	
PCE	GSM850(4Tx Slots)	28.00	0.74	28.00	0.72	28.00	0.79	1.49
	GSM1900(4Tx Slots)	28.00	1.00	28.00	0.74	28.00	1.18	
	WCDMA Band V	25.00	0.62	25.00	0.67	25.00	0.71	
	WCDMA Band II	24.00	0.85	24.00	0.67	24.00	1.18	
	LTE Band 5	25.00	0.72	25.00	0.77	25.00	0.81	
	LTE Band 2	24.00	0.72	24.00	0.65	24.00	1.19	
	LTE Band 7	23.00	1.12	23.00	0.56	23.00	1.05	
DTS	2.4GHz WLAN	18.00	0.51	18.00	0.34	18.00	0.87	1.49
NII	5.2GHz WLAN	14.00	0.25	14.00	0.08	14.00	0.16	1.27
	5.3GHz WLAN	14.00	0.25	14.00	0.07			
	5.5GHz WLAN	14.00	0.24	14.00	0.04			
	5.8GHz WLAN	14.00	0.38	14.00	0.05	14.00	0.08	
DSS	Bluetooth	11.00	0.01					1.46
Date of Testing:		2014/12/15~2015/03/05						

Frequency Band		Highest SAR Summary						Simultaneous Transmission 10g SAR (W/kg)
		Head (Separation 0mm)		Body-worn (Separation 15mm)		Wireless Router (Separation 10mm)		
		Maximum Power (dBm)	10g SAR (W/kg)	Maximum Power (dBm)	10g SAR (W/kg)	Maximum Power (dBm)	10g SAR (W/kg)	
GSM	GSM850(4Tx Slots)	28.00	0.58	28.00	0.56	28.00	0.62	1.14
	GSM1900(4Tx Slots)	28.00	0.62	28.00	0.44	28.00	0.75	
WCDMA	Band V	25.00	0.48	25.00	0.52	25.00	0.56	
	Band II	24.00	0.52	24.00	0.44	24.00	0.70	
LTE	Band 5	25.00	0.54	25.00	0.58	25.00	0.61	
	Band 2	24.00	0.44	24.00	0.40	24.00	0.72	
	Band 7	23.00	0.58	23.00	0.31	23.00	0.56	
WLAN	2.4GHz WLAN	18.00	0.23	18.00	0.17	18.00	0.38	1.14
	5.2GHz WLAN	14.00	0.07	14.00	0.03	14.00	0.05	0.78
	5.3GHz WLAN	14.00	0.08	14.00	0.03			
	5.5GHz WLAN	14.00	0.07	14.00	0.02			
	5.8GHz WLAN	14.00	0.12	14.00	0.02	14.00	0.02	
Bluetooth	2.4GHz Band	11.00	< 0.01					0.86
Date of Testing:		2014/12/15~2015/03/05						

This device is in compliance with Specific Absorption Rate (SAR) for general population/uncontrolled exposure limits (1.6 W/kg) specified in FCC 47 CFR part 2 (2.1093) and ANSI/IEEE C95.1-1992, and had been tested in accordance with the measurement methods and procedures specified in IEEE 1528-2003.



2. Administration Data

Testing Laboratory	
Test Site	SPORTON INTERNATIONAL INC.
Test Site Location	No.52, Hwa Ya 1st Rd., Hwa Ya Technology Park, Kwei-Shan District, Taoyuan City, Taiwan (R.O.C.) TEL: +886-3-327-3456 FAX: +886-3-328-4978

Applicant	
Company Name	Sony Mobile Communications Inc
Address	Nya Vattentornet 22188 Lund/Sweden

Manufacturer	
Company Name	Sony Mobile Communications Inc
Address	Nya Vattentornet 22188 Lund/Sweden

3. Guidance Standard

The Specific Absorption Rate (SAR) testing specification, method, and procedure for this device is in accordance with the following standards:

- FCC 47 CFR Part 2 (2.1093)
- ANSI/IEEE C95.1-1992
- IEEE 1528-2003
- FCC KDB 865664 D01 SAR Measurement 100 MHz to 6 GHz v01r03
- FCC KDB 865664 D02 SAR Reporting v01r01
- FCC KDB 447498 D01 General RF Exposure Guidance v05r02
- FCC KDB 648474 D04 SAR Evaluation Considerations for Wireless Handsets v01r02
- FCC KDB 248227 D01 SAR meas for 802 11abg v01r02
- FCC KDB 941225 D01 3G SAR Procedures v03
- FCC KDB 941225 D05 SAR for LTE Devices v02r03
- FCC KDB 941225 D06 Hotspot Mode SAR v02



4. Equipment Under Test (EUT)

4.1 General Information

The equipment under test is a smart phone supporting, GSM850/900/1800/1900, UMTS I / II / V / VIII, LTE Band 1 / 2 / 3 / 5 / 7 / 8 / 20, 802.11 a/b/g/n, Bluetooth, FM Receiver, NFC, ANT+ and GPS features, and below is details of information. For FCC only wireless modes in US frequency bands are tested.

Product Feature & Specification	
Equipment Name	PDA Phone
Brand Name	Sony
Type Name	PM-0780-BV
FCC ID	PY7-PM0780
Wireless Technology and Frequency Range	GSM850: 824.2 MHz ~ 848.8 MHz GSM1900: 1850.2 MHz ~ 1909.8 MHz WCDMA Band V: 826.4 MHz ~ 846.6 MHz WCDMA Band II: 1852.4 MHz ~ 1907.6 MHz LTE Band 5: 824.7 MHz ~ 848.3 MHz LTE Band 2: 1850.7 MHz ~ 1909.3 MHz LTE Band 7: 2502.5 MHz ~ 2567.5 MHz WLAN 2.4GHz Band: 2412 MHz ~ 2462 MHz WLAN 5.2GHz Band: 5180 MHz ~ 5240 MHz WLAN 5.3GHz Band: 5260 MHz ~ 5320 MHz WLAN 5.5GHz Band: 5500 MHz ~ 5700 MHz WLAN 5.8GHz Band: 5745 MHz ~ 5825 MHz Bluetooth: 2402 MHz ~ 2480 MHz NFC : 13.56 MHz
Mode	<ul style="list-style-type: none"> • GSM/GPRS/EGPRS • RMC/AMR 12.2Kbps • HSDPA • HSUPA • DC-HSDPA • LTE: QPSK, 16QAM • 802.11a/b/g/n HT20/HT40 • Bluetooth v3.0+EDR , Bluetooth v4.0-LE • NFC:ASK • ANT+
HW Version	AP
SW Version	26.1.A.0.79
GSM / (E)GPRS Dual Transfer mode	Class A – EUT can support Packet Switched and Circuit Switched Network simultaneously.
EUT Stage	Identical Prototype
Remark:	
<ol style="list-style-type: none"> 1. This device 2.4GHz supports Hotspot and 5.2GHz / 5.8GHz WLAN supports WiFi Direct (GC/GO) operation, and 5.3GHz / 5.5GHz WLAN supports WiFi Direct (GC only). 2. This device supported VoIP in EGPRS, WCDMA, LTE (e.g. 3rd party VoIP) and 802.11n-HT40 is not supported in 2.4GHz WLAN. 3. WLAN operation in 5600 MHz ~ 5650 MHz is notched. 	



4.2 Device Serial Number

Sample	Serial Number	IMEI Code
GSM850 SAR measurements	YT910ZRWDA	004402453306981
WCDMA V SAR measurements	YT910ZRWE7	004402453306999
LTE B2 / B7 SAR measurements	YT910ZRWXC	004402453307310
GSM1900 / WCDMA B2 / LTE B5 SAR measurements	YT910ZRWBV	004402452032802
BT SAR measurements	YT910ZRWBX	004402453307021
WLAN SAR measurements	YT910ZRWDA	004402453307252
GSM50 Conducted measurements	YT910ZRWDA	004402453306981
UMTS Conducted measurements	YT910ZRWE7	004402453306999
LTE B2 / B7 Conducted measurements	YT910ZRWXC	004402453307310
GSM1900 / WCDMA B2 / LTE B5 Conducted measurements	YT910ZRWBV	004402452032802
WLAN Conducted measurements	YT910ZRWBX	004402453275632
BT Conducted measurements	YT910ZR3D	004402453307021

Note: Several samples were used with identical hardware to support SAR testing. The manufacturer has confirmed that the device tested gave the same physical, mechanical and thermal characteristics and are within operational tolerances expected for production units.

4.3 Maximum Tune-up Limit

Mode	Burst average power(dBm)	
	GSM 850	GSM 1900
GSM (GMSK, 1 Tx slot)	34.00	31.00
GPRS (GMSK, 1 Tx slot)	34.00	31.00
GPRS (GMSK, 2 Tx slots)	30.00	30.00
GPRS (GMSK, 3 Tx slots)	29.00	29.00
GPRS (GMSK, 4 Tx slots)	28.00	28.00
EDGE (8PSK, 1 Tx slot)	27.00	26.00
EDGE (8PSK, 2 Tx slots)	26.00	26.00
EDGE (8PSK, 3 Tx slots)	26.00	26.00
EDGE (8PSK, 4 Tx slots)	25.00	25.00
DTM 5 (2Tx slots)	GSM (GMSK, 1 Tx slot)	30.00
	GPRS (GMSK, 1 Tx slot)	30.00
DTM 9 (2Tx slots)	GSM (GMSK, 1 Tx slot)	30.00
	GPRS (GMSK, 1 Tx slot)	30.00
DTM 11 (3Tx slots)	GSM (GMSK, 1 Tx slot)	29.00
	GPRS (GMSK, 2 Tx slots)	29.00
DTM 5 (2Tx slots)	GSM (GMSK, 1 Tx slot)	30.00
	EDGE (8PSK, 1 Tx slot)	26.00
DTM 9 (2Tx slots)	GSM (GMSK, 1 Tx slot)	30.00
	EDGE (8PSK, 1 Tx slot)	26.00
DTM 11 (3Tx slots)	GSM (GMSK, 1 Tx slot)	29.00
	EDGE (8PSK, 2 Tx slots)	26.00



Mode		Average Power (dBm)	
WCDMA	Band V	25.00	
	Band II	24.00	
LTE	Band 5	25.00	
	Band 2	24.00	
	Band 7	23.00	
2.4GHz WLAN	802.11b	18.00	
	802.11g	15.00	
	802.11n-HT20	13.00	
5GHz WLAN	802.11a	14.00	
	802.11n-HT20	12.50	
	802.11n-HT40	5.2GHz	12.00
		5.3GHz	12.00
		5.5GHz	11.00
5.8GHz		11.00	
Bluetooth v3.0+EDR	Low	10.00	
	Middle	11.00	
	High	10.00	
Bluetooth v4.0+LE		3.00	



4.4 General LTE SAR Test and Reporting Considerations

Summarized necessary items addressed in KDB 941225 D05 v02r03																																																										
FCC ID	PY7-PM0780																																																									
Equipment Name	PDA Phone																																																									
Operating Frequency Range of each LTE transmission band	LTE Band 5: 824.7 MHz ~ 848.3 MHz LTE Band 2: 1850.7 MHz ~ 1909.3 MHz LTE Band 7: 2502.5 MHz ~ 2567.5 MHz																																																									
Channel Bandwidth	LTE Band 5: 1.4MHz, 3MHz, 5MHz, 10MHz LTE Band 2: 1.4MHz, 3MHz, 5MHz, 10MHz, 15MHz, 20MHz LTE Band 7: 5MHz, 10MHz, 15MHz, 20MHz																																																									
Release and Category	Rel10, Cat4																																																									
Uplink modulations used	QPSK, and 16QAM																																																									
LTE Voice / Data requirements	Data only																																																									
LTE MPR permanently built-in by design	<table border="1"> <thead> <tr> <th colspan="8">Table 6.2.3-1: Maximum Power Reduction (MPR) for Power Class 3</th> </tr> <tr> <th rowspan="2">Modulation</th> <th colspan="6">Channel bandwidth / Transmission bandwidth (RB)</th> <th rowspan="2">MPR (dB)</th> </tr> <tr> <th>1.4 MHz</th> <th>3.0 MHz</th> <th>5 MHz</th> <th>10 MHz</th> <th>15 MHz</th> <th>20 MHz</th> </tr> </thead> <tbody> <tr> <td>QPSK</td> <td>>5</td> <td>>4</td> <td>>8</td> <td>>12</td> <td>>16</td> <td>>18</td> <td>≤ 1</td> </tr> <tr> <td>16 QAM</td> <td>≤ 5</td> <td>≤ 4</td> <td>≤ 8</td> <td>≤ 12</td> <td>≤ 16</td> <td>≤ 18</td> <td>≤ 1</td> </tr> <tr> <td>16 QAM</td> <td>>5</td> <td>>4</td> <td>>8</td> <td>>12</td> <td>>16</td> <td>>18</td> <td>≤ 2</td> </tr> </tbody> </table>												Table 6.2.3-1: Maximum Power Reduction (MPR) for Power Class 3								Modulation	Channel bandwidth / Transmission bandwidth (RB)						MPR (dB)	1.4 MHz	3.0 MHz	5 MHz	10 MHz	15 MHz	20 MHz	QPSK	>5	>4	>8	>12	>16	>18	≤ 1	16 QAM	≤ 5	≤ 4	≤ 8	≤ 12	≤ 16	≤ 18	≤ 1	16 QAM	>5	>4	>8	>12	>16	>18	≤ 2
Table 6.2.3-1: Maximum Power Reduction (MPR) for Power Class 3																																																										
Modulation	Channel bandwidth / Transmission bandwidth (RB)						MPR (dB)																																																			
	1.4 MHz	3.0 MHz	5 MHz	10 MHz	15 MHz	20 MHz																																																				
QPSK	>5	>4	>8	>12	>16	>18	≤ 1																																																			
16 QAM	≤ 5	≤ 4	≤ 8	≤ 12	≤ 16	≤ 18	≤ 1																																																			
16 QAM	>5	>4	>8	>12	>16	>18	≤ 2																																																			
LTE A-MPR	In the base station simulator configuration, Network Setting value is set to NS_01 to disable A-MPR during SAR testing and the LTE SAR tests was transmitting on all TTI frames (Maximum TTI)																																																									
Spectrum plots for RB configuration	A properly configured base station simulator was used for the SAR and power measurement; therefore, spectrum plots for each RB allocation and offset configuration are not included in the SAR report.																																																									
Transmission (H, M, L) channel numbers and frequencies in each LTE band																																																										
LTE Band 5																																																										
	Bandwidth 1.4 MHz		Bandwidth 3 MHz		Bandwidth 5 MHz		Bandwidth 10 MHz																																																			
	Ch. #	Freq. (MHz)	Ch. #	Freq. (MHz)	Ch. #	Freq. (MHz)	Ch. #	Freq. (MHz)	Ch. #	Freq. (MHz)																																																
L	20407	824.7	20415	825.5	20425	826.5	20450	829																																																		
M	20525	836.5	20525	836.5	20525	836.5	20525	836.5																																																		
H	20643	848.3	20635	847.5	20625	846.5	20600	844																																																		
LTE Band 2																																																										
	Bandwidth 1.4 MHz		Bandwidth 3 MHz		Bandwidth 5 MHz		Bandwidth 10 MHz		Bandwidth 15 MHz		Bandwidth 20 MHz																																															
	Ch. #	Freq. (MHz)	Ch. #	Freq. (MHz)	Ch. #	Freq. (MHz)	Ch. #	Freq. (MHz)	Ch. #	Freq. (MHz)	Ch. #	Freq. (MHz)																																														
L	18607	1850.7	18615	1851.5	18625	1852.5	18650	1855	18675	1857.5	18700	1860																																														
M	18900	1880	18900	1880	18900	1880	18900	1880	18900	1880	18900	1880																																														
H	19193	1909.3	19185	1908.5	19175	1907.5	19150	1905	19125	1902.5	19100	1900																																														
LTE Band 7																																																										
	Bandwidth 5 MHz		Bandwidth 10 MHz		Bandwidth 15 MHz		Bandwidth 20 MHz																																																			
	Ch. #	Freq. (MHz)	Ch. #	Freq. (MHz)	Ch. #	Freq. (MHz)	Ch. #	Freq. (MHz)	Ch. #	Freq. (MHz)																																																
L	20775	2502.5	20800	2505	20825	2507.5	20850	2510																																																		
M	21100	2535	21100	2535	21100	2535	21100	2535																																																		
H	21425	2567.5	21400	2565	21375	2562.5	21350	2560																																																		



5. RF Exposure Limits

5.1 Uncontrolled Environment

Uncontrolled Environments are defined as locations where there is the exposure of individuals who have no knowledge or control of their exposure. The general population/uncontrolled exposure limits are applicable to situations in which the general public may be exposed or in which persons who are exposed as a consequence of their employment may not be made fully aware of the potential for exposure or cannot exercise control over their exposure. Members of the general public would come under this category when exposure is not employment-related; for example, in the case of a wireless transmitter that exposes persons in its vicinity.

5.2 Controlled Environment

Controlled Environments are defined as locations where there is exposure that may be incurred by persons who are aware of the potential for exposure, (i.e. as a result of employment or occupation). In general, occupational/controlled exposure limits are applicable to situations in which persons are exposed as a consequence of their employment, who have been made fully aware of the potential for exposure and can exercise control over their exposure. The exposure category is also applicable when the exposure is of a transient nature due to incidental passage through a location where the exposure levels may be higher than the general population/uncontrolled limits, but the exposed person is fully aware of the potential for exposure and can exercise control over his or her exposure by leaving the area or by some other appropriate means.

Limits for Occupational/Controlled Exposure (W/kg)

Whole-Body	Partial-Body	Hands, Wrists, Feet and Ankles
0.4	8.0	20.0

Limits for General Population/Uncontrolled Exposure (W/kg)

Whole-Body	Partial-Body	Hands, Wrists, Feet and Ankles
0.08	1.6	4.0

1. Whole-Body SAR is averaged over the entire body, partial-body SAR is averaged over any 1gram of tissue defined as a tissue volume in the shape of a cube. SAR for hands, wrists, feet and ankles is averaged over any 10 grams of tissue defined as a tissue volume in the shape of a cube.

6. Specific Absorption Rate (SAR)

6.1 Introduction

SAR is related to the rate at which energy is absorbed per unit mass in an object exposed to a radio field. The SAR distribution in a biological body is complicated and is usually carried out by experimental techniques or numerical modeling. The standard recommends limits for two tiers of groups, occupational/controlled and general population/uncontrolled, based on a person's awareness and ability to exercise control over his or her exposure. In general, occupational/controlled exposure limits are higher than the limits for general population/uncontrolled.

6.2 SAR Definition

The SAR definition is the time derivative (rate) of the incremental energy (dW) absorbed by (dissipated in) an incremental mass (dm) contained in a volume element (dv) of a given density (ρ). The equation description is as below:

$$\text{SAR} = \frac{d}{dt} \left(\frac{dW}{dm} \right) = \frac{d}{dt} \left(\frac{dW}{\rho dv} \right)$$

SAR is expressed in units of Watts per kilogram (W/kg)

$$\text{SAR} = \frac{\sigma |E|^2}{\rho}$$

Where: σ is the conductivity of the tissue, ρ is the mass density of the tissue and E is the RMS electrical field strength.

7. System Description and Setup

The DASY system used for performing compliance tests consists of the following items:

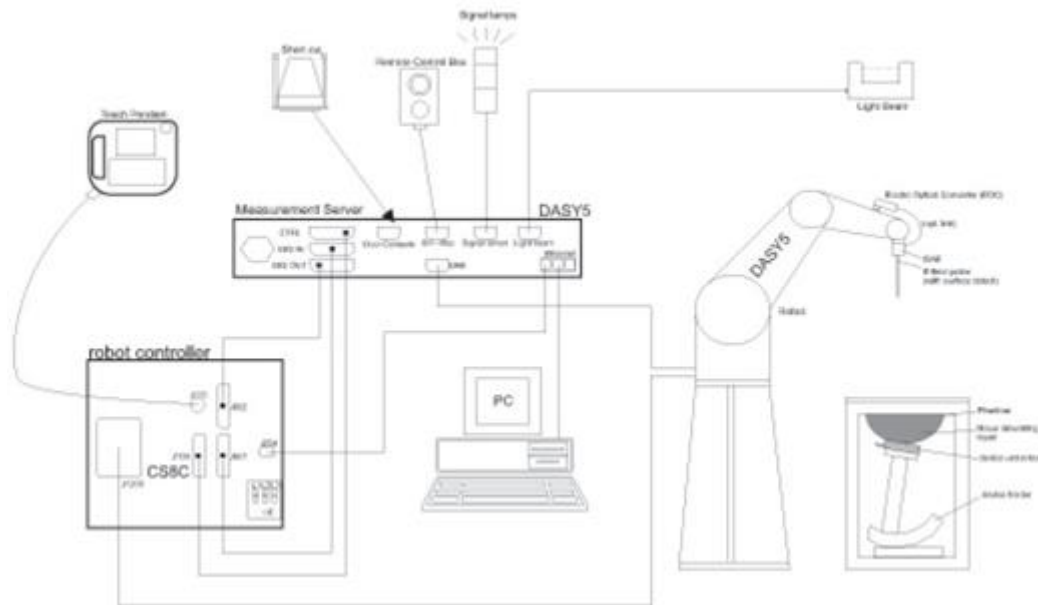

- A standard high precision 6-axis robot with controller, teach pendant and software. An arm extension for accommodating the data acquisition electronics (DAE).
- An isotropic Field probe optimized and calibrated for the targeted measurement.
- A data acquisition electronics (DAE) which performs the signal amplification, signal multiplexing, AD-conversion, offset measurements, mechanical surface detection, collision detection, etc. The unit is battery powered with standard or rechargeable batteries. The signal is optically transmitted to the EOC.
- The Electro-optical converter (EOC) performs the conversion from optical to electrical signals for the digital communication to the DAE. To use optical surface detection, a special version of the EOC is required. The EOC signal is transmitted to the measurement server.
- The function of the measurement server is to perform the time critical tasks such as signal filtering, control of the robot operation and fast movement interrupts.
- The Light Beam used is for probe alignment. This improves the (absolute) accuracy of the probe positioning.
- A computer running WinXP or Win7 and the DASY5 software.
- Remote control and teach pendant as well as additional circuitry for robot safety such as warning lamps, etc.
- The phantom, the device holder and other accessories according to the targeted measurement.

8. Measurement Procedures

The measurement procedures are as follows:

<Conducted power measurement>

- (a) For WWAN power measurement, use base station simulator to configure EUT WWAN transmission in conducted connection with RF cable, at maximum power in each supported wireless interface and frequency band.
- (b) Read the WWAN RF power level from the base station simulator.
- (c) For WLAN/BT power measurement, use engineering software to configure EUT WLAN/BT continuously transmission, at maximum RF power in each supported wireless interface and frequency band
- (d) Connect EUT RF port through RF cable to the power meter, and measure WLAN/BT output power

<SAR measurement>

- (a) Use base station simulator to configure EUT WWAN transmission in radiated connection, and engineering software to configure EUT WLAN/BT continuously transmission, at maximum RF power, in the highest power channel.
- (b) Place the EUT in the positions as Appendix D demonstrates.
- (c) Set scan area, grid size and other setting on the DASY software.
- (d) Measure SAR results for the highest power channel on each testing position.
- (e) Find out the largest SAR result on these testing positions of each band
- (f) Measure SAR results for other channels in worst SAR testing position if the reported SAR of highest power channel is larger than 0.8 W/kg

According to the test standard, the recommended procedure for assessing the peak spatial-average SAR value consists of the following steps:

- (a) Power reference measurement
- (b) Area scan
- (c) Zoom scan
- (d) Power drift measurement

8.1 Spatial Peak SAR Evaluation

The procedure for spatial peak SAR evaluation has been implemented according to the test standard. It can be conducted for 1g and 10g, as well as for user-specific masses. The DASY software includes all numerical procedures necessary to evaluate the spatial peak SAR value.

The base for the evaluation is a "cube" measurement. The measured volume must include the 1g and 10g cubes with the highest averaged SAR values. For that purpose, the center of the measured volume is aligned to the interpolated peak SAR value of a previously performed area scan.

The entire evaluation of the spatial peak values is performed within the post-processing engine (SEMCAD). The system always gives the maximum values for the 1g and 10g cubes. The algorithm to find the cube with highest averaged SAR is divided into the following stages:

- (a) Extraction of the measured data (grid and values) from the Zoom Scan
- (b) Calculation of the SAR value at every measurement point based on all stored data (A/D values and measurement parameters)
- (c) Generation of a high-resolution mesh within the measured volume
- (d) Interpolation of all measured values from the measurement grid to the high-resolution grid
- (e) Extrapolation of the entire 3-D field distribution to the phantom surface over the distance from sensor to surface
- (f) Calculation of the averaged SAR within masses of 1g and 10g

8.2 Power Reference Measurement

The Power Reference Measurement and Power Drift Measurements are for monitoring the power drift of the device under test in the batch process. The minimum distance of probe sensors to surface determines the closest measurement point to phantom surface. This distance cannot be smaller than the distance of sensor calibration points to probe tip as defined in the probe properties.

8.3 Area Scan

The area scan is used as a fast scan in two dimensions to find the area of high field values, before doing a fine measurement around the hot spot. The sophisticated interpolation routines implemented in DASY software can find the maximum found in the scanned area, within a range of the global maximum. The range (in dB0 is specified in the standards for compliance testing. For example, a 2 dB range is required in IEEE standard 1528 and IEC 62209 standards, whereby 3 dB is a requirement when compliance is assessed in accordance with the ARIB standard (Japan), if only one zoom scan follows the area scan, then only the absolute maximum will be taken as reference. For cases where multiple maximums are detected, the number of zoom scans has to be increased accordingly.

Area scan parameters extracted from FCC KDB 865664 D01v01r03 SAR measurement 100 MHz to 6 GHz.

	≤ 3 GHz	> 3 GHz
Maximum distance from closest measurement point (geometric center of probe sensors) to phantom surface	5 ± 1 mm	$\frac{1}{2} \cdot \delta \cdot \ln(2) \pm 0.5$ mm
Maximum probe angle from probe axis to phantom surface normal at the measurement location	30° ± 1°	20° ± 1°
Maximum area scan spatial resolution: $\Delta x_{Area}, \Delta y_{Area}$	≤ 2 GHz: ≤ 15 mm 2 – 3 GHz: ≤ 12 mm	3 – 4 GHz: ≤ 12 mm 4 – 6 GHz: ≤ 10 mm
	When the x or y dimension of the test device, in the measurement plane orientation, is smaller than the above, the measurement resolution must be ≤ the corresponding x or y dimension of the test device with at least one measurement point on the test device.	

8.4 Zoom Scan

Zoom scans are used assess the peak spatial SAR values within a cubic averaging volume containing 1 gram and 10 gram of simulated tissue. The zoom scan measures points (refer to table below) within a cube shoes base faces are centered on the maxima found in a preceding area scan job within the same procedure. When the measurement is done, the zoom scan evaluates the averaged SAR for 1 gram and 10 gram and displays these values next to the job's label.

Zoom scan parameters extracted from FCC KDB 865664 D01v01r03 SAR measurement 100 MHz to 6 GHz.

		≤ 3 GHz	> 3 GHz	
Maximum zoom scan spatial resolution: $\Delta x_{Zoom}, \Delta y_{Zoom}$		≤ 2 GHz: ≤ 8 mm 2 – 3 GHz: ≤ 5 mm*	3 – 4 GHz: ≤ 5 mm* 4 – 6 GHz: ≤ 4 mm*	
Maximum zoom scan spatial resolution, normal to phantom surface	uniform grid: $\Delta z_{Zoom}(n)$	≤ 5 mm	3 – 4 GHz: ≤ 4 mm 4 – 5 GHz: ≤ 3 mm 5 – 6 GHz: ≤ 2 mm	
	graded grid	$\Delta z_{Zoom}(1)$: between 1 st two points closest to phantom surface	≤ 4 mm	3 – 4 GHz: ≤ 3 mm 4 – 5 GHz: ≤ 2.5 mm 5 – 6 GHz: ≤ 2 mm
		$\Delta z_{Zoom}(n>1)$: between subsequent points	$\leq 1.5 \cdot \Delta z_{Zoom}(n-1)$	
Minimum zoom scan volume	x, y, z	≥ 30 mm	3 – 4 GHz: ≥ 28 mm 4 – 5 GHz: ≥ 25 mm 5 – 6 GHz: ≥ 22 mm	
Note: δ is the penetration depth of a plane-wave at normal incidence to the tissue medium; see draft standard IEEE P1528-2011 for details. * When zoom scan is required and the <i>reported</i> SAR from the <i>area scan based 1-g SAR estimation</i> procedures of KDB 447498 is ≤ 1.4 W/kg, ≤ 8 mm, ≤ 7 mm and ≤ 5 mm zoom scan resolution may be applied, respectively, for 2 GHz to 3 GHz, 3 GHz to 4 GHz and 4 GHz to 6 GHz.				

8.5 Volume Scan Procedures

The volume scan is used for assess overlapping SAR distributions for antennas transmitting in different frequency bands. It is equivalent to an oversized zoom scan used in standalone measurements. The measurement volume will be used to enclose all the simultaneous transmitting antennas. For antennas transmitting simultaneously in different frequency bands, the volume scan is measured separately in each frequency band. In order to sum correctly to compute the 1g aggregate SAR, the EUT remain in the same test position for all measurements and all volume scan use the same spatial resolution and grid spacing. When all volume scan were completed, the software, SEMCAD postprocessor can combine and subsequently superpose these measurement data to calculating the multiband SAR.

8.6 Power Drift Monitoring

All SAR testing is under the EUT install full charged battery and transmit maximum output power. In DASy measurement software, the power reference measurement and power drift measurement procedures are used for monitoring the power drift of EUT during SAR test. Both these procedures measure the field at a specified reference position before and after the SAR testing. The software will calculate the field difference in dB. If the power drifts more than 5%, the SAR will be retested.



9. Test Equipment List

Manufacturer	Name of Equipment	Type/Model	Serial Number	Calibration	
				Last Cal.	Due Date
SPEAG	835MHz System Validation Kit	D835V2	4d162	Nov. 19, 2014	Nov. 18, 2015
SPEAG	1900MHz System Validation Kit	D1900V2	5d182	Nov. 14, 2014	Nov. 13, 2015
SPEAG	2450MHz System Validation Kit	D2450V2	924	Nov. 19, 2014	Nov. 18, 2015
SPEAG	2600MHz System Validation Kit	D2600V2	1070	Nov. 19, 2014	Nov. 18, 2015
SPEAG	5GHz System Validation Kit	D5GHzV2	1006	Sep. 25, 2014	Sep. 24, 2015
SPEAG	Data Acquisition Electronics	DAE4	778	Aug. 21, 2014	Aug. 20, 2015
SPEAG	Data Acquisition Electronics	DAE4	1279	Jul. 23, 2014	Jul. 22, 2015
SPEAG	Data Acquisition Electronics	DAE3	495	May. 19, 2014	May. 18, 2015
SPEAG	Data Acquisition Electronics	DAE4	1399	Nov. 13, 2014	Nov. 12, 2015
SPEAG	Dosimetric E-Field Probe	ES3DV3	3270	Sep. 26, 2014	Sep. 25, 2015
SPEAG	Dosimetric E-Field Probe	EX3DV4	3954	Nov. 21, 2014	Nov. 20, 2015
SPEAG	Dosimetric E-Field Probe	EX3DV4	3955	Nov. 21, 2014	Nov. 20, 2015
SPEAG	Dosimetric E-Field Probe	EX3DV4	3925	May. 22, 2014	May. 21, 2015
Wisewind	Thermometer	ETP-101	TM685	Oct. 21, 2014	Oct. 20, 2015
Wisewind	Thermometer	HTC-1	TM642	Oct. 21, 2014	Oct. 20, 2015
Wisewind	Thermometer	HTC-1	TM281	Oct. 21, 2014	Oct. 20, 2015
H.M.IRIS	Thermometer	TH-08	TM658	Oct. 21, 2014	Oct. 20, 2015
Anritsu	Radio Communication Analyzer	MT8820C	6201074414	Feb. 11, 2014	Feb. 10, 2015
Anritsu	Radio Communication Analyzer	MT8820C	6201381760	May. 28, 2014	May. 27, 2015
Agilent	Wireless Communication Test Set	E5515C	MY50266977	May. 27, 2014	May. 26, 2015
R&S	BT Base Station	CBT32	100522	Feb. 19, 2014	Feb. 18, 2015
SPEAG	Device Holder	N/A	N/A	NCR	NCR
R&S	Signal Generator	SMU200A	102502	Jul. 07, 2014	Jul. 06, 2015
SPEAG	Dielectric Probe Kit	DAKS-3.5	0004	Mar. 04, 2014	Mar. 03, 2015
SPEAG	Dielectric Probe Kit	DAK-3.5	1138	Nov. 18, 2014	Nov. 17, 2015
Agilent	ENA Network Analyzer	E5071C	MY46101588	May. 31, 2014	May. 30, 2015
Anritsu	Power Meter	ML2495A	1036004	Aug. 09, 2014	Aug. 08, 2015
Anritsu	Power Sensor	MA2411B	1027253	Aug. 11, 2014	Aug. 10, 2015
R&S	Spectrum Analyzer	FSP 30	101329	Jun. 14, 2014	Jun. 13, 2015
Agilent	Dual Directional Coupler	778D	50422	Note1	
Woken	Attenuator 1	WK0602-XX	N/A	Note1	
PE	Attenuator 2	PE7005-10	N/A	Note1	
PE	Attenuator 3	PE7005- 3	N/A	Note1	
AR	Power Amplifier	5S1G4M2	0328767	Note1	
Mini-Circuits	Power Amplifier	ZVE-3W	162601250	Note1	
Mini-Circuits	Power Amplifier	ZHL-42W+	13440021344	Note1	

General Note:

1. Prior to system verification and validation, the path loss from the signal generator to the system check source and the power meter, which includes the amplifier, cable, attenuator and directional coupler, was measured by the network analyzer. The reading of the power meter was offset by the path loss difference between the path to the power meter and the path to the system check source to monitor the actual power level fed to the system check source.



10. System Verification

10.1 Tissue Verification

The following tissue formulations are provided for reference only as some of the parameters have not been thoroughly verified. The composition of ingredients may be modified accordingly to achieve the desired target tissue parameters required for routine SAR evaluation.

Frequency (MHz)	Water (%)	Sugar (%)	Cellulose (%)	Salt (%)	Preventol (%)	DGBE (%)	Conductivity (σ)	Permittivity (ϵ_r)
For Head								
750	41.1	57.0	0.2	1.4	0.2	0	0.89	41.9
835	40.3	57.9	0.2	1.4	0.2	0	0.90	41.5
900	40.3	57.9	0.2	1.4	0.2	0	0.97	41.5
1800, 1900, 2000	55.2	0	0	0.3	0	44.5	1.40	40.0
2450	55.0	0	0	0	0	45.0	1.80	39.2
2600	54.8	0	0	0.1	0	45.1	1.96	39.0
For Body								
750	51.7	47.2	0	0.9	0.1	0	0.96	55.5
835	50.8	48.2	0	0.9	0.1	0	0.97	55.2
900	50.8	48.2	0	0.9	0.1	0	1.05	55.0
1800, 1900, 2000	70.2	0	0	0.4	0	29.4	1.52	53.3
2450	68.6	0	0	0	0	31.4	1.95	52.7
2600	68.1	0	0	0.1	0	31.8	2.16	52.5

Simulating Liquid for 5GHz, Manufactured by SPEAG

Ingredients	(% by weight)
Water	64~78%
Mineral oil	11~18%
Emulsifiers	9~15%
Additives and Salt	2~3%



<Tissue Dielectric Parameter Check Results>

Frequency (MHz)	Tissue Type	Liquid Temp. (°C)	Conductivity (σ)	Permittivity (ε _r)	Conductivity Target (σ)	Permittivity Target (ε _r)	Delta (σ) (%)	Delta (ε _r) (%)	Limit (%)	Date
835	HSL	22.3	0.921	41.777	0.90	41.50	2.33	0.67	±5	2014/12/16
835	HSL	22.3	0.900	40.826	0.90	41.50	0.00	-1.62	±5	2014/12/22
835	MSL	22.3	0.984	54.486	0.97	55.20	1.44	-1.29	±5	2014/12/16
835	MSL	22.4	0.972	54.215	0.97	55.20	0.21	-1.78	±5	2015/2/14
1900	HSL	22.3	1.432	39.040	1.40	40.00	2.29	-2.40	±5	2014/12/22
1900	HSL	22.4	1.449	38.532	1.40	40.00	3.50	-3.67	±5	2015/2/15
1900	HSL	22.5	1.419	40.384	1.40	40.00	1.36	0.96	±5	2015/2/17
1900	MSL	22.2	1.521	54.415	1.52	53.30	0.07	2.09	±5	2014/12/15
1900	MSL	22.3	1.567	51.574	1.52	53.30	3.09	-3.24	±5	2014/12/20
1900	MSL	22.5	1.532	53.576	1.52	53.30	0.79	0.52	±5	2015/2/17
2450	HSL	22.4	1.840	38.700	1.80	39.20	2.22	-1.28	±5	2014/12/23
2450	HSL	22.4	1.840	38.600	1.80	39.20	2.22	-1.53	±5	2014/12/31
2450	MSL	22.4	1.984	51.263	1.95	52.70	1.74	-2.73	±5	2015/2/16
2600	HSL	22.5	2.003	37.466	1.96	39.00	2.19	-3.93	±5	2014/12/19
2600	MSL	22.5	2.235	54.528	2.16	52.50	3.47	3.86	±5	2014/12/19
5200	HSL	22.4	4.812	35.445	4.66	36.00	3.26	-1.54	±5	2015/2/16
5200	MSL	22.4	5.240	47.500	5.30	49.00	-1.13	-3.06	±5	2014/12/26
5200	MSL	22.4	5.432	47.957	5.30	49.00	2.49	-2.13	±5	2015/3/5
5300	HSL	22.4	4.920	35.315	4.76	35.90	3.36	-1.63	±5	2015/1/16
5300	MSL	22.4	5.380	47.200	5.42	48.90	-0.74	-3.48	±5	2014/12/26
5600	HSL	22.4	5.231	34.710	5.07	35.50	3.18	-2.23	±5	2015/2/16
5600	MSL	22.4	5.770	46.800	5.77	48.50	0.00	-3.51	±5	2014/12/26
5800	HSL	22.5	5.390	34.400	5.27	35.30	2.28	-2.55	±5	2014/12/25
5800	MSL	22.4	6.130	46.500	6.00	48.20	2.17	-3.53	±5	2014/12/26
5800	MSL	22.4	6.251	46.901	6.00	48.20	4.18	-2.70	±5	2015/3/5

10.2 System Performance Check Results

Comparing to the original SAR value provided by SPEAG, the verification data should be within its specification of 10 %. Below table shows the target SAR and measured SAR after normalized to 1W input power. The table below indicates the system performance check can meet the variation criterion and the plots can be referred to Appendix A of this report.

Date	Frequency (MHz)	Tissue Type	Input Power (mW)	Dipole S/N	Probe S/N	DAE S/N	Measured 1g SAR (W/kg)	Targeted 1g SAR (W/kg)	Normalized 1g SAR (W/kg)	Deviation (%)
2014/12/16	835	HSL	250	D835V2-4d162	EX3DV4 - SN3954	DAE4 Sn1279	2.41	9.15	9.64	5.36
2014/12/22	835	HSL	250	D835V2-4d162	EX3DV4 - SN3925	DAE3 Sn495	2.20	9.15	8.80	-3.83
2014/12/16	835	MSL	250	D835V2-4d162	EX3DV4 - SN3954	DAE4 Sn1279	2.52	9.56	10.08	5.44
2015/2/14	835	MSL	250	D835V2-4d162	EX3DV4 - SN3954	DAE4 Sn1279	2.33	9.56	9.32	-2.51
2014/12/22	1900	HSL	250	D1900V2-5d182	EX3DV4 - SN3925	DAE3 Sn495	10.20	39.80	40.80	2.51
2015/2/15	1900	HSL	250	D1900V2-5d182	EX3DV4 - SN3954	DAE4 Sn1279	9.90	39.80	39.60	-0.50
2015/2/17	1900	HSL	250	D1900V2-5d182	EX3DV4 - SN3954	DAE4 Sn1279	9.42	39.80	37.68	-5.33
2014/12/15	1900	MSL	250	D1900V2-5d182	EX3DV4 - SN3954	DAE4 Sn1279	9.93	40.00	39.72	-0.70
2014/12/20	1900	MSL	250	D1900V2-5d182	EX3DV4 - SN3925	DAE3 Sn495	10.50	40.00	42.00	5.00
2015/2/17	1900	MSL	250	D1900V2-5d182	EX3DV4 - SN3954	DAE4 Sn1279	10.40	40.00	41.60	4.00
2014/12/23	2450	HSL	250	D2450V2-924	ES3DV3 - SN3270	DAE4 Sn778	13.90	51.90	55.60	7.13
2014/12/31	2450	HSL	250	D2450V2-924	ES3DV3 - SN3270	DAE4 Sn778	13.20	51.90	52.80	1.73
2015/2/16	2450	MSL	250	D2450V2-924	EX3DV4 - SN3955	DAE4 Sn1399	12.10	51.40	48.40	-5.84
2014/12/19	2600	HSL	250	D2600V2-1070	EX3DV4 - SN3925	DAE3 Sn495	14.80	56.90	59.20	4.04
2014/12/19	2600	MSL	250	D2600V2-1070	EX3DV4 - SN3925	DAE3 Sn495	13.50	55.30	54.00	-2.35
2015/2/16	5200	HSL	100	D5GHZV2-1006	EX3DV4 - SN3955	DAE4 Sn1399	8.32	81.10	83.20	2.59
2014/12/26	5200	MSL	100	D5GHZV2-1006	EX3DV4 - SN3925	DAE3 Sn495	7.79	77.50	77.90	0.52
2015/3/5	5200	MSL	100	D5GHZV2-1006	EX3DV4 - SN3925	DAE3 Sn495	7.83	77.50	78.30	1.03
2015/1/16	5300	HSL	100	D5GHZV2-1006	EX3DV4 - SN3955	DAE4 Sn1399	8.87	86.60	88.70	2.42
2014/12/26	5300	MSL	100	D5GHZV2-1006	EX3DV4 - SN3925	DAE3 Sn495	7.97	80.00	79.70	-0.37
2015/2/16	5600	HSL	100	D5GHZV2-1006	EX3DV4 - SN3955	DAE4 Sn1399	9.21	85.80	92.10	7.34
2014/12/26	5600	MSL	100	D5GHZV2-1006	EX3DV4 - SN3925	DAE3 Sn495	8.32	85.20	83.20	-2.35
2014/12/25	5800	HSL	100	D5GHZV2-1006	EX3DV4 - SN3925	DAE3 Sn495	8.75	82.90	87.50	5.55
2014/12/26	5800	MSL	100	D5GHZV2-1006	EX3DV4 - SN3925	DAE3 Sn495	8.40	78.40	84.00	7.14
2015/3/5	5800	MSL	100	D5GHZV2-1006	EX3DV4 - SN3925	DAE3 Sn495	7.77	78.40	77.70	-0.89

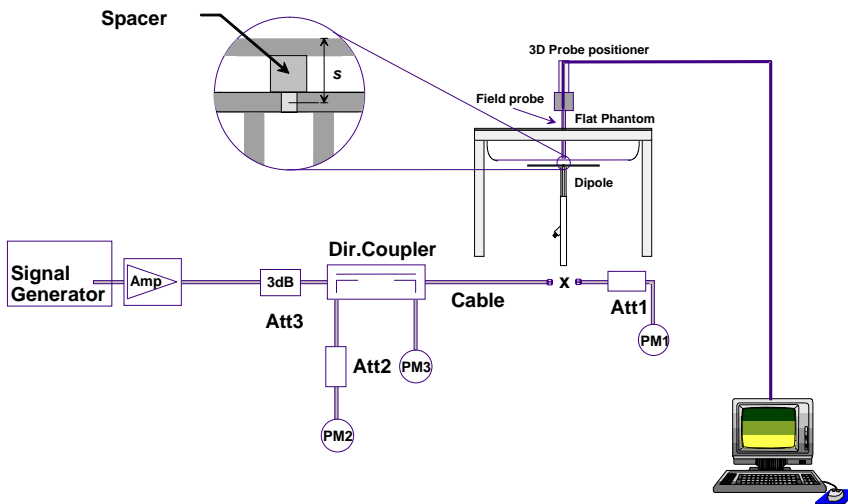

Fig 8.3.1 System Performance Check Setup



Fig 8.3.2 Setup Photo

11. RF Exposure Positions

11.1 Ear and handset reference point

Figure 9.1.1 shows the front, back, and side views of the SAM phantom. The center-of-mouth reference point is labeled “M,” the left ear reference point (ERP) is marked “LE,” and the right ERP is marked “RE.” Each ERP is 15 mm along the B-M (back-mouth) line behind the entrance-to-ear-canal (EEC) point, as shown in Figure 9.1.2 The Reference Plane is defined as passing through the two ear reference points and point M. The line N-F (neck-front), also called the reference pivoting line, is normal to the Reference Plane and perpendicular to both a line passing through RE and LE and the B-M line (see Figure 9.1.3). Both N-F and B-M lines should be marked on the exterior of the phantom shell to facilitate handset positioning. Posterior to the N-F line the ear shape is a flat surface with 6 mm thickness at each ERP, and forward of the N-F line the ear is truncated, as illustrated in Figure 9.1.2. The ear truncation is introduced to preclude the ear lobe from interfering with handset tilt, which could lead to unstable positioning at the cheek.

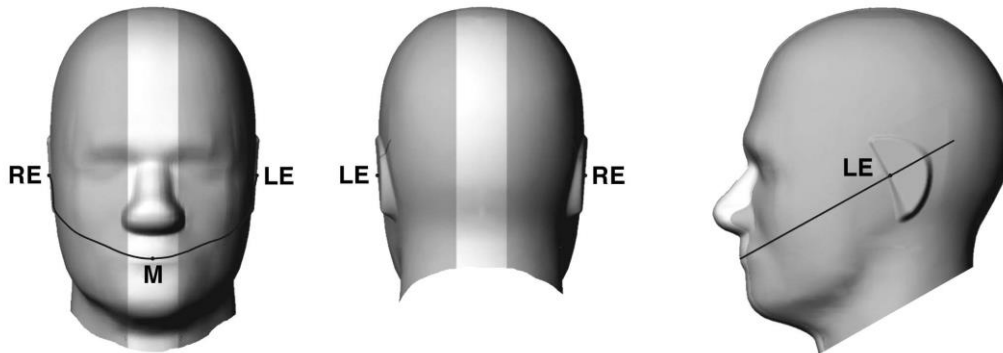

Fig 9.1.1 Front, back, and side views of SAM twin phantom



Fig 9.1.2 Close-up side view of phantom showing the ear region.

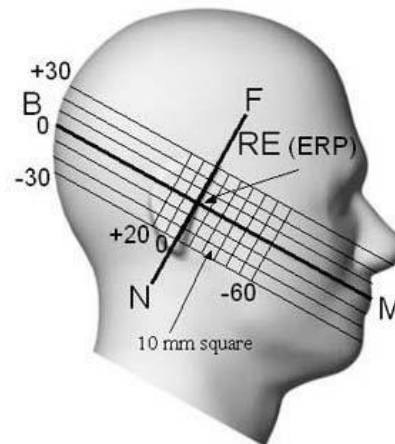

Fig 9.1.3 Side view of the phantom showing relevant markings and seven cross-sectional plane locations

11.2 Definition of the cheek position

1. Ready the handset for talk operation, if necessary. For example, for handsets with a cover piece (flip cover), open the cover. If the handset can transmit with the cover closed, both configurations must be tested.
2. Define two imaginary lines on the handset—the vertical centerline and the horizontal line. The vertical centerline passes through two points on the front side of the handset—the midpoint of the width w_t of the handset at the level of the acoustic output (point A in Figure 9.2.1 and Figure 9.2.2), and the midpoint of the width w_b of the bottom of the handset (point B). The horizontal line is perpendicular to the vertical centerline and passes through the center of the acoustic output (see Figure 9.2.1). The two lines intersect at point A. Note that for many handsets, point A coincides with the center of the acoustic output; however, the acoustic output may be located elsewhere on the horizontal line. Also note that the vertical centerline is not necessarily parallel to the front face of the handset (see Figure 9.2.2), especially for clamshell handsets, handsets with flip covers, and other irregularly-shaped handsets.
3. Position the handset close to the surface of the phantom such that point A is on the (virtual) extension of the line passing through points RE and LE on the phantom (see Figure 9.2.3), such that the plane defined by the vertical centerline and the horizontal line of the handset is approximately parallel to the sagittal plane of the phantom.
4. Translate the handset towards the phantom along the line passing through RE and LE until handset point A touches the pinna at the ERP.
5. While maintaining the handset in this plane, rotate it around the LE-RE line until the vertical centerline is in the plane normal to the plane containing B-M and N-F lines, i.e., the Reference Plane.
6. Rotate the handset around the vertical centerline until the handset (horizontal line) is parallel to the N-F line.
7. While maintaining the vertical centerline in the Reference Plane, keeping point A on the line passing through RE and LE, and maintaining the handset contact with the pinna, rotate the handset about the N-F line until any point on the handset is in contact with a phantom point below the pinna on the cheek. See Figure 9.2.3. The actual rotation angles should be documented in the test report.



Fig 9.2.1 Handset vertical and horizontal reference lines—“fixed case”

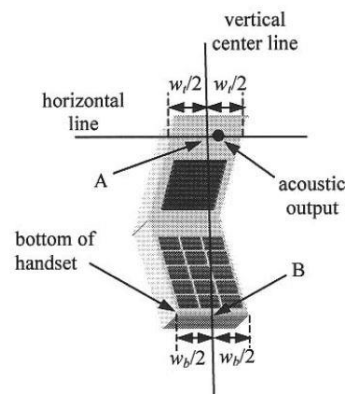

Fig 9.2.2 Handset vertical and horizontal reference lines—“clam-shell case”

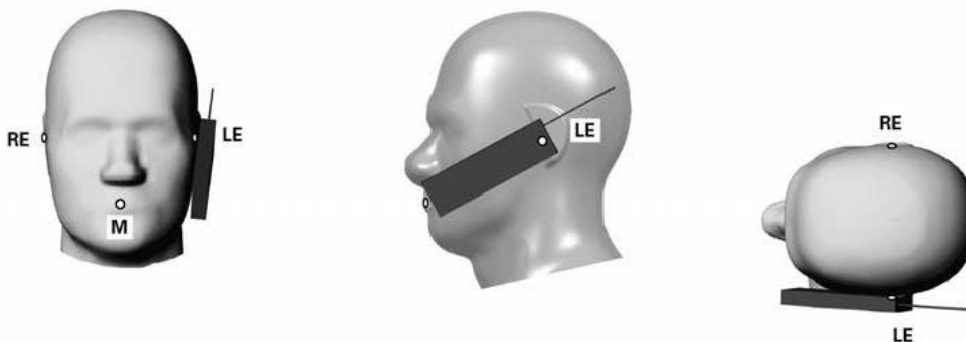

Fig 9.2.3 cheek or touch position. The reference points for the right ear (RE), left ear (LE), and mouth (M), which establish the Reference Plane for handset positioning, are indicated.

11.3 Definition of the tilt position

1. Ready the handset for talk operation, if necessary. For example, for handsets with a cover piece (flip cover), open the cover. If the handset can transmit with the cover closed, both configurations must be tested.
2. While maintaining the orientation of the handset, move the handset away from the pinna along the line passing through RE and LE far enough to allow a rotation of the handset away from the cheek by 15°.
3. Rotate the handset around the horizontal line by 15°.
4. While maintaining the orientation of the handset, move the handset towards the phantom on the line passing through RE and LE until any part of the handset touches the ear. The tilt position is obtained when the contact point is on the pinna. See Figure 9.3.1. If contact occurs at any location other than the pinna, e.g., the antenna at the back of the phantom head, the angle of the handset should be reduced. In this case, the tilt position is obtained if any point on the handset is in contact with the pinna and a second point

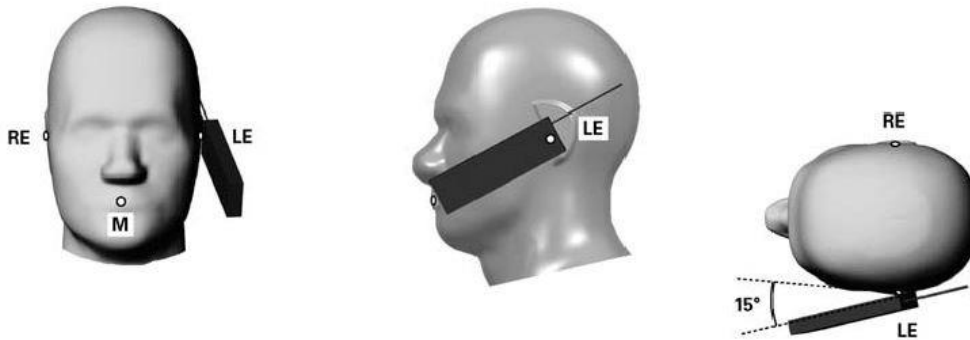

Fig 9.3.1 Tilt position. The reference points for the right ear (RE), left ear (LE), and mouth (M), which define the Reference Plane for handset positioning, are indicated.

11.4 Body Worn Accessory

Body-worn operating configurations are tested with the belt-clips and holsters attached to the device and positioned against a flat phantom in a normal use configuration (see Figure 9.4). Per KDB 648474 D04v01r02, body-worn accessory exposure is typically related to voice mode operations when handsets are carried in body-worn accessories. The body-worn accessory procedures in FCC KDB 447498 D01v05r02 should be used to test for body-worn accessory SAR compliance, without a headset connected to it. This enables the test results for such configuration to be compatible with that required for hotspot mode when the body-worn accessory test separation distance is greater than or equal to that required for hotspot mode, when applicable. When the reported SAR for body-worn accessory, measured without a headset connected to the handset is < 1.2 W/kg, the highest reported SAR configuration for that wireless mode and frequency band should be repeated for that body-worn accessory with a headset attached to the handset.

Accessories for body-worn operation configurations are divided into two categories: those that do not contain metallic components and those that do contain metallic components. When multiple accessories that do not contain metallic components are supplied with the device, the device is tested with only the accessory that dictates the closest spacing to the body. Then multiple accessories that contain metallic components are test with the device with each accessory. If multiple accessories share an identical metallic component (i.e. the same metallic belt-clip used with different holsters with no other metallic components) only the accessory that dictates the closest spacing to the body is tested.

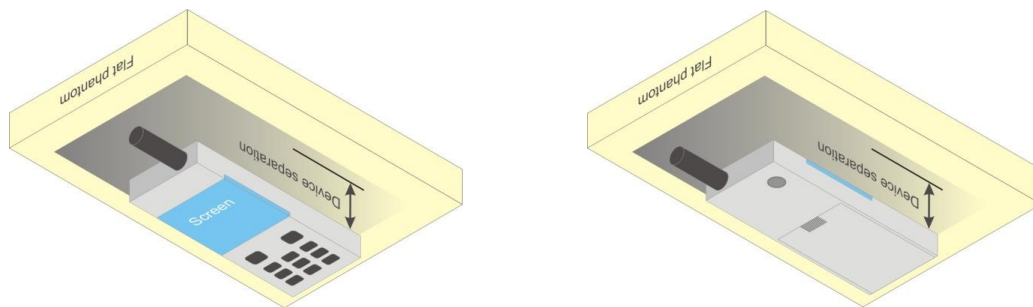

Fig 9.4 Body Worn Position

11.5 Wireless Router

Some battery-operated handsets have the capability to transmit and receive user through simultaneous transmission of WIFI simultaneously with a separate licensed transmitter. The FCC has provided guidance in FCC HDB Publication 941225 D06 v02 where SAR test considerations for handsets (L x W ≥ 9 cm x 5 cm) are based on a composite test separation distance of 10mm from the front, back and edges of the device containing transmitting antennas within 2.5cm of their edges, determined from general mixed use conditions for this type of devices. Since the hotspot SAR results may overlap with the body-worn accessory SAR requirements, the more conservative configurations can be considered, thus excluding some body-worn accessory SAR tests.

When the user enables the personal wireless router functions for the handset, actual operations include simultaneous transmission of both the WIFI transmitter and another licensed transmitter. Both transmitters often do not transmit at the same transmitting frequency and thus cannot be evaluated for SAR under actual use conditions due to the limitations of the SAR assessment probes. Therefore, SAR must be evaluated for each frequency transmission and mode separately and spatially summed with the WIFI transmitter according to FCC KDB Publication 447498 D01v05r02 publication procedures. The "Portable Hotspot" feature on the handset was NOT activated during SAR assessments, to ensure the SAR measurements were evaluated for a single transmission frequency RF signal at a time.



12. Conducted RF Output Power (Unit: dBm)

<GSM Conducted Power>

General Note:

- For DTM multi-slot class mode, the device was linked with base station simulator (Agilent E5515C) and transmit maximum power on maximum number of TX slots, i.e. one CS timeslot, and additional PS timeslots (1 for DTM class 5 and 9, 2 for DTM class 11) in one TDMA frame.
- Agilent E5515C was used to setup the device operated under DTM mode for power measurement and SAR testing. For conducted power, the power of the burst for voice and the power of the bursts for data was reported separately in the table above, and the frame-average power is derived below to determine SAR testing.

$$DTM \text{ frame average power (dBm)} = 10 * \log [\sum(\text{power of each slot, in mW})/8]$$
- Per KDB 447498 D01v05r02, the maximum output power channel is used for SAR testing and for further SAR test reduction.
- Per KDB 941225 D01v03, considering the possibility of e.g. 3rd party VoIP operation for Head and body-worn SAR test reduction for GSM and GPRS and EDGE modes is determined by the source-based time-averaged output power including tune-up tolerance. The mode with highest specified time-averaged output power should be tested for SAR compliance in the applicable exposure conditions. For modes with the same specified maximum output power and tolerance, the higher number time-slot configuration should be tested. Therefore, the EUT was set in GPRS (4Tx slots) for GSM850/GSM1900.
- Per KDB 941225 D01v03, for Hotspot SAR test reduction for GPRS and EDGE modes is determined by the source-based time-averaged output power including tune-up tolerance, for modes with the same specified maximum output power and tolerance, the higher number time-slot configuration should be tested, therefore, the EUT was set in GPRS (4Tx slots) for GSM850/GSM1900.

Band GSM850		Burst Average Power (dBm)			Tune-up Limit (dBm)	Frame-Average Power (dBm)			Tune-up Limit (dBm)
TX Channel		128	189	251		128	189	251	
Frequency (MHz)		824.2	836.4	848.8		824.2	836.4	848.8	
GSM (GMSK, 1 Tx slot)		33.58	33.62	33.66	34.00	24.58	24.62	24.66	25.00
GPRS (GMSK, 1 Tx slot)		33.59	33.63	33.66	34.00	24.59	24.63	24.66	25.00
GPRS (GMSK, 2 Tx slots)		29.89	29.91	29.98	30.00	23.89	23.91	23.98	24.00
GPRS (GMSK, 3 Tx slots)		28.88	28.95	28.97	29.00	24.62	24.69	24.71	24.74
GPRS (GMSK, 4 Tx slots)		27.56	27.72	27.80	28.00	24.56	24.72	24.80	25.00
EDGE (8PSK, 1 Tx slot)		26.72	26.72	26.76	27.00	17.72	17.72	17.76	18.00
EDGE (8PSK, 2 Tx slots)		25.98	25.95	25.99	26.00	19.98	19.95	19.99	20.00
EDGE (8PSK, 3 Tx slots)		25.97	25.94	25.98	26.00	21.71	21.68	21.72	21.74
EDGE (8PSK, 4 Tx slots)		24.87	24.83	24.90	25.00	21.87	21.83	21.90	22.00
DTM 5 (2Tx slots)	GSM (GMSK, 1 Tx slot)	29.80	29.87	29.95	30.00	23.72	23.78	23.93	23.98
	GPRS (GMSK, 1 Tx slot)	29.68	29.74	29.96	30.00				
DTM 9 (2Tx slots)	GSM (GMSK, 1 Tx slot)	29.78	29.85	29.96	30.00	23.70	23.80	23.93	23.98
	GPRS (GMSK, 1 Tx slot)	29.66	29.80	29.95	30.00				
DTM 11 (3Tx slots)	GSM (GMSK, 1 Tx slot)	28.68	28.81	28.88	29.00	24.34	24.48	24.55	24.74
	GPRS (GMSK, 2 Tx slots)	28.56	28.70	28.78	29.00				
DTM 5 (2Tx slots)	GSM (GMSK, 1 Tx slot)	29.85	29.91	29.98	30.00	22.30	22.34	22.40	22.42
	EDGE (8PSK, 1 Tx slot)	25.95	25.93	25.98	26.00				
DTM 9 (2Tx slots)	GSM (GMSK, 1 Tx slot)	29.81	29.95	29.98	30.00	22.27	22.36	22.40	22.42
	EDGE (8PSK, 1 Tx slot)	25.93	25.90	25.95	26.00				
DTM 11 (3Tx slots)	GSM (GMSK, 1 Tx slot)	28.84	28.94	28.99	29.00	22.89	22.91	22.95	22.98
	EDGE (8PSK, 2 Tx slots)	25.97	25.91	25.95	26.00				



Band GSM1900		Burst Average Power (dBm)			Tune-up Limit (dBm)	Frame-Average Power (dBm)			Tune-up Limit (dBm)
TX Channel		512	661	810		512	661	810	
Frequency (MHz)		1850.2	1880	1909.8	1850.2	1880	1909.8		
GSM (GMSK, 1 Tx slot)		30.83	30.77	30.89	31.00	21.83	21.77	21.89	22.00
GPRS (GMSK, 1 Tx slot)		30.84	30.78	30.90	31.00	21.84	21.78	21.90	22.00
GPRS (GMSK, 2 Tx slots)		29.70	29.71	29.76	30.00	23.70	23.71	23.76	24.00
GPRS (GMSK, 3 Tx slots)		28.38	28.46	28.55	29.00	24.12	24.20	24.29	24.74
GPRS (GMSK, 4 Tx slots)		26.92	26.97	27.05	28.00	23.92	23.97	24.05	25.00
EDGE (8PSK, 1 Tx slot)		25.90	25.99	26.00	26.00	16.90	16.99	17.00	17.00
EDGE (8PSK, 2 Tx slots)		25.86	25.94	25.97	26.00	19.86	19.94	19.97	20.00
EDGE (8PSK, 3 Tx slots)		25.28	25.35	25.39	26.00	21.02	21.09	21.13	21.74
EDGE (8PSK, 4 Tx slots)		24.64	24.75	24.82	25.00	21.64	21.75	21.82	22.00
DTM 5 (2Tx slots)	GSM (GMSK, 1 Tx slot)	29.68	29.68	29.73	30.00	23.64	23.65	23.70	23.98
	GPRS (GMSK, 1 Tx slot)	29.65	29.66	29.71	30.00				
DTM 9 (2Tx slots)	GSM (GMSK, 1 Tx slot)	29.67	29.65	29.68	30.00	23.63	23.62	23.64	23.98
	GPRS (GMSK, 1 Tx slot)	29.64	29.63	29.65	30.00				
DTM 11 (3Tx slots)	GSM (GMSK, 1 Tx slot)	28.35	28.43	28.51	29.00	24.07	24.16	24.22	24.74
	GPRS (GMSK, 2 Tx slots)	28.32	28.41	28.46	29.00				
DTM 5 (2Tx slots)	GSM (GMSK, 1 Tx slot)	29.68	29.69	29.74	30.00	22.15	22.18	22.22	22.42
	EDGE (8PSK, 1 Tx slot)	25.84	25.91	25.94	26.00				
DTM 9 (2Tx slots)	GSM (GMSK, 1 Tx slot)	29.64	29.65	29.71	30.00	22.11	22.14	22.19	22.42
	EDGE (8PSK, 1 Tx slot)	25.81	25.87	25.90	26.00				
DTM 11 (3Tx slots)	GSM (GMSK, 1 Tx slot)	28.35	28.44	28.51	29.00	22.28	22.36	22.42	22.98
	EDGE (8PSK, 2 Tx slots)	25.25	25.31	25.35	26.00				

<WCDMA Conducted Power>

1. The following tests were conducted according to the test requirements outlines in 3GPP TS 34.121 specification.
2. The procedures in KDB 941225 D01 are applied for 3GPP Rel. 6 HSPA to configure the device in the required sub-test mode(s) to determine SAR test exclusion.
3. For DC-HSDPA, the device was configured according to the H-Set 12, Fixed Reference Channel (FRC) configuration in Table C.8.1.12 of 3GPP TS 34.121-1, with the primary and the secondary serving HS-DSCH Cell enabled during the power measurement.

A summary of these settings are illustrated below:

HSDPA Setup Configuration:

- a. The EUT was connected to Base Station Agilent E5515C referred to the Setup Configuration.
- b. The RF path losses were compensated into the measurements.
- c. A call was established between EUT and Base Station with following setting:
 - i. Set Gain Factors (β_c and β_d) and parameters were set according to each
 - ii. Specific sub-test in the following table, C10.1.4, quoted from the TS 34.121
 - iii. Set RMC 12.2Kbps + HSDPA mode.
 - iv. Set Cell Power = -86 dBm
 - v. Set HS-DSCH Configuration Type to FRC (H-set 1, QPSK)
 - vi. Select HSDPA Uplink Parameters
 - vii. Set Delta ACK, Delta NACK and Delta CQI = 8
 - viii. Set Ack-Nack Repetition Factor to 3
 - ix. Set CQI Feedback Cycle (k) to 4 ms
 - x. Set CQI Repetition Factor to 2
 - xi. Power Ctrl Mode = All Up bits
- d. The transmitted maximum output power was recorded.

Table C.10.1.4: β values for transmitter characteristics tests with HS-DPCCH

Sub-test	β_c	β_d	β_d (SF)	β_c/β_d	β_{HS} (Note 1, Note 2)	CM (dB) (Note 3)	MPR (dB) (Note 3)
1	2/15	15/15	64	2/15	4/15	0.0	0.0
2	12/15 (Note 4)	15/15 (Note 4)	64	12/15 (Note 4)	24/15	1.0	0.0
3	15/15	8/15	64	15/8	30/15	1.5	0.5
4	15/15	4/15	64	15/4	30/15	1.5	0.5

Note 1: $\Delta_{ACK}, \Delta_{NACK}$ and $\Delta_{CQI} = 30/15$ with $\beta_{HS} = 30/15 * \beta_c$.

Note 2: For the HS-DPCCH power mask requirement test in clause 5.2C, 5.7A, and the Error Vector Magnitude (EVM) with HS-DPCCH test in clause 5.13.1A, and HSDPA EVM with phase discontinuity in clause 5.13.1AA, Δ_{ACK} and $\Delta_{NACK} = 30/15$ with $\beta_{HS} = 30/15 * \beta_c$, and $\Delta_{CQI} = 24/15$ with $\beta_{HS} = 24/15 * \beta_c$.

Note 3: CM = 1 for $\beta_c/\beta_d = 12/15, \beta_{HS}/\beta_c = 24/15$. For all other combinations of DPCCH, DPDCCH and HS-DPCCH the MPR is based on the relative CM difference. This is applicable for only UEs that support HSDPA in release 6 and later releases.

Note 4: For subtest 2 the β_c/β_d ratio of 12/15 for the TFC during the measurement period (TF1, TF0) is achieved by setting the signalled gain factors for the reference TFC (TF1, TF1) to $\beta_c = 11/15$ and $\beta_d = 15/15$.

Setup Configuration

HSUPA Setup Configuration:

- a. The EUT was connected to Base Station Agilent E5515C referred to the Setup Configuration.
- b. The RF path losses were compensated into the measurements.
- c. A call was established between EUT and Base Station with following setting * :
 - i. Call Configs = 5.2B, 5.9B, 5.10B, and 5.13.2B with QPSK
 - ii. Set the Gain Factors (β_c and β_d) and parameters (AG Index) were set according to each specific sub-test in the following table, C11.1.3, quoted from the TS 34.121
 - iii. Set Cell Power = -86 dBm
 - iv. Set Channel Type = 12.2k + HSPA
 - v. Set UE Target Power
 - vi. Power Ctrl Mode= Alternating bits
 - vii. Set and observe the E-TFCl
 - viii. Confirm that E-TFCl is equal to the target E-TFCl of 75 for sub-test 1, and other subtest's E-TFCl
- d. The transmitted maximum output power was recorded.

Table C.11.1.3: β values for transmitter characteristics tests with HS-DPCCH and E-DCH

Sub-test	β_c	β_d	β_d (SF)	β_c/β_d	β_{HS} (Note 1)	β_{ec}	β_{ed} (Note 5) (Note 6)	β_{ed} (SF)	β_{ed} (Codes)	CM (dB) (Note 2)	MPR (dB) (Note 2)	AG Index (Note 6)	E-TFCl
1	11/15 (Note 3)	15/15 (Note 3)	64	11/15 (Note 3)	22/15	209/25	1309/225	4	1	1.0	0.0	20	75
2	6/15	15/15	64	6/15	12/15	12/15	94/75	4	1	3.0	2.0	12	67
3	15/15	9/15	64	15/9	30/15	30/15	$\beta_{ed1}: 47/15$ $\beta_{ed2}: 47/15$	4 4	2	2.0	1.0	15	92
4	2/15	15/15	64	2/15	4/15	2/15	56/75	4	1	3.0	2.0	17	71
5	15/15 (Note 4)	15/15 (Note 4)	64	15/15 (Note 4)	30/15	24/15	134/15	4	1	1.0	0.0	21	81

Note 1: $\Delta_{ACK}, \Delta_{NACK}$ and $\Delta_{CQI} = 30/15$ with $\beta_{hs} = 30/15 * \beta_c$.

Note 2: CM = 1 for $\beta_c/\beta_d = 12/15$, $\beta_{hs}/\beta_c = 24/15$. For all other combinations of DPDCH, DPCCH, HS- DPCCH, E-DPDCH and E-DPCCH the MPR is based on the relative CM difference.

Note 3: For subtest 1 the β_c/β_d ratio of 11/15 for the TFC during the measurement period (TF1, TF0) is achieved by setting the signalled gain factors for the reference TFC (TF1, TF1) to $\beta_c = 10/15$ and $\beta_d = 15/15$.

Note 4: For subtest 5 the β_c/β_d ratio of 15/15 for the TFC during the measurement period (TF1, TF0) is achieved by setting the signalled gain factors for the reference TFC (TF1, TF1) to $\beta_c = 14/15$ and $\beta_d = 15/15$.

Note 5: In case of testing by UE using E-DPDCH Physical Layer category 1, Sub-test 3 is omitted according to TS25.306 Table 5.1g.

Note 6: β_{ed} can not be set directly, it is set by Absolute Grant Value.

Setup Configuration

DC-HSDPA 3GPP release 8 Setup Configuration:

- a. The EUT was connected to Base Station Agilent E5515C referred to the Setup Configuration below
- b. The RF path losses were compensated into the measurements.
- c. A call was established between EUT and Base Station with following setting:
 - i. Set RMC 12.2Kbps + HSDPA mode.
 - ii. Set Cell Power = -25 dBm
 - iii. Set HS-DSCH Configuration Type to FRC (H-set 12, QPSK)
 - iv. Select HSDPA Uplink Parameters
 - v. Set Gain Factors (β_c and β_d) and parameters were set according to each Specific sub-test in the following table, C10.1.4, quoted from the TS 34.121
 - a). Subtest 1: $\beta_c/\beta_d=2/15$
 - b). Subtest 2: $\beta_c/\beta_d=12/15$
 - c). Subtest 3: $\beta_c/\beta_d=15/8$
 - d). Subtest 4: $\beta_c/\beta_d=15/4$
 - vi. Set Delta ACK, Delta NACK and Delta CQI = 8
 - vii. Set Ack-Nack Repetition Factor to 3
 - viii. Set CQI Feedback Cycle (k) to 4 ms
 - ix. Set CQI Repetition Factor to 2
 - x. Power Ctrl Mode = All Up bits
- d. The transmitted maximum output power was recorded.

The following tests were conducted according to the test requirements outlines in 3GPP TS 34.121 specification. A summary of these settings are illustrated below:

C.8.1.12 Fixed Reference Channel Definition H-Set 12

Table C.8.1.12: Fixed Reference Channel H-Set 12

Parameter	Unit	Value
Nominal Avg. Inf. Bit Rate	kbps	60
Inter-TTI Distance	TTI's	1
Number of HARQ Processes	Processes	6
Information Bit Payload (N_{INF})	Bits	120
Number Code Blocks	Blocks	1
Binary Channel Bits Per TTI	Bits	960
Total Available SML's in UE	SML's	19200
Number of SML's per HARQ Proc.	SML's	3200
Coding Rate		0.15
Number of Physical Channel Codes	Codes	1
Modulation		QPSK
Note 1: The RMC is intended to be used for DC-HSDPA mode and both cells shall transmit with identical parameters as listed in the table. Note 2: Maximum number of transmission is limited to 1, i.e., retransmission is not allowed. The redundancy and constellation version 0 shall be used.		



Figure C.8.19: Coding rate for Fixed reference Channel H-Set 12 (QPSK)

Setup Configuration



<WCDMA Conducted Power>

General Note:

1. Per KDB 941225 D01v03, SAR for Head / Hotspot / Body-worn exposure is measured using a 12.2 kbps RMC with TPC bits configured to all "1's".
2. Per KDB 941225 D01v03, RMC 12.2kbps setting is used to evaluate SAR. If the maximum output power and tune-up tolerance specified for production units in HSDPA / HSUPA / DC-HSDPA is $\leq \frac{1}{4}$ dB higher than RMC 12.2Kbps or when the highest reported SAR of the RMC12.2Kbps is scaled by the ratio of specified maximum output power and tune-up tolerance of HSDPA / HSUPA / DC-HSDPA to RMC12.2Kbps and the adjusted SAR is ≤ 1.2 W/kg, SAR measurement is not required for HSDPA / HSUPA / DC-HSDPA.

Band			WCDMA V			WCDMA II		
TX Channel			4132	4182	4233	9262	9400	9538
Frequency (MHz)			826.4	836.4	846.6	1852.4	1880	1907.6
3GPP MPR (dB)	3GPP Rel 99	AMR 12.2Kbps	24.56	24.59	24.64	23.01	22.88	23.00
	3GPP Rel 99	RMC 12.2Kbps	24.58	24.60	24.67	23.05	22.95	23.04
0	3GPP Rel 6	HSDPA Subtest-1	23.58	23.62	23.77	22.24	22.10	22.21
0	3GPP Rel 6	HSDPA Subtest-2	23.62	23.63	23.72	22.23	22.17	22.24
0.5	3GPP Rel 6	HSDPA Subtest-3	23.18	23.25	23.29	21.93	21.77	21.83
0.5	3GPP Rel 6	HSDPA Subtest-4	23.14	23.15	23.19	21.85	21.75	21.82
0	3GPP Rel 8	DC-HSDPA Subtest-1	23.55	23.61	23.75	22.22	22.08	22.18
0	3GPP Rel 8	DC-HSDPA Subtest-2	23.59	23.61	23.70	22.21	22.14	22.22
0.5	3GPP Rel 8	DC-HSDPA Subtest-3	23.16	23.22	23.26	21.90	21.75	21.81
0.5	3GPP Rel 8	DC-HSDPA Subtest-4	23.12	23.14	23.15	21.83	21.74	21.80
0	3GPP Rel 6	HSUPA Subtest-1	23.52	23.68	23.83	22.13	22.03	22.01
2	3GPP Rel 6	HSUPA Subtest-2	22.35	22.38	22.53	21.25	21.14	21.06
1	3GPP Rel 6	HSUPA Subtest-3	22.16	22.23	22.28	21.26	21.11	21.07
2	3GPP Rel 6	HSUPA Subtest-4	22.48	22.68	22.80	21.17	21.08	21.10
0	3GPP Rel 6	HSUPA Subtest-5	23.40	23.43	23.46	22.30	22.16	22.01

**<LTE Conducted Power>****General Note:**

1. Anritsu MT8820C base station simulator was used to setup the connection with EUT; the frequency band, channel bandwidth, RB allocation configuration, modulation type are set in the base station simulator to configure EUT transmitting at maximum power and at different configurations which are requested to be reported to FCC, for conducted power measurement and SAR testing.
2. Per KDB 941225 D05v02r03, when a properly configured base station simulator is used for the SAR and power measurements, spectrum plots for each RB allocation and offset configuration is not required.
3. Per KDB 941225 D05v02r03, start with the largest channel bandwidth and measure SAR for QPSK with 1 RB allocation, using the RB offset and required test channel combination with the highest maximum output power for RB offsets at the upper edge, middle and lower edge of each required test channel.
4. Per KDB 941225 D05v02r03, 50% RB allocation for QPSK SAR testing follows 1RB QPSK allocation procedure.
5. Per KDB 941225 D05v02r03, For QPSK with 100% RB allocation, SAR is not required when the highest maximum output power for 100 % RB allocation is less than the highest maximum output power in 50% and 1 RB allocations and the highest reported SAR for 1 RB and 50% RB allocation are ≤ 0.8 W/kg. Otherwise, SAR is measured for the highest output power channel; and if the reported SAR is > 1.45 W/kg, the remaining required test channels must also be tested.
6. Per KDB 941225 D05v02r03, 16QAM output power for each RB allocation configuration is $>$ not $\frac{1}{2}$ dB higher than the same configuration in QPSK and the reported SAR for the QPSK configuration is ≤ 1.45 W/kg; Per KDB 941225 D05v02r03, 16QAM SAR testing is not required.
7. Per KDB 941225 D05v02r03, Smaller bandwidth output power for each RB allocation configuration is $>$ not $\frac{1}{2}$ dB higher than the same configuration in the largest supported bandwidth, and the reported SAR for the largest supported bandwidth is ≤ 1.45 W/kg; Per KDB 941225 D05v02r03, smaller bandwidth SAR testing is not required.



<LTE Band 5>

BW [MHz]	Modulation	RB Size	RB Offset	Power Low Ch. / Freq.	Power Middle Ch. / Freq.	Power High Ch. / Freq.	Tune up Limit (dBm)	MPR (dB)
Channel				20450	20525	20600		
Frequency (MHz)				829	836.5	844		
10	QPSK	1	0	24.17	23.98	24.00	25	0
10	QPSK	1	24	23.90	23.89	23.85		
10	QPSK	1	49	23.82	23.82	23.78		
10	QPSK	25	0	23.04	22.97	22.92	24	1
10	QPSK	25	12	22.93	22.84	22.90		
10	QPSK	25	24	22.87	22.90	23.00		
10	QPSK	50	0	22.98	22.88	22.95	24	1
10	16QAM	1	0	22.82	22.81	22.55		
10	16QAM	1	24	22.90	22.91	22.52		
10	16QAM	1	49	22.76	22.87	22.56	23	2
10	16QAM	25	0	21.86	22.03	21.93		
10	16QAM	25	12	21.73	21.87	21.70		
10	16QAM	25	24	21.79	21.74	21.72		
10	16QAM	50	0	21.67	21.80	21.89		
Channel				20425	20525	20625		
Frequency (MHz)				826.5	836.5	846.5		
5	QPSK	1	0	23.98	23.80	23.93	25	0
5	QPSK	1	12	23.75	23.71	23.91		
5	QPSK	1	24	23.65	23.59	23.73		
5	QPSK	12	0	22.83	22.86	22.70	24	1
5	QPSK	12	6	22.82	22.84	22.75		
5	QPSK	12	11	22.94	22.93	22.74		
5	QPSK	25	0	22.85	22.82	22.76	24	1
5	16QAM	1	0	23.00	22.77	22.73		
5	16QAM	1	12	22.83	22.62	22.74		
5	16QAM	1	24	22.64	22.29	22.32	23	2
5	16QAM	12	0	21.68	21.86	21.75		
5	16QAM	12	6	21.84	21.91	21.58		
5	16QAM	12	11	21.82	21.82	21.54		
5	16QAM	25	0	21.83	21.89	21.83		
Channel				20415	20525	20635		
Frequency (MHz)				825.5	836.5	847.5		
3	QPSK	1	0	23.98	24.06	24.16	25	0
3	QPSK	1	7	23.70	23.69	23.80		
3	QPSK	1	14	23.58	23.68	23.86		
3	QPSK	8	0	22.75	22.89	22.87	24	1
3	QPSK	8	4	22.82	22.76	22.84		
3	QPSK	8	7	22.72	22.84	22.71		
3	QPSK	15	0	22.72	22.82	22.76	24	1
3	16QAM	1	0	23.05	23.14	23.03		
3	16QAM	1	7	23.10	22.91	22.77		
3	16QAM	1	14	22.82	22.87	22.67	23	2
3	16QAM	8	0	21.81	21.95	21.82		
3	16QAM	8	4	21.60	22.13	21.88		
3	16QAM	8	7	21.79	22.06	22.02		
3	16QAM	15	0	21.81	21.90	21.71		



Channel				20407	20525	20643	Tune up Limit (dBm)	Target MPR (dB)
Frequency (MHz)				824.7	836.5	848.3		
1.4	QPSK	1	0	24.09	23.97	23.84	25	0
1.4	QPSK	1	2	23.81	23.92	23.86		
1.4	QPSK	1	5	23.61	23.88	23.95		
1.4	QPSK	3	0	23.70	23.87	24.02		
1.4	QPSK	3	1	23.54	23.63	23.92		
1.4	QPSK	3	2	23.80	23.90	23.97		
1.4	QPSK	6	0	22.99	22.81	22.97	24	1
1.4	16QAM	1	0	23.11	23.14	22.73	24	1
1.4	16QAM	1	2	22.91	22.66	22.67		
1.4	16QAM	1	5	22.85	22.54	22.39		
1.4	16QAM	3	0	23.00	22.77	22.58		
1.4	16QAM	3	1	22.96	23.09	22.69		
1.4	16QAM	3	2	23.01	22.60	22.66		
1.4	16QAM	6	0	22.04	21.87	21.92	23	2



<LTE Band 2>

BW [MHz]	Modulation	RB Size	RB Offset	Power Low Ch. / Freq.	Power Middle Ch. / Freq.	Power High Ch. / Freq.	Tune up Limit (dBm)	MPR (dB)
Channel				18700	18900	19100		
Frequency (MHz)				1860	1880	1900		
20	QPSK	1	0	23.45	23.64	23.76	24	0
20	QPSK	1	49	23.36	23.50	23.72		
20	QPSK	1	99	23.21	23.43	23.57		
20	QPSK	50	0	22.60	22.49	22.68	23	1
20	QPSK	50	24	22.57	22.47	22.62		
20	QPSK	50	49	22.50	22.46	22.55		
20	QPSK	100	0	22.54	22.45	22.61	23	1
20	16QAM	1	0	22.62	22.45	22.47		
20	16QAM	1	49	22.52	22.34	22.34		
20	16QAM	1	99	22.48	22.31	22.42	22	2
20	16QAM	50	0	21.61	21.55	21.46		
20	16QAM	50	24	21.54	21.55	21.43		
20	16QAM	50	49	21.48	21.54	21.44	22	2
20	16QAM	100	0	21.51	21.52	21.47		
Channel				18675	18900	19125		
Frequency (MHz)				1857.5	1880	1902.5		
15	QPSK	1	0	23.49	23.56	23.69	24	0
15	QPSK	1	37	23.47	23.46	23.68		
15	QPSK	1	74	23.32	23.45	23.46		
15	QPSK	36	0	22.56	22.48	22.66	23	1
15	QPSK	36	18	22.50	22.38	22.59		
15	QPSK	36	37	22.43	22.44	22.52		
15	QPSK	75	0	22.46	22.42	22.52	23	1
15	16QAM	1	0	22.70	22.38	22.49		
15	16QAM	1	37	22.62	22.35	22.34		
15	16QAM	1	74	22.59	22.21	22.35	22	2
15	16QAM	36	0	21.45	21.54	21.66		
15	16QAM	36	18	21.43	21.45	21.50		
15	16QAM	36	37	21.40	21.50	21.52	22	2
15	16QAM	75	0	21.52	21.43	21.42		
Channel				18650	18900	19150		
Frequency (MHz)				1855	1880	1905		
10	QPSK	1	0	23.61	23.64	23.42	24	0
10	QPSK	1	24	23.57	23.62	23.39		
10	QPSK	1	49	23.60	23.49	23.30		
10	QPSK	25	0	22.41	22.32	22.45	23	1
10	QPSK	25	12	22.47	22.40	22.48		
10	QPSK	25	24	22.42	22.41	22.52		
10	QPSK	50	0	22.39	22.40	22.56	23	1
10	16QAM	1	0	22.25	22.25	22.28		
10	16QAM	1	24	21.95	22.11	22.19		
10	16QAM	1	49	22.00	22.16	22.23	22	2
10	16QAM	25	0	21.33	21.30	21.39		
10	16QAM	25	12	21.32	21.30	21.42		
10	16QAM	25	24	21.29	21.24	21.40	22	2
10	16QAM	50	0	21.48	21.38	21.53		



Channel				18625	18900	19175	Tune up Limit (dBm)	MPR (dB)
Frequency (MHz)				1852.5	1880	1907.5		
5	QPSK	1	0	23.69	23.43	23.54	24	0
5	QPSK	1	12	23.22	23.27	23.37		
5	QPSK	1	24	23.27	23.16	23.39		
5	QPSK	12	0	22.37	22.28	22.42	23	1
5	QPSK	12	6	22.38	22.36	22.55		
5	QPSK	12	11	22.33	22.38	22.46		
5	QPSK	25	0	22.37	22.36	22.50		
5	16QAM	1	0	22.49	22.45	22.51	23	1
5	16QAM	1	12	22.42	22.37	22.49		
5	16QAM	1	24	22.20	22.30	22.40		
5	16QAM	12	0	21.52	21.37	21.46	22	2
5	16QAM	12	6	21.55	21.37	21.46		
5	16QAM	12	11	21.57	21.36	21.45		
5	16QAM	25	0	21.30	21.26	21.36		
Channel				18615	18900	19185	Tune up Limit (dBm)	MPR (dB)
Frequency (MHz)				1851.5	1880	1908.5		
3	QPSK	1	0	23.69	23.69	23.55	24	0
3	QPSK	1	7	23.46	23.64	23.37		
3	QPSK	1	14	23.27	23.60	23.44		
3	QPSK	8	0	22.42	22.49	22.52	23	1
3	QPSK	8	4	22.35	22.53	22.52		
3	QPSK	8	7	22.40	22.48	22.55		
3	QPSK	15	0	22.35	22.44	22.50		
3	16QAM	1	0	22.77	22.74	22.64	23	1
3	16QAM	1	7	22.63	22.62	22.53		
3	16QAM	1	14	22.22	22.64	22.45		
3	16QAM	8	0	21.46	21.34	21.68	22	2
3	16QAM	8	4	21.30	21.48	21.54		
3	16QAM	8	7	21.54	21.44	21.75		
3	16QAM	15	0	21.44	21.24	21.50		
Channel				18607	18900	19193	Tune up Limit (dBm)	MPR (dB)
Frequency (MHz)				1850.7	1880	1909.3		
1.4	QPSK	1	0	23.57	23.60	23.61	24	0
1.4	QPSK	1	2	23.50	23.50	23.55		
1.4	QPSK	1	5	23.40	23.51	23.50		
1.4	QPSK	3	0	23.42	23.53	23.51		
1.4	QPSK	3	1	23.43	23.48	23.58		
1.4	QPSK	3	2	23.52	23.53	23.60		
1.4	QPSK	6	0	22.46	22.40	22.55	23	1
1.4	16QAM	1	0	22.73	22.70	22.69	23	1
1.4	16QAM	1	2	22.64	22.62	22.51		
1.4	16QAM	1	5	22.44	22.40	22.48		
1.4	16QAM	3	0	22.55	22.44	22.46		
1.4	16QAM	3	1	22.33	22.47	22.00		
1.4	16QAM	3	2	22.32	22.51	22.68		
1.4	16QAM	6	0	21.35	21.16	21.43	22	2



<LTE Band 7>

BW [MHz]	Modulation	RB Size	RB Offset	Power Low Ch. / Freq.	Power Middle Ch. / Freq.	Power High Ch. / Freq.	Tune up Limit (dBm)	MPR (dB)
Channel				20850	21100	21350		
Frequency (MHz)				2510	2535	2560		
20	QPSK	1	0	22.78	22.53	22.60	23	0
20	QPSK	1	49	22.45	22.47	22.32		
20	QPSK	1	99	22.22	22.31	22.36		
20	QPSK	50	0	21.52	21.45	21.38	22	1
20	QPSK	50	24	21.31	21.28	21.27		
20	QPSK	50	49	21.31	21.26	21.25		
20	QPSK	100	0	21.36	21.31	21.26		
20	16QAM	1	0	21.90	21.74	21.76	22	1
20	16QAM	1	49	21.56	21.71	21.75		
20	16QAM	1	99	21.73	21.71	21.59		
20	16QAM	50	0	20.45	20.55	20.57	21	2
20	16QAM	50	24	20.37	20.41	20.49		
20	16QAM	50	49	20.43	20.36	20.36		
20	16QAM	100	0	20.51	20.36	20.40		
Channel				20825	21100	21375	Tune up Limit (dBm)	MPR (dB)
Frequency (MHz)				2507.5	2535	2562.5		
15	QPSK	1	0	22.51	22.44	22.36	23	0
15	QPSK	1	37	22.38	22.40	22.46		
15	QPSK	1	74	22.36	22.28	22.21		
15	QPSK	36	0	21.42	21.53	21.55	22	1
15	QPSK	36	18	21.34	21.38	21.45		
15	QPSK	36	37	21.39	21.32	21.31		
15	QPSK	75	0	21.41	21.33	21.37		
15	16QAM	1	0	21.40	21.24	21.46	22	1
15	16QAM	1	37	21.24	21.23	21.20		
15	16QAM	1	74	21.10	21.09	21.07		
15	16QAM	36	0	20.51	20.47	20.42	21	2
15	16QAM	36	18	20.38	20.42	20.27		
15	16QAM	36	37	20.40	20.40	20.28		
15	16QAM	75	0	20.33	20.39	20.21		
Channel				20800	21100	21400	Tune up Limit (dBm)	MPR (dB)
Frequency (MHz)				2505	2535	2565		
10	QPSK	1	0	22.49	22.56	22.33	23	0
10	QPSK	1	24	22.23	22.48	22.21		
10	QPSK	1	49	22.22	22.30	22.11		
10	QPSK	25	0	21.55	21.27	21.39	22	1
10	QPSK	25	12	21.28	21.30	21.22		
10	QPSK	25	24	21.24	21.30	21.22		
10	QPSK	50	0	21.34	21.30	21.22		
10	16QAM	1	0	21.39	21.70	21.36	22	1
10	16QAM	1	24	21.59	21.94	21.50		
10	16QAM	1	49	21.57	21.86	21.80		
10	16QAM	25	0	20.56	20.40	20.24	21	2
10	16QAM	25	12	20.53	20.33	20.27		
10	16QAM	25	24	20.49	20.42	20.38		
10	16QAM	50	0	20.46	20.14	20.27		



Channel				20775	21100	21425	Tune up Limit (dBm)	MPR (dB)
Frequency (MHz)				2502.5	2535	2567.5		
5	QPSK	1	0	22.41	22.16	22.26	23	0
5	QPSK	1	12	22.33	22.40	22.18		
5	QPSK	1	24	22.30	22.15	22.08		
5	QPSK	12	0	21.65	21.26	21.35	22	1
5	QPSK	12	6	21.46	21.33	21.25		
5	QPSK	12	11	21.33	21.34	21.18		
5	QPSK	25	0	21.52	21.30	21.22		
5	16QAM	1	0	21.58	21.37	21.66	22	1
5	16QAM	1	12	21.53	21.34	21.20		
5	16QAM	1	24	21.39	21.29	21.01		
5	16QAM	12	0	20.61	20.41	20.29	21	2
5	16QAM	12	6	20.52	20.29	20.46		
5	16QAM	12	11	20.31	20.30	20.12		
5	16QAM	25	0	20.52	20.36	20.30		

<WLAN Conducted Power>

General Note:

- For 2.4GHz WLAN SAR testing, highest average RF output power channel for the lowest data rate for 802.11b were selected for SAR evaluation. 802.11g/n HT20 were not investigated since the average output powers over all channels and data rates were not more than 0.25 dB higher than the tested channel in the lowest data rate of 802.11b mode.
- For 5 GHz WLAN SAR testing, highest average RF output power channel for the lowest data rate for 802.11a were selected for SAR evaluation. 802.11n HT20/HT40 modes were not investigated since the average output powers over all channels and data rates were not more than 0.25 dB higher than the tested channel in the lowest data rate of 802.11a mode.

<2.4GHz WLAN>

WLAN 2.4GHz 802.11b Average Power (dBm)					
Power vs. Channel			Power vs. Data Rate		
Channel	Frequency (MHz)	Data Rate	2Mbps	5.5Mbps	11Mbps
		1Mbps			
CH 1	2412	17.91	17.96	17.92	17.95
CH 6	2437	17.98			
CH 11	2462	18.00			

WLAN 2.4GHz 802.11g Average Power (dBm)									
Power vs. Channel			Power vs. Data Rate						
Channel	Frequency (MHz)	Data Rate	9Mbps	12Mbps	18Mbps	24Mbps	36Mbps	48Mbps	54Mbps
		6Mbps							
CH 1	2412	14.98	14.89	14.90	14.92	14.92	14.89	14.87	14.91
CH 6	2437	14.72							
CH 11	2462	14.93							

WLAN 2.4GHz 802.11n-HT20 Average Power (dBm)									
Power vs. Channel			Power vs. MCS Index						
Channel	Frequency (MHz)	MCS Index	MCS1	MCS2	MCS3	MCS4	MCS5	MCS6	MCS7
		MCS0							
CH 1	2412	12.97	12.96	12.95	12.95	12.94	12.96	12.95	12.97
CH 6	2437	13.00							
CH 11	2462	12.86							



<5GHz WLAN>

WLAN 5GHz 802.11a Average Power (dBm)									
Power vs. Channel			Power vs. Data Rate						
Channel	Frequency (MHz)	Data Rate	9Mbps	12Mbps	18Mbps	24Mbps	36Mbps	48Mbps	54Mbps
		6Mbps							
CH 36	5180	13.90	13.52	13.48	13.58	13.61	13.76	13.71	13.76
CH 40	5200	13.78							
CH 44	5220	13.87							
CH 48	5240	13.85							
CH 52	5260	13.73	13.82	13.81	13.82	13.84	13.89	13.87	13.88
CH 56	5280	13.71							
CH 60	5300	13.89							
CH 64	5320	13.63							
CH 100	5500	13.65	13.06	13.11	13.13	13.18	13.29	13.13	13.29
CH 104	5520	13.61							
CH 108	5540	13.59							
CH 112	5560	13.52							
CH 116	5580	13.60							
CH 132	5660	13.46							
CH 136	5680	13.42							
CH 140	5700	13.70	13.63	13.65	13.67	13.68	13.78	13.72	13.74
CH 149	5745	13.98							
CH 153	5765	13.74							
CH 157	5785	13.80							
CH 161	5805	13.77							
CH 165	5825	13.93							



WLAN 5GHz 802.11n-HT20 Average Power (dBm)									
Power vs. Channel			Power vs. MCS Index						
Channel	Frequency (MHz)	Data Rate	9Mbps	12Mbps	18Mbps	24Mbps	36Mbps	48Mbps	54Mbps
		6Mbps							
CH 36	5180	12.47	12.40	12.34	12.32	12.44	12.47	12.41	12.42
CH 40	5200	12.29							
CH 44	5220	12.31							
CH 48	5240	12.22							
CH 52	5260	12.33	12.35	12.31	12.28	12.44	12.43	12.25	12.37
CH 56	5280	12.31							
CH 60	5300	12.43							
CH 64	5320	12.46							
CH 100	5500	12.44							
CH 104	5520	12.34	12.32	12.30	12.27	12.35	12.38	12.31	12.39
CH 108	5540	12.31							
CH 112	5560	12.29							
CH 116	5580	12.39							
CH 132	5660	12.18							
CH 136	5680	12.21							
CH 140	5700	12.29	12.11	12.07	12.15	12.17	12.26	12.23	12.21
CH 149	5745	12.42							
CH 153	5765	12.23							
CH 157	5785	12.17							
CH 161	5805	12.14							
CH 165	5825	12.35							

WLAN 5GHz 802.11n-HT40 Average Power (dBm)									
Power vs. Channel			Power vs. MCS Index						
Channel	Frequency (MHz)	MCS Index	MCS1	MCS2	MCS3	MCS4	MCS5	MCS6	MCS7
		MCS0							
CH 38	5190	11.56	11.57	11.84	11.79	11.85	11.84	11.81	11.82
CH 46	5230	11.87							
CH 54	5270	11.94							
CH 62	5310	11.85	11.81	11.91	11.88	11.90	11.93	11.92	11.93
CH 102	5510	10.95	10.65	10.78	10.68	10.89	10.75	10.95	10.91
CH 110	5550	10.78							
CH 134	5670	10.99							
CH 151	5755	10.98	10.63	10.83	10.70	10.82	10.81	10.91	10.95
CH 159	5795	10.97							



<2.4GHz Bluetooth>

General Note:

1. For 2.4GHz Bluetooth Head SAR testing was selected 1Mbps, due to its highest average power.
2. The duty factor is selected theoretical 83.3% perform Bluetooth SAR testing.
3. Base on the maximum tune-up limit of Bluetooth (rounded to the nearest mW) and the minimum separation distance, the Hotspot and Body-worn Bluetooth SAR were not required; $[(13/10)*\sqrt{2.480}]=2.05 < 3$, $[(13/15)*\sqrt{2.480}]=1.36 < 3$, Per KDB 447498 D01v05r02.

Mode	Channel	Frequency (MHz)	Average power (dBm)		
			1Mbps	2Mbps	3Mbps
v3.0 with EDR	CH 00	2402	9.90	7.82	7.74
	CH 39	2441	10.86	8.83	8.81
	CH 78	2480	8.88	6.79	6.78

Mode	Channel	Frequency (MHz)	Average power (dBm)
			GFSK
v4.0 with LE	CH 00	2402	1.74
	CH 19	2440	2.79
	CH 39	2480	1.32

13. Antenna Location

<Mobile Phone>

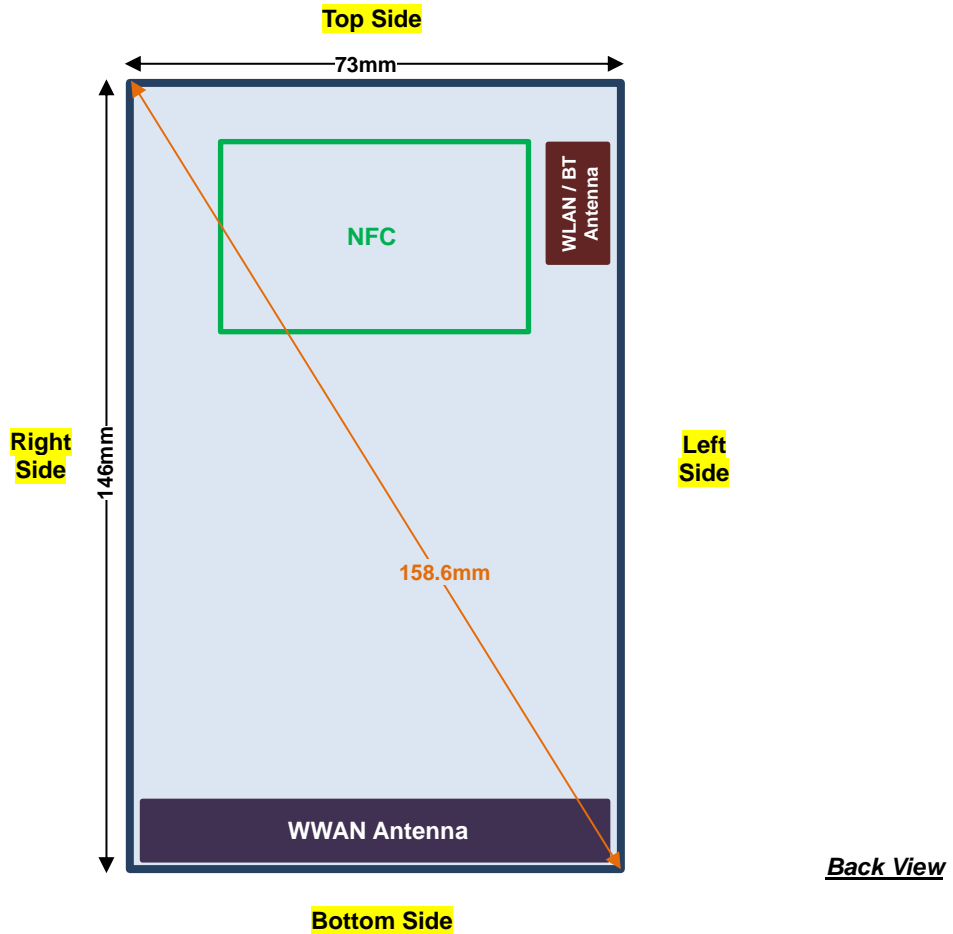

Distance of the Antenna to the EUT surface/edge						
Antennas	Back	Front	Top Side	Bottom Side	Right Side	Left Side
WWAN Main	≤ 25mm	≤ 25mm	> 25mm	≤ 25mm	≤ 25mm	≤ 25mm
BT&WLAN	≤ 25mm	≤ 25mm	≤ 25mm	> 25mm	> 25mm	≤ 25mm

Positions for SAR tests; Hotspot mode						
Antennas	Back	Front	Top Side	Bottom Side	Right Side	Left Side
WWAN Main	Yes	Yes	No	Yes	Yes	Yes
BT&WLAN	Yes	Yes	Yes	No	No	Yes

General Note:

Referring to KDB 941225 D06 v02, when the overall device length and width are ≥ 9cm*5cm, the test distance is 10 mm. SAR must be measured for all sides and surfaces with a transmitting antenna located within 25mm from that surface or edge



14. SAR Test Results

General Note:

1. Per KDB 447498 D01v05r02, the reported SAR is the measured SAR value adjusted for maximum tune-up tolerance.
 - a. Tune-up scaling Factor = tune-up limit power (mW) / EUT RF power (mW), where tune-up limit is the maximum rated power among all production units.
 - b. For SAR testing of WLAN signal with non-100% duty cycle, the measured SAR is scaled-up by the duty cycle scaling factor which is equal to "1/(duty cycle)"
 - c. For WWAN: Reported SAR(W/kg)= Measured SAR(W/kg)*Tune-up Scaling Factor
 - d. For WLAN: Reported SAR(W/kg)= Measured SAR(W/kg)* Duty Cycle scaling factor * Tune-up scaling factor
2. Per KDB 447498 D01v05r02, for each exposure position, testing of other required channels within the operating mode of a frequency band is not required when the *reported* 1-g or 10-g SAR for the mid-band or highest output power channel is:
 - ≤ 0.8 W/kg or 2.0 W/kg, for 1-g or 10-g respectively, when the transmission band is ≤ 100 MHz
 - ≤ 0.6 W/kg or 1.5 W/kg, for 1-g or 10-g respectively, when the transmission band is between 100 MHz and 200 MHz
 - ≤ 0.4 W/kg or 1.0 W/kg, for 1-g or 10-g respectively, when the transmission band is ≥ 200 MHz
3. Per KDB 941225 D01v03, considering the possibility of e.g. 3rd party VoIP operation for Head and body-worn SAR test reduction for GSM and GPRS and EDGE modes is determined by the source-based time-averaged output power including tune-up tolerance. The mode with highest specified time-averaged output power should be tested for SAR compliance in the applicable exposure conditions. For modes with the same specified maximum output power and tolerance, the higher number time-slot configuration should be tested. Therefore, the EUT was set in GPRS (4Tx slots) for GSM850/GSM1900.
4. Per KDB 941225 D01v03, for Hotspot SAR test reduction for GPRS and EDGE modes is determined by the source-based time-averaged output power including tune-up tolerance, for modes with the same specified maximum output power and tolerance, the higher number time-slot configuration should be tested, therefore, the EUT was set in GPRS (4Tx slots) for GSM850/GSM1900.
5. Per KDB 941225 D01v03, SAR for Head / Hotspot / Body-worn exposure is measured using a 12.2 kbps RMC with TPC bits configured to all "1's".
6. Per KDB 941225 D01v03, RMC 12.2kbps setting is used to evaluate SAR. If the maximum output power and tune-up tolerance specified for production units in HSDPA / HSUPA / DC-HSDPA is $\leq \frac{1}{4}$ dB higher than RMC 12.2Kbps or when the highest reported SAR of the RMC12.2Kbps is scaled by the ratio of specified maximum output power and tune-up tolerance of HSDPA / HSUPA / DC-HSDPA to RMC12.2Kbps and the adjusted SAR is ≤ 1.2 W/kg, SAR measurement is not required for HSDPA / HSUPA / DC-HSDPA.
7. Per KDB 941225 D05v02r03, start with the largest channel bandwidth and measure SAR for QPSK with 1 RB allocation, using the RB offset and required test channel combination with the highest maximum output power for RB offsets at the upper edge, middle and lower edge of each required test channel.
8. Per KDB 941225 D05v02r03, 50% RB allocation for QPSK SAR testing follows 1RB QPSK allocation procedure.
9. Per KDB 941225 D05v02r03, For QPSK with 100% RB allocation, SAR is not required when the highest maximum output power for 100 % RB allocation is less than the highest maximum output power in 50% and 1 RB allocations and the highest reported SAR for 1 RB and 50% RB allocation are ≤ 0.8 W/kg. Otherwise, SAR is measured for the highest output power channel; and if the reported SAR is > 1.45 W/kg, the remaining required test channels must also be tested.
10. Per KDB 941225 D05v02r03, 16QAM output power for each RB allocation configuration is $> \text{not } \frac{1}{2}$ dB higher than the same configuration in QPSK and the reported SAR for the QPSK configuration is ≤ 1.45 W/kg; Per KDB 941225 D05v02r03, 16QAM SAR testing is not required.
11. Per KDB 941225 D05v02r03, Smaller bandwidth output power for each RB allocation configuration is $> \text{not } \frac{1}{2}$ dB higher than the same configuration in the largest supported bandwidth, and the reported SAR for the largest supported bandwidth is ≤ 1.45 W/kg; Per KDB 941225 D05v02r03, smaller bandwidth SAR testing is not required.
12. During SAR testing the WLAN transmission was verified using a spectrum analyzer.



14.1 Head SAR

<GSM SAR>

Plot No.	Band	Modulation	Mode	Test Position	Ch.	Freq. (MHz)	Average Power (dBm)	Tune-Up Limit (dBm)	Tune-up Scaling Factor	Power Drift (dB)	Measured 1g SAR (W/kg)	Reported 1g SAR (W/kg)	Measured 10g SAR (W/kg)	Reported 10g SAR (W/kg)
01	GSM850	GMSK	GPRS (4 Tx slots)	Right Cheek	251	848.8	27.80	28.00	1.047	0.02	0.709	0.742	0.550	0.576
	GSM850	GMSK	GPRS (4 Tx slots)	Right Tilted	251	848.8	27.80	28.00	1.047	0.01	0.367	0.384	0.290	0.304
	GSM850	GMSK	GPRS (4 Tx slots)	Left Cheek	251	848.8	27.80	28.00	1.047	0.01	0.699	0.732	0.535	0.560
	GSM850	GMSK	GPRS (4 Tx slots)	Left Tilted	251	848.8	27.80	28.00	1.047	0.07	0.361	0.378	0.284	0.297
	GSM1900	GMSK	GPRS (4 Tx slots)	Right Cheek	810	1909.8	27.05	28.00	1.245	-0.01	0.479	0.596	0.296	0.368
	GSM1900	GMSK	GPRS (4 Tx slots)	Right Tilted	810	1909.8	27.05	28.00	1.245	0	0.252	0.314	0.147	0.183
	GSM1900	GMSK	GPRS (4 Tx slots)	Left Cheek	810	1909.8	27.05	28.00	1.245	-0.06	0.772	0.961	0.444	0.553
02	GSM1900	GMSK	GPRS (4 Tx slots)	Left Cheek	512	1850.2	26.92	28.00	1.282	-0.03	0.783	1.004	0.487	0.624
	GSM1900	GMSK	GPRS (4 Tx slots)	Left Cheek	661	1880	26.97	28.00	1.268	-0.09	0.787	0.998	0.462	0.586
	GSM1900	GMSK	GPRS (4 Tx slots)	Left Tilted	810	1909.8	27.05	28.00	1.245	0.02	0.163	0.203	0.097	0.121

<WCDMA SAR>

Plot No.	Band	Modulation	Mode	Test Position	Ch.	Freq. (MHz)	Average Power (dBm)	Tune-Up Limit (dBm)	Tune-up Scaling Factor	Power Drift (dB)	Measured 1g SAR (W/kg)	Reported 1g SAR (W/kg)	Measured 10g SAR (W/kg)	Reported 10g SAR (W/kg)
03	WCDMA V	QPSK	RMC 12.2Kbps	Right Cheek	4233	846.6	24.67	25.00	1.079	0.11	0.575	0.620	0.445	0.480
	WCDMA V	QPSK	RMC 12.2Kbps	Right Tilted	4233	846.6	24.67	25.00	1.079	0.08	0.297	0.320	0.234	0.252
	WCDMA V	QPSK	RMC 12.2Kbps	Left Cheek	4233	846.6	24.67	25.00	1.079	0.08	0.565	0.610	0.433	0.467
	WCDMA V	QPSK	RMC 12.2Kbps	Left Tilted	4233	846.6	24.67	25.00	1.079	-0.01	0.312	0.337	0.245	0.264
	WCDMA II	QPSK	RMC 12.2Kbps	Right Cheek	9262	1852.4	23.05	24.00	1.245	-0.01	0.369	0.459	0.243	0.302
	WCDMA II	QPSK	RMC 12.2Kbps	Right Tilted	9262	1852.4	23.05	24.00	1.245	0.02	0.158	0.197	0.097	0.121
04	WCDMA II	QPSK	RMC 12.2Kbps	Left Cheek	9262	1852.4	23.05	24.00	1.245	0.03	0.684	0.851	0.421	0.524
	WCDMA II	QPSK	RMC 12.2Kbps	Left Cheek	9400	1880	22.95	24.00	1.274	0.12	0.655	0.834	0.397	0.506
	WCDMA II	QPSK	RMC 12.2Kbps	Left Cheek	9538	1907.6	23.04	24.00	1.247	0.04	0.675	0.842	0.417	0.520
	WCDMA II	QPSK	RMC 12.2Kbps	Left Tilted	9262	1852.4	23.05	24.00	1.245	0.04	0.208	0.259	0.130	0.162

<LTE SAR>

Plot No.	Band	BW (MHz)	Modulation	RB Size	RB offset	Test Position	Ch.	Freq. (MHz)	Average Power (dBm)	Tune-Up Limit (dBm)	Tune-up Scaling Factor	Power Drift (dB)	Measured 1g SAR (W/kg)	Reported 1g SAR (W/kg)	Measured 10g SAR (W/kg)	Reported 10g SAR (W/kg)
05	LTE Band 5	10M	QPSK	1RB	Offset	Right Cheek	20450	829	24.17	25.00	1.211	-0.13	0.593	0.718	0.448	0.542
	LTE Band 5	10M	QPSK	25RB	Offset	Right Cheek	20450	829	23.04	24.00	1.247	0.08	0.471	0.588	0.364	0.454
	LTE Band 5	10M	QPSK	1RB	Offset	Right Tilted	20450	829	24.17	25.00	1.211	-0.12	0.329	0.398	0.256	0.310
	LTE Band 5	10M	QPSK	25RB	Offset	Right Tilted	20450	829	23.04	24.00	1.247	0.11	0.258	0.322	0.200	0.249
	LTE Band 5	10M	QPSK	1RB	Offset	Left Cheek	20450	829	24.17	25.00	1.211	-0.01	0.560	0.678	0.434	0.525
	LTE Band 5	10M	QPSK	25RB	Offset	Left Cheek	20450	829	23.04	24.00	1.247	0.04	0.443	0.553	0.336	0.419
	LTE Band 5	10M	QPSK	1RB	Offset	Left Tilted	20450	829	24.17	25.00	1.211	-0.06	0.345	0.418	0.265	0.321
	LTE Band 5	10M	QPSK	25RB	Offset	Left Tilted	20450	829	23.04	24.00	1.247	-0.14	0.260	0.324	0.200	0.249
	LTE Band 2	20M	QPSK	1RB	Offset	Right Cheek	19100	1900	23.76	24.00	1.057	-0.01	0.408	0.431	0.261	0.276
	LTE Band 2	20M	QPSK	50RB	Offset	Right Cheek	19100	1900	22.68	23.00	1.076	0.05	0.317	0.341	0.202	0.217
	LTE Band 2	20M	QPSK	1RB	Offset	Right Tilted	19100	1900	23.76	24.00	1.057	0.1	0.177	0.187	0.106	0.112
	LTE Band 2	20M	QPSK	50RB	Offset	Right Tilted	19100	1900	22.68	23.00	1.076	0.11	0.140	0.151	0.084	0.090
06	LTE Band 2	20M	QPSK	1RB	Offset	Left Cheek	19100	1900	23.76	24.00	1.057	0.09	0.684	0.723	0.416	0.440
	LTE Band 2	20M	QPSK	50RB	Offset	Left Cheek	19100	1900	22.68	23.00	1.076	0.03	0.551	0.593	0.333	0.358
	LTE Band 2	20M	QPSK	1RB	Offset	Left Tilted	19100	1900	23.76	24.00	1.057	-0.1	0.186	0.197	0.115	0.122
	LTE Band 2	20M	QPSK	50RB	Offset	Left Tilted	19100	1900	22.68	23.00	1.076	-0.02	0.142	0.153	0.087	0.094



Plot No.	Band	BW (MHz)	Modulation	RB Size	RB offset	Test Position	Ch.	Freq. (MHz)	Average Power (dBm)	Tune-Up Limit (dBm)	Tune-up Scaling Factor	Power Drift (dB)	Measured 1g SAR (W/kg)	Reported 1g SAR (W/kg)	Measured 10g SAR (W/kg)	Reported 10g SAR (W/kg)
	LTE Band 7	20M	QPSK	1RB	0offset	Right Cheek	20850	2510	22.78	23.00	1.052	-0.02	0.529	0.556	0.282	0.297
	LTE Band 7	20M	QPSK	50RB	0offset	Right Cheek	20850	2510	21.52	22.00	1.117	0.04	0.402	0.449	0.216	0.241
	LTE Band 7	20M	QPSK	1RB	0offset	Right Tilted	20850	2510	22.78	23.00	1.052	0.1	0.230	0.242	0.115	0.121
	LTE Band 7	20M	QPSK	50RB	0offset	Right Tilted	20850	2510	21.52	22.00	1.117	0.17	0.179	0.200	0.089	0.099
	LTE Band 7	20M	QPSK	1RB	0offset	Left Cheek	20850	2510	22.78	23.00	1.052	0.05	1.010	1.062	0.539	0.567
	LTE Band 7	20M	QPSK	1RB	0offset	Left Cheek	21100	2535	22.53	23.00	1.114	0.14	0.980	1.092	0.508	0.566
07	LTE Band 7	20M	QPSK	1RB	0offset	Left Cheek	21350	2560	22.60	23.00	1.096	0.07	1.020	1.118	0.525	0.576
	LTE Band 7	20M	QPSK	50RB	0offset	Left Cheek	20850	2510	21.52	22.00	1.117	0.08	0.841	0.939	0.435	0.486
	LTE Band 7	20M	QPSK	50RB	0offset	Left Cheek	21100	2535	21.45	22.00	1.135	0.05	0.820	0.931	0.421	0.478
	LTE Band 7	20M	QPSK	50RB	0offset	Left Cheek	21350	2560	21.38	22.00	1.153	0.07	0.846	0.976	0.432	0.498
	LTE Band 7	20M	QPSK	100RB	0offset	Left Cheek	20850	2510	21.36	22.00	1.159	0.03	0.867	1.005	0.448	0.519
	LTE Band 7	20M	QPSK	1RB	0offset	Left Tilted	20850	2510	22.78	23.00	1.052	0.12	0.206	0.217	0.106	0.112
	LTE Band 7	20M	QPSK	50RB	0offset	Left Tilted	20850	2510	21.52	22.00	1.117	0.1	0.164	0.183	0.082	0.092

<WLAN SAR>

Plot No.	Band	Modulation	Mode	Test Position	Ch.	Freq. (MHz)	Average Power (dBm)	Tune-Up Limit (dBm)	Tune-up Scaling Factor	Duty Cycle %	Duty Cycle Scaling Factor	Power Drift (dB)	Measured 1g SAR (W/kg)	Reported 1g SAR (W/kg)	Measured 10g SAR (W/kg)	Reported 10g SAR (W/kg)
08	WLAN2.4GHz	DBPSK	802.11b 1Mbps	Right Cheek	6	2437	17.98	18.00	1.005	97.63	1.024	0.05	0.498	0.512	0.226	0.232
	WLAN2.4GHz	DBPSK	802.11b 1Mbps	Right Tilted	6	2437	17.98	18.00	1.005	97.63	1.024	0.041	0.250	0.257	0.116	0.119
	WLAN2.4GHz	DBPSK	802.11b 1Mbps	Left Cheek	6	2437	17.98	18.00	1.005	97.63	1.024	0.166	0.167	0.172	0.079	0.081
	WLAN2.4GHz	DBPSK	802.11b 1Mbps	Left Tilted	6	2437	17.98	18.00	1.005	97.63	1.024	0.125	0.123	0.127	0.060	0.062
09	WLAN5GHz	OFDM	802.11a 6Mbps	Right Cheek	36	5180	13.90	14.00	1.023	87.26	1.146	-0.03	0.209	0.245	0.061	0.072
	WLAN5GHz	OFDM	802.11a 6Mbps	Right Tilted	36	5180	13.90	14.00	1.023	87.26	1.146	-0.02	0.097	0.114	0.030	0.035
	WLAN5GHz	OFDM	802.11a 6Mbps	Left Cheek	36	5180	13.90	14.00	1.023	87.26	1.146	-0.06	0.056	0.066	0.019	0.022
	WLAN5GHz	OFDM	802.11a 6Mbps	Left Tilted	36	5180	13.90	14.00	1.023	87.26	1.146	0.09	0.034	0.040	0.009	0.010
10	WLAN5GHz	OFDM	802.11a 6Mbps	Right Cheek	60	5300	13.89	14.00	1.025	87.26	1.146	-0.16	0.216	0.254	0.067	0.079
	WLAN5GHz	OFDM	802.11a 6Mbps	Right Tilted	60	5300	13.89	14.00	1.025	87.26	1.146	-0.16	0.102	0.120	0.033	0.039
	WLAN5GHz	OFDM	802.11a 6Mbps	Left Cheek	60	5300	13.89	14.00	1.025	87.26	1.146	0.03	0.091	0.107	0.031	0.036
	WLAN5GHz	OFDM	802.11a 6Mbps	Left Tilted	60	5300	13.89	14.00	1.025	87.26	1.146	0.09	0.055	0.065	0.019	0.022
11	WLAN5GHz	OFDM	802.11a 6Mbps	Right Cheek	140	5700	13.70	14.00	1.072	87.26	1.146	0.04	0.196	0.241	0.055	0.068
	WLAN5GHz	OFDM	802.11a 6Mbps	Right Tilted	140	5700	13.70	14.00	1.072	87.26	1.146	0.06	0.144	0.177	0.050	0.061
	WLAN5GHz	OFDM	802.11a 6Mbps	Left Cheek	140	5700	13.70	14.00	1.072	87.26	1.146	0.05	0.120	0.147	0.042	0.052
	WLAN5GHz	OFDM	802.11a 6Mbps	Left Tilted	140	5700	13.70	14.00	1.072	87.26	1.146	0.1	0.062	0.076	0.022	0.027
12	WLAN5GHz	OFDM	802.11a 6Mbps	Right Cheek	149	5745	13.98	14.00	1.004	87.26	1.146	0.092	0.332	0.382	0.100	0.115
	WLAN5GHz	OFDM	802.11a 6Mbps	Right Tilted	149	5745	13.98	14.00	1.004	87.26	1.146	0.163	0.093	0.107	0.034	0.039
	WLAN5GHz	OFDM	802.11a 6Mbps	Left Cheek	149	5745	13.98	14.00	1.004	87.26	1.146	0.096	0.070	0.081	0.024	0.028
	WLAN5GHz	OFDM	802.11a 6Mbps	Left Tilted	149	5745	13.98	14.00	1.004	87.26	1.146	0.162	0.042	0.048	0.014	0.016

<Bluetooth SAR>

Plot No.	Band	Modulation	Mode	Test Position	Ch.	Freq. (MHz)	Average Power (dBm)	Tune-Up Limit (dBm)	Tune-up Scaling Factor	Power Drift (dB)	Measured 1g SAR (W/kg)	Reported 1g SAR (W/kg)	Measured 10g SAR (W/kg)	Reported 10g SAR (W/kg)
13	Bluetooth	GFSK	1Mbps	Right Cheek	39	2441	10.86	11.00	1.033	-0.055	0.011	0.011	0.003	0.003
	Bluetooth	GFSK	1Mbps	Right Tilted	39	2441	10.86	11.00	1.033	0.01	0.004	0.004	0.001	0.001
	Bluetooth	GFSK	1Mbps	Left Cheek	39	2441	10.86	11.00	1.033	0.029	0.004	0.004	0.001	0.001
	Bluetooth	GFSK	1Mbps	Left Tilted	39	2441	10.86	11.00	1.033	0.07	0.002	0.002	0.001	0.001



14.2 Hotspot SAR

<GSM SAR>

Plot No.	Band	Modulation	Mode	Test Position	Gap (cm)	Ch.	Freq. (MHz)	Average Power (dBm)	Tune-Up Limit (dBm)	Tune-up Scaling Factor	Power Drift (dB)	Measured 1g SAR (W/kg)	Reported 1g SAR (W/kg)	Measured 10g SAR (W/kg)	Reported 10g SAR (W/kg)
14	GSM850	GMSK	GPRS (4 Tx slots)	Front	1cm	251	848.8	27.80	28.00	1.047	-0.03	0.754	0.790	0.589	0.617
	GSM850	GMSK	GPRS (4 Tx slots)	Back	1cm	251	848.8	27.80	28.00	1.047	0.07	0.709	0.742	0.482	0.505
	GSM850	GMSK	GPRS (4 Tx slots)	Left Side	1cm	251	848.8	27.80	28.00	1.047	-0.05	0.574	0.601	0.403	0.422
	GSM850	GMSK	GPRS (4 Tx slots)	Right Side	1cm	251	848.8	27.80	28.00	1.047	-0.01	0.613	0.642	0.429	0.449
	GSM850	GMSK	GPRS (4 Tx slots)	Bottom Side	1cm	251	848.8	27.80	28.00	1.047	-0.11	0.153	0.160	0.096	0.101
	GSM1900	GMSK	GPRS (4 Tx slots)	Front	1cm	810	1909.8	27.05	28.00	1.245	0	0.768	0.956	0.452	0.563
	GSM1900	GMSK	GPRS (4 Tx slots)	Front	1cm	512	1850.2	26.92	28.00	1.282	-0.08	0.846	1.085	0.522	0.669
	GSM1900	GMSK	GPRS (4 Tx slots)	Front	1cm	661	1880	26.97	28.00	1.268	-0.08	0.826	1.047	0.498	0.631
	GSM1900	GMSK	GPRS (4 Tx slots)	Back	1cm	810	1909.8	27.05	28.00	1.245	-0.05	0.903	1.124	0.560	0.697
	GSM1900	GMSK	GPRS (4 Tx slots)	Back	1cm	512	1850.2	26.92	28.00	1.282	-0.02	0.920	1.180	0.587	0.753
15	GSM1900	GMSK	GPRS (4 Tx slots)	Back	1cm	661	1880	26.97	28.00	1.268	-0.04	0.910	1.154	0.572	0.725
	GSM1900	GMSK	GPRS (4 Tx slots)	Left Side	1cm	810	1909.8	27.05	28.00	1.245	-0.16	0.475	0.591	0.286	0.356
	GSM1900	GMSK	GPRS (4 Tx slots)	Right Side	1cm	810	1909.8	27.05	28.00	1.245	-0.06	0.082	0.102	0.051	0.063
	GSM1900	GMSK	GPRS (4 Tx slots)	Bottom Side	1cm	810	1909.8	27.05	28.00	1.245	-0.03	0.279	0.347	0.169	0.210

<WCDMA SAR>

Plot No.	Band	Modulation	Mode	Test Position	Gap (cm)	Ch.	Freq. (MHz)	Average Power (dBm)	Tune-Up Limit (dBm)	Tune-up Scaling Factor	Power Drift (dB)	Measured 1g SAR (W/kg)	Reported 1g SAR (W/kg)	Measured 10g SAR (W/kg)	Reported 10g SAR (W/kg)
16	WCDMA V	QPSK	RMC 12.2Kbps	Front	1cm	4233	846.6	24.67	25.00	1.079	0.06	0.662	0.714	0.522	0.563
	WCDMA V	QPSK	RMC 12.2Kbps	Back	1cm	4233	846.6	24.67	25.00	1.079	0	0.575	0.620	0.370	0.399
	WCDMA V	QPSK	RMC 12.2Kbps	Left Side	1cm	4233	846.6	24.67	25.00	1.079	0.05	0.500	0.539	0.351	0.379
	WCDMA V	QPSK	RMC 12.2Kbps	Right Side	1cm	4233	846.6	24.67	25.00	1.079	0.05	0.568	0.613	0.394	0.425
	WCDMA V	QPSK	RMC 12.2Kbps	Bottom Side	1cm	4233	846.6	24.67	25.00	1.079	-0.09	0.132	0.142	0.084	0.091
17	WCDMA II	QPSK	RMC 12.2Kbps	Front	1cm	9262	1852.4	23.05	24.00	1.245	0	0.771	0.960	0.483	0.601
	WCDMA II	QPSK	RMC 12.2Kbps	Front	1cm	9400	1880	22.95	24.00	1.274	0.03	0.716	0.912	0.425	0.541
	WCDMA II	QPSK	RMC 12.2Kbps	Front	1cm	9538	1907.6	23.04	24.00	1.247	-0.02	0.693	0.864	0.405	0.505
	WCDMA II	QPSK	RMC 12.2Kbps	Back	1cm	9262	1852.4	23.05	24.00	1.245	-0.07	0.950	1.182	0.566	0.704
	WCDMA II	QPSK	RMC 12.2Kbps	Back	1cm	9400	1880	22.95	24.00	1.274	-0.1	0.920	1.172	0.541	0.689
	WCDMA II	QPSK	RMC 12.2Kbps	Back	1cm	9538	1907.6	23.04	24.00	1.247	0.06	0.940	1.173	0.550	0.686
	WCDMA II	QPSK	RMC 12.2Kbps	Left Side	1cm	9262	1852.4	23.05	24.00	1.245	0.07	0.405	0.504	0.249	0.310
	WCDMA II	QPSK	RMC 12.2Kbps	Right Side	1cm	9262	1852.4	23.05	24.00	1.245	-0.04	0.130	0.162	0.081	0.101
	WCDMA II	QPSK	RMC 12.2Kbps	Bottom Side	1cm	9262	1852.4	23.05	24.00	1.245	-0.1	0.192	0.239	0.119	0.148

<LTE SAR>

Plot No.	Band	BW (MHz)	Modulation	RB Size	RB offset	Test Position	Gap (cm)	Ch.	Freq. (MHz)	Average Power (dBm)	Tune-Up Limit (dBm)	Tune-up Scaling Factor	Power Drift (dB)	Measured 1g SAR (W/kg)	Reported 1g SAR (W/kg)	Measured 10g SAR (W/kg)	Reported 10g SAR (W/kg)
18	LTE Band 5	10M	QPSK	1RB	0offset	Front	1cm	20450	829	24.17	25.00	1.211	-0.01	0.667	0.807	0.505	0.611
	LTE Band 5	10M	QPSK	1RB	0offset	Front	1cm	20525	836.5	23.98	25.00	1.265	-0.06	0.610	0.771	0.472	0.597
	LTE Band 5	10M	QPSK	1RB	0offset	Front	1cm	20600	844	24.00	25.00	1.259	0.12	0.597	0.752	0.460	0.579
	LTE Band 5	10M	QPSK	25RB	0offset	Front	1cm	20450	829	23.04	24.00	1.247	0	0.525	0.655	0.408	0.509
	LTE Band 5	10M	QPSK	50RB	0offset	Front	1cm	20450	829	22.98	24.00	1.265	-0.02	0.498	0.630	0.386	0.488
	LTE Band 5	10M	QPSK	1RB	0offset	Back	1cm	20450	829	24.17	25.00	1.211	0.07	0.646	0.782	0.495	0.599
	LTE Band 5	10M	QPSK	25RB	0offset	Back	1cm	20450	829	23.04	24.00	1.247	-0.02	0.516	0.644	0.399	0.498
	LTE Band 5	10M	QPSK	1RB	0offset	Left Side	1cm	20450	829	24.17	25.00	1.211	0.11	0.565	0.684	0.397	0.481
	LTE Band 5	10M	QPSK	25RB	0offset	Left Side	1cm	20450	829	23.04	24.00	1.247	-0.01	0.451	0.563	0.317	0.395
	LTE Band 5	10M	QPSK	1RB	0offset	Right Side	1cm	20450	829	24.17	25.00	1.211	-0.14	0.622	0.753	0.433	0.524
	LTE Band 5	10M	QPSK	25RB	0offset	Right Side	1cm	20450	829	23.04	24.00	1.247	-0.1	0.506	0.631	0.350	0.437
	LTE Band 5	10M	QPSK	1RB	0offset	Bottom Side	1cm	20450	829	24.17	25.00	1.211	-0.05	0.137	0.166	0.083	0.100
	LTE Band 5	10M	QPSK	25RB	0offset	Bottom Side	1cm	20450	829	23.04	24.00	1.247	-0.09	0.114	0.142	0.070	0.087
	LTE Band 2	20M	QPSK	1RB	0offset	Front	1cm	19100	1900	23.76	24.00	1.057	-0.14	0.727	0.768	0.436	0.461
	LTE Band 2	20M	QPSK	50RB	0offset	Front	1cm	19100	1900	22.68	23.00	1.076	0.08	0.644	0.693	0.381	0.410
	LTE Band 2	20M	QPSK	1RB	0offset	Back	1cm	19100	1900	23.76	24.00	1.057	-0.19	1.120	1.184	0.643	0.680
19	LTE Band 2	20M	QPSK	1RB	0offset	Back	1cm	18700	1860	23.45	24.00	1.135	-0.05	1.046	1.187	0.632	0.717
	LTE Band 2	20M	QPSK	1RB	0offset	Back	1cm	18900	1880	23.64	24.00	1.086	0.14	1.020	1.108	0.649	0.705
	LTE Band 2	20M	QPSK	50RB	0offset	Back	1cm	19100	1900	22.68	23.00	1.076	-0.06	0.870	0.937	0.503	0.541
	LTE Band 2	20M	QPSK	50RB	0offset	Back	1cm	18700	1860	22.60	23.00	1.096	-0.08	0.862	0.945	0.504	0.553
	LTE Band 2	20M	QPSK	50RB	0offset	Back	1cm	18900	1880	22.49	23.00	1.125	-0.05	0.863	0.971	0.503	0.566
	LTE Band 2	20M	QPSK	100RB	0offset	Back	1cm	19100	1900	22.61	23.00	1.094	-0.09	0.873	0.955	0.500	0.547
	LTE Band 2	20M	QPSK	1RB	0offset	Left Side	1cm	19100	1900	23.76	24.00	1.057	0.11	0.508	0.537	0.302	0.319
	LTE Band 2	20M	QPSK	50RB	0offset	Left Side	1cm	19100	1900	22.68	23.00	1.076	-0.04	0.396	0.426	0.237	0.255
	LTE Band 2	20M	QPSK	1RB	0offset	Right Side	1cm	19100	1900	23.76	24.00	1.057	-0.02	0.154	0.163	0.092	0.097
	LTE Band 2	20M	QPSK	50RB	0offset	Right Side	1cm	19100	1900	22.68	23.00	1.076	0	0.118	0.127	0.070	0.075
	LTE Band 2	20M	QPSK	1RB	0offset	Bottom Side	1cm	19100	1900	23.76	24.00	1.057	-0.11	0.239	0.253	0.147	0.155
	LTE Band 2	20M	QPSK	50RB	0offset	Bottom Side	1cm	19100	1900	22.68	23.00	1.076	0	0.190	0.205	0.117	0.126
	LTE Band 7	20M	QPSK	1RB	0offset	Front	1cm	20850	2510	22.78	23.00	1.052	0.07	0.822	0.865	0.459	0.483
	LTE Band 7	20M	QPSK	1RB	0offset	Front	1cm	21100	2535	22.53	23.00	1.114	0	0.807	0.899	0.449	0.500
	LTE Band 7	20M	QPSK	1RB	0offset	Front	1cm	21350	2560	22.60	23.00	1.096	0.07	0.784	0.860	0.430	0.471
	LTE Band 7	20M	QPSK	50RB	0offset	Front	1cm	20850	2510	21.52	22.00	1.117	-0.04	0.746	0.833	0.397	0.443
	LTE Band 7	20M	QPSK	50RB	0offset	Front	1cm	21100	2535	21.45	22.00	1.135	0	0.757	0.859	0.411	0.466
	LTE Band 7	20M	QPSK	50RB	0offset	Front	1cm	21350	2560	21.38	22.00	1.153	0.04	0.760	0.877	0.411	0.474
	LTE Band 7	20M	QPSK	100RB	0offset	Front	1cm	20850	2510	21.36	22.00	1.159	-0.06	0.763	0.884	0.406	0.470
20	LTE Band 7	20M	QPSK	1RB	0offset	Back	1cm	20850	2510	22.78	23.00	1.052	0	0.998	1.050	0.528	0.555
	LTE Band 7	20M	QPSK	1RB	0offset	Back	1cm	21100	2535	22.53	23.00	1.114	-0.06	0.825	0.919	0.439	0.489
	LTE Band 7	20M	QPSK	1RB	0offset	Back	1cm	21350	2560	22.60	23.00	1.096	0.01	0.804	0.882	0.427	0.468
	LTE Band 7	20M	QPSK	50RB	0offset	Back	1cm	20850	2510	21.52	22.00	1.117	-0.09	0.654	0.730	0.347	0.388
	LTE Band 7	20M	QPSK	100RB	0offset	Back	1cm	20850	2510	21.36	22.00	1.159	-0.11	0.717	0.831	0.378	0.438
	LTE Band 7	20M	QPSK	1RB	0offset	Left Side	1cm	20850	2510	22.78	23.00	1.052	-0.07	0.659	0.693	0.337	0.355
	LTE Band 7	20M	QPSK	50RB	0offset	Left Side	1cm	20850	2510	21.52	22.00	1.117	-0.14	0.485	0.542	0.250	0.279
	LTE Band 7	20M	QPSK	1RB	0offset	Right Side	1cm	20850	2510	22.78	23.00	1.052	-0.18	0.059	0.062	0.030	0.032
	LTE Band 7	20M	QPSK	50RB	0offset	Right Side	1cm	20850	2510	21.52	22.00	1.117	-0.07	0.048	0.054	0.024	0.027
	LTE Band 7	20M	QPSK	1RB	0offset	Bottom Side	1cm	20850	2510	22.78	23.00	1.052	-0.13	0.657	0.691	0.303	0.319
	LTE Band 7	20M	QPSK	50RB	0offset	Bottom Side	1cm	20850	2510	21.52	22.00	1.117	-0.12	0.495	0.553	0.228	0.255



<WLAN SAR>

Plot No.	Band	Mode	Mode	Test Position	Gap (cm)	Ch.	Freq. (MHz)	Average Power (dBm)	Tune-Up Limit (dBm)	Tune-up Scaling Factor	Duty Cycle %	Duty Cycle Scaling Factor	Power Drift (dB)	Measured 1g SAR (W/kg)	Reported 1g SAR (W/kg)	Measured 10g SAR (W/kg)	Reported 10g SAR (W/kg)
	WLAN2.4GHz	DBPSK	802.11b 1Mbps	Front	1cm	6	2437	17.98	18.00	1.005	97.63	1.024	0.04	0.133	0.137	0.066	0.068
21	WLAN2.4GHz	DBPSK	802.11b 1Mbps	Back	1cm	6	2437	17.98	18.00	1.005	97.63	1.024	-0.01	0.841	0.865	0.373	0.384
	WLAN2.4GHz	DBPSK	802.11b 1Mbps	Back	1cm	1	2412	17.91	18.00	1.020	97.63	1.024	-0.02	0.460	0.480	0.203	0.212
	WLAN2.4GHz	DBPSK	802.11b 1Mbps	Back	1cm	11	2462	17.97	18.00	1.006	97.63	1.024	-0.02	0.700	0.721	0.305	0.314
	WLAN2.4GHz	DBPSK	802.11b 1Mbps	Left Side	1cm	6	2437	17.98	18.00	1.005	97.63	1.024	-0.02	0.535	0.550	0.250	0.257
	WLAN2.4GHz	DBPSK	802.11b 1Mbps	Top Side	1cm	6	2437	17.98	18.00	1.005	97.63	1.024	0.04	0.050	0.051	0.025	0.026
22	WLAN5GHz	OFDM	802.11a 6Mbps	Front	1cm	36	5180	13.90	14.00	1.023	87.26	1.146	0.08	0.140	0.164	0.041	0.048
	WLAN5GHz	OFDM	802.11a 6Mbps	Back	1cm	36	5180	13.90	14.00	1.023	87.26	1.146	0.04	0.070	0.082	0.020	0.023
	WLAN5GHz	OFDM	802.11a 6Mbps	Left Side	1cm	36	5180	13.90	14.00	1.023	87.26	1.146	-0.04	0.030	0.035	0.009	0.010
	WLAN5GHz	OFDM	802.11a 6Mbps	Top Side	1cm	36	5180	13.90	14.00	1.023	87.26	1.146	-0.06	0.000	0.001	0.000	0.000
	WLAN5GHz	OFDM	802.11a 6Mbps	Front	1cm	149	5745	13.98	14.00	1.004	87.26	1.146	-0.07	0.024	0.028	0.004	0.005
23	WLAN5GHz	OFDM	802.11a 6Mbps	Back	1cm	149	5745	13.98	14.00	1.004	87.26	1.146	0.07	0.072	0.083	0.021	0.024
	WLAN5GHz	OFDM	802.11a 6Mbps	Left Side	1cm	149	5745	13.98	14.00	1.004	87.26	1.146	-0.08	0.013	0.015	0.003	0.003
	WLAN5GHz	OFDM	802.11a 6Mbps	Top Side	1cm	149	5745	13.98	14.00	1.004	87.26	1.146	-0.01	0.006	0.007	0.001	0.002

14.3 Body Worn Accessory SAR

<GSM SAR>

Plot No.	Band	Modulation	Mode	Test Position	Gap (cm)	Ch.	Freq. (MHz)	Average Power (dBm)	Tune-Up Limit (dBm)	Tune-up Scaling Factor	Power Drift (dB)	Measured 1g SAR (W/kg)	Reported 1g SAR (W/kg)	Measured 10g SAR (W/kg)	Reported 10g SAR (W/kg)
24	GSM850	GMSK	GPRS (4 Tx slots)	Front	1.5cm	251	848.8	27.80	28.00	1.047	0	0.690	0.723	0.537	0.562
	GSM850	GMSK	GPRS (4 Tx slots)	Back	1.5cm	251	848.8	27.80	28.00	1.047	-0.01	0.686	0.718	0.534	0.559
	GSM1900	GMSK	GPRS (4 Tx slots)	Front	1.5cm	810	1909.8	27.05	28.00	1.245	-0.06	0.434	0.540	0.283	0.352
25	GSM1900	GMSK	GPRS (4 Tx slots)	Back	1.5cm	810	1909.8	27.05	28.00	1.245	-0.06	0.596	0.742	0.357	0.444

<WCDMA SAR>

Plot No.	Band	Modulation	Mode	Test Position	Gap (cm)	Ch.	Freq. (MHz)	Average Power (dBm)	Tune-Up Limit (dBm)	Tune-up Scaling Factor	Power Drift (dB)	Measured 1g SAR (W/kg)	Reported 1g SAR (W/kg)	Measured 10g SAR (W/kg)	Reported 10g SAR (W/kg)
26	WCDMA V	QPSK	RMC 12.2Kbps	Front	1.5cm	4233	846.6	24.67	25.00	1.079	0.04	0.622	0.671	0.482	0.520
	WCDMA V	QPSK	RMC 12.2Kbps	Back	1.5cm	4233	846.6	24.67	25.00	1.079	0	0.589	0.635	0.458	0.494
	WCDMA II	QPSK	RMC 12.2Kbps	Front	1.5cm	9262	1852.4	23.05	24.00	1.245	0.01	0.419	0.521	0.273	0.340
27	WCDMA II	QPSK	RMC 12.2Kbps	Back	1.5cm	9262	1852.4	23.05	24.00	1.245	-0.03	0.541	0.673	0.351	0.437

<LTE SAR>

Plot No.	Band	BW (MHz)	Modulation	RB Size	RB offset	Test Position	Gap (cm)	Ch.	Freq. (MHz)	Average Power (dBm)	Tune-Up Limit (dBm)	Tune-up Scaling Factor	Power Drift (dB)	Measured 1g SAR (W/kg)	Reported 1g SAR (W/kg)	Measured 10g SAR (W/kg)	Reported 10g SAR (W/kg)
28	LTE Band 5	10M	QPSK	1RB	0offset	Front	1.5cm	20450	829	24.17	25.00	1.211	-0.02	0.632	0.765	0.482	0.584
	LTE Band 5	10M	QPSK	25RB	0offset	Front	1.5cm	20450	829	23.04	24.00	1.247	0	0.500	0.624	0.384	0.479
	LTE Band 5	10M	QPSK	1RB	0offset	Back	1.5cm	20450	829	24.17	25.00	1.211	-0.04	0.609	0.737	0.462	0.559
	LTE Band 5	10M	QPSK	25RB	0offset	Back	1.5cm	20450	829	23.04	24.00	1.247	-0.01	0.492	0.614	0.378	0.472
	LTE Band 2	20M	QPSK	1RB	0offset	Front	1.5cm	19100	1900	23.76	24.00	1.057	0.09	0.413	0.436	0.265	0.280
	LTE Band 2	20M	QPSK	50RB	0offset	Front	1.5cm	19100	1900	22.68	23.00	1.076	-0.03	0.326	0.351	0.209	0.225
29	LTE Band 2	20M	QPSK	1RB	0offset	Back	1.5cm	19100	1900	23.76	24.00	1.057	-0.01	0.619	0.654	0.376	0.397
	LTE Band 2	20M	QPSK	50RB	0offset	Back	1.5cm	19100	1900	22.68	23.00	1.076	-0.11	0.493	0.531	0.298	0.321
	LTE Band 7	20M	QPSK	1RB	0offset	Front	1.5cm	20850	2510	22.78	23.00	1.052	0.07	0.486	0.511	0.275	0.289
	LTE Band 7	20M	QPSK	50RB	0offset	Front	1.5cm	20850	2510	21.52	22.00	1.117	0.07	0.374	0.418	0.209	0.233
30	LTE Band 7	20M	QPSK	1RB	0offset	Back	1.5cm	20850	2510	22.78	23.00	1.052	-0.06	0.534	0.562	0.291	0.306
	LTE Band 7	20M	QPSK	50RB	0offset	Back	1.5cm	20850	2510	21.52	22.00	1.117	0.07	0.408	0.456	0.222	0.248



<WLAN SAR>

Plot No.	Band	Modulation	Mode	Test Position	Gap (cm)	Ch.	Freq. (MHz)	Average Power (dBm)	Tune-Up Limit (dBm)	Tune-up Scaling Factor	Duty Cycle %	Duty Cycle Scaling Factor	Power Drift (dB)	Measured 1g SAR (W/kg)	Reported 1g SAR (W/kg)	Measured 10g SAR (W/kg)	Reported 10g SAR (W/kg)
	WLAN2.4GHz	DBPSK	802.11b 1Mbps	Front	1.5cm	6	2437	17.98	18.00	1.005	97.63	1.024	0.05	0.072	0.074	0.037	0.038
31	WLAN2.4GHz	DBPSK	802.11b 1Mbps	Back	1.5cm	6	2437	17.98	18.00	1.005	97.63	1.024	-0.03	0.333	0.343	0.162	0.167
32	WLAN5GHz	OFDM	802.11a 6Mbps	Front	1.5cm	36	5180	13.90	14.00	1.023	87.26	1.146	0.047	0.071	0.083	0.025	0.029
	WLAN5GHz	OFDM	802.11a 6Mbps	Back	1.5cm	36	5180	13.90	14.00	1.023	87.26	1.146	-0.013	0.045	0.053	0.016	0.019
33	WLAN5GHz	OFDM	802.11a 6Mbps	Front	1.5cm	60	5300	13.89	14.00	1.025	87.26	1.146	0.04	0.060	0.070	0.022	0.026
	WLAN5GHz	OFDM	802.11a 6Mbps	Back	1.5cm	60	5300	13.89	14.00	1.025	87.26	1.146	-0.078	0.050	0.059	0.016	0.019
	WLAN5GHz	OFDM	802.11a 6Mbps	Front	1.5cm	140	5700	13.70	14.00	1.072	87.26	1.146	0.184	0.024	0.029	0.009	0.011
34	WLAN5GHz	OFDM	802.11a 6Mbps	Back	1.5cm	140	5700	13.70	14.00	1.072	87.26	1.146	0.028	0.035	0.043	0.014	0.017
	WLAN5GHz	OFDM	802.11a 6Mbps	Front	1.5cm	149	5745	13.98	14.00	1.004	87.26	1.146	0.031	0.013	0.015	0.002	0.002
35	WLAN5GHz	OFDM	802.11a 6Mbps	Back	1.5cm	149	5745	13.98	14.00	1.004	87.26	1.146	-0.098	0.041	0.047	0.014	0.016

14.4 Repeated SAR Measurement

No.	Band	BW (MHz)	Modulation	RB Size	RB offset	Modulation	Mode	Test Position	Gap (cm)	Ch.	Freq. (MHz)	Average Power (dBm)	Tune-Up Limit (dBm)	Tune-up Scaling Factor	Duty Cycle %	Duty Cycle Scaling Factor	Power Drift (dB)	Measured 1g SAR (W/kg)	Ratio	Reported 1g SAR (W/kg)
1st	LTE Band 2	20M	QPSK	1RB	0offset			Back	1cm	19100	1900	23.76	24.00	1.057		1.000	-0.19	1.120	-	1.184
2nd	LTE Band 2	20M	QPSK	1RB	0offset			Back	1cm	19100	1900	23.76	24.00	1.057		1.000	0	1.110	1.01	1.173
1st	LTE Band 7	20M	QPSK	1RB	0offset			Left Cheek		21350	2560	22.60	23.00	1.096		1.000	0.07	1.020	-	1.118
2nd	LTE Band 7	20M	QPSK	1RB	0offset			Left Cheek		21350	2560	22.60	23.00	1.096		1.000	0.01	1.020	1.00	1.118
1st	WLAN2.4GHz					DBPSK	802.11b 1Mbps	Back	1cm	6	2437	17.98	18.00	1.005	97.63	1.024	-0.01	0.841	-	0.865
2nd	WLAN2.4GHz					DBPSK	802.11b 1Mbps	Back	1cm	6	2437	17.98	18.00	1.005	97.63	1.024	0.01	0.825	1.02	0.849

General Note:

- Per KDB 865664 D01v01r03, for each frequency band, repeated SAR measurement is required only when the measured SAR is ≥ 0.8 W/kg
- Per KDB 865664 D01v01r03, if the ratio among the repeated measurement is ≤ 1.2 and the measured SAR < 1.45 W/kg, only one repeated measurement is required.
- The ratio is the difference in percentage between original and repeated *measured* SAR.
- All measurement SAR result is scaled-up to account for tune-up tolerance and is compliant.

15. Simultaneous Transmission Analysis

NO.	Simultaneous Transmission Configurations	Portable Handset			Note
		Head	Body-worn	Hotspot	
1.	GSM(Voice) + WLAN2.4GHz(data)	Yes	Yes		
2.	WCDMA(Voice) + WLAN2.4GHz(data)	Yes	Yes		
3.	GSM(Voice) + Bluetooth(data)	Yes	Yes		
4.	WCDMA((Voice) + Bluetooth(data)	Yes	Yes		
5.	GSM(Voice) + WLAN5GHz(data)	Yes	Yes		
6.	WCDMA((Voice) + WLAN5GHz(data)	Yes	Yes		
7.	GPRS/EDGE(Data) + WLAN2.4GHz(data)	Yes	Yes	Yes	2.4GHz Hotspot
8.	WCDMA(Data) + WLAN2.4GHz(data)	Yes	Yes	Yes	2.4GHz Hotspot
9.	LTE(Data) + WLAN2.4GHz(data)	Yes	Yes	Yes	2.4GHz Hotspot
10.	GPRS/EDGE(Data) + Bluetooth(data)	Yes	Yes	Yes	Bluetooth Tethering
11.	WCDMA(Data) + Bluetooth(data)	Yes	Yes	Yes	Bluetooth Tethering
12.	LTE(Data) + Bluetooth(data)	Yes	Yes	Yes	Bluetooth Tethering
13.	GPRS/EDGE(data) + WLAN5GHz(data)	Yes	Yes	Yes	WiFi Direct
14.	WCDMA(data) + WLAN5GHz(data)	Yes	Yes	Yes	WiFi Direct
15.	LTE(data) + WLAN5GHz(data)	Yes	Yes	Yes	WiFi Direct

General Note:

- This device supported VoIP in EGPRS, WCDMA, LTE (e.g. 3rd party VoIP).
- This device 2.4GHz supports Hotspot and 5.2GHz / 5.8GHz WLAN supports WiFi Direct (GC/GO) operation, and 5.3GHz / 5.5GHz WLAN supports WiFi Direct (GC only).
- WLAN and Bluetooth share the same antenna, and cannot transmit simultaneously.
- EUT will choose either WLAN 2.4GHz or WLAN 5GHz according to the network signal condition; therefore, 2.4GHz WLAN and 5GHz WLAN will not operate simultaneously at any moment.
- The worst case 5 GHz WLAN reported SAR for each configuration was used for SAR summation. Therefore, the following summations represent the absolute worst cases for simultaneous transmission with 5 GHz WLAN.
- The Scaled SAR summation is calculated based on the same configuration and test position.
- Per KDB 447498 D01v05r02, simultaneous transmission SAR is compliant if,
 - Scalar SAR summation < 1.6W/kg.
 - $SPLSR = (SAR1 + SAR2)^{1.5} / (\text{min. separation distance, mm})$, and the peak separation distance is determined from the square root of $[(x1-x2)^2 + (y1-y2)^2 + (z1-z2)^2]$, where (x1, y1, z1) and (x2, y2, z2) are the coordinates of the extrapolated peak SAR locations in the zoom scan.
 - If $SPLSR \leq 0.04$, simultaneously transmission SAR measurement is not necessary.
 - Simultaneously transmission SAR measurement, and the reported multi-band SAR < 1.6W/kg.
 - The SPLSR calculated results please refer to section 15.4.
- For simultaneous transmission analysis, Bluetooth SAR is estimated per KDB 447498 D01v05r02 based on the formula below.
 - $(\text{max. power of channel, including tune-up tolerance, mW}) / (\text{min. test separation distance, mm}) \cdot [\sqrt{f(\text{GHz})} / x] \text{ W/kg}$ for test separation distances $\leq 50 \text{ mm}$; where $x = 7.5$ for 1-g SAR, and $x = 18.75$ for 10-g SAR.
 - When the minimum separation distance is < 5mm, the distance is used 5mm to determine SAR test exclusion.
 - 0.4 W/kg for 1-g SAR and 1.0 W/kg for 10-g SAR, when the test separation distances is > 50 mm.

Bluetooth Max Power	Exposure Position	Hotspot	Body-worn
	Test separation	10 mm	15 mm
11 dBm	Estimated 1g SAR (W/kg)	0.273 W/kg	0.182 W/kg
	Estimated 10g SAR (W/kg)	0.109 W/kg	0.073 W/kg



15.1 Head Exposure Conditions

WWAN Band		Exposure Position	1	2	3	1+2 Summed 1g SAR (W/kg)	1+3 Summed 1g SAR (W/kg)	SPLSR	Case No
			WWAN 1g SAR (W/kg)	2.4GHz WLAN 1g SAR (W/kg)	2.4GHz Bluetooth 1g SAR (W/kg)				
GSM	GSM850	Right Cheek	0.742	0.512	0.011	1.25	0.75		
		Right Tilted	0.384	0.257	0.004	0.64	0.39		
		Left Cheek	0.732	0.172	0.004	0.90	0.74		
		Left Tilted	0.378	0.127	0.002	0.51	0.38		
	GSM1900	Right Cheek	0.596	0.512	0.011	1.11	0.61		
		Right Tilted	0.314	0.257	0.004	0.57	0.32		
		Left Cheek	1.004	0.172	0.004	1.18	1.01		
		Left Tilted	0.203	0.127	0.002	0.33	0.21		
WCDMA	Band V	Right Cheek	0.620	0.512	0.011	1.13	0.63		
		Right Tilted	0.320	0.257	0.004	0.58	0.32		
		Left Cheek	0.610	0.172	0.004	0.78	0.61		
		Left Tilted	0.337	0.127	0.002	0.46	0.34		
	Band II	Right Cheek	0.459	0.512	0.011	0.97	0.47		
		Right Tilted	0.197	0.257	0.004	0.45	0.20		
		Left Cheek	0.851	0.172	0.004	1.02	0.86		
		Left Tilted	0.259	0.127	0.002	0.39	0.26		
LTE	Band 5	Right Cheek	0.718	0.512	0.011	1.23	0.73		
		Right Tilted	0.398	0.257	0.004	0.66	0.40		
		Left Cheek	0.678	0.172	0.004	0.85	0.68		
		Left Tilted	0.418	0.127	0.002	0.55	0.42		
	Band 2	Right Cheek	0.431	0.512	0.011	0.94	0.44		
		Right Tilted	0.187	0.257	0.004	0.44	0.19		
		Left Cheek	0.723	0.172	0.004	0.90	0.73		
		Left Tilted	0.197	0.127	0.002	0.32	0.20		
	Band 7	Right Cheek	0.556	0.512	0.011	1.07	0.57		
		Right Tilted	0.242	0.257	0.004	0.50	0.25		
		Left Cheek	1.118	0.172	0.004	1.29	1.12		
		Left Tilted	0.217	0.127	0.002	0.34	0.22		



WWAN Band		Exposure Position	1	2		1+2 Summed 1g SAR (W/kg)	SPLSR	Case No
			WWAN	5GHz WLAN				
			1g SAR (W/kg)	Band	1g SAR (W/kg)			
GSM	GSM850	Right Cheek	0.742	5.8GHz	0.382	1.12		
		Right Tilted	0.384	5.5GHz	0.177	0.56		
		Left Cheek	0.732	5.5GHz	0.147	0.88		
		Left Tilted	0.378	5.5GHz	0.076	0.45		
	GSM1900	Right Cheek	0.596	5.8GHz	0.382	0.98		
		Right Tilted	0.314	5.5GHz	0.177	0.49		
		Left Cheek	1.004	5.5GHz	0.147	1.15		
		Left Tilted	0.203	5.5GHz	0.076	0.28		
WCDMA	Band V	Right Cheek	0.620	5.8GHz	0.382	1.00		
		Right Tilted	0.320	5.5GHz	0.177	0.50		
		Left Cheek	0.610	5.5GHz	0.147	0.76		
		Left Tilted	0.337	5.5GHz	0.076	0.41		
	Band II	Right Cheek	0.459	5.8GHz	0.382	0.84		
		Right Tilted	0.197	5.5GHz	0.177	0.37		
		Left Cheek	0.851	5.5GHz	0.147	1.00		
		Left Tilted	0.259	5.5GHz	0.076	0.34		
LTE	Band 5	Right Cheek	0.718	5.8GHz	0.382	1.10		
		Right Tilted	0.398	5.5GHz	0.177	0.58		
		Left Cheek	0.678	5.5GHz	0.147	0.83		
		Left Tilted	0.418	5.5GHz	0.076	0.49		
	Band 2	Right Cheek	0.431	5.8GHz	0.382	0.81		
		Right Tilted	0.187	5.5GHz	0.177	0.36		
		Left Cheek	0.723	5.5GHz	0.147	0.87		
		Left Tilted	0.197	5.5GHz	0.076	0.27		
	Band 7	Right Cheek	0.556	5.8GHz	0.382	0.94		
		Right Tilted	0.242	5.5GHz	0.177	0.42		
		Left Cheek	1.118	5.5GHz	0.147	1.27		
		Left Tilted	0.217	5.5GHz	0.076	0.29		



WWAN Band		Exposure Position	1	2	3	1+2 Summed 10g SAR (W/kg)	1+3 Summed 10g SAR (W/kg)	SPLSR	Case No
			WWAN	2.4GHz WLAN	2.4GHz Bluetooth				
			10g SAR (W/kg)	10g SAR (W/kg)	10g SAR (W/kg)				
GSM	GSM850	Right Cheek	0.576	0.232	0.003	0.81	0.58		
		Right Tilted	0.304	0.119	0.001	0.42	0.31		
		Left Cheek	0.560	0.081	0.001	0.64	0.56		
		Left Tilted	0.297	0.062	0.001	0.36	0.30		
	GSM1900	Right Cheek	0.368	0.232	0.003	0.60	0.37		
		Right Tilted	0.183	0.119	0.001	0.30	0.18		
		Left Cheek	0.624	0.081	0.001	0.71	0.63		
		Left Tilted	0.121	0.062	0.001	0.18	0.12		
WCDMA	Band V	Right Cheek	0.480	0.232	0.003	0.71	0.48		
		Right Tilted	0.252	0.119	0.001	0.37	0.25		
		Left Cheek	0.467	0.081	0.001	0.55	0.47		
		Left Tilted	0.264	0.062	0.001	0.33	0.27		
	Band II	Right Cheek	0.302	0.232	0.003	0.53	0.31		
		Right Tilted	0.121	0.119	0.001	0.24	0.12		
		Left Cheek	0.524	0.081	0.001	0.61	0.53		
		Left Tilted	0.162	0.062	0.001	0.22	0.16		
LTE	Band 5	Right Cheek	0.542	0.232	0.003	0.77	0.55		
		Right Tilted	0.310	0.119	0.001	0.43	0.31		
		Left Cheek	0.525	0.081	0.001	0.61	0.53		
		Left Tilted	0.321	0.062	0.001	0.38	0.32		
	Band 2	Right Cheek	0.276	0.232	0.003	0.51	0.28		
		Right Tilted	0.112	0.119	0.001	0.23	0.11		
		Left Cheek	0.440	0.081	0.001	0.52	0.44		
		Left Tilted	0.122	0.062	0.001	0.18	0.12		
	Band 7	Right Cheek	0.297	0.232	0.003	0.53	0.30		
		Right Tilted	0.121	0.119	0.001	0.24	0.12		
		Left Cheek	0.576	0.081	0.001	0.66	0.58		
		Left Tilted	0.112	0.062	0.001	0.17	0.11		



WWAN Band		Exposure Position	1	2		1+2 Summed 10g SAR (W/kg)	SPLSR	Case No
			WWAN	5GHz WLAN				
			10g SAR (W/kg)	Band	10g SAR (W/kg)			
GSM	GSM850	Right Cheek	0.576	5.8GHz	0.115	0.69		
		Right Tilted	0.304	5.5GHz	0.061	0.37		
		Left Cheek	0.560	5.5GHz	0.052	0.61		
		Left Tilted	0.297	5.5GHz	0.027	0.32		
	GSM1900	Right Cheek	0.368	5.8GHz	0.115	0.48		
		Right Tilted	0.183	5.5GHz	0.061	0.24		
		Left Cheek	0.624	5.5GHz	0.052	0.68		
		Left Tilted	0.121	5.5GHz	0.027	0.15		
WCDMA	Band V	Right Cheek	0.480	5.8GHz	0.115	0.60		
		Right Tilted	0.252	5.5GHz	0.061	0.31		
		Left Cheek	0.467	5.5GHz	0.052	0.52		
		Left Tilted	0.264	5.5GHz	0.027	0.29		
	Band II	Right Cheek	0.302	5.8GHz	0.115	0.42		
		Right Tilted	0.121	5.5GHz	0.061	0.18		
		Left Cheek	0.524	5.5GHz	0.052	0.58		
		Left Tilted	0.162	5.5GHz	0.027	0.19		
LTE	Band 5	Right Cheek	0.542	5.8GHz	0.115	0.66		
		Right Tilted	0.310	5.5GHz	0.061	0.37		
		Left Cheek	0.525	5.5GHz	0.052	0.58		
		Left Tilted	0.321	5.5GHz	0.027	0.35		
	Band 2	Right Cheek	0.276	5.8GHz	0.115	0.39		
		Right Tilted	0.112	5.5GHz	0.061	0.17		
		Left Cheek	0.440	5.5GHz	0.052	0.49		
		Left Tilted	0.122	5.5GHz	0.027	0.15		
	Band 7	Right Cheek	0.297	5.8GHz	0.115	0.41		
		Right Tilted	0.121	5.5GHz	0.061	0.18		
		Left Cheek	0.576	5.5GHz	0.052	0.63		
		Left Tilted	0.112	5.5GHz	0.027	0.14		



15.2 Hotspot Exposure Conditions

WWAN Band	Exposure Position	1	2	3	1+2 Summed 1g SAR (W/kg)	1+3 Summed 1g SAR (W/kg)	SPLSR	Case No	
		WWAN	2.4GHz WLAN	2.4GHz Bluetooth					
		1g SAR (W/kg)	1g SAR (W/kg)	Estimated 1g SAR (W/kg)					
GSM	GSM850	Front	0.790	0.137	0.273	0.93	1.06		
		Back	0.742	0.865	0.273	1.61	1.02	0.02	Case 1
		Left side	0.601	0.550	0.273	1.15	0.87		
		Right side	0.642			0.64	0.64		
		Top side		0.051	0.273	0.05	0.27		
		Bottom side	0.160			0.16	0.16		
	GSM1900	Front	1.085	0.137	0.273	1.22	1.36		
		Back	1.180	0.865	0.273	2.05	1.45	0.03	Case 2
		Left side	0.591	0.550	0.273	1.14	0.86		
		Right side	0.102			0.10	0.10		
		Top side		0.051	0.273	0.05	0.27		
		Bottom side	0.347			0.35	0.35		
WCDMA	Band V	Front	0.714	0.137	0.273	0.85	0.99		
		Back	0.620	0.865	0.273	1.49	0.89		
		Left side	0.539	0.550	0.273	1.09	0.81		
		Right side	0.613			0.61	0.61		
		Top side		0.051	0.273	0.05	0.27		
		Bottom side	0.142			0.14	0.14		
	Band II	Front	0.960	0.137	0.273	1.10	1.23		
		Back	1.182	0.865	0.273	2.05	1.46	0.03	Case 3
		Left side	0.504	0.550	0.273	1.05	0.78		
		Right side	0.162			0.16	0.16		
		Top side		0.051	0.273	0.05	0.27		
		Bottom side	0.239			0.24	0.24		
LTE	Band 5	Front	0.807	0.137	0.273	0.94	1.08		
		Back	0.782	0.865	0.273	1.65	1.06	0.03	Case 4
		Left side	0.684	0.550	0.273	1.23	0.96		
		Right side	0.753			0.75	0.75		
		Top side		0.051	0.273	0.05	0.27		
		Bottom side	0.166			0.17	0.17		
	Band 2	Front	0.768	0.137	0.273	0.91	1.04		
		Back	1.187	0.865	0.273	2.05	1.46	0.03	Case 5
		Left side	0.537	0.550	0.273	1.09	0.81		
		Right side	0.163			0.16	0.16		
		Top side		0.051	0.273	0.05	0.27		
		Bottom side	0.253			0.25	0.25		
	Band 7	Front	0.899	0.137	0.273	1.04	1.17		
		Back	1.050	0.865	0.273	1.92	1.32	0.03	Case 6
		Left side	0.693	0.550	0.273	1.24	0.97		
		Right side	0.062			0.06	0.06		
		Top side		0.051	0.273	0.05	0.27		
		Bottom side	0.691			0.69	0.69		



WWAN Band		Exposure Position	1	2		1+2 Summed 1g SAR (W/kg)	SPLSR	Case No
			WWAN	5GHz WLAN				
			SAR (W/kg)	Band	SAR (W/kg)			
GSM	GSM850	Front	0.790	5.2GHz	0.164	0.95		
		Back	0.742	5.8GHz	0.083	0.83		
		Left side	0.601	5.2GHz	0.035	0.64		
		Right side	0.642			0.64		
		Top side		5.8GHz	0.007	0.01		
		Bottom side	0.160			0.16		
	GSM1900	Front	1.085	5.2GHz	0.164	1.25		
		Back	1.180	5.8GHz	0.083	1.26		
		Left side	0.591	5.2GHz	0.035	0.63		
		Right side	0.102			0.10		
		Top side		5.8GHz	0.007	0.01		
		Bottom side	0.347			0.35		
WCDMA	Band V	Front	0.714	5.2GHz	0.164	0.88		
		Back	0.620	5.8GHz	0.083	0.70		
		Left side	0.539	5.2GHz	0.035	0.57		
		Right side	0.613			0.61		
		Top side		5.8GHz	0.007	0.01		
		Bottom side	0.142			0.14		
	Band II	Front	0.960	5.2GHz	0.164	1.12		
		Back	1.182	5.8GHz	0.083	1.27		
		Left side	0.504	5.2GHz	0.035	0.54		
		Right side	0.162			0.16		
		Top side		5.8GHz	0.007	0.01		
		Bottom side	0.239			0.24		
LTE	Band 5	Front	0.807	5.2GHz	0.164	0.97		
		Back	0.782	5.8GHz	0.083	0.87		
		Left side	0.684	5.2GHz	0.035	0.72		
		Right side	0.753			0.75		
		Top side		5.8GHz	0.007	0.01		
		Bottom side	0.166			0.17		
	Band 2	Front	0.768	5.2GHz	0.164	0.93		
		Back	1.187	5.8GHz	0.083	1.27		
		Left side	0.537	5.2GHz	0.035	0.57		
		Right side	0.163			0.16		
		Top side		5.8GHz	0.007	0.01		
		Bottom side	0.253			0.25		
	Band 7	Front	0.899	5.2GHz	0.164	1.06		
		Back	1.050	5.8GHz	0.083	1.13		
		Left side	0.693	5.2GHz	0.035	0.73		
		Right side	0.062			0.06		
		Top side		5.8GHz	0.007	0.01		
		Bottom side	0.691			0.69		



WWAN Band	Exposure Position	1	2	3	1+2 Summed 10g SAR (W/kg)	1+3 Summed 10g SAR (W/kg)	SPLSR	Case No	
		WWAN	2.4GHz WLAN	2.4GHz Bluetooth					
		10g SAR (W/kg)	10g SAR (W/kg)	Estimated 10g SAR (W/kg)					
GSM	GSM850	Front	0.617	0.068	0.109	0.69	0.73		
		Back	0.505	0.384	0.109	0.89	0.61		
		Left side	0.422	0.257	0.109	0.68	0.53		
		Right side	0.449			0.45	0.45		
		Top side		0.026	0.109	0.03	0.11		
		Bottom side	0.101			0.10	0.10		
	GSM1900	Front	0.669	0.068	0.109	0.74	0.78		
		Back	0.753	0.384	0.109	1.14	0.86		
		Left side	0.356	0.257	0.109	0.61	0.47		
		Right side	0.063			0.06	0.06		
		Top side		0.026	0.109	0.03	0.11		
		Bottom side	0.210			0.21	0.21		
WCDMA	Band V	Front	0.563	0.068	0.109	0.63	0.67		
		Back	0.399	0.384	0.109	0.78	0.51		
		Left side	0.379	0.257	0.109	0.64	0.49		
		Right side	0.425			0.43	0.43		
		Top side		0.026	0.109	0.03	0.11		
		Bottom side	0.091			0.09	0.09		
	Band II	Front	0.601	0.068	0.109	0.67	0.71		
		Back	0.704	0.384	0.109	1.09	0.81		
		Left side	0.310	0.257	0.109	0.57	0.42		
		Right side	0.101			0.10	0.10		
		Top side		0.026	0.109	0.03	0.11		
		Bottom side	0.148			0.15	0.15		
LTE	Band 5	Front	0.611	0.068	0.109	0.68	0.72		
		Back	0.599	0.384	0.109	0.98	0.71		
		Left side	0.481	0.257	0.109	0.74	0.59		
		Right side	0.524			0.52	0.52		
		Top side		0.026	0.109	0.03	0.11		
		Bottom side	0.100			0.10	0.10		
	Band 2	Front	0.461	0.068	0.109	0.53	0.57		
		Back	0.717	0.384	0.109	1.10	0.83		
		Left side	0.319	0.257	0.109	0.58	0.43		
		Right side	0.097			0.10	0.10		
		Top side		0.026	0.109	0.03	0.11		
		Bottom side	0.155			0.16	0.16		
	Band 7	Front	0.500	0.068	0.109	0.57	0.61		
		Back	0.555	0.384	0.109	0.94	0.66		
		Left side	0.355	0.257	0.109	0.61	0.46		
		Right side	0.032			0.03	0.03		
		Top side		0.026	0.109	0.03	0.11		
		Bottom side	0.319			0.32	0.32		



WWAN Band		Exposure Position	1	2		1+2 Summed 10g SAR (W/kg)	SPLSR	Case No
			WWAN	5GHz WLAN				
			10g SAR (W/kg)	Band	10g SAR (W/kg)			
GSM	GSM850	Front	0.617	5.2GHz	0.048	0.67		
		Back	0.505	5.8GHz	0.024	0.53		
		Left side	0.422	5.2GHz	0.010	0.43		
		Right side	0.449			0.45		
		Top side		5.8GHz	0.002	0.01		
		Bottom side	0.101			0.10		
	GSM1900	Front	0.669	5.2GHz	0.048	0.72		
		Back	0.753	5.8GHz	0.024	0.78		
		Left side	0.356	5.2GHz	0.010	0.37		
		Right side	0.063			0.06		
		Top side		5.8GHz	0.002	0.01		
		Bottom side	0.210			0.21		
WCDMA	Band V	Front	0.563	5.2GHz	0.048	0.61		
		Back	0.399	5.8GHz	0.024	0.42		
		Left side	0.379	5.2GHz	0.010	0.39		
		Right side	0.425			0.43		
		Top side		5.8GHz	0.002	0.01		
		Bottom side	0.091			0.09		
	Band II	Front	0.601	5.2GHz	0.048	0.65		
		Back	0.704	5.8GHz	0.024	0.73		
		Left side	0.310	5.2GHz	0.010	0.32		
		Right side	0.101			0.10		
		Top side		5.8GHz	0.002	0.01		
		Bottom side	0.148			0.15		
LTE	Band 5	Front	0.611	5.2GHz	0.048	0.66		
		Back	0.599	5.8GHz	0.024	0.62		
		Left side	0.481	5.2GHz	0.010	0.49		
		Right side	0.524			0.52		
		Top side		5.8GHz	0.002	0.01		
		Bottom side	0.100			0.10		
	Band 2	Front	0.461	5.2GHz	0.048	0.51		
		Back	0.717	5.8GHz	0.024	0.74		
		Left side	0.319	5.2GHz	0.010	0.33		
		Right side	0.097			0.10		
		Top side		5.8GHz	0.002	0.01		
		Bottom side	0.155			0.16		
	Band 7	Front	0.500	5.2GHz	0.048	0.55		
		Back	0.555	5.8GHz	0.024	0.58		
		Left side	0.355	5.2GHz	0.010	0.37		
		Right side	0.032			0.03		
		Top side		5.8GHz	0.002	0.01		
		Bottom side	0.319			0.32		



15.3 Body-Worn Accessory Exposure Conditions

WWAN Band		Exposure Position	1	2	3	1+2 Summed 1g SAR (W/kg)	1+3 Summed 1g SAR (W/kg)	SPLSR	Case No
			WWAN 1g SAR (W/kg)	2.4GHz WLAN 1g SAR (W/kg)	2.4GHz Bluetooth Estimated 1g SAR (W/kg)				
GSM	GSM850	Front	0.723	0.074	0.182	0.80	0.91		
		Back	0.718	0.343	0.182	1.06	0.90		
	GSM1900	Front	0.540	0.074	0.182	0.61	0.72		
		Back	0.742	0.343	0.182	1.09	0.92		
WCDMA	Band V	Front	0.671	0.074	0.182	0.75	0.85		
		Back	0.635	0.343	0.182	0.98	0.82		
	Band II	Front	0.521	0.074	0.182	0.60	0.70		
		Back	0.673	0.343	0.182	1.02	0.86		
LTE	Band 5	Front	0.765	0.074	0.182	0.84	0.95		
		Back	0.737	0.343	0.182	1.08	0.92		
	Band 2	Front	0.436	0.074	0.182	0.51	0.62		
		Back	0.654	0.343	0.182	1.00	0.84		
	Band 7	Front	0.511	0.074	0.182	0.59	0.69		
		Back	0.562	0.343	0.182	0.91	0.74		

WWAN Band		Exposure Position	1	2		1+2 Summed 1g SAR (W/kg)	SPLSR	Case No
			WWAN 1g SAR (W/kg)	5GHz WLAN				
				Band	1g SAR (W/kg)			
GSM	GSM850	Front	0.723	5.2GHz	0.083	0.81		
		Back	0.718	5.3GHz	0.059	0.78		
	GSM1900	Front	0.540	5.2GHz	0.083	0.62		
		Back	0.742	5.3GHz	0.059	0.80		
WCDMA	Band V	Front	0.671	5.2GHz	0.083	0.75		
		Back	0.635	5.3GHz	0.059	0.69		
	Band II	Front	0.521	5.2GHz	0.083	0.60		
		Back	0.673	5.3GHz	0.059	0.73		
LTE	Band 5	Front	0.765	5.2GHz	0.083	0.85		
		Back	0.737	5.3GHz	0.059	0.80		
	Band 2	Front	0.436	5.2GHz	0.083	0.52		
		Back	0.654	5.3GHz	0.059	0.71		
	Band 7	Front	0.511	5.2GHz	0.083	0.59		
		Back	0.562	5.3GHz	0.059	0.62		



WWAN Band		Exposure Position	1	2	3	1+2 Summed 10g SAR (W/kg)	1+3 Summed 10g SAR (W/kg)	SPLSR	Case No
			WWAN	2.4GHz WLAN	2.4GHz Bluetooth				
			10g SAR (W/kg)	10g SAR (W/kg)	Estimated 10g SAR (W/kg)				
GSM	GSM850	Front	0.562	0.038	0.073	0.60	0.64		
		Back	0.559	0.167	0.073	0.73	0.63		
	GSM1900	Front	0.352	0.038	0.073	0.39	0.43		
		Back	0.444	0.167	0.073	0.61	0.52		
WCDMA	Band V	Front	0.520	0.038	0.073	0.56	0.59		
		Back	0.494	0.167	0.073	0.66	0.57		
	Band II	Front	0.340	0.038	0.073	0.38	0.41		
		Back	0.437	0.167	0.073	0.60	0.51		
LTE	Band 5	Front	0.584	0.038	0.073	0.62	0.66		
		Back	0.559	0.167	0.073	0.73	0.63		
	Band 2	Front	0.280	0.038	0.073	0.32	0.35		
		Back	0.397	0.167	0.073	0.56	0.47		
	Band 7	Front	0.289	0.038	0.073	0.33	0.36		
		Back	0.306	0.167	0.073	0.47	0.38		

WWAN Band		Exposure Position	1	2		1+2 Summed 10g SAR (W/kg)	SPLSR	Case No
			WWAN	5GHz WLAN				
			10g SAR (W/kg)	Band	10g SAR (W/kg)			
GSM	GSM850	Front	0.562	5.2GHz	0.029	0.59		
		Back	0.559	5.3GHz	0.019	0.58		
	GSM1900	Front	0.352	5.2GHz	0.029	0.38		
		Back	0.444	5.3GHz	0.019	0.46		
WCDMA	Band V	Front	0.520	5.2GHz	0.029	0.55		
		Back	0.494	5.3GHz	0.019	0.51		
	Band II	Front	0.340	5.2GHz	0.029	0.37		
		Back	0.437	5.3GHz	0.019	0.46		
LTE	Band 5	Front	0.584	5.2GHz	0.029	0.61		
		Back	0.559	5.3GHz	0.019	0.58		
	Band 2	Front	0.280	5.2GHz	0.029	0.31		
		Back	0.397	5.3GHz	0.019	0.42		
	Band 7	Front	0.289	5.2GHz	0.029	0.32		
		Back	0.306	5.3GHz	0.019	0.33		

15.4 SPLSR Evaluation and Analysis

General Note:

- SPLSR = $(SAR_1 + SAR_2)^{1.5} / (\text{min. separation distance, mm})$. If $SPLSR \leq 0.04$, simultaneously transmission SAR measurement is not necessary

Case 1	Band	Position	SAR (W/kg)	Gap (cm)	SAR peak location (m)			3D distance (mm)	Summed SAR (W/kg)	SPLSR Results	Simultaneous SAR
	GSM850				X	Y	Z				
	2.4GHz WLAN	Back	0.742	1cm	-0.0045	-0.058	-0.205	110.1	1.61	0.02	Not required
			0.865	1cm	0.0146	0.0504	-0.205				

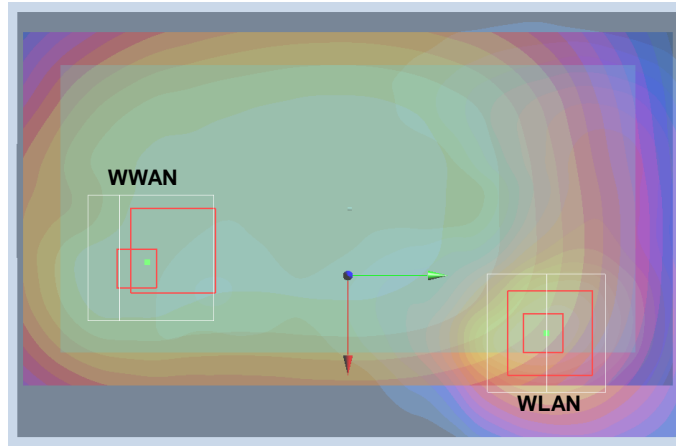

Case 2	Band	Position	SAR (W/kg)	Gap (cm)	SAR peak location (m)			3D distance (mm)	Summed SAR (W/kg)	SPLSR Results	Simultaneous SAR
	GSM1900				X	Y	Z				
	2.4GHz WLAN	Back	1.180	1cm	0.005	-0.0525	-0.205	103.3	2.05	0.03	Not required
			0.865	1cm	0.0146	0.0504	-0.205				

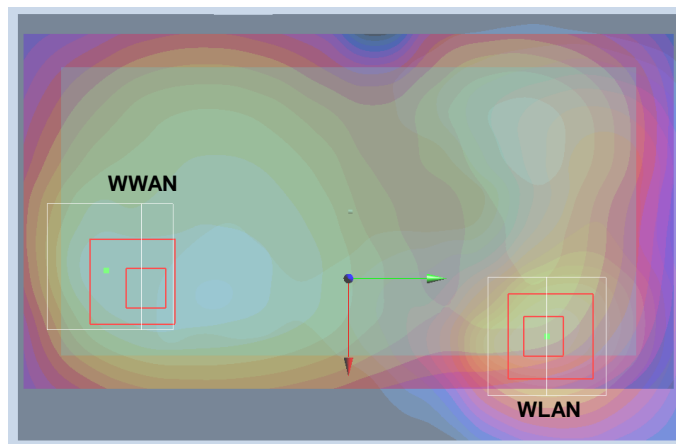

Case 3	Band	Position	SAR (W/kg)	Gap (cm)	SAR peak location (m)			3D distance (mm)	Summed SAR (W/kg)	SPLSR Results	Simultaneous SAR
					X	Y	Z				
	WCDMA II	Back	1.182	1cm	-0.003	-0.062	-0.205	113.8	2.05	0.03	Not required
	2.4GHz WLAN		0.865	1cm	0.0146	0.0504	-0.205				

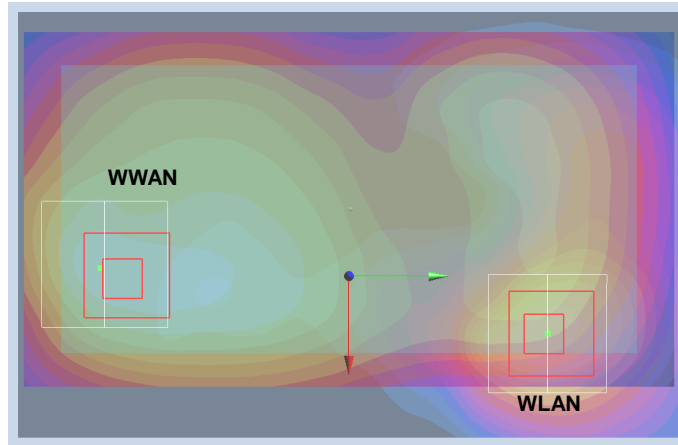

Case 4	Band	Position	SAR (W/kg)	Gap (cm)	SAR peak location (m)			3D distance (mm)	Summed SAR (W/kg)	SPLSR Results	Simultaneous SAR
					X	Y	Z				
	LTE Band 5	Back	0.782	1	-0.0195	-0.000993	-0.205	61.7	1.65	0.03	Not required
	2.4GHz WLAN		0.865	1	0.0146	0.0504	-0.205				

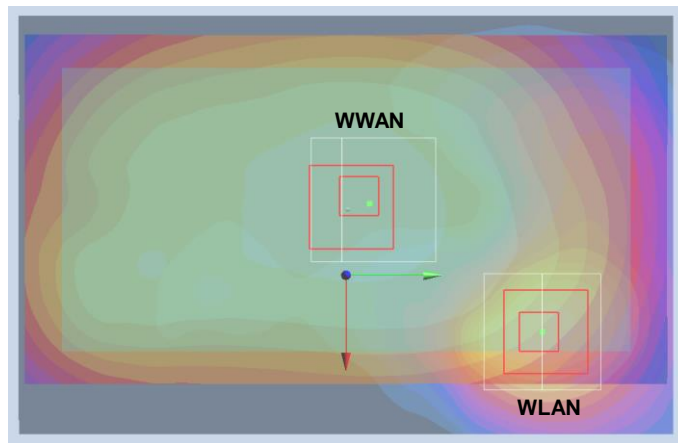

Case 5	Band	Position	SAR (W/kg)	Gap (cm)	SAR peak location (m)			3D distance (mm)	Summed SAR (W/kg)	SPLSR Results	Simultaneous SAR
	LTE Band 2				X	Y	Z				
	2.4GHz WLAN	Back	1.187	1	-0.0045	-0.0605	-0.205	112.5	2.05	0.03	Not required
			0.865	1	0.0146	0.0504	-0.205				

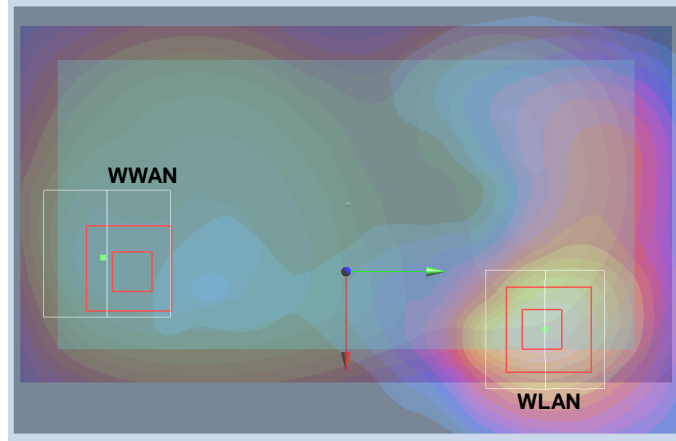

Case 6	Band	Position	SAR (W/kg)	Gap (cm)	SAR peak location (m)			3D distance (mm)	Summed SAR (W/kg)	SPLSR Results	Simultaneous SAR
	LTE Band 7				X	Y	Z				
	2.4GHz WLAN	Back	1.050	1	0.006	-0.055	-0.205	105.8	1.92	0.03	Not required
			0.865	1	0.0146	0.0504	-0.205				

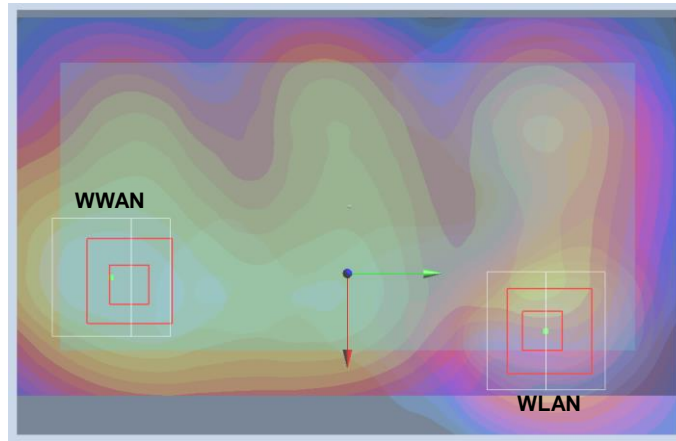

Test Engineer : Ken Li, Tommy Chen, Steven Chang, Domo Hsiao, Jerry Hu and Bevis Chang

16. Uncertainty Assessment

The component of uncertainty may generally be categorized according to the methods used to evaluate them. The evaluation of uncertainty by the statistical analysis of a series of observations is termed a Type A evaluation of uncertainty. The evaluation of uncertainty by means other than the statistical analysis of a series of observation is termed a Type B evaluation of uncertainty. Each component of uncertainty, however evaluated, is represented by an estimated standard deviation, termed standard uncertainty, which is determined by the positive square root of the estimated variance.

A Type A evaluation of standard uncertainty may be based on any valid statistical method for treating data. This includes calculating the standard deviation of the mean of a series of independent observations; using the method of least squares to fit a curve to the data in order to estimate the parameter of the curve and their standard deviations; or carrying out an analysis of variance in order to identify and quantify random effects in certain kinds of measurement.

A type B evaluation of standard uncertainty is typically based on scientific judgment using all of the relevant information available. These may include previous measurement data, experience, and knowledge of the behavior and properties of relevant materials and instruments, manufacture’s specification, data provided in calibration reports and uncertainties assigned to reference data taken from handbooks. Broadly speaking, the uncertainty is either obtained from an outdoor source or obtained from an assumed distribution, such as the normal distribution, rectangular or triangular distributions indicated in table below.

Uncertainty Distributions	Normal	Rectangular	Triangular	U-Shape
Multi-plying Factor ^(a)	1/k ^(b)	1/√3	1/√6	1/√2

(a) standard uncertainty is determined as the product of the multiplying factor and the estimated range of variations in the measured quantity

(b) κ is the coverage factor

Table 16.1. Standard Uncertainty for Assumed Distribution

The combined standard uncertainty of the measurement result represents the estimated standard deviation of the result. It is obtained by combining the individual standard uncertainties of both Type A and Type B evaluation using the usual “root-sum-squares” (RSS) methods of combining standard deviations by taking the positive square root of the estimated variances.

Expanded uncertainty is a measure of uncertainty that defines an interval about the measurement result within which the measured value is confidently believed to lie. It is obtained by multiplying the combined standard uncertainty by a coverage factor. Typically, the coverage factor ranges from 2 to 3. Using a coverage factor allows the true value of a measured quantity to be specified with a defined probability within the specified uncertainty range. For purpose of this document, a coverage factor two is used, which corresponds to confidence interval of about 95 %. The DASY uncertainty Budget is shown in the following tables.



Error Description	Uncertainty Value (±%)	Probability Distribution	Divisor	Ci (1g)	Ci (10g)	Standard Uncertainty (1g)	Standard Uncertainty (10g)
Measurement System							
Probe Calibration	6.0	Normal	1	1	1	± 6.0 %	± 6.0 %
Axial Isotropy	4.7	Rectangular	√3	0.7	0.7	± 1.9 %	± 1.9 %
Hemispherical Isotropy	9.6	Rectangular	√3	0.7	0.7	± 3.9 %	± 3.9 %
Boundary Effects	1.0	Rectangular	√3	1	1	± 0.6 %	± 0.6 %
Linearity	4.7	Rectangular	√3	1	1	± 2.7 %	± 2.7 %
System Detection Limits	1.0	Rectangular	√3	1	1	± 0.6 %	± 0.6 %
Readout Electronics	0.3	Normal	1	1	1	± 0.3 %	± 0.3 %
Response Time	0.8	Rectangular	√3	1	1	± 0.5 %	± 0.5 %
Integration Time	2.6	Rectangular	√3	1	1	± 1.5 %	± 1.5 %
RF Ambient Noise	3.0	Rectangular	√3	1	1	± 1.7 %	± 1.7 %
RF Ambient Reflections	3.0	Rectangular	√3	1	1	± 1.7 %	± 1.7 %
Probe Positioner	0.4	Rectangular	√3	1	1	± 0.2 %	± 0.2 %
Probe Positioning	2.9	Rectangular	√3	1	1	± 1.7 %	± 1.7 %
Max. SAR Eval.	1.0	Rectangular	√3	1	1	± 0.6 %	± 0.6 %
Test Sample Related							
Device Positioning	2.9	Normal	1	1	1	± 2.9 %	± 2.9 %
Device Holder	3.6	Normal	1	1	1	± 3.6 %	± 3.6 %
Power Drift	5.0	Rectangular	√3	1	1	± 2.9 %	± 2.9 %
Phantom and Setup							
Phantom Uncertainty	4.0	Rectangular	√3	1	1	± 2.3 %	± 2.3 %
Liquid Conductivity (Target)	5.0	Rectangular	√3	0.64	0.43	± 1.8 %	± 1.2 %
Liquid Conductivity (Meas.)	2.5	Normal	1	0.64	0.43	± 1.6 %	± 1.1 %
Liquid Permittivity (Target)	5.0	Rectangular	√3	0.6	0.49	± 1.7 %	± 1.4 %
Liquid Permittivity (Meas.)	2.5	Normal	1	0.6	0.49	± 1.5 %	± 1.2 %
Combined Standard Uncertainty						± 11.0 %	± 10.8 %
Coverage Factor for 95 %						K=2	
Expanded Uncertainty						± 22.0 %	± 21.5 %

Table 16.2. Uncertainty Budget for frequency range 300 MHz to 3 GHz

Error Description	Uncertainty Value (±%)	Probability Distribution	Divisor	Ci (1g)	Ci (10g)	Standard Uncertainty (1g)	Standard Uncertainty (10g)
Measurement System							
Probe Calibration	6.55	Normal	1	1	1	± 6.55 %	± 6.55 %
Axial Isotropy	4.7	Rectangular	√3	0.7	0.7	± 1.9 %	± 1.9 %
Hemispherical Isotropy	9.6	Rectangular	√3	0.7	0.7	± 3.9 %	± 3.9 %
Boundary Effects	2.0	Rectangular	√3	1	1	± 1.2 %	± 1.2 %
Linearity	4.7	Rectangular	√3	1	1	± 2.7 %	± 2.7 %
System Detection Limits	1.0	Rectangular	√3	1	1	± 0.6 %	± 0.6 %
Readout Electronics	0.3	Normal	1	1	1	± 0.3 %	± 0.3 %
Response Time	0.8	Rectangular	√3	1	1	± 0.5 %	± 0.5 %
Integration Time	2.6	Rectangular	√3	1	1	± 1.5 %	± 1.5 %
RF Ambient Noise	3.0	Rectangular	√3	1	1	± 1.7 %	± 1.7 %
RF Ambient Reflections	3.0	Rectangular	√3	1	1	± 1.7 %	± 1.7 %
Probe Positioner	0.8	Rectangular	√3	1	1	± 0.5 %	± 0.5 %
Probe Positioning	9.9	Rectangular	√3	1	1	± 5.7 %	± 5.7 %
Max. SAR Eval.	4.0	Rectangular	√3	1	1	± 2.3 %	± 2.3 %
Test Sample Related							
Device Positioning	2.9	Normal	1	1	1	± 2.9 %	± 2.9 %
Device Holder	3.6	Normal	1	1	1	± 3.6 %	± 3.6 %
Power Drift	5.0	Rectangular	√3	1	1	± 2.9 %	± 2.9 %
Phantom and Setup							
Phantom Uncertainty	4.0	Rectangular	√3	1	1	± 2.3 %	± 2.3 %
Liquid Conductivity (Target)	5.0	Rectangular	√3	0.64	0.43	± 1.8 %	± 1.2 %
Liquid Conductivity (Meas.)	2.5	Normal	1	0.64	0.43	± 1.6 %	± 1.1 %
Liquid Permittivity (Target)	5.0	Rectangular	√3	0.6	0.49	± 1.7 %	± 1.4 %
Liquid Permittivity (Meas.)	2.5	Normal	1	0.6	0.49	± 1.5 %	± 1.2 %
Combined Standard Uncertainty						± 12.8 %	± 12.6 %
Coverage Factor for 95 %						K=2	
Expanded Uncertainty						± 25.6 %	± 25.2 %

Table 16.3. Uncertainty Budget for frequency range 3 GHz to 6 GHz



17. References

- [1] FCC 47 CFR Part 2 "Frequency Allocations and Radio Treaty Matters; General Rules and Regulations"
- [2] ANSI/IEEE Std. C95.1-1992, "IEEE Standard for Safety Levels with Respect to Human Exposure to Radio Frequency Electromagnetic Fields, 3 kHz to 300 GHz", September 1992
- [3] IEEE Std. 1528-2003, "Recommended Practice for Determining the Peak Spatial-Average Specific Absorption Rate (SAR) in the Human Head from Wireless Communications Devices: Measurement Techniques", December 2003
- [4] SPEAG DASY System Handbook
- [5] FCC KDB 248227 D01 v01r02, "SAR Measurement Procedures for 802.11 a/b/g Transmitters", May 2007
- [6] FCC KDB 447498 D01 v05r02, "Mobile and Portable Device RF Exposure Procedures and Equipment Authorization Policies", Feb 2014
- [7] FCC KDB 648474 D04 v01r02, "SAR Evaluation Considerations for Wireless Handsets", Dec 2013.
- [8] FCC KDB 941225 D01 v03, "3G SAR MEAUREMENT PROCEDURES", Oct 2014
- [9] FCC KDB 941225 D05 v02r03, "SAR Evaluation Considerations for LTE Devices", Dec 2013
- [10] FCC KDB 941225 D06 v02, "SAR Evaluation Procedures for Portable Devices with Wireless Router Capabilities", Oct 2014.
- [11] FCC KDB 865664 D01 v01r03, "SAR Measurement Requirements for 100 MHz to 6 GHz", Feb 2014.
- [12] FCC KDB 865664 D02 v01r01, "RF Exposure Compliance Reporting and Documentation Considerations" May 2013.