



FCC RF Test Report

APPLICANT : Sony Mobile Communications Inc.
EQUIPMENT : Smart phone
BRAND NAME : SONY
TYPE NAME : PM-0633-BV
FCC ID : PY7-PM0633
STANDARD : FCC Part 15 Subpart C §15.247
CLASSIFICATION : (DSS) Spread Spectrum Transmitter

The product was received on Oct. 21, 2014 and testing was completed on Nov. 07, 2014. We, SPORTON INTERNATIONAL INC., would like to declare that the tested sample has been evaluated in accordance with the test procedures and has been in compliance with the applicable technical standards.

The test results in this report apply exclusively to the tested model / sample. Without written approval of SPORTON INTERNATIONAL INC., the test report shall not be reproduced except in full.

Reviewed by: Joseph Lin / Supervisor

Approved by: Jones Tsai / Manager



SPORTON INTERNATIONAL INC.

No. 52, Hwa Ya 1st Rd., Hwa Ya Technology Park, Kwei-Shan Hsiang, Tao Yuan Hsien, Taiwan, R.O.C.

SPORTON INTERNATIONAL INC.

TEL : 886-3-327-3456

FAX : 886-3-328-4978

FCC ID : PY7-PM0633

Page Number : 1 of 74

Report Issued Date : Dec. 24, 2014

Report Version : Rev. 01

Report Template No.: BU5-FR15CBT Version 1.0



TABLE OF CONTENTS

REVISION HISTORY.....3

SUMMARY OF TEST RESULT4

1 GENERAL DESCRIPTION.....5

 1.1 Applicant.....5

 1.2 Manufacturer.....5

 1.3 Product Feature of Equipment Under Test.....5

 1.4 Product Specification subjective to this standard6

 1.5 Modification of EUT7

 1.6 Testing Location7

 1.7 Applicable Standards.....7

2 TEST CONFIGURATION OF EQUIPMENT UNDER TEST.....8

 2.1 Descriptions of Test Mode.....8

 2.2 Test Mode.....9

 2.3 Connection Diagram of Test System.....10

 2.4 Support Unit used in test configuration and system11

 2.5 EUT Operation Test Setup11

 2.6 Measurement Results Explanation Example.....11

3 TEST RESULT12

 3.1 Number of Channel Measurement12

 3.2 Hopping Channel Separation Measurement14

 3.3 Dwell Time Measurement.....21

 3.4 20dB Bandwidth Measurement24

 3.5 Peak Output Power Measurement31

 3.6 Conducted Band Edges Measurement33

 3.7 Conducted Spurious Emission Measurement40

 3.8 Radiated Band Edges and Spurious Emission Measurement59

 3.9 AC Conducted Emission Measurement.....67

 3.10 Antenna Requirements.....71

4 LIST OF MEASURING EQUIPMENT.....72

5 UNCERTAINTY OF EVALUATION.....74

APPENDIX A. TEST RESULT OF RADIATED EMISSION



SUMMARY OF TEST RESULT

Report Section	FCC Rule	Description	Limit	Result	Remark
3.1	15.247(a)(1)	Number of Channels	≥ 15 Chs	Pass	-
3.2	15.247(a)(1)	Hopping Channel Separation	$\geq 2/3$ of 20dB BW	Pass	-
3.3	15.247(a)(1)	Dwell Time of Each Channel	≤ 0.4 sec in 31.6sec period	Pass	-
3.4	15.247(a)(1)	20dB Bandwidth	NA	Pass	-
3.5	15.247(b)(1)	Peak Output Power	≤ 125 mW	Pass	-
3.6	15.247(d)	Conducted Band Edges	≤ 20 dBc	Pass	-
3.7	15.247(d)	Conducted Spurious Emission	≤ 20 dBc	Pass	-
3.8	15.247(d)	Radiated Band Edges and Radiated Spurious Emission	15.209(a) & 15.247(d)	Pass	Under limit 10.73 dB at 41.340 MHz
3.9	15.207	AC Conducted Emission	15.207(a)	Pass	Under limit 13.50 dB at 0.446 MHz
3.10	15.203 & 15.247(b)	Antenna Requirement	N/A	Pass	-



1 General Description

1.1 Applicant

Sony Mobile Communications Inc.
Nya Vattentorget, 22188 Lund, Sweden

1.2 Manufacturer

Arima Communications Corp.
6F, No. 866, Jhongjheng Rd., Jhonghe Dist., New Taipei City 23586, Taiwan

1.3 Product Feature of Equipment Under Test

The Equipment Under Test (hereafter called: EUT) is Smart phone supporting, GSM / WCDMA, Wi-Fi 2.4GHz 802.11b/g/n, Bluetooth with FM Receiver, and GPS features, and below is details of information.

Product Feature	
Equipment	Smart phone
Brand Name	SONY
Type Name	PM-0633-BV
FCC ID	PY7-PM0633
GSM Operating Band(s)	GSM 850/900/1800/1900MHz
GPRS / EGPRS Multi Slot Class	GPRS Class 12, EGPRS Class 12
WCDMA Operating Band(s)	FDD Band I / II / V
WCDMA Rel. Version	Rel. 7
Wi-Fi Specification	802.11b/g/n (HT20/HT40)
Bluetooth Version	v3.0 + EDR / v4.0 - LE
Power Supply	Battery / AC Adapter / Car Charger

Remark: The above EUT's information was declared by manufacturer. Please refer to the specifications or user's manual for more detailed description.



1.4 Product Specification subjective to this standard

Product Specification subjective to this standard	
Tx/Rx Frequency Range	2402 MHz ~ 2480 MHz
Number of Channels	79
Carrier Frequency of Each Channel	2402+n*1 MHz; n=0~78
Maximum Output Power to Antenna	Bluetooth BR(1Mbps) : 5.78 dBm (0.0038 W) Bluetooth EDR (2Mbps) : 5.58 dBm (0.0036 W) Bluetooth EDR (3Mbps) : 5.84 dBm (0.0038 W)
Antenna Type	IFA Antenna type with gain 0.30 dBi
Type of Modulation	Bluetooth BR (1Mbps) : GFSK Bluetooth EDR (2Mbps) : $\pi/4$ -DQPSK Bluetooth EDR (3Mbps) : 8-DPSK

EUT Information List				
IMEI	HW Version	SW Version	S/N	Performed Test Item
IMEI 1: 004402147947752 IMEI 2: 004402147947760	A	24.0.B.0.16	FR4A12D59203	RF conducted measurement
IMEI 1: 004402147947893 IMEI 2: 004402147947701			FR4A12D59321	Radiated Spurious Emission
IMEI 1: 004402147947539 IMEI 2: 004402147947547			FR4A12D59194	Conducted Emission

Accessory List	
AC Adapter	Model No. : EP800
	Type No. : AC-0030-US
	S/N : 3113W46622717 (for Radiated Spurious Emission) 3113W46622770 (for Conducted Emission)
Battery	Model No. : Charles
Earphone	Model No. : MH410c
	Type No. : AG-1103
	S/N : 1411204600BC914 (for Radiated Spurious Emission) 1411204B00BC72C (for Conducted Emission)
USB Cable 1	Model No. : EC450
	Type No. : AI-0700
	S/N : 1412D1122420A (for Radiated Spurious Emission) 1412D01471694 (for Conducted Emission)

Note:

1. Above EUT list and accessory list used are electrically identical per declared by manufacturer.
2. Above the accessories list are used to exercise the EUT during test.
3. For other wireless features of this EUT, test report will be issued separately.



1.5 Modification of EUT

No modifications are made to the EUT during all test items.

1.6 Testing Location

Sporton Lab is accredited to ISO 17025 by Taiwan Accreditation Foundation (TAF code : 1190) and the FCC designation No. TW1022 under the FCC 2.948(e) by Mutual Recognition Agreement (MRA) in FCC Test.

Test Site	SPORTON INTERNATIONAL INC.		
Test Site Location	No. 52, Hwa Ya 1 st Rd., Hwa Ya Technology Park, Kwei-Shan Hsiang, Tao Yuan Hsien, Taiwan, R.O.C. TEL: +886-3-327-3456 FAX: +886-3-328-4978		
Test Site No.	Sporton Site No.		
	TH02-HY	CO05-HY	03CH07-HY

1.7 Applicable Standards

According to the specifications of the manufacturer, the EUT must comply with the requirements of the following standards:

- FCC Part 15 Subpart C §15.247
- FCC Public Notice DA 00-705
- ANSI C63.4-2003

Remark:

1. All test items were verified and recorded according to the standards and without any deviation during the test.
2. This EUT has also been tested and complied with the requirements of FCC Part 15, Subpart B, recorded in a separate test report.



2 Test Configuration of Equipment Under Test

2.1 Descriptions of Test Mode

Preliminary tests were performed in different data rates and recorded the RF output power in the following table:

Channel	Frequency	Bluetooth RF Output Power		
		Data Rate / Modulation		
		GFSK	π /4-DQPSK	8-DPSK
		1Mbps	2Mbps	3Mbps
Ch00	2402MHz	5.50 dBm	5.30 dBm	5.51 dBm
Ch39	2441MHz	5.78 dBm	5.58 dBm	5.84 dBm
Ch78	2480MHz	5.70 dBm	5.46 dBm	5.78 dBm

Remark:

1. All the test data for each data rate were verified, but only the worst case was reported.
 2. The data rate was set in 3Mbps for all the test items due to the highest RF output power.
-
- a. The EUT has been associated with peripherals and configuration operated in a manner tended to maximize its emission characteristics in a typical application. Frequency range investigated: conduction (150 kHz to 30 MHz), radiation (9 kHz to the 10th harmonic of the highest fundamental frequency or to 40 GHz, whichever is lower). Pre-scanned tests, X, Y, Z in three orthogonal panels, and different data rates were conducted to determine the final configuration (Y plane as worst plane) from all possible combinations, and the worst mode of radiated spurious emissions is Bluetooth 3Mbps mode, and recorded in this report.
 - b. AC power line Conducted Emission was tested under maximum output power.



2.2 Test Mode

The following summary table is showing all test modes to demonstrate in compliance with the standard.

Summary table of Test Cases			
Test Item	Data Rate / Modulation		
	Bluetooth BR 1Mbps GFSK	Bluetooth EDR 2Mbps $\pi/4$ -DQPSK	Bluetooth EDR 3Mbps 8-DPSK
Conducted Test Cases	Mode 1: CH00_2402 MHz Mode 2: CH39_2441 MHz Mode 3: CH78_2480 MHz	Mode 4: CH00_2402 MHz Mode 5: CH39_2441 MHz Mode 6: CH78_2480 MHz	Mode 7: CH00_2402 MHz Mode 8: CH39_2441 MHz Mode 9: CH78_2480 MHz
Radiated Test Cases	Bluetooth BR 1Mbps GFSK	Bluetooth EDR 2Mbps $\pi/4$ -DQPSK	Bluetooth EDR 3Mbps 8-DPSK
	Mode 1: CH00_2402 MHz Mode 2: CH39_2441 MHz Mode 3: CH78_2480 MHz	Mode 4: CH00_2402 MHz Mode 5: CH39_2441 MHz Mode 6: CH78_2480 MHz	Mode 7: CH00_2402 MHz Mode 8: CH39_2441 MHz Mode 9: CH78_2480 MHz
AC Conducted Emission	Mode 1 :GSM1900 Idle + Bluetooth Link + WLAN Link + Earphone + Battery + USB Cable 1 (Charging from Adapter) + MP3		

2.3 Connection Diagram of Test System

<Bluetooth Tx Mode>

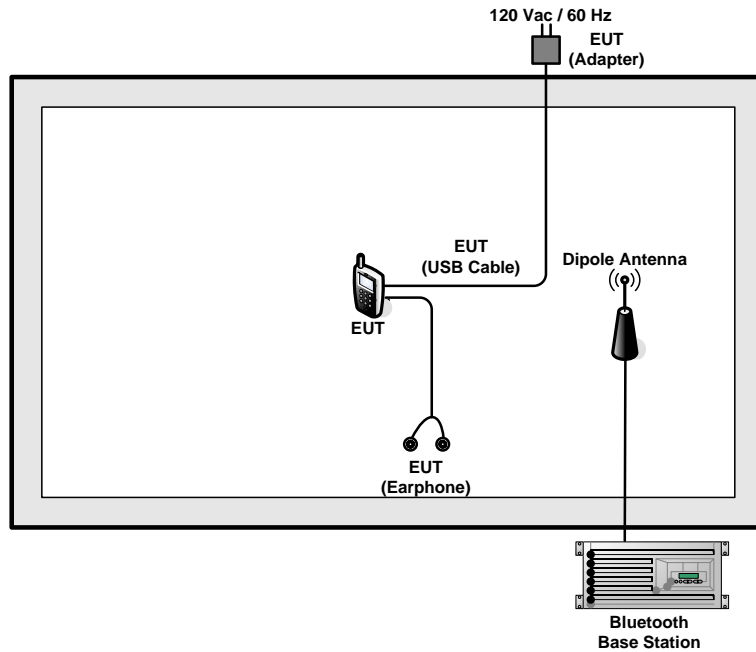

<AC Conducted Emission Mode>

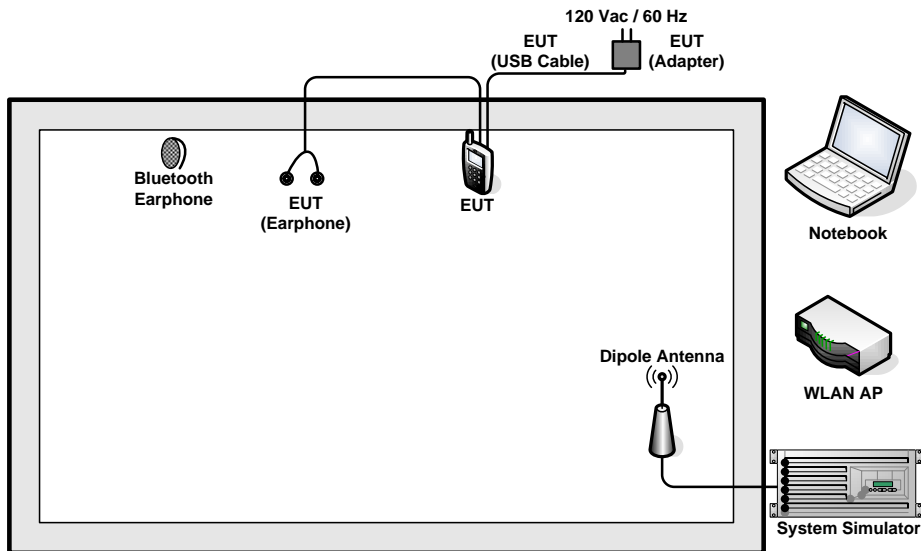



2.4 Support Unit used in test configuration and system

Item	Equipment	Trade Name	Model Name	FCC ID	Data Cable	Power Cord
1.	System Simulator	R&S	CMU 200	N/A	N/A	Unshielded, 1.8 m
2.	Bluetooth Base Station	R&S	CBT32	N/A	N/A	Unshielded, 1.8 m
3.	WLAN AP	D-Link	DIR-865L	KA2IR865LA1	N/A	Unshielded, 1.8 m
4.	Bluetooth Earphone	Sony	SBH20	PY7-RD0010	Unshielded, 0.75m	N/A
5.	Notebook	DELL	Latitude E6320	FCC DoC/ Contains FCC ID: QDS-BRCM1054	N/A	AC I/P: Unshielded, 1.2 m DC O/P: Shielded, 1.8 m
6.	SD Card	SanDisk	MicroSD HC	FCC DoC	N/A	N/A

2.5 EUT Operation Test Setup

For Bluetooth test items, an engineering test program was provided and enabled to make EUT contact with Bluetooth base station for continuous transmitting and receiving signals.

2.6 Measurement Results Explanation Example

For all conducted test items:

The offset level is set in the spectrum analyzer to compensate the RF cable loss and attenuator factor between EUT conducted output port and spectrum analyzer. With the offset compensation, the spectrum analyzer reading level is exactly the EUT RF output level.

Example:

The spectrum analyzer offset is derived from RF cable loss and attenuator factor.

Offset = RF cable loss + attenuator factor.

Following shows an offset computation example with cable loss 4.2 dB and 10dB attenuator.

$$\begin{aligned}
 \text{Offset(dB)} &= \text{RF cable loss(dB)} + \text{attenuator factor(dB)}. \\
 &= 4.2 + 10 = 14.2 \text{ (dB)}
 \end{aligned}$$

3 Test Result

3.1 Number of Channel Measurement

3.1.1 Limits of Number of Hopping Frequency

Frequency hopping systems in the 2400-2483.5 MHz band shall use at least 15 channels.

3.1.2 Measuring Instruments

The measuring equipment is listed in the section 4 of this test report.

3.1.3 Test Procedure

1. The testing follows FCC Public Notice DA 00-705 Measurement Guidelines.
2. The RF output of EUT was connected to the spectrum analyzer by RF cable and attenuator. The path loss was compensated to the results for each measurement.
3. Set to the maximum power setting and enable the EUT transmit continuously.
4. Enable the EUT hopping function.
5. Use the following spectrum analyzer settings: Span = the frequency band of operation; RBW \geq 1% of the span; VBW \geq RBW; Sweep = auto; Detector function = peak; Trace = max hold.
6. The number of hopping frequency used is defined as the number of total channel.
7. Record the measurement data derived from spectrum analyzer.

3.1.4 Test Setup

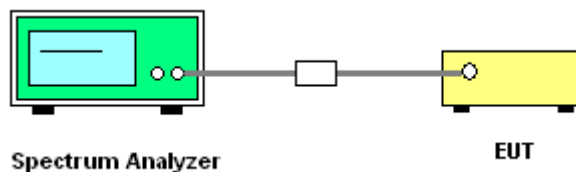

3.1.5 Test Result of Number of Hopping Frequency

Test Mode :	3Mbps	Temperature :	24~26°C
Test Engineer :	Stuart Lin and Derek Hsu	Relative Humidity :	48~51%
Number of Hopping (Channel)	Adaptive Frequency Hopping (Channel)	Limits (Channel)	Pass/Fail
79	20	> 15	Pass



Number of Hopping Channel Plot on Channel 00 - 78

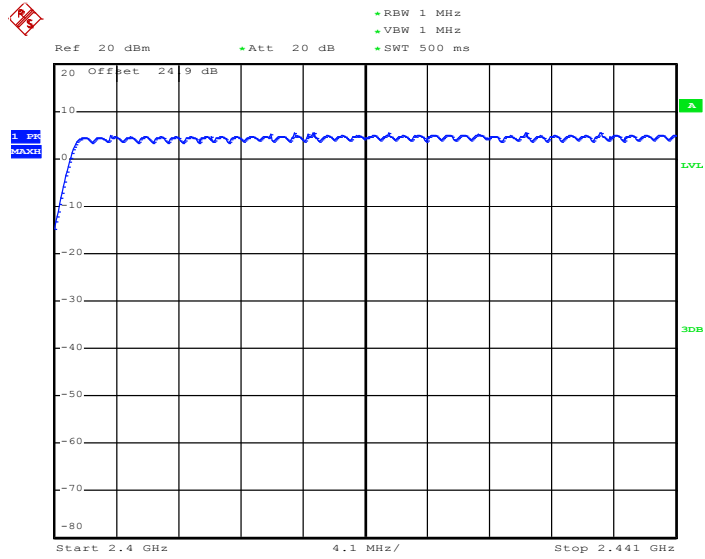

4
Date: 2.NOV.2014 16:48:51

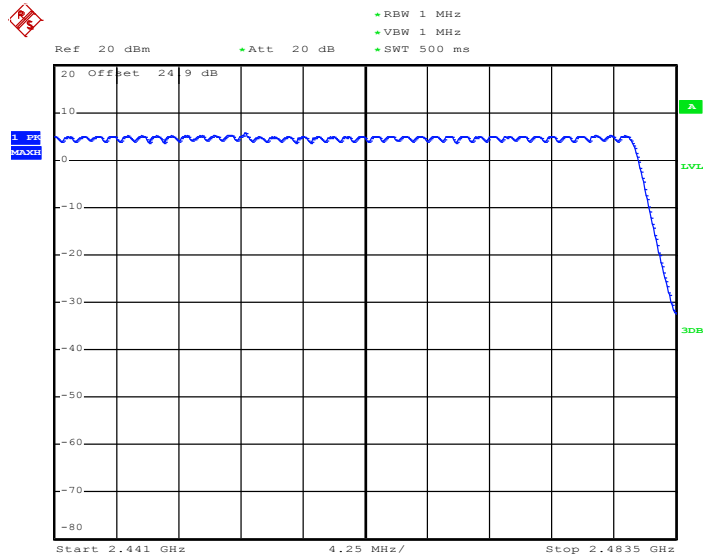

4
Date: 2.NOV.2014 16:49:32

Note: The total loss is 24.9 dB of the RF cable and attenuator, and has been compensated to the spectrum analyzer offset.

3.2 Hopping Channel Separation Measurement

3.2.1 Limit of Hopping Channel Separation

Frequency hopping systems operating in the 2400-2483.5 MHz band may have hopping channel carrier frequencies that are separated by 25 kHz or two-thirds of the 20 dB bandwidth of the hopping channel, whichever is greater.

3.2.2 Measuring Instruments

The measuring equipment is listed in the section 4 of this test report.

3.2.3 Test Procedures

1. The testing follows FCC Public Notice DA 00-705 Measurement Guidelines.
2. The RF output of EUT was connected to the spectrum analyzer by RF cable and attenuator. The path loss was compensated to the results for each measurement.
3. Set to the maximum power setting and enable the EUT transmit continuously.
4. Enable the EUT hopping function.
5. Use the following spectrum analyzer settings:
Span = wide enough to capture the peaks of two adjacent channels; RBW \geq 1% of the span;
VBW \geq RBW; Sweep = auto; Detector function = peak; Trace = max hold.
6. Measure and record the results in the test report.

3.2.4 Test Setup

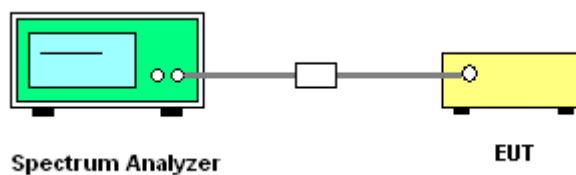



3.2.5 Test Result of Hopping Channel Separation

Test Mode :	1Mbps	Temperature :	24~26°C
Test Engineer :	Stuart Lin and Derek Hsu	Relative Humidity :	48~51%

Channel	Frequency (MHz)	Frequency Separation (MHz)	(2/3 of 20dB BW) Limits (MHz)	Pass/Fail
00	2402	1.002	0.6053	Pass
39	2441	1.002	0.6240	Pass
78	2480	1.002	0.6267	Pass

Channel Separation Plot on Channel 00 - 01

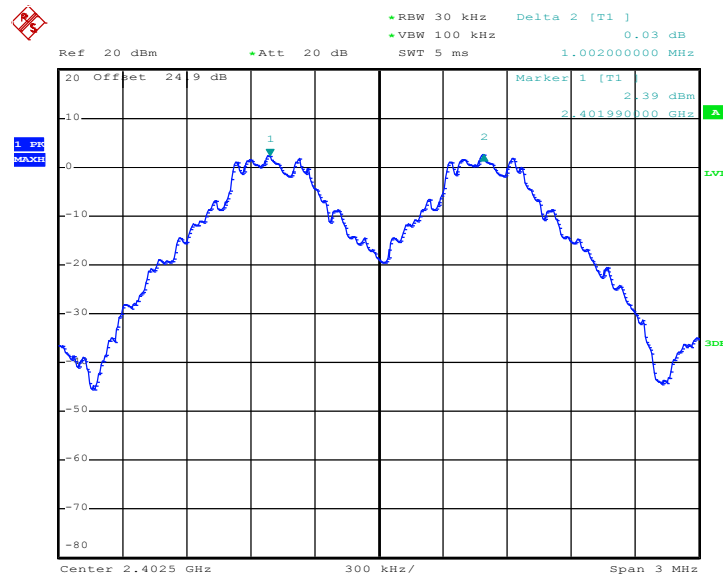

4
Date: 2.NOV.2014 16:11:47

Note: The total loss is 24.9 dB of the RF cable and attenuator, and has been compensated to the spectrum analyzer offset.



Channel Separation Plot on Channel 39 - 40

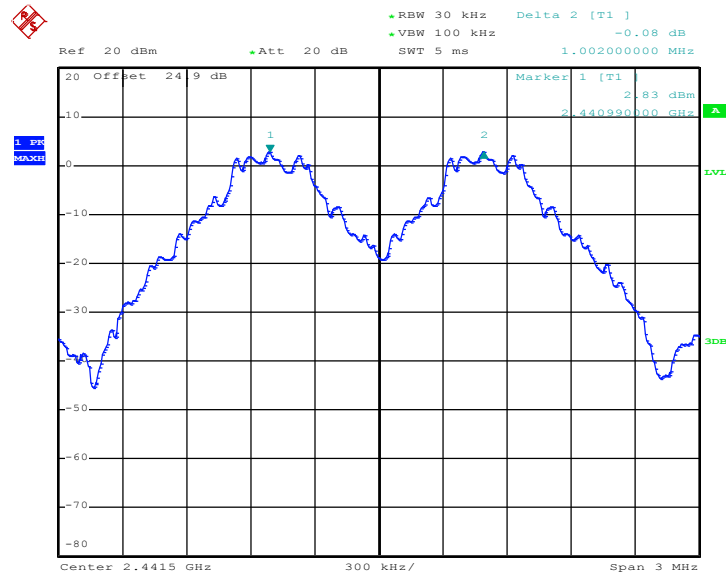

4

Date: 2.NOV.2014 16:12:33

Channel Separation Plot on Channel 77 - 78

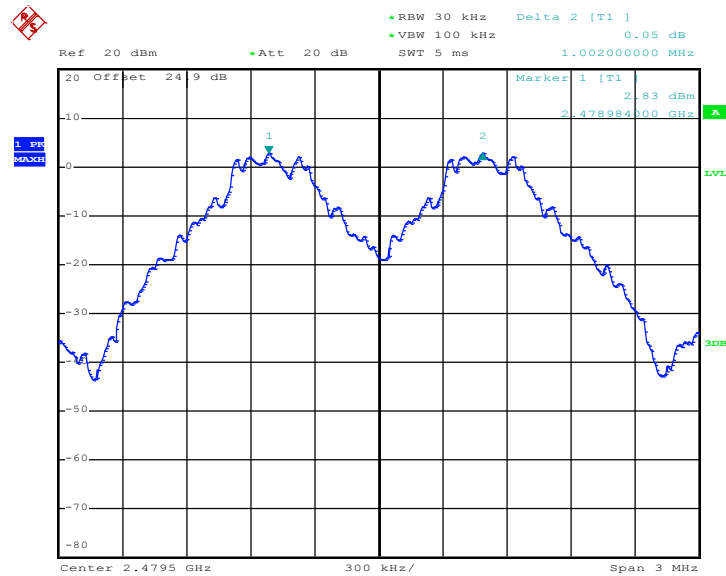

4

Date: 2.NOV.2014 16:13:27



Test Mode :	2Mbps	Temperature :	24~26°C
Test Engineer :	Stuart Lin and Derek Hsu	Relative Humidity :	48~51%

Channel	Frequency (MHz)	Frequency Separation (MHz)	(2/3 of 20dB BW) Limits (MHz)	Pass/Fail
00	2402	1.002	0.8440	Pass
39	2441	1.002	0.8440	Pass
78	2480	1.008	0.8440	Pass

Channel Separation Plot on Channel 00 - 01

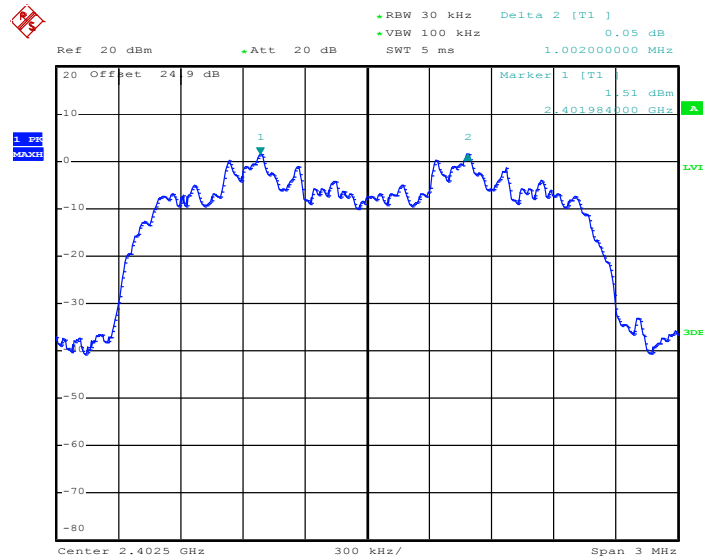

4

Date: 2.NOV.2014 16:15:01

Note: The total loss is 24.9 dB of the RF cable and attenuator, and has been compensated to the spectrum analyzer offset.



Channel Separation Plot on Channel 39 - 40

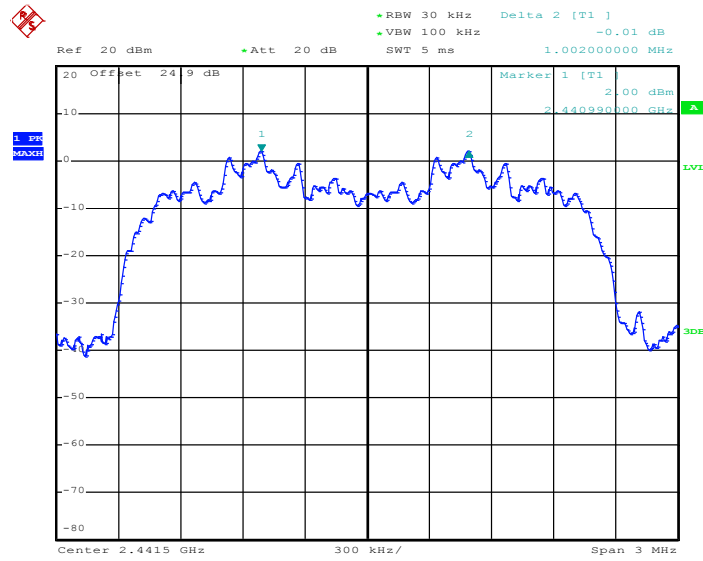

4
Date: 2.NOV.2014 16:15:47

Channel Separation Plot on Channel 77 - 78

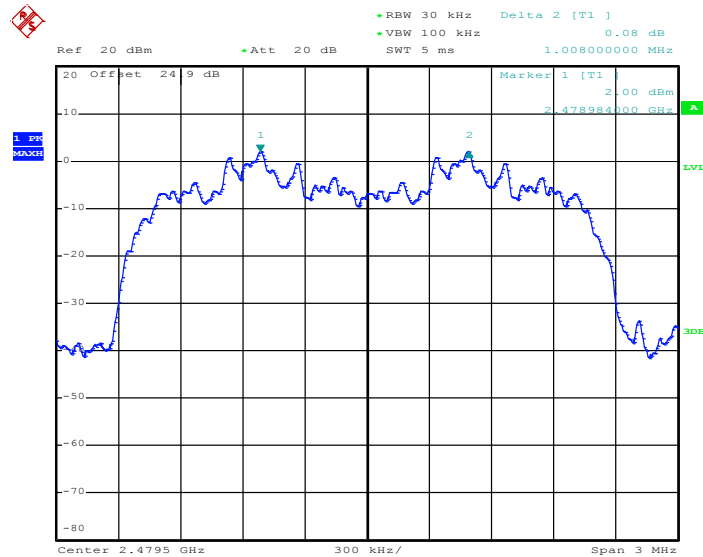

4
Date: 2.NOV.2014 16:16:28



Test Mode :	3Mbps	Temperature :	24~26°C
Test Engineer :	Stuart Lin and Derek Hsu	Relative Humidity :	48~51%

Channel	Frequency (MHz)	Frequency Separation (MHz)	(2/3 of 20dB BW) Limits (MHz)	Pass/Fail
00	2402	1.008	0.8360	Pass
39	2441	1.002	0.8360	Pass
78	2480	1.008	0.8360	Pass

Channel Separation Plot on Channel 00 - 01

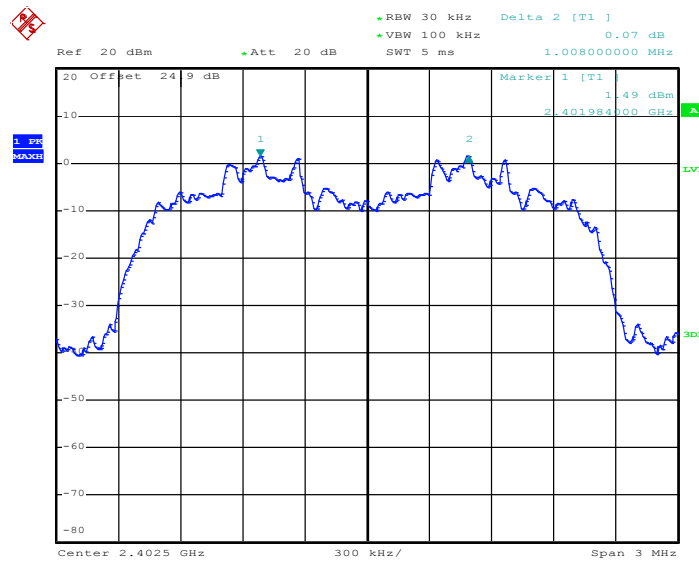

4

Date: 2.NOV.2014 16:17:10

Note: The total loss is 24.9 dB of the RF cable and attenuator, and has been compensated to the spectrum analyzer offset.



Channel Separation Plot on Channel 39 - 40

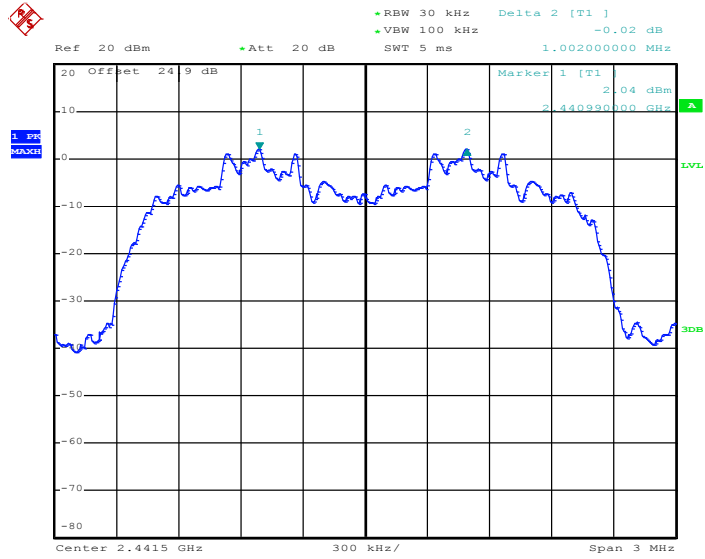

4
Date: 2.NOV.2014 16:18:18

Channel Separation Plot on Channel 77 - 78

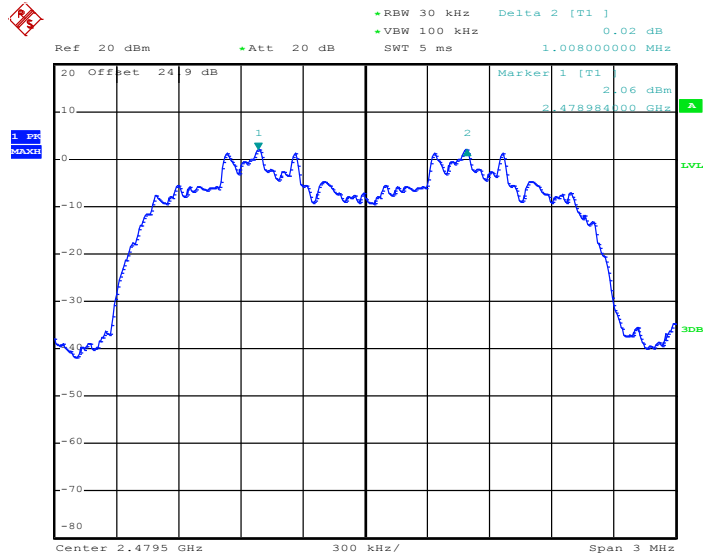

4
Date: 2.NOV.2014 16:19:00

3.3 Dwell Time Measurement

3.3.1 Limit of Dwell Time

The average time of occupancy on any channel shall not be greater than 0.4 seconds within a period of 0.4 seconds multiplied by the number of hopping channels employed.

3.3.2 Measuring Instruments

The measuring equipment is listed in the section 4 of this test report.

3.3.3 Test Procedures

1. The testing follows FCC Public Notice DA 00-705 Measurement Guidelines.
2. The RF output of EUT was connected to the spectrum analyzer by RF cable and attenuator. The path loss was compensated to the results for each measurement.
3. Set to the maximum power setting and enable the EUT transmit continuously.
4. Enable the EUT hopping function.
5. Use the following spectrum analyzer settings: Span = zero span, centered on a hopping channel; RBW = 1 MHz; VBW \geq RBW; Sweep = as necessary to capture the entire dwell time per hopping channel; Detector function = peak; Trace = max hold.
6. Measure and record the results in the test report.

3.3.4 Test Setup

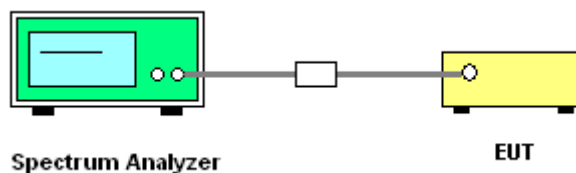



3.3.5 Test Result of Dwell Time

Test Mode :	DH5	Temperature :	24~26°C
Test Engineer :	Stuart Lin and Derek Hsu	Relative Humidity :	48~51%

Mode	Hopping Channel Number	Hops Over Occupancy Time(hops)	Package Transfer Time (msec)	Dwell Time (sec)	Limits (sec)	Pass/Fail
Normal	79	106.67	2.90	0.31	0.4	Pass
AFH	20	53.33	2.90	0.15	0.4	Pass

Remark:

1. In normal mode, hopping rate is 1600 hops/s with 6 slots in 79 hopping channels.
With channel hopping rate (1600 / 6 / 79) in Occupancy Time Limit (0.4 x 79) (s),
Hops Over Occupancy Time comes to (1600 / 6 / 79) x (0.4 x 79) = 106.67 hops.
2. In AFH mode, hopping rate is 800 hops/s with 6 slots in 20 hopping channels.
With channel hopping rate (800 / 6 / 20) in Occupancy Time Limit (0.4 x 20) (s),
Hops Over Occupancy Time comes to (800 / 6 / 20) x (0.4 x 20) = 53.33 hops.
3. Dwell Time(s) = Hops Over Occupancy Time (hops) x Package Transfer Time



Package Transfer Time Plot

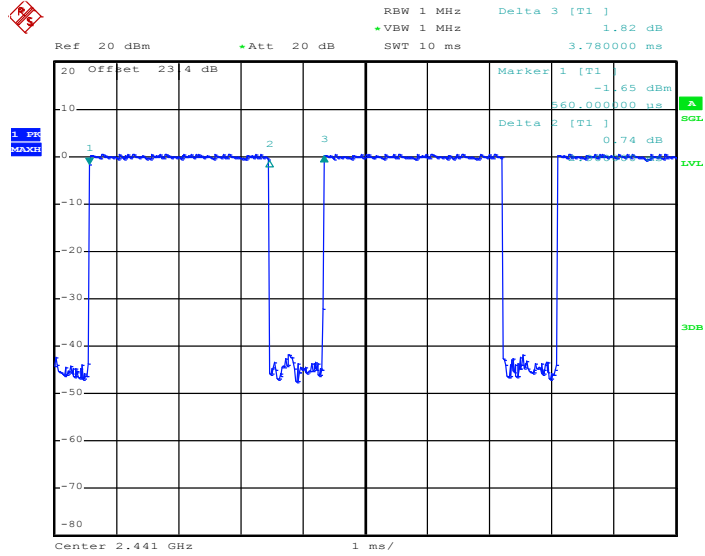

4
Date: 28.OCT.2014 19:37:39

Note: The total loss is 23.4 dB of the RF cable and attenuator, and has been compensated to the spectrum analyzer offset.

3.4 20dB Bandwidth Measurement

3.4.1 Limit of 20dB Bandwidth

Reporting only

3.4.2 Measuring Instruments

The measuring equipment is listed in the section 4 of this test report.

3.4.3 Test Procedures

1. The testing follows FCC Public Notice DA 00-705 Measurement Guidelines.
2. The RF output of EUT was connected to the spectrum analyzer by RF cable and attenuator. The path loss was compensated to the results for each measurement.
3. Set to the maximum power setting and enable the EUT transmit continuously.
4. Use the following spectrum analyzer settings for 20dB Bandwidth measurement.
Span = approximately 2 to 3 times the 20 dB bandwidth, centered on a hopping channel;
RBW \geq 1% of the 20 dB bandwidth; VBW \geq RBW; Sweep = auto; Detector function = peak;
Trace = max hold.
5. Measure and record the results in the test report.

3.4.4 Test Setup

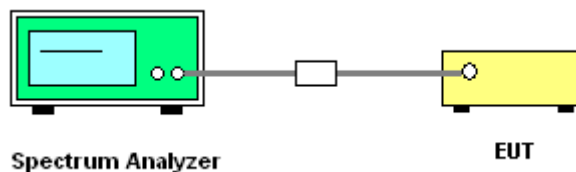



3.4.5 Test Result of 20dB Bandwidth

Test Mode :	1Mbps	Temperature :	24~26°C
Test Engineer :	Stuart Lin and Derek Hsu	Relative Humidity :	48~51%

Channel	Frequency (MHz)	20dB Bandwidth (MHz)
00	2402	0.908
39	2441	0.936
78	2480	0.940

20 dB Bandwidth Plot on Channel 00

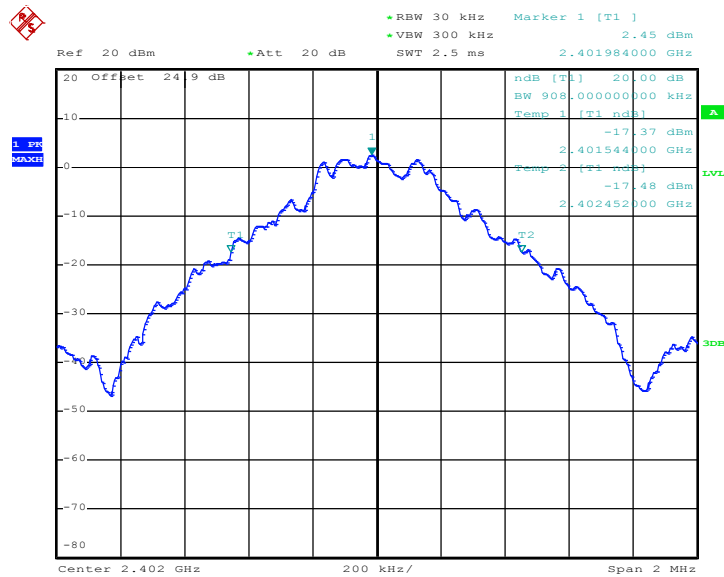

4
Date: 2.NOV.2014 16:19:15

Note: The total loss is 24.9 dB of the RF cable and attenuator, and has been compensated to the spectrum analyzer offset.



20 dB Bandwidth Plot on Channel 39

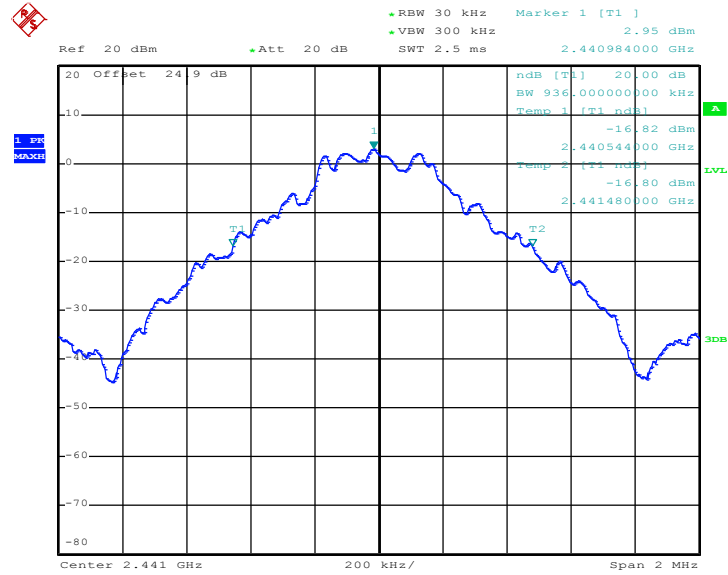

4

Date: 2.NOV.2014 16:19:45

20 dB Bandwidth Plot on Channel 78

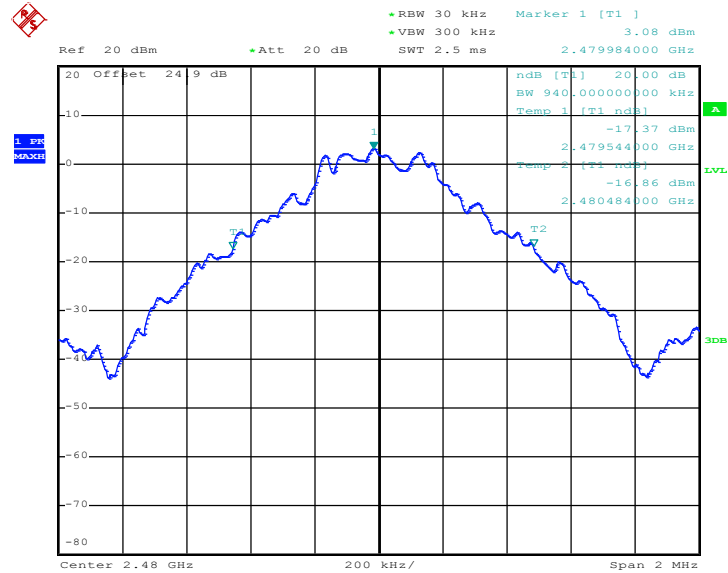

4

Date: 2.NOV.2014 16:20:24



Test Mode :	2Mbps	Temperature :	24~26°C
Test Engineer :	Stuart Lin and Derek Hsu	Relative Humidity :	48~51%

Channel	Frequency (MHz)	20dB Bandwidth (MHz)
00	2402	1.266
39	2441	1.266
78	2480	1.266

20 dB Bandwidth Plot on Channel 00

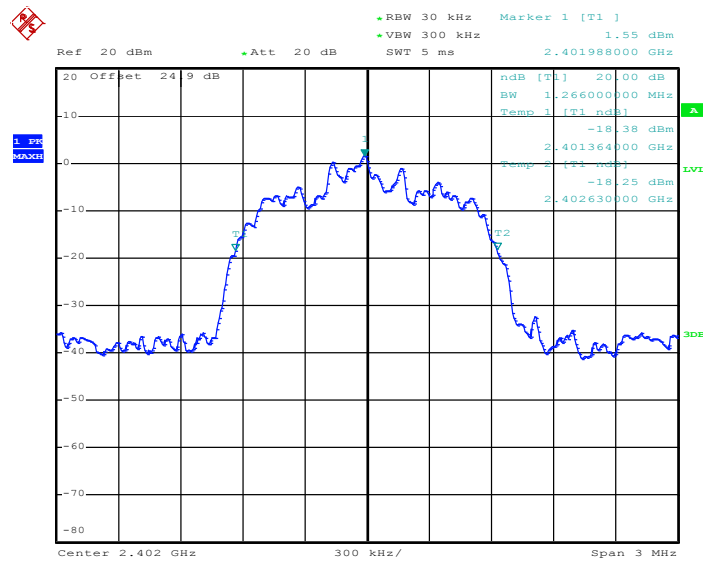

4

Date: 2.NOV.2014 16:21:27

Note: The total loss is 24.9 dB of the RF cable and attenuator, and has been compensated to the spectrum analyzer offset.



20 dB Bandwidth Plot on Channel 39

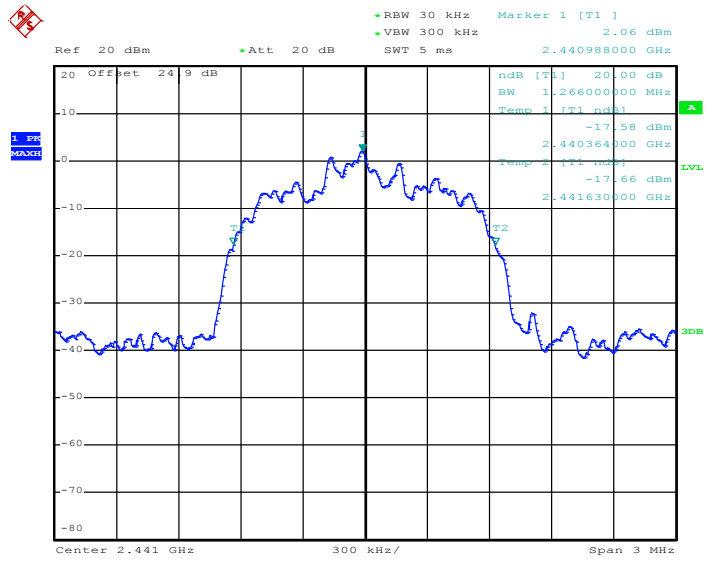

4
Date: 2.NOV.2014 16:22:07

20 dB Bandwidth Plot on Channel 78

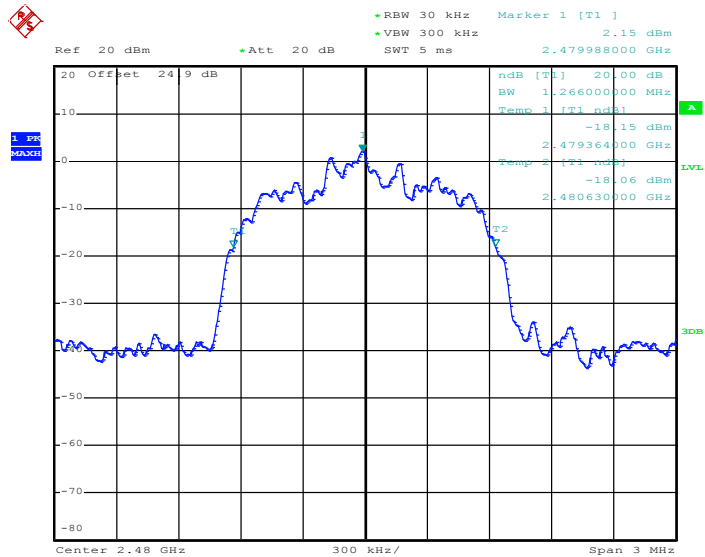

4
Date: 2.NOV.2014 16:22:46



Test Mode :	3Mbps	Temperature :	24~26°C
Test Engineer :	Stuart Lin and Derek Hsu	Relative Humidity :	48~51%

Channel	Frequency (MHz)	20dB Bandwidth (MHz)
00	2402	1.254
39	2441	1.254
78	2480	1.254

20 dB Bandwidth Plot on Channel 00

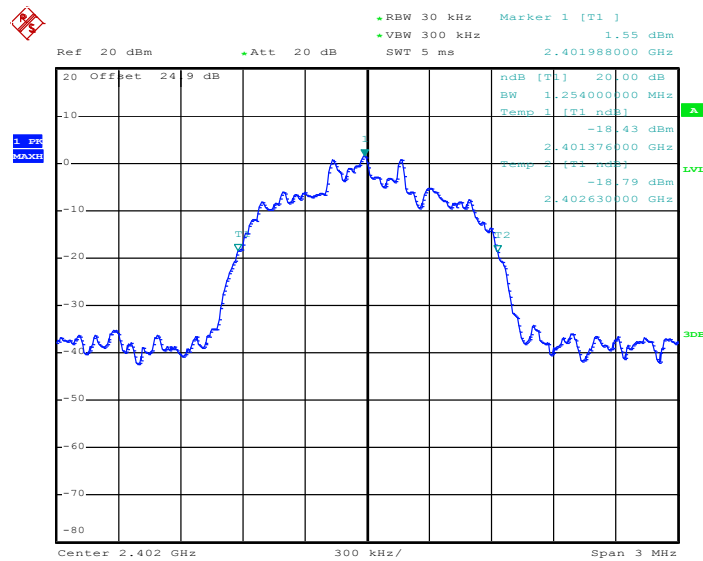

4

Date: 2.NOV.2014 16:23:03

Note: The total loss is 24.9 dB of the RF cable and attenuator, and has been compensated to the spectrum analyzer offset.



20 dB Bandwidth Plot on Channel 39

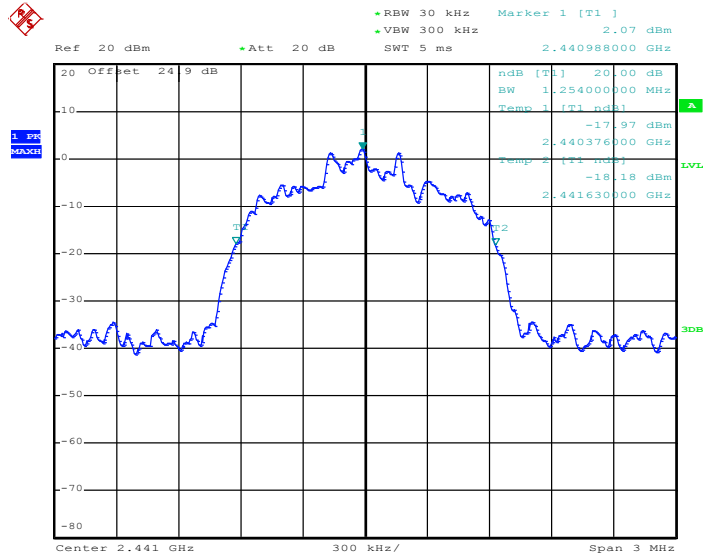

4
Date: 2.NOV.2014 16:23:43

20 dB Bandwidth Plot on Channel 78

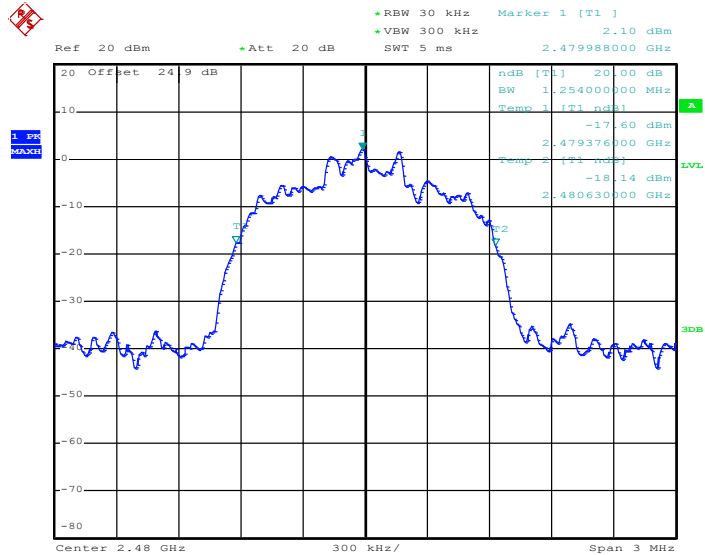

4
Date: 2.NOV.2014 16:24:01

3.5 Peak Output Power Measurement

3.5.1 Limit of Peak Output Power

Section 15.247 (b) The maximum peak conducted output power of the intentional radiator shall not exceed the following: (1) For frequency hopping systems operating in the 2400-2483.5 MHz band employing at least 75 non-overlapping hopping channels, and all frequency hopping systems in the 5725-5850 MHz band: 1 watt. For all other frequency hopping systems in the 2400-2483.5 MHz band 0.125 watts. The power limit for 1Mbps is 1watt, and for 2Mbps, 3Mbps and AFH are 0.125 watts.

3.5.2 Measuring Instruments

The measuring equipment is listed in the section 4 of this test report.

3.5.3 Test Procedures

1. The testing follows FCC Public Notice DA 00-705 Measurement Guidelines.
2. The RF output of EUT was connected to the power meter by RF cable and attenuator. The path loss was compensated to the results for each measurement.
3. Set to the maximum power setting and enable the EUT transmit continuously.
4. Measure the conducted output power with cable loss and record the results in the test report.
5. Measure and record the results in the test report.

3.5.4 Test Setup

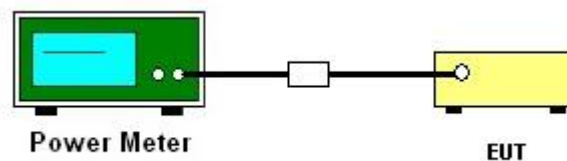



3.5.5 Test Result of Peak Output Power

Test Mode :	1Mbps	Temperature :	24~26°C
Test Engineer :	Stuart Lin and Derek Hsu	Relative Humidity :	48~51%

Channel	Frequency (MHz)	RF Power (dBm)		
		GFSK	Max. Limits (dBm)	Pass/Fail
		1 Mbps		
00	2402	5.50	20.97	Pass
39	2441	5.78	20.97	Pass
78	2480	5.70	20.97	Pass

Note: For AFH mode using 20 hopping channels, the maximum output power limit is 20.97dBm.

Test Mode :	2Mbps	Temperature :	24~26°C
Test Engineer :	Stuart Lin and Derek Hsu	Relative Humidity :	48~51%

Channel	Frequency (MHz)	RF Power (dBm)		
		$\pi/4$ -DQPSK	Max. Limits (dBm)	Pass/Fail
		2 Mbps		
00	2402	5.30	20.97	Pass
39	2441	5.58	20.97	Pass
78	2480	5.46	20.97	Pass

Test Mode :	3Mbps	Temperature :	24~26°C
Test Engineer :	Stuart Lin and Derek Hsu	Relative Humidity :	48~51%

Channel	Frequency (MHz)	RF Power (dBm)		
		8-DPSK	Max. Limits (dBm)	Pass/Fail
		3 Mbps		
00	2402	5.51	20.97	Pass
39	2441	5.84	20.97	Pass
78	2480	5.78	20.97	Pass

3.6 Conducted Band Edges Measurement

3.6.1 Limit of Band Edges

In any 100 kHz bandwidth outside the intentional radiation frequency band, the radio frequency power shall be at least 20 dB below the highest level of the radiated power. In addition, radiated emissions which fall in the restricted bands must also comply with the radiated emission limits.

3.6.2 Measuring Instruments

The measuring equipment is listed in the section 4 of this test report.

3.6.3 Test Procedures

1. The testing follows the guidelines in Band-edge Compliance of RF Conducted Emissions of FCC Public Notice DA 00-705 Measurement Guidelines.
2. Set to the maximum power setting and enable the EUT transmit continuously.
3. Set RBW = 100kHz ($\geq 1\%$ span=10MHz), VBW = 300kHz (\geq RBW). Band edge emissions must be at least 20 dB down from the highest emission level within the authorized band as measured with a 100kHz RBW. The attenuation shall be 30 dB instead of 20 dB when RMS conducted output power procedure is used.
4. Enable hopping function of the EUT and then repeat step 2. and 3.
5. Measure and record the results in the test report.

3.6.4 Test Setup

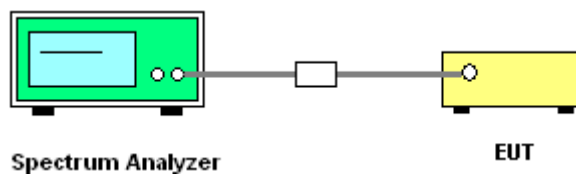



3.6.5 Test Result of Conducted Band Edges

Test Mode :	1Mbps	Temperature :	24~26°C
Test Channel :	00 and 78	Relative Humidity :	48~51%
		Test Engineer :	Stuart Lin and Derek Hsu

Low Band Edge Plot on Channel 00

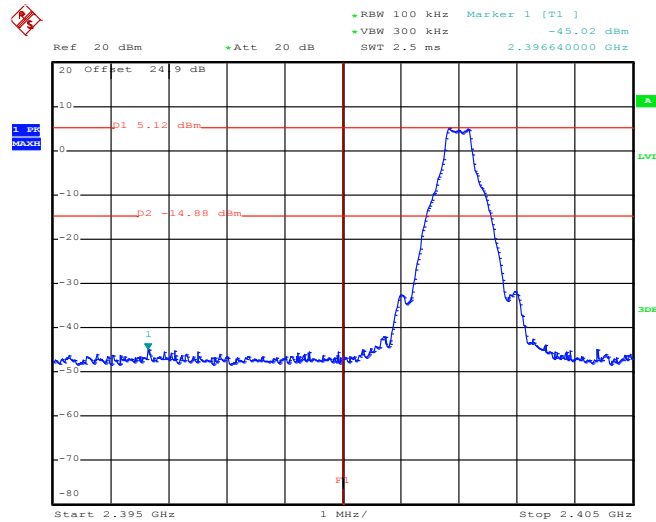

4

Date: 2.NOV.2014 16:24:54

High Band Edge Plot on Channel 78

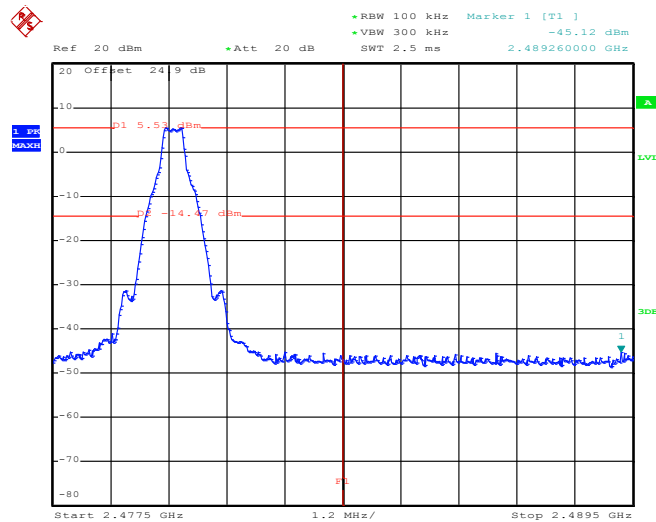

4

Date: 2.NOV.2014 16:25:46

Note: The total loss is 24.9 dB of the RF cable and attenuator, and has been compensated to the spectrum analyzer offset.



Test Mode :	2Mbps	Temperature :	24~26°C
Test Channel :	00 and 78	Relative Humidity :	48~51%
		Test Engineer :	Stuart Lin and Derek Hsu

Low Band Edge Plot on Channel 00

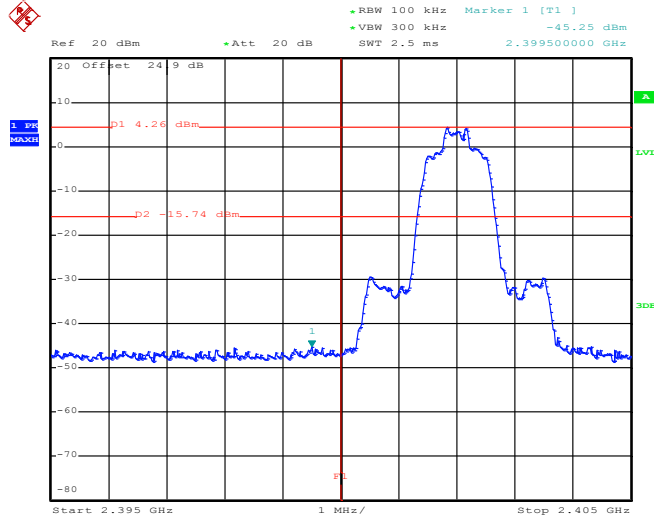

4
Date: 2.NOV.2014 16:26:37

High Band Edge Plot on Channel 78

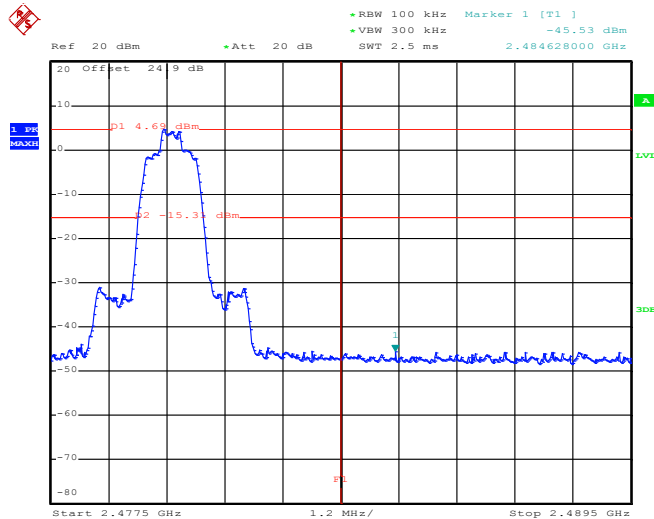

4
Date: 2.NOV.2014 16:27:28

Note: The total loss is 24.9 dB of the RF cable and attenuator, and has been compensated to the spectrum analyzer offset.



Test Mode :	3Mbps	Temperature :	24~26°C
Test Channel :	00 and 78	Relative Humidity :	48~51%
		Test Engineer :	Stuart Lin and Derek Hsu

Low Band Edge Plot on Channel 00

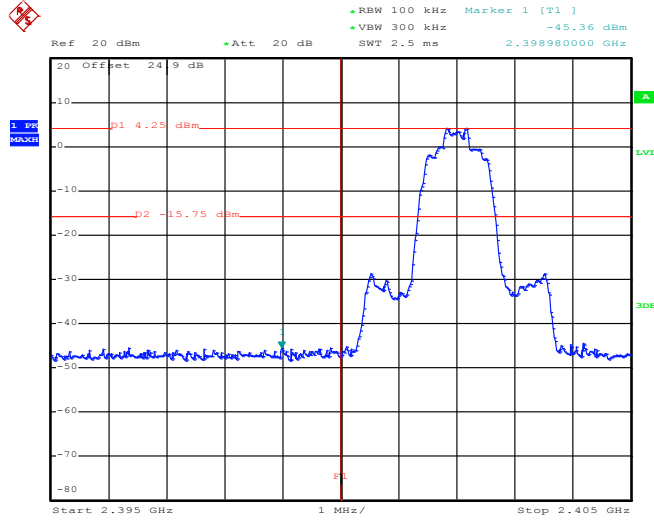

4
Date: 2.NOV.2014 16:28:20

High Band Edge Plot on Channel 78

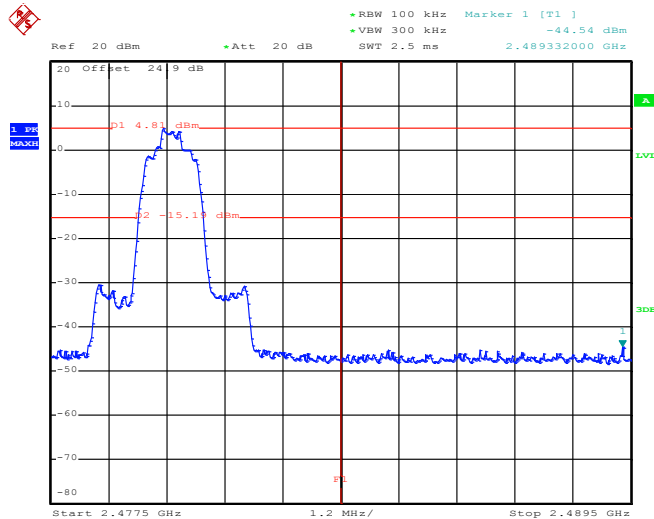

4
Date: 2.NOV.2014 16:29:12

Note: The total loss is 24.9 dB of the RF cable and attenuator, and has been compensated to the spectrum analyzer offset.



3.6.6 Test Result of Conducted Hopping Mode Band Edges

Test Mode :	1Mbps	Temperature :	24~26°C
Test Engineer :	Stuart Lin and Derek Hsu	Relative Humidity :	48~51%

1Mbps Hopping Mode Low Band Edge Plot

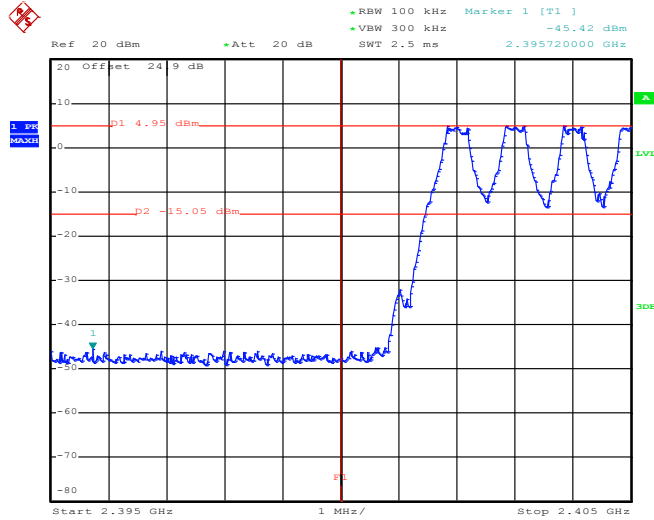

4
Date: 2.NOV.2014 17:07:36

1Mbps Hopping Mode High Band Edge Plot

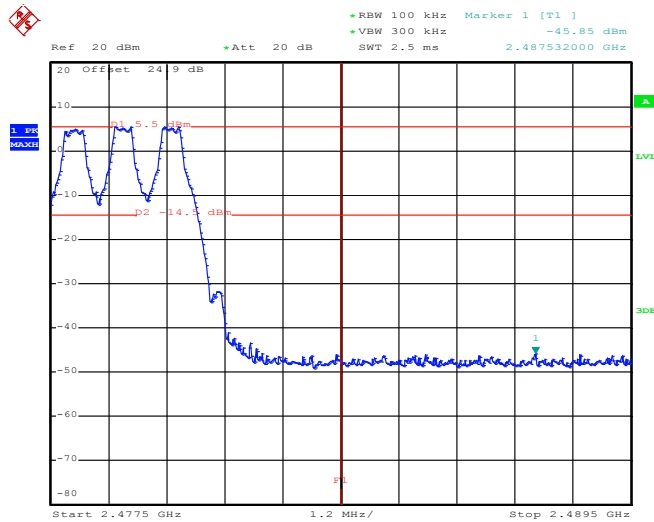

4
Date: 2.NOV.2014 17:07:07



Test Mode :	2Mbps	Temperature :	24~26°C
Test Engineer :	Stuart Lin and Derek Hsu	Relative Humidity :	48~51%

2Mbps Hopping Mode Low Band Edge Plot

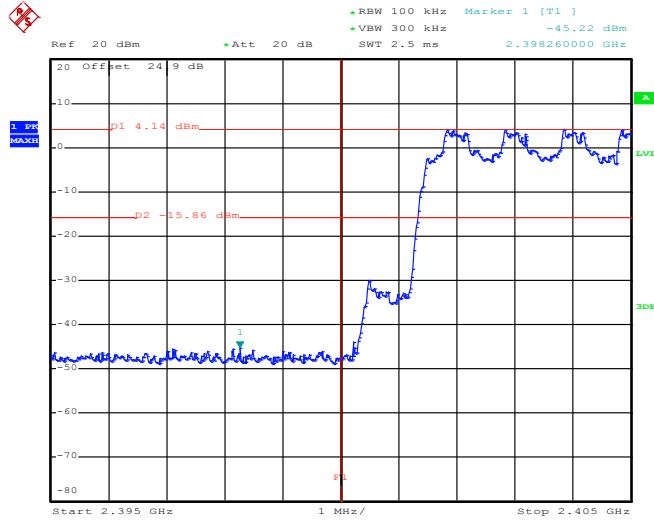

4
Date: 2.NOV.2014 17:08:11

2Mbps Hopping Mode High Band Edge Plot

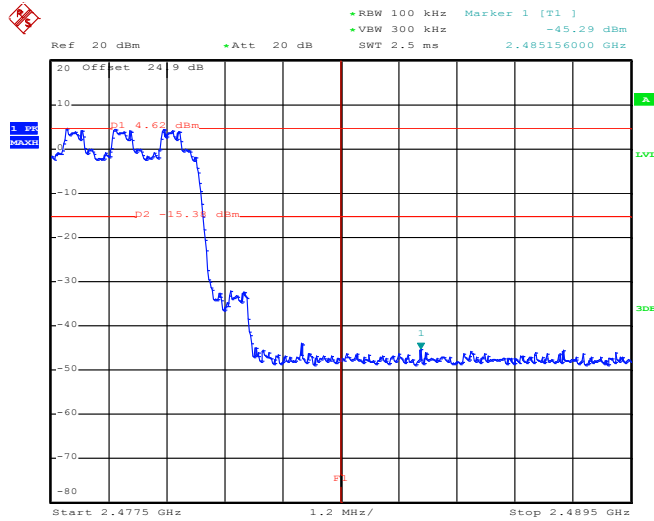

4
Date: 2.NOV.2014 17:08:37



Test Mode :	3Mbps	Temperature :	24~26°C
Test Engineer :	Stuart Lin and Derek Hsu	Relative Humidity :	48~51%

3Mbps Hopping Mode Low Band Edge Plot

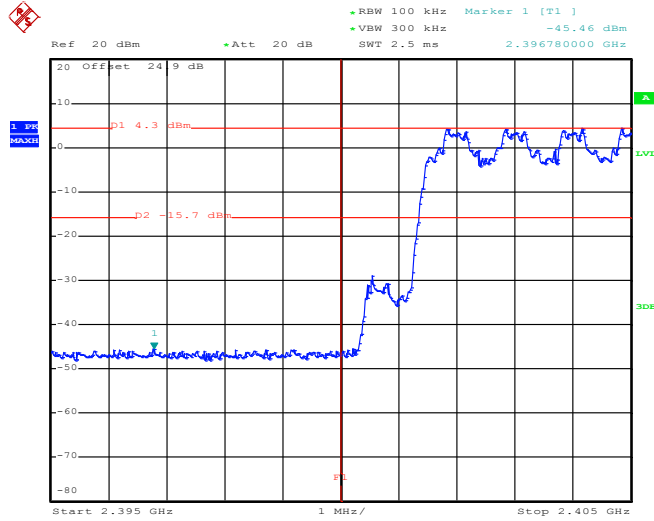

4
Date: 2.NOV.2014 17:10:55

3Mbps Hopping Mode High Band Edge Plot

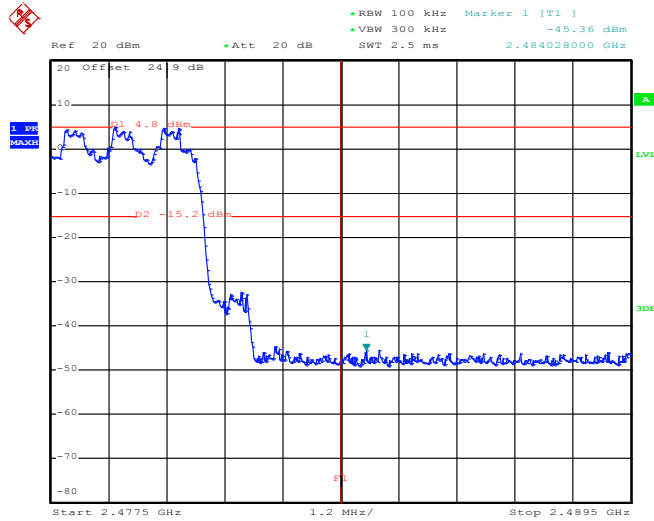

4
Date: 2.NOV.2014 17:09:00

3.7 Conducted Spurious Emission Measurement

3.7.1 Limit of Spurious Emission Measurement

In any 100 kHz bandwidth outside the intentional radiation frequency band, the radio frequency power shall be at least 20 dB below the highest level of the radiated power. In addition, radiated emissions which fall in the restricted bands must also comply with the radiated emission limits.

3.7.2 Measuring Instruments

The measuring equipment is listed in the section 4 of this test report.

3.7.3 Test Procedure

1. The testing follows the guidelines in Spurious RF Conducted Emissions of FCC Public Notice DA 00-705 Measurement Guidelines
2. The RF output of EUT was connected to the spectrum analyzer by RF cable and attenuator. The path loss was compensated to the results for each measurement.
3. Set to the maximum power setting and enable the EUT transmit continuously.
4. Set RBW = 100 kHz, VBW = 300kHz, scan up through 10th harmonic. All harmonics / spurs must be at least 20 dB down from the highest emission level within the authorized band as measured with a 100 kHz RBW.
5. Measure and record the results in the test report.
6. The RF fundamental frequency should be excluded against the limit line in the operating frequency band.

3.7.4 Test Setup

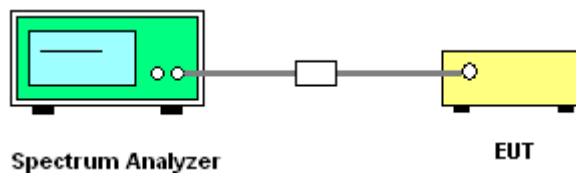



3.7.5 Test Result of Conducted Spurious Emission

Test Mode :	1Mbps	Temperature :	24~26°C
Test Channel :	00	Relative Humidity :	48~51%
		Test Engineer :	Stuart Lin and Derek Hsu

1Mbps CSE Plot on Ch 00 between 30MHz ~ 3 GHz

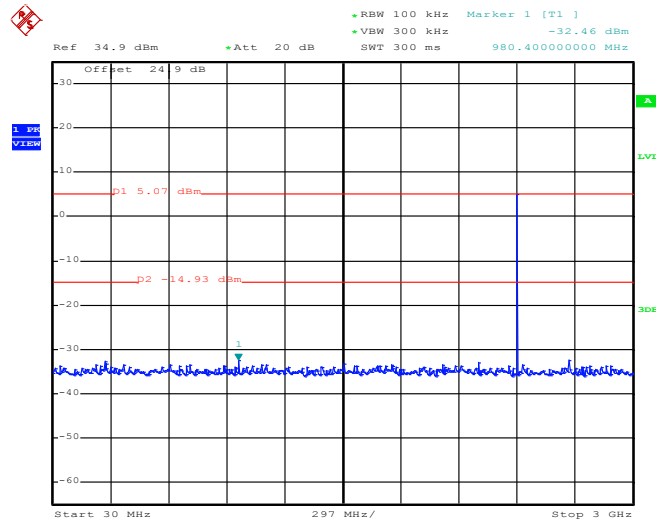

Date: 6.NOV.2014 15:23:33

Note:

1. The total loss is 24.9 dB of the RF cable and attenuator, and has been compensated to the spectrum analyzer offset.
2. The RF fundamental frequency should be excluded against the limit line in the operating frequency band.



1Mbps CSE Plot on Ch 00 between 2 GHz ~ 25 GHz

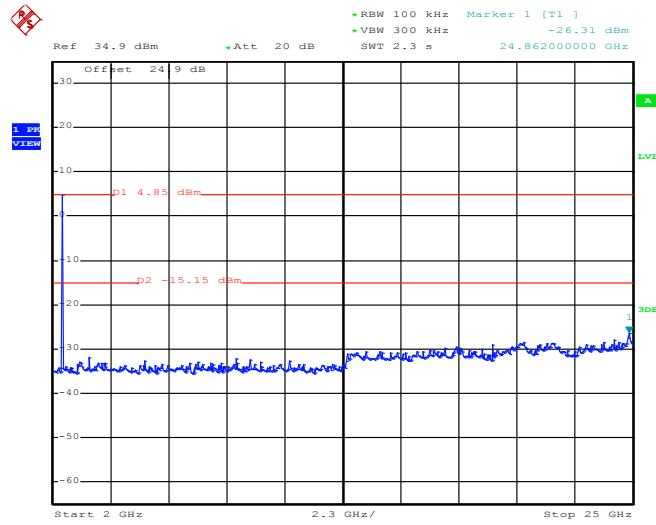

Date: 6.NOV.2014 15:23:55

Note:

1. The total loss is 24.9 dB of the RF cable and attenuator, and has been compensated to the spectrum analyzer offset.
2. The RF fundamental frequency should be excluded against the limit line in the operating frequency band.



Test Mode :	1Mbps	Temperature :	24~26°C
Test Channel :	39	Relative Humidity :	48~51%
		Test Engineer :	Stuart Lin and Derek Hsu

1Mbps CSE Plot on Ch 39 between 30MHz ~ 3 GHz

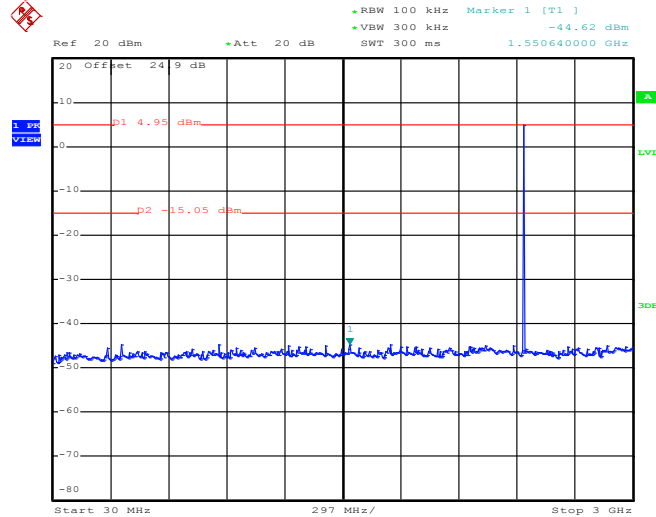

Date: 6.NOV.2014 15:26:59

Note:

1. The total loss is 24.9 dB of the RF cable and attenuator, and has been compensated to the spectrum analyzer offset.
2. The RF fundamental frequency should be excluded against the limit line in the operating frequency band.



1Mbps CSE Plot on Ch 39 between 2 GHz ~ 25 GHz

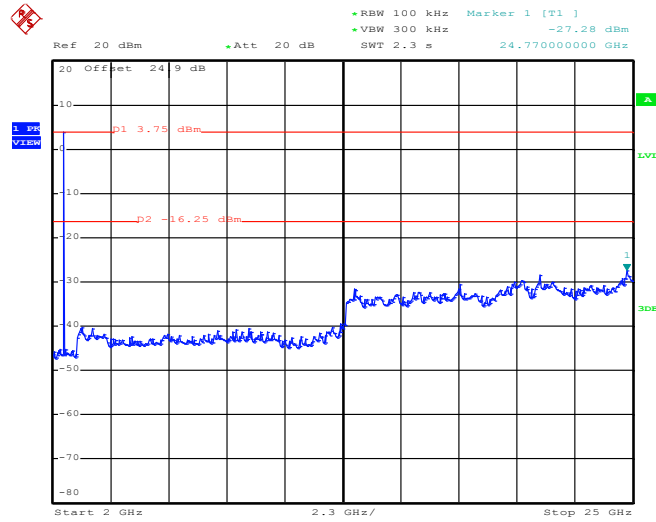

Date: 6.NOV.2014 15:27:20

Note:

1. The total loss is 24.9 dB of the RF cable and attenuator, and has been compensated to the spectrum analyzer offset.
2. The RF fundamental frequency should be excluded against the limit line in the operating frequency band.



Test Mode :	1Mbps	Temperature :	24~26°C
Test Channel :	78	Relative Humidity :	48~51%
		Test Engineer :	Stuart Lin and Derek Hsu

1Mbps CSE Plot on Ch 78 between 30MHz ~ 3 GHz

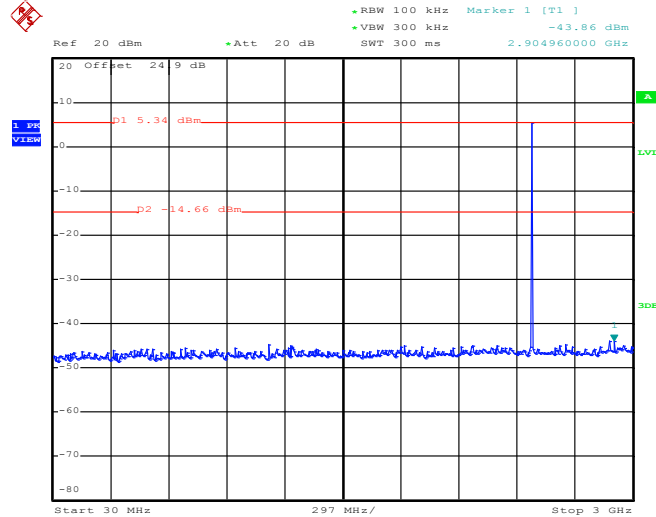

Date: 6.NOV.2014 15:28:24

Note:

1. The total loss is 24.9 dB of the RF cable and attenuator, and has been compensated to the spectrum analyzer offset.
2. The RF fundamental frequency should be excluded against the limit line in the operating frequency band.



1Mbps CSE Plot on Ch 78 between 2 GHz ~ 25 GHz

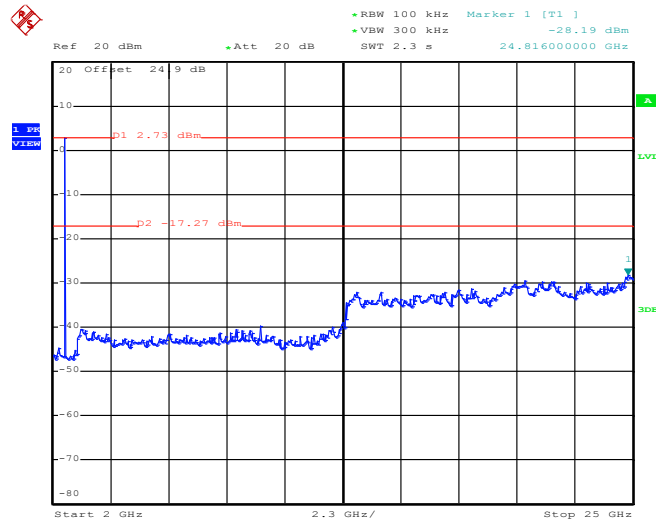

Date: 6.NOV.2014 15:28:46

Note:

1. The total loss is 24.9 dB of the RF cable and attenuator, and has been compensated to the spectrum analyzer offset.
2. The RF fundamental frequency should be excluded against the limit line in the operating frequency band.



Test Mode :	2Mbps	Temperature :	24~26°C
Test Channel :	00	Relative Humidity :	48~51%
		Test Engineer :	Stuart Lin and Derek Hsu

2Mbps CSE Plot on Ch 00 between 30MHz ~ 3 GHz

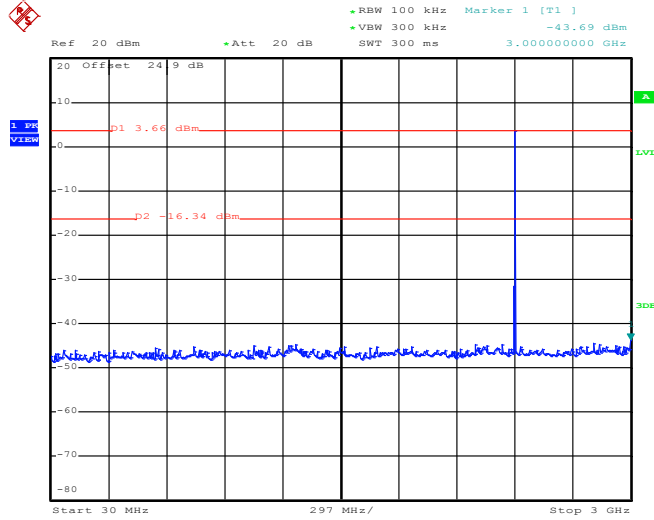

Date: 6.NOV.2014 15:31:39

Note:

1. The total loss is 24.9 dB of the RF cable and attenuator, and has been compensated to the spectrum analyzer offset.
2. The RF fundamental frequency should be excluded against the limit line in the operating frequency band.



2Mbps CSE Plot on Ch 00 between 2 GHz ~ 25 GHz

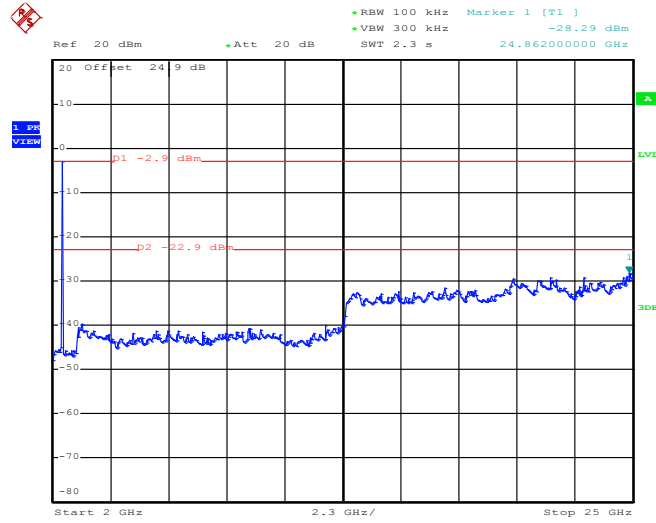

Date: 6.NOV.2014 15:32:01

Note:

1. The total loss is 24.9 dB of the RF cable and attenuator, and has been compensated to the spectrum analyzer offset.
2. The RF fundamental frequency should be excluded against the limit line in the operating frequency band.



Test Mode :	2Mbps	Temperature :	24~26°C
Test Channel :	39	Relative Humidity :	48~51%
		Test Engineer :	Stuart Lin and Derek Hsu

2Mbps CSE Plot on Ch 39 between 30MHz ~ 3 GHz

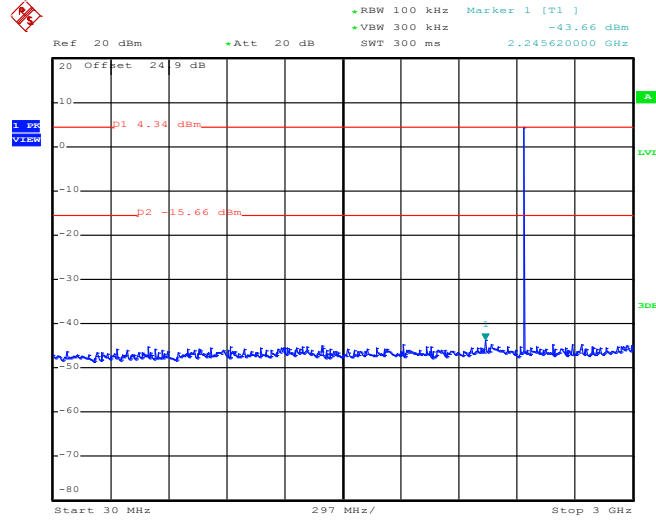

Date: 6.NOV.2014 15:30:41

Note:

1. The total loss is 24.9 dB of the RF cable and attenuator, and has been compensated to the spectrum analyzer offset.
2. The RF fundamental frequency should be excluded against the limit line in the operating frequency band.



2Mbps CSE Plot on Ch 39 between 2 GHz ~ 25 GHz

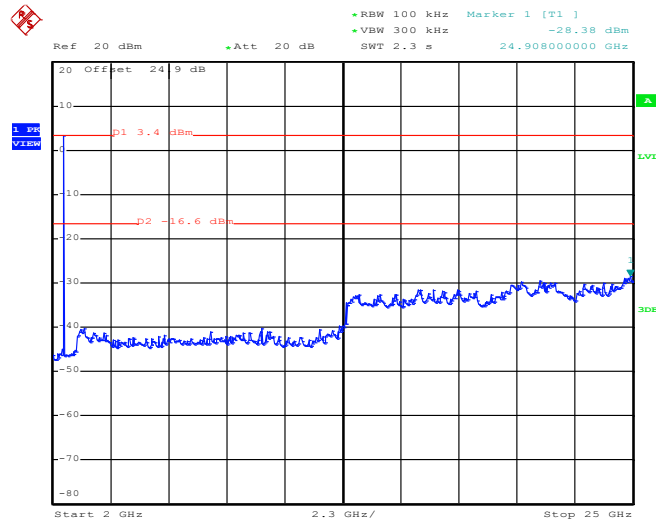

Date: 6.NOV.2014 15:31:03

Note:

1. The total loss is 24.9 dB of the RF cable and attenuator, and has been compensated to the spectrum analyzer offset.
2. The RF fundamental frequency should be excluded against the limit line in the operating frequency band.



Test Mode :	2Mbps	Temperature :	24~26°C
Test Channel :	78	Relative Humidity :	48~51%
		Test Engineer :	Stuart Lin and Derek Hsu

2Mbps CSE Plot on Ch 78 between 30MHz ~ 3 GHz

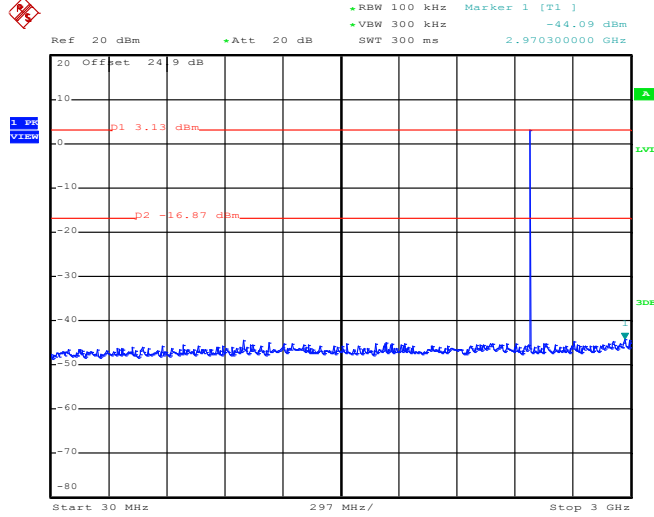

Date: 6.NOV.2014 15:29:37

Note:

1. The total loss is 24.9 dB of the RF cable and attenuator, and has been compensated to the spectrum analyzer offset.
2. The RF fundamental frequency should be excluded against the limit line in the operating frequency band.



2Mbps CSE Plot on Ch 78 between 2 GHz ~ 25 GHz

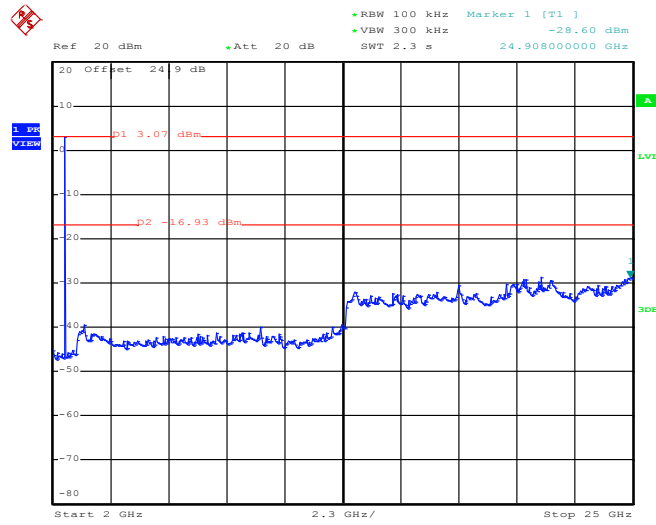

Date: 6.NOV.2014 15:29:58

Note:

1. The total loss is 24.9 dB of the RF cable and attenuator, and has been compensated to the spectrum analyzer offset.
2. The RF fundamental frequency should be excluded against the limit line in the operating frequency band.



Test Mode :	3Mbps	Temperature :	24~26°C
Test Channel :	00	Relative Humidity :	48~51%
		Test Engineer :	Stuart Lin and Derek Hsu

3Mbps CSE Plot on Ch 00 between 30MHz ~ 3 GHz

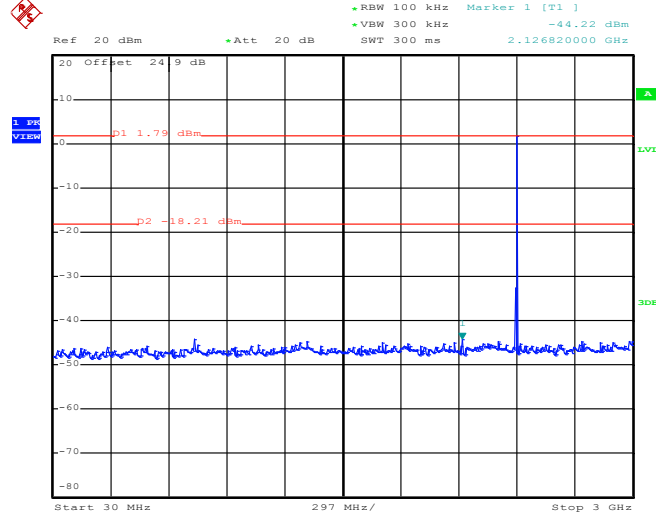

Date: 6.NOV.2014 15:33:15

Note:

1. The total loss is 24.9 dB of the RF cable and attenuator, and has been compensated to the spectrum analyzer offset.
2. The RF fundamental frequency should be excluded against the limit line in the operating frequency band.



3Mbps CSE Plot on Ch 00 between 2 GHz ~ 25 GHz

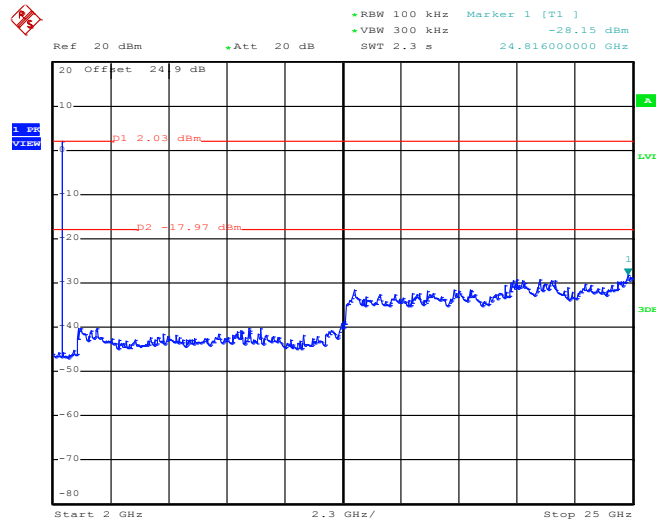

Date: 6.NOV.2014 15:33:37

Note:

1. The total loss is 24.9 dB of the RF cable and attenuator, and has been compensated to the spectrum analyzer offset.
2. The RF fundamental frequency should be excluded against the limit line in the operating frequency band.



Test Mode :	3Mbps	Temperature :	24~26°C
Test Channel :	39	Relative Humidity :	48~51%
		Test Engineer :	Stuart Lin and Derek Hsu

3Mbps CSE Plot on Ch 39 between 30MHz ~ 3 GHz

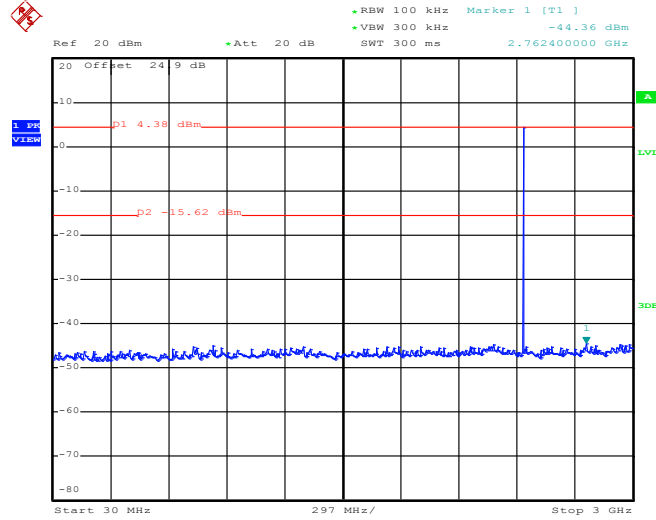

Date: 6.NOV.2014 15:34:24

Note:

1. The total loss is 24.9 dB of the RF cable and attenuator, and has been compensated to the spectrum analyzer offset.
2. The RF fundamental frequency should be excluded against the limit line in the operating frequency band.



3Mbps CSE Plot on Ch 39 between 2 GHz ~ 25 GHz

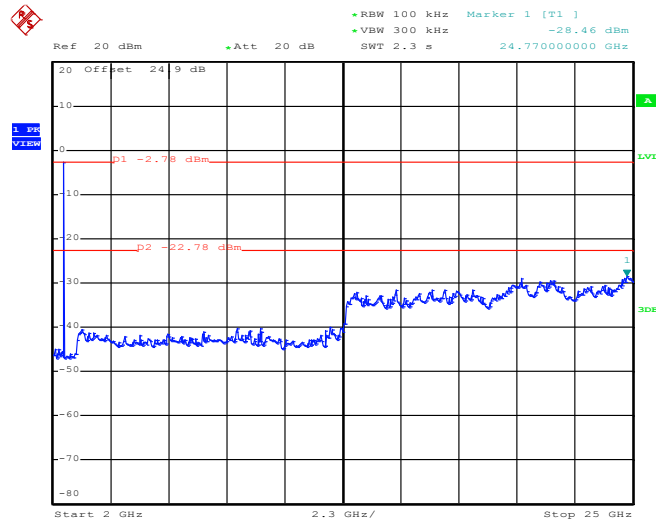

Date: 6.NOV.2014 15:34:46

Note:

1. The total loss is 24.9 dB of the RF cable and attenuator, and has been compensated to the spectrum analyzer offset.
2. The RF fundamental frequency should be excluded against the limit line in the operating frequency band.



Test Mode :	3Mbps	Temperature :	24~26°C
Test Channel :	78	Relative Humidity :	48~51%
		Test Engineer :	Stuart Lin and Derek Hsu

3Mbps CSE Plot on Ch 78 between 30MHz ~ 3 GHz

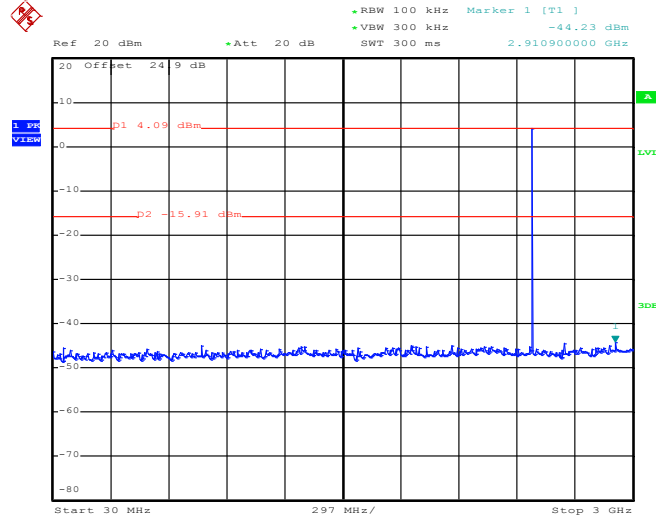

Date: 6.NOV.2014 15:35:31

Note:

1. The total loss is 24.9 dB of the RF cable and attenuator, and has been compensated to the spectrum analyzer offset.
2. The RF fundamental frequency should be excluded against the limit line in the operating frequency band.



3Mbps CSE Plot on Ch 78 between 2 GHz ~ 25 GHz

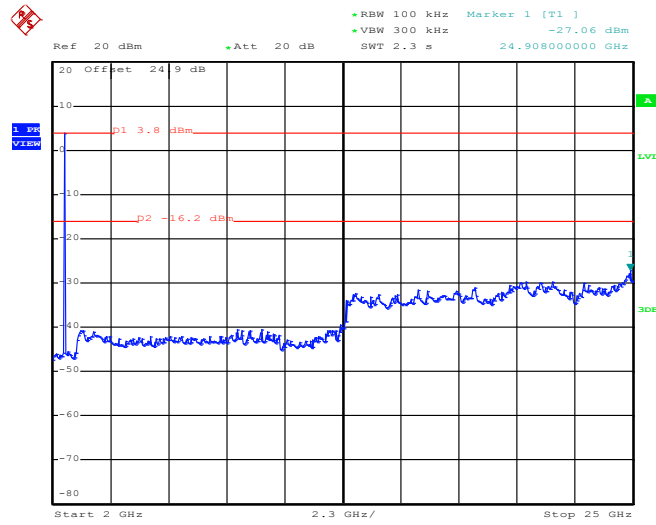

Date: 6.NOV.2014 15:35:53

Note:

1. The total loss is 24.9 dB of the RF cable and attenuator, and has been compensated to the spectrum analyzer offset.
2. The RF fundamental frequency should be excluded against the limit line in the operating frequency band.



3.8 Radiated Band Edges and Spurious Emission Measurement

3.8.1 Limit of Radiated Band Edges and Spurious Emission

In any 100 kHz bandwidth outside the intentional radiator frequency band, all harmonics/spurious must be at least 20 dB below the highest emission level within the authorized band. In addition, radiated emissions which fall in the restricted bands must also comply with the FCC section 15.209 limits as below.

Frequency (MHz)	Field Strength (microvolts/meter)	Measurement Distance (meters)
0.009 – 0.490	2400/F(kHz)	300
0.490 – 1.705	24000/F(kHz)	30
1.705 – 30.0	30	30
30 – 88	100	3
88 – 216	150	3
216 - 960	200	3
Above 960	500	3

3.8.2 Measuring Instruments

The measuring equipment is listed in the section 4 of this test report.



3.8.3 Test Procedures

1. The testing follows the guidelines in Spurious Radiated Emissions of FCC Public Notice DA 00-705 Measurement Guidelines.
2. The EUT was placed on a turntable with 0.8 meter above ground.
3. The EUT was set 3 meters from the interference receiving antenna, which was mounted on the top of a variable height antenna tower.
4. For each suspected emission, the EUT was arranged to its worst case and then tune the Antenna tower (from 1 m to 4 m) and turntable (from 0 degree to 360 degrees) to find the maximum reading. A pre-amp and a high pass filter are used for the test in order to get better signal level to comply with the guidelines.
5. Set to the maximum power setting and enable the EUT transmit continuously.
6. Use the following spectrum analyzer settings:
 - (1) Span shall wide enough to fully capture the emission being measured;
 - (2) Set RBW=100 kHz for $f < 1$ GHz, RBW=1MHz for $f > 1$ GHz ; VBW \geq RBW; Sweep = auto; Detector function = peak; Trace = max hold for peak
 - (3) For average measurement: use duty cycle correction factor method per 15.35(c).
Duty cycle = On time/100 milliseconds
On time = $N_1 * L_1 + N_2 * L_2 + \dots + N_{n-1} * L_{n-1} + N_n * L_n$
Where N_1 is number of type 1 pulses, L_1 is length of type 1 pulses, etc.
Average Emission Level = Peak Emission Level + $20 * \log(\text{Duty cycle})$
7. Corrected Reading: Antenna Factor + Cable Loss + Read Level - Preamp Factor = Level

Note: The average levels were calculated from the peak level corrected with duty cycle correction factor (-24.79dB for 1Mbps, -24.79dB for 2Mbps, and -24.79dB for 3Mbps,) derived from $20 \log(\text{dwell time}/100\text{ms})$. This correction is only for signals that hop with the fundamental signal, such as band-edge and harmonic. Other spurious signals that are independent of the hopping signal would not use this correction.

3.8.4 Test Setup

For radiated emissions below 30MHz

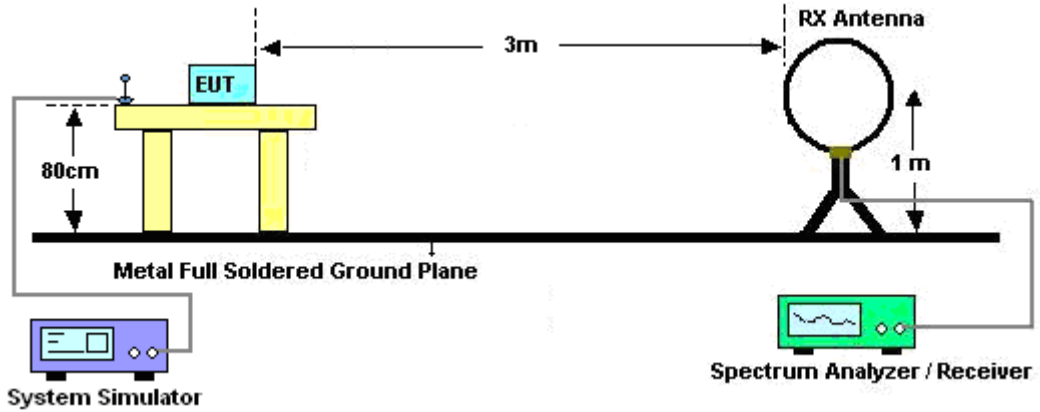

For radiated emissions from 30MHz to 1GHz

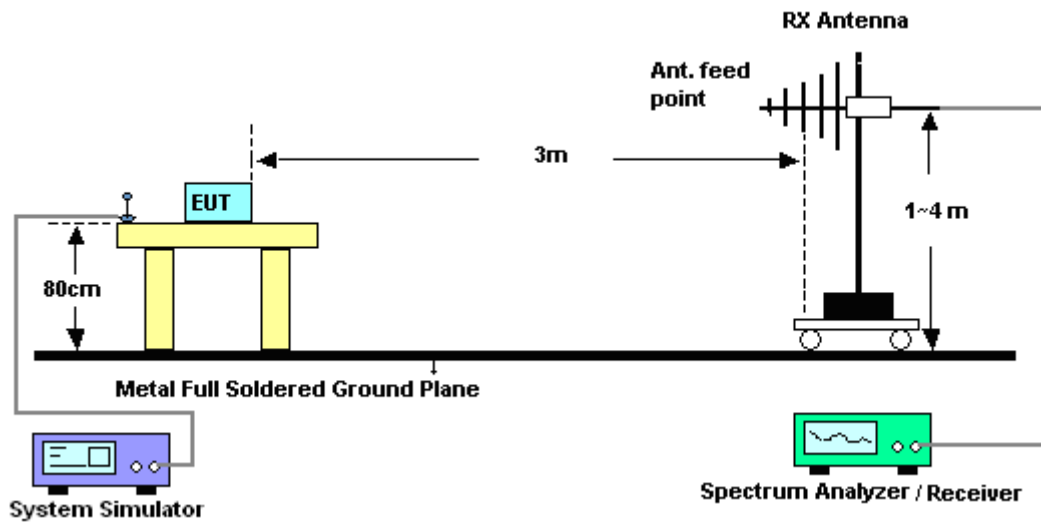

For radiated emissions above 1GHz

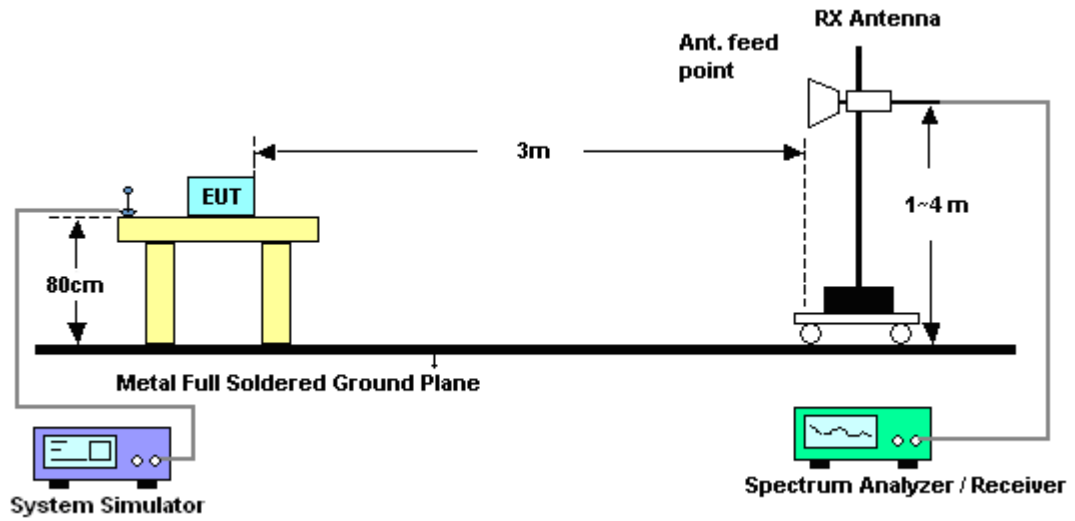

3.8.5 Test Results of Radiated Spurious Emissions (9 kHz ~ 30 MHz)

The low frequency, which started from 9 kHz to 30MHz, was pre-scanned and the result which was 20dB lower than the limit line per 15.31(o) was not reported.



3.8.6 Duty cycle correction factor for average measurement

DH5 on time (One Pulse) Plot on Channel 39

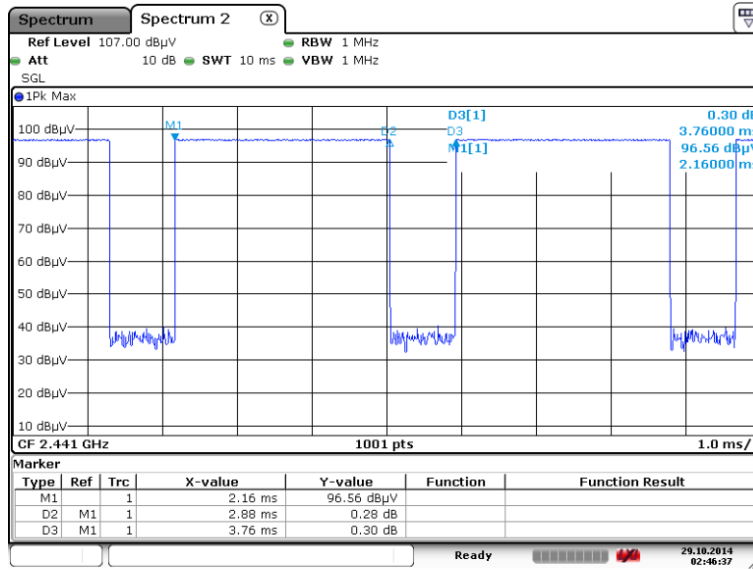

Date: 29.OCT.2014 02:46:38

DH5 on time (Count Pulses) Plot on Channel 39

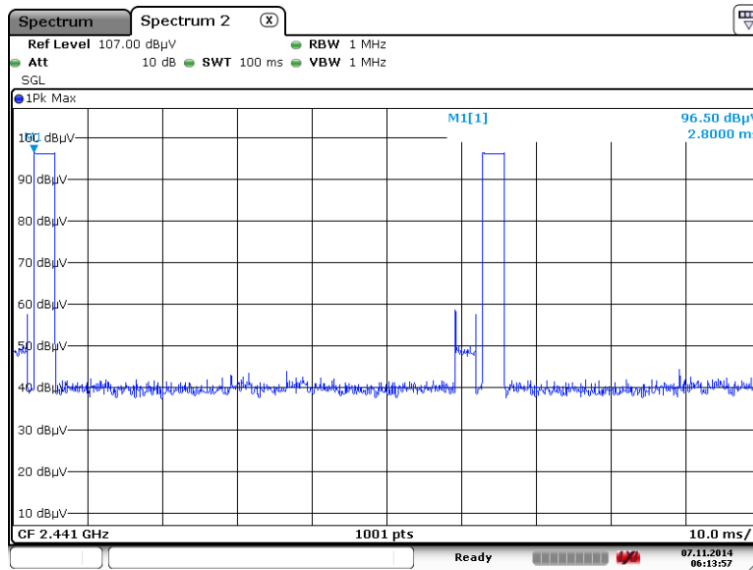

Date: 7.NOV.2014 06:13:58

Note:

1. Worst case Duty cycle = on time/100 milliseconds = 2 * 2.88 / 100 = 5.76 %
2. Worst case Duty cycle correction factor = 20*log(Duty cycle) = -24.79 dB
3. DH5 has the highest duty cycle worst case and is reported.



2DH5 on time (One Pulse) Plot on Channel 39

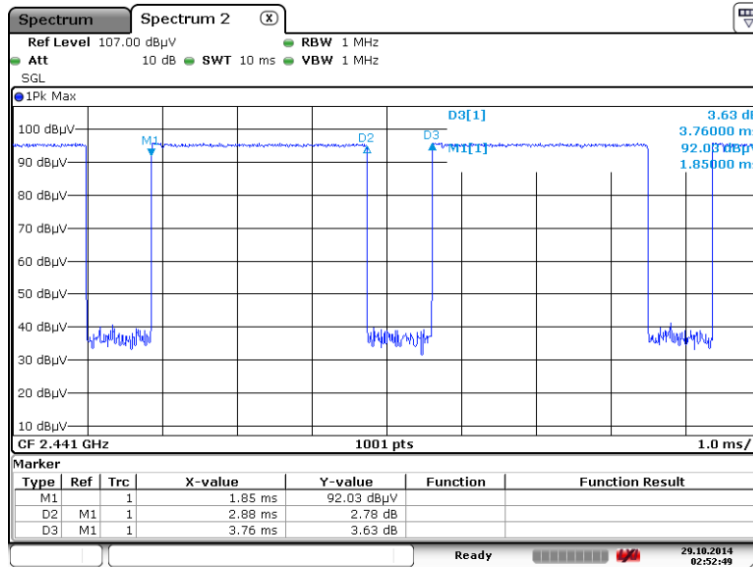

Date: 29.OCT.2014 02:52:49

2DH5 on time (Count Pulses) Plot on Channel 39

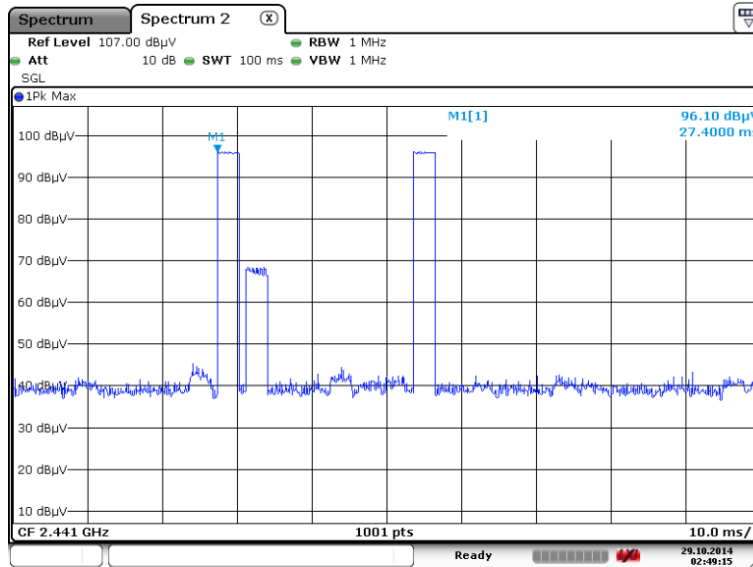

Date: 29.OCT.2014 02:49:16

Note:

1. Worst case Duty cycle = on time/100 milliseconds = 2 * 2.88 / 100 = 5.76 %
2. Worst case Duty cycle correction factor = 20*log(Duty cycle) = -24.79 dB
3. DH5 has the highest duty cycle worst case and is reported.



3DH5 on time (One Pulse) Plot on Channel 39

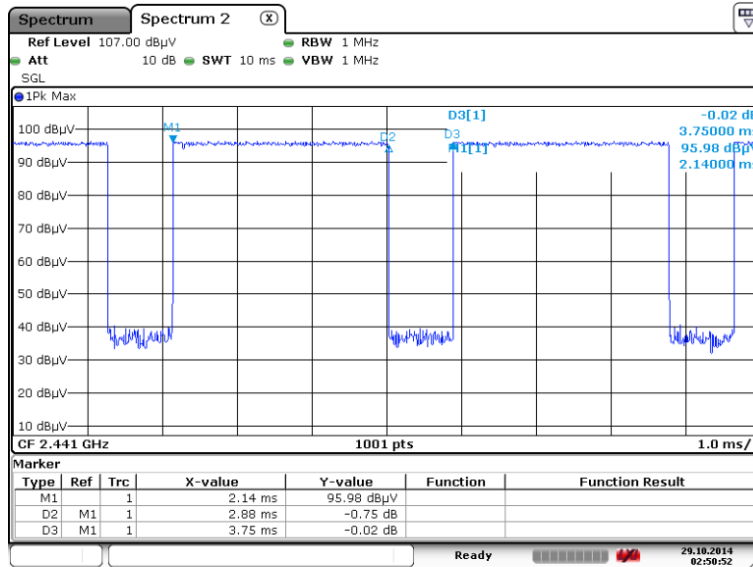

Date: 29.OCT.2014 02:50:52

3DH5 on time (Count Pulses) Plot on Channel 39

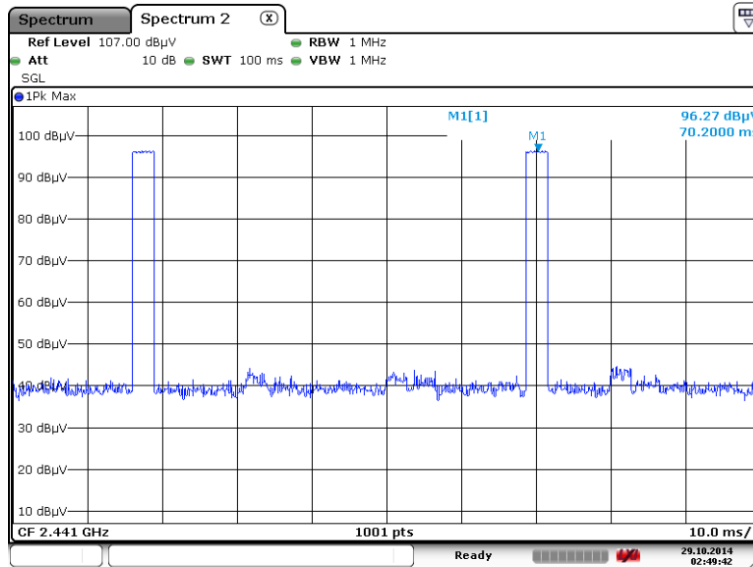

Date: 29.OCT.2014 02:49:43

Note:

1. Worst case Duty cycle = on time/100 milliseconds = 2 * 2.88 / 100 = 5.76 %
2. Worst case Duty cycle correction factor = 20*log(Duty cycle) = -24.79 dB
3. DH5 has the highest duty cycle worst case and is reported.



Duty Cycle Correction Factor Consideration for AFH mode:

Bluetooth normal hopping rate is 1600Hz and reduced to 800Hz in AFH mode; due to the reduced number of hopping frequencies, with the same packet configuration the dwell time in each channel frequency within 100msec period is longer in AFH mode than normal mode.

In AFH mode, the minimum hopping frequencies are 20, to get the longest dwell time DH5 packet is observed; the period to have DH5 packet completing one hopping sequence is

$$2.88 \text{ ms} \times 20 \text{ channels} = 57.6 \text{ ms for 1Mbps, 2Mbps and 3Mbps}$$

There cannot be 2 complete hopping sequences within 100ms period, considering the random hopping behavior, maximum 2 hops can be possibly observed within the period. $[100\text{ms} / 57.6\text{ms}] = 2 \text{ hops}$

Thus, the maximum possible ON time:

$$2.88 \text{ ms} \times 2 = 5.76 \text{ ms for 1Mbps, 2Mbps and 3Mbps}$$

Worst case Duty Cycle Correction factor, which is derived from the maximum possible ON time,

$$20 \times \log(5.76 \text{ ms}/100\text{ms}) = -24.79 \text{ dB for 1Mbps, 2Mbps and 3Mbps}$$

3.8.7 Test Result

Please refer to appendix A as below.



3.9 AC Conducted Emission Measurement

3.9.1 Limit of AC Conducted Emission

For equipment that is designed to be connected to the public utility (AC) power line, the radio frequency voltage that is conducted back onto the AC power line on any frequency or frequencies within the band 150 kHz to 30 MHz shall not exceed the limits in the following table.

Frequency of emission (MHz)	Conducted limit (dB μ V)	
	Quasi-peak	Average
0.15-0.5	66 to 56*	56 to 46*
0.5-5	56	46
5-30	60	50

*Decreases with the logarithm of the frequency.

3.9.2 Measuring Instruments

The measuring equipment is listed in the section 4 of this test report.

3.9.3 Test Procedures

1. The EUT was placed 0.4 meter from the conducting wall of the shielding room was kept at least 80 centimeters from any other grounded conducting surface.
2. Connect EUT to the power mains through a line impedance stabilization network (LISN).
3. All the support units are connecting to the other LISN.
4. The LISN provides 50 ohm coupling impedance for the measuring instrument.
5. The FCC states that a 50 ohm, 50 microhenry LISN should be used.
6. Both sides of AC line were checked for maximum conducted interference.
7. The frequency range from 150 kHz to 30 MHz was searched.
8. Set the test-receiver system to Peak Detect Function and specified bandwidth (IF Bandwidth = 9kHz) with Maximum Hold Mode. Then measurement is also conducted by Average Detector and Quasi-Peak Detector Function respectively.

3.9.4 Test Setup

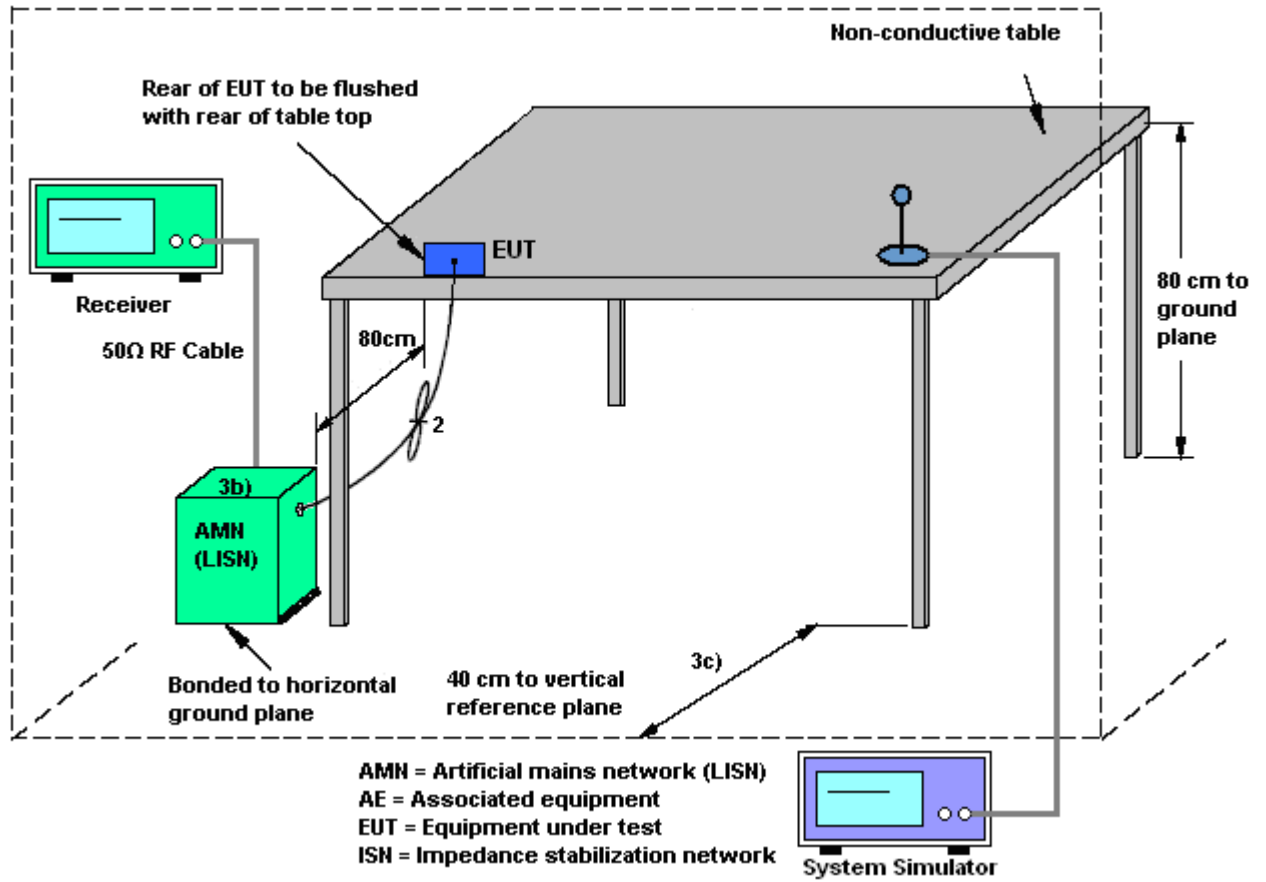



3.9.5 Test Result of AC Conducted Emission

Test Mode :	Mode 1	Temperature :	21~23°C
Test Engineer :	Eric Jeng	Relative Humidity :	46~48%
Test Voltage :	120Vac / 60Hz	Phase :	Line
Function Type :	GSM1900 Idle + Bluetooth Link + WLAN Link + Earphone + Battery + USB Cable 1 (Charging from Adapter) + MP3		

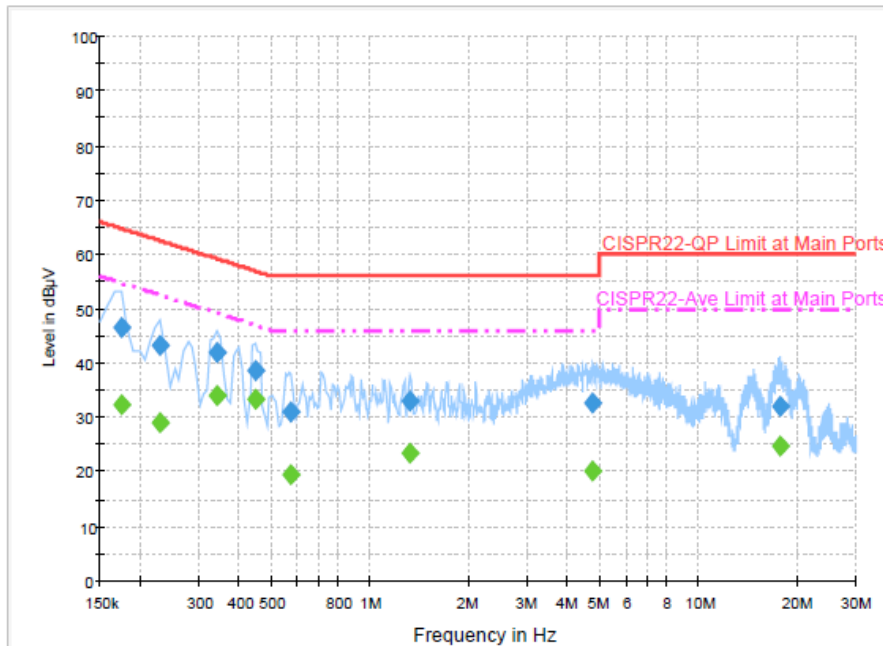

Final Result : Quasi-Peak

Frequency (MHz)	Quasi-Peak (dBµV)	Filter	Line	Corr. (dB)	Margin (dB)	Limit (dBµV)
0.174000	46.5	Off	L1	19.4	18.3	64.8
0.230000	43.1	Off	L1	19.5	19.3	62.4
0.342000	42.0	Off	L1	19.5	17.2	59.2
0.446000	38.6	Off	L1	19.5	18.3	56.9
0.574000	30.9	Off	L1	19.5	25.1	56.0
1.318000	32.9	Off	L1	19.5	23.1	56.0
4.766000	32.8	Off	L1	19.6	23.2	56.0
17.694000	32.1	Off	L1	19.9	27.9	60.0

Final Result : Average

Frequency (MHz)	Average (dBµV)	Filter	Line	Corr. (dB)	Margin (dB)	Limit (dBµV)
0.174000	32.4	Off	L1	19.4	22.4	54.8
0.230000	29.0	Off	L1	19.5	23.4	52.4
0.342000	34.1	Off	L1	19.5	15.1	49.2
0.446000	33.4	Off	L1	19.5	13.5	46.9
0.574000	19.5	Off	L1	19.5	26.5	46.0
1.318000	23.3	Off	L1	19.5	22.7	46.0
4.766000	20.0	Off	L1	19.6	26.0	46.0
17.694000	24.9	Off	L1	19.9	25.1	50.0



Test Mode :	Mode 1	Temperature :	21~23°C
Test Engineer :	Eric Jeng	Relative Humidity :	46~48%
Test Voltage :	120Vac / 60Hz	Phase :	Neutral
Function Type :	GSM1900 Idle + Bluetooth Link + WLAN Link + Earphone + Battery + USB Cable 1 (Charging from Adapter) + MP3		

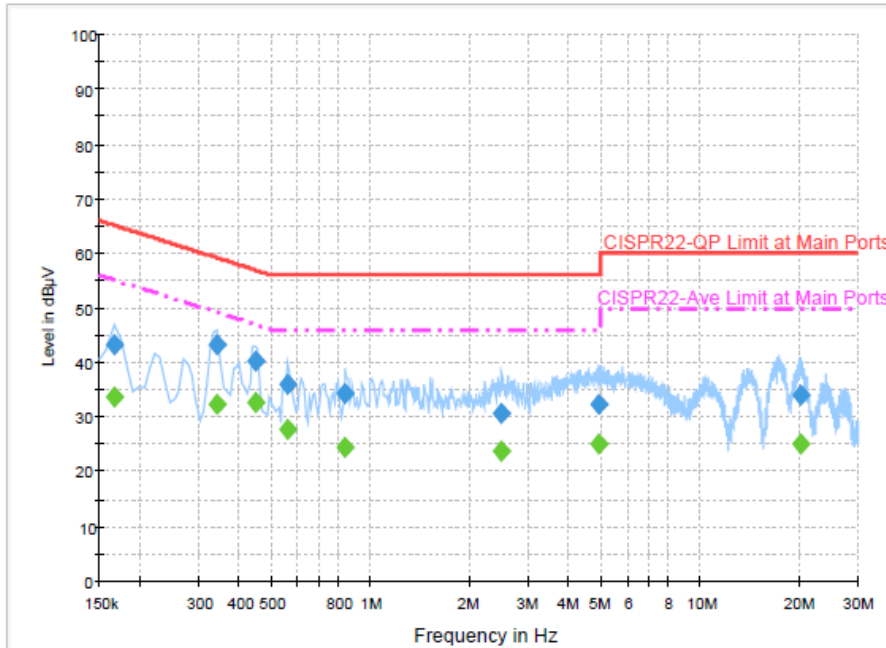

Final Result : Quasi-Peak

Frequency (MHz)	Quasi-Peak (dBµV)	Filter	Line	Corr. (dB)	Margin (dB)	Limit (dBµV)
0.166000	43.3	Off	N	19.5	21.9	65.2
0.342000	43.3	Off	N	19.5	15.9	59.2
0.446000	40.2	Off	N	19.5	16.7	56.9
0.558000	35.9	Off	N	19.5	20.1	56.0
0.838000	34.3	Off	N	19.5	21.7	56.0
2.494000	30.9	Off	N	19.5	25.1	56.0
4.902000	32.3	Off	N	19.6	23.7	56.0
20.078000	33.9	Off	N	20.0	26.1	60.0

Final Result : Average

Frequency (MHz)	Average (dBµV)	Filter	Line	Corr. (dB)	Margin (dB)	Limit (dBµV)
0.166000	33.7	Off	N	19.5	21.5	55.2
0.342000	32.3	Off	N	19.5	16.9	49.2
0.446000	32.5	Off	N	19.5	14.4	46.9
0.558000	27.8	Off	N	19.5	18.2	46.0
0.838000	24.4	Off	N	19.5	21.6	46.0
2.494000	23.7	Off	N	19.5	22.3	46.0
4.902000	25.0	Off	N	19.6	21.0	46.0
20.078000	25.1	Off	N	20.0	24.9	50.0



3.10 Antenna Requirements

3.10.1 Standard Applicable

If directional gain of transmitting antennas is greater than 6dBi, the power shall be reduced by the same level in dB comparing to gain minus 6dBi. The use of a permanently attached antenna or of an antenna that uses a unique coupling to the intentional radiator shall be considered sufficient to comply with the FCC rule.

3.10.2 Antenna Anti-Replacement Construction

An embedded-in antenna design is used.

3.10.3 Antenna Gain

The antenna peak gain of EUT is less than 6 dBi. Therefore, it is not necessary to reduce maximum peak output power limit.



4 List of Measuring Equipment

Instrument	Manufacturer	Model No.	Serial No.	Characteristics	Calibration Date	Test Date	Due Date	Remark
Spectrum Analyzer	Rohde & Schwarz	FSP40	100055	9kHz~40GHz	Jun. 09, 2014	Oct. 28, 2014 ~ Nov. 06, 2014	Jun. 08, 2015	Conducted (TH02-HY)
Power Meter	Agilent	E4416A	GB41292344	300MHz~40GHz	Jan. 28, 2014	Oct. 28, 2014 ~ Nov. 06, 2014	Jan. 27, 2015	Conducted (TH02-HY)
Power Sensor	Agilent	E9327A	US40441548	300MHz~40GHz	Jan. 28, 2014	Oct. 28, 2014 ~ Nov. 06, 2014	Jan. 27, 2015	Conducted (TH02-HY)
Hygrometer	Testo	608-H1	34897199	N/A	May 06, 2014	Oct. 28, 2014 ~ Nov. 06, 2014	May 05, 2015	Conducted (TH02-HY)
RF cable	WOKEN	S05	S05-130708-038	N/A	Jan. 22, 2014	Oct. 28, 2014 ~ Nov. 06, 2014	Jan. 21, 2015	Conducted (TH02-HY)
EMI Test Receiver	Rohde & Schwarz	ESCI 7	100724	9 kHz~7 GHz	Aug. 30, 2014	Oct. 29, 2014 ~ Nov. 07, 2014	Aug. 29, 2015	Radiation (03CH07-HY)
Spectrum Analyzer	Rohde & Schwarz	FSV30	101749	10Hz ~ 30GHz	Feb. 10, 2014	Oct. 29, 2014 ~ Nov. 07, 2014	Feb. 09, 2015	Radiation (03CH07-HY)
Loop Antenna	TESEQ	HLA 6120	31244	9 kHz~30 MHz	Dec. 02, 2012	Oct. 29, 2014 ~ Nov. 07, 2014	Dec. 01, 2014	Radiation (03CH07-HY)
Bilog Antenna	Schaffner	CBL6111C	2726	30MHz ~ 1GHz	Sep. 27, 2014	Oct. 29, 2014 ~ Nov. 07, 2014	Sep. 26, 2015	Radiation (03CH07-HY)
Double Ridge Horn Antenna	ESCO	3117	75962	1GHz~18GHz	Aug. 19, 2014	Oct. 29, 2014 ~ Nov. 07, 2014	Aug. 18, 2015	Radiation (03CH07-HY)
SHF-EHF Horn Antenna	SCHWARZBECK	BBHA 9170	BBHA9170251	18GHz~40GHz	Oct. 02, 2014	Oct. 29, 2014 ~ Nov. 07, 2014	Oct. 01, 2015	Radiation (03CH07-HY)
Preamplifier	COM-POWER	PA-103A	161241	10 MHz ~ 1000MHz	Mar. 17, 2014	Oct. 29, 2014 ~ Nov. 07, 2014	Mar. 16, 2015	Radiation (03CH07-HY)
Preamplifier	Agilent	8449B	3008A02362	1 GHz~26.5 GHz	Nov. 29, 2013	Oct. 29, 2014 ~ Nov. 07, 2014	Nov. 28, 2014	Radiation (03CH07-HY)
Preamplifier	MITEQ	AMF-7D-00 101800-30-10P	1590075	DC~18 GHz	Apr. 21, 2014	Oct. 29, 2014 ~ Nov. 07, 2014	Apr. 20, 2015	Radiation (03CH07-HY)
Turn Table	ChainTek	ChainTek 3000	N/A	0 ~ 360 degree	N/A	Oct. 29, 2014 ~ Nov. 07, 2014	N/A	Radiation (03CH07-HY)
Antenna Mast	ChainTek	ChainTek 3000	N/A	N/A	N/A	Oct. 29, 2014 ~ Nov. 07, 2014	N/A	Radiation (03CH07-HY)
Hygrometer	Testo	608-H1	34897197	N/A	May 06, 2014	Oct. 29, 2014 ~ Nov. 07, 2014	May 05, 2015	Radiation (03CH07-HY)
LF RF Cable	Warison+HUBER SUHNER	WCBA-WC 04NM.NM2	N/A	30MHz~1GHz	Nov. 28, 2013	Oct. 29, 2014 ~ Nov. 07, 2014	Nov. 27, 2014	Radiation (03CH07-HY)
HF RF Cable	HUBER SUHNER	SUCOFLEX 104	38411/6	1GHz~26.5GHz	Nov. 28, 2013	Oct. 29, 2014 ~ Nov. 07, 2014	Nov. 27, 2014	Radiation (03CH07-HY)
Test Software	Audix	E3 V6.0	N/A	N/A	N/A	Oct. 29, 2014 ~ Nov. 07, 2014	N/A	Radiation (03CH07-HY)
Low Pass Filter	Wainwright Instruments Gmbh	WLKS1200-8SS	SN3	1.2G LPF	Oct. 01, 2014	Oct. 29, 2014 ~ Nov. 07, 2014	Sep. 30, 2015	Radiation (03CH07-HY)
High Pass Filter	Microwave Circuits	H3G018G1	SN477220	3G HPF	Oct. 01, 2014	Oct. 29, 2014 ~ Nov. 07, 2014	Sep. 30, 2015	Radiation (03CH07-HY)



Instrument	Manufacturer	Model No.	Serial No.	Characteristics	Calibration Date	Test Date	Due Date	Remark
EMI Test Receiver	Rohde & Schwarz	ESCS 30	100356	9kHz ~ 2.75GHz	Nov. 15, 2013	Nov. 01, 2014	Nov. 14, 2014	Conduction (CO05-HY)
LISN	Rohde & Schwarz	ENV216	100081	9kHz ~ 30MHz	Dec. 12, 2013	Nov. 01, 2014	Dec. 11, 2014	Conduction (CO05-HY)
LISN (for auxiliary equipment)	Rohde & Schwarz	ENV216	100080	9kHz ~ 30MHz	Dec. 04, 2013	Nov. 01, 2014	Dec. 03, 2014	Conduction (CO05-HY)
AC Power Source	APC	APC-1000 W	N/A	N/A	N/A	Nov. 01, 2014	N/A	Conduction (CO05-HY)
Test Software	N/A	EMC32	8.40.0	N/A	N/A	Nov. 01, 2014	N/A	Conduction (CO05-HY)
Hygrometer	Testo	608-H1	34913912	N/A	Apr. 23, 2014	Nov. 01, 2014	Apr. 22, 2015	Conduction (CO05-HY)
LF Cable	Shuner	RG-402	N/A	N/A	Oct. 07, 2014	Nov. 01, 2014	Oct. 06, 2015	Conduction (CO05-HY)

Note: Test equipment calibration is traceable to the procedure of ISO17025.



5 Uncertainty of Evaluation

Uncertainty of Conducted Emission Measurement (150 kHz ~ 30 MHz)

Measuring Uncertainty for a Level of Confidence of 95% ($U = 2Uc(y)$)	2.26
---	------

Uncertainty of Radiated Emission Measurement (30 MHz ~ 1000 MHz)

Measuring Uncertainty for a Level of Confidence of 95% ($U = 2Uc(y)$)	4.50
---	------



Appendix A. Radiated Spurious Emission

Test Engineer :	Nick Yu, Ken Wu, and Derreck Chen	Temperature :	23~25°C
		Relative Humidity :	48~51%

15C 2.4GHz 2400~2483.5MHz

BT (Band Edge @ 3m)

BT	Note	Frequency	Level	Over	Limit	Read	Antenna	Cable	Preamp	Ant	Table	Peak	Pol.	
DH5				Limit	Line	Level	Factor	Loss	Factor	Pos	Pos	Avg.		
		(MHz)	(dBμV/m)	(dB)	(dBμV/m)	(dBμV)	(dB/m)	(dB)	(dB)	(cm)	(deg)	(P/A)	(H/V)	
BT CH00 2402MHz		2388.52	48.79	-25.21	74	43.97	32.18	6.91	34.27	100	306	P	H	
		2388.52	24	-30	54	-	-	-	-	-	-	A	H	
	*	2402.04	105.12	-	-	100.33	32.18	6.91	34.3	100	306	P	H	
	*	2402.04	80.33	-	-	-	-	-	-	-	-	A	H	
													H	
														H
			2344.84	47.38	-26.62	74	42.68	32.11	6.84	34.25	130	360	P	V
			2344.84	22.59	-31.41	54	-	-	-	-	-	-	A	V
	*		2402.04	101.8	-	-	97.01	32.18	6.91	34.3	130	360	P	V
	*		2402.04	77.01	-	-	-	-	-	-	-	-	A	V
														V
														V
Remark	1. No other spurious found. 2. All results are PASS against Peak and Average limit line.													



BT	Note	Frequency	Level	Over	Limit	Read	Antenna	Cable	Preamp	Ant	Table	Peak	Pol.
DH5				Limit	Line	Level	Factor	Loss	Factor	Pos	Pos	Avg.	
		(MHz)	(dBμV/m)	(dB)	(dBμV/m)	(dBμV)	(dB/m)	(dB)	(dB)	(cm)	(deg)	(P/A)	(H/V)
BT CH 39 2441MHz		2320.07	48.08	-25.92	74	43.41	32.09	6.8	34.22	178	344	P	H
		2320.07	23.29	-30.71	54	-	-	-	-	-	-	A	H
	*	2441.29	105.56	-	-	100.76	32.24	6.95	34.39	178	344	P	H
	*	2441.29	80.77	-	-	-	-	-	-	-	-	A	H
		2490.12	47.31	-26.69	74	42.44	32.3	7	34.43	178	344	P	H
		2490.12	22.52	-31.48	54	-	-	-	-	-	-	A	H
		2373.27	47.4	-26.6	74	42.64	32.16	6.87	34.27	123	357	P	V
		2373.27	22.61	-31.39	54	-	-	-	-	-	-	A	V
	*	2441.1	102.69	-	-	97.89	32.24	6.95	34.39	123	357	P	V
	*	2441.1	77.9	-	-	-	-	-	-	-	-	A	V
		2487.08	46.84	-27.16	74	41.99	32.28	7	34.43	123	357	P	V
		2487.08	22.05	-31.95	54	-	-	-	-	-	-	A	V
BT CH 78 2480MHz	*	2480.19	104.04	-	-	99.19	32.28	7	34.43	146	300	P	H
	*	2480.19	79.25	-	-	-	-	-	-	-	-	A	H
		2484.39	50.41	-23.59	74	45.56	32.28	7	34.43	146	300	P	H
		2484.39	25.62	-28.38	54	-	-	-	-	-	-	A	H
													H
													H
	*	2479.91	102.29	-	-	97.44	32.28	7	34.43	125	360	P	V
	*	2479.91	77.5	-	-	-	-	-	-	-	-	A	V
		2485.23	50.03	-23.97	74	45.18	32.28	7	34.43	125	360	P	V
		2485.23	25.24	-28.76	54	-	-	-	-	-	-	A	V
												V	
												V	
Remark	1. No other spurious found. 2. All results are PASS against Peak and Average limit line.												



15C 2.4GHz 2400~2483.5MHz

BT (Harmonic @ 3m)

BT	Note	Frequency	Level	Over	Limit	Read	Antenna	Cable	Preamp	Ant	Table	Peak	Pol.
DH5				Limit	Line	Level	Factor	Loss	Factor	Pos	Pos	Avg.	
		(MHz)	(dBμV/m)	(dB)	(dBμV/m)	(dBμV)	(dB/m)	(dB)	(dB)	(cm)	(deg)	(P/A)	(H/V)
BT CH 00 2402MHz		4804	40.34	-33.66	74	56.32	34.25	8.73	58.96	100	0	P	H
		4804	15.55	-38.45	54	-	-	-	-	-	-	A	H
		7206	48.82	-36.3	85.12	59.96	35.6	10.89	57.63	100	0	P	H
		9608	43.8	-41.32	85.12	52.21	36.6	13.67	58.68	100	0	P	H
		4804	40.73	-33.27	74	56.71	34.25	8.73	58.96	100	0	P	V
		4804	15.94	-38.06	54	-	-	-	-	-	-	A	V
		7206	48.28	-33.52	81.8	59.42	35.6	10.89	57.63	100	0	P	V
		9608	43.91	-37.89	81.8	52.32	36.6	13.67	58.68	100	0	P	V
BT CH 39 2441MHz		4882	39.97	-34.03	74	55.57	34.3	8.93	58.83	100	0	P	H
		4882	15.18	-38.82	54	-	-	-	-	-	-	A	H
		7326	47.89	-26.11	74	59.01	35.6	11.02	57.74	100	0	P	H
		7326	23.1	-30.9	54	-	-	-	-	-	-	A	H
		9765	44.26	-41.3	85.56	52.51	36.78	13.7	58.73	100	0	P	H
		4884	40.46	-33.54	74	56.06	34.3	8.93	58.83	100	0	P	V
		4884	15.67	-38.33	54	-	-	-	-	-	-	A	V
		7326	46.05	-27.95	74	57.17	35.6	11.02	57.74	100	0	P	V
		7326	21.26	-32.74	54	-	-	-	-	-	-	A	V
		9765	43.54	-39.15	82.69	51.79	36.78	13.7	58.73	100	0	P	V
Remark	1. No other spurious found. 2. All results are PASS against Peak and Average limit line.												



BT	Note	Frequency	Level	Over	Limit	Read	Antenna	Cable	Preamp	Ant	Table	Peak	Pol.
DH5				Limit	Line	Level	Factor	Loss	Factor	Pos	Pos	Avg.	
		(MHz)	(dBμV/m)	(dB)	(dBμV/m)	(dBμV)	(dB/m)	(dB)	(dB)	(cm)	(deg)	(P/A)	(H/V)
BT CH 78 2480MHz		4962	41.67	-32.33	74	56.87	34.37	9.09	58.66	100	0	P	H
		4962	16.88	-37.12	54	-	-	-	-	-	-	A	H
		7440	44.79	-29.21	74	55.92	35.6	11.12	57.85	100	0	P	H
		7440	20	-34	54	-	-	-	-	-	-	A	H
		9918	43.1	-40.94	84.04	51.26	36.93	13.69	58.78	100	0	P	H
		4960	40.73	-33.27	74	55.93	34.37	9.09	58.66	100	0	P	V
		4960	15.94	-38.06	54	-	-	-	-	-	-	A	V
		7440	43.48	-30.52	74	54.61	35.6	11.12	57.85	100	0	P	V
		7440	18.69	-35.31	54	-	-	-	-	-	-	A	V
		9918	43.12	-39.17	82.29	51.28	36.93	13.69	58.78	100	0	P	V
Remark	1. No other spurious found. 2. All results are PASS against Peak and Average limit line.												



15C 2.4GHz 2400~2483.5MHz

BT (Band Edge @ 3m)

BT	Note	Frequency	Level	Over	Limit	Read	Antenna	Cable	Preamp	Ant	Table	Peak	Pol.	
2DH5				Limit	Line	Level	Factor	Loss	Factor	Pos	Pos	Avg.		
		(MHz)	(dBμV/m)	(dB)	(dBμV/m)	(dBμV)	(dB/m)	(dB)	(dB)	(cm)	(deg)	(P/A)	(H/V)	
BT CH00 2402MHz		2389.17	48.12	-25.88	74	43.3	32.18	6.91	34.27	100	306	P	H	
		2389.17	23.33	-30.67	54	-	-	-	-	-	-	A	H	
	*	2402.3	104.48	-	-	99.69	32.18	6.91	34.3	100	306	P	H	
	*	2402.3	79.69	-	-	-	-	-	-	-	-	A	H	
													H	
														H
			2386.96	47.91	-26.09	74	43.09	32.18	6.91	34.27	130	360	P	V
			2386.96	23.12	-30.88	54	-	-	-	-	-	-	A	V
	*		2402.17	101	-	-	96.21	32.18	6.91	34.3	130	360	P	V
	*		2402.17	76.21	-	-	-	-	-	-	-	-	A	V
														V
														V
BT CH 39 2441MHz		2380.49	47.09	-26.91	74	42.29	32.16	6.91	34.27	178	344	P	H	
		2380.49	22.3	-31.7	54	-	-	-	-	-	-	A	H	
	*	2441.29	104.76	-	-	99.96	32.24	6.95	34.39	178	344	P	H	
	*	2441.29	79.97	-	-	-	-	-	-	-	-	A	H	
			2485.56	46.61	-27.39	74	41.76	32.28	7	34.43	178	344	P	H
			2485.56	21.82	-32.18	54	-	-	-	-	-	-	A	H
			2368.14	47.86	-26.14	74	43.13	32.13	6.87	34.27	123	357	P	V
			2368.14	23.07	-30.93	54	-	-	-	-	-	-	A	V
	*		2440.91	102.03	-	-	97.23	32.24	6.95	34.39	123	357	P	V
	*		2440.91	77.24	-	-	-	-	-	-	-	-	A	V
			2485.37	46.6	-27.4	74	41.75	32.28	7	34.43	123	357	P	V
			2485.37	21.81	-32.19	54	-	-	-	-	-	-	A	V
Remark	1. No other spurious found. 2. All results are PASS against Peak and Average limit line.													



BT	Note	Frequency	Level	Over	Limit	Read	Antenna	Cable	Preamp	Ant	Table	Peak	Pol.	
2DH5				Limit	Line	Level	Factor	Loss	Factor	Pos	Pos	Avg.		
		(MHz)	(dBμV/m)	(dB)	(dBμV/m)	(dBμV)	(dB/m)	(dB)	(dB)	(cm)	(deg)	(P/A)	(H/V)	
BT CH 78 2480MHz	*	2479.91	103.34	-	-	98.49	32.28	7	34.43	146	300	P	H	
	*	2479.91	78.55	-	-	-	-	-	-	-	-	A	H	
		2483.5	53.37	-20.63	74	48.52	32.28	7	34.43	146	300	P	H	
		2483.5	28.58	-25.42	54	-	-	-	-	-	-	A	H	
													H	
														H
	*	2479.91	101.54	-	-	96.69	32.28	7	34.43	125	360	P	V	
	*	2479.91	76.75	-	-	-	-	-	-	-	-	-	A	V
		2483.5	51.76	-22.24	74	46.91	32.28	7	34.43	125	360	P	V	
		2483.5	26.97	-27.03	54	-	-	-	-	-	-	A	V	
														V
														V
Remark	1. No other spurious found. 2. All results are PASS against Peak and Average limit line.													



15C 2.4GHz 2400~2483.5MHz

BT (Harmonic @ 3m) (2Mbps)

BT	Note	Frequency	Level	Over	Limit	Read	Antenna	Cable	Preamp	Ant	Table	Peak	Pol.
2DH5				Limit	Line	Level	Factor	Loss	Factor	Pos	Pos	Avg.	
		(MHz)	(dBμV/m)	(dB)	(dBμV/m)	(dBμV)	(dB/m)	(dB)	(dB)	(cm)	(deg)	(P/A)	(H/V)
BT CH 00 2402MHz		4806	40.48	-33.52	74	56.41	34.25	8.78	58.96	100	0	P	H
		4806	15.69	-38.31	54	-	-	-	-	-	-	A	H
		7206	40.66	-43.82	84.48	51.8	35.6	10.89	57.63	100	0	P	H
		9608	44.91	-39.57	84.48	53.32	36.6	13.67	58.68	100	0	P	H
		4806	41.73	-32.27	74	57.66	34.25	8.78	58.96	100	0	P	V
		4806	16.94	-37.06	54	-	-	-	-	-	-	A	V
		7206	40.39	-40.61	81	51.53	35.6	10.89	57.63	100	0	P	V
		9608	43.68	-37.32	81	52.09	36.6	13.67	58.68	100	0	P	V
BT CH 39 2441MHz		4884	40.71	-33.29	74	56.31	34.3	8.93	58.83	100	0	P	H
		4884	15.92	-38.08	54	-	-	-	-	-	-	A	H
		7323	40.66	-33.34	74	51.81	35.6	10.99	57.74	100	0	P	H
		7323	15.87	-38.13	54	-	-	-	-	-	-	A	H
		4884	40.71	-33.29	74	56.31	34.3	8.93	58.83	100	0	P	V
		4884	15.92	-38.08	54	-	-	-	-	-	-	A	V
		7323	41.38	-32.62	74	52.53	35.6	10.99	57.74	100	0	P	V
		7323	16.59	-37.41	54	-	-	-	-	-	-	A	V
BT CH 78 2480MHz		4960	40.25	-33.75	74	55.45	34.37	9.09	58.66	100	0	P	H
		4960	15.46	-38.54	54	-	-	-	-	-	-	A	H
		7440	42.74	-31.26	74	53.87	35.6	11.12	57.85	100	0	P	H
		7440	17.95	-36.05	54	-	-	-	-	-	-	A	H
		4962	40.27	-33.73	74	55.47	34.37	9.09	58.66	100	0	P	V
		4962	15.48	-38.52	54	-	-	-	-	-	-	A	V
		7440	42.04	-31.96	74	53.17	35.6	11.12	57.85	100	0	P	V
		7440	17.25	-36.75	54	-	-	-	-	-	-	A	V
Remark	1. No other spurious found. 2. All results are PASS against Peak and Average limit line.												



15C 2.4GHz 2400~2483.5MHz

BT (Band Edge @ 3m)

BT	Note	Frequency	Level	Over	Limit	Read	Antenna	Cable	Preamp	Ant	Table	Peak	Pol.	
3DH5				Limit	Line	Level	Factor	Loss	Factor	Pos	Pos	Avg.		
		(MHz)	(dBμV/m)	(dB)	(dBμV/m)	(dBμV)	(dB/m)	(dB)	(dB)	(cm)	(deg)	(P/A)	(H/V)	
BT CH00 2402MHz		2385.79	48.37	-25.63	74	43.55	32.18	6.91	34.27	100	306	P	H	
		2385.79	23.58	-30.42	54	-	-	-	-	-	-	A	H	
	*	2402.17	104.43	-	-	99.64	32.18	6.91	34.3	100	306	P	H	
	*	2402.17	79.64	-	-	-	-	-	-	-	-	A	H	
													H	
														H
			2388.52	47.63	-26.37	74	42.81	32.18	6.91	34.27	130	360	P	V
			2388.52	22.84	-31.16	54	-	-	-	-	-	-	A	V
	*		2402.04	101.08	-	-	96.29	32.18	6.91	34.3	130	360	P	V
	*		2402.04	76.29	-	-	-	-	-	-	-	-	A	V
														V
														V
BT CH 39 2441MHz		2383.91	47.27	-26.73	74	42.47	32.16	6.91	34.27	178	344	P	H	
		2383.91	22.48	-31.52	54	-	-	-	-	-	-	A	H	
	*	2441.1	104.88	-	-	100.08	32.24	6.95	34.39	178	344	P	H	
	*	2441.1	80.09	-	-	-	-	-	-	-	-	A	H	
			2489.17	47.7	-26.3	74	42.83	32.3	7	34.43	178	344	P	H
			2489.17	22.91	-31.09	54	-	-	-	-	-	-	A	H
			2343.82	47.22	-26.78	74	42.52	32.11	6.84	34.25	123	357	P	V
			2343.82	22.43	-31.57	54	-	-	-	-	-	-	A	V
	*		2441.1	102.01	-	-	97.21	32.24	6.95	34.39	123	357	P	V
	*		2441.1	77.22	-	-	-	-	-	-	-	-	A	V
			2486.51	47.15	-26.85	74	42.3	32.28	7	34.43	123	357	P	V
			2486.51	22.36	-31.64	54	-	-	-	-	-	-	A	V
Remark	1. No other spurious found. 2. All results are PASS against Peak and Average limit line.													



BT	Note	Frequency	Level	Over	Limit	Read	Antenna	Cable	Preamp	Ant	Table	Peak	Pol.	
3DH5				Limit	Line	Level	Factor	Loss	Factor	Pos	Pos	Avg.		
		(MHz)	(dBμV/m)	(dB)	(dBμV/m)	(dBμV)	(dB/m)	(dB)	(dB)	(cm)	(deg)	(P/A)	(H/V)	
BT CH 78 2480MHz	*	2480.05	103.37	-	-	98.52	32.28	7	34.43	146	300	P	H	
	*	2480.05	78.58	-	-	-	-	-	-	-	-	A	H	
		2484.04	52.59	-21.41	74	47.74	32.28	7	34.43	146	300	P	H	
		2484.04	27.8	-26.2	54	-	-	-	-	-	-	A	H	
													H	
													H	
	*	2479.98	101.61	-	-	96.76	32.28	7	34.43	125	360	P	V	
	*	2479.98	76.82	-	-	-	-	-	-	-	-	-	A	V
		2483.5	51.3	-22.7	74	46.45	32.28	7	34.43	125	360	P	V	
		2483.5	26.51	-27.49	54	-	-	-	-	-	-	A	V	
													V	
													V	
Remark	1. No other spurious found. 2. All results are PASS against Peak and Average limit line.													



15C 2.4GHz 2400~2483.5MHz

BT (Harmonic @ 3m)

BT	Note	Frequency	Level	Over	Limit	Read	Antenna	Cable	Preamp	Ant	Table	Peak	Pol.
3DH5				Limit	Line	Level	Factor	Loss	Factor	Pos	Pos	Avg.	
		(MHz)	(dBμV/m)	(dB)	(dBμV/m)	(dBμV)	(dB/m)	(dB)	(dB)	(cm)	(deg)	(P/A)	(H/V)
BT CH 00 2402MHz		4806	40.55	-33.45	74	56.48	34.25	8.78	58.96	100	0	P	H
		4806	15.76	-38.24	54	-	-	-	-	-	-	A	H
		7206	40.33	-44.1	84.43	51.47	35.6	10.89	57.63	100	0	P	H
		9608	43.41	-41.02	84.43	51.82	36.6	13.67	58.68	100	0	P	H
		4804	40.51	-33.49	74	56.49	34.25	8.73	58.96	100	0	P	V
		4804	15.72	-38.28	54	-	-	-	-	-	-	A	V
		7206	40.7	-40.38	81.08	51.84	35.6	10.89	57.63	100	0	P	V
		9608	44.12	-36.96	81.08	52.53	36.6	13.67	58.68	100	0	P	V
BT CH 39 2441MHz		4884	41.22	-32.78	74	56.82	34.3	8.93	58.83	100	0	P	H
		4884	16.43	-37.57	54	-	-	-	-	-	-	A	H
		7323	41.65	-32.35	74	52.8	35.6	10.99	57.74	100	0	P	H
		7323	16.86	-37.14	54	-	-	-	-	-	-	A	H
		4884	40.18	-33.82	74	55.78	34.3	8.93	58.83	100	0	P	V
		4884	15.39	-38.61	54	-	-	-	-	-	-	A	V
		7323	40.58	-33.42	74	51.73	35.6	10.99	57.74	100	0	P	V
		7323	15.79	-38.21	54	-	-	-	-	-	-	A	V
BT CH 78 2480MHz		4962	40.44	-33.56	74	55.64	34.37	9.09	58.66	100	0	P	H
		4962	15.65	-38.35	54	-	-	-	-	-	-	A	H
		7440	43.11	-30.89	74	54.24	35.6	11.12	57.85	100	0	P	H
		7440	18.32	-35.68	54	-	-	-	-	-	-	A	H
		4962	40.53	-33.47	74	55.73	34.37	9.09	58.66	100	0	P	V
		4962	15.74	-38.26	54	-	-	-	-	-	-	A	V
		7440	42.96	-31.04	74	54.09	35.6	11.12	57.85	100	0	P	V
		7440	18.17	-35.83	54	-	-	-	-	-	-	A	V
Remark	1. No other spurious found. 2. All results are PASS against Peak and Average limit line.												



15C Emission below 1GHz

2.4GHz BT (LF)

BT	Note	Frequency	Level	Over	Limit	Read	Antenna	Cable	Preamp	Ant	Table	Peak	Pol.	
		(MHz)	(dBμV/m)	(dB)	(dBμV/m)	(dBμV)	(dB/m)	(dB)	(dB)	(cm)	(deg)	(P/A)	(H/V)	
2.4GHz BT LF		32.43	20.57	-19.43	40	34.15	17.24	0.56	31.38	-	-	P	H	
		110.73	30.77	-12.73	43.5	50.06	10.85	1.05	31.19	100	188	P	H	
		115.05	29.61	-13.89	43.5	48.55	11.13	1.08	31.15	-	-	P	H	
		615.7	21.74	-24.26	46	29.49	20.08	2.74	30.57	-	-	P	H	
		839.7	26.07	-19.93	46	30.01	23.2	3.24	30.38	-	-	P	H	
		983.2	27.87	-26.13	54	29.72	24.93	3.49	30.27	-	-	P	H	
														H
														H
														H
														H
			41.34	29.27	-10.73	40	47.24	12.6	0.63	31.2	130	56	P	V
			106.95	16.91	-26.59	43.5	36.43	10.62	1.03	31.17	-	-	P	V
			128.01	16.54	-26.96	43.5	34.66	11.84	1.14	31.1	-	-	P	V
			650	22.27	-23.73	46	29.53	20.4	2.84	30.5	-	-	P	V
			822.9	25.17	-20.83	46	29.74	22.58	3.2	30.35	-	-	P	V
			955.9	28.35	-17.65	46	30.67	24.59	3.47	30.38	-	-	P	V
														V
														V
													V	
													V	
Remark	1. No other spurious found. 2. All results are PASS against limit line.													



Note symbol

*	Fundamental Frequency which can be ignored. However, the level of any unwanted emissions shall not exceed the level of the fundamental frequency per 15.209(c).
!	Test result is over limit line.
P/A	Peak or Average
H/V	Horizontal or Vertical



A calculation example for radiated spurious emission is shown as below:

WIFI	Note	Frequency	Level	Over	Limit	Read	Antenna	Cable	Preamp	Ant	Table	Peak	Pol.
Ant.				Limit	Line	Level	Factor	Loss	Factor	Pos	Pos	Avg.	
1+2		(MHz)	(dBμV/m)	(dB)	(dBμV/m)	(dBμV)	(dB/m)	(dB)	(dB)	(cm)	(deg)	(P/A)	(H/V)
802.11b		2390	55.45	-18.55	74	54.51	32.22	4.58	35.86	103	308	P	H
CH 01													
2412MHz		2390	43.54	-10.46	54	42.6	32.22	4.58	35.86	103	308	A	H

- Level(dBμV/m) =
Antenna Factor(dB/m) + Cable Loss(dB) + Read Level(dBμV) - Preamp Factor(dB)
- Over Limit(dB) = Level(dBμV/m) – Limit Line(dBμV/m)

For Peak Limit @ 2390MHz:

- Level(dBμV/m)
= Antenna Factor(dB/m) + Cable Loss(dB) + Read Level(dBμV) - Preamp Factor(dB)
= 32.22(dB/m) + 4.58(dB) + 54.51(dBμV) – 35.86 (dB)
= 55.45 (dBμV/m)
- Over Limit(dB)
= Level(dBμV/m) – Limit Line(dBμV/m)
= 55.45(dBμV/m) – 74(dBμV/m)
= -18.55(dB)

For Average Limit @ 2390MHz:

- Level(dBμV/m)
= Antenna Factor(dB/m) + Cable Loss(dB) + Read Level(dBμV) - Preamp Factor(dB)
= 32.22(dB/m) + 4.58(dB) + 42.6(dBμV) – 35.86 (dB)
= 43.54 (dBμV/m)
- Over Limit(dB)
= Level(dBμV/m) – Limit Line(dBμV/m)
= 43.54(dBμV/m) – 54(dBμV/m)
= -10.46(dB)

Both peak and average measured complies with the limit line, so test result is “PASS”.