



FCC RF Test Report

APPLICANT : Sony Mobile Communications Inc.
EQUIPMENT : GSM/WCDMA/LTE Phone+Bluetooth, DTS/UNII
a/b/g/n and NFC
BRAND NAME : Sony
FCC ID : PY7-84773W
STANDARD : FCC Part 15 Subpart E §15.407
CLASSIFICATION : (NII) Unlicensed National Information Infrastructure

The product was received on Sep. 22, 2016 and testing was completed on Oct. 17, 2016. We, SPORTON INTERNATIONAL INC., would like to declare that the tested sample has been evaluated in accordance with the test procedures and has been in compliance with the applicable technical standards.

The test results in this report apply exclusively to the tested model / sample. Without written approval of SPORTON INTERNATIONAL INC., the test report shall not be reproduced except in full.

Reviewed by: Joseph Lin / Supervisor

Approved by: Jones Tsai / Manager



SPORTON INTERNATIONAL INC.

No. 52, Hwa Ya 1st Rd., Hwa Ya Technology Park, Kwei-Shan District, Tao Yuan City, Taiwan, R.O.C.

SPORTON INTERNATIONAL INC.

TEL : 886-3-327-3456

FAX : 886-3-328-4978

FCC ID : PY7-84773W

Page Number : 1 of 35

Report Issued Date : Feb. 06, 2017

Report Version : Rev. 01

Report Template No.: BU5-FR15EWL Version 1.4



TABLE OF CONTENTS

SUMMARY OF TEST RESULT 4

1 GENERAL DESCRIPTION 5

 1.1 Applicant 5

 1.2 Manufacturer 5

 1.3 Product Feature of Equipment Under Test 5

 1.4 Modification of EUT 6

 1.5 Testing Location 7

 1.6 Applicable Standards 8

2 TEST CONFIGURATION OF EQUIPMENT UNDER TEST 9

 2.1 Carrier Frequency Channel 9

 2.2 Test Mode 10

 2.3 Connection Diagram of Test System 11

 2.4 Support Unit used in test configuration and system 12

 2.5 EUT Operation Test Setup 12

 2.6 Measurement Results Explanation Example 12

3 TEST RESULT 13

 3.1 26dB & 99% Occupied Bandwidth Measurement 13

 3.2 Maximum Conducted Output Power Measurement 15

 3.3 Power Spectral Density Measurement 18

 3.4 Unwanted Radiated Emission Measurement 21

 3.5 AC Conducted Emission Measurement 26

 3.6 Frequency Stability Measurement 30

 3.7 Automatically Discontinue Transmission 31

 3.8 Antenna Requirements 32

4 LIST OF MEASURING EQUIPMENTS 33

5 UNCERTAINTY OF EVALUATION 35

APPENDIX A. CONDUCTED TEST RESULTS

APPENDIX B. RADIATED SPURIOUS EMISSION

APPENDIX C. RADIATED SPURIOUS EMISSION PLOTS

APPENDIX D. DUTY CYCLE PLOTS



SUMMARY OF TEST RESULT

Report Section	FCC Rule	Description	Limit	Result	Remark
3.1	2.1049 15.403(i)	26dB & 99% Bandwidth	-	Pass	-
3.2	15.407(a)	Maximum Conducted Output Power	FCC ≤ 24 dBm (depend on band)	Pass	-
3.3	15.407(a)	Power Spectral Density	FCC ≤ 11 dBm (depend on band)	Pass	-
3.4	15.407(b)	Unwanted Emissions	≤ -17, -27 dBm (depend on band)&15.209(a)	Pass	Under limit 3.00 dB at 5350.080 MHz
3.5	15.207	AC Conducted Emission	15.207(a)	Pass	Under limit 14.10 dB at 0.462 MHz
3.6	15.407(g)	Frequency Stability	Within Operation Band	Pass	-
3.7	15.407(c)	Automatically Discontinue Transmission	Discontinue Transmission	Pass	-
3.8	15.203 & 15.407(a)	Antenna Requirement	N/A	Pass	-



1 General Description

1.1 Applicant

Sony Mobile Communications Inc.

4-12-3 Higashi-Shinagawa, Shinagawa-ku, Tokyo, 140-0002, Japan

1.2 Manufacturer

Sony Mobile Communications Inc.

4-12-3 Higashi-Shinagawa, Shinagawa-ku, Tokyo, 140-0002, Japan

1.3 Product Feature of Equipment Under Test

GSM/WCDMA/LTE, Bluetooth, DTS/UNII, a/b/g/n, GPS, and NFC

Standards-related Product Specification	
Antenna Type	PIFA Antenna
Antenna Gain	<5150 MHz ~ 5250 MHz> -3.40 dBi
	<5250 MHz ~ 5350 MHz> -2.70 dBi
	<5470 MHz ~ 5725 MHz> -1.50 dBi

EUT Information List			
HW Version	SW Version	S/N	Performed Test Item
A	0.85	RQ3002HXPA	RF conducted measurement
		RQ3002HWLU	Radiated Spurious Emission
		RQ3002HWM1	Conducted Emission



Accessory List	
AC Adapter 1	Model No. : UCH20
	S/N :
	1215W48600011 (for radiated spurious emission) 1215W48600039 (for conducted emission)
Earphone 1	Model No. : MH410c
	S/N:
	1632A86300007A6 (for radiated spurious emission) 1632A8640000088 (for conducted emission)
USB Cable	Model No. : UCB20
	S/N :
	1625A912000332E (for radiated spurious emission) 1625A91900007E2 (for conducted emission)

Note:

1. Above EUT list and accessory list used are electrically identical per declared by manufacturer.
2. Above the accessories list are used to exercise the EUT during test.
3. For other wireless features of this EUT, test report will be issued separately.

1.4 Modification of EUT

No modifications are made to the EUT during all test items.



1.5 Testing Location

Sporton Lab is accredited to ISO 17025 by Taiwan Accreditation Foundation (TAF code : 1190) and the FCC designation No. TW1022 under the FCC 2.948(e) by Mutual Recognition Agreement (MRA) in FCC Test.

Test Site	SPORTON INTERNATIONAL INC.	
Test Site Location	No. 52, Hwa Ya 1 st Rd., Hwa Ya Technology Park, Kwei-Shan District, Tao Yuan City, Taiwan, R.O.C. TEL: +886-3-327-3456 FAX: +886-3-328-4978	
Test Site No.	Sporton Site No.	
	TH05-HY	CO05-HY

Note: The test site complies with ANSI C63.4 2014 requirement.

Test Site	SPORTON INTERNATIONAL INC.	
Test Site Location	No.58, Aly. 75, Ln. 564, Wenhua 3rd Rd. Guishan Dist, Taoyuan City, Taiwan (R.O.C.) TEL: +886-3-327-0868 FAX: +886-3-327-0855	
Test Site No.	Sporton Site No.	
	03CH12-HY	

Note: The test site complies with ANSI C63.4 2014 requirement.



1.6 Applicable Standards

According to the specifications of the manufacturer, the EUT must comply with the requirements of the following standards:

- ♦ FCC Part 15 Subpart E
- ♦ FCC KDB 789033 D02 General UNII Test Procedures New Rules v01r03
- ♦ ANSI C63.10-2013

Remark:

1. All test items were verified and recorded according to the standards and without any deviation during the test.
2. This EUT has also been tested and complied with the requirements of FCC Part 15, Subpart B, recorded in a separate test report.



2 Test Configuration of Equipment Under Test

The EUT has been associated with peripherals and configuration operated in a manner tended to maximize its emission characteristics in a typical application. Frequency range investigated: conducted emission (150 kHz to 30 MHz) and radiated emission (9 kHz to the 10th harmonic of the highest fundamental frequency or to 40 GHz, whichever is lower). For radiated measurement, pre-scanned in three orthogonal panels, X, Y, Z. The worst cases (X plane) were recorded in this report.

2.1 Carrier Frequency Channel

Frequency Band	Channel	Freq. (MHz)	Channel	Freq. (MHz)
5150-5250 MHz Band 1 (U-NII-1)	36	5180	44	5220
	38*	5190	46*	5230
	40	5200	48	5240
	-	-		

Frequency Band	Channel	Freq. (MHz)	Channel	Freq. (MHz)
5250-5350 MHz Band 2 (U-NII-2A)	52	5260	60	5300
	54*	5270	62*	5310
	56	5280	64	5320
	-	-		

Frequency Band	Channel	Freq. (MHz)	Channel	Freq. (MHz)
5470-5725 MHz Band 3 (U-NII-2C)	100	5500	112	5560
	102*	5510	116	5580
	104	5520	132	5660
	-	-	134*	5670
	108	5540	136	5680
	110*	5550	140	5700

Frequency Band	Channel	Freq. (MHz)	Channel	Freq. (MHz)
Straddle Channel	-	-	144	5720
	142*	5710		

Note: The above Frequency and Channel in "*" were 802.11n HT40



2.2 Test Mode

Final test mode of conducted test items and radiated spurious emissions are considering the modulation and worse data rates as below table.

Modulation	Data Rate
802.11a	6 Mbps
802.11n HT20	MCS0
802.11n HT40	MCS0

AC Conducted Emission	Mode 1 : GSM1900 Idle + Bluetooth Link + WLAN (5GHz) Link + MP3 + Earphone 1 + Battery + USB Cable (Charging from Adapter 1)
------------------------------	--

Ch. #		Band I : 5150-5250 MHz	Band II : 5250-5350 MHz	Band III : 5470-5725MHz
		802.11a	802.11a	802.11a
L	Low	36	52	100
M	Middle	44	60	116
H	High	48	64	140
Straddle		-	-	144

Ch. #		Band I : 5150-5250 MHz	Band II : 5250-5350 MHz	Band III : 5470-5725MHz
		802.11n HT20	802.11n HT20	802.11n HT20
L	Low	36	52	100
M	Middle	44	60	116
H	High	48	64	140
Straddle		-	-	144

Ch. #		Band I : 5150-5250 MHz	Band II : 5250-5350 MHz	Band III : 5470-5725MHz
		802.11n HT40	802.11n HT40	802.11n HT40
L	Low	38	54	102
M	Middle	-	-	110
H	High	46	62	134
Straddle		-	-	142

2.3 Connection Diagram of Test System

<WLAN Tx Mode>

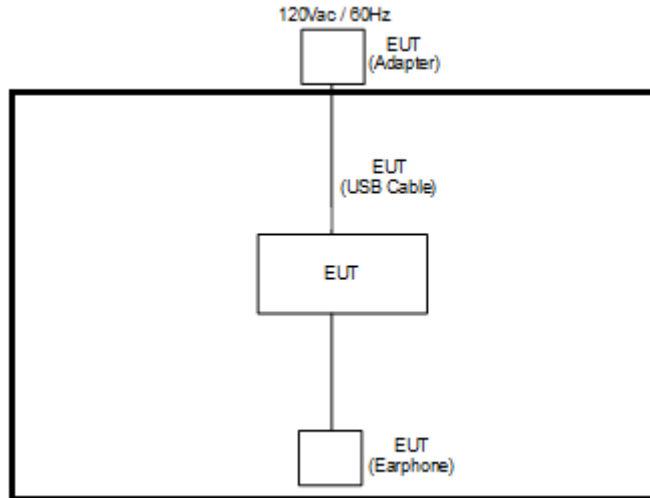

<AC Conducted Emission Mode>

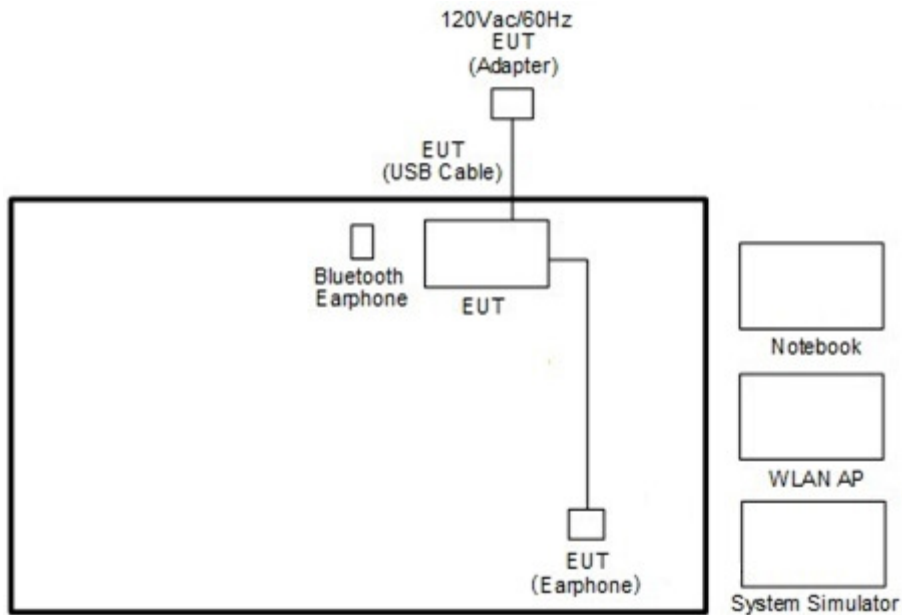



2.4 Support Unit used in test configuration and system

Item	Equipment	Trade Name	Model Name	FCC ID	Data Cable	Power Cord
1.	System Simulator	Anritsu	MT8820C	N/A	N/A	Unshielded, 1.8 m
2.	WLAN AP	ASUS	RT-AC66U	MSQ-RTAC66U	N/A	Unshielded, 1.8m
3.	Notebook	DELL	Latitude E6320	FCC DoC/ Contains FCC ID: QDS-BRCM1054	N/A	AC I/P: Unshielded, 1.2 m DC O/P: Shielded, 1.8 m
4.	Bluetooth Earphone	Sony	SBH20	PY7-RD0010	N/A	N/A
5.	SD Card	SanDisk	MicroSD HC	FCC DoC	N/A	N/A

2.5 EUT Operation Test Setup

For RF test items, an engineering test program was provided and enabled to make EUT transmitting signals.

2.6 Measurement Results Explanation Example

For all conducted test items:

The offset level is set in the spectrum analyzer to compensate the RF cable loss and attenuator factor between EUT conducted output port and spectrum analyzer. With the offset compensation, the spectrum analyzer reading level is exactly the EUT RF output level.

Example :

The spectrum analyzer offset is derived from RF cable loss and attenuator factor.

Offset = RF cable loss + attenuator factor.

Following shows an offset computation example with cable loss 4.2 dB and 10dB attenuator.

$$\begin{aligned} \text{Offset(dB)} &= \text{RF cable loss(dB)} + \text{attenuator factor(dB)}. \\ &= 4.2 + 10 = 14.2 \text{ (dB)} \end{aligned}$$

3 Test Result

3.1 26dB & 99% Occupied Bandwidth Measurement

3.1.1 Description of 26dB & 99% Occupied Bandwidth

This section is for reporting purpose only.

There is no restriction limits for bandwidth.

For Straddle Channel, U-NII procedures and limits were applied for operations in the frequency band in accordance with FCC KDB 644545 D03.

3.1.2 Measuring Instruments

The measuring equipment is listed in the section 4 of this test report.

3.1.3 Test Procedures

1. The testing follows FCC KDB 789033 D02 General UNII Test Procedures New Rules v01r03. Section C) Emission bandwidth
2. Set RBW = approximately 1% of the emission bandwidth.
3. Set the VBW > RBW.
4. Detector = Peak.
5. Trace mode = max hold
6. Measure the maximum width of the emission that is 26 dB down from the peak of the emission. Compare this with the RBW setting of the analyzer. Readjust RBW and repeat measurement as needed until the RBW/EBW ratio is approximately 1%.
7. For 99% Bandwidth Measurement, the spectrum analyzer's resolution bandwidth (RBW) is set 1MHz and set the Video bandwidth (VBW) $\geq 3 * RBW$.
8. Measure and record the results in the test report.

3.1.4 Test Setup

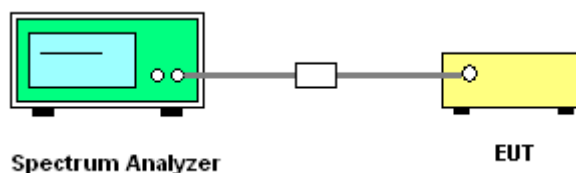



3.1.5 Test Result of 26dB & 99% Occupied Bandwidth Plots

Please refer to Appendix A.

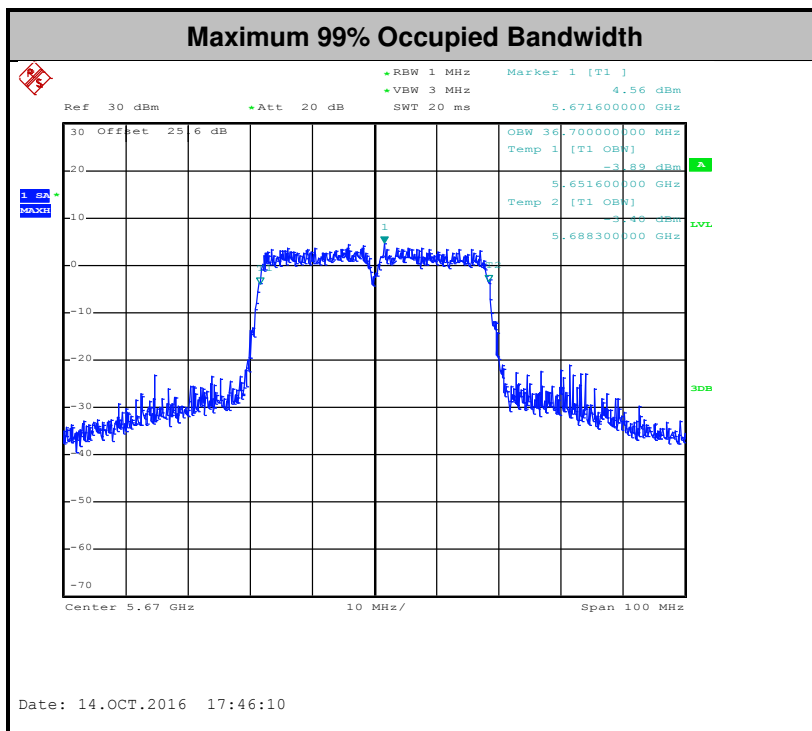
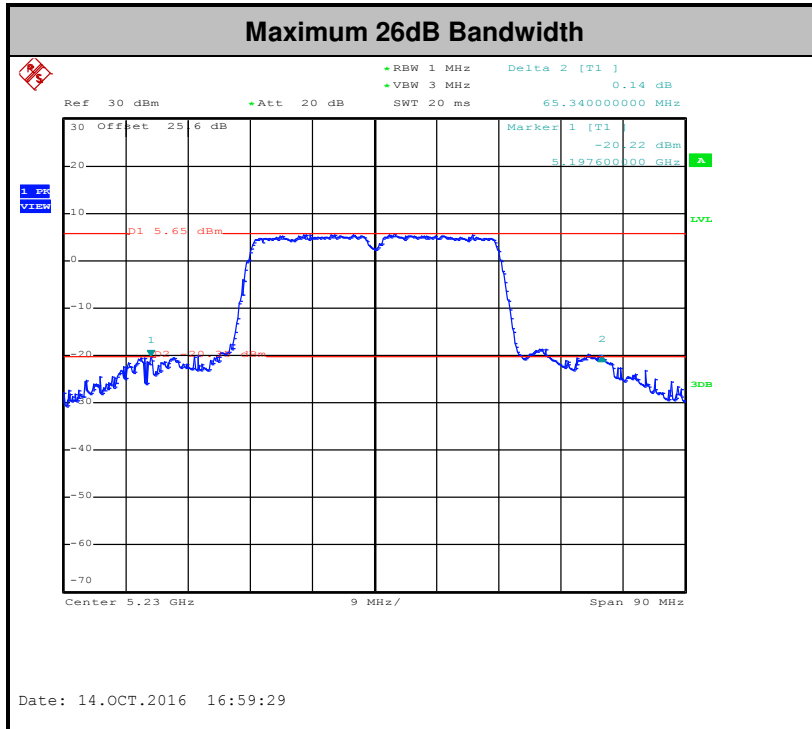



3.2 Maximum Conducted Output Power Measurement

3.2.1 Limit of Maximum Conducted Output Power

<FCC 14-30 CFR 15.407>

For mobile and portable client devices in the 5.15–5.25 GHz band, the maximum conducted output power over the frequency band of operation shall not exceed 250 mW.

For the 5.25–5.725 GHz bands, the maximum conducted output power over the frequency bands of operation shall not exceed the lesser of 250 mW or $11 \text{ dBm} + 10 \log B$, where B is the 26 dB emission bandwidth in megahertz.

For Straddle Channel, U-NII procedures and limits were applied for operations in the frequency band in accordance with FCC KDB 644545 D03.

If transmitting antennas of directional gain greater than 6 dBi are used, the peak output power shall be reduced by the amount in dB that the directional gain of the antenna exceeds 6 dBi.

Note that U-NII-2 band, devices with a maximum e.i.r.p. greater than 500 mW shall implement TPC in order to have the capability to operate at least 6 dB below the maximum permitted e.i.r.p. of 1 W.

3.2.2 Measuring Instruments

The measuring equipment is listed in the section 4 of this test report.

3.2.3 Test Procedures

The testing follows Method PM of FCC KDB 789033 D02 General UNII Test Procedures New Rules v01r03.

Method PM (Measurement using an RF average power meter):

1. Measurement is performed using a wideband RF power meter.
2. The EUT is configured to transmit continuously with a consistent duty cycle at its maximum power control level.
3. Measure the average power of the transmitter, and the average power is corrected with duty factor, $10 \log(1/x)$, where x is the duty cycle.

For straddle channel, the testing follows Method SA-3 (RMS detection with max hold) of FCC KDB 789033 D02 General UNII Test Procedures New Rules v01r03.

Compute power by integrating the spectrum across the 99% occupied bandwidth of the signal using the instrument's band power measurement function.

3.2.4 Test Setup

For normal channel:

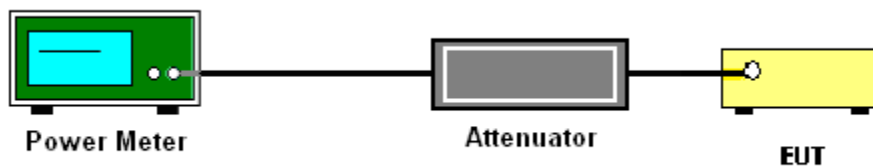

For straddle channel:

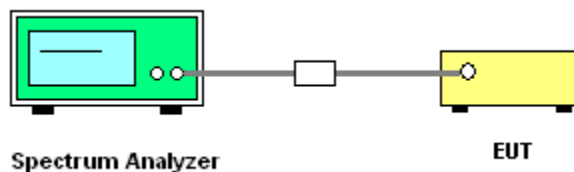



3.2.5 Test Result of Maximum Conducted Output Power

Please refer to Appendix A.

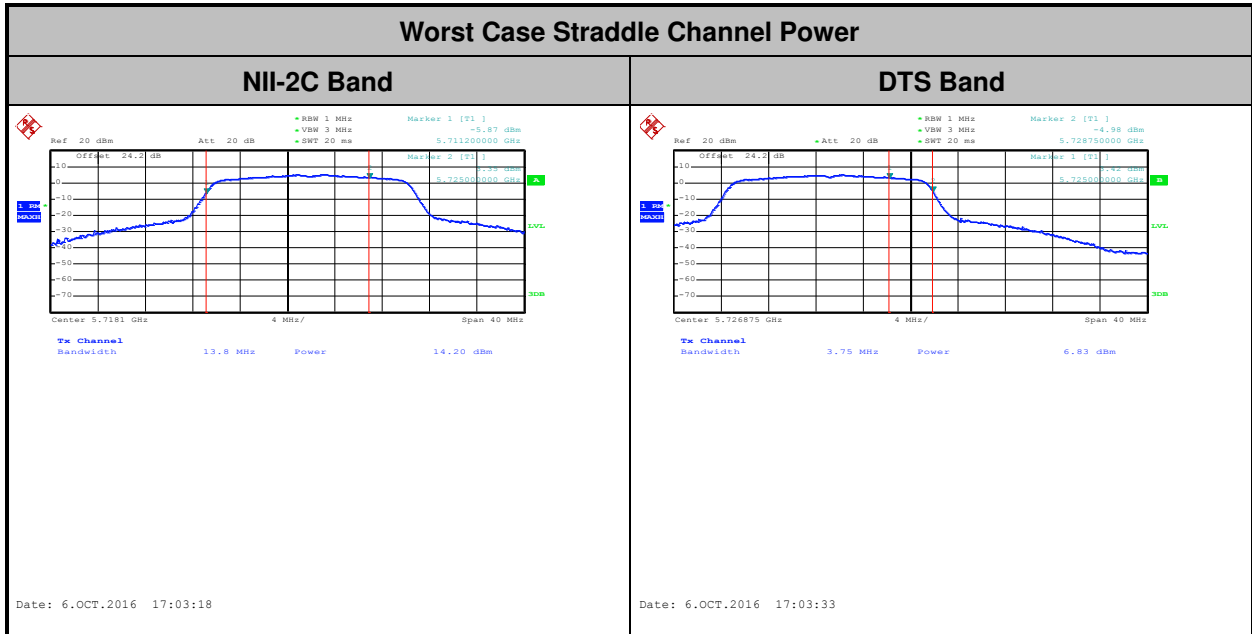



3.3 Power Spectral Density Measurement

3.3.1 Limit of Power Spectral Density

<FCC 14-30 CFR 15.407>

For mobile and portable client devices in the 5.15–5.25 GHz band, the maximum power spectral density shall not exceed 11dBm in any 1 megahertz band.

For the 5.25–5.725 GHz bands, the maximum power spectral density shall not exceed 11 dBm in any 1 megahertz band.

For Straddle Channel, U-NII procedures and limits were applied for operations in the frequency band in accordance with FCC KDB 644545 D03.

If transmitting antennas of directional gain greater than 6 dBi are used, the peak output power shall be reduced by the amount in dB that the directional gain of the antenna exceeds 6 dBi.

3.3.2 Measuring Instruments

The measuring equipment is listed in the section 4 of this test report.

3.3.3 Test Procedures

The testing follows FCC KDB 789033 D02 General UNII Test Procedures New Rules v01r03.
Section F) Maximum power spectral density.

Method SA-2

(trace averaging across on and off times of the EUT transmissions, followed by duty cycle correction).

1. The testing follows Method SA-2 of FCC KDB 789033 D02 General UNII Test Procedures New Rules v01r03.
 - Measure the duty cycle.
 - Set span to encompass the entire emission bandwidth (EBW) of the signal.
 - Set RBW = 1 MHz.
 - Set VBW \geq 3 MHz.
 - Number of points in sweep \geq 2 Span / RBW.
 - Sweep time = auto.
 - Detector = RMS
 - Trace average at least 100 traces in power averaging mode.
 - Add $10 \log(1/x)$, where x is the duty cycle, to the measured power in order to compute the average power during the actual transmission times. For example, add $10 \log(1/0.25) = 6$ dB if the duty cycle is 25 percent.
2. The RF output of EUT was connected to the spectrum analyzer by a low loss cable.
3. Each plot has already offset with cable loss, and attenuator loss. Measure the PPSD and record it.

3.3.4 Test Setup

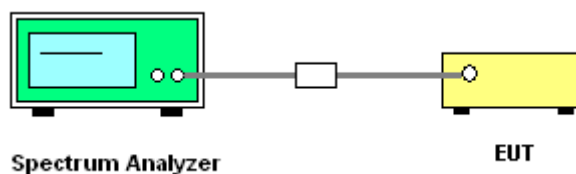



3.3.5 Test Result of Power Spectral Density

Please refer to Appendix A.

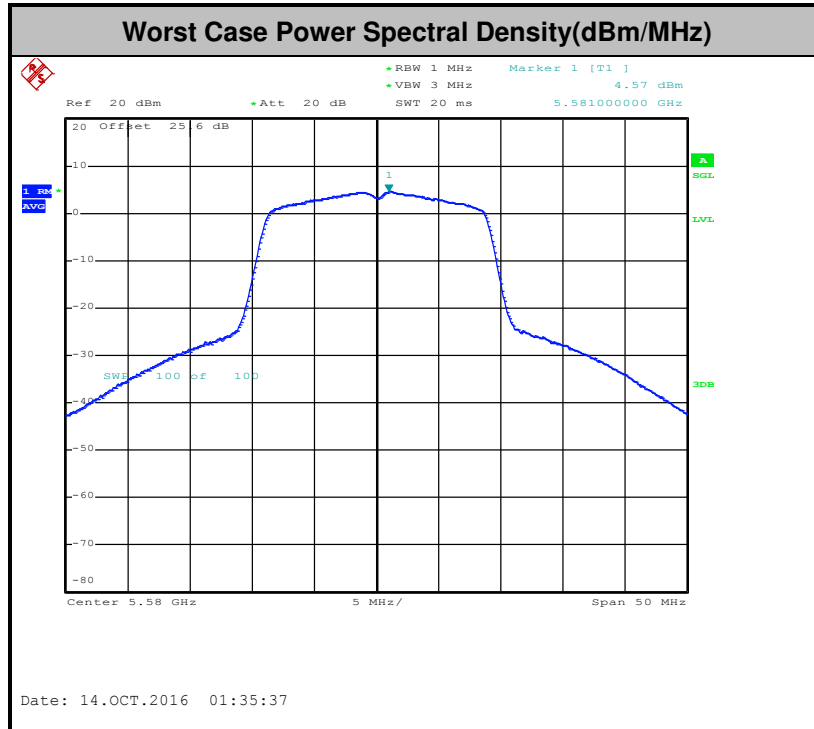

Note: Average Power Density (dB) = Measured value+ Duty Factor



3.4 Unwanted Radiated Emission Measurement

This section as specified in FCC Part 15.407(b) is to measure unwanted emissions through radiated measurement for band edge spurious emissions and out of band emissions measurement. The unwanted emissions shall comply with 15.407(b)(1) to (6), and restricted bands per FCC Part15.205.

3.4.1 Limit of Unwanted Emissions

- (1) For transmitters operating in the 5150-5250 MHz band: all emissions outside of the 5150-5350 MHz band shall not exceed an EIRP of -27dBm/MHz.

For transmitters operating in the 5250-5350 MHz band: all emissions outside of the 5150-5350 MHz band shall not exceed an EIRP of -27 dBm/MHz. Devices operating in the 5250-5350 MHz band that generate emissions in the 5150-5250 MHz band must meet all applicable technical requirements for operation in the 5150-5250 MHz band (including indoor use) or alternatively meet an out-of-band emission EIRP limit of -27 dBm/MHz in the 5150-5250 MHz band.

For transmitters operating in the 5470-5725MHz band: all emissions outside of the 5470-5725MHz band shall not exceed an EIRP of -27 dBm/MHz.

- (2) Unwanted spurious emissions fallen in restricted bands per FCC Part15.205 shall comply with the general field strength limits set forth in § 15.209 as below table,

Frequency (MHz)	Field Strength (microvolts/meter)	Measurement Distance (meters)
0.009 – 0.490	2400/F(kHz)	300
0.490 – 1.705	24000/F(kHz)	30
1.705 – 30.0	30	30
30 – 88	100	3
88 – 216	150	3
216 - 960	200	3
Above 960	500	3

Note: The following formula is used to convert the EIRP to field strength.

$$E = \frac{1000000\sqrt{30P}}{3} \mu V/m, \text{ where } P \text{ is the eirp (Watts)}$$



EIRP (dBm)	Field Strength at 3m (dBμV/m)
-17	78.3
- 27	68.3

(3) KDB789033 D01 v01r03 G)2)c) As specified in 15.407(b), emissions above 1000 MHz that are outside of the restricted bands are subject to a peak emission limit of -27 dBm/MHz (or -17 dBm/MHz as specified in 15.407(b)(4)). However, an out-of-band emission that complies with both the average and peak limits of 15.209 is not required to satisfy the -27 dBm/MHz or -17 dBm/MHz peak emission limit.

3.4.2 Measuring Instruments

The measuring equipment is listed in the section 4 of this test report.

3.4.3 Test Procedures

1. The testing follows FCC KDB 789033 D02 General UNII Test Procedures New Rules v01r03. Section G) Unwanted emissions measurement.

(1) Procedure for Unwanted Emissions Measurements Below 1000MHz

- RBW = 120 kHz
- VBW = 300 kHz
- Detector = Peak
- Trace mode = max hold

(2) Procedure for Peak Unwanted Emissions Measurements Above 1000 MHz

- RBW = 1 MHz
- VBW ≥ 3 MHz
- Detector = Peak
- Sweep time = auto
- Trace mode = max hold

(3) Procedures for Average Unwanted Emissions Measurements Above 1000MHz

- RBW = 1 MHz
- VBW = 10 Hz, when duty cycle is no less than 98 percent.
- VBW ≥ 1/T, when duty cycle is less than 98 percent where T is the minimum transmission duration over which the transmitter is on and is transmitting at its maximum power control level for the tested mode of operation.

2. The EUT was placed on a turntable with 0.8 meter for frequency below 1GHz and 1.5 meter for frequency above 1GHz respectively above ground.
3. The EUT was set 3 meters from the interference receiving antenna which was mounted on the top of a variable height antenna tower.
4. The antenna is a broadband antenna and its height is adjusted between one meter and four meters above ground to find the maximum value of the field strength for both horizontal polarization and vertical polarization of the antenna.
5. For each suspected emission, the EUT was arranged to its worst case and then adjust the antenna tower (from 1 m to 4 m) and turntable (from 0 degree to 360 degrees) to find the maximum reading.
6. For testing below 1GHz, if the emission level of the EUT in peak mode was 3 dB lower than the limit specified, then peak values of EUT will be reported, otherwise, the emissions will be repeated one by one using the CISPR quasi-peak method and reported.
7. For testing above 1GHz, the emission level of the EUT in peak mode was 20dB lower than average limit (that means the emission level in average mode also complies with the limit in average mode), then peak values of EUT will be reported, otherwise, the emissions will be measured in average mode again and reported.

3.4.4 Test Setup

For radiated emissions below 30MHz

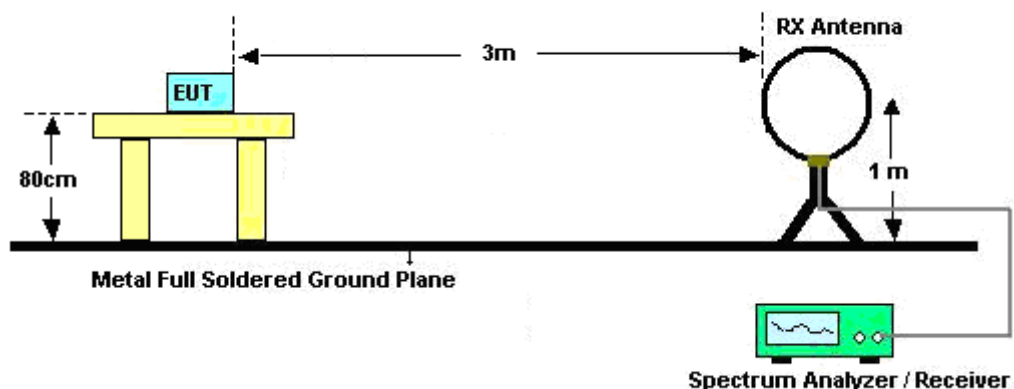

For radiated emissions from 30MHz to 1GHz

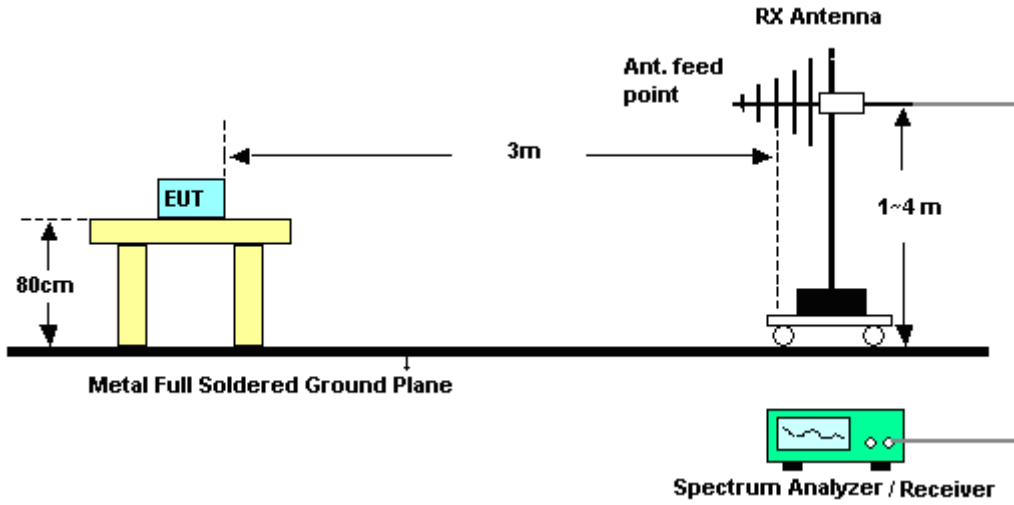

For radiated emissions above 1GHz

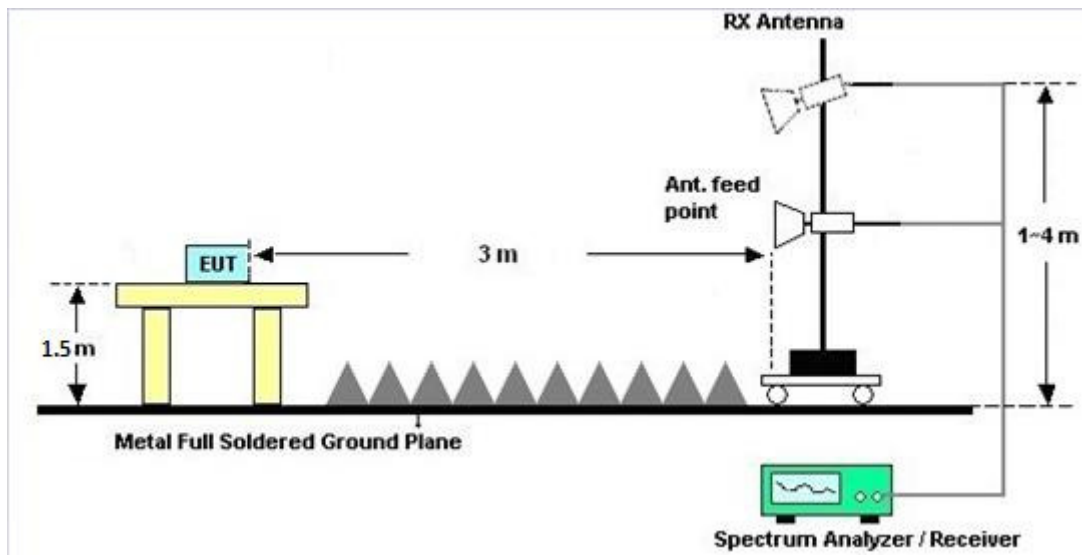



3.4.5 Test Results of Radiated Spurious Emissions (9 kHz ~ 30 MHz)

The low frequency, which started from 9 kHz to 30MHz, was pre-scanned and the result which was 20dB lower than the limit line per 15.31(o) was not reported.

3.4.6 Test Result of Radiated Spurious at Band Edges

Please refer to Appendix B and C.

3.4.7 Duty Cycle

Please refer to Appendix D.

3.4.8 Test Result of Radiated Spurious Emissions (30MHz ~ 10th Harmonic)

Please refer to Appendix B and C.



3.5 AC Conducted Emission Measurement

3.5.1 Limit of AC Conducted Emission

For equipment that is designed to be connected to the public utility (AC) power line, the radio frequency voltage that is conducted back onto the AC power line on any frequency or frequencies within the band 150 kHz to 30 MHz shall not exceed the limits in the following table.

Frequency of emission (MHz)	Conducted limit (dB μ V)	
	Quasi-peak	Average
0.15-0.5	66 to 56*	56 to 46*
0.5-5	56	46
5-30	60	50

*Decreases with the logarithm of the frequency.

3.5.2 Measuring Instruments

The measuring equipment is listed in the section 4 of this test report.

3.5.3 Test Procedures

1. The EUT was placed 0.4 meter from the conducting wall of the shielding room was kept at least 80 centimeters from any other grounded conducting surface.
2. Connect EUT to the power mains through a line impedance stabilization network (LISN).
3. All the support units are connecting to the other LISN.
4. The LISN provides 50 ohm coupling impedance for the measuring instrument.
5. The FCC states that a 50 ohm, 50 microhenry LISN should be used.
6. Both sides of AC line were checked for maximum conducted interference.
7. The frequency range from 150 kHz to 30 MHz was searched.
8. Set the test-receiver system to Peak Detect Function and specified bandwidth with Maximum Hold Mode.

3.5.4 Test Setup

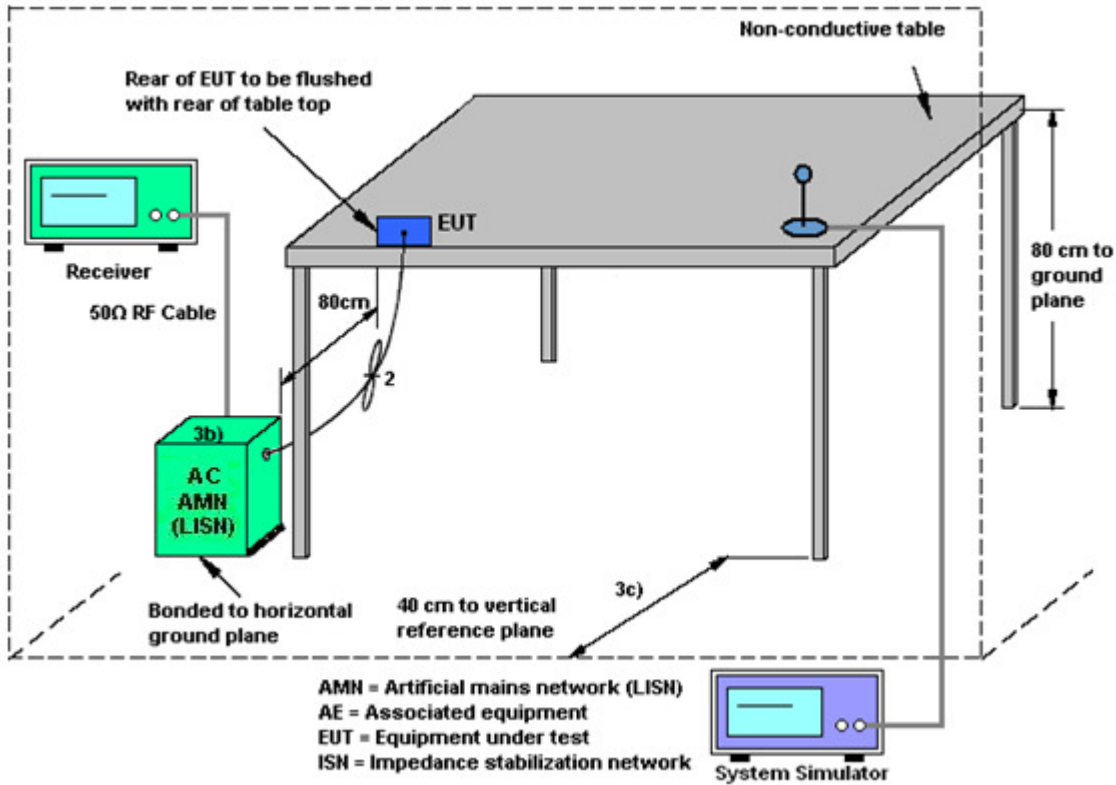

3.5.5 Test Result of AC Conducted Emission

Test Mode :	Mode 1	Temperature :	21~23°C
Test Engineer :	Arthur Hsieh	Relative Humidity :	51~53%
Test Voltage :	120Vac / 60Hz	Phase :	Line
Function Type :	GSM1900 Idle + Bluetooth Link + WLAN (5GHz) Link + MP3 + Earphone 1 + Battery + USB Cable (Charging from Adapter 1)		

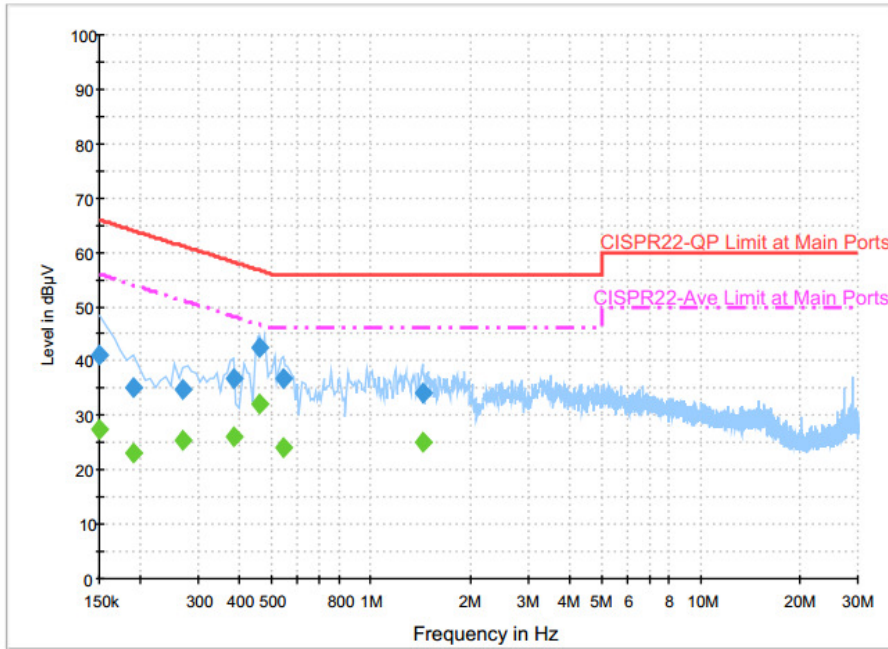

Final Result : QuasiPeak

Frequency (MHz)	QuasiPeak (dBµV)	Filter	Line	Corr. (dB)	Margin (dB)	Limit (dBµV)
0.150000	41.3	Off	L1	19.6	24.7	66.0
0.190000	35.1	Off	L1	19.6	28.9	64.0
0.270000	34.9	Off	L1	19.6	26.2	61.1
0.382000	36.7	Off	L1	19.6	21.5	58.2
0.462000	42.6	Off	L1	19.6	14.1	56.7
0.542000	36.7	Off	L1	19.6	19.3	56.0
1.438000	34.3	Off	L1	19.7	21.7	56.0

Final Result : Average

Frequency (MHz)	Average (dBµV)	Filter	Line	Corr. (dB)	Margin (dB)	Limit (dBµV)
0.150000	27.5	Off	L1	19.6	28.5	56.0
0.190000	23.2	Off	L1	19.6	30.8	54.0
0.270000	25.5	Off	L1	19.6	25.6	51.1
0.382000	26.2	Off	L1	19.6	22.0	48.2
0.462000	32.1	Off	L1	19.6	14.6	46.7
0.542000	24.2	Off	L1	19.6	21.8	46.0
1.438000	25.2	Off	L1	19.7	20.8	46.0



Test Mode :	Mode 1	Temperature :	21~23°C
Test Engineer :	Arthur Hsieh	Relative Humidity :	51~53%
Test Voltage :	120Vac / 60Hz	Phase :	Neutral
Function Type :	GSM1900 Idle + Bluetooth Link + WLAN (5GHz) Link + MP3 + Earphone 1 + Battery + USB Cable (Charging from Adapter 1)		

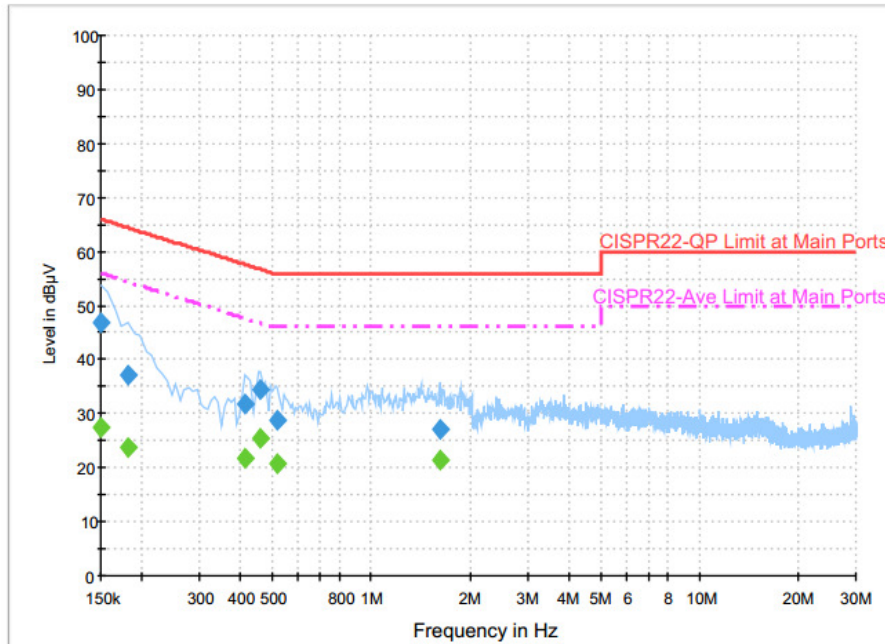

Final Result : QuasiPeak

Frequency (MHz)	QuasiPeak (dBµV)	Filter	Line	Corr. (dB)	Margin (dB)	Limit (dBµV)
0.150000	46.7	Off	N	19.6	19.3	66.0
0.182000	37.1	Off	N	19.6	27.3	64.4
0.414000	31.8	Off	N	19.6	25.8	57.6
0.462000	34.4	Off	N	19.6	22.3	56.7
0.518000	28.7	Off	N	19.6	27.3	56.0
1.622000	27.2	Off	N	19.7	28.8	56.0

Final Result : Average

Frequency (MHz)	Average (dBµV)	Filter	Line	Corr. (dB)	Margin (dB)	Limit (dBµV)
0.150000	27.6	Off	N	19.6	28.4	56.0
0.182000	23.6	Off	N	19.6	30.8	54.4
0.414000	21.9	Off	N	19.6	25.7	47.6
0.462000	25.5	Off	N	19.6	21.2	46.7
0.518000	20.6	Off	N	19.6	25.4	46.0
1.622000	21.3	Off	N	19.7	24.7	46.0

3.6 Frequency Stability Measurement

3.6.1 Limit of Frequency Stability

Manufacturers of U-NII devices are responsible for ensuring frequency stability such that an emission is maintained within the band of operation under all conditions of normal operation as specified in the user's manual.

3.6.2 Measuring Instruments

The measuring equipment is listed in the section 4 of this test report.

3.6.3 Test Procedures

1. To ensure emission at the band edge is maintained within the authorized band, those values shall be measured by radiation emissions at upper and lower frequency points, and finally compensated by frequency deviation as procedures below.
2. The EUT was operated at the maximum output power, and connected to the spectrum analyzer, which is set to maximum hold function and peak detector. The peak value of the power envelope was measured and noted. The upper and lower frequency points were respectively measured relatively 10dB lower than the measured peak value.
3. The frequency deviation was calculated by adding the upper frequency point and the lower frequency point divided by two. Those detailed values of frequency deviation are provided in table below.

3.6.4 Test Setup

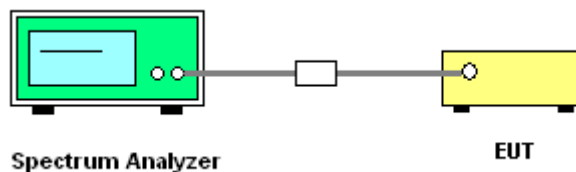

3.6.5 Test Result of Frequency Stability

Please refer to Appendix A.



3.7 Automatically Discontinue Transmission

3.7.1 Limit of Automatically Discontinue Transmission

The device shall automatically discontinue transmission in case of either absence of information to transmit or operational failure. These provisions are not intended to preclude the transmission of control or signaling information or the use of repetitive codes used by certain digital technologies to complete frame or burst intervals. Applicants shall include in their application for equipment authorization to describe how this requirement is met.

3.7.2 Measuring Instruments

The measuring equipment is listed in the section 4 of this test report.

3.7.3 Test Result of Automatically Discontinue Transmission

While the EUT is not transmitting any information, the EUT can automatically discontinue transmission and become standby mode for power saving. The EUT can detect the controlling signal of ACK message transmitting from remote device and verify whether it shall resend or discontinue transmission.



3.8 Antenna Requirements

3.8.1 Standard Applicable

According to FCC 47 CFR Section 15.407(a)(1)(2) ,if transmitting antenna directional gain is greater than 6 dBi, both the peak transmit power and the peak power spectral density shall be reduced by the amount in dB that the directional gain of the antenna exceeds 6 dBi.

3.8.2 Antenna Anti-Replacement Construction

An embedded-in antenna design is used.

3.8.3 Antenna Gain

The antenna gain is less than 6 dBi. Therefore, it is not necessary to reduce maximum peak output power limit.



4 List of Measuring Equipments

Instrument	Manufacturer	Model No.	Serial No.	Characteristics	Calibration Date	Test Date	Due Date	Remark
Spectrum Analyzer	Rohde & Schwarz	FSP40	100057	9kHz-40GHz	Nov. 23, 2015	Oct. 06, 2016 ~ Oct. 17, 2016	Nov. 22, 2016	Conducted (TH05-HY)
Power Meter	Anritsu	ML2495A	1240001	300MHz~40GHz	Sep. 07, 2016	Oct. 06, 2016 ~ Oct. 17, 2016	Sep. 06, 2017	Conducted (TH05-HY)
Power Sensor	Anritsu	MA2411B	1207349	300MHz~40GHz	Sep. 07, 2016	Oct. 06, 2016 ~ Oct. 17, 2016	Sep. 06, 2017	Conducted (TH05-HY)
Hygrometer	Testo	608-H2	41410069	N/A	Aug. 28, 2016	Oct. 06, 2016 ~ Oct. 17, 2016	Aug. 27, 2017	Conducted (TH05-HY)
RF Cable	HUBER + SUHNER	SUCOFLEX 104	MY84209521	1GHz~26GHz	Dec. 03, 2015	Oct. 06, 2016 ~ Oct. 12, 2016	Dec. 02, 2016	Conducted (TH05-HY)
Temperature Chamber	ESPEC	SH-641	92013720	-40°C ~90°C	Sep. 01, 2016	Oct. 06, 2016 ~ Oct. 17, 2016	Aug. 31, 2017	Conducted (TH05-HY)
AC Power Source	ChainTek	APC-1000W	N/A	N/A	N/A	Oct. 11, 2016	N/A	Conduction (CO05-HY)
EMI Test Receiver	Rohde & Schwarz	ESCI 7	100724	9kHz~7GHz	Aug. 30, 2016	Oct. 11, 2016	Aug. 29, 2017	Conduction (CO05-HY)
Hygrometer	Testo	608-H1	34913912	N/A	Apr. 19, 2016	Oct. 11, 2016	Apr. 18, 2017	Conduction (CO05-HY)
LISN	Rohde & Schwarz	ENV216	100080	9kHz~30MHz	Dec. 02, 2015	Oct. 11, 2016	Dec. 01, 2016	Conduction (CO05-HY)
LF Cable	HUBER + SUHNER	RG-214/U	LF01	N/A	Jan. 06, 2016	Oct. 11, 2016	Jan. 05, 2017	Conduction (CO05-HY)
Test Software	N/A	EMC32	8.40.0	N/A	N/A	Oct. 11, 2016	N/A	Conduction (CO05-HY)
Loop Antenna	Rohde & Schwarz	HFH2-Z2	100315	9 kHz~30 MHz	Sep. 02, 2015	Oct. 06, 2016 ~ Oct. 13, 2016	Sep. 01, 2017	Radiation (03CH12-HY)
Amplifier	SONOMA	310N	187312	9kHz~1GHz	Nov. 20, 2015	Oct. 06, 2016 ~ Oct. 13, 2016	Nov. 19, 2016	Radiation (03CH12-HY)
Bilog Antenna	TESEQ	CBL 6111D&N-6-06	35414&AT-N 0602	30MHz~1GHz	Nov. 17, 2015	Oct. 06, 2016 ~ Oct. 13, 2016	Nov. 16, 2016	Radiation (03CH12-HY)
Horn Antenna	SCHWARZBECK	BBHA 9120D	9120D-1328	1GHz ~ 18GHz	Nov. 02, 2015	Oct. 06, 2016 ~ Oct. 13, 2016	Nov. 01, 2016	Radiation (03CH12-HY)
SHF-EHF Horn Antenna	SCHWARZBECK	BBHA 9170	BBHA9170584	18GHz- 40GHz	Nov. 02, 2015	Oct. 06, 2016 ~ Oct. 13, 2016	Nov. 01, 2016	Radiation (03CH12-HY)
EMI Test Receiver	Rohde & Schwarz	ESU26	100390	20Hz~26.5GHz	Dec. 21, 2015	Oct. 06, 2016 ~ Oct. 13, 2016	Dec. 20, 2016	Radiation (03CH12-HY)
Spectrum Analyzer	Agilent	N9030A	MY52350276	3Hz~44GHz	Mar. 21, 2016	Oct. 06, 2016 ~ Oct. 13, 2016	Mar. 20, 2017	Radiation (03CH12-HY)
Preamplifier	MITEQ	TTA0204	1872107	2GHz~40GHz	Feb. 15, 2016	Oct. 06, 2016 ~ Oct. 13, 2016	Feb. 14, 2017	Radiation (03CH12-HY)
Preamplifier	MITEQ	AMF-7D-0010 1800-30-10P	1815698	1GHz~18GHz	Dec. 14, 2015	Oct. 06, 2016 ~ Oct. 13, 2016	Dec. 13, 2016	Radiation (03CH12-HY)
Preamplifier	Keysight	83017A	MY53270148	1GHz~26.5GHz	Jan. 30, 2016	Oct. 06, 2016 ~ Oct. 13, 2016	Jan. 29, 2017	Radiation (03CH12-HY)



Instrument	Manufacturer	Model No.	Serial No.	Characteristics	Calibration Date	Test Date	Due Date	Remark
Hygrometer	TECPEL	DTM-303B	TP140349	N/A	Nov. 17, 2015	Oct. 06, 2016 ~ Oct. 13, 2016	Nov. 16, 2016	Radiation (03CH12-HY)
RF Cable	HUBER + SUHNER	SUCOFLEX 104	MY24958/4, MY28653/4, MY9839/4PE	26GHz~40GHz	Jan. 12, 2016	Oct. 06, 2016 ~ Oct. 13, 2016	Jan. 11, 2017	Radiation (03CH12-HY)
RF Cable	HUBER + SUHNER	SUCOFLEX 104	MY24958/4, MY28653/4, MY9839/4PE	1GHz~26GHz	Jan. 12, 2016	Oct. 06, 2016 ~ Oct. 13, 2016	Jan. 11, 2017	Radiation (03CH12-HY)
RF Cable	HUBER + SUHNER	SUCOFLEX 104	MY24958/4, MY28653/4, MY9839/4PE	30MHz~1GHz	Jan. 12, 2016	Oct. 06, 2016 ~ Oct. 13, 2016	Jan. 11, 2017	Radiation (03CH12-HY)
RF Cable	HUBER + SUHNER	SUCOFLEX 104	MY24958/4, MY28653/4, MY9839/4PE	9K~30MHz	Jan. 12, 2016	Oct. 06, 2016 ~ Oct. 13, 2016	Jan. 11, 2017	Radiation (03CH12-HY)
Controller	EMEC	EM1000	N/A	Control Turn table & Ant Mast	N/A	Oct. 06, 2016 ~ Oct. 13, 2016	N/A	Radiation (03CH12-HY)
Antenna Mast	EMEC	AM-BS-4500-B	N/A	1m~4m	N/A	Oct. 06, 2016 ~ Oct. 13, 2016	N/A	Radiation (03CH12-HY)
Turn Table	EMEC	TT2000	N/A	0~360 Degree	N/A	Oct. 06, 2016 ~ Oct. 13, 2016	N/A	Radiation (03CH12-HY)
Test Software	Audix	E3	6.2009-8-24	N/A	N/A	Oct. 06, 2016 ~ Oct. 13, 2016	N/A	Radiation (03CH12-HY)
Filter	Wainwright	WLKS4500-8S S	SN19	4.5G Low Pass	Sep. 19, 2016	Oct. 06, 2016 ~ Oct. 13, 2016	Sep. 18, 2017	Radiation (03CH12-HY)
Filter	Wainwright	WHKX8-5872. 5-6750-18000- 40ST	SN3	6.75 GHz Highpass	Sep. 19, 2016	Oct. 06, 2016 ~ Oct. 13, 2016	Sep. 18, 2017	Radiation (03CH12-HY)



5 Uncertainty of Evaluation

Uncertainty of Conducted Emission Measurement (150kHz ~ 30MHz)

Measuring Uncertainty for a Level of Confidence of 95% ($U = 2Uc(y)$)	2.70
---	------

Uncertainty of Radiated Emission Measurement (30 MHz ~ 1000 MHz)

Measuring Uncertainty for a Level of Confidence of 95% ($U = 2Uc(y)$)	5.10
---	------

Uncertainty of Radiated Emission Measurement (1000 MHz ~ 18000 MHz)

Measuring Uncertainty for a Level of Confidence of 95% ($U = 2Uc(y)$)	5.20
---	------

Uncertainty of Radiated Emission Measurement (18000 MHz ~ 40000 MHz)

Measuring Uncertainty for a Level of Confidence of 95% ($U = 2Uc(y)$)	4.70
---	------



Appendix A. Conducted Test Results

Test Engineer:	Luffy Lin / Tommy Lee	Temperature:	21~25	°C
Test Date:	2016/10/6-10/17	Relative Humidity:	51~54	%

TEST RESULTS DATA
26dB and 99% OBW

Band I										
Mod.	Data Rate	NTX	CH.	Freq. (MHz)	99% Bandwidth (MHz)	26 dB Bandwidth (MHz)	IC 99% Bandwidth Power Limit (dBm)	IC 99% Bandwidth EIRP Limit (dBm)		
11a	6Mbps	1	36	5180	18.55	32.30	-	22.68		
11a	6Mbps	1	44	5220	18.40	35.30	-	22.65		
11a	6Mbps	1	48	5240	18.45	32.50	-	22.66		
HT20	MCS0	1	36	5180	18.45	34.10	-	22.66		
HT20	MCS0	1	44	5220	18.40	31.30	-	22.65		
HT20	MCS0	1	48	5240	18.40	32.90	-	22.65		
HT40	MCS0	1	38	5190	36.60	57.24	-	23.01		
HT40	MCS0	1	46	5230	36.60	65.34	-	23.01		

TEST RESULTS DATA
Average Power Table

FCC Band I										
Mod.	Data Rate	NTX	CH.	Freq. (MHz)	Duty Factor (dB)	Average Conducted Power (dBm)	FCC Conducted Power Limit (dBm)	DG (dBi)		Pass/Fail
11a	6Mbps	1	36	5180	0.15	14.87	24.00	-3.40		Pass
11a	6Mbps	1	44	5220	0.15	14.85	24.00	-3.40		Pass
11a	6Mbps	1	48	5240	0.15	14.84	24.00	-3.40		Pass
HT20	MCS0	1	36	5180	0.15	14.99	24.00	-3.40		Pass
HT20	MCS0	1	44	5220	0.15	14.90	24.00	-3.40		Pass
HT20	MCS0	1	48	5240	0.15	14.89	24.00	-3.40		Pass
HT40	MCS0	1	38	5190	0.26	12.44	24.00	-3.40		Pass
HT40	MCS0	1	46	5230	0.26	12.42	24.00	-3.40		Pass

TEST RESULTS DATA
Power Spectral Density

FCC Band I										
Mod.	Data Rate	NTX	CH.	Freq. (MHz)	Duty Factor (dB)	Average Power Density (dBm/MHz)	Average PSD Limit (dBm/MHz)	DG (dBi)	-	Pass/Fail
11a	6Mbps	1	36	5180	0.15	4.05	11.00	-3.40		Pass
11a	6Mbps	1	44	5220	0.15	4.39	11.00	-3.40		Pass
11a	6Mbps	1	48	5240	0.15	4.56	11.00	-3.40		Pass
HT20	MCS0	1	36	5180	0.15	3.85	11.00	-3.40		Pass
HT20	MCS0	1	44	5220	0.15	3.60	11.00	-3.40		Pass
HT20	MCS0	1	48	5240	0.15	3.65	11.00	-3.40		Pass
HT40	MCS0	1	38	5190	0.26	-3.31	11.00	-3.40		Pass
HT40	MCS0	1	46	5230	0.26	-2.98	11.00	-3.40		Pass

TEST RESULTS DATA
26dB and 99% OBW

Band II										
Mod.	Data Rate	NTX	CH.	Freq. (MHz)	99% Bandwidth (MHz)	26 dB Bandwidth (MHz)	IC 99% Bandwidth Power Limit (dBm)	IC 99% Bandwidth EIRP Limit (dBm)	FCC 26dB Bandwidth Power Limit (dBm)	Note
11a	6M bps	1	52	5260	18.40	33.85	23.65	29.65	23.98	
11a	6M bps	1	60	5300	18.40	33.00	23.65	29.65	23.98	
11a	6M bps	1	64	5320	18.30	32.80	23.62	29.62	23.98	
HT20	MCS 0	1	52	5260	18.30	31.70	23.62	29.62	23.98	
HT20	MCS 0	1	60	5300	18.40	31.90	23.65	29.65	23.98	
HT20	MCS 0	1	64	5320	18.35	30.60	23.64	29.64	23.98	
HT40	MCS 0	1	54	5270	36.50	65.16	23.98	30.00	23.98	
HT40	MCS 0	1	62	5310	36.70	54.36	23.98	30.00	23.98	

TEST RESULTS DATA
Average Power Table

FCC Band II										
Mod.	Data Rate	NTX	CH.	Freq. (MHz)	Duty Factor (dB)	Average Conducted Power (dBm)	FCC Conducted Power Limit (dBm)	DG (dBi)	EIRP Power Limit (dBm)	Pass/Fail
11a	6M bps	1	52	5260	0.15	14.99	23.98	-2.70	26.99	Pass
11a	6M bps	1	60	5300	0.15	14.80	23.98	-2.70	26.99	Pass
11a	6M bps	1	64	5320	0.15	14.76	23.98	-2.70	26.99	Pass
HT20	MCS 0	1	52	5260	0.15	14.90	23.98	-2.70	26.99	Pass
HT20	MCS 0	1	60	5300	0.15	14.84	23.98	-2.70	26.99	Pass
HT20	MCS 0	1	64	5320	0.15	14.81	23.98	-2.70	26.99	Pass
HT40	MCS 0	1	54	5270	0.26	12.38	23.98	-2.70	26.99	Pass
HT40	MCS 0	1	62	5310	0.26	12.34	23.98	-2.70	26.99	Pass

TEST RESULTS DATA
Power Spectral Density

Band II										
Mod.	Data Rate	NTX	CH.	Freq. (MHz)	Duty Factor (dB)	Average Power Density (dBm/MHz)	Average PSD Limit (dBm/MHz)	DG (dBi)		Pass/Fail
11a	6M bps	1	52	5260	0.15	4.52	11.00	-2.70		Pass
11a	6M bps	1	60	5300	0.15	4.09	11.00	-2.70		Pass
11a	6M bps	1	64	5320	0.15	4.17	11.00	-2.70		Pass
HT20	MCS 0	1	52	5260	0.15	3.36	11.00	-2.70		Pass
HT20	MCS 0	1	60	5300	0.15	3.31	11.00	-2.70		Pass
HT20	MCS 0	1	64	5320	0.15	3.47	11.00	-2.70		Pass
HT40	MCS 0	1	54	5270	0.26	-3.16	11.00	-2.70		Pass
HT40	MCS 0	1	62	5310	0.26	-3.23	11.00	-2.70		Pass

TEST RESULTS DATA
26dB and 99% OBW

Band III										
Mod.	Data Rate	NTX	CH.	Freq. (MHz)	99% Bandwidth (MHz)	26 dB Bandwidth (MHz)	IC 99% Bandwidth Power Limit (dBm)	IC 99% Bandwidth EIRP Limit (dBm)	FCC 26dB Bandwidth Power Limit (dBm)	Note
11a	6M bps	1	100	5500	18.70	28.10	23.72	29.72	23.98	
11a	6M bps	1	116	5580	18.35	30.90	23.64	29.64	23.98	
11a	6M bps	1	140	5700	18.45	32.10	23.66	29.66	23.98	
HT20	MCS 0	1	100	5500	18.20	29.50	23.60	29.60	23.98	
HT20	MCS 0	1	116	5580	18.40	29.80	23.65	29.65	23.98	
HT20	MCS 0	1	140	5700	18.30	30.60	23.62	29.62	23.98	
HT40	MCS 0	1	102	5510	36.70	44.28	23.98	30.00	23.98	
HT40	MCS 0	1	110	5550	36.70	45.18	23.98	30.00	23.98	
HT40	MCS 0	1	134	5670	36.70	45.54	23.98	30.00	23.98	

TEST RESULTS DATA
Average Power Table

FCC Band III										
Mod.	Data Rate	NTX	CH.	Freq. (MHz)	Duty Factor (dB)	Average Conducted Power (dBm)	FCC Conducted Power Limit (dBm)	DG (dBi)	EIRP Power Limit (dBm)	Pass/Fail
11a	6M bps	1	100	5500	0.15	14.95	23.98	-1.50	26.99	Pass
11a	6M bps	1	116	5580	0.15	14.96	23.98	-1.50	26.99	Pass
11a	6M bps	1	140	5700	0.15	14.82	23.98	-1.50	26.99	Pass
HT20	MCS 0	1	100	5500	0.15	14.99	23.98	-1.50	26.99	Pass
HT20	MCS 0	1	116	5580	0.15	14.97	23.98	-1.50	26.99	Pass
HT20	MCS 0	1	140	5700	0.15	14.83	23.98	-1.50	26.99	Pass
HT40	MCS 0	1	102	5510	0.26	12.48	23.98	-1.50	26.99	Pass
HT40	MCS 0	1	110	5550	0.26	12.43	23.98	-1.50	26.99	Pass
HT40	MCS 0	1	134	5670	0.26	12.29	23.98	-1.50	26.99	Pass

TEST RESULTS DATA
Power Spectral Density

Band III										
Mod.	Data Rate	NTX	CH.	Freq. (MHz)	Duty Factor (dB)	Average Power Density (dBm/MHz)	Average PSD Limit (dBm/MHz)	DG (dBi)		Pass/Fail
11a	6M bps	1	100	5500	0.15	4.25	11.00	-1.50		Pass
11a	6M bps	1	116	5580	0.15	4.72	11.00	-1.50		Pass
11a	6M bps	1	140	5700	0.15	4.49	11.00	-1.50		Pass
HT20	MCS 0	1	100	5500	0.15	4.48	11.00	-1.50		Pass
HT20	MCS 0	1	116	5580	0.15	4.42	11.00	-1.50		Pass
HT20	MCS 0	1	140	5700	0.15	3.01	11.00	-1.50		Pass
HT40	MCS 0	1	102	5510	0.26	-2.14	11.00	-1.50		Pass
HT40	MCS 0	1	110	5550	0.26	-2.30	11.00	-1.50		Pass
HT40	MCS 0	1	134	5670	0.26	-3.34	11.00	-1.50		Pass

TEST RESULTS DATA
26dB and 99% OBW

Straddle Channel											
Mod.	Data Rate	NTX	CH.	Freq. (MHz)	99% Bandwidth (MHz)	26dB Emission Bandwidth (MHz)	6dB Emission Bandwidth (MHz)	IC 99% Bandwidth Power Limit (dBm)	IC 99% Bandwidth EIRP Limit (dBm)	FCC 26dB Bandwidth Power Limit (dBm)	Note
11a	6Mbps	1	144	5720	17.55	34.20	15.12	-	-	-	
				NII-2C	13.8	21.8	12.58	22.40	28.40	23.98	
				NII-3	3.75	12.4	2.54	30.00	36.02	-	
HT20	MCS0	1	144	5720	18.25	27.34	15.08	-	-	-	
				NII-2C	14.15	24.8	12.54	22.51	28.51	23.98	
				NII-3	4.1	2.54	2.54	30.00	36.02	-	
HT40	MCS0	1	142	5710	36.80	41.20	38.00	-	-	-	
				NII-2C	33.4	38.04	24.80	23.98	30.00	23.98	
				NII-3	3.4	3.16	13.20	30.00	36.02	-	

TEST RESULTS DATA
Average Power Table

FCC Straddle Channel										
Mod.	Data Rate	NTX	CH.	Freq. (MHz)	Duty Factor (dB)	Average Conducted Power (dBm)	FCC Conducted Power Limit (dBm)	DG (dBi)		Pass/Fail
11a	6Mbps	1	144	5720	0.15	14.93	-	-1.50		Pass
				NII-2C	0.15	14.20	23.98	-1.50	Pass	
				NII-3	0.15	6.83	30.00	-1.50	Pass	
HT20	MCS0	1	144	5720	0.15	14.82	-	-1.50		Pass
				NII-2C	0.15	13.97	23.98	-1.50	Pass	
				NII-3	0.15	7.32	30.00	-1.50	Pass	
HT40	MCS0	1	142	5710	0.26	12.40	-	-1.50		Pass
				NII-2C	0.26	12.11	23.98	-1.50	Pass	
				NII-3	0.26	0.46	30.00	-1.50	Pass	

TEST RESULTS DATA
Power Spectral Density

Straddle Channel										
Mod.	Data Rate	NTX	CH.	Freq. (MHz)	Duty Factor (dB)	Average Power Density (dBm/MHz)	Average PSD Limit (dBm/MHz)	DG (dBi)		Pass/Fail
11a	6Mbps	1	144	NII-2C	0.15	3.29	11.00	-1.50		Pass
				NII-3	0.15	3.29	30.00	-1.50		Pass
HT20	MCS0	1	144	NII-2C	0.15	3.01	11.00	-1.50		Pass
				NII-3	0.15	3.01	30.00	-1.50		Pass
HT40	MCS0	1	142	NII-2C	0.26	-4.27	11.00	-1.50		Pass
				NII-3	0.26	-4.27	30.00	-1.50		Pass

TEST RESULTS DATA
Frequency Stability

Band I										
Mod.	Data Rate	NTX	CH.	Freq. (MHz)	Center Frequency (MHz)	Frequency Deviation (MHz)	Frequency Stability (ppm)	Temperature (°C)	Voltage (V)	Note
11a	6Mbps	1	36	5180	5180.050	0.050	9.65	50	3.8	
11a	6Mbps	1	36	5180	5180.050	0.050	9.65	-30	3.8	
11a	6Mbps	1	36	5180	5180.000	0.000	0.00	20	4.35	
11a	6Mbps	1	36	5180	5180.050	0.050	9.65	20	3.4	
11a	6Mbps	1	36	5180	5180.000	0.000	0.00	20	3.8	

Band II										
Mod.	Data Rate	NTX	CH.	Freq. (MHz)	Center Frequency (MHz)	Frequency Deviation (MHz)	Frequency Stability (ppm)	Temperature (°C)	Voltage (V)	Note
11a	6Mbps	1	64	5320	5320.000	0.000	0.00	50	3.8	
11a	6Mbps	1	64	5320	5320.000	0.000	0.00	-30	3.8	
11a	6Mbps	1	64	5320	5320.000	0.000	0.00	20	4.35	
11a	6Mbps	1	64	5320	5320.000	0.000	0.00	20	3.4	
11a	6Mbps	1	64	5320	5320.050	0.050	9.40	20	3.8	

Band III										
Mod.	Data Rate	NTX	CH.	Freq. (MHz)	Center Frequency (MHz)	Frequency Deviation (MHz)	Frequency Stability (ppm)	Temperature (°C)	Voltage (V)	Note
11a	6Mbps	1	100	5500	5500.000	0.000	0.00	50	3.8	
11a	6Mbps	1	100	5500	5500.000	0.000	0.00	-30	3.8	
11a	6Mbps	1	100	5500	5500.000	0.000	0.00	20	4.35	
11a	6Mbps	1	100	5500	5500.000	0.000	0.00	20	3.4	
11a	6Mbps	1	100	5500	5500.000	0.000	0.00	20	3.8	



Appendix B. Radiated Spurious Emission

Test Engineer :	Peter Chiu, Karl Hou, Nick Yu, and Citta Ke	Temperature :	21~23°C
		Relative Humidity :	54~58%

Band 1 - 5150~5250MHz

WIFI 802.11a (Band Edge @ 3m)

WIFI Ant. 1	Note	Frequency (MHz)	Level (dBμV/m)	Over Limit (dB)	Limit Line (dBμV/m)	Read Level (dBμV)	Antenna Factor (dB/m)	Cable Loss (dB)	Preamp Factor (dB)	Ant Pos (cm)	Table Pos (deg)	Peak Avg. (P/A)	Pol. (H/V)	
802.11a CH 36 5180MHz		5073.58	59.03	-14.97	74	47.13	31.58	11.27	30.95	368	320	P	H	
		5146.38	47.82	-6.18	54	35.91	31.65	11.21	30.95	368	320	A	H	
	*	5180	106.46	-	-	93.74	32.46	11.21	30.95	368	320	P	H	
	*	5180	95.88	-	-	83.16	32.46	11.21	30.95	368	320	A	H	
													H	
														H
			5085.8	58.99	-15.01	74	47.09	31.58	11.27	30.95	125	169	P	V
			5149.76	47.67	-6.33	54	35.76	31.65	11.21	30.95	125	169	A	V
	*		5180	103.78	-	-	91.06	32.46	11.21	30.95	125	169	P	V
	*		5180	92.86	-	-	80.14	32.46	11.21	30.95	125	169	A	V
														V
														V
802.11a CH 44 5220MHz		5122.2	59.32	-14.68	74	47.41	31.62	11.24	30.95	254	323	P	H	
		5146.64	47.63	-6.37	54	35.72	31.65	11.21	30.95	254	323	A	H	
	*	5220	108.21	-	-	95.52	32.46	11.18	30.95	254	323	P	H	
	*	5220	97.82	-	-	85.13	32.46	11.18	30.95	254	323	A	H	
			5403.36	59.4	-14.6	74	46.85	31.9	11.6	30.95	254	323	P	H
			5420.16	48.17	-5.83	54	35.56	31.92	11.64	30.95	254	323	A	H
			5150	59.19	-14.81	74	47.21	31.72	11.21	30.95	131	167	P	V
			5143.78	47.49	-6.51	54	35.58	31.65	11.21	30.95	131	167	A	V
	*		5220	105.51	-	-	92.82	32.46	11.18	30.95	131	167	P	V
	*		5220	94.42	-	-	81.73	32.46	11.18	30.95	131	167	A	V
			5432.88	60.41	-13.59	74	47.79	31.93	11.64	30.95	131	167	P	V
			5392.08	48.19	-5.81	54	35.66	31.88	11.6	30.95	131	167	A	V



802.11a CH 48 5240MHz		5140.4	58.55	-15.45	74	46.64	31.65	11.21	30.95	398	326	P	H
		5146.9	47.54	-6.46	54	35.63	31.65	11.21	30.95	398	326	A	H
	*	5240	107.96	-	-	95.2	32.45	11.26	30.95	398	326	P	H
	*	5240	97.27	-	-	84.51	32.45	11.26	30.95	398	326	A	H
		5363.28	59.62	-14.38	74	47.18	31.87	11.52	30.95	398	326	P	H
		5408.16	48.13	-5.87	54	35.58	31.9	11.6	30.95	398	326	A	H
		5008.84	59.19	-14.81	74	47.28	31.52	11.34	30.95	303	169	P	V
		5129.48	47.47	-6.53	54	35.55	31.63	11.24	30.95	303	169	A	V
	*	5240	104.13	-	-	91.37	32.45	11.26	30.95	303	169	P	V
	*	5240	93.21	-	-	80.45	32.45	11.26	30.95	303	169	A	V
		5376	58.88	-15.12	74	46.44	31.87	11.52	30.95	303	169	P	V
		5439.36	48.03	-5.97	54	35.41	31.93	11.64	30.95	303	169	A	V
Remark	1. No other spurious found. 2. All results are PASS against Peak and Average limit line.												



Band 1 5150~5250MHz

WIFI 802.11a (Harmonic @ 3m)

WIFI Ant. 1	Note	Frequency (MHz)	Level (dBμV/m)	Over Limit (dB)	Limit Line (dBμV/m)	Read Level (dBμV)	Antenna Factor (dB/m)	Cable Loss (dB)	Preamp Factor (dB)	Ant Pos (cm)	Table Pos (deg)	Peak Avg. (P/A)	Pol. (H/V)
802.11a CH 36 5180MHz		10360	49.07	-24.93	74	49.82	39.59	17.13	57.47	100	0	P	H
		15540	58.47	-15.53	74	57.13	38.26	21.61	58.53	100	9	P	H
		15540	41.53	-12.47	54	40.19	38.26	21.61	58.53	100	9	A	H
													H
		10360	47.57	-26.43	74	48.32	39.59	17.13	57.47	100	0	P	V
		15540	49.78	-24.22	74	48.44	38.26	21.61	58.53	100	0	P	V
802.11a CH 44 5220MHz		10440	53.8	-20.2	74	54.22	39.69	17.22	57.33	103	174	P	H
		10440	40.05	-13.95	54	40.47	39.69	17.22	57.33	103	174	A	H
		15660	59.51	-14.49	74	57.99	38.11	21.7	58.29	100	13	P	H
		15660	43.47	-10.53	54	41.95	38.11	21.7	58.29	100	13	A	H
		10440	48.27	-25.73	74	48.69	39.69	17.22	57.33	100	0	P	V
		15660	59.2	-14.8	74	57.68	38.11	21.7	58.29	116	349	P	V
		15660	42.72	-11.28	54	41.2	38.11	21.7	58.29	116	349	A	V
802.11a CH 48 5240MHz		10480	49.49	-24.51	74	49.68	39.77	17.27	57.23	100	0	P	H
		15720	58.36	-15.64	74	56.72	38.03	21.76	58.15	100	8	P	H
		15720	42.47	-11.53	54	40.83	38.03	21.76	58.15	100	8	A	H
													H
		10480	48.72	-25.28	74	48.91	39.77	17.27	57.23	100	0	P	V
		15720	57.31	-16.69	74	55.67	38.03	21.76	58.15	120	344	P	V
		15720	41.65	-12.35	54	40.01	38.03	21.76	58.15	120	344	A	V
													V
Remark	1. No other spurious found. 2. All results are PASS against Peak and Average limit line.												



Band 1 5150~5250MHz

WIFI 802.11n HT20 (Band Edge @ 3m)

WIFI Ant. 1	Note	Frequency (MHz)	Level (dBμV/m)	Over Limit (dB)	Limit Line (dBμV/m)	Read Level (dBμV)	Antenna Factor (dB/m)	Cable Loss (dB)	Preamp Factor (dB)	Ant Pos (cm)	Table Pos (deg)	Peak Avg. (P/A)	Pol. (H/V)	
802.11n HT20 CH 36 5180MHz		5142.22	58.62	-15.38	74	46.71	31.65	11.21	30.95	200	26	P	H	
		5140.14	48.05	-5.95	54	36.14	31.65	11.21	30.95	200	26	A	H	
	*	5180	107.11	-	-	94.39	32.46	11.21	30.95	200	26	P	H	
	*	5180	96.33	-	-	83.61	32.46	11.21	30.95	200	26	A	H	
													H	
														H
			5081.64	58.9	-15.1	74	47	31.58	11.27	30.95	175	301	P	V
			5149.5	47.88	-6.12	54	35.97	31.65	11.21	30.95	175	301	A	V
		*	5180	104.54	-	-	91.82	32.46	11.21	30.95	175	301	P	V
		*	5180	93.43	-	-	80.71	32.46	11.21	30.95	175	301	A	V
														V
														V
802.11n HT20 CH 44 5220MHz		5098.02	59.92	-14.08	74	48	31.6	11.27	30.95	193	25	P	H	
		5140.4	47.73	-6.27	54	35.82	31.65	11.21	30.95	193	25	A	H	
		*	5220	108.02	-	-	95.33	32.46	11.18	30.95	193	25	P	H
		*	5220	97.21	-	-	84.52	32.46	11.18	30.95	193	25	A	H
			5365.92	59.45	-14.55	74	47.01	31.87	11.52	30.95	193	25	P	H
			5406	48.26	-5.74	54	35.71	31.9	11.6	30.95	193	25	A	H
			5003.9	58.97	-15.03	74	47.06	31.52	11.34	30.95	184	313	P	V
			5000.26	47.73	-6.27	54	35.84	31.5	11.34	30.95	184	313	A	V
		*	5220	105.11	-	-	92.42	32.46	11.18	30.95	184	313	P	V
		*	5220	93.92	-	-	81.23	32.46	11.18	30.95	184	313	A	V
			5406.24	59.57	-14.43	74	47.02	31.9	11.6	30.95	184	313	P	V
			5447.52	48.2	-5.8	54	35.56	31.95	11.64	30.95	184	313	A	V



802.11n HT20 CH 48 5240MHz		5128.18	58.46	-15.54	74	46.54	31.63	11.24	30.95	190	25	P	H
		5132.86	47.56	-6.44	54	35.64	31.63	11.24	30.95	190	25	A	H
	*	5240	107.47	-	-	94.71	32.45	11.26	30.95	190	25	P	H
	*	5240	96.34	-	-	83.58	32.45	11.26	30.95	190	25	A	H
		5423.28	59.63	-14.37	74	47.02	31.92	11.64	30.95	190	25	P	H
		5394	48.26	-5.74	54	35.73	31.88	11.6	30.95	190	25	A	H
		5061.62	58.98	-15.02	74	47.09	31.57	11.27	30.95	188	298	P	V
		5063.18	47.52	-6.48	54	35.63	31.57	11.27	30.95	188	298	A	V
	*	5240	104.55	-	-	91.79	32.45	11.26	30.95	188	298	P	V
	*	5240	93.52	-	-	80.76	32.45	11.26	30.95	188	298	A	V
		5426.88	59.33	-14.67	74	46.72	31.92	11.64	30.95	188	298	P	V
	5404.08	48.05	-5.95	54	35.5	31.9	11.6	30.95	188	298	A	V	
Remark	1. No other spurious found. 2. All results are PASS against Peak and Average limit line.												



Band 1 5150~5250MHz

WIFI 802.11n HT20 (Harmonic @ 3m)

WIFI Ant. 1	Note	Frequency (MHz)	Level (dBμV/m)	Over Limit (dB)	Limit Line (dBμV/m)	Read Level (dBμV)	Antenna Factor (dB/m)	Cable Loss (dB)	Preamp Factor (dB)	Ant Pos (cm)	Table Pos (deg)	Peak Avg. (P/A)	Pol. (H/V)
802.11n HT20 CH 36 5180MHz		10360	46.1	-27.9	74	46.85	39.59	17.13	57.47	100	0	P	H
		15540	51.35	-22.65	74	50.01	38.26	21.61	58.53	184	67	P	H
		15540	41.67	-12.33	54	40.33	38.26	21.61	58.53	184	67	A	H
													H
		10360	46.91	-27.09	74	47.66	39.59	17.13	57.47	100	0	P	V
		15540	51.43	-22.57	74	50.09	38.26	21.61	58.53	400	141	P	V
		15540	39.88	-14.12	54	38.54	38.26	21.61	58.53	400	141	A	V
													V
802.11n HT20 CH 44 5220MHz		10440	48.81	-25.19	74	49.23	39.69	17.22	57.33	100	0	P	H
		15660	55.01	-18.99	74	53.49	38.11	21.7	58.29	150	68	P	H
		15660	43.29	-10.71	54	41.77	38.11	21.7	58.29	150	68	A	H
													H
		10440	48	-26	74	48.42	39.69	17.22	57.33	100	0	P	V
		15660	54.19	-19.81	74	52.67	38.11	21.7	58.29	400	146	P	V
		15660	40.85	-13.15	54	39.33	38.11	21.7	58.29	400	146	A	V
													V
802.11n HT20 CH 48 5240MHz		10480	48.2	-25.8	74	48.39	39.77	17.27	57.23	100	0	P	H
		15720	53	-21	74	51.36	38.03	21.76	58.15	100	10	P	H
		15720	41.19	-12.81	54	39.55	38.03	21.76	58.15	100	10	A	H
													H
		10480	47.04	-26.96	74	47.23	39.77	17.27	57.23	100	0	P	V
		15720	52.74	-21.26	74	51.1	38.03	21.76	58.15	391	140	P	V
		15720	40.65	-13.35	54	39.01	38.03	21.76	58.15	391	140	A	V
													V
Remark	1. No other spurious found. 2. All results are PASS against Peak and Average limit line.												



Band 1 5150~5250MHz

WIFI 802.11n HT40 (Band Edge @ 3m)

WIFI Ant. 1	Note	Frequency (MHz)	Level (dBμV/m)	Over Limit (dB)	Limit Line (dBμV/m)	Read Level (dBμV)	Antenna Factor (dB/m)	Cable Loss (dB)	Preamp Factor (dB)	Ant Pos (cm)	Table Pos (deg)	Peak Avg. (P/A)	Pol. (H/V)	
802.11n HT40 CH 38 5190MHz		5147.94	60.08	-13.92	74	48.17	31.65	11.21	30.95	207	30	P	H	
		5150	50.65	-3.35	54	38.74	31.65	11.21	30.95	207	30	A	H	
	*	5190	101.14	-	-	88.45	32.46	11.18	30.95	207	30	P	H	
	*	5190	90.15	-	-	77.46	32.46	11.18	30.95	207	30	A	H	
		5423.04	59.27	-14.73	74	46.66	31.92	11.64	30.95	207	30	P	H	
		5377.92	48.96	-5.04	54	36.51	31.88	11.52	30.95	207	30	A	H	
		5147.94	59.27	-14.73	74	47.36	31.65	11.21	30.95	150	0	P	V	
		5150	49.43	-4.57	54	37.52	31.65	11.21	30.95	150	0	A	V	
	*	5190	98.8	-	-	86.11	32.46	11.18	30.95	150	0	P	V	
	*	5190	87.96	-	-	75.27	32.46	11.18	30.95	150	0	A	V	
		5416.08	59.25	-14.75	74	46.68	31.92	11.6	30.95	150	0	P	V	
		5437.44	49.03	-4.97	54	36.41	31.93	11.64	30.95	150	0	A	V	
	802.11n HT40 CH 46 5230MHz		5106.08	58.69	-15.31	74	46.78	31.62	11.24	30.95	194	25	P	H
			5012.22	48.14	-5.86	54	36.23	31.52	11.34	30.95	194	25	A	H
*		5230	101.51	-	-	89.47	31.73	11.26	30.95	194	25	P	H	
*		5230	90.34	-	-	78.3	31.73	11.26	30.95	194	25	A	H	
		5381.04	60.41	-13.59	74	47.88	31.88	11.6	30.95	194	25	P	H	
		5388.72	48.74	-5.26	54	36.21	31.88	11.6	30.95	194	25	A	H	
		5108.94	58.82	-15.18	74	46.91	31.62	11.24	30.95	132	0	P	V	
		5001.04	48.38	-5.62	54	36.49	31.5	11.34	30.95	132	0	A	V	
*		5230	97.82	-	-	85.78	31.73	11.26	30.95	132	0	P	V	
*		5230	86.95	-	-	74.91	31.73	11.26	30.95	132	0	A	V	
	5402.16	59.28	-14.72	74	46.73	31.9	11.6	30.95	132	0	P	V		
	5428.32	48.88	-5.12	54	36.27	31.92	11.64	30.95	132	0	A	V		
Remark	1. No other spurious found. 2. All results are PASS against Peak and Average limit line.													



Band 1 5150~5250MHz

WIFI 802.11n HT40 (Harmonic @ 3m)

WIFI Ant. 1	Note	Frequency (MHz)	Level (dBμV/m)	Over Limit (dB)	Limit Line (dBμV/m)	Read Level (dBμV)	Antenna Factor (dB/m)	Cable Loss (dB)	Preamp Factor (dB)	Ant Pos (cm)	Table Pos (deg)	Peak Avg. (P/A)	Pol. (H/V)
802.11n HT40 CH 38 5190MHz		10380	46.48	-27.52	74	47.17	39.61	17.13	57.43	100	0	P	H
		15570	45.29	-28.71	74	43.89	38.22	21.64	58.46	100	0	P	H
													H
													H
		10380	46.33	-27.67	74	47.02	39.61	17.13	57.43	100	0	P	V
		15570	44.41	-29.59	74	43.01	38.22	21.64	58.46	100	0	P	V
													V
													V
802.11n HT40 CH 46 5230MHz		10460	47.23	-26.77	74	47.59	39.72	17.22	57.3	100	0	P	H
		15690	47.9	-26.1	74	46.32	38.07	21.73	58.22	100	0	P	H
													H
													H
		10460	47.27	-26.73	74	47.63	39.72	17.22	57.3	100	0	P	V
		15690	46.3	-27.7	74	44.72	38.07	21.73	58.22	100	0	P	V
													V
													V
Remark	1. No other spurious found. 2. All results are PASS against Peak and Average limit line.												



Band 1 5150~5250MHz

Band 2 - 5250~5350MHz

WIFI 802.11a (Band Edge @ 3m)

WIFI Ant.	Note	Frequency	Level	Over Limit	Limit Line	Read Level	Antenna Factor	Cable Loss	Preamp Factor	Ant Pos	Table Pos	Peak Avg.	Pol.
1		(MHz)	(dBμV/m)	(dB)	(dBμV/m)	(dBμV)	(dB/m)	(dB)	(dB)	(cm)	(deg)	(P/A)	(H/V)
802.11a CH 52 5260MHz		5009.62	59.89	-14.11	74	47.98	31.52	11.34	30.95	263	329	P	H
		5120.9	47.39	-6.61	54	35.48	31.62	11.24	30.95	263	329	A	H
	*	5260	107.06	-	-	94.3	32.45	11.26	30.95	263	329	P	H
	*	5260	96.4	-	-	83.64	32.45	11.26	30.95	263	329	A	H
		5388.72	59.82	-14.18	74	47.29	31.88	11.6	30.95	263	329	P	H
		5412	48.12	-5.88	54	35.55	31.92	11.6	30.95	263	329	A	H
		5114.14	58.99	-15.01	74	47.08	31.62	11.24	30.95	287	169	P	V
		5139.62	47.41	-6.59	54	35.47	31.65	11.24	30.95	287	169	A	V
	*	5260	104.09	-	-	92.01	31.77	11.26	30.95	287	169	P	V
	*	5260	93.55	-	-	81.47	31.77	11.26	30.95	287	169	A	V
		5459.04	58.99	-15.01	74	46.35	31.95	11.64	30.95	287	169	P	V
		5427.36	48.05	-5.95	54	35.44	31.92	11.64	30.95	287	169	A	V
802.11a CH 60 5300MHz		5027.82	58.73	-15.27	74	46.84	31.53	11.31	30.95	245	320	P	H
		5023.14	47.52	-6.48	54	35.63	31.53	11.31	30.95	245	320	A	H
	*	5300	108.14	-	-	95.3	32.44	11.35	30.95	245	320	P	H
	*	5300	97.23	-	-	84.39	32.44	11.35	30.95	245	320	A	H
		5350.08	59.72	-14.28	74	47.3	31.85	11.52	30.95	245	320	P	H
		5351.04	48.75	-5.25	54	36.33	31.85	11.52	30.95	245	320	A	H
		5129.48	59.07	-14.93	74	47.15	31.63	11.24	30.95	130	163	P	V
		5068.64	47.5	-6.5	54	35.61	31.57	11.27	30.95	130	163	A	V
	*	5300	104.48	-	-	91.64	32.44	11.35	30.95	130	163	P	V
	*	5300	93.73	-	-	80.89	32.44	11.35	30.95	130	163	A	V
		5353.2	59.78	-14.22	74	47.36	31.85	11.52	30.95	130	163	P	V
		5362.32	48.26	-5.74	54	35.82	31.87	11.52	30.95	130	163	A	V



802.11a CH 64 5320MHz	*	5320	107.66	-	-	94.74	32.44	11.43	30.95	387	329	P	H
	*	5320	96.77	-	-	83.85	32.44	11.43	30.95	387	329	A	H
		5416.48	59.8	-14.2	74	47.23	31.92	11.6	30.95	387	329	P	H
		5361.44	48.6	-5.4	54	36.16	31.87	11.52	30.95	387	329	A	H
													H
													H
	*	5320	103.99	-	-	91.69	31.82	11.43	30.95	148	164	P	V
	*	5320	92.74	-	-	80.44	31.82	11.43	30.95	148	164	A	V
		5360.8	59.95	-14.05	74	47.51	31.87	11.52	30.95	148	164	P	V
		5352.64	48.28	-5.72	54	35.86	31.85	11.52	30.95	148	164	A	V
													V
													V
Remark	1. No other spurious found. 2. All results are PASS against Peak and Average limit line.												



Band 2 5250~5350MHz

WIFI 802.11a (Harmonic @ 3m)

WIFI Ant. 1	Note	Frequency (MHz)	Level (dBμV/m)	Over Limit (dB)	Limit Line (dBμV/m)	Read Level (dBμV)	Antenna Factor (dB/m)	Cable Loss (dB)	Preamp Factor (dB)	Ant Pos (cm)	Table Pos (deg)	Peak Avg. (P/A)	Pol. (H/V)
802.11a CH 52 5260MHz		10520	53.48	-20.52	74	53.55	39.82	17.31	57.2	100	175	P	H
		10520	39.66	-14.34	54	39.73	39.82	17.31	57.2	100	175	A	H
		15780	60.36	-13.64	74	58.65	37.97	21.79	58.05	100	9	P	H
		15780	43.96	-10.04	54	42.25	37.97	21.79	58.05	100	9	A	H
		10520	48.06	-25.94	74	48.13	39.82	17.31	57.2	100	0	P	V
		15780	57.99	-16.01	74	56.28	37.97	21.79	58.05	121	346	P	V
		15780	41.79	-12.21	54	40.08	37.97	21.79	58.05	121	346	A	V
802.11a CH 60 5300MHz		10600	56.6	-17.4	74	56.46	39.92	17.4	57.18	112	172	P	H
		10600	42.4	-11.6	54	42.26	39.92	17.4	57.18	112	172	A	H
		15900	60.1	-13.9	74	58.21	37.82	21.88	57.81	100	8	P	H
		15900	44.17	-9.83	54	42.28	37.82	21.88	57.81	100	8	A	H
		10600	53.05	-20.95	74	52.91	39.92	17.4	57.18	266	250	P	V
		10600	39.59	-14.41	54	39.45	39.92	17.4	57.18	266	250	A	V
		15900	58.71	-15.29	74	56.82	37.82	21.88	57.81	100	10	P	V
		15900	42.15	-11.85	54	40.26	37.82	21.88	57.81	100	10	A	V
802.11a CH 64 5320MHz		10640	49.78	-24.22	74	49.53	39.97	17.45	57.17	100	0	P	H
		15960	60.92	-13.08	74	58.91	37.74	21.94	57.67	100	9	P	H
		15960	44.39	-9.61	54	42.38	37.74	21.94	57.67	100	9	A	H
													H
		10640	49.23	-24.77	74	48.98	39.97	17.45	57.17	100	0	P	V
		15960	58.99	-15.01	74	56.98	37.74	21.94	57.67	287	162	P	V
		15960	42.82	-11.18	54	40.81	37.74	21.94	57.67	287	162	A	V
Remark	1. No other spurious found. 2. All results are PASS against Peak and Average limit line.												



Band 2 5250~5350MHz

WIFI 802.11n HT20 (Band Edge @ 3m)

WIFI Ant. 1	Note	Frequency (MHz)	Level (dBμV/m)	Over Limit (dB)	Limit Line (dBμV/m)	Read Level (dBμV)	Antenna Factor (dB/m)	Cable Loss (dB)	Preamp Factor (dB)	Ant Pos (cm)	Table Pos (deg)	Peak Avg. (P/A)	Pol. (H/V)
802.11n HT20 CH 52 5260MHz		5052	60.07	-13.93	74	48.16	31.55	11.31	30.95	189	23	P	H
		5149.76	47.4	-6.6	54	35.49	31.65	11.21	30.95	189	23	A	H
	*	5260	107.29	-	-	95.21	31.77	11.26	30.95	189	23	P	H
	*	5260	96.25	-	-	84.17	31.77	11.26	30.95	189	23	A	H
		5366.16	59.37	-14.63	74	46.93	31.87	11.52	30.95	189	23	P	H
		5424.48	48.18	-5.82	54	35.57	31.92	11.64	30.95	189	23	A	H
		5008.58	58.57	-15.43	74	46.66	31.52	11.34	30.95	178	298	P	V
		5089.18	47.61	-6.39	54	35.69	31.6	11.27	30.95	178	298	A	V
	*	5260	104.7	-	-	91.94	32.45	11.26	30.95	178	298	P	V
	*	5260	93.66	-	-	80.9	32.45	11.26	30.95	178	298	A	V
		5357.76	59.5	-14.5	74	47.08	31.85	11.52	30.95	178	298	P	V
		5431.2	48.14	-5.86	54	35.52	31.93	11.64	30.95	178	298	A	V
	802.11n HT20 CH 60 5300MHz		5009.88	58.85	-15.15	74	46.94	31.52	11.34	30.95	177	316	P
		5130	47.64	-6.36	54	35.72	31.63	11.24	30.95	177	316	A	H
*		5300	107.18	-	-	94.34	32.44	11.35	30.95	177	316	P	H
*		5300	96.03	-	-	83.19	32.44	11.35	30.95	177	316	A	H
		5397.84	60.42	-13.58	74	47.87	31.9	11.6	30.95	177	316	P	H
		5355.84	48.6	-5.4	54	36.18	31.85	11.52	30.95	177	316	A	H
		5104.78	58.66	-15.34	74	46.77	31.6	11.24	30.95	182	305	P	V
		5148.98	47.58	-6.42	54	35.67	31.65	11.21	30.95	182	305	A	V
*		5300	103.7	-	-	90.86	32.44	11.35	30.95	182	305	P	V
*		5300	92.64	-	-	79.8	32.44	11.35	30.95	182	305	A	V
		5391.84	59.55	-14.45	74	47.02	31.88	11.6	30.95	182	305	P	V
	5382.96	48.24	-5.76	54	35.71	31.88	11.6	30.95	182	305	A	V	



802.11n HT20 CH 64 5320MHz	*	5320	108.04	-	-	95.74	31.82	11.43	30.95	183	324	P	H
	*	5320	97.31	-	-	85.01	31.82	11.43	30.95	183	324	A	H
		5366.56	60.17	-13.83	74	47.73	31.87	11.52	30.95	183	324	P	H
		5351.04	49.17	-4.83	54	36.75	31.85	11.52	30.95	183	324	A	H
													H
													H
	*	5320	104.47	-	-	92.17	31.82	11.43	30.95	156	297	P	V
	*	5320	93.84	-	-	81.54	31.82	11.43	30.95	156	297	A	V
		5380.48	59.79	-14.21	74	47.26	31.88	11.6	30.95	156	297	P	V
		5366.4	48.47	-5.53	54	36.03	31.87	11.52	30.95	156	297	A	V
												V	
												V	
Remark	1. No other spurious found. 2. All results are PASS against Peak and Average limit line.												



Band 2 5250~5350MHz

WIFI 802.11n HT20 (Harmonic @ 3m)

WIFI Ant. 1	Note	Frequency (MHz)	Level (dBμV/m)	Over Limit (dB)	Limit Line (dBμV/m)	Read Level (dBμV)	Antenna Factor (dB/m)	Cable Loss (dB)	Preamp Factor (dB)	Ant Pos (cm)	Table Pos (deg)	Peak Avg. (P/A)	Pol. (H/V)
802.11n HT20 CH 52 5260MHz		10520	47.1	-26.9	74	47.17	39.82	17.31	57.2	100	0	P	H
		15780	53.27	-20.73	74	51.56	37.97	21.79	58.05	100	13	P	H
		15780	41.82	-12.18	54	40.11	37.97	21.79	58.05	100	13	A	H
													H
		10520	47.42	-26.58	74	47.49	39.82	17.31	57.2	100	0	P	V
		15780	52.92	-21.08	74	51.21	37.97	21.79	58.05	400	344	P	V
		15780	40.65	-13.35	54	38.94	37.97	21.79	58.05	400	344	A	V
													V
802.11n HT20 CH 60 5300MHz		10600	50.23	-23.77	74	50.09	39.92	17.4	57.18	100	0	P	H
		15900	53.02	-20.98	74	51.13	37.82	21.88	57.81	100	11	P	H
		15900	41.8	-12.2	54	39.91	37.82	21.88	57.81	100	11	A	H
													H
		10600	49.42	-24.58	74	49.28	39.92	17.4	57.18	100	0	P	V
		15900	51.61	-22.39	74	49.72	37.82	21.88	57.81	398	164	P	V
		15900	40.78	-13.22	54	38.89	37.82	21.88	57.81	398	164	A	V
													V
802.11n HT20 CH 64 5320MHz		10640	48.35	-25.65	74	48.1	39.97	17.45	57.17	100	0	P	H
		15960	54.78	-19.22	74	52.77	37.74	21.94	57.67	100	13	P	H
		15960	43.55	-10.45	54	41.54	37.74	21.94	57.67	100	13	A	H
													H
		10640	47.73	-26.27	74	47.48	39.97	17.45	57.17	100	0	P	V
		15960	54.21	-19.79	74	52.2	37.74	21.94	57.67	400	161	P	V
		15960	42.56	-11.44	54	40.55	37.74	21.94	57.67	400	161	A	V
													V
Remark	1. No other spurious found. 2. All results are PASS against Peak and Average limit line.												



Band 2 5250~5350MHz

WIFI 802.11n HT40 (Band Edge @ 3m)

WIFI Ant. 1	Note	Frequency (MHz)	Level (dBμV/m)	Over Limit (dB)	Limit Line (dBμV/m)	Read Level (dBμV)	Antenna Factor (dB/m)	Cable Loss (dB)	Preamp Factor (dB)	Ant Pos (cm)	Table Pos (deg)	Peak Avg. (P/A)	Pol. (H/V)
802.11n HT40 CH 54 5270MHz		5038.74	58.69	-15.31	74	46.78	31.55	11.31	30.95	200	27	P	H
		5147.94	48.53	-5.47	54	36.62	31.65	11.21	30.95	200	27	A	H
	*	5270	101.53	-	-	88.68	32.45	11.35	30.95	200	27	P	H
	*	5270	90.3	-	-	77.45	32.45	11.35	30.95	200	27	A	H
		5388.24	59.56	-14.44	74	47.03	31.88	11.6	30.95	200	27	P	H
		5366.88	48.82	-5.18	54	36.38	31.87	11.52	30.95	200	27	A	H
		5100.88	59.56	-14.44	74	47.67	31.6	11.24	30.95	137	0	P	V
		5009.36	48.12	-5.88	54	36.21	31.52	11.34	30.95	137	0	A	V
	*	5270	98.8	-	-	85.95	32.45	11.35	30.95	137	0	P	V
	*	5270	87.69	-	-	74.84	32.45	11.35	30.95	137	0	A	V
		5454	59.05	-14.95	74	46.41	31.95	11.64	30.95	137	0	P	V
		5432.16	48.97	-5.03	54	36.35	31.93	11.64	30.95	137	0	A	V
	802.11n HT40 CH 62 5310MHz		5094.64	58.64	-15.36	74	46.72	31.6	11.27	30.95	199	324	P
		5108.42	48.15	-5.85	54	36.24	31.62	11.24	30.95	199	324	A	H
*		5310	100.98	-	-	88.06	32.44	11.43	30.95	199	324	P	H
*		5310	90.13	-	-	77.21	32.44	11.43	30.95	199	324	A	H
		5352.72	63.27	-10.73	74	50.85	31.85	11.52	30.95	199	324	P	H
		5350.08	51	-3	54	38.55	31.88	11.52	30.95	199	324	A	H
		5058.24	58.95	-15.05	74	47.02	31.57	11.31	30.95	180	305	P	V
		5057.2	48.16	-5.84	54	36.23	31.57	11.31	30.95	180	305	A	V
*		5310	96.2	-	-	83.28	32.44	11.43	30.95	180	305	P	V
*		5310	85.49	-	-	72.57	32.44	11.43	30.95	180	305	A	V
	5389.68	60.15	-13.85	74	47.62	31.88	11.6	30.95	180	305	P	V	
	5350.08	49.53	-4.47	54	37.11	31.85	11.52	30.95	180	305	A	V	
Remark	1. No other spurious found. 2. All results are PASS against Peak and Average limit line.												



Band 2 5250~5350MHz

WIFI 802.11n HT40 (Harmonic @ 3m)

WIFI Ant. 1	Note	Frequency (MHz)	Level (dBμV/m)	Over Limit (dB)	Limit Line (dBμV/m)	Read Level (dBμV)	Antenna Factor (dB/m)	Cable Loss (dB)	Preamp Factor (dB)	Ant Pos (cm)	Table Pos (deg)	Peak Avg. (P/A)	Pol. (H/V)
802.11n HT40 CH 54 5270MHz		10540	45.94	-28.06	74	45.98	39.84	17.31	57.19	100	0	P	H
		15810	45.72	-28.28	74	43.95	37.93	21.82	57.98	100	0	P	H
													H
													H
		10540	45.64	-28.36	74	45.68	39.84	17.31	57.19	100	0	P	V
		15810	46.66	-27.34	74	44.89	37.93	21.82	57.98	100	0	P	V
													V
802.11n HT40 CH 62 5310MHz		10620	47.06	-26.94	74	46.9	39.94	17.4	57.18	100	0	P	H
		15930	44.61	-29.39	74	42.66	37.78	21.91	57.74	100	0	P	H
													H
													H
		10620	46.45	-27.55	74	46.29	39.94	17.4	57.18	100	0	P	V
		15930	44.12	-29.88	74	42.17	37.78	21.91	57.74	100	0	P	V
													V
Remark	1. No other spurious found.												
	2. All results are PASS against Peak and Average limit line.												



Band 2 5250~5350MHz

Band 3 - 5470~5725MHz

WIFI 802.11a (Band Edge @ 3m)

WIFI Ant.	Note	Frequency	Level	Over Limit	Limit Line	Read Level	Antenna Factor	Cable Loss	Preamp Factor	Ant Pos	Table Pos	Peak Avg.	Pol.	
1		(MHz)	(dBμV/m)	(dB)	(dBμV/m)	(dBμV)	(dB/m)	(dB)	(dB)	(cm)	(deg)	(P/A)	(H/V)	
802.11a CH 100 5500MHz		5458.96	60.79	-13.21	74	48.15	31.95	11.64	30.95	148	322	P	H	
		5469.04	49.69	-4.31	54	37	31.97	11.67	30.95	148	322	A	H	
	*	5500	108.5	-	-	95.78	32	11.67	30.95	148	322	P	H	
	*	5500	98.18	-	-	85.46	32	11.67	30.95	148	322	A	H	
													H	
														H
			5456.88	59.76	-14.24	74	47.12	31.95	11.64	30.95	100	183	P	V
			5463.28	48.45	-5.55	54	35.76	31.97	11.67	30.95	100	183	A	V
	*		5500	101.63	-	-	88.91	32	11.67	30.95	100	183	P	V
	*		5500	90.66	-	-	77.94	32	11.67	30.95	100	183	A	V
														V
														V
802.11a CH 116 5580MHz		5393.2	60.02	-13.98	74	47.49	31.88	11.6	30.95	158	321	P	H	
		5454.88	48.32	-5.68	54	35.68	31.95	11.64	30.95	158	321	A	H	
	*	5580	108.06	-	-	95.2	32.1	11.74	30.98	158	321	P	H	
	*	5580	97.58	-	-	84.72	32.1	11.74	30.98	158	321	A	H	
			5730.525	60.29	-13.71	74	47.17	32.31	11.84	31.03	158	321	P	H
			5732.1	48.7	-5.3	54	35.58	32.31	11.84	31.03	158	321	A	H
			5369.2	59.3	-14.7	74	46.86	31.87	11.52	30.95	100	150	P	V
			5432.32	48.13	-5.87	54	35.51	31.93	11.64	30.95	100	150	A	V
	*		5580	100.37	-	-	87.51	32.1	11.74	30.98	100	150	P	V
	*		5580	90.02	-	-	77.16	32.1	11.74	30.98	100	150	A	V
			5757.125	60.01	-13.99	74	46.83	32.36	11.86	31.04	100	150	P	V
			5753.975	48.66	-5.34	54	35.47	32.36	11.86	31.03	100	150	A	V



802.11a CH 140 5700MHz	*	5700	106.65	-	-	93.57	32.27	11.82	31.01	142	322	P	H
	*	5700	95.73	-	-	82.65	32.27	11.82	31.01	142	322	A	H
		5725.96	61.95	-12.05	74	48.82	32.31	11.84	31.02	142	322	P	H
		5726.52	49.46	-4.54	54	36.33	32.31	11.84	31.02	142	322	A	H
													H
													H
	*	5700	101.63	-	-	88.55	32.27	11.82	31.01	121	158	P	V
	*	5700	90.96	-	-	77.88	32.27	11.82	31.01	121	158	A	V
		5737.88	61.05	-12.95	74	47.9	32.34	11.84	31.03	121	158	P	V
		5727.08	49.04	-4.96	54	35.91	32.31	11.84	31.02	121	158	A	V
													V
													V
Remark	1. No other spurious found. 2. All results are PASS against Peak and Average limit line.												



Band 3 - 5470~5725MHz

WIFI 802.11a (Harmonic @ 3m)

WIFI Ant. 1	Note	Frequency (MHz)	Level (dBμV/m)	Over Limit (dB)	Limit Line (dBμV/m)	Read Level (dBμV)	Antenna Factor (dB/m)	Cable Loss (dB)	Preamp Factor (dB)	Ant Pos (cm)	Table Pos (deg)	Peak Avg. (P/A)	Pol. (H/V)	
802.11a CH 100 5500MHz		11000	49.21	-24.79	74	48.05	40.4	17.86	57.1	100	0	P	H	
		16500	62.69	-11.31	74	56.97	39.3	22.42	56	278	95	P	H	
		16500	46.97	-7.03	54	41.25	39.3	22.42	56	278	95	A	H	
													H	
		11000	48.35	-25.65	74	47.19	40.4	17.86	57.1	100	0	P	V	
		16500	63.5	-10.5	74	57.78	39.3	22.42	56	100	164	P	V	
		16500	47.25	-6.75	54	41.53	39.3	22.42	56	100	164	A	V	
														V
802.11a CH 116 5580MHz		11160	48.72	-25.28	74	47.71	40.3	18.04	57.33	100	0	P	H	
		16740	59.01	-14.99	74	52.43	40.07	22.65	56.14	262	88	P	H	
		16740	43.21	-10.79	54	36.63	40.07	22.65	56.14	262	88	A	H	
													H	
		11160	48.26	-25.74	74	47.25	40.3	18.04	57.33	100	0	P	V	
		16740	57.21	-16.79	74	50.63	40.07	22.65	56.14	116	156	P	V	
		16740	41.76	-12.24	54	35.18	40.07	22.65	56.14	116	156	A	V	
														V
802.11a CH 140 5700MHz		11400	48.39	-25.61	74	47.58	40.16	18.31	57.66	100	0	P	H	
		17100	57.24	-16.76	74	49.69	41.22	22.99	56.66	260	85	P	H	
		17100	41.23	-12.77	54	33.68	41.22	22.99	56.66	260	85	A	H	
													H	
		11400	47.16	-26.84	74	46.35	40.16	18.31	57.66	100	0	P	V	
		17100	49.81	-24.19	74	42.26	41.22	22.99	56.66	100	0	P	V	
														V
														V
Remark	1. No other spurious found. 2. All results are PASS against Peak and Average limit line.													



Band 3 - 5470~5725MHz

WIFI 802.11n HT20 (Band Edge @ 3m)

WIFI Ant. 1	Note	Frequency (MHz)	Level (dBμV/m)	Over Limit (dB)	Limit Line (dBμV/m)	Read Level (dBμV)	Antenna Factor (dB/m)	Cable Loss (dB)	Preamp Factor (dB)	Ant Pos (cm)	Table Pos (deg)	Peak Avg. (P/A)	Pol. (H/V)	
802.11n HT20 CH 100 5500MHz		5441.2	60.55	-13.45	74	47.93	31.93	11.64	30.95	310	319	P	H	
		5467.92	48.84	-5.16	54	36.15	31.97	11.67	30.95	310	319	A	H	
	*	5500	107.99	-	-	95.27	32	11.67	30.95	310	319	P	H	
	*	5500	96.94	-	-	84.22	32	11.67	30.95	310	319	A	H	
													H	
														H
			5354.96	59.67	-14.33	74	47.25	31.85	11.52	30.95	187	301	P	V
			5464.72	48.34	-5.66	54	35.65	31.97	11.67	30.95	187	301	A	V
		*	5500	102.17	-	-	89.45	32	11.67	30.95	187	301	P	V
		*	5500	91.02	-	-	78.3	32	11.67	30.95	187	301	A	V
													V	
													V	
802.11n HT20 CH 116 5580MHz		5460.88	59.4	-14.6	74	46.73	31.95	11.67	30.95	319	314	P	H	
		5464.48	48.3	-5.7	54	35.61	31.97	11.67	30.95	319	314	A	H	
	*	5580	108.62	-	-	95.24	32.62	11.74	30.98	319	314	P	H	
	*	5580	97.53	-	-	84.15	32.62	11.74	30.98	319	314	A	H	
			5749.6	59.76	-14.24	74	46.59	32.34	11.86	31.03	319	314	P	H
			5734.2	48.68	-5.32	54	35.56	32.31	11.84	31.03	319	314	A	H
			5437.84	59.94	-14.06	74	47.32	31.93	11.64	30.95	184	307	P	V
			5405.44	48.17	-5.83	54	35.62	31.9	11.6	30.95	184	307	A	V
		*	5580	101.23	-	-	87.85	32.62	11.74	30.98	184	307	P	V
		*	5580	90.26	-	-	76.88	32.62	11.74	30.98	184	307	A	V
		5761.5	59.81	-14.19	74	46.63	32.36	11.86	31.04	184	307	P	V	
		5754.15	48.79	-5.21	54	35.6	32.36	11.86	31.03	184	307	A	V	



802.11n HT20 CH 140 5700MHz	*	5700	107.69	-	-	93.92	32.96	11.82	31.01	304	314	P	H
	*	5700	96.37	-	-	82.6	32.96	11.82	31.01	304	314	A	H
		5727.64	66.53	-7.47	74	53.4	32.31	11.84	31.02	304	314	P	H
		5725	50.69	-3.31	54	37.56	32.31	11.84	31.02	304	314	A	H
													H
													H
	*	5700	103.54	-	-	89.77	32.96	11.82	31.01	108	0	P	V
	*	5700	92.29	-	-	78.52	32.96	11.82	31.01	108	0	A	V
		5725.24	61.7	-12.3	74	48.57	32.31	11.84	31.02	108	0	P	V
		5725.64	49.33	-4.67	54	36.2	32.31	11.84	31.02	108	0	A	V
												V	
												V	
Remark	1. No other spurious found. 2. All results are PASS against Peak and Average limit line.												



Band 3 - 5470~5725MHz

WIFI 802.11n HT20 (Harmonic @ 3m)

WIFI Ant. 1	Note	Frequency (MHz)	Level (dBμV/m)	Over Limit (dB)	Limit Line (dBμV/m)	Read Level (dBμV)	Antenna Factor (dB/m)	Cable Loss (dB)	Preamp Factor (dB)	Ant Pos (cm)	Table Pos (deg)	Peak Avg. (P/A)	Pol. (H/V)
802.11n HT20 CH 100 5500MHz		11000	48.42	-25.58	74	47.26	40.4	17.86	57.1	100	0	P	H
		16500	62.59	-11.41	74	56.87	39.3	22.42	56	234	170	P	H
		16500	46.57	-7.43	54	40.85	39.3	22.42	56	234	170	A	H
													H
		11000	48.32	-25.68	74	47.16	40.4	17.86	57.1	100	0	P	V
		16500	62.35	-11.65	74	56.63	39.3	22.42	56	100	161	P	V
		16500	46.62	-7.38	54	40.9	39.3	22.42	56	100	161	A	V
													V
802.11n HT20 CH 116 5580MHz		11160	48.73	-25.27	74	47.72	40.3	18.04	57.33	100	0	P	H
		16740	57.34	-16.66	74	50.76	40.07	22.65	56.14	243	85	P	H
		16740	41.32	-12.68	54	34.74	40.07	22.65	56.14	243	85	A	H
													H
		11160	47.04	-26.96	74	46.03	40.3	18.04	57.33	100	0	P	V
		16740	55.76	-18.24	74	49.18	40.07	22.65	56.14	116	151	P	V
		16740	40.19	-13.81	54	33.61	40.07	22.65	56.14	116	151	A	V
													V
802.11n HT20 CH 140 5700MHz		11400	47.19	-26.81	74	46.38	40.16	18.31	57.66	100	0	P	H
		17100	56.76	-17.24	74	49.21	41.22	22.99	56.66	256	86	P	H
		17100	41.35	-12.65	54	33.8	41.22	22.99	56.66	256	86	A	H
													H
		11400	47.11	-26.89	74	46.3	40.16	18.31	57.66	100	0	P	V
		17100	48.82	-25.18	74	41.27	41.22	22.99	56.66	100	0	P	V
													V
Remark	1. No other spurious found. 2. All results are PASS against Peak and Average limit line.												



Band 3 - 5470~5725MHz

WIFI 802.11n HT40 (Band Edge @ 3m)

WIFI Ant. 1	Note	Frequency (MHz)	Level (dBμV/m)	Over Limit (dB)	Limit Line (dBμV/m)	Read Level (dBμV)	Antenna Factor (dB/m)	Cable Loss (dB)	Preamp Factor (dB)	Ant Pos (cm)	Table Pos (deg)	Peak Avg. (P/A)	Pol. (H/V)
802.11n HT40 CH 102 5510MHz		5428	59.9	-14.1	74	47.29	31.92	11.64	30.95	175	334	P	H
		5466.88	64.38	-3.82	68.2	51.69	31.97	11.67	30.95	175	334	P	H
		5459.92	49.33	-4.67	54	36.69	31.95	11.64	30.95	175	334	P	H
	*	5510	101.76	-	-	88.59	32.43	11.7	30.96	175	334	P	H
	*	5510	90.64	-	-	77.47	32.43	11.7	30.96	175	334	A	H
		5744.35	59.27	-8.93	68.2	46.1	32.34	11.86	31.03	175	334	P	H
		5457.04	59.06	-14.94	74	46.42	31.95	11.64	30.95	100	312	P	V
		5468.56	60.1	-8.1	68.2	47.41	31.97	11.67	30.95	100	312	P	V
		5438.08	49.09	-4.91	54	36.47	31.93	11.64	30.95	100	312	A	V
	*	5510	94.15	-	-	80.98	32.43	11.7	30.96	100	312	P	V
	*	5510	83.76	-	-	70.59	32.43	11.7	30.96	100	312	A	V
		5725.01	59.72	-8.48	68.2	46.59	32.31	11.84	31.02	100	312	P	V
802.11n HT40 CH 110 5550MHz		5358.16	59.41	-14.59	74	46.99	31.85	11.52	30.95	174	328	P	H
		5465.92	49	-5	54	36.31	31.97	11.67	30.95	174	328	A	H
	*	5550	102.25	-	-	88.94	32.54	11.74	30.97	174	328	P	H
	*	5550	90.92	-	-	77.61	32.54	11.74	30.97	174	328	A	H
		5759.575	59.62	-14.38	74	46.44	32.36	11.86	31.04	174	328	P	H
		5744.175	49.3	-4.7	54	36.13	32.34	11.86	31.03	174	328	A	H
		5396.08	55.95	-18.05	74	43.4	31.9	11.6	30.95	114	311	P	V
		5403.76	45.05	-8.95	54	32.5	31.9	11.6	30.95	114	311	A	V
	*	5550	94.2	-	-	80.89	32.54	11.74	30.97	114	311	P	V
	*	5550	83.14	-	-	69.83	32.54	11.74	30.97	114	311	A	V
		5750.3	55.87	-18.13	74	42.7	32.34	11.86	31.03	114	311	P	V
		5764.825	45.5	-8.5	54	32.32	32.36	11.86	31.04	114	311	A	V



802.11n HT40 CH 134 5670MHz		5382.88	55.35	-18.65	74	42.82	31.88	11.6	30.95	241	321	P	H
		5371.84	45.17	-8.83	54	32.73	31.87	11.52	30.95	241	321	A	H
	*	5670	102.31	-	-	88.62	32.88	11.82	31.01	241	321	P	H
	*	5670	91.12	-	-	77.43	32.88	11.82	31.01	241	321	A	H
		5732.625	56.73	-17.27	74	43.61	32.31	11.84	31.03	241	321	P	H
		5734.725	45.94	-8.06	54	32.79	32.34	11.84	31.03	241	321	A	H
		5432.08	55.48	-18.52	74	42.86	31.93	11.64	30.95	100	0	P	V
		5443.6	45.19	-8.81	54	32.57	31.93	11.64	30.95	100	0	A	V
	*	5670	96.72	-	-	83.03	32.88	11.82	31.01	100	0	P	V
	*	5670	85.65	-	-	71.96	32.88	11.82	31.01	100	0	A	V
		5729.3	56.45	-17.55	74	43.32	32.31	11.84	31.02	100	0	P	V
	5740.675	45.55	-8.45	54	32.38	32.34	11.86	31.03	100	0	A	V	
Remark	1. No other spurious found. 2. All results are PASS against Peak and Average limit line.												



Band 3 - 5470~5725MHz

WIFI 802.11n HT40 (Harmonic @ 3m)

WIFI Ant. 1	Note	Frequency (MHz)	Level (dBμV/m)	Over Limit (dB)	Limit Line (dBμV/m)	Read Level (dBμV)	Antenna Factor (dB/m)	Cable Loss (dB)	Preamp Factor (dB)	Ant Pos (cm)	Table Pos (deg)	Peak Avg. (P/A)	Pol. (H/V)	
802.11n HT40 CH 102 5510MHz		11020	46.09	-27.91	74	44.96	40.39	17.86	57.12	100	0	P	H	
		16530	46.96	-21.24	68.2	41.11	39.41	22.46	56.02	100	0	P	H	
													H	
													H	
			11020	47.39	-26.61	74	46.26	40.39	17.86	57.12	100	0	P	V
			16530	45.93	-22.27	68.2	40.08	39.41	22.46	56.02	100	0	P	V
														V
802.11n HT40 CH 110 5550MHz		11100	45.89	-28.11	74	44.84	40.34	17.95	57.24	100	0	P	H	
		16650	47.35	-26.65	74	41.07	39.8	22.57	56.09	100	0	P	H	
													H	
													H	
			11100	47.14	-26.86	74	46.09	40.34	17.95	57.24	100	0	P	V
			16650	47.95	-26.05	74	41.67	39.8	22.57	56.09	100	0	P	V
														V
802.11n HT40 CH 134 5670MHz		11340	46.1	-27.9	74	45.25	40.2	18.22	57.57	100	0	P	H	
		17010	47.28	-26.72	74	39.78	40.95	22.91	56.36	100	0	P	H	
													H	
													H	
			11340	46.1	-27.9	74	45.25	40.2	18.22	57.57	100	0	P	V
			17010	47.07	-26.93	74	39.57	40.95	22.91	56.36	100	0	P	V
														V
Remark	1. No other spurious found.													
	2. All results are PASS against Peak and Average limit line.													



Band 3 - 5470~5725MHz

Band 3 - Straddle Channel

WIFI 802.11a (Band Edge @ 3m)

WIFI Ant.	Note	Frequency	Level	Over Limit	Limit Line	Read Level	Antenna Factor	Cable Loss	Preamp Factor	Ant Pos	Table Pos	Peak Avg.	Pol.
1		(MHz)	(dBµV/m)	(dB)	(dBµV/m)	(dBµV)	(dB/m)	(dB)	(dB)	(cm)	(deg)	(P/A)	(H/V)
802.11a CH 144 5720MHz	*	5720	107.37	-	-	93.53	33.02	11.84	31.02	100	317	P	H
	*	5720	95.99	-	-	82.15	33.02	11.84	31.02	100	317	A	H
													H
													H
													H
													H
	*	5720	102.22	-	-	88.38	33.02	11.84	31.02	100	163	P	V
	*	5720	91.7	-	-	77.86	33.02	11.84	31.02	100	163	A	V
													V
													V
													V
Remark	1. No other spurious found. 2. All results are PASS against Peak and Average limit line.												



Band 3 - Straddle Channel
WIFI 802.11a (Harmonic @ 3m)

WIFI Ant. 1	Note	Frequency (MHz)	Level (dBμV/m)	Over Limit (dB)	Limit Line (dBμV/m)	Read Level (dBμV)	Antenna Factor (dB/m)	Cable Loss (dB)	Preamp Factor (dB)	Ant Pos (cm)	Table Pos (deg)	Peak Avg. (P/A)	Pol. (H/V)	
802.11a CH 144 5720MHz		11440	46.23	-27.77	74	45.44	40.14	18.36	57.71	100	0	P	H	
		17160	50.72	-23.28	74	43.13	41.43	23.06	56.9	100	0	P	H	
													H	
													H	
			11440	46.25	-27.75	74	45.46	40.14	18.36	57.71	100	0	P	V
			17160	48.56	-25.44	74	40.97	41.43	23.06	56.9	100	0	P	V
														V
														V
Remark	1. No other spurious found. 2. All results are PASS against Peak and Average limit line.													



Band 3 - Straddle Channel
WIFI 802.11n HT20 (Band Edge @ 3m)

WIFI Ant. 1	Note	Frequency (MHz)	Level (dBμV/m)	Over Limit (dB)	Limit Line (dBμV/m)	Read Level (dBμV)	Antenna Factor (dB/m)	Cable Loss (dB)	Preamp Factor (dB)	Ant Pos (cm)	Table Pos (deg)	Peak Avg. (P/A)	Pol. (H/V)
802.11n HT20 CH 144 5720MHz	*	5720	107.04	-	-	93.2	33.02	11.84	31.02	100	322	P	H
	*	5720	96.2	-	-	82.36	33.02	11.84	31.02	100	322	A	H
													H
													H
													H
													H
	*	5720	102.25	-	-	88.41	33.02	11.84	31.02	100	168	P	V
	*	5720	91.72	-	-	77.88	33.02	11.84	31.02	100	168	A	V
													V
													V
												V	
												V	
Remark	1. No other spurious found. 2. All results are PASS against Peak and Average limit line.												



Band 3 - Straddle Channel
WIFI 802.11n HT20 (Harmonic @ 3m)

WIFI Ant. 1	Note	Frequency (MHz)	Level (dBμV/m)	Over Limit (dB)	Limit Line (dBμV/m)	Read Level (dBμV)	Antenna Factor (dB/m)	Cable Loss (dB)	Preamp Factor (dB)	Ant Pos (cm)	Table Pos (deg)	Peak Avg. (P/A)	Pol. (H/V)	
802.11n HT20 CH 144 5720MHz		11440	46.35	-27.65	74	45.56	40.14	18.36	57.71	100	0	P	H	
		17160	50.88	-23.12	74	43.29	41.43	23.06	56.9	100	0	P	H	
													H	
													H	
			11440	47.15	-26.85	74	46.36	40.14	18.36	57.71	100	0	P	V
			17160	47.25	-26.75	74	39.66	41.43	23.06	56.9	100	0	P	V
														V
													V	
Remark	1. No other spurious found. 2. All results are PASS against Peak and Average limit line.													



Band 3 - Straddle Channel
WIFI 802.11n HT40 (Band Edge @ 3m)

WIFI Ant. 1	Note	Frequency (MHz)	Level (dBμV/m)	Over Limit (dB)	Limit Line (dBμV/m)	Read Level (dBμV)	Antenna Factor (dB/m)	Cable Loss (dB)	Preamp Factor (dB)	Ant Pos (cm)	Table Pos (deg)	Peak Avg. (P/A)	Pol. (H/V)
802.11n HT40 CH 142 5710MHz	*	5710	101.16	-	-	88.05	32.29	11.84	31.02	131	323	P	H
	*	5710	90.13	-	-	77.02	32.29	11.84	31.02	131	323	A	H
													H
													H
													H
													H
	*	5710	96.11	-	-	83	32.29	11.84	31.02	100	155	P	V
	*	5710	85.42	-	-	72.31	32.29	11.84	31.02	100	155	A	V
													V
													V
												V	
												V	
Remark	1. No other spurious found. 2. All results are PASS against Peak and Average limit line.												



Band 3 - Straddle Channel
WIFI 802.11n HT40 (Harmonic @ 3m)

WIFI Ant. 1	Note	Frequency (MHz)	Level (dBμV/m)	Over Limit (dB)	Limit Line (dBμV/m)	Read Level (dBμV)	Antenna Factor (dB/m)	Cable Loss (dB)	Preamp Factor (dB)	Ant Pos (cm)	Table Pos (deg)	Peak Avg. (P/A)	Pol. (H/V)	
802.11n HT40 CH 142 5710MHz		11420	47.73	-26.27	74	46.95	40.15	18.31	57.68	100	0	P	H	
		17130	49	-25	74	41.43	41.33	23.02	56.78	100	0	P	H	
													H	
													H	
			11420	46.82	-27.18	74	46.04	40.15	18.31	57.68	100	0	P	V
			17130	49.82	-24.18	74	42.25	41.33	23.02	56.78	100	0	P	V
														V
													V	
Remark	1. No other spurious found. 2. All results are PASS against Peak and Average limit line.													



Emission below 1GHz

WIFI 802.11a (LF @ 3m)

WIFI	Note	Frequency	Level	Over	Limit	Read	Antenna	Cable	Preamp	Ant	Table	Peak	Pol.	
Ant.				Limit	Line	Level	Factor	Loss	Factor	Pos	Pos	Avg.		
1		(MHz)	(dBμV/m)	(dB)	(dBμV/m)	(dBμV)	(dB/m)	(dB)	(dB)	(cm)	(deg)	(P/A)	(H/V)	
802.11a LF		137.46	28.47	-15.03	43.5	41.54	17.92	1.43	32.42	100	0	P	H	
		159.6	25.49	-18.01	43.5	39.26	16.9	1.75	32.42			P	H	
		201.45	24.98	-18.52	43.5	39.65	16.04	1.7	32.41			P	H	
		761.3	28.14	-17.86	46	28.61	27.84	3.97	32.28			P	H	
		885.9	30.77	-15.23	46	28.87	29.11	4.45	31.66			P	H	
		974.8	32.07	-21.93	54	27.68	30.55	4.75	30.91			P	H	
														H
														H
														H
														H
														H
														H
														H
			30.27	36.48	-3.52	40	42.46	25.7	0.78	32.46	100	0	P	V
			33.51	34.22	-5.78	40	42.28	23.62	0.78	32.46			P	V
			40.53	31.83	-8.17	40	43.77	19.74	0.78	32.46			P	V
			746.6	30.2	-15.8	46	30.9	27.64	3.97	32.31			P	V
			861.4	29.64	-16.36	46	28.04	28.97	4.45	31.82			P	V
			958	31.79	-14.21	46	27.52	30.58	4.75	31.06			P	V
														V
													V	
													V	
													V	
													V	
													V	
Remark	1. No other spurious found. 2. All results are PASS against limit line.													



Emission below 1GHz

WIFI 802.11n HT20 (LF @ 3m)

WIFI	Note	Frequency	Level	Over	Limit	Read	Antenna	Cable	Preamp	Ant	Table	Peak	Pol.	
Ant.				Limit	Line	Level	Factor	Loss	Factor	Pos	Pos	Avg.		
1		(MHz)	(dBμV/m)	(dB)	(dBμV/m)	(dBμV)	(dB/m)	(dB)	(dB)	(cm)	(deg)	(P/A)	(H/V)	
802.11n HT20 LF		135.84	28.14	-15.36	43.5	41.19	17.94	1.43	32.42			P	H	
		157.71	25.4	-18.1	43.5	39.07	17	1.75	32.42			P	H	
		194.43	28.47	-15.03	43.5	43.53	15.65	1.7	32.41			P	H	
		737.5	34.72	-11.28	46	35.71	27.45	3.89	32.33	100	0	P	H	
		952.4	32.47	-13.53	46	28.24	30.59	4.75	31.11			P	H	
		991.6	32.75	-21.25	54	29.07	30.52	3.92	30.76			P	H	
													H	
													H	
													H	
													H	
													H	
													H	
			30	29.57	-10.43	40	35.55	25.7	0.78	32.46	100	0	P	V
			35.67	29	-11	40	38.14	22.54	0.78	32.46			P	V
			99.12	25.5	-18	43.5	40.89	15.98	1.06	32.43			P	V
			466.6	33.21	-12.79	46	38.96	23.56	3.08	32.39			P	V
			746.6	32.95	-13.05	46	33.65	27.64	3.97	32.31			P	V
			940.5	31.73	-14.27	46	27.85	30.35	4.75	31.22			P	V
														V
														V
													V	
													V	
													V	
													V	
Remark	1. No other spurious found. 2. All results are PASS against limit line.													



Emission below 1GHz

WIFI 802.11n HT40 (LF @ 3m)

WIFI	Note	Frequency	Level	Over	Limit	Read	Antenna	Cable	Preamp	Ant	Table	Peak	Pol.	
Ant.				Limit	Line	Level	Factor	Loss	Factor	Pos	Pos	Avg.		
1		(MHz)	(dBμV/m)	(dB)	(dBμV/m)	(dBμV)	(dB/m)	(dB)	(dB)	(cm)	(deg)	(P/A)	(H/V)	
802.11n HT40 LF		84.54	24.38	-15.62	40	41.58	14.18	1.06	32.44			P	H	
		139.08	29.09	-14.41	43.5	42.17	17.91	1.43	32.42	100	0	P	H	
		201.18	26.39	-17.11	43.5	41.08	16.02	1.7	32.41			P	H	
		731.2	27.45	-18.55	46	28.57	27.33	3.89	32.34			P	H	
		859.3	29.97	-16.03	46	28.56	28.96	4.28	31.83			P	H	
		997.2	31.7	-22.3	54	27.99	30.51	3.92	30.72			P	H	
														H
														H
														H
														H
														H
														H
			30	30.26	-9.74	40	36.24	25.7	0.78	32.46	100	0	P	V
			35.67	29.54	-10.46	40	38.68	22.54	0.78	32.46			P	V
			95.34	28.17	-15.33	43.5	44.04	15.5	1.06	32.43			P	V
			787.2	29.45	-16.55	46	29.39	28.15	4.14	32.23			P	V
			856.5	29.61	-16.39	46	28.24	28.94	4.28	31.85			P	V
			938.4	32.21	-13.79	46	28.58	30.27	4.6	31.24			P	V
														V
														V
													V	
													V	
													V	
													V	
Remark	1. No other spurious found. 2. All results are PASS against limit line.													



Note symbol

*	Fundamental Frequency which can be ignored. However, the level of any unwanted emissions shall not exceed the level of the fundamental frequency.
!	Test result is over limit line.
P/A	Peak or Average
H/V	Horizontal or Vertical



A calculation example for radiated spurious emission is shown as below:

WIFI	Note	Frequency	Level	Over	Limit	Read	Antenna	Cable	Preamp	Ant	Table	Peak	Pol.
Ant.				Limit	Line	Level	Factor	Loss	Factor	Pos	Pos	Avg.	
1		(MHz)	(dBμV/m)	(dB)	(dBμV/m)	(dBμV)	(dB/m)	(dB)	(dB)	(cm)	(deg)	(P/A)	(H/V)
802.11b		2390	55.45	-18.55	74	54.51	32.22	4.58	35.86	103	308	P	H
CH 01													
2412MHz		2390	43.54	-10.46	54	42.6	32.22	4.58	35.86	103	308	A	H

- Level(dBμV/m) =
Antenna Factor(dB/m) + Cable Loss(dB) + Read Level(dBμV) - Preamp Factor(dB)
- Over Limit(dB) = Level(dBμV/m) – Limit Line(dBμV/m)

For Peak Limit @ 2390MHz:

- Level(dBμV/m)
= Antenna Factor(dB/m) + Cable Loss(dB) + Read Level(dBμV) - Preamp Factor(dB)
= 32.22(dB/m) + 4.58(dB) + 54.51(dBμV) – 35.86 (dB)
= 55.45 (dBμV/m)
- Over Limit(dB)
= Level(dBμV/m) – Limit Line(dBμV/m)
= 55.45(dBμV/m) – 74(dBμV/m)
= -18.55(dB)

For Average Limit @ 2390MHz:

- Level(dBμV/m)
= Antenna Factor(dB/m) + Cable Loss(dB) + Read Level(dBμV) - Preamp Factor(dB)
= 32.22(dB/m) + 4.58(dB) + 42.6(dBμV) – 35.86 (dB)
= 43.54 (dBμV/m)
- Over Limit(dB)
= Level(dBμV/m) – Limit Line(dBμV/m)
= 43.54(dBμV/m) – 54(dBμV/m)
= -10.46(dB)

Both peak and average measured complies with the limit line, so test result is “PASS”.



Appendix C. Radiated Spurious Emission

Test Engineer :	Peter Chiu, Karl Hou, Nick Yu, and Citta Ke	Temperature :	21~23°C
		Relative Humidity :	54~58%

Note symbol

-L	Low channel location
-R	High channel location



Band 1 - 5150~5250MHz
WIFI 802.11a (Band Edge @ 3m)

Table with 2 columns (WIFI, ANT) and 2 rows (Peak, Avg.). The Peak row shows 'Horizontal' and 'Fundamental' plots. The Avg. row shows a 'Horizontal' plot and 'Left blank'.

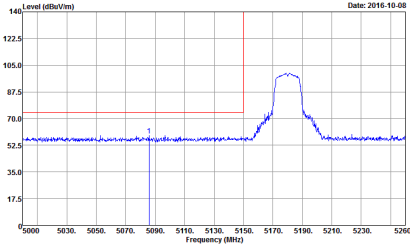
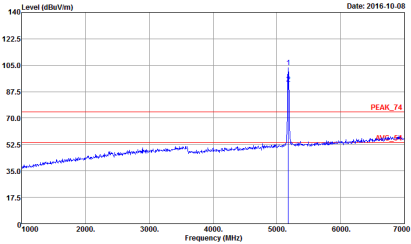
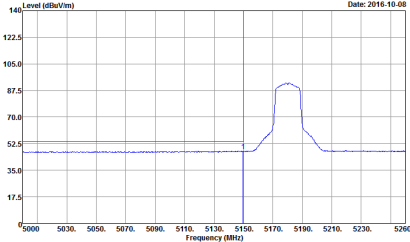

WIFI	Band 1 5150~5250MHz Band Edge @ 3m	
ANT	802.11a CH36 5180MHz	
1	Vertical	Fundamental
Peak	 <p>Site Condition : 03CH12-HY : PEAK_BE_74 3m HORN_9120D_1328 VERTICAL.</p>	 <p>Site Condition : 03CH12-HY : PEAK_74 3m HORN_9120D_1328 VERTICAL.</p>
Avg.	 <p>Site Condition : 03CH12-HY : AVG_BE_54 3m HORN_9120D_1328 VERTICAL.</p>	Left blank

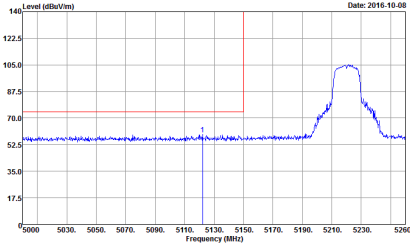
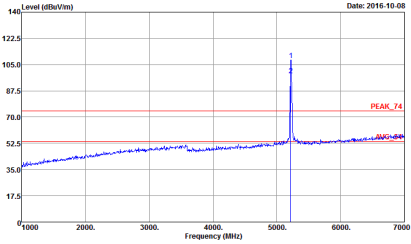
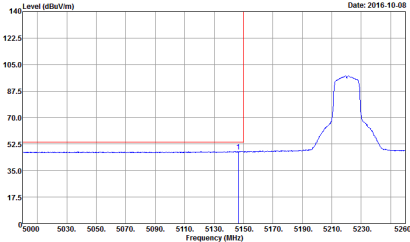

WIFI	Band 1 5150~5250MHz Band Edge @ 3m	
ANT	802.11a CH44 5220MHz - L	
1	Horizontal	Fundamental
Peak	 <p>Date: 2016-10-08</p> <p>Site Condition : :03CH12-HY : PEAK_BE_74 3m HORN_9120D_1328 HORIZONTAL</p>	 <p>Date: 2016-10-08</p> <p>Site Condition : :03CH12-HY : PEAK_74 3m HORN_9120D_1328 HORIZONTAL</p>
Avg.	 <p>Date: 2016-10-08</p> <p>Site Condition : :03CH12-HY : AVG_BE_54 3m HORN_9120D_1328 HORIZONTAL</p>	Left blank

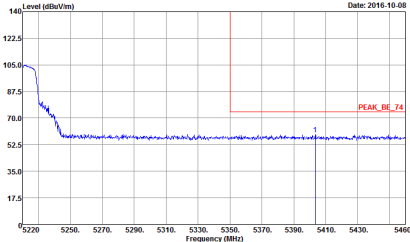
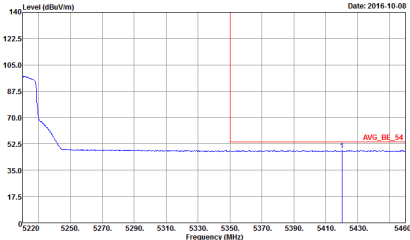

WIFI	Band 1 5150~5250MHz Band Edge @ 3m	
ANT	802.11a CH44 5220MHz - R	
1	Horizontal	Fundamental
Peak	 <p>Site Condition : 03CH12-HY : PEAK_BE_74 3m HORN_9120D_1328 HORIZONTAL</p>	Left blank
Avg.	 <p>Site Condition : 03CH12-HY : AVG_BE_54 3m HORN_9120D_1328 HORIZONTAL</p>	Left blank

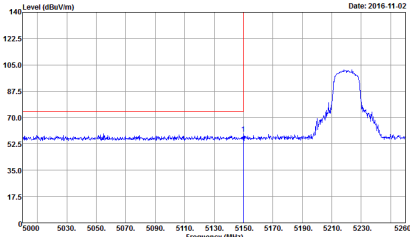
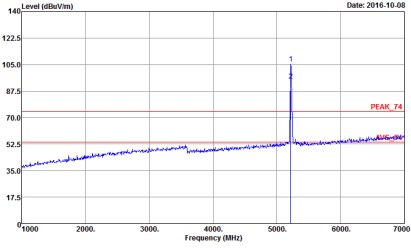
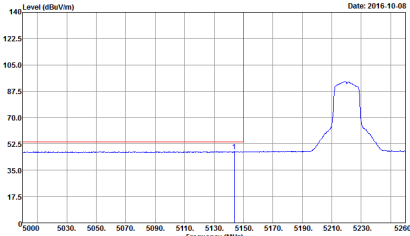

WIFI	Band 1 5150~5250MHz Band Edge @ 3m	
ANT	802.11a CH44 5220MHz - L	
1	Vertical	Fundamental
Peak	 <p>Date: 2016-11-02</p> <p>Site Condition : 03CH12-HY : PEAK_BE_74 3m HORN_9120D_1328 VERTICAL</p>	 <p>Date: 2016-10-08</p> <p>Site Condition : 03CH12-HY : PEAK_74 3m HORN_9120D_1328 VERTICAL</p>
Avg.	 <p>Date: 2016-10-08</p> <p>Site Condition : 03CH12-HY : AVG_BE_54 3m HORN_9120D_1328 VERTICAL</p>	Left blank



WIFI	Band 1 5150~5250MHz Band Edge @ 3m	
ANT	802.11a CH44 5220MHz - R	
1	Vertical	Fundamental
Peak	<p>Site Condition : :03CH12-HY : PEAK_BE_74 3m HORN_9120D_1328 VERTICAL</p>	Left blank
Avg.	<p>Site Condition : :03CH12-HY : AVG_BE_54 3m HORN_9120D_1328 VERTICAL</p>	Left blank



WIFI	Band 1 5150~5250MHz Band Edge @ 3m	
ANT	802.11a CH48 5240MHz - L	
1	Horizontal	Fundamental
Peak	<p>Level (dBuV/m) vs Frequency (MHz) plot for Peak Horizontal. The plot shows a baseline around 52.5 dBuV/m with a significant peak at approximately 5240 MHz reaching about 105 dBuV/m. A red vertical line is at 5150 MHz. Site Condition: :03CH12-HY :PEAK_BE_74 3m HORN_9120D_1328 HORIZONTAL</p>	<p>Level (dBuV/m) vs Frequency (MHz) plot for Peak Fundamental. The plot shows a sharp peak at approximately 5240 MHz reaching about 105 dBuV/m. A red horizontal line is at approximately 75 dBuV/m. Site Condition: :03CH12-HY :PEAK_74 3m HORN_9120D_1328 HORIZONTAL</p>
Avg.	<p>Level (dBuV/m) vs Frequency (MHz) plot for Avg. Horizontal. The plot shows a baseline around 52.5 dBuV/m with a peak at approximately 5240 MHz reaching about 105 dBuV/m. A red vertical line is at 5150 MHz. Site Condition: :03CH12-HY :AVG_BE_54 3m HORN_9120D_1328 HORIZONTAL</p>	Left blank

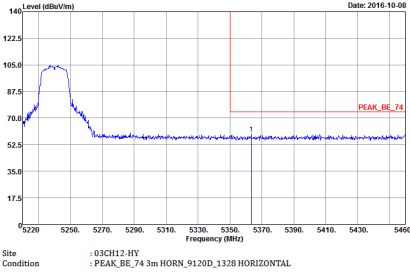
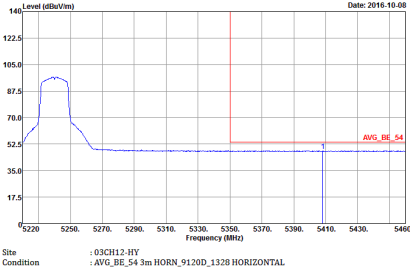

WIFI	Band 1 5150~5250MHz Band Edge @ 3m	
ANT	802.11a CH48 5240MHz - R	
1	Horizontal	Fundamental
Peak		Left blank
Avg.		Left blank

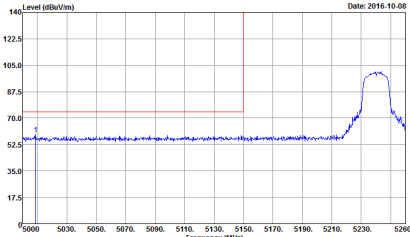
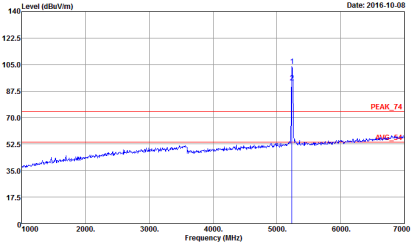
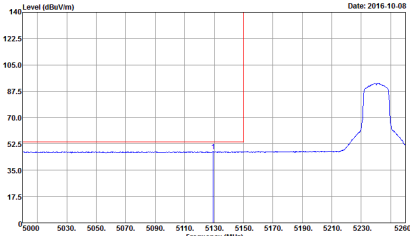

WIFI	Band 1 5150~5250MHz Band Edge @ 3m	
ANT	802.11a CH48 5240MHz - L	
1	Vertical	Fundamental
Peak	 <p>Date: 2016-10-08</p> <p>Site Condition : 03CH12-HY : PEAK_BE_74 3m HORN_9120D_1328 VERTICAL</p>	 <p>Date: 2016-10-08</p> <p>Site Condition : 03CH12-HY : PEAK_74 3m HORN_9120D_1328 VERTICAL</p>
Avg.	 <p>Date: 2016-10-08</p> <p>Site Condition : 03CH12-HY : AVG_BE_54 3m HORN_9120D_1328 VERTICAL</p>	Left blank

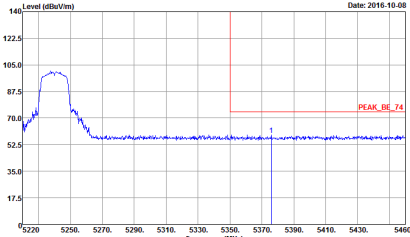
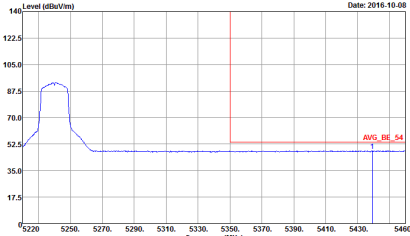

WIFI	Band 1 5150~5250MHz Band Edge @ 3m	
ANT	802.11a CH48 5240MHz - R	
1	Vertical	Fundamental
Peak	 <p>Date: 2016-10-08</p> <p>Site Condition : :03CH12-HY : PEAK_BE_74 3m HORN_9120D_1328 VERTICAL</p>	Left blank
Avg.	 <p>Date: 2016-10-08</p> <p>Site Condition : :03CH12-HY : AVG_BE_54 3m HORN_9120D_1328 VERTICAL</p>	Left blank

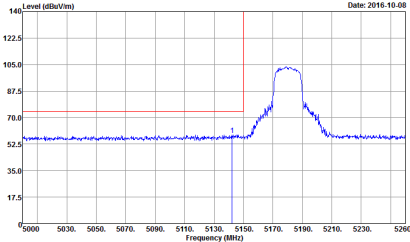
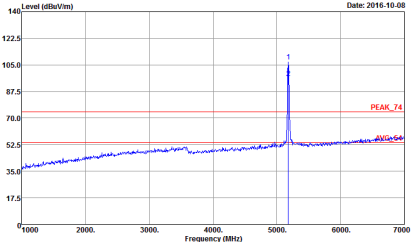
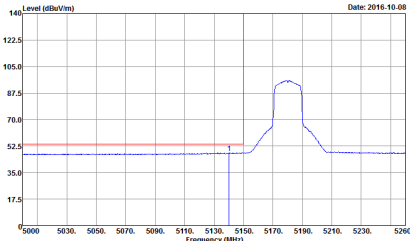

**Band 1 5150~5250MHz
WIFI 802.11n HT20 (Band Edge @ 3m)**

WIFI	Band 1 5150~5250MHz Band Edge @ 3m	
ANT	802.11n HT20 CH36 5180MHz	
1	Horizontal	Fundamental
Peak	 <p>Level (dBuV/m) vs Frequency (MHz) plot showing a peak at 5180 MHz. The y-axis ranges from 17.5 to 140 dBuV/m, and the x-axis ranges from 5000 to 5260 MHz. A red horizontal line is drawn at approximately 75 dBuV/m. The plot title is 'Date: 2016-10-08'. Site Condition : :03CH12-HY : PEAK_BE_74 3m HORN_9120D_1328 HORIZONTAL</p>	 <p>Level (dBuV/m) vs Frequency (MHz) plot showing a sharp peak at 5180 MHz. The y-axis ranges from 17.5 to 140 dBuV/m, and the x-axis ranges from 1000 to 7000 MHz. A red horizontal line is drawn at approximately 75 dBuV/m. The plot title is 'Date: 2016-10-08'. Site Condition : :03CH12-HY : PEAK_74 3m HORN_9120D_1328 HORIZONTAL</p>
Avg.	 <p>Level (dBuV/m) vs Frequency (MHz) plot showing the average signal. The y-axis ranges from 17.5 to 140 dBuV/m, and the x-axis ranges from 5000 to 5260 MHz. A red horizontal line is drawn at approximately 75 dBuV/m. The plot title is 'Date: 2016-10-08'. Site Condition : :03CH12-HY : AVG_BE_54 3m HORN_9120D_1328 HORIZONTAL</p>	Left blank



WIFI	Band 1 5150~5250MHz Band Edge @ 3m	
ANT	802.11n HT20 CH36 5180MHz	
1	Vertical	Fundamental
Peak	<p>Site Condition :03CH12-HY : PEAK_BE_74 3m HORN_9120D_1328 VERTICAL</p>	<p>Site Condition :03CH12-HY : PEAK_74 3m HORN_9120D_1328 VERTICAL</p>
Avg.	<p>Site Condition :03CH12-HY : AVG_BE_54 3m HORN_9120D_1328 VERTICAL</p>	Left blank

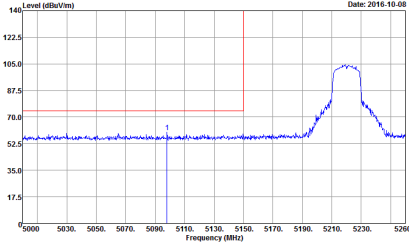
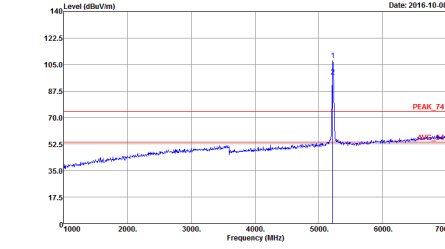
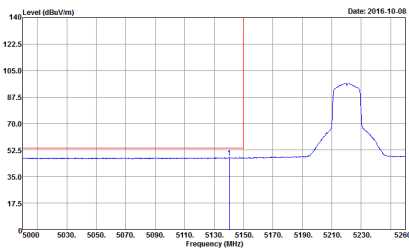

WIFI	Band 1 5150~5250MHz Band Edge @ 3m	
ANT	802.11n HT20 CH44 5220MHz - L	
1	Horizontal	Fundamental
Peak	 <p>Level (dBuV/m) vs Frequency (MHz) plot showing a peak at approximately 5220 MHz. The y-axis ranges from 17.5 to 140 dBuV/m, and the x-axis ranges from 5000 to 5260 MHz. A red vertical line is at 5150 MHz. Site Condition: :03CH12-HY :PEAK_BE_74 3m HORN_9120D_1328 HORIZONTAL</p>	 <p>Level (dBuV/m) vs Frequency (MHz) plot showing a sharp peak at approximately 5220 MHz. The y-axis ranges from 17.5 to 140 dBuV/m, and the x-axis ranges from 1000 to 7000 MHz. A red vertical line is at 5150 MHz. Site Condition: :03CH12-HY :PEAK_74 3m HORN_9120D_1328 HORIZONTAL</p>
Avg.	 <p>Level (dBuV/m) vs Frequency (MHz) plot showing an averaged peak at approximately 5220 MHz. The y-axis ranges from 17.5 to 140 dBuV/m, and the x-axis ranges from 5000 to 5260 MHz. A red vertical line is at 5150 MHz. Site Condition: :03CH12-HY :AVG_BE_54 3m HORN_9120D_1328 HORIZONTAL</p>	Left blank



WIFI	Band 1 5150~5250MHz Band Edge @ 3m	
ANT	802.11n HT20 CH44 5220MHz - R	
1	Horizontal	Fundamental
Peak	<p>Date: 2016-10-08</p> <p>Site Condition : :03CH12-HY :PEAK_BE_74 3m HORN_9120D_1328 HORIZONTAL</p>	Left blank
Avg.	<p>Date: 2016-10-08</p> <p>Site Condition : :03CH12-HY :AVG_BE_54 3m HORN_9120D_1328 HORIZONTAL</p>	Left blank

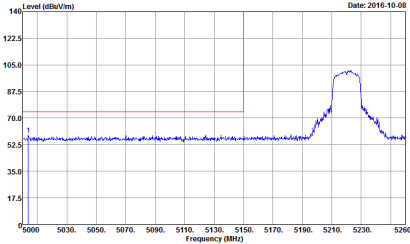
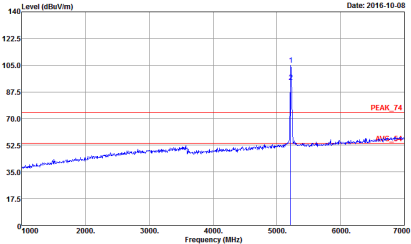
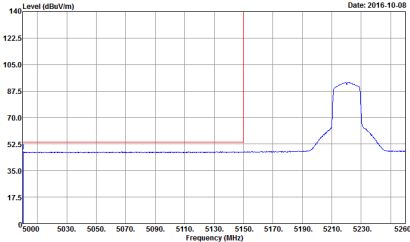

WIFI	Band 1 5150~5250MHz Band Edge @ 3m	
ANT	802.11n HT20 CH44 5220MHz - L	
1	Vertical	Fundamental
Peak	 <p>Site Condition : :03CH12-HY : PEAK_BE_74 3m HORN_9120D_1328 VERTICAL</p>	 <p>Site Condition : :03CH12-HY : PEAK_74 3m HORN_9120D_1328 VERTICAL</p>
Avg.	 <p>Site Condition : :03CH12-HY : AVG_BE_54 3m HORN_9120D_1328 VERTICAL</p>	Left blank



WIFI	Band 1 5150~5250MHz Band Edge @ 3m	
ANT	802.11n HT20 CH44 5220MHz - R	
1	Vertical	Fundamental
Peak	<p>Site Condition : 03CH12-HY : PEAK_BE_74 3m HORN_9120D_1328 VERTICAL</p>	Left blank
Avg.	<p>Site Condition : 03CH12-HY : AVG_BE_54 3m HORN_9120D_1328 VERTICAL</p>	Left blank

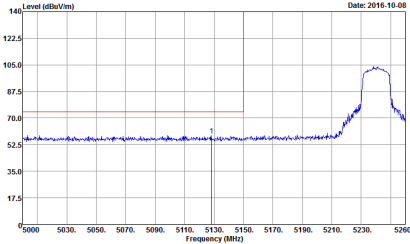
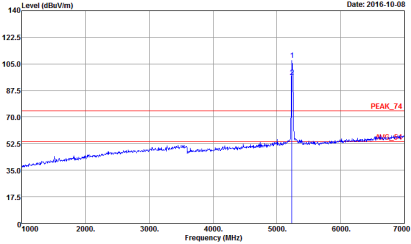
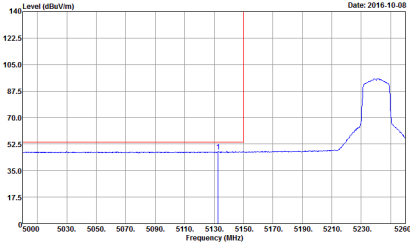

WIFI	Band 1 5150~5250MHz Band Edge @ 3m	
ANT	802.11n HT20 CH48 5240MHz - L	
1	Horizontal	Fundamental
Peak	 <p>Site Condition : :03CH12-HY : PEAK_BE_74 3m HORN_9120D_1328 HORIZONTAL</p>	 <p>Site Condition : :03CH12-HY : PEAK_74 3m HORN_9120D_1328 HORIZONTAL</p>
Avg.	 <p>Site Condition : :03CH12-HY : AVG_BE_54 3m HORN_9120D_1328 HORIZONTAL</p>	Left blank



WIFI	Band 1 5150~5250MHz Band Edge @ 3m	
ANT	802.11n HT20 CH48 5240MHz - R	
1	Horizontal	Fundamental
Peak	<p>Site Condition : :03CH12-HY : PEAK_BE_74 3m HORN_9120D_1328 HORIZONTAL</p>	Left blank
Avg.	<p>Site Condition : :03CH12-HY : AVG_BE_54 3m HORN_9120D_1328 HORIZONTAL</p>	Left blank

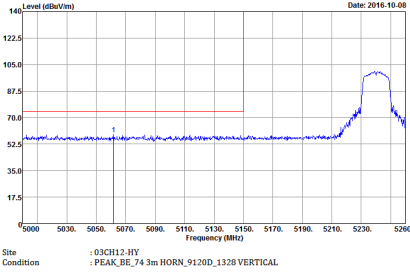
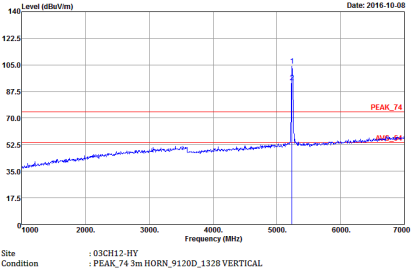
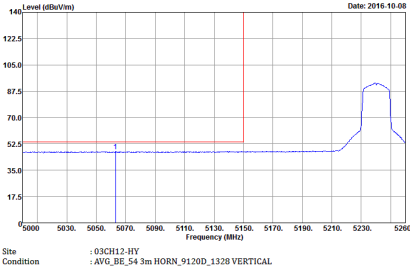

WIFI	Band 1 5150~5250MHz Band Edge @ 3m	
ANT	802.11n HT20 CH48 5240MHz - L	
1	Vertical	Fundamental
Peak	 <p>Site Condition : :03CH12-HY : PEAK_BE_74 3m HORN_9120D_1328 VERTICAL</p>	 <p>Site Condition : :03CH12-HY : PEAK_74 3m HORN_9120D_1328 VERTICAL</p>
Avg.	 <p>Site Condition : :03CH12-HY : AVG_BE_54 3m HORN_9120D_1328 VERTICAL</p>	Left blank

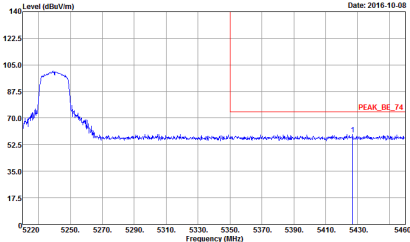
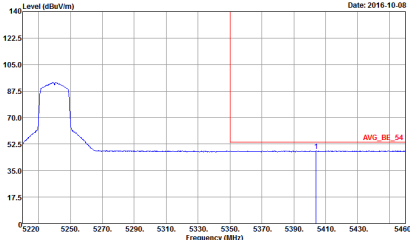

WIFI	Band 1 5150~5250MHz Band Edge @ 3m	
ANT	802.11n HT20 CH48 5240MHz - R	
1	Vertical	Fundamental
Peak	 <p>Date: 2016-10-08</p> <p>Site Condition : :03CH12-HY : PEAK_BE_74 3m HORN_9120D_1328 VERTICAL</p>	Left blank
Avg.	 <p>Date: 2016-10-08</p> <p>Site Condition : :03CH12-HY : AVG_BE_54 3m HORN_9120D_1328 VERTICAL</p>	Left blank



Band 1 5150~5250MHz
WIFI 802.11n HT40 (Band Edge @ 3m)

WIFI	Band 1 5150~5250MHz Band Edge @ 3m	
ANT	802.11n HT40 CH38 5190MHz - L	
1	Horizontal	Fundamental
Peak	<p>Level (dBuV/m) vs Frequency (MHz) plot showing a signal between 5150 and 5250 MHz. The y-axis ranges from 0 to 140 dBuV/m. A red vertical line is at 5150 MHz. A red horizontal line is at approximately 75 dBuV/m. The signal level rises to about 100 dBuV/m between 5170 and 5210 MHz. Date: 2016-10-08</p> <p>Site Condition : 03CH12-HY : PEAK_BE_74 3m HORN_9120D_1328 HORIZONTAL</p>	<p>Level (dBuV/m) vs Frequency (MHz) plot showing a sharp peak at 5190 MHz. The y-axis ranges from 0 to 140 dBuV/m. A red horizontal line is at approximately 75 dBuV/m. The peak reaches about 100 dBuV/m. Date: 2016-10-08</p> <p>Site Condition : 03CH12-HY : PEAK_74 3m HORN_9120D_1328 HORIZONTAL</p>
Avg.	<p>Level (dBuV/m) vs Frequency (MHz) plot showing the average signal between 5150 and 5250 MHz. The y-axis ranges from 0 to 140 dBuV/m. A red vertical line is at 5150 MHz. A red horizontal line is at approximately 75 dBuV/m. The signal level rises to about 100 dBuV/m between 5170 and 5210 MHz. Date: 2016-10-08</p> <p>Site Condition : 03CH12-HY : AVG_BE_54 3m HORN_9120D_1328 HORIZONTAL</p>	Left blank



WIFI	Band 1 5150~5250MHz Band Edge @ 3m	
ANT	802.11n HT40 CH38 5190MHz - R	
1	Horizontal	Fundamental
Peak	<p>Site Condition : :03CH12-HY :PEAK_BE_74 3m HORN_9120D_1328 HORIZONTAL</p>	Left blank
Avg.	<p>Site Condition : :03CH12-HY :AVG_BE_54 3m HORN_9120D_1328 HORIZONTAL</p>	Left blank

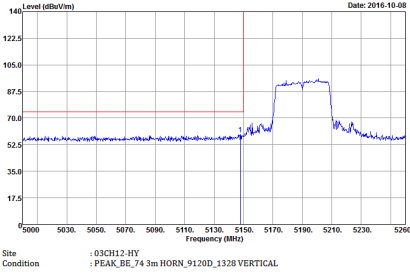
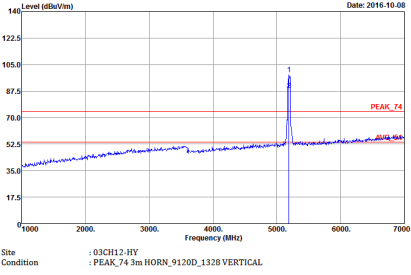
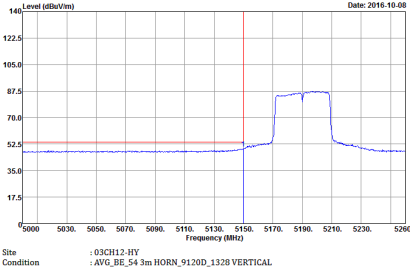

WIFI	Band 1 5150~5250MHz Band Edge @ 3m	
ANT	802.11n HT40 CH38 5190MHz - L	
1	Vertical	Fundamental
Peak		
Avg.		Left blank



WIFI	Band 1 5150~5250MHz Band Edge @ 3m	
ANT	802.11n HT40 CH38 5190MHz - R	
1	Vertical	Fundamental
Peak	<p>Site Condition : :03CH12-HY : PEAK_BE_74 3m HORN_9120D_1328 VERTICAL</p>	Left blank
Avg.	<p>Site Condition : :03CH12-HY : AVG_BE_54 3m HORN_9120D_1328 VERTICAL</p>	Left blank



WIFI	Band 1 5150~5250MHz Band Edge @ 3m	
ANT	802.11n HT40 CH46 5230MHz - L	
1	Horizontal	Fundamental
Peak	<p>Site Condition : 03CH12-HY : PEAK_BE_74 3m HORN_9120D_1328 HORIZONTAL</p>	<p>Site Condition : 03CH12-HY : PEAK_74 3m HORN_9120D_1328 HORIZONTAL</p>
Avg.	<p>Site Condition : 03CH12-HY : AVG_BE_54 3m HORN_9120D_1328 HORIZONTAL</p>	Left blank

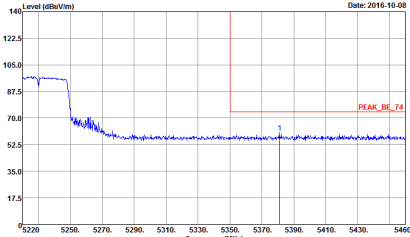
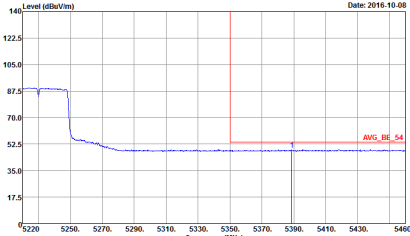

WIFI	Band 1 5150~5250MHz Band Edge @ 3m	
ANT	802.11n HT40 CH46 5230MHz - R	
1	Horizontal	Fundamental
Peak	 <p>Date: 2016-10-08</p> <p>Site Condition : :03CH12-HY :PEAK_BE_74 3m HORN_9120D_1328 HORIZONTAL</p>	Left blank
Avg.	 <p>Date: 2016-10-08</p> <p>Site Condition : :03CH12-HY :AVG_BE_54 3m HORN_9120D_1328 HORIZONTAL</p>	Left blank



WIFI	Band 1 5150~5250MHz Band Edge @ 3m	
ANT	802.11n HT40 CH46 5230MHz - L	
1	Vertical	Fundamental
Peak	<p>Site Condition : 03CH12-HY : PEAK_BE_74 3m HORN_9120D_1328 VERTICAL</p>	<p>Site Condition : 03CH12-HY : PEAK_74 3m HORN_9120D_1328 VERTICAL</p>
Avg.	<p>Site Condition : 03CH12-HY : AVG_BE_54 3m HORN_9120D_1328 VERTICAL</p>	Left blank

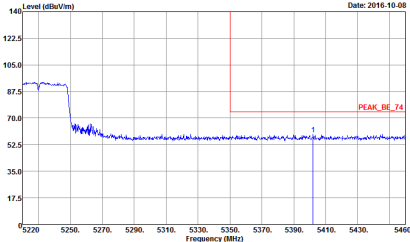
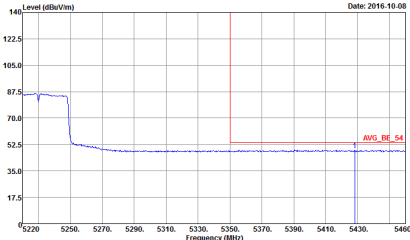

WIFI	Band 1 5150~5250MHz Band Edge @ 3m	
ANT	802.11n HT40 CH46 5230MHz - R	
1	Vertical	Fundamental
Peak	 <p>Site Condition : :03CH12-HY : PEAK_BE_74 3m HORN_9120D_1328 VERTICAL</p>	Left blank
Avg.	 <p>Site Condition : :03CH12-HY : AVG_BE_54 3m HORN_9120D_1328 VERTICAL</p>	Left blank



Band 1 5150~5250MHz

Band 1 - 5150~5250MHz

WIFI 802.11a (Harmonic @ 3m)

WIFI	Band 1 5150~5250MHz Harmonic @ 3m	
ANT	802.11a CH36 5180MHz	
1	Horizontal	Vertical
Peak Avg.	<p>Site Condition : 03CH12-HY : PEAK_74 3m HORN_9120D_1328 HORIZONTAL</p>	<p>Site Condition : 03CH12-HY : PEAK_74 3m HORN_9120D_1328 VERTICAL</p>



WIFI	Band 1 5150~5250MHz Harmonic @ 3m	
ANT	802.11a CH44 5220MHz	
1	Horizontal	Vertical
Peak Avg.	<p>Site Condition : :03CH12-HY : PEAK_74 3m HORN_9120D_1328 HORIZONTAL</p>	<p>Site Condition : :03CH12-HY : PEAK_74 3m HORN_9120D_1328 VERTICAL</p>



WIFI	Band 1 5150~5250MHz Harmonic @ 3m	
ANT	802.11a CH48 5240MHz	
1	Horizontal	Vertical
Peak Avg.	<p>Site Condition : 03CH12-HY : PEAK_74 3m HORN_9120D_1328 HORIZONTAL</p>	<p>Site Condition : 03CH12-HY : PEAK_74 3m HORN_9120D_1328 VERTICAL</p>



Band 1 5150~5250MHz
WIFI 802.11n HT20 (Harmonic @ 3m)

WIFI	Band 1 5150~5250MHz Harmonic @ 3m	
ANT	802.11n HT20 CH36 5180MHz	
1	Horizontal	Vertical
<p>Peak Avg.</p>	<p>Site Condition : 03CH12-HY : PEAK_74 3m HORN_9120D_1328 HORIZONTAL</p>	<p>Site Condition : 03CH12-HY : PEAK_74 3m HORN_9120D_1328 VERTICAL</p>

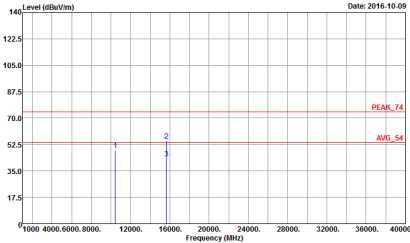
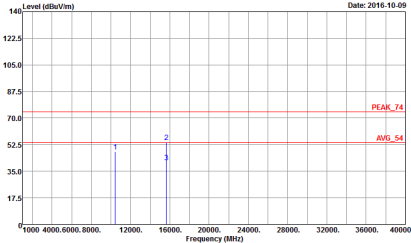

WIFI	Band 1 5150~5250MHz Harmonic @ 3m	
ANT	802.11n HT20 CH44 5220MHz	
1	Horizontal	Vertical
<p>Peak</p> <p>Avg.</p>	 <p>Site Condition : :03CH12-HY : PEAK_74 3m HORN_9120D_1328 HORIZONTAL</p>	 <p>Site Condition : :03CH12-HY : PEAK_74 3m HORN_9120D_1328 VERTICAL</p>



WIFI	Band 1 5150~5250MHz Harmonic @ 3m	
ANT	802.11n HT20 CH48 5240MHz	
1	Horizontal	Vertical
Peak Avg.	<p>Site Condition : :03CH12-HY : PEAK_74 3m HORN_9120D_1328 HORIZONTAL</p>	<p>Site Condition : :03CH12-HY : PEAK_74 3m HORN_9120D_1328 VERTICAL</p>



Band 1 5150~5250MHz
WIFI 802.11n HT40 (Harmonic @ 3m)

Table with 3 columns: WIFI, ANT, and measurement results for Horizontal and Vertical orientations. Includes peak and average level graphs for 802.11n HT40 CH38 5190MHz.



WIFI	Band 1 5150~5250MHz Harmonic @ 3m	
ANT	802.11n HT40 CH46 5230MHz	
1	Horizontal	Vertical
Peak Avg.	<p>Site Condition : :03CH12-HY : PEAK_74 3m HORN_9120D_1328 HORIZONTAL</p>	<p>Site Condition : :03CH12-HY : PEAK_74 3m HORN_9120D_1328 VERTICAL</p>



Band 2 - 5250~5350MHz
WIFI 802.11a (Band Edge @ 3m)

WIFI	Band 2 5250~5350MHz Band Edge @ 3m	
ANT	802.11a CH52 5260MHz - L	
1	Horizontal	Fundamental
Peak	<p>Site Condition : 03CH12-HY : PEAK_BE_74 3m HORN_9120D_1328 HORIZONTAL</p>	<p>Site Condition : 03CH12-HY : PEAK_74 3m HORN_9120D_1328 HORIZONTAL</p>
Avg.	<p>Site Condition : 03CH12-HY : AVG_BE_54 3m HORN_9120D_1328 HORIZONTAL</p>	Left blank

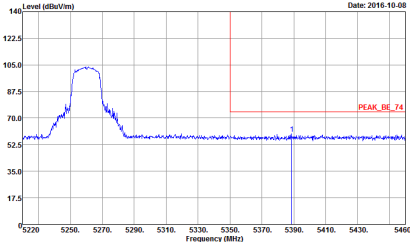
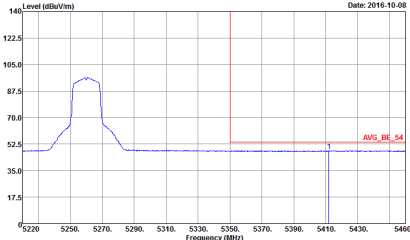

WIFI	Band 2 5250~5350MHz Band Edge @ 3m	
ANT	802.11a CH52 5260MHz - R	
1	Horizontal	Fundamental
Peak	 <p>Site : 03CH12-HY Condition : PEAK_BE_74 3m HORN_9120D_1328 HORIZONTAL</p>	Left blank
Avg.	 <p>Site : 03CH12-HY Condition : AVG_BE_54 3m HORN_9120D_1328 HORIZONTAL</p>	Left blank



WIFI	Band 2 5250~5350MHz Band Edge @ 3m	
ANT	802.11a CH52 5260MHz - L	
1	Vertical	Fundamental
Peak	<p>Site Condition :03CH12-HY :PEAK_BE_74 3m HORN_9120D_1328 VERTICAL</p>	<p>Site Condition :03CH12-HY :PEAK_74 3m HORN_9120D_1328 VERTICAL</p>
Avg.	<p>Site Condition :03CH12-HY :AVG_BE_54 3m HORN_9120D_1328 VERTICAL</p>	Left blank

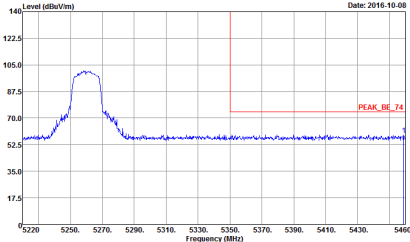
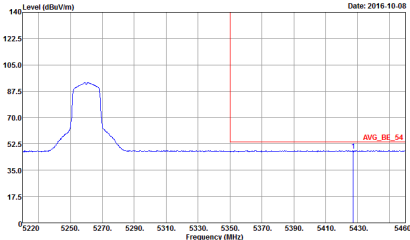

WIFI	Band 2 5250~5350MHz Band Edge @ 3m	
ANT	802.11a CH52 5260MHz - R	
1	Vertical	Fundamental
Peak	 <p>Date: 2016-10-08</p> <p>Site Condition : :03CH12-HY : PEAK_BE_74 3m HORN_9120D_1328 VERTICAL</p>	Left blank
Avg.	 <p>Date: 2016-10-08</p> <p>Site Condition : :03CH12-HY : AVG_BE_54 3m HORN_9120D_1328 VERTICAL</p>	Left blank

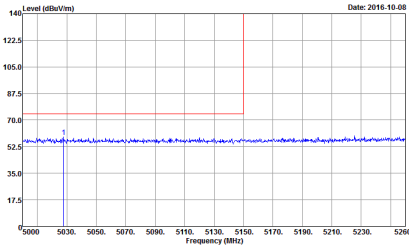
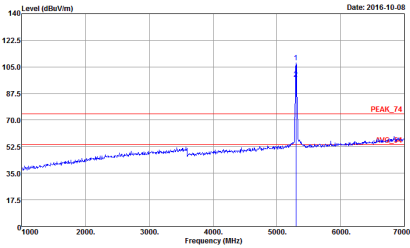
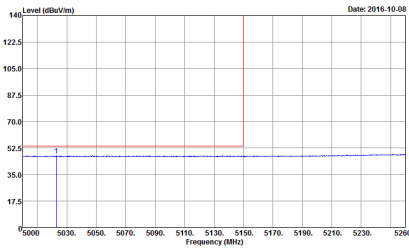

WIFI	Band 2 5250~5350MHz Band Edge @ 3m	
ANT	802.11a CH60 5300MHz - L	
1	Horizontal	Fundamental
Peak	 <p>Level (dBuV/m) vs Frequency (MHz) plot. Date: 2016-10-08. Site Condition: :03CH12-HY : PEAK_BE_74 3m HORN_9120D_1328 HORIZONTAL</p>	 <p>Level (dBuV/m) vs Frequency (MHz) plot. Date: 2016-10-08. Site Condition: :03CH12-HY : PEAK_74 3m HORN_9120D_1328 HORIZONTAL</p>
Avg.	 <p>Level (dBuV/m) vs Frequency (MHz) plot. Date: 2016-10-08. Site Condition: :03CH12-HY : AVG_BE_54 3m HORN_9120D_1328 HORIZONTAL</p>	Left blank



WIFI	Band 2 5250~5350MHz Band Edge @ 3m	
ANT	802.11a CH60 5300MHz - R	
1	Horizontal	Fundamental
Peak		Left blank
Avg.		Left blank

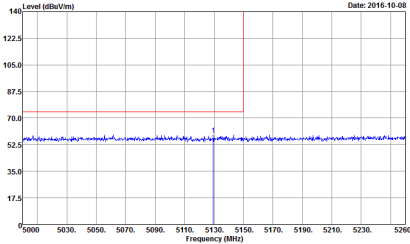
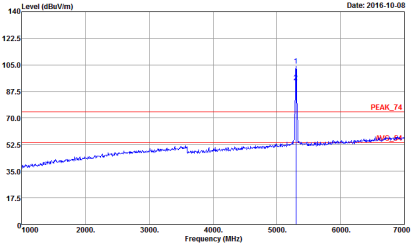
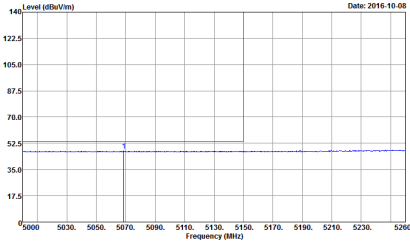

WIFI	Band 2 5250~5350MHz Band Edge @ 3m	
ANT	802.11a CH60 5300MHz - L	
1	Vertical	Fundamental
Peak	 <p>Date: 2016-10-08</p> <p>Site Condition : 03CH12-HY : PEAK_BE_74 3m HORN_9120D_1328 VERTICAL</p>	 <p>Date: 2016-10-08</p> <p>Site Condition : 03CH12-HY : PEAK_74 3m HORN_9120D_1328 VERTICAL</p>
Avg.	 <p>Date: 2016-10-08</p> <p>Site Condition : 03CH12-HY : AVG_BE_54 3m HORN_9120D_1328 VERTICAL</p>	Left blank



WIFI	Band 2 5250~5350MHz Band Edge @ 3m	
ANT	802.11a CH60 5300MHz - R	
1	Vertical	Fundamental
Peak	<p>Site Condition : 03CH12-HY : PEAK_BE_74 3m HORN_9120D_1328 VERTICAL</p>	Left blank
Avg.	<p>Site Condition : 03CH12-HY : AVG_BE_54 3m HORN_9120D_1328 VERTICAL</p>	Left blank

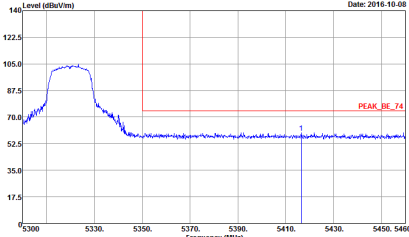
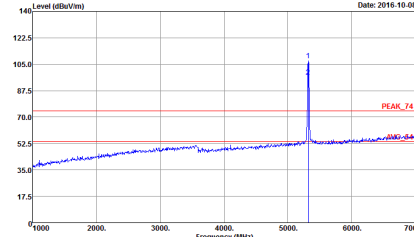
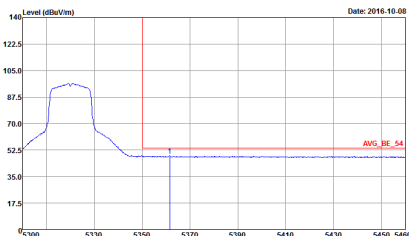

WIFI	Band 2 5250~5350MHz Band Edge @ 3m	
ANT	802.11a CH64 5320MHz	
1	Horizontal	Fundamental
Peak	 <p>Date: 2016-10-08</p> <p>Site Condition : 03CH12-HY : PEAK_BE_74 3m HORN_9120D_1328 HORIZONTAL</p>	 <p>Date: 2016-10-08</p> <p>Site Condition : 03CH12-HY : PEAK_74 3m HORN_9120D_1328 HORIZONTAL</p>
Avg.	 <p>Date: 2016-10-08</p> <p>Site Condition : 03CH12-HY : AVG_BE_54 3m HORN_9120D_1328 HORIZONTAL</p>	Left blank



WIFI	Band 2 5250~5350MHz Band Edge @ 3m	
ANT	802.11a CH64 5320MHz	
1	Vertical	Fundamental
Peak	<p>Site Condition : :03CH12-HY : PEAK_BE_74 3m HORN_9120D_1328 VERTICAL</p>	<p>Site Condition : :03CH12-HY : PEAK_74 3m HORN_9120D_1328 VERTICAL</p>
Avg.	<p>Site Condition : :03CH12-HY : AVG_BE_54 3m HORN_9120D_1328 VERTICAL</p>	Left blank



Band 2 5250~5350MHz
WIFI 802.11n HT20 (Band Edge @ 3m)

Table with 3 columns: WIFI, ANT, and test results. Row 1: Peak, Horizontal, Fundamental. Row 2: Avg., Left blank. Includes spectral plots for each test.

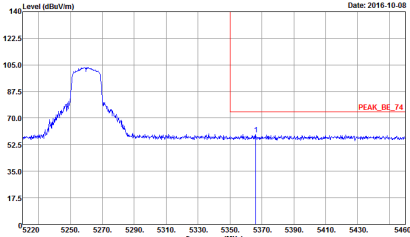
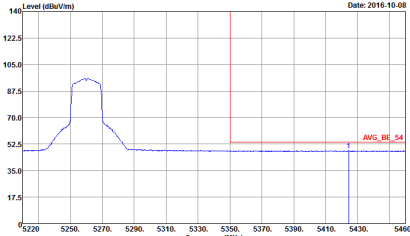

WIFI	Band 2 5250~5350MHz Band Edge @ 3m	
ANT	802.11n HT20 CH52 5260MHz - R	
1	Horizontal	Fundamental
Peak	 <p>Date: 2016-10-08</p> <p>Site Condition : :03CH12-HY : PEAK_BE_74 3m HORN_9120D_1328 HORIZONTAL</p>	Left blank
Avg.	 <p>Date: 2016-10-08</p> <p>Site Condition : :03CH12-HY : AVG_BE_54 3m HORN_9120D_1328 HORIZONTAL</p>	Left blank

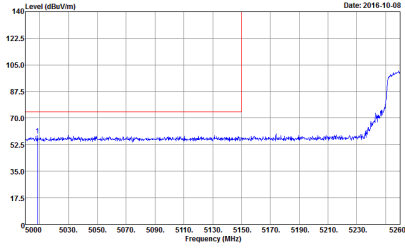
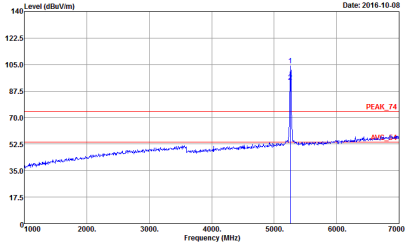
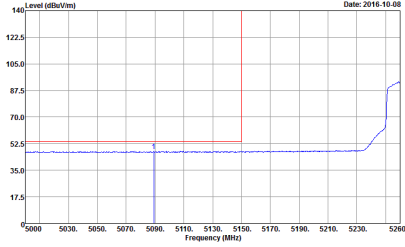

WIFI	Band 2 5250~5350MHz Band Edge @ 3m	
ANT	802.11n HT20 CH52 5260MHz - L	
1	Vertical	Fundamental
Peak	 <p>Date: 2016-10-08</p> <p>Site Condition : 03CH12-HY : PEAK_BE_74 3m HORN_9120D_1328 VERTICAL</p>	 <p>Date: 2016-10-08</p> <p>Site Condition : 03CH12-HY : PEAK_74 3m HORN_9120D_1328 VERTICAL</p>
Avg.	 <p>Date: 2016-10-08</p> <p>Site Condition : 03CH12-HY : AVG_BE_54 3m HORN_9120D_1328 VERTICAL</p>	Left blank

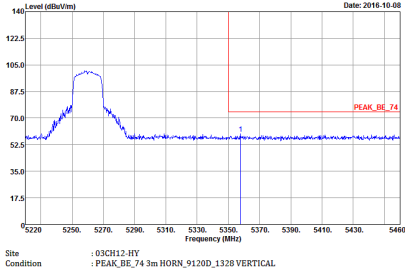
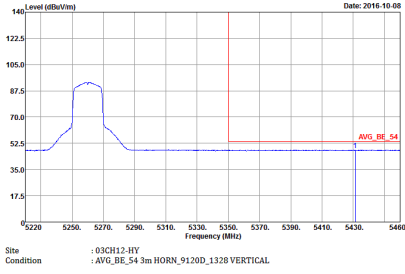

WIFI	Band 2 5250~5350MHz Band Edge @ 3m	
ANT	802.11n HT20 CH52 5260MHz - R	
1	Vertical	Fundamental
Peak	 <p>Site Condition : 03CH12-HY : PEAK_BE_74 3m HORN_9120D_1328 VERTICAL</p>	Left blank
Avg.	 <p>Site Condition : 03CH12-HY : AVG_BE_54 3m HORN_9120D_1328 VERTICAL</p>	Left blank

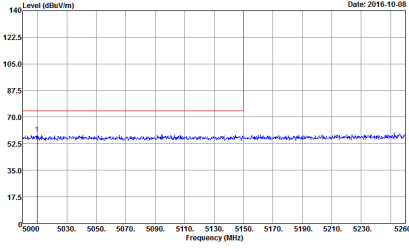
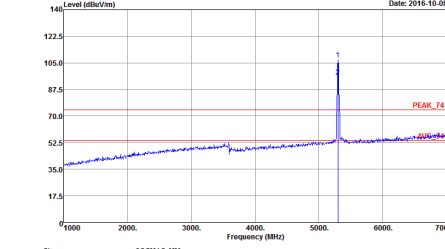
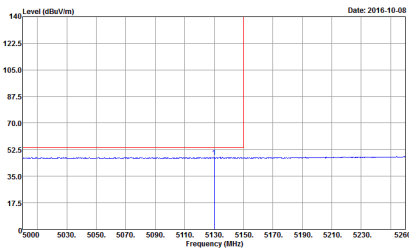

WIFI	Band 2 5250~5350MHz Band Edge @ 3m	
ANT	802.11n HT20 CH60 5300MHz - L	
1	Horizontal	Fundamental
Peak	 <p>Level (dBuV/m) vs Frequency (MHz) plot. Date: 2016-10-08. Site Condition: :03CH12-HY : PEAK_BE_74 3m HORN_9120D_1328 HORIZONTAL</p>	 <p>Level (dBuV/m) vs Frequency (MHz) plot. Date: 2016-10-08. Site Condition: :03CH12-HY : PEAK_74 3m HORN_9120D_1328 HORIZONTAL</p>
Avg.	 <p>Level (dBuV/m) vs Frequency (MHz) plot. Date: 2016-10-08. Site Condition: :03CH12-HY : AVG_BE_54 3m HORN_9120D_1328 HORIZONTAL</p>	Left blank

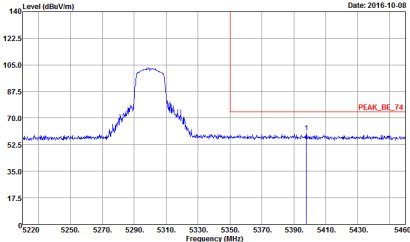
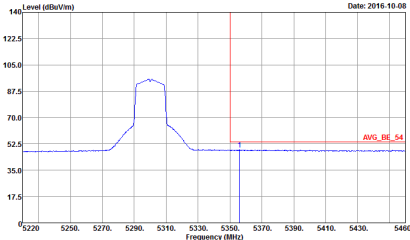

WIFI	Band 2 5250~5350MHz Band Edge @ 3m	
ANT	802.11n HT20 CH60 5300MHz - R	
1	Horizontal	Vertical
Peak	 <p>Date: 2016-10-08</p> <p>Site Condition : 03CH12-HY : PEAK_BE_74 3m HORN_9120D_1328 HORIZONTAL</p>	Left blank
Avg.	 <p>Date: 2016-10-08</p> <p>Site Condition : 03CH12-HY : AVG_BE_54 3m HORN_9120D_1328 HORIZONTAL</p>	Left blank

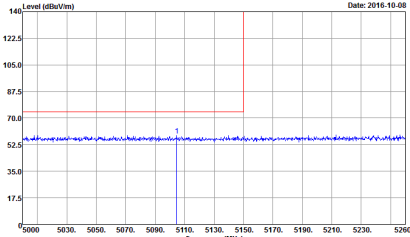
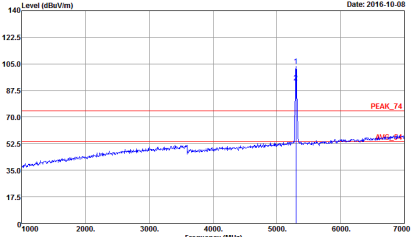
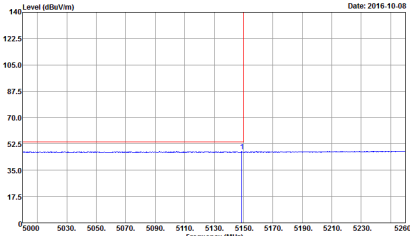

WIFI	Band 2 5250~5350MHz Band Edge @ 3m	
ANT	802.11n HT20 CH60 5300MHz - L	
1	Vertical	Fundamental
Peak	 <p>Site Condition : 03CH12-HY : PEAK_BE_74 3m HORN_9120D_1328 VERTICAL</p>	 <p>Site Condition : 03CH12-HY : PEAK_74 3m HORN_9120D_1328 VERTICAL</p>
Avg.	 <p>Site Condition : 03CH12-HY : AVG_BE_54 3m HORN_9120D_1328 VERTICAL</p>	Left blank



WIFI	Band 2 5250~5350MHz Band Edge @ 3m	
ANT	802.11n HT20 CH60 5300MHz - R	
1	Vertical	Fundamental
Peak	<p>Date: 2016-10-08</p> <p>Site Condition : :03CH12-HY :PEAK_BE_74 3m HORN_9120D_1328 VERTICAL</p>	Left blank
Avg.	<p>Date: 2016-10-08</p> <p>Site Condition : :03CH12-HY :AVG_BE_54 3m HORN_9120D_1328 VERTICAL</p>	Left blank



WIFI	Band 2 5250~5350MHz Band Edge @ 3m	
ANT	802.11n HT20 CH64 5320MHz	
1	Horizontal	Fundamental
Peak	<p>Date: 2016-10-08</p> <p>Site Condition : 03CH12-HY : PEAK_BE_74 3m HORN_9120D_1328 HORIZONTAL</p>	<p>Date: 2016-10-08</p> <p>Site Condition : 03CH12-HY : PEAK_74 3m HORN_9120D_1328 HORIZONTAL</p>
Avg.	<p>Date: 2016-10-08</p> <p>Site Condition : 03CH12-HY : AVG_BE_54 3m HORN_9120D_1328 HORIZONTAL</p>	Left blank



WIFI	Band 2 5250~5350MHz Band Edge @ 3m	
ANT	802.11n HT20 CH64 5320MHz	
1	Vertical	Fundamental
Peak	<p>Site Condition : 03CH12-HY : PEAK_BE_74 3m HORN_9120D_1328 VERTICAL</p>	<p>Site Condition : 03CH12-HY : PEAK_74 3m HORN_9120D_1328 VERTICAL</p>
Avg.	<p>Site Condition : 03CH12-HY : AVG_BE_54 3m HORN_9120D_1328 VERTICAL</p>	Left blank



Band 2 5250~5350MHz
WIFI 802.11n HT40 (Band Edge @ 3m)

Table with 2 columns: Horizontal, Fundamental. Rows include Peak and vg. Each cell contains a spectral plot with Level (dBuV/m) vs Frequency (MHz) and associated site/condition data.



WIFI	Band 2 5250~5350MHz Band Edge @ 3m	
ANT	802.11n HT40 CH54 5270 - R	
1	Horizontal	Fundamental
Peak	<p>Site Condition : 03CH12-HY : PEAK_BE_74 3m HORN_9120D_1328 HORIZONTAL</p>	Left blank
Avg.	<p>Site Condition : 03CH12-HY : AVG_BE_54 3m HORN_9120D_1328 HORIZONTAL</p>	Left blank



WIFI	Band 2 5250~5350MHz Band Edge @ 3m	
ANT	802.11n HT40 CH54 5270 - L	
1	Vertical	Vertical
Peak	<p>Site Condition : 03CH12-HY : PEAK_BE_74 3m HORN_9120D_1328 VERTICAL</p>	<p>Site Condition : 03CH12-HY : PEAK_74 3m HORN_9120D_1328 VERTICAL</p>
Avg.	<p>Site Condition : 03CH12-HY : AVG_BE_54 3m HORN_9120D_1328 VERTICAL</p>	Left blank

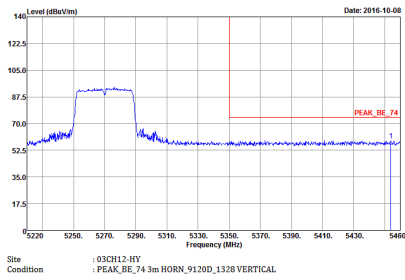
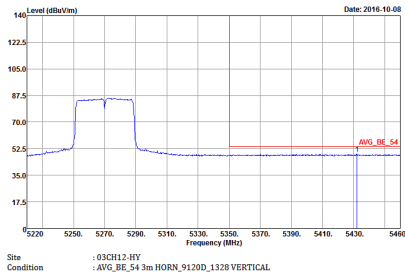

WIFI	Band 2 5250~5350MHz Band Edge @ 3m	
ANT	802.11n HT40 CH54 5270 - R	
1	Vertical	Vertical
Peak		Left blank
Avg.		Left blank

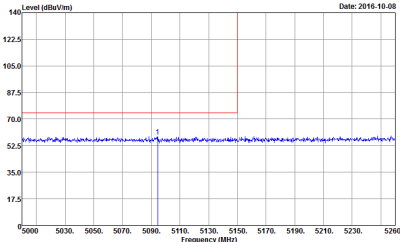
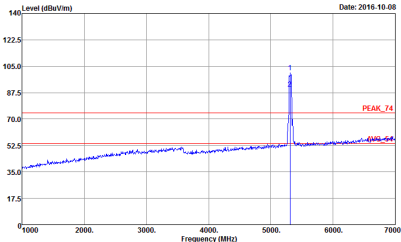
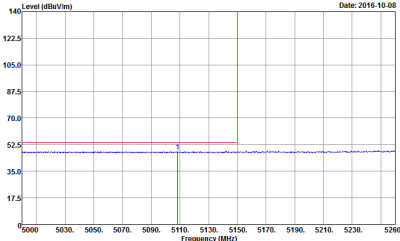

WIFI	Band 2 5250~5350MHz Band Edge @ 3m	
ANT	802.11n HT40 CH62 5310 - L	
1	Horizontal	Fundamental
Peak	 <p>Site Condition : 03CH12-HY : PEAK_BE_74 3m HORN_9120D_1328 HORIZONTAL</p>	 <p>Site Condition : 03CH12-HY : PEAK_74 3m HORN_9120D_1328 HORIZONTAL</p>
Avg.	 <p>Site Condition : 03CH12-HY : AVG_BE_54 3m HORN_9120D_1328 HORIZONTAL</p>	Left blank



WIFI	Band 2 5250~5350MHz Band Edge @ 3m	
ANT	802.11n HT40 CH62 5310 - R	
1	Horizontal	Fundamental
Peak	<p>Site Condition : 03CH12-HY : PEAK_BE_74 3m HORN_9120D_1328 HORIZONTAL</p>	Left blank
Avg.	<p>Site Condition : 03CH12-HY : AVG_BE_54 3m HORN_9120D_1328 HORIZONTAL</p>	Left blank

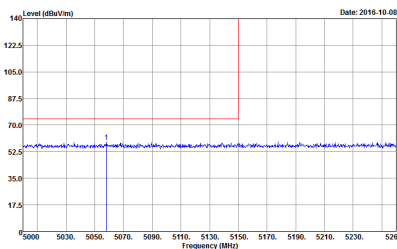
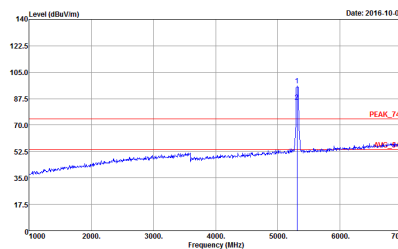
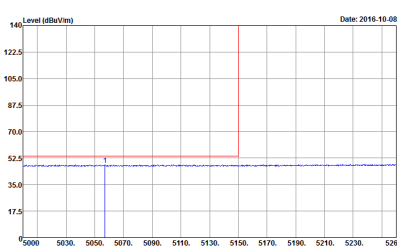

WIFI	Band 2 5250~5350MHz Band Edge @ 3m	
ANT	802.11n HT40 CH62 5310 - L	
1	Vertical	Fundamental
Peak	 <p>Date: 2016-10-08</p> <p>Site Condition : 03CH12-HY : PEAK_BE_74 3m HORN_9120D_1328 VERTICAL</p>	 <p>Date: 2016-10-08</p> <p>Site Condition : 03CH12-HY : PEAK_74 3m HORN_9120D_1328 VERTICAL</p>
Avg.	 <p>Date: 2016-10-08</p> <p>Site Condition : 03CH12-HY : AVG_BE_54 3m HORN_9120D_1328 VERTICAL</p>	Left blank

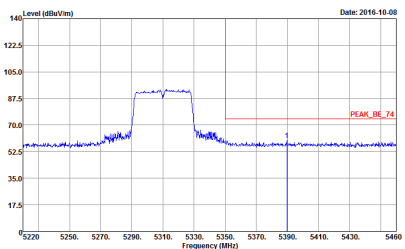
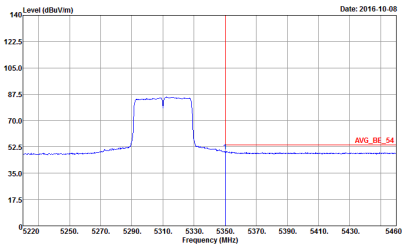

WIFI	Band 2 5250~5350MHz Band Edge @ 3m	
ANT	802.11n HT40 CH62 5310 - R	
1	Vertical	Fundamental
Peak	 <p>Site : 03CH12-HY Condition : PEAK_BE_74 3m HORN_9120D_1328 VERTICAL</p>	Left blank
Avg.	 <p>Site : 03CH12-HY Condition : AVG_BE_54 3m HORN_9120D_1328 VERTICAL</p>	Left blank



Band 2 - 5250~5350MHz
WIFI 802.11a (Harmonic @ 3m)

WIFI	Band 2 5250~5350MHz Harmonic @ 3m	
ANT	802.11a CH52 5260MHz	
1	Horizontal	Vertical
Peak Avg.	<p>Site Condition : 03CH12-HY : PEAK_74 3m HORN_9120D_1328 HORIZONTAL</p>	<p>Site Condition : 03CH12-HY : PEAK_74 3m HORN_9120D_1328 VERTICAL</p>



WIFI	Band 2 5250~5350MHz Harmonic @ 3m	
ANT	802.11a CH60 5300MHz	
1	Horizontal	Vertical
Peak Avg.	<p>Site Condition : :03CH12-HY : PEAK_74 3m HORN_9120D_1328 HORIZONTAL</p>	<p>Site Condition : :03CH12-HY : PEAK_74 3m HORN_9120D_1328 VERTICAL</p>

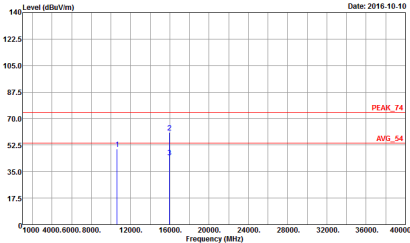
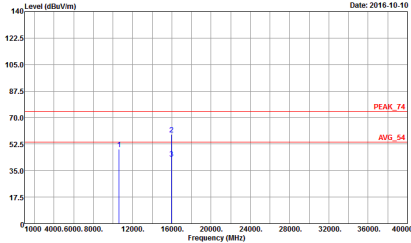

WIFI	Band 2 5250~5350MHz Harmonic @ 3m	
ANT	802.11a CH64 5320MHz	
1	Horizontal	Vertical
Peak Avg.	 <p>Site Condition : :03CH12-HY : PEAK_74 3m HORN_9120D_1328 HORIZONTAL</p>	 <p>Site Condition : :03CH12-HY : PEAK_74 3m HORN_9120D_1328 VERTICAL</p>



Band 2 5250~5350MHz
WIFI 802.11n HT20 (Harmonic @ 3m)

WIFI	Band 2 5250~5350MHz Harmonic @ 3m	
ANT	802.11n HT20 CH52 5260MHz	
1	Horizontal	Vertical
Peak Avg.	<p>Site Condition : 03CH12-HY : PEAK_74 3m HORN_9120D_1328 HORIZONTAL</p>	<p>Site Condition : 03CH12-VY : PEAK_74 3m HORN_9120D_1328 VERTICAL</p>



WIFI	Band 2 5250~5350MHz Harmonic @ 3m	
ANT	802.11n HT20 CH60 5300MHz	
1	Horizontal	Vertical
Peak Avg.	<p>Site Condition : 03CH12-HY : PEAK_74 3m HORN_9120D_1328 HORIZONTAL</p>	<p>Site Condition : 03CH12-HY : PEAK_74 3m HORN_9120D_1328 VERTICAL</p>

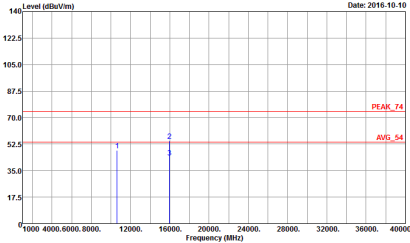
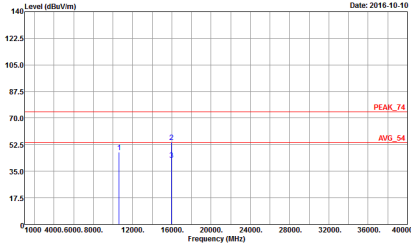

WIFI	Band 2 5250~5350MHz Harmonic @ 3m	
ANT	802.11n HT20 CH64 5320MHz	
1	Horizontal	Vertical
<p>Peak Avg.</p>	 <p>Site Condition : :03CH12-HY : PEAK_74 3m HORN_9120D_1328 HORIZONTAL</p>	 <p>Site Condition : :03CH12-HY : PEAK_74 3m HORN_9120D_1328 VERTICAL</p>

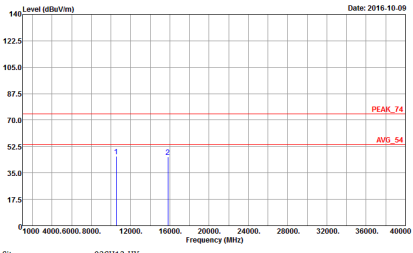
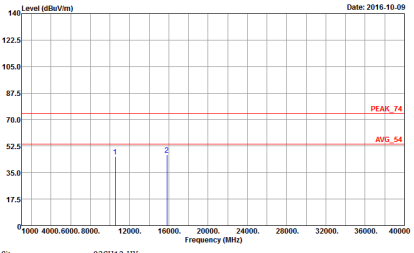

Band 2 5250~5350MHz
WIFI 802.11n HT40 (Harmonic @ 3m)

WIFI	Band 2 5250~5350MHz Harmonic @ 3m	
ANT	802.11n HT40 CH54 5270	
1	Horizontal	Vertical
<p>Peak Avg.</p>	 <p>Site Condition : 03CH12-11Y : PEAK_74 3m HORN_9120D_1328 HORIZONTAL</p>	 <p>Site Condition : 03CH12-11Y : PEAK_74 3m HORN_9120D_1328 VERTICAL</p>

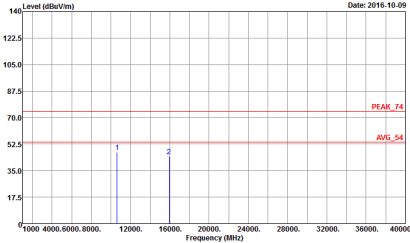
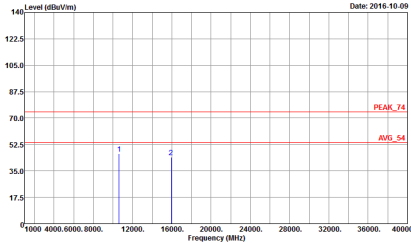

WIFI	Band 2 5250~5350MHz Harmonic @ 3m	
ANT	802.11n HT40 CH62 5310	
1	Horizontal	Vertical
<p>Peak</p> <p>Avg.</p>	 <p>Site Condition : :03CH12-HY : PEAK_74 3m HORN_9120D_1328 HORIZONTAL</p>	 <p>Site Condition : :03CH12-HY : PEAK_74 3m HORN_9120D_1328 VERTICAL</p>



Band 3 - 5470~5725MHz
WIFI 802.11a (Band Edge @ 3m)

WIFI	Band 3 5470~5725MHz Band Edge @ 3m	
ANT	802.11a CH100 5500MHz	
1	Horizontal	Fundamental
Peak	<p>Date: 2016-10-07</p> <p>Site Condition : 03CH12-HY : PEAK_BE_74 3m HORN_9120D_1328 HORIZONTAL</p>	<p>Date: 2016-10-07</p> <p>Site Condition : 03CH12-HY : PEAK_74 3m HORN_9120D_1328 HORIZONTAL</p>
Avg.	<p>Date: 2016-10-07</p> <p>Site Condition : 03CH12-HY : AVG_BE_54 3m HORN_9120D_1328 HORIZONTAL</p>	Left blank



WIFI	Band 3 5470~5725MHz Band Edge @ 3m	
ANT	802.11a CH100 5500MHz	
1	Vertical	Fundamental
Peak	<p>Level (dBuV/m) vs Frequency (MHz) graph. Date: 2016-10-07. The graph shows a baseline level around 52.5 dBuV/m until approximately 5470 MHz, where it begins to rise, reaching a peak of about 105 dBuV/m at 5500 MHz. A red vertical line is drawn at 5500 MHz. Site Condition: :03CH12-HY :PEAK_BE_74 3m HORN_9120D_1328 VERTICAL.</p>	<p>Level (dBuV/m) vs Frequency (MHz) graph. Date: 2016-10-08. The graph shows a baseline level around 52.5 dBuV/m until approximately 5470 MHz, where it begins to rise, reaching a peak of about 105 dBuV/m at 5500 MHz. A red vertical line is drawn at 5500 MHz. Site Condition: :03CH12-HY :PEAK_74 3m HORN_9120D_1328 VERTICAL.</p>
Avg.	<p>Level (dBuV/m) vs Frequency (MHz) graph. Date: 2016-10-07. The graph shows a baseline level around 52.5 dBuV/m until approximately 5470 MHz, where it begins to rise, reaching a peak of about 105 dBuV/m at 5500 MHz. A red vertical line is drawn at 5500 MHz. Site Condition: :03CH12-HY :AVG_BE_54 3m HORN_9120D_1328 VERTICAL.</p>	Left blank



WIFI	Band 3 5470~5725MHz Band Edge @ 3m	
ANT	802.11a CH116 5580MHz - L	
1	Horizontal	Fundamental
Peak	<p>Site Condition : :03CH12-HY : PEAK_BE_74 3m HORN_9120D_1328 HORIZONTAL</p>	<p>Site Condition : :03CH12-HY : PEAK_74 3m HORN_9120D_1328 HORIZONTAL</p>
Avg.	<p>Site Condition : :03CH12-HY : AVG_BE_54 3m HORN_9120D_1328 HORIZONTAL</p>	Left blank

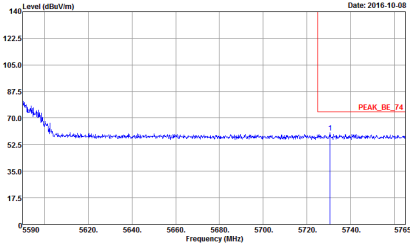
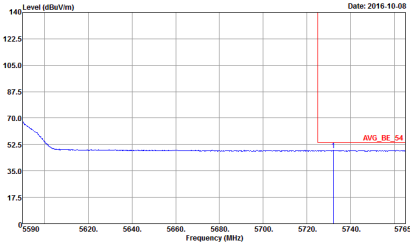

WIFI	Band 3 5470~5725MHz Band Edge @ 3m	
ANT	802.11a CH116 5580MHz - R	
1	Horizontal	Fundamental
<p>Peak</p>	 <p>Site Condition : :03CH12-HY : PEAK_BE_74 3m HORN_9120D_1328 HORIZONTAL</p>	<p>Left blank</p>
<p>Avg.</p>	 <p>Site Condition : :03CH12-HY : AVG_BE_54 3m HORN_9120D_1328 HORIZONTAL</p>	<p>Left blank</p>



WIFI	Band 3 5470~5725MHz Band Edge @ 3m	
ANT	802.11a CH116 5580MHz - L	
1	Vertical	Fundamental
Peak	<p>Date: 2016-10-08</p> <p>Site Condition : :03CH12-HY : PEAK_BE_74 3m HORN_9120D_1328 VERTICAL</p>	<p>Date: 2016-10-08</p> <p>Site Condition : :03CH12-HY : PEAK_74 3m HORN_9120D_1328 VERTICAL</p>
Avg.	<p>Date: 2016-10-08</p> <p>Site Condition : :03CH12-HY : AVG_BE_54 3m HORN_9120D_1328 VERTICAL</p>	Left blank

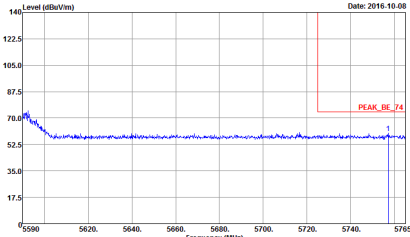
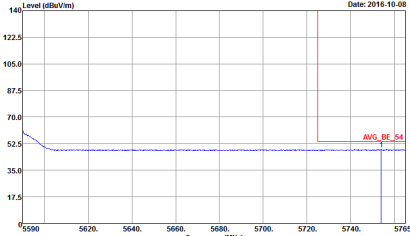

WIFI	Band 3 5470~5725MHz Band Edge @ 3m	
ANT	802.11a CH116 5580MHz - R	
1	Vertical	Fundamental
Peak	 <p>Date: 2016-10-08</p> <p>Site Condition : :03CH112-HY : PEAK_BE_74 3m HORN_9120D_1328 VERTICAL</p>	Left blank
Avg.	 <p>Date: 2016-10-08</p> <p>Site Condition : :03CH112-HY : AVG_BE_54 3m HORN_9120D_1328 VERTICAL</p>	Left blank



WIFI	Band 3 5470~5725MHz Band Edge @ 3m	
ANT	802.11a CH140 5700MHZ	
1	Horizontal	Fundamental
Peak	<p>Site Condition : 03CH12-HY : PEAK_BE_74 3m HORN_9120D_1328 HORIZONTAL</p>	<p>Site Condition : 03CH12-HY : PEAK_74 3m HORN_9120D_1328 HORIZONTAL</p>
Avg.	<p>Site Condition : 03CH12-HY : AVG_BE_54 3m HORN_9120D_1328 HORIZONTAL</p>	Left blank

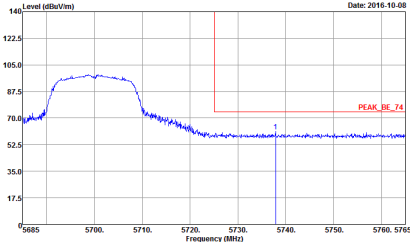
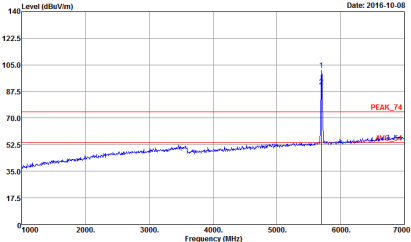
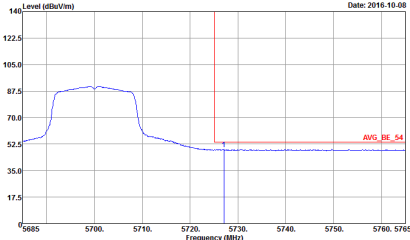

WIFI	Band 3 5470~5725MHz Band Edge @ 3m	
ANT	802.11a CH140 5700MHz	
1	Vertical	Fundamental
Peak	 <p>Date: 2016-10-08</p> <p>Site Condition : :03CH12-HY : PEAK_BE_74 3m HORN_9120D_1328 VERTICAL.</p>	 <p>Date: 2016-10-08</p> <p>Site Condition : :03CH12-HY : PEAK_74 3m HORN_9120D_1328 VERTICAL.</p>
Avg.	 <p>Date: 2016-10-08</p> <p>Site Condition : :03CH12-HY : AVG_BE_54 3m HORN_9120D_1328 VERTICAL.</p>	Left blank



Band 3 5470~5725MHz
WIFI 802.11n HT20 (Band Edge @ 3m)

Table with 3 columns: WIFI, ANT, and test results. Row 1: Peak, Horizontal, Fundamental. Row 2: Avg., Horizontal, Left blank. Includes spectral plots for each test.



WIFI	Band 3 5470~5725MHz Band Edge @ 3m	
ANT	802.11n HT20 CH100 5500MHz	
1	Vertical	Fundamental
Peak	<p>Site Condition : 03CH12-HY : PEAK_BE_74 3m HORN_9120D_1328 VERTICAL</p>	<p>Site Condition : 03CH12-HY : PEAK_74 3m HORN_9120D_1328 VERTICAL</p>
Avg.	<p>Site Condition : 03CH12-HY : AVG_BE_54 3m HORN_9120D_1328 VERTICAL</p>	Left blank

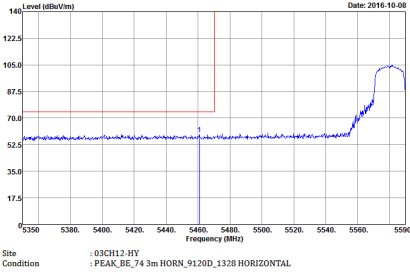
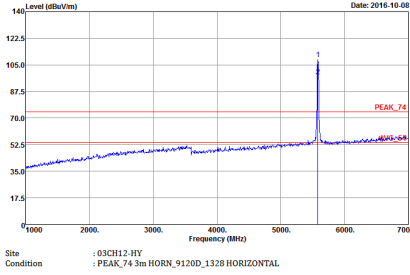
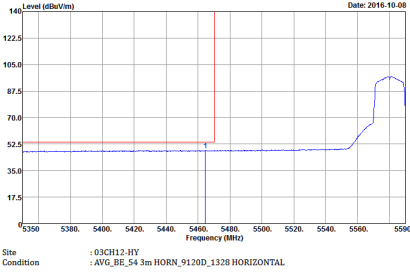

WIFI	Band 3 5470~5725MHz Band Edge @ 3m	
ANT	802.11n HT20 CH116 5580MHz - L	
1	Horizontal	Fundamental
Peak		
Avg.		Left blank



WIFI	Band 3 5470~5725MHz Band Edge @ 3m	
ANT	802.11n HT20 CH116 5580MHz - R	
1	Horizontal	Fundamental
Peak	<p>Site Condition : 03CH12-HY : PEAK_BE_74 3m HORN_9120D_1328 HORIZONTAL</p>	Left blank
Avg.	<p>Site Condition : 03CH12-HY : AVG_BE_54 3m HORN_9120D_1328 HORIZONTAL</p>	Left blank



WIFI	Band 3 5470~5725MHz Band Edge @ 3m	
ANT	802.11n HT20 CH116 5580MHz - L	
1	Vertical	Fundamental
Peak	<p>Site Condition : :03CH12-HY : PEAK_BE_74 3m HORN_9120D_1328 VERTICAL</p>	<p>Site Condition : :03CH12-HY : PEAK_74 3m HORN_9120D_1328 VERTICAL</p>
Avg.	<p>Site Condition : :03CH12-HY : AVG_BE_54 3m HORN_9120D_1328 VERTICAL</p>	Left blank



WIFI	Band 3 5470~5725MHz Band Edge @ 3m	
ANT	802.11n HT20 CH116 5580MHz - R	
1	Vertical	Fundamental
Peak	<p>Site Condition : :03CH12-HY : PEAK_BE_74 3m HORN_9120D_1328 VERTICAL.</p>	Left blank
Avg.	<p>Site Condition : :03CH12-HY : AVG_BE_54 3m HORN_9120D_1328 VERTICAL.</p>	Left blank

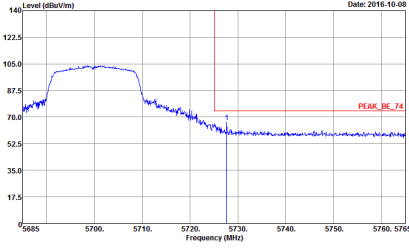
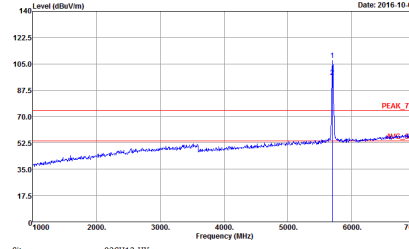
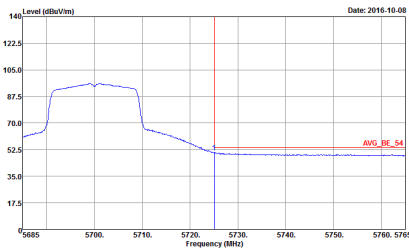

WIFI	Band 3 5470~5725MHz Band Edge @ 3m	
ANT	802.11n HT20 CH140 5700MHz	
1	Horizontal	Fundamental
Peak	 <p>Site Condition : 03CH12-HY : PEAK_BE_74 3m HORN_9120D_1328 HORIZONTAL</p>	 <p>Site Condition : 03CH12-HY : PEAK_74 3m HORN_9120D_1328 HORIZONTAL</p>
Avg.	 <p>Site Condition : 03CH12-HY : AVG_BE_54 3m HORN_9120D_1328 HORIZONTAL</p>	Left blank

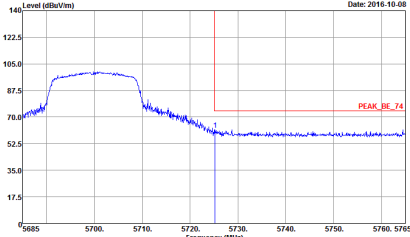
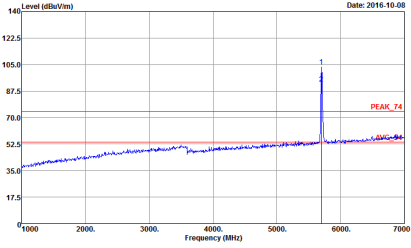
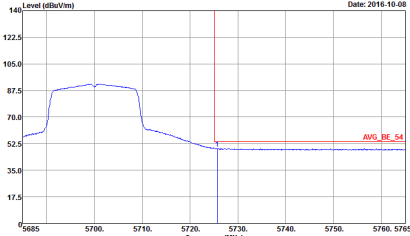

WIFI	Band 3 5470~5725MHz Band Edge @ 3m	
ANT	802.11n HT20 CH140 5700MHz	
1	Vertical	Fundamental
Peak.	 <p>Date: 2016-10-08</p> <p>Site Condition : :03CH12-HY : PEAK_BE_74 3m HORN_9120D_1328 VERTICAL</p>	 <p>Date: 2016-10-08</p> <p>Site Condition : :03CH12-HY : PEAK_74 3m HORN_9120D_1328 VERTICAL</p>
Avg.	 <p>Date: 2016-10-08</p> <p>Site Condition : :03CH12-HY : AVG_BE_54 3m HORN_9120D_1328 VERTICAL</p>	Left blank



Band 3 5470~5725MHz
WIFI 802.11n HT40 (Band Edge @ 3m)

Table with 3 columns: WIFI, ANT, and test results. Row 1: Peak, Horizontal, Fundamental. Row 2: Avg., Left blank.



WIFI	Band 3 5470~5725MHz Band Edge @ 3m	
ANT	802.11n HT40 CH102 5510MHz - R	
1	Horizontal	Fundamental
Peak	<p>Site Condition : 03CH12-HY : PEAK_BE(UNII)_B3 3m HORN_9120D_1328 HORIZONTAL</p>	Left blank



WIFI	Band 3 5470~5725MHz Band Edge @ 3m	
ANT	802.11n HT40 CH102 5510MHz - L	
1	Vertical	Fundamental
Peak	<p>Site Condition : 03CH12-HY : PEAK_BE(UNII)_B3 3m HORN_9120D_1328 VERTICAL</p>	<p>Site Condition : 03CH12-HY : PEAK(UNII) 3m HORN_9120D_1328 VERTICAL</p>
Avg.	<p>Site Condition : 03CH12-HY : AVG_BE(UNII)_B3 3m HORN_9120D_1328 VERTICAL</p>	Left blank



WIFI	Band 3 5470~5725MHz Band Edge @ 3m	
ANT	802.11n HT40 CH102 5510MHz - R	
1	Vertical	Fundamental
Peak	<p>Site : 03CH12-HY Condition : PEAK_BE(UNII)_B3 3m HORN_9120D_1328 VERTICAL</p>	Left blank



WIFI	Band 3 5470~5725MHz Band Edge @ 3m	
ANT	802.11n HT40 CH110 5550MHz - L	
1	Horizontal	Fundamental
Peak	<p>Site Condition : 03CH12-HY : PEAK_BE_74 3m HORN_9120D_1328 HORIZONTAL</p>	<p>Site Condition : 03CH12-HY : PEAK_74 3m HORN_9120D_1328 HORIZONTAL</p>
Avg.	<p>Site Condition : 03CH12-HY : AVG_BE_54 3m HORN_9120D_1328 HORIZONTAL</p>	Left blank

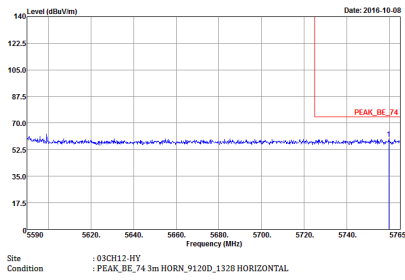
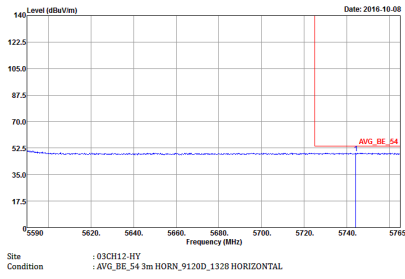

WIFI	Band 3 5470~5725MHz Band Edge @ 3m	
ANT	802.11n HT40 CH110 5550MHz - R	
1	Horizontal	Fundamental
Peak		Left blank
Avg.		Left blank



WIFI	Band 3 5470~5725MHz Band Edge @ 3m	
ANT	802.11n HT40 CH110 5550MHz - L	
1	Vertical	Fundamental
Peak	<p>Site Condition : 03CH12-HY : PEAK_BE_74 3m HORN_9120D_1328 VERTICAL</p>	<p>Site Condition : 03CH12-HY : PEAK_74 3m HORN_9120D_1328 VERTICAL</p>
Avg.	<p>Site Condition : 03CH12-HY : AVG_BE_54 3m HORN_9120D_1328 VERTICAL</p>	Left blank

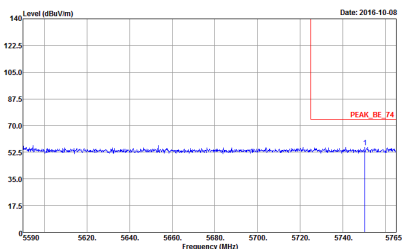
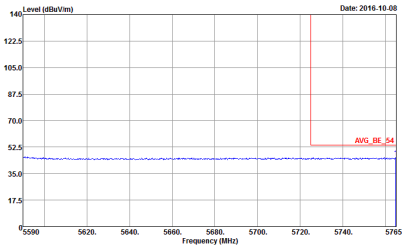

WIFI	Band 3 5470~5725MHz Band Edge @ 3m	
ANT	802.11n HT40 CH110 5550MHz - R	
1	Vertical	Fundamental
Peak	 <p>Date: 2016-10-08</p> <p>Site Condition : 03CH12.HY : PEAK_BE_74 3m HORN_9120D_1328 VERTICAL</p>	Left blank
Avg.	 <p>Date: 2016-10-08</p> <p>Site Condition : 03CH12.HY : AVG_BE_54 3m HORN_9120D_1328 VERTICAL</p>	Left blank



WIFI	Band 3 5470~5725MHz Band Edge @ 3m	
ANT	802.11n HT40 CH134 5670MHz - L	
1	Horizontal	Fundamental
Peak	<p>Date: 2016-10-08</p> <p>Site Condition : 03CH12-HY : PEAK_BE_74 3m HORN_9120D_1328 HORIZONTAL</p>	<p>Date: 2016-10-08</p> <p>Site Condition : 03CH12-HY : PEAK_74 3m HORN_9120D_1328 HORIZONTAL</p>
Avg.	<p>Date: 2016-10-08</p> <p>Site Condition : 03CH12-HY : AVG_BE_54 3m HORN_9120D_1328 HORIZONTAL</p>	Left blank

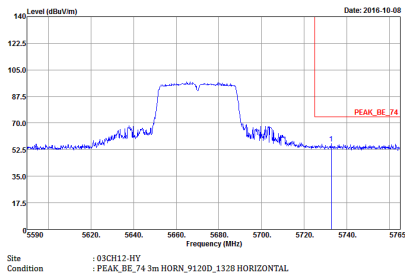
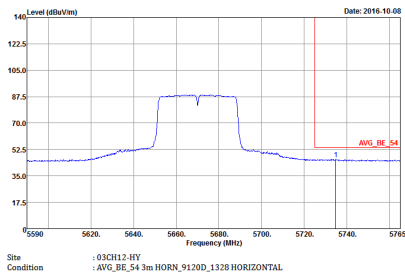

WIFI	Band 3 5470~5725MHz Band Edge @ 3m	
ANT	802.11n HT40 CH134 5670MHz - R	
1	Horizontal	Fundamental
Peak		Left blank
Avg.		Left blank

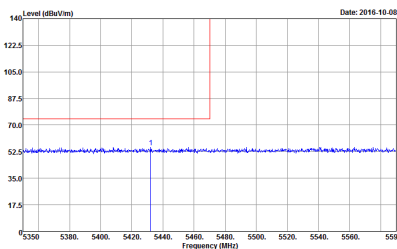
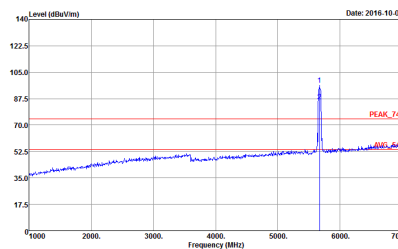
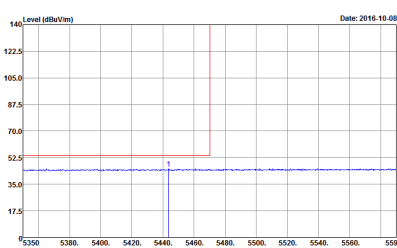

WIFI	Band 3 5470~5725MHz Band Edge @ 3m	
ANT	802.11n HT40 CH134 5670MHz - L	
1	Vertical	Fundamental
Peak	 <p>Date: 2016-10-08</p> <p>Site Condition : 03CH12-HY : PEAK_BE_74 3m HORN_9120D_1328 VERTICAL</p>	 <p>Date: 2016-10-08</p> <p>Site Condition : 03CH12-HY : PEAK_74 3m HORN_9120D_1328 VERTICAL</p>
Avg.	 <p>Date: 2016-10-08</p> <p>Site Condition : 03CH12-HY : AVG_BE_54 3m HORN_9120D_1328 VERTICAL</p>	Left blank



WIFI	Band 3 5470~5725MHz Band Edge @ 3m	
ANT	802.11n HT40 CH134 5670MHz - R	
1	Vertical	Fundamental
Peak	<p>Site Condition : 03CH12-HY : PEAK_BE_74 3m HORN_9120D_1328 VERTICAL</p>	Left blank
Avg.	<p>Site Condition : 03CH12-HY : AVG_BE_54 3m HORN_9120D_1328 VERTICAL</p>	Left blank



Band 3 - 5470~5725MHz
WIFI 802.11a (Harmonic @ 3m)

WIFI	Band 3 5470~5725MHz Harmonic @ 3m	
ANT	802.11a CH100 5500MHz	
1	Horizontal	Vertical
Peak Avg.	<p>Site Condition : 03CH12-HY : PEAK_74 3m HORN_9120D_1328 HORIZONTAL</p>	<p>Site Condition : 03CH12-HY : PEAK_74 3m HORN_9120D_1328 VERTICAL</p>

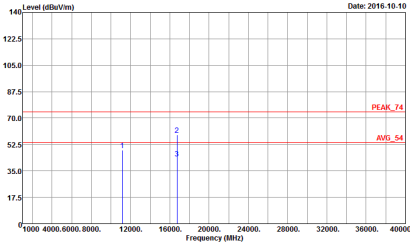
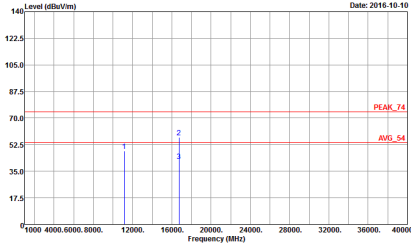

WIFI	Band 3 5470~5725MHz Harmonic @ 3m	
ANT	802.11a CH116 5580MHz	
1	Horizontal	Vertical
<p>Peak Avg.</p>	 <p>Site Condition : :03CH12-HY : PEAK_74 3m HORN_9120D_1328 HORIZONTAL</p>	 <p>Site Condition : :03CH12-HY : PEAK_74 3m HORN_9120D_1328 VERTICAL</p>



WIFI	Band 3 5470~5725MHz Harmonic @ 3m	
ANT	802.11a CH140 5700MHz	
1	Horizontal	Vertical
Peak Avg.	<p>Site Condition : :03CH12-HY : PEAK_74 3m HORN_9120D_1328 HORIZONTAL</p>	<p>Site Condition : :03CH12-HY : PEAK_74 3m HORN_9120D_1328 VERTICAL</p>



Band 3 5470~5725MHz
WIFI 802.11n HT20 (Harmonic @ 3m)

WIFI	Band 3 5470~5725MHz Harmonic @ 3m	
ANT	802.11n HT20 CH100 5500MHz	
1	Horizontal	Vertical
Peak Avg.	<p>Site Condition : 03CH12-11Y : PEAK_74 3m HORN_9120D_1328 HORIZONTAL</p>	<p>Site Condition : 03CH12-11Y : PEAK_74 3m HORN_9120D_1328 VERTICAL</p>

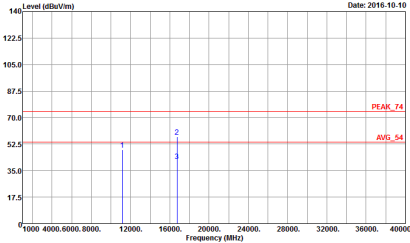
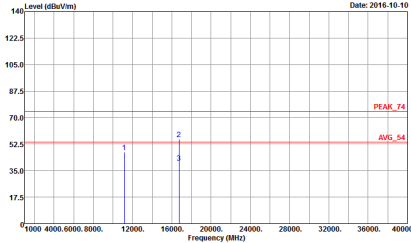

WIFI	Band 3 5470~5725MHz Harmonic @ 3m	
ANT	802.11n HT20 CH116 5580MHz	
1	Horizontal	Vertical
<p>Peak</p> <p>Avg.</p>	 <p>Site Condition : :03CH12-HY : PEAK_74 3m HORN_9120D_1328 HORIZONTAL</p>	 <p>Site Condition : :03CH12-HY : PEAK_74 3m HORN_9120D_1328 VERTICAL</p>



WIFI	Band 3 5470~5725MHz Harmonic @ 3m	
ANT	802.11n HT20 CH140 5700MHz	
1	Horizontal	Vertical
Peak Avg.	<p>Site Condition : :03CH12-HY : PEAK_74 3m HORN_9120D_1328 HORIZONTAL</p>	<p>Site Condition : :03CH12-HY : PEAK_74 3m HORN_9120D_1328 VERTICAL</p>



Band 3 5470~5725MHz
WIFI 802.11n HT40 (Harmonic @ 3m)

WIFI	Band 3 5470~5725MHz Harmonic @ 3m	
ANT	802.11n HT40 CH102 5510MHz	
1	Horizontal	Vertical
Peak Avg.	<p>Site Condition : 03CH12-HY : PEAK(UNI) 3m HORN_9120D_1328 HORIZONTAL</p>	<p>Site Condition : 03CH12-HY : PEAK(UNI) 3m HORN_9120D_1328 VERTICAL</p>



WIFI	Band 3 5470~5725MHz Harmonic @ 3m	
ANT	802.11n HT40 CH110 5550MHz	
1	Horizontal	Vertical
Peak Avg.	<p>Site Condition : 03CH12-HY : PEAK_74 3m HORN_9120D_1328 HORIZONTAL</p>	<p>Site Condition : 03CH12-HY : PEAK_74 3m HORN_9120D_1328 VERTICAL</p>



WIFI	Band 3 5470~5725MHz Harmonic @ 3m	
ANT	802.11n HT40 CH134 5670MHz	
1	Horizontal	Vertical
Peak Avg.	<p>Site Condition : 03CH12-HY : PEAK_74 3m HORN_9120D_1328 HORIZONTAL</p>	<p>Site Condition : 03CH12-HY : PEAK_74 3m HORN_9120D_1328 VERTICAL</p>



Band 3 5470~5725MHz

Band 3 - Straddle Channel

WIFI 802.11a (Fundamental @ 3m)

WIFI	Band 3 Straddle Channel Fundamental @ 3m	
ANT	802.11a CH144 5720MHz	
1	Horizontal	Vertical
<p>Peak Avg.</p>		



Band 3 – Straddle Channel
WIFI 802.11n HT20 (Fundamental @ 3m)

WIFI	Band 3 Straddle Channel Fundamental @ 3m	
ANT	802.11n HT20 CH144 5720MHz	
1	Horizontal	Vertical
Peak Avg.		

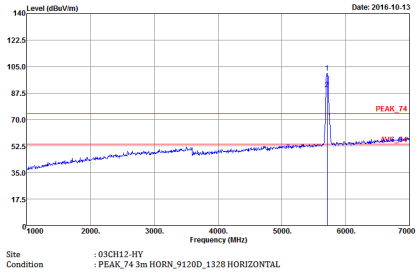
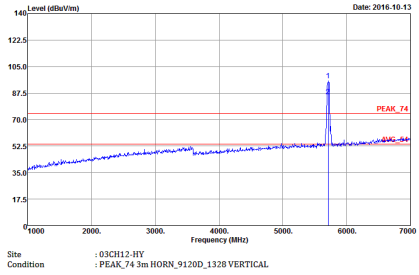

Band 3 – Straddle Channel
WIFI 802.11n HT40 (Fundamental @ 3m)

WIFI	Band 3 Straddle Channel Fundamental @ 3m	
ANT	802.11n HT40 CH142 5710MHz	
1	Horizontal	Vertical
Peak Avg.	 <p>Site Condition : 03CH12-11Y : PEAK_74 3m HORN_9120D_1328 HORIZONTAL</p>	 <p>Site Condition : 03CH12-11Y : PEAK_74 3m HORN_9120D_1328 VERTICAL</p>



Band 3 – Straddle Channel

Band 3 - Straddle Channel

WIFI 802.11a (Harmonic @ 3m)

WIFI	Band 3 Straddle Channel Harmonic @ 3m	
ANT	802.11a CH144 5720MHz	
1	Horizontal	Vertical
Peak Avg.	<p>Site Condition : 03CH12-HY : PEAK_74 3m HORN_9120D_1328 HORIZONTAL</p>	<p>Site Condition : 03CH12-HY : PEAK_74 3m HORN_9120D_1328 VERTICAL</p>



Band 3 – Straddle Channel
WIFI 802.11n HT20 (Harmonic @ 3m)

WIFI	Band 3 Straddle Channel Harmonic @ 3m	
ANT	802.11n HT20 CH144 5720MHz	
1	Horizontal	Vertical
<p>Peak Avg.</p>	<p>Site Condition : 03CH12-HY : PEAK_74 3m HORN_9120D_1328 HORIZONTAL</p>	<p>Site Condition : 03CH12-HY : PEAK_74 3m HORN_9120D_1328 VERTICAL</p>



Band 3 – Straddle Channel
WIFI 802.11n HT40 (Harmonic @ 3m)

WIFI	Band 3 Straddle Channel Harmonic @ 3m	
ANT	802.11n HT40 CH142 5710MHz	
1	Horizontal	Vertical
Peak Avg.	<p>Site Condition : 03CH12-HY : PEAK_74 3m HORN_9120D_1328 HORIZONTAL</p>	<p>Site Condition : 03CH12-HY : PEAK_74 3m HORN_9120D_1328 VERTICAL</p>



Band 3 – Straddle Channel

Emission below 1GHz

5GHz WIFI 802.11a (LF)

WIFI	5GHz WIFI	
ANT	802.11a LF	
1	Horizontal	Vertical
QP / Peak	<p>Site Condition : 03CH12-HY : QP 3m BILOG_6111D_37059 HORIZONTAL</p>	<p>Site Condition : 03CH12-HY : QP 3m BILOG_6111D_37059 VERTICAL</p>



Emission below 1GHz
5GHz WIFI 802.11n HT20 (LF)

WIFI	5GHz WIFI	
ANT	802.11n HT20 LF	
1	Horizontal	Vertical
QP / Peak	<p>Horizontal emission spectrum plot showing Level (dBuV/m) vs Frequency (MHz) from 30 to 1000 MHz. The plot shows a blue signal line with several peaks and a red step function. The date is 2016-10-11. Site Condition: :03CH12-HY :QP 3m BILOG_6111D_37059 HORIZONTAL.</p>	<p>Vertical emission spectrum plot showing Level (dBuV/m) vs Frequency (MHz) from 30 to 1000 MHz. The plot shows a blue signal line with several peaks and a red step function. The date is 2016-10-11. Site Condition: :03CH12-HY :QP 3m BILOG_6111D_37059 VERTICAL.</p>

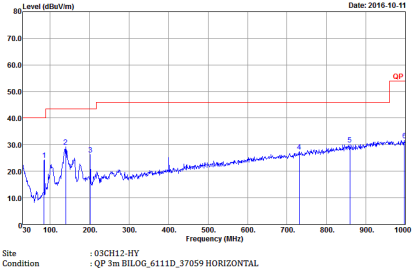
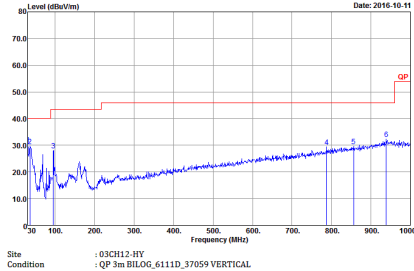

Emission below 1GHz
5GHz WIFI 802.11n HT40 (LF)

WIFI	5GHz WIFI	
ANT	802.11n HT40 LF	
1	Horizontal	Vertical
QP / Peak		



Appendix D Duty Cycle Plots

Band	Duty Cycle(%)	T(us)	1/T(kHz)	VBW Setting
802.11a	96.53	1390	0.72	1kHz
5GHz 802.11n HT20	96.65	1300	0.77	1kHz
5GHz 802.11n HT40	94.2	650	1.54	3kHz

802.11a

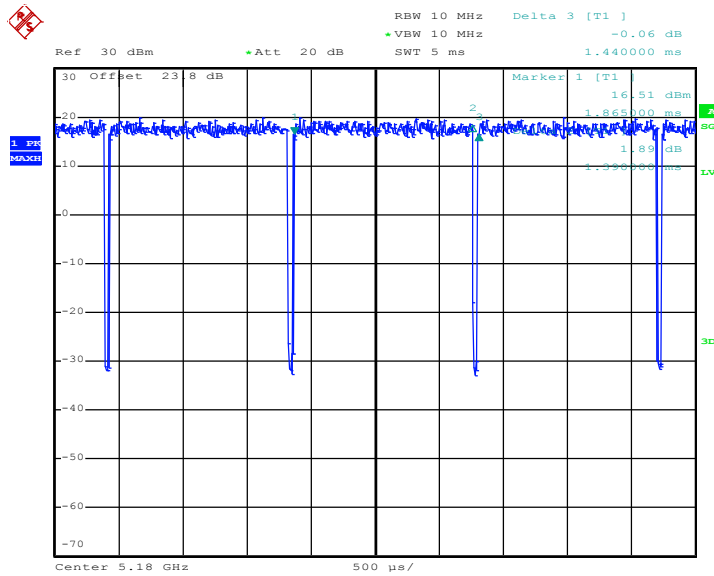

Date: 6.OCT.2016 10:29:57



5GHz 802.11n HT20

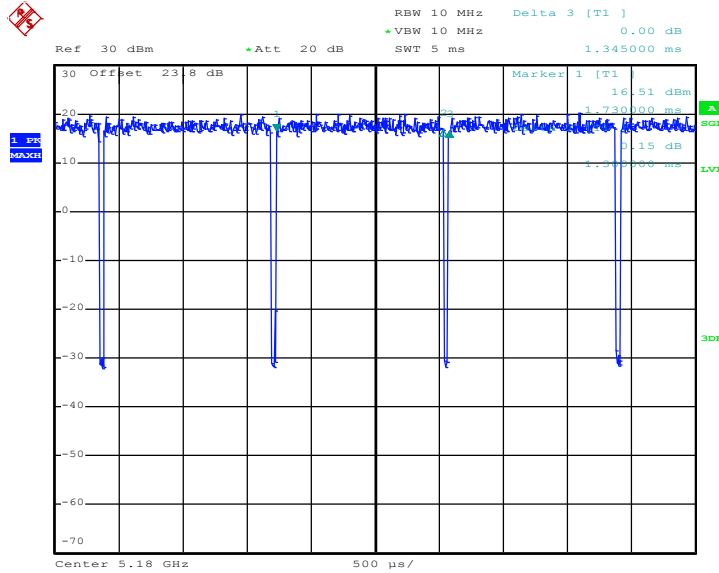

Date: 6.OCT.2016 10:41:44

5GHz 802.11n HT40

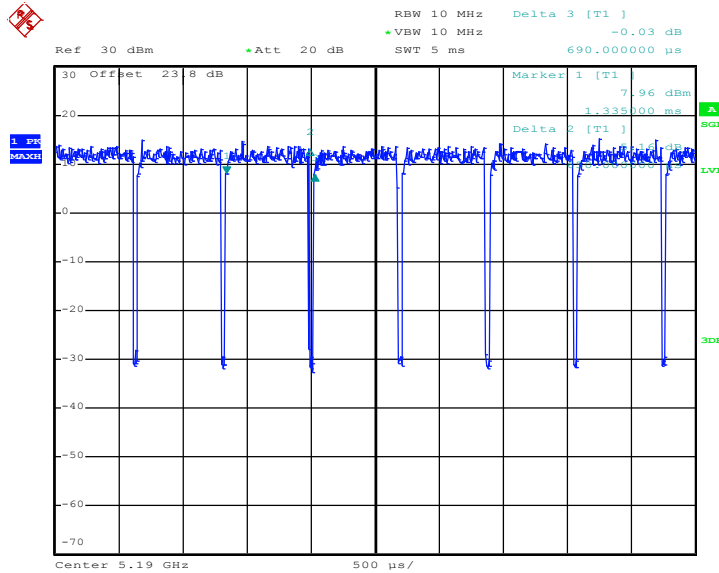

Date: 6.OCT.2016 10:43:58