



FCC RF Test Report

APPLICANT : Sony Mobile Communications Inc.
EQUIPMENT : GSM/WCDMA/LTE Phone+Bluetooth, DTS/UNII a/b/g/n and NFC
BRAND NAME : Sony
FCC ID : PY7-84773W
STANDARD : FCC Part 15 Subpart C §15.225
CLASSIFICATION : (DXX) Low Power Communication Device Transmitter

The testing was completed on Nov. 11, 2016. We, SPORTON INTERNATIONAL INC., would like to declare that the tested sample has been evaluated in accordance with the test procedures and has been in compliance with the applicable technical standards.

The test results in this report apply exclusively to the tested model / sample. Without written approval of SPORTON INTERNATIONAL INC., the test report shall not be reproduced except in full.

Reviewed by: Joseph Lin / Supervisor

Approved by: Jones Tsai / Manager



SPORTON INTERNATIONAL INC.

No. 52, Hwa Ya 1st Rd., Hwa Ya Technology Park, Kwei-Shan District, Tao Yuan City, Taiwan, R.O.C.



TABLE OF CONTENTS

SUMMARY OF THE TEST RESULT4

1. GENERAL INFORMATION.....5

1.1 Applicant..... 5

1.2 Manufacturer 5

1.3 Product Feature of Equipment Under Test 5

1.4 Product Specification of Equipment Under Test 6

1.5 Modification of EUT 6

1.6 Testing Location 7

1.7 Applicable Standards..... 7

2. TEST CONFIGURATION OF EQUIPMENT UNDER TEST8

2.1 Descriptions of Test Mode 8

2.2 Connection Diagram of Test System 8

2.3 Table for Supporting Units 9

2.4 EUT Operation Test Setup 9

3. TEST RESULTS.....10

3.1 AC Power Line Conducted Emissions Measurement 10

3.2 20dB and 99% OBW Spectrum Bandwidth Measurement..... 12

3.3 Frequency Stability Measurement 13

3.4 Field Strength of Fundamental Emissions and Mask Measurement..... 14

3.5 Radiated Emissions Measurement 16

3.6 Antenna Requirements..... 19

4. LIST OF MEASURING EQUIPMENT20

APPENDIX A. TEST RESULTS OF CONDUCTED EMISSION TEST

APPENDIX B. TEST RESULTS OF CONDUCTED TEST ITEMS

B1. Test Result of 20dB Spectrum Bandwidth

B2. Test Result of Frequency Stability

APPENDIX C. TEST RESULTS OF RADIATED TEST ITEMS

C1. Test Result of Field Strength of Fundamental Emissions

C2. Results of Radiated Emissions (9 kHz~30MHz)

C3. Results of Radiated Emissions (30MHz~1GHz)

APPENDIX D. VERIFICATION OF RADIATED SPURIOUS EMISSIONS AT OPEN-AREA TEST SITE

D.1 Results of Radiated Emissions (9 kHz~30MHz)

D.2 LIST OF MEASURING EQUIPMENT



REVISION HISTORY

REPORT NO.	VERSION	DESCRIPTION	ISSUED DATE
FR692208-01D	Rev. 01	Initial issue of report	Feb. 06, 2017



SUMMARY OF THE TEST RESULT

Applied Standard: 47 CFR FCC Part 15 Subpart C / IC RSS-210 issue 9				
Part	FCC Rule	Description of Test	Result	Under Limit
3.1	15.207	AC Power Line Conducted Emissions	Complies	14.20 dB at 0.462MHz
3.2	15.215(c)	20dB Spectrum Bandwidth	Complies	-
	-	99% OBW Spectrum Bandwidth	Complies	-
3.3	15.225(e)	Frequency Stability	Complies	-
3.4	15.225(a)(b)(c)	Field Strength of Fundamental Emissions	Complies	59.81 dB at 13.560 MHz
3.5	15.225(d) 15.209	Radiated Emissions	Complies	3.03 dB at 40.680 MHz for Quasi-Peak
3.6	15.203	Antenna Requirements	Complies	-

Test Items	Uncertainty	Remark
AC Power Line Conducted Emissions	±2.70dB	Confidence levels of 95%
Radiated Emissions (30MHz~1000MHz)	±5.70dB	Confidence levels of 95%



1. GENERAL INFORMATION

1.1 Applicant

Sony Mobile Communications Inc.

4-12-3 Higashi-Shinagawa, Shinagawa-ku, Tokyo, 140-0002, Japan

1.2 Manufacturer

Sony Mobile Communications Inc.

4-12-3 Higashi-Shinagawa, Shinagawa-ku, Tokyo, 140-0002, Japan

1.3 Product Feature of Equipment Under Test

GSM/WCDMA/LTE, Bluetooth, DTS/UNII, a/b/g/n, GPS, and NFC

Standards-related Product Specification			
Antenna Type / Gain		Loop Antenna	
EUT Information List			
HW Version	SW Version	S/N	Performed Test Item
A	0.85	RQ3002HXP A	RF Conducted Measurement
		RQ3002HXP8	Radiated Emission
		RQ3002HWM1	AC Conducted Emission

Accessory List	
AC Adapter 1	Model No. : UCH20
	S/N :
	1215W486000045 (for radiated spurious emission) 1215W486000039 (for conducted emission)
Earphone 1	Model No. : MH410c
	S/N:
	1632A86100002D8 (for radiated spurious emission) 1632A8640000088 (for conducted emission)
USB Cable	Model No. : UCB20
	S/N : 1625A91900007E2

Note:

1. Above EUT list and accessory list used are electrically identical per declared by manufacturer.
2. Above the accessories list are used to exercise the EUT during test.
3. For other wireless features of this EUT, test report will be issued separately.

1.4 Product Specification of Equipment Under Test

Standards-related Product Specification	
Tx/Rx Frequency Range	13.553 ~ 13.567MHz
Channel Number	1
20dBW	2.64 KHz
99%OBW	2.24 KHz
Type of Modulation	ASK

Remark: The above EUT's information was declared by manufacturer. Please refer to the specifications or user's manual for more detailed description.

1.5 Modification of EUT

No modifications are made to the EUT during all test items.

1.6 Testing Location

Sporton Lab is accredited to ISO 17025 by Taiwan Accreditation Foundation (TAF code : 1190) and the FCC designation No. TW1022 under the FCC 2.948(e) by Mutual Recognition Agreement (MRA) in FCC Test.

Test Site	SPORTON INTERNATIONAL INC.		
Test Site Location	No. 52, Hwa Ya 1 st Rd., Hwa Ya Technology Park, Kwei-Shan District, Tao Yuan City, Taiwan, R.O.C. TEL: +886-3-3273456 / FAX: +886-3-3284978		
Test Site No.	Sporton Site No.		
	TH03-HY	CO05-HY	03CH07-HY
Test Engineer	William Liao	Arthur Hsieh	Jess Wang
Temperature	22~24°C	21~23°C	21~23°C
Relative Humidity	53~55%	51~53%	55~58%

Note: The test site complies with ANSI C63.4 2014 requirement.

Test Site	SPORTON INTERNATIONAL INC.		
Test Site Location	No. 30-2, Dingfu Tsuen, Linkou District, New Taipei City, Taiwan 244, R.O.C. TEL: +886-2-2603-5367 / +886-2-2601-1640 FAX: +886-2-2601-1695		
Test Site No.	Sporton Site No.		
	OS03-LK		
Test Engineer	Eric Jeng		
Temperature	23~25°C		
Relative Humidity	51~54%		

Note: The test site complies with ANSI C63.4 2014 requirement.

1.7 Applicable Standards

According to the specifications of the manufacturer, the EUT must comply with the requirements of the following standards:

- ♦ FCC Part 15 Subpart C §15.225
- ♦ ANSI C63.10-2013

2. TEST CONFIGURATION OF EQUIPMENT UNDER TEST

2.1 Descriptions of Test Mode

Investigation has been done on all the possible configurations.

The following table is a list of the test modes shown in this test report.

Test Items	
AC Power Line Conducted Emissions	Field Strength of Fundamental Emissions
20dB Spectrum Bandwidth	Frequency Stability
Radiated Emissions 9kHz~30MHz	Radiated Emissions 30MHz~1GHz

The worst type (type F) declared by manufacturer was used and recorded in this report.

2.2 Connection Diagram of Test System

<AC Conducted Emissions>

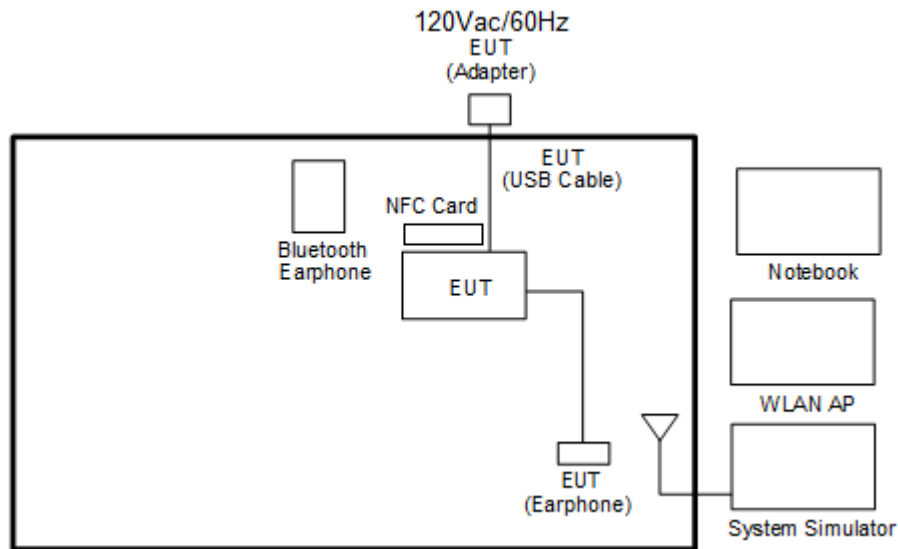

< For Fundamental Emissions and Mask and Radiated Emissions Measurement >

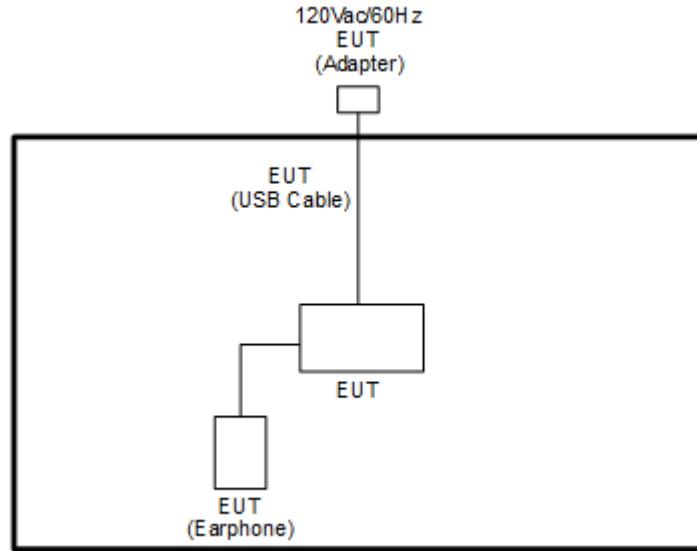

2.3 Table for Supporting Units

Support Unit	Manufacturer	Model	FCC ID
System Simulator	Anritsu	MT8820C	N/A
Bluetooth Earphone	Sony	SBH20	PY7-RD0010
WLAN AP	ASUS	RT-AC66U	MSQ-RTAC66U
Notebook	DELL	Latitude E6320	FCC DoC/ Contains FCC ID: QDS-BRCM1054
SD Card	SanDisk	MicroSD HC	FCC DoC
NFC Card	Metro Taipei	Easy Card	N/A

2.4 EUT Operation Test Setup

The EUT was programmed to be in continuously transmitting mode.

The ancillary equipment, NFC card, is used to make the EUT (NFC) continuously transmit at 13.56MHz and is placed around 2 cm gap to the EUT.



3. TEST RESULTS

3.1 AC Power Line Conducted Emissions Measurement

3.1.1 Limit of AC Conducted Emission

For equipment that is designed to be connected to the public utility (AC) power line, the radio frequency voltage that is conducted back onto the AC power line on any frequency or frequencies within the band 150 kHz to 30 MHz shall not exceed the limits in the following table.

Frequency of Emission (MHz)	Conducted Limit (dB μ V)	
	Quasi-Peak	Average
0.15-0.5	66 to 56*	56 to 46*
0.5-5	56	46
5-30	60	50

*Decreases with the logarithm of the frequency.

For terminal test result, the testing follows FCC KDB 174176.

3.1.2 Measuring Instruments

See list of measuring instruments of this test report.

3.1.3 Test Procedures

1. The EUT was placed 0.4 meter from the conducting wall of the shielding room, and it was kept at least 80 centimeters from any other grounded conducting surface.
2. Connect EUT to the power mains through a line impedance stabilization network (LISN).
3. All the support units are connecting to the other LISN.
4. The LISN provides 50 ohm coupling impedance for the measuring instrument.
5. The FCC states that a 50 ohm, 50 microhenry LISN should be used.
6. Both sides of AC line were checked for maximum conducted interference.
7. The frequency range from 150 kHz to 30 MHz was searched.
8. Set the test-receiver system to Peak Detect Function and specified bandwidth (IF Bandwidth = 9kHz) with Maximum Hold Mode. Then measurement is also conducted by Average Detector and Quasi-Peak Detector Function respectively.

3.1.4 Test setup

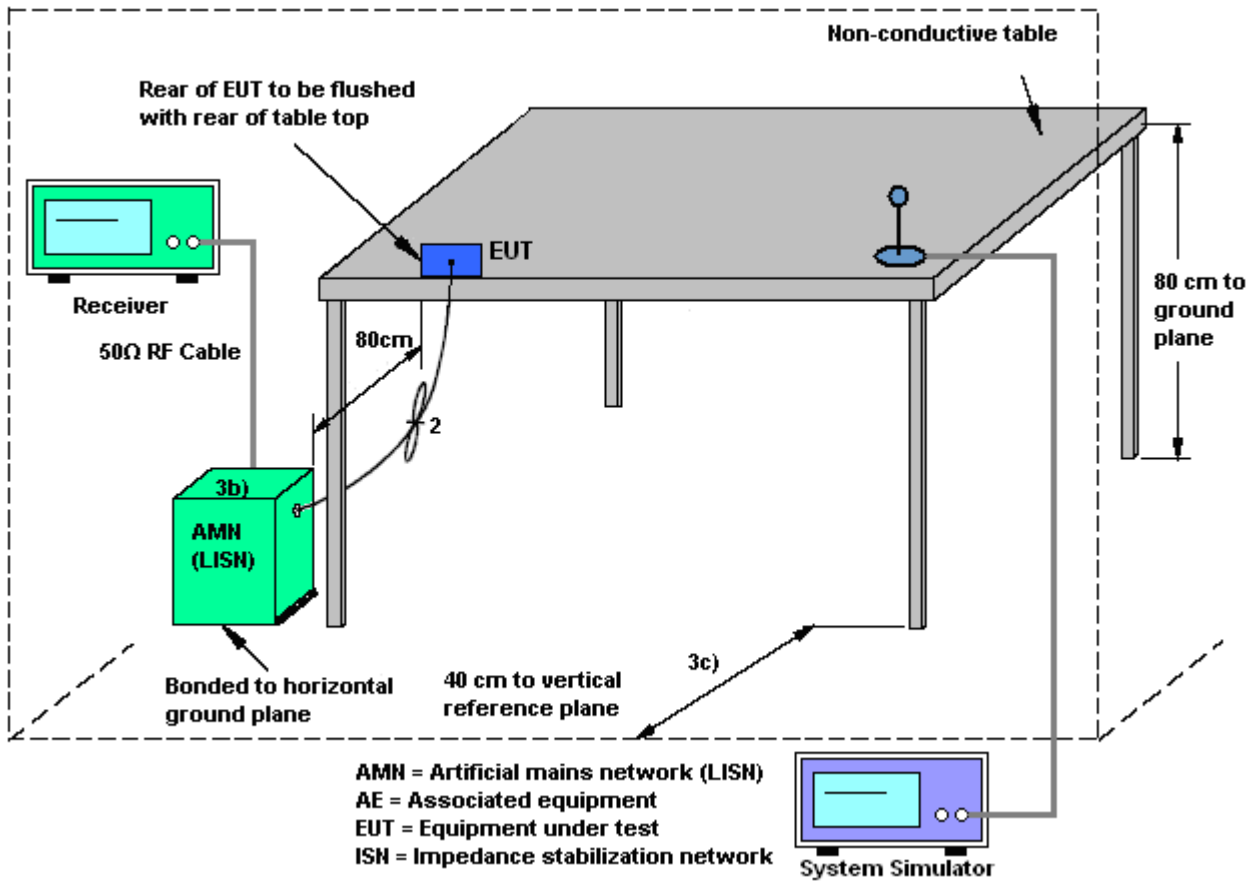

3.1.5 Test Result of AC Conducted Emission

Please refer to Appendix A.

3.2 20dB and 99% OBW Spectrum Bandwidth Measurement

3.2.1 Limit

Intentional radiators must be designed to ensure that the 20dB and 99% emission bandwidth in the specific band 13.553~13.567MHz.

3.2.2 Measuring Instruments

See list of measuring instruments of this test report.

3.2.3 Test Procedures

1. The spectrum analyzer connected via a receive antenna placed near the EUT in peak Max hold mode.
2. The resolution bandwidth of 1 kHz and the video bandwidth of 3 kHz were used.
3. Measured the spectrum width with power higher than 20dB below carrier.
4. Measured the 99% OBW.

3.2.4 Test Setup

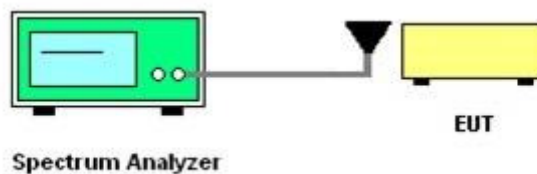

3.2.5 Test Result of Conducted Test Items

Please refer to Appendix B.

3.3 Frequency Stability Measurement

3.3.1 Limit

The frequency tolerance of the carrier signal shall be maintained within +/- 0.01% (100ppm) of the operating frequency over a temperature variation of -20 degrees to +50 degrees C at normal supply voltage, and for a variation in the primary supply voltage from 85% to 115% of the rated supply voltage at a temperature of 20 degrees C. For battery operated equipment, the equipment tests shall be performed using a new battery.

3.3.2 Measuring Instruments

See list of measuring instruments of this test report.

3.3.3 Test Procedures

1. The spectrum analyzer connected via a receive antenna placed near the EUT.
2. EUT have transmitted signal and fixed channelize.
3. Set the spectrum analyzer span to view the entire emissions bandwidth.
4. Set RBW = 1 kHz, VBW = 3 kHz with peak detector and maxhold settings.
5. The f_c is declaring of channel frequency. Then the frequency error formula is $(f_c - f) / f_c \times 10^6$ ppm and the limit is less than ± 100 ppm.
6. Extreme temperature rule is -20°C~50°C.

3.3.4 Test Setup

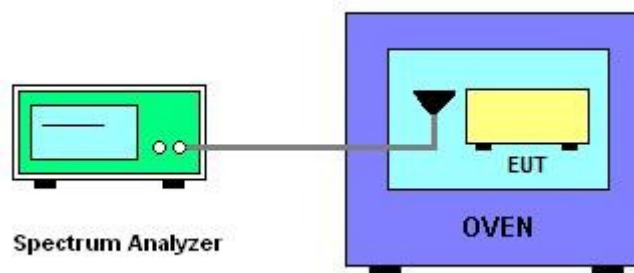

3.3.5 Test Result of Conducted Test Items

Please refer to Appendix C.



3.4 Field Strength of Fundamental Emissions and Mask Measurement

3.4.1 Limit

Rules and specifications	FCC CFR 47 Part 15 section 15.225			
Description	Compliance with the spectrum mask is tested with RBW set to 9kHz.			
Freq. of Emission (MHz)	Field Strength ($\mu\text{V/m}$) at 30m	Field Strength ($\text{dB}\mu\text{V/m}$) at 30m	Field Strength ($\text{dB}\mu\text{V/m}$) at 10m	Field Strength ($\text{dB}\mu\text{V/m}$) at 3m
1.705~13.110	30	29.5	48.58	69.5
13.110~13.410	106	40.5	59.58	80.5
13.410~13.553	334	50.5	69.58	90.5
13.553~13.567	15848	84.0	103.08	124.0
13.567~13.710	334	50.5	69.58	90.5
13.710~14.010	106	40.5	59.58	80.5
14.010~30.000	30	29.5	48.58	69.5

3.4.2 Measuring Instruments

See list of measuring instruments of this test report.

3.4.3 Test Procedures

1. Configure the EUT according to ANSI C63.10. The EUT was placed on the top of the turntable 0.8 meter above ground. The phase center of the loop receiving antenna mounted antenna tower was placed 3 meters far away from the turntable.
2. Power on the EUT and all the supporting units. The turntable was rotated by 360 degrees to determine the position of the highest radiation.
3. The height of the receiving antenna was fixed at one meter above ground to find the maximum emissions field strength.
4. For Fundamental emissions, use the receiver to measure QP reading.
5. When the radiated emissions limits are expressed in terms of the average value of the emissions, and pulsed operation is employed, the measurement field strength shall be determined by averaging over one complete pulse train, including blanking intervals, as long as the pulse train does not exceed 0.1 seconds. As an alternative (provided the transmitter operates for longer than 0.1 seconds) or in cases where the pulse train exceeds 0.1 seconds, the measured field strength shall be determined from the average absolute voltage during a 0.1 second interval during which the field strength is at its maximum value.
6. Compliance with the spectrum mask is tested with RBW set to 9kHz.
Note: Emission level (dB μ V/m) = 20 log Emission level (μ V/m).

3.4.4 Test Setup

For radiated emissions below 30MHz

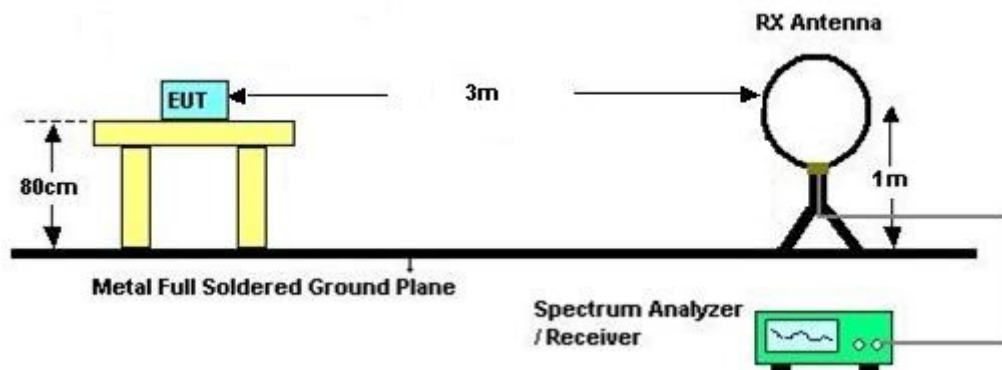

3.4.5 Test Result of Field Strength of Fundamental Emissions and Mask

Please refer to Appendix D.

3.5 Radiated Emissions Measurement

3.5.1 Limit

The field strength of any emissions which appear outside of 13.110 ~14.010MHz band shall not exceed the general radiated emissions limits.

Frequencies (MHz)	Field Strength (µV/m)	Measurement Distance (meters)
0.009~0.490	2400/F(kHz)	300
0.490~1.705	24000/F(kHz)	30
1.705~30.0	30	30
30~88	100	3
88~216	150	3
216~960	200	3
Above 960	500	3

3.5.2 Measuring Instruments

See list of measuring instruments of this test report.

3.5.3 Measuring Instrument Setting

The following table is the setting of receiver.

Receiver Parameter	Setting
Attenuation	Auto
Frequency Range: 9kHz~150kHz	RBW 200Hz for QP
Frequency Range: 150kHz~30MHz	RBW 9kHz for QP
Frequency Range: 30MHz~1000MHz	RBW 120kHz for Peak

Note: The emission limits shown in the above table are based on measurements employing a CISPR quasi-peak detector except for the frequency bands 9-90 kHz, 110-490 kHz. Radiated emission limits in these two bands are based on measurements employing an average detector.



3.5.4 Test Procedures

1. Configure the EUT according to ANSI C63.10. The EUT was placed on the top of the turntable 0.8 meter above ground. The phase center of the receiving antenna mounted on the top of a height-variable antenna tower was placed 3 meters far away from the turntable.
2. Power on the EUT and all the supporting units. The turntable was rotated by 360 degrees to determine the position of the highest radiation.
3. The height of the broadband receiving antenna was varied between one meter and four meters above ground to find the maximum emissions field strength of both horizontal and vertical polarization.
4. For each suspected emissions, the antenna tower was scan (from 1 M to 4 M) and then the turntable was rotated (from 0 degree to 360 degrees) to find the maximum reading.
5. Set the test-receiver system to Peak or CISPR quasi-peak Detect Function with specified bandwidth under Maximum Hold Mode.
6. When the radiated emissions limits are expressed in terms of the average value of the emissions, and pulsed operation is employed, the measurement field strength shall be determined by averaging over one complete pulse train, including blanking intervals, as long as the pulse train does not exceed 0.1 seconds. As an alternative (provided the transmitter operates for longer than 0.1 seconds) or in cases where the pulse train exceeds 0.1 seconds, the measured field strength shall be determined from the average absolute voltage during a 0.1 second interval during which the field strength is at its maximum value.
7. In case the emission is lower than 30MHz, loop antenna has to be used for measurement and the recorded data should be QP measured by receiver. Antenna Requirements

3.5.5 Test Setup

For radiated emissions below 30MHz

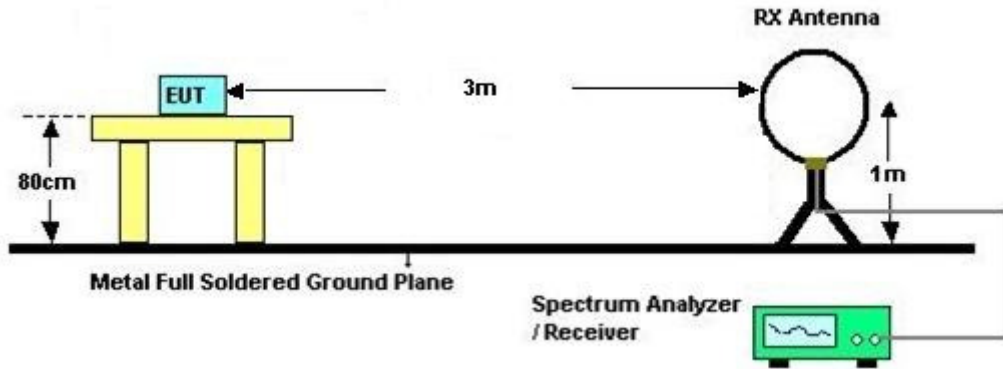

For radiated emissions above 30MHz

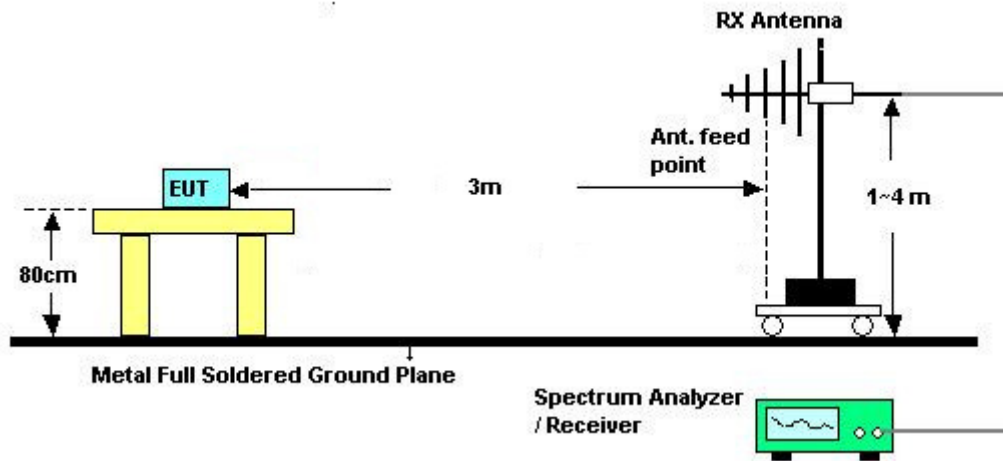

3.5.6 Test Result of Radiated Emissions Measurement

Please refer to Appendix D.



3.6 Antenna Requirements

3.6.1 Standard Applicable

Except for special regulations, the Low-power Radio-frequency Devices must not be equipped with any jacket for installing an antenna with extension cable. An intentional radiator shall be designed to ensure that no antenna other than that furnished by the responsible party shall be used with the device. The use of a permanently attached antenna or of an antenna that uses a unique coupling to the intentional radiator shall be considered sufficient to comply with the provisions of this Section. The manufacturer may design the unit so that the user can replace a broken antenna, but the use of a standard antenna jack or electrical connector is prohibited.

The use of a permanently attached antenna or of an antenna that uses a unique coupling to the intentional radiator shall be considered sufficient to comply with the FCC rule.

3.6.2 Antenna Anti-Replacement Construction

An embedded-in antenna design is used.



4. LIST OF MEASURING EQUIPMENT

Instrument	Manufacturer	Model No.	Serial No.	Characteristics	Calibration Date	Test Date	Due Date	Remark
AC Power Source	AC POWER	AFC-500W	F104070011	50Hz~60Hz	Dec. 02, 2015	Oct. 22, 2016	Dec. 01, 2016	Conducted (TH03-HY)
Hygrometer	Testo	608-H1	34893241	N/A	May 03, 2016	Oct. 22, 2016	May 02, 2017	Conducted (TH03-HY)
Spectrum Analyzer	Rohde & Schwarz	FSP30	101329	9kHz~30GHz	Jun. 27, 2016	Oct. 22, 2016	Jun. 26, 2017	Conducted (TH03-HY)
Temperature Chamber	ESPEC	SU-641	92013721	-30℃ ~70℃	Nov. 20, 2015	Oct. 22, 2016	Nov. 19, 2016	Conducted (TH03-HY)
AC Power Source	ChainTek	APC-1000W	N/A	N/A	N/A	Oct. 11, 2016 ~ Oct. 18, 2016	N/A	Conduction (CO05-HY)
EMI Test Receiver	Rohde & Schwarz	ESCI 7	100724	9kHz~7GHz	Aug. 30, 2016	Oct. 11, 2016 ~ Oct. 18, 2016	Aug. 29, 2017	Conduction (CO05-HY)
Hygrometer	Testo	608-H1	34913912	N/A	Apr. 19, 2016	Oct. 11, 2016 ~ Oct. 18, 2016	Apr. 18, 2017	Conduction (CO05-HY)
LISN	Rohde & Schwarz	ENV216	100080	9kHz~30MHz	Dec. 02, 2015	Oct. 11, 2016 ~ Oct. 18, 2016	Dec. 01, 2016	Conduction (CO05-HY)
LF Cable	HUBER + SUHNER	RG-214/U	LF01	N/A	Jan. 06, 2016	Oct. 11, 2016 ~ Oct. 18, 2016	Jan. 05, 2017	Conduction (CO05-HY)
Test Software	N/A	EMC32	8.40.0	N/A	N/A	Oct. 11, 2016 ~ Oct. 18, 2016	N/A	Conduction (CO05-HY)
Bilog Antenna	TESEQ	CBL 6111D&0080 0N1D01N-06	35419&03	30MHz to 1GHz	Jan. 13, 2016	Nov. 08, 2016	Jan. 12, 2017	Radiation (03CH07-HY)
Loop Antenna	Rohde & Schwarz	HFH2-Z2	100315	9 kHz~30 MHz	Sep. 02, 2015	Nov. 08, 2016	Sep. 01, 2017	Radiation (03CH07-HY)
EMI Test Receiver	Keysight	N9038A (MXE)	MY5413008 5	20Hz ~ 8.4GHz	Oct. 26, 2016	Nov. 08, 2016	Oct. 25, 2017	Radiation (03CH07-HY)
Preamplifier	COM-POWER	PA-103A	161241	10MHz-1GHz	Mar. 18, 2016	Nov. 08, 2016	Mar. 17, 2017	Radiation (03CH07-HY)
Spectrum Analyzer	Agilent	N9010A	MY5347011 8	10Hz~44GHz	Feb. 27, 2016	Nov. 08, 2016	Feb. 26, 2017	Radiation (03CH07-HY)
Hygrometer	Testo	608-H1	34897197	N/A	N/A	Nov. 08, 2016	N/A	Radiation (03CH07-HY)
Filter	Wainwright	WHK20 /1000C7/40S S	SN1	20M High Pass	Sep. 26, 2016	Nov. 08, 2016	Sep. 25, 2017	Radiation (03CH07-HY)
RF Cable	HUBER + SUHNER	SUCOFLEX 104	MY8420952 1	30MHz~1GHz	Dec. 03, 2015	Nov. 08, 2016	Dec. 02, 2016	Radiation (03CH07-HY)
RF Cable	HUBER + SUHNER	SUCOFLEX 104	MY8420952 1	9KHz~30MHz	Dec. 03, 2015	Nov. 08, 2016	Dec. 02, 2016	Radiation (03CH07-HY)
Controller	ChainTek	Chaintek 3000	N/A	Control Turn table	N/A	Nov. 08, 2016	N/A	Radiation (03CH07-HY)
Controller	Max-Full	MF7802	MF7802083 68	Control Ant Mast	N/A	Nov. 08, 2016	N/A	Radiation (03CH07-HY)
Antenna Mast	Max-Full	MFA520BS	N/A	1m~4m	N/A	Nov. 08, 2016	N/A	Radiation (03CH07-HY)
Turn Table	ChainTek	Chaintek 3000	N/A	0~360 Degree	N/A	Nov. 08, 2016	N/A	Radiation (03CH07-HY)
Test Software	Audix	E3	6.2009-8-24 (sporton)	N/A	N/A	Nov. 08, 2016	N/A	Radiation (03CH07-HY)



Instrument	Manufacturer	Model No.	Serial No.	Characteristics	Calibration Date	Test Date	Due Date	Remark
Open Area Test Site	SPORTON	OATS-10	OS03-LK	30 MHz ~ 1 GHz 10m, 3m	May 21, 2016	Nov. 11, 2016	May 20, 2017	Radiation (OS03-LK)
Spectrum Analyzer	R&S	FSP 7	100641	9 kHz ~ 7 GHz	Jun. 23, 2016	Nov. 11, 2016	Jun. 22, 2017	Radiation (OS03-LK)
Test Receiver	R&S	ESCS 30	836858/024	9 kHz ~ 2.75 GHz	Jun. 24, 2016	Nov. 11, 2016	Jun. 23, 2017	Radiation (OS03-LK)
Turn Table	EMCO	2080	9711-2021	0 ~ 360 degree	N/A	Nov. 11, 2016	N/A	Radiation (OS03-LK)
Antenna Mast	EMCO	2075	9711-2115	1 m ~ 4 m	N/A	Nov. 11, 2016	N/A	Radiation (OS03-LK)
Loop Antenna	Rohde & Schwarz	HFH2-Z2	100315	9 kHz~30 MHz	Sep. 02, 2015	Nov. 11, 2016	Sep. 01, 2017	Radiation (OS03-LK)
Preamplifier	COM-POWER	PA-103A	161241	10MHz-1GHz	Mar. 18, 2016	Nov. 11, 2016	Mar. 17, 2017	Radiation (OS03-LK)
Test Software	Audix	E3	4	N/A	N/A	Nov. 11, 2016	N/A	Radiation (OS03-LK)

Appendix A. Test Results of Conducted Emission Test

<Original test result with NFC antenna>

Test Mode :	NFC Tx	Test Voltage :	120Vac / 60Hz
Function Type :	GSM1900 Idle + Bluetooth Link + WLAN (2.4GHz) Link + NFC Tx + MP3 + Battery + Earphone 1 + USB Cable (Charging from Adapter 1)		

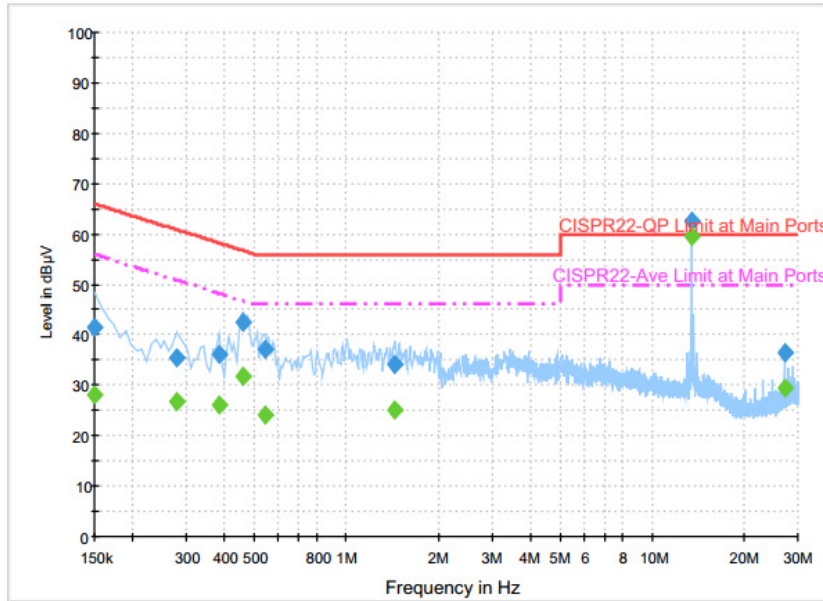

Final Result : Quasi-Peak

Frequency (MHz)	Quasi-Peak (dBµV)	Filter	Line	Corr. (dB)	Margin (dB)	Limit (dBµV)
0.150000	41.4	Off	L1	19.6	24.6	66.0
0.278000	35.3	Off	L1	19.6	25.6	60.9
0.382000	36.2	Off	L1	19.6	22.0	58.2
0.462000	42.5	Off	L1	19.6	14.2	56.7
0.542000	37.2	Off	L1	19.6	18.8	56.0
1.446000	34.1	Off	L1	19.7	21.9	56.0
13.558000	62.4	Off	L1	20.3	-2.4	60.0
27.118000	36.4	Off	L1	21.0	23.6	60.0

Final Result : Average

Frequency (MHz)	Average (dBµV)	Filter	Line	Corr. (dB)	Margin (dB)	Limit (dBµV)
0.150000	28.3	Off	L1	19.6	27.7	56.0
0.278000	26.8	Off	L1	19.6	24.1	50.9
0.382000	26.2	Off	L1	19.6	22.0	48.2
0.462000	31.9	Off	L1	19.6	14.8	46.7
0.542000	24.2	Off	L1	19.6	21.8	46.0
1.446000	25.2	Off	L1	19.7	20.8	46.0
13.558000	59.4	Off	L1	20.3	-9.4	50.0
27.118000	29.3	Off	L1	21.0	20.7	50.0

Test Mode :	NFC Tx	Test Voltage :	120Vac / 60Hz
Function Type :	GSM1900 Idle + Bluetooth Link + WLAN (2.4GHz) Link + NFC Tx + MP3 + Battery + Earphone 1 + USB Cable (Charging from Adapter 1)		

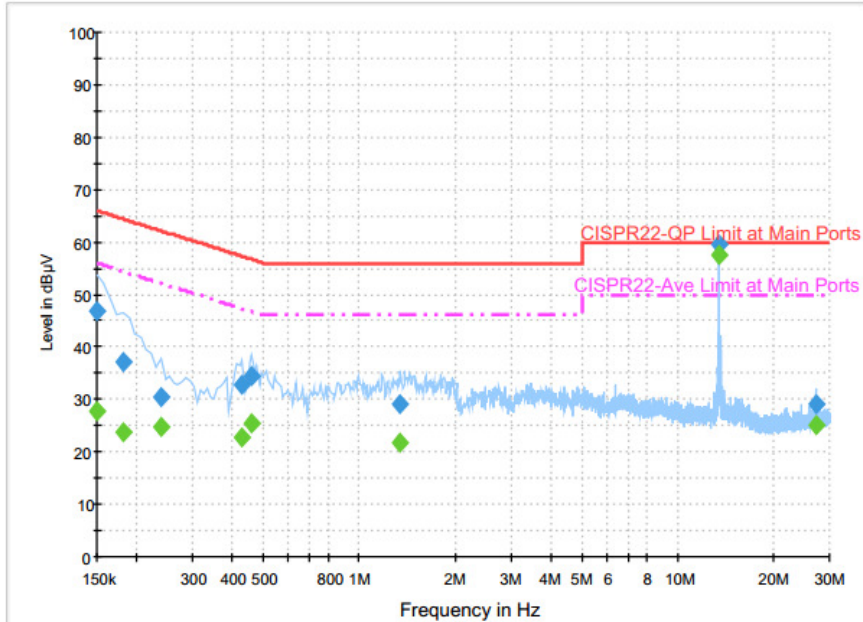

Final Result : Quasi-Peak

Frequency (MHz)	Quasi-Peak (dBµV)	Filter	Line	Corr. (dB)	Margin (dB)	Limit (dBµV)
0.150000	46.9	Off	N	19.6	19.1	66.0
0.182000	37.2	Off	N	19.6	27.2	64.4
0.238000	30.5	Off	N	19.6	31.7	62.2
0.430000	32.9	Off	N	19.6	24.4	57.3
0.462000	34.4	Off	N	19.6	22.3	56.7
1.342000	29.2	Off	N	19.7	26.8	56.0
13.558000	59.4	Off	N	20.4	0.6	60.0
27.118000	29.1	Off	N	21.2	30.9	60.0

Final Result : Average

Frequency (MHz)	Average (dBµV)	Filter	Line	Corr. (dB)	Margin (dB)	Limit (dBµV)
0.150000	27.8	Off	N	19.6	28.2	56.0
0.182000	23.6	Off	N	19.6	30.8	54.4
0.238000	24.7	Off	N	19.6	27.5	52.2
0.430000	22.8	Off	N	19.6	24.5	47.3
0.462000	25.6	Off	N	19.6	21.1	46.7
1.342000	21.6	Off	N	19.7	24.4	46.0
13.558000	57.5	Off	N	20.4	-7.5	50.0
27.118000	25.0	Off	N	21.2	25.0	50.0

<Terminal test result with dummy load>

Test Mode :	NFC Tx	Test Voltage :	120Vac / 60Hz
Function Type :	GSM1900 Idle + Bluetooth Link + WLAN (2.4GHz) Link + NFC Tx + MP3 + Battery + Earphone 1 + USB Cable (Charging from Adapter 1)		

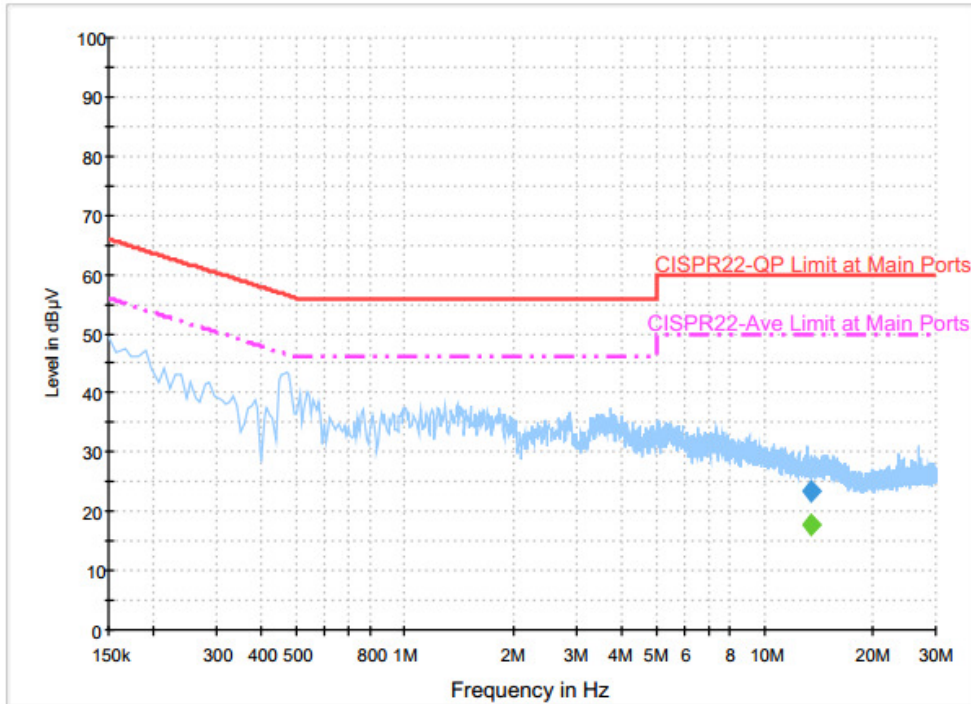

Final Result : Quasi-Peak

Frequency (MHz)	Quasi-Peak (dBµV)	Filter	Line	Corr. (dB)	Margin (dB)	Limit (dBµV)
13.558000	23.3	Off	L1	20.2	36.7	60.0

Final Result : Average

Frequency (MHz)	Average (dBµV)	Filter	Line	Corr. (dB)	Margin (dB)	Limit (dBµV)
13.558000	17.8	Off	L1	20.2	32.2	50.0



Test Mode :	NFC Tx	Test Voltage :	120Vac / 60Hz
Function Type :	GSM1900 Idle + Bluetooth Link + WLAN (2.4GHz) Link + NFC Tx + MP3 + Battery + Earphone 1 + USB Cable (Charging from Adapter 1)		

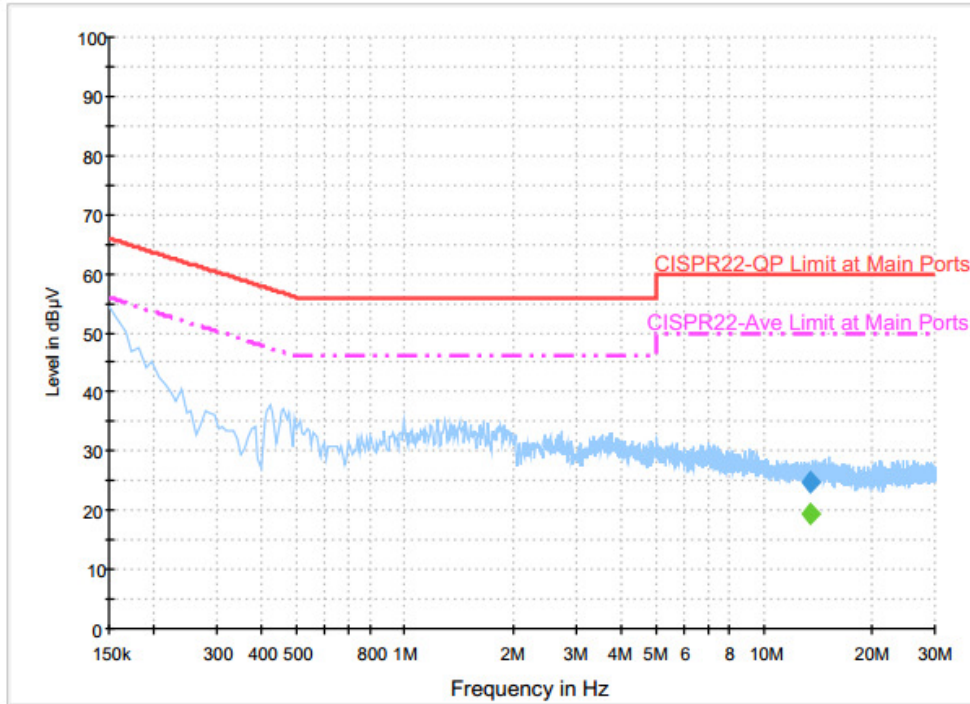

Final Result : Quasi-Peak

Frequency (MHz)	Quasi-Peak (dBµV)	Filter	Line	Corr. (dB)	Margin (dB)	Limit (dBµV)
13.558000	24.9	Off	N	20.3	35.1	60.0

Final Result : Average

Frequency (MHz)	Average (dBµV)	Filter	Line	Corr. (dB)	Margin (dB)	Limit (dBµV)
13.558000	19.5	Off	N	20.3	30.5	50.0

(1) with antenna

Remark: 13.558 MHz is the NFC RF fundamental signal.

(2) with dummy load

Remark: Only the fundamental NFC signal needs to be retested per C63.4.



Appendix B. Test Results of Conducted Test Items

B1. Test Result of 20dB Spectrum Bandwidth

Test mode	NFC Tx	Test Frequency (MHz)	13.56
<p>Ref 20 dBm Att 30 dB RBW 1 kHz VBW 3 kHz SWT 20 ms</p> <p>Marker 1 [T1] -4.95 dBm 13.560640000 MHz</p> <p>ndB [T1] 20.00 dB BW 2.640000000 kHz Temp 1 [T1 ndB] -24.81 dBm 13.559280000 MHz Temp 2 [T2 ndB] -25.19 dBm 13.561920000 MHz</p> <p>Center 13.56 MHz 1 kHz/ Span 10 kHz</p> <p>Date: 12.OCT.2016 14:12:53</p>		<p>Ref 20 dBm Att 30 dB RBW 1 kHz VBW 3 kHz SWT 20 ms</p> <p>Marker 1 [T1] -4.94 dBm 13.560640000 MHz</p> <p>OBW 2.240000000 kHz Temp 1 [T1 OBW] -19.66 dBm 13.559480000 MHz Temp 2 [T2 OBW] -13.36 dBm 13.561720000 MHz</p> <p>Center 13.56 MHz 1 kHz/ Span 10 kHz</p> <p>Date: 12.OCT.2016 14:12:34</p>	
20dB Bandwidth (kHz)	2.640	99% OccupiedBW(kHz)	2.240
Frequency range (MHz)	$f_L > 13.553$	13.55928	Test Result
	$f_H < 13.567$	13.56192	Complies



B2. Test Result of Frequency Stability

B3. Voltage vs. Frequency Stability		Temperature vs. Frequency Stability		
Voltage (Vac)	Measurement Frequency (MHz)	Temperature (°C)	Time	Measurement Frequency (MHz)
120	13.560600	-20	0	13.560600
102	13.560600		2	13.560600
138	13.560600		5	13.560600
			10	13.560600
		-10	0	13.560600
			2	13.560600
			5	13.560600
			10	13.560600
		0	0	13.560600
			2	13.560600
			5	13.560600
			10	13.560600
		10	0	13.560600
			2	13.560600
			5	13.560600
			10	13.560600
		20	0	13.560600
			2	13.560600
			5	13.560600
			10	13.560600
		30	0	13.560600
			2	13.560600
			5	13.560600
			10	13.560600
		40	0	13.560600
			2	13.560600
			5	13.560600
			10	13.560600



Voltage vs. Frequency Stability		Temperature vs. Frequency Stability		
Voltage (Vac)	Measurement Frequency (MHz)	Temperature (°C)	Time	Measurement Frequency (MHz)
		50	0	13.560600
			2	13.560600
			5	13.560600
			10	13.560600
Max.Deviation (MHz)	0.000600	Max.Deviation (MHz)		0.000600
Max.Deviation (ppm)	44.2478	Max.Deviation (ppm)		44.2478
Limit	FS < ±100 ppm	Limit		FS < ±100 ppm
Test Result	PASS	Test Result		PASS



Appendix C. Test Results of Radiated Test Items

C1. Test Result of Field Strength of Fundamental Emissions

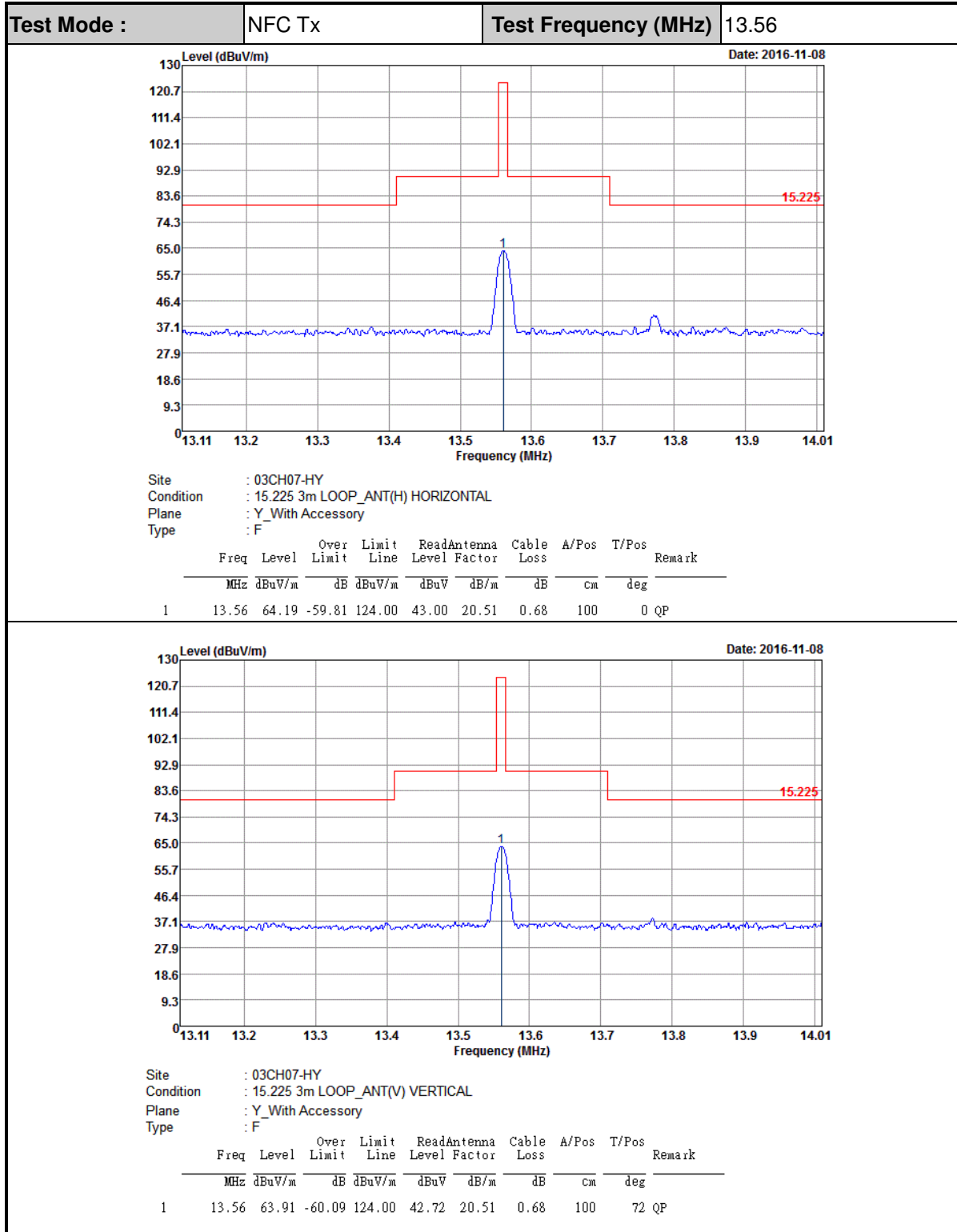



C2. Results of Radiated Spurious Emissions (9 kHz~30MHz)

Test Mode :	NFC Tx	Polarization :	Horizontal
-------------	--------	----------------	------------

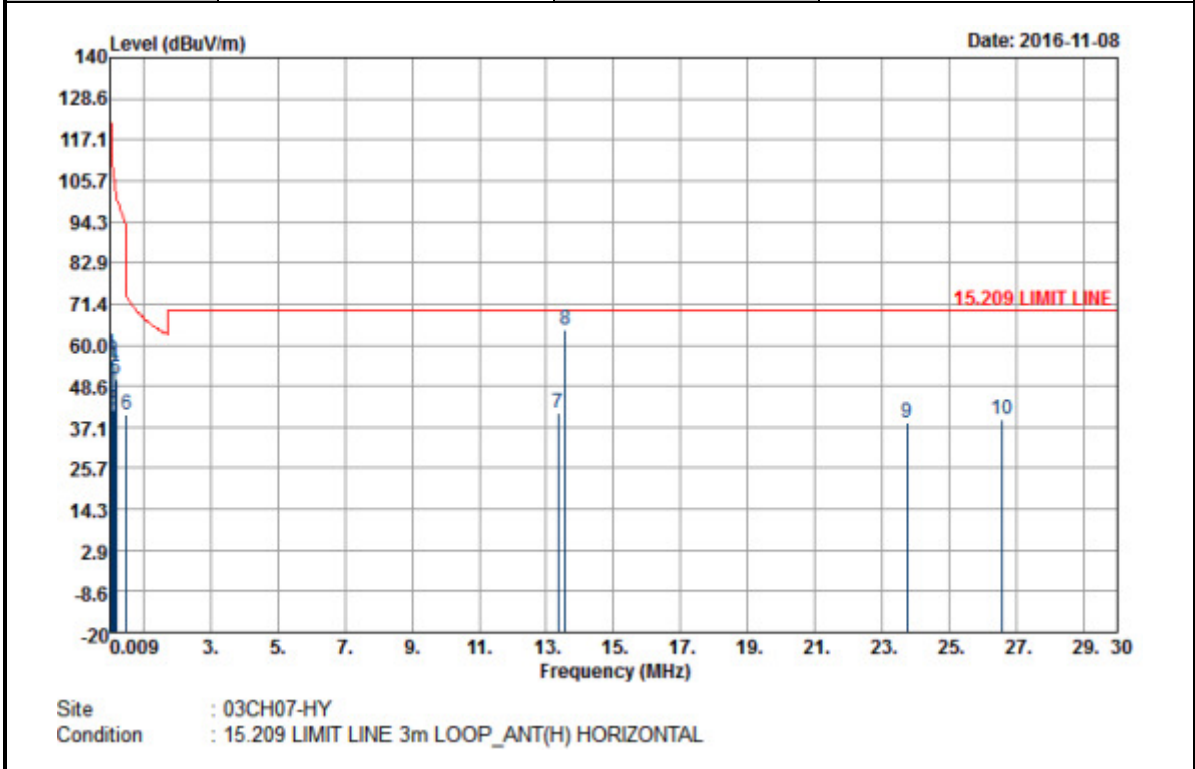

Frequency (MHz)	Level (dBμV/m)	Over Limit (dB)	Limit Line (dBμV/m)	Read Level (dBμV)	Antenna Factor (dB)	Cable Loss (dB)	Ant Pos (cm)	Table Pos (deg)	Remark
0.01033	57.37	-69.96	127.33	33.79	22.9	0.68	-	-	Average
0.06468	55.88	-55.51	111.39	36.2	19	0.68	-	-	Average
0.09132	42.05	-66.34	108.39	22.57	18.8	0.68	-	-	QP
0.12936	53.79	-51.58	105.37	34.32	18.79	0.68	-	-	Average
0.19488	50.2	-51.61	101.81	30.76	18.76	0.68	-	-	Average
0.49751	40.65	-33.02	73.67	21.37	18.6	0.68	-	-	QP
13.352	41.11	-28.39	69.5	19.96	20.47	0.68	100	43	QP
13.56	64.19	-5.31	69.5	43	20.51	0.68	-	-	QP
23.731	38.49	-31.01	69.5	15.4	22.02	1.07	-	-	QP
26.59	39.19	-30.31	69.5	15.93	22.19	1.07	-	-	QP

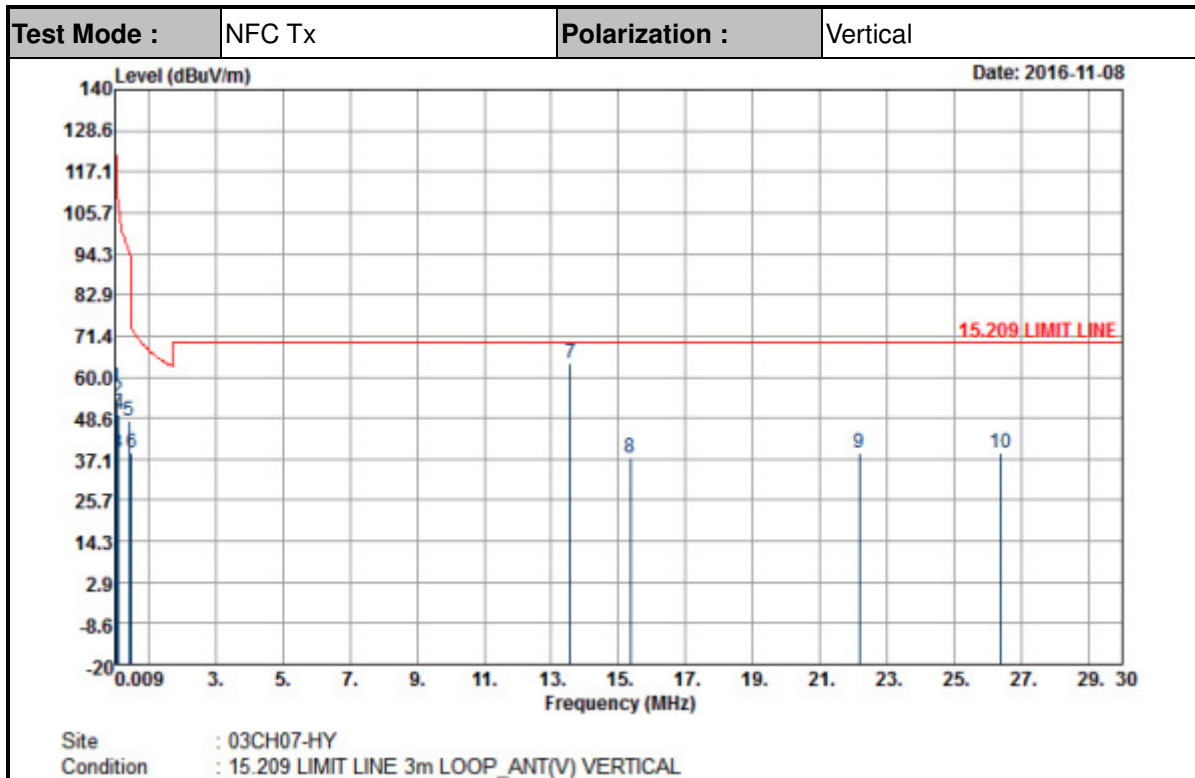

Frequency (MHz)	Level (dBμV/m)	Over Limit (dB)	Limit Line (dBμV/m)	Read Level (dBμV)	Antenna Factor (dB)	Cable Loss (dB)	Ant Pos (cm)	Table Pos (deg)	Remark
0.01318	56.98	-68.23	125.21	33.4	22.9	0.68	-	-	Average
0.06468	53.68	-57.71	111.39	34	19	0.68	-	-	Average
0.0912	38.68	-69.72	108.4	19.2	18.8	0.68	-	-	QP
0.11836	49.61	-56.53	106.14	30.14	18.79	0.68	-	-	Average
0.41724	47.87	-47.33	95.2	28.56	18.63	0.68	-	-	Average
0.49751	38.67	-35	73.67	19.39	18.6	0.68	-	-	QP
13.56	63.91	-5.59	69.5	42.72	20.51	0.68	-	-	QP
15.344	37.68	-31.82	69.5	16.13	20.87	0.68	100	114	QP
22.174	38.94	-30.56	69.5	15.94	21.93	1.07	-	-	QP
26.4	38.93	-30.57	69.5	15.68	22.18	1.07	-	-	QP

Note:

1. 13.56 MHz is fundamental signal which can be ignored.
2. The amplitude of spurious emissions which are attenuated by more than 20dB below the permissible value has no need to be reported.
3. Distance extrapolation factor = 40 log (specific distance / test distance) (dB);
4. Limit line = specific limits (dBμV) + distance extrapolation factor.



C3. Results of Radiated Spurious Emissions (30MHz~1GHz)

Test Mode :	NFC Tx	Polarization :	Horizontal
-------------	--------	----------------	------------

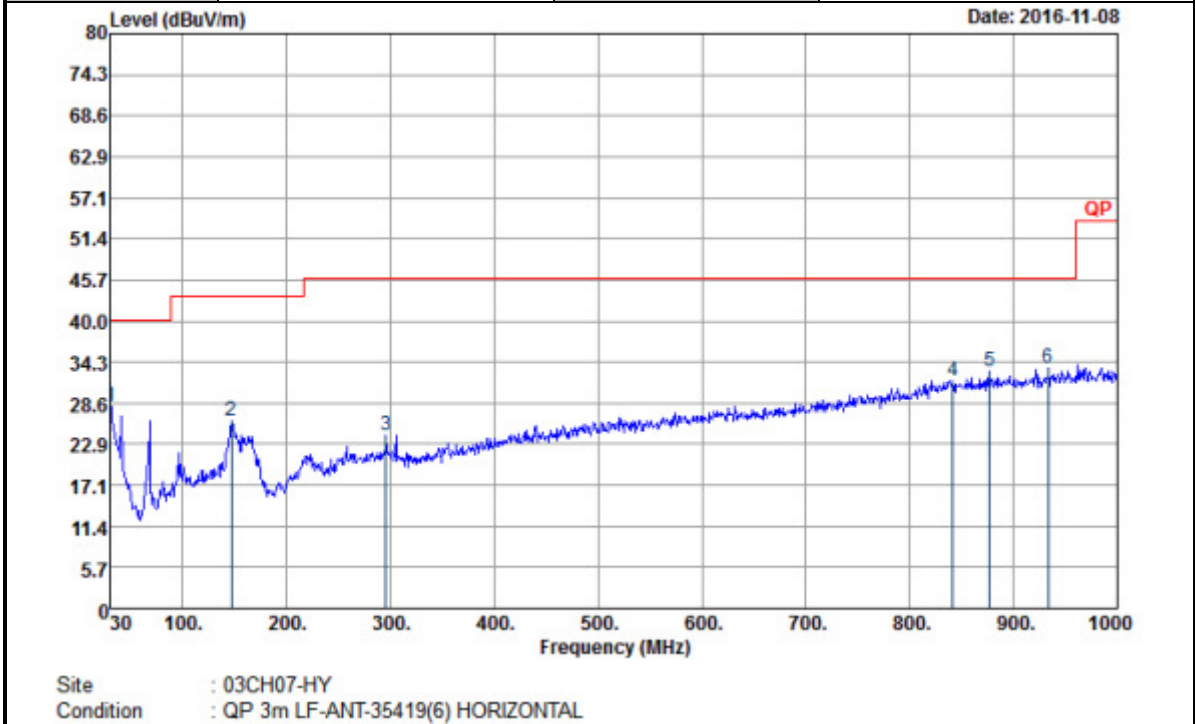

Frequency (MHz)	Level (dB μ V/m)	Over Limit (dB)	Limit Line (dB μ V/m)	Read Level (dB μ V)	Antenna Factor (dB)	Cable Loss (dB)	Preamp Factor (dB)	Ant Pos (cm)	Table Pos (deg)	Remark
30.27	28.1	-11.9	40	32.38	26	1.07	31.35	102	63	Peak
146.91	26.05	-17.45	43.5	37.99	17.78	1.78	31.5	-	-	Peak
295.41	24.11	-21.89	46	33.31	19.76	2.32	31.28	-	-	Peak
841.8	31.71	-14.29	46	29.64	28.54	4.1	30.57	-	-	Peak
876.8	32.97	-13.03	46	30.49	28.86	4.17	30.55	-	-	Peak
933.5	33.36	-12.64	46	29.97	29.8	4.12	30.53	-	-	Peak



Test Mode :	NFC Tx	Polarization :	Vertical
-------------	--------	----------------	----------

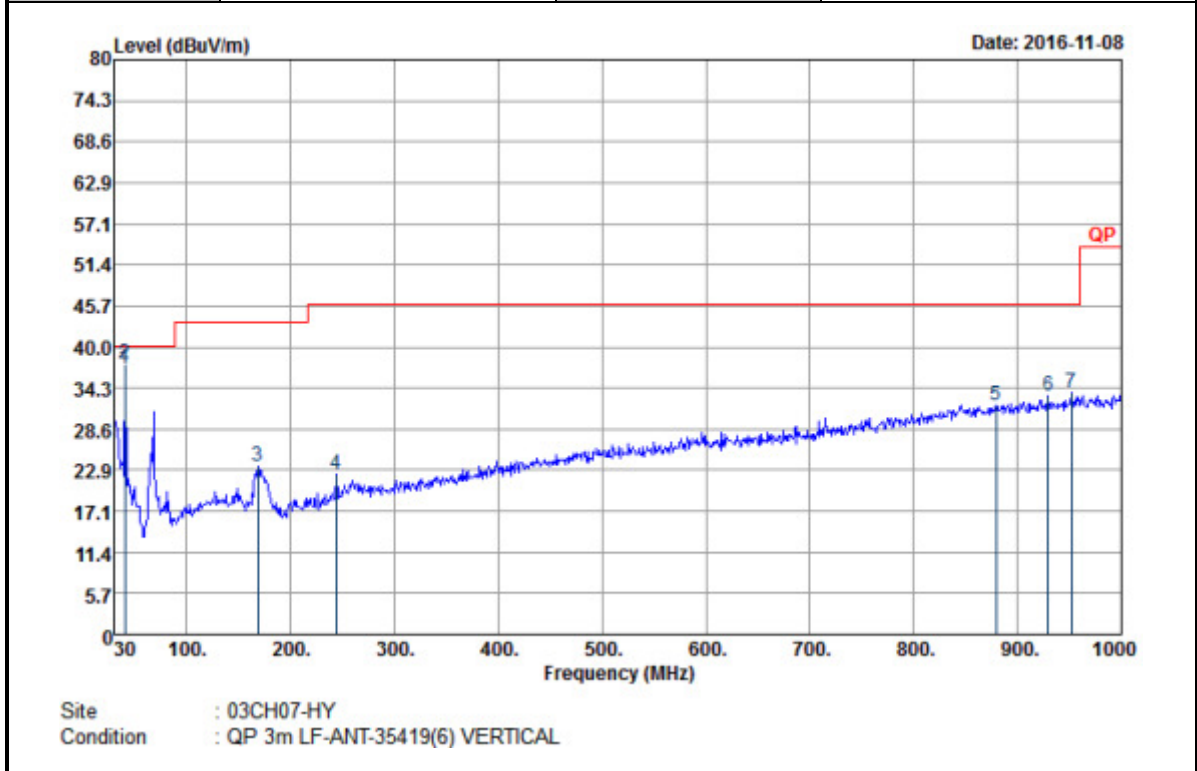

Frequency (MHz)	Level (dBuV/m)	Over Limit (dB)	Limit Line (dBuV/m)	Read Level (dBuV)	Antenna Factor (dB)	Cable Loss (dB)	Preamp Factor (dB)	Ant Pos (cm)	Table Pos (deg)	Remark
40.68	36.97	-3.03	40	47.55	19.84	1.07	31.49	100	247	QP
40.68	37.76	-2.24	40	48.34	19.84	1.07	31.49	100	247	Peak
168.24	23.35	-20.15	43.5	36.96	16.1	1.78	31.49	-	-	Peak
244.11	22.23	-23.77	46	33.1	18.45	2.07	31.39	-	-	Peak
879.6	31.97	-14.03	46	29.47	28.88	4.17	30.55	-	-	Peak
929.3	33.19	-12.81	46	29.89	29.71	4.12	30.53	-	-	Peak
951.7	33.73	-12.27	46	29.99	30.2	4.07	30.53	-	-	Peak

Note:

1. The amplitude of spurious emissions which are attenuated by more than 20dB below the permissible value has no need to be reported.
2. Emission level (dBuV/m) = 20 log Emission level (uV/m).
3. Corrected Reading: Antenna Factor + Cable Loss + Read Level - Preamp Factor= Level.



Appendix D. Verification of Radiated Spurious Emissions at open-area test site

D.1 Results of Radiated Emissions (9 kHz~30MHz)

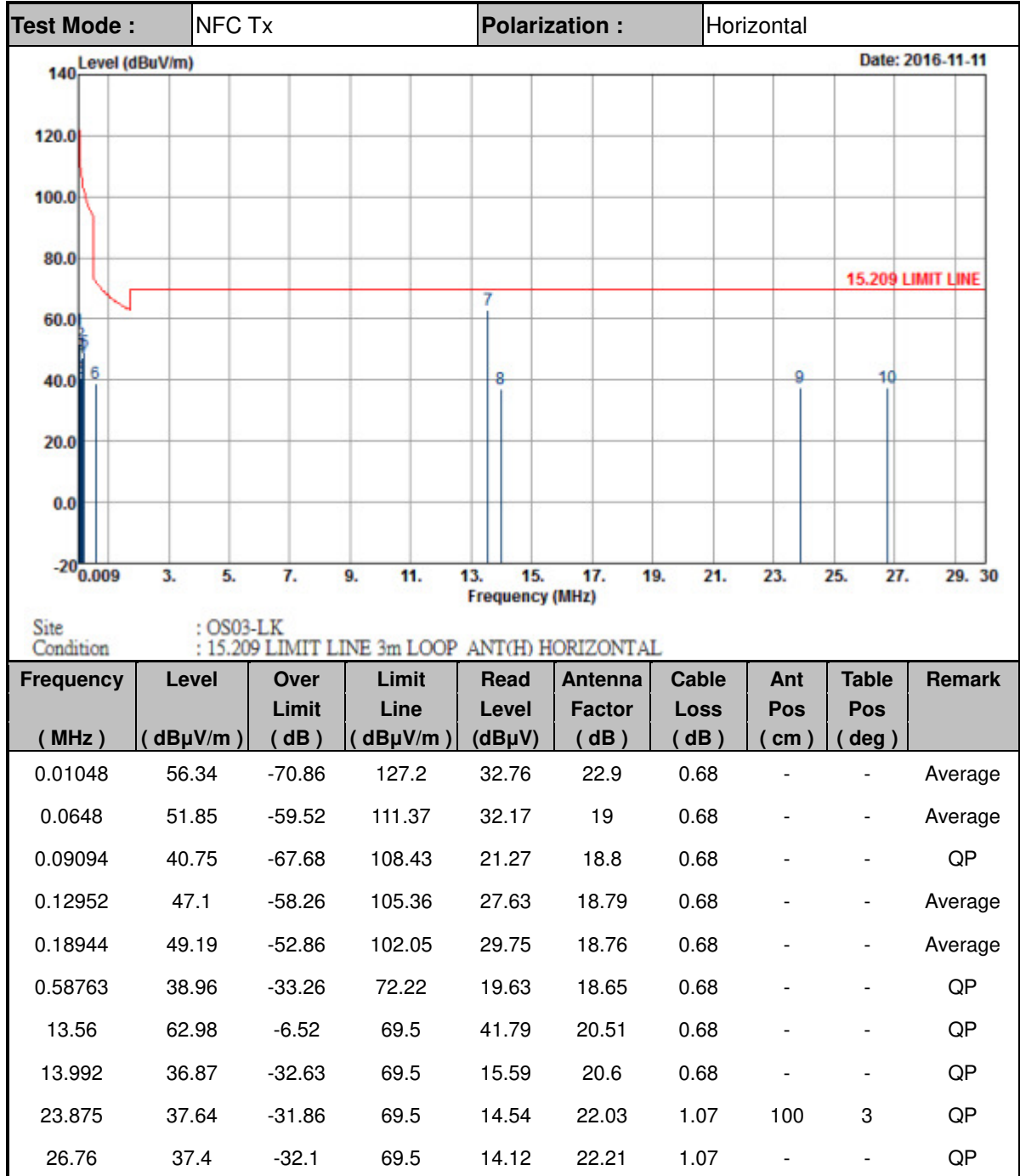

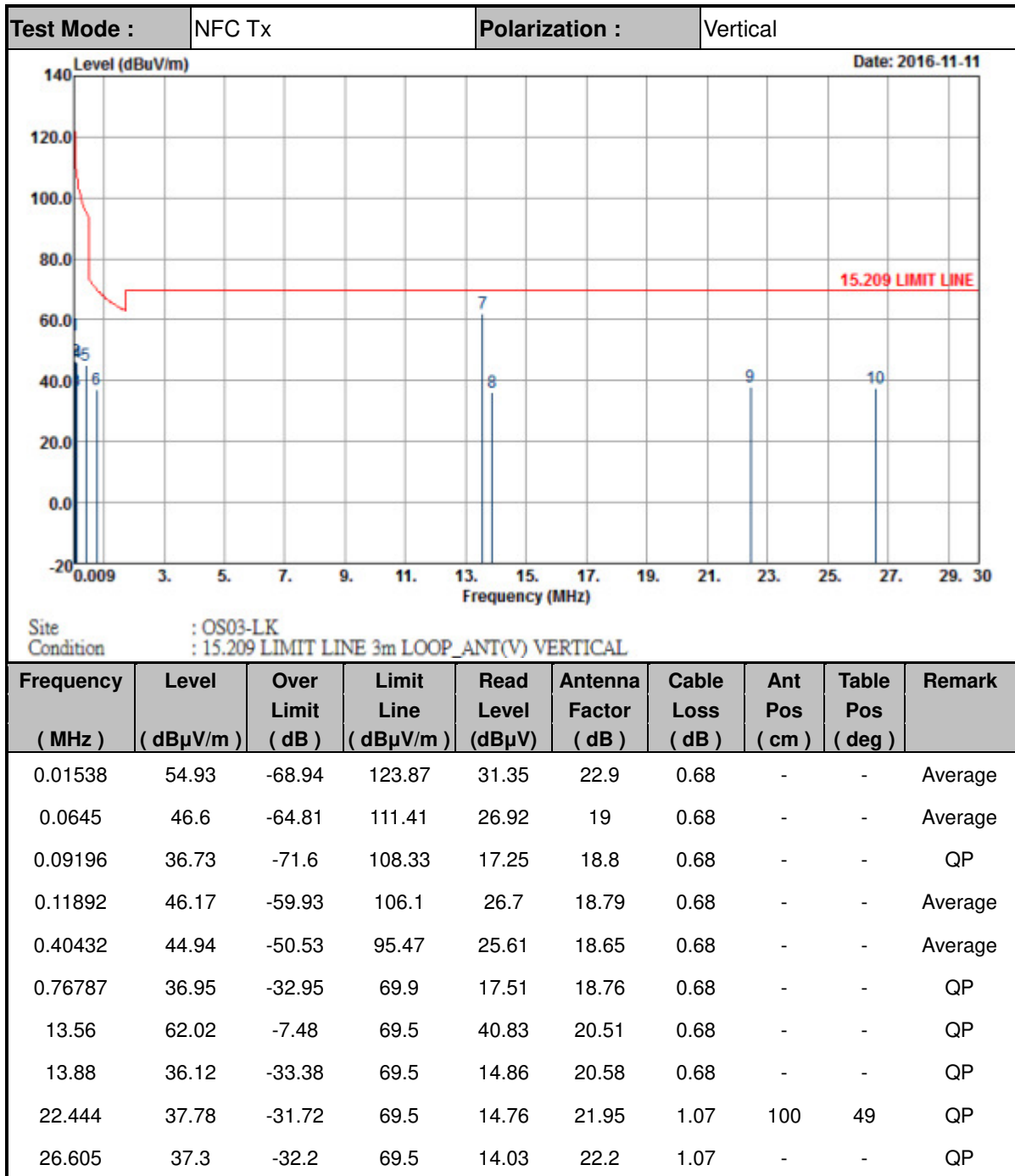

Note:

1. 13.56 MHz are fundamental signal which can be ignored.
2. The amplitude of spurious emissions which are attenuated by more than 20dB below the permissible value has no need to be reported.
3. Distance extrapolation factor = 40 log (specific distance / test distance) (dB);
4. Limit line = specific limits (dBμV) + distance extrapolation factor.
5. The test distance between the receiving antenna and the EUT is 3meter.