



SETUP PHOTOS EXHIBIT

Report Number: R14311585-EP2

Applicant : Sony Corporation
1-7-1 Konan Minato-ku
Tokyo, 108-0075, Japan

FCC ID : PY7-93060R

EUT Description : GSM/WCDMA/LTE Phone with BT, DTS/UNII a/b/g/n/ac/ax, GPS,
WPT & NFC

Test Standard(s) : FCC 47 CFR PART 15 SUBPART C AND E

Date Of Issue:

2022-08-15

Prepared by:

UL LLC

12 Laboratory Dr.

Research Triangle Park, NC 27709 U.S.A.

TEL: (919) 549-1400



REVISION HISTORY

Rev.	Issue Date	Revisions	Revised By
V1	2022-08-02	Initial Issue	Charles Moody
V2	2022-08-15	Updated DFS testing setup photos	Charles Moody

TABLE OF CONTENTS

REVISION HISTORY	2
TABLE OF CONTENTS	3
1. SETUP PHOTOS.....	4
END OF REPORT	11

1. SETUP DIAGRAMS

Radiated:

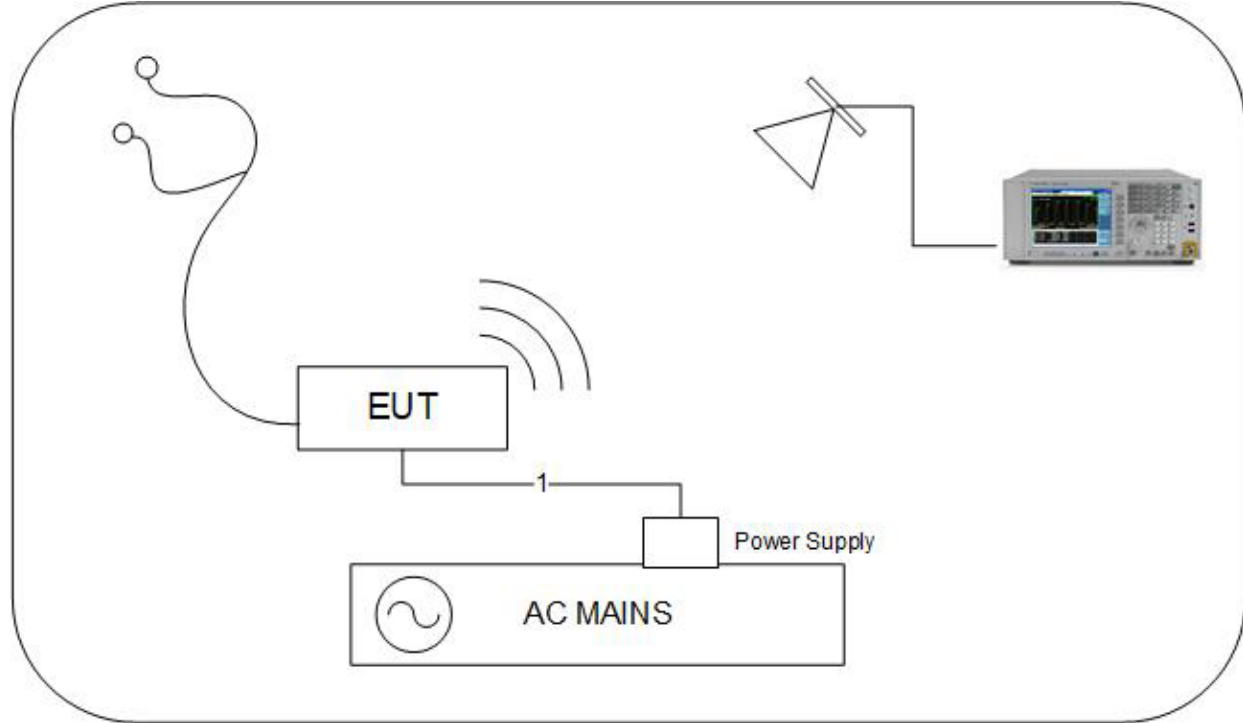

2. SETUP PHOTOS

RADIATED RF MEASUREMENT SETUP



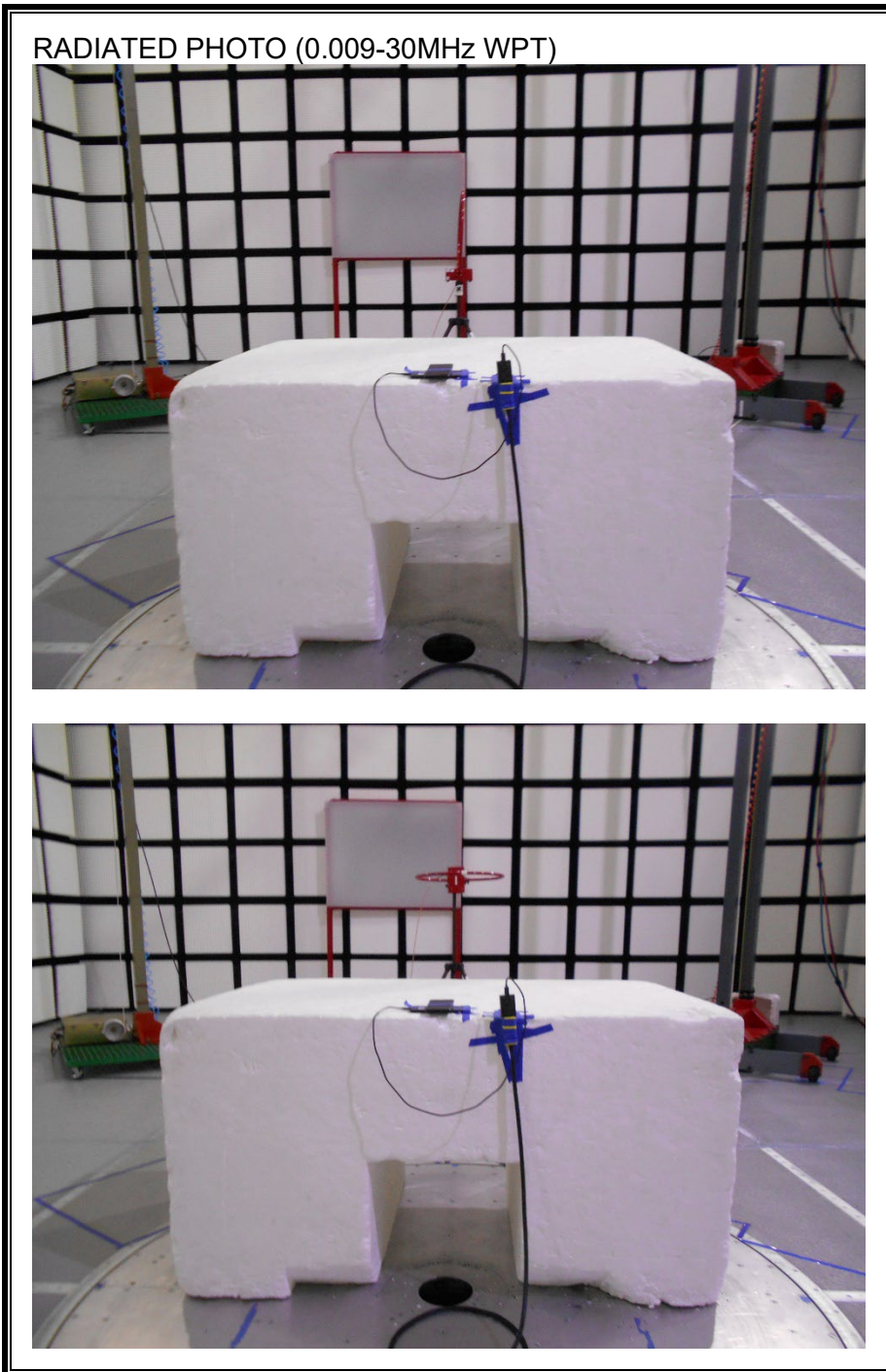



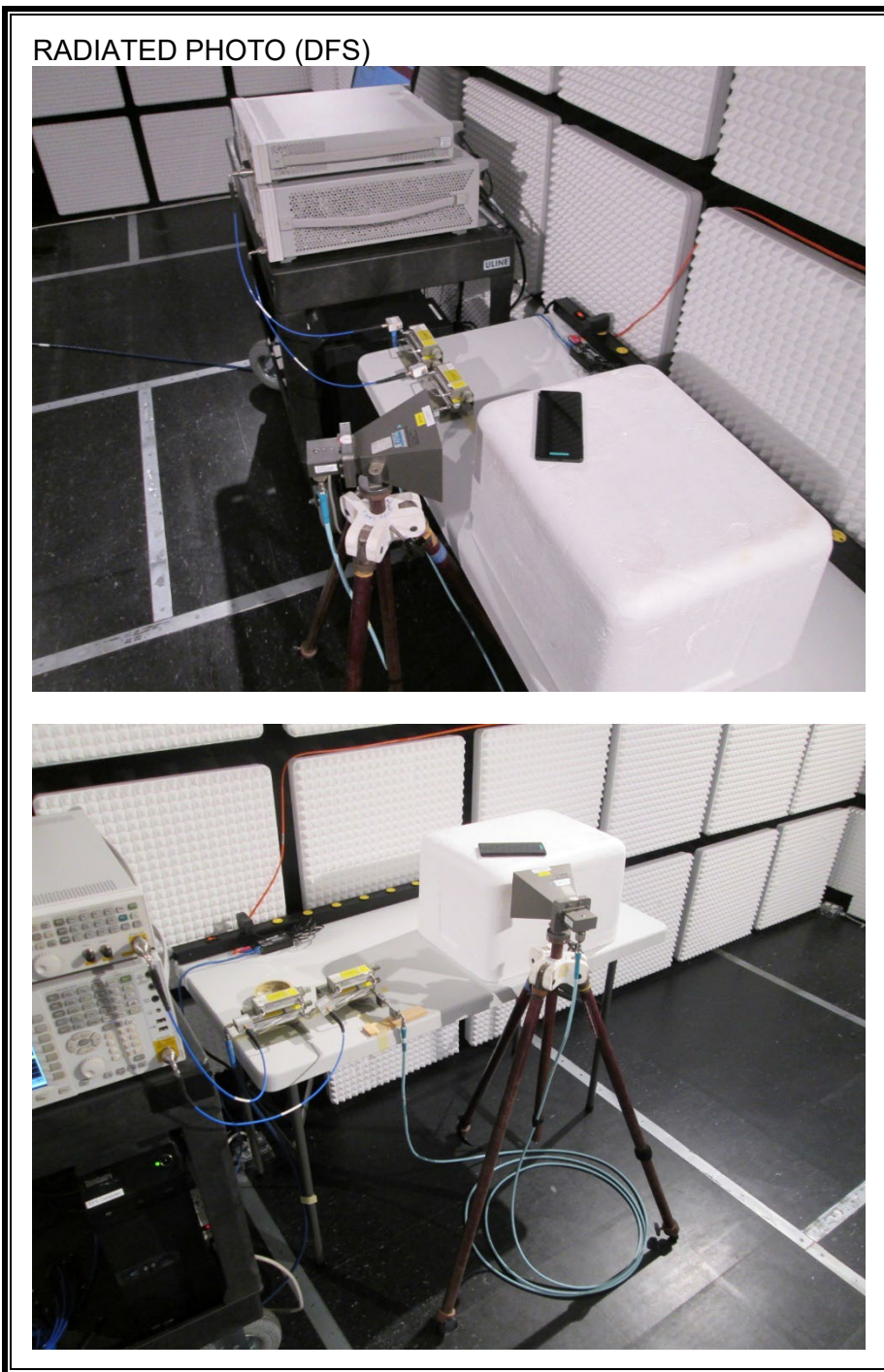

DFS TESTING SETUP

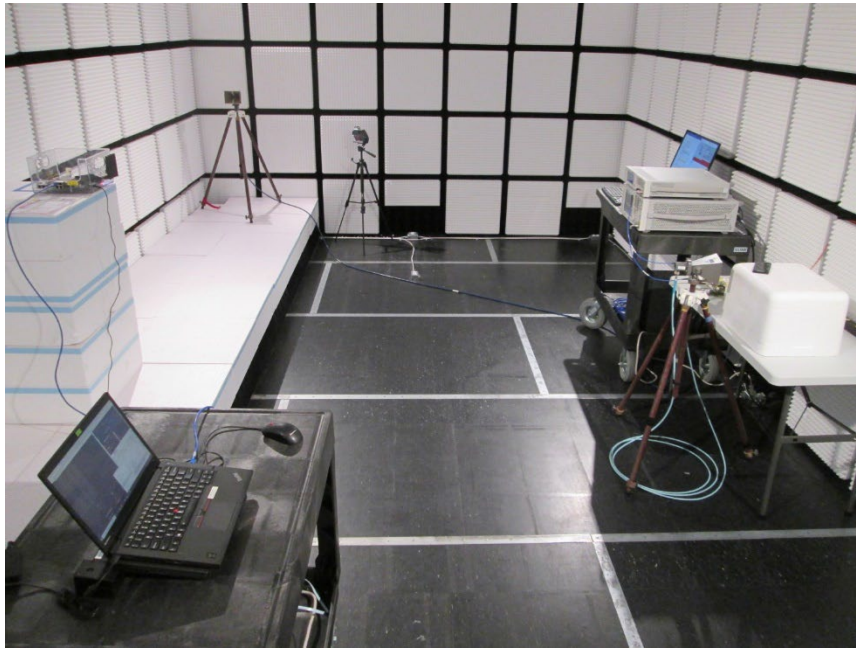

X-ORIENTATION

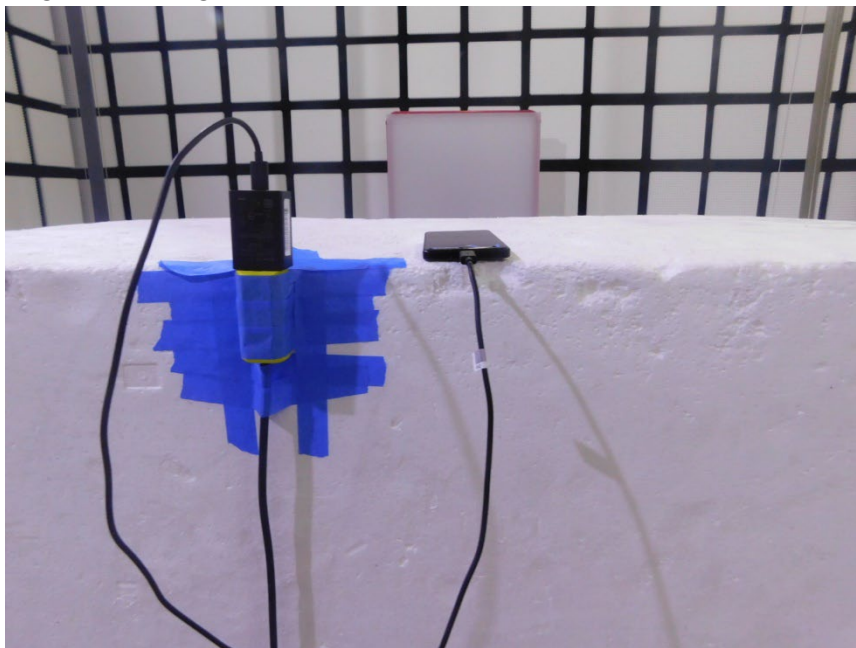

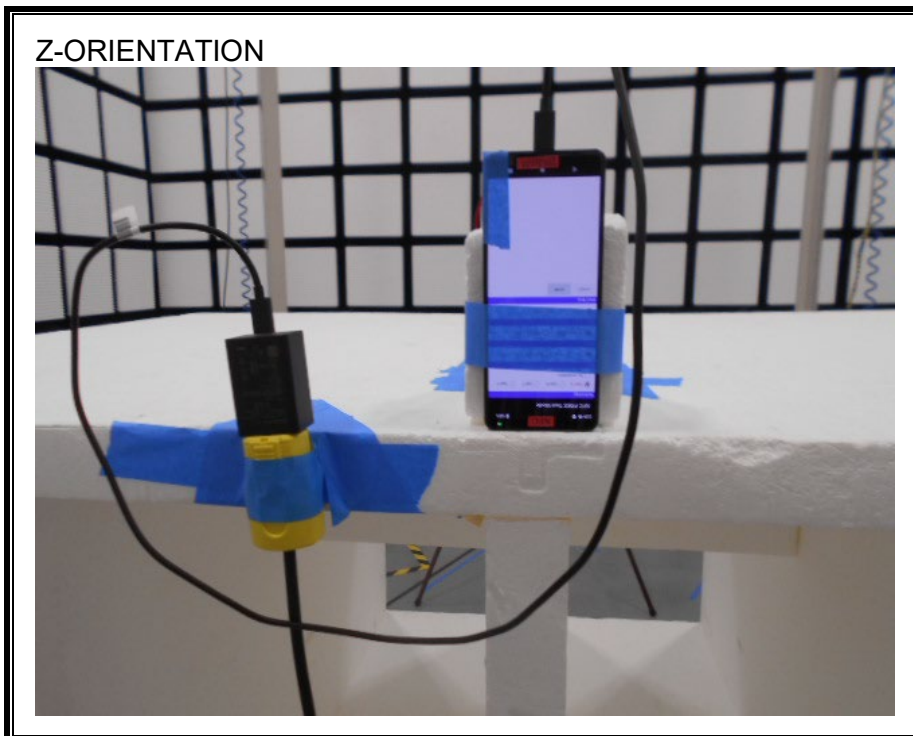
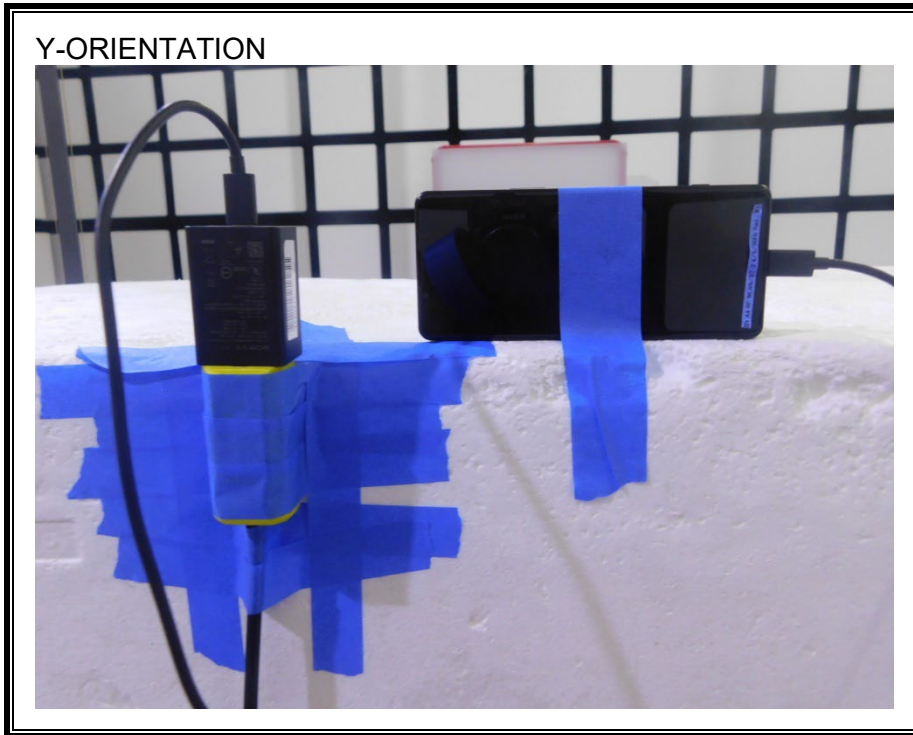

END OF REPORT