



SETUP PHOTO EXHIBIT

Report Number : R14311585-EP3

Applicant : Sony Corporation
1-7-1 Konan Minato-ku
Tokyo, 108-0076, Japan

FCC ID : PY7-93060R

EUT Description : GSM/WCDMA/LTE Phone with BT, DTS/UNII a/b/g/n/ac/ax, GPS, WPT & NFC

Test Standard(s) : FCC 47 CFR PART 15 SUBPART C

Date Of Issue:
2022-07-21

Prepared by:
UL LLC
12 Laboratory Dr.
Research Triangle Park, NC 27709 U.S.A.
TEL: (919) 549-1400



REPORT REVISION HISTORY

Rev.	Issue Date	Revisions	Revised By
V1	2022-07-21	Initial Issue	Brian Kiewra

TABLE OF CONTENTS

REPORT REVISION HISTORY	2
TABLE OF CONTENTS	3
1. SETUP DIAGRAMS	4
2. SETUP PHOTOS.....	5
END OF TEST REPORT	11

1. SETUP DIAGRAMS

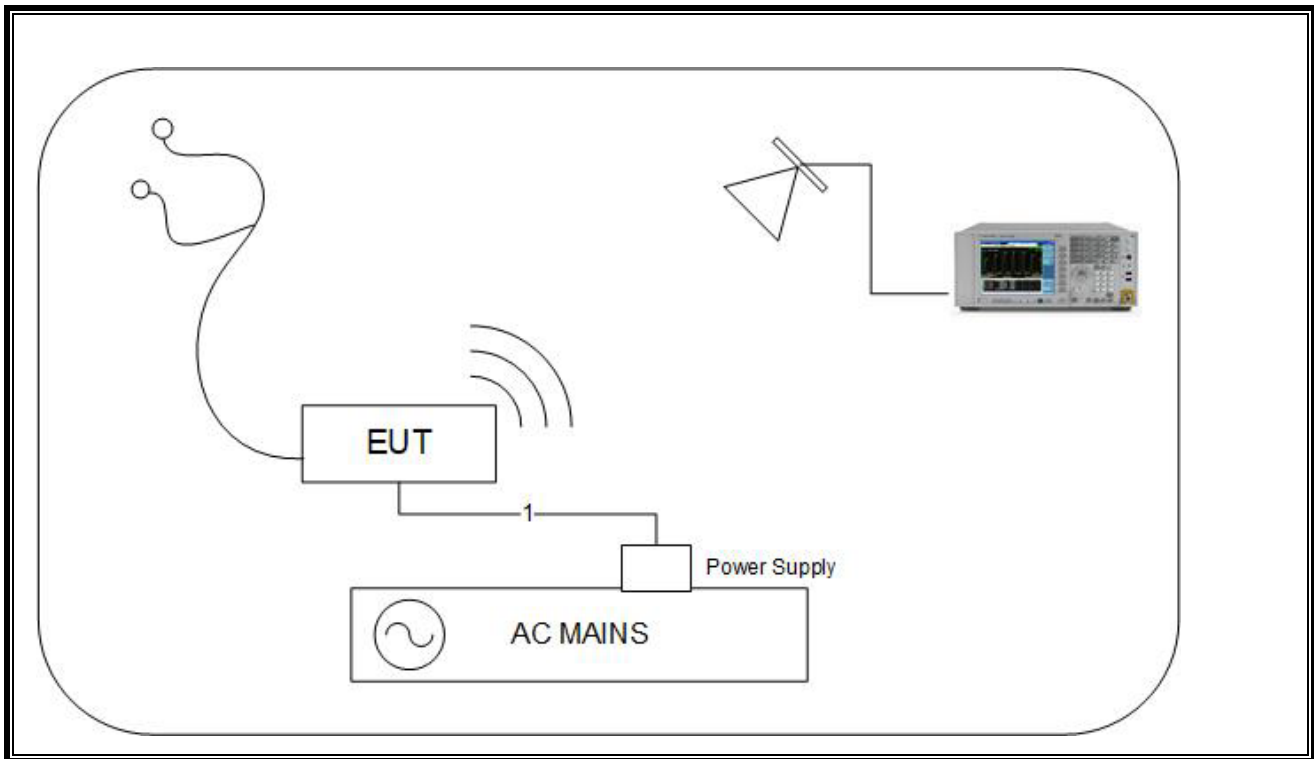

2. SETUP PHOTOS

FREQUENCY STABILITY

ENVIRONMENTAL CHAMBER PHOTO

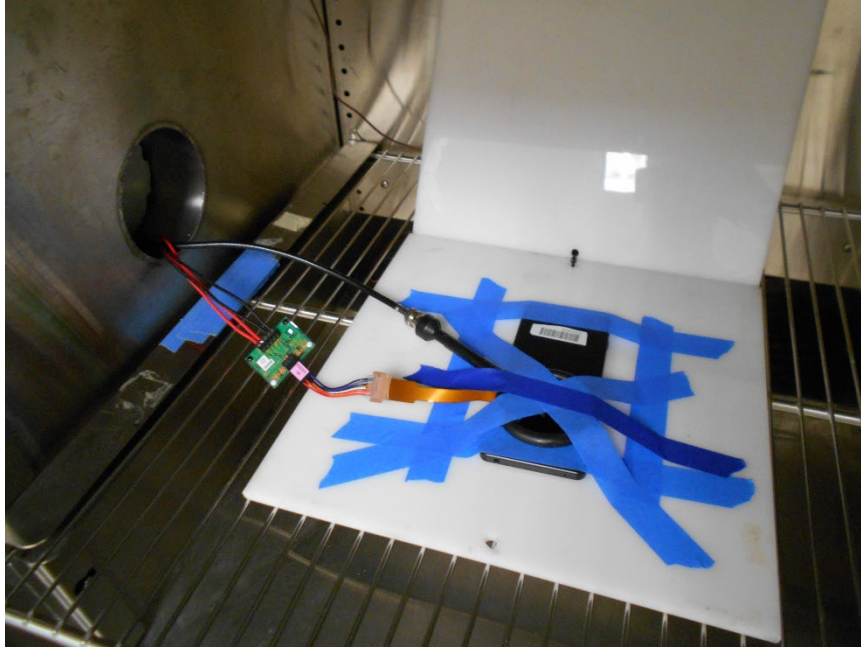

RADIATED RF MEASUREMENT SETUP

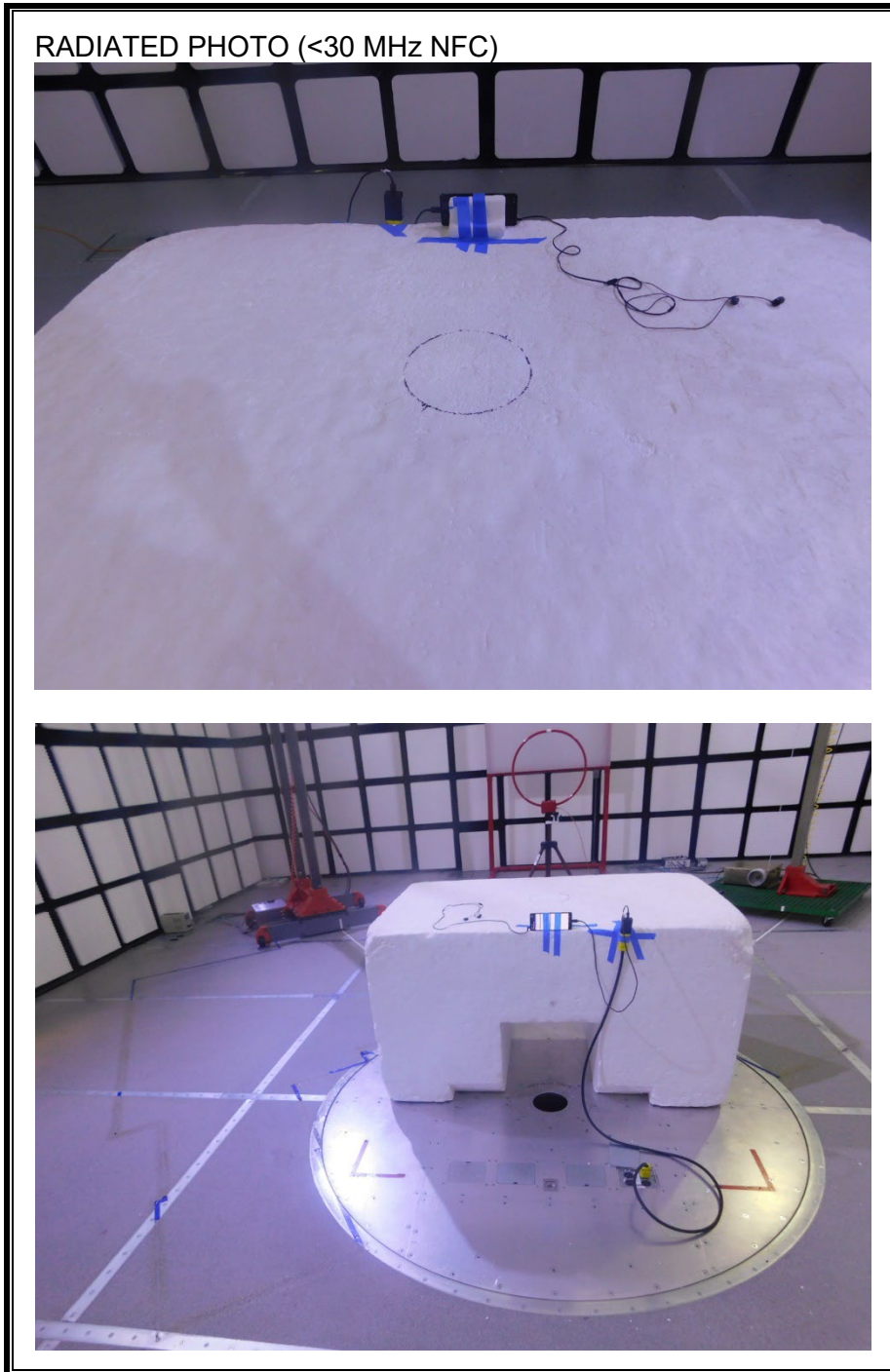

RADIATED PHOTO (<30 MHz NFC)

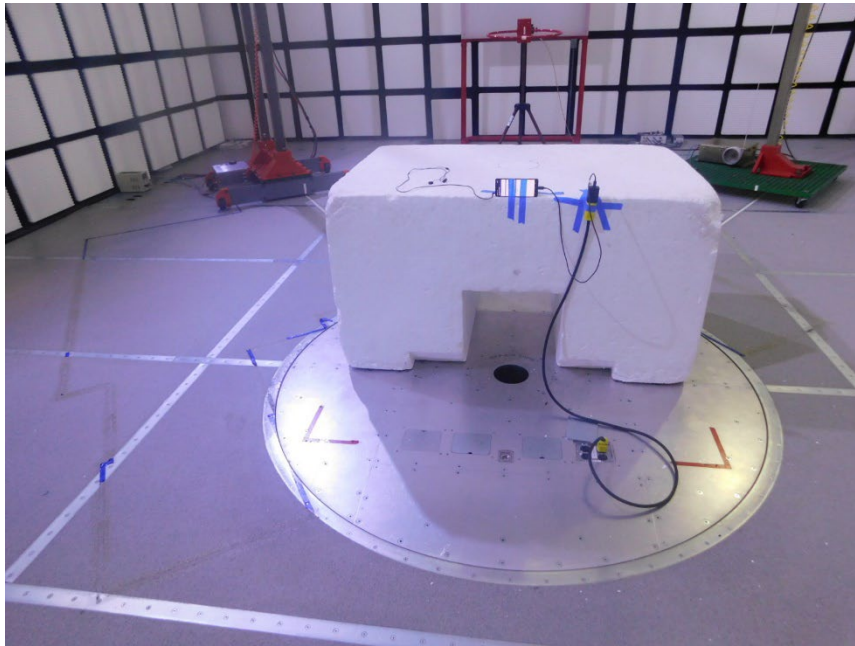
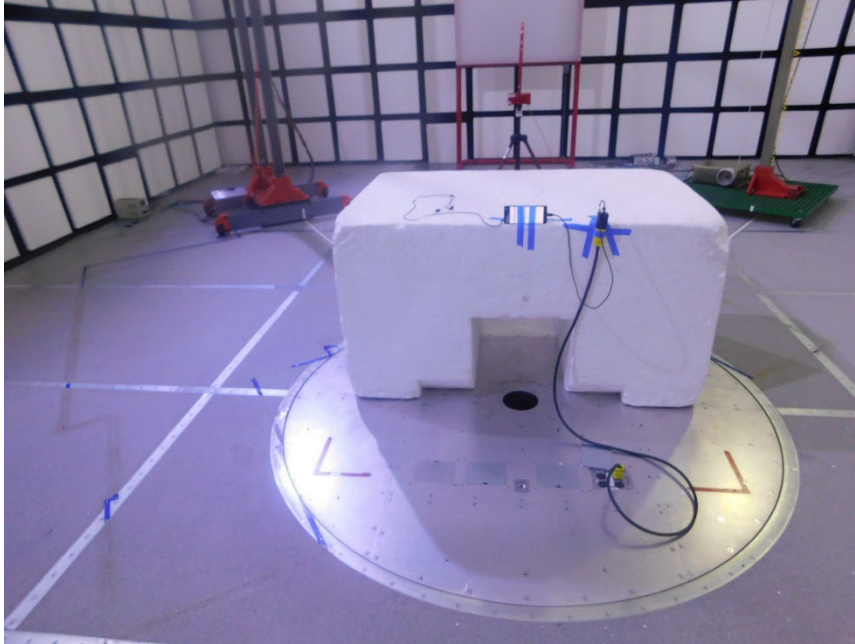

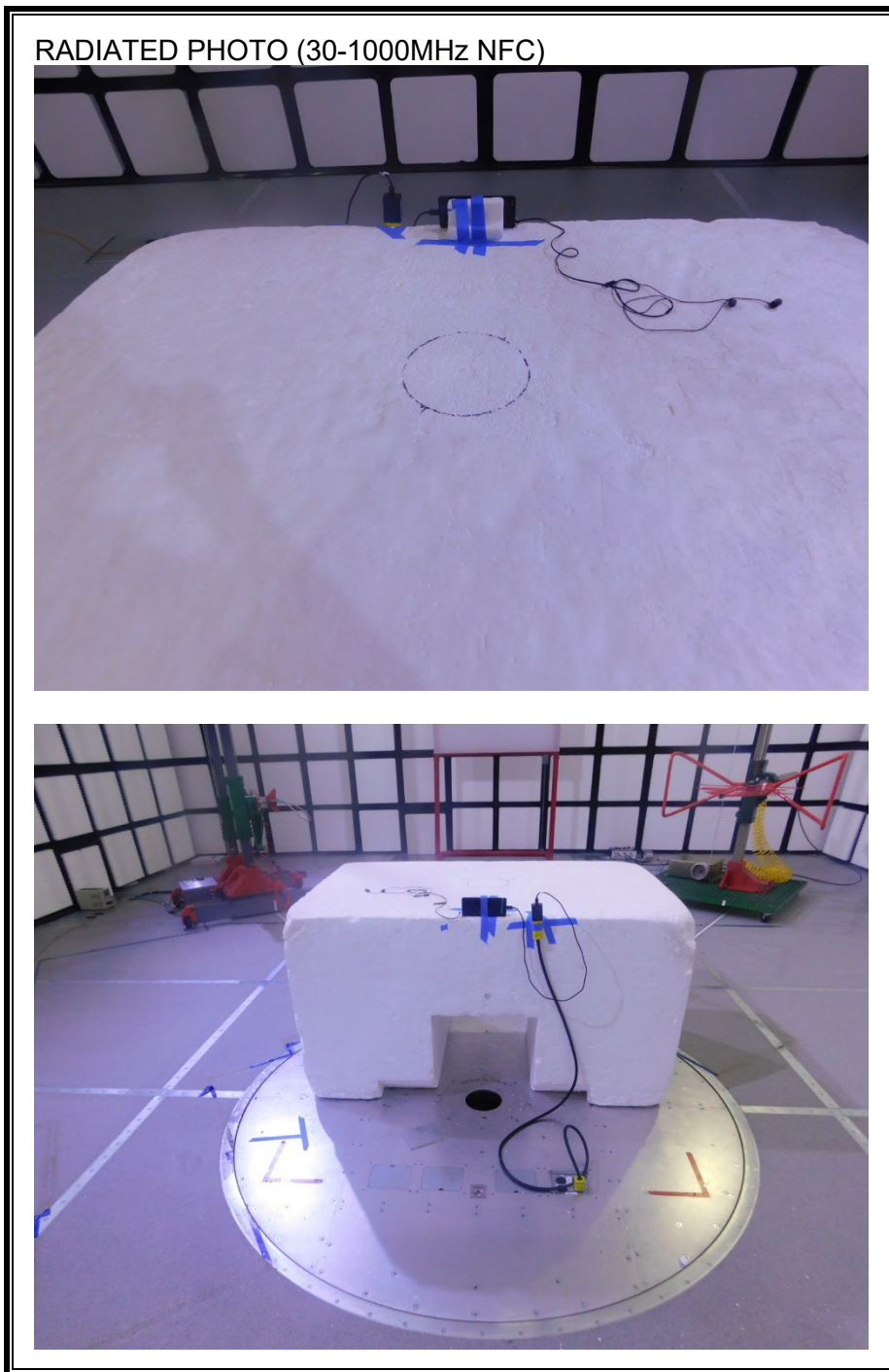

XYZ SETUP PHOTOS

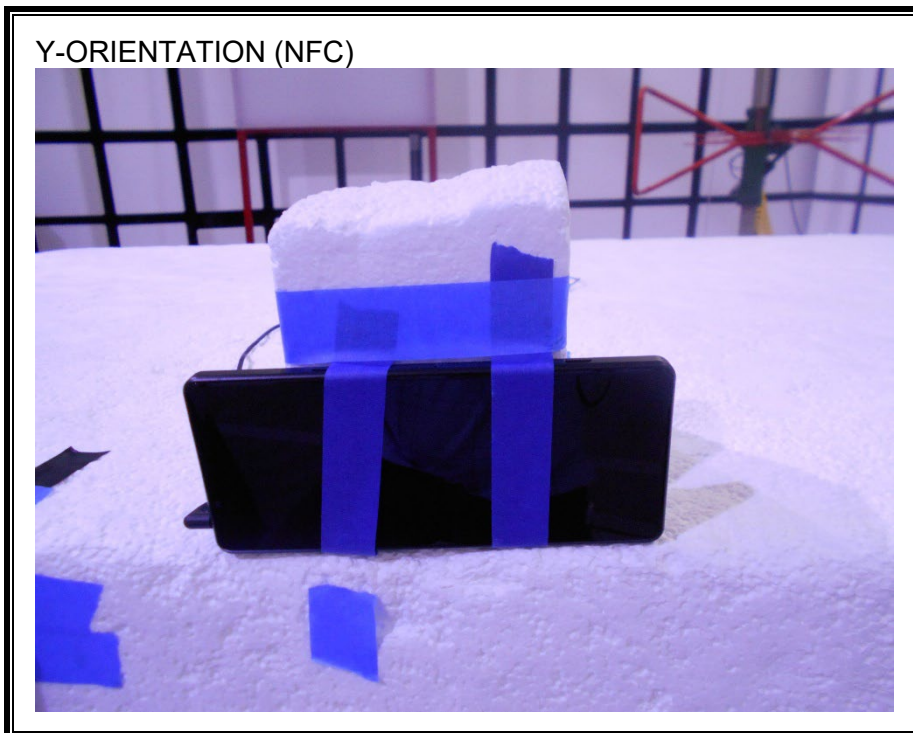
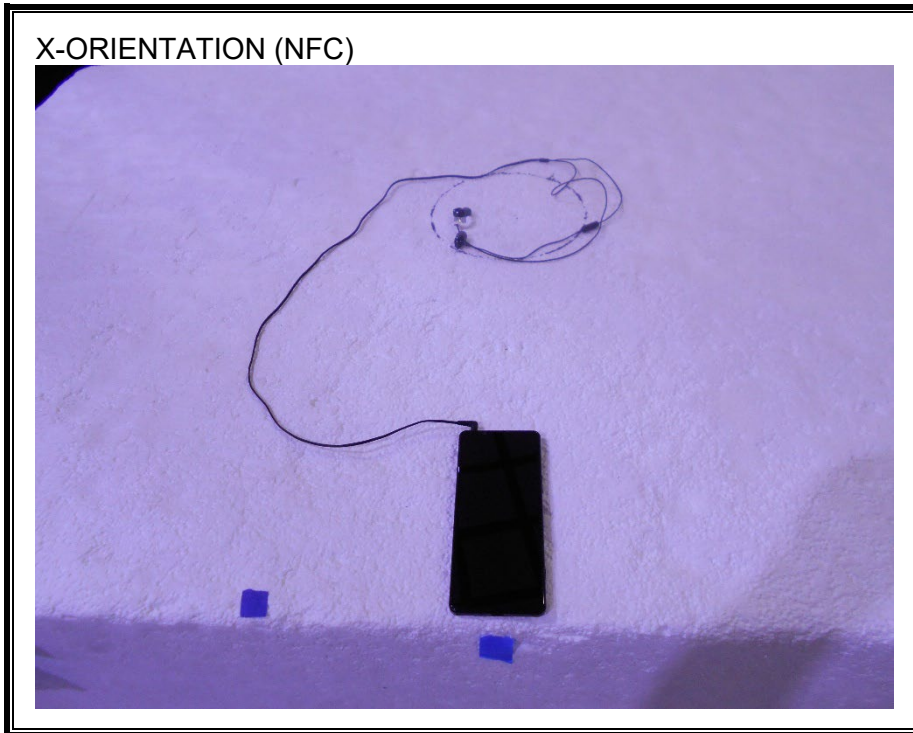

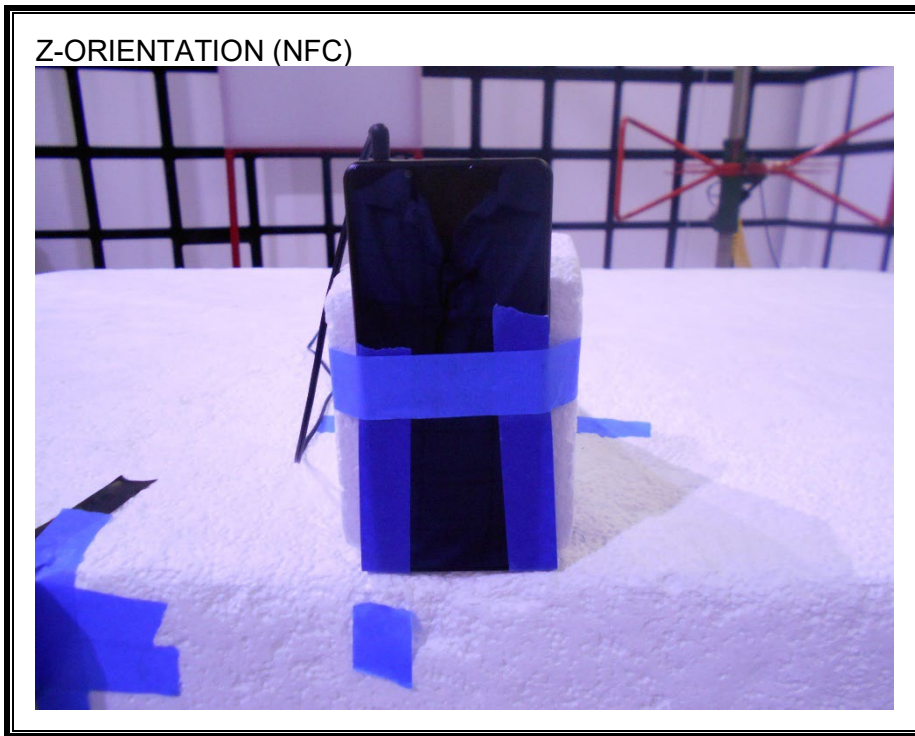

AC MAINS LINE CONDUCTED MEASUREMENT SETUP

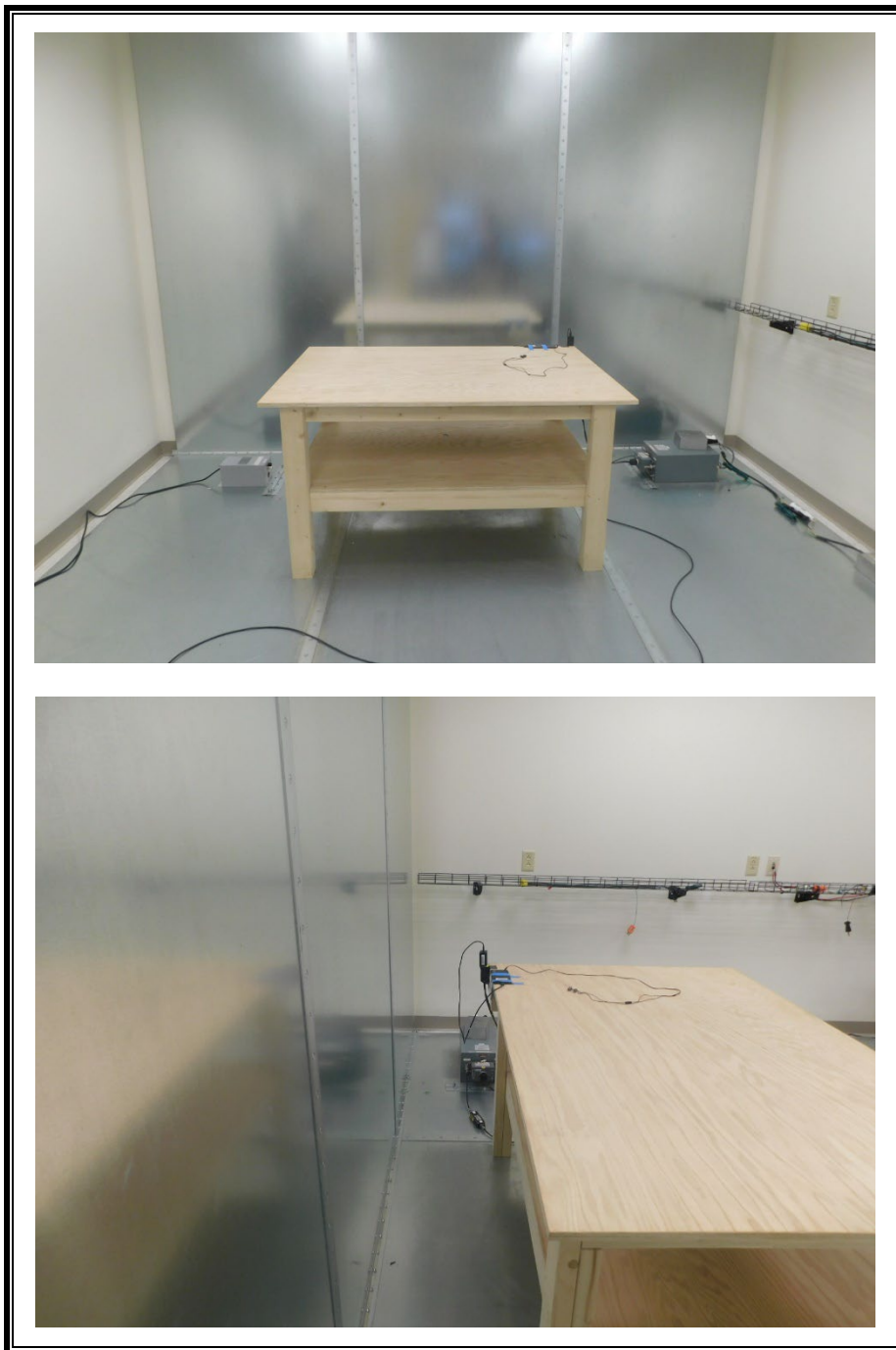

END OF TEST REPORT