



# **CERTIFICATION TEST REPORT**

**Report Number. :** 11785223-E2V1

**Applicant :** SONY MOBILE COMMUNICATIONS, INC.  
4-12-3 HIGASHI-SHINAGAWA,  
SHINAGAWA -KU, TOKYO, 140-0002, JAPAN

**FCC ID :** PY7-65365K

**EUT Description :** GSM/WCDMA/LTE Phone with BT, DTS/UNII a/b/g/n/ac, GPS & NFC

**Test Standard(s) :** FCC 47 CFR PART 15 SUBPART C

**Date Of Issue:**

July 14, 2017

**Prepared by:**

UL Verification Services Inc.  
47173 Benicia Street  
Fremont, CA 94538, U.S.A.  
TEL: (510) 771-1000  
FAX: (510) 661-0888



NVLAP LAB CODE 200065-0

---

Revision History

<u>Rev.</u>	<u>Issue Date</u>	<u>Revisions</u>	<u>Revised By</u>
V1	07/14/17	Initial Review	D. Corona

## TABLE OF CONTENTS

<b>1. ATTESTATION OF TEST RESULTS</b>	<b>5</b>
<b>2. TEST METHODOLOGY</b>	<b>6</b>
<b>3. FACILITIES AND ACCREDITATION</b>	<b>6</b>
<b>4. CALIBRATION AND UNCERTAINTY</b>	<b>7</b>
4.1. MEASURING INSTRUMENT CALIBRATION	7
4.2. SAMPLE CALCULATION	7
4.3. MEASUREMENT UNCERTAINTY	7
<b>5. EQUIPMENT UNDER TEST</b>	<b>8</b>
5.1. DESCRIPTION OF EUT	8
5.2. MAXIMUM OUTPUT POWER	8
5.3. DESCRIPTION OF AVAILABLE ANTENNAS	8
5.4. SOFTWARE AND FIRMWARE	8
5.5. WORST-CASE CONFIGURATION AND MODE	9
5.6. DESCRIPTION OF TEST SETUP	10
<b>6. TEST AND MEASUREMENT EQUIPMENT</b>	<b>13</b>
<b>7. ANTENNA PORT TEST RESULTS</b>	<b>14</b>
7.1. BASIC DATA RATE GFSK MODULATION	15
7.1.1. 20 dB AND 99% BANDWIDTH	15
7.1.2. HOPPING FREQUENCY SEPARATION	18
7.1.3. NUMBER OF HOPPING CHANNELS	19
7.1.4. AVERAGE TIME OF OCCUPANCY	22
7.1.5. OUTPUT POWER	26
7.1.6. AVERAGE POWER	27
7.1.7. CONDUCTED BANDEDGE AND SPURIOUS EMISSIONS	28
7.2. ENHANCED DATA RATE 8PSK MODULATION	32
7.2.1. 20 dB AND 99% BANDWIDTH	32
7.2.2. HOPPING FREQUENCY SEPARATION	35
7.2.3. NUMBER OF HOPPING CHANNELS	36
7.2.4. AVERAGE TIME OF OCCUPANCY	39
7.2.5. OUTPUT POWER	43
7.2.6. AVERAGE POWER	44
7.2.7. CONDUCTED BANDEDGE AND SPURIOUS EMISSIONS	45
<b>8. RADIATED TEST RESULTS</b>	<b>49</b>
8.1. LIMITS AND PROCEDURE	49

---

8.2.	<i>BASIC DATA RATE GFSK MODULATION</i> .....	50
8.2.1.	RESTRICTED BANDEDGE (LOW CHANNEL).....	50
8.2.2.	AUTHORIZED BANDEDGE (HIGH CHANNEL) .....	52
8.2.3.	HARMONICS AND SPURIOUS EMISSIONS .....	54
8.3.	<i>ENHANCED DATA RATE 8PSK MODULATION</i> .....	60
8.3.1.	RESTRICTED BANDEDGE (LOW CHANNEL).....	60
8.3.2.	AUTHORIZED BANDEDGE (HIGH CHANNEL) .....	62
8.3.3.	HARMONICS AND SPURIOUS EMISSIONS .....	64
8.4.	<i>WORST-CASE BELOW 30 MHz</i> .....	70
8.5.	<i>WORST-CASE BELOW 1 GHz</i> .....	71
8.6.	<i>WORST-CASE ABOVE 18 GHz</i> .....	73
<b>9.</b>	<b>AC POWER LINE CONDUCTED EMISSIONS</b> .....	<b>75</b>
<b>10.</b>	<b>SETUP PHOTOS</b> .....	<b>78</b>

# 1. ATTESTATION OF TEST RESULTS

**COMPANY NAME:** SONY MOBILE COMMUNICATIONS, INC.  
4-12-3 HIGASHI-SHINAGAWA,  
SHINAGAWA -KU, TOKYO, 140-0002, JAPAN

**EUT DESCRIPTION:** GSM/WCDMA/LTE Phone with BT, DTS/UNII a/b/g/n/ac, GPS & NFC

**SERIAL NUMBER:** RADIATED: BH9000SN81; BH9000BP81  
CONDUCTED: BH9000BS82

**DATE TESTED:** JUNE 6 – JULY 13, 2017

APPLICABLE STANDARDS	
STANDARD	TEST RESULTS
CFR 47 Part 15 Subpart C	Pass

UL Verification Services Inc. tested the above equipment in accordance with the requirements set forth in the above standards. All indications of Pass/Fail in this report are opinions expressed by UL Verification Services Inc. based on interpretations and/or observations of test results. Measurement Uncertainties were not taken into account and are published for informational purposes only. The test results show that the equipment tested is capable of demonstrating compliance with the requirements as documented in this report.

**Note:** The results documented in this report apply only to the tested sample, under the conditions and modes of operation as described herein. This document may not be altered or revised in any way unless done so by UL Verification Services Inc. and all revisions are duly noted in the revisions section. Any alteration of this document not carried out by UL Verification Services Inc. will constitute fraud and shall nullify the document. This report must not be used by the client to claim product certification, approval, or endorsement by NVLAP, NIST, any agency of the Federal Government, or any agency of any government.

Approved & Released For  
UL Verification Services Inc. By:



DAN CORONIA  
WISE PROJECT LEAD  
UL VERIFICATION SERVICES INC.

Prepared By:



GLENN ESCANO  
WISE LAB ENGINEER  
UL VERIFICATION SERVICES INC.

## 2. TEST METHODOLOGY

The tests documented in this report were performed in accordance with FCC CFR 47 Part 2, FCC CFR 47 Part 15, ANSI C63.10-2013.

## 3. FACILITIES AND ACCREDITATION

The test sites and measurement facilities used to collect data are located at 47173 and 47266 Benicia Street, Fremont, California, USA. Line conducted emissions are measured only at the 47173 address. The following table identifies which facilities were utilized for radiated emission measurements documented in this report. Specific facilities are also identified in the test results sections.

47173 Benicia Street	47266 Benicia Street
<input type="checkbox"/> Chamber A(IC: 2324B-1)	<input type="checkbox"/> Chamber D(IC: 22541-1)
<input checked="" type="checkbox"/> Chamber B(IC: 2324B-2)	<input type="checkbox"/> Chamber E(IC: 22541-2)
<input checked="" type="checkbox"/> Chamber C(IC: 2324B-3)	<input type="checkbox"/> Chamber F(IC: 22541-3)
	<input type="checkbox"/> Chamber G(IC: 22541-4)
	<input type="checkbox"/> Chamber H(IC: 22541-5)

The above test sites and facilities are covered under FCC Test Firm Registration # 208313. UL Verification Services Inc. is accredited by NVLAP, Laboratory Code 200065-0. Chambers A through C are covered under Industry Canada company address code 2324B with site numbers 2324B -1 through 2324B-3, respectively. Chambers D through H are covered under Industry Canada company address code 22541 with site numbers 22541 -1 through 22541-5, respectively.

## 4. CALIBRATION AND UNCERTAINTY

### 4.1. MEASURING INSTRUMENT CALIBRATION

The measuring equipment utilized to perform the tests documented in this report has been calibrated in accordance with the manufacturer's recommendations, and is traceable to recognized national standards.

### 4.2. SAMPLE CALCULATION

Where relevant, the following sample calculation is provided:

$$\begin{aligned} \text{Field Strength (dBuV/m)} &= \text{Measured Voltage (dBuV)} + \text{Antenna Factor (dB/m)} + \\ &\text{Cable Loss (dB)} - \text{Preamp Gain (dB)} \\ 36.5 \text{ dBuV} + 18.7 \text{ dB/m} + 0.6 \text{ dB} - 26.9 \text{ dB} &= 28.9 \text{ dBuV/m} \end{aligned}$$

### 4.3. MEASUREMENT UNCERTAINTY

Where relevant, the following measurement uncertainty levels have been estimated for tests performed on the apparatus:

Parameter	Uncertainty
Worst Case Conducted Disturbance, 9KHz to 0.15 MHz	3.84 dB
Worst Case Conducted Disturbance, 0.15 to 30 MHz	3.65 dB
Worst Case Radiated Disturbance, 9KHz to 30 MHz	3.15 dB
Worst Case Radiated Disturbance, 30 to 1000 MHz	5.36 dB
Worst Case Radiated Disturbance, 1000 to 18000 MHz	4.32 dB
Worst Case Radiated Disturbance, 18000 to 26000 MHz	4.45 dB
Worst Case Radiated Disturbance, 26000 to 40000 MHz	5.24 dB

Uncertainty figures are valid to a confidence level of 95%.

## 5. EQUIPMENT UNDER TEST

### 5.1. DESCRIPTION OF EUT

The EUT is a GSM/WCDMA/LTE Phone with BT, DTS/UNII a/b/g/n/ac, GPS & NFC.

### 5.2. MAXIMUM OUTPUT POWER

The transmitter has a maximum peak conducted output power as follows:

Frequency Range (MHz)	Mode	Output Power (dBm)	Output Power (mW)
2402 - 2480	Basic GFSK	11.28	13.43
2402 - 2480	Enhanced 8PSK	10.91	12.33

### 5.3. DESCRIPTION OF AVAILABLE ANTENNAS

The radio utilizes integrated antenna, with the maximum gains:

Frequency Band (GHz)	Antenna Gain (dBi)
2402-2480	-2.80

### 5.4. SOFTWARE AND FIRMWARE

The firmware installed in the EUT during testing was SONY, s\_atp\_1\_00139\_B\_10\_5.  
The test utility software used during testing was Tera Term Ver 4.79.



---

## 5.5. WORST-CASE CONFIGURATION AND MODE

Radiated band edge, harmonics, and spurious emissions from 1 GHz to 18GHz were performed with the EUT was set to transmit at the Low/Middle/High channels.

Radiated emission below 30MHz, below 1GHz, above 18GHz, and power line conducted emission were performed with the EUT was set to transmit at the channel with highest output power as worst-case scenario.

The fundamental of the EUT was investigated in three orthogonal orientations X, Y, & Z, and it was determined that Z-Axis orientation was worst-case orientation; therefore, all final radiated testing was performed with the EUT in Z-Axis orientation.

Worst-case data rates were:

GFSK mode: DH5  
8PSK mode: 3-DH5

DQPSK mode has been verified to have the lowest power.

## 5.6. DESCRIPTION OF TEST SETUP

### SUPPORT EQUIPMENT

Support Equipment List				
Description	Manufacturer	Model	Serial Number	FCC ID
Laptop	Lenovo	20B7S0A200	PC015REW	NA
AC Adapter	SONY	1300-7137.1	4016W40310044	NA
Headphones	SONY	N/A	N/A	N/A

### I/O CABLES (CONDUCTED TEST)

I/O Cable List						
Cable No	Port	# of identical ports	Connector Type	Cable Type	Cable Length (m)	Remarks
1	Antenna	1	RF	Shielded	0.2	To spectrum Analyzer
2	USB	1	USB	Shielded	1	N/A
3	DC	1	DC	Shielded	0.3	N/A

### I/O CABLES (RADIATED AND CONDUCTED EMISSIONS)

I/O Cable List						
Cable No	Port	# of identical ports	Connector Type	Cable Type	Cable Length (m)	Remarks
1	USB	1	USB	Shielded	3	N/A
2	Audio	1	3.5mm	Shielded	1	N/A

**TEST SETUP- CONDUCTED PORT**

The EUT was tested connected to a host Laptop via USB cable adapter and spectrum analyzer to antenna port. Test software exercised the EUT.

**SETUP DIAGRAM**

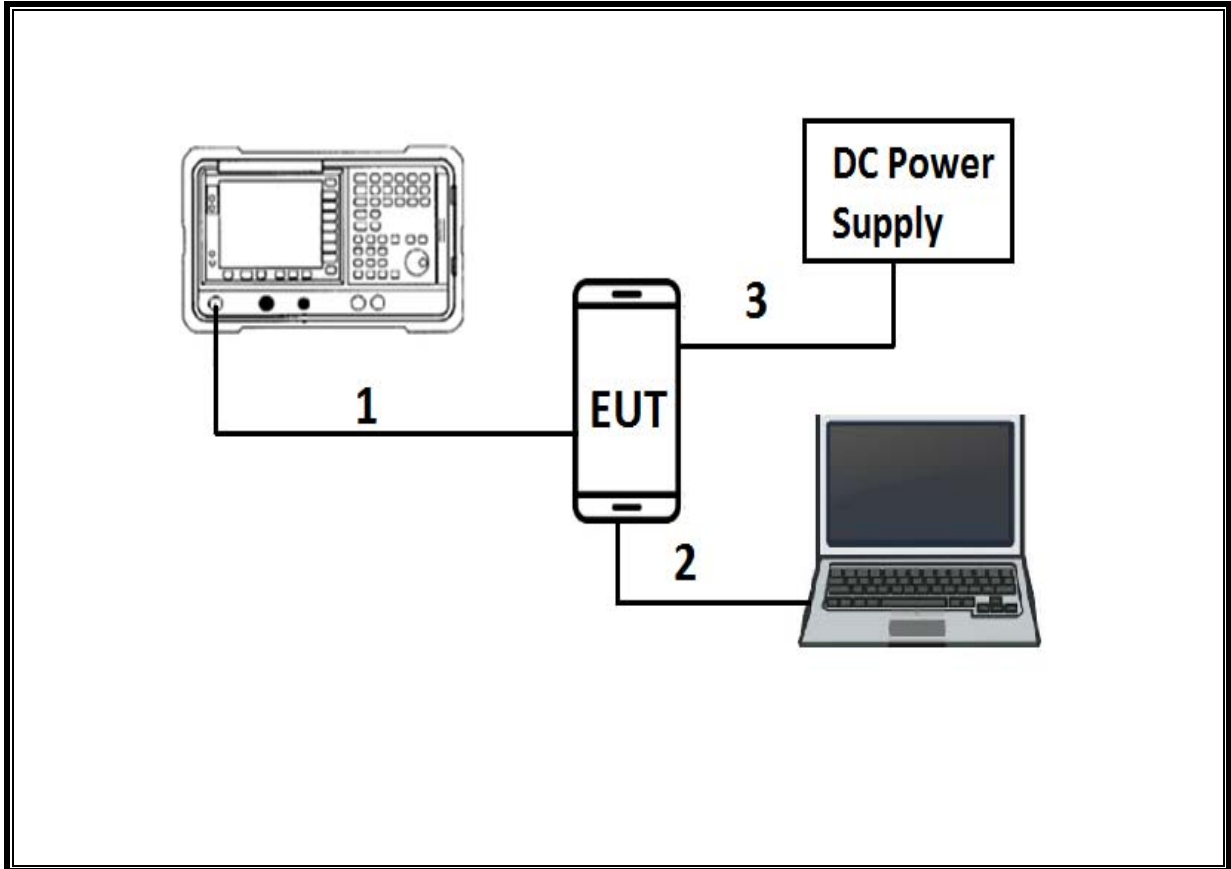

**TEST SETUP- RADIATED-ABOVE 1 GHZ and AC LINE CONDUCTED TESTS**

The EUT was powered by AC Adapter. Test software exercised the EUT.

**SETUP DIAGRAM**

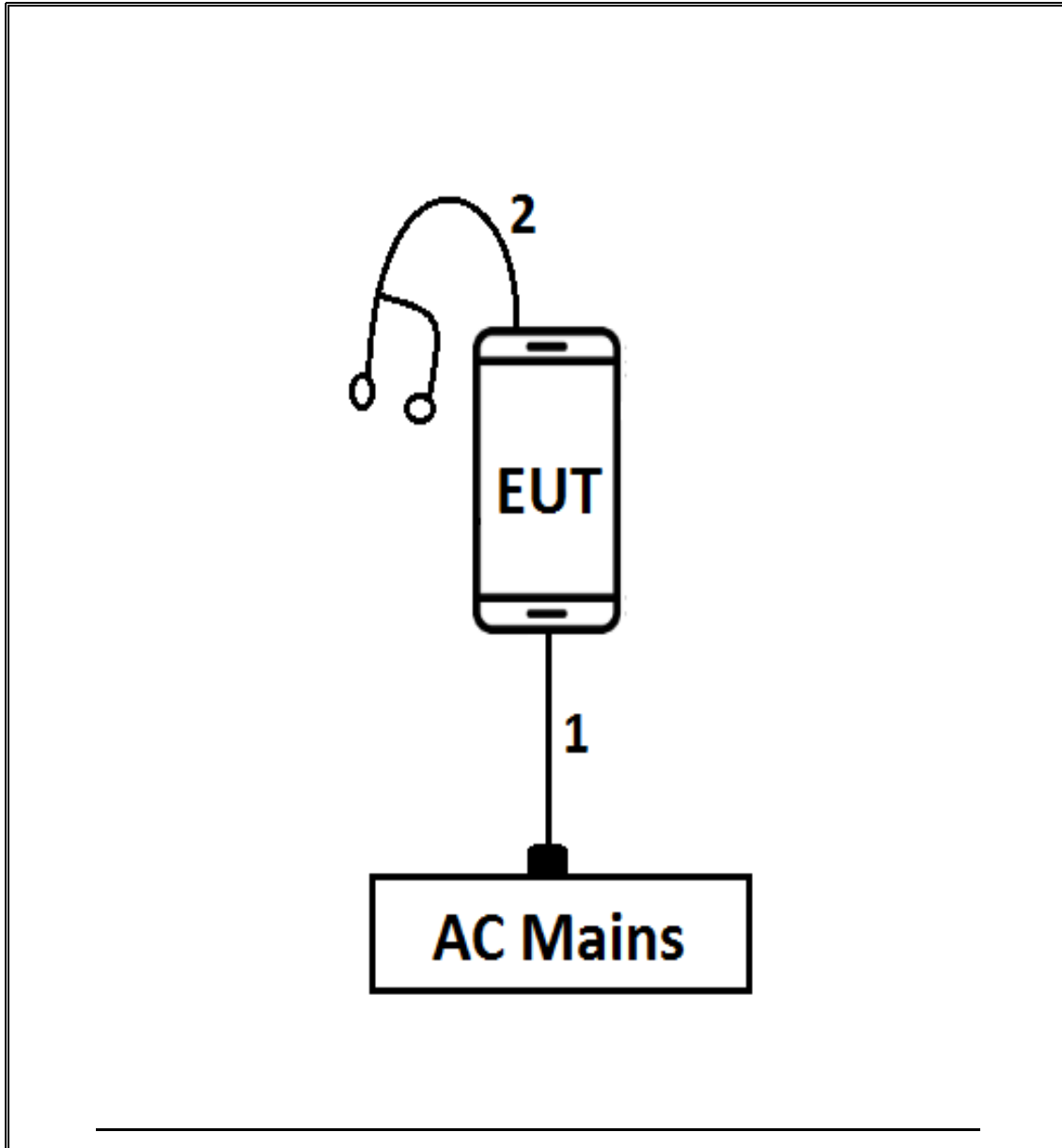

## 6. TEST AND MEASUREMENT EQUIPMENT

TEST EQUIPMENT LIST				
Description	Manufacturer	Model	Asset	Cal Due
Antenna, Broadband Hybrid, 30MHz to 2000MHz w/4dB Pad	Sunol Sciences Corp.	JB3	T477	06/22/2018
Antenna, Active Loop 9kHz-30MHz	ETS-Lindgren	6502	T1683	02/17/2018
Antenna, Horn 1-18GHz	ETS-Lindgren	3117	T345	03/07/2018
Antenna, Horn 18-26.5GHz	ARA	MWH-1826/B	T449	05/26/2018
Power Meter, P-series single channel	Agilent (Keysight) Technologies	N1911A	T1264	07/08/2018
Power Sensor, P – series, 50MHz to 18GHz, Wideband	Agilent (Keysight) Technologies	N1921A	T413	06/20/2018
Amplifier, 1-26.5GHz	Agilent (Keysight) Technologies	8449B	T404	07/05/2018
Amplifier, 10kHz-1GHz	Agilent (Keysight) Technologies	8447D	T15	08/26/2017
RF Amplifier	MITEQ	AFS42-00101800-25-S-42	T493	02/15/2018
Spectrum Analyzer, PSA, 3Hz to 26.5GHz	Agilent (Keysight) Technologies	E4440A	T199	07/22/2017
Spectrum Analyzer, PXA, 3Hz to 44GHz	Agilent (Keysight) Technologies	N9030A	T907	01/23/2018
Spectrum Analyzer, PSA, 3Hz to 26.5GHz	Agilent (Keysight) Technologies	E9030A	T905	01/11/2018
LISN	FISCHER	FCC-LISN-50/250-25-2-01	T1310	01/17/2018

Test Software List			
Description	Manufacturer	Model	Version
Radiated Software	UL	UL EMC	Ver 9.5, Apr 26, 2016
Conducted Software	UL	UL EMC	Ver 9.5, May 26, 2015
Antenna Port Software	UL	UL RF	Ver 5.1.1, July 15, 2016

## 7. ANTENNA PORT TEST RESULTS

### ON TIME AND DUTY CYCLE

#### LIMITS

None; for reporting purposes only.

#### PROCEDURE

KDB 558074 Zero-Span Spectrum Analyzer Method.

### ON TIME AND DUTY CYCLE RESULTS

ON TIME AND DUTY CYCLE RESULTS						
Mode	ON Time B (msec)	Period (msec)	Duty Cycle x (linear)	Duty Cycle (%)	Duty Cycle Correction Factor (dB)	1/T Minimum VBW (kHz)
GFSK	2.885	3.750	0.769	76.93%	1.14	0.347
8PSK	2.889	3.750	0.770	77.04%	1.13	0.346

### DUTY CYCLE PLOTS

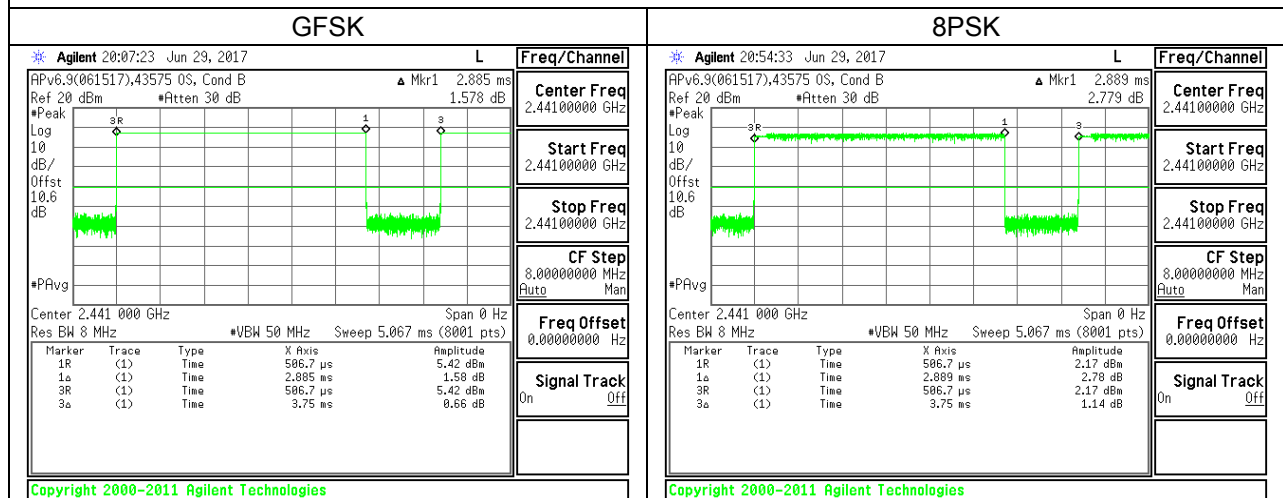

NOTE: HOPPING OFF

## 7.1. BASIC DATA RATE GFSK MODULATION

### 7.1.1. 20 dB AND 99% BANDWIDTH

#### LIMITS

None; for reporting purposes only.

#### TEST PROCEDURE

The transmitter output is connected to a spectrum analyzer. The RBW is set to  $\geq 1\%$  of the 20 dB bandwidth. The VBW is set to  $\geq$  RBW. The sweep time is coupled.

#### RESULTS

Channel	Frequency (MHz)	20 dB Bandwidth (KHz)	99% Bandwidth (KHz)
Low	2402	865.07	855.66
Middle	2441	874.06	857.01
High	2480	846.62	860.06

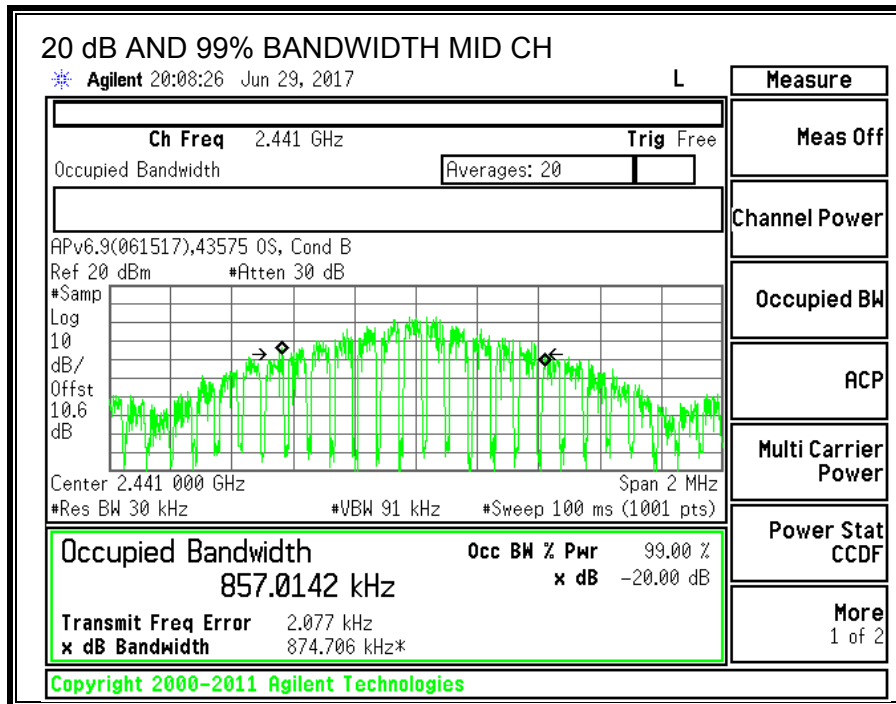
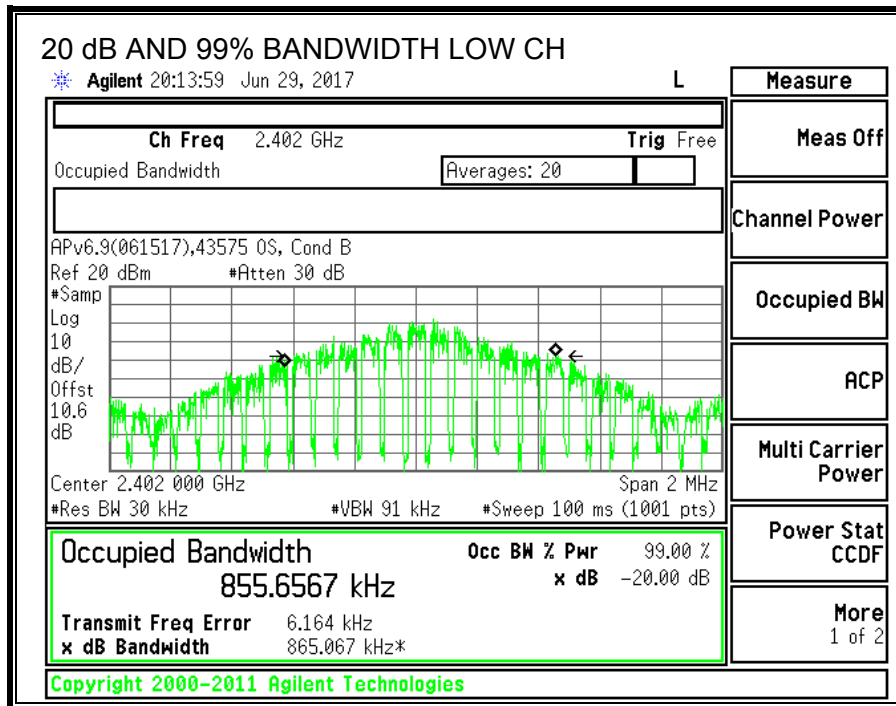



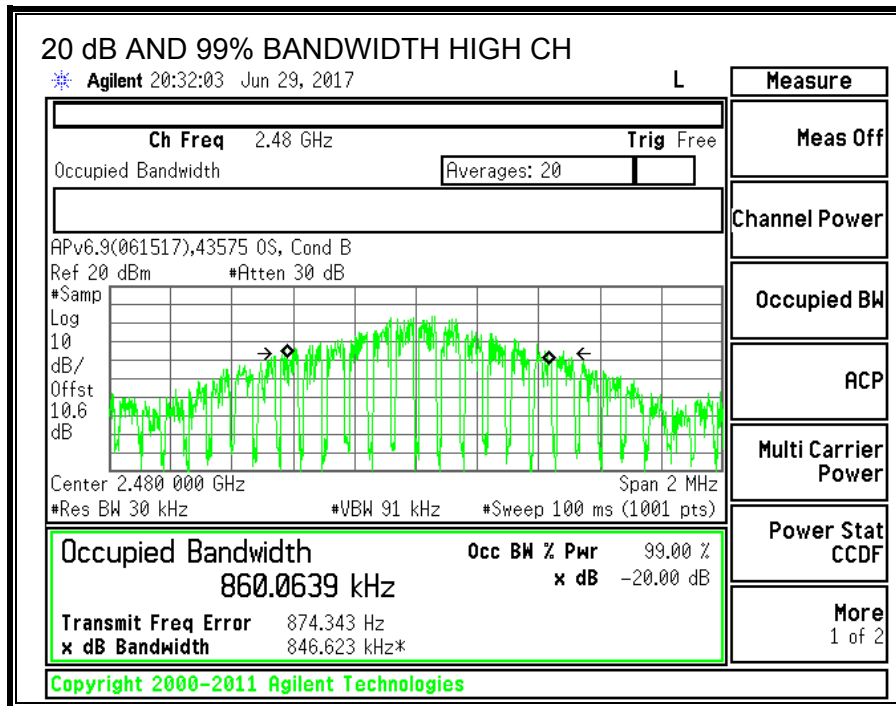

### 7.1.2. HOPPING FREQUENCY SEPARATION

#### LIMITS

FCC §15.247 (a) (1)

Frequency hopping systems shall have hopping channel carrier frequencies separated by a minimum of 25 kHz or the 20 dB bandwidth of the hopping channel, whichever is greater.

Alternatively, frequency hopping systems operating in the 2400-2483.5 MHz band may have hopping channel carrier frequencies that are separated by 25 kHz or two-thirds of the 20 dB bandwidth of the hopping channel, whichever is greater, provided the systems operate with an output power no greater than 125 mW.

#### TEST PROCEDURE

The transmitter output is connected to a spectrum analyzer. The RBW is set to 300 kHz and the VBW is set to 910 kHz. The sweep time is coupled.

#### RESULTS

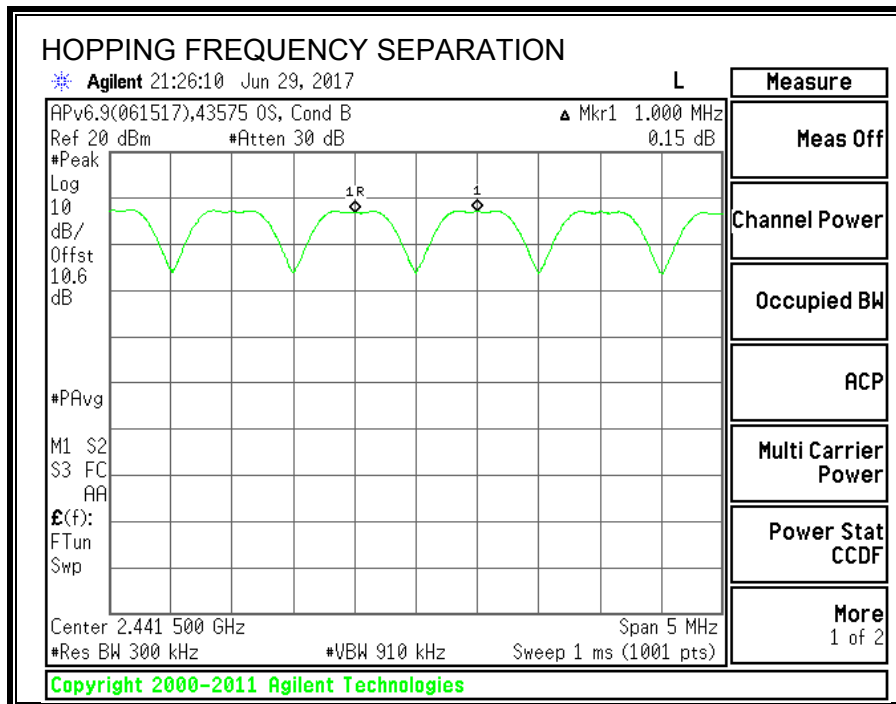

### 7.1.3. NUMBER OF HOPPING CHANNELS

#### LIMITS

FCC §15.247 (a) (1) (iii)

Frequency hopping systems in the 2400 – 2483.5 MHz band shall use at least 15 non-overlapping channels.

#### TEST PROCEDURE

The transmitter output is connected to a spectrum analyzer. The span is set to cover the entire authorized band, in either a single sweep or in multiple contiguous sweeps. The RBW is set to a maximum of 1 % of the span. The analyzer is set to Max Hold.

#### RESULTS

Normal Mode: 79 Channels observed.

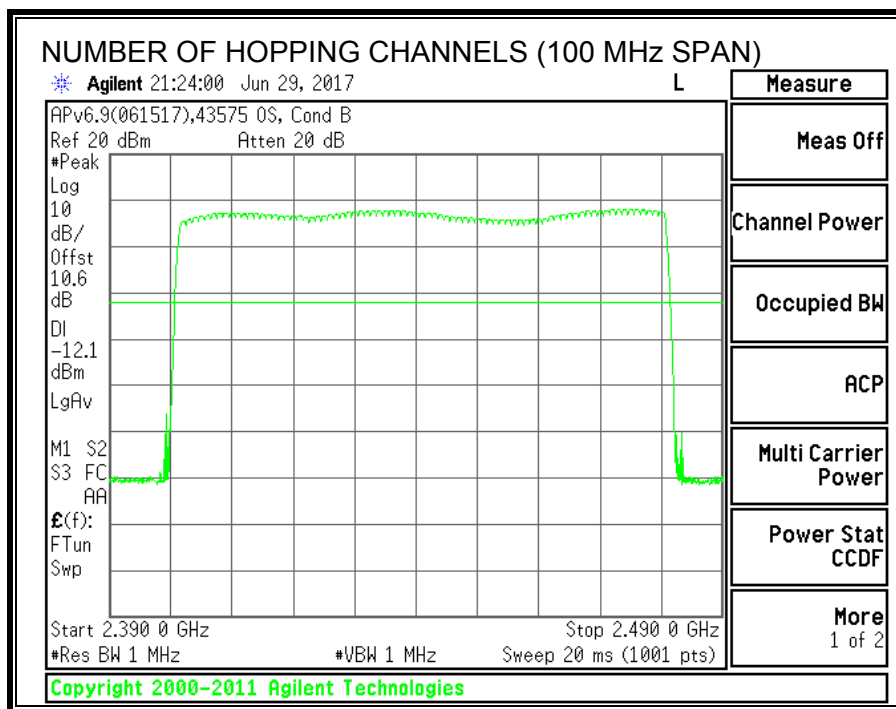

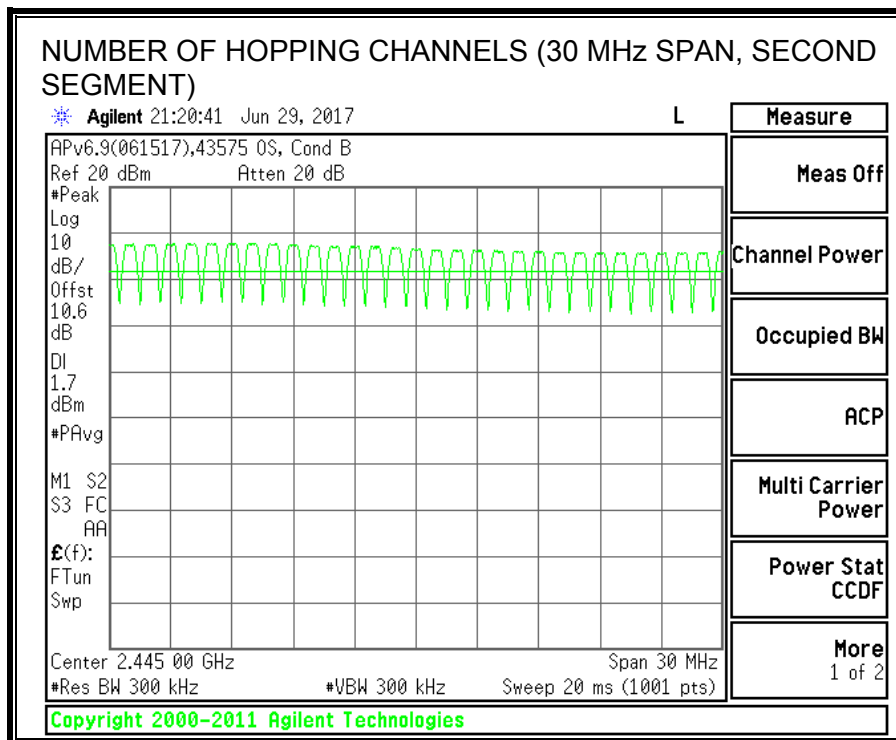
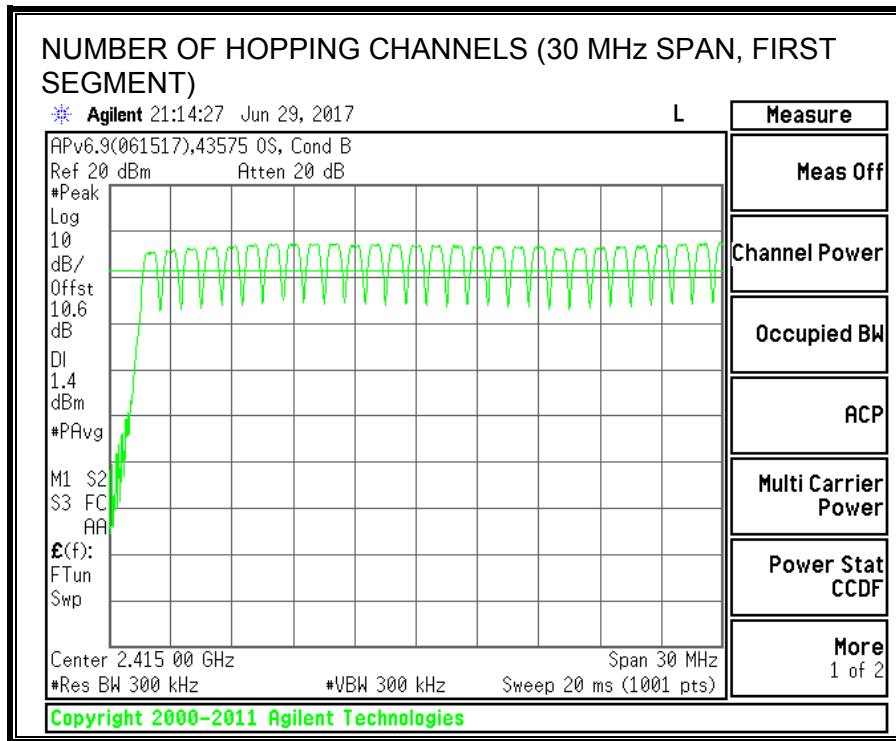

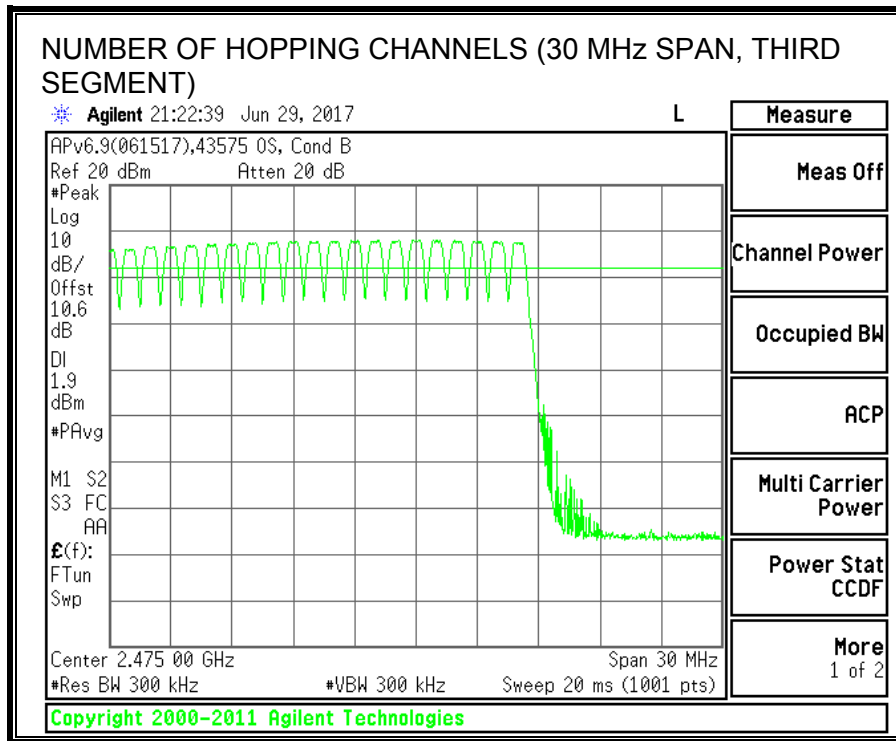

### 7.1.4. AVERAGE TIME OF OCCUPANCY

#### LIMITS

FCC §15.247 (a) (1) (iii)

The average time of occupancy on any channel shall not be greater than 0.4 seconds within a period of 0.4 seconds multiplied by the number of hopping channels employed.

#### TEST PROCEDURE

The transmitter output is connected to a spectrum analyzer. The span is set to 0 Hz, centered on a single, selected hopping channel. The width of a single pulse is measured in a fast scan. The number of pulses is measured in a 3.16 second scan, to enable resolution of each occurrence.

The average time of occupancy in the specified 31.6 second period (79 channels \* 0.4 s) is equal to  $10 * (\# \text{ of pulses in } 3.16 \text{ s}) * \text{ pulse width}$ .

For AFH mode, the average time of occupancy in the specified 8 second period (20 channels \* 0.4 seconds) is equal to  $10 * (\# \text{ of pulses in } 0.8 \text{ s}) * \text{ pulse width}$ .

#### RESULTS

AVERAGE TIME OF OCCUPANCY					
DH Packet	Pulse Width (msec)	Number of Pulses in 3.16 seconds	Average Time of Occupancy (sec)	Limit (sec)	Margin (sec)
GFSK Normal Mode					
DH1	0.383	29	0.1110	0.4	-0.2890
DH3	1.639	15	0.2459	0.4	-0.1542
DH5	2.886	5	0.1443	0.4	-0.2557
DH Packet	Pulse Width (sec)	Number of Pulses in 0.8 seconds	Average Time of Occupancy (sec)	Limit (sec)	Margin (sec)
GFSK AFH Mode					
DH1	0.383	7.25	0.02776	0.4	-0.3722
DH3	1.639	3.75	0.06146	0.4	-0.3385
DH5	2.886	1.25	0.03608	0.4	-0.3639

NOTE: --

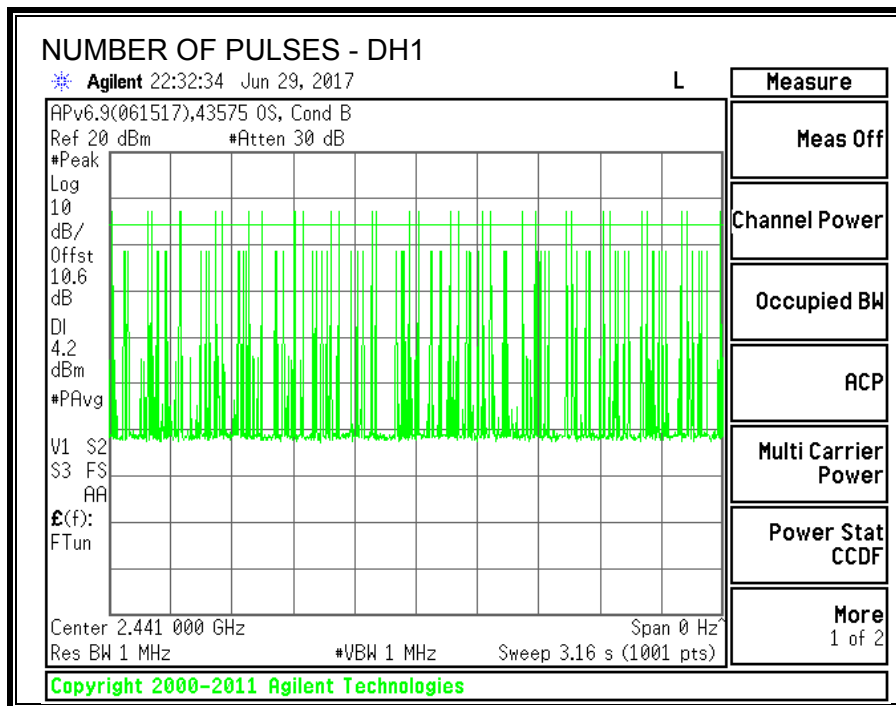
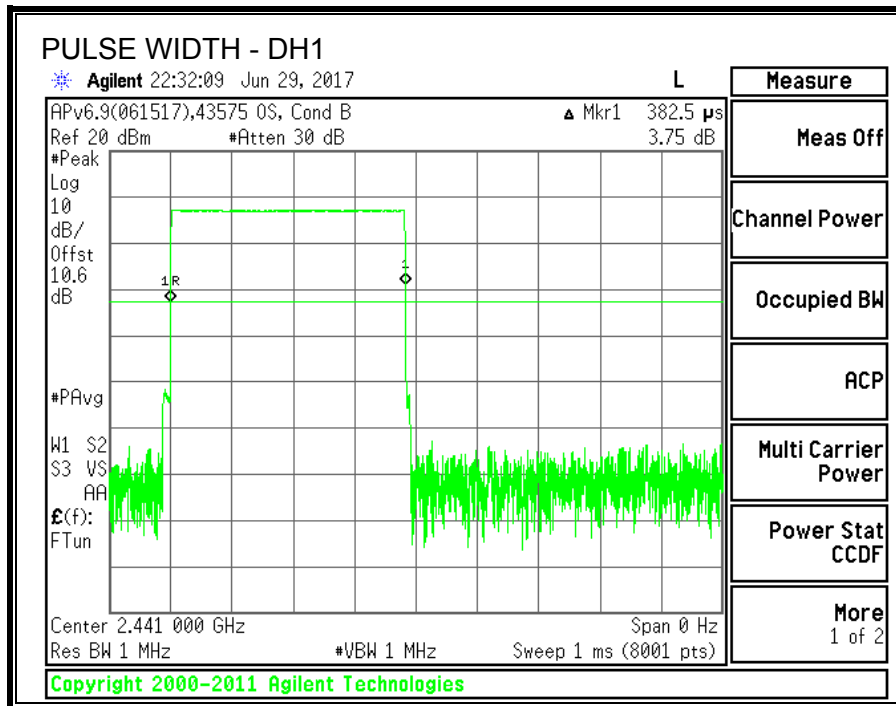

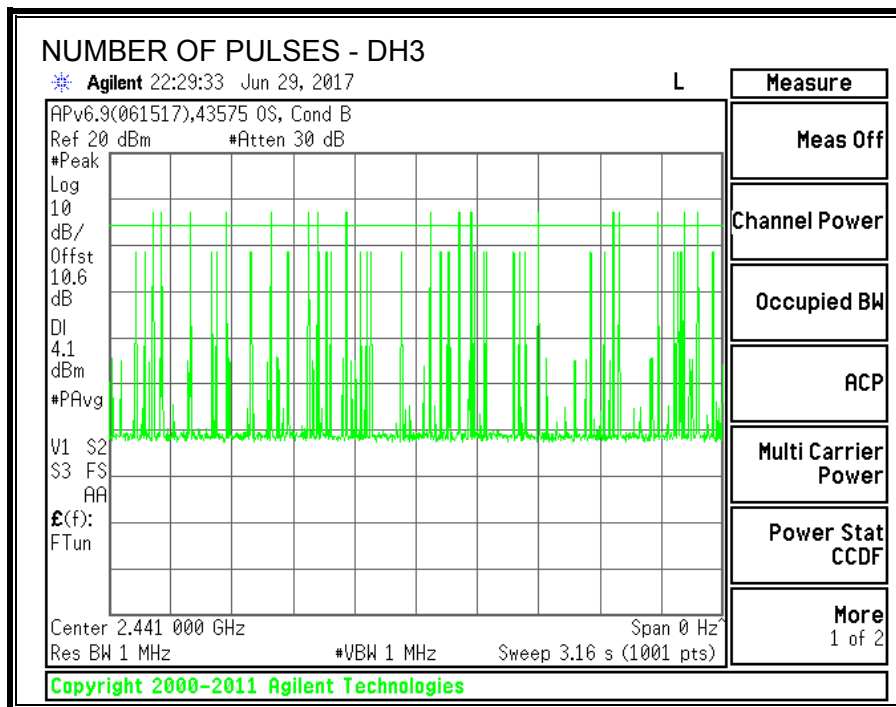
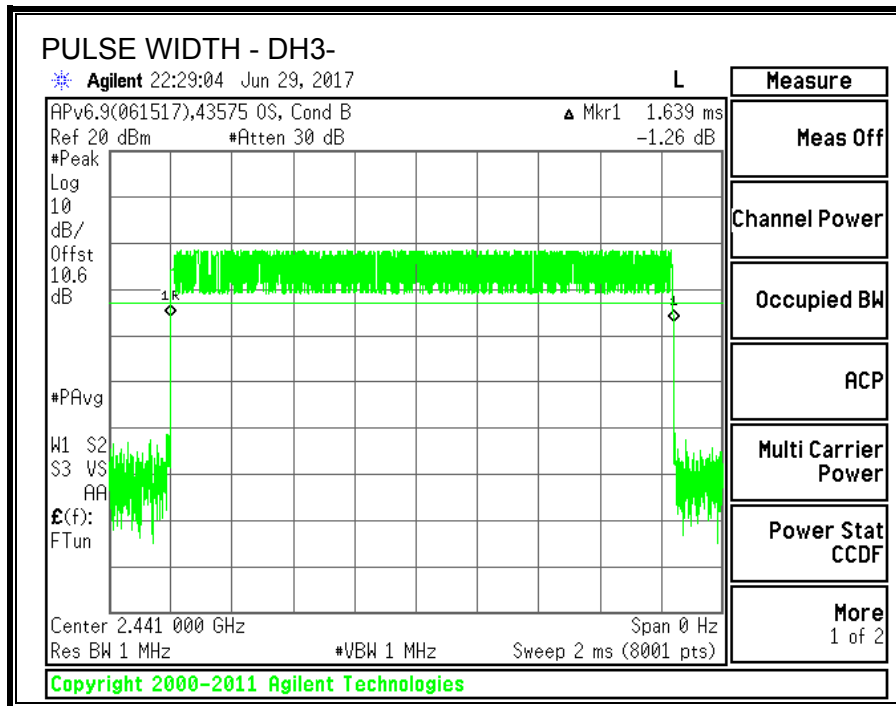



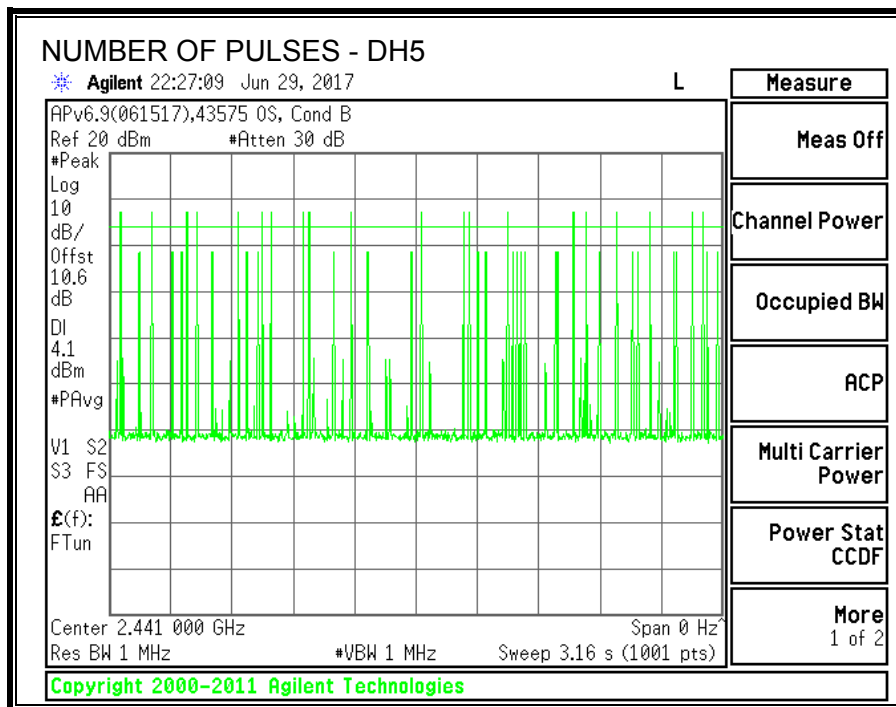
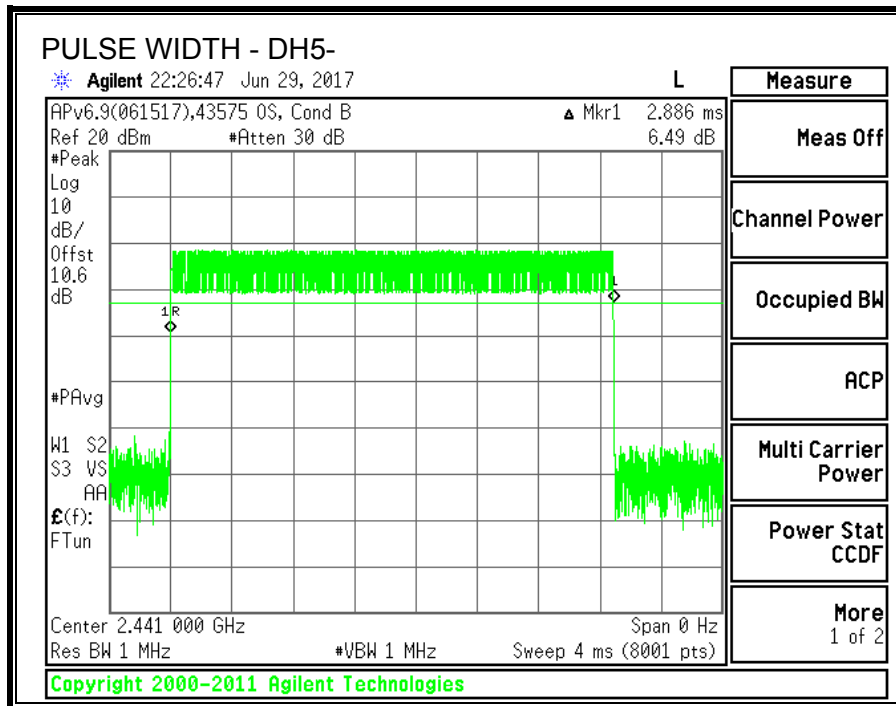

### 7.1.5. OUTPUT POWER

#### LIMITS

§15.247 (b) (1)

The maximum antenna gain is less than 6 dBi, therefore the limit is 30 dBm.

#### TEST PROCEDURE

The transmitter output is connected to a spectrum analyzer.

#### RESULTS

<b>TEST ENGINEER:</b>	39317	<b>Date:</b>	07/11/2017
-----------------------	-------	--------------	------------

TEST RESULT TABLE	LOW CHANNEL																				
<table border="1" style="width: 100%; border-collapse: collapse;"> <thead> <tr> <th>Channel</th> <th>Frequency (MHz)</th> <th>Output Power (dBm)</th> <th>Limit (dBm)</th> <th>Margin (dB)</th> </tr> </thead> <tbody> <tr> <td>Low</td> <td>2402</td> <td>10.53</td> <td>30</td> <td>-19.47</td> </tr> <tr> <td>Middle</td> <td>2441</td> <td>10.90</td> <td>30</td> <td>-19.10</td> </tr> <tr> <td>High</td> <td>2480</td> <td>11.28</td> <td>30</td> <td>-18.72</td> </tr> </tbody> </table>	Channel	Frequency (MHz)	Output Power (dBm)	Limit (dBm)	Margin (dB)	Low	2402	10.53	30	-19.47	Middle	2441	10.90	30	-19.10	High	2480	11.28	30	-18.72	
Channel	Frequency (MHz)	Output Power (dBm)	Limit (dBm)	Margin (dB)																	
Low	2402	10.53	30	-19.47																	
Middle	2441	10.90	30	-19.10																	
High	2480	11.28	30	-18.72																	
MID CHANNEL	HIGH CHANNEL																				
NOTE:																					

### 7.1.6. AVERAGE POWER

#### LIMITS

None; for reporting purposes only.

#### TEST PROCEDURE

The transmitter output is connected to a power meter.

#### RESULTS

The cable assembly insertion loss of 10.6 dB (including 10 dB pad and 0.6 dB cable) was entered as an offset in the power meter to allow for direct reading of power.

<b>TEST ENGINEER:</b>	43578	<b>Date:</b>	6/26/2017
-----------------------	-------	--------------	-----------

Channel	Frequency (MHz)	Average Power (dBm)
Low	2402	10.48
Middle	2441	10.79
High	2480	10.88

### 7.1.7. CONDUCTED BANDEDGE AND SPURIOUS EMISSIONS

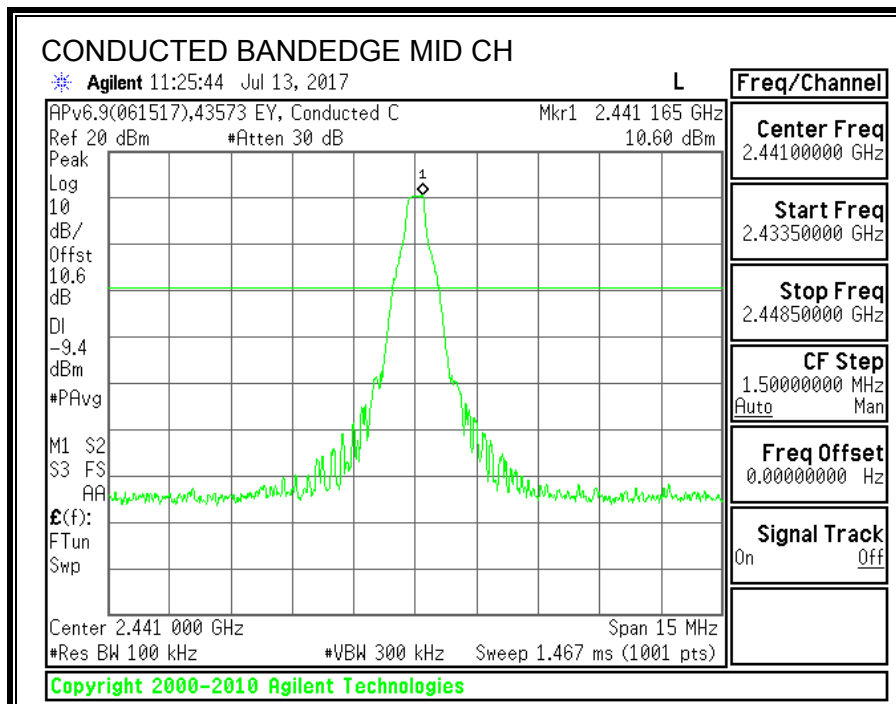
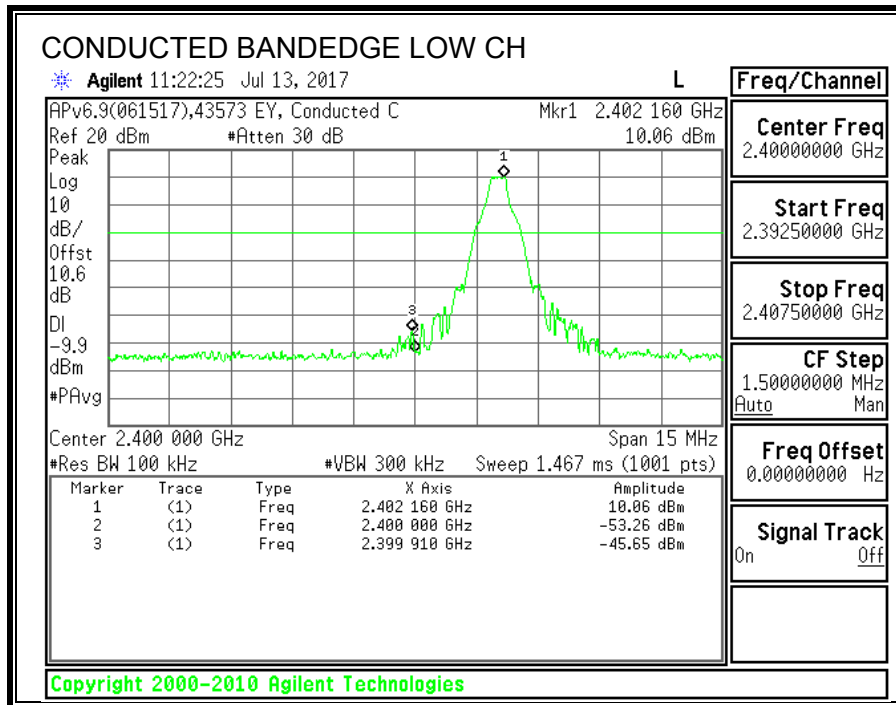

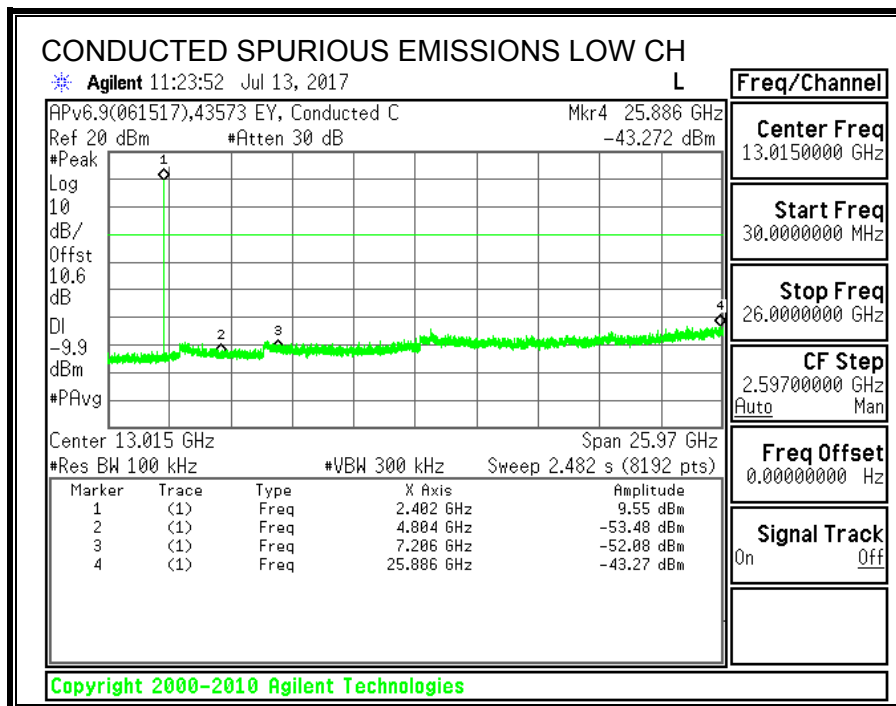
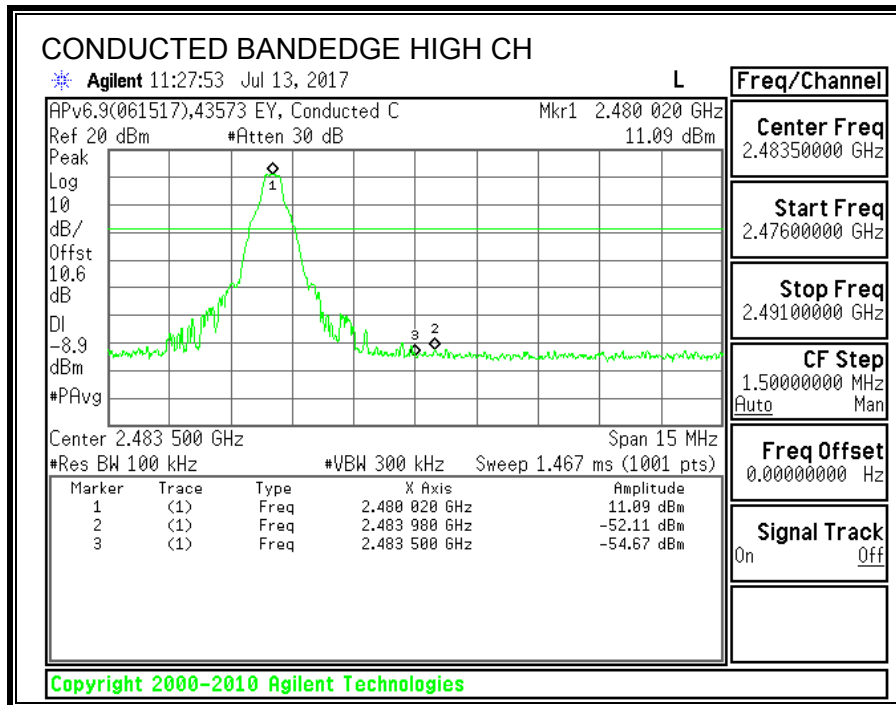

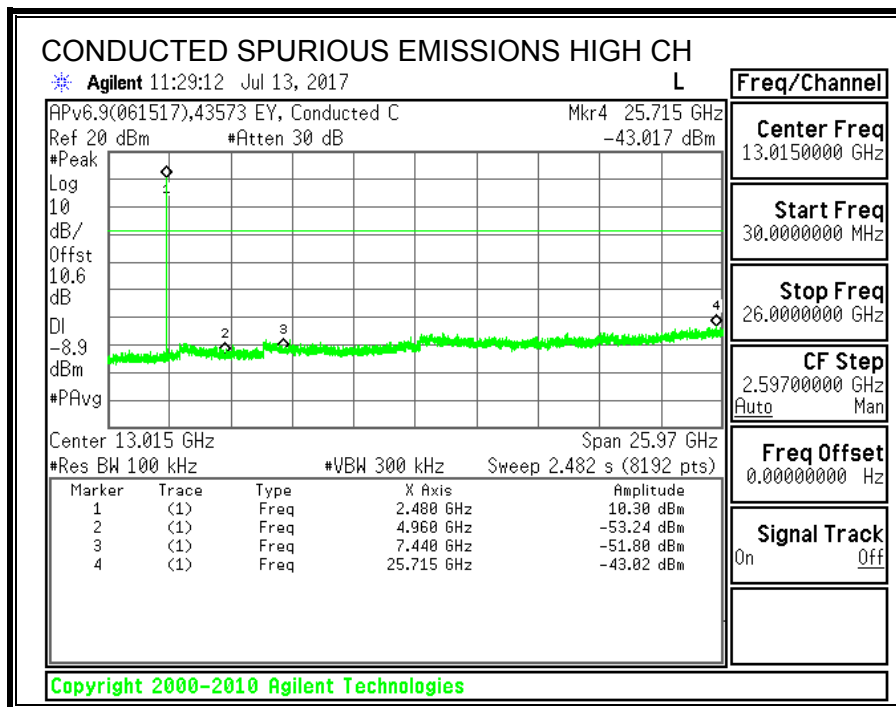
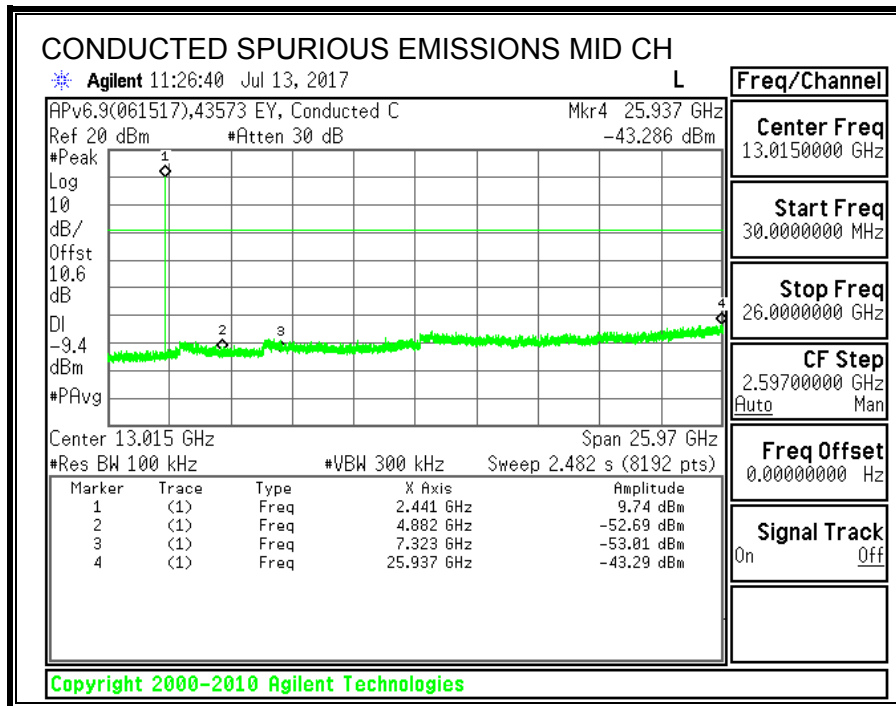

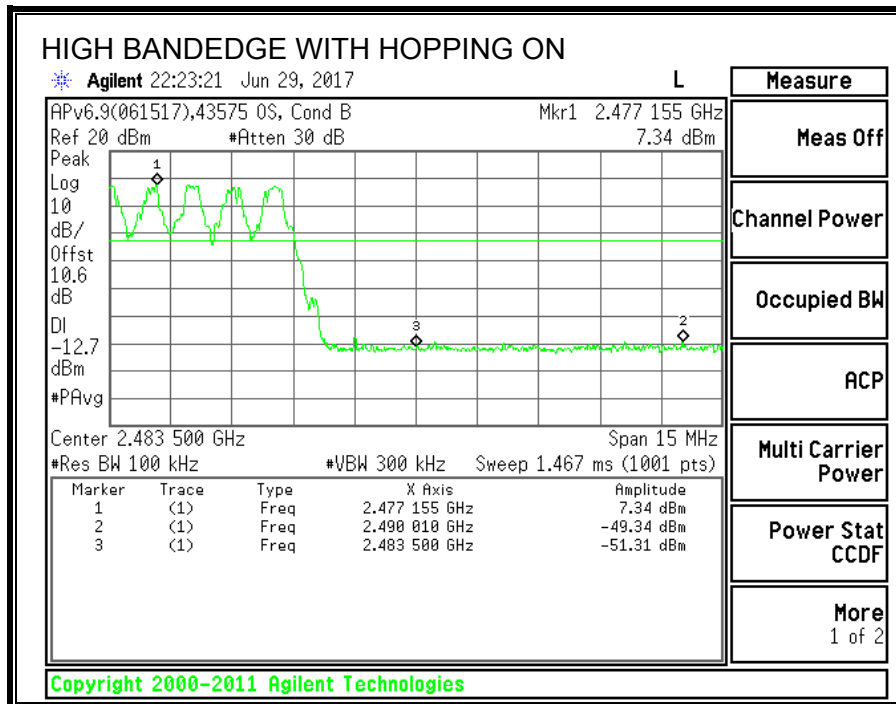
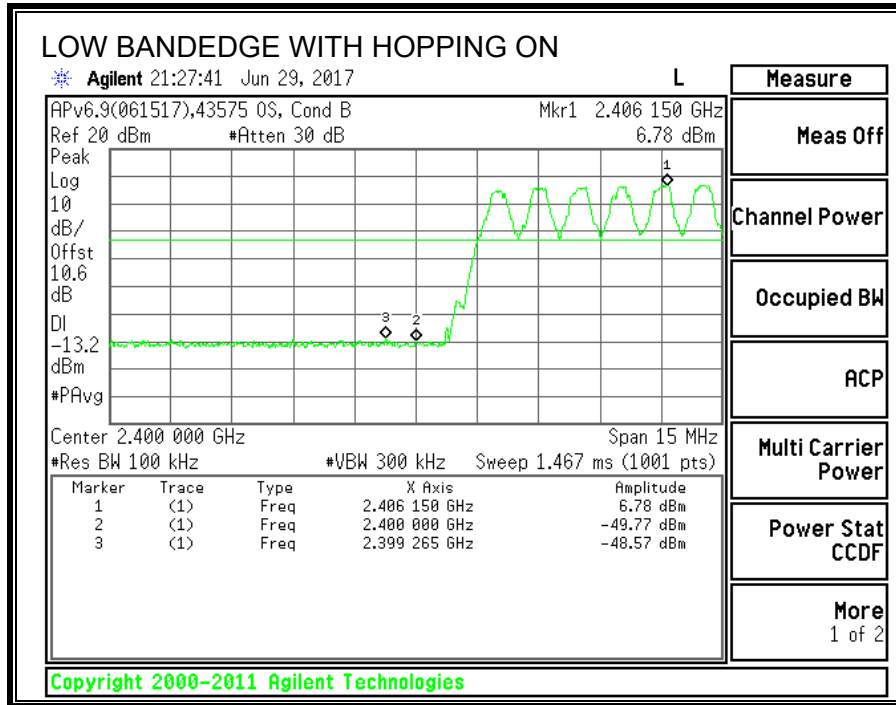

## 7.2. ENHANCED DATA RATE 8PSK MODULATION

### 7.2.1. 20 dB AND 99% BANDWIDTH

#### LIMITS

None; for reporting purposes only.

#### TEST PROCEDURE

The transmitter output is connected to a spectrum analyzer. The RBW is set to  $\geq 1\%$  of the 20 dB bandwidth. The VBW is set to  $\geq$  RBW. The sweep time is coupled.

#### RESULTS

Channel	Frequency (MHz)	20 dB Bandwidth (MHz)	99% Bandwidth (MHz)
Low	2402	1.280	1.190
Middle	2441	1.286	1.196
High	2480	1.302	1.210



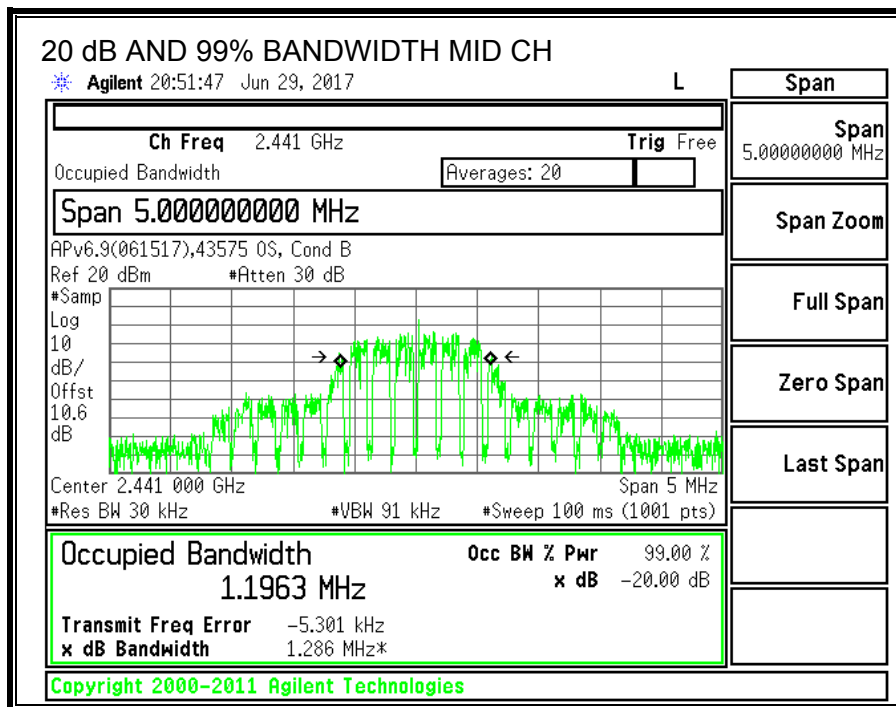
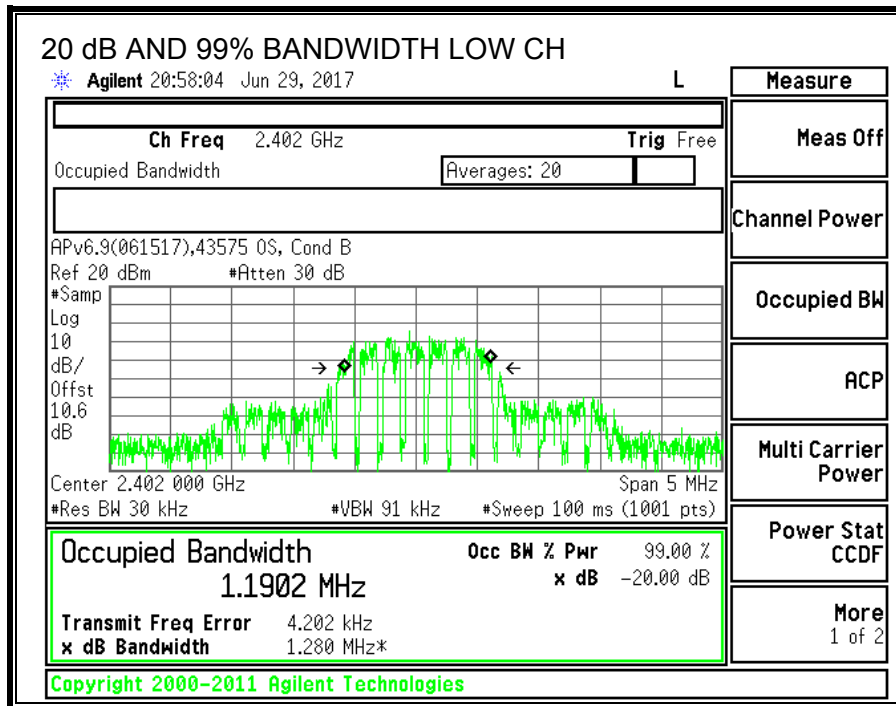

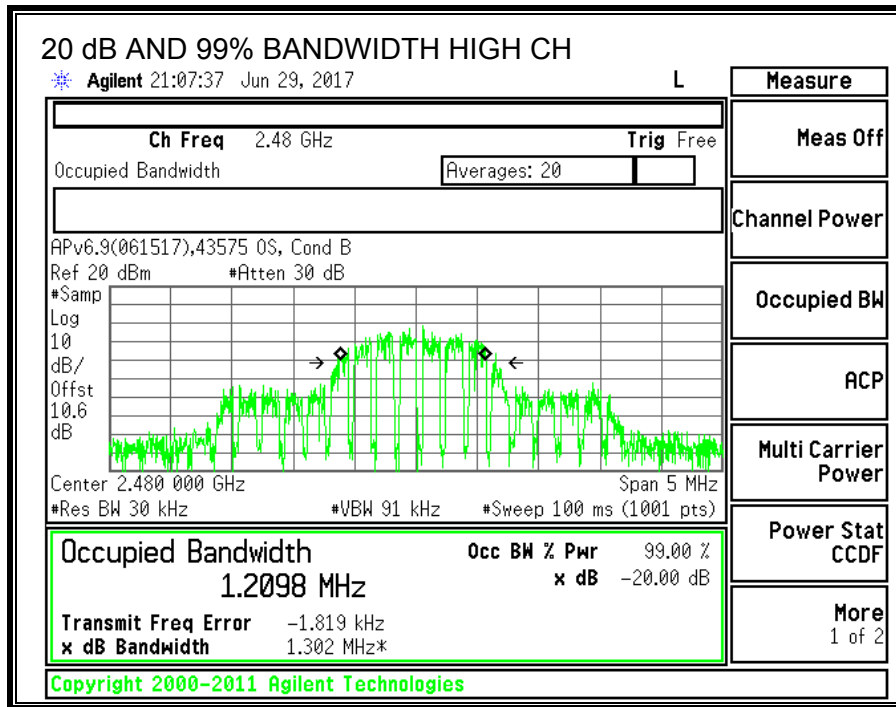

## 7.2.2. HOPPING FREQUENCY SEPARATION

### LIMITS

FCC §15.247 (a) (1)

Frequency hopping systems shall have hopping channel carrier frequencies separated by a minimum of 25 kHz or the 20 dB bandwidth of the hopping channel, whichever is greater.

Alternatively, frequency hopping systems operating in the 2400-2483.5 MHz band may have hopping channel carrier frequencies that are separated by 25 kHz or two-thirds of the 20 dB bandwidth of the hopping channel, whichever is greater, provided the systems operate with an output power no greater than 125 mW.

### TEST PROCEDURE

The transmitter output is connected to a spectrum analyzer. The RBW is set to 300 kHz and the VBW is set to 910 kHz. The sweep time is coupled.

### RESULTS

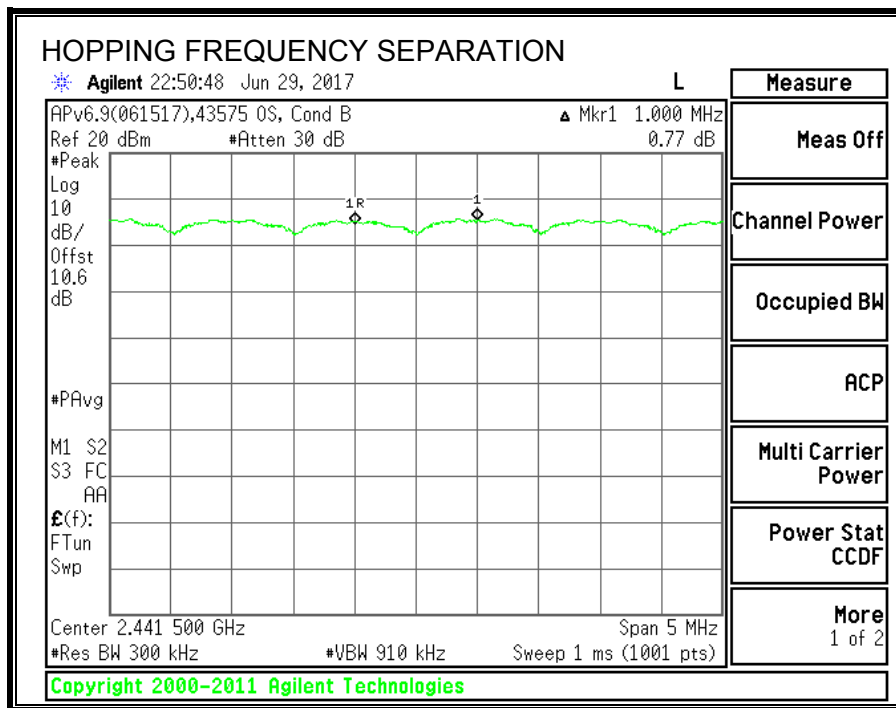

### 7.2.3. NUMBER OF HOPPING CHANNELS

#### LIMITS

FCC §15.247 (a) (1) (iii)

Frequency hopping systems in the 2400 – 2483.5 MHz band shall use at least 15 non-overlapping channels.

#### TEST PROCEDURE

The transmitter output is connected to a spectrum analyzer. The span is set to cover the entire authorized band, in either a single sweep or in multiple contiguous sweeps. The RBW is set to a maximum of 1 % of the span. The analyzer is set to Max Hold.

#### RESULTS

Normal Mode: 79 Channels observed.

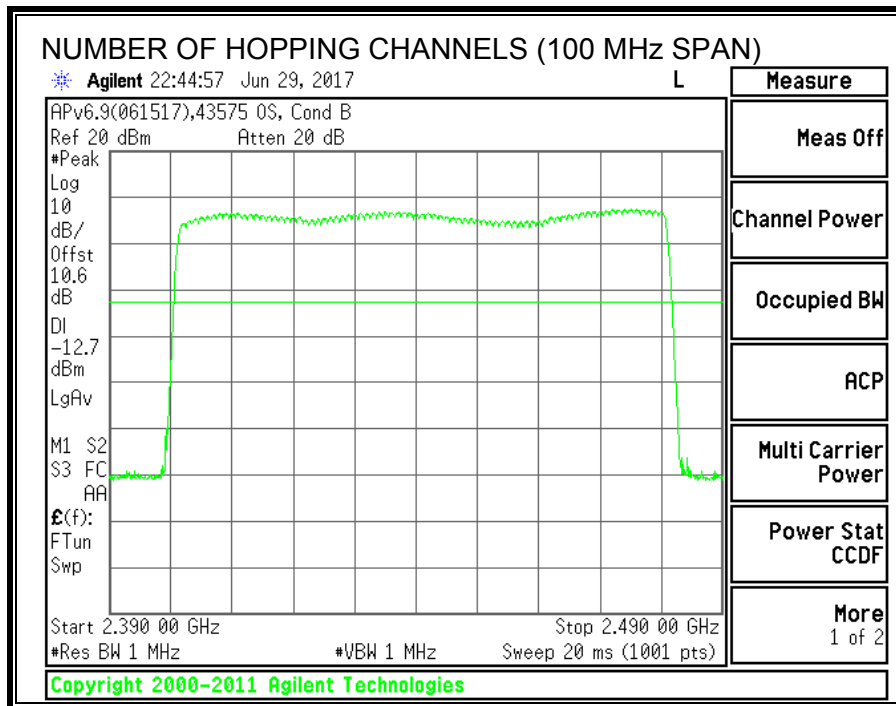

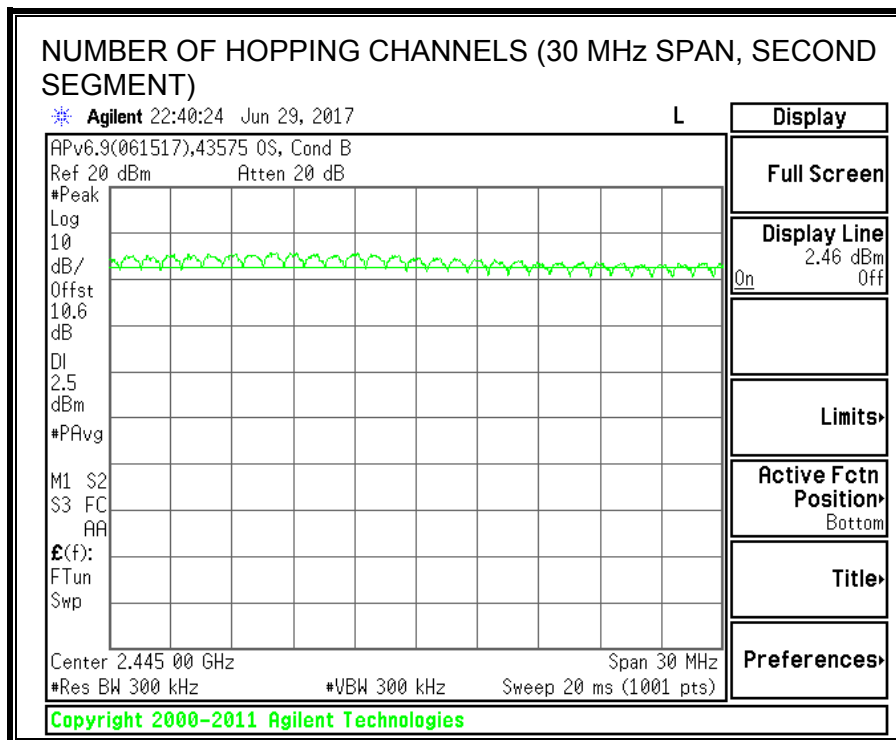
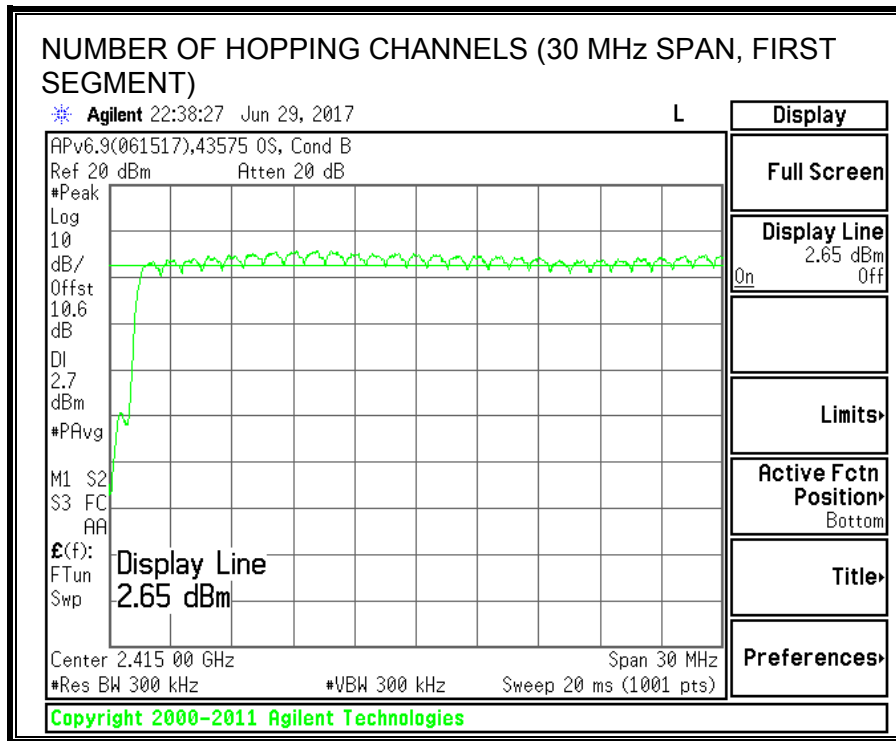

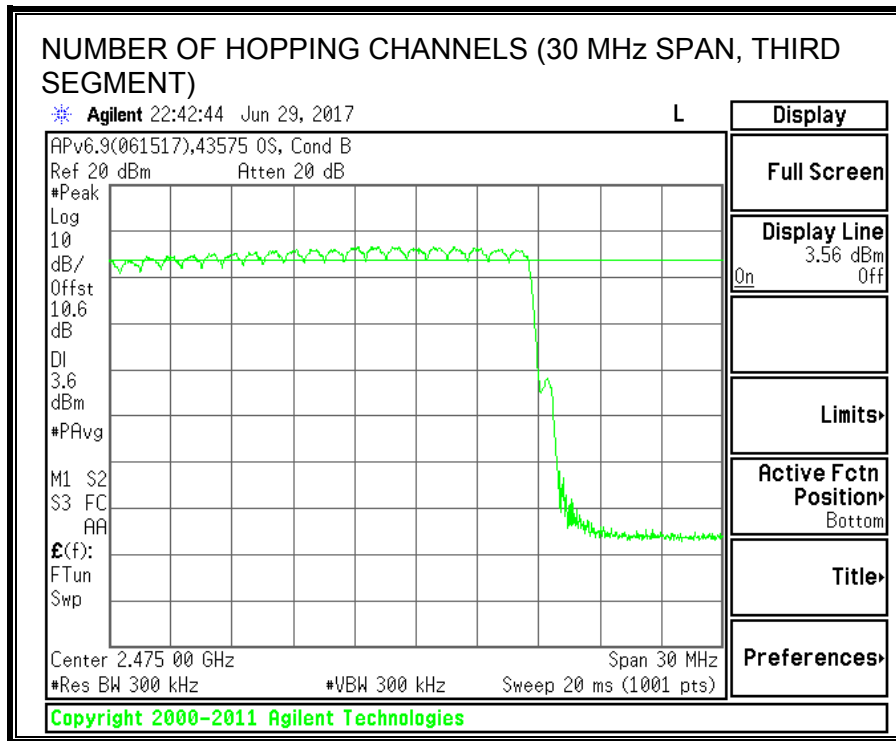

### 7.2.4. AVERAGE TIME OF OCCUPANCY

#### LIMITS

FCC §15.247 (a) (1) (iii)

The average time of occupancy on any channel shall not be greater than 0.4 seconds within a period of 0.4 seconds multiplied by the number of hopping channels employed.

#### TEST PROCEDURE

The transmitter output is connected to a spectrum analyzer. The span is set to 0 Hz, centered on a single, selected hopping channel. The width of a single pulse is measured in a fast scan. The number of pulses is measured in a 3.16 second scan, to enable resolution of each occurrence.

The average time of occupancy in the specified 31.6 second period (79 channels \* 0.4 s) is equal to  $10 * (\# \text{ of pulses in } 3.16 \text{ s}) * \text{ pulse width}$ .

For AFH mode, the average time of occupancy in the specified 8 second period (20 channels \* 0.4 seconds) is equal to  $10 * (\# \text{ of pulses in } 0.8 \text{ s}) * \text{ pulse width}$ .

#### RESULTS

AVERAGE TIME OF OCCUPANCY					
DH Packet	Pulse Width (msec)	Number of Pulses in 3.16 seconds	Average Time of Occupancy (sec)	Limit (sec)	Margin (sec)
<b>8PSK Normal Mode</b>					
DH1	0.388	31	0.1204	0.4	-0.2796
DH3	1.639	16	0.2622	0.4	-0.1378
DH5	2.889	13	0.3756	0.4	-0.0244
DH Packet	Pulse Width (sec)	Number of Pulses in 0.8 seconds	Average Time of Occupancy (sec)	Limit (sec)	Margin (sec)
<b>8PSK AFH Mode</b>					
DH1	0.388	7.75	0.03009	0.4	-0.3699
DH3	1.639	4	0.06556	0.4	-0.3344
DH5	2.889	3.25	0.09389	0.4	-0.3061
NOTE: --					

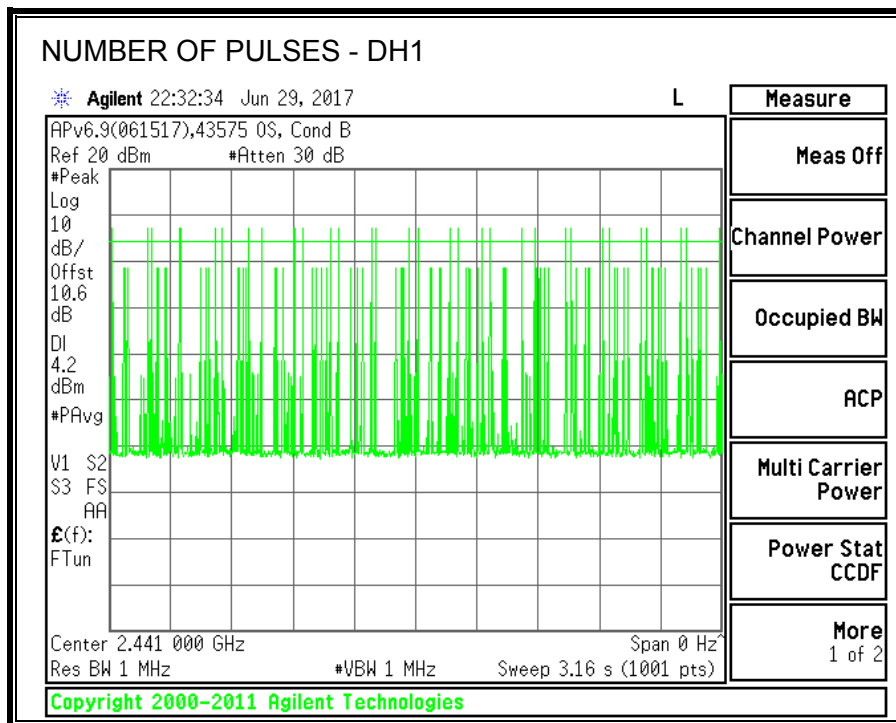
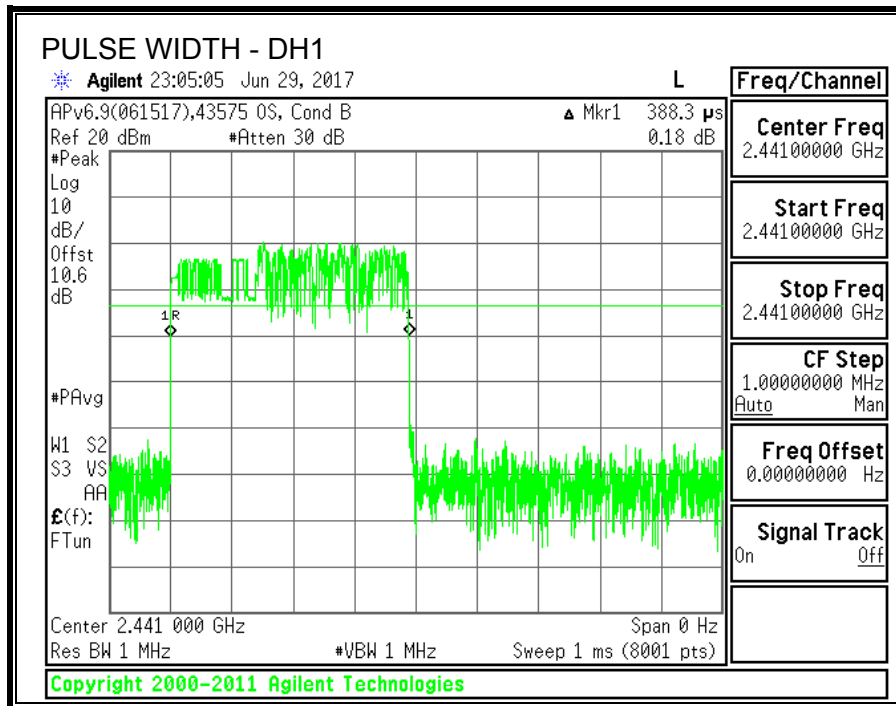



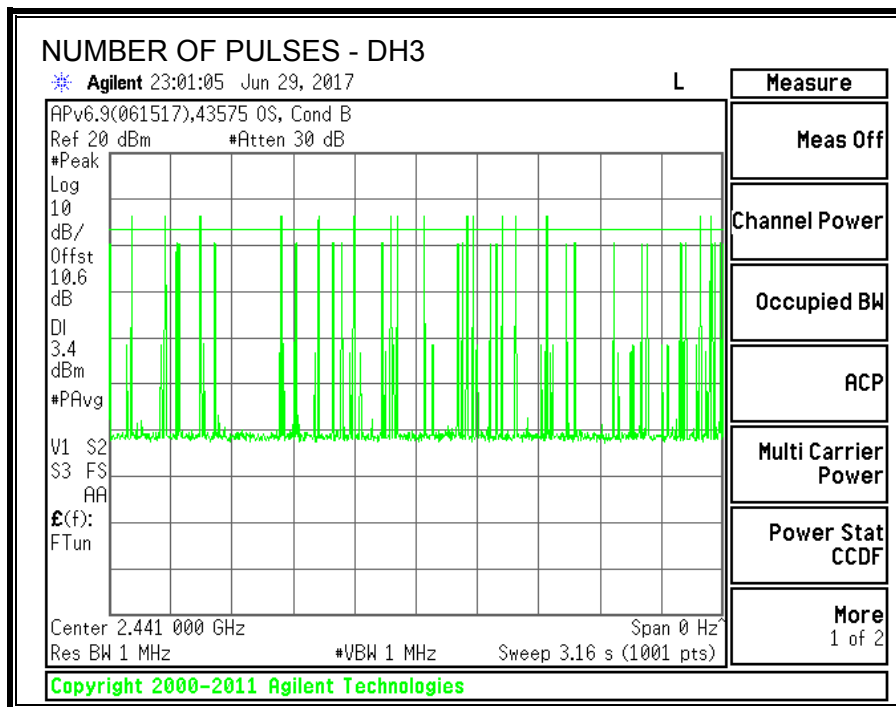
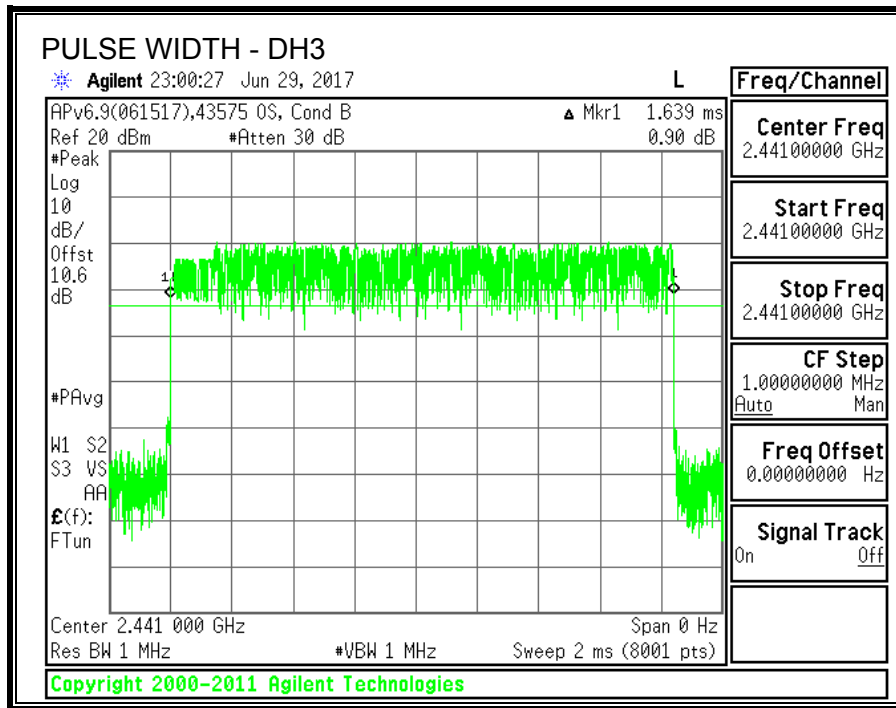

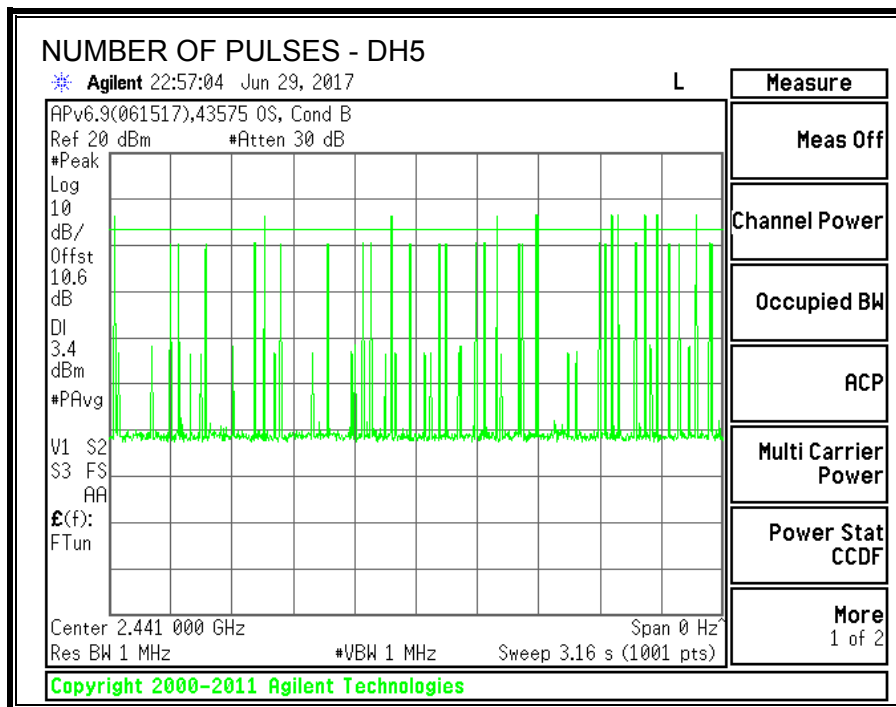
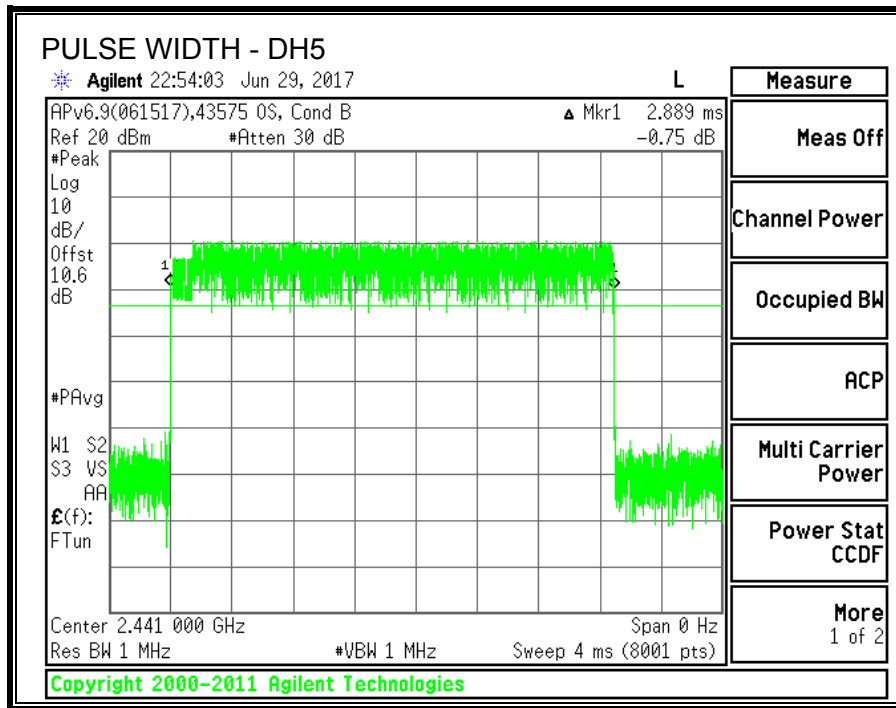

### 7.2.5. OUTPUT POWER

#### LIMITS

§15.247 (b) (1)

The maximum antenna gain is less than 6 dBi, therefore the limit is 30 dBm.

#### TEST PROCEDURE

The transmitter output is connected to a spectrum analyzer.

#### RESULTS

<b>TEST ENGINEER:</b>	39317	<b>Date:</b>	07/11/2017
-----------------------	-------	--------------	------------

TEST RESULT TABLE					LOW CHANNEL	

Channel	Frequency (MHz)	Output Power (dBm)	Limit (dBm)	Margin (dB)
Low	2402	9.97	30	-20.03
Middle	2441	10.28	30	-19.72
High	2480	10.91	30	-19.09

**NOTE:**

## 7.2.6. AVERAGE POWER

### LIMITS

None; for reporting purposes only.

### TEST PROCEDURE

The transmitter output is connected to a power meter.

### RESULTS

The cable assembly insertion loss of 10.6 dB (including 10 dB pad and 0.6 dB cable) was entered as an offset in the power meter to allow for direct reading of power.

<b>TEST ENGINEER:</b>	43578	<b>Date:</b>	6/26/2017
-----------------------	-------	--------------	-----------

Channel	Frequency (MHz)	Average Power (dBm)
Low	2402	8.03
Middle	2441	8.31
High	2480	9.02

### 7.2.7. CONDUCTED BANDEDGE AND SPURIOUS EMISSIONS

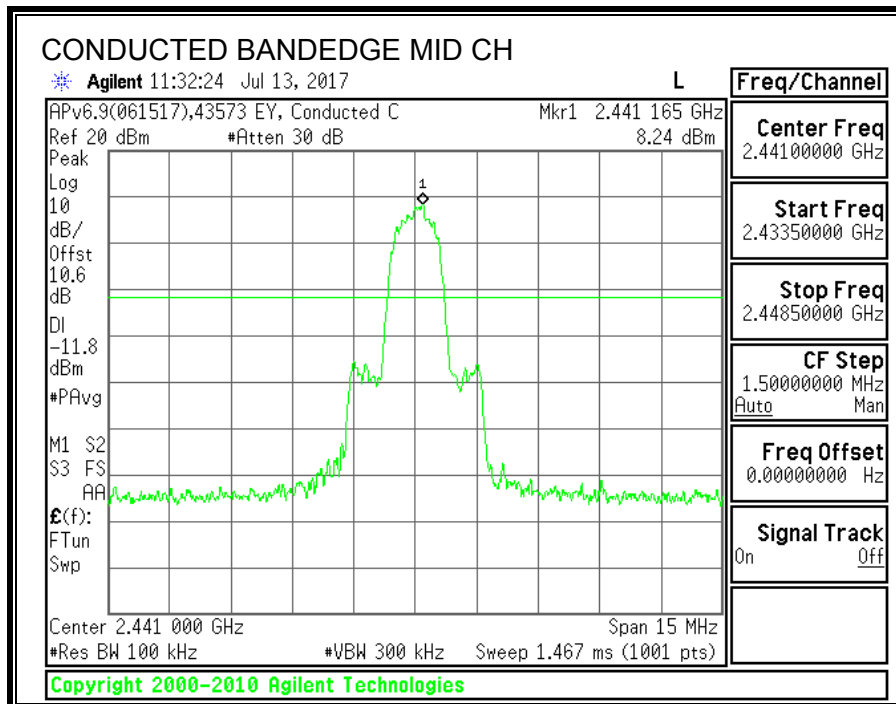
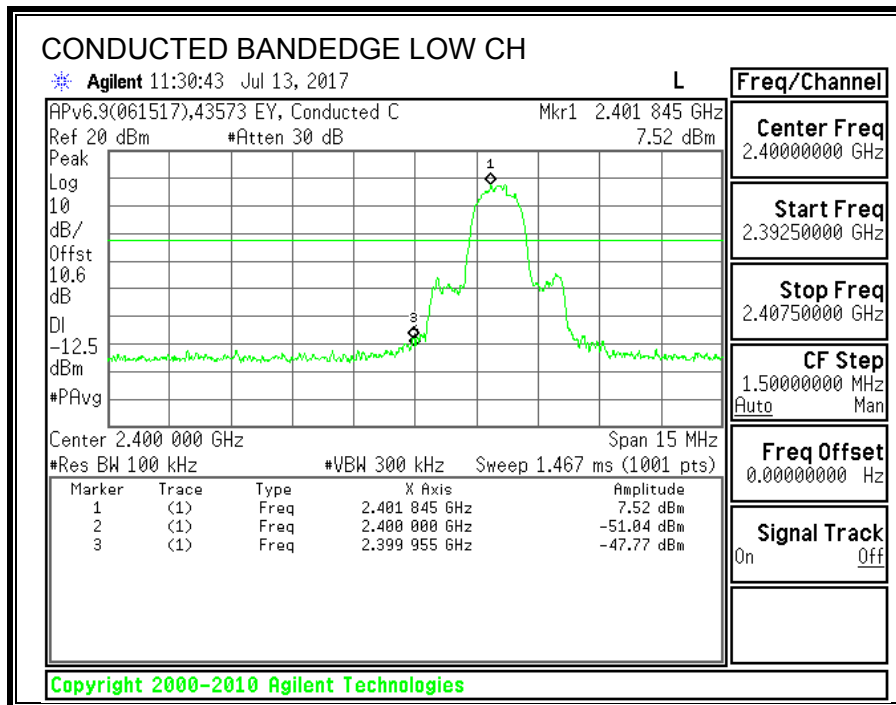

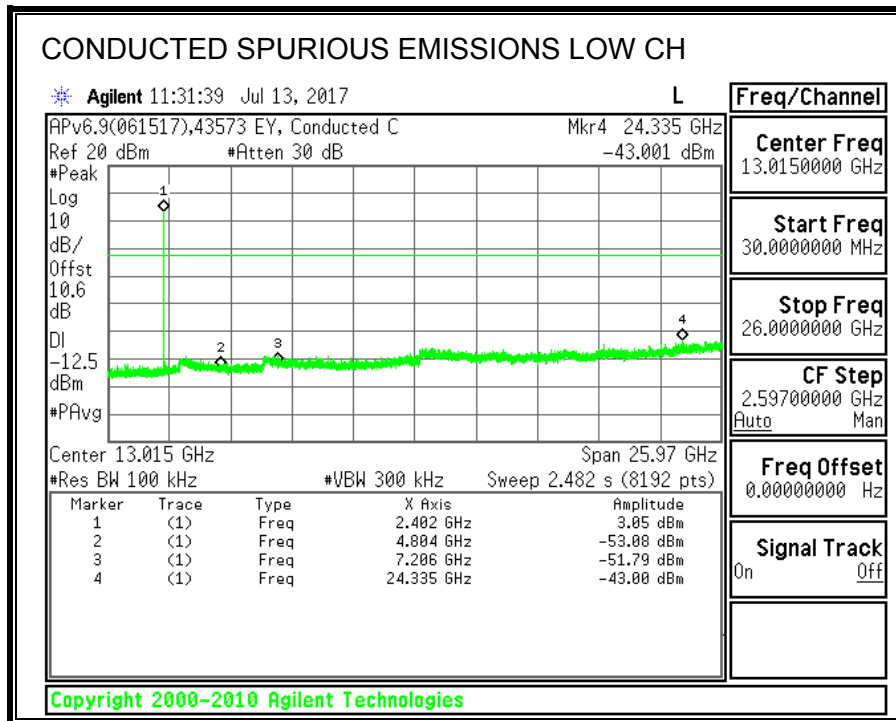
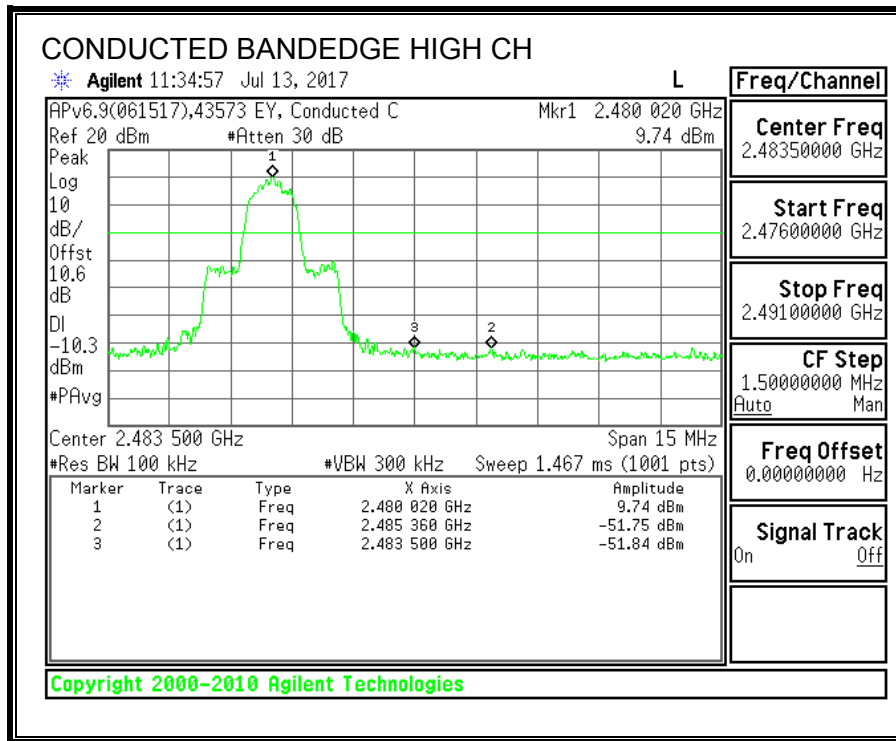

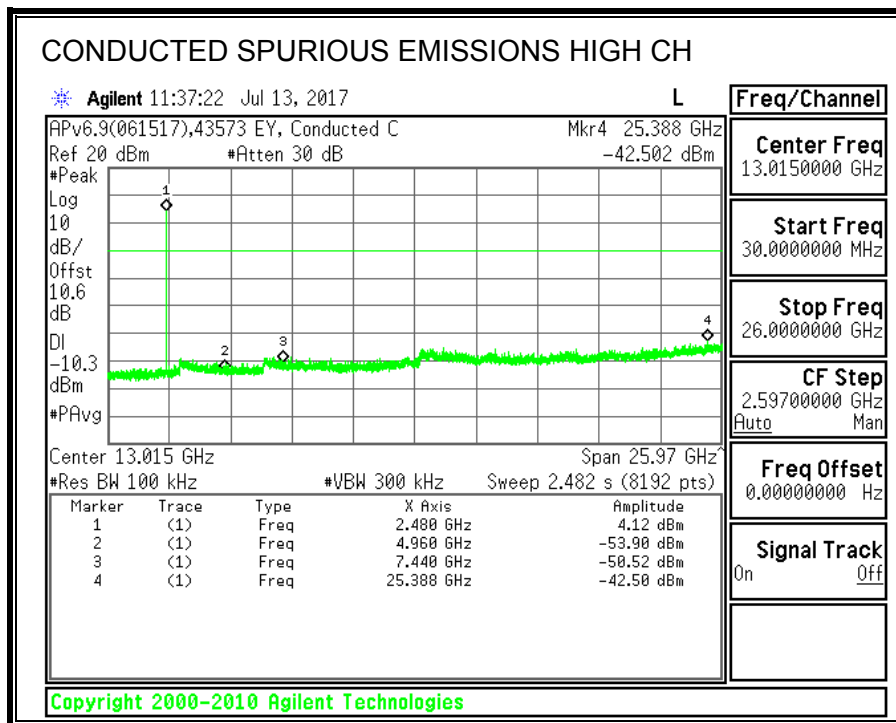
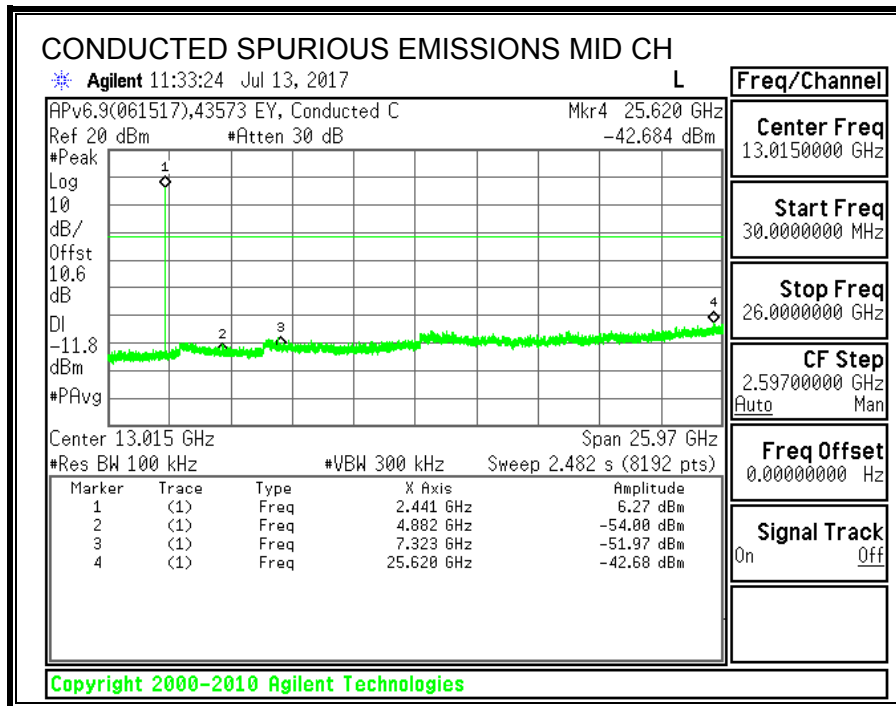

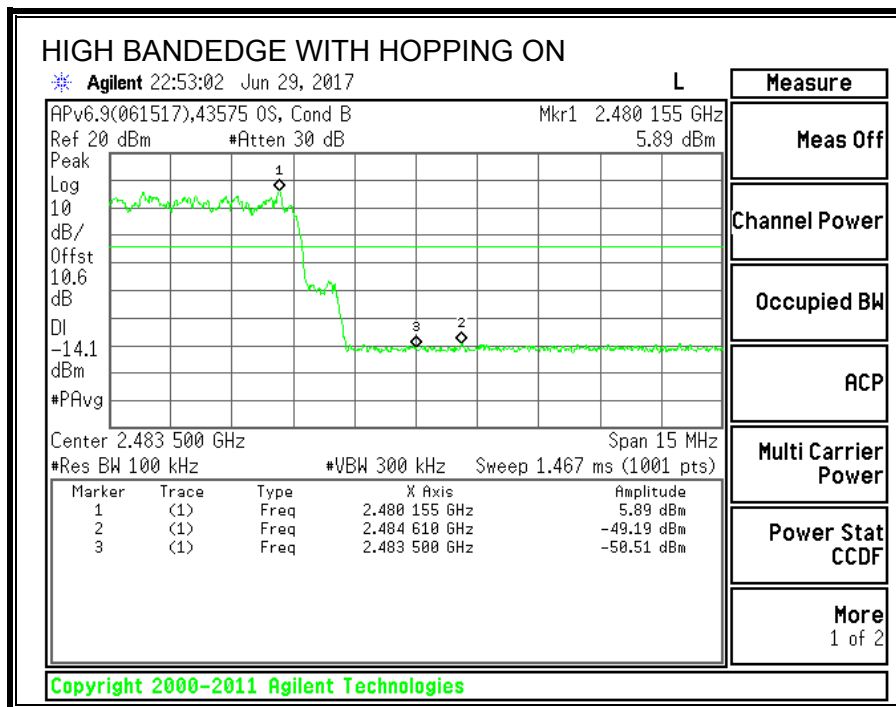
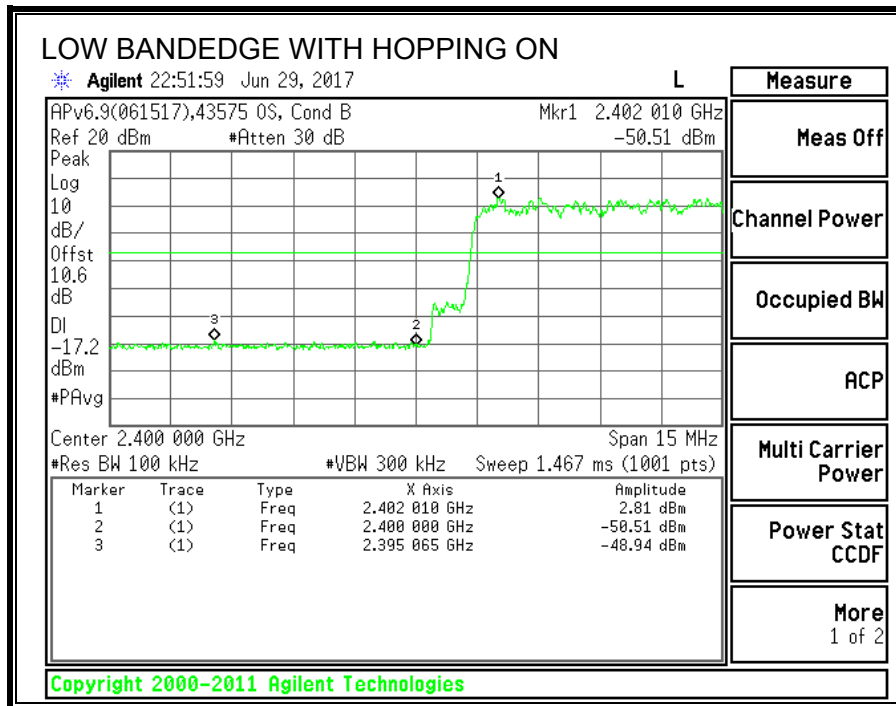



## 8. RADIATED TEST RESULTS

### 8.1. LIMITS AND PROCEDURE

#### LIMITS

FCC §15.205 and §15.209

Frequency Range (MHz)	Field Strength Limit (uV/m) at 3 m	Field Strength Limit (dBuV/m) at 3 m
0.009-0.490	2400/F(kHz) @ 300 m	-
0.490-1.705	24000/F(kHz) @ 30 m	-
1.705 - 30	30 @ 30m	-
30 - 88	100	40
88 - 216	150	43.5
216 - 960	200	46
Above 960	500	54

#### TEST PROCEDURE

The EUT is placed on a non-conducting table 80 cm above the ground plane for measurement below 1GHz; 1.5 m above the ground plane for measurement above 1GHz. The antenna to EUT distance is 3 meters. The EUT is configured in accordance with ANSI C63.10. The EUT is set to transmit in a continuous mode.

For measurements below 1 GHz the resolution bandwidth is set to 100 kHz for peak detection measurements or 120 kHz for quasi-peak detection measurements. Peak detection is used unless otherwise noted as quasi-peak.

For measurements above 1 GHz the resolution bandwidth is set to 1 MHz, then the video bandwidth is set to 3 MHz for peak measurements and 1 MHz resolution bandwidth with 1/T (10 Hz) video bandwidth with peak detector for average measurements.

The spectrum from 1 GHz to 18 GHz is investigated with the transmitter set to the lowest, middle, and highest channels in each applicable band. Below 1GHz and above 18GHz emissions, the channel with the highest output power was tested.

The frequency range of interest is monitored at a fixed antenna height and EUT azimuth. The EUT is rotated through 360 degrees to maximize emissions received. The antenna is scanned from 1 to 4 meters above the ground plane to further maximize the emission. Measurements are made with the antenna polarized in both the vertical and the horizontal positions.

#### RESULTS

## 8.2. BASIC DATA RATE GFSK MODULATION

### 8.2.1. RESTRICTED BANDEDGE (LOW CHANNEL)

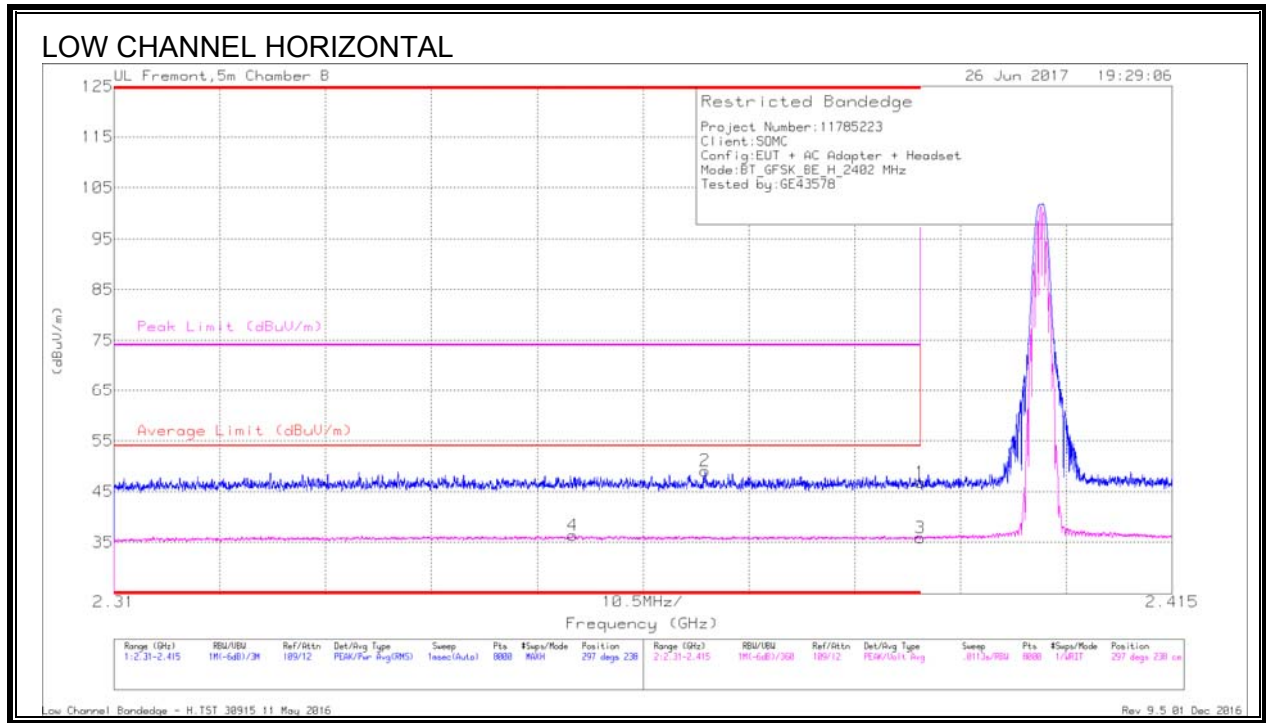

Marker	Frequency (GHz)	Meter Reading (dBuV)	Det	AF T346 (dB/m)	Amp/Cb/Fkr/Pa d (dB)	Corrected Reading (dBuV/m)	Average Limit (dBuV/m)	Margin (dB)	Peak Limit (dBuV/m)	PK Margin (dB)	Azimuth (Degs)	Height (cm)	Polarity
1	* 2.39	36	Pk	32	-21.2	46.8	-	-	74	-27.2	297	238	H
2	* 2.369	38.31	Pk	31.9	-21.1	49.11	-	-	74	-24.89	297	238	H
3	* 2.39	25.1	VA1T	32	-21.2	35.9	54	-18.1	-	-	297	238	H
4	* 2.355	25.53	VA1T	31.9	-21	36.43	54	-17.57	-	-	297	238	H

\* - indicates frequency in CFR47 Pt 15 / IC RSS-Restricted Band

Pk - Peak detector

VA1T - FHSS: Linear Voltage Average  $V_B=1/T_{on}$  where:  $T_{on}$  is transmit duration

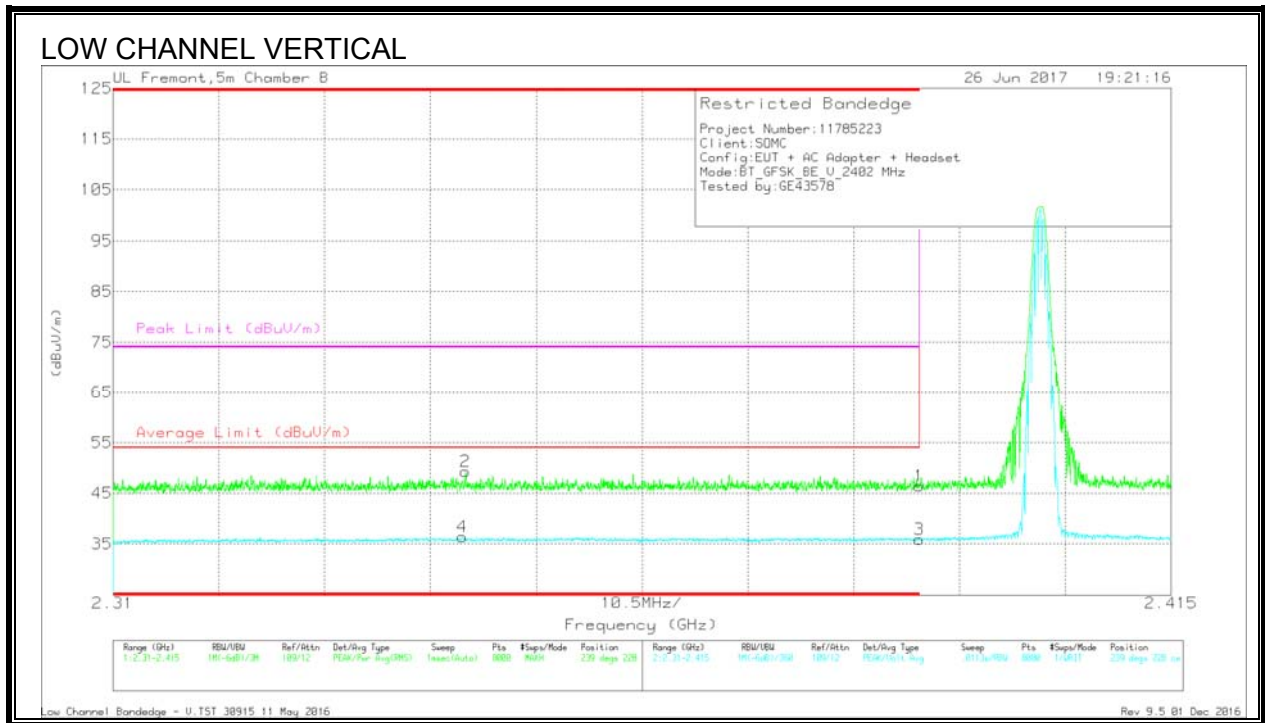

Marker	Frequency (GHz)	Meter Reading (dBuV)	Det	AFT346 (dB/m)	Amp/Cbl/Filtr/Pad (dB)	Corrected Reading (dBuV/m)	Average Limit (dBuV/m)	Margin (dB)	Peak Limit (dBuV/m)	PK Margin (dB)	Azimuth (Degs)	Height (cm)	Polarity
1	* 2.39	35.65	Pk	32	-21.2	46.45	-	-	74	-27.55	239	228	V
2	* 2.345	38.51	Pk	31.8	-21	49.31	-	-	74	-24.69	239	228	V
3	* 2.39	25.12	VA1T	32	-21.2	35.92	54	-18.08	-	-	239	228	V
4	* 2.345	25.57	VA1T	31.8	-21	36.37	54	-17.63	-	-	239	228	V

\* - indicates frequency in CFR47 Pt 15 / IC RSS-Restricted Band

Pk - Peak detector

VA1T - FHSS: Linear Voltage Average  $V_B = 1/T_{on}$  where:  $T_{on}$  is transmit duration

### 8.2.2. AUTHORIZED BANDEDGE (HIGH CHANNEL)

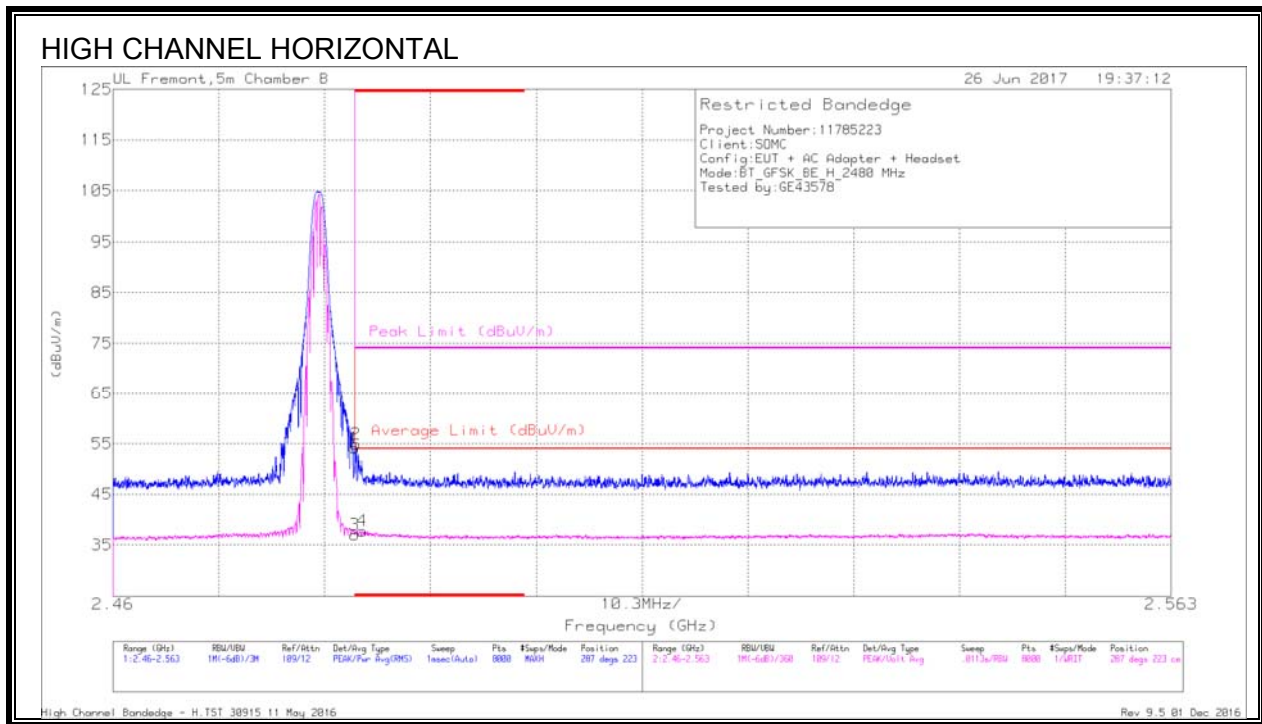

Marker	Frequency (GHz)	Meter Reading (dBuV)	Det	AFT346 (dB/m)	Amp/Cbl/Fitr/Pad (dB)	Corrected Reading (dBuV/m)	Average Limit (dBuV/m)	Margin (dB)	Peak Limit (dBuV/m)	PK Margin (dB)	Azimuth (Degs)	Height (cm)	Polarity
1	* 2.484	42.95	Pk	32.1	-20.9	54.15	-	-	74	-19.85	287	223	H
2	* 2.484	43.66	Pk	32.1	-20.9	54.86	-	-	74	-19.14	287	223	H
3	* 2.484	25.75	VA1T	32.1	-20.9	36.95	54	-17.05	-	-	287	223	H
4	* 2.484	26.58	VA1T	32.1	-20.9	37.78	54	-16.22	-	-	287	223	H

\* - indicates frequency in CFR47 Pt 15 / IC RSS-Restricted Band

Pk - Peak detector

VA1T - FHSS: Linear Voltage Average  $V_B=1/T_{on}$  where:  $T_{on}$  is transmit duration

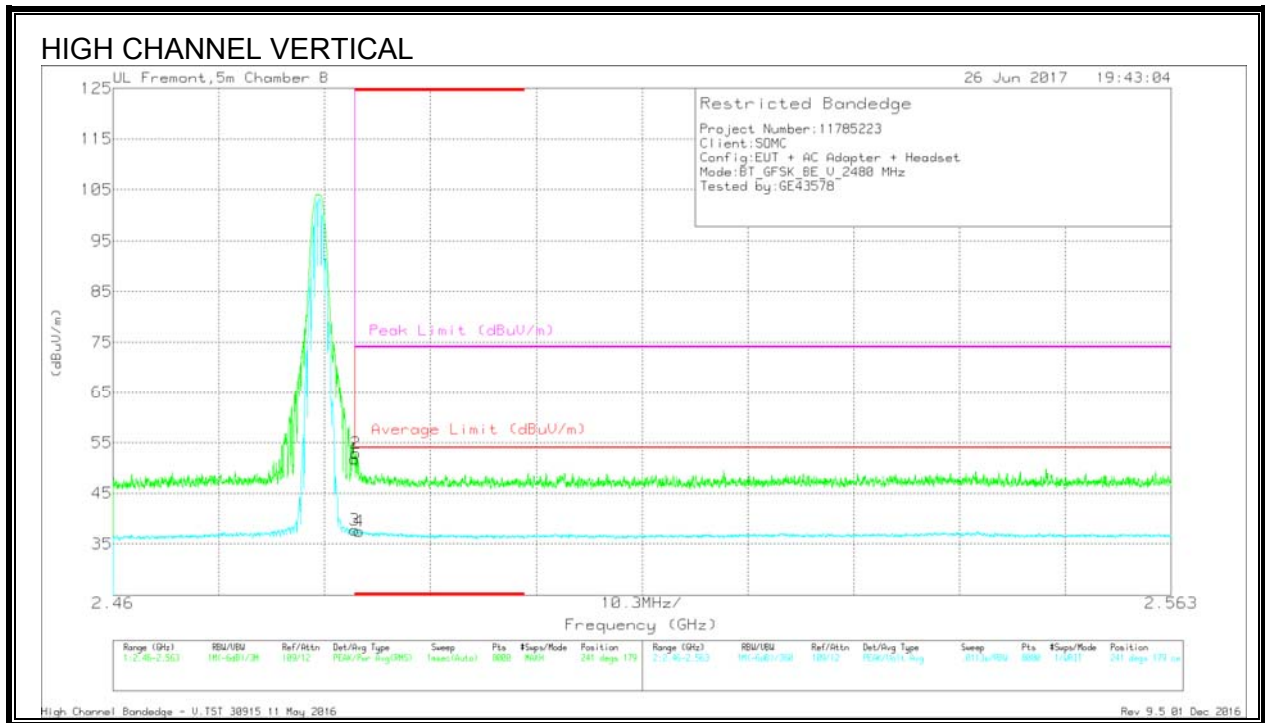

Marker	Frequency (GHz)	Meter Reading (dBuV)	Det	AFT346 (dB/m)	Amp/Cbl/Filtr/Pad (dB)	Corrected Reading (dBuV/m)	Average Limit (dBuV/m)	Margin (dB)	Peak Limit (dBuV/m)	PK Margin (dB)	Azimuth (Degs)	Height (cm)	Polarity
1	* 2.484	40.56	Pk	32.1	-20.9	51.76	-	-	74	-22.24	241	179	V
2	* 2.484	41.72	Pk	32.1	-20.9	52.92	-	-	74	-21.08	241	179	V
3	* 2.484	26.53	VA1T	32.1	-20.9	37.73	54	-16.27	-	-	241	179	V
4	* 2.484	26.32	VA1T	32.1	-20.9	37.52	54	-16.48	-	-	241	179	V

\* - indicates frequency in CFR47 Pt 15 / IC RSS-Restricted Band

Pk - Peak detector

VA1T - FHSS: Linear Voltage Average  $V_B = 1/T_{on}$  where:  $T_{on}$  is transmit duration

### 8.2.3. HARMONICS AND SPURIOUS EMISSIONS

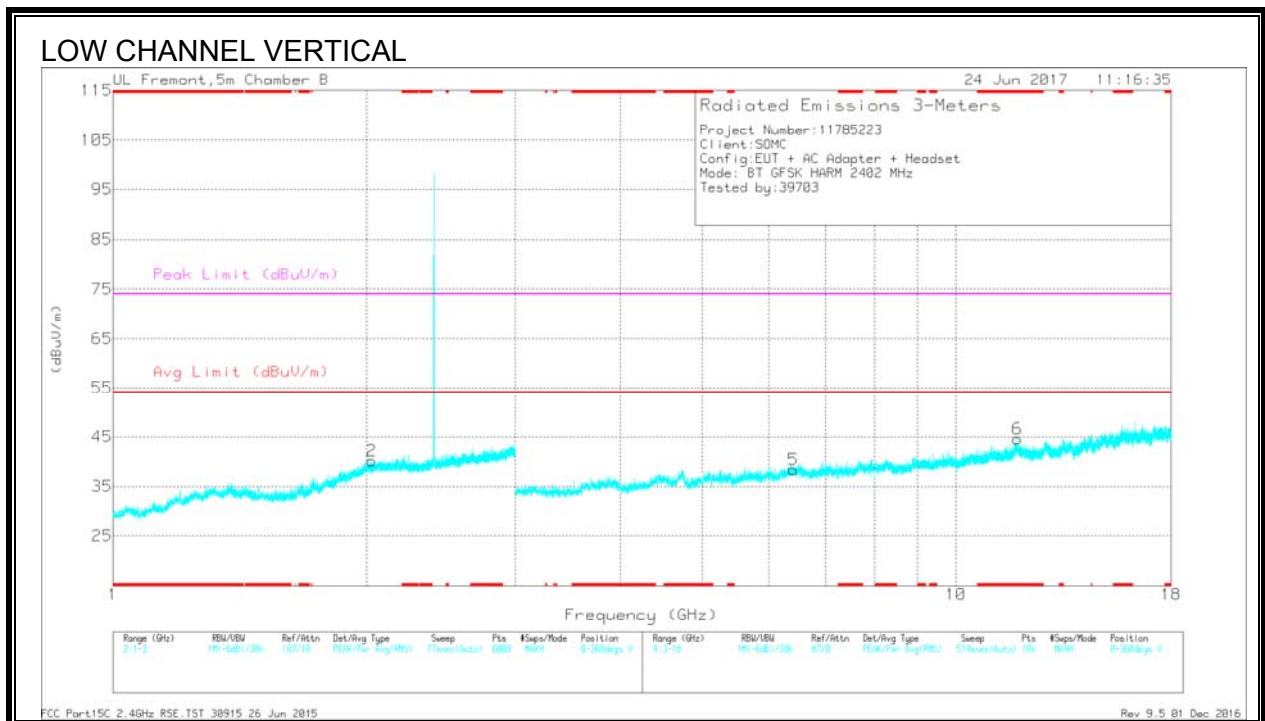
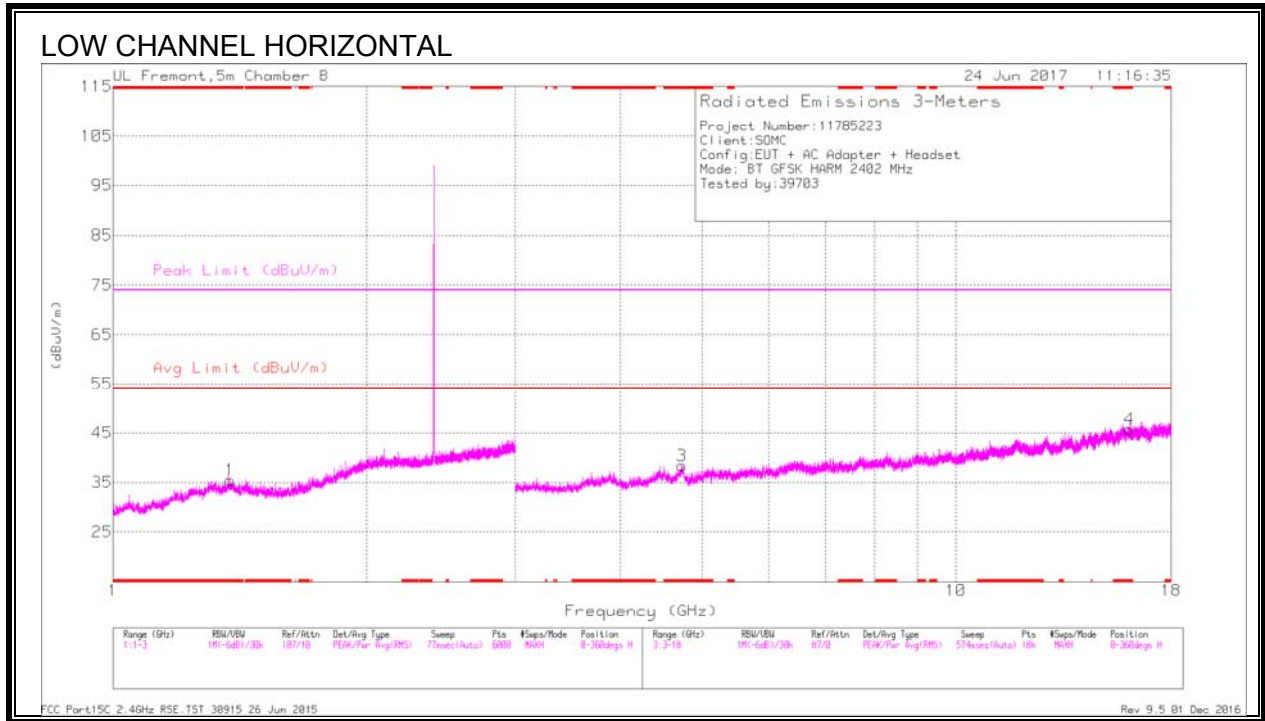

Frequency (GHz)	Meter Reading (dBuV)	Det	AF T346 (dB/m)	Amp/Cbl/Fitr/Pad (dB)	Corrected Reading (dBuV/m)	Avg Limit (dBuV/m)	Margin (dB)	Peak Limit (dBuV/m)	PK Margin (dB)	Azimuth (Degs)	Height (cm)	Polarity
* 1.378	33.43	PKFH	28.8	-21.8	40.43	-	-	74	-33.57	0	101	H
* 1.377	16.23	VA1T	28.8	-21.7	23.33	54	-30.67	-	-	0	101	H
* 4.731	39.19	PKFH	34.4	-28.7	44.89	-	-	74	-29.11	0	101	H
* 4.733	26	VA1T	34.4	-28.7	31.7	54	-22.3	-	-	0	101	H
* 16.06	30.12	PKFH	41.6	-20.7	51.02	-	-	74	-22.98	0	101	H
* 16.062	16.3	VA1T	41.6	-20.7	37.2	54	-16.8	-	-	0	101	H
* 11.83	31.23	PKFH	39.4	-22.4	48.23	-	-	74	-25.77	0	200	V
* 11.83	18.27	VA1T	39.4	-22.4	35.27	54	-18.73	-	-	0	200	V
2.024	33.71	PKFH	32.1	-21.1	44.71	-	-	-	-	0	101	V
2.027	15.34	VA1T	32.1	-21	26.44	-	-	-	-	0	101	V
6.417	36.69	PKFH	36.2	-28.7	44.19	-	-	-	-	0	101	V
6.42	24.73	VA1T	36.2	-28.6	32.33	-	-	-	-	0	101	V

\* - indicates frequency in CFR47 Pt 15 / IC RSS-Restricted Band

PKFH - FHSS: RB=100k/1MHz VB=3 x RB, Peak

VA1T - FHSS: Linear Voltage Average VB=1/Ton where: Ton is transmit duration

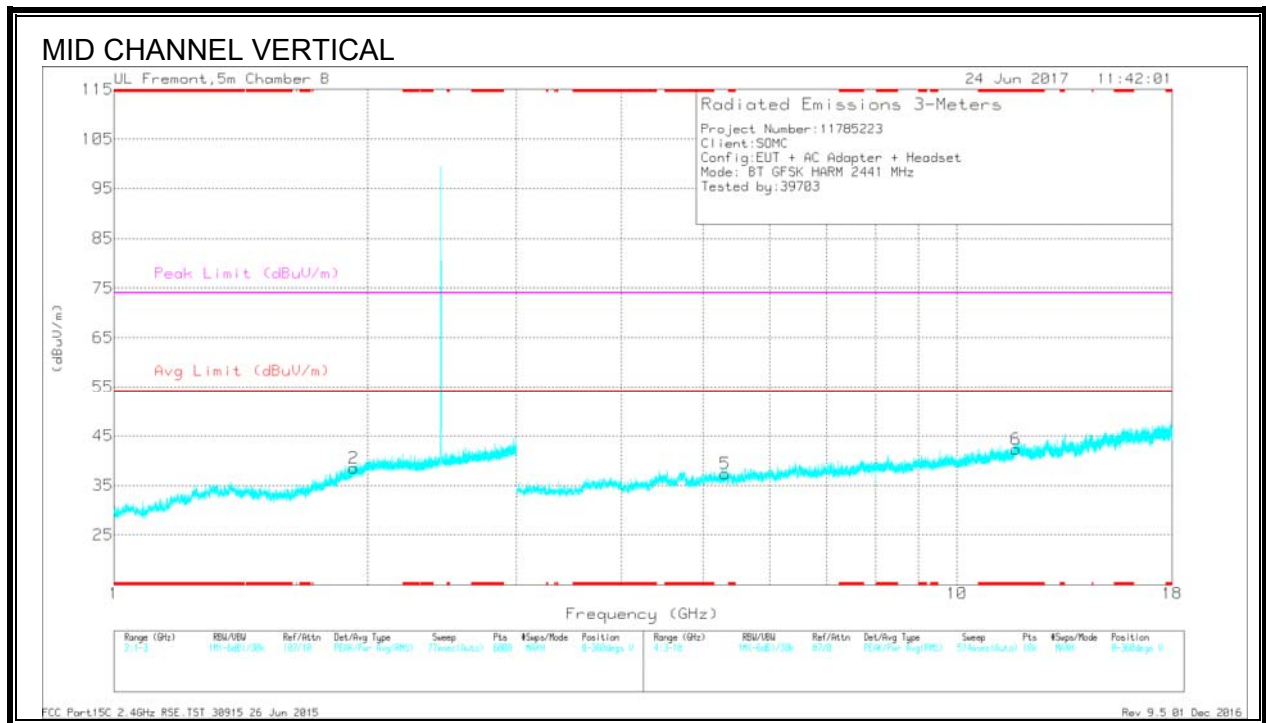
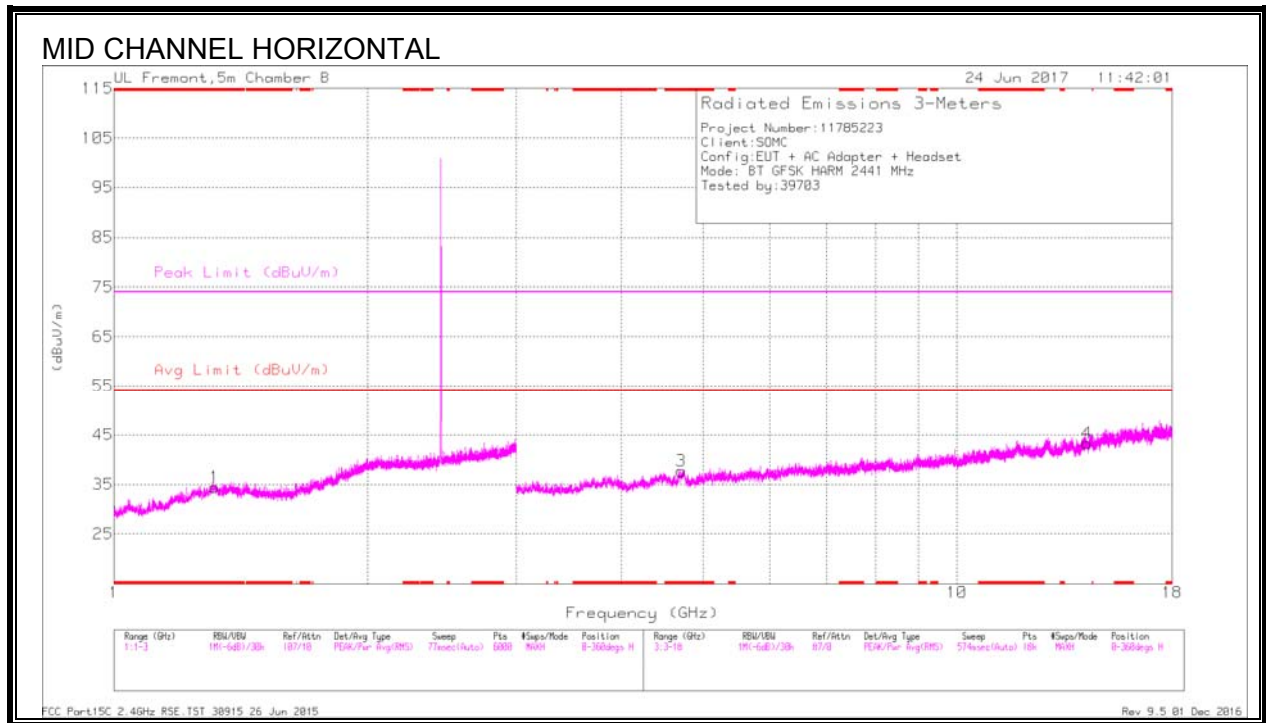



Frequency (GHz)	Meter Reading (dBuV)	Det	AF T346 (dB/m)	Amp/Cbl/Fitr/Pad (dB)	Corrected Reading (dBuV/m)	Avg Limit (dBuV/m)	Margin (dB)	Peak Limit (dBuV/m)	PK Margin (dB)	Azimuth (Degs)	Height (cm)	Polarity
* 1.315	32.88	PKFH	28.9	-22.1	39.68	-	-	74	-34.32	0	199	H
* 1.316	16.16	VA1T	28.9	-22.1	22.96	54	-31.04	-	-	0	199	H
* 4.709	37.4	PKFH	34.4	-29.3	42.5	-	-	74	-31.5	0	104	H
* 4.711	25.75	VA1T	34.4	-29.3	30.85	54	-23.15	-	-	0	104	H
* 11.745	30.94	PKFH	39.3	-22.7	47.54	-	-	74	-26.46	0	200	V
* 11.748	17.75	VA1T	39.3	-22.6	34.45	54	-19.55	-	-	0	200	V
1.923	15.49	VA1T	31.1	-21.1	25.49	-	-	-	-	0	104	V
1.925	33.07	PKFH	31.2	-21.1	43.17	-	-	-	-	0	104	V
5.308	37.14	PKFH	35	-28.8	43.34	-	-	-	-	0	104	V
5.31	24.76	VA1T	35	-28.8	30.96	-	-	-	-	0	104	V
14.268	30.75	PKFH	40.1	-22.1	48.75	-	-	-	-	0	199	H
14.268	17.14	VA1T	40.1	-22.1	35.14	-	-	-	-	0	199	H

\* - indicates frequency in CFR47 Pt 15 / IC RSS-Restricted Band

PKFH - FHSS: RB=100k/1MHz VB=3 x RB, Peak

VA1T - FHSS: Linear Voltage Average VB=1/Ton where: Ton is transmit duration

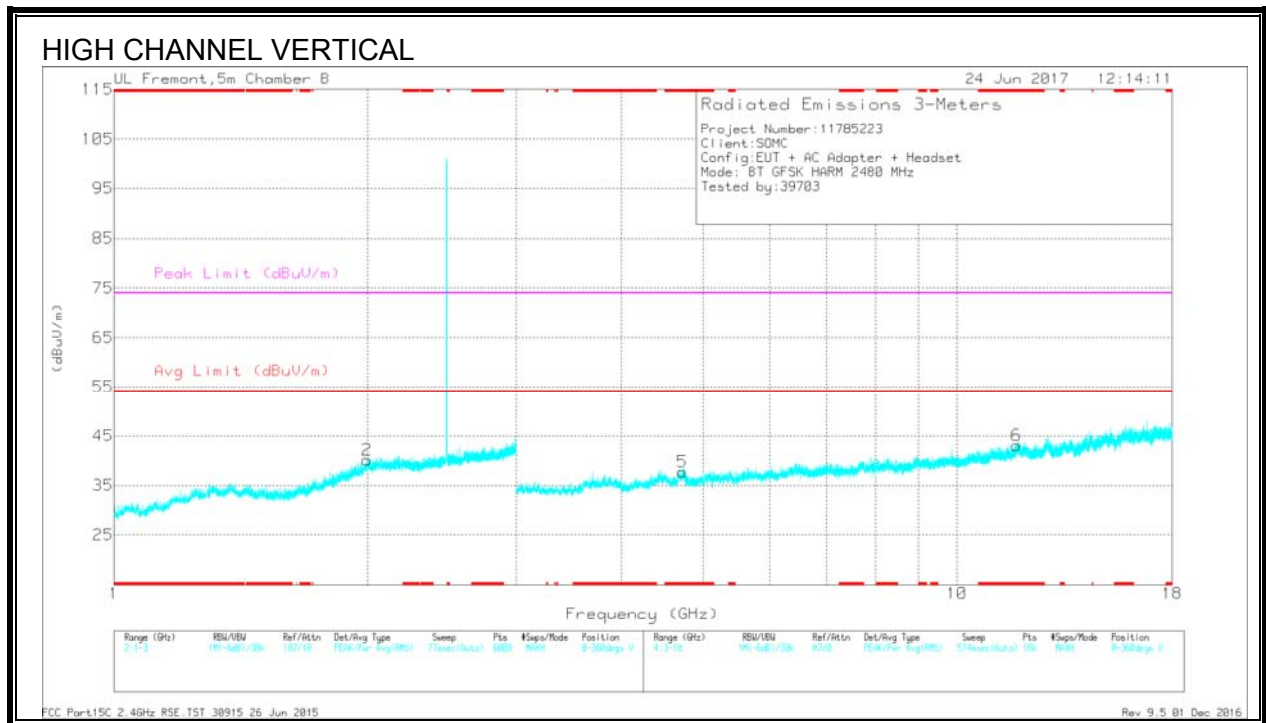
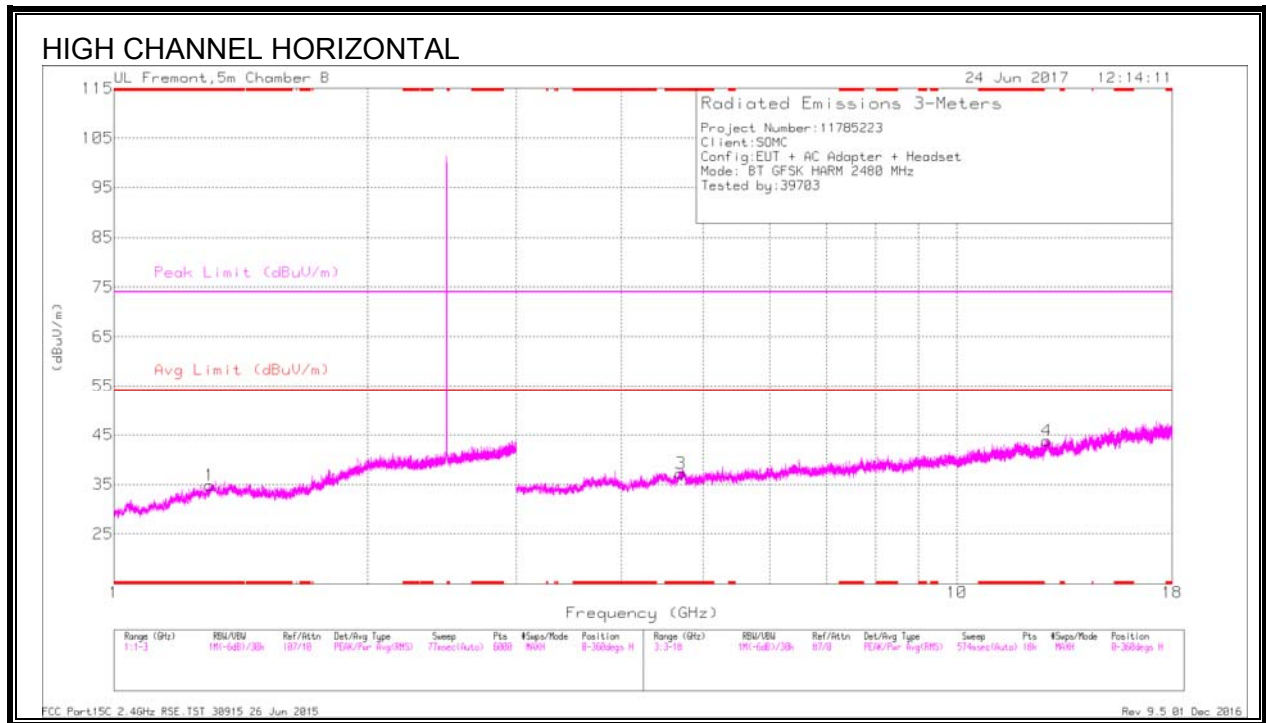

Frequency (GHz)	Meter Reading (dBuV)	Det	AF T346 (dB/m)	Amp/Cbl/Fitr/Pad (dB)	Corrected Reading (dBuV/m)	Avg Limit (dBuV/m)	Margin (dB)	Peak Limit (dBuV/m)	PK Margin (dB)	Azimuth (Degs)	Height (cm)	Polarity
* 1.299	32.31	PKFH	28.9	-22.1	39.11	-	-	74	-34.89	0	104	H
* 1.298	15.46	VA1T	28.9	-22.1	22.26	54	-31.74	-	-	0	104	H
* 4.704	37.73	PKFH	34.4	-29.5	42.63	-	-	74	-31.37	0	199	H
* 4.703	25.55	VA1T	34.4	-29.5	30.45	54	-23.55	-	-	0	199	H
* 4.719	37.63	PKFH	34.4	-29	43.03	-	-	74	-30.97	0	199	V
* 4.72	25.81	VA1T	34.4	-29	31.21	54	-22.79	-	-	0	199	V
* 11.768	32.76	PKFH	39.4	-22.6	49.56	-	-	74	-24.44	0	199	V
* 11.768	18.54	VA1T	39.4	-22.6	35.34	54	-18.66	-	-	0	199	V
1.995	15.5	VA1T	32	-20.9	26.6	-	-	-	-	0	102	V
1.999	33.55	PKFH	32.1	-20.9	44.75	-	-	-	-	0	102	V
12.78	17.98	VA1T	39.8	-21.9	35.88	-	-	-	-	0	199	H
12.782	32.14	PKFH	39.8	-21.9	50.04	-	-	-	-	0	199	H

\* - indicates frequency in CFR47 Pt 15 / IC RSS-Restricted Band

PKFH - FHSS: RB=100k/1MHz VB=3 x RB, Peak

VA1T - FHSS: Linear Voltage Average VB=1/Ton where: Ton is transmit duration

### 8.3. ENHANCED DATA RATE 8PSK MODULATION

#### 8.3.1. RESTRICTED BANDEDGE (LOW CHANNEL)

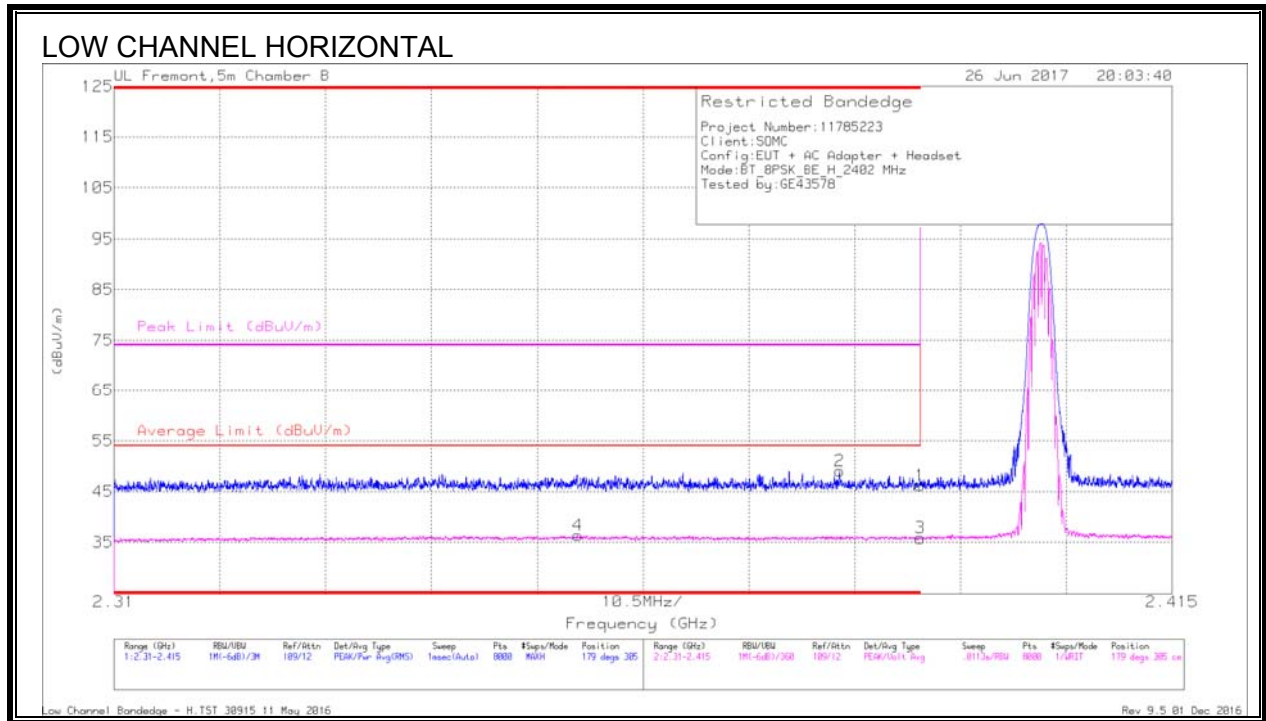

Trace Markers

Marker	Frequency (GHz)	Meter Reading (dBuV)	Det	AF T346 (dB/m)	Amp/Cb/Fktr/Pa d (dB)	Corrected Reading (dBuV/m)	Average Limit (dBuV/m)	Margin (dB)	Peak Limit (dBuV/m)	PK Margin (dB)	Azimuth (Degs)	Height (cm)	Polarity
1	* 2.39	35.42	Pk	32	-21.2	46.22	-	-	74	-27.78	179	305	H
2	* 2.382	38.27	Pk	31.9	-21.1	49.07	-	-	74	-24.93	179	305	H
3	* 2.39	25.03	VA1T	32	-21.2	35.83	54	-18.17	-	-	179	305	H
4	* 2.356	25.54	VA1T	31.9	-21	36.44	54	-17.56	-	-	179	305	H

\* - indicates frequency in CFR47 Pt 15 / IC RSS-Restricted Band

Pk - Peak detector

VA1T - FHSS: Linear Voltage Average  $V_B=1/T_{on}$  where:  $T_{on}$  is transmit duration

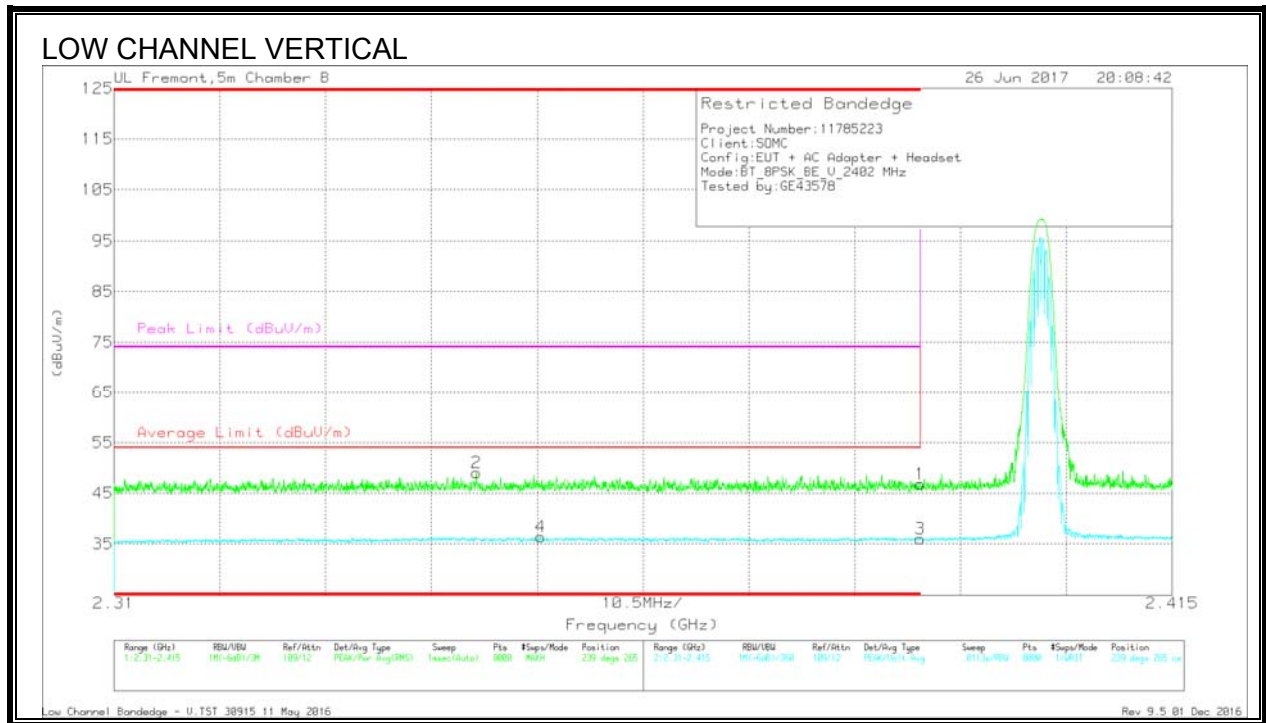

Trace Markers

Marker	Frequency (GHz)	Meter Reading (dBuV)	Det	AF T346 (dB/m)	Amp/Cbl/Fitr/Pad (dB)	Corrected Reading (dBuV/m)	Average Limit (dBuV/m)	Margin (dB)	Peak Limit (dBuV/m)	PK Margin (dB)	Azimuth (Degs)	Height (cm)	Polarity
1	* 2.39	35.98	Pk	32	-21.2	46.78	-	-	74	-27.22	239	265	V
2	* 2.346	38.2	Pk	31.8	-21	49	-	-	74	-25	239	265	V
3	* 2.39	25.24	VA1T	32	-21.2	36.04	54	-17.96	-	-	239	265	V
4	* 2.352	25.64	VA1T	31.8	-21.1	36.34	54	-17.66	-	-	239	265	V

\* - indicates frequency in CFR47 Pt 15 / IC RSS-Restricted Band

Pk - Peak detector

VA1T - FHSS: Linear Voltage Average  $V_B=1/T_{on}$  where:  $T_{on}$  is transmit duration

### 8.3.2. AUTHORIZED BANDEDGE (HIGH CHANNEL)

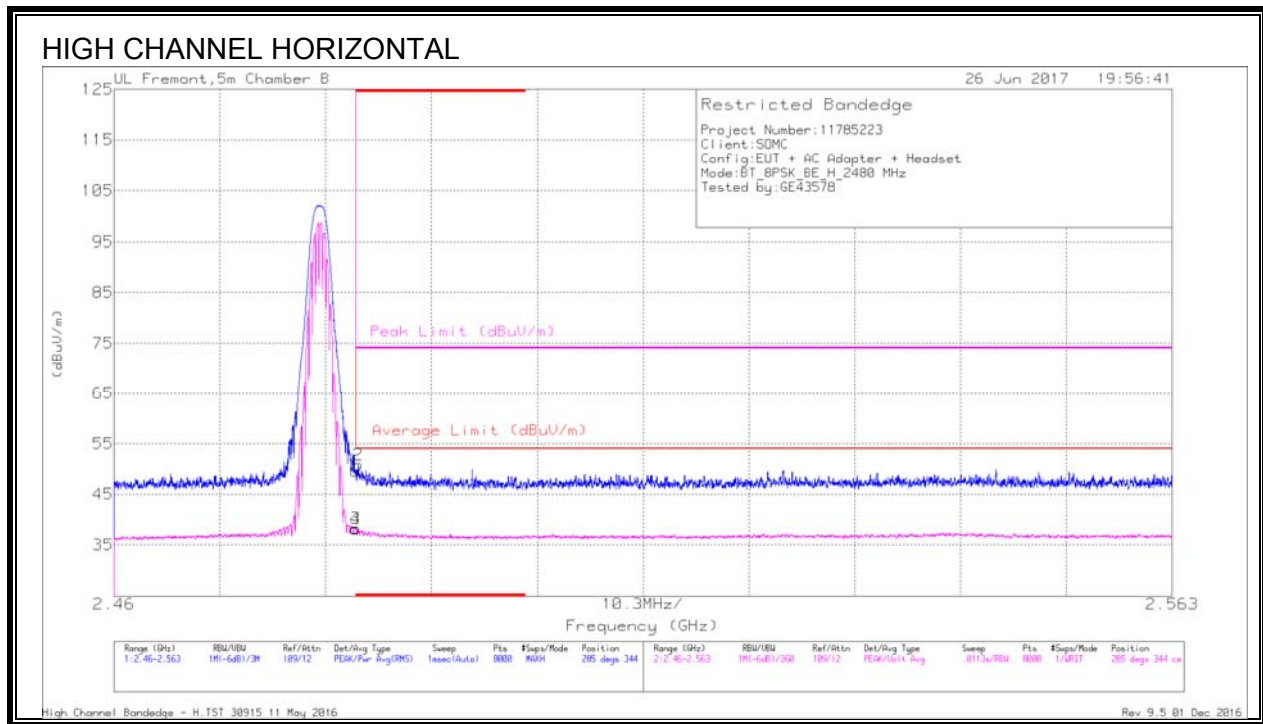

Trace Markers

Marker	Frequency (GHz)	Meter Reading (dBuV)	Det	AFT346 (dB/m)	Amp/Cbl/Filtr/Pad (dB)	Corrected Reading (dBuV/m)	Average Limit (dBuV/m)	Margin (dB)	Peak Limit (dBuV/m)	PK Margin (dB)	Azimuth (Degs)	Height (cm)	Polarity
1	* 2.484	38.37	Pk	32.1	-20.9	49.57	-	-	74	-24.43	285	344	H
2	* 2.484	39.54	Pk	32.1	-20.9	50.74	-	-	74	-23.26	285	344	H
3	* 2.484	27.06	VA1T	32.1	-20.9	38.26	54	-15.74	-	-	285	344	H
4	* 2.484	26.95	VA1T	32.1	-20.9	38.15	54	-15.85	-	-	285	344	H

\* - indicates frequency in CFR47 Pt 15 / IC RSS-Restricted Band

Pk - Peak detector

VA1T - FHSS: Linear Voltage Average VB=1/Ton where: Ton is transmit duration

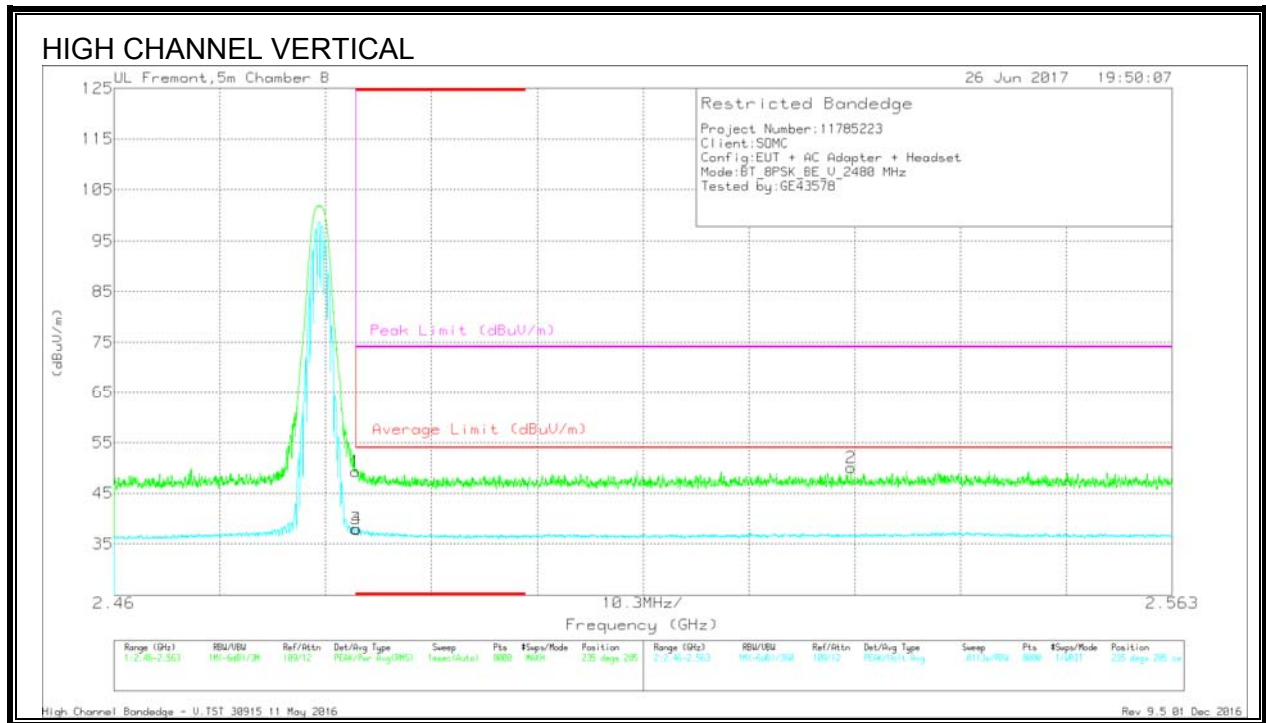

Trace Markers

Marker	Frequency (GHz)	Meter Reading (dBuV)	Det	AF T346 (dB/m)	Amp/Cbl/Fitr/Pad (dB)	Corrected Reading (dBuV/m)	Average Limit (dBuV/m)	Margin (dB)	Peak Limit (dBuV/m)	PK Margin (dB)	Azimuth (Degs)	Height (cm)	Polarity
1	* 2.484	38.11	Pk	32.1	-20.9	49.31	-	-	74	-24.69	235	285	V
3	* 2.484	26.76	VA1T	32.1	-20.9	37.96	54	-16.04	-	-	235	285	V
4	* 2.484	26.74	VA1T	32.1	-20.9	37.94	54	-16.06	-	-	235	285	V
2	2.532	38.87	Pk	32.1	-20.9	50.07	-	-	74	-23.93	235	285	V

\* - indicates frequency in CFR47 Pt 15 / IC RSS-Restricted Band

Pk - Peak detector

VA1T - FHSS: Linear Voltage Average  $VB=1/Ton$  where: Ton is transmit duration

### 8.3.3. HARMONICS AND SPURIOUS EMISSIONS

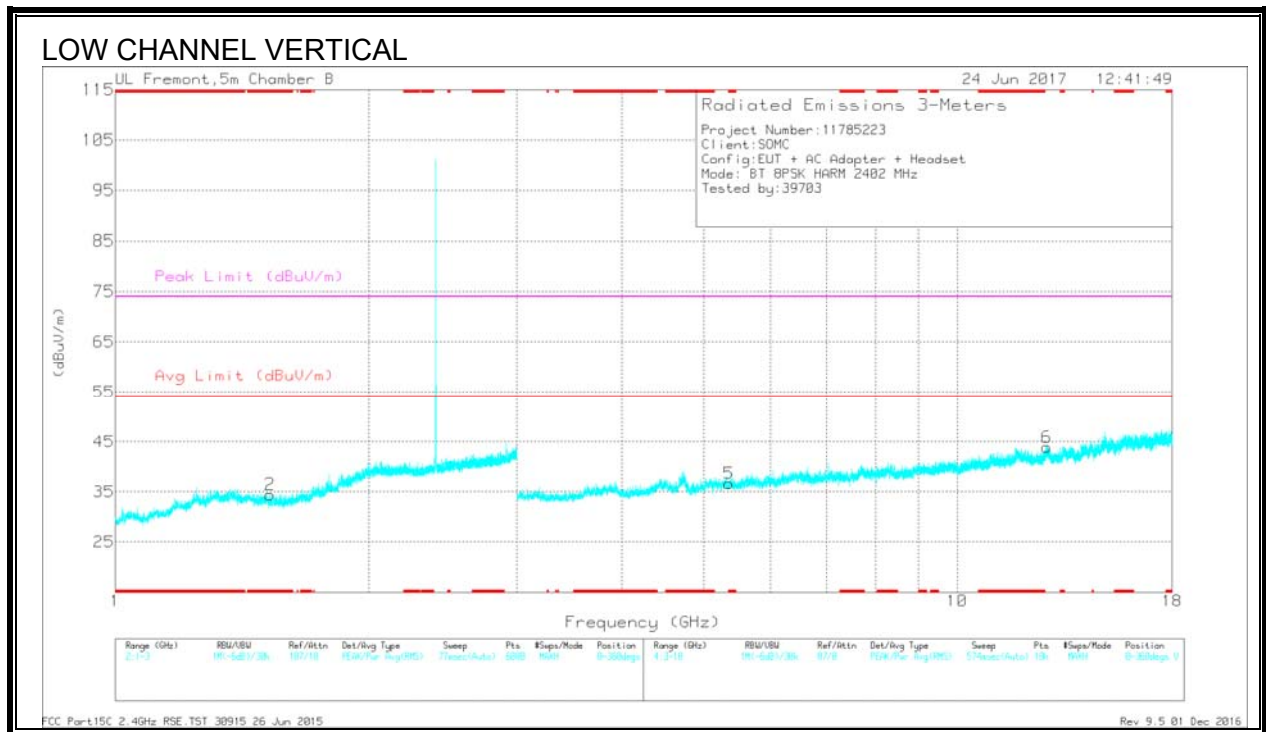
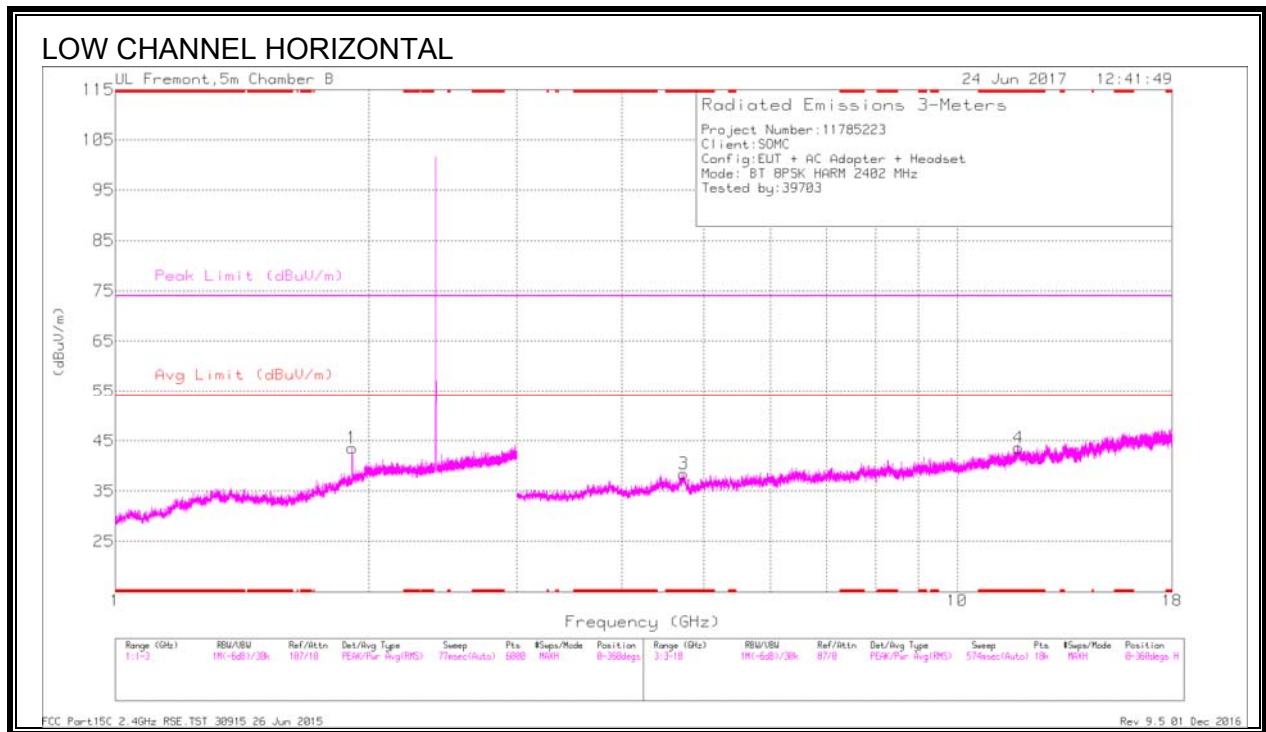



Frequency (GHz)	Meter Reading (dBuV)	Det	AF T346 (dB/m)	Amp/Cbl/Fitr/Pad (dB)	Corrected Reading (dBuV/m)	Avg Limit (dBuV/m)	Margin (dB)	Peak Limit (dBuV/m)	PK Margin (dB)	Azimuth (Degs)	Height (cm)	Polarity
* 1.529	32.13	PKFH	27.5	-21.3	38.33	-	-	74	-35.67	0	104	V
* 1.527	14.73	VA1T	27.5	-21.2	21.03	54	-32.97	-	-	0	104	V
* 4.734	38.37	PKFH	34.4	-28.6	44.17	-	-	74	-29.83	0	104	H
* 4.732	25.86	VA1T	34.4	-28.7	31.56	54	-22.44	-	-	0	104	H
* 11.827	31.93	PKFH	39.4	-22.3	49.03	-	-	74	-24.97	0	199	H
* 11.83	17.96	VA1T	39.4	-22.4	34.96	54	-19.04	-	-	0	199	H
* 5.356	35.87	PKFH	35	-28.9	41.97	-	-	74	-32.03	0	104	V
* 5.359	24.21	VA1T	35	-28.9	30.31	54	-23.69	-	-	0	104	V
1.911	32.88	PKFH	31	-21.1	42.78	-	-	-	-	0	200	H
1.914	15.18	VA1T	31	-21.1	25.08	-	-	-	-	0	200	H
12.782	17.83	VA1T	39.8	-21.9	35.73	-	-	-	-	0	200	V
12.783	30.63	PKFH	39.8	-22	48.43	-	-	-	-	0	200	V

\* - indicates frequency in CFR47 Pt 15 / IC RSS-Restricted Band

PKFH - FHSS: RB=100k/1MHz VB=3 x RB, Peak

VA1T - FHSS: Linear Voltage Average VB=1/Ton where: Ton is transmit duration

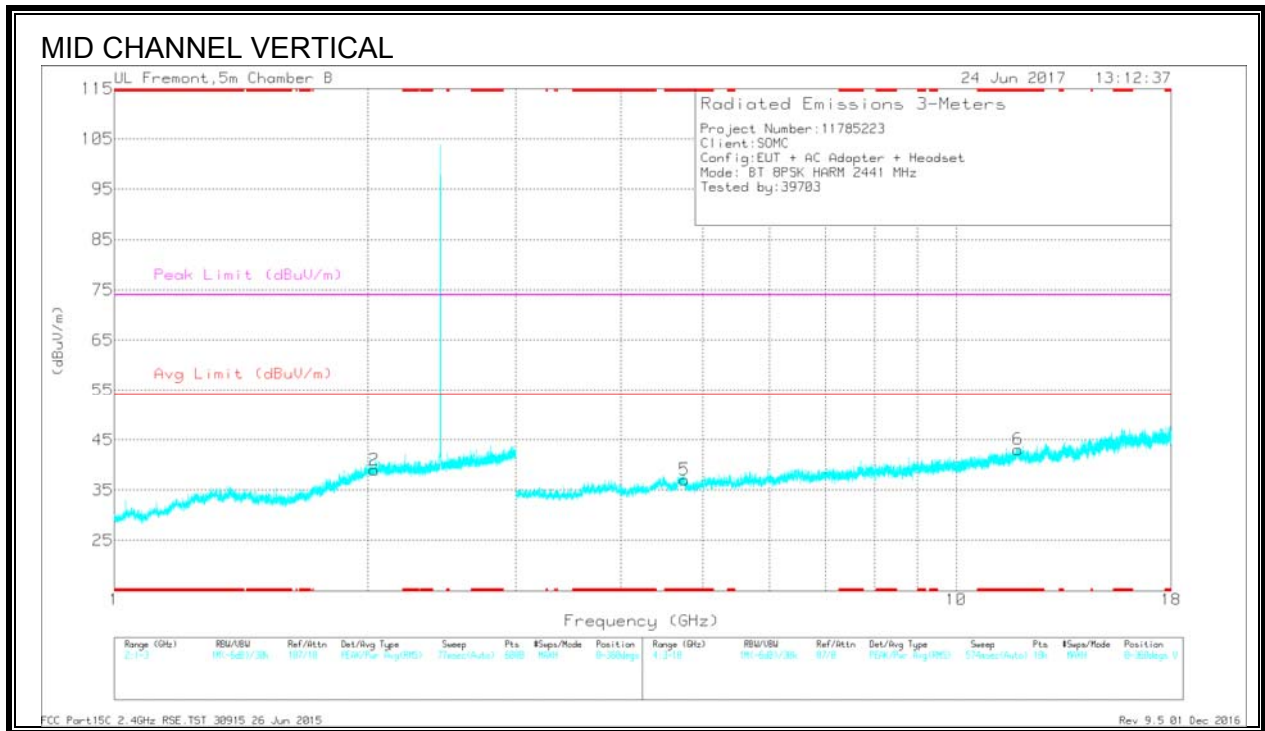
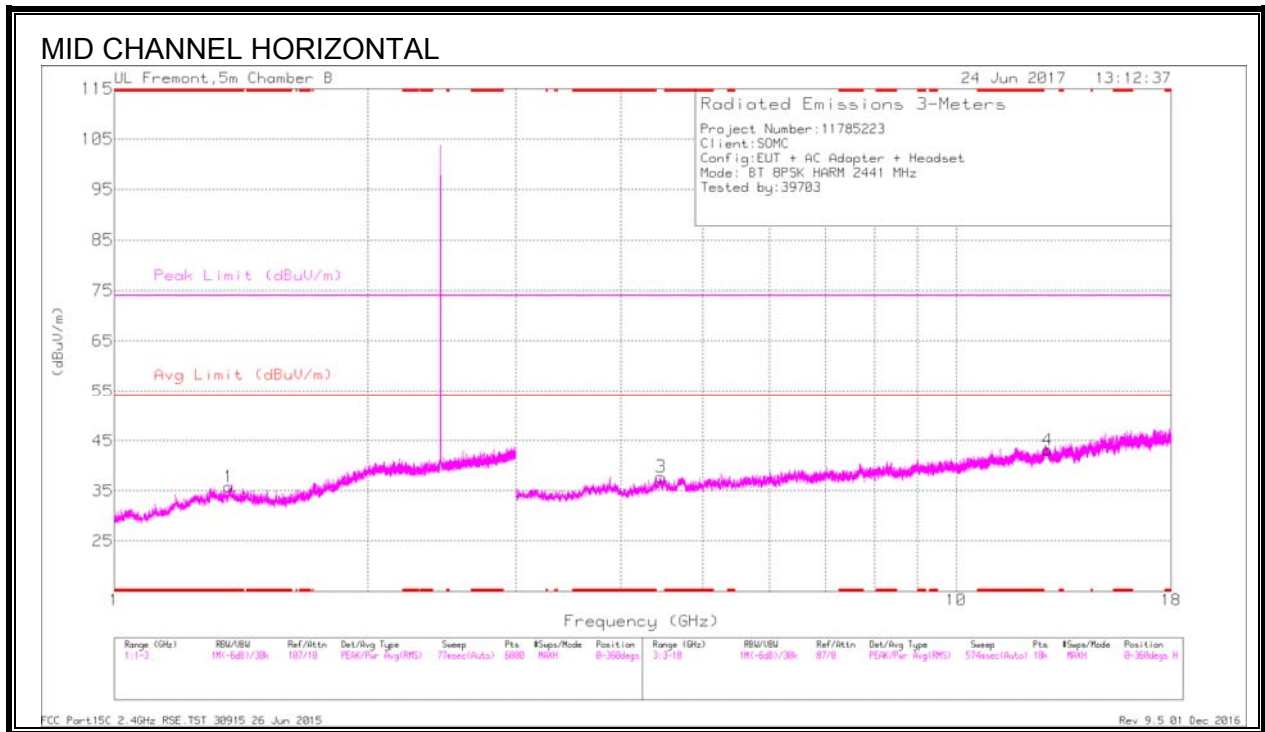

Frequency (GHz)	Meter Reading (dBuV)	Det	AF T346 (dB/m)	Amp/Cbl/Fitr/Pad (dB)	Corrected Reading (dBuV/m)	Avg Limit (dBuV/m)	Margin (dB)	Peak Limit (dBuV/m)	PK Margin (dB)	Azimuth (Degs)	Height (cm)	Polarity
* 1.368	33.3	PKFH	28.8	-21.8	40.3	-	-	74	-33.7	0	199	H
* 1.369	15.61	VA1T	28.8	-21.7	22.71	54	-31.29	-	-	0	199	H
* 4.757	37.35	PKFH	34.4	-28.6	43.15	-	-	74	-30.85	0	103	V
* 4.758	25.25	VA1T	34.4	-28.6	31.05	54	-22.95	-	-	0	103	V
* 11.848	31.43	PKFH	39.4	-22.7	48.13	-	-	74	-25.87	0	200	V
* 11.848	17.62	VA1T	39.4	-22.7	34.32	54	-19.68	-	-	0	200	V
2.039	33.62	PKFH	32.1	-21.3	44.42	-	-	-	-	0	103	V
2.039	15.35	VA1T	32.1	-21.3	26.15	-	-	-	-	0	103	V
4.46	36.89	PKFH	34.3	-28.8	42.39	-	-	-	-	0	103	H
4.46	24.84	VA1T	34.3	-28.8	30.34	-	-	-	-	0	103	H
12.846	31	PKFH	39.8	-22.4	48.4	-	-	-	-	0	103	H
12.846	18.16	VA1T	39.8	-22.4	35.56	-	-	-	-	0	103	H

\* - indicates frequency in CFR47 Pt 15 / IC RSS-Restricted Band

PKFH - FHSS: RB=100k/1MHz VB=3 x RB, Peak

VA1T - FHSS: Linear Voltage Average VB=1/Ton where: Ton is transmit duration

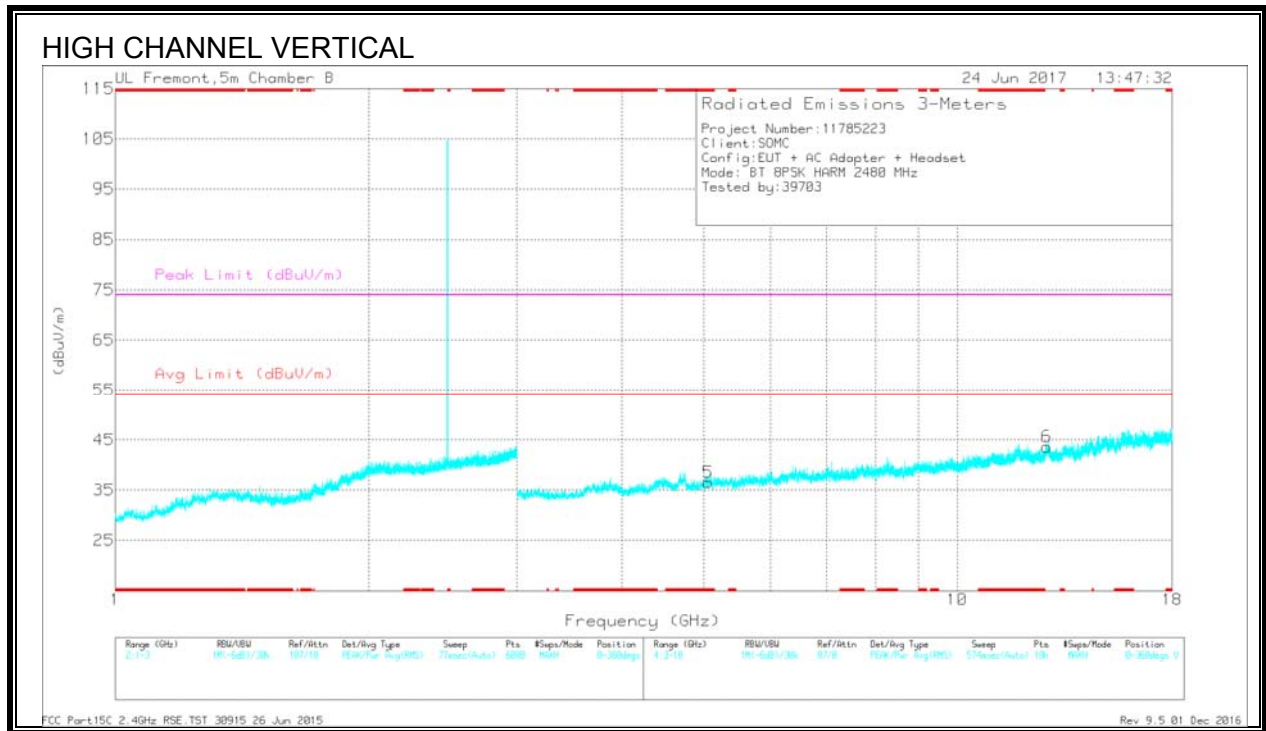
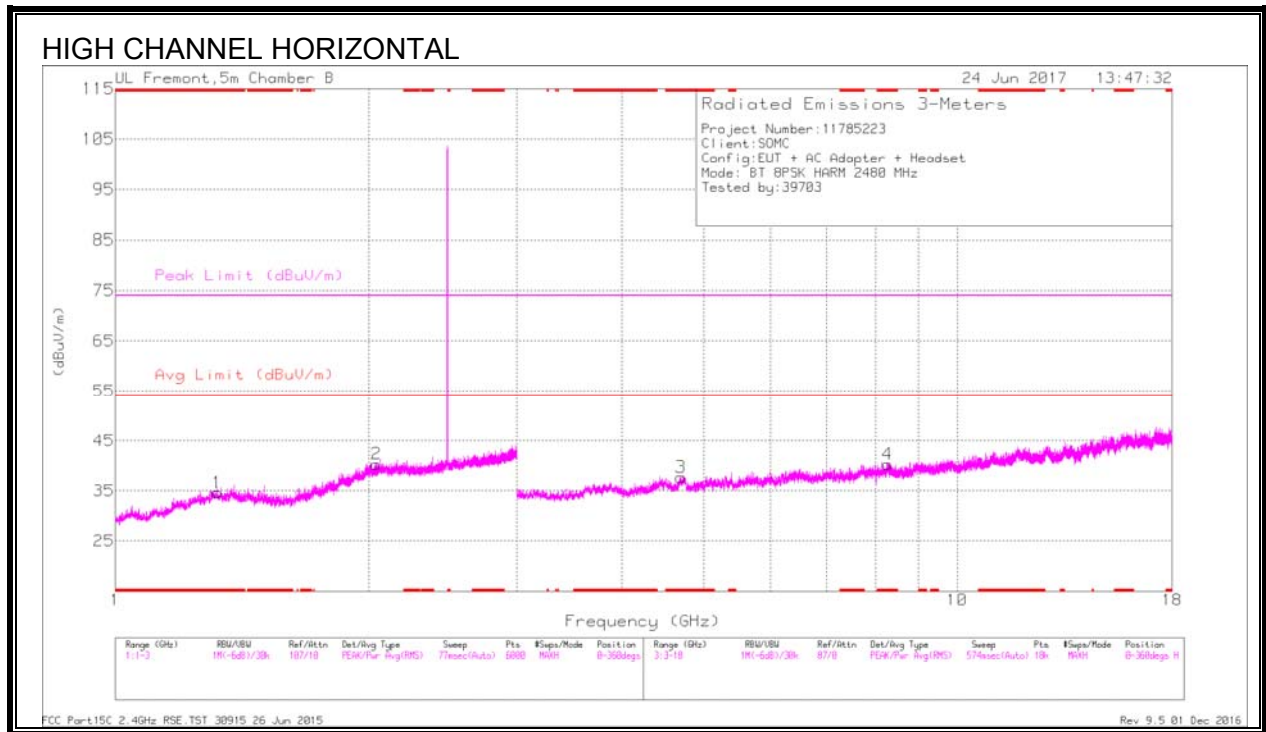

Frequency (GHz)	Meter Reading (dBuV)	Det	AF T346 (dB/m)	Amp/Cbl/Fitr/Pad (dB)	Corrected Reading (dBuV/m)	Avg Limit (dBuV/m)	Margin (dB)	Peak Limit (dBuV/m)	PK Margin (dB)	Azimuth (Degs)	Height (cm)	Polarity
* 1.322	33.84	PKFH	28.9	-21.8	40.94	-	-	74	-33.06	0	200	H
* 1.321	15.49	VA1T	28.9	-21.8	22.59	54	-31.41	-	-	0	200	H
* 8.262	35.81	PKFH	36.5	-25.9	46.41	-	-	74	-27.59	0	199	H
* 8.262	22.34	VA1T	36.5	-25.9	32.94	54	-21.06	-	-	0	199	H
* 5.062	36.48	PKFH	34.6	-28.5	42.58	-	-	74	-31.42	0	199	V
* 5.065	24.47	VA1T	34.6	-28.5	30.57	54	-23.43	-	-	0	199	V
2.044	34.05	PKFH	32.1	-21.1	45.05	-	-	-	-	0	104	H
2.044	15.66	VA1T	32.1	-21.1	26.66	-	-	-	-	0	104	H
12.778	17.79	VA1T	39.8	-21.8	35.79	-	-	-	-	0	104	V
12.78	31.43	PKFH	39.8	-21.9	49.33	-	-	-	-	0	104	V

\* - indicates frequency in CFR47 Pt 15 / IC RSS-Restricted Band

PKFH - FHSS: RB=100k/1MHz VB=3 x RB, Peak

VA1T - FHSS: Linear Voltage Average VB=1/Ton where: Ton is transmit duration

### 8.4. WORST-CASE BELOW 30 MHz

#### SPURIOUS EMISSIONS BELOW 30 MHz (WORST-CASE CONFIGURATION)

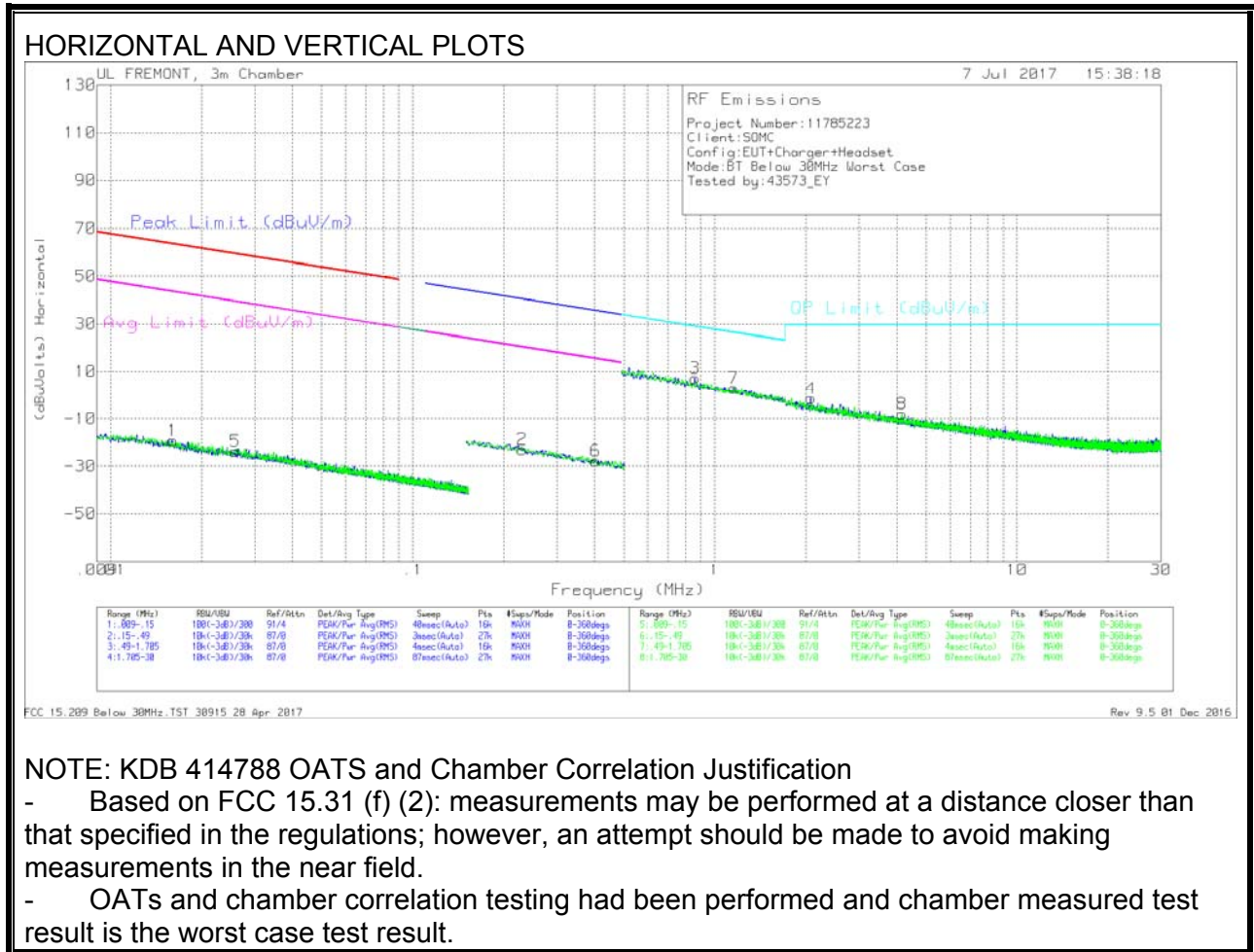

#### Trace Markers

Marker	Frequency (MHz)	Meter Reading (dBuV)	Det	Loop Antenna (dBm)	Cbl (dB)	Dist Corr 30m	Corrected Reading (dBuVolts)	Peak Limit (dBuV/m)	Margin (dB)	Avg Limit (dBuV/m)	Margin (dB)	Peak Limit (dBuV/m)	Margin (dB)	Avg Limit (dBuV/m)	Margin (dB)	Azimuth (Degs)
1	0.01602	42.23	Pk	17	1.4	-80	-19.37	63.49	-82.86	43.49	-82.86	-	-	-	-	0-360
5	0.2596	40.04	Pk	14.7	1.4	-80	-23.86	59.33	-83.19	39.33	-83.19	-	-	-	-	0-360
2	2.3078	43.95	Pk	11.5	1.5	-80	-23.05	-	-	-	-	40.35	-83.4	20.35	-43.4	0-360
6	4.0284	39.11	Pk	11.5	1.5	-80	-27.89	-	-	-	-	35.5	-63.39	15.5	-43.39	0-360

#### Pk - Peak detector

Marker	Frequency (MHz)	Meter Reading (dBuV)	Det	Loop Antenna (dBm)	Cbl (dB)	Dist Corr 30m	Corrected Reading (dBuVolts)	OP Limit (dBuV/m)	Margin (dB)	Azimuth (Degs)
3	85833	34.29	Pk	11.5	1.5	-40	7.29	28.94	-21.65	0-360
7	1.15378	29.96	Pk	11.5	1.5	-40	2.96	26.38	-23.42	0-360
4	2.07442	25.31	Pk	11.6	1.5	-40	-1.59	29.5	-31.09	0-360
8	4.15627	18.77	Pk	11.6	1.5	-40	-8.13	29.5	-37.63	0-360

#### Pk - Peak detector

### 8.5. WORST-CASE BELOW 1 GHz

#### SPURIOUS EMISSIONS 30 TO 1000 MHz (WORST-CASE CONFIGURATION)

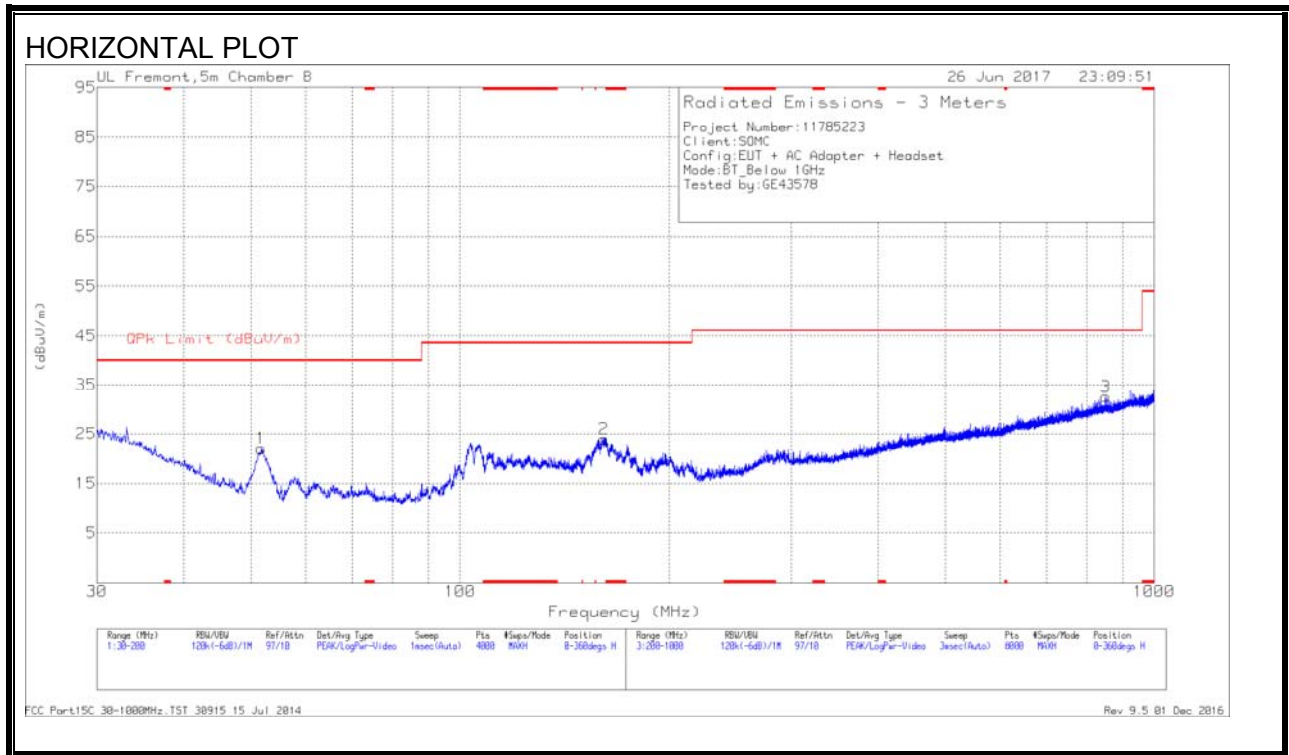

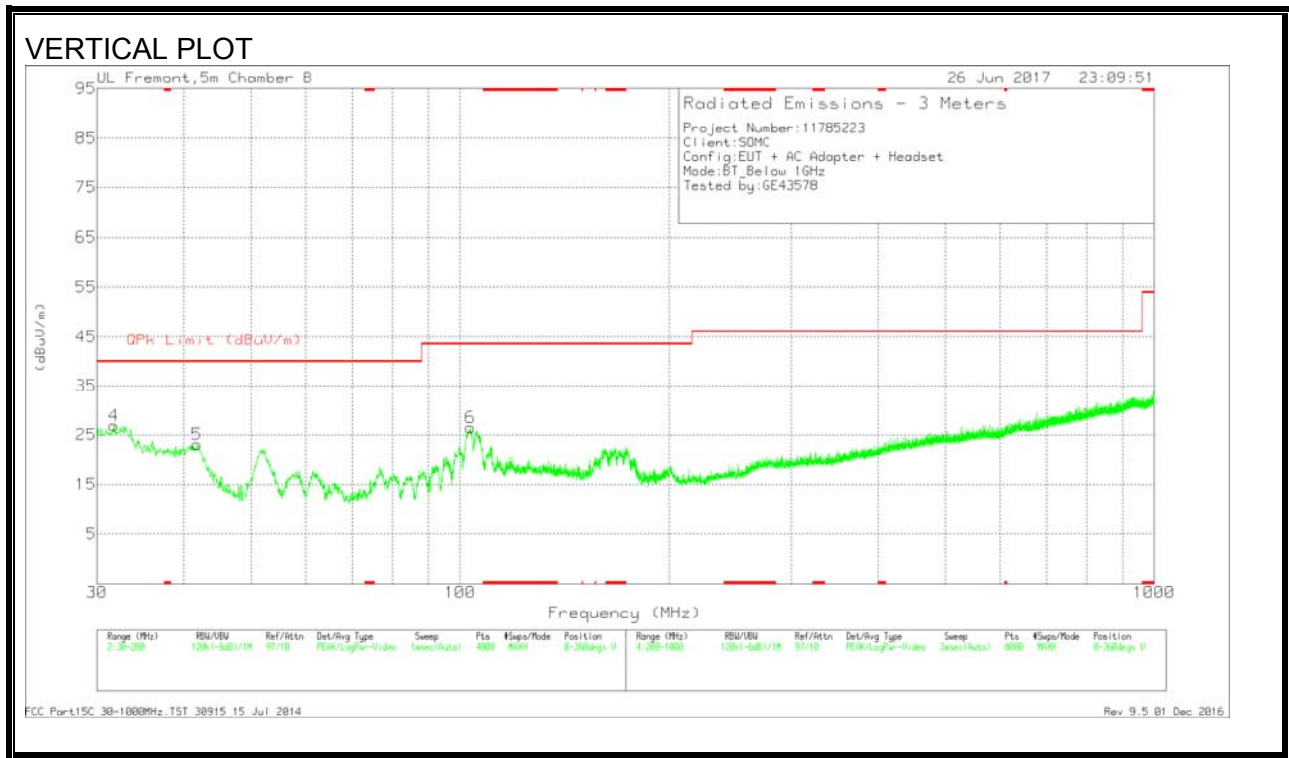

**DATA**

Marker	Frequency (MHz)	Meter Reading (dBuV)	Det	AF T899 (dB/m)	Amp/Cbl (dB)	Corrected Reading (dBuV/m)	QPk Limit (dBuV/m)	Margin (dB)	Azimuth (Degs)	Height (cm)	Polarity
4	31.743	31.54	Pk	24.1	-28.8	26.84	40	-13.16	0-360	100	V
5	41.7755	34.71	Pk	16.9	-28.6	23.01	40	-16.99	0-360	100	V
1	51.7231	39.52	Pk	11	-28.5	22.02	40	-17.98	0-360	400	H
6	103.5015	39.05	Pk	15.3	-27.9	26.45	43.52	-17.07	0-360	100	V
2	161.1889	35.3	Pk	15.9	-27.2	24	43.52	-19.52	0-360	200	H
3	850.4846	30.59	Pk	25.9	-23.9	32.59	46.02	-13.43	0-360	400	H

Pk - Peak detector



## 8.6. WORST-CASE ABOVE 18 GHz

### SPURIOUS EMISSIONS 18 TO 26 GHz (WORST-CASE CONFIGURATION)

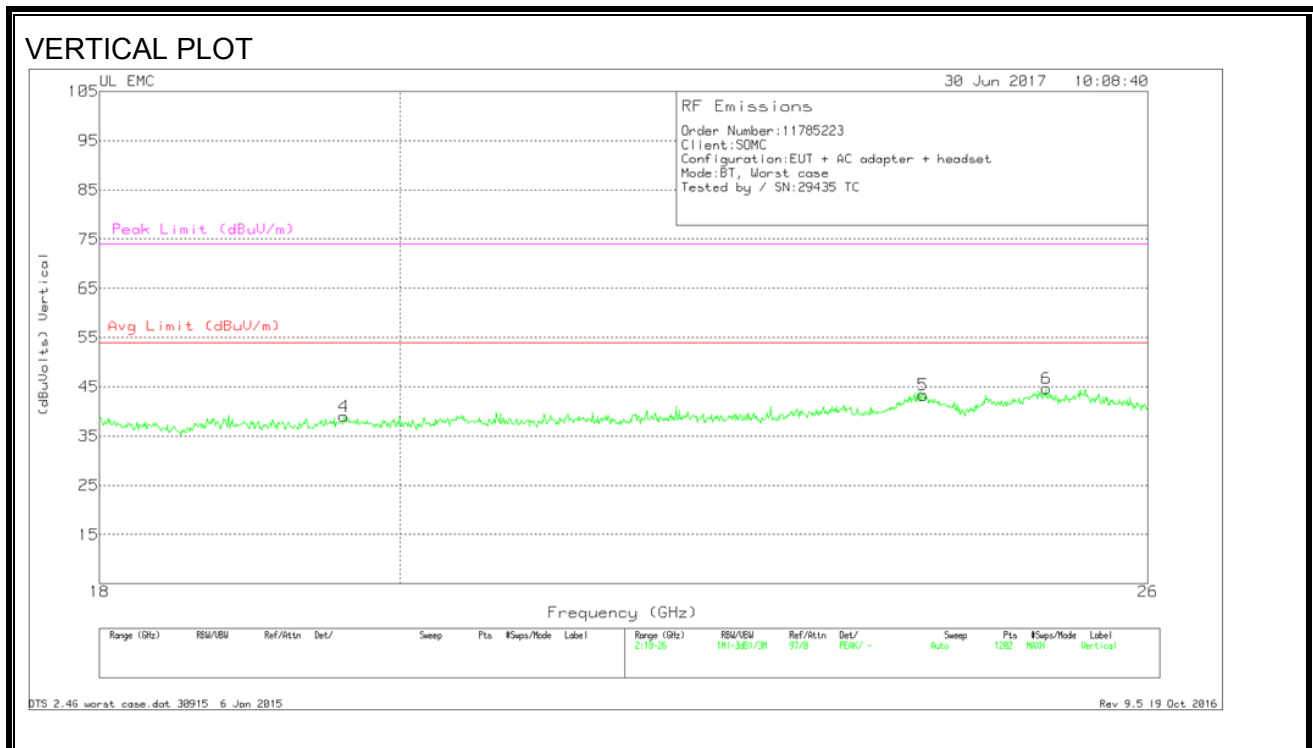
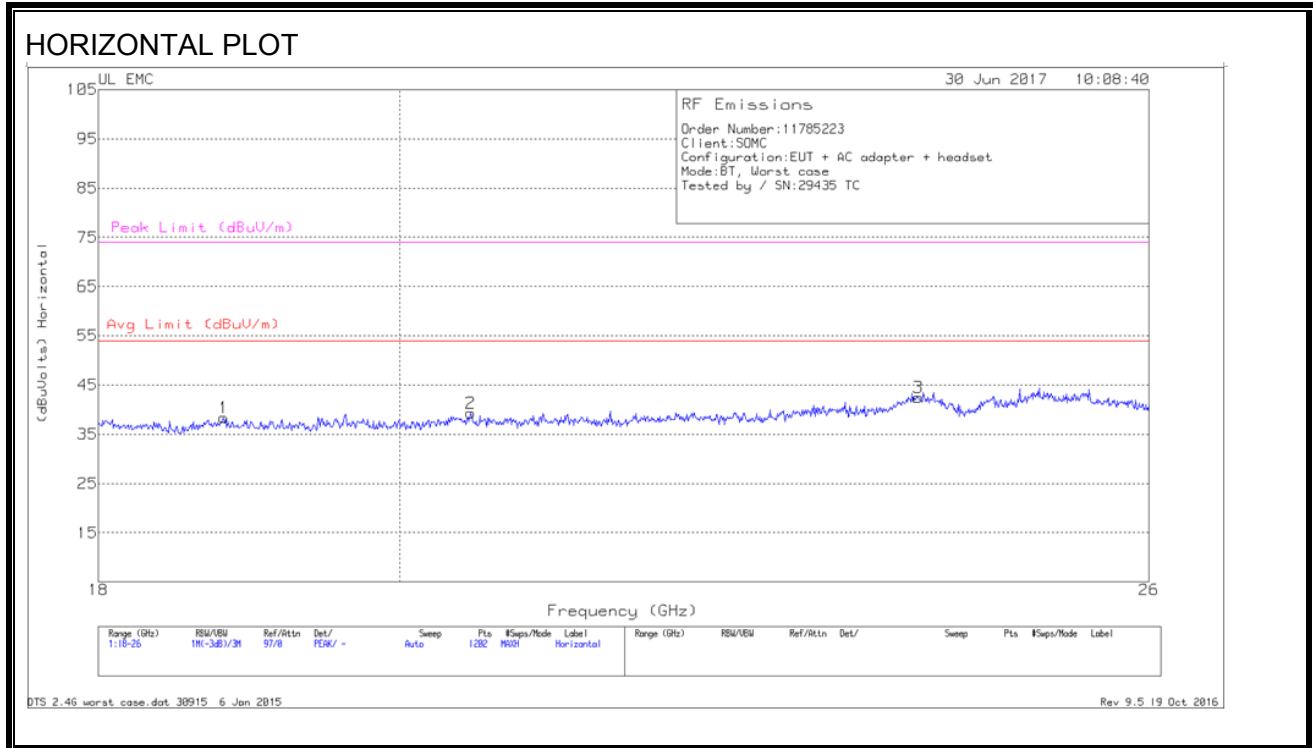

**Data**

Trace Markers

Marker	Frequency (GHz)	Meter Reading (dBuV)	Det	T449 AF (dB/m)	Amp/Cbl (dB)	Dist Corr (dB)	Corrected Reading (dBuVolts)	Avg Limit (dBuV/m)	Margin (dB)	Peak Limit (dBuV/m)	PK Margin (dB)
1	18.806	40.33	Pk	32.3	-24.8	-9.5	38.333	54	-15.667	74	-35.667
2	20.505	40.83	Pk	33.1	-25.1	-9.5	39.333	54	-14.667	74	-34.667
3	23.982	42.4	Pk	33.9	-24.3	-9.5	42.5	54	-11.5	74	-31.5
4	19.612	40.8	Pk	32.7	-25	-9.5	39	54	-15	74	-35
5	24.028	43.03	Pk	33.9	-24.1	-9.5	43.333	54	-10.667	74	-30.667
6	25.087	44.37	Pk	34.3	-24.5	-9.5	44.667	54	-9.33	74	-29.33

## 9. AC POWER LINE CONDUCTED EMISSIONS

### LIMITS

FCC §15.207 (a)

Frequency of Emission (MHz)	Conducted Limit (dB $\mu$ V)	
	Quasi-peak	Average
0.15-0.5	66 to 56 *	56 to 46 *
0.5-5	56	46
5-30	60	50

\*Decreases with the logarithm of the frequency.

### TEST PROCEDURE

The EUT is placed on a non-conducting table 40 cm from the vertical ground plane and 80 cm above the horizontal ground plane. The EUT is configured in accordance with ANSI C63.10.

The receiver is set to a resolution bandwidth of 9 kHz. Peak detection is used unless otherwise noted as quasi-peak or average.

Line conducted data is recorded for both NEUTRAL and HOT lines.

### RESULTS

**LINE 1 RESULTS**

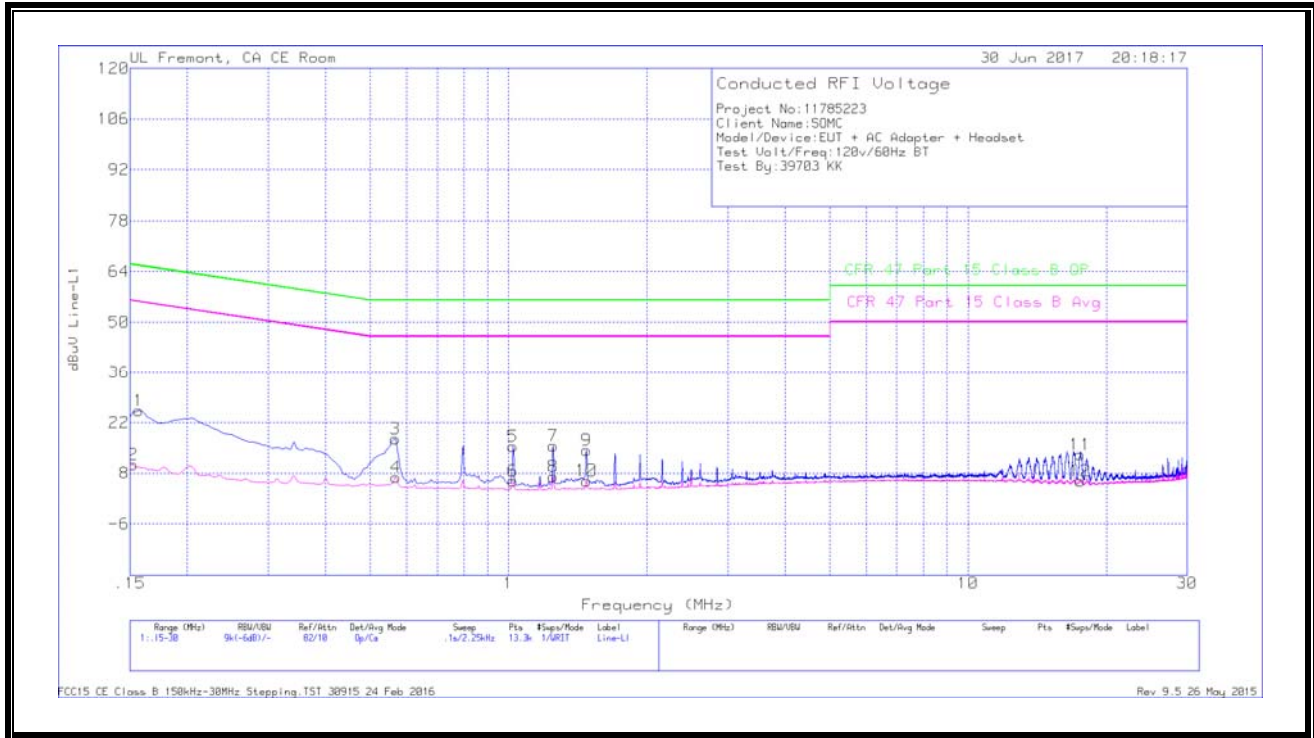

**WORST EMISSIONS**

Range 1: Line-L1 .15 - 30MHz

Marker	Frequency (MHz)	Meter Reading (dBuV)	Det	LISN L1	LC Cables C1&C3	Limiter (dB)	Corrected Reading dBuV	CFR 47 Part 15 Class B QP	QP Margin (dB)	CFR 47 Part 15 Class B Avg	Av(CISPR) Margin (dB)
1	.15675	15.08	Qp	.1	.1	10.1	25.38	65.63	-40.25	-	-
2	.15225	.06	Ca	.1	.1	10.1	10.36	-	-	55.88	-45.52
3	.56625	7.35	Qp	0	.1	10.1	17.55	56	-38.45	-	-
4	.5685	-3.38	Ca	0	.1	10.1	6.82	-	-	46	-39.18
5	1.023	5.15	Qp	0	.1	10.1	15.35	56	-40.65	-	-
6	1.023	-4.43	Ca	0	.1	10.1	5.77	-	-	46	-40.23
7	1.25025	5.33	Qp	0	.1	10.1	15.53	56	-40.47	-	-
8	1.25025	-3.19	Ca	0	.1	10.1	7.01	-	-	46	-38.99
9	1.4775	4.24	Qp	0	.1	10.1	14.44	56	-41.56	-	-
10	1.4775	-4.27	Ca	0	.1	10.1	5.93	-	-	46	-40.07
11	17.55825	2.58	Qp	0	.2	10.3	13.08	60	-46.92	-	-
12	17.55825	-4.73	Ca	0	.2	10.3	5.77	-	-	50	-44.23

Qp - Quasi-Peak detector

Ca - CISPR average detection

**LINE 2 RESULTS**

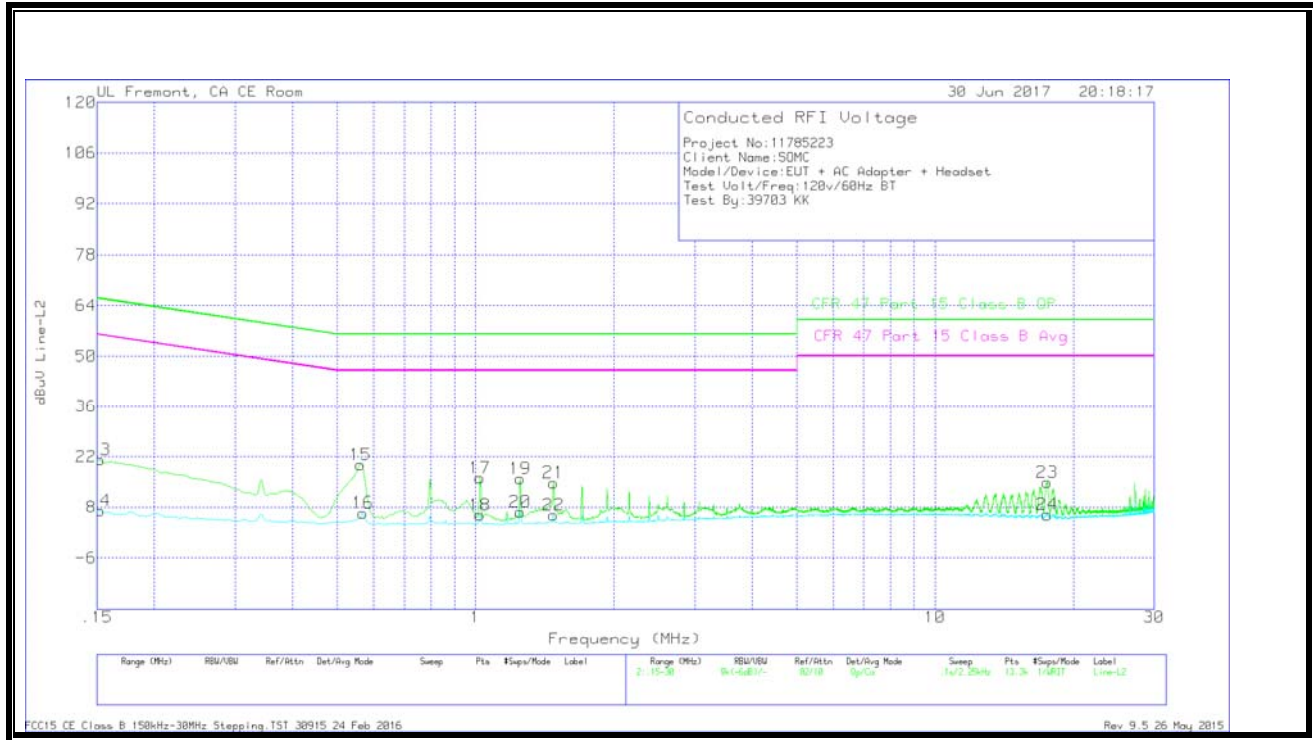

**WORST EMISSIONS**

Range 2: Line-L2 .15 - 30MHz

Marker	Frequency (MHz)	Meter Reading (dBuV)	Det	LISN L2	LC Cables C2&C3	Limiter (dB)	Corrected Reading dBuV	CFR 47 Part 15 Class B QP	QP Margin (dB)	CFR 47 Part 15 Class B Avg	Av(CISPR) Margin (dB)
13	.15225	11.01	Qp	0	0	10.1	21.11	65.88	-44.77	-	-
14	.15225	-3.03	Ca	0	0	10.1	7.07	-	-	55.88	-48.81
15	.56175	9.6	Qp	0	.1	10.1	19.8	56	-36.2	-	-
16	.5685	-3.75	Ca	0	.1	10.1	6.45	-	-	46	-39.55
17	1.023	5.89	Qp	0	.1	10.1	16.09	56	-39.91	-	-
18	1.023	-4.29	Ca	0	.1	10.1	5.91	-	-	46	-40.09
19	1.25025	5.7	Qp	0	.1	10.1	15.9	56	-40.1	-	-
20	1.25025	-3.42	Ca	0	.1	10.1	6.78	-	-	46	-39.22
21	1.4775	4.6	Qp	0	.1	10.1	14.8	56	-41.2	-	-
22	1.4775	-4.33	Ca	0	.1	10.1	5.87	-	-	46	-40.13
23	17.556	4.35	Qp	0	.2	10.3	14.85	60	-45.15	-	-
24	17.547	-4.56	Ca	0	.2	10.3	5.94	-	-	50	-44.06

Qp - Quasi-Peak detector

Ca - CISPR average detection