



FCC RADIO TEST REPORT

FCC ID : PY7-87261H
Equipment : GSM/WCDMA/LTE Phone with BT, DTS/UNII
a/b/g/n/ac/ax, GPS, WPC and NFC
Brand Name : Sony
Applicant : Sony Mobile Communications Inc.
4-12-3 Higashi-Shinagawa, Shinagawa-ku,
Tokyo, 140-0002, Japan
Manufacturer : Sony Mobile Communications Inc.
4-12-3 Higashi-Shinagawa, Shinagawa-ku,
Tokyo, 140-0002, Japan
Standard : 47 CFR Part 2, 22(H), 24(E)

The product was received on Dec. 04, 2019 and testing was started from Jan. 02, 2020 and completed on Jan. 24, 2020. We, SPORTON INTERNATIONAL INC. EMC & Wireless Communications Laboratory, would like to declare that the tested sample has been evaluated in accordance with the test procedures given in ANSI / TIA-603-E and has been in compliance with the applicable technical standards.

The report must not be used by the client to claim product certification, approval, or endorsement by TAF or any agency of government.

The test results in this report apply exclusively to the tested model / sample. Without written approval of SPORTON INTERNATIONAL INC. EMC & Wireless Communications Laboratory, the test report shall not be reproduced except in full.

Louis Wu

Approved by: Louis Wu

SPORTON INTERNATIONAL INC. EMC & Wireless Communications Laboratory

No. 52, Huaya 1st Rd., Guishan Dist., Taoyuan City, Taiwan (R.O.C.)



Table of Contents

History of this test report	3
Summary of Test Result	4
1 General Description.....	5
1.1 Product Feature of Equipment Under Test	5
1.2 Modification of EUT	5
1.3 Maximum ERP/EIRP Power, Frequency Tolerance, and Emission Designator	6
1.4 Testing Location	7
1.5 Applicable Standards	7
2 Test Configuration of Equipment Under Test.....	8
2.1 Test Mode	8
2.2 Connection Diagram of Test System	9
2.3 Support Unit used in test configuration	10
2.4 Measurement Results Explanation Example	10
2.5 Frequency List of Low/Middle/High Channels	11
3 Conducted Test Result.....	12
3.1 Measuring Instruments	12
3.2 Conducted Output Power and ERP/EIRP.....	13
3.3 Peak-to-Average Ratio.....	14
3.4 99% Occupied Bandwidth and 26dB Bandwidth Measurement	15
3.5 Conducted Band Edge	16
3.6 Conducted Spurious Emission.....	17
3.7 Frequency Stability.....	18
4 Radiated Test Items	19
4.1 Measuring Instruments	19
4.2 Test Setup	19
4.3 Test Result of Radiated Test	19
4.4 Field Strength of Spurious Radiation Measurement	20
5 List of Measuring Equipment	21
6 Uncertainty of Evaluation.....	23
Appendix A. Test Results of Conducted Test	
Appendix B. Test Results of ERP/EIRP and Radiated Test	



History of this test report

Report No.	Version	Description	Issued Date
FG901542-02A	01	Initial issue of report	Feb. 04, 2020



Summary of Test Result

Report Clause	Ref Std. Clause	Test Items	Result (PASS/FAIL)	Remark
3.2	§2.1046	Conducted Output Power	Pass	-
	§22.913 (a)(2)	Effective Radiated Power (GSM850) (WCDMA Band V)		
	§24.232 (c)	Equivalent Isotropic Radiated Power (GSM1900)		
3.3	§24.232 (d)	Peak-to-Average Ratio	Pass	
3.4	§2.1049 §22.917 (b) §24.238 (b)	Occupied Bandwidth (GSM850) (WCDMA Band V) (GSM1900)	Pass	-
3.5	§2.1051 §22.917 (a) §24.238 (a)	Band Edge Measurement (GSM850) (WCDMA Band V) (GSM1900)	Pass	-
3.6	§2.1051 §22.917 (a) §24.238 (a)	Conducted Emission (GSM850) (WCDMA Band V) (GSM1900)	Pass	-
3.7	§2.1055 §22.355 §24.235	Frequency Stability Temperature & Voltage	Pass	-
4.4	§2.1053 §22.917 (a) §24.238 (a)	Field Strength of Spurious Radiation (GSM850) (WCDMA Band V) (GSM1900)	Pass	Under limit 24.25 dB at 2544.000 MHz

Declaration of Conformity:

The test results with all measurement uncertainty excluded are presented in accordance with the regulation limits or requirements declared by manufacturers.

Comments and Explanations:

The declared of product specification for EUT presented in the report are provided by the manufacturer, and the manufacturer takes all the responsibilities for the accuracy of product specification.

Reviewed by: Wii Chang

Report Producer: Ann Lee



1 General Description

1.1 Product Feature of Equipment Under Test

GSM/WCDMA/LTE, Bluetooth, DTS/UNII a/b/g/n/ac/ax, NFC, GNSS and WPC.

Product Specification subjective to this standard	
Antenna Type	Loop Antenna

EUT Information List			
HW Version	SW Version	S/N	Performed Test Item
A	2.38	QV7100PG2A	Conducted Measurement
		QV7100A92A	Radiated Spurious Emission
			ERP/EIRP Test

Accessory List	
AC Adapter	Model Name : UCH32
	S/N: 6218W30200140
Earphone	Model Name.: STH40D
	S/N : N/A
USB Cable	Model Name.: UCB24
	S/N : N/A
Audio Cable	Model Name : EC234
	S/N : N/A

Note:

1. Above EUT list used are electrically identical per declared by manufacturer.
2. Above the accessories list are used to exercise the EUT during test, and the serial number of each type of accessories is listed in each section of this report. .
3. For other wireless features of this EUT, test report will be issued separately.

1.2 Modification of EUT

No modifications are made to the EUT during all test items.



1.3 Maximum ERP/EIRP Power, Frequency Tolerance, and Emission Designator

FCC Rule	Frequency Range (MHz)	System	Type of Modulation	Maximum ERP/EIRP (W)	Frequency Tolerance (ppm)	Emission Designator
Part 22	824.2 ~848.8	GSM850 GPRS class 8	GMSK	0.2698	0.0801 ppm	250KGXW
Part 22	824.2 ~848.8	GSM850 EDGE class 8	8PSK	0.0695	0.0179 ppm	245KG7W
Part 22	826.4 ~846.6	WCDMA Band V RMC 12.2Kbps	BPSK	0.0393	0.0072 ppm	4M16F9W
Part 24	1850.2 ~1909.8	GSM1900 GPRS class 8	GMSK	0.3236	0.0122 ppm	244KGXW
Part 24	1850.2 ~1909.8	GSM1900 EDGE class 8	8PSK	0.2163	0.0356 ppm	249KG7W



1.4 Testing Location

Test Site	SPORTON INTERNATIONAL INC. EMC & Wireless Communications Laboratory
Test Site Location	No.52, Huaya 1st Rd., Guishan Dist., Taoyuan City, Taiwan (R.O.C.) TEL: +886-3-327-3456 FAX: +886-3-328-4978
Test Site No.	Sporton Site No. TH03-HY
Test Engineer	Louis Chung
Temperature	21~24 °C
Relative Humidity	51~55 %

Note: The test site complies with ANSI C63.4 2014 requirement.

Test Site	SPORTON INTERNATIONAL INC. EMC & Wireless Communications Laboratory
Test Site Location	No.58, Aly. 75, Ln. 564, Wenhua 3rd, Rd., Guishan Dist., Taoyuan City, Taiwan (R.O.C.) TEL: +886-3-327-0868 FAX: +886-3-327-0855
Test Site No.	Sporton Site No. 03CH12-HY
Test Engineer	Jack Cheng, Lance Chiang, and Chuan Chu
Temperature	22~26 °C
Relative Humidity	52~62 %

Note: The test site complies with ANSI C63.4 2014 requirement.

FCC Designation No.: TW1190 and TW0007

1.5 Applicable Standards

According to the specifications of the manufacturer, the EUT must comply with the requirements of the following standards:

- ♦ ANSI C63.26-2015
- ♦ ANSI / TIA-603-E
- ♦ 47 CFR Part 2, 22(H), 24(E)
- ♦ FCC KDB 971168 D01 Power Meas. License Digital Systems v03r01
- ♦ FCC KDB 412172 D01 Determining ERP and EIRP v01r01

Remark:

1. All test items were verified and recorded according to the standards and without any deviation during the test.
2. This EUT has also been tested and complied with the requirements of FCC Part 15, Subpart B, recorded in a separate test report.



2 Test Configuration of Equipment Under Test

2.1 Test Mode

Antenna port conducted and radiated test items were performed according to KDB 971168 D01 Power Meas. License Digital Systems v03r01 with maximum output power.

For radiated measurement, pre-scanned in three orthogonal panels, X, Y, Z. The worst cases (X plane) were recorded in this report.

Radiated emissions were investigated as following frequency range:

1. 30 MHz to 9000 MHz for GSM850 and WCDMA Band V
2. 30 MHz to 19100 MHz for GSM1900

All modes and data rates and positions were investigated.

Test modes are chosen to be reported as the worst case configuration below:

Test Modes		
Band	Radiated TCs	Conducted TCs
GSM850	<ul style="list-style-type: none">■ GPRS Class 8 Link■ EDGE Class 8 Link	<ul style="list-style-type: none">■ GPRS Class 8 Link■ EDGE Class 8 Link
GSM1900	<ul style="list-style-type: none">■ GPRS Class 8 Link■ EDGE Class 8 Link	<ul style="list-style-type: none">■ GPRS Class 8 Link■ EDGE Class 8 Link
WCDMA Band V	<ul style="list-style-type: none">■ RMC 12.2Kbps Link	<ul style="list-style-type: none">■ RMC 12.2Kbps Link

2.2 Connection Diagram of Test System

<EUT with Accessory>

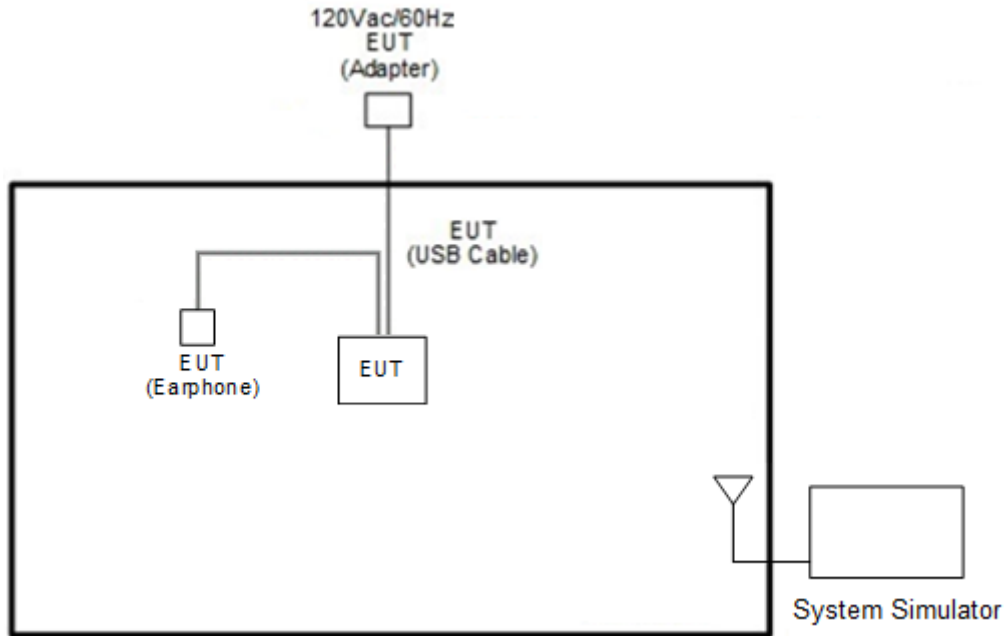

<EUT without Accessory>



<WPC Mode>

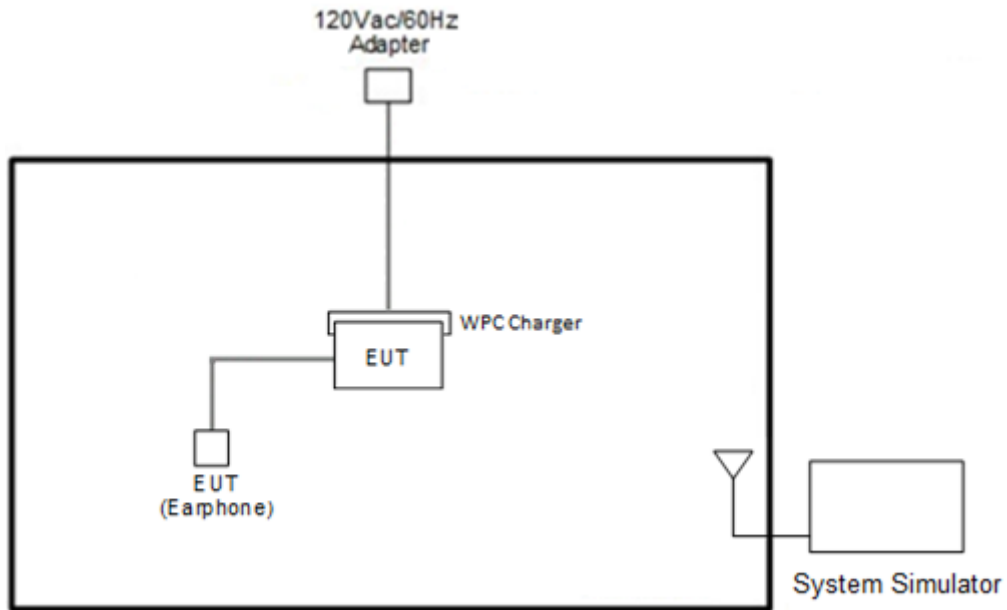

2.3 Support Unit used in test configuration

Item	Equipment	Trade Name	Model No.	FCC ID	Data Cable	Power Cord
1.	System Simulator	R&S	CMU 200	N/A	N/A	Unshielded, 1.8 m
2.	Wireless charging pad	belkin	F7U050	FCC DoC	N/A	Unshielded, 1.2m

2.4 Measurement Results Explanation Example

For all conducted test items:

The offset level is set in the spectrum analyzer to compensate the RF cable loss and attenuator factor between RF conducted output port and spectrum analyzer. With the offset compensation, the spectrum analyzer reading level will be exactly the RF output level.

The spectrum analyzer offset is derived from RF cable loss and attenuator factor.

Offset = RF cable loss + attenuator factor.

The following shows an offset computation example with RF cable loss 4.2 dB and a 10dB attenuator.

Example:

$$\begin{aligned}
 \text{Offset}(dB) &= \text{RF cable loss}(dB) + \text{attenuator factor}(dB). \\
 &= 4.2 + 10 = 14.2 \text{ (dB)}
 \end{aligned}$$



2.5 Frequency List of Low/Middle/High Channels

Frequency List				
Band	Channel/Frequency(MHz)	Lowest	Middle	Highest
GSM850	Channel	128	189	251
	Frequency	824.2	836.4	848.8
WCDMA Band V	Channel	4132	4182	4233
	Frequency	826.4	836.4	846.6
GSM1900	Channel	512	661	810
	Frequency	1850.2	1880.0	1909.8

3 Conducted Test Result

3.1 Measuring Instruments

See list of measuring instruments of this test report.

3.1.1 Test Setup

3.1.2 Conducted Output Power

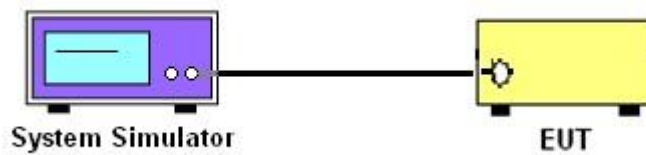

3.1.3 Peak-to-Average Ratio, Occupied Bandwidth, Conducted Band-Edge and Conducted Spurious Emission

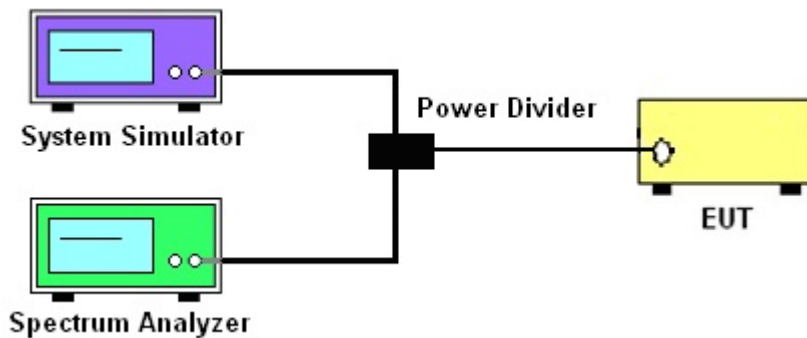

3.1.4 Frequency Stability

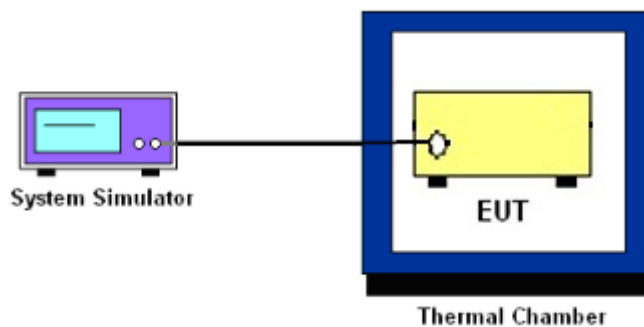

3.1.5 Test Result of Conducted Test

Please refer to Appendix A.



3.2 Conducted Output Power and ERP/EIRP

3.2.1 Description of the Conducted Output Power and ERP/EIRP

A system simulator was used to establish communication with the EUT. Its parameters were set to enforce EUT transmitting at the maximum power. The measured power in the radio frequency on the transmitter output terminals shall be reported.

The ERP of mobile transmitters must not exceed 7 Watts for GSM850 and WCDMA Band V

The EIRP of mobile transmitters must not exceed 2 Watts for GSM1900

According to KDB 412172 D01 Power Approach,

$EIRP = P_T + G_T - L_C$, $ERP = EIRP - 2.15$, where

P_T = transmitter output power in dBm

G_T = gain of the transmitting antenna in dBi

L_C = signal attenuation in the connecting cable between the transmitter and antenna in dB

3.2.2 Test Procedures

1. The transmitter output port was connected to the system simulator.
2. Set EUT at maximum power through system simulator.
3. Select lowest, middle, and highest channels for each band and different modulation.
4. Measure the maximum burst average power for GSM and maximum average power for other modulation signal.



3.3 Peak-to-Average Ratio

3.3.1 Description of the PAR Measurement

The peak-to-average ratio (PAR) of the transmission may not exceed 13 dB.

3.3.2 Test Procedures

The testing follows ANSI C63.26-2015 Section 5.2.6

1. The EUT was connected to spectrum analyzer and system simulator via a power divider.
2. Set EUT to transmit at maximum output power.
3. When the duty cycle is less than 98%, then signal gating will be implemented on the spectrum analyzer by triggering from the system simulator.
4. Set the CCDF (Complementary Cumulative Distribution Function) option of the spectrum analyzer.
5. Record the maximum PAPR level associated with a probability of 0.1%.



3.4 99% Occupied Bandwidth and 26dB Bandwidth Measurement

3.4.1 Description of 99% Occupied Bandwidth and 26dB Bandwidth Measurement

The occupied bandwidth is the width of a frequency band such that, below the lower and above the upper frequency limits, the mean powers emitted are each equal to a specified percentage 0.5% of the total mean transmitted power.

The 26 dB emission bandwidth is defined as the frequency range between two points, one above and one below the carrier frequency, at which the spectral density of the emission is attenuated 26 dB below the maximum in-band spectral density of the modulated signal. Spectral density (power per unit bandwidth) is to be measured with a detector of resolution bandwidth equal to approximately 1.0% of the emission bandwidth.

3.4.2 Test Procedures

The testing follows ANSI C63.26-2015 Section 5.4.3 (26dB) and Section 5.4.4 (99OB)

1. The EUT was connected to spectrum analyzer and system simulator via a power divider.
2. The spectrum analyzer center frequency is set to the nominal EUT channel center frequency. The span range for the spectrum analyzer shall be between two and five times the anticipated OBW.
3. The nominal resolution bandwidth (RBW) shall be in the range of 1 to 5 % of the anticipated OBW, and the VBW shall be at least 3 times the RBW.
4. Set the detection mode to peak, and the trace mode to max hold.
5. Determine the reference value: Set the EUT to transmit a modulated signal. Allow the trace to stabilize. Set the spectrum analyzer marker to the highest level of the displayed trace.
(this is the reference value)
6. Determine the “-26 dB down amplitude” as equal to (Reference Value – X).
7. Place two markers, one at the lowest and the other at the highest frequency of the envelope of the spectral display such that each marker is at or slightly below the “-X dB down amplitude” determined in step 6. If a marker is below this “-X dB down amplitude” value it shall be placed as close as possible to this value. The OBW is the positive frequency difference between the two markers.
8. Use the 99 % power bandwidth function of the spectrum analyzer and report the measured bandwidth.



3.5 Conducted Band Edge

3.5.1 Description of Conducted Band Edge Measurement

The power of any emission outside of the authorized operating frequency ranges must be lower than the transmitter power (P) by a factor of at least $43 + 10 \log (P)$ dB.

3.5.2 Test Procedures

The testing follows FCC KDB 971168 D01 v03r01 Section 6.1.

1. The EUT was connected to the spectrum analyzer and system simulator via a power divider.
2. The RF output of EUT was connected to the spectrum analyzer by an RF cable and attenuator. The path loss was compensated to the results for each measurement.
3. The band edges of low and high channels for the highest RF powers were measured.
4. The RF fundamental frequency should be excluded against the limit line in the operating frequency band.
5. The limit line is derived from $43 + 10\log(P)$ dB below the transmitter power P(Watts)



3.6 Conducted Spurious Emission

3.6.1 Description of Conducted Spurious Emission Measurement

The power of any emission outside of the authorized operating frequency ranges must be lower than the transmitter power (P) by a factor of at least $43 + 10 \log (P)$ dB.

It is measured by means of a calibrated spectrum analyzer and scanned from 30 MHz up to a frequency including its 10th harmonic.

3.6.2 Test Procedures

The testing follows FCC KDB 971168 D01 v03r01 Section 6.1.

1. The EUT was connected to the spectrum analyzer and system simulator via a power divider.
2. The RF output of EUT was connected to the spectrum analyzer by an RF cable and attenuator. The path loss was compensated to the results for each measurement.
3. The middle channel for the highest RF power within the transmitting frequency was measured.
4. The conducted spurious emission for the whole frequency range was taken.
5. The RF fundamental frequency should be excluded against the limit line in the operating frequency band.
6. The limit line is derived from $43 + 10\log(P)$ dB below the transmitter power P(Watts)



3.7 Frequency Stability

3.7.1 Description of Frequency Stability Measurement

22.355

The frequency stability shall be measured by variation of ambient temperature and variation of primary supply voltage to ensure that the fundamental emission stays within the authorized frequency block. The frequency stability of the transmitter shall be maintained within $\pm 0.00025\%$ ($\pm 2.5\text{ppm}$) of the center frequency.

24.235

The frequency stability shall be sufficient to ensure that the fundamental emission stays within the authorized frequency block.

3.7.2 Test Procedures for Temperature Variation

The testing follows FCC KDB 971168 D01 v03r01 Section 9.0.

1. The EUT was set up in the thermal chamber and connected with the system simulator.
2. With power OFF, the temperature was decreased to -30°C and the EUT was stabilized before testing. Power was applied and the maximum change in frequency was recorded within one minute.
3. With power OFF, the temperature was raised in 10°C steps up to 50°C . The EUT was stabilized at each step for at least half an hour. Power was applied and the maximum frequency change was recorded within one minute.

3.7.3 Test Procedures for Voltage Variation

The testing follows FCC KDB 971168 D01 v03r01 Section 9.0.

1. The EUT was placed in a temperature chamber at $20\pm 5^{\circ}\text{C}$ and connected with the system simulator.
2. The power supply voltage to the EUT was varied from 85% to 115% of the nominal value measured at the input to the EUT.
3. The variation in frequency was measured for the worst case.

4 Radiated Test Items

4.1 Measuring Instruments

See list of measuring instruments of this test report.

4.2 Test Setup

For radiated test from 30MHz to 1GHz

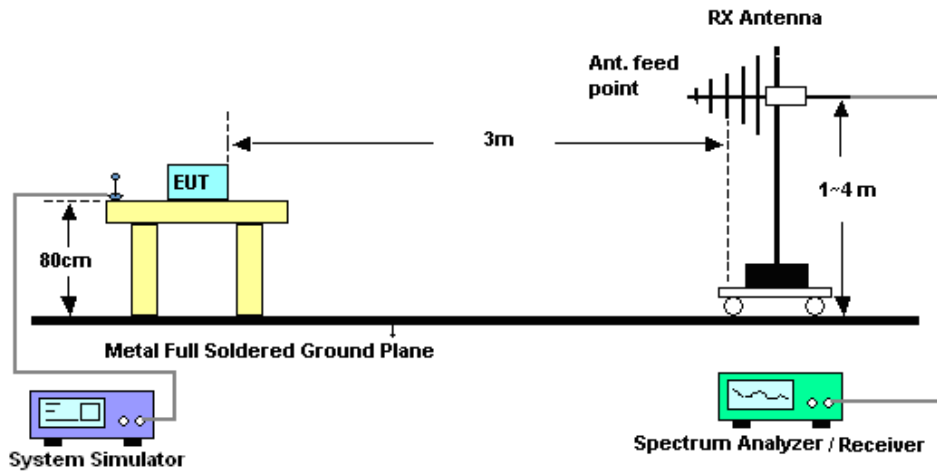

For radiated test above 1GHz

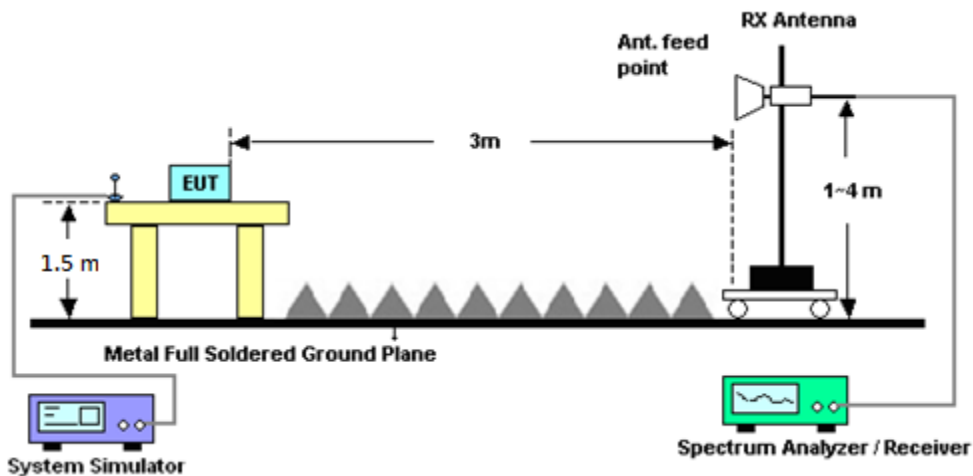

4.3 Test Result of Radiated Test

Please refer to Appendix B.



4.4 Field Strength of Spurious Radiation Measurement

4.4.1 Description of Field Strength of Spurious Radiated Measurement

The power of any emission outside of the authorized operating frequency ranges must be attenuated below the transmitter power (P) by a factor of at least $43 + 10 \log (P)$ dB. The spectrum is scanned from 30 MHz up to a frequency including its 10th harmonic.

4.4.2 Test Procedures

The testing follows FCC KDB 971168 D01 v03r01 Section 7 and ANSI / TIA-603-E Section 2.2.12.

1. The EUT was placed on a rotatable wooden table 0.8 meters for frequency below 1GHz and 1.5 meter for frequency above 1GHz above the ground.
2. The EUT was set 3 meters from the receiving antenna, which was mounted on the antenna tower.
3. The table was rotated 360 degrees to determine the position of the highest spurious emission.
4. The height of the receiving antenna is varied between one meter and four meters to search for the maximum spurious emission for both horizontal and vertical polarizations.
5. Make the measurement with the spectrum analyzer's RBW = 1MHz, VBW = 3MHz, taking record of maximum spurious emission.
6. A horn antenna was substituted in place of the EUT and was driven by a signal generator.
7. Tune the output power of signal generator to the same emission level with EUT maximum spurious emission.
8. Taking the record of output power at antenna port.
9. Repeat step 7 to step 8 for another polarization.
10. $EIRP \text{ (dBm)} = S.G. \text{ Power} - Tx \text{ Cable Loss} + Tx \text{ Antenna Gain}$
 $ERP \text{ (dBm)} = EIRP - 2.15$
11. The RF fundamental frequency should be excluded against the limit line in the operating frequency band.
12. The limit line is derived from $43 + 10\log(P)$ dB below the transmitter power P(Watts)



5 List of Measuring Equipment

Instrument	Manufacturer	Model No.	Serial No.	Characteristics	Calibration Date	Test Date	Due Date	Remark
Loop Antenna	Rohde & Schwarz	HFH2-Z2	100315	9 kHz~30 MHz	Dec. 26, 2019	Jan. 18, 2020~ Jan. 24, 2020	Dec. 25, 2020	Radiation (03CH12-HY)
Bilog Antenna	TESEQ	CBL 6111D & 00800N1D01N -06	41912 & 05	30MHz~1GHz	Feb. 12, 2019	Jan. 18, 2020~ Jan. 24, 2020	Feb 11, 2020	Radiation (03CH12-HY)
Horn Antenna	SCHWARZBE CK	BBHA 9120D	9120D-1328	1GHz ~ 18GHz	Nov. 14, 2019	Jan. 18, 2020~ Jan. 24, 2020	Nov. 13, 2020	Radiation (03CH12-HY)
Horn Antenna	SCHWARZBE CK	BBHA 9120D	9120D-1522	1GHz ~ 18GHz	Sep. 19, 2019	Jan. 18, 2020~ Jan. 24, 2020	Sep. 18, 2020	Radiation (03CH12-HY)
SHF-EHF Horn Antenna	SCHWARZBE CK	BBHA 9170	BBHA917058 4	18GHz ~ 40GHz	Dec. 10, 2019	Jan. 18, 2020~ Jan. 24, 2020	Dec. 09, 2020	Radiation (03CH12-HY)
SHF-EHF Horn Antenna	SCHWARZBE CK	BBHA 9170	BBHA917025 1	18GHz- 40GHz	Nov. 26, 2019	Jan. 18, 2020~ Jan. 24, 2020	Nov. 25, 2020	Radiation (03CH12-HY)
Preamplifier	COM-POWER	PA-103	161075	10MHz~1GHz	Mar. 25, 2019	Jan. 18, 2020~ Jan. 24, 2020	Mar. 24, 2020	Radiation (03CH12-HY)
Preamplifier	Jet-Power	JPA00101800- 30-10P	1601180002	1GHz~18GHz	Aug. 01, 2019	Jan. 18, 2020~ Jan. 24, 2020	Jul. 01, 2020	Radiation (03CH12-HY)
Preamplifier	EMEC	EM18G40G	060715	18GHz ~ 40GHz	Dec. 13, 2019	Jan. 18, 2020~ Jan. 24, 2020	Dec. 12, 2020	Radiation (03CH12-HY)
Preamplifier	Agilent	8449B	3008A02375	1GHz~26.5GHz	May 27, 2019	Jan. 18, 2020~ Jan. 24, 2020	May 26, 2020	Radiation (03CH12-HY)
EMI Test Receiver	Agilent	N9038A(MXE)	MY53290045	20MHz~8.4GHz	Jan. 18, 2020	Jan. 18, 2020~ Jan. 24, 2020	Jan. 17, 2021	Radiation (03CH12-HY)
Spectrum Analyzer	Keysight	N9010A	MY55370526	10Hz~44GHz	Mar. 19, 2019	Jan. 18, 2020~ Jan. 24, 2020	Mar. 18, 2020	Radiation (03CH12-HY)
Signal Generator	Rohde & Schwarz	SMB100A	101107	100kHz~40GHz	Aug. 27, 2019	Jan. 18, 2020~ Jan. 24, 2020	Aug. 26, 2020	Radiation (03CH12-HY)
Hygrometer	TECEPEL	DTM-303B	TP161243	N/A	May 11, 2019	Jan. 18, 2020~ Jan. 24, 2020	May 10, 2020	Radiation (03CH12-HY)
Notch Filter	Wainwright	WRCG1710/1 755-1690/1775 -45/7SS	SN2	AWS Band	Nov. 05, 2019	Jan. 18, 2020~ Jan. 24, 2020	Nov. 04, 2020	Radiation (03CH12-HY)
Filter	Wainwright	WLKS1200-12 SS	SN2	1.2GHz Low Pass	Mar. 22, 2019	Jan. 18, 2020~ Jan. 24, 2020	Mar. 21, 2020	Radiation (03CH12-HY)
Filter	Wainwright	WHKX12-1080 -1200-1500-60 ST	SN1	1.2G High Pass	Mar. 19, 2019	Jan. 18, 2020~ Jan. 24, 2020	Mar. 18, 2020	Radiation (03CH12-HY)
Filter	Wainwright	WHKX12-2700 -3000-18000-6 0ST	SN2	3G High Pass	Jul. 15, 2019	Jan. 18, 2020~ Jan. 24, 2020	Jul. 14, 2020	Radiation (03CH12-HY)
Filter	Wainwright	WHKX12-2700 -3000-18000-6 0ST	SN2	3G High Pass	Jul. 15, 2019	Jan. 18, 2020~ Jan. 24, 2020	Jul. 14, 2020	Radiation (03CH12-HY)
RF Cable	HUBER + SUHNER	SUCOFLEX 126E	0058/126E	30M-18G	Mar. 13, 2019	Jan. 18, 2020~ Jan. 24, 2020	Mar. 12, 2020	Radiation (03CH12-HY)
RF Cable	HUBER + SUHNER	SUCOFLEX 102	505134/2	30M~40GHz	Feb. 26, 2019	Jan. 18, 2020~ Jan. 24, 2020	Feb. 25, 2020	Radiation (03CH12-HY)
RF Cable	HUBER + SUHNER	SUCOFLEX 102	800740/2	30M~40GHz	Feb. 26, 2019	Jan. 18, 2020~ Jan. 24, 2020	Feb. 25, 2020	Radiation (03CH12-HY)
Controller	EMEC	EM1000	N/A	Control Turn table & Ant Mast	N/A	Jan. 18, 2020~ Jan. 24, 2020	N/A	Radiation (03CH12-HY)
Antenna Mast	EMEC	AM-BS-4500-B	N/A	1m~4m	N/A	Jan. 18, 2020~ Jan. 24, 2020	N/A	Radiation (03CH12-HY)
Turn Table	EMEC	TT2000	N/A	0~360 Degree	N/A	Jan. 18, 2020~ Jan. 24, 2020	N/A	Radiation (03CH12-HY)
Software	Audix	E3 6.2009-8-24	RK-000989	N/A	N/A	Jan. 18, 2020~ Jan. 24, 2020	N/A	Radiation (03CH12-HY)



Instrument	Manufacturer	Model No.	Serial No.	Characteristics	Calibration Date	Test Date	Due Date	Remark
Hygrometer	Testo	608-H1	34893241	N/A	Mar. 06, 2019	Jan. 02, 2020~ Jan. 03, 2020	Mar. 05, 2020	Conducted (TH03-HY)
Spectrum Analyzer	Rohde & Schwarz	FSP30	101329	9kHz~30GHz	Sep. 04, 2019	Jan. 02, 2020~ Jan. 03, 2020	Sep. 03, 2020	Conducted (TH03-HY)
Temperature Chamber	ESPEC	SU-641	92013721	-30℃ ~70℃	Nov. 26, 2019	Jan. 02, 2020~ Jan. 03, 2020	Nov. 25, 2020	Conducted (TH03-HY)
Programmable Power Supply	GW Instek	PSS-2005	EL890001	1V~20V 0.5A~4A	Oct. 09, 2019	Jan. 02, 2020~ Jan. 03, 2020	Oct. 08, 2020	Conducted (TH03-HY)
Base Station (Measure)	Rohde & Schwarz	CMU200	117995	GSM / GPRS / WCDMA / CDMA	Aug. 23, 2019	Jan. 02, 2020~ Jan. 03, 2020	Aug. 22, 2020	Conducted (TH03-HY)
Power Divider	Warison	WCOU-0.4-26. 5S-20	#A	N/A	Nov. 06, 2019	Jan. 02, 2020~ Jan. 03, 2020	Nov. 05, 2020	Conducted (TH03-HY)



6 Uncertainty of Evaluation

Uncertainty of Radiated Emission Measurement (30 MHz ~ 1000 MHz)

Measuring Uncertainty for a Level of Confidence of 95% ($U = 2Uc(y)$)	3.24
---	------

Uncertainty of Radiated Emission Measurement (1 GHz ~ 18 GHz)

Measuring Uncertainty for a Level of Confidence of 95% ($U = 2Uc(y)$)	3.62
---	------

Uncertainty of Radiated Emission Measurement (18 GHz ~ 40 GHz)

Measuring Uncertainty for a Level of Confidence of 95% ($U = 2Uc(y)$)	4.06
---	------



Appendix A. Test Results of Conducted Test

Conducted Output Power(Average power)

Conducted Power (*Unit: dBm)						
Band	GSM850			GSM1900		
Channel	128	189	251	512	661	810
Frequency	824.2	836.4	848.8	1850.2	1880	1909.8
GSM	32.62	32.75	32.63	27.42	27.85	27.81
GPRS class 8	32.64	32.77	32.64	27.43	27.89	27.84
GPRS class 10	30.78	30.81	30.56	25.47	25.77	25.72
GPRS class 11	28.52	28.70	28.46	23.35	23.79	23.79
GPRS class 12	27.50	27.65	27.56	22.34	22.75	22.71
EGPRS class 8	26.88	26.64	26.63	25.41	26.10	26.14
EGPRS class 10	25.09	25.17	25.02	23.78	24.15	24.29
EGPRS class 11	23.30	23.15	23.05	21.80	22.14	22.22
EGPRS class 12	22.11	22.19	22.00	20.78	21.40	21.37

Conducted Power (*Unit: dBm)			
Band	WCDMA Band V		
Channel	4132	4182	4233
Frequency	826.4	836.4	846.6
RMC 12.2K	24.40	24.33	24.27
HSDPA Subtest-1	23.50	23.43	23.38
HSDPA Subtest-2	23.53	23.49	23.36
HSDPA Subtest-3	23.01	22.61	22.55
HSDPA Subtest-4	23.02	22.95	22.89
HSUPA Subtest-1	23.47	23.49	23.37
HSUPA Subtest-2	21.54	21.46	21.18
HSUPA Subtest-3	22.53	22.40	22.37
HSUPA Subtest-4	21.54	21.49	21.37
HSUPA Subtest-5	23.50	23.40	23.40



A2. GSM

Peak-to-Average Ratio

Mode	GSM850		Limit: 13dB
Mod.	GPRS class 8	EDGE class 8	Result
Lowest CH	0.28	3.24	PASS
Middle CH	0.28	3.36	
Highest CH	0.28	3.28	

Mode	GSM1900		Limit: 13dB
Mod.	GPRS class 8	EDGE class 8	Result
Lowest CH	0.40	3.48	PASS
Middle CH	0.40	3.40	
Highest CH	0.40	3.20	

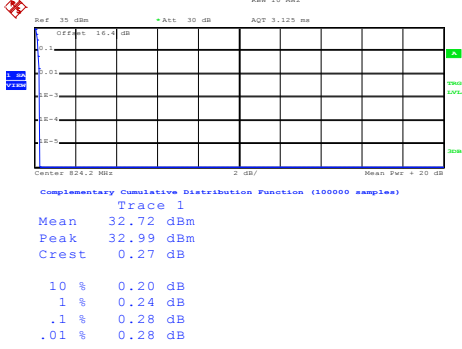
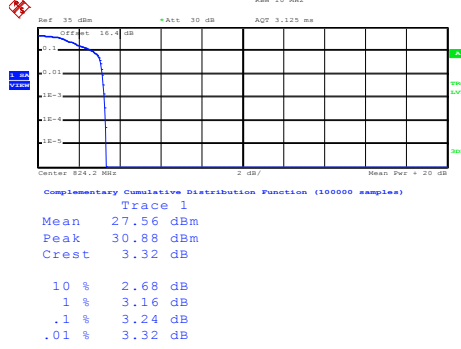
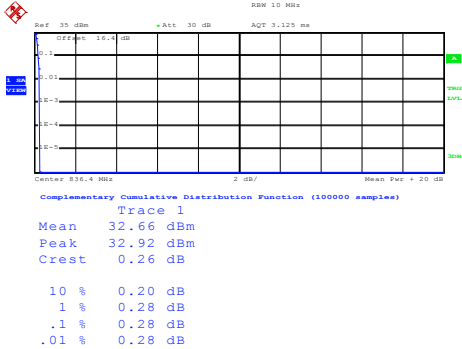
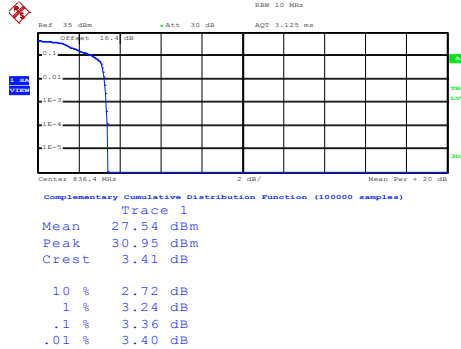
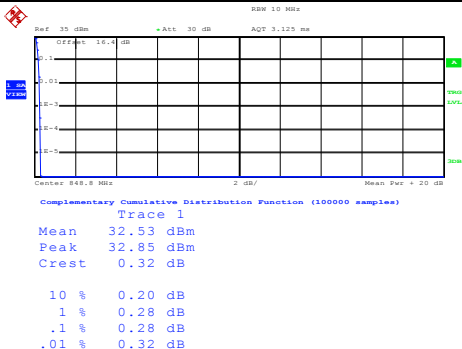
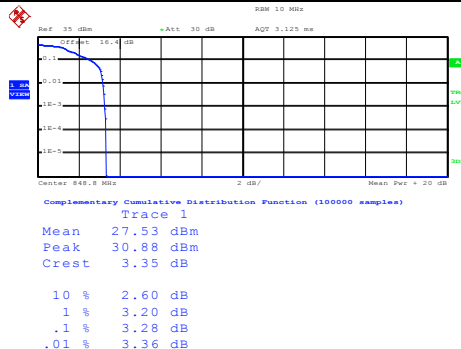

GSM850 (GPRS class 8)	GSM850 (EDGE class 8)
<p align="center">Lowest Channel</p>  <p align="center">Date: 2.JAN.2020 17:28:42</p>	<p align="center">Lowest Channel</p>  <p align="center">Date: 30.DEC.2019 17:53:49</p>
<p align="center">Middle Channel</p>  <p align="center">Date: 2.JAN.2020 17:28:59</p>	<p align="center">Middle Channel</p>  <p align="center">Date: 30.DEC.2019 17:54:03</p>
<p align="center">Highest Channel</p>  <p align="center">Date: 2.JAN.2020 17:29:14</p>	<p align="center">Highest Channel</p>  <p align="center">Date: 30.DEC.2019 17:54:15</p>

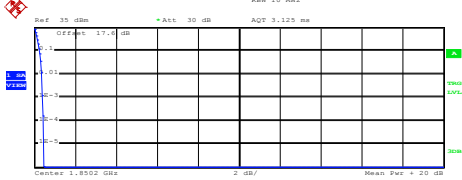
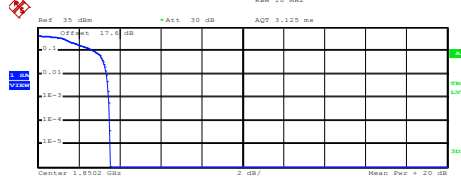
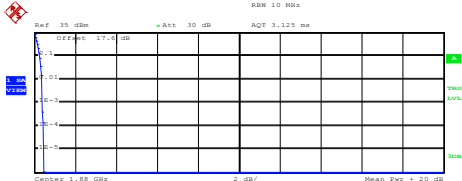
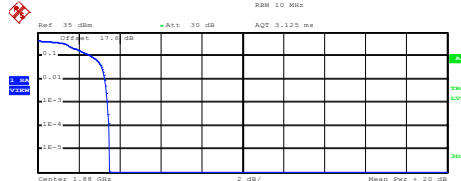
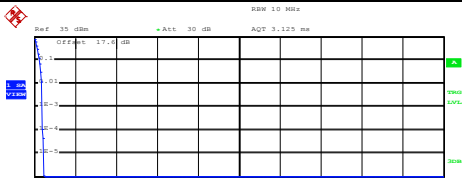
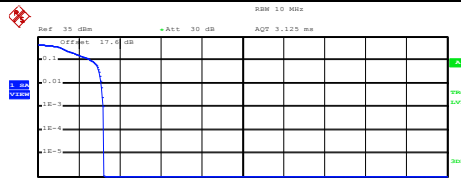

GSM1900 (GPRS class 8)	GSM1900 (EDGE class 8)																
<p align="center">Lowest Channel</p>  <p>Center 1.8502 GHz 2 dB/ Mean Pwr = 20 dB</p> <p>Complementary Cumulative Distribution Function (100000 samples) Trace 1 Mean 27.12 dBm Peak 27.56 dBm Crest 0.45 dB</p> <table border="1"> <tr><td>10 %</td><td>0.28 dB</td></tr> <tr><td>1 %</td><td>0.36 dB</td></tr> <tr><td>.1 %</td><td>0.40 dB</td></tr> <tr><td>.01 %</td><td>0.44 dB</td></tr> </table> <p>Date: 2.JAN.2020 17:16:27</p>	10 %	0.28 dB	1 %	0.36 dB	.1 %	0.40 dB	.01 %	0.44 dB	<p align="center">Lowest Channel</p>  <p>Center 1.8502 GHz 2 dB/ Mean Pwr = 20 dB</p> <p>Complementary Cumulative Distribution Function (100000 samples) Trace 1 Mean 25.67 dBm Peak 29.18 dBm Crest 3.52 dB</p> <table border="1"> <tr><td>10 %</td><td>2.76 dB</td></tr> <tr><td>1 %</td><td>3.36 dB</td></tr> <tr><td>.1 %</td><td>3.48 dB</td></tr> <tr><td>.01 %</td><td>3.52 dB</td></tr> </table> <p>Date: 30.DEC.2019 17:42:15</p>	10 %	2.76 dB	1 %	3.36 dB	.1 %	3.48 dB	.01 %	3.52 dB
10 %	0.28 dB																
1 %	0.36 dB																
.1 %	0.40 dB																
.01 %	0.44 dB																
10 %	2.76 dB																
1 %	3.36 dB																
.1 %	3.48 dB																
.01 %	3.52 dB																
<p align="center">Middle Channel</p>  <p>Center 1.85 GHz 2 dB/ Mean Pwr = 20 dB</p> <p>Complementary Cumulative Distribution Function (100000 samples) Trace 1 Mean 27.38 dBm Peak 27.84 dBm Crest 0.46 dB</p> <table border="1"> <tr><td>10 %</td><td>0.28 dB</td></tr> <tr><td>1 %</td><td>0.36 dB</td></tr> <tr><td>.1 %</td><td>0.40 dB</td></tr> <tr><td>.01 %</td><td>0.44 dB</td></tr> </table> <p>Date: 2.JAN.2020 17:16:44</p>	10 %	0.28 dB	1 %	0.36 dB	.1 %	0.40 dB	.01 %	0.44 dB	<p align="center">Middle Channel</p>  <p>Center 1.85 GHz 2 dB/ Mean Pwr = 20 dB</p> <p>Complementary Cumulative Distribution Function (100000 samples) Trace 1 Mean 25.89 dBm Peak 29.40 dBm Crest 3.51 dB</p> <table border="1"> <tr><td>10 %</td><td>2.64 dB</td></tr> <tr><td>1 %</td><td>3.28 dB</td></tr> <tr><td>.1 %</td><td>3.40 dB</td></tr> <tr><td>.01 %</td><td>3.48 dB</td></tr> </table> <p>Date: 30.DEC.2019 17:42:30</p>	10 %	2.64 dB	1 %	3.28 dB	.1 %	3.40 dB	.01 %	3.48 dB
10 %	0.28 dB																
1 %	0.36 dB																
.1 %	0.40 dB																
.01 %	0.44 dB																
10 %	2.64 dB																
1 %	3.28 dB																
.1 %	3.40 dB																
.01 %	3.48 dB																
<p align="center">Highest Channel</p>  <p>Center 1.9098 GHz 2 dB/ Mean Pwr = 20 dB</p> <p>Complementary Cumulative Distribution Function (100000 samples) Trace 1 Mean 27.16 dBm Peak 27.63 dBm Crest 0.47 dB</p> <table border="1"> <tr><td>10 %</td><td>0.24 dB</td></tr> <tr><td>1 %</td><td>0.36 dB</td></tr> <tr><td>.1 %</td><td>0.40 dB</td></tr> <tr><td>.01 %</td><td>0.40 dB</td></tr> </table> <p>Date: 2.JAN.2020 17:17:00</p>	10 %	0.24 dB	1 %	0.36 dB	.1 %	0.40 dB	.01 %	0.40 dB	<p align="center">Highest Channel</p>  <p>Center 1.9098 GHz 2 dB/ Mean Pwr = 20 dB</p> <p>Complementary Cumulative Distribution Function (100000 samples) Trace 1 Mean 25.89 dBm Peak 29.11 dBm Crest 3.23 dB</p> <table border="1"> <tr><td>10 %</td><td>2.60 dB</td></tr> <tr><td>1 %</td><td>3.12 dB</td></tr> <tr><td>.1 %</td><td>3.20 dB</td></tr> <tr><td>.01 %</td><td>3.24 dB</td></tr> </table> <p>Date: 30.DEC.2019 17:42:42</p>	10 %	2.60 dB	1 %	3.12 dB	.1 %	3.20 dB	.01 %	3.24 dB
10 %	0.24 dB																
1 %	0.36 dB																
.1 %	0.40 dB																
.01 %	0.40 dB																
10 %	2.60 dB																
1 %	3.12 dB																
.1 %	3.20 dB																
.01 %	3.24 dB																



26dB Bandwidth

Mode	GSM850: 26dB BW (MHz)	
Mod.	GPRS class 8	EDGE class 8
Lowest CH	0.312	0.299
Middle CH	0.303	0.273
Highest CH	0.310	0.303

Mode	GSM1900: 26dB BW (MHz)	
Mod.	GPRS class 8	EDGE class 8
Lowest CH	0.304	0.307
Middle CH	0.313	0.297
Highest CH	0.312	0.306

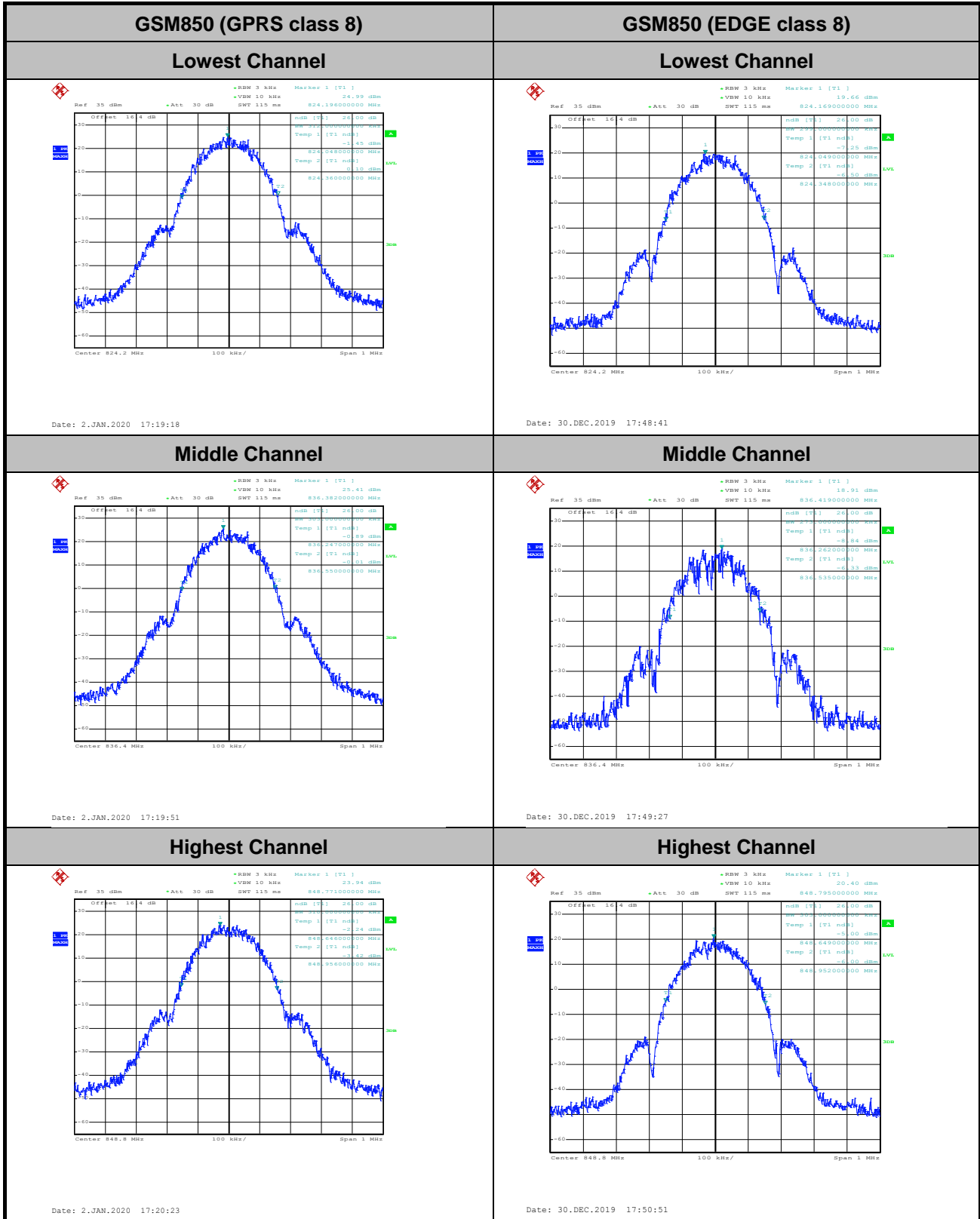

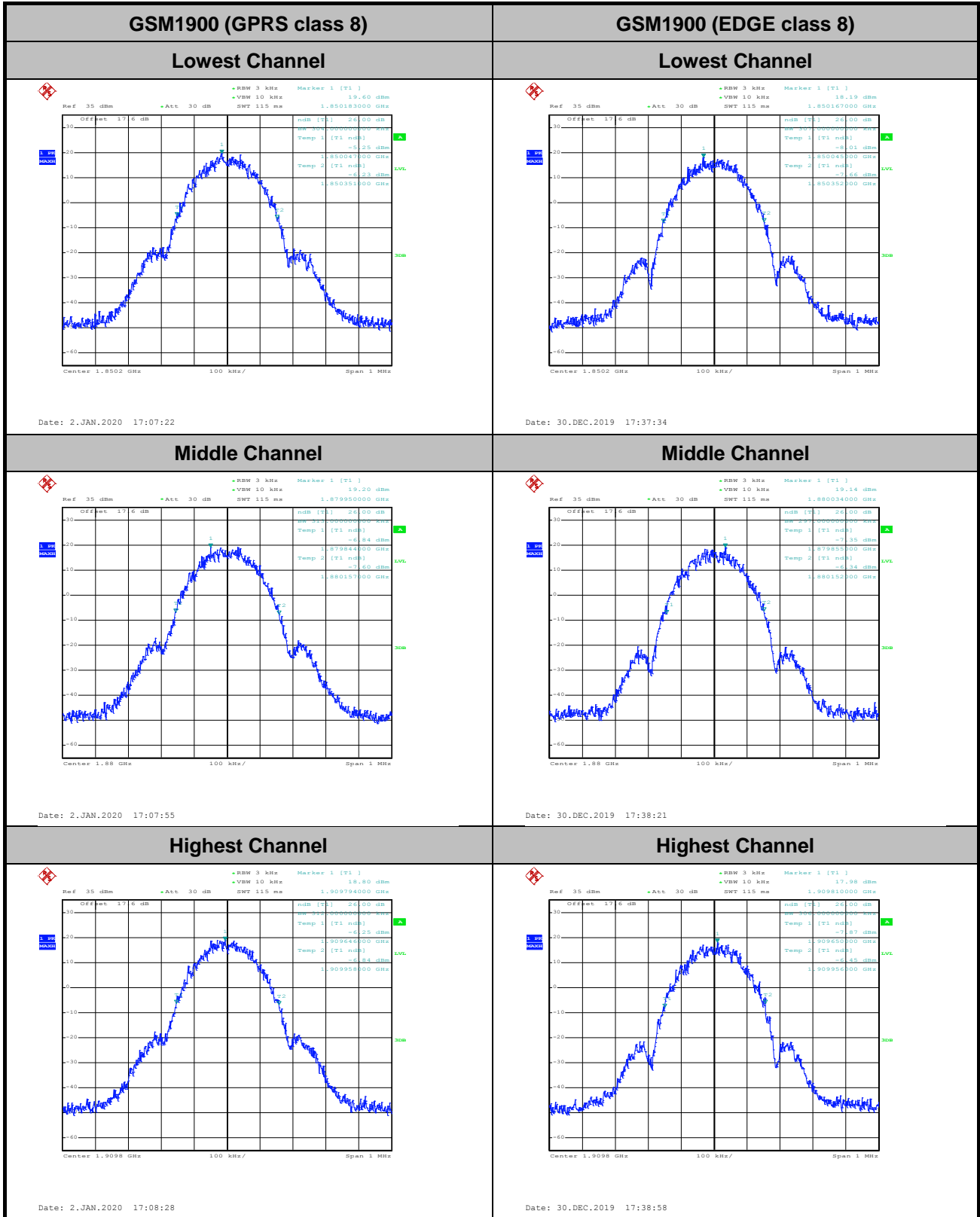



Occupied Bandwidth

Mode	GSM850: 99% OBW (MHz)	
Mod.	GPRS class 8	EDGE class 8
Lowest CH	0.243	0.245
Middle CH	0.243	0.244
Highest CH	0.250	0.244

Mode	GSM1900: 99% OBW (MHz)	
Mod.	GPRS class 8	EDGE class 8
Lowest CH	0.242	0.247
Middle CH	0.244	0.245
Highest CH	0.244	0.249

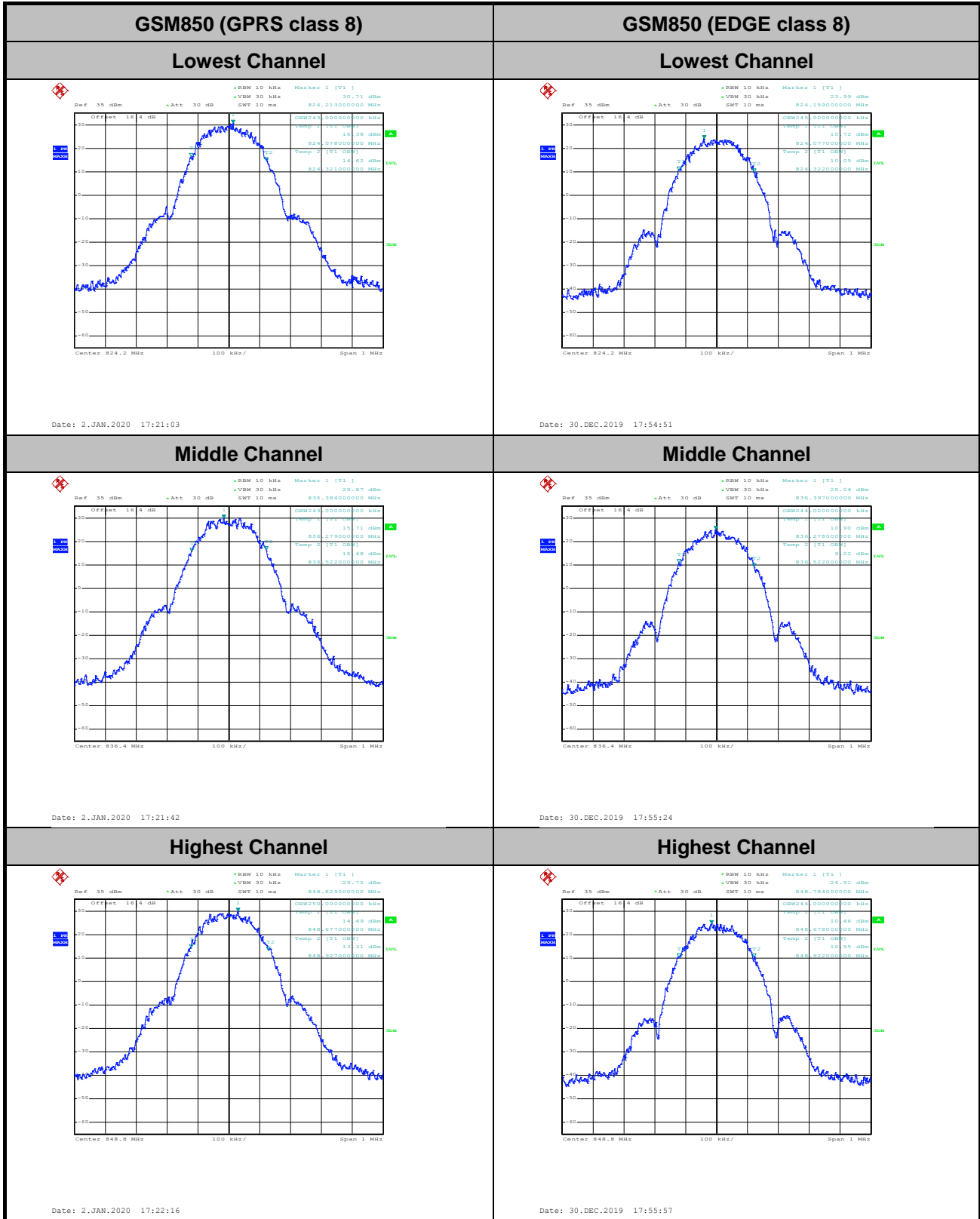

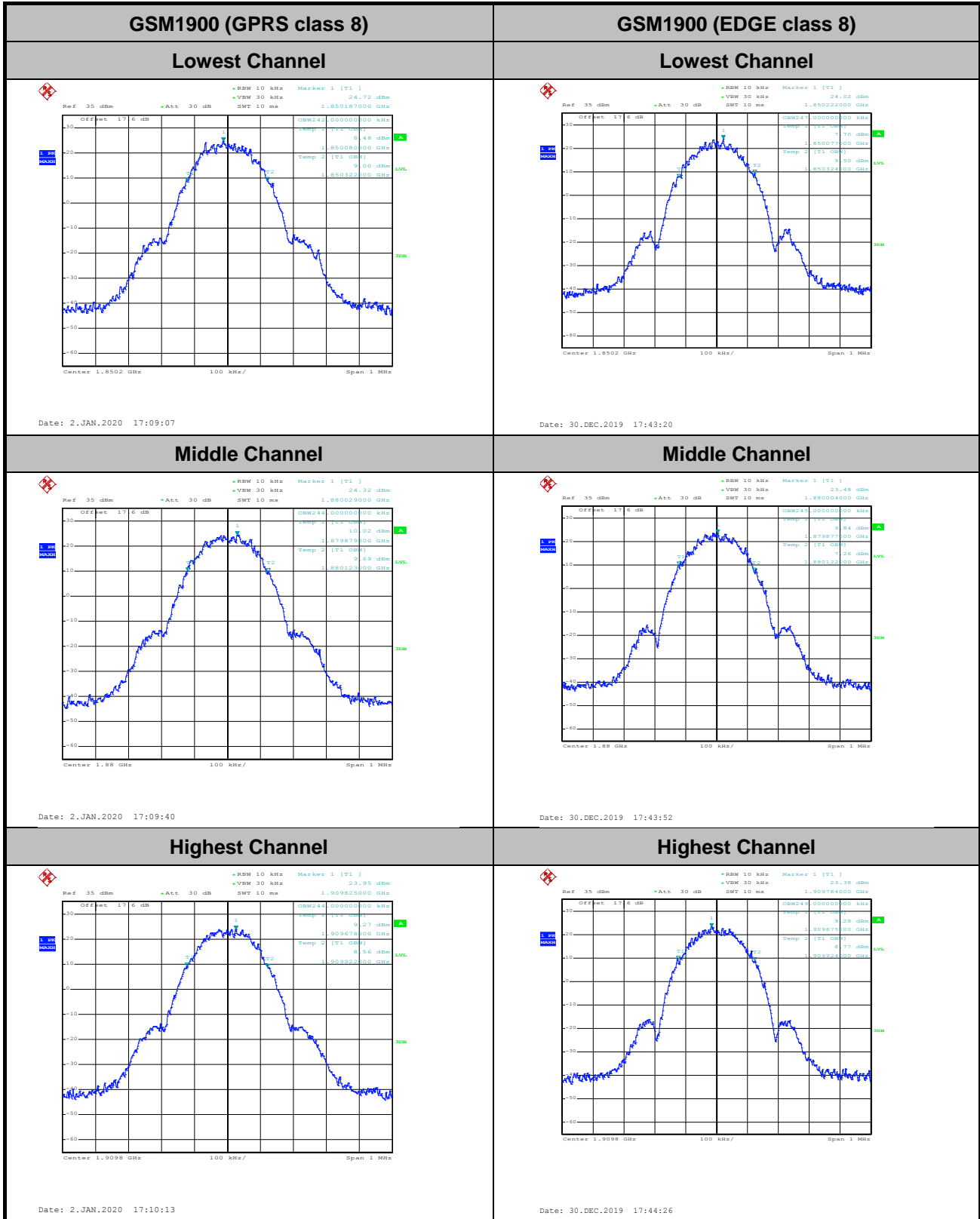



Conducted Band Edge

GSM850 (GPRS class 8)

Lowest Band Edge

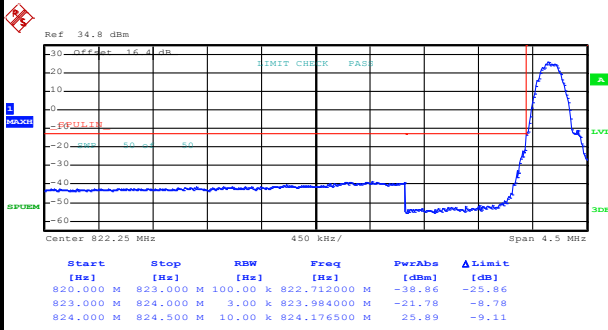

Date: 2.JAN.2020 17:23:54

Highest Band Edge

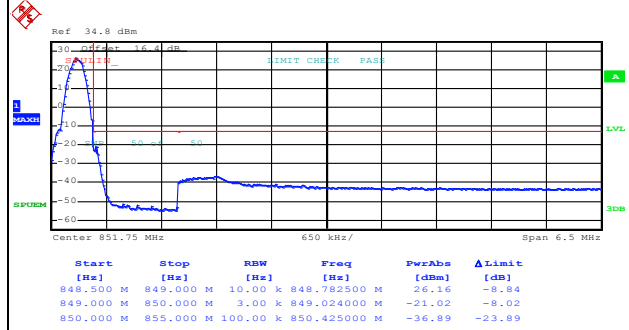

Date: 2.JAN.2020 17:25:27

GSM850 (EDGE class 8)

Lowest Band Edge

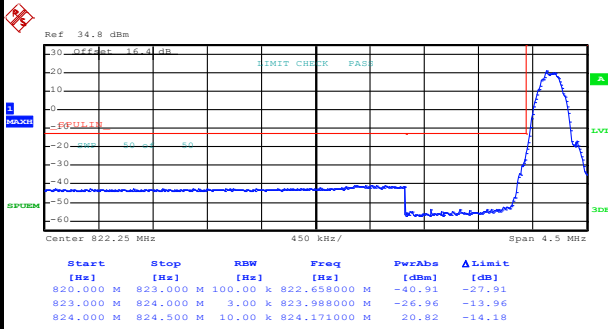

Date: 30.DEC.2019 17:57:32

Highest Band Edge

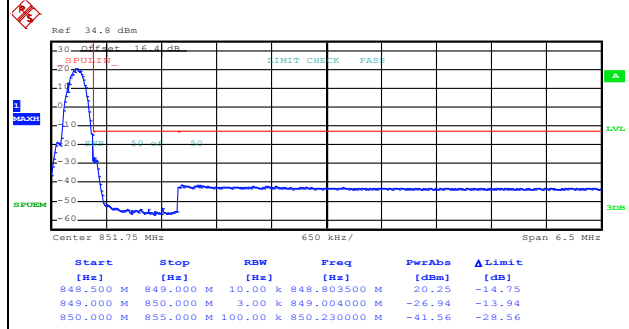

Date: 30.DEC.2019 17:59:17



GSM1900 (GPRS class 8)

Lowest Band Edge

Highest Band Edge

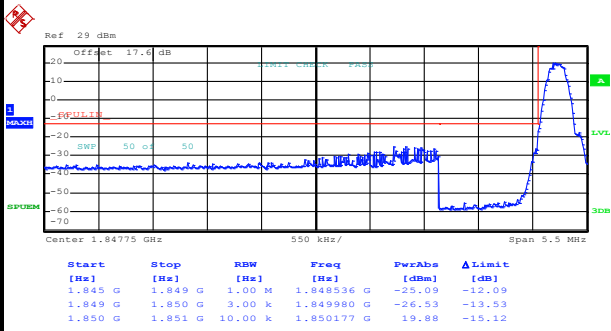

Date: 2.JAN.2020 17:11:48

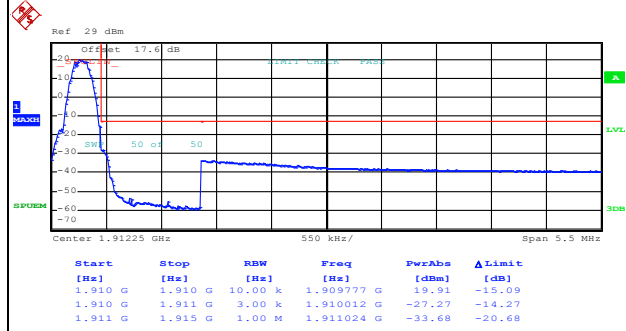

Date: 2.JAN.2020 17:13:21

GSM1900 (EDGE class 8)

Lowest Band Edge

Highest Band Edge

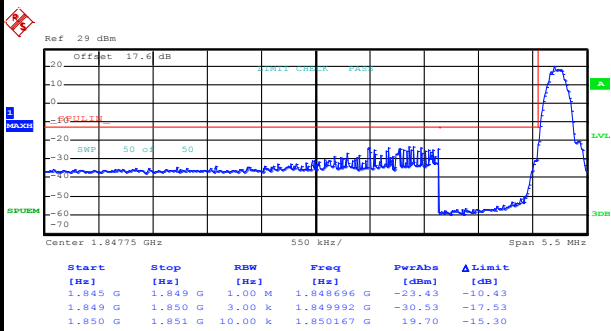

Date: 30.DEC.2019 17:46:04

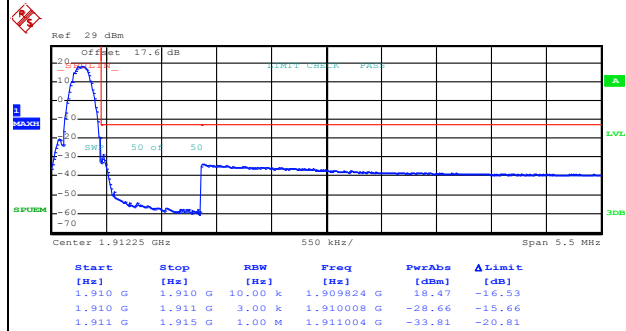

Date: 30.DEC.2019 17:47:42

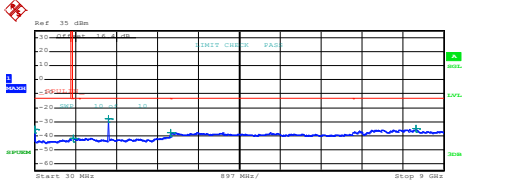
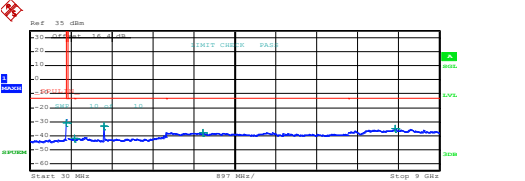
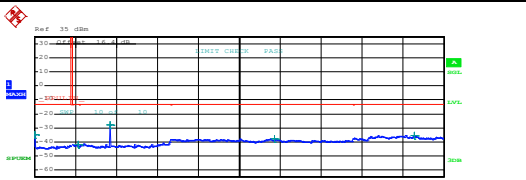
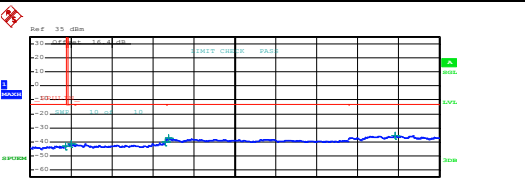
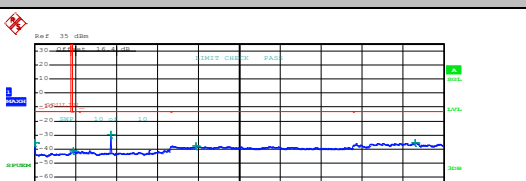
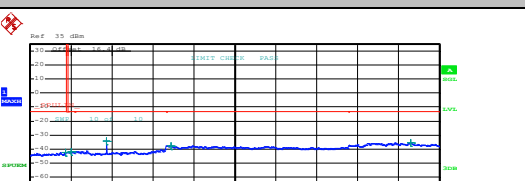

Conducted Spurious Emission

GSM850 (GPRS class 8)	GSM850 (EDGE class 8)																																																																								
Lowest Channel	Lowest Channel																																																																								
 <table border="1" data-bbox="239 660 702 739"> <thead> <tr> <th>Start [Hz]</th> <th>Stop [Hz]</th> <th>RBW [Hz]</th> <th>Freq [Hz]</th> <th>PwrAve [dBm]</th> <th>ΔLimit [dB]</th> </tr> </thead> <tbody> <tr> <td>30,000 M</td> <td>820,000 M</td> <td>1,000 M</td> <td>30,000000 M</td> <td>-35.42</td> <td>-22.42</td> </tr> <tr> <td>835,000 M</td> <td>1,000 G</td> <td>1,000 M</td> <td>867,723751 M</td> <td>-42.07</td> <td>-29.07</td> </tr> <tr> <td>1,000 G</td> <td>3,000 G</td> <td>1,000 M</td> <td>1,6488000 G</td> <td>-27.02</td> <td>-24.02</td> </tr> <tr> <td>3,000 G</td> <td>7,000 G</td> <td>1,000 M</td> <td>3,0020000 G</td> <td>-37.56</td> <td>-24.56</td> </tr> <tr> <td>7,000 G</td> <td>9,000 G</td> <td>1,000 M</td> <td>8,3945000 G</td> <td>-35.04</td> <td>-22.04</td> </tr> </tbody> </table> <p>Date: 2.JAN.2020 17:26:23</p>	Start [Hz]	Stop [Hz]	RBW [Hz]	Freq [Hz]	PwrAve [dBm]	ΔLimit [dB]	30,000 M	820,000 M	1,000 M	30,000000 M	-35.42	-22.42	835,000 M	1,000 G	1,000 M	867,723751 M	-42.07	-29.07	1,000 G	3,000 G	1,000 M	1,6488000 G	-27.02	-24.02	3,000 G	7,000 G	1,000 M	3,0020000 G	-37.56	-24.56	7,000 G	9,000 G	1,000 M	8,3945000 G	-35.04	-22.04	 <table border="1" data-bbox="893 660 1356 739"> <thead> <tr> <th>Start [Hz]</th> <th>Stop [Hz]</th> <th>RBW [Hz]</th> <th>Freq [Hz]</th> <th>PwrAve [dBm]</th> <th>ΔLimit [dB]</th> </tr> </thead> <tbody> <tr> <td>30,000 M</td> <td>820,000 M</td> <td>1,000 M</td> <td>819,802500 M</td> <td>-35.81</td> <td>-27.81</td> </tr> <tr> <td>835,000 M</td> <td>1,000 G</td> <td>1,000 M</td> <td>999,238760 M</td> <td>-41.99</td> <td>-28.99</td> </tr> <tr> <td>1,000 G</td> <td>3,000 G</td> <td>1,000 M</td> <td>1,6488000 G</td> <td>-27.54</td> <td>-20.54</td> </tr> <tr> <td>3,000 G</td> <td>7,000 G</td> <td>1,000 M</td> <td>3,8100000 G</td> <td>-37.75</td> <td>-24.75</td> </tr> <tr> <td>7,000 G</td> <td>9,000 G</td> <td>1,000 M</td> <td>8,0390000 G</td> <td>-35.02</td> <td>-22.02</td> </tr> </tbody> </table> <p>Date: 30.DEC.2019 17:51:48</p>	Start [Hz]	Stop [Hz]	RBW [Hz]	Freq [Hz]	PwrAve [dBm]	ΔLimit [dB]	30,000 M	820,000 M	1,000 M	819,802500 M	-35.81	-27.81	835,000 M	1,000 G	1,000 M	999,238760 M	-41.99	-28.99	1,000 G	3,000 G	1,000 M	1,6488000 G	-27.54	-20.54	3,000 G	7,000 G	1,000 M	3,8100000 G	-37.75	-24.75	7,000 G	9,000 G	1,000 M	8,0390000 G	-35.02	-22.02
Start [Hz]	Stop [Hz]	RBW [Hz]	Freq [Hz]	PwrAve [dBm]	ΔLimit [dB]																																																																				
30,000 M	820,000 M	1,000 M	30,000000 M	-35.42	-22.42																																																																				
835,000 M	1,000 G	1,000 M	867,723751 M	-42.07	-29.07																																																																				
1,000 G	3,000 G	1,000 M	1,6488000 G	-27.02	-24.02																																																																				
3,000 G	7,000 G	1,000 M	3,0020000 G	-37.56	-24.56																																																																				
7,000 G	9,000 G	1,000 M	8,3945000 G	-35.04	-22.04																																																																				
Start [Hz]	Stop [Hz]	RBW [Hz]	Freq [Hz]	PwrAve [dBm]	ΔLimit [dB]																																																																				
30,000 M	820,000 M	1,000 M	819,802500 M	-35.81	-27.81																																																																				
835,000 M	1,000 G	1,000 M	999,238760 M	-41.99	-28.99																																																																				
1,000 G	3,000 G	1,000 M	1,6488000 G	-27.54	-20.54																																																																				
3,000 G	7,000 G	1,000 M	3,8100000 G	-37.75	-24.75																																																																				
7,000 G	9,000 G	1,000 M	8,0390000 G	-35.02	-22.02																																																																				
Middle Channel	Middle Channel																																																																								
 <table border="1" data-bbox="239 1173 702 1252"> <thead> <tr> <th>Start [Hz]</th> <th>Stop [Hz]</th> <th>RBW [Hz]</th> <th>Freq [Hz]</th> <th>PwrAve [dBm]</th> <th>ΔLimit [dB]</th> </tr> </thead> <tbody> <tr> <td>30,000 M</td> <td>820,000 M</td> <td>1,000 M</td> <td>30,000000 M</td> <td>-34.81</td> <td>-21.81</td> </tr> <tr> <td>835,000 M</td> <td>1,000 G</td> <td>1,000 M</td> <td>989,162200 M</td> <td>-41.86</td> <td>-28.86</td> </tr> <tr> <td>1,000 G</td> <td>3,000 G</td> <td>1,000 M</td> <td>1,6730000 G</td> <td>-27.61</td> <td>-24.61</td> </tr> <tr> <td>3,000 G</td> <td>7,000 G</td> <td>1,000 M</td> <td>3,2980000 G</td> <td>-37.94</td> <td>-24.94</td> </tr> <tr> <td>7,000 G</td> <td>9,000 G</td> <td>1,000 M</td> <td>8,3945000 G</td> <td>-35.32</td> <td>-22.32</td> </tr> </tbody> </table> <p>Date: 2.JAN.2020 17:27:15</p>	Start [Hz]	Stop [Hz]	RBW [Hz]	Freq [Hz]	PwrAve [dBm]	ΔLimit [dB]	30,000 M	820,000 M	1,000 M	30,000000 M	-34.81	-21.81	835,000 M	1,000 G	1,000 M	989,162200 M	-41.86	-28.86	1,000 G	3,000 G	1,000 M	1,6730000 G	-27.61	-24.61	3,000 G	7,000 G	1,000 M	3,2980000 G	-37.94	-24.94	7,000 G	9,000 G	1,000 M	8,3945000 G	-35.32	-22.32	 <table border="1" data-bbox="893 1173 1356 1252"> <thead> <tr> <th>Start [Hz]</th> <th>Stop [Hz]</th> <th>RBW [Hz]</th> <th>Freq [Hz]</th> <th>PwrAve [dBm]</th> <th>ΔLimit [dB]</th> </tr> </thead> <tbody> <tr> <td>30,000 M</td> <td>820,000 M</td> <td>1,000 M</td> <td>795,312500 M</td> <td>-42.95</td> <td>-29.95</td> </tr> <tr> <td>835,000 M</td> <td>1,000 G</td> <td>1,000 M</td> <td>820,222500 M</td> <td>-41.56</td> <td>-28.56</td> </tr> <tr> <td>1,000 G</td> <td>3,000 G</td> <td>1,000 M</td> <td>2,9905000 G</td> <td>-40.25</td> <td>-27.25</td> </tr> <tr> <td>3,000 G</td> <td>7,000 G</td> <td>1,000 M</td> <td>3,0540000 G</td> <td>-37.18</td> <td>-24.18</td> </tr> <tr> <td>7,000 G</td> <td>9,000 G</td> <td>1,000 M</td> <td>8,0290000 G</td> <td>-35.56</td> <td>-22.56</td> </tr> </tbody> </table> <p>Date: 30.DEC.2019 17:52:39</p>	Start [Hz]	Stop [Hz]	RBW [Hz]	Freq [Hz]	PwrAve [dBm]	ΔLimit [dB]	30,000 M	820,000 M	1,000 M	795,312500 M	-42.95	-29.95	835,000 M	1,000 G	1,000 M	820,222500 M	-41.56	-28.56	1,000 G	3,000 G	1,000 M	2,9905000 G	-40.25	-27.25	3,000 G	7,000 G	1,000 M	3,0540000 G	-37.18	-24.18	7,000 G	9,000 G	1,000 M	8,0290000 G	-35.56	-22.56
Start [Hz]	Stop [Hz]	RBW [Hz]	Freq [Hz]	PwrAve [dBm]	ΔLimit [dB]																																																																				
30,000 M	820,000 M	1,000 M	30,000000 M	-34.81	-21.81																																																																				
835,000 M	1,000 G	1,000 M	989,162200 M	-41.86	-28.86																																																																				
1,000 G	3,000 G	1,000 M	1,6730000 G	-27.61	-24.61																																																																				
3,000 G	7,000 G	1,000 M	3,2980000 G	-37.94	-24.94																																																																				
7,000 G	9,000 G	1,000 M	8,3945000 G	-35.32	-22.32																																																																				
Start [Hz]	Stop [Hz]	RBW [Hz]	Freq [Hz]	PwrAve [dBm]	ΔLimit [dB]																																																																				
30,000 M	820,000 M	1,000 M	795,312500 M	-42.95	-29.95																																																																				
835,000 M	1,000 G	1,000 M	820,222500 M	-41.56	-28.56																																																																				
1,000 G	3,000 G	1,000 M	2,9905000 G	-40.25	-27.25																																																																				
3,000 G	7,000 G	1,000 M	3,0540000 G	-37.18	-24.18																																																																				
7,000 G	9,000 G	1,000 M	8,0290000 G	-35.56	-22.56																																																																				
Highest Channel	Highest Channel																																																																								
 <table border="1" data-bbox="239 1686 702 1765"> <thead> <tr> <th>Start [Hz]</th> <th>Stop [Hz]</th> <th>RBW [Hz]</th> <th>Freq [Hz]</th> <th>PwrAve [dBm]</th> <th>ΔLimit [dB]</th> </tr> </thead> <tbody> <tr> <td>30,000 M</td> <td>820,000 M</td> <td>1,000 M</td> <td>30,000000 M</td> <td>-35.13</td> <td>-22.13</td> </tr> <tr> <td>835,000 M</td> <td>1,000 G</td> <td>1,000 M</td> <td>872,291251 M</td> <td>-41.08</td> <td>-28.08</td> </tr> <tr> <td>1,000 G</td> <td>3,000 G</td> <td>1,000 M</td> <td>1,6975000 G</td> <td>-29.84</td> <td>-26.84</td> </tr> <tr> <td>3,000 G</td> <td>7,000 G</td> <td>1,000 M</td> <td>3,5690000 G</td> <td>-37.96</td> <td>-24.96</td> </tr> <tr> <td>7,000 G</td> <td>9,000 G</td> <td>1,000 M</td> <td>8,3750000 G</td> <td>-35.52</td> <td>-22.52</td> </tr> </tbody> </table> <p>Date: 2.JAN.2020 17:28:06</p>	Start [Hz]	Stop [Hz]	RBW [Hz]	Freq [Hz]	PwrAve [dBm]	ΔLimit [dB]	30,000 M	820,000 M	1,000 M	30,000000 M	-35.13	-22.13	835,000 M	1,000 G	1,000 M	872,291251 M	-41.08	-28.08	1,000 G	3,000 G	1,000 M	1,6975000 G	-29.84	-26.84	3,000 G	7,000 G	1,000 M	3,5690000 G	-37.96	-24.96	7,000 G	9,000 G	1,000 M	8,3750000 G	-35.52	-22.52	 <table border="1" data-bbox="893 1686 1356 1765"> <thead> <tr> <th>Start [Hz]</th> <th>Stop [Hz]</th> <th>RBW [Hz]</th> <th>Freq [Hz]</th> <th>PwrAve [dBm]</th> <th>ΔLimit [dB]</th> </tr> </thead> <tbody> <tr> <td>30,000 M</td> <td>820,000 M</td> <td>1,000 M</td> <td>805,385000 M</td> <td>-42.53</td> <td>-29.53</td> </tr> <tr> <td>835,000 M</td> <td>1,000 G</td> <td>1,000 M</td> <td>926,340005 M</td> <td>-41.80</td> <td>-28.80</td> </tr> <tr> <td>1,000 G</td> <td>3,000 G</td> <td>1,000 M</td> <td>1,6980000 G</td> <td>-34.83</td> <td>-22.83</td> </tr> <tr> <td>3,000 G</td> <td>7,000 G</td> <td>1,000 M</td> <td>3,1170000 G</td> <td>-37.64</td> <td>-24.64</td> </tr> <tr> <td>7,000 G</td> <td>9,000 G</td> <td>1,000 M</td> <td>8,3750000 G</td> <td>-35.59</td> <td>-22.59</td> </tr> </tbody> </table> <p>Date: 30.DEC.2019 17:53:29</p>	Start [Hz]	Stop [Hz]	RBW [Hz]	Freq [Hz]	PwrAve [dBm]	ΔLimit [dB]	30,000 M	820,000 M	1,000 M	805,385000 M	-42.53	-29.53	835,000 M	1,000 G	1,000 M	926,340005 M	-41.80	-28.80	1,000 G	3,000 G	1,000 M	1,6980000 G	-34.83	-22.83	3,000 G	7,000 G	1,000 M	3,1170000 G	-37.64	-24.64	7,000 G	9,000 G	1,000 M	8,3750000 G	-35.59	-22.59
Start [Hz]	Stop [Hz]	RBW [Hz]	Freq [Hz]	PwrAve [dBm]	ΔLimit [dB]																																																																				
30,000 M	820,000 M	1,000 M	30,000000 M	-35.13	-22.13																																																																				
835,000 M	1,000 G	1,000 M	872,291251 M	-41.08	-28.08																																																																				
1,000 G	3,000 G	1,000 M	1,6975000 G	-29.84	-26.84																																																																				
3,000 G	7,000 G	1,000 M	3,5690000 G	-37.96	-24.96																																																																				
7,000 G	9,000 G	1,000 M	8,3750000 G	-35.52	-22.52																																																																				
Start [Hz]	Stop [Hz]	RBW [Hz]	Freq [Hz]	PwrAve [dBm]	ΔLimit [dB]																																																																				
30,000 M	820,000 M	1,000 M	805,385000 M	-42.53	-29.53																																																																				
835,000 M	1,000 G	1,000 M	926,340005 M	-41.80	-28.80																																																																				
1,000 G	3,000 G	1,000 M	1,6980000 G	-34.83	-22.83																																																																				
3,000 G	7,000 G	1,000 M	3,1170000 G	-37.64	-24.64																																																																				
7,000 G	9,000 G	1,000 M	8,3750000 G	-35.59	-22.59																																																																				

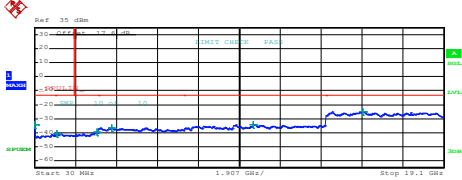
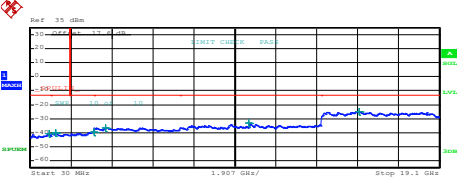
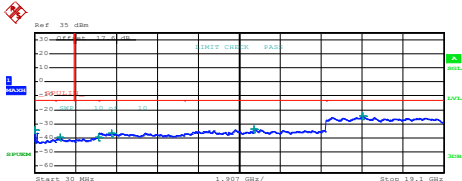
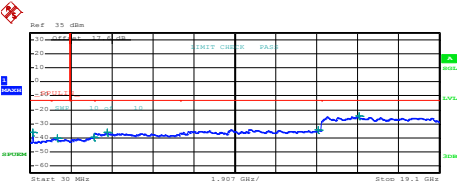
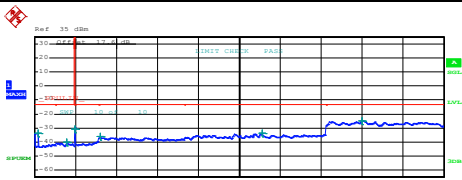
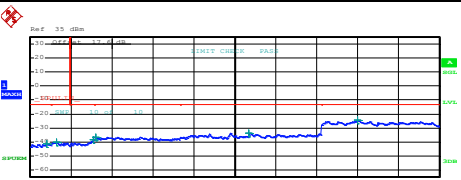

GSM1900 (GPRS class 8)	GSM1900 (EDGE class 8)																																																																																				
Lowest Channel	Lowest Channel																																																																																				
 <table border="1" data-bbox="239 577 638 672"> <thead> <tr> <th>Start [Hz]</th> <th>Stop [Hz]</th> <th>RBW [Hz]</th> <th>Freq [Hz]</th> <th>PwrAbs [dBm]</th> <th>ΔLimit [dB]</th> </tr> </thead> <tbody> <tr><td>30.0000 M</td><td>1.0000 G</td><td>1.000 M</td><td>30.0000000 M</td><td>-34.12</td><td>-21.12</td></tr> <tr><td>1.0000 G</td><td>1.845 G</td><td>1.000 M</td><td>1.0749994 G</td><td>-40.63</td><td>-27.63</td></tr> <tr><td>1.845 G</td><td>3.0000 G</td><td>1.000 M</td><td>2.0267503 G</td><td>-39.39</td><td>-26.39</td></tr> <tr><td>3.0000 G</td><td>7.0000 G</td><td>1.000 M</td><td>3.6320000 G</td><td>-36.47</td><td>-23.47</td></tr> <tr><td>7.0000 G</td><td>13.6000 G</td><td>1.000 M</td><td>10.2191500 G</td><td>-34.03</td><td>-21.03</td></tr> <tr><td>13.6000 G</td><td>19.1000 G</td><td>1.000 M</td><td>15.3098113 G</td><td>-24.82</td><td>-11.82</td></tr> </tbody> </table> <p>Date: 2.JAN.2020 17:14:17</p>	Start [Hz]	Stop [Hz]	RBW [Hz]	Freq [Hz]	PwrAbs [dBm]	ΔLimit [dB]	30.0000 M	1.0000 G	1.000 M	30.0000000 M	-34.12	-21.12	1.0000 G	1.845 G	1.000 M	1.0749994 G	-40.63	-27.63	1.845 G	3.0000 G	1.000 M	2.0267503 G	-39.39	-26.39	3.0000 G	7.0000 G	1.000 M	3.6320000 G	-36.47	-23.47	7.0000 G	13.6000 G	1.000 M	10.2191500 G	-34.03	-21.03	13.6000 G	19.1000 G	1.000 M	15.3098113 G	-24.82	-11.82	 <table border="1" data-bbox="893 577 1292 672"> <thead> <tr> <th>Start [Hz]</th> <th>Stop [Hz]</th> <th>RBW [Hz]</th> <th>Freq [Hz]</th> <th>PwrAbs [dBm]</th> <th>ΔLimit [dB]</th> </tr> </thead> <tbody> <tr><td>30.0000 M</td><td>1.0000 G</td><td>1.000 M</td><td>888.652500 M</td><td>-40.79</td><td>-27.79</td></tr> <tr><td>1.0000 G</td><td>1.845 G</td><td>1.000 M</td><td>1.2159998 G</td><td>-40.00</td><td>-27.00</td></tr> <tr><td>1.845 G</td><td>3.0000 G</td><td>1.000 M</td><td>2.9932519 G</td><td>-39.88</td><td>-26.88</td></tr> <tr><td>3.0000 G</td><td>7.0000 G</td><td>1.000 M</td><td>3.5280000 G</td><td>-36.59</td><td>-23.59</td></tr> <tr><td>7.0000 G</td><td>13.6000 G</td><td>1.000 M</td><td>10.2157500 G</td><td>-32.88</td><td>-19.88</td></tr> <tr><td>13.6000 G</td><td>19.1000 G</td><td>1.000 M</td><td>15.3455563 G</td><td>-24.66</td><td>-11.66</td></tr> </tbody> </table> <p>Date: 30.DEC.2019 17:40:03</p>	Start [Hz]	Stop [Hz]	RBW [Hz]	Freq [Hz]	PwrAbs [dBm]	ΔLimit [dB]	30.0000 M	1.0000 G	1.000 M	888.652500 M	-40.79	-27.79	1.0000 G	1.845 G	1.000 M	1.2159998 G	-40.00	-27.00	1.845 G	3.0000 G	1.000 M	2.9932519 G	-39.88	-26.88	3.0000 G	7.0000 G	1.000 M	3.5280000 G	-36.59	-23.59	7.0000 G	13.6000 G	1.000 M	10.2157500 G	-32.88	-19.88	13.6000 G	19.1000 G	1.000 M	15.3455563 G	-24.66	-11.66
Start [Hz]	Stop [Hz]	RBW [Hz]	Freq [Hz]	PwrAbs [dBm]	ΔLimit [dB]																																																																																
30.0000 M	1.0000 G	1.000 M	30.0000000 M	-34.12	-21.12																																																																																
1.0000 G	1.845 G	1.000 M	1.0749994 G	-40.63	-27.63																																																																																
1.845 G	3.0000 G	1.000 M	2.0267503 G	-39.39	-26.39																																																																																
3.0000 G	7.0000 G	1.000 M	3.6320000 G	-36.47	-23.47																																																																																
7.0000 G	13.6000 G	1.000 M	10.2191500 G	-34.03	-21.03																																																																																
13.6000 G	19.1000 G	1.000 M	15.3098113 G	-24.82	-11.82																																																																																
Start [Hz]	Stop [Hz]	RBW [Hz]	Freq [Hz]	PwrAbs [dBm]	ΔLimit [dB]																																																																																
30.0000 M	1.0000 G	1.000 M	888.652500 M	-40.79	-27.79																																																																																
1.0000 G	1.845 G	1.000 M	1.2159998 G	-40.00	-27.00																																																																																
1.845 G	3.0000 G	1.000 M	2.9932519 G	-39.88	-26.88																																																																																
3.0000 G	7.0000 G	1.000 M	3.5280000 G	-36.59	-23.59																																																																																
7.0000 G	13.6000 G	1.000 M	10.2157500 G	-32.88	-19.88																																																																																
13.6000 G	19.1000 G	1.000 M	15.3455563 G	-24.66	-11.66																																																																																
Middle Channel	Middle Channel																																																																																				
 <table border="1" data-bbox="239 1093 638 1187"> <thead> <tr> <th>Start [Hz]</th> <th>Stop [Hz]</th> <th>RBW [Hz]</th> <th>Freq [Hz]</th> <th>PwrAbs [dBm]</th> <th>ΔLimit [dB]</th> </tr> </thead> <tbody> <tr><td>30.0000 M</td><td>1.0000 G</td><td>1.000 M</td><td>30.0000000 M</td><td>-34.49</td><td>-21.49</td></tr> <tr><td>1.0000 G</td><td>1.845 G</td><td>1.000 M</td><td>1.0200000 G</td><td>-39.34</td><td>-26.34</td></tr> <tr><td>1.845 G</td><td>3.0000 G</td><td>1.000 M</td><td>2.9848466 G</td><td>-39.37</td><td>-26.37</td></tr> <tr><td>3.0000 G</td><td>7.0000 G</td><td>1.000 M</td><td>3.6020000 G</td><td>-36.63</td><td>-23.63</td></tr> <tr><td>7.0000 G</td><td>13.6000 G</td><td>1.000 M</td><td>10.2430000 G</td><td>-33.99</td><td>-20.99</td></tr> <tr><td>13.6000 G</td><td>19.1000 G</td><td>1.000 M</td><td>15.323563 G</td><td>-24.63</td><td>-11.63</td></tr> </tbody> </table> <p>Date: 2.JAN.2020 17:15:07</p>	Start [Hz]	Stop [Hz]	RBW [Hz]	Freq [Hz]	PwrAbs [dBm]	ΔLimit [dB]	30.0000 M	1.0000 G	1.000 M	30.0000000 M	-34.49	-21.49	1.0000 G	1.845 G	1.000 M	1.0200000 G	-39.34	-26.34	1.845 G	3.0000 G	1.000 M	2.9848466 G	-39.37	-26.37	3.0000 G	7.0000 G	1.000 M	3.6020000 G	-36.63	-23.63	7.0000 G	13.6000 G	1.000 M	10.2430000 G	-33.99	-20.99	13.6000 G	19.1000 G	1.000 M	15.323563 G	-24.63	-11.63	 <table border="1" data-bbox="893 1093 1292 1187"> <thead> <tr> <th>Start [Hz]</th> <th>Stop [Hz]</th> <th>RBW [Hz]</th> <th>Freq [Hz]</th> <th>PwrAbs [dBm]</th> <th>ΔLimit [dB]</th> </tr> </thead> <tbody> <tr><td>30.0000 M</td><td>1.0000 G</td><td>1.000 M</td><td>141.7925000 M</td><td>-36.15</td><td>-23.15</td></tr> <tr><td>1.0000 G</td><td>1.845 G</td><td>1.000 M</td><td>1.0200000 G</td><td>-39.86</td><td>-26.86</td></tr> <tr><td>1.845 G</td><td>3.0000 G</td><td>1.000 M</td><td>2.9861666 G</td><td>-39.71</td><td>-26.71</td></tr> <tr><td>3.0000 G</td><td>7.0000 G</td><td>1.000 M</td><td>3.6150000 G</td><td>-36.30</td><td>-23.30</td></tr> <tr><td>7.0000 G</td><td>13.6000 G</td><td>1.000 M</td><td>10.4392519 G</td><td>-34.10</td><td>-21.10</td></tr> <tr><td>13.6000 G</td><td>19.1000 G</td><td>1.000 M</td><td>15.372375 G</td><td>-24.59</td><td>-11.59</td></tr> </tbody> </table> <p>Date: 30.DEC.2019 17:40:54</p>	Start [Hz]	Stop [Hz]	RBW [Hz]	Freq [Hz]	PwrAbs [dBm]	ΔLimit [dB]	30.0000 M	1.0000 G	1.000 M	141.7925000 M	-36.15	-23.15	1.0000 G	1.845 G	1.000 M	1.0200000 G	-39.86	-26.86	1.845 G	3.0000 G	1.000 M	2.9861666 G	-39.71	-26.71	3.0000 G	7.0000 G	1.000 M	3.6150000 G	-36.30	-23.30	7.0000 G	13.6000 G	1.000 M	10.4392519 G	-34.10	-21.10	13.6000 G	19.1000 G	1.000 M	15.372375 G	-24.59	-11.59
Start [Hz]	Stop [Hz]	RBW [Hz]	Freq [Hz]	PwrAbs [dBm]	ΔLimit [dB]																																																																																
30.0000 M	1.0000 G	1.000 M	30.0000000 M	-34.49	-21.49																																																																																
1.0000 G	1.845 G	1.000 M	1.0200000 G	-39.34	-26.34																																																																																
1.845 G	3.0000 G	1.000 M	2.9848466 G	-39.37	-26.37																																																																																
3.0000 G	7.0000 G	1.000 M	3.6020000 G	-36.63	-23.63																																																																																
7.0000 G	13.6000 G	1.000 M	10.2430000 G	-33.99	-20.99																																																																																
13.6000 G	19.1000 G	1.000 M	15.323563 G	-24.63	-11.63																																																																																
Start [Hz]	Stop [Hz]	RBW [Hz]	Freq [Hz]	PwrAbs [dBm]	ΔLimit [dB]																																																																																
30.0000 M	1.0000 G	1.000 M	141.7925000 M	-36.15	-23.15																																																																																
1.0000 G	1.845 G	1.000 M	1.0200000 G	-39.86	-26.86																																																																																
1.845 G	3.0000 G	1.000 M	2.9861666 G	-39.71	-26.71																																																																																
3.0000 G	7.0000 G	1.000 M	3.6150000 G	-36.30	-23.30																																																																																
7.0000 G	13.6000 G	1.000 M	10.4392519 G	-34.10	-21.10																																																																																
13.6000 G	19.1000 G	1.000 M	15.372375 G	-24.59	-11.59																																																																																
Highest Channel	Highest Channel																																																																																				
 <table border="1" data-bbox="239 1608 638 1702"> <thead> <tr> <th>Start [Hz]</th> <th>Stop [Hz]</th> <th>RBW [Hz]</th> <th>Freq [Hz]</th> <th>PwrAbs [dBm]</th> <th>ΔLimit [dB]</th> </tr> </thead> <tbody> <tr><td>30.0000 M</td><td>1.0000 G</td><td>1.000 M</td><td>171.6000000 M</td><td>-33.94</td><td>-20.94</td></tr> <tr><td>1.0000 G</td><td>1.845 G</td><td>1.000 M</td><td>1.5150228 G</td><td>-40.37</td><td>-27.37</td></tr> <tr><td>1.845 G</td><td>3.0000 G</td><td>1.000 M</td><td>1.9132071 G</td><td>-39.75</td><td>-27.75</td></tr> <tr><td>3.0000 G</td><td>7.0000 G</td><td>1.000 M</td><td>3.0690000 G</td><td>-36.33</td><td>-23.33</td></tr> <tr><td>7.0000 G</td><td>13.6000 G</td><td>1.000 M</td><td>10.648975 G</td><td>-33.64</td><td>-20.64</td></tr> <tr><td>13.6000 G</td><td>19.1000 G</td><td>1.000 M</td><td>15.300388 G</td><td>-24.80</td><td>-11.80</td></tr> </tbody> </table> <p>Date: 2.JAN.2020 17:16:02</p>	Start [Hz]	Stop [Hz]	RBW [Hz]	Freq [Hz]	PwrAbs [dBm]	ΔLimit [dB]	30.0000 M	1.0000 G	1.000 M	171.6000000 M	-33.94	-20.94	1.0000 G	1.845 G	1.000 M	1.5150228 G	-40.37	-27.37	1.845 G	3.0000 G	1.000 M	1.9132071 G	-39.75	-27.75	3.0000 G	7.0000 G	1.000 M	3.0690000 G	-36.33	-23.33	7.0000 G	13.6000 G	1.000 M	10.648975 G	-33.64	-20.64	13.6000 G	19.1000 G	1.000 M	15.300388 G	-24.80	-11.80	 <table border="1" data-bbox="893 1608 1292 1702"> <thead> <tr> <th>Start [Hz]</th> <th>Stop [Hz]</th> <th>RBW [Hz]</th> <th>Freq [Hz]</th> <th>PwrAbs [dBm]</th> <th>ΔLimit [dB]</th> </tr> </thead> <tbody> <tr><td>30.0000 M</td><td>1.0000 G</td><td>1.000 M</td><td>798.7250000 M</td><td>-41.59</td><td>-28.59</td></tr> <tr><td>1.0000 G</td><td>1.845 G</td><td>1.000 M</td><td>1.245473 G</td><td>-40.28</td><td>-27.28</td></tr> <tr><td>1.845 G</td><td>3.0000 G</td><td>1.000 M</td><td>2.9752519 G</td><td>-39.32</td><td>-26.32</td></tr> <tr><td>3.0000 G</td><td>7.0000 G</td><td>1.000 M</td><td>3.0890000 G</td><td>-36.51</td><td>-23.51</td></tr> <tr><td>7.0000 G</td><td>13.6000 G</td><td>1.000 M</td><td>10.208425 G</td><td>-33.77</td><td>-20.77</td></tr> <tr><td>13.6000 G</td><td>19.1000 G</td><td>1.000 M</td><td>15.292625 G</td><td>-24.51</td><td>-11.51</td></tr> </tbody> </table> <p>Date: 30.DEC.2019 17:41:45</p>	Start [Hz]	Stop [Hz]	RBW [Hz]	Freq [Hz]	PwrAbs [dBm]	ΔLimit [dB]	30.0000 M	1.0000 G	1.000 M	798.7250000 M	-41.59	-28.59	1.0000 G	1.845 G	1.000 M	1.245473 G	-40.28	-27.28	1.845 G	3.0000 G	1.000 M	2.9752519 G	-39.32	-26.32	3.0000 G	7.0000 G	1.000 M	3.0890000 G	-36.51	-23.51	7.0000 G	13.6000 G	1.000 M	10.208425 G	-33.77	-20.77	13.6000 G	19.1000 G	1.000 M	15.292625 G	-24.51	-11.51
Start [Hz]	Stop [Hz]	RBW [Hz]	Freq [Hz]	PwrAbs [dBm]	ΔLimit [dB]																																																																																
30.0000 M	1.0000 G	1.000 M	171.6000000 M	-33.94	-20.94																																																																																
1.0000 G	1.845 G	1.000 M	1.5150228 G	-40.37	-27.37																																																																																
1.845 G	3.0000 G	1.000 M	1.9132071 G	-39.75	-27.75																																																																																
3.0000 G	7.0000 G	1.000 M	3.0690000 G	-36.33	-23.33																																																																																
7.0000 G	13.6000 G	1.000 M	10.648975 G	-33.64	-20.64																																																																																
13.6000 G	19.1000 G	1.000 M	15.300388 G	-24.80	-11.80																																																																																
Start [Hz]	Stop [Hz]	RBW [Hz]	Freq [Hz]	PwrAbs [dBm]	ΔLimit [dB]																																																																																
30.0000 M	1.0000 G	1.000 M	798.7250000 M	-41.59	-28.59																																																																																
1.0000 G	1.845 G	1.000 M	1.245473 G	-40.28	-27.28																																																																																
1.845 G	3.0000 G	1.000 M	2.9752519 G	-39.32	-26.32																																																																																
3.0000 G	7.0000 G	1.000 M	3.0890000 G	-36.51	-23.51																																																																																
7.0000 G	13.6000 G	1.000 M	10.208425 G	-33.77	-20.77																																																																																
13.6000 G	19.1000 G	1.000 M	15.292625 G	-24.51	-11.51																																																																																



Frequency Stability

Test Conditions	Middle Channel	GSM850 (GSM)	GSM850 (EDGE class 8)	Limit 2.5ppm
Temperature (°C)	Voltage (Volt)	Deviation (ppm)		Result
50	Normal Voltage	0.0801	0.0048	PASS
40	Normal Voltage	0.0143	0.0048	
30	Normal Voltage	0.0120	0.0012	
20(Ref.)	Normal Voltage	0.0000	0.0000	
10	Normal Voltage	0.0120	0.0084	
0	Normal Voltage	0.0048	0.0000	
-10	Normal Voltage	0.0120	0.0120	
-20	Normal Voltage	0.0060	0.0143	
-30	Normal Voltage	0.0024	0.0179	
20	Maximum Voltage	0.0060	0.0108	
20	Normal Voltage	0.0000	0.0000	
20	Battery End Point	0.0777	0.0143	



Test Conditions	Middle Channel	GSM1900 (GSM)	GSM1900 (EDGE class 8)	Limit Note 2.
Temperature (°C)	Voltage (Volt)	Deviation (ppm)		Result
50	Normal Voltage	0.0011	0.0319	PASS
40	Normal Voltage	0.0112	0.0223	
30	Normal Voltage	0.0011	0.0059	
20(Ref.)	Normal Voltage	0.0000	0.0000	
10	Normal Voltage	0.0011	0.0303	
0	Normal Voltage	0.0122	0.0223	
-10	Normal Voltage	0.0053	0.0356	
-20	Normal Voltage	0.0021	0.0223	
-30	Normal Voltage	0.0005	0.0106	
20	Maximum Voltage	0.0011	0.0037	
20	Normal Voltage	0.0000	0.0000	
20	Battery End Point	0.0048	0.0298	

Note:

1. Normal Voltage = 3.85V. ; Battery End Point (BEP) = 3.65V. ; Maximum Voltage =4.25 V
2. The frequency fundamental emissions stay within the authorized frequency block.



A3. WCDMA

Peak-to-Average Ratio

Mode	WCDMA Band V	Limit: 13dB
Mod.	RMC 12.2Kbps	Result
Lowest CH	3.28	PASS
Middle CH	3.28	
Highest CH	3.32	

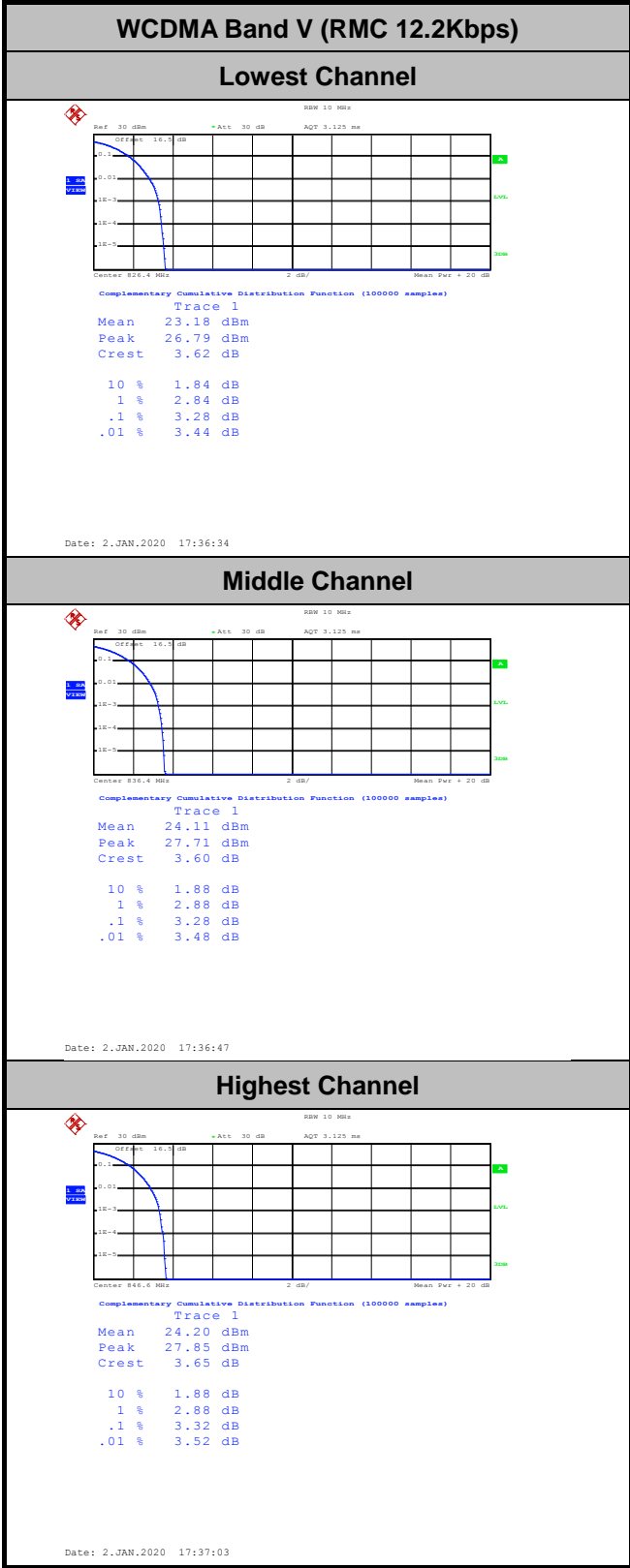



26dB Bandwidth

Mode	WCDMA Band V 26dB BW(MHz)
Mod.	RMC 12.2Kbps
Lowest CH	4.71
Middle CH	4.71
Highest CH	4.72



WCDMA Band V (RMC 12.2Kbps)

Lowest Channel

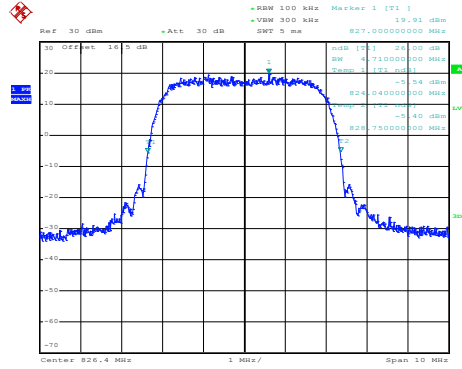

Date: 2, JAN, 2020 17:32:16

Middle Channel

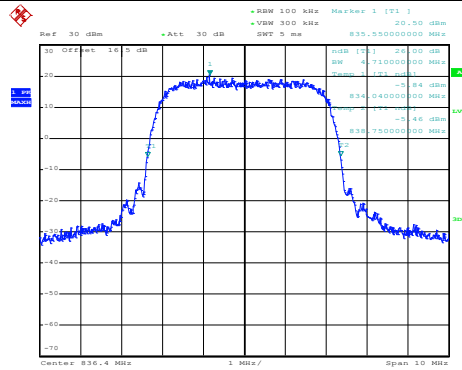

Date: 2, JAN, 2020 17:32:53

Highest Channel

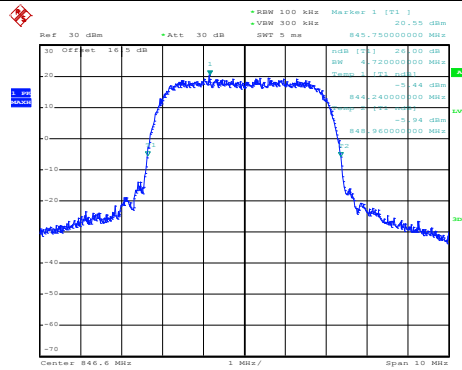

Date: 2, JAN, 2020 17:33:27



Occupied Bandwidth

Mode	WCDMA Band V 99% OBW(MHz)
Mod.	RMC 12.2Kbps
Lowest CH	4.14
Middle CH	4.16
Highest CH	4.16



WCDMA Band V (RMC 12.2Kbps)

Lowest Channel

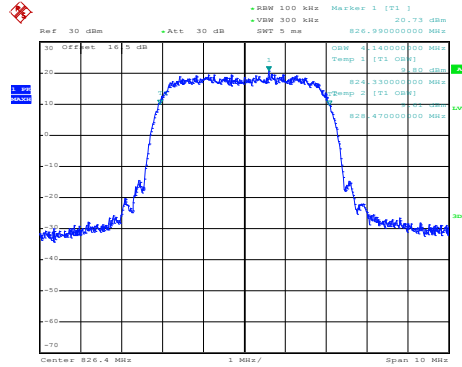

Date: 2, JAN, 2020 17:37:45

Middle Channel

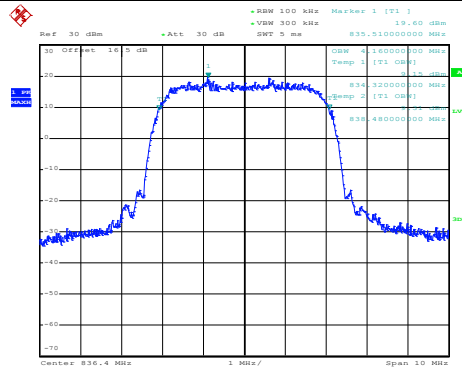

Date: 2, JAN, 2020 17:38:18

Highest Channel

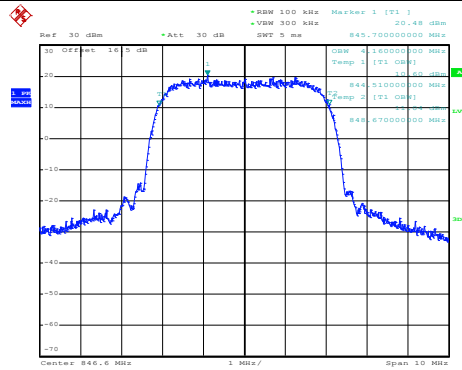

Date: 2, JAN, 2020 17:38:52



Conducted Band Edge

WCDMA Band V (RMC 12.2Kbps)

Lowest Band Edge

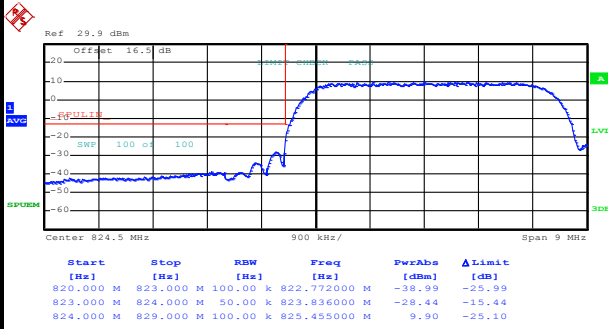

Date: 2.JAN.2020 17:41:45

Highest Band Edge

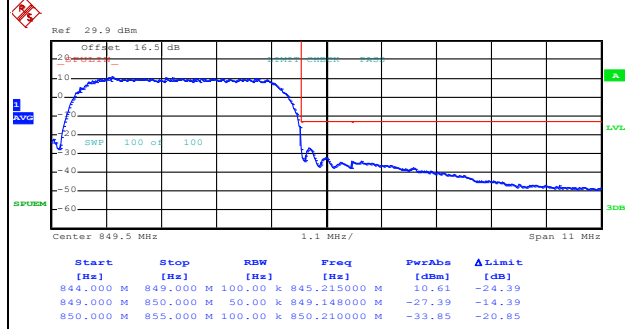

Date: 2.JAN.2020 17:44:36



Conducted Spurious Emission

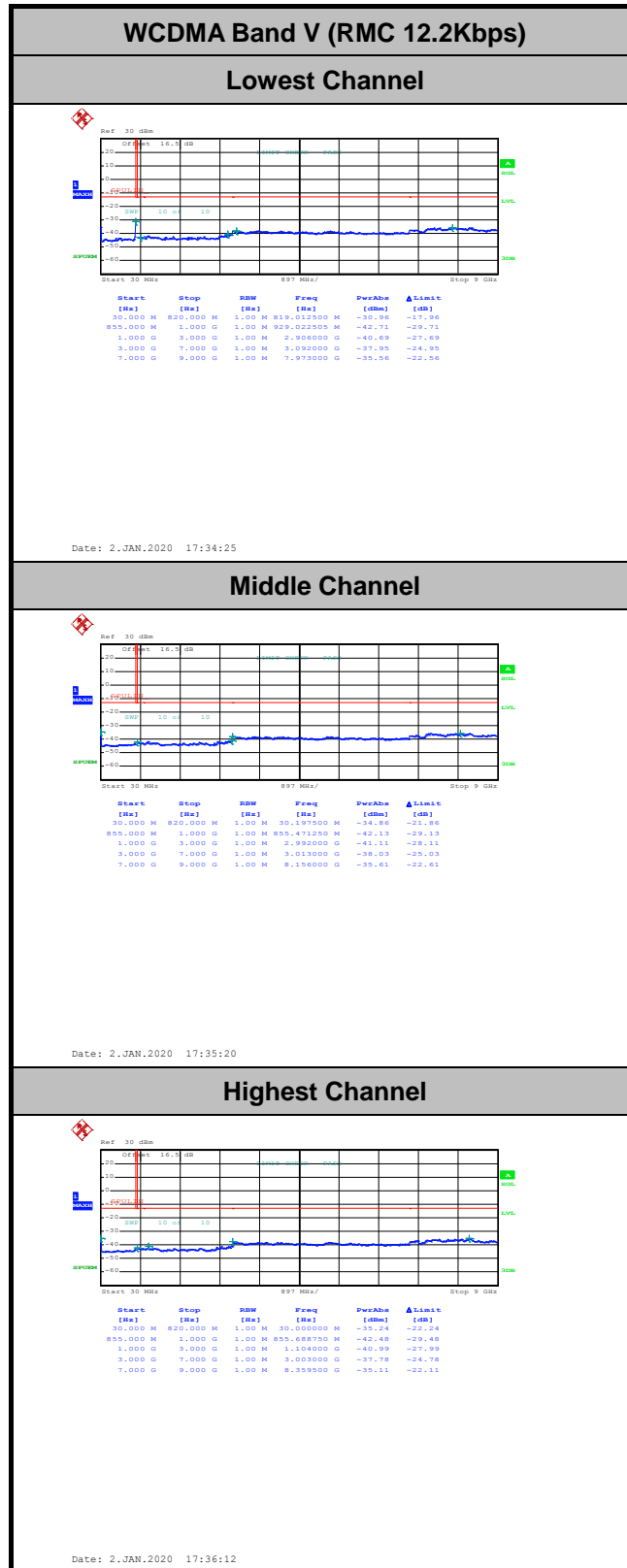



Frequency Stability

Test Conditions	Middle Channel	WCDMA Band V (RMC 12.2Kbps)	Limit 2.5ppm
Temperature (°C)	Voltage (Volt)	Deviation (ppm)	Result
50	Normal Voltage	0.0048	PASS
40	Normal Voltage	0.0060	
30	Normal Voltage	0.0036	
20(Ref.)	Normal Voltage	0.0000	
10	Normal Voltage	0.0036	
0	Normal Voltage	0.0036	
-10	Normal Voltage	0.0060	
-20	Normal Voltage	0.0060	
-30	Normal Voltage	0.0072	
20	Maximum Voltage	0.0072	
20	Normal Voltage	0.0000	
20	Battery End Point	0.0060	

Note:

- 1. Normal Voltage = 3.85V. ; Battery End Point (BEP) = 3.65 V. ; Maximum Voltage =4.25 V
- 2. The frequency fundamental emissions stay within the authorized frequency block.



Appendix B. Test Results of ERP/EIRP and Radiated Test

ERP/EIRP

Channel	Mode	Conducted		ERP	
		Power (dBm)	Power (Watts)	ERP(dBm)	ERP(W)
Lowest	GSM850	32.64	1.8365	24.18	0.2618
Middle	GPRS class 8	32.77	1.8923	24.31	0.2698
Highest	GT - LC = -6.31 dB	32.64	1.8365	24.18	0.2618
Lowest	GSM850	26.88	0.4875	18.42	0.0695
Middle	EDGE class 8	26.64	0.4613	18.18	0.0658
Highest	GT - LC = -6.31 dB	26.63	0.4603	18.17	0.0656
Lowest	WCDMA Band V	24.40	0.2754	15.94	0.0393
Middle	RMC 12.2Kbps	24.33	0.2710	15.87	0.0386
Highest	GT - LC = -6.31 dB	24.27	0.2673	15.81	0.0381
Limit	ERP < 7W	Result		PASS	

Channel	Mode	Conducted		EIRP	
		Power (dBm)	Power (Watts)	EIRP(dBm)	EIRP(W)
Lowest	GSM1900	27.43	0.5534	24.64	0.2911
Middle	GPRS class 8	27.89	0.6152	25.10	0.3236
Highest	GT - LC = -2.79 dB	27.84	0.6081	25.05	0.3199
Lowest	GSM1900	25.41	0.3475	22.62	0.1828
Middle	EDGE class 8	26.10	0.4074	23.31	0.2143
Highest	GT - LC = -2.79 dB	26.14	0.4111	23.35	0.2163
Limit	EIRP < 2W	Result		PASS	



Radiated Spurious Emission

GPRS850

GPRS 850									
Channel	Frequency (MHz)	ERP (dBm)	Limit (dBm)	Over Limit (dB)	SPA Reading (dBm)	S.G. Power (dBm)	TX Cable loss (dB)	TX Antenna Gain (dBi)	Polarization (H/V)
Lowest	1648	-52.17	-13	-39.17	-62.26	-57.76	0.92	8.66	H
	2473	-41.34	-13	-28.34	-55.65	-48.71	1.14	10.66	H
	3297	-55.48	-13	-42.48	-71.15	-64.02	1.32	12.01	H
									H
									H
									H
	1648	-57.99	-13	-44.99	-67.55	-63.58	0.92	8.66	V
	2473	-38.83	-13	-25.83	-53.29	-46.20	1.14	10.66	V
	3297	-55.09	-13	-42.09	-71.4	-63.63	1.32	12.01	V
									V
									V
									V
Middle	1672	-53.50	-13	-40.50	-63.66	-59.18	0.93	8.75	H
	2509	-41.27	-13	-28.27	-55.56	-48.68	1.15	10.71	H
	3346	-55.42	-13	-42.42	-70.96	-64.07	1.33	12.13	H
									H
									H
									H
	1672	-58.19	-13	-45.19	-67.72	-63.87	0.93	8.75	V
	2509	-38.32	-13	-25.32	-52.81	-45.73	1.15	10.71	V
	3346	-55.20	-13	-42.20	-71.19	-63.85	1.33	12.13	V
									V
									V
									V



Highest	1696	-55.18	-13	-42.18	-65.42	-60.94	0.94	8.84	H
	2544	-39.70	-13	-26.70	-53.96	-47.14	1.16	10.75	H
	3395	-55.53	-13	-42.53	-70.96	-64.29	1.34	12.25	H
									H
									H
									H
									H
	1696	-60.20	-13	-47.20	-69.73	-65.96	0.94	8.84	V
	2544	-37.25	-13	-24.25	-51.62	-44.69	1.16	10.75	V
	3395	-55.00	-13	-42.00	-70.86	-63.76	1.34	12.25	V
									V
									V
									V
									V

Remark: Spurious emissions within 30-1000MHz were found more than 20dB below limit line.



EDGE 850

EDGE 850									
Channel	Frequency (MHz)	ERP (dBm)	Limit (dBm)	Over Limit (dB)	SPA Reading (dBm)	S.G. Power (dBm)	TX Cable loss (dB)	TX Antenna Gain (dBi)	Polarization (H/V)
Lowest	1648	-59.53	-13	-46.53	-69.62	-65.12	0.92	8.66	H
	2473	-48.31	-13	-35.31	-62.62	-55.68	1.14	10.66	H
	3297	-55.82	-13	-42.82	-71.49	-64.36	1.32	12.01	H
									H
									H
									H
									H
	1648	-60.92	-13	-47.92	-70.48	-66.51	0.92	8.66	V
	2473	-49.63	-13	-36.63	-64.09	-57.00	1.14	10.66	V
	3297	-55.40	-13	-42.40	-71.55	-63.94	1.32	12.01	V
									V
									V
									V
									V
Middle	1673	-61.20	-13	-48.20	-71.37	-66.88	0.93	8.76	H
	2509	-46.20	-13	-33.20	-60.49	-53.61	1.15	10.71	H
	3344	-56.11	-13	-43.11	-71.66	-64.75	1.33	12.13	H
									H
									H
									H
									H
	1673	-61.85	-13	-48.85	-71.38	-67.53	0.93	8.76	V
	2509	-45.94	-13	-32.94	-60.43	-53.35	1.15	10.71	V
	3344	-55.41	-13	-42.41	-71.4	-64.05	1.33	12.13	V
									V
									V
									V
									V



Highest	1696	-60.54	-13	-47.54	-70.78	-66.30	0.94	8.84	H
	2544	-47.25	-13	-34.25	-61.51	-54.69	1.16	10.75	H
	3392	-55.93	-13	-42.93	-71.37	-64.68	1.34	12.24	H
									H
									H
									H
									H
	1696	-61.49	-13	-48.49	-71.02	-67.25	0.94	8.84	V
	2544	-47.26	-13	-34.26	-61.63	-54.70	1.16	10.75	V
	3392	-55.27	-13	-42.27	-71.14	-64.02	1.34	12.24	V
									V
									V
									V
									V

Remark: Spurious emissions within 30-1000MHz were found more than 20dB below limit line.



WCDMA 850

WCDMA 850									
Channel	Frequency (MHz)	ERP (dBm)	Limit (dBm)	Over Limit (dB)	SPA Reading (dBm)	S.G. Power (dBm)	TX Cable loss (dB)	TX Antenna Gain (dBi)	Polarization (H/V)
Lowest	1656	-60.61	-13	-47.61	-70.73	-66.23	0.92	8.69	H
	2479	-57.01	-13	-44.01	-71.32	-64.39	1.15	10.67	H
	3304	-55.59	-13	-42.59	-71.24	-64.14	1.32	12.03	H
									H
									H
									H
									H
	1656	-61.50	-13	-48.50	-71.05	-67.12	0.92	8.69	V
	2479	-57.01	-13	-44.01	-71.5	-64.39	1.15	10.67	V
	3304	-55.69	-13	-42.69	-71.81	-64.24	1.32	12.03	V
									V
									V
									V
									V
Middle	1672	-61.30	-13	-48.30	-71.46	-66.98	0.93	8.75	H
	2512	-57.35	-13	-44.35	-71.64	-64.76	1.15	10.71	H
	3344	-55.93	-13	-42.93	-71.48	-64.57	1.33	12.13	H
									H
									H
									H
									H
	1672	-61.84	-13	-48.84	-71.37	-67.52	0.93	8.75	V
	2512	-57.21	-13	-44.21	-71.69	-64.62	1.15	10.71	V
	3344	-55.75	-13	-42.75	-71.75	-64.39	1.33	12.13	V
									V
									V
									V
									V



Highest	1696	-61.05	-13	-48.05	-71.29	-66.81	0.94	8.84	H
	2536	-55.73	-13	-42.73	-70	-63.16	1.16	10.74	H
	3386	-56.22	-13	-43.22	-71.66	-64.96	1.34	12.23	H
									H
									H
									H
									H
	1693	-61.76	-13	-48.76	-71.29	-67.51	0.94	8.83	V
	2540	-55.41	-13	-42.41	-69.8	-62.85	1.16	10.75	V
	3386	-55.66	-13	-42.66	-71.54	-64.40	1.34	12.23	V
									V
									V
									V
									V

Remark: Spurious emissions within 30-1000MHz were found more than 20dB below limit line.



GPRS 1900

GPRS 1900									
Channel	Frequency (MHz)	EIRP (dBm)	Limit (dBm)	Over Limit (dB)	SPA Reading (dBm)	S.G. Power (dBm)	TX Cable loss (dB)	TX Antenna Gain (dBi)	Polarization (H/V)
Lowest	3700	-51.57	-13	-38.57	-69.78	-62.78	1.41	12.62	H
	5550	-46.71	-13	-33.71	-69.77	-58.27	1.74	13.30	H
	7403	-42.53	-13	-29.53	-69.6	-51.85	1.94	11.26	H
									H
									H
									H
	3700	-51.34	-13	-38.34	-69.69	-62.55	1.41	12.62	V
	5550	-47.36	-13	-34.36	-69.94	-58.92	1.74	13.30	V
	7403	-42.77	-13	-29.77	-69.68	-52.09	1.94	11.26	V
									V
									V
									V
Middle	3763	-51.34	-13	-38.34	-69.77	-62.57	1.43	12.66	H
	5639	-46.40	-13	-33.40	-69.49	-57.97	1.73	13.30	H
	7522	-44.21	-13	-31.21	-70.71	-53.32	1.99	11.10	H
									H
									H
									H
	3763	-51.27	-13	-38.27	-69.92	-62.50	1.43	12.66	V
	5639	-47.13	-13	-34.13	-69.82	-58.70	1.73	13.30	V
	7522	-44.15	-13	-31.15	-70.61	-53.26	1.99	11.10	V
									V
									V
									V



Highest	3819	-51.41	-13	-38.41	-70.01	-62.66	1.44	12.69	H
	5730	-46.10	-13	-33.10	-69.63	-57.67	1.73	13.30	H
	7641	-44.42	-13	-31.42	-70.47	-53.54	2.01	11.13	H
									H
									H
									H
									H
	3819	-51.03	-13	-38.03	-69.87	-62.28	1.44	12.69	V
	5730	-46.68	-13	-33.68	-69.57	-58.25	1.73	13.30	V
	7641	-44.85	-13	-31.85	-70.8	-53.97	2.01	11.13	V
									V
									V
									V
								V	

Remark: Spurious emissions within 30-1000MHz were found more than 20dB below limit line.



EDGE1900

EDGE 1900									
Channel	Frequency (MHz)	EIRP (dBm)	Limit (dBm)	Over Limit (dB)	SPA Reading (dBm)	S.G. Power (dBm)	TX Cable loss (dB)	TX Antenna Gain (dBi)	Polarization (H/V)
Lowest	3700	-51.78	-13	-38.78	-69.99	-62.99	1.41	12.62	H
	5550	-47.13	-13	-34.13	-70.19	-58.69	1.74	13.30	H
	7403	-42.67	-13	-29.67	-69.74	-51.99	1.94	11.26	H
									H
									H
									H
	3700	-51.54	-13	-38.54	-69.89	-62.75	1.41	12.62	V
	5550	-47.33	-13	-34.33	-69.91	-58.89	1.74	13.30	V
	7403	-43.06	-13	-30.06	-69.97	-52.38	1.94	11.26	V
									V
									V
									V
Middle	3763	-51.45	-13	-38.45	-69.88	-62.68	1.43	12.66	H
	5639	-46.58	-13	-33.58	-69.68	-58.15	1.73	13.30	H
	7522	-44.56	-13	-31.56	-71.07	-53.67	1.99	11.10	H
									H
									H
									H
	3763	-51.06	-13	-38.06	-69.71	-62.29	1.43	12.66	V
	5639	-47.08	-13	-34.08	-69.77	-58.65	1.73	13.30	V
	7522	-44.25	-13	-31.25	-70.71	-53.36	1.99	11.10	V
									V
									V
									V



Highest	3819	-50.98	-13	-37.98	-69.58	-62.23	1.44	12.69	H
	5730	-46.13	-13	-33.13	-69.66	-57.70	1.73	13.30	H
	7641	-44.80	-13	-31.80	-70.85	-53.92	2.01	11.13	H
									H
									H
									H
									H
	3819	-51.34	-13	-38.34	-70.18	-62.59	1.44	12.69	V
	5730	-46.73	-13	-33.73	-69.62	-58.30	1.73	13.30	V
	7641	-44.75	-13	-31.75	-70.7	-53.87	2.01	11.13	V
									V
									V
									V
									V

Remark: Spurious emissions within 30-1000MHz were found more than 20dB below limit line.



<WPC Mode>

GPRS 850									
Channel	Frequency (MHz)	EIRP (dBm)	Limit (dBm)	Over Limit (dB)	SPA Reading (dBm)	S.G. Power (dBm)	TX Cable loss (dB)	TX Antenna Gain (dBi)	Polarization (H/V)
Highest	1697	-55.73	-13	-42.73	-65.97	-61.49	0.94	8.85	H
	2544	-41.63	-13	-28.63	-55.89	-49.07	1.16	10.75	H
	3392	-56.14	-13	-43.14	-71.58	-64.89	1.34	12.24	H
									H
									H
									H
									H
	1697	-58.36	-13	-45.36	-67.89	-64.12	0.94	8.85	V
	2544	-41.13	-13	-28.13	-55.5	-48.57	1.16	10.75	V
	3392	-55.81	-13	-42.81	-71.68	-64.56	1.34	12.24	V
									V
									V
									V
									V

Remark: Spurious emissions within 30-1000MHz were found more than 20dB below limit line.