



FCC RADIO TEST REPORT

FCC ID : PY7-87261H
Equipment : GSM/WCDMA/LTE Phone with BT, DTS/UNII
a/b/g/n/ac/ax, GPS, WPC and NFC
Brand Name : Sony
Applicant : Sony Mobile Communications Inc.
4-12-3 Higashi-Shinagawa, Shinagawa-ku,
Tokyo, 140-0002, Japan
Manufacturer : Sony Mobile Communications Inc.
4-12-3 Higashi-Shinagawa, Shinagawa-ku,
Tokyo, 140-0002, Japan
Standard : FCC Part 15 Subpart C §15.247

The product was received on Dec. 04, 2019 and testing was started from Dec. 22, 2019 and completed on Jan. 31, 2020. We, SPORTON INTERNATIONAL INC. EMC & Wireless Communications Laboratory, would like to declare that the tested sample has been evaluated in accordance with the test procedures and has been in compliance with the applicable technical standards.

The report must not be used by the client to claim product certification, approval, or endorsement by TAF or any agency of government.

The test results in this report apply exclusively to the tested model / sample. Without written approval of SPORTON INTERNATIONAL INC. EMC & Wireless Communications Laboratory, the test report shall not be reproduced except in full.

Louis Wu

Approved by: Louis Wu

SPORTON INTERNATIONAL INC. EMC & Wireless Communications Laboratory

No. 52, Huaya 1st Rd., Guishan Dist., Taoyuan City, Taiwan (R.O.C.)



Table of Contents

History of this test report.....	3
Summary of Test Result.....	4
1 General Description.....	5
1.1 Product Feature of Equipment Under Test.....	5
1.2 Modification of EUT.....	5
1.3 Testing Location.....	6
1.4 Applicable Standards.....	6
2 Test Configuration of Equipment Under Test.....	7
2.1 Carrier Frequency Channel.....	7
2.2 Test Mode.....	8
2.3 Connection Diagram of Test System.....	9
2.4 Support Unit used in test configuration and system.....	11
2.5 EUT Operation Test Setup.....	11
2.6 Measurement Results Explanation Example.....	11
3 Test Result.....	12
3.1 6dB and 99% Bandwidth Measurement.....	12
3.2 Output Power Measurement.....	19
3.3 Power Spectral Density Measurement.....	20
3.4 Conducted Band Edges and Spurious Emission Measurement.....	27
3.5 Radiated Band Edges and Spurious Emission Measurement.....	36
3.6 AC Conducted Emission Measurement.....	41
3.7 Antenna Requirements.....	43
4 List of Measuring Equipment.....	44
5 Uncertainty of Evaluation.....	46
Appendix A. Conducted Test Results	
Appendix B. AC Conducted Emission Test Result	
Appendix C. Radiated Spurious Emission	
Appendix D. Radiated Spurious Emission Plots	
Appendix E. Duty Cycle Plots	



History of this test report

Report No.	Version	Description	Issued Date
FR901542-02B	01	Initial issue of report	Feb. 04, 2020



Summary of Test Result

Report Clause	Ref Std. Clause	Test Items	Result (PASS/FAIL)	Remark
3.1	15.247(a)(2)	6dB Bandwidth	Pass	-
3.1	2.1049	99% Occupied Bandwidth	Reporting only	-
3.2	15.247(b)(3)	Output Power	Pass	-
3.3	15.247(e)	Power Spectral Density	Pass	-
3.4	15.247(d)	Conducted Band Edges and Spurious Emission	Pass	-
3.5	15.247(d)	Radiated Band Edges and Spurious Emission	Pass	Under limit 8.13 dB at 2323.860 MHz
3.6	15.207	AC Conducted Emission	Pass	Under limit 11.23 dB at 1.585 MHz
3.7	15.203 & 15.247(b)	Antenna Requirement	Pass	-

Declaration of Conformity:

The test results with all measurement uncertainty excluded are presented in accordance with the regulation limits or requirements declared by manufacturers.

Comments and Explanations:

The declared of product specification for EUT presented in the report are provided by the manufacturer, and the manufacturer takes all the responsibilities for the accuracy of product specification.

Reviewed by: Wii Chang

Report Producer: Yvonne Cheng



1 General Description

1.1 Product Feature of Equipment Under Test

GSM/WCDMA/LTE, Bluetooth, DTS/UNII a/b/g/n/ac/ax, NFC, GNSS and WPC.

Standards-related Product Specification	
Antenna Type / Gain	Loop Antenna with gain -2.40 dBi

EUT Information List			
HW Version	SW Version	S/N	Performed Test Item
A	0.261	BH950071J7	RF conducted measurement
	2.98	QV7100AP2A	Radiated Spurious Emission
	2.38	QV7100Q62A	AC Conducted Emission

Accessory List	
AC Adapter	Model Name : UCH32
	S/N: 6218W30200178 (for Radiated Spurious Emission) 6218W30200005 (for Conducted Emission)
Earphone	Model Name : STH40D
	S/N : S458096
Bluetooth Earphone	Model Name : SBH82D
	S/N : N/A
USB Cable	Model Name : UCB24
	S/N : N/A
Audio Cable	Model Name : EC234
	S/N : N/A

Note:

1. Above EUT list used are electrically identical per declared by manufacturer.
2. Above the accessories list are used to exercise the EUT during test, and the serial number of each type of accessories is listed in each section of this report. .
3. For other wireless features of this EUT, test report will be issued separately.

1.2 Modification of EUT

No modifications are made to the EUT during all test items.



1.3 Testing Location

Test Site	SPORTON INTERNATIONAL INC. EMC & Wireless Communications Laboratory	
Test Site Location	No.52, Huaya 1st Rd., Guishan Dist., Taoyuan City, Taiwan (R.O.C.) TEL: +886-3-327-3456 FAX: +886-3-328-4978	
Test Site No.	Sporton Site No.	
	TH05-HY	CO05-HY

Note: The test site complies with ANSI C63.4 2014 requirement.

Test Site	SPORTON INTERNATIONAL INC. EMC & Wireless Communications Laboratory	
Test Site Location	No.58, Aly. 75, Ln. 564, Wenhua 3rd, Rd., Guishan Dist., Taoyuan City, Taiwan (R.O.C.) TEL: +886-3-327-0868 FAX: +886-3-327-0855	
Test Site No.	Sporton Site No.	
	03CH16-HY	

Note: The test site complies with ANSI C63.4 2014 requirement.

FCC Designation No.: TW1190 and TW0007

1.4 Applicable Standards

According to the specifications of the manufacturer, the EUT must comply with the requirements of the following standards:

- ♦ FCC Part 15 Subpart C §15.247
- ♦ FCC KDB Publication No. 558074 D01 DTS Meas. Guidance v05r02
- ♦ FCC KDB 414788 D01 Radiated Test Site v01r01.
- ♦ ANSI C63.10-2013

Remark:

1. All test items were verified and recorded according to the standards and without any deviation during the test.
2. This EUT has also been tested and complied with the requirements of FCC Part 15, Subpart B, recorded in a separate test report.



2 Test Configuration of Equipment Under Test

2.1 Carrier Frequency Channel

Frequency Band	Channel	Freq. (MHz)	Channel	Freq. (MHz)
2400-2483.5 MHz	0	2402	21	2444
	1	2404	22	2446
	2	2406	23	2448
	3	2408	24	2450
	4	2410	25	2452
	5	2412	26	2454
	6	2414	27	2456
	7	2416	28	2458
	8	2418	29	2460
	9	2420	30	2462
	10	2422	31	2464
	11	2424	32	2466
	12	2426	33	2468
	13	2428	34	2470
	14	2430	35	2472
	15	2432	36	2474
	16	2434	37	2476
	17	2436	38	2478
	18	2438	39	2480
	19	2440	-	-
20	2442	-	-	



2.2 Test Mode

- a. The EUT has been associated with peripherals and configuration operated in a manner tended to maximize its emission characteristics in a typical application. Frequency range investigated: conduction emission (150 kHz to 30 MHz), radiation emission (9 kHz to the 10th harmonic of the highest fundamental frequency or to 40 GHz, whichever is lower). For radiated measurement, pre-scanned in three orthogonal panels, X, Y, Z. The worst cases (X plnae) were recorded in this report.
- b. AC power line Conducted Emission was tested under maximum output power.

The following summary table is showing all test modes to demonstrate in compliance with the standard.

Summary table of Test Cases	
Test Item	Data Rate / Modulation
	Bluetooth – LE / GFSK
Conducted Test Cases	Mode 1: Bluetooth Tx CH00_2402 MHz_1Mbps Mode 2: Bluetooth Tx CH19_2440 MHz_1Mbps Mode 3: Bluetooth Tx CH39_2480 MHz_1Mbps Mode 4: Bluetooth Tx CH00_2402 MHz_2Mbps Mode 5: Bluetooth Tx CH19_2440 MHz_2Mbps Mode 6: Bluetooth Tx CH39_2480 MHz_2Mbps
Radiated Test Cases	Mode 1: Bluetooth Tx CH00_2402 MHz_1Mbps Mode 2: Bluetooth Tx CH19_2440 MHz_1Mbps Mode 3: Bluetooth Tx CH39_2480 MHz_1Mbps Mode 4: Bluetooth Tx CH00_2402 MHz_2Mbps Mode 5: Bluetooth Tx CH19_2440 MHz_2Mbps Mode 6: Bluetooth Tx CH39_2480 MHz_2Mbps
AC Conducted Emission	Mode 1 : GSM850 Idle + Bluetooth Link + WLAN (2.4GHz) Link + MPEG4 + USB Cable (Charging from Adapter) + Earphone + Battery Mode 2 : GSM850 Idle + Bluetooth Link + WLAN (2.4GHz) Link + MPEG4 + Earphone + Battery + WPC Charging pad (Charging from Adapter)

2.3 Connection Diagram of Test System

<AC Conducted Emission>

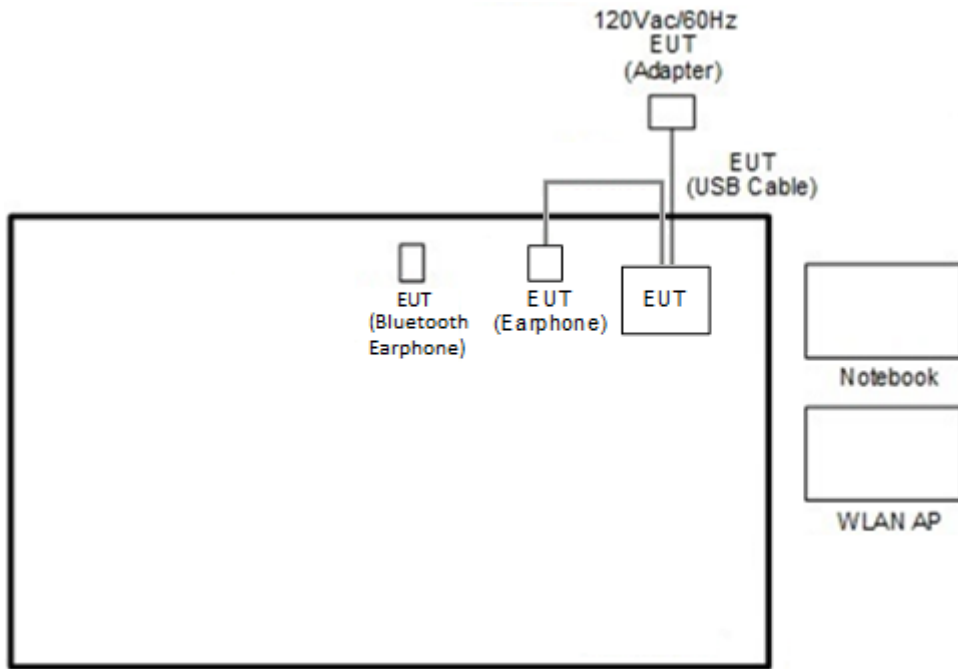

<AC Conducted Emission with WPC Charger>

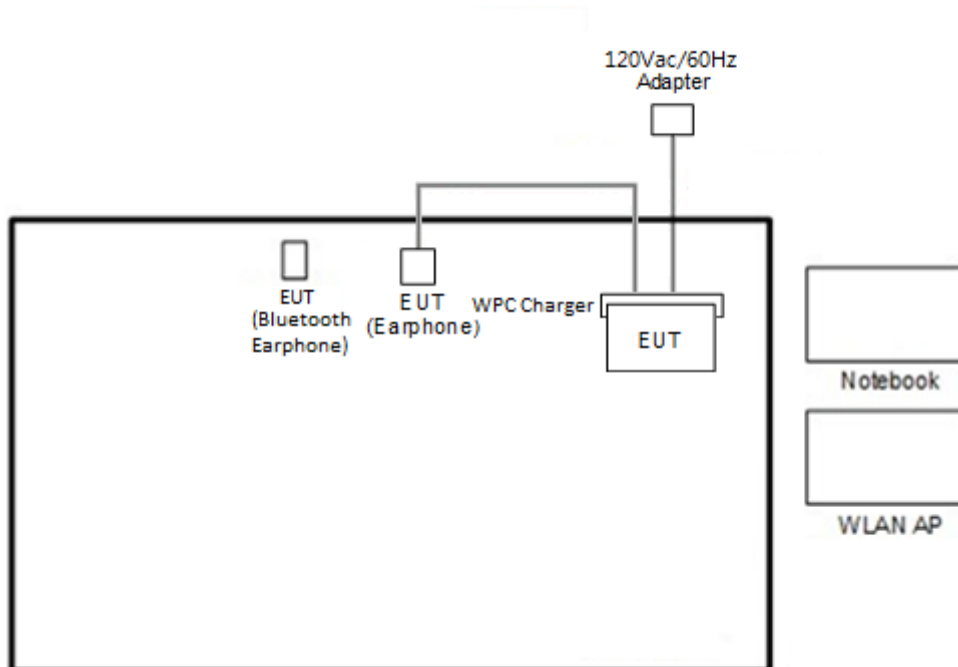

< For Radiated Emissions Measurement >

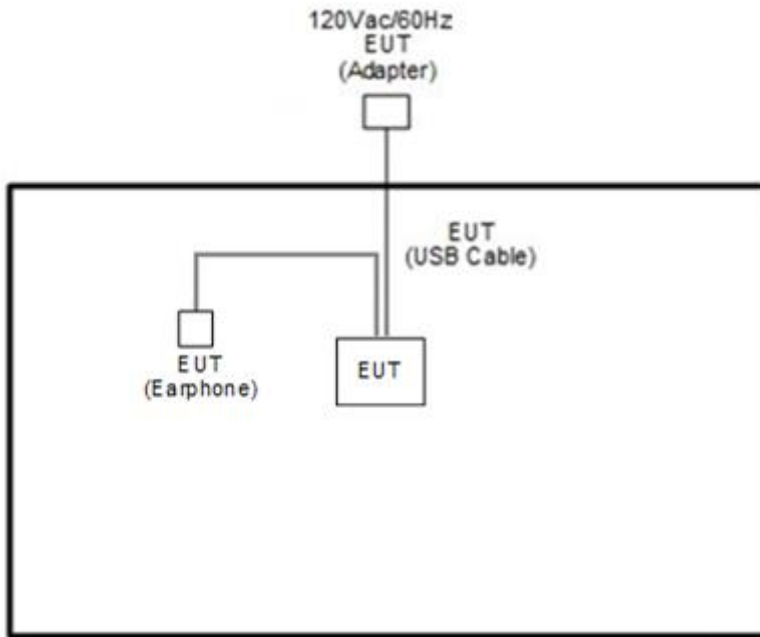

<For Radiated Emissions Measurement with WPC Charger>

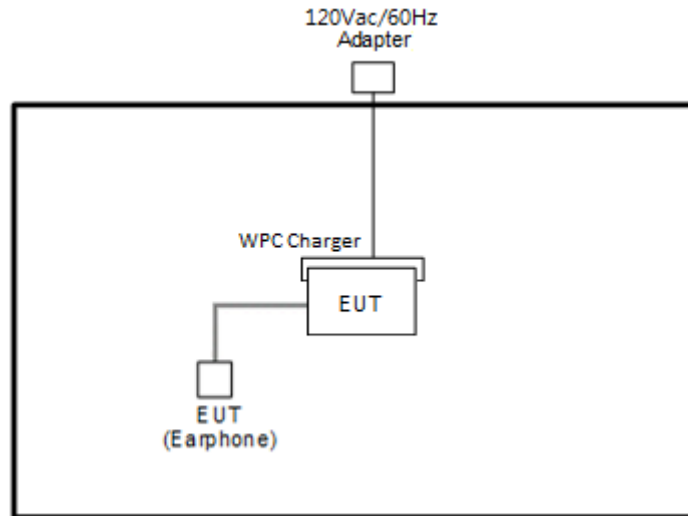



2.4 Support Unit used in test configuration and system

Item	Equipment	Trade Name	Model Name	FCC ID	Data Cable	Power Cord
1.	System Simulator	R&S	CMU 200	N/A	N/A	Unshielded, 1.8 m
2.	WLAN AP	ASUS	RT-AC66U	MSQ-RTAC66U	N/A	Unshielded, 1.8 m
3.	Notebook	DELL	Latitude E3400	FCC DoC	N/A	AC I/P: Unshielded, 1.2 m DC O/P: Shielded, 1.8 m
4.	SD Card	SanDisk	MicroSD HC	FCC DoC	N/A	N/A
5.	Wireless charging pad	belkin	F7U050	N/A	N/A	N/A

2.5 EUT Operation Test Setup

The RF test items, utility “FTMC_bridge_forURC_v0.39” was installed in Notebook which was programmed in order to make the EUT get into the engineering modes to provide channel selection, power level, data rate and the application type and for continuous transmitting signals.

2.6 Measurement Results Explanation Example

For all conducted test items:

The offset level is set in the spectrum analyzer to compensate the RF cable loss and attenuator factor between EUT conducted output port and spectrum analyzer. With the offset compensation, the spectrum analyzer reading level is exactly the EUT RF output level.

Example :

The spectrum analyzer offset is derived from RF cable loss and attenuator factor.

Offset = RF cable loss + attenuator factor.

Following shows an offset computation example with cable loss 4.2 dB and 10dB attenuator.

$$\begin{aligned} \text{Offset(dB)} &= \text{RF cable loss(dB)} + \text{attenuator factor(dB)}. \\ &= 4.2 + 10 = 14.2 \text{ (dB)} \end{aligned}$$

3 Test Result

3.1 6dB and 99% Bandwidth Measurement

3.1.1 Limit of 6dB and 99% Bandwidth

The minimum 6 dB bandwidth shall be at least 500 kHz.

3.1.2 Measuring Instruments

See list of measuring equipment of this test report.

3.1.3 Test Procedures

1. The testing follows the ANSI C63.10 Section 6.9.3 (OBW) and 11.8.1 (6dB BW).
2. The RF output of EUT was connected to the spectrum analyzer by RF cable and attenuator. The path loss was compensated to the results for each measurement.
3. Set to the maximum power setting and enable the EUT transmit continuously.
4. Make the measurement with the spectrum analyzer's resolution bandwidth (RBW) = 100 kHz. Set the Video bandwidth (VBW) = 300 kHz. In order to make an accurate measurement. The 6 dB bandwidth must be greater than 500 kHz.
5. For 99% Bandwidth Measurement, the spectrum analyzer's resolution bandwidth (RBW) is set 1-5% of the emission bandwidth and set the Video bandwidth (VBW) $\geq 3 * RBW$.
6. Measure and record the results in the test report.

3.1.4 Test Setup





3.1.5 Test Result of 6dB Bandwidth

Please refer to Appendix A.

<1 Mbps>

6 dB Bandwidth Plot on Channel 00

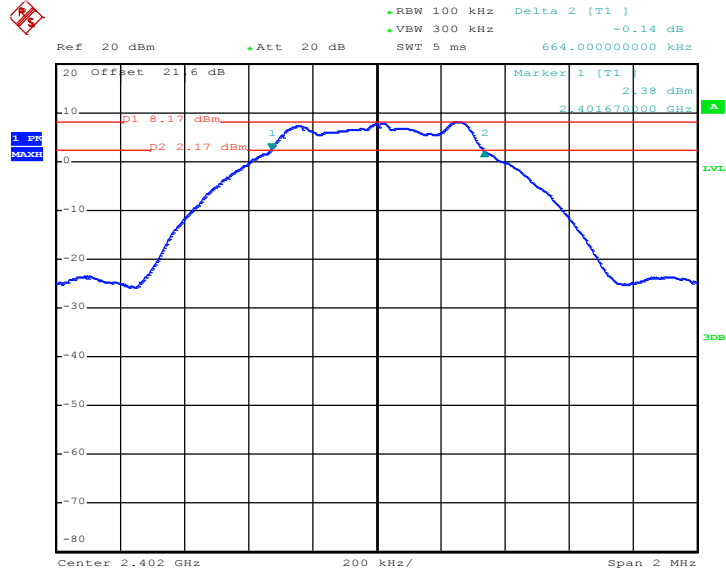

Date: 14.JAN.2020 15:00:36

6 dB Bandwidth Plot on Channel 19

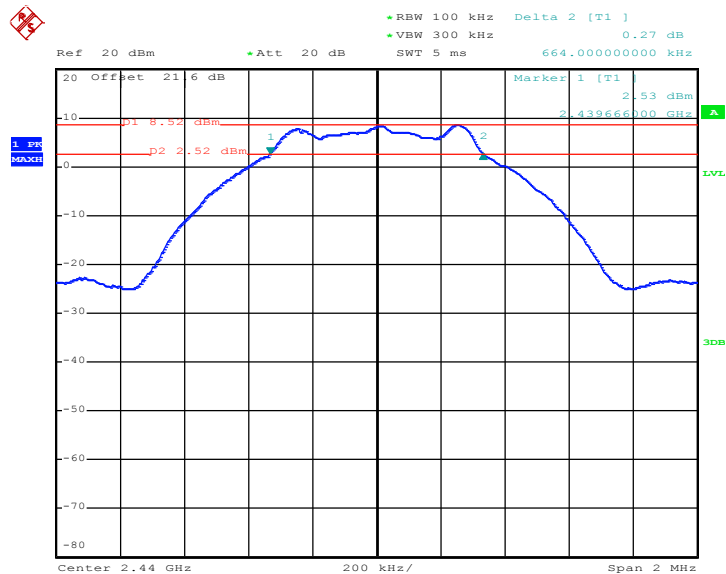

Date: 14.JAN.2020 15:18:57



6 dB Bandwidth Plot on Channel 39

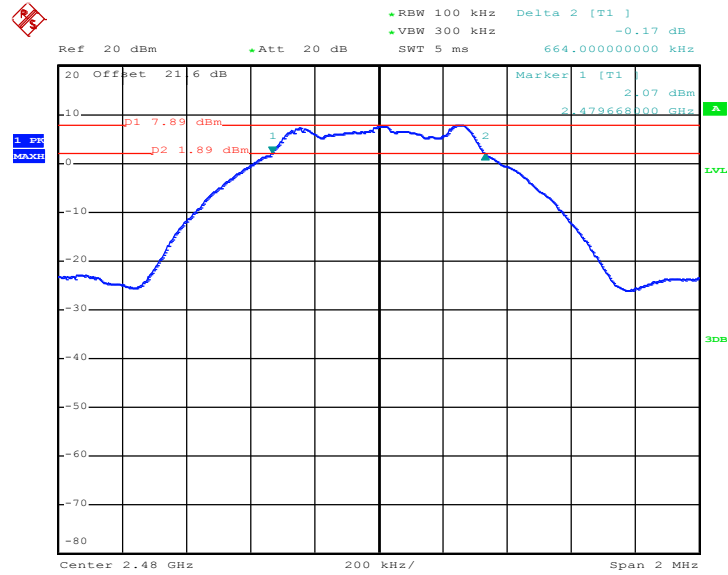

Date: 14.JAN.2020 16:40:50

<2 Mbps>

6 dB Bandwidth Plot on Channel 00

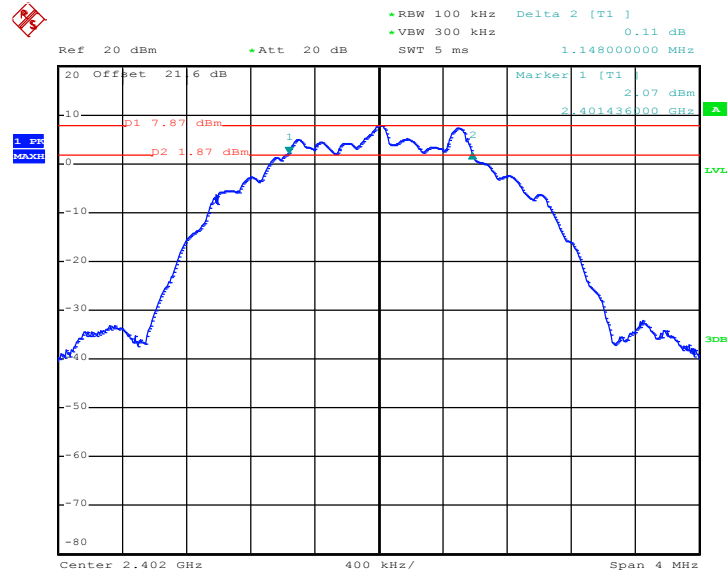

Date: 14.JAN.2020 17:21:20



6 dB Bandwidth Plot on Channel 19

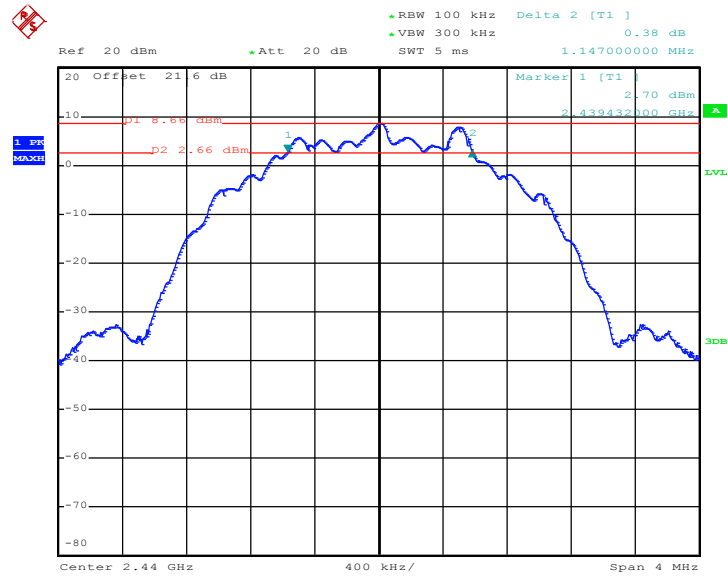

Date: 14.JAN.2020 19:27:38

6 dB Bandwidth Plot on Channel 39

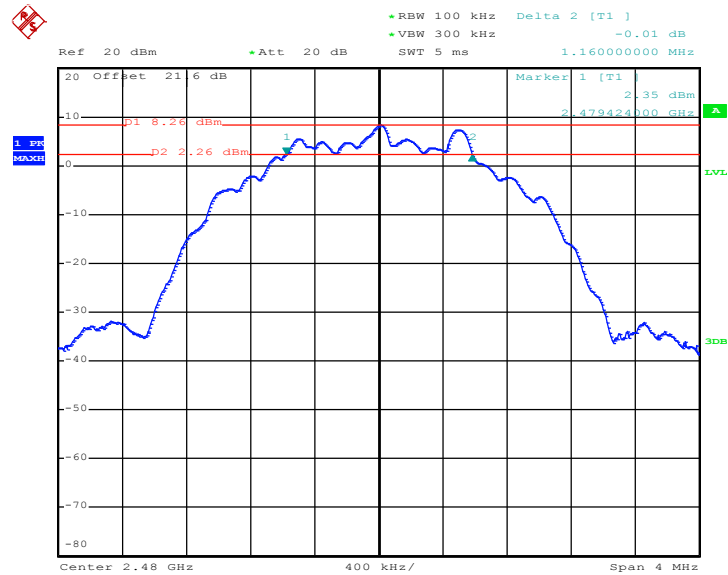

Date: 14.JAN.2020 19:35:51



3.1.6 Test Result of 99% Occupied Bandwidth

Please refer to Appendix A.

<1 Mbps>

99% Bandwidth Plot on Channel 00

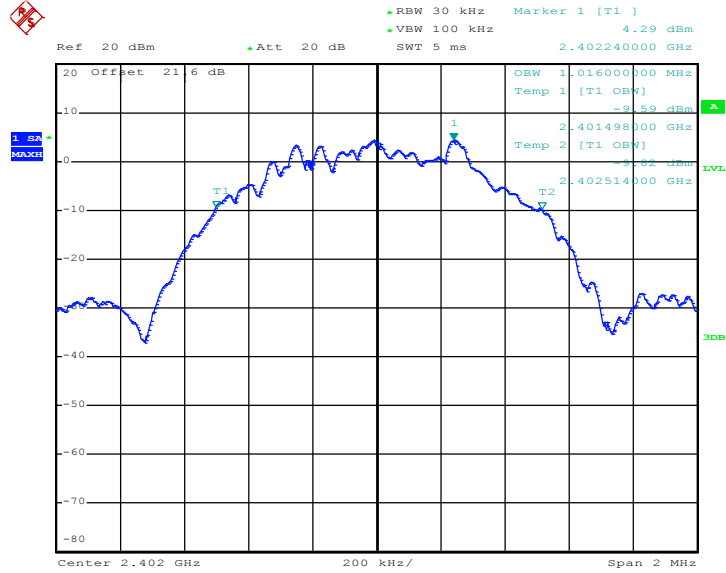

Date: 14.JAN.2020 15:08:56

99% Occupied Bandwidth Plot on Channel 19

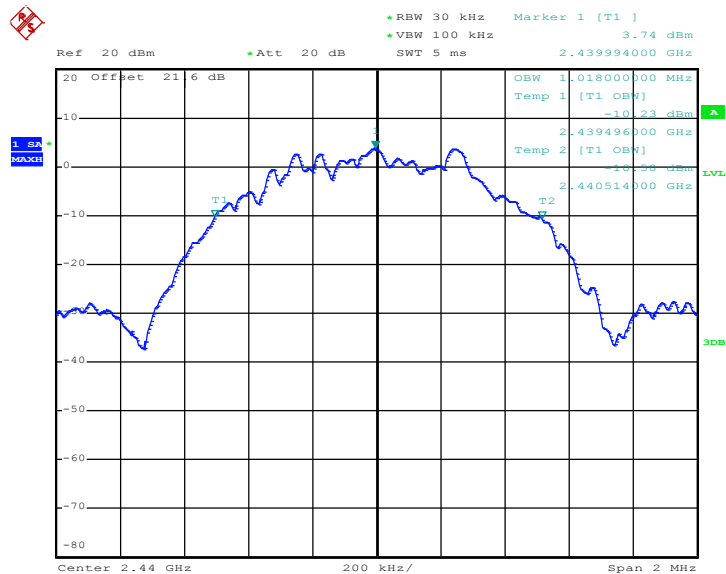

Date: 14.JAN.2020 16:30:21



99% Occupied Bandwidth Plot on Channel 39

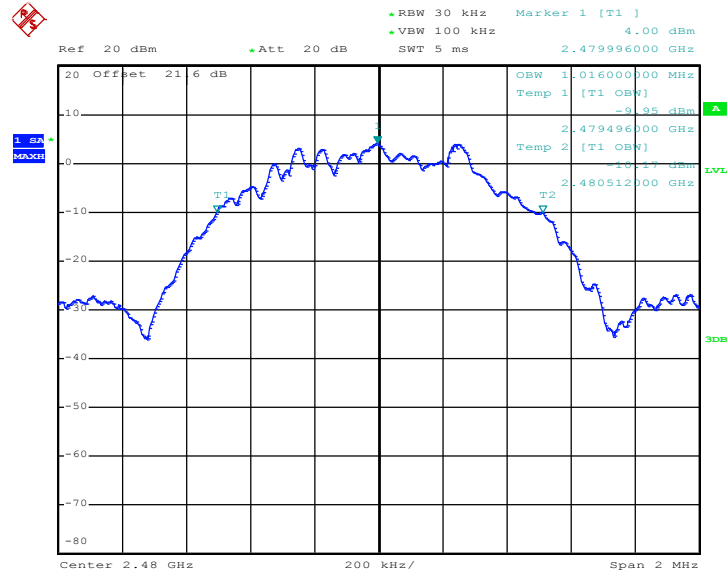

Date: 14.JAN.2020 16:47:50

<2 Mbps>

99% Bandwidth Plot on Channel 00

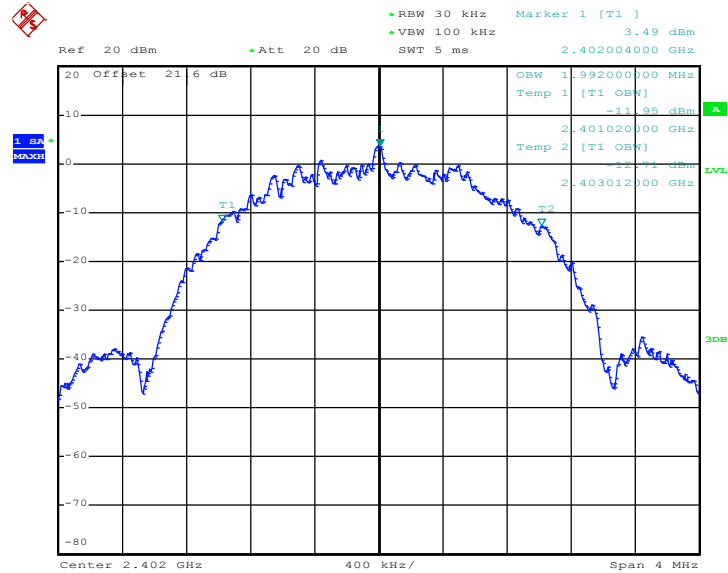

Date: 14.JAN.2020 19:24:55



99% Occupied Bandwidth Plot on Channel 19

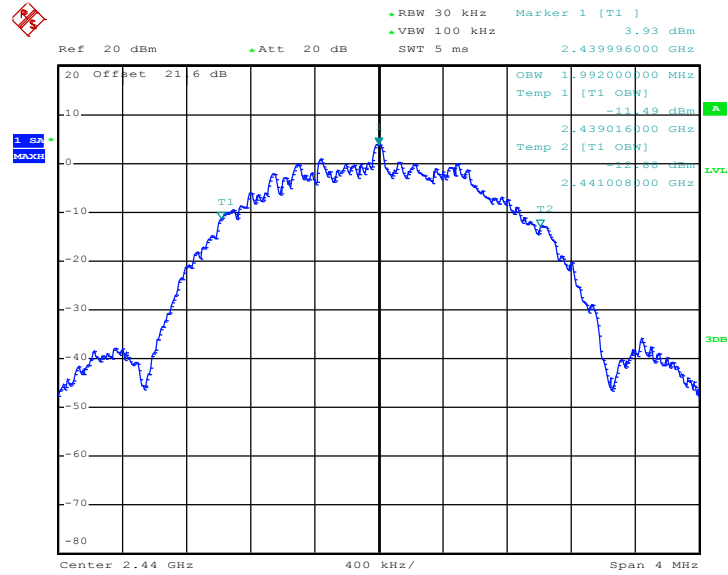

Date: 14.JAN.2020 19:32:21

99% Occupied Bandwidth Plot on Channel 39

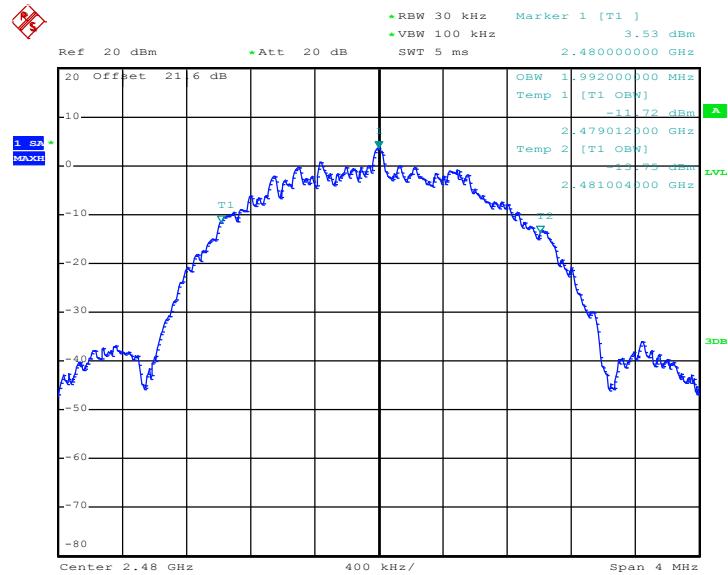

Date: 14.JAN.2020 19:40:34

Note: The occupied channel bandwidth is maintained within the band of operation for all of the modulations.

3.2 Output Power Measurement

3.2.1 Limit of Output Power

For systems using digital modulation in the 2400-2483.5MHz, the limit for peak output power is 30dBm. If transmitting antenna of directional gain greater than 6dBi is used, the peak output power from the intentional radiator shall be reduced below the above stated value by the amount in dB that the directional gain of the antenna exceeds 6 dBi. In case of point-to-point operation, the limit has to be reduced by 1dB for every 3dB that the directional gain of the antenna exceeds 6dBi.

3.2.2 Measuring Instruments

See list of measuring equipment of this test report.

3.2.3 Test Procedures

1. For Average Power, the testing follows ANSI C63.10 Section 11.9.2.3.2 Method AVGP-M-G.
2. The RF output of EUT was connected to the power meter by RF cable and attenuator.
3. The path loss was compensated to the results for each measurement.
4. Set to the maximum power setting and enable the EUT transmit continuously.
5. Measure the conducted output power and record the results in the test report.

3.2.4 Test Setup

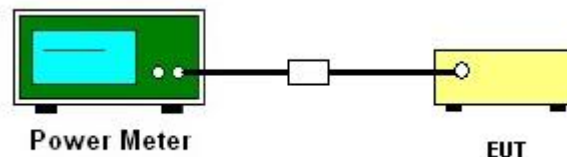

3.2.5 Test Result of Average Output Power

Please refer to Appendix A.

3.3 Power Spectral Density Measurement

3.3.1 Limit of Power Spectral Density

The peak power spectral density shall not be greater than 8dBm in any 3kHz band at any time interval of continuous transmission.

3.3.2 Measuring Instruments

See list of measuring equipment of this test report.

3.3.3 Test Procedures

1. The testing follows the ANSI C63.10 Section 11.10.2 Method PKPSD.
2. The RF output of EUT was connected to the spectrum analyzer by RF cable and attenuator. The path loss was compensated to the results for each measurement.
3. Set to the maximum power setting and enable the EUT transmit continuously.
4. Make the measurement with the spectrum analyzer's resolution bandwidth (RBW) = 3 kHz. Video bandwidth VBW = 10 kHz In order to make an accurate measurement, set the span to 1.5 times DTS Channel Bandwidth. (6dB BW)
5. Detector = peak, Sweep time = auto couple, Trace mode = max hold, Allow trace to fully stabilize. Use the peak marker function to determine the maximum power level.
6. Measure and record the results in the test report.
7. The Measured power density (dBm)/ 100kHz is a reference level and used as 20dBc down limit line for Conducted Band Edges and Conducted Spurious Emission.

3.3.4 Test Setup

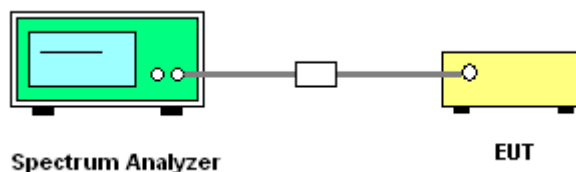

3.3.5 Test Result of Power Spectral Density

Please refer to Appendix A.



3.3.6 Test Result of Power Spectral Density Plots (100kHz)

<1 Mbps>

PSD 100kHz Plot on Channel 00

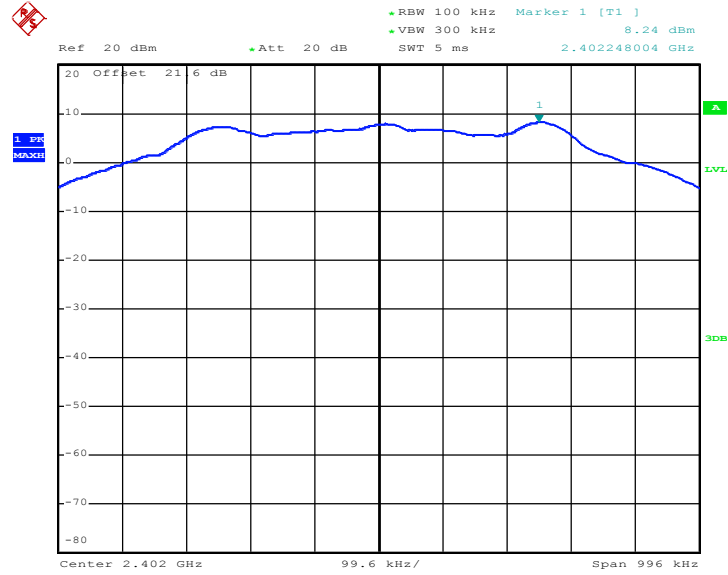

Date: 14.JAN.2020 15:03:51

PSD 100kHz Plot on Channel 19

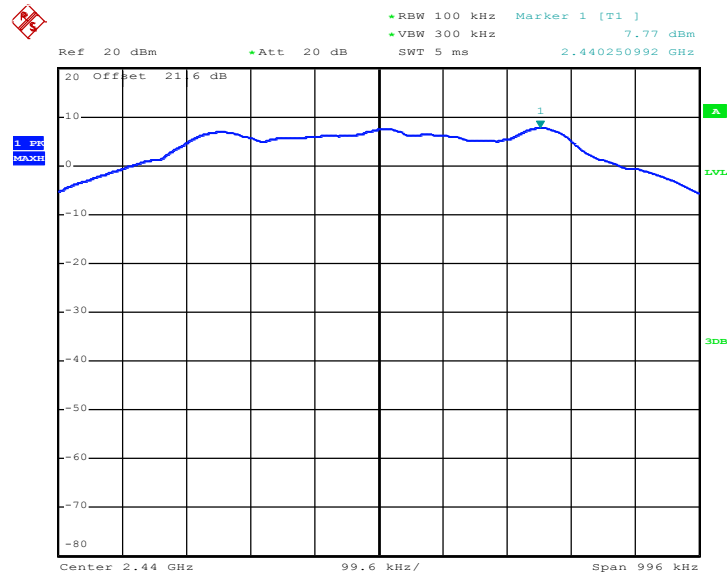

Date: 14.JAN.2020 15:40:54



PSD 100kHz Plot on Channel 39

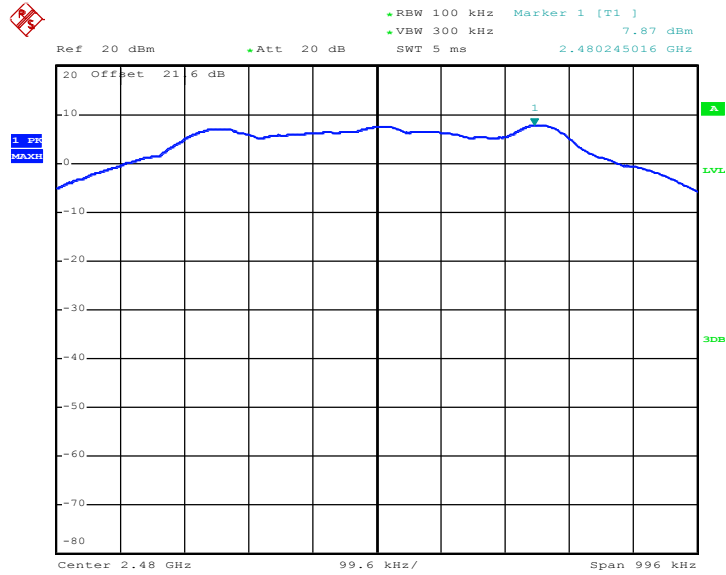

Date: 14.JAN.2020 16:43:35

<2 Mbps>

PSD 100kHz Plot on Channel 00

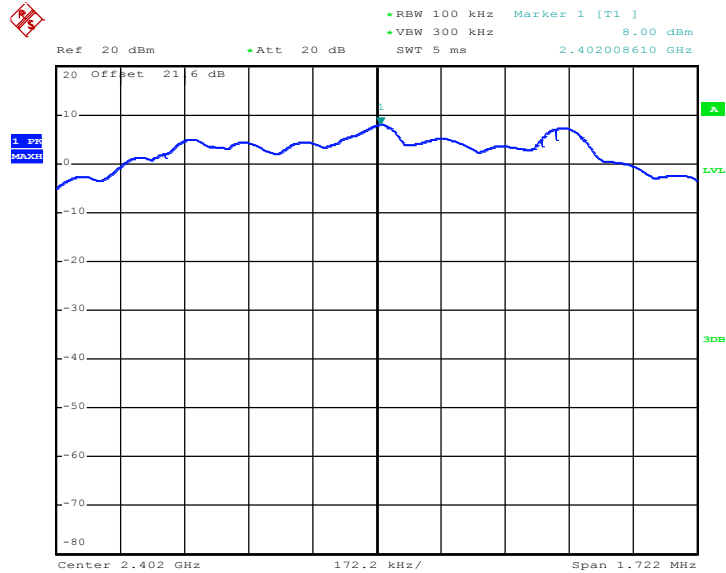

Date: 14.JAN.2020 17:24:36



PSD 100kHz Plot on Channel 19

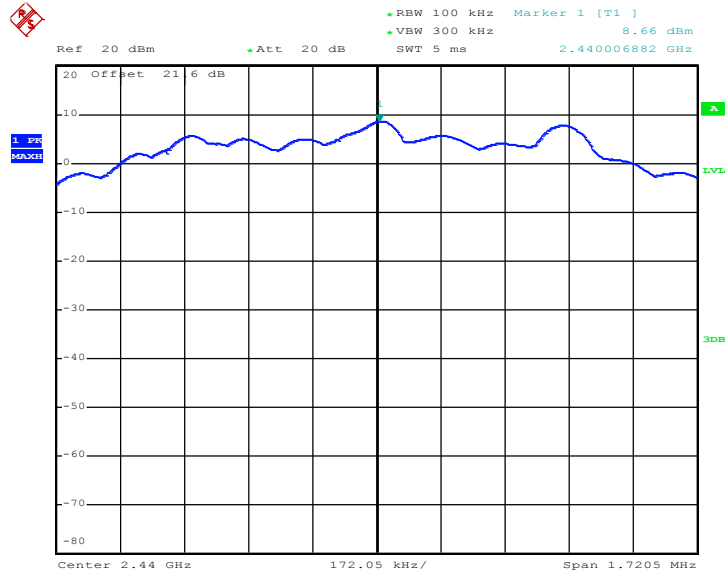

Date: 14.JAN.2020 19:30:30

PSD 100kHz Plot on Channel 39

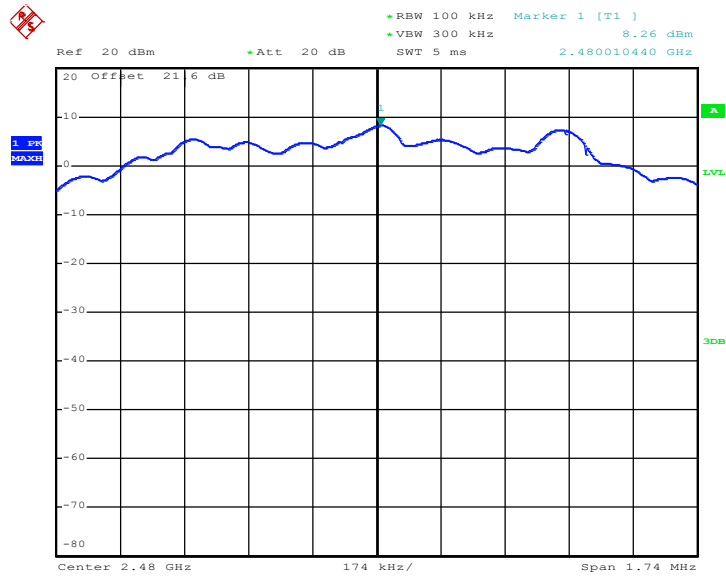

Date: 14.JAN.2020 19:37:15



3.3.7 Test Result of Power Spectral Density Plots (3kHz)

<1 Mbps>

PSD 3kHz Plot on Channel 00

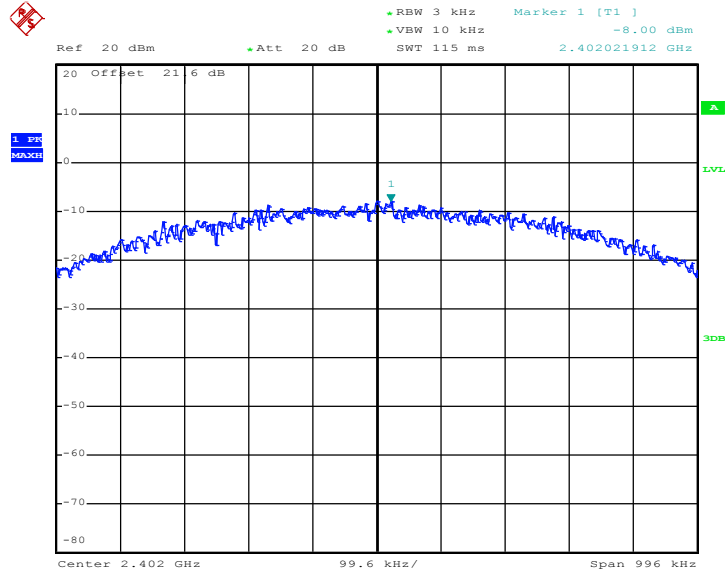

Date: 14.JAN.2020 15:02:06

PSD 3kHz Plot on Channel 19

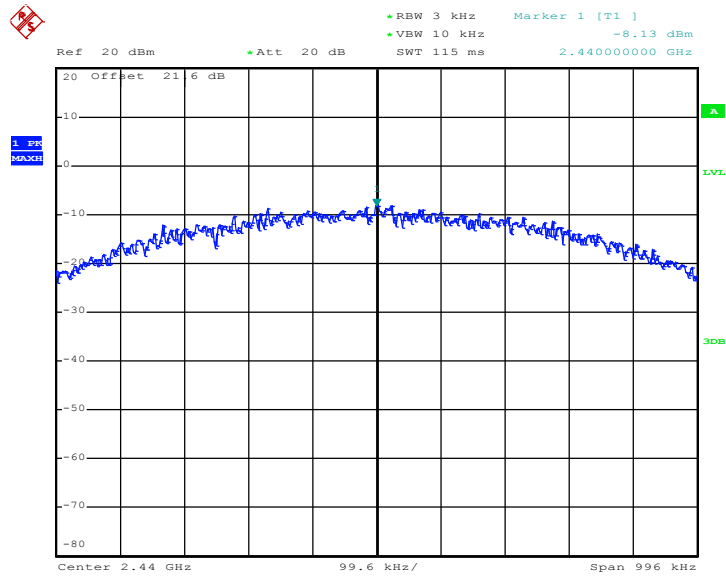

Date: 14.JAN.2020 15:40:09



PSD 3kHz Plot on Channel 39

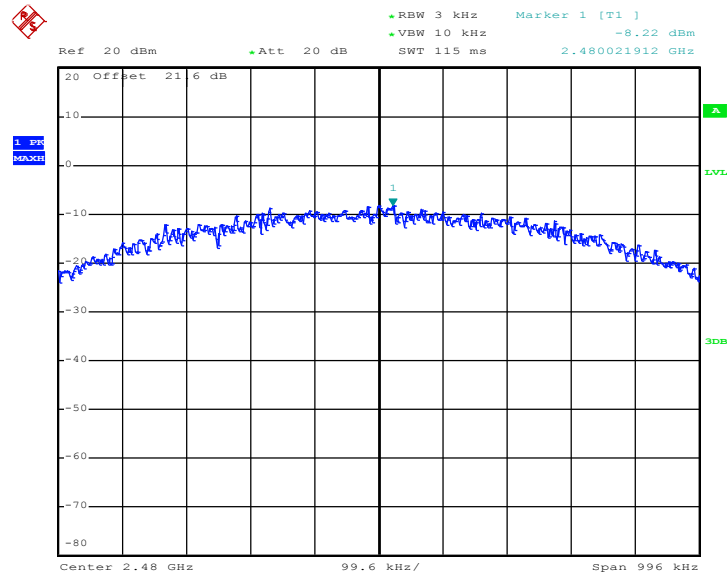

Date: 14.JAN.2020 16:42:18

<2 Mbps>

PSD 3kHz Plot on Channel 00

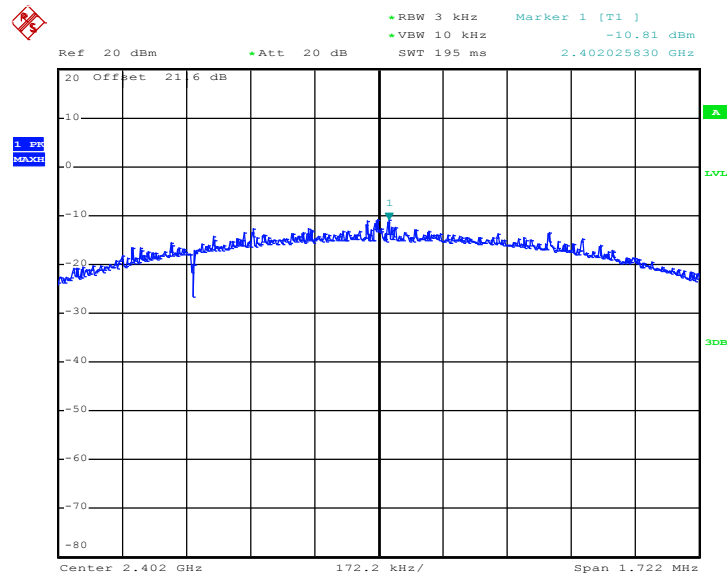

Date: 14.JAN.2020 17:23:46



PSD 3kHz Plot on Channel 19

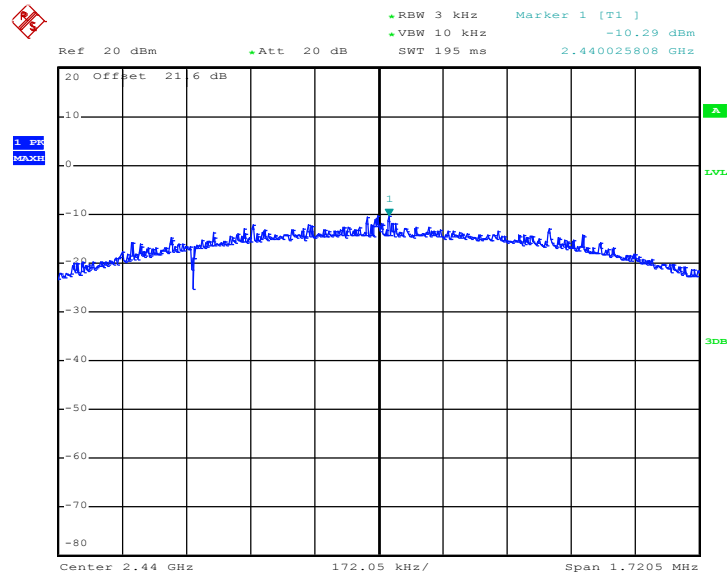

Date: 14.JAN.2020 19:28:36

PSD 3kHz Plot on Channel 39

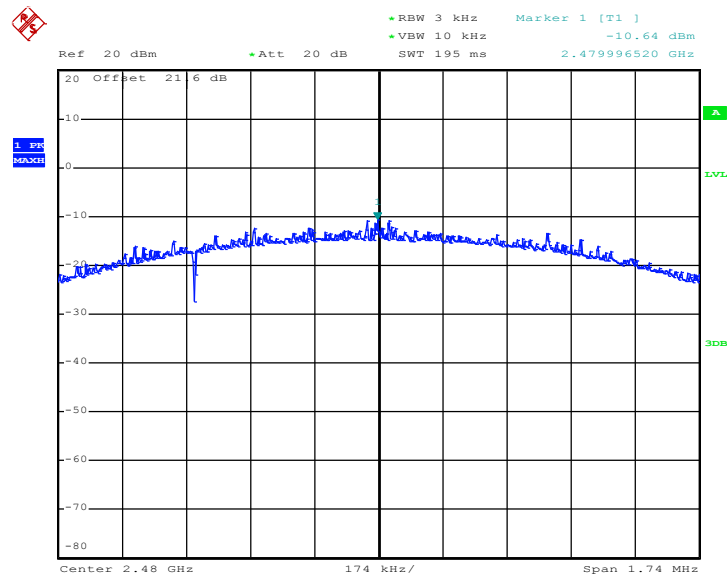

Date: 14.JAN.2020 19:36:43

3.4 Conducted Band Edges and Spurious Emission Measurement

3.4.1 Limit of Conducted Band Edges and Spurious Emission

All harmonics/spurious must be at least 30 dB down from the highest emission level within the authorized band.

3.4.2 Measuring Instruments

See list of measuring equipment of this test report.

3.4.3 Test Procedure

1. The testing follows the ANSI C63.10 Section 11.11.3 Emission level measurement.
2. The RF output of EUT was connected to the spectrum analyzer by RF cable and attenuator. The path loss was compensated to the results for each measurement.
3. Set to the maximum power setting and enable the EUT transmit continuously.
4. Set RBW = 100 kHz, VBW=300 kHz, Peak Detector. Unwanted Emissions measured in any 100 kHz bandwidth outside of the authorized frequency band shall be attenuated by at least 20 dB relative to the maximum in-band peak PSD level in 100 kHz when maximum peak conducted output power procedure is used. If the transmitter complies with the conducted power limits based on the use of RMS averaging over a time interval, the attenuation required under this paragraph shall be 30 dB instead of 20 dB.
5. Measure and record the results in the test report.
6. The RF fundamental frequency should be excluded against the limit line in the operating frequency band.

3.4.4 Test Setup





3.4.5 Test Result of Conducted Band Edges Plots

<1 Mbps>

Low Band Edge Plot on Channel 00

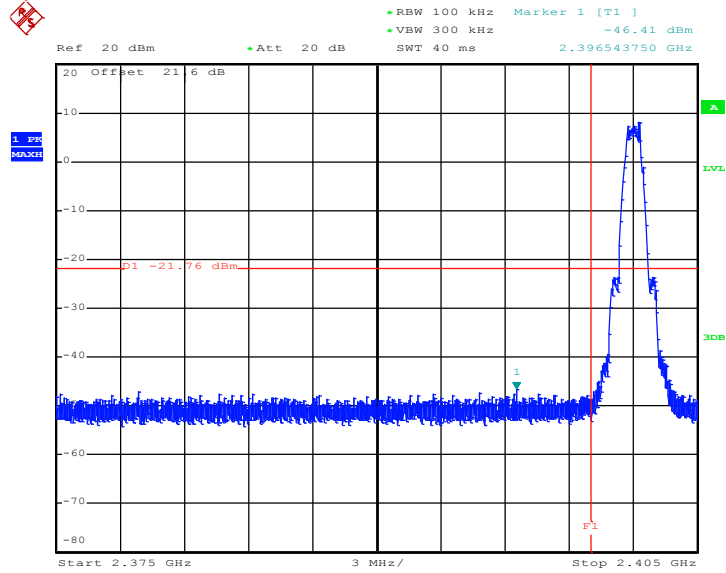

Date: 14.JAN.2020 15:05:20

High Band Edge Plot on Channel 39

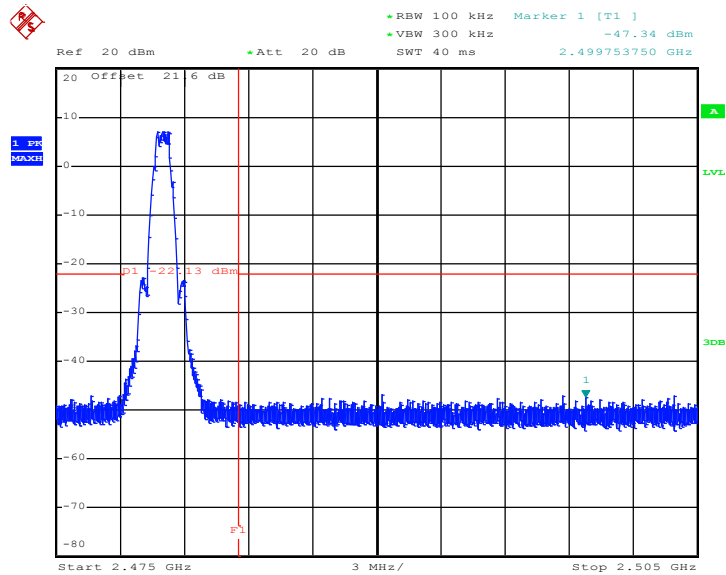

Date: 14.JAN.2020 16:44:49



<2 Mbps>

Low Band Edge Plot on Channel 00

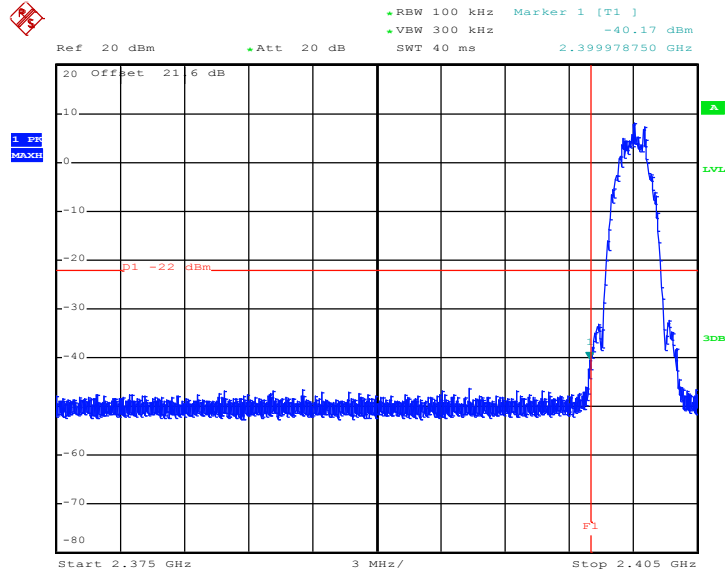

Date: 14.JAN.2020 17:26:06

High Band Edge Plot on Channel 39

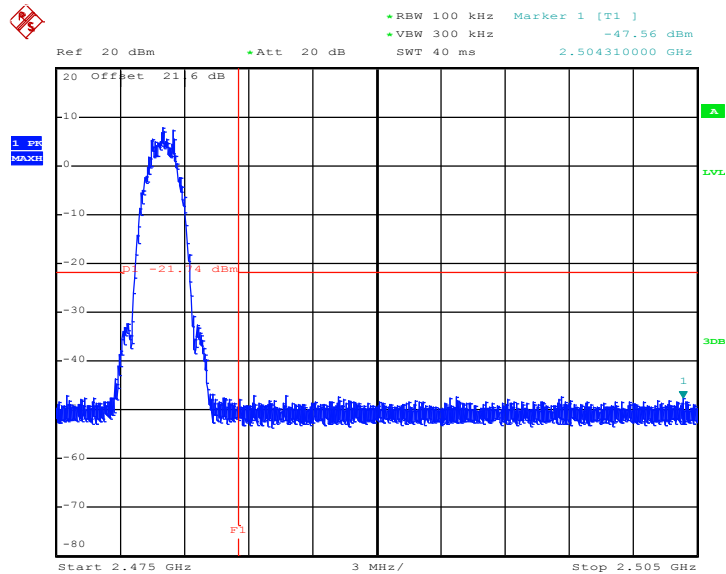

Date: 14.JAN.2020 19:38:19



3.4.6 Test Result of Conducted Spurious Emission Plots

Conducted Spurious Emission Plot on Bluetooth LE 1Mbps GFSK Channel 00

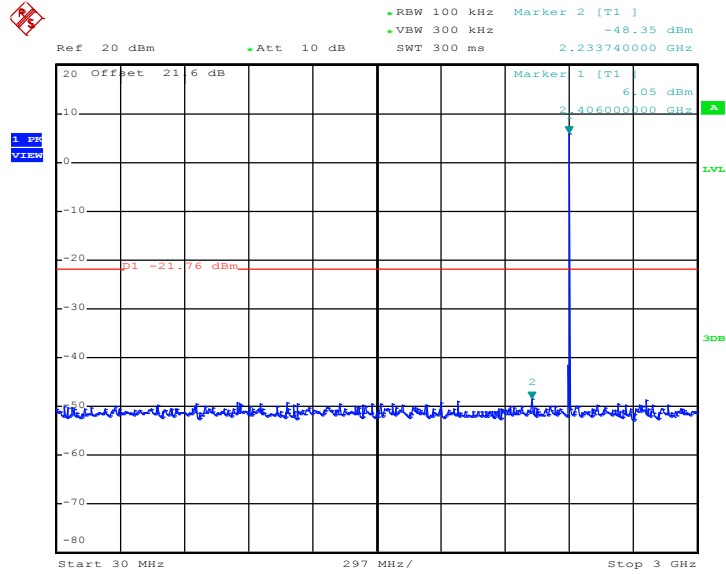

Date: 14.JAN.2020 15:06:22

Conducted Spurious Emission Plot on Bluetooth LE 1Mbps GFSK Channel 00

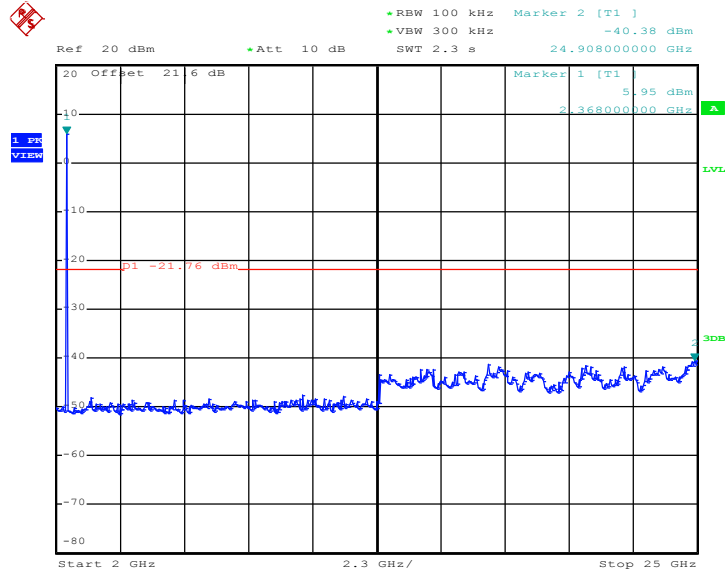

Date: 14.JAN.2020 15:06:39



Conducted Spurious Emission Plot on Bluetooth LE 1Mbps GFSK Channel 19

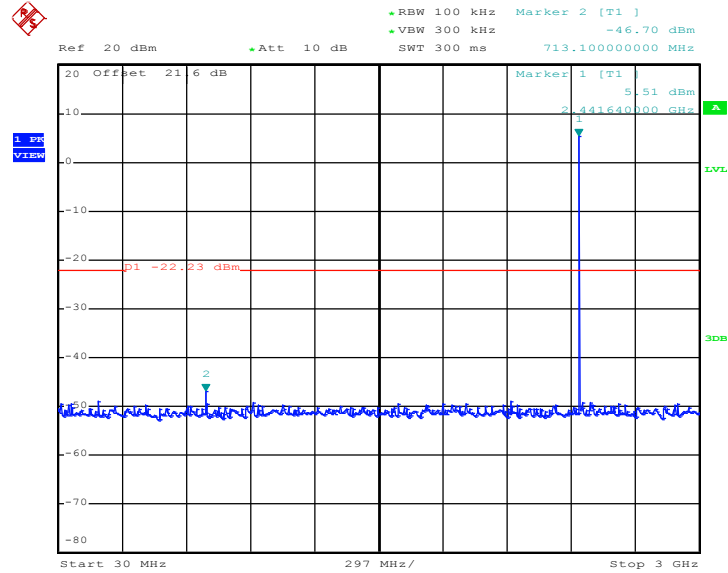

Date: 14.JAN.2020 15:43:33

Conducted Spurious Emission Plot on Bluetooth LE 1Mbps GFSK Channel 19

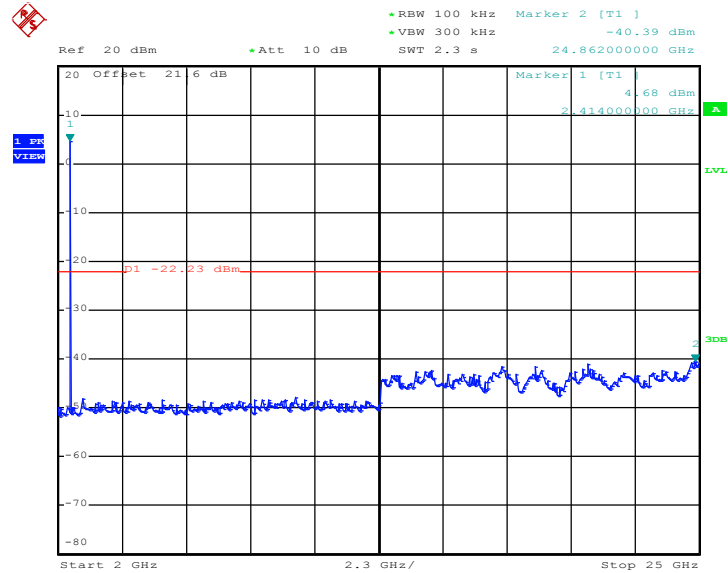

Date: 14.JAN.2020 15:43:53



Conducted Spurious Emission Plot on Bluetooth LE 1Mbps GFSK Channel 39

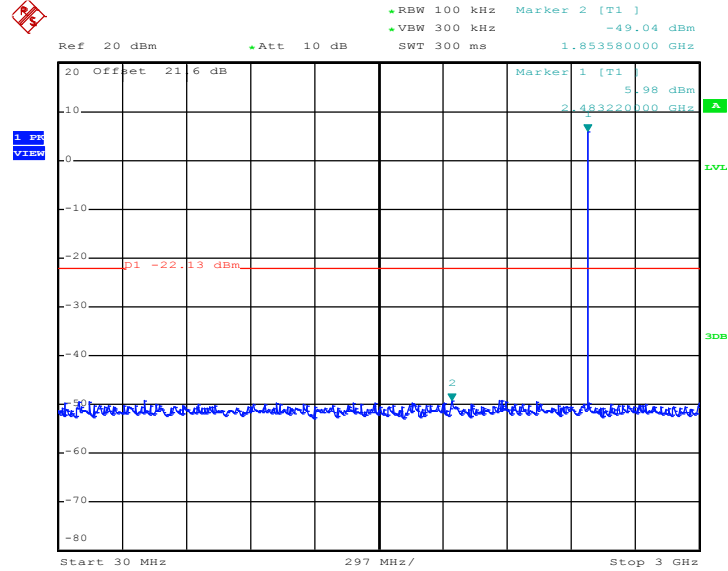

Date: 14.JAN.2020 16:46:35

Conducted Spurious Emission Plot on Bluetooth LE 1Mbps GFSK Channel 39

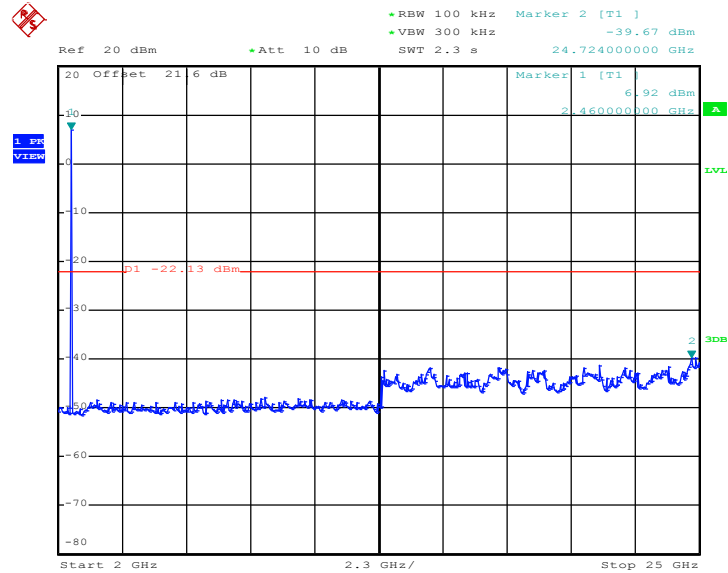

Date: 14.JAN.2020 16:46:50



Conducted Spurious Emission Plot on Bluetooth LE 2Mbps GFSK Channel 00

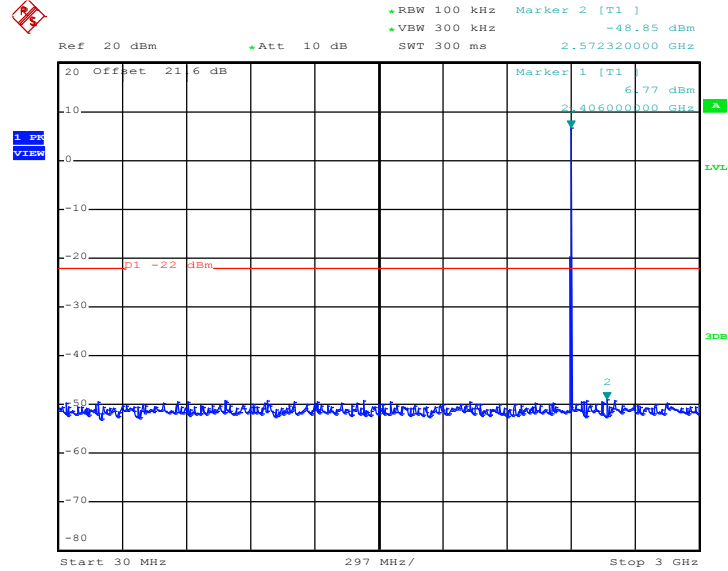

Date: 14.JAN.2020 19:16:40

Conducted Spurious Emission Plot on Bluetooth LE 2Mbps GFSK Channel 00

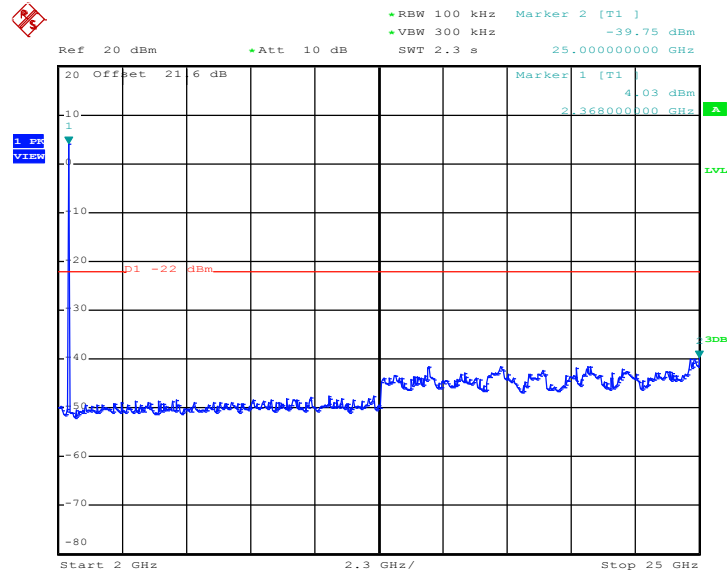

Date: 14.JAN.2020 19:17:00



Conducted Spurious Emission Plot on Bluetooth LE 2Mbps GFSK Channel 19

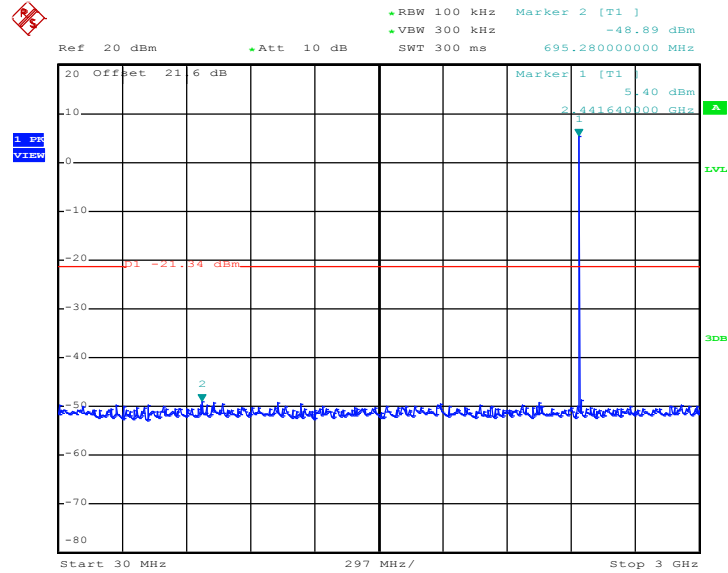

Date: 14.JAN.2020 19:31:08

Conducted Spurious Emission Plot on Bluetooth LE 2Mbps GFSK Channel 19

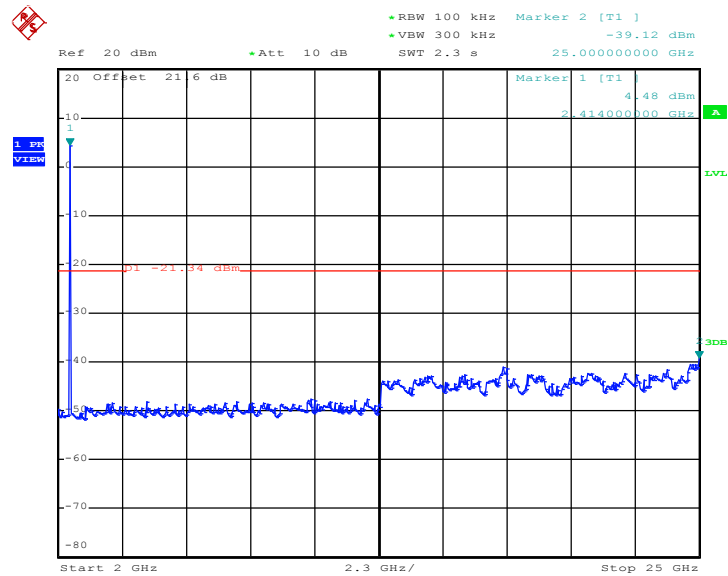

Date: 14.JAN.2020 19:31:27



Conducted Spurious Emission Plot on Bluetooth LE 2Mbps GFSK Channel 39

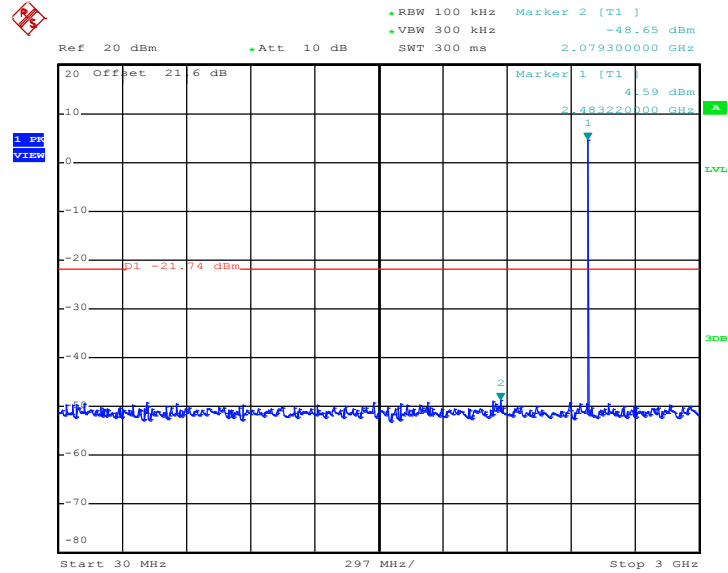

Date: 14.JAN.2020 19:39:16

Conducted Spurious Emission Plot on Bluetooth LE 2Mbps GFSK Channel 39

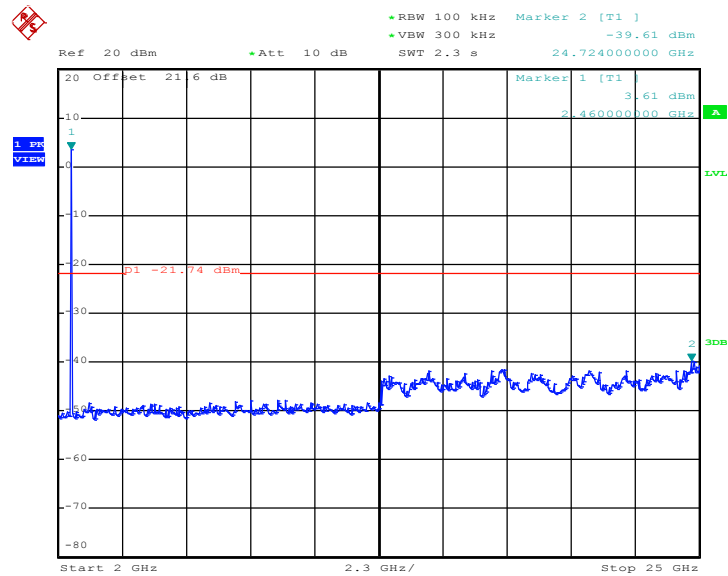

Date: 14.JAN.2020 19:39:32



3.5 Radiated Band Edges and Spurious Emission Measurement

3.5.1 Limit of Radiated Band Edges and Spurious Emission

In any 100 kHz bandwidth outside the intentional radiator frequency band, all harmonics/spurious must be at least 20 dB below the highest emission level within the authorized band. If the output power of this device was measured by spectrum analyzer, the attenuation under this paragraph shall be 30 dB instead of 20 dB. In addition, radiated emissions which fall in the restricted bands must also comply with the limits as below.

Frequency (MHz)	Field Strength (microvolts/meter)	Measurement Distance (meters)
0.009 – 0.490	2400/F(kHz)	300
0.490 – 1.705	24000/F(kHz)	30
1.705 – 30.0	30	30
30 – 88	100	3
88 – 216	150	3
216 - 960	200	3
Above 960	500	3

3.5.2 Measuring Instruments

See list of measuring equipment of this test report.



3.5.3 Test Procedures

1. The testing follows the ANSI C63.10 Section 11.12.1 Radiated emission measurements.
2. The EUT was arranged to its worst case and then tune the antenna tower (from 1 m to 4 m) and turntable (from 0 degree to 360 degrees) to find the maximum reading. A pre-amp and a high pass filter are used for the test in order to get better signal level.
3. The EUT was placed on a turntable with 0.8 meter for frequency below 1GHz and 1.5 meter for frequency above 1GHz respectively above ground.
4. The EUT was set 3 meters from the interference receiving antenna, which was mounted on the top of a variable height antenna tower.
5. Corrected Reading: Antenna Factor + Cable Loss + Read Level - Preamp Factor = Level
6. For testing below 1GHz, if the emission level of the EUT in peak mode was 3 dB lower than the limit specified, then peak values of EUT will be reported, otherwise, the emissions will be repeated one by one using the CISPR quasi-peak method and reported.
7. For testing above 1GHz, the emission level of the EUT in peak mode was 20dB lower than average limit (that means the emission level in average mode also complies with the limit in average mode), then peak values of EUT will be reported, otherwise, the emissions will be measured in average mode again and reported.
8. Use the following spectrum analyzer settings:
 - (1) Span shall wide enough to fully capture the emission being measured;
 - (2) Set RBW=100 kHz for $f < 1$ GHz; $VBW \geq RBW$; Sweep = auto; Detector function = peak; Trace = max hold;
 - (3) Set RBW = 1 MHz, VBW= 3MHz for $f \geq 1$ GHz for peak measurement.
For average measurement:
 - $VBW = 10$ Hz, when duty cycle is no less than 98 percent.
 - $VBW \geq 1/T$, when duty cycle is less than 98 percent where T is the minimum transmission duration over which the transmitter is on and is transmitting at its maximum power control level for the tested mode of operation.

3.5.4 Test Setup

For radiated emissions below 30MHz

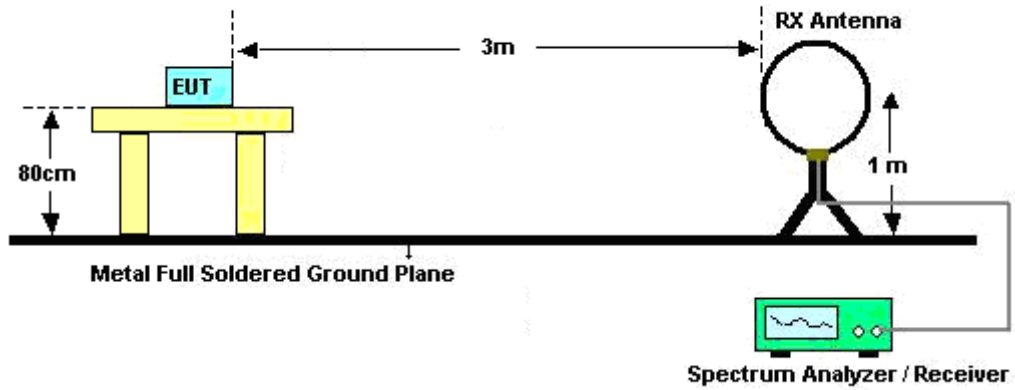

For radiated emissions from 30MHz to 1GHz

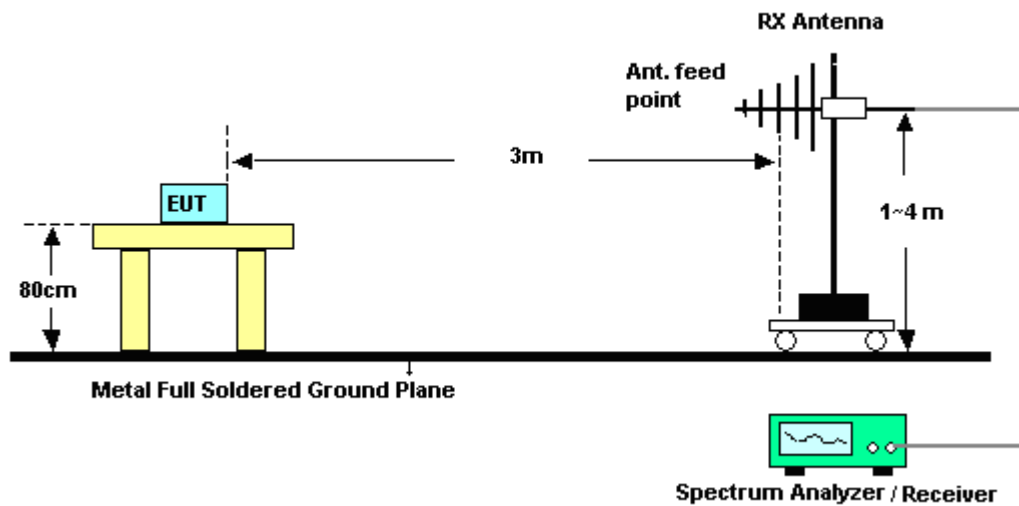

For radiated emissions from 1GHz to 18GHz

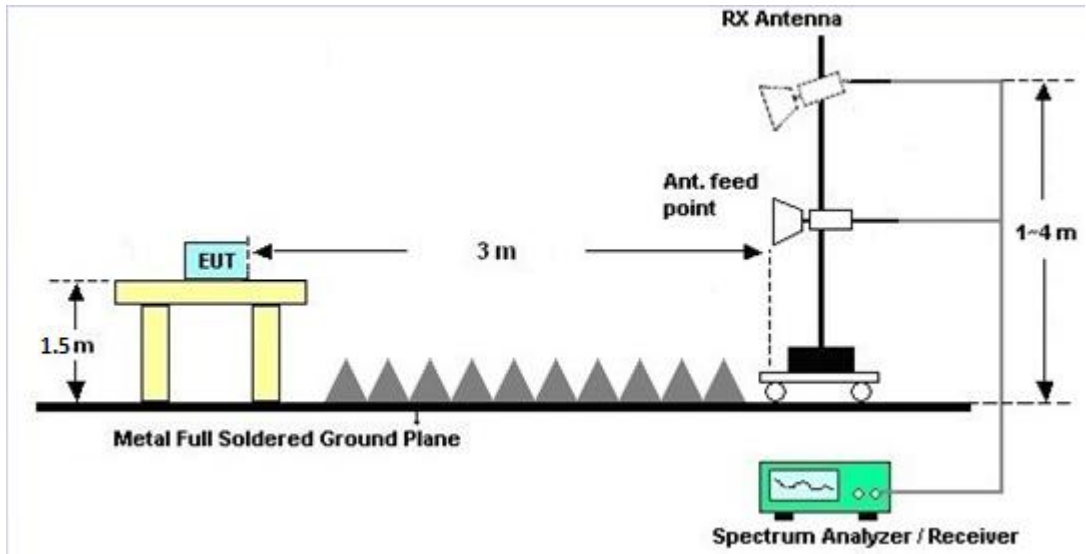

For radiated emissions from 18GHz to 26GHz

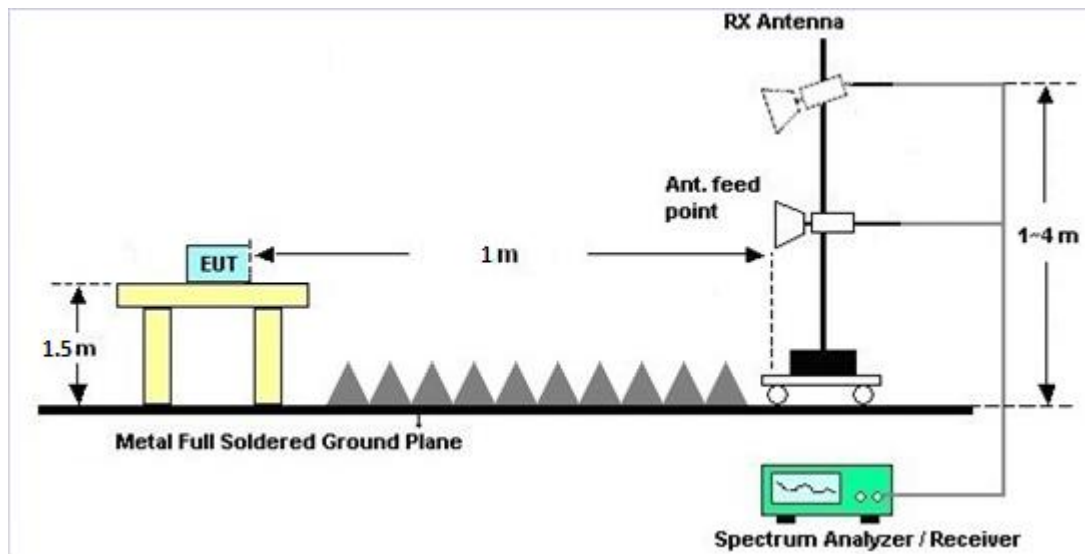



3.5.5 Test Results of Radiated Spurious Emissions (9 kHz ~ 30 MHz)

The low frequency, which started from 9 kHz to 30MHz, was pre-scanned and the result which was 20dB lower than the limit line was not reported.

There is a comparison data of both open-field test site and alternative test site - semi-Anechoic chamber according to 414788 D01 Radiated Test Site v01r01, and the result came out very similar.

3.5.6 Test Result of Radiated Spurious at Band Edges

Please refer to Appendix C and D.

3.5.7 Duty Cycle

Please refer to Appendix E.

3.5.8 Test Result of Radiated Spurious Emission (30MHz ~ 10th Harmonic)

Please refer to Appendix C and D.



3.6 AC Conducted Emission Measurement

3.6.1 Limit of AC Conducted Emission

For equipment that is designed to be connected to the public utility (AC) power line, the radio frequency voltage that is conducted back onto the AC power line on any frequency or frequencies within the band 150 kHz to 30 MHz shall not exceed the limits in the following table.

Frequency of emission (MHz)	Conducted limit (dB μ V)	
	Quasi-peak	Average
0.15-0.5	66 to 56*	56 to 46*
0.5-5	56	46
5-30	60	50

*Decreases with the logarithm of the frequency.

3.6.2 Measuring Instruments

See list of measuring equipment of this test report.

3.6.3 Test Procedures

1. The EUT was placed 0.4 meter from the conducting wall of the shielding room was kept at least 80 centimeters from any other grounded conducting surface.
2. Connect EUT to the power mains through a line impedance stabilization network (LISN).
3. All the support units are connecting to the other LISN.
4. The LISN provides 50 ohm coupling impedance for the measuring instrument.
5. The FCC states that a 50 ohm, 50 microhenry LISN should be used.
6. Both sides of AC line were checked for maximum conducted interference.
7. The frequency range from 150 kHz to 30 MHz was searched.
8. Set the test-receiver system to Peak Detect Function and specified bandwidth (IF Bandwidth = 9kHz) with Maximum Hold Mode. Then measurement is also conducted by Average Detector and Quasi-Peak Detector Function respectively.

3.6.4 Test Setup

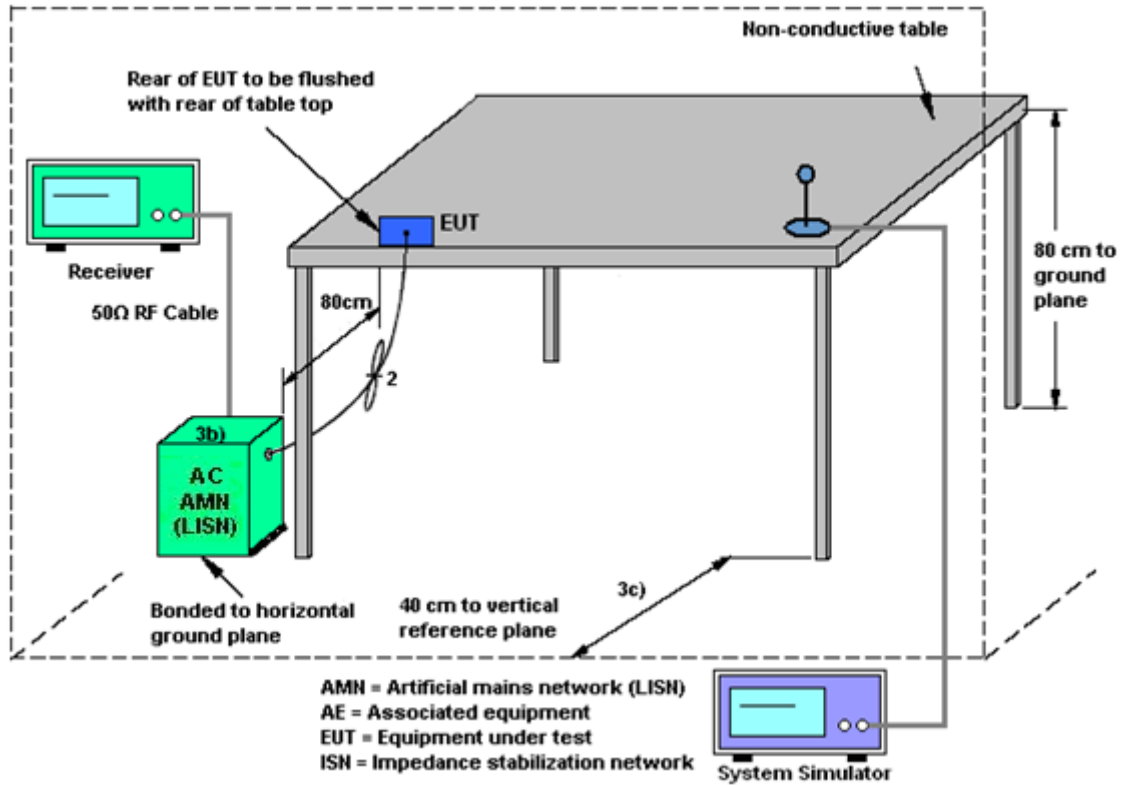

3.6.5 Test Result of AC Conducted Emission

Please refer to Appendix B.



3.7 Antenna Requirements

3.7.1 Standard Applicable

If directional gain of transmitting antennas is greater than 6dBi, the power shall be reduced by the same level in dB comparing to gain minus 6dBi. The use of a permanently attached antenna or of an antenna that uses a unique coupling to the intentional radiator shall be considered sufficient to comply with the rule.

3.7.2 Antenna Anti-Replacement Construction

An embedded-in antenna design is used.

3.7.3 Antenna Gain

The antenna peak gain of EUT is less than 6 dBi. Therefore, it is not necessary to reduce maximum peak output power limit.



4 List of Measuring Equipment

Instrument	Manufacturer	Model No.	Serial No.	Characteristics	Calibration Date	Test Date	Due Date	Remark
Loop Antenna	Rohde & Schwarz	HFH2-Z2	100488	9 kHz~30 MHz	Dec. 26, 2019	Jan. 04, 2020~ Jan. 31, 2020	Dec. 25, 2020	Radiation (03CH16-HY)
Bilog Antenna	TESEQ	CBL6111D& 00802N1D0 1N-06	47020&06	30MHz to 1GHz	Oct. 13, 2019	Jan. 04, 2020~ Jan. 31, 2020	Oct. 12, 2020	Radiation (03CH16-HY)
Horn Antenna	SCHWARZBE CK	BBHA 9120 D	9120D-1522	1G~18GHz	Sep. 19, 2019	Jan. 04, 2020~ Jan. 31, 2020	Sep. 18, 2020	Radiation (03CH16-HY)
Amplifier	SONOMA	310N	371607	9kHz~1000MHz	Oct. 01, 2019	Jan. 04, 2020~ Jan. 31, 2020	Sep. 30, 2020	Radiation (03CH16-HY)
Preamplifier	Jet-Power	JPA0118-55- 303	1710001800 054001	1GHz~18GHz	May 19, 2019	Jan. 04, 2020~ Jan. 31, 2020	May 18, 2020	Radiation (03CH16-HY)
Preamplifier	EMEC	EMC184045 B	980192	18GHz ~40GHz	Jul. 10, 2019	Jan. 04, 2020~ Jan. 31, 2020	Jul. 09, 2020	Radiation (03CH16-HY)
Preamplifier	Keysight	83017A	MY53270264	1GHz~26.5GHz	Dec. 11, 2019	Jan. 04, 2020~ Jan. 31, 2020	Dec. 10, 2020	Radiation (03CH16-HY)
EMI Test Receiver	Keysight	N9038A (MXE)	MY55420170	20MHz~8.4GHz	Mar. 08, 2019	Jan. 04, 2020~ Jan. 31, 2020	Mar. 07, 2020	Radiation (03CH16-HY)
Spectrum Analyzer	Agilent	E4446A	MY50180136	3Hz~44GHz	Apr. 29, 2019	Jan. 04, 2020~ Jan. 31, 2020	Apr. 28, 2020	Radiation (03CH16-HY)
RF Cable	HUBER + SUHNER	SUCOFLEX 104	MY11680/4P E	NA	Aug. 30, 2019	Jan. 04, 2020~ Jan. 31, 2020	Aug. 29, 2020	Radiation (03CH16-HY)
RF Cable	HUBER + SUHNER	SUCOFLEX 104	MY11688/4P E	NA	Aug. 30, 2019	Jan. 04, 2020~ Jan. 31, 2020	Aug. 29, 2020	Radiation (03CH16-HY)
RF Cable	HUBER + SUHNER	SUCOFLEX 102	EC-A5-300-5 757	NA	Aug. 30, 2019	Jan. 04, 2020~ Jan. 31, 2020	Aug. 29, 2020	Radiation (03CH16-HY)
RF Cable	HUBER + SUHNER	SUCOFLEX 102	505134/2	30MHz~40GHz	Feb. 26, 2019	Jan. 04, 2020~ Jan. 31, 2020	Feb. 25, 2020	Radiation (03CH16-HY)
RF Cable	HUBER + SUHNER	SUCOFLEX 102	800740/2	30MHz~40GHz	Feb. 26, 2019	Jan. 04, 2020~ Jan. 31, 2020	Feb. 25, 2020	Radiation (03CH16-HY)
SHF-EHF Horn Antenna	SCHWARZBE CK	BBHA 9170	BBHA91705 76	18GHz~40GHz	May 14, 2019	Jan. 04, 2020~ Jan. 31, 2020	May 13, 2020	Radiation (03CH16-HY)
Preamplifier	EMEC	EM18G40G	060715	18GHz~40GHz	Dec. 13, 2019	Jan. 04, 2020~ Jan. 31, 2020	Dec. 12, 2020	Radiation (03CH16-HY)
Hygrometer	TECPEL	DTM-303B	TP161243	N/A	Jun. 17, 2019	Jan. 04, 2020~ Jan. 31, 2020	Jun. 16, 2020	Radiation (03CH16-HY)
Software	Audix	E3 6.2009-8-24	RK-001136	N/A	N/A	Jan. 04, 2020~ Jan. 31, 2020	N/A	Radiation (03CH16-HY)
Filter	Wainwright	WLK4-1000- 1530-8000-4 0SS	SN11	1.53G Low Pass	Sep. 15, 2019	Jan. 04, 2020~ Jan. 31, 2020	Sep. 14, 2020	Radiation (03CH16-HY)
Filter	Wainwright	WHKX12-27 00-3000-180 00-60SS	SN3	3GHz High Pass Filter	Sep. 15, 2019	Jan. 04, 2020~ Jan. 31, 2020	Sep. 14, 2020	Radiation (03CH16-HY)



Instrument	Manufacturer	Model No.	Serial No.	Characteristics	Calibration Date	Test Date	Due Date	Remark
AC Power Source	ChainTek	APC-1000W	N/A	N/A	N/A	Dec. 26, 2019~ Jan. 16, 2020	N/A	Conduction (CO05-HY)
EMI Test Receiver	Rohde & Schwarz	ESR3	102388	9kHz~3.6GHz	Nov. 15, 2019	Dec. 26, 2019~ Jan. 16, 2020	Nov. 14, 2020	Conduction (CO05-HY)
Hygrometer	Testo	608-H1	34913912	N/A	Mar. 19, 2019	Dec. 26, 2019~ Jan. 16, 2020	Mar. 18, 2020	Conduction (CO05-HY)
LISN	Rohde & Schwarz	ENV216	100081	9kHz~30MHz	Nov. 15, 2019	Dec. 26, 2019~ Jan. 16, 2020	Nov. 14, 2020	Conduction (CO05-HY)
Software	Rohde & Schwarz	EMC32 V10.30	N/A	N/A	N/A	Dec. 26, 2019~ Jan. 16, 2020	N/A	Conduction (CO05-HY)
LF Cable	HUBER + SUHNER	RG-214/U	LF01	N/A	Dec. 31, 2018	Dec. 26, 2019	Dec. 30, 2019	Conduction (CO05-HY)
LF Cable	HUBER + SUHNER	RG-214/U	LF01	N/A	Jan. 02, 2020	Jan. 16, 2020	Jan. 01, 2021	Conduction (CO05-HY)
Pulse Limiter	Rohde & Schwarz	ESH3-Z2	100851	N/A	Dec. 31, 2018	Dec. 26, 2019	Dec. 30, 2019	Conduction (CO05-HY)
Pulse Limiter	Rohde & Schwarz	ESH3-Z2	100851	N/A	Jan. 02, 2020	Jan. 16, 2020	Jan. 01, 2021	Conduction (CO05-HY)
Hygrometer	Testo	608-H2	41410069	N/A	Jun. 17, 2019	Dec. 22, 2019~ Jan. 14, 2020	Jun. 16, 2020	Conducted (TH05-HY)
Power Sensor	DARE	RPR3006W	13100030SN O32	9kHz~6GHz	Dec. 17, 2019	Dec. 22, 2019~ Jan. 14, 2020	Dec. 16, 2020	Conducted (TH05-HY)
Signal Analyzer	Rohde & Schwarz	FSV40	101566	10Hz~40GHz	Jul. 15, 2019	Dec. 22, 2019~ Jan. 14, 2020	Jul. 14, 2020	Conducted (TH05-HY)
Spectrum Analyzer	Rohde & Schwarz	FSP40	100055	9kHz-40GHz	Aug. 14, 2019	Dec. 22, 2019~ Jan. 14, 2020	Aug. 13, 2020	Conducted (TH05-HY)
Switch Box & RF Cable	Burgeon	ETF-058	EC1208382	N/A	Mar. 27, 2019	Dec. 22, 2019~ Jan. 14, 2020	Mar. 26, 2020	Conducted (TH05-HY)



5 Uncertainty of Evaluation

Uncertainty of Conducted Emission Measurement (150 kHz ~ 30 MHz)

Measuring Uncertainty for a Level of Confidence of 95% ($U = 2Uc(y)$)	2.0
---	-----

Uncertainty of Radiated Emission Measurement (30 MHz ~ 1000 MHz)

Measuring Uncertainty for a Level of Confidence of 95% ($U = 2Uc(y)$)	4.9
---	-----

Uncertainty of Radiated Emission Measurement (1000 MHz ~ 18000 MHz)

Measuring Uncertainty for a Level of Confidence of 95% ($U = 2Uc(y)$)	6.7
---	-----

Uncertainty of Radiated Emission Measurement (18000 MHz ~ 40000 MHz)

Measuring Uncertainty for a Level of Confidence of 95% ($U = 2Uc(y)$)	3.9
---	-----

Appendix A. Test Result of Conducted Test Items

Test Engineer:	Derek Hsu and Shiming Liu	Temperature:	21~25	°C
Test Date:	2019/12/22~2020/1/14	Relative Humidity:	51~54	%

TEST RESULTS DATA
6dB and 99% Occupied Bandwidth

Mod.	Data Rate	NTX	CH.	Freq. (MHz)	99% Occupied BW (MHz)	6dB BW (MHz)	6dB BW Limit (MHz)	Pass/Fail
BLE	1Mbps	1	0	2402	1.016	0.664	0.50	Pass
BLE	1Mbps	1	19	2440	1.018	0.664	0.50	Pass
BLE	1Mbps	1	39	2480	1.016	0.664	0.50	Pass

TEST RESULTS DATA
Average Power Table

Mod.	Data Rate	NTX	CH.	Freq. (MHz)	Average Conducted Power (dBm)	Conducted Power Limit (dBm)	DG (dBi)	EIRP Power (dBm)	EIRP Power Limit (dBm)	Pass /Fail
BLE	1Mbps	1	0	2402	8.80	30.00	-2.40	6.40	36.00	Pass
BLE	1Mbps	1	19	2440	9.10	30.00	-2.40	6.70	36.00	Pass
BLE	1Mbps	1	39	2480	8.60	30.00	-2.40	6.20	36.00	Pass

TEST RESULTS DATA
Peak Power Density

Mod.	Data Rate	NTX	CH.	Freq. (MHz)	Peak PSD (dBm /100kHz)	Peak PSD (dBm /3kHz)	DG (dBi)	Peak PSD Limit (dBm /3kHz)	Pass/Fail
BLE	1Mbps	1	0	2402	8.24	-8.00	-2.40	8.00	Pass
BLE	1Mbps	1	19	2440	7.77	-8.13	-2.40	8.00	Pass
BLE	1Mbps	1	39	2480	7.87	-8.22	-2.40	8.00	Pass

Note: PSD (dBm/ 100kHz) is a reference level used for Conducted Band Edges and Conducted Spurious Emission 30dBc limit.

TEST RESULTS DATA
6dB and 99% Occupied Bandwidth

Mod.	Data Rate	NTX	CH.	Freq. (MHz)	99% Occupied BW (MHz)	6dB BW (MHz)	6dB BW Limit (MHz)	Pass/Fail
BLE5.0	2Mbps	1	0	2402	1.992	1.148	0.50	Pass
BLE5.0	2Mbps	1	19	2440	1.992	1.147	0.50	Pass
BLE5.0	2Mbps	1	39	2480	1.992	1.160	0.50	Pass

TEST RESULTS DATA
Average Power Table

Mod.	Data Rate	NTX	CH.	Freq. (MHz)	Average Conducted Power (dBm)	Conducted Power Limit (dBm)	DG (dBi)	EIRP Power (dBm)	EIRP Power Limit (dBm)	Pass /Fail
BLE5.0	2Mbps	1	0	2402	9.00	30.00	-2.40	6.60	36.00	Pass
BLE5.0	2Mbps	1	19	2440	9.20	30.00	-2.40	6.80	36.00	Pass
BLE5.0	2Mbps	1	39	2480	8.80	30.00	-2.40	6.40	36.00	Pass

TEST RESULTS DATA
Peak Power Density

Mod.	Data Rate	NTX	CH.	Freq. (MHz)	Peak PSD (dBm /100kHz)	Peak PSD (dBm /3kHz)	DG (dBi)	Peak PSD Limit (dBm /3kHz)	Pass/Fail
BLE5.0	2Mbps	1	0	2402	8.00	-10.81	-2.40	8.00	Pass
BLE5.0	2Mbps	1	19	2440	8.66	-10.29	-2.40	8.00	Pass
BLE5.0	2Mbps	1	39	2480	8.26	-10.64	-2.40	8.00	Pass

Note: PSD (dBm/ 100kHz) is a reference level used for Conducted Band Edges and Conducted Spurious Emission 30dBc limit.



Appendix B. AC Conducted Emission Test Results

Test Engineer :	Howard Huang and Tom Lee	Temperature :	22~25°C
		Relative Humidity :	45~52%

EUT Information

Report NO : 9O1542-02
 Test Mode : Mode 1
 Test Voltage : 120Vac/60Hz
 Phase : Line

Full Spectrum

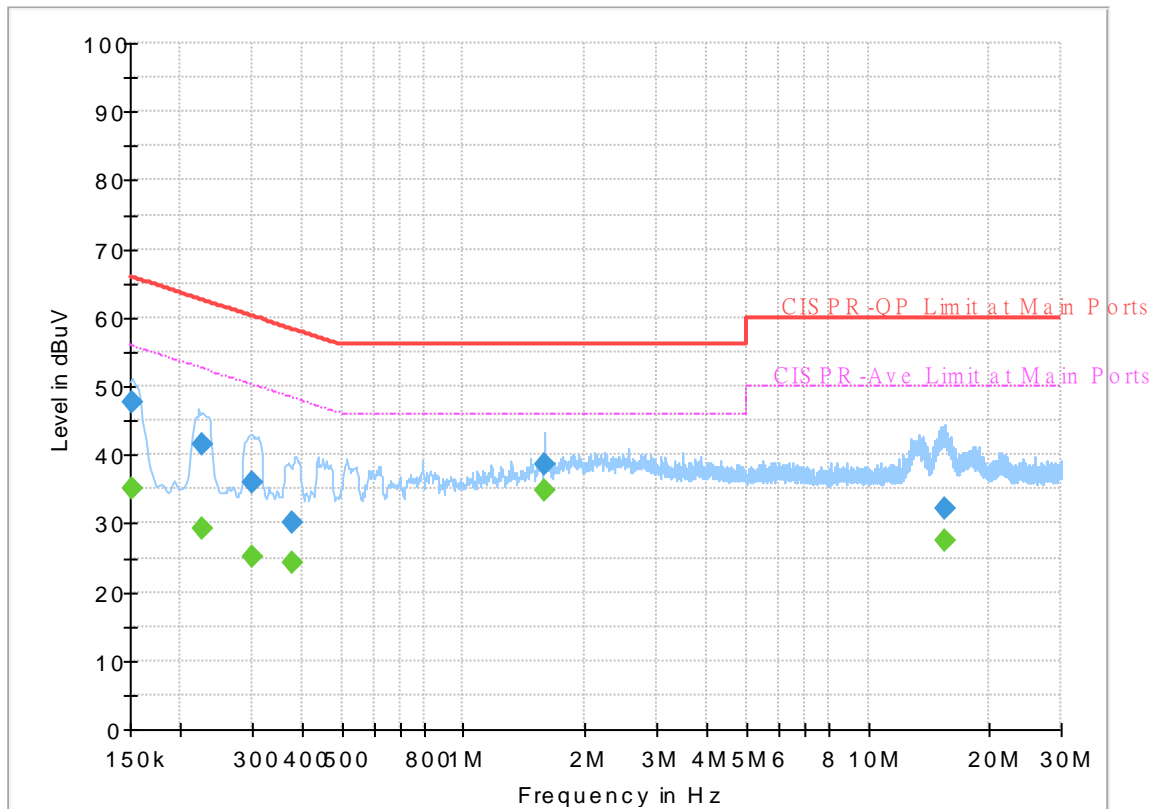

Final Result

Frequency (MHz)	QuasiPeak (dBuV)	CAverage (dBuV)	Limit (dBuV)	Margin (dB)	Line	Filter	Corr. (dB)
0.150878	---	35.14	55.95	20.81	L1	OFF	19.5
0.150878	47.61	---	65.95	18.34	L1	OFF	19.5
0.224970	---	29.16	52.63	23.47	L1	OFF	19.5
0.224970	41.40	---	62.63	21.23	L1	OFF	19.5
0.300750	---	25.12	50.22	25.10	L1	OFF	19.5
0.300750	35.94	---	60.22	24.28	L1	OFF	19.5
0.379500	---	24.29	48.29	24.00	L1	OFF	19.5
0.379500	30.06	---	58.29	28.23	L1	OFF	19.5
1.585320	---	34.77	46.00	11.23	L1	OFF	19.6
1.585320	38.73	---	56.00	17.27	L1	OFF	19.6
15.531000	---	27.45	50.00	22.55	L1	OFF	20.1
15.531000	32.23	---	60.00	27.77	L1	OFF	20.1

EUT Information

Report NO : 9O1542-02
 Test Mode : Mode 1
 Test Voltage : 120Vac/60Hz
 Phase : Neutral

Full Spectrum

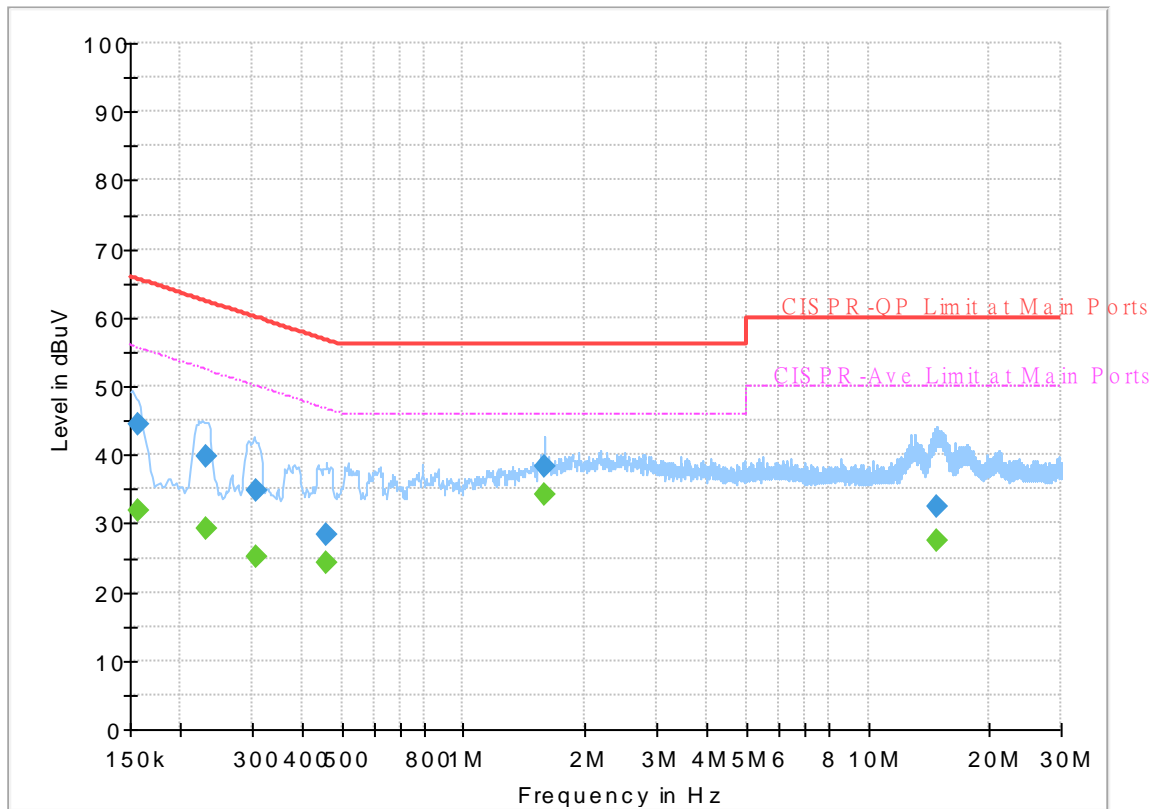

Final Result

Frequency (MHz)	QuasiPeak (dBuV)	CAverage (dBuV)	Limit (dBuV)	Margin (dB)	Line	Filter	Corr. (dB)
0.156750	---	31.87	55.63	23.76	N	OFF	19.5
0.156750	44.30	---	65.63	21.33	N	OFF	19.5
0.231000	---	29.33	52.41	23.08	N	OFF	19.5
0.231000	39.67	---	62.41	22.74	N	OFF	19.5
0.305880	---	25.13	50.08	24.95	N	OFF	19.5
0.305880	34.71	---	60.08	25.37	N	OFF	19.5
0.456000	---	24.28	46.77	22.49	N	OFF	19.5
0.456000	28.50	---	56.77	28.27	N	OFF	19.5
1.585050	---	34.32	46.00	11.68	N	OFF	19.6
1.585050	38.41	---	56.00	17.59	N	OFF	19.6
14.820000	---	27.35	50.00	22.65	N	OFF	20.1
14.820000	32.54	---	60.00	27.46	N	OFF	20.1

EUT Information

Report NO : 901542-02
 Test Mode : Mode 2
 Test Voltage : 120Vac/60Hz
 Phase : Line

Full Spectrum

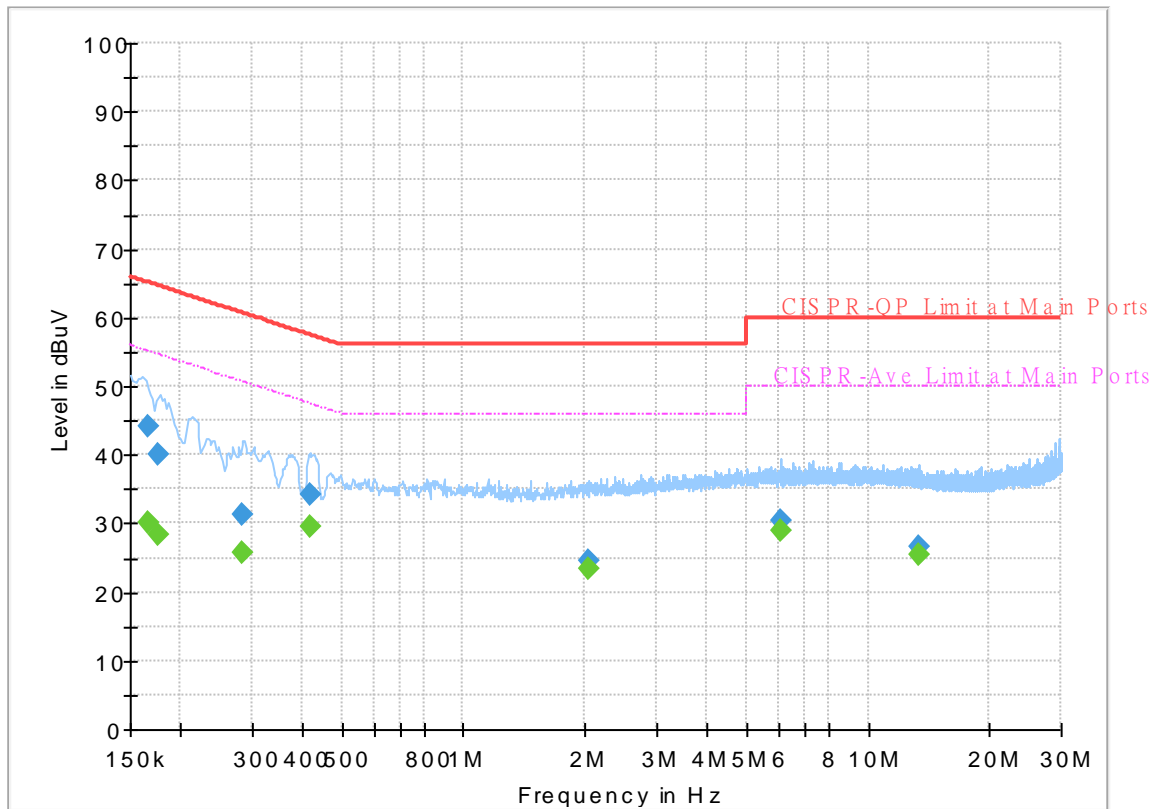

Final_Result

Frequency (MHz)	QuasiPeak (dBuV)	CAverage (dBuV)	Limit (dBuV)	Margin (dB)	Line	Filter	Corr. (dB)
0.165750	---	30.16	55.17	25.01	L1	OFF	19.5
0.165750	44.10	---	65.17	21.07	L1	OFF	19.5
0.176100	---	28.25	54.67	26.42	L1	OFF	19.5
0.176100	39.96	---	64.67	24.71	L1	OFF	19.5
0.285090	---	25.60	50.67	25.07	L1	OFF	19.5
0.285090	31.36	---	60.67	29.31	L1	OFF	19.5
0.419460	---	29.56	47.46	17.90	L1	OFF	19.5
0.419460	34.30	---	57.46	23.16	L1	OFF	19.5
2.036310	---	23.25	46.00	22.75	L1	OFF	19.7
2.036310	24.48	---	56.00	31.52	L1	OFF	19.7
6.056520	---	28.81	50.00	21.19	L1	OFF	19.8
6.056520	30.28	---	60.00	29.72	L1	OFF	19.8
13.328250	---	25.37	50.00	24.63	L1	OFF	20.1
13.328250	26.61	---	60.00	33.39	L1	OFF	20.1

EUT Information

Report NO : 9O1542-02
 Test Mode : Mode 2
 Test Voltage : 120Vac/60Hz
 Phase : Neutral

Full Spectrum

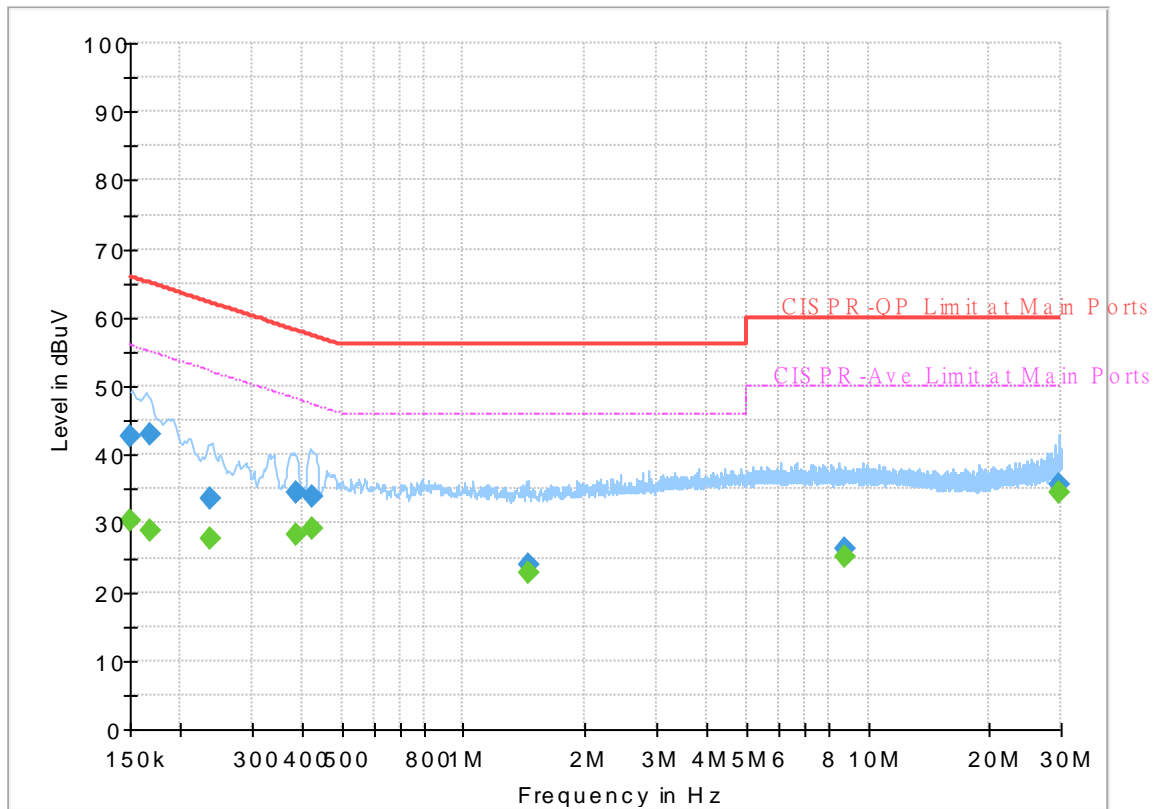

Final_Result

Frequency (MHz)	QuasiPeak (dBuV)	CAverage (dBuV)	Limit (dBuV)	Margin (dB)	Line	Filter	Corr. (dB)
0.150000	---	30.28	56.00	25.72	N	OFF	19.6
0.150000	42.55	---	66.00	23.45	N	OFF	19.6
0.168000	---	28.87	55.06	26.19	N	OFF	19.6
0.168000	42.85	---	65.06	22.21	N	OFF	19.6
0.235500	---	27.84	52.25	24.41	N	OFF	19.6
0.235500	33.54	---	62.25	28.71	N	OFF	19.6
0.385890	---	28.48	48.15	19.67	N	OFF	19.6
0.385890	34.42	---	58.15	23.73	N	OFF	19.6
0.422250	---	29.25	47.40	18.15	N	OFF	19.6
0.422250	33.93	---	57.40	23.47	N	OFF	19.6
1.448070	---	22.72	46.00	23.28	N	OFF	19.6
1.448070	23.85	---	56.00	32.15	N	OFF	19.6
8.797290	---	25.13	50.00	24.87	N	OFF	20.0
8.797290	26.28	---	60.00	33.72	N	OFF	20.0
29.674860	---	34.49	50.00	15.51	N	OFF	20.7
29.674860	35.67	---	60.00	24.33	N	OFF	20.7



Appendix C. Radiated Spurious Emission

Test Engineer :	Jacky Hung, Andy Yang, and CR Liao	Temperature :	20~25°C
		Relative Humidity :	50~60%

<1Mbps>

2.4GHz 2400~2483.5MHz

BLE (Band Edge @ 3m)

BLE	Note	Frequency	Level	Over Limit	Limit Line	Read Level	Antenna Factor	Path Loss	Preamp Factor	Ant Pos	Table Pos	Peak Avg.	Pol.	
		(MHz)	(dBμV/m)	(dB)	(dBμV/m)	(dBμV)	(dB/m)	(dB)	(dB)	(cm)	(deg)	(P/A)	(H/V)	
BLE CH 00 2402MHz		2328.06	57.18	-16.82	74	41.06	27.89	17.99	29.76	113	60	P	H	
		2367.96	45.48	-8.52	54	29.46	27.73	18.06	29.77	113	60	A	H	
	*	2402	102.77	-	-	86.85	27.6	18.11	29.79	113	60	P	H	
	*	2402	102.21	-	-	86.29	27.6	18.11	29.79	113	60	A	H	
													H	
			2332.05	57.9	-16.1	74	41.79	27.87	18	29.76	400	92	P	V
			2374.47	45.54	-8.46	54	29.55	27.7	18.07	29.78	400	92	A	V
	*		2402	100.38	-	-	84.46	27.6	18.11	29.79	400	92	P	V
	*		2402	99.81	-	-	83.89	27.6	18.11	29.79	400	92	A	V
														V
BLE CH 19 2440MHz		2385.6	56.84	-17.16	74	40.87	27.66	18.09	29.78	111	69	P	H	
		2369.22	45.43	-8.57	54	29.43	27.72	18.06	29.78	111	69	A	H	
	*	2440	104.8	-	-	88.83	27.6	18.17	29.8	111	69	P	H	
	*	2440	104.19	-	-	88.22	27.6	18.17	29.8	111	69	A	H	
			2487.68	55.91	-18.09	74	39.96	27.52	18.25	29.82	111	69	P	H
			2486.49	45.59	-8.41	54	29.63	27.53	18.25	29.82	111	69	A	H
			2380	56.29	-17.71	74	40.31	27.68	18.08	29.78	346	91	P	V
			2336.18	45.59	-8.41	54	29.49	27.86	18	29.76	346	91	A	V
	*		2440	102.45	-	-	86.48	27.6	18.17	29.8	346	91	P	V
	*		2440	101.83	-	-	85.86	27.6	18.17	29.8	346	91	A	V
			2491.6	56.83	-17.17	74	40.88	27.52	18.26	29.83	346	91	P	V
			2488.8	45.41	-8.59	54	29.47	27.52	18.25	29.83	346	91	A	V



BLE CH 39 2480MHz	*	2480	102.74	-	-	86.78	27.54	18.24	29.82	107	67	P	H
	*	2480	102.08	-	-	86.12	27.54	18.24	29.82	107	67	A	H
		2499.88	56.48	-17.52	74	40.54	27.5	18.27	29.83	107	67	P	H
		2491.68	45.52	-8.48	54	29.57	27.52	18.26	29.83	107	67	A	H
													H
													H
	*	2480	100.39	-	-	84.43	27.54	18.24	29.82	383	107	P	V
	*	2480	99.77	-	-	83.81	27.54	18.24	29.82	383	107	A	V
		2486.4	56.84	-17.16	74	40.88	27.53	18.25	29.82	383	107	P	V
		2498.52	45.67	-8.33	54	29.73	27.5	18.27	29.83	383	107	A	V
													V
													V
Remark	<ol style="list-style-type: none"> 1. No other spurious found. 2. All results are PASS against Peak and Average limit line. 												



2.4GHz 2400~2483.5MHz
BLE (Harmonic @ 3m)

BLE	Note	Frequency (MHz)	Level (dBµV/m)	Over Limit (dB)	Limit Line (dBµV/m)	Read Level (dBµV)	Antenna Factor (dB/m)	Path Loss (dB)	Preamp Factor (dB)	Ant Pos (cm)	Table Pos (deg)	Peak Avg. (P/A)	Pol. (H/V)	
BLE CH 00 2402MHz		4804	36.71	-37.29	74	51.28	31.11	12.43	58.11	100	0	P	H	
													H	
													H	
													H	
			4804	36.52	-37.48	74	51.09	31.11	12.43	58.11	100	0	P	V
														V
														V
BLE CH 19 2440MHz		4880	37.02	-36.98	74	51.57	31.08	12.5	58.13	100	0	P	H	
		7320	43.04	-30.96	74	48.45	36.48	15.6	57.49	100	0	P	H	
													H	
													H	
			4880	36.14	-37.86	74	50.69	31.08	12.5	58.13	100	0	P	V
			7320	43.15	-30.85	74	48.56	36.48	15.6	57.49	100	0	P	V
														V
BLE CH 39 2480MHz		4960	36.95	-37.05	74	51.27	31.26	12.56	58.14	100	0	P	H	
		7440	43.85	-30.15	74	48.88	36.58	15.72	57.33	100	0	P	H	
													H	
													H	
			4960	37.35	-36.65	74	51.67	31.26	12.56	58.14	100	0	P	V
			7440	43.13	-30.87	74	48.16	36.58	15.72	57.33	100	0	P	V
														V
Remark	1. No other spurious found.													
	2. All results are PASS against Peak and Average limit line.													



<2Mbps>

2.4GHz 2400~2483.5MHz

BLE (Band Edge @ 3m)

BLE	Note	Frequency	Level	Over Limit	Limit Line	Read Level	Antenna Factor	Path Loss	Preamp Factor	Ant Pos	Table Pos	Peak Avg.	Pol.	
		(MHz)	(dBμV/m)	(dB)	(dBμV/m)	(dBμV)	(dB/m)	(dB)	(dB)	(cm)	(deg)	(P/A)	(H/V)	
BLE CH 00 2402MHz		2372.475	56.98	-17.02	74	40.99	27.71	18.06	29.78	100	15	P	H	
		2335.095	45.51	-8.49	54	29.41	27.86	18	29.76	100	15	A	H	
	*	2402	101.79	-	-	85.87	27.6	18.11	29.79	100	15	P	H	
	*	2402	100.1	-	-	84.18	27.6	18.11	29.79	100	15	A	H	
													H	
														H
			2337.72	56.53	-17.47	74	40.43	27.85	18.01	29.76	400	91	P	V
			2323.86	45.87	-8.13	54	29.75	27.9	17.98	29.76	400	91	A	V
	*		2402	99.99	-	-	84.07	27.6	18.11	29.79	400	91	P	V
	*		2402	98.47	-	-	82.55	27.6	18.11	29.79	400	91	A	V
														V
														V
BLE CH 19 2440MHz		2326.94	56.41	-17.59	74	40.29	27.89	17.99	29.76	110	15	P	H	
		2354.94	45.51	-8.49	54	29.46	27.78	18.04	29.77	110	15	A	H	
	*	2440	104.46	-	-	88.49	27.6	18.17	29.8	110	15	P	H	
	*	2440	102.96	-	-	86.99	27.6	18.17	29.8	110	15	A	H	
			2498.11	56.03	-17.97	74	40.09	27.5	18.27	29.83	110	15	P	H
			2492.02	45.64	-8.36	54	29.69	27.52	18.26	29.83	110	15	A	H
			2332.4	56.57	-17.43	74	40.46	27.87	18	29.76	390	91	P	V
			2326.66	45.49	-8.51	54	29.37	27.89	17.99	29.76	390	91	A	V
	*		2440	102.32	-	-	86.35	27.6	18.17	29.8	390	91	P	V
	*		2440	100.77	-	-	84.8	27.6	18.17	29.8	390	91	A	V
			2493	56.36	-17.64	74	40.42	27.51	18.26	29.83	390	91	P	V
			2484.95	45.82	-8.18	54	29.86	27.53	18.25	29.82	390	91	A	V



BLE CH 39 2480MHz	*	2480	102.78	-	-	86.82	27.54	18.24	29.82	112	52	P	H
	*	2480	100.72	-	-	84.76	27.54	18.24	29.82	112	52	A	H
		2499.96	56.27	-17.73	74	40.33	27.5	18.27	29.83	112	52	P	H
		2489.8	45.83	-8.17	54	29.89	27.52	18.25	29.83	112	52	A	H
													H
													H
	*	2480	100.51	-	-	84.55	27.54	18.24	29.82	384	88	P	V
	*	2480	98.77	-	-	82.81	27.54	18.24	29.82	384	88	A	V
		2484.44	57.02	-16.98	74	41.06	27.53	18.25	29.82	384	88	P	V
		2497.16	45.7	-8.3	54	29.75	27.51	18.27	29.83	384	88	A	V
													V
													V
Remark	1. No other spurious found. 2. All results are PASS against Peak and Average limit line.												



2.4GHz 2400~2483.5MHz
BLE (Harmonic @ 3m)

BLE	Note	Frequency (MHz)	Level (dBµV/m)	Over Limit (dB)	Limit Line (dBµV/m)	Read Level (dBµV)	Antenna Factor (dB/m)	Path Loss (dB)	Preamp Factor (dB)	Ant Pos (cm)	Table Pos (deg)	Peak Avg. (P/A)	Pol. (H/V)
BLE CH 00 2402MHz		4804	36.45	-37.55	74	51.02	31.11	12.43	58.11	100	0	P	H
													H
													H
													H
		4804	36.48	-37.52	74	51.05	31.11	12.43	58.11	100	0	P	V
													V
													V
BLE CH 19 2440MHz		4880	36.79	-37.21	74	51.34	31.08	12.5	58.13	100	0	P	H
		7320	43.66	-30.34	74	49.07	36.48	15.6	57.49	100	0	P	H
													H
													H
		4880	36.73	-37.27	74	51.28	31.08	12.5	58.13	100	0	P	V
		7320	43.04	-30.96	74	48.45	36.48	15.6	57.49	100	0	P	V
													V
BLE CH 39 2480MHz		4960	37.45	-36.55	74	51.77	31.26	12.56	58.14	100	0	P	H
		7440	44.92	-29.08	74	49.95	36.58	15.72	57.33	100	0	P	H
													H
													H
		4960	37.46	-36.54	74	51.78	31.26	12.56	58.14	100	0	P	V
		7440	43.87	-30.13	74	48.9	36.58	15.72	57.33	100	0	P	V
													V
Remark	1. No other spurious found.												
	2. All results are PASS against Peak and Average limit line.												



Emission above 18GHz

BLE SHF

BLE	Note	Frequency	Level	Over	Limit	Read	Antenna	Path	Preamp	Ant	Table	Peak	Pol.	
				Limit	Line	Level	Factor	Loss	Factor	Pos	Pos	Avg.		
		(MHz)	(dBμV/m)	(dB)	(dBμV/m)	(dBμV)	(dB/m)	(dB)	(dB)	(cm)	(deg)	(P/A)	(H/V)	
2.4GHz BLE SHF		24111	41.31	-32.69	74	41.26	40.33	13.06	53.34	150	0	P	H	
													H	
													H	
													H	
													H	
													H	
			24111	41.31	-32.69	74	41.26	40.33	13.06	53.34	150	0	P	V
														V
														V
														V
Remark	1. No other spurious found. 2. All results are PASS against limit line.													



Emission below 1GHz

2.4GHz BLE (LF)

BLE	Note	Frequency	Level	Over	Limit	Read	Antenna	Path	Preamp	Ant	Table	Peak	Pol.	
		(MHz)	(dBμV/m)	(dB)	(dBμV/m)	(dBμV)	(dB/m)	(dB)	(dB)	(cm)	(deg)	(P/A)	(H/V)	
2.4GHz BLE LF		30.97	22.53	-17.47	40	29.71	24.09	0.94	32.21	-	-	P	H	
		103.72	23.92	-19.58	43.5	38.15	16.29	1.73	32.25	-	-	P	H	
		162.89	26.52	-16.98	43.5	40.41	16.14	2.26	32.29	-	-	P	H	
		182.29	28.15	-15.35	43.5	43.31	14.8	2.35	32.31	-	-	P	H	
		218.18	28.11	-17.89	46	42.51	15.37	2.56	32.33	-	-	P	H	
		952.47	34.62	-11.38	46	29.8	30.8	5.32	31.3	100	0	P	H	
													H	
													H	
													H	
													H	
													H	
													H	
			37.76	28.81	-11.19	40	39.52	20.55	1.03	32.29	-	-	P	V
			43.58	29.95	-10.05	40	43.83	17.38	1.09	32.35	100	0	P	V
			102.75	23.43	-20.07	43.5	37.77	16.19	1.72	32.25	-	-	P	V
			178.41	24.62	-18.88	43.5	39.62	14.97	2.33	32.3	-	-	P	V
			745.86	31.52	-14.48	46	30.97	28.1	4.7	32.25	-	-	P	V
			955.38	34.5	-11.5	46	29.55	30.89	5.33	31.27	-	-	P	V
														V
														V
													V	
													V	
													V	
													V	
Remark	1. No other spurious found. 2. All results are PASS against limit line.													



<WPC Mode>

2.4GHz 2400~2483.5MHz

BLE (Band Edge @ 3m)

BLE	Note	Frequency	Level	Over Limit	Limit Line	Read Level	Antenna Factor	Path Loss	Preamp Factor	Ant Pos	Table Pos	Peak Avg.	Pol.	
		(MHz)	(dBμV/m)	(dB)	(dBμV/m)	(dBμV)	(dB/m)	(dB)	(dB)	(cm)	(deg)	(P/A)	(H/V)	
BLE CH 00 2402MHz		2312.835	56.8	-17.2	74	40.63	27.95	17.97	29.75	100	90	P	H	
		2321.55	45.56	-8.44	54	29.43	27.91	17.98	29.76	100	90	A	H	
	*	2402	101.85	-	-	85.93	27.6	18.11	29.79	100	90	P	H	
	*	2402	98.4	-	-	82.48	27.6	18.11	29.79	100	90	A	H	
													H	
													H	
			2314.41	56.91	-17.09	74	40.75	27.94	17.97	29.75	391	85	P	V
			2325.645	45.55	-8.45	54	29.42	27.9	17.99	29.76	391	85	A	V
	*		2402	99.95	-	-	84.03	27.6	18.11	29.79	391	85	P	V
	*		2402	98.03	-	-	82.11	27.6	18.11	29.79	391	85	A	V
													V	
													V	



**2.4GHz 2400~2483.5MHz
BLE (Harmonic @ 3m)**

BLE	Note	Frequency (MHz)	Level (dBμV/m)	Over Limit (dB)	Limit Line (dBμV/m)	Read Level (dBμV)	Antenna Factor (dB/m)	Path Loss (dB)	Preamp Factor (dB)	Ant Pos (cm)	Table Pos (deg)	Peak Avg. (P/A)	Pol. (H/V)	
BLE CH 00 2402MHz		4804	36.66	-37.34	74	51.26	31.11	12.4	58.11	100	0	P	H	
													H	
													H	
													H	
			4804	35.97	-38.03	74	50.57	31.11	12.4	58.11	100	0	P	V
														V
														V
														V



Note symbol

*	Fundamental Frequency which can be ignored. However, the level of any unwanted emissions shall not exceed the level of the fundamental frequency.
!	Test result is over limit line.
P/A	Peak or Average
H/V	Horizontal or Vertical



A calculation example for radiated spurious emission is shown as below:

BLE	Note	Frequency	Level	Over	Limit	Read	Antenna	Path	Preamp	Ant	Table	Peak	Pol.
		(MHz)	(dBμV/m)	(dB)	(dBμV/m)	(dBμV)	(dB/m)	(dB)	(dB)	(cm)	(deg)	(P/A)	(H/V)
BLE CH 00 2402MHz		2390	55.45	-18.55	74	54.51	32.22	4.58	35.86	103	308	P	H
		2390	43.54	-10.46	54	42.6	32.22	4.58	35.86	103	308	A	H

1. Path Loss(dB) = Cable loss(dB) + Filter loss(dB) + Attenuator loss(dB)
2. Level(dBμV/m) =
Antenna Factor(dB/m) + Path Loss(dB) + Read Level(dBμV) - Preamp Factor(dB)
3. Over Limit(dB) = Level(dBμV/m) – Limit Line(dBμV/m)

For Peak Limit @ 2390MHz:

1. Level(dBμV/m)
= Antenna Factor(dB/m) + Path Loss(dB) + Read Level(dBμV) - Preamp Factor(dB)
= 32.22(dB/m) + 4.58(dB) + 54.51(dBμV) – 35.86 (dB)
= 55.45 (dBμV/m)
2. Over Limit(dB)
= Level(dBμV/m) – Limit Line(dBμV/m)
= 55.45(dBμV/m) – 74(dBμV/m)
= -18.55(dB)

For Average Limit @ 2390MHz:

1. Level(dBμV/m)
= Antenna Factor(dB/m) + Path Loss(dB) + Read Level(dBμV) - Preamp Factor(dB)
= 32.22(dB/m) + 4.58(dB) + 42.6(dBμV) – 35.86 (dB)
= 43.54 (dBμV/m)
2. Over Limit(dB)
= Level(dBμV/m) – Limit Line(dBμV/m)
= 43.54(dBμV/m) – 54(dBμV/m)
= -10.46(dB)

Both peak and average measured complies with the limit line, so test result is “PASS”.



Appendix D. Radiated Spurious Emission Plots

Test Engineer :	Jacky Hung, Andy Yang, and CR Liao	Temperature :	20~25°C
		Relative Humidity :	50~60%

Note symbol

-L	Low channel location
-R	High channel location



<1Mbps>

2.4GHz 2400~2483.5MHz

BLE (Band Edge @ 3m)

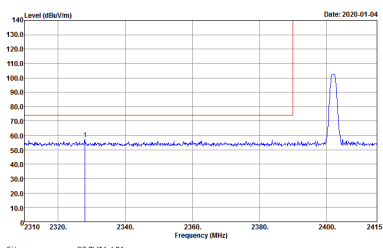
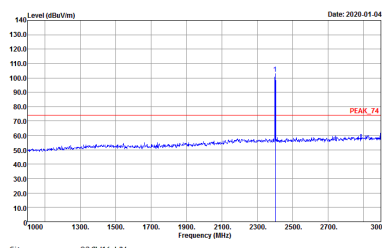
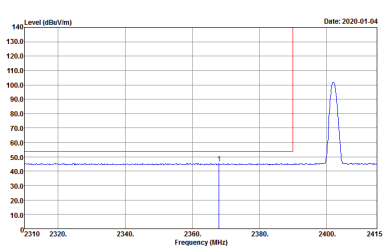
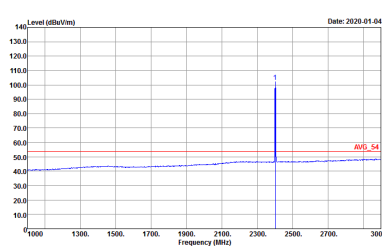
BLE	2.4GHz 2400~2483.5MHz Band Edge @ 3m	
BLE CH00 2402MHz		
Horizontal		Fundamental
Peak	 <p>Date: 2020-01-04</p> <p>Site : 03CH16-HY Condition : PEAK_BE_74 3m 91200_1522 HORIZONTAL RBW:1000.000KHz VBW:3000.000KHz SWT:Auto Detector : Peak Project : 901542-02</p>	 <p>Date: 2020-01-04</p> <p>Site : 03CH16-HY Condition : PEAK_74 3m 91200_1522 HORIZONTAL RBW:1000.000KHz VBW:3000.000KHz SWT:Auto Detector : Peak Project : 901542-02</p>
Avg.	 <p>Date: 2020-01-04</p> <p>Site : 03CH16-HY Condition : AVG_BE_54 3m 91200_1522 HORIZONTAL RBW:1000.000KHz VBW:1000KHz SWT:Auto Detector : Peak Project : 901542-02</p>	 <p>Date: 2020-01-04</p> <p>Site : 03CH16-HY Condition : AVG_54 3m 91200_1522 HORIZONTAL RBW:1000.000KHz VBW:1000KHz SWT:Auto Detector : Peak Project : 901542-02</p>

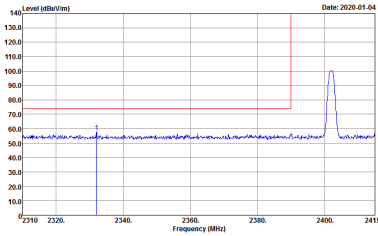
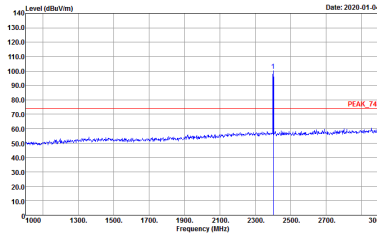
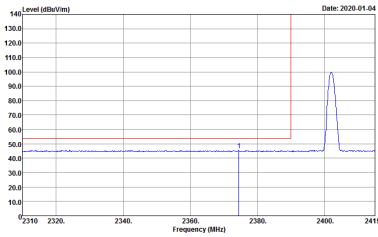
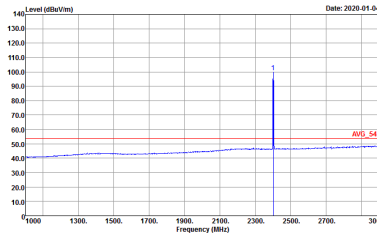

BLE	2.4GHz 2400~2483.5MHz Band Edge @ 3m	
BLE CH00 2402MHz		
	Vertical	Fundamental
<p>Peak</p>	 <p>Date: 2020-01-04</p> <p>Site : 03CH16-HY Condition : PEAK_BE_74 3m 91200_1522 VERTICAL RBW:1000.000KHz VBW:3000.000KHz SWT:Auto Detector : Peak Project : 901542-02</p>	 <p>Date: 2020-01-04</p> <p>Site : 03CH16-HY Condition : PEAK_74 3m 91200_1522 VERTICAL RBW:1000.000KHz VBW:3000.000KHz SWT:Auto Detector : Peak Project : 901542-02</p>
<p>Avg</p>	 <p>Date: 2020-01-04</p> <p>Site : 03CH16-HY Condition : AVG_BE_54 3m 91200_1522 VERTICAL RBW:1000.000KHz VBW:1000KHz SWT:Auto Detector : Peak Project : 901542-02</p>	 <p>Date: 2020-01-04</p> <p>Site : 03CH16-HY Condition : AVG_54 3m 91200_1522 VERTICAL RBW:1000.000KHz VBW:1000KHz SWT:Auto Detector : Peak Project : 901542-02</p>

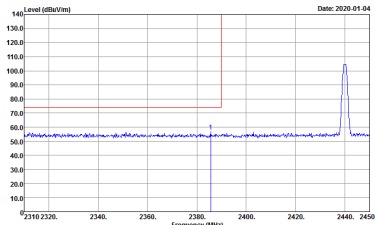
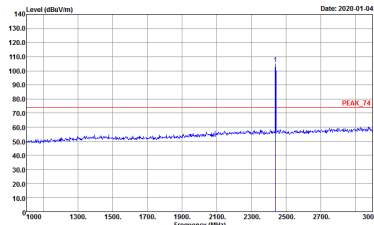
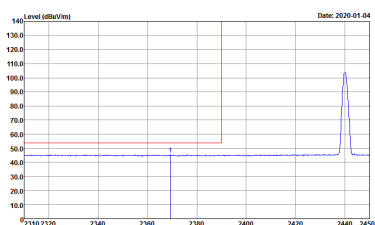
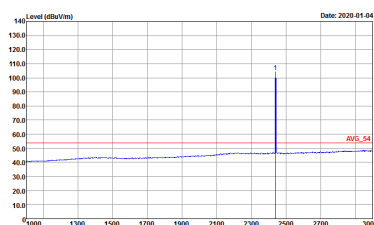

BLE	2.4GHz 2400~2483.5MHz Band Edge @ 3m	
BLE CH19 2440MHz - L		
	Horizontal	Fundamental
Peak	 <p>Date: 2020-01-04</p> <p>Site : 03CH16-HV Condition : PEAK_BE_74 3m 91200_1522 HORIZONTAL : RBW:1000.000KHz VBW:3000.000KHz SWT:Auto Detector : Peak Project : 901542-02</p>	 <p>Date: 2020-01-04</p> <p>Site : 03CH16-HV Condition : PEAK_74 3m 91200_1522 HORIZONTAL : RBW:1000.000KHz VBW:3000.000KHz SWT:Auto Detector : Peak Project : 901542-02</p>
Avg.	 <p>Date: 2020-01-04</p> <p>Site : 03CH16-HV Condition : AVG_BE_54 3m 91200_1522 HORIZONTAL : RBW:1000.000KHz VBW:1.000KHz SWT:Auto Detector : Peak Project : 901542-02</p>	 <p>Date: 2020-01-04</p> <p>Site : 03CH16-HV Condition : AVG_54 3m 91200_1522 HORIZONTAL : RBW:1000.000KHz VBW:1.000KHz SWT:Auto Detector : Peak Project : 901542-02</p>

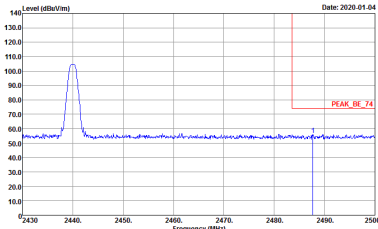
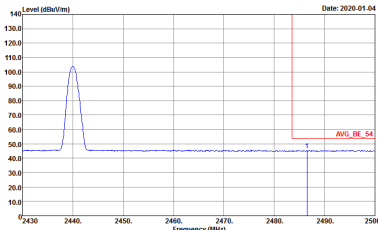

BLE	2.4GHz 2400~2483.5MHz Band Edge @ 3m	
BLE CH19 2440MHz - R		
	Horizontal	Fundamental
<p>Peak</p>	 <p>Site : 03CH16-HY Condition : PEAK_BE_74 3m 91200_1522 HORIZONTAL RBW:1000.000kHz VBW:3000.000kHz SWF:Auto Detector : Peak Project : 901542-02</p>	<p>Left blank</p>
<p>Avg.</p>	 <p>Site : 03CH16-HY Condition : AVG_BE_54 3m 91200_1522 HORIZONTAL RBW:1000.000kHz VBW:1.000kHz SWF:Auto Detector : Peak Project : 901542-02</p>	<p>Left blank</p>

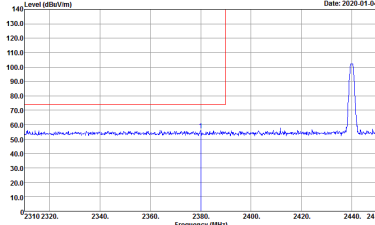
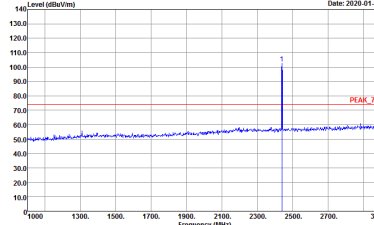
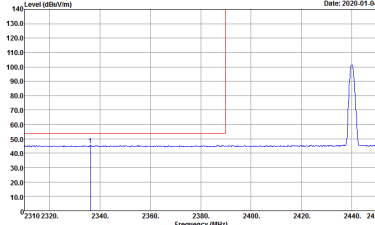

BLE	2.4GHz 2400~2483.5MHz Band Edge @ 3m	
BLE CH19 2440MHz - L		
	Vertical	Fundamental
Peak	 <p>Site : 03CH16-HY Condition : PEAK_BE_74 3m 91200_1522 VERTICAL RBW:1000.000KHz VBW:3000.000KHz SWT:Auto Detector : Peak Project : 901542-02</p>	 <p>Site : 03CH16-HY Condition : PEAK_74 3m 91200_1522 VERTICAL RBW:1000.000KHz VBW:3000.000KHz SWT:Auto Detector : Peak Project : 901542-02</p>
Avg.	 <p>Site : 03CH16-HY Condition : AVG_BE_54 3m 91200_1522 VERTICAL RBW:1000.000KHz VBW:1000KHz SWT:Auto Detector : Peak Project : 901542-02</p>	 <p>Site : 03CH16-HY Condition : AVG_54 3m 91200_1522 VERTICAL RBW:1000.000KHz VBW:1000KHz SWT:Auto Detector : Peak Project : 901542-02</p>

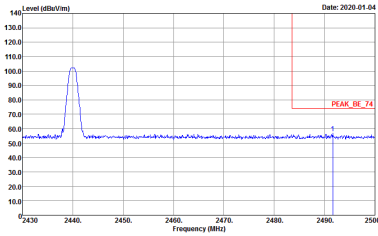
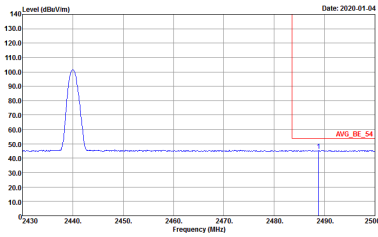

BLE	2.4GHz 2400~2483.5MHz Band Edge @ 3m	
BLE CH19 2440MHz - R		
	Vertical	Fundamental
<p>Peak</p>	 <p>Date: 2020-01-04</p> <p>Site : 03CH16-HY Condition : PEAK_BE_74 3m 91200_1522 VERTICAL RBW:1000.000KHz VBW:3000.000KHz SWF:Auto Detector : Peak Project : 901542-02</p>	<p>Left blank</p>
<p>Avg.</p>	 <p>Date: 2020-01-04</p> <p>Site : 03CH16-HY Condition : AVG_BE_54 3m 91200_1522 VERTICAL RBW:1000.000KHz VBW:1.000KHz SWF:Auto Detector : Peak Project : 901542-02</p>	<p>Left blank</p>



BLE	2.4GHz 2400~2483.5MHz Band Edge @ 3m	
BLE CH39 2480MHz		
	Horizontal	Fundamental
Peak	<p>Site : 03CH16-HY Condition : PEAK_BE_74 3m 91200_1522 HORIZONTAL RBW:1000.000KHz VBW:3000.000KHz SWT:Auto Detector : Peak Project : 901542-02</p>	<p>Site : 03CH16-HY Condition : PEAK_74 3m 91200_1522 HORIZONTAL RBW:1000.000KHz VBW:3000.000KHz SWT:Auto Detector : Peak Project : 901542-02</p>
Avg.	<p>Site : 03CH16-HY Condition : AVG_BE_54 3m 91200_1522 HORIZONTAL RBW:1000.000KHz VBW:1000KHz SWT:Auto Detector : Peak Project : 901542-02</p>	<p>Site : 03CH16-HY Condition : AVG_54 3m 91200_1522 HORIZONTAL RBW:1000.000KHz VBW:1000KHz SWT:Auto Detector : Peak Project : 901542-02</p>



BLE	2.4GHz 2400~2483.5MHz Band Edge @ 3m	
BLE CH39 2480MHz		
	Vertical	Fundamental
<p>Peak</p>	<p>Site : 03CH16-HY Condition : PEAK_BE_74 3m 91200_1522 VERTICAL RBW:1000.000KHz VBW:3000.000KHz SWT:Auto Detector : Peak Project : 901542-02</p>	<p>Site : 03CH16-HY Condition : PEAK_74 3m 91200_1522 VERTICAL RBW:1000.000KHz VBW:3000.000KHz SWT:Auto Detector : Peak Project : 901542-02</p>
<p>Avg.</p>	<p>Site : 03CH16-HY Condition : AVG_BE_54 3m 91200_1522 VERTICAL RBW:1000.000KHz VBW:1000KHz SWT:Auto Detector : Peak Project : 901542-02</p>	<p>Site : 03CH16-HY Condition : AVG_54 3m 91200_1522 VERTICAL RBW:1000.000KHz VBW:1000KHz SWT:Auto Detector : Peak Project : 901542-02</p>



2.4GHz 2400~2483.5MHz

BLE (Harmonic @ 3m)

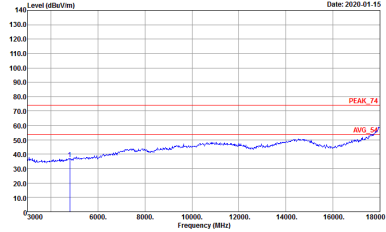
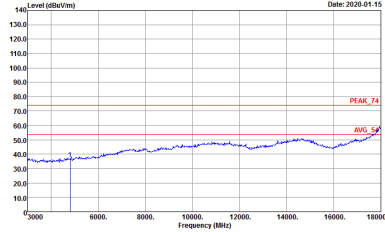
BLE	2.4GHz 2400~2483.5MHz Harmonic @ 3m	
	BLE CH00 2402MHz	
	Horizontal	Vertical
<p>Peak</p> <p>Avg.</p>	 <p>Site : 03CH16-1FY Condition : PEAK_74 3m 91200_1522 HORIZONTAL Detector : Peak Project : 901542-02</p>	 <p>Site : 03CH16-1FY Condition : PEAK_74 3m 91200_1522 VERTICAL Detector : Peak Project : 901542-02</p>



BLE	2.4GHz 2400~2483.5MHz Harmonic @ 3m	
	BLE CH19 2440MHz	
	Horizontal	Vertical
Peak Avg.	<p>Site : 03CH16-HY Condition : PEAK_74 3m 91200_1522 HORIZONTAL Detector : Peak Project : 901542-02</p>	<p>Site : 03CH16-HY Condition : PEAK_74 3m 91200_1522 VERTICAL Detector : Peak Project : 901542-02</p>



BLE	2.4GHz 2400~2483.5MHz Harmonic @ 3m	
	BLE CH39 2480MHz	
	Horizontal	Vertical
Peak	<p>Site : 03CH16-HY Condition : PEAK_74 3m 91200_1522 HORIZONTAL Detector : Peak Project : 901542-02</p>	<p>Site : 03CH16-HY Condition : PEAK_74 3m 91200_1522 VERTICAL Detector : Peak Project : 901542-02</p>



<2Mbps>

2.4GHz 2400~2483.5MHz

BLE (Band Edge @ 3m)

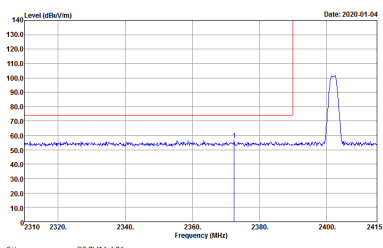
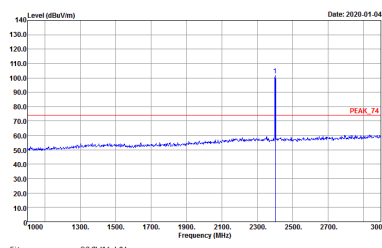
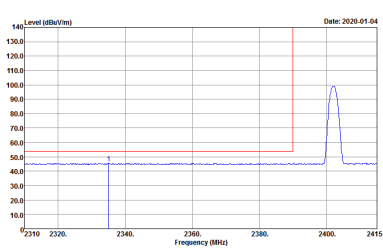
BLE	2.4GHz 2400~2483.5MHz Band Edge @ 3m	
BLE CH00 2402MHz		
Horizontal		Fundamental
Peak	 <p>Site : 03CH16-HY Condition : PEAK_BE_74 3m 91200_1522 HORIZONTAL RBW:1000.000KHz VBW:3000.000KHz SWT:Auto Detector : Peak Project : 901542-02</p>	 <p>Site : 03CH16-HY Condition : PEAK_74 3m 91200_1522 HORIZONTAL RBW:1000.000KHz VBW:3000.000KHz SWT:Auto Detector : Peak Project : 901542-02</p>
Avg.	 <p>Site : 03CH16-HY Condition : AVG_BE_54 3m 91200_1522 HORIZONTAL RBW:1000.000KHz VBW:1000KHz SWT:Auto Detector : Peak Project : 901542-02</p>	 <p>Site : 03CH16-HY Condition : AVG_54 3m 91200_1522 HORIZONTAL RBW:1000.000KHz VBW:1000KHz SWT:Auto Detector : Peak Project : 901542-02</p>



BLE	2.4GHz 2400~2483.5MHz Band Edge @ 3m	
BLE CH00 2402MHz		
	Vertical	Fundamental
<p>Peak</p>	<p>Date: 2020-01-04</p> <p>Site : 03CH16-HY Condition : PEAK_BE_74 3m 91200_1522 VERTICAL RBW:1000.000KHz VBW:3000.000KHz SWT:Auto Detector : Peak Project : 901542-02</p>	<p>Date: 2020-01-04</p> <p>Site : 03CH16-HY Condition : PEAK_74 3m 91200_1522 VERTICAL RBW:1000.000KHz VBW:3000.000KHz SWT:Auto Detector : Peak Project : 901542-02</p>
<p>Avg</p>	<p>Date: 2020-01-04</p> <p>Site : 03CH16-HY Condition : AVG_BE_54 3m 91200_1522 VERTICAL RBW:1000.000KHz VBW:1000KHz SWT:Auto Detector : Peak Project : 901542-02</p>	<p>Date: 2020-01-04</p> <p>Site : 03CH16-HY Condition : AVG_54 3m 91200_1522 VERTICAL RBW:1000.000KHz VBW:1000KHz SWT:Auto Detector : Peak Project : 901542-02</p>

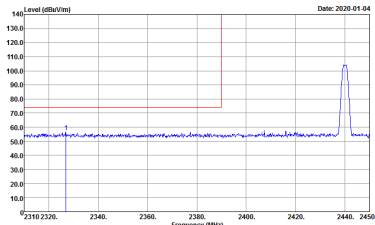
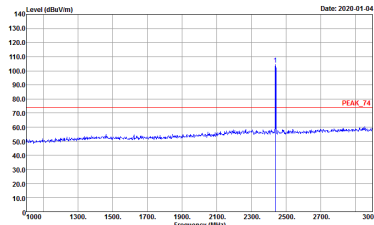
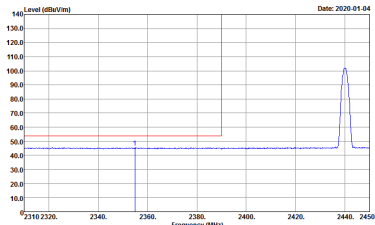
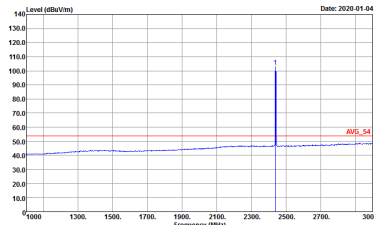

BLE	2.4GHz 2400~2483.5MHz Band Edge @ 3m	
BLE CH19 2440MHz - L		
	Horizontal	Fundamental
<p>Peak</p>	 <p>Date: 2020-01-04</p> <p>Site : 03CH16-HV Condition : PEAK_BE_74 3m 91200_1522 HORIZONTAL : RBW:1000.000KHz VBW:3000.000KHz SWT:Auto Detector : Peak Project : 901542-02</p>	 <p>Date: 2020-01-04</p> <p>Site : 03CH16-HV Condition : PEAK_74 3m 91200_1522 HORIZONTAL : RBW:1000.000KHz VBW:3000.000KHz SWT:Auto Detector : Peak Project : 901542-02</p>
<p>Avg.</p>	 <p>Date: 2020-01-04</p> <p>Site : 03CH16-HV Condition : AVG_BE_54 3m 91200_1522 HORIZONTAL : RBW:1000.000KHz VBW:1.000KHz SWT:Auto Detector : Peak Project : 901542-02</p>	 <p>Date: 2020-01-04</p> <p>Site : 03CH16-HV Condition : AVG_54 3m 91200_1522 HORIZONTAL : RBW:1000.000KHz VBW:1.000KHz SWT:Auto Detector : Peak Project : 901542-02</p>

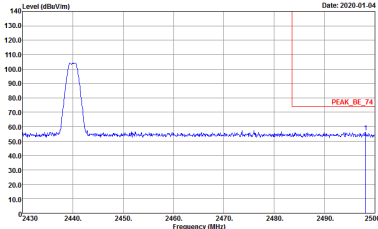
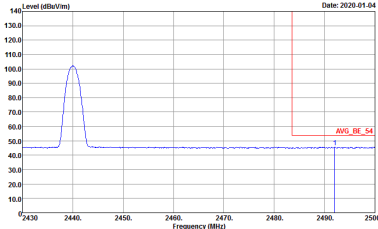

BLE	2.4GHz 2400~2483.5MHz Band Edge @ 3m	
BLE CH19 2440MHz - R		
	Horizontal	Fundamental
<p>Peak</p>	 <p>Site : 03CH16-HY Condition : PEAK_BE_74 3m 91200_1522 HORIZONTAL RBW:1000.000KHz VBW:3000.000KHz SWF:Auto Detector : Peak Project : 901542-02</p>	<p>Left blank</p>
<p>Avg.</p>	 <p>Site : 03CH16-HY Condition : AVG_BE_54 3m 91200_1522 HORIZONTAL RBW:1000.000KHz VBW:1000KHz SWF:Auto Detector : Peak Project : 901542-02</p>	<p>Left blank</p>

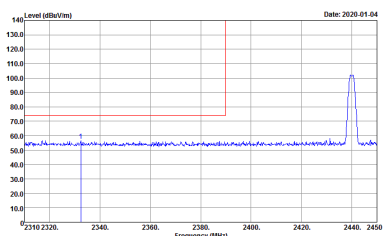
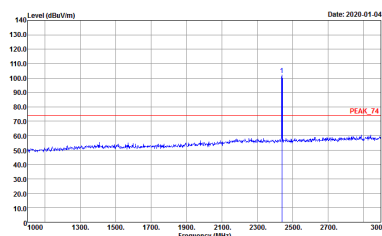
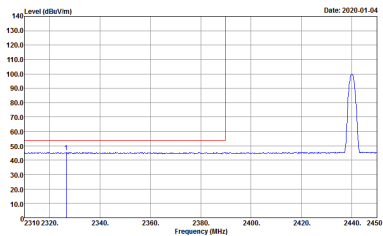
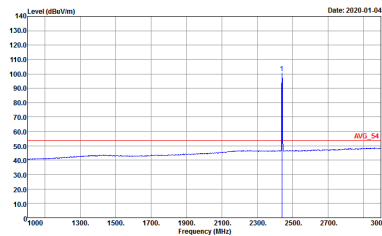

BLE	2.4GHz 2400~2483.5MHz Band Edge @ 3m	
BLE CH19 2440MHz - L		
	Vertical	Fundamental
<p>Peak</p>	 <p>Site : 03CH16-HY Condition : PEAK_BE_74 3m 91200_1522 VERTICAL RBW:1000.000KHz VBW:3000.000KHz SWT:Auto Detector : Peak Project : 901542-02</p>	 <p>Site : 03CH16-HY Condition : PEAK_74 3m 91200_1522 VERTICAL RBW:1000.000KHz VBW:3000.000KHz SWT:Auto Detector : Peak Project : 901542-02</p>
<p>Avg.</p>	 <p>Site : 03CH16-HY Condition : AVG_BE_54 3m 91200_1522 VERTICAL RBW:1000.000KHz VBW:1000KHz SWT:Auto Detector : Peak Project : 901542-02</p>	 <p>Site : 03CH16-HY Condition : AVG_54 3m 91200_1522 VERTICAL RBW:1000.000KHz VBW:1000KHz SWT:Auto Detector : Peak Project : 901542-02</p>

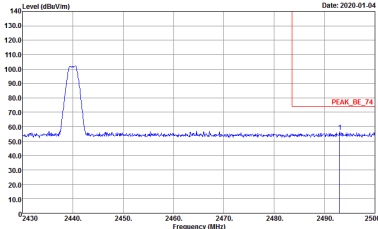
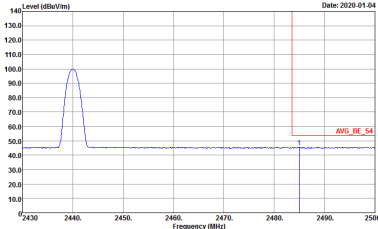

BLE	2.4GHz 2400~2483.5MHz Band Edge @ 3m	
BLE CH19 2440MHz - R		
	Vertical	Fundamental
<p>Peak</p>	 <p>Site : 03CH16-HY Condition : PEAK_BE_74 3m 91200_1522 VERTICAL RBW:1000.000KHz VBW:3000.000KHz SWF:Auto Detector : Peak Project : 901542-02</p>	<p>Left blank</p>
<p>Avg.</p>	 <p>Site : 03CH16-HY Condition : AVG_BE_54 3m 91200_1522 VERTICAL RBW:1000.000KHz VBW:1.000KHz SWF:Auto Detector : Peak Project : 901542-02</p>	<p>Left blank</p>

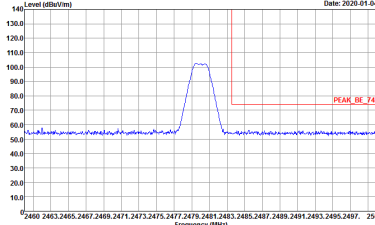
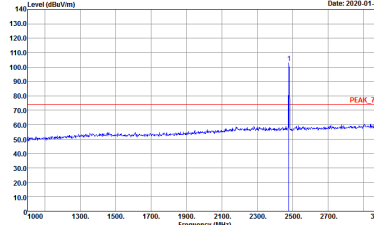
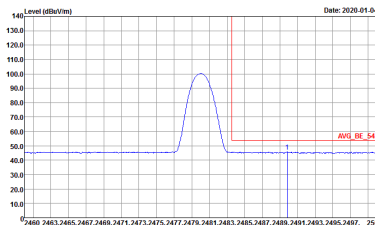
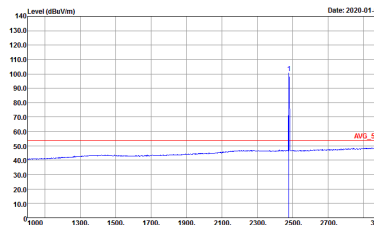

BLE	2.4GHz 2400~2483.5MHz Band Edge @ 3m	
BLE CH39 2480MHz		
	Horizontal	Fundamental
<p>Peak</p>	 <p>Site : 03CH16-HY Condition : PEAK_BE_74 3m 91200_1522 HORIZONTAL RBW:1000.000KHz VBW:3000.000KHz SWT:Auto Detector : Peak Project : 901542-02</p>	 <p>Site : 03CH16-HY Condition : PEAK_74 3m 91200_1522 HORIZONTAL RBW:1000.000KHz VBW:3000.000KHz SWT:Auto Detector : Peak Project : 901542-02</p>
<p>Avg.</p>	 <p>Site : 03CH16-HY Condition : AVG_BE_54 3m 91200_1522 HORIZONTAL RBW:1000.000KHz VBW:1000KHz SWT:Auto Detector : Peak Project : 901542-02</p>	 <p>Site : 03CH16-HY Condition : AVG_54 3m 91200_1522 HORIZONTAL RBW:1000.000KHz VBW:1000KHz SWT:Auto Detector : Peak Project : 901542-02</p>

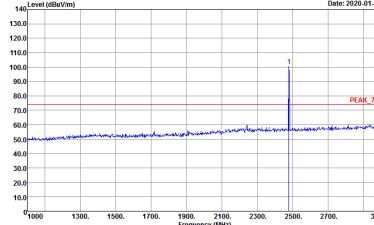
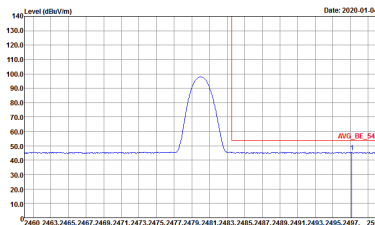
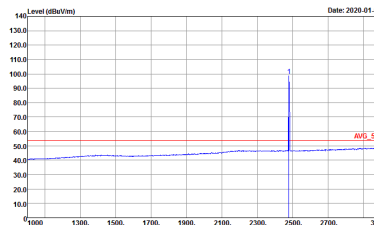

BLE	2.4GHz 2400~2483.5MHz Band Edge @ 3m	
BLE CH39 2480MHz		
	Vertical	Fundamental
Peak	 <p>Date: 2020-01-04</p> <p>Site : 03CH16-HY Condition : PEAK_BE_74 3m 91200_1522 VERTICAL RBW:1000.000KHz VBW:3000.000KHz SWT:Auto Detector : Peak Project : 901542-02</p>	 <p>Date: 2020-01-04</p> <p>Site : 03CH16-HY Condition : PEAK_74 3m 91200_1522 VERTICAL RBW:1000.000KHz VBW:3000.000KHz SWT:Auto Detector : Peak Project : 901542-02</p>
Avg.	 <p>Date: 2020-01-04</p> <p>Site : 03CH16-HY Condition : AVG_BE_54 3m 91200_1522 VERTICAL RBW:1000.000KHz VBW:1000KHz SWT:Auto Detector : Peak Project : 901542-02</p>	 <p>Date: 2020-01-04</p> <p>Site : 03CH16-HY Condition : AVG_54 3m 91200_1522 VERTICAL RBW:1000.000KHz VBW:1000KHz SWT:Auto Detector : Peak Project : 901542-02</p>



2.4GHz 2400~2483.5MHz

BLE (Harmonic @ 3m)

BLE	2.4GHz 2400~2483.5MHz Harmonic @ 3m	
	BLE CH00 2402MHz	
	Horizontal	Vertical
Peak Avg.	<p>Site : 03CH16-1FY Condition : PEAK_74 3m 91200_1522 HORIZONTAL Detector : Peak Project : 901542-02</p>	<p>Site : 03CH16-1FY Condition : PEAK_74 3m 91200_1522 VERTICAL Detector : Peak Project : 901542-02</p>



BLE	2.4GHz 2400~2483.5MHz Harmonic @ 3m	
	BLE CH19 2440MHz	
	Horizontal	Vertical
Peak Avg.	<p>Site : 03CH16-HY Condition : PEAK_74 3m 91200_1522 HORIZONTAL Detector : Peak Project : 901542-02</p>	<p>Site : 03CH16-HY Condition : PEAK_74 3m 91200_1522 VERTICAL Detector : Peak Project : 901542-02</p>



BLE	2.4GHz 2400~2483.5MHz Harmonic @ 3m	
	BLE CH39 2480MHz	
	Horizontal	Vertical
Peak	<p>Site : 03CH16-HY Condition : PEAK_74 3m 91200_1522 HORIZONTAL Detector : Peak Project : 901542-02</p>	<p>Site : 03CH16-HY Condition : PEAK_74 3m 91200_1522 VERTICAL Detector : Peak Project : 901542-02</p>



Emission above 18GHz

BLE (Harmonic @ 3m) (SHF)

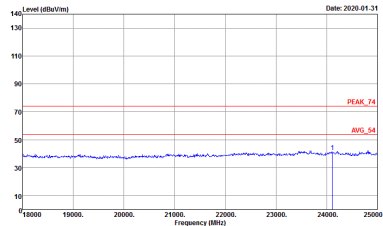
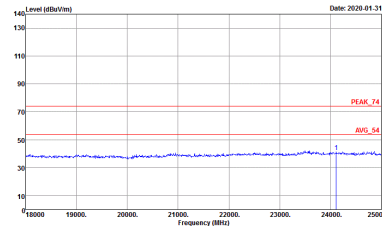
WIFI	2.4GHz 2400~2483.5MHz Harmonic @ 3m	
	BLE SHF	
	Horizontal	Vertical
Peak Avg.	 <p>Site : 03CH16-HY Condition : PEAK_74 3m 91200_1522 HORIZONTAL Detector : Peak Project : 901542-02</p>	 <p>Site : 03CH16-HY Condition : PEAK_74 3m 91200_1522 VERTICAL Detector : Peak Project : 901542-02</p>

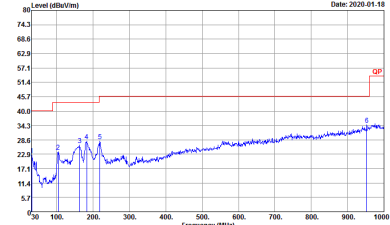
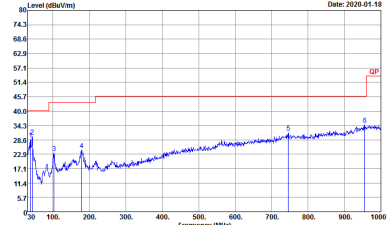

Emission below 1GHz
2.4GHz BLE (LF)

BLE	2.4GHz 2400~2483.5MHz	
	BLE LF	
	Horizontal	Vertical
<p>QP / Peak</p>	 <p>Site : 03CH16-1FY Condition : QP 3m BTL06_47020406 HORIZONTAL Detector : Peak Project : 901542-02</p>	 <p>Site : 03CH16-1FY Condition : QP 3m BTL06_47020406 VERTICAL Detector : Peak Project : 901542-02</p>



<WPC Mode>

2.4GHz 2400~2483.5MHz

BLE (Band Edge @ 3m)

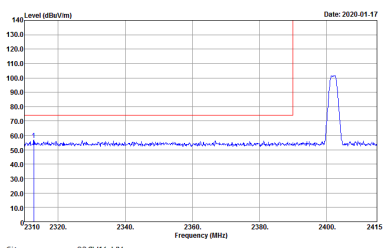
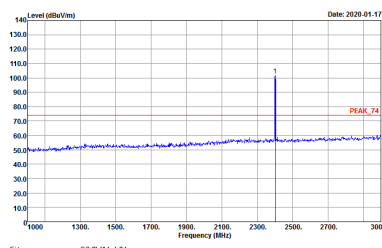
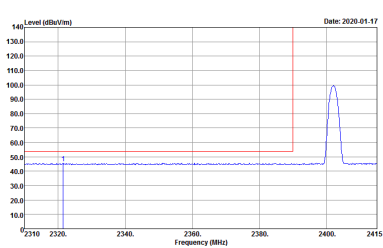
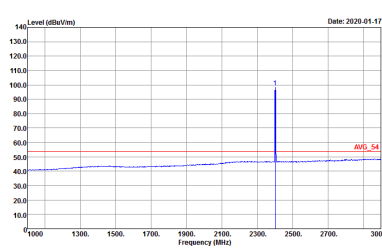
BLE	2.4GHz 2400~2483.5MHz Band Edge @ 3m	
BLE CH00 2402MHz		
	Horizontal	Fundamental
Peak	 <p>Date: 2020-01-17</p> <p>Site : 03CH16-HY Condition : PEAK_BE_74 3m 91200_1522 HORIZONTAL : RBW:1000.000KHz VBW:3000.000KHz SWT:Auto Detector : Peak Project : 901542-02</p>	 <p>Date: 2020-01-17</p> <p>Site : 03CH16-HY Condition : PEAK_74 3m 91200_1522 HORIZONTAL : RBW:1000.000KHz VBW:3000.000KHz SWT:Auto Detector : Peak Project : 901542-02</p>
Avg.	 <p>Date: 2020-01-17</p> <p>Site : 03CH16-HY Condition : AVG_BE_54 3m 91200_1522 HORIZONTAL : RBW:1000.000KHz VBW:1000KHz SWT:Auto Detector : Peak Project : 901542-02</p>	 <p>Date: 2020-01-17</p> <p>Site : 03CH16-HY Condition : AVG_54 3m 91200_1522 HORIZONTAL : RBW:1000.000KHz VBW:1000KHz SWT:Auto Detector : Peak Project : 901542-02</p>

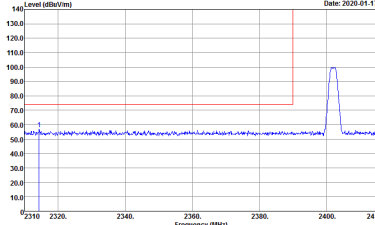
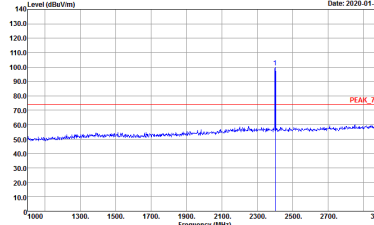
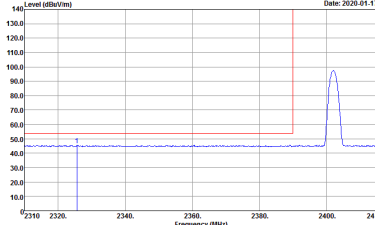
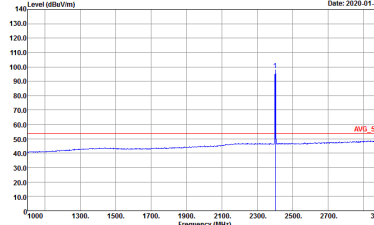

BLE	2.4GHz 2400~2483.5MHz Band Edge @ 3m	
BLE CH00 2402MHz		
Vertical		Fundamental
Peak	 <p>Site : 03CH16-HY Condition : PEAK_BE_74 3m 91200_1522 VERTICAL RBW:1000.000KHz VBW:3000.000KHz SWT:Auto Detector : Peak Project : 901542-02</p>	 <p>Site : 03CH16-HY Condition : PEAK_74 3m 91200_1522 VERTICAL RBW:1000.000KHz VBW:3000.000KHz SWT:Auto Detector : Peak Project : 901542-02</p>
Avg	 <p>Site : 03CH16-HY Condition : AVG_BE_54 3m 91200_1522 VERTICAL RBW:1000.000KHz VBW:1000KHz SWT:Auto Detector : Peak Project : 901542-02</p>	 <p>Site : 03CH16-HY Condition : AVG_54 3m 91200_1522 VERTICAL RBW:1000.000KHz VBW:1000KHz SWT:Auto Detector : Peak Project : 901542-02</p>



2.4GHz 2400~2483.5MHz

BLE (Harmonic @ 3m)

BLE	2.4GHz 2400~2483.5MHz Harmonic @ 3m	
	BLE CH00 2402MHz	
	Horizontal	Vertical
Peak Avg.	<p>Site : 03CH16-1FY Condition : PEAK_74 3m 91200_1522 HORIZONTAL Detector : Peak Project : 901542-02</p>	<p>Site : 03CH16-1FY Condition : PEAK_74 3m 91200_1522 VERTICAL Detector : Peak Project : 901542-02</p>

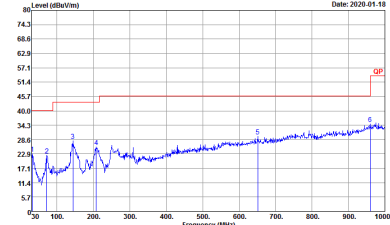
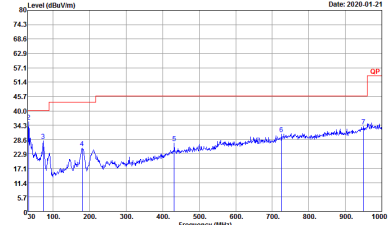

Emission below 1GHz
2.4GHz BLE (LF)

BLE	2.4GHz 2400~2483.5MHz	
BLE LF		
Horizontal		Vertical
QP / Peak	 <p>Date: 2020-01-18</p> <p>Site : 03CH16-HY Condition : QP 3m 81L06_47020406 HORIZONTAL Detector : Peak Project : 901542-02</p>	 <p>Date: 2020-01-21</p> <p>Site : 03CH16-HY Condition : QP 3m 81L06_47020406 VERTICAL Detector : Peak Project : 901542-02</p>



Appendix E. Duty Cycle Plots

Band	Duty Cycle(%)	T(us)	1/T(kHz)	VBW Setting	Duty Factor(dB)
Bluetooth LE for 1Mbps	85.2	2130	0.47	1kHz	0.70
Bluetooth LE for 2Mbps	57.33	1075	0.93	1kHz	2.42



Bluetooth - LE

<1 Mbps>

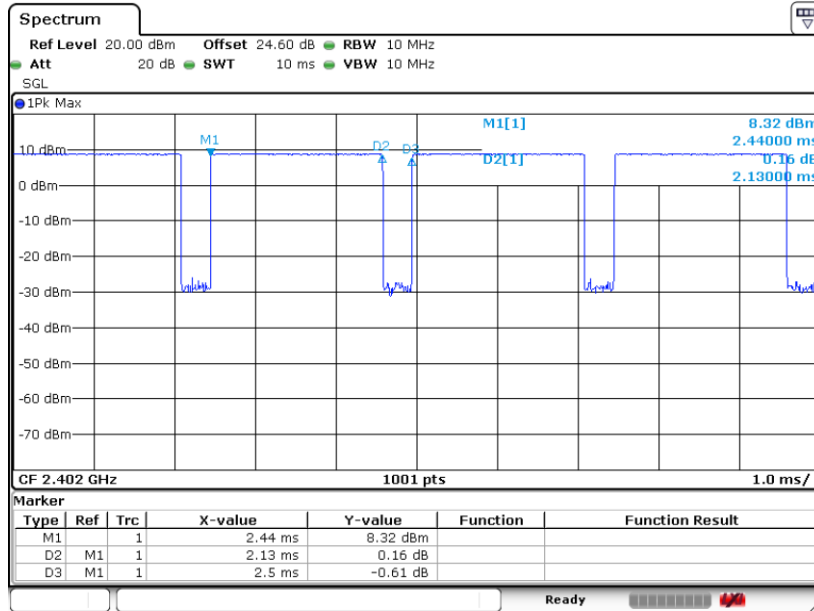

Date: 22.DEC.2019 17:32:11

<2 Mbps>

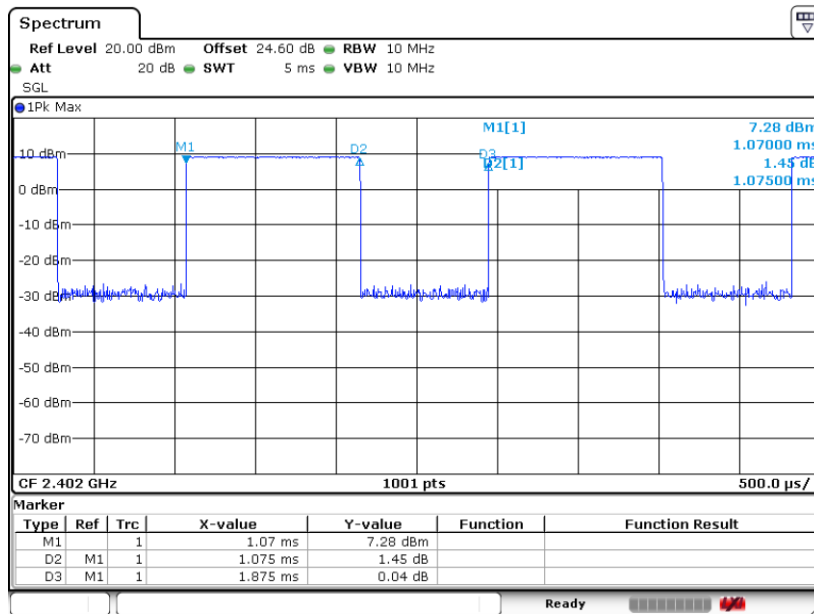

Date: 22.DEC.2019 17:38:08

—THE END—