



FCC RADIO TEST REPORT

FCC ID : PY7-87607S
Equipment : GSM/WCDMA/LTE Phone with BT, DTS/UNII a/b/g/n/ac/ax, GPS, WPC and NFC
Brand Name : Sony
Applicant : Sony Mobile Communications Inc.
4-12-3 Higashi-Shinagawa, Shinagawa-ku,
Tokyo, 140-0002, Japan
Manufacturer : Sony Mobile Communications Inc.
4-12-3 Higashi-Shinagawa, Shinagawa-ku,
Tokyo, 140-0002, Japan
Standard : FCC Part 15 Subpart C §15.247

The product was received on Dec. 04, 2019 and testing was started from Jan. 22, 2020 and completed on Feb. 10, 2020. We, SPORTON INTERNATIONAL INC., EMC & Wireless Communications Laboratory, would like to declare that the tested sample has been evaluated in accordance with the test procedures and has been in compliance with the applicable technical standards.

The report must not be used by the client to claim product certification, approval, or endorsement by TAF or any agency of government.

The test results in this Spot check data report apply exclusively to the tested model / sample. Without written approval of SPORTON INTERNATIONAL INC. EMC & Wireless Communications Laboratory, the test report shall not be reproduced except in full.

Louis Wu

Reviewed by: Louis Wu

SPORTON INTERNATIONAL INC. EMC & Wireless Communications Laboratory

No. 52, Huaya 1st Rd., Guishan Dist., Taoyuan City, Taiwan (R.O.C.)



Table of Contents

History of this test report	3
Summary of Test Result	4
1 General Description	5
1.1 Product Feature of Equipment Under Test	5
1.2 Modification of EUT	5
1.3 Testing Location	6
1.4 Applicable Standards	6
2 Test Configuration of Equipment Under Test	7
2.1 Carrier Frequency Channel.....	7
2.2 Test Mode	8
2.3 Connection Diagram of Test System	9
2.4 Support Unit used in test configuration and system	9
2.5 EUT Operation Test Setup	9
3 Test Result	10
3.1 Output Power Measurement	10
3.2 Radiated Band Edges and Spurious Emission Measurement.....	11
3.3 Antenna Requirements	15
4 List of Measuring Equipment	16
5 Uncertainty of Evaluation	18
Appendix A. Conducted Test Results	
Appendix B. Radiated Spurious Emission	
Appendix C. Radiated Spurious Emission Plots	
Appendix D. Duty Cycle Plots	



History of this test report

Report No.	Version	Description	Issued Date
FR901543-01A	01	Initial issue of report	Feb. 20, 2020



Summary of Test Result

Report Clause	Ref Std. Clause	Test Items	Result (PASS/FAIL)	Remark
-	15.247(a)(1)	Number of Channels	Not Required	-
-	15.247(a)(1)	Hopping Channel Separation	Not Required	-
-	15.247(a)(1)	Dwell Time of Each Channel	Not Required	-
-	15.247(a)(1)	20dB Bandwidth	Not Required	-
-	2.1049	99% Occupied Bandwidth	Not Required	-
3.1	15.247(b)(1)	Peak Output Power	Pass	-
-	15.247(d)	Conducted Band Edges	Not Required	-
-	15.247(d)	Conducted Spurious Emission	Not Required	-
3.2	15.247(d)	Radiated Band Edges and Radiated Spurious Emission	Pass	Under limit 10.60 dB at 38.730 MHz
-	15.207	AC Conducted Emission	Not Required	-
3.3	15.203 & 15.247(b)	Antenna Requirement	Pass	-

Remark: This is a spot check data report and data performed in appendix of this report are chosen from the worst case of the original FCC ID report. All the test cases were performed on original report which can be referred to Sporton Report Number FR901542-02A.

Declaration of Conformity:
The test results with all measurement uncertainty excluded are presented in accordance with the regulation limits or requirements declared by manufacturers.
Comments and Explanations:
The declared of product specification for EUT presented in the report are provided by the manufacturer, and the manufacturer takes all the responsibilities for the accuracy of product specification.

Reviewed by: Wii Chang

Report Producer: Fiona Wu



1 General Description

1.1 Product Feature of Equipment Under Test

GSM/WCDMA/LTE, Bluetooth, DTS/UNII a/b/g/n/ac/ax, NFC, GNSS and WPC.

Standards-related Product Specification	
Antenna Type / Gain	Loop Antenna with gain -2.40 dBi

EUT Information List			
HW Version	SW Version	S/N	Performed Test Item
A	0.320	QV7100872C	Conducted Measurement
	0.360	QV71004V2C	Radiated Spurious Emission

Accessory List	
AC Adapter	Model Name : UCH32
	S/N: 6218W30200197
Earphone	Model Name : STH40D
	S/N : N/A
Bluetooth Earphone	Model Name : SBH82D
	S/N : N/A
USB Cable	Model Name : UCB24
	S/N : N/A
Audio Cable	Model Name : EC234
	S/N : N/A

Note:

1. Above EUT list used are electrically identical per declared by manufacturer.
2. Above the accessories list are used to exercise the EUT during test, and the serial number of each type of accessories is listed in each section of this report.
3. For other wireless features of this EUT, test report will be issued separately.

1.2 Modification of EUT

No modifications are made to the EUT during all test items.



1.3 Testing Location

Test Site	SPORTON INTERNATIONAL INC. EMC & Wireless Communications Laboratory
Test Site Location	No.52, Huaya 1st Rd., Guishan Dist., Taoyuan City, Taiwan (R.O.C.) TEL: +886-3-327-3456 FAX: +886-3-328-4978
Test Site No.	Sporton Site No.
	TH05-HY

Note: The test site complies with ANSI C63.4 2014 requirement.

Test Site	SPORTON INTERNATIONAL INC. EMC & Wireless Communications Laboratory
Test Site Location	No.58, Aly. 75, Ln. 564, Wenhua 3rd, Rd., Guishan Dist., Taoyuan City, Taiwan (R.O.C.) TEL: +886-3-327-0868 FAX: +886-3-327-0855
Test Site No.	Sporton Site No.
	03CH16-HY

Note: The test site complies with ANSI C63.4 2014 requirement.

FCC designation No.: TW1190 and TW0007

1.4 Applicable Standards

According to the specifications of the manufacturer, the EUT must comply with the requirements of the following standards:

- ♦ FCC Part 15 Subpart C §15.247
- ♦ FCC KDB Publication No. 558074 D01 DTS Meas. Guidance v05r02
- ♦ FCC KDB 414788 D01 Radiated Test Site v01r01
- ♦ ANSI C63.10-2013

Remark:

1. All test items were verified and recorded according to the standards and without any deviation during the test.
2. This EUT has also been tested and complied with the requirements of FCC Part 15, Subpart B, recorded in a separate test report.



2 Test Configuration of Equipment Under Test

2.1 Carrier Frequency Channel

Frequency Band	Channel	Freq. (MHz)	Channel	Freq. (MHz)	Channel	Freq. (MHz)
2400-2483.5 MHz	0	2402	27	2429	54	2456
	1	2403	28	2430	55	2457
	2	2404	29	2431	56	2458
	3	2405	30	2432	57	2459
	4	2406	31	2433	58	2460
	5	2407	32	2434	59	2461
	6	2408	33	2435	60	2462
	7	2409	34	2436	61	2463
	8	2410	35	2437	62	2464
	9	2411	36	2438	63	2465
	10	2412	37	2439	64	2466
	11	2413	38	2440	65	2467
	12	2414	39	2441	66	2468
	13	2415	40	2442	67	2469
	14	2416	41	2443	68	2470
	15	2417	42	2444	69	2471
	16	2418	43	2445	70	2472
	17	2419	44	2446	71	2473
	18	2420	45	2447	72	2474
	19	2421	46	2448	73	2475
	20	2422	47	2449	74	2476
	21	2423	48	2450	75	2477
	22	2424	49	2451	76	2478
	23	2425	50	2452	77	2479
	24	2426	51	2453	78	2480
	25	2427	52	2454	-	-
	26	2428	53	2455	-	-



2.2 Test Mode

- a. The EUT has been associated with peripherals and configuration operated in a manner tended to maximize its emission characteristics in a typical application. Frequency range investigated: radiation emission (9 kHz to the 10th harmonic of the highest fundamental frequency or to 40 GHz, whichever is lower). For radiated measurement, pre-scanned in three orthogonal panels, X, Y, Z. The worst cases (X plane) were recorded in this report, and the worst mode of radiated spurious emissions is Bluetooth 3Mbps mode, and recorded in this report.

The following summary table is showing all test modes to demonstrate in compliance with the standard.

Summary table of Test Cases	
Test Item	Data Rate / Modulation
Radiated Test Cases	Bluetooth EDR 3Mbps 8-DPSK
	Mode 1: CH78_2480 MHz

2.3 Connection Diagram of Test System

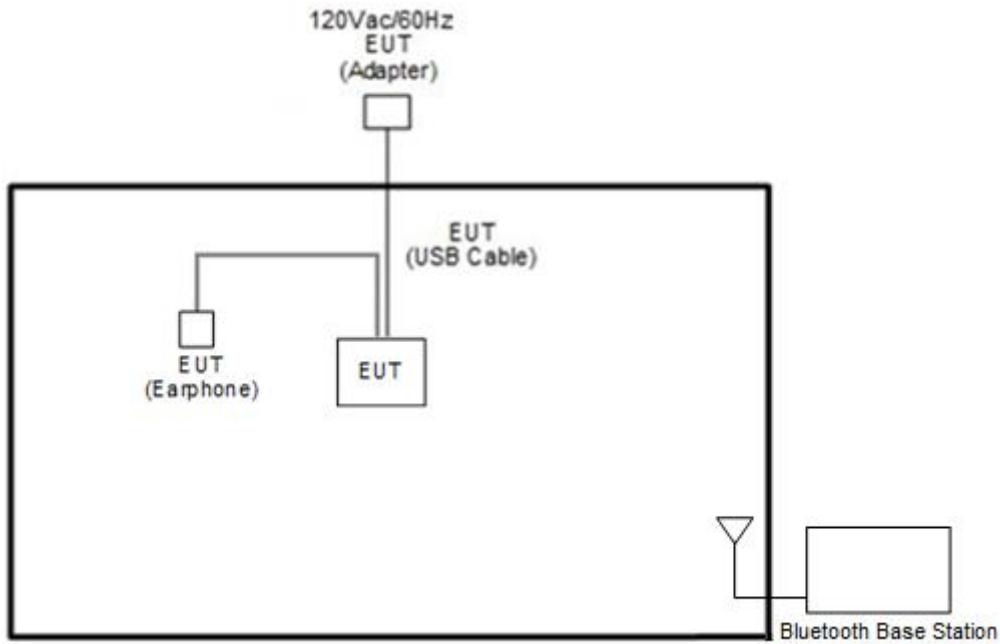

2.4 Support Unit used in test configuration and system

Item	Equipment	Trade Name	Model Name	FCC ID	Data Cable	Power Cord
1.	Bluetooth Base Station	R&S	CBT32	N/A	N/A	Unshielded, 1.8 m

2.5 EUT Operation Test Setup

The RF test items, utility “FTMC_bridge_forURC_v0.39” was installed in Notebook which was programmed in order to make the EUT get into the engineering modes to contact with base station to provide channel selection, power level, data rate and the application type and for continuous transmitting signals.

3 Test Result

3.1 Output Power Measurement

3.1.1 Limit of Output Power

The maximum peak conducted output power of the intentional radiator shall not exceed the following:
For frequency hopping systems operating in the 2400-2483.5 MHz band employing at least 75 non-overlapping hopping channels, and all frequency hopping systems in the 5725-5850 MHz band: 1 watt. For all other frequency hopping systems in the 2400-2483.5 MHz band 0.125 watts.

3.1.2 Measuring Instruments

See list of measuring equipment of this test report.

3.1.3 Test Procedures

1. The testing follows ANSI C63.10-2013 clause 7.8.5.
1. The RF output of EUT was connected to the power meter by RF cable and attenuator. The path loss was compensated to the results for each measurement.
2. Set to the maximum power setting and enable the EUT transmit continuously.
3. Measure the conducted output power with cable loss and record the results in the test report.
4. Measure and record the results in the test report.

3.1.4 Test Setup

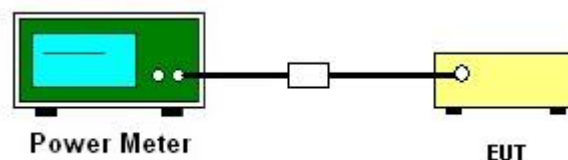

3.1.5 Test Result of Peak Output Power

Please refer to Appendix A.

3.1.6 Test Result of Average Output Power (Reporting Only)

Please refer to Appendix A.



3.2 Radiated Band Edges and Spurious Emission Measurement

3.2.1 Limit of Radiated Band Edges and Spurious Emission

In any 100 kHz bandwidth outside the intentional radiator frequency band, all harmonics/spurious must be at least 20 dB below the highest emission level within the authorized band. In addition, radiated emissions which fall in the restricted bands must also comply with the limits as below.

Frequency (MHz)	Field Strength (microvolts/meter)	Measurement Distance (meters)
0.009 – 0.490	2400/F(kHz)	300
0.490 – 1.705	24000/F(kHz)	30
1.705 – 30.0	30	30
30 – 88	100	3
88 – 216	150	3
216 - 960	200	3
Above 960	500	3

3.2.2 Measuring Instruments

See list of measuring equipment of this test report.

**3.2.3 Test Procedures**

1. The EUT was placed on a turntable with 0.8 meter for frequency below 1GHz and 1.5 meter for frequency above 1GHz respectively above ground.
2. The EUT was set 3 meters from the interference receiving antenna, which was mounted on the top of a variable height antenna tower.
3. For each suspected emission, the EUT was arranged to its worst case and then tune the Antenna tower (from 1 m to 4 m) and turntable (from 0 degree to 360 degrees) to find the maximum reading. A pre-amp and a high pass filter are used for the test in order to get better signal level to comply with the guidelines.
4. Set to the maximum power setting and enable the EUT transmit continuously.
5. Use the following spectrum analyzer settings:
 - (1) Span shall wide enough to fully capture the emission being measured;
 - (2) Set RBW=100 kHz for $f < 1 \text{ GHz}$, RBW=1MHz for $f > 1\text{GHz}$; VBW \geq RBW; Sweep = auto; Detector function = peak; Trace = max hold for peak
 - (3) For average measurement: use duty cycle correction factor method per 15.35(c).
Duty cycle = On time/100 milliseconds
On time = $N_1 * L_1 + N_2 * L_2 + \dots + N_{n-1} * L_{n-1} + N_n * L_n$
Where N_1 is number of type 1 pulses, L_1 is length of type 1 pulses, etc.
Average Emission Level = Peak Emission Level + $20 * \log(\text{Duty cycle})$
6. Corrected Reading: Antenna Factor + Cable Loss + Read Level - Preamp Factor = Level
7. For testing below 1GHz, if the emission level of the EUT in peak mode was 3 dB lower than the limit specified, then peak values of EUT will be reported, otherwise, the emissions will be repeated one by one using the CISPR quasi-peak method and reported.
8. For testing above 1GHz, the emission level of the EUT in peak mode was 20dB lower than average limit (that means the emission level in average mode also complies with the limit in average mode), then peak values of EUT will be reported, otherwise, the emissions will be measured in average mode again and reported.

Note: The average levels were calculated from the peak level corrected with duty cycle correction factor (-24.79dB) derived from $20 \log(\text{dwell time}/100\text{ms})$. This correction is only for signals that hop with the fundamental signal, such as band-edge and harmonic. Other spurious signals that are independent of the hopping signal would not use this correction.

3.2.4 Test Setup

For radiated emissions below 30MHz

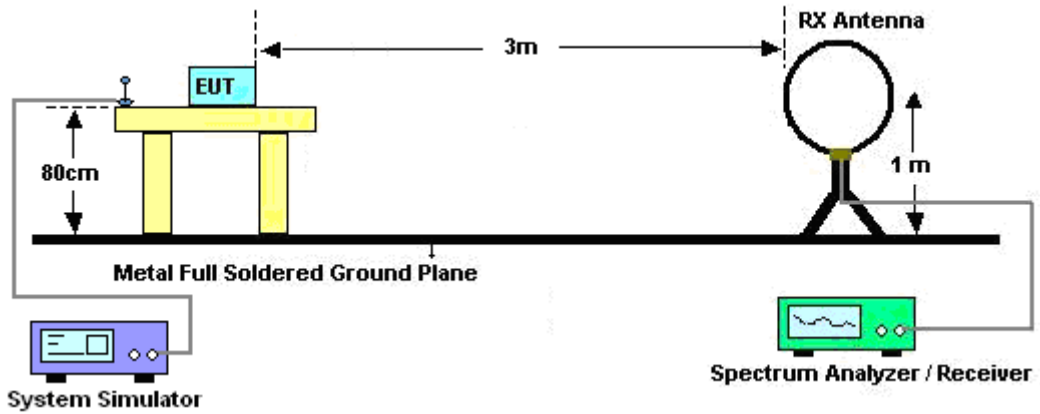

For radiated emissions from 30MHz to 1GHz

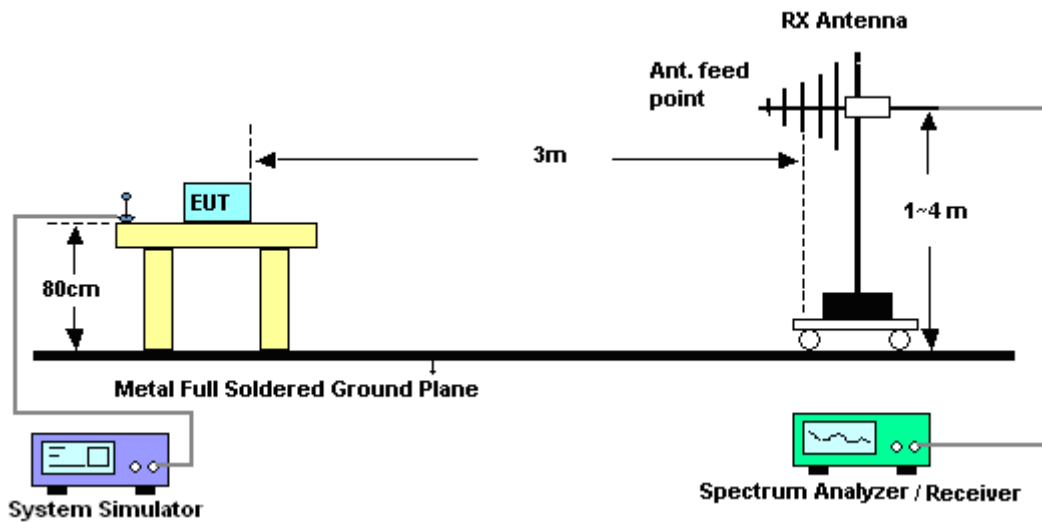

For radiated emissions above 1GHz

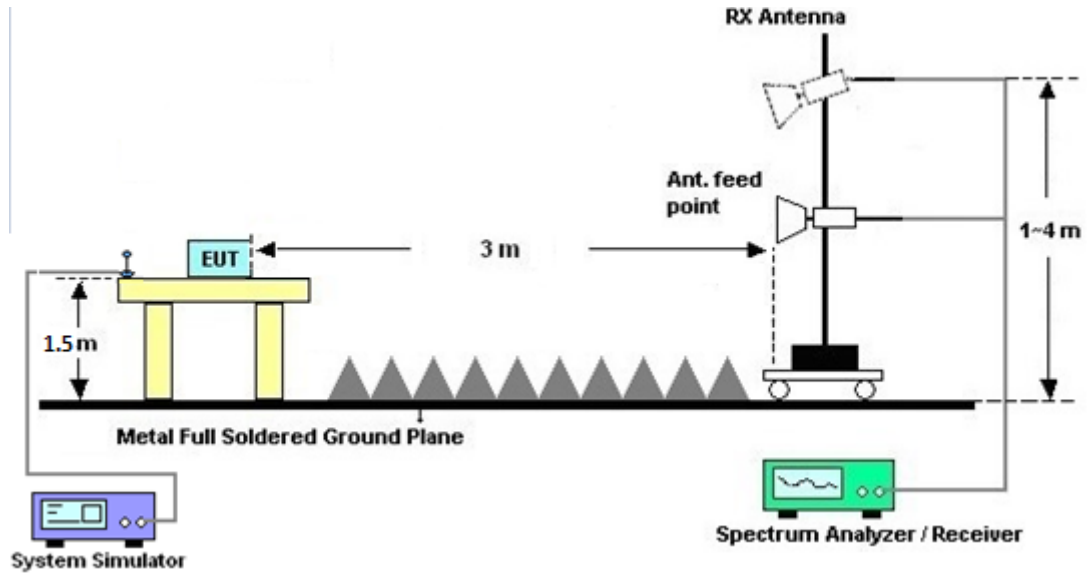

3.2.5 Test Results of Radiated Spurious Emissions (9 kHz ~ 30 MHz)

The low frequency, which started from 9 kHz to 30MHz, was pre-scanned and the result which was 20dB lower than the limit line was not reported.

There is a comparison data of both open-field test site and alternative test site - semi-Anechoic chamber according to 414788 D01 Radiated Test Site v01r01, and the result came out very similar.

3.2.6 Test Result of Radiated Spurious at Band Edges

Please refer to Appendix B and C.

3.2.7 Duty Cycle

Please refer to Appendix D.

3.2.8 Test Result of Radiated Spurious Emission (30MHz ~ 10th Harmonic)

Please refer to Appendix B and C.



3.3 Antenna Requirements

3.3.1 Standard Applicable

If directional gain of transmitting antennas is greater than 6dBi, the power shall be reduced by the same level in dB comparing to gain minus 6dBi. The use of a permanently attached antenna or of an antenna that uses a unique coupling to the intentional radiator shall be considered sufficient to comply with the rule.

3.3.2 Antenna Anti-Replacement Construction

An embedded-in antenna design is used.

3.3.3 Antenna Gain

The antenna peak gain of EUT is less than 6 dBi. Therefore, it is not necessary to reduce maximum peak output power limit.



4 List of Measuring Equipment

Instrument	Manufacturer	Model No.	Serial No.	Characteristics	Calibration Date	Test Date	Due Date	Remark
Loop Antenna	Rohde & Schwarz	HFH2-Z2	100488	9 kHz~30 MHz	Dec. 26, 2019	Feb. 06.,2020~ Feb. 10.,2020	Dec. 25, 2020	Radiation (03CH16-HY)
Bilog Antenna	TESEQ	CBL6111D&0 0802N1D01N- 06	47020&06	30MHz to 1GHz	Oct. 13, 2019	Feb. 06.,2020~ Feb. 10.,2020	Oct. 12, 2020	Radiation (03CH16-HY)
Horn Antenna	SCHWARZBE CK	BBHA 9120 D	9120D-152 2	1G~18GHz	Sep. 19, 2019	Feb. 06.,2020~ Feb. 10.,2020	Sep. 18, 2020	Radiation (03CH16-HY)
Amplifier	SONOMA	310N	371607	9kHz~1000MHz	Oct. 01. 2019	Feb. 06.,2020~ Feb. 10.,2020	Sep. 30. 2020	Radiation (03CH16-HY)
Preamplifier	Jet-Power	JPA0118-55-3 03	171000180 0054001	1GHz~18GHz	May 19, 2019	Feb. 06.,2020~ Feb. 10.,2020	May 18, 2020	Radiation (03CH16-HY)
Preamplifier	EMEC	EMC184045B	980192	18GHz ~40GHz	Jul. 10, 2019	Feb. 06.,2020~ Feb. 10.,2020	Jul. 09, 2020	Radiation (03CH16-HY)
Preamplifier	Keysight	83017A	MY532702 64	1GHz~26.5GHz	Dec. 11, 2019	Feb. 06.,2020~ Feb. 10.,2020	Dec.10, 2020	Radiation (03CH16-HY)
EMI Test Receiver	Keysight	N9038A (MXE)	MY554201 70	20MHz~8.4GHz	Mar. 08, 2019	Feb. 06.,2020~ Feb. 10.,2020	Mar. 07, 2020	Radiation (03CH16-HY)
Spectrum Analyzer	Agilent	E4446A	MY501801 36	3Hz~44GHz	Apr. 29, 2019	Feb. 06.,2020~ Feb. 10.,2020	Apr. 28, 2020	Radiation (03CH16-HY)
RF Cable	HUBER + SUHNER	SUCOFLEX 104	MY11680/ 4PE	NA	Aug. 30, 2019	Feb. 06.,2020~ Feb. 10.,2020	Aug. 29, 2020	Radiation (03CH16-HY)
RF Cable	HUBER + SUHNER	SUCOFLEX 104	MY11688/ 4PE	NA	Aug. 30, 2019	Feb. 06.,2020~ Feb. 10.,2020	Aug. 29, 2020	Radiation (03CH16-HY)
RF Cable	HUBER + SUHNER	SUCOFLEX 102	EC-A5-300 -5757	NA	Aug. 30, 2019	Feb. 06.,2020~ Feb. 10.,2020	Aug. 29, 2020	Radiation (03CH16-HY)
RF Cable	HUBER + SUHNER	SUCOFLEX 102	505134/2	30MHz~40GHz	Feb. 26, 2019	Feb. 06.,2020~ Feb. 10.,2020	Feb. 25, 2020	Radiation (03CH16-HY)
RF Cable	HUBER + SUHNER	SUCOFLEX 102	800740/2	30MHz~40GHz	Feb. 26, 2019	Feb. 06.,2020~ Feb. 10.,2020	Feb. 25, 2020	Radiation (03CH16-HY)
SHF-EHF Horn Antenna	SCHWARZBE CK	BBHA 9170	BBHA9170 576	18GHz~40GHz	May14.2019	Feb. 06.,2020~ Feb. 10.,2020	May 13.2020	Radiation (03CH16-HY)
Preamplifier	EMEC	EM18G40G	060715	18GHz~40GHz	Dec. 13, 2019	Feb. 06.,2020~ Feb. 10.,2020	Dec. 12, 2020	Radiation (03CH16-HY)
Hygrometer	TECPEL	DTM-303B	TP161243	N/A	Jun. 17, 2019	Feb. 06.,2020~ Feb. 10.,2020	Jun. 16, 2020	Radiation (03CH16-HY)
Software	Audix	E3 6.2009-8-24	RK-001136	N/A	N/A	Feb. 06.,2020~ Feb. 10.,2020	N/A	Radiation (03CH16-HY)
Filter	Wainwright	WLK4-1000-1 530-8000-40S S	SN11	1.53G Low Pass	Sep. 15, 2019	Feb. 06.,2020~ Feb. 10.,2020	Sep. 14, 2020	Radiation (03CH16-HY)
Filter	Wainwright	WHKX12-270 0-3000-18000 -60SS	SN3	3GHz High Pass Filter	Sep. 15, 2019	Feb. 06.,2020~ Feb. 10.,2020	Sep. 14, 2020	Radiation (03CH16-HY)



Instrument	Manufacturer	Model No.	Serial No.	Characteristics	Calibration Date	Test Date	Due Date	Remark
Hygrometer	Testo	608-H2	41410069	N/A	Jun. 17, 2019	Jan. 22, 2020	Jun. 16, 2020	Conducted (TH05-HY)
Power Meter	Agilent	E4416A	GB412923 44	N/A	Dec. 21, 2019	Jan. 22, 2020	Dec. 20, 2020	Conducted (TH05-HY)
Power Sensor	Agilent	E9327A	US404415 48	50MHz~18GHz	Dec. 21, 2019	Jan. 22, 2020	Dec. 20, 2020	Conducted (TH05-HY)
Spectrum Analyzer	Rohde & Schwarz	FSP40	100055	9kHz-40GHz	Aug. 14, 2019	Jan. 22, 2020	Aug. 13, 2020	Conducted (TH05-HY)
Switch Box & RF Cable	Burgeon	ETF-058	EC120838 2	N/A	Mar. 27, 2019	Jan. 22, 2020	Mar. 26, 2020	Conducted (TH05-HY)



5 Uncertainty of Evaluation

Uncertainty of Radiated Emission Measurement (30 MHz ~ 1000 MHz)

Measuring Uncertainty for a Level of Confidence of 95% ($U = 2Uc(y)$)	4.9
---	-----

Uncertainty of Radiated Emission Measurement (1000 MHz ~ 18000 MHz)

Measuring Uncertainty for a Level of Confidence of 95% ($U = 2Uc(y)$)	6.7
---	-----

Uncertainty of Radiated Emission Measurement (18000 MHz ~ 40000 MHz)

Measuring Uncertainty for a Level of Confidence of 95% ($U = 2Uc(y)$)	3.9
---	-----

Appendix A. Test Result of Conducted Test Items

Test Engineer:	Hank Hsu	Temperature:	21~25	°C
Test Date:	2020/1/22	Relative Humidity:	51~54	%

TEST RESULTS DATA**Peak Power Table**

DH	CH.	NTX	Peak Power (dBm)	Power Limit (dBm)	Test Result
DH1	0	1	13.77	20.97	Pass
	39	1	13.66	20.97	Pass
	78	1	13.37	20.97	Pass
2DH1	0	1	14.25	20.97	Pass
	39	1	14.09	20.97	Pass
	78	1	13.77	20.97	Pass
3DH1	0	1	14.76	20.97	Pass
	39	1	14.52	20.97	Pass
	78	1	14.17	20.97	Pass

TEST RESULTS DATA**Average Power Table*****(Reporting Only)***

DH	CH.	NTX	Average Power (dBm)	Duty Factor (dB)
DH1	0	1	13.09	5.21
	39	1	13.06	5.21
	78	1	12.88	5.21
2DH1	0	1	12.41	5.10
	39	1	11.80	5.10
	78	1	11.72	5.10
3DH1	0	1	11.94	5.14
	39	1	11.67	5.14
	78	1	11.37	5.14



Appendix B. Radiated Spurious Emission

Test Engineer :	Andy Yang and CR Liro	Temperature :	20~25°C
		Relative Humidity :	50~60%

<For 3Mbps>

2.4GHz 2400~2483.5MHz

BT (Band Edge @ 3m)

BT	Note	Frequency	Level	Over	Limit	Read	Antenna	Path	Preamp	Ant	Table	Peak	Pol.	
		(MHz)	(dBμV/m)	(dB)	Limit	Level	Factor	Loss	Factor	Pos	Pos	Avg.		
					Line	(dBμV)	(dB/m)	(dB)	(dB)	(cm)	(deg)	(P/A)	(H/V)	
BT CH 78 2480MHz	*	2480	107.34	-	-	101.3	27.54	8.32	29.82	109	26	P	H	
	*	2480	82.55	-	-	-	-	-	-	-	-	A	H	
		2483.56	51.02	-22.98	74	44.99	27.53	8.32	29.82	109	26	P	H	
		2483.56	26.23	-27.77	54	-	-	-	-	-	-	A	H	
													H	
														H
	*	2480	103.1	-	-	97.06	27.54	8.32	29.82	384	105	P	V	
	*	2480	78.31	-	-	-	-	-	-	-	-	-	A	V
		2485.32	47.85	-26.15	74	41.81	27.53	8.33	29.82	384	105	P	V	
		2485.32	23.06	-30.94	54	-	-	-	-	-	-	A	V	
														V
														V
Remark	1. No other spurious found. 2. All results are PASS against Peak and Average limit line.													



2.4GHz 2400~2483.5MHz
BT (Harmonic @ 3m)

BT	Note	Frequency	Level	Over	Limit	Read	Antenna	Path	Preamp	Ant	Table	Peak	Pol.
		(MHz)	(dBμV/m)	Limit	Line	Level	Factor	Loss	Factor	Pos	Pos	Avg.	
				(dB)	(dBμV/m)	(dBμV)	(dB/m)	(dB)	(dB)	(cm)	(deg)	(P/A)	(H/V)
BT CH 78 2480MHz		4960	35.87	-38.13	74	50.19	31.26	12.56	58.14	100	0	P	H
		4960	11.08	-42.92	54	-	-	-	-	-	-	A	H
		7440	42.82	-31.18	74	47.85	36.58	15.72	57.33	100	0	P	H
		7440	18.03	-35.97	54	-	-	-	-	-	-	A	H
		4960	37.84	-36.16	74	52.16	31.26	12.56	58.14	100	0	P	V
		4960	13.05	-40.95	54	-	-	-	-	-	-	A	V
		7440	42.04	-31.96	74	47.07	36.58	15.72	57.33	100	0	P	V
		7440	17.25	-36.75	54	-	-	-	-	-	-	A	V
Remark	1. No other spurious found. 2. All results are PASS against Peak and Average limit line.												



Emission above 18GHz

2.4GHz BT (SHF)

BT	Note	Frequency	Level	Over	Limit	Read	Antenna	Path	Preamp	Ant	Table	Peak	Pol.	
		(MHz)	(dBμV/m)	(dB)	Line	Level	Factor	Loss	Factor	Pos	Pos	Avg.	(H/V)	
					(dBμV/m)	(dBμV)	(dB/m)	(dB)	(dB)	(cm)	(deg)	(P/A)		
2.4GHz BT SHF		18252	39.74	-34.26	74	45.71	37.35	10.93	54.25	150	0	P	H	
													H	
													H	
													H	
													H	
													H	
			22494	40.56	-33.44	74	42.51	38.69	12.86	53.5	150	0	P	V
														V
														V
														V
														V
Remark	1. No other spurious found. 2. All results are PASS against limit line.													



Emission below 1GHz

2.4GHz BT (LF)

BT	Note	Frequency	Level	Over	Limit	Read	Antenna	Path	Preamp	Ant	Table	Peak	Pol.	
		(MHz)	(dBμV/m)	(dB)	Line	Level	Factor	Loss	Factor	Pos	Pos	Avg.	(H/V)	
					(dBμV/m)	(dBμV)	(dB/m)	(dB)	(dB)	(cm)	(deg)	(P/A)		
2.4GHz BT LF		30	22.84	-17.16	40	29.71	24.39	0.93	32.19	-	-	P	H	
		101.78	23.59	-19.91	43.5	38.04	16.09	1.71	32.25	-	-	P	H	
		153.19	27.93	-15.57	43.5	41.24	16.79	2.19	32.29	-	-	P	H	
		184.23	26.54	-16.96	43.5	41.72	14.77	2.36	32.31	-	-	P	H	
		740.04	31.16	-14.84	46	30.7	28.02	4.68	32.24	-	-	P	H	
		948.59	33.7	-12.3	46	29.07	30.67	5.31	31.35	100	0	P	H	
														H
														H
														H
														H
														H
														H
			38.73	29.4	-10.6	40	40.59	20.07	1.04	32.3	100	0	P	V
			183.26	29.77	-13.73	43.5	44.94	14.78	2.36	32.31	-	-	P	V
			562.53	28.91	-17.09	46	30.67	26.15	4.07	31.98	-	-	P	V
			721.61	33.06	-12.94	46	33.6	27.05	4.61	32.2	-	-	P	V
			734.22	34.24	-11.76	46	34.01	27.8	4.66	32.23	-	-	P	V
			944.71	33.9	-12.1	46	29.48	30.52	5.29	31.39	-	-	P	V
														V
														V
													V	
													V	
													V	
													V	
Remark	3. No other spurious found. 4. All results are PASS against limit line.													



Note symbol

*	Fundamental Frequency which can be ignored. However, the level of any unwanted emissions shall not exceed the level of the fundamental frequency.
!	Test result is over limit line.
P/A	Peak or Average
H/V	Horizontal or Vertical



A calculation example for radiated spurious emission is shown as below:

BT	Note	Frequency	Level	Over	Limit	Read	Antenna	Path	Preamp	Ant	Table	Peak	Pol.
		(MHz)	(dBμV/m)	(dB)	Limit Line	Level	Factor	Loss	Factor	Pos	Pos	Avg.	
					(dBμV/m)	(dBμV)	(dB/m)	(dB)	(dB)	(cm)	(deg)	(P/A)	(H/V)
BT CH 00 2402MHz		2390	55.45	-18.55	74	54.51	32.22	4.58	35.86	103	308	P	H
		2390	43.54	-10.46	54	42.6	32.22	4.58	35.86	103	308	A	H

1. Path Loss(dB) = Cable loss(dB) + Filter loss(dB) + Attenuator loss(dB)
2. Level(dBμV/m) =
Antenna Factor(dB/m) + Path Loss(dB) + Read Level(dBμV) - Preamp Factor(dB)
3. Over Limit(dB) = Level(dBμV/m) – Limit Line(dBμV/m)

For Peak Limit @ 2390MHz:

1. Level(dBμV/m)
= Antenna Factor(dB/m) + Path Loss(dB) + Read Level(dBμV) - Preamp Factor(dB)
= 32.22(dB/m) + 4.58(dB) + 54.51(dBμV) – 35.86 (dB)
= 55.45 (dBμV/m)
2. Over Limit(dB)
= Level(dBμV/m) – Limit Line(dBμV/m)
= 55.45(dBμV/m) – 74(dBμV/m)
= -18.55(dB)

For Average Limit @ 2390MHz:

1. Level(dBμV/m)
= Antenna Factor(dB/m) + Path Loss(dB) + Read Level(dBμV) - Preamp Factor(dB)
= 32.22(dB/m) + 4.58(dB) + 42.6(dBμV) – 35.86 (dB)
= 43.54 (dBμV/m)
2. Over Limit(dB)
= Level(dBμV/m) – Limit Line(dBμV/m)
= 43.54(dBμV/m) – 54(dBμV/m)
= -10.46(dB)

Both peak and average measured complies with the limit line, so test result is “PASS”.



Appendix C. Radiated Spurious Emission Plots

Test Engineer :	Andy Yang and CR Liro	Temperature :	20~25°C
		Relative Humidity :	50~60%

Note symbol

-L	Low channel location
-R	High channel location



<For 3Mbps>

2.4GHz 2400~2483.5MHz

BT (Band Edge @ 3m)

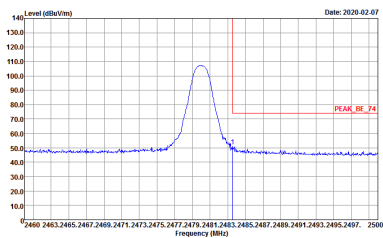
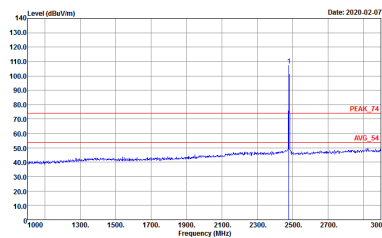
BT	2.4GHz 2400~2483.5MHz Band Edge @ 3m	
	BT CH78 2480MHz	
	Horizontal	Fundamental
Peak	 <p>Date: 2020-02-07</p> <p>Site : 03CH16-11Y Condition : PEAK_BE_74 3m 91200_1522 HORIZONTAL RBW:1000.000kHz VBW:3000.000kHz SWT:Auto Detector : Peak Project : 901543-01</p>	 <p>Date: 2020-02-07</p> <p>Site : 03CH16-11Y Condition : PEAK_74 3m 91200_1522 HORIZONTAL RBW:1000.000kHz VBW:3000.000kHz SWT:Auto Detector : Peak Project : 901543-01</p>

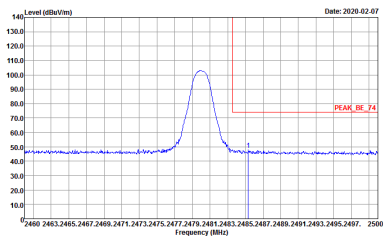
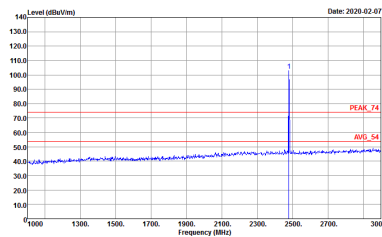

BT	2.4GHz 2400~2483.5MHz Band Edge @ 3m	
BT CH78 2480MHz		
Vertical		Fundamental
Peak	 <p>Site : 03CH6-11Y Condition : PEAK_BE_74 3m 91200_1522 VERTICAL Detector : Peak Project : 901543-01</p>	 <p>Site : 03CH6-11Y Condition : PEAK_74 3m 91200_1522 VERTICAL Detector : Peak Project : 901543-01</p>



2.4GHz 2400~2483.5MHz

BT (Harmonic @ 3m)

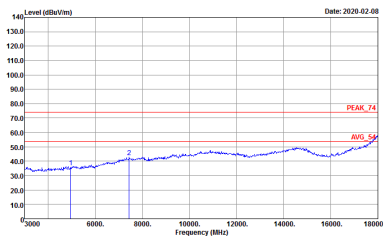
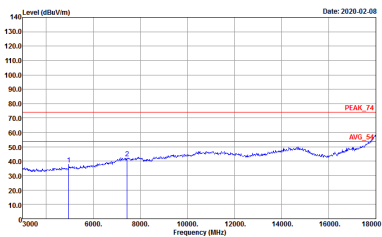
BT	2.4GHz 2400~2483.5MHz Harmonic @ 3m	
	BT CH78 2480MHz	
	Horizontal	Vertical
<p>Peak Avg.</p>	 <p>Site : 03CH16-11Y Condition : PEAK_74 3m 9120D_1522 HORIZONTAL Detector : Peak Project : 901543-01</p>	 <p>Site : 03CH16-11Y Condition : PEAK_74 3m 9120D_1522 VERTICAL Detector : Peak Project : 901543-01</p>



Emission above 18GHz

2.4GHz BT (SHF)

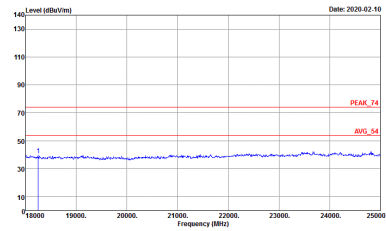
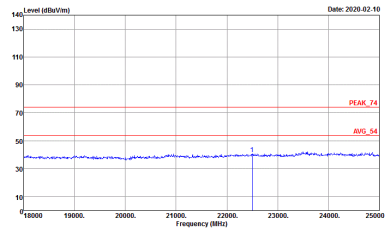
BT	2.4GHz 2400~2483.5MHz	
	BT SHF	
	Horizontal	Vertical
QP / Peak	 <p>Site : 03CH16-#Y Condition : PEAK_74 3m 91200_1522 HORIZONTAL Detector : Peak Project : 901543-01</p>	 <p>Site : 03CH16-#Y Condition : PEAK_74 3m 91200_1522 VERTICAL Detector : Peak Project : 901543-01</p>



Emission below 1GHz

2.4GHz BT (LF)

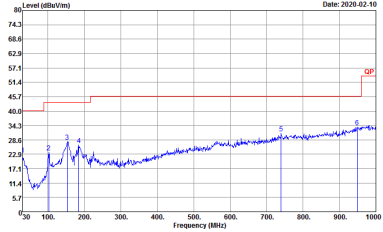
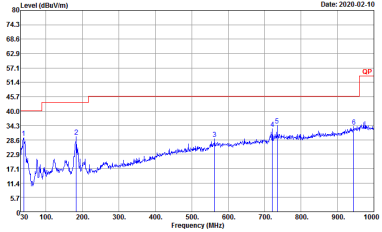
BT	2.4GHz 2400~2483.5MHz	
	BT LF	
	Horizontal	Vertical
QP / Peak	 <p data-bbox="432 878 670 925">Site : 03CH16-HY Condition : QP 3m 81LOG_47020406 HORIZONTAL Detector : Peak Project : 901543-01</p>	 <p data-bbox="908 878 1145 925">Site : 03CH16-HY Condition : QP 3m 81LOG_47020406 VERTICAL Detector : Peak Project : 901543-01</p>



Appendix D. Duty Cycle Plots

3DH5 on time (One Pulse) Plot on Channel 39

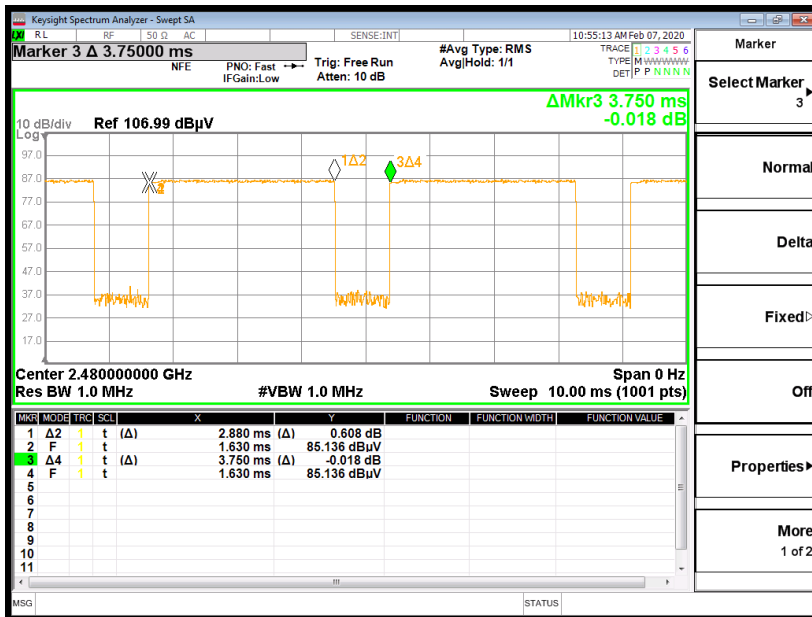

on time (Count Pulses) Plot on Channel 39

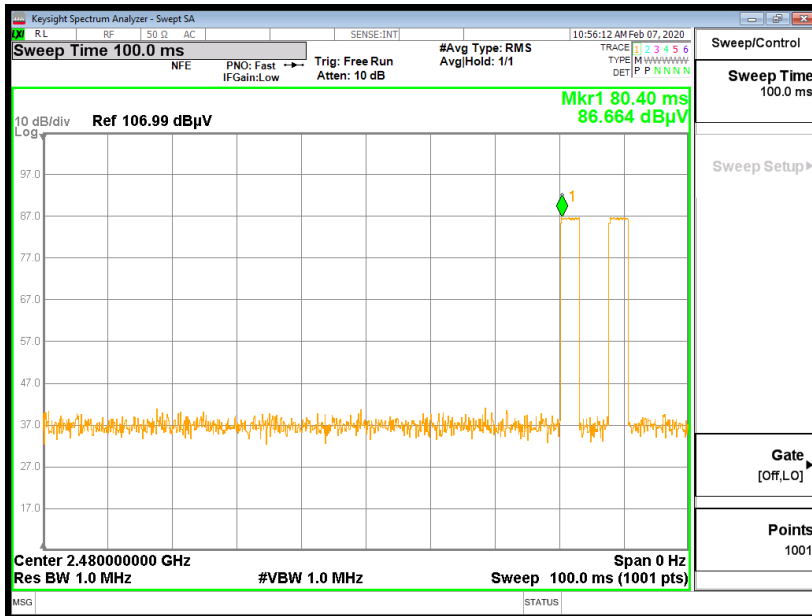

Note:

1. Worst case Duty cycle = on time/100 milliseconds = 2 * 2.88 / 100 = 5.76 %
2. Worst case Duty cycle correction factor = 20*log(Duty cycle) = -24.79 dB
3. 3DH5 has the highest duty cycle worst case and is reported.



Duty Cycle Correction Factor Consideration for AFH mode:

Bluetooth normal hopping rate is 1600Hz and reduced to 800Hz in AFH mode; due to the reduced number of hopping frequencies, with the same packet configuration the dwell time in each channel frequency within 100msec period is longer in AFH mode than normal mode.

In AFH mode, the minimum hopping frequencies are 20, to get the longest dwell time DH5 packet is observed; the period to have DH5 packet completing one hopping sequence is

$$2.88 \text{ ms} \times 20 \text{ channels} = 57.6 \text{ ms}$$

There cannot be 2 complete hopping sequences within 100ms period, considering the random hopping behavior, maximum 2 hops can be possibly observed within the period. $[100\text{ms} / 57.6\text{ms}] = 2$ hops

Thus, the maximum possible ON time:

$$2.88 \text{ ms} \times 2 = 5.76 \text{ ms}$$

Worst case Duty Cycle Correction factor, which is derived from the maximum possible ON time,

$$20 \times \log(5.76 \text{ ms}/100\text{ms}) = -24.79 \text{ dB}$$

—————THE END—————