



# FCC RF Test Report

**APPLICANT** : Sony Mobile Communications Inc.  
**EQUIPMENT** : GSM/WCDMA/LTE Phone+Bluetooth,  
DTS/UNII a/b/g/n and NFC  
**BRAND NAME** : Sony  
**FCC ID** : PY7-87507S  
**STANDARD** : FCC Part 15 Subpart C §15.247  
**CLASSIFICATION** : (DSS) Spread Spectrum Transmitter

This is a variant report which is only valid together with the original test report. The product was received on Aug. 22, 2017 and testing was completed on Sep. 05, 2017. We, SPORTON INTERNATIONAL INC., would like to declare that the tested sample has been evaluated in accordance with the test procedures and has been in compliance with the applicable technical standards.

The test results in this report apply exclusively to the tested model / sample. Without written approval of SPORTON INTERNATIONAL INC., the test report shall not be reproduced except in full.

Reviewed by: Joseph Lin / Supervisor

Approved by: Jones Tsai / Manager



## **SPORTON INTERNATIONAL INC.**

**No. 52, Hwa Ya 1<sup>st</sup> Rd., Hwa Ya Technology Park, Kwei-Shan District, Tao Yuan City, Taiwan, R.O.C.**

SPORTON INTERNATIONAL INC.

TEL : 886-3-327-3456

FAX : 886-3-328-4978

FCC ID : PY7-87507S

Page Number : 1 of 17

Report Issued Date : Oct. 30, 2017

Report Version : Rev. 01

Report Template No.: BU5-FR15CBT Version 2.0



# TABLE OF CONTENTS

**REVISION HISTORY..... 3**

**SUMMARY OF TEST RESULT ..... 4**

**1 GENERAL DESCRIPTION..... 5**

    1.1 Applicant ..... 5

    1.2 Manufacturer ..... 5

    1.3 Product Feature of Equipment Under Test..... 5

    1.4 Modification of EUT ..... 5

    1.5 Testing Location ..... 6

    1.6 Applicable Standards..... 6

**2 TEST CONFIGURATION OF EQUIPMENT UNDER TEST..... 7**

    2.1 Carrier Frequency Channel ..... 7

    2.2 Descriptions of Test Mode ..... 8

    2.3 Test Mode..... 8

    2.4 Connection Diagram of Test System..... 9

    2.5 Support Unit used in test configuration and system ..... 9

    2.6 EUT Operation Test Setup ..... 9

**3 TEST RESULT ..... 10**

    3.1 Radiated Band Edges and Spurious Emission Measurement ..... 10

    3.2 Antenna Requirements ..... 14

**4 LIST OF MEASURING EQUIPMENT..... 15**

**5 UNCERTAINTY OF EVALUATION..... 17**

**APPENDIX A. RADIATED SPURIOUS EMISSION**

**APPENDIX B. RADIATED SPURIOUS EMISSION PLOTS**

**APPENDIX C. DUTY CYCLE PLOTS**

**APPENDIX D. ORIGINAL REPORT**



### REVISION HISTORY

| REPORT NO. | VERSION | DESCRIPTION             | ISSUED DATE   |
|------------|---------|-------------------------|---------------|
| FR782203A  | Rev. 01 | Initial issue of report | Oct. 30, 2017 |
|            |         |                         |               |
|            |         |                         |               |
|            |         |                         |               |
|            |         |                         |               |
|            |         |                         |               |
|            |         |                         |               |
|            |         |                         |               |
|            |         |                         |               |
|            |         |                         |               |
|            |         |                         |               |
|            |         |                         |               |
|            |         |                         |               |
|            |         |                         |               |
|            |         |                         |               |
|            |         |                         |               |
|            |         |                         |               |



### SUMMARY OF TEST RESULT

| Report Section | FCC Rule           | Description  | Limit                 | Result | Remark                                  |
|----------------|--------------------|--|-----------------------|--------|---|
| 3.1            | 15.247(d)          | Radiated Band Edges and Radiated Spurious Emission | 15.209(a) & 15.247(d) | Pass   | Under limit<br>3.39 dB at<br>42.690 MHz |
| 3.2            | 15.203 & 15.247(b) | Antenna Requirement                                | N/A                   | Pass   | -                                       |



# 1 General Description

## 1.1 Applicant

**Sony Mobile Communications Inc.**

4-12-3 Higashi-Shinagawa, Shinagawa-ku, Tokyo, 140-0002, Japan

## 1.2 Manufacturer

**Sony Mobile Communications Inc.**

4-12-3 Higashi-Shinagawa, Shinagawa-ku, Tokyo, 140-0002, Japan

## 1.3 Product Feature of Equipment Under Test

GSM/WCDMA/LTE, Bluetooth, DTS/UNII a/b/g/n, FM Receiver, NFC, and GPS.

| Standards-related Product Specification |                                       |
|---|---------------------------------------|
| Antenna Type / Gain                     | PIFA Antenna type with gain -1.20 dBi |

**Remark:** This is a variant report. All the test cases were performed on original report which can be referred to Sporton Report Number FR782113A.

| EUT Information List |            |            |                            |
|----------------------|------------|------------|----------------------------|
| HW Version           | SW Version | S/N        | Performed Test Item        |
| A                    | 1.8        | WUJ01Q22RY | RF conducted measurement   |
|                      |            | WUJ01Q23X7 | Radiated Spurious Emission |

| Accessory List |                      |
|----------------|----------------------|
| AC Adapter     | Model Name: EP800    |
|                | S/N: 2916W46610569   |
| Earphone       | Model Name: MH410c   |
|                | S/N: N/A             |
| USB Cable      | Model Name: UCB20    |
|                | S/N: 1635A91C00314D8 |

**Note:**

1. Above EUT list and accessory list used are electrically identical per declared by manufacturer.
2. Above the accessories list are used to exercise the EUT during test.
3. For other wireless features of this EUT, test report will be issued separately.

## 1.4 Modification of EUT

No modifications are made to the EUT during all test items.



### 1.5 Testing Location

Sporton Lab is accredited to ISO 17025 by Taiwan Accreditation Foundation (TAF code : 1190) and the FCC designation No. TW1190 and TW0007 under the FCC 2.948(e) by Mutual Recognition Agreement (MRA) in FCC Test.

|                           |  |
|---------------------------|--|
| <b>Test Site</b>          | SPORTON INTERNATIONAL INC.   |
| <b>Test Site Location</b> | No. 52, Hwa Ya 1 <sup>st</sup> Rd., Hwa Ya Technology Park,<br>Kwei-Shan District, Tao Yuan City, Taiwan, R.O.C.<br>TEL: +886-3-327-3456<br>FAX: +886-3-328-4978 |
| <b>Test Site No.</b>      | <b>Sporton Site No.</b>  |
|                           | TH05-HY  |

**Note:** The test site complies with ANSI C63.4 2014 requirement.

|                           |  |
|---------------------------|--|
| <b>Test Site</b>          | SPORTON INTERNATIONAL INC.   |
| <b>Test Site Location</b> | No.58, Aly. 75, Ln. 564, Wenhua 3rd Rd. Guishan Dist,<br>Taoyuan City, Taiwan (R.O.C.)<br>TEL: +886-3-327-0868<br>FAX: +886-3-327-0855 |
| <b>Test Site No.</b>      | <b>Sporton Site No.</b>  |
|                           | 03CH10-HY  |

**Note:** The test site complies with ANSI C63.4 2014 requirement.

### 1.6 Applicable Standards

According to the specifications of the manufacturer, the EUT must comply with the requirements of the following standards:

- ♦ FCC Part 15 Subpart C §15.247
- ♦ ANSI C63.10-2013

**Remark:**

1. All test items were verified and recorded according to the standards and without any deviation during the test.
2. This EUT has also been tested and complied with the requirements of FCC Part 15, Subpart B, recorded in a separate test report.



## 2 Test Configuration of Equipment Under Test

### 2.1 Carrier Frequency Channel

| Frequency Band  | Channel | Freq. (MHz) | Channel | Freq. (MHz) | Channel | Freq. (MHz) |
|-----------------|---------|-------------|---------|-------------|---------|-------------|
| 2400-2483.5 MHz | 0       | 2402        | 27      | 2429        | 54      | 2456        |
|                 | 1       | 2403        | 28      | 2430        | 55      | 2457        |
|                 | 2       | 2404        | 29      | 2431        | 56      | 2458        |
|                 | 3       | 2405        | 30      | 2432        | 57      | 2459        |
|                 | 4       | 2406        | 31      | 2433        | 58      | 2460        |
|                 | 5       | 2407        | 32      | 2434        | 59      | 2461        |
|                 | 6       | 2408        | 33      | 2435        | 60      | 2462        |
|                 | 7       | 2409        | 34      | 2436        | 61      | 2463        |
|                 | 8       | 2410        | 35      | 2437        | 62      | 2464        |
|                 | 9       | 2411        | 36      | 2438        | 63      | 2465        |
|                 | 10      | 2412        | 37      | 2439        | 64      | 2466        |
|                 | 11      | 2413        | 38      | 2440        | 65      | 2467        |
|                 | 12      | 2414        | 39      | 2441        | 66      | 2468        |
|                 | 13      | 2415        | 40      | 2442        | 67      | 2469        |
|                 | 14      | 2416        | 41      | 2443        | 68      | 2470        |
|                 | 15      | 2417        | 42      | 2444        | 69      | 2471        |
|                 | 16      | 2418        | 43      | 2445        | 70      | 2472        |
|                 | 17      | 2419        | 44      | 2446        | 71      | 2473        |
|                 | 18      | 2420        | 45      | 2447        | 72      | 2474        |
|                 | 19      | 2421        | 46      | 2448        | 73      | 2475        |
|                 | 20      | 2422        | 47      | 2449        | 74      | 2476        |
|                 | 21      | 2423        | 48      | 2450        | 75      | 2477        |
|                 | 22      | 2424        | 49      | 2451        | 76      | 2478        |
|                 | 23      | 2425        | 50      | 2452        | 77      | 2479        |
|                 | 24      | 2426        | 51      | 2453        | 78      | 2480        |
|                 | 25      | 2427        | 52      | 2454        | -       | -           |
|                 | 26      | 2428        | 53      | 2455        | -       | -           |



## 2.2 Descriptions of Test Mode

Preliminary tests were performed in different data rates and recorded the RF output power in the following table:

| Channel | Frequency | Bluetooth RF Output Peak Power |                |          |
|---------|-----------|--------------------------------|----------------|----------|
|         |           | Data Rate / Modulation         |                |          |
|         |           | GFSK                           | $\pi/4$ -DQPSK | 8-DPSK   |
|         |           | 1Mbps                          | 2Mbps          | 3Mbps    |
| Ch00    | 2402MHz   | 7.15 dBm                       | 6.23 dBm       | 6.28 dBm |
| Ch39    | 2441MHz   | <b>8.18 dBm</b>                | 7.31 dBm       | 7.44 dBm |
| Ch78    | 2480MHz   | 7.32 dBm                       | 6.35 dBm       | 6.56 dBm |

| Channel | Frequency | Bluetooth RF Output Average Power |                |          |
|---------|-----------|-----------------------------------|----------------|----------|
|         |           | Data Rate / Modulation            |                |          |
|         |           | GFSK                              | $\pi/4$ -DQPSK | 8-DPSK   |
|         |           | 1Mbps                             | 2Mbps          | 3Mbps    |
| Ch00    | 2402MHz   | 6.15 dBm                          | 3.86 dBm       | 3.81 dBm |
| Ch39    | 2441MHz   | <b>6.98 dBm</b>                   | 4.98 dBm       | 4.99 dBm |
| Ch78    | 2480MHz   | 6.73 dBm                          | 4.56 dBm       | 4.52 dBm |

- a. The EUT has been associated with peripherals and configuration operated in a manner tended to maximize its emission characteristics in a typical application. Frequency range investigated: radiation emission (9 kHz to the 10th harmonic of the highest fundamental frequency or to 40 GHz, whichever is lower). Pre-scanned tests, X, Y, Z in three orthogonal panels, and different data rates were conducted to determine the final configuration (X plane as worst plane) from all possible combinations.

## 2.3 Test Mode

The following summary table is showing all test modes to demonstrate in compliance with the standard.

| Summary table of Test Cases |                            |
|-----------------------------|----------------------------|
| Test Item                   | Data Rate / Modulation     |
|                             | Bluetooth EDR 3Mbps 8-DPSK |
| Radiated Test Cases         | Mode 1: CH78_2480 MHz      |



## 2.4 Connection Diagram of Test System

<Bluetooth Tx Mode>

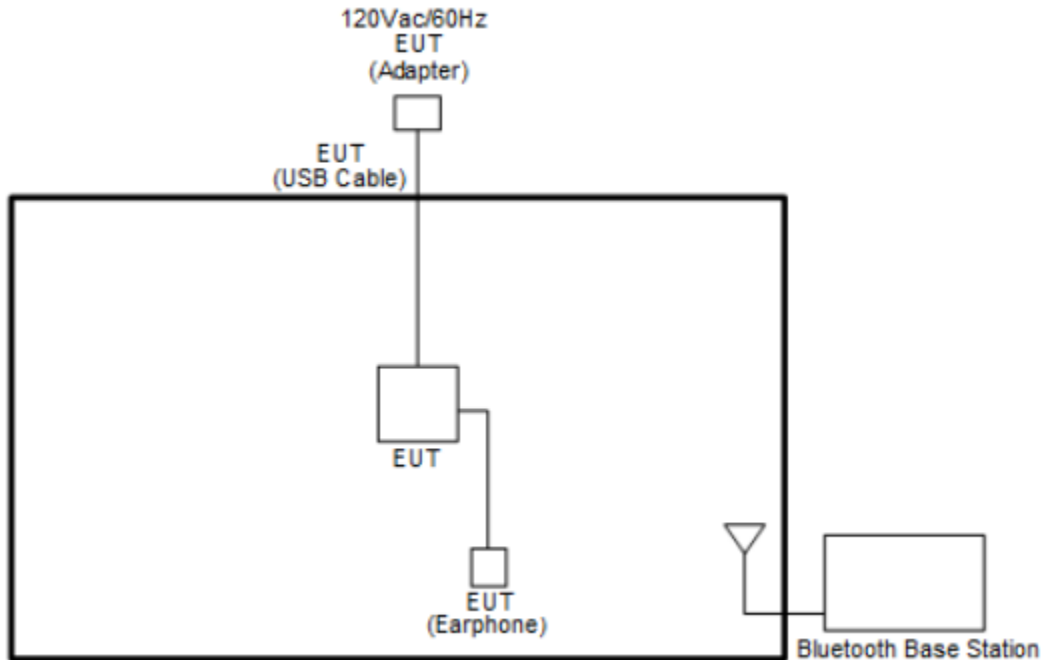

## 2.5 Support Unit used in test configuration and system

| Item | Equipment              | Trade Name | Model Name | FCC ID | Data Cable | Power Cord        |
|------|------------------------|------------|------------|--------|------------|-------------------|
| 1.   | Bluetooth Base Station | R&S        | CBT32      | N/A    | N/A        | Unshielded, 1.8 m |

## 2.6 EUT Operation Test Setup

The RF test items utility, an engineering test program was programmed in order to make the EUT get into the engineering modes to contact with base station for continuous transmitting.



### 3 Test Result

#### 3.1 Radiated Band Edges and Spurious Emission Measurement

##### 3.1.1 Limit of Radiated Band Edges and Spurious Emission

In any 100 kHz bandwidth outside the intentional radiator frequency band, all harmonics/spurious must be at least 20 dB below the highest emission level within the authorized band. In addition, radiated emissions which fall in the restricted bands must also comply with the limits as below.

| Frequency (MHz) | Field Strength (microvolts/meter) | Measurement Distance (meters) |
|-----------------|-----------------------------------|-------------------------------|
| 0.009 – 0.490   | 2400/F(kHz)                       | 300                           |
| 0.490 – 1.705   | 24000/F(kHz)                      | 30                            |
| 1.705 – 30.0    | 30                                | 30                            |
| 30 – 88         | 100                               | 3                             |
| 88 – 216        | 150                               | 3                             |
| 216 - 960       | 200                               | 3                             |
| Above 960       | 500                               | 3                             |

##### 3.1.2 Measuring Instruments

The measuring equipment is listed in the section 4 of this test report.



### 3.1.3 Test Procedures

1. The EUT was placed on a turntable with 0.8 meter for frequency below 1GHz and 1.5 meter for frequency above 1GHz respectively above ground.
2. The EUT was set 3 meters from the interference receiving antenna, which was mounted on the top of a variable height antenna tower.
3. For each suspected emission, the EUT was arranged to its worst case and then tune the Antenna tower (from 1 m to 4 m) and turntable (from 0 degree to 360 degrees) to find the maximum reading. A pre-amp and a high pass filter are used for the test in order to get better signal level to comply with the guidelines.
4. Set to the maximum power setting and enable the EUT transmit continuously.
5. Use the following spectrum analyzer settings:
  - (1) Span shall wide enough to fully capture the emission being measured;
  - (2) Set RBW=100 kHz for  $f < 1 \text{ GHz}$ , RBW=1MHz for  $f > 1\text{GHz}$  ; VBW  $\geq$  RBW; Sweep = auto; Detector function = peak; Trace = max hold for peak
  - (3) For average measurement: use duty cycle correction factor method per 15.35(c).  
Duty cycle = On time/100 milliseconds  
On time =  $N_1 * L_1 + N_2 * L_2 + \dots + N_{n-1} * L_{n-1} + N_n * L_n$   
Where  $N_1$  is number of type 1 pulses,  $L_1$  is length of type 1 pulses, etc.  
Average Emission Level = Peak Emission Level +  $20 * \log(\text{Duty cycle})$
6. Corrected Reading: Antenna Factor + Cable Loss + Read Level - Preamp Factor = Level
7. For testing below 1GHz, if the emission level of the EUT in peak mode was 3 dB lower than the limit specified, then peak values of EUT will be reported, otherwise, the emissions will be repeated one by one using the CISPR quasi-peak method and reported.
8. For testing above 1GHz, the emission level of the EUT in peak mode was 20dB lower than average limit (that means the emission level in average mode also complies with the limit in average mode), then peak values of EUT will be reported, otherwise, the emissions will be measured in average mode again and reported.

Note: The average levels were calculated from the peak level corrected with duty cycle correction factor (-24.79dB) derived from  $20 \log(\text{dwell time}/100\text{ms})$ . This correction is only for signals that hop with the fundamental signal, such as band-edge and harmonic. Other spurious signals that are independent of the hopping signal would not use this correction.

### 3.1.4 Test Setup

For radiated emissions below 30MHz

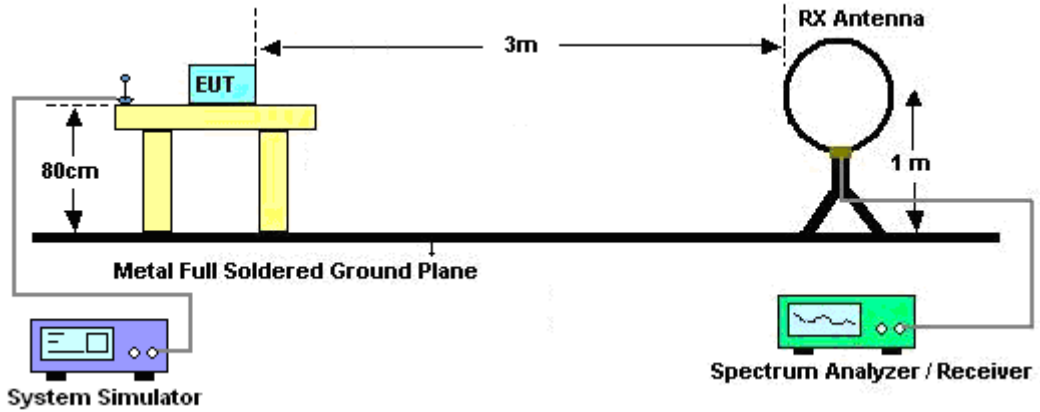

For radiated emissions from 30MHz to 1GHz

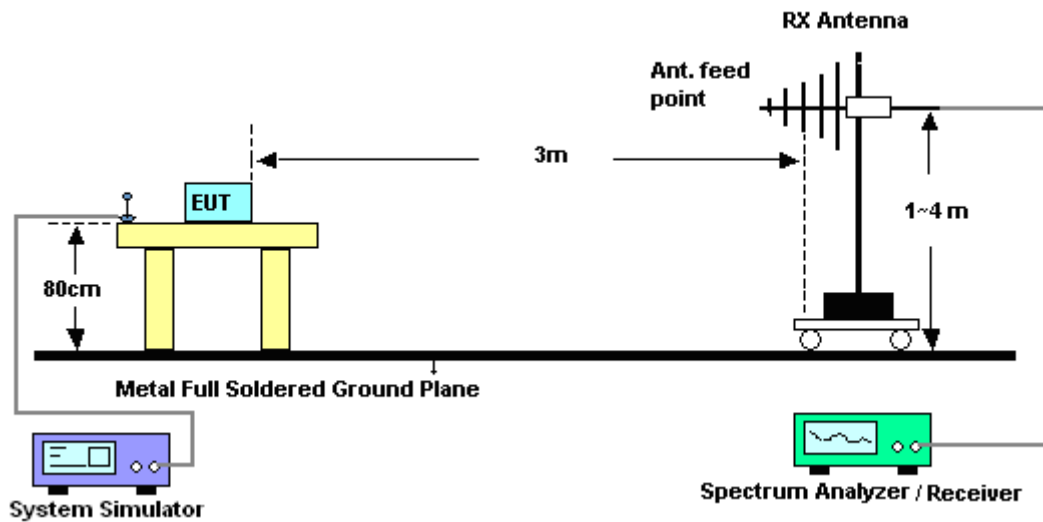

For radiated emissions above 1GHz

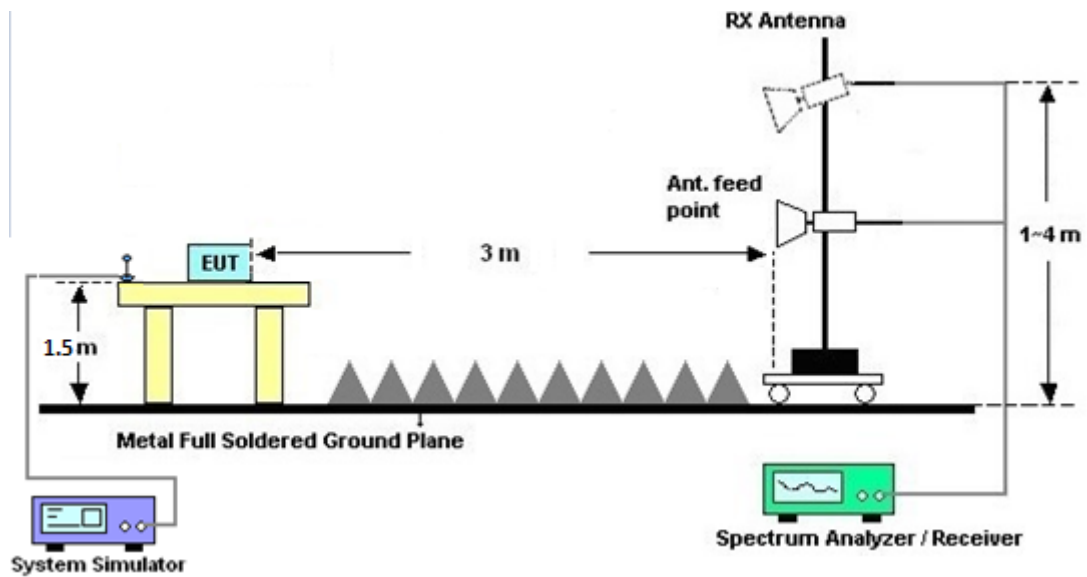

### 3.1.5 Test Results of Radiated Spurious Emissions (9 kHz ~ 30 MHz)

The low frequency, which started from 9 kHz to 30MHz, was pre-scanned and the result which was 20dB lower than the limit line was not reported.

There is a comparison data of both open-field test site and semi-Anechoic chamber, and the result came out very similar.

### 3.1.6 Test Result of Radiated Spurious at Band Edges

Please refer to Appendix A and B.

### 3.1.7 Duty Cycle

Please refer to Appendix C.

### 3.1.8 Test Result of Radiated Spurious Emission (30MHz ~ 10<sup>th</sup> Harmonic)

Please refer to Appendix A and B.



## **3.2 Antenna Requirements**

### **3.2.1 Standard Applicable**

If directional gain of transmitting antennas is greater than 6dBi, the power shall be reduced by the same level in dB comparing to gain minus 6dBi. The use of a permanently attached antenna or of an antenna that uses a unique coupling to the intentional radiator shall be considered sufficient to comply with the rule.

### **3.2.2 Antenna Anti-Replacement Construction**

An embedded-in antenna design is used.

### **3.2.3 Antenna Gain**

The antenna peak gain of EUT is less than 6 dBi. Therefore, it is not necessary to reduce maximum peak output power limit.



## 4 List of Measuring Equipment

| Instrument           | Manufacturer    | Model No.                 | Serial No.   | Characteristics               | Calibration Date | Test Date                       | Due Date      | Remark                |
|----------------------|-----------------|---------------------------|--------------|-------------------------------|------------------|---------------------------------|---------------|-----------------------|
| Power Meter          | Anritsu         | ML2495A                   | 0932001      | N/A                           | Sep. 29, 2016    | Aug. 23, 2017                   | Sep. 28, 2017 | Conducted (TH05-HY)   |
| Power Sensor         | Anritsu         | MA2411B                   | 0846202      | 300MHz~40GHz                  | Sep. 29, 2016    | Aug. 23, 2017                   | Sep. 28, 2017 | Conducted (TH05-HY)   |
| Spectrum Analyzer    | Rohde & Schwarz | FSP30                     | 101067       | 9kHz ~ 30GHz                  | Nov. 17, 2016    | Aug. 23, 2017                   | Nov. 16, 2017 | Conducted (TH05-HY)   |
| Hygrometer           | TECEPEL         | DTM-303B                  | TP157151     | N/A                           | Mar. 20, 2017    | Aug. 23, 2017                   | Mar. 19, 2018 | Conducted (TH05-HY)   |
| RF Cable             | HUBER + SUHNER  | SUCOFLEX 104              | MY842095 21  | 1GHz~26GHz                    | Dec. 02, 2016    | Aug. 23, 2017                   | Dec. 01, 2017 | Conducted (TH05-HY)   |
| Loop Antenna         | Rohde & Schwarz | HFH2-Z2                   | 100315       | 9 kHz~30 MHz                  | May 15, 2017     | Aug. 29, 2017~<br>Sep. 05, 2017 | May 14, 2019  | Radiation (03CH10-HY) |
| Bilog Antenna        | TESEQ           | CBL 6111D&00800 N1D01N-06 | 35413&02     | 30MHz~1GHz                    | Jan. 07, 2017    | Aug. 29, 2017~<br>Sep. 05, 2017 | Jan. 06, 2018 | Radiation (03CH10-HY) |
| Horn Antenna         | SCHWARZBECK     | BBHA 9120 D               | 9120D-132 5  | 1GHz ~ 18GHz                  | Sep. 30, 2016    | Aug. 29, 2017~<br>Sep. 05, 2017 | Sep. 29, 2017 | Radiation (03CH10-HY) |
| SHF-EHF Horn Antenna | SCHWARZBECK     | BBHA 9170                 | BBHA9170 584 | 18GHz- 40GHz                  | Nov. 08, 2016    | Aug. 29, 2017~<br>Sep. 05, 2017 | Nov. 07, 2017 | Radiation (03CH10-HY) |
| Spectrum Analyzer    | Keysight        | N9010A                    | MY542004 85  | 10Hz ~ 44GHz                  | Oct. 17, 2016    | Aug. 29, 2017~<br>Sep. 05, 2017 | Oct. 16, 2017 | Radiation (03CH10-HY) |
| EMI Test Receiver    | Agilent         | N9038A(MXE )              | MY532900 45  | 20Hz to 8.4GHz                | Jan. 19, 2017    | Aug. 29, 2017~<br>Sep. 05, 2017 | Jan. 18, 2018 | Radiation (03CH10-HY) |
| Amplifier            | SONOMA          | 310N                      | 187311       | 9kHz~1GHz                     | Oct. 26, 2016    | Aug. 29, 2017~<br>Sep. 05, 2017 | Oct. 25, 2017 | Radiation (03CH10-HY) |
| Preamplifier         | Keysight        | 83017A                    | MY532700 78  | 1GHz~26.5GHz                  | Oct. 26, 2016    | Aug. 29, 2017~<br>Sep. 05, 2017 | Oct. 25, 2017 | Radiation (03CH10-HY) |
| Preamplifier         | MITEQ           | TTA1840-35-HG             | 1871923      | 18GHz~40GHz, VSWR : 2.5:1 max | Jul. 21, 2017    | Aug. 29, 2017~<br>Sep. 05, 2017 | Jul. 20, 2018 | Radiation (03CH10-HY) |
| Preamplifier         | MITEQ           | AMF-7D-0010 1800-30-10P   | 1815698      | 1GHz~18GHz                    | Dec. 01, 2016    | Aug. 29, 2017~<br>Sep. 05, 2017 | Nov. 30, 2018 | Radiation (03CH10-HY) |



| Instrument    | Manufacturer      | Model No.                           | Serial No.                       | Characteristics                  | Calibration Date | Test Date                       | Due Date      | Remark                   |
|---------------|-------------------|-------------------------------------|----------------------------------|----------------------------------|------------------|---------------------------------|---------------|--------------------------|
| Hygrometer    | TECEPIL           | DTM-303B                            | TP140320                         | N/A                              | Nov. 14, 2016    | Aug. 29, 2017~<br>Sep. 05, 2017 | Nov. 13, 2017 | Radiation<br>(03CH10-HY) |
| RF Cable      | HUBER +<br>SUHNER | SUCOFLEX<br>104                     | MY249564<br>MY249524<br>MY283184 | 25GHz~40GHz                      | Sep. 30, 2016    | Aug. 29, 2017~<br>Sep. 05, 2017 | Sep. 29, 2017 | Radiation<br>(03CH10-HY) |
| RF Cable      | HUBER +<br>SUHNER | SUCOFLEX<br>104                     | MY249564<br>MY249524<br>MY283184 | 30MHz~1GHz                       | Sep. 30, 2016    | Aug. 29, 2017~<br>Sep. 05, 2017 | Sep. 29, 2017 | Radiation<br>(03CH10-HY) |
| RF Cable      | HUBER +<br>SUHNER | SUCOFLEX<br>104                     | MY249564<br>MY249524<br>MY283184 | 1GHz~25GHz                       | Sep. 30, 2016    | Aug. 29, 2017~<br>Sep. 05, 2017 | Sep. 29, 2017 | Radiation<br>(03CH10-HY) |
| Controller    | EMEC              | EM 1000                             | N/A                              | Control Turn<br>table & Ant Mast | N/A              | Aug. 29, 2017~<br>Sep. 05, 2017 | N/A           | Radiation<br>(03CH10-HY) |
| Antenna Mast  | EMEC              | AM-BS-450<br>0-B                    | N/A                              | 1~4m                             | N/A              | Aug. 29, 2017~<br>Sep. 05, 2017 | N/A           | Radiation<br>(03CH10-HY) |
| Turn Table    | EMEC              | TT 2200                             | N/A                              | 0~360 Degree                     | N/A              | Aug. 29, 2017~<br>Sep. 05, 2017 | N/A           | Radiation<br>(03CH10-HY) |
| Test Software | Audix             | E3                                  | 6.2009-8-24                      | N/A                              | N/A              | Aug. 29, 2017~<br>Sep. 05, 2017 | N/A           | Radiation<br>(03CH10-HY) |
| Filter        | Wainwright        | WLKS1200-<br>12SS                   | SN2                              | 1.2G Low Pass                    | Sep. 19, 2016    | Aug. 29, 2017~<br>Sep. 05, 2017 | Sep. 18, 2017 | Radiation<br>(03CH10-HY) |
| Filter        | Wainwright        | WHKX12-27<br>00-3000-18<br>000-60SS | SN2                              | 3G High Pass                     | Sep. 20, 2016    | Aug. 29, 2017~<br>Sep. 05, 2017 | Sep. 19, 2017 | Radiation<br>(03CH10-HY) |





## 5 Uncertainty of Evaluation

### Uncertainty of Radiated Emission Measurement (30 MHz ~ 1000 MHz)

|   |      |
|---|------|
| Measuring Uncertainty for a Level of Confidence of 95% ( $U = 2Uc(y)$ ) | 5.60 |
|---|------|

### Uncertainty of Radiated Emission Measurement (1000 MHz ~ 18000 MHz)

|   |      |
|---|------|
| Measuring Uncertainty for a Level of Confidence of 95% ( $U = 2Uc(y)$ ) | 5.90 |
|---|------|

### Uncertainty of Radiated Emission Measurement (18000 MHz ~ 40000 MHz)

|   |      |
|---|------|
| Measuring Uncertainty for a Level of Confidence of 95% ( $U = 2Uc(y)$ ) | 5.20 |
|---|------|



### Appendix A. Radiated Spurious Emission

|                 |                                       |                     |         |
|-----------------|---------------------------------------|---------------------|---------|
| Test Engineer : | Tsung Li , Stan Hsieh and Kyle Chuang | Temperature :       | 22~24°C |
|                 |                                       | Relative Humidity : | 43~44%  |

#### 2.4GHz 2400~2483.5MHz

#### BT (3M) (Band Edge @ 3m)

| BT                     | Note | Frequency | Level      | Over   | Limit      | Read     | Antenna  | Cable  | Preamp | Ant    | Table   | Peak    | Pol.    |   |
|------------------------|------|-----------|------------|--------|------------|----------|----------|--------|--------|--------|---------|---------|---------|---|
|                        |      | ( MHz )   | ( dBμV/m ) | ( dB ) | ( dBμV/m ) | ( dBμV ) | ( dB/m ) | ( dB ) | ( dB ) | ( cm ) | ( deg ) | ( P/A ) | ( H/V ) |   |
| BT<br>CH 78<br>2480MHz | *    | 2480      | 99.84      | -      | -          | 101.26   | 27.24    | 4.51   | 33.17  | 100    | 76      | P       | H       |   |
|                        | *    | 2480      | 75.05      | -      | -          |          |          |        |        |        |         | A       | H       |   |
|                        |      | 2484.88   | 42.89      | -31.11 | 74         | 44.29    | 27.24    | 4.53   | 33.17  | 100    | 76      | P       | H       |   |
|                        |      | 2484.88   | 18.1       | -35.9  | 54         |          |          |        |        |        |         | A       | H       |   |
|                        |      |           |            |        |            |          |          |        |        |        |         |         | H       |   |
|                        |      |           |            |        |            |          |          |        |        |        |         |         |         | H |
|                        | *    | 2480      | 97.46      | -      | -          | 98.88    | 27.24    | 4.51   | 33.17  | 367    | 49      | P       | V       |   |
|                        | *    | 2480      | 72.67      | -      | -          |          |          |        |        |        |         |         | A       | V |
|                        |      | 2483.72   | 42.26      | -31.74 | 74         | 43.66    | 27.24    | 4.53   | 33.17  | 367    | 49      | P       | V       |   |
|                        |      | 2483.72   | 17.47      | -36.53 | 54         |          |          |        |        |        |         |         | A       | V |
|                        |      |           |            |        |            |          |          |        |        |        |         |         |         | V |
|                        |      |           |            |        |            |          |          |        |        |        |         |         |         | V |

|        |  |
|--------|--|
| Remark | 1. No other spurious found.                                  |
|        | 2. All results are PASS against Peak and Average limit line. |



2.4GHz 2400~2483.5MHz

BT (3M) (Harmonic @ 3m)

| BT                     | Note  | Frequency<br>( MHz ) | Level<br>( dBμV/m ) | Over<br>Limit<br>( dB ) | Limit<br>Line<br>( dBμV/m ) | Read<br>Level<br>( dBμV ) | Antenna<br>Factor<br>( dB/m ) | Cable<br>Loss<br>( dB ) | Preamp<br>Factor<br>( dB ) | Ant<br>Pos<br>( cm ) | Table<br>Pos<br>( deg ) | Peak<br>Avg.<br>( P/A ) | Pol.<br>( H/V ) |
|------------------------|---|----------------------|---------------------|-------------------------|-----------------------------|---------------------------|-------------------------------|-------------------------|----------------------------|----------------------|-------------------------|-------------------------|-----------------|
| BT<br>CH 78<br>2480MHz |   | 4960                 | 39.27               | -34.73                  | 74                          | 57.67                     | 32.42                         | 6.86                    | 58.14                      | 100                  | 0                       | P                       | H               |
|                        |   | 4960                 | 14.48               | -39.52                  | 54                          |                           |                               |                         |                            |                      |                         | A                       | H               |
|                        |   | 7440                 | 41.33               | -32.67                  | 74                          | 54.33                     | 37.32                         | 8.5                     | 59.17                      | 100                  | 0                       | P                       | H               |
|                        |   | 7440                 | 16.54               | -37.46                  | 54                          |                           |                               |                         |                            |                      |                         | A                       | H               |
|                        |   | 4960                 | 37.73               | -36.27                  | 74                          | 56.13                     | 32.42                         | 6.86                    | 58.14                      | 100                  | 0                       | P                       | V               |
|                        |   | 4960                 | 12.94               | -41.06                  | 54                          |                           |                               |                         |                            |                      |                         | A                       | V               |
|                        |   | 7440                 | 41.59               | -32.41                  | 74                          | 54.59                     | 37.32                         | 8.5                     | 59.17                      | 100                  | 0                       | P                       | V               |
|                        |   | 7440                 | 16.8                | -37.2                   | 54                          |                           |                               |                         |                            |                      |                         | A                       | V               |
| Remark                 | 1. No other spurious found.<br>2. All results are PASS against Peak and Average limit line. |                      |                     |                         |                             |                           |                               |                         |                            |                      |                         |                         |                 |



Emission below 1GHz

2.4GHz BT (LF)

| BT                 | Note   | Frequency | Level      | Over   | Limit      | Read     | Antenna  | Cable  | Preamp | Ant    | Table   | Peak    | Pol.    |   |
|--------------------|--|-----------|------------|--------|------------|----------|----------|--------|--------|--------|---------|---------|---------|---|
|                    |  | ( MHz )   | ( dBμV/m ) | ( dB ) | ( dBμV/m ) | ( dBμV ) | ( dB/m ) | ( dB ) | ( dB ) | ( cm ) | ( deg ) | ( P/A ) | ( H/V ) |   |
| 2.4GHz<br>BT<br>LF |  | 43.23     | 25         | -15    | 40         | 39.62    | 17.33    | 0.69   | 32.75  | -      | -       | P       | H       |   |
|                    |  | 105.06    | 29.98      | -13.52 | 43.5       | 45.01    | 16.53    | 0.97   | 32.77  | -      | -       | P       | H       |   |
|                    |  | 130.71    | 25.59      | -17.91 | 43.5       | 39.4     | 17.54    | 1.12   | 32.76  | -      | -       | P       | H       |   |
|                    |  | 308.4     | 25.37      | -20.63 | 46         | 36.74    | 19.3     | 1.65   | 32.71  | -      | -       | P       | H       |   |
|                    |  | 773.2     | 29.9       | -16.1  | 46         | 31.33    | 28.33    | 2.54   | 32.92  | -      | -       | P       | H       |   |
|                    |  | 942.6     | 32.87      | -13.13 | 46         | 30.65    | 30.47    | 2.78   | 31.83  | 100    | 0       | P       | H       |   |
|                    |  |           |            |        |            |          |          |        |        |        |         |         | H       |   |
|                    |  |           |            |        |            |          |          |        |        |        |         |         | H       |   |
|                    |  |           |            |        |            |          |          |        |        |        |         |         | H       |   |
|                    |  |           |            |        |            |          |          |        |        |        |         |         | H       |   |
|                    |  |           |            |        |            |          |          |        |        |        |         |         | H       |   |
|                    |  |           |            |        |            |          |          |        |        |        |         |         | H       |   |
|                    |  |           |            |        |            |          |          |        |        |        |         |         | H       |   |
|                    |  |           | 42.69      | 36.61  | -3.39      | 40       | 50.71    | 17.85  | 0.69   | 32.75  | 100     | 0       | P       | V |
|                    |  |           | 100.47     | 26.62  | -16.88     | 43.5     | 42.03    | 16.15  | 0.97   | 32.77  | -       | -       | P       | V |
|                    |  |           | 210.09     | 17.28  | -26.22     | 43.5     | 33.12    | 15.08  | 1.44   | 32.75  | -       | -       | P       | V |
|                    |  |           | 419.7      | 23.79  | -22.21     | 46       | 31.59    | 22.62  | 1.93   | 32.78  | -       | -       | P       | V |
|                    |  |           | 640.9      | 27.43  | -18.57     | 46       | 30.95    | 26.57  | 2.32   | 33     | -       | -       | P       | V |
|                    |  |           | 946.8      | 32.86  | -13.14     | 46       | 30.45    | 30.61  | 2.78   | 31.78  | -       | -       | P       | V |
|                    |  |           |            |        |            |          |          |        |        |        |         |         |         | V |
|                    |  |           |            |        |            |          |          |        |        |        |         |         | V       |   |
|                    |  |           |            |        |            |          |          |        |        |        |         |         | V       |   |
|                    |  |           |            |        |            |          |          |        |        |        |         |         | V       |   |
|                    |  |           |            |        |            |          |          |        |        |        |         |         | V       |   |
|                    |  |           |            |        |            |          |          |        |        |        |         |         | V       |   |
| Remark             | 1. No other spurious found.<br>2. All results are PASS against limit line. |           |            |        |            |          |          |        |        |        |         |         |         |   |



Note symbol

|     |  |
|-----|--|
| *   | <b>Fundamental Frequency</b> which can be ignored. However, the level of any unwanted emissions shall not exceed the level of the fundamental frequency. |
| !   | Test result is <b>over limit</b> line.   |
| P/A | <b>Peak</b> or <b>Average</b>  |
| H/V | <b>Horizontal</b> or <b>Vertical</b>   |



A calculation example for radiated spurious emission is shown as below:

| WIFI    | Note | Frequency | Level      | Over   | Limit      | Read     | Antenna  | Cable  | Preamp | Ant    | Table   | Peak    | Pol.    |
|---------|------|-----------|------------|--------|------------|----------|----------|--------|--------|--------|---------|---------|---------|
| Ant.    |      |           |            | Limit  | Line       | Level    | Factor   | Loss   | Factor | Pos    | Pos     | Avg.    |         |
| 1+2     |      | ( MHz )   | ( dBμV/m ) | ( dB ) | ( dBμV/m ) | ( dBμV ) | ( dB/m ) | ( dB ) | ( dB ) | ( cm ) | ( deg ) | ( P/A ) | ( H/V ) |
| 802.11b |      | 2390      | 55.45      | -18.55 | 74         | 54.51    | 32.22    | 4.58   | 35.86  | 103    | 308     | P       | H       |
| CH 01   |      |           |            |        |            |          |          |        |        |        |         |         |         |
| 2412MHz |      | 2390      | 43.54      | -10.46 | 54         | 42.6     | 32.22    | 4.58   | 35.86  | 103    | 308     | A       | H       |

- Level(dBμV/m) =  
Antenna Factor(dB/m) + Cable Loss(dB) + Read Level(dBμV) - Preamp Factor(dB)
- Over Limit(dB) = Level(dBμV/m) – Limit Line(dBμV/m)

**For Peak Limit @ 2390MHz:**

- Level(dBμV/m)  
= Antenna Factor(dB/m) + Cable Loss(dB) + Read Level(dBμV) - Preamp Factor(dB)  
= 32.22(dB/m) + 4.58(dB) + 54.51(dBμV) – 35.86 (dB)  
= 55.45 (dBμV/m)
- Over Limit(dB)  
= Level(dBμV/m) – Limit Line(dBμV/m)  
= 55.45(dBμV/m) – 74(dBμV/m)  
= -18.55(dB)

**For Average Limit @ 2390MHz:**

- Level(dBμV/m)  
= Antenna Factor(dB/m) + Cable Loss(dB) + Read Level(dBμV) - Preamp Factor(dB)  
= 32.22(dB/m) + 4.58(dB) + 42.6(dBμV) – 35.86 (dB)  
= 43.54 (dBμV/m)
- Over Limit(dB)  
= Level(dBμV/m) – Limit Line(dBμV/m)  
= 43.54(dBμV/m) – 54(dBμV/m)  
= -10.46(dB)

Both peak and average measured complies with the limit line, so test result is “PASS”.



## Appendix B. Radiated Spurious Emission Plots

|                 |                                       |                     |         |
|-----------------|---------------------------------------|---------------------|---------|
| Test Engineer : | Tsung Li , Stan Hsieh and Kyle Chuang | Temperature :       | 22~24°C |
|                 |                                       | Relative Humidity : | 43~44%  |

**Note symbol**

|    |                       |
|----|-----------------------|
| -L | Low channel location  |
| -R | High channel location |

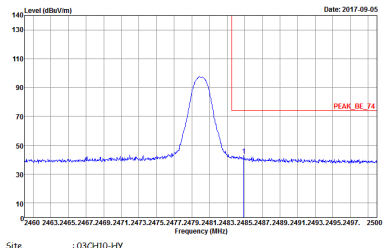
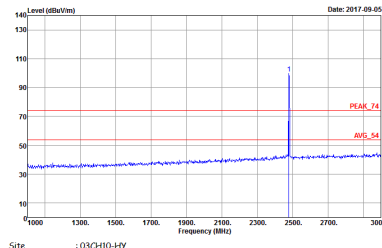

2.4GHz 2400~2483.5MHz  
BT (3M) (Band Edge @ 3m)

| BT              | 2.4GHz 2400~2483.5MHz Band Edge @ 3m   |  |
|-----------------|--|--|
| BT CH78 2480MHz |  |  |
|                 | Horizontal   | Fundamental  |
| Peak            |  <p>Site : 03CH10-HY<br/>Condition : PEAK BE 74 3m HORN 91200-HF HORIZONTAL</p> |  <p>Site : 03CH10-HY<br/>Condition : PEAK 74 3m HORN 91200-HF HORIZONTAL</p> |



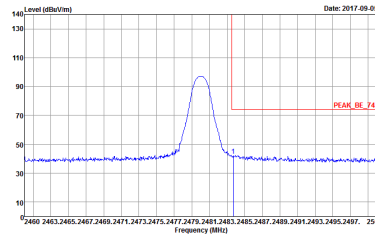
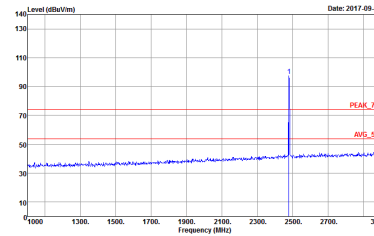

| BT              | 2.4GHz 2400~2483.5MHz Band Edge @ 3m  |   |
|-----------------|---|---|
| BT CH78 2480MHz |   |   |
|                 | Vertical  | Fundamental   |
| <b>Peak</b>     |  <p>Site : 03CH10-14Y<br/>Condition : PEAK_BE_74 3m HORN 9120D-HF VERTICAL</p> |  <p>Site : 03CH10-14Y<br/>Condition : PEAK_74 3m HORN 9120D-HF VERTICAL</p> |

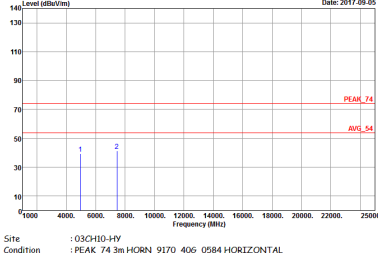
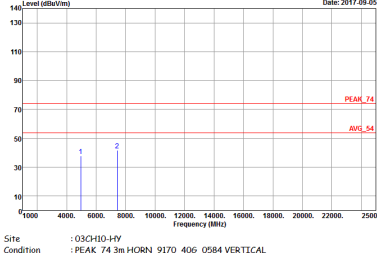

2.4GHz 2400~2483.5MHz  
BT (3M) (Harmonic @ 3m)

| BT           | 2.4GHz 2400~2483.5MHz Harmonic @ 3m  |   |
|--------------|--|---|
|              | BT CH78 2480MHz  |   |
|              | Horizontal   | Vertical  |
| Peak<br>Avg. |  <p>Site : 03CH10-HY<br/>Condition : PEAK 74 3m HORN 9170 40G 0584 HORIZONTAL</p> |  <p>Site : 03CH10-HY<br/>Condition : PEAK 74 3m HORN 9170 40G 0584 VERTICAL</p> |



Emission below 1GHz

2.4GHz BT (LF)

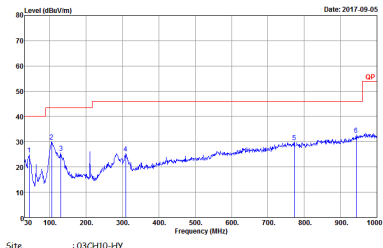
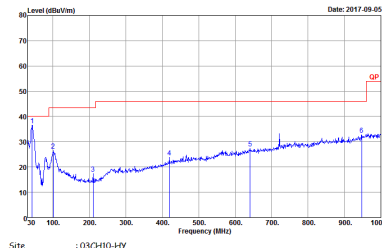
| BT           | 2.4GHz 2400~2483.5MHz  |  |
|--------------|--|--|
| BT LF        |  |  |
| Horizontal   |  | Vertical   |
| QP /<br>Peak |  <p data-bbox="430 884 813 907">Site : 03CH10-HY<br/>Condition : QP-3m BT-LOG-6111D-LF HORIZONTAL</p> |  <p data-bbox="901 884 1284 907">Site : 03CH10-HY<br/>Condition : QP-3m BT-LOG-6111D-LF VERTICAL</p> |

## Appendix C. Duty Cycle Plots

3DH5 on time (One Pulse) Plot on Channel 39

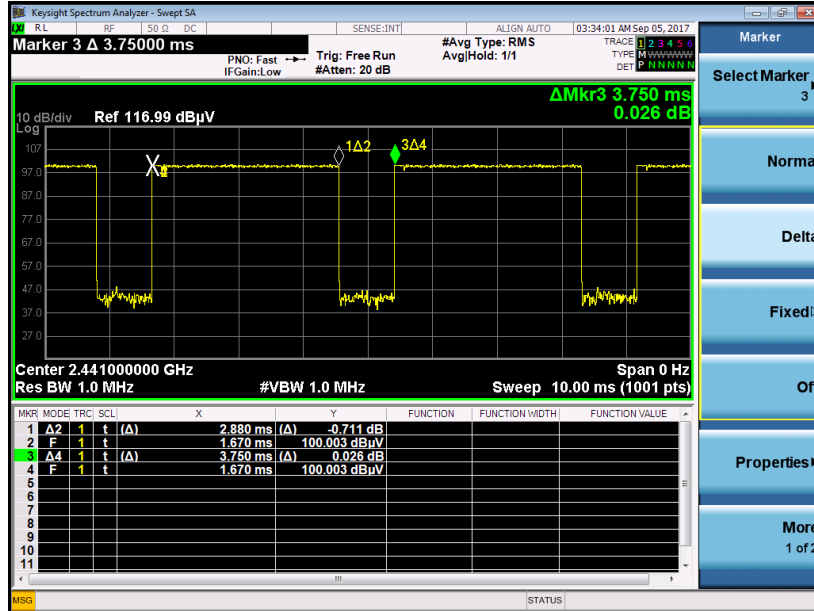

on time (Count Pulses) Plot on Channel 39

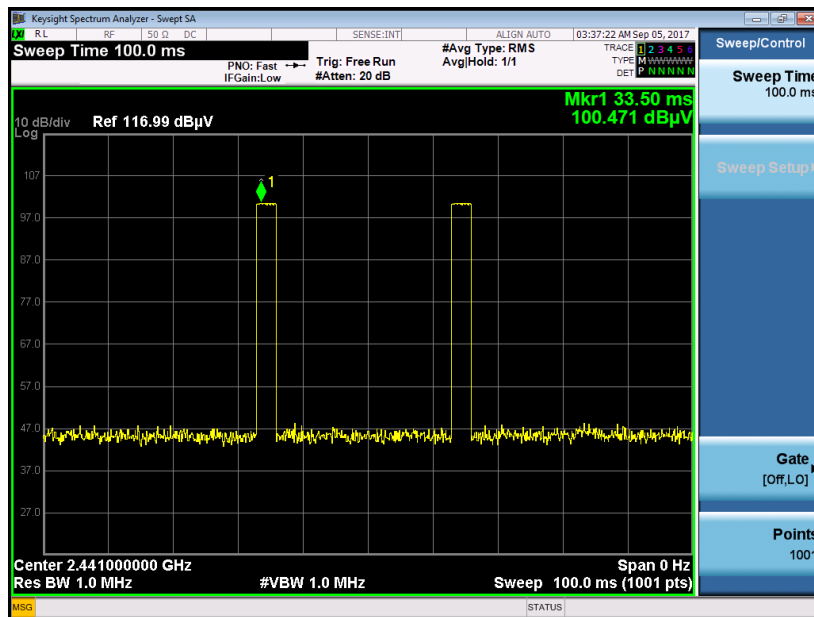

**Note:**

1. Worst case Duty cycle = on time/100 milliseconds =  $2 * 2.88 / 100 = 5.76 \%$
2. Worst case Duty cycle correction factor =  $20 * \log(\text{Duty cycle}) = -24.79 \text{ dB}$
3. **3DH5** has the highest duty cycle worst case and is reported.



**Duty Cycle Correction Factor Consideration for AFH mode:**

Bluetooth normal hopping rate is 1600Hz and reduced to 800Hz in AFH mode; due to the reduced number of hopping frequencies, with the same packet configuration the dwell time in each channel frequency within 100msec period is longer in AFH mode than normal mode.

In AFH mode, the minimum hopping frequencies are 20, to get the longest dwell time DH5 packet is observed; the period to have DH5 packet completing one hopping sequence is

$$2.88 \text{ ms} \times 20 \text{ channels} = 57.6 \text{ ms}$$

There cannot be 2 complete hopping sequences within 100ms period, considering the random hopping behavior, maximum 2 hops can be possibly observed within the period.  $[100\text{ms} / 57.6\text{ms}] = 2$  hops

Thus, the maximum possible ON time:

$$2.88 \text{ ms} \times 2 = 5.76 \text{ ms}$$

Worst case Duty Cycle Correction factor, which is derived from the maximum possible ON time,

$$20 \times \log(5.76 \text{ ms}/100\text{ms}) = -24.79 \text{ dB}$$



## Appendix D. Original Report

Please refer to Sporton report number FR782113A