



FCC RF Test Report

APPLICANT : Sony Mobile Communications Inc.
EQUIPMENT : GSM/WCDMA/LTE Phone+Bluetooth,
DTS/UNII a/b/g/n and NFC
BRAND NAME : Sony
FCC ID : PY7-87507S
STANDARD : FCC Part 15 Subpart C §15.247
CLASSIFICATION : (DTS) Digital Transmission System

This is a variant report which is only valid together with the original test report. The product was received on Aug. 22, 2017 and testing was completed on Sep. 05, 2017. We, SPORTON INTERNATIONAL INC., would like to declare that the tested sample has been evaluated in accordance with the test procedures and has been in compliance with the applicable technical standards.

The test results in this report apply exclusively to the tested model / sample. Without written approval of SPORTON INTERNATIONAL INC., the test report shall not be reproduced except in full.

Reviewed by: Joseph Lin / Supervisor

Approved by: Jones Tsai / Manager



SPORTON INTERNATIONAL INC.

No. 52, Hwa Ya 1st Rd., Hwa Ya Technology Park, Kwei-Shan District, Tao Yuan City, Taiwan, R.O.C.

SPORTON INTERNATIONAL INC.

TEL : 886-3-327-3456

FAX : 886-3-328-4978

FCC ID : PY7-87507S

Page Number : 1 of 17

Report Issued Date : Oct. 30, 2017

Report Version : Rev. 01

Report Template No.: BU5-FR15CBT4.0 Version 2.0



TABLE OF CONTENTS

REVISION HISTORY.....3

SUMMARY OF TEST RESULT4

1 GENERAL DESCRIPTION.....5

 1.1 Applicant5

 1.2 Manufacturer.....5

 1.3 Product Feature of Equipment Under Test.....5

 1.4 Modification of EUT5

 1.5 Testing Location6

 1.6 Applicable Standards.....6

2 TEST CONFIGURATION OF EQUIPMENT UNDER TEST.....7

 2.1 Carrier Frequency Channel7

 2.2 Descriptions of Test Mode8

 2.3 Test Mode.....8

 2.4 Connection Diagram of Test System.....9

 2.5 EUT Operation Test Setup9

3 TEST RESULT10

 3.1 Radiated Band Edges and Spurious Emission Measurement10

 3.2 Antenna Requirements14

4 LIST OF MEASURING EQUIPMENT.....15

5 UNCERTAINTY OF EVALUATION.....17

APPENDIX A. RADIATED SPURIOUS EMISSION

APPENDIX B. RADIATED SPURIOUS EMISSION PLOTS

APPENDIX C. DUTY CYCLE PLOTS

APPENDIX D. ORIGINAL REPORT



REVISION HISTORY

REPORT NO.	VERSION	DESCRIPTION	ISSUED DATE
FR782203B	Rev. 01	Initial issue of report	Oct. 30, 2017



SUMMARY OF TEST RESULT

Report Section	FCC Rule	Description	Limit	Result	Remark
3.1	15.247(d)	Radiated Band Edges and Spurious Emission	15.209(a) & 15.247(d)	Pass	Under limit 4.12 dB at 41.070 MHz
3.2	15.203 & 15.247(b)	Antenna Requirement	N/A	Pass	-



1 General Description

1.1 Applicant

Sony Mobile Communications Inc.

4-12-3 Higashi-Shinagawa, Shinagawa-ku, Tokyo, 140-0002, Japan

1.2 Manufacturer

Sony Mobile Communications Inc.

4-12-3 Higashi-Shinagawa, Shinagawa-ku, Tokyo, 140-0002, Japan

1.3 Product Feature of Equipment Under Test

GSM/WCDMA/LTE, Bluetooth, DTS/UNII a/b/g/n, FM Receiver, NFC, and GPS.

Standards-related Product Specification	
Antenna Type / Gain	PIFA Antenna type with gain -1.20 dBi

Remark: This is a variant report. All the test cases were performed on original report which can be referred to Sporton Report Number FR782113B.

EUT Information List			
HW Version	SW Version	S/N	Performed Test Item
A	1.8	WUJ01Q22RY	RF conducted measurement
		WUJ01Q23X7	Radiated Spurious Emission

Accessory List	
AC Adapter	Model Name: EP800
	S/N: 2916W46610569
Earphone	Model Name: MH410c
	S/N: N/A
USB Cable	Model Name: UCB20
	S/N: 1635A91C00314D8

Note:

1. Above EUT list and accessory list used are electrically identical per declared by manufacturer.
2. Above the accessories list are used to exercise the EUT during test.
3. For other wireless features of this EUT, test report will be issued separately.

1.4 Modification of EUT

No modifications are made to the EUT during all test items.



1.5 Testing Location

Sporton Lab is accredited to ISO 17025 by Taiwan Accreditation Foundation (TAF code : 1190) and the FCC designation No. TW1190 and TW0007 under the FCC 2.948(e) by Mutual Recognition Agreement (MRA) in FCC Test.

Test Site	SPORTON INTERNATIONAL INC.
Test Site Location	No. 52, Hwa Ya 1 st Rd., Hwa Ya Technology Park, Kwei-Shan District, Tao Yuan City, Taiwan, R.O.C. TEL: +886-3-327-3456 FAX: +886-3-328-4978
Test Site No.	Sporton Site No.
	TH05-HY

Note: The test site complies with ANSI C63.4 2014 requirement.

Test Site	SPORTON INTERNATIONAL INC.
Test Site Location	No.58, Aly. 75, Ln. 564, Wenhua 3rd Rd. Guishan Dist, Taoyuan City, Taiwan (R.O.C.) TEL: +886-3-327-0868 FAX: +886-3-327-0855
Test Site No.	Sporton Site No.
	03CH10-HY

Note: The test site complies with ANSI C63.4 2014 requirement.

1.6 Applicable Standards

According to the specifications of the manufacturer, the EUT must comply with the requirements of the following standards:

- ♦ FCC Part 15 Subpart C §15.247
- ♦ FCC KDB Publication No. 558074 D01 DTS Meas. Guidance v04
- ♦ ANSI C63.10-2013

Remark:

1. All test items were verified and recorded according to the standards and without any deviation during the test.
2. This EUT has also been tested and complied with the requirements of FCC Part 15, Subpart B, recorded in a separate test report.



2 Test Configuration of Equipment Under Test

2.1 Carrier Frequency Channel

Frequency Band	Channel	Freq. (MHz)	Channel	Freq. (MHz)
2400-2483.5 MHz	0	2402	21	2444
	1	2404	22	2446
	2	2406	23	2448
	3	2408	24	2450
	4	2410	25	2452
	5	2412	26	2454
	6	2414	27	2456
	7	2416	28	2458
	8	2418	29	2460
	9	2420	30	2462
	10	2422	31	2464
	11	2424	32	2466
	12	2426	33	2468
	13	2428	34	2470
	14	2430	35	2472
	15	2432	36	2474
	16	2434	37	2476
	17	2436	38	2478
	18	2438	39	2480
	19	2440	-	-
20	2442	-	-	



2.2 Descriptions of Test Mode

The RF output power was recorded in the following table:

Channel	Frequency	Bluetooth – LE RF Output Power
		Data Rate / Modulation
		GFSK
		1Mbps
Ch00	2402MHz	2.28 dBm
Ch19	2440MHz	3.11 dBm
Ch39	2480MHz	3.39 dBm

- a. The EUT has been associated with peripherals and configuration operated in a manner tended to maximize its emission characteristics in a typical application. Frequency range investigated: radiation emission (9 kHz to the 10th harmonic of the highest fundamental frequency or to 40 GHz, whichever is lower). Pre-scanned tests, X, Y, Z in three orthogonal panels, and different data rates were conducted to determine the final configuration (X plane as worst plane) from all possible combinations.

2.3 Test Mode

The following summary table is showing all test modes to demonstrate in compliance with the standard.

Summary table of Test Cases	
Test Item	Data Rate / Modulation
	Bluetooth – LE / GFSK
Radiated TCs	Mode 1: Bluetooth Tx CH39_2480 MHz_1Mbps

2.4 Connection Diagram of Test System

<Bluetooth LE Tx Mode>

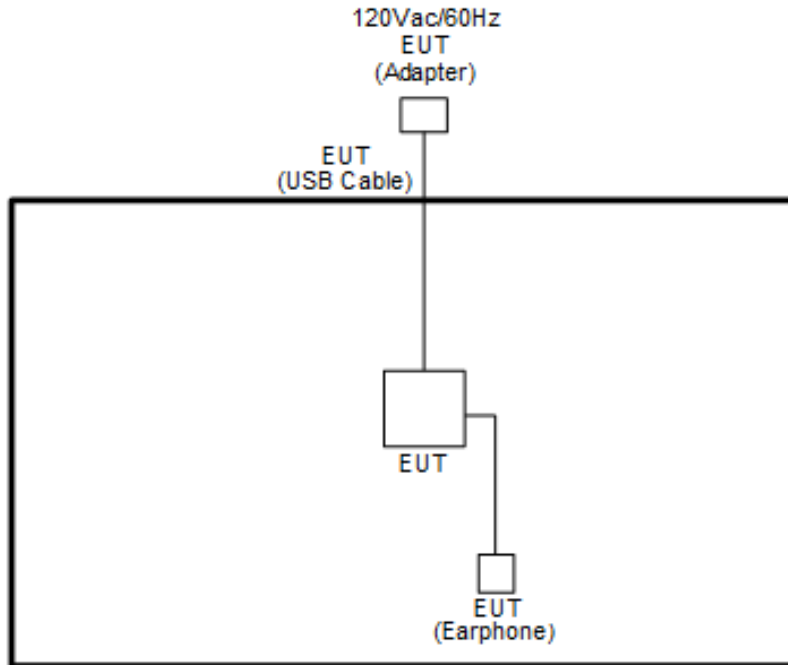

2.5 EUT Operation Test Setup

The RF test items, an engineering test program was provided and enabled to make EUT transmitting signals.



3 Test Result

3.1 Radiated Band Edges and Spurious Emission Measurement

3.1.1 Limit of Radiated Band Edges and Spurious Emission

In any 100 kHz bandwidth outside the intentional radiator frequency band, all harmonics/spurious must be at least 20 dB below the highest emission level within the authorized band. If the output power of this device was measured by spectrum analyzer, the attenuation under this paragraph shall be 30 dB instead of 20 dB. In addition, radiated emissions which fall in the restricted bands must also comply with the limits as below.

Frequency (MHz)	Field Strength (microvolts/meter)	Measurement Distance (meters)
0.009 – 0.490	2400/F(kHz)	300
0.490 – 1.705	24000/F(kHz)	30
1.705 – 30.0	30	30
30 – 88	100	3
88 – 216	150	3
216 - 960	200	3
Above 960	500	3

3.1.2 Measuring Instruments

The section 4.0 of List of Measuring Equipment of this test report is used for test.



3.1.3 Test Procedures

1. The testing follows FCC KDB Publication No. 558074 D01 DTS Meas. Guidance v04.
2. The EUT was arranged to its worst case and then tune the antenna tower (from 1 m to 4 m) and turntable (from 0 degree to 360 degrees) to find the maximum reading. A pre-amp and a high pass filter are used for the test in order to get better signal level.
3. The EUT was placed on a turntable with 0.8 meter for frequency below 1GHz and 1.5 meter for frequency above 1GHz respectively above ground.
4. The EUT was set 3 meters from the interference receiving antenna, which was mounted on the top of a variable height antenna tower.
5. Corrected Reading: Antenna Factor + Cable Loss + Read Level - Preamp Factor = Level
6. For testing below 1GHz, if the emission level of the EUT in peak mode was 3 dB lower than the limit specified, then peak values of EUT will be reported, otherwise, the emissions will be repeated one by one using the CISPR quasi-peak method and reported.
7. For testing above 1GHz, the emission level of the EUT in peak mode was 20dB lower than average limit (that means the emission level in average mode also complies with the limit in average mode), then peak values of EUT will be reported, otherwise, the emissions will be measured in average mode again and reported.
8. Use the following spectrum analyzer settings:
 - (1) Span shall wide enough to fully capture the emission being measured;
 - (2) Set RBW=100 kHz for $f < 1$ GHz; VBW \geq RBW; Sweep = auto; Detector function = peak; Trace = max hold;
 - (3) Set RBW = 1 MHz, VBW= 3MHz for $f \geq 1$ GHz for peak measurement.
For average measurement:
 - VBW = 10 Hz, when duty cycle is no less than 98 percent.
 - VBW $\geq 1/T$, when duty cycle is less than 98 percent where T is the minimum transmission duration over which the transmitter is on and is transmitting at its maximum power control level for the tested mode of operation.

3.1.4 Test Setup

For radiated emissions below 30MHz

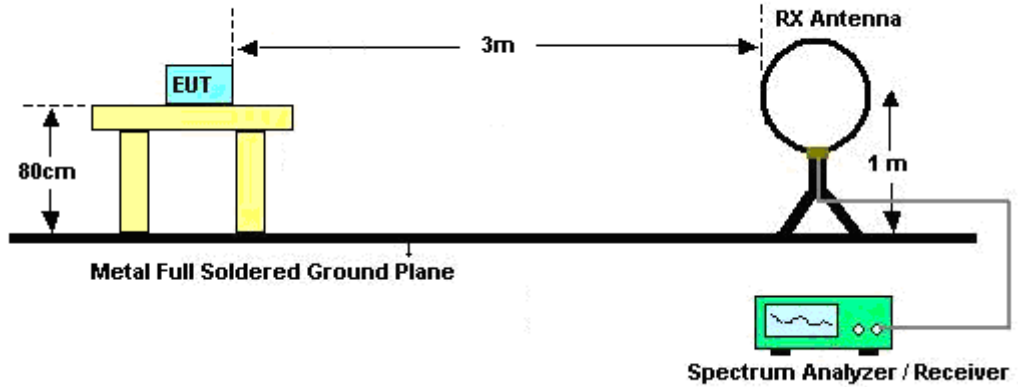

For radiated emissions from 30MHz to 1GHz

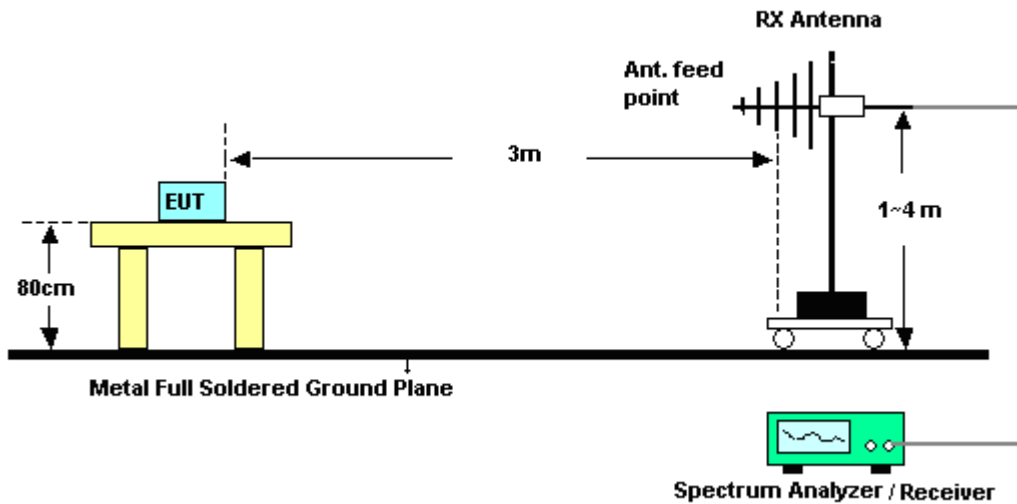

For radiated emissions above 1GHz

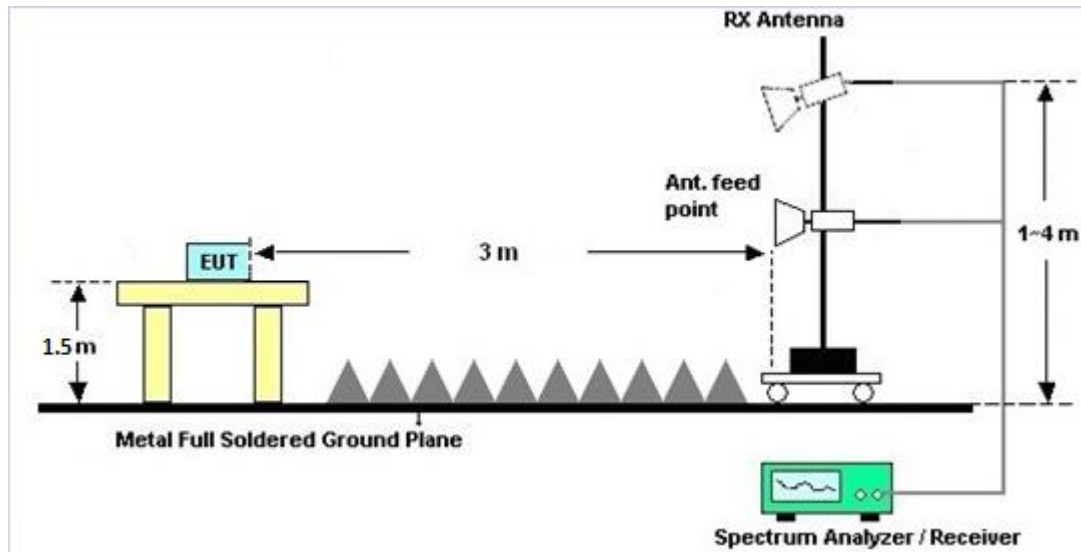

3.1.5 Test Results of Radiated Spurious Emissions (9 kHz ~ 30 MHz)

The low frequency, which started from 9 kHz to 30MHz, was pre-scanned and the result which was 20dB lower than the limit line was not reported.

There is a comparison data of both open-field test site and semi-Anechoic chamber, and the result came out very similar.

3.1.6 Test Result of Radiated Spurious at Band Edges

Please refer to Appendix A and B.

3.1.7 Duty Cycle

Please refer to Appendix C.

3.1.8 Test Result of Radiated Spurious Emission (30MHz ~ 10th Harmonic)

Please refer to Appendix A and B.



3.2 Antenna Requirements

3.2.1 Standard Applicable

If directional gain of transmitting antennas is greater than 6dBi, the power shall be reduced by the same level in dB comparing to gain minus 6dBi. The use of a permanently attached antenna or of an antenna that uses a unique coupling to the intentional radiator shall be considered sufficient to comply with the rule.

3.2.2 Antenna Anti-Replacement Construction

An embedded-in antenna design is used.

3.2.3 Antenna Gain

The antenna peak gain of EUT is less than 6 dBi. Therefore, it is not necessary to reduce maximum peak output power limit.



4 List of Measuring Equipment

Instrument	Manufacturer	Model No.	Serial No.	Characteristics	Calibration Date	Test Date	Due Date	Remark
Power Meter	Anritsu	ML2495A	0932001	N/A	Sep. 29, 2016	Aug. 23, 2017	Sep. 28, 2017	Conducted (TH05-HY)
Power Sensor	Anritsu	MA2411B	0846202	300MHz~40GHz	Sep. 29, 2016	Aug. 23, 2017	Sep. 28, 2017	Conducted (TH05-HY)
Spectrum Analyzer	Rohde & Schwarz	FSP30	101067	9kHz ~ 30GHz	Nov. 17, 2016	Aug. 23, 2017	Nov. 16, 2017	Conducted (TH05-HY)
Hygrometer	TECEPEL	DTM-303B	TP157151	N/A	Mar. 20, 2017	Aug. 23, 2017	Mar. 19, 2018	Conducted (TH05-HY)
RF Cable	HUBER + SUHNER	SUCOFLEX 104	MY842095 21	1GHz~26GHz	Dec. 02, 2016	Aug. 23, 2017	Dec. 01, 2017	Conducted (TH05-HY)
Loop Antenna	Rohde & Schwarz	HFH2-Z2	100315	9 kHz~30 MHz	May 15, 2017	Aug. 29, 2017~ Sep. 05, 2017	May 14, 2019	Radiation (03CH10-HY)
Bilog Antenna	TESEQ	CBL 6111D&00800 N1D01N-06	35413&02	30MHz~1GHz	Jan. 07, 2017	Aug. 29, 2017~ Sep. 05, 2017	Jan. 06, 2018	Radiation (03CH10-HY)
Horn Antenna	SCHWARZBECK	BBHA 9120 D	9120D-132 5	1GHz ~ 18GHz	Sep. 30, 2016	Aug. 29, 2017~ Sep. 05, 2017	Sep. 29, 2017	Radiation (03CH10-HY)
SHF-EHF Horn Antenna	SCHWARZBECK	BBHA 9170	BBHA9170 584	18GHz- 40GHz	Nov. 08, 2016	Aug. 29, 2017~ Sep. 05, 2017	Nov. 07, 2017	Radiation (03CH10-HY)
Spectrum Analyzer	Keysight	N9010A	MY542004 85	10Hz ~ 44GHz	Oct. 17, 2016	Aug. 29, 2017~ Sep. 05, 2017	Oct. 16, 2017	Radiation (03CH10-HY)
EMI Test Receiver	Agilent	N9038A(MXE)	MY532900 45	20Hz to 8.4GHz	Jan. 19, 2017	Aug. 29, 2017~ Sep. 05, 2017	Jan. 18, 2018	Radiation (03CH10-HY)
Amplifier	SONOMA	310N	187311	9kHz~1GHz	Oct. 26, 2016	Aug. 29, 2017~ Sep. 05, 2017	Oct. 25, 2017	Radiation (03CH10-HY)
Preamplifier	Keysight	83017A	MY532700 78	1GHz~26.5GHz	Oct. 26, 2016	Aug. 29, 2017~ Sep. 05, 2017	Oct. 25, 2017	Radiation (03CH10-HY)
Preamplifier	MITEQ	TTA1840-35-HG	1871923	18GHz~40GHz, VSWR : 2.5:1 max	Jul. 21, 2017	Aug. 29, 2017~ Sep. 05, 2017	Jul. 20, 2018	Radiation (03CH10-HY)
Preamplifier	MITEQ	AMF-7D-0010 1800-30-10P	1815698	1GHz~18GHz	Dec. 01, 2016	Aug. 29, 2017~ Sep. 05, 2017	Nov. 30, 2018	Radiation (03CH10-HY)



Instrument	Manufacturer	Model No.	Serial No.	Characteristics	Calibration Date	Test Date	Due Date	Remark
Hygrometer	TECEP	DTM-303B	TP140320	N/A	Nov. 14, 2016	Aug. 29, 2017~ Sep. 05, 2017	Nov. 13, 2017	Radiation (03CH10-HY)
RF Cable	HUBER + SUHNER	SUCOFLEX 104	MY249564 MY249524 MY283184	25GHz~40GHz	Sep. 30, 2016	Aug. 29, 2017~ Sep. 05, 2017	Sep. 29, 2017	Radiation (03CH10-HY)
RF Cable	HUBER + SUHNER	SUCOFLEX 104	MY249564 MY249524 MY283184	30MHz~1GHz	Sep. 30, 2016	Aug. 29, 2017~ Sep. 05, 2017	Sep. 29, 2017	Radiation (03CH10-HY)
RF Cable	HUBER + SUHNER	SUCOFLEX 104	MY249564 MY249524 MY283184	1GHz~25GHz	Sep. 30, 2016	Aug. 29, 2017~ Sep. 05, 2017	Sep. 29, 2017	Radiation (03CH10-HY)
Controller	EMEC	EM 1000	N/A	Control Turn table & Ant Mast	N/A	Aug. 29, 2017~ Sep. 05, 2017	N/A	Radiation (03CH10-HY)
Antenna Mast	EMEC	AM-BS-450 0-B	N/A	1~4m	N/A	Aug. 29, 2017~ Sep. 05, 2017	N/A	Radiation (03CH10-HY)
Turn Table	EMEC	TT 2200	N/A	0~360 Degree	N/A	Aug. 29, 2017~ Sep. 05, 2017	N/A	Radiation (03CH10-HY)
Test Software	Audix	E3	6.2009-8-24	N/A	N/A	Aug. 29, 2017~ Sep. 05, 2017	N/A	Radiation (03CH10-HY)
Filter	Wainwright	WLKS1200- 12SS	SN2	1.2G Low Pass	Sep. 19, 2016	Aug. 29, 2017~ Sep. 05, 2017	Sep. 18, 2017	Radiation (03CH10-HY)
Filter	Wainwright	WHKX12-27 00-3000-18 000-60SS	SN2	3G High Pass	Sep. 20, 2016	Aug. 29, 2017~ Sep. 05, 2017	Sep. 19, 2017	Radiation (03CH10-HY)



5 Uncertainty of Evaluation

Uncertainty of Radiated Emission Measurement (30 MHz ~ 1000 MHz)

Measuring Uncertainty for a Level of Confidence of 95% ($U = 2Uc(y)$)	5.60
---	------

Uncertainty of Radiated Emission Measurement (1000 MHz ~ 18000 MHz)

Measuring Uncertainty for a Level of Confidence of 95% ($U = 2Uc(y)$)	5.90
---	------

Uncertainty of Radiated Emission Measurement (18000 MHz ~ 40000 MHz)

Measuring Uncertainty for a Level of Confidence of 95% ($U = 2Uc(y)$)	5.20
---	------



Appendix A. Radiated Spurious Emission

Test Engineer :	Tsung Li , Stan Hsieh and Kyle Chuang	Temperature :	22~24°C
		Relative Humidity :	43~44%

2.4GHz 2400~2483.5MHz

BLE (Band Edge @ 3m)

BLE	Note	Frequency	Level	Over	Limit	Read	Antenna	Cable	Preamp	Ant	Table	Peak	Pol.
		(MHz)	(dBμV/m)	(dB)	(dBμV/m)	(dBμV)	(dB/m)	(dB)	(dB)	(cm)	(deg)	(P/A)	(H/V)
BLE CH 39 2480MHz	*	2480	94.23	-	-	85.67	27.24	4.51	33.17	123	92	P	H
	*	2480	92.8	-	-	84.24	27.24	4.51	33.17	123	92	A	H
		2496.92	51.35	-22.65	74	42.7	27.3	4.53	33.16	123	92	P	H
		2492.04	41.72	-12.28	54	33.07	27.3	4.53	33.16	123	92	A	H
													H
													H
	*	2480	91.76	-	-	83.2	27.24	4.51	33.17	307	33	P	V
	*	2480	91.34	-	-	82.78	27.24	4.51	33.17	307	33	A	V
		2499.76	51.14	-22.86	74	42.49	27.3	4.53	33.16	307	33	P	V
		2486.88	42.11	-11.89	54	33.53	27.24	4.53	33.17	307	33	A	V
													V
													V

Remark	1. No other spurious found.
	2. All results are PASS against Peak and Average limit line.



2.4GHz 2400~2483.5MHz
BLE (Harmonic @ 3m)

BLE	Note	Frequency (MHz)	Level (dBμV/m)	Over Limit (dB)	Limit Line (dBμV/m)	Read Level (dBμV)	Antenna Factor (dB/m)	Cable Loss (dB)	Preamp Factor (dB)	Ant Pos (cm)	Table Pos (deg)	Peak Avg. (P/A)	Pol. (H/V)	
BLE CH 39 2480MHz		4960	37.12	-36.88	74	55.52	32.42	6.86	58.14	100	0	P	H	
		7440	39.1	-34.9	74	52.1	37.32	8.5	59.17	100	0	P	H	
													H	
													H	
			4960	38.07	-35.93	74	56.47	32.42	6.86	58.14	100	0	P	V
			7440	40.35	-33.65	74	53.35	37.32	8.5	59.17	100	0	P	V
														V
														V
Remark	1. No other spurious found. 2. All results are PASS against Peak and Average limit line.													



Emission below 1GHz

2.4GHz BLE (LF)

BLE	Note	Frequency	Level	Over	Limit	Read	Antenna	Cable	Preamp	Ant	Table	Peak	Pol.	
		(MHz)	(dBμV/m)	(dB)	(dBμV/m)	(dBμV)	(dB/m)	(dB)	(dB)	(cm)	(deg)	(P/A)	(H/V)	
2.4GHz BLE LF		41.61	24.61	-15.39	40	38.18	18.38	0.69	32.75	-	-	P	H	
		105.06	30.36	-13.14	43.5	45.39	16.53	0.97	32.77	100	0	P	H	
		210.09	25.1	-18.4	43.5	40.94	15.08	1.44	32.75	-	-	P	H	
		559.7	26.89	-19.11	46	30.86	26.21	2.18	32.95	-	-	P	H	
		720.7	29.57	-16.43	46	32.18	27.31	2.46	32.97	-	-	P	H	
		846	31.79	-14.21	46	31.98	29.12	2.65	32.62	-	-	P	H	
														H
														H
														H
														H
														H
														H
			41.07	35.88	-4.12	40	48.93	18.9	0.69	32.75	100	0	P	V
			99.93	25.47	-18.03	43.5	40.98	16.05	0.97	32.77	-	-	P	V
			152.58	21.38	-22.12	43.5	35.53	17.02	1.2	32.76	-	-	P	V
			566.7	27.27	-18.73	46	31.44	26	2.21	32.96	-	-	P	V
			810.3	30.14	-15.86	46	31.55	28.18	2.61	32.84	-	-	P	V
			950.3	32.63	-13.37	46	30.03	30.76	2.78	31.75	-	-	P	V
														V
														V
													V	
													V	
													V	
													V	
Remark	1. No other spurious found. 2. All results are PASS against limit line.													



Note symbol

*	Fundamental Frequency which can be ignored. However, the level of any unwanted emissions shall not exceed the level of the fundamental frequency.
!	Test result is over limit line.
P/A	Peak or Average
H/V	Horizontal or Vertical



A calculation example for radiated spurious emission is shown as below:

WIFI	Note	Frequency	Level	Over	Limit	Read	Antenna	Cable	Preamp	Ant	Table	Peak	Pol.
Ant.				Limit	Line	Level	Factor	Loss	Factor	Pos	Pos	Avg.	
1+2		(MHz)	(dBμV/m)	(dB)	(dBμV/m)	(dBμV)	(dB/m)	(dB)	(dB)	(cm)	(deg)	(P/A)	(H/V)
802.11b		2390	55.45	-18.55	74	54.51	32.22	4.58	35.86	103	308	P	H
CH 01													
2412MHz		2390	43.54	-10.46	54	42.6	32.22	4.58	35.86	103	308	A	H

- Level(dBμV/m) =
Antenna Factor(dB/m) + Cable Loss(dB) + Read Level(dBμV) - Preamp Factor(dB)
- Over Limit(dB) = Level(dBμV/m) – Limit Line(dBμV/m)

For Peak Limit @ 2390MHz:

- Level(dBμV/m)
= Antenna Factor(dB/m) + Cable Loss(dB) + Read Level(dBμV) - Preamp Factor(dB)
= 32.22(dB/m) + 4.58(dB) + 54.51(dBμV) – 35.86 (dB)
= 55.45 (dBμV/m)
- Over Limit(dB)
= Level(dBμV/m) – Limit Line(dBμV/m)
= 55.45(dBμV/m) – 74(dBμV/m)
= -18.55(dB)

For Average Limit @ 2390MHz:

- Level(dBμV/m)
= Antenna Factor(dB/m) + Cable Loss(dB) + Read Level(dBμV) - Preamp Factor(dB)
= 32.22(dB/m) + 4.58(dB) + 42.6(dBμV) – 35.86 (dB)
= 43.54 (dBμV/m)
- Over Limit(dB)
= Level(dBμV/m) – Limit Line(dBμV/m)
= 43.54(dBμV/m) – 54(dBμV/m)
= -10.46(dB)

Both peak and average measured complies with the limit line, so test result is “PASS”.



Appendix B. Radiated Spurious Emission Plots

Test Engineer :	Tsung Li , Stan Hsieh and Kyle Chuang	Temperature :	22~24°C
		Relative Humidity :	43~44%

Note symbol

-L	Low channel location
-R	High channel location



2.4GHz 2400~2483.5MHz

BLE (Band Edge @ 3m)

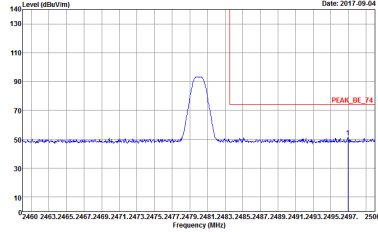
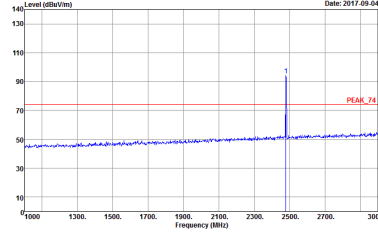
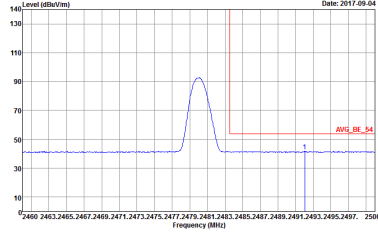
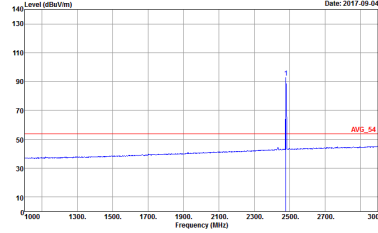
BLE	2.4GHz 2400~2483.5MHz Band Edge @ 3m	
	BLE CH39 2480MHz	
	Horizontal	Fundamental
Peak	 <p>Site : 03CH10-HY Condition : PEAK BE 74 3m HORN 9120D-HF HORIZONTAL</p>	 <p>Site : 03CH10-HY Condition : PEAK 74 3m HORN 9120D-HF HORIZONTAL</p>
Avg.	 <p>Site : 03CH10-HY Condition : AVG BE 54 3m HORN 9120D-HF HORIZONTAL</p>	 <p>Site : 03CH10-HY Condition : AVG 54 3m HORN 9120D-HF HORIZONTAL</p>



BLE	2.4GHz 2400~2483.5MHz Band Edge @ 3m	
BLE CH39 2480MHz		
	Vertical	Fundamental
<p>Peak</p>	<p>Site : 03CH10-HY Condition : PEAK_BE 74 3m HORN 9120D-HF VERTICAL</p>	<p>Site : 03CH10-HY Condition : PEAK_74 3m HORN 9120D-HF VERTICAL</p>
<p>Avg.</p>	<p>Site : 03CH10-HY Condition : AVG_BE 54 3m HORN 9120D-HF VERTICAL</p>	<p>Site : 03CH10-HY Condition : AVG_54 3m HORN 9120D-HF VERTICAL</p>



2.4GHz 2400~2483.5MHz

BLE (Harmonic @ 3m)

BLE	2.4GHz 2400~2483.5MHz Harmonic @ 3m	
	BLE CH39 2480MHz	
	Horizontal	Vertical
Peak	<p>Site : 03CH10-HY Condition : PEAK 74 3m HORN 9170 40G 0584 HORIZONTAL</p>	<p>Site : 03CH10-HY Condition : PEAK 74 3m HORN 9170 40G 0584 VERTICAL</p>



Emission below 1GHz
2.4GHz BLE (LF)

BLE	2.4GHz 2400~2483.5MHz	
	BLE LF	
	Horizontal	Vertical
QP / Peak	<p>Site : 03CH10-HY Condition : QP-3m BE-LOG-6111D-LF HORIZONTAL</p>	<p>Site : 03CH10-HY Condition : QP-3m BE-LOG-6111D-LF VERTICAL</p>

Appendix C. Duty Cycle Plots

Band	Duty Cycle(%)	T(us)	1/T(kHz)	VBW Setting
Bluetooth -LE	59.74	374.00	2.67	3kHz

Bluetooth - LE

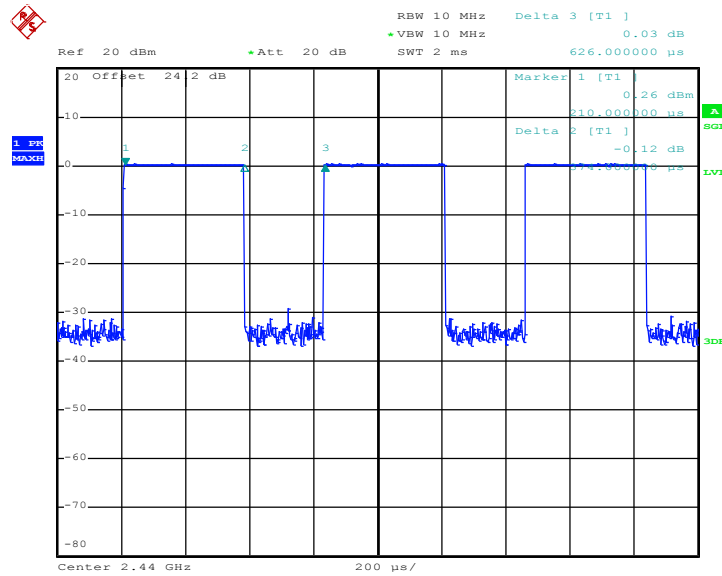

Date: 23.AUG.2017 21:30:31



Appendix D. Original Report

Please refer to Sporton report number FR782113B