



FCC RADIO TEST REPORT

FCC ID : PY7-87261H
Equipment : GSM/WCDMA/LTE Phone with BT, DTS/UNII
a/b/g/n/ac/ax, GPS, WPC and NFC
Brand Name : Sony
Applicant : Sony Mobile Communications Inc.
4-12-3 Higashi-Shinagawa, Shinagawa-ku,
Tokyo, 140-0002, Japan
Manufacturer : Sony Mobile Communications Inc.
4-12-3 Higashi-Shinagawa, Shinagawa-ku,
Tokyo, 140-0002, Japan
Standard : FCC Part 15 Subpart E §15.407

The product was received on Dec. 04, 2019 and testing was started from Dec. 19, 2019 and completed on Feb. 19, 2020. We, SPORTON INTERNATIONAL INC., EMC & Wireless Communications Laboratory, would like to declare that the tested sample has been evaluated in accordance with the test procedures and has been in compliance with the applicable technical standards.

The report must not be used by the client to claim product certification, approval, or endorsement by TAF or any agency of government.

The test results in this report apply exclusively to the tested model / sample. Without written approval of SPORTON INTERNATIONAL INC. EMC & Wireless Communications Laboratory, the test report shall not be reproduced except in full.

Louis Wu

Approved by: Louis Wu

SPORTON INTERNATIONAL INC. EMC & Wireless Communications Laboratory
No. 52, Huaya 1st Rd., Guishan Dist., Taoyuan City, Taiwan (R.O.C.)



Table of Contents

History of this test report..... 3

Summary of Test Result..... 4

1 General Description 5

 1.1 Product Feature of Equipment Under Test..... 5

 1.2 Modification of EUT 6

 1.3 Testing Location 6

 1.4 Applicable Standards..... 6

2 Test Configuration of Equipment Under Test 7

 2.1 Carrier Frequency and Channel 7

 2.2 Test Mode..... 8

 2.3 Connection Diagram of Test System..... 11

 2.4 Support Unit used in test configuration and system 13

 2.5 EUT Operation Test Setup 13

 2.6 Measurement Results Explanation Example..... 13

3 Test Result 14

 3.1 6dB & 26dB & 99% Occupied Bandwidth Measurement..... 14

 3.2 Maximum Conducted Output Power Measurement 18

 3.3 Power Spectral Density Measurement 20

 3.4 Unwanted Emissions Measurement..... 22

 3.5 AC Conducted Emission Measurement..... 27

 3.6 Automatically Discontinue Transmission 29

 3.7 Antenna Requirements..... 31

4 List of Measuring Equipment..... 32

5 Uncertainty of Evaluation..... 34

Appendix A. Conducted Test Results

Appendix B. AC Conducted Emission Test Result

Appendix C. Radiated Spurious Emission

Appendix D. Radiated Spurious Emission Plots

Appendix E. Duty Cycle Plots



History of this test report

Report No.	Version	Description	Issued Date
FR9O1542-02E	01	Initial issue of report	Feb. 04, 2020
FR9O1542-02E	02	Add simultaneous power.	Feb. 20, 2020



Summary of Test Result

Report Clause	Ref Std. Clause	Test Items	Result (PASS/FAIL)	Remark
3.1	15.403(i)	6dB & 26dB Bandwidth	Pass	-
3.1	2.1049	99% Occupied Bandwidth	Reporting only	-
3.2	15.407(a)	Maximum Conducted Output Power	Pass	-
3.3	15.407(a)	Power Spectral Density	Pass	-
3.4	15.407(b)	Unwanted Emissions	Pass	Under limit 4.12 dB at 5469.760 MHz
3.5	15.207	AC Conducted Emission	Pass	Under limit 11.64 dB at 1.586 MHz
3.6	15.407(c)	Automatically Discontinue Transmission	Pass	-
3.7	15.203 15.407(a)	Antenna Requirement	Pass	-

Declaration of Conformity:

The test results with all measurement uncertainty excluded are presented in accordance with the regulation limits or requirements declared by manufacturers.

Comments and Explanations:

The declared of product specification for EUT presented in the report are provided by the manufacturer, and the manufacturer takes all the responsibilities for the accuracy of product specification.

Reviewed by: Wii Chang**Report Producer: Yvonne Cheng**



1 General Description

1.1 Product Feature of Equipment Under Test

GSM/WCDMA/LTE, Bluetooth, DTS/UNII a/b/g/n/ac/ax, NFC, GNSS and WPC.

Product Specification subjective to this standard	
Antenna Type	<Ant. 1>: Loop Antenna <Ant. 2>: Monopole Antenna
Antenna Gain	<Ant 1>: <5150 MHz ~ 5250 MHz> : -1.90 dBi <5250 MHz ~ 5350 MHz> : -2.00 dBi <5470 MHz ~ 5725 MHz> : -4.10 dBi <Ant 2>: <5150 MHz ~ 5250 MHz> : -6.10 dBi <5250 MHz ~ 5350 MHz> : -6.70 dBi <5470 MHz ~ 5725 MHz> : -4.40 dBi

EUT Information List			
HW Version	SW Version	S/N	Performed Test Item
A	0.261	BH9500AVJ7 BH95006JJ7	RF Conducted Measurement
	2.94	QV7100302A QV7100FD2A	Radiated Spurious Emission
	2.38	QV7100Q62A	Conducted Emission

Accessory List	
AC Adapter	Model Name : UCH32
	S/N: 6218W30200178 (for Radiated Spurious Emission) 6218W30200005 (for Conducted Emission)
Earphone	Model Name.: STH40D
	S/N : S458096
Bluetooth Earphone	Model Name : SBH82D
	S/N : N/A
USB Cable	Model Name : UCB24
	S/N : N/A
Audio Cable	Model Name : EC234
	S/N : N/A

Note:

1. Above EUT list used are electrically identical per declared by manufacturer.
2. Above the accessories list are used to exercise the EUT during test, and the serial number of each type of accessories is listed in each section of this report.
3. For other wireless features of this EUT, test report will be issued separately.



1.2 Modification of EUT

No modifications are made to the EUT during all test items.

1.3 Testing Location

Test Site	SPORTON INTERNATIONAL INC. EMC & Wireless Communications Laboratory	
Test Site Location	No.52, Huaya 1st Rd., Guishan Dist., Taoyuan City, Taiwan (R.O.C.) TEL: +886-3-327-3456 FAX: +886-3-328-4978	
Test Site No.	Sporton Site No.	
	TH05-HY	CO05-HY

Note: The test site complies with ANSI C63.4 2014 requirement.

Test Site	SPORTON INTERNATIONAL INC. EMC & Wireless Communications Laboratory	
Test Site Location	No.58, Aly. 75, Ln. 564, Wenhua 3rd, Rd., Guishan Dist., Taoyuan City, Taiwan (R.O.C.) TEL: +886-3-327-0868 FAX: +886-3-327-0855	
Test Site No.	Sporton Site No.	
	03CH16-HY	

Note: The test site complies with ANSI C63.4 2014 requirement.

FCC designation No.: TW1190 and TW0007

1.4 Applicable Standards

According to the specifications of the manufacturer, the EUT must comply with the requirements of the following standards:

- ♦ FCC Part 15 Subpart E
- ♦ FCC KDB 789033 D02 General UNII Test Procedures New Rules v02r01.
- ♦ FCC KDB 414788 D01 Radiated Test Site v01r01.
- ♦ FCC KDB 662911 D01 Multiple Transmitter Output v02r01.
- ♦ ANSI C63.10-2013

Remark:

1. All test items were verified and recorded according to the standards and without any deviation during the test.
2. This EUT has also been tested and complied with the requirements of FCC Part 15, Subpart B, recorded in a separate test report.



2 Test Configuration of Equipment Under Test

- a. The EUT has been associated with peripherals and configuration operated in a manner tended to maximize its emission characteristics in a typical application. Frequency range investigated: conduction emission (150 kHz to 30 MHz), radiation emission (9 kHz to the 10th harmonic of the highest fundamental frequency or to 40 GHz, whichever is lower). For radiated measurement, pre-scanned in three orthogonal panels, X, Y, Z. The worst cases (Y plane; 802.11ax: X plane for Full RU Mode, Y plane for Partial RU Mode) were recorded in this report.
- b. AC power line Conducted Emission was tested under maximum output power.

2.1 Carrier Frequency and Channel

Frequency Band	Channel	Freq. (MHz)	Channel	Freq. (MHz)
5150-5250 MHz Band 1 (U-NII-1)	36	5180	44	5220
	38*	5190	46*	5230
	40	5200	48	5240
	42 [#]	5210		

Frequency Band	Channel	Freq. (MHz)	Channel	Freq. (MHz)
5250-5350 MHz Band 2 (U-NII-2A)	52	5260	60	5300
	54*	5270	62*	5310
	56	5280	64	5320
	58 [#]	5290		

Frequency Band	Channel	Freq. (MHz)	Channel	Freq. (MHz)
5470-5725 MHz Band 3 (U-NII-2C)	100	5500	112	5560
	102*	5510	116	5580
	104	5520	132	5660
	106 [#]	5530	134*	5670
	108	5540	136	5680
	110*	5550	140	5700



Frequency Band	Channel	Freq. (MHz)	Channel	Freq. (MHz)
TDWR Channel	118*	5590	124	5620
	120	5600	126*	5630
	122 [#]	5610	128	5640

Frequency Band	Channel	Freq. (MHz)	Channel	Freq. (MHz)
Straddle Channel	138 [#]	5690	144	5720
	142*	5710		

Note:

1. The above Frequency and Channel in "*" were 802.11n HT40, 802.11ac VHT40, and 802.11ax HE40.
2. The above Frequency and Channel in "[#]" were 802.11ac VHT80 and 802.11ax HE80.

2.2 Test Mode

Final test modes are considering the modulation and worse data rates as below table.

MIMO Mode

Modulation	Data Rate
802.11a	6 Mbps
802.11n HT20	MCS0
802.11n HT40	MCS0
802.11ac VHT20 (Covered by HT20)	MCS0
802.11ac VHT40 (Covered by HT40)	MCS0
802.11ac VHT80	MCS0
802.11ax HE20	MCS0
802.11ax HE40	MCS0
802.11ax HE80	MCS0

Test Cases	
AC Conducted Emission	Mode 1 : GSM850 Idle + WLAN (5GHz) Link + Bluetooth Link + MPEG4 + USB Cable (Charging from Adapter) + Earphone + Battery Mode 2 : GSM850 Idle + WLAN (5GHz) Link + Bluetooth Link + MPEG4 + Earphone + Battery + WPC Charging pad (Charging from Adapter)



Ch. #		Band I : 5150-5250 MHz	Band II : 5250-5350 MHz	Band III : 5470-5725MHz
		802.11a	802.11a	802.11a
L	Low	36	52	100
M	Middle	44	60	116
H	High	48	64	140
Straddle		-	-	144

Ch. #		Band I : 5150-5250 MHz	Band II : 5250-5350 MHz	Band III : 5470-5725MHz
		802.11n HT20	802.11n HT20	802.11n HT20
L	Low	36	52	100
M	Middle	44	60	116
H	High	48	64	140
Straddle		-	-	144

Ch. #		Band I : 5150-5250 MHz	Band II : 5250-5350 MHz	Band III : 5470-5725MHz
		802.11n HT40	802.11n HT40	802.11n HT40
L	Low	38	54	102
M	Middle	-	-	110
H	High	46	62	134
Straddle		-	-	142

Ch. #		Band I : 5150-5250 MHz	Band II : 5250-5350 MHz	Band III : 5470-5725MHz
		802.11ac VHT80	802.11ac VHT80	802.11ac VHT80
L	Low	-	-	106
M	Middle	42	58	122
H	High	-	-	-
Straddle		-	-	138



Ch. #		Band I : 5150-5250 MHz	Band II : 5250-5350 MHz	Band III : 5470-5725MHz
		802.11ax HE20	802.11ax HE20	802.11ax HE20
L	Low	36	52	100
M	Middle	44	60	116
H	High	48	64	140
Straddle		-	-	144

Ch. #		Band I : 5150-5250 MHz	Band II : 5250-5350 MHz	Band III : 5470-5725MHz
		802.11ax HE40	802.11ax HE40	802.11ax HE40
L	Low	38	54	102
M	Middle	-	-	110
H	High	46	62	134
Straddle		-	-	142

Ch. #		Band I : 5150-5250 MHz	Band II : 5250-5350 MHz	Band III : 5470-5725MHz
		802.11ax HE80	802.11ax HE80	802.11ax HE80
L	Low	-	-	106
M	Middle	42	58	122
H	High	-	-	-
Straddle		-	-	138

2.3 Connection Diagram of Test System

<AC Conducted Emission>

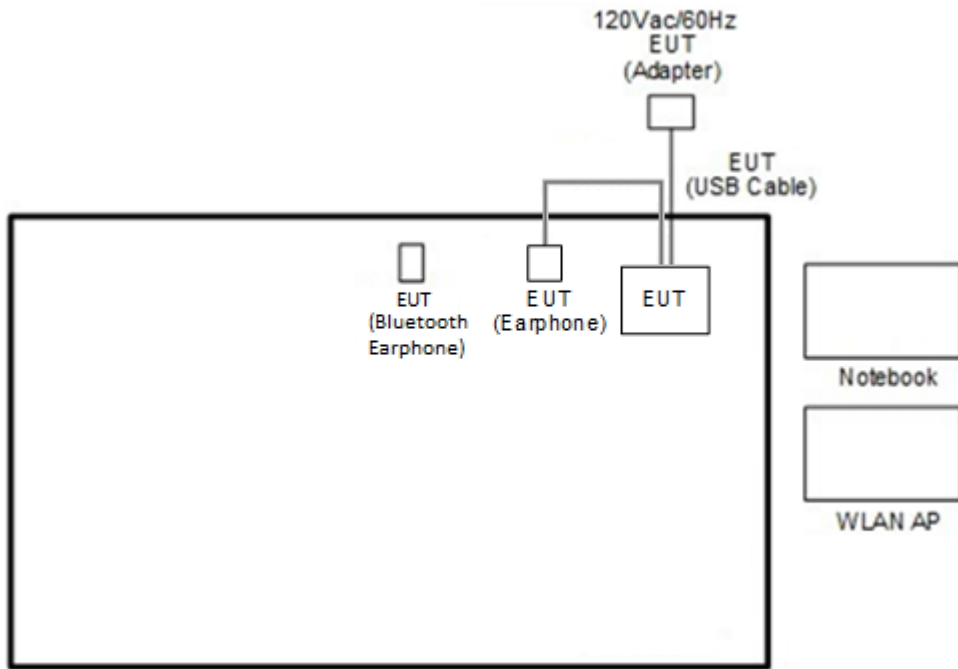

<AC Conducted Emission with WPC Charger>

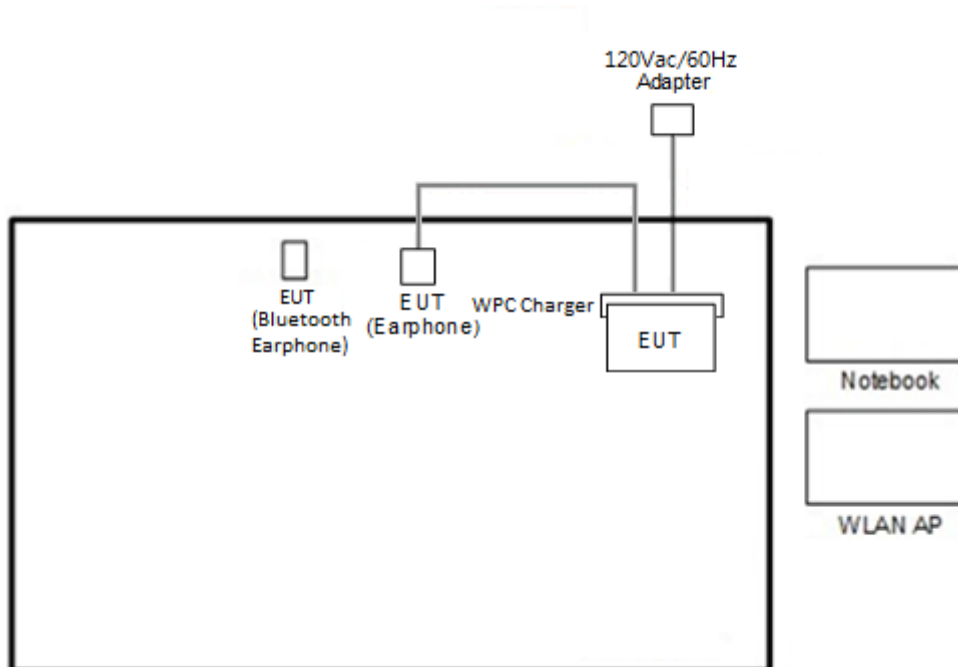

< For Radiated Emissions Measurement >

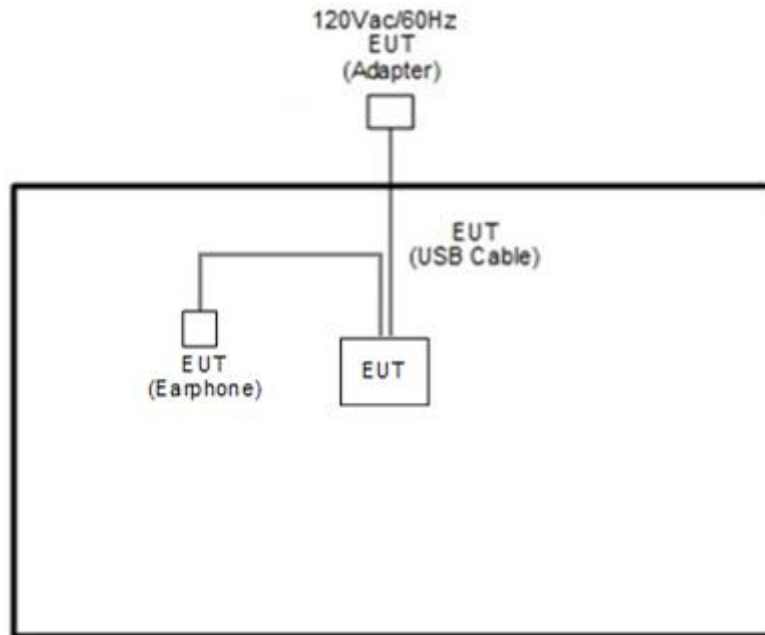

<For Radiated Emissions Measurement with WPC Charger>

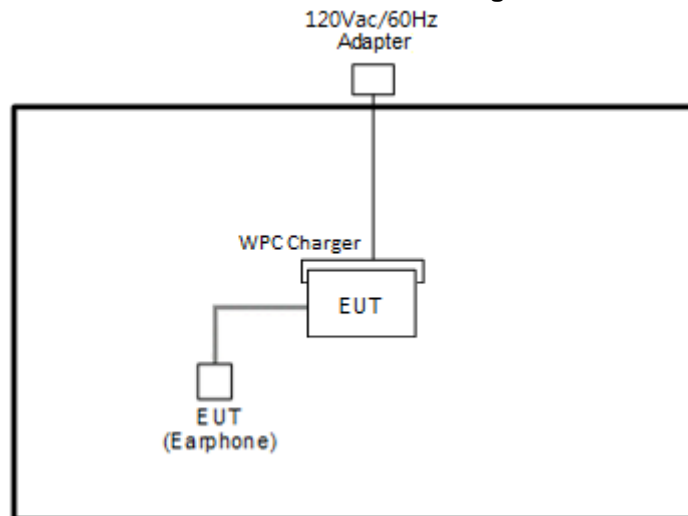



2.4 Support Unit used in test configuration and system

Item	Equipment	Trade Name	Model Name	FCC ID	Data Cable	Power Cord
1.	System Simulator	R&S	CMU 200	N/A	N/A	Unshielded, 1.8 m
2.	WLAN AP	ASUS	RT-AC66U	MSQ-RTAC66U	N/A	Unshielded, 1.8 m
3.	Notebook	DELL	Latitude E3400	FCC DoC	N/A	AC I/P: Unshielded, 1.2 m DC O/P: Shielded, 1.8 m
4.	SD Card	SanDisk	MicroSD HC	FCC DoC	N/A	N/A
5.	Wireless charging pad	belkin	F7U050	N/A	N/A	N/A

2.5 EUT Operation Test Setup

The RF test items, utility "FTMC_bridge_forURC_v0.39" was installed in Notebook which was programmed in order to make the EUT get into the engineering modes to provide channel selection, power level, data rate and the application type and for continuous transmitting signals.

2.6 Measurement Results Explanation Example

For all conducted test items:

The offset level is set in the spectrum analyzer to compensate the RF cable loss and attenuator factor between EUT conducted output port and spectrum analyzer. With the offset compensation, the spectrum analyzer reading level is exactly the EUT RF output level.

Example :

The spectrum analyzer offset is derived from RF cable loss and attenuator factor.

Offset = RF cable loss + attenuator factor.

Following shows an offset computation example with cable loss 4.2 dB and 10dB attenuator.

$$\begin{aligned} \text{Offset(dB)} &= \text{RF cable loss(dB)} + \text{attenuator factor(dB)}. \\ &= 4.2 + 10 = 14.2 \text{ (dB)} \end{aligned}$$



3 Test Result

3.1 6dB & 26dB & 99% Occupied Bandwidth Measurement

3.1.1 Description of 26dB & 99% Occupied Bandwidth

This section is for reporting purpose only.

There is no restriction limits for bandwidth.

For Straddle Channel, according to KDB 789033 D02 General UNII Test Procedures New Rules v02r01, if the power and PSD of the devices are uniform and comply with the lower limits specified for the U-NII-2 bands, a single measurement over the entire emission bandwidth can be performed to show compliance.

3.1.2 Measuring Instruments

See list of measuring equipment of this test report.

3.1.3 Test Procedures

The testing follows FCC KDB 789033 D02 General UNII Test Procedures New Rules v02r01.

For 26dB & 99OB

Section C) Emission bandwidth

1. Set RBW = approximately 1% of the emission bandwidth.
2. Set the VBW > RBW.
3. Detector = Peak.
4. Trace mode = max hold
5. Measure the maximum width of the emission that is 26 dB down from the peak of the emission. Compare this with the RBW setting of the analyzer. Readjust RBW and repeat measurement as needed until the RBW/EBW ratio is approximately 1%.
6. For 99% Bandwidth Measurement, the spectrum analyzer's resolution bandwidth (RBW) is set 1-5% of the emission bandwidth and set the Video bandwidth (VBW) $\geq 3 * RBW$.
7. Measure and record the results in the test report.

For 6dB

Section C) Emission bandwidth

1. Set RBW = 100kHz.
2. Set the VBW $\geq 3 * RBW$.
3. Detector = Peak.
4. Trace mode = max hold
5. Measure the maximum width of the emission that is 6 dB down from the peak of the emission.
6. Measure and record the results in the test report.

3.1.4 Test Setup

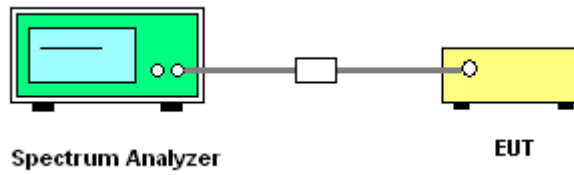

3.1.5 Test Result of 6dB & 26dB & 99% Occupied Bandwidth

Please refer to Appendix A.

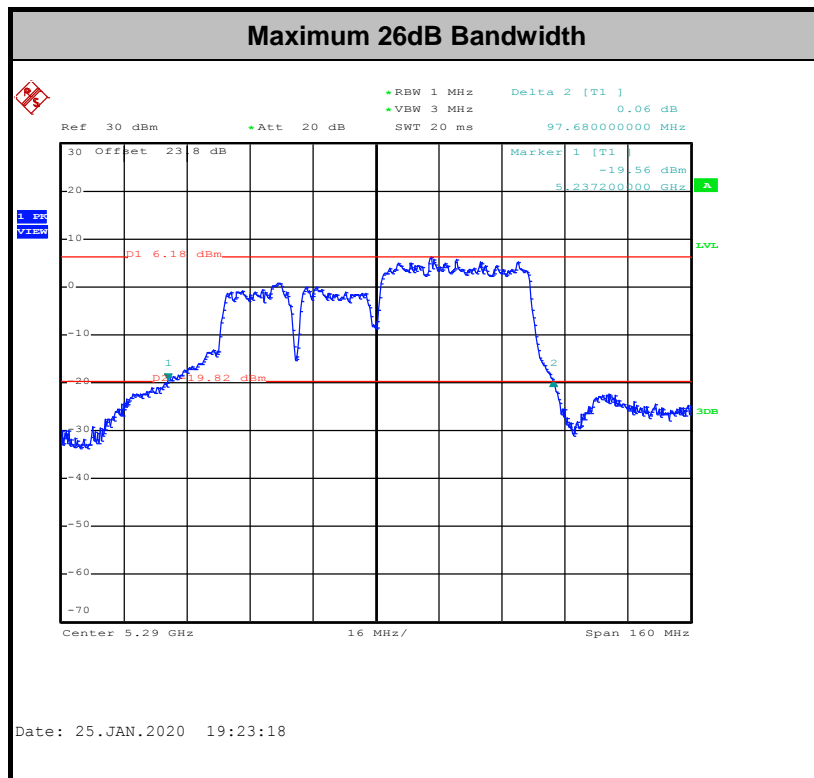

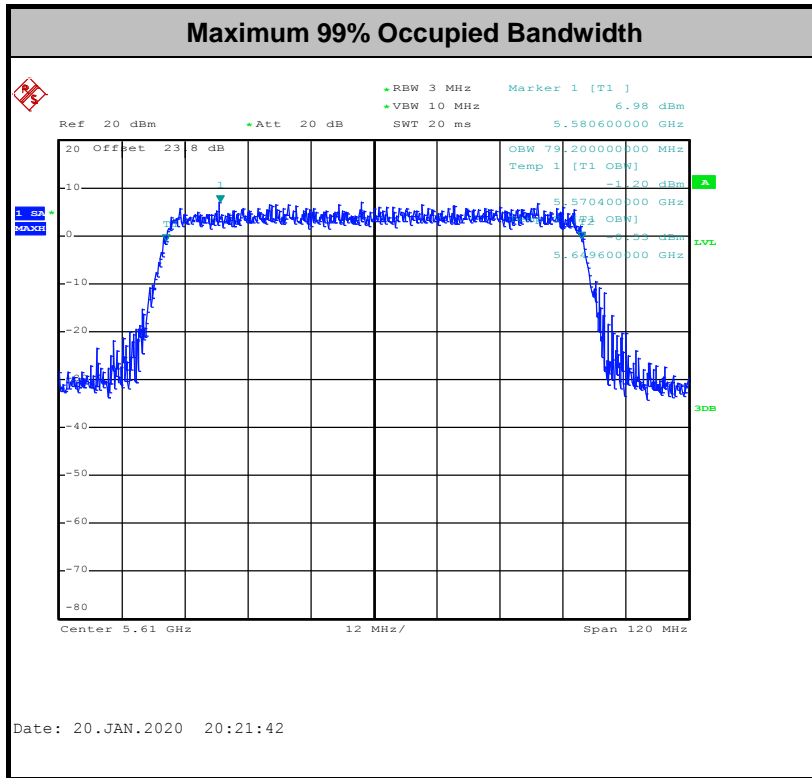

Note: The occupied channel bandwidth is maintained within the band of operation for all of the modulations.

<Straddle Channel>

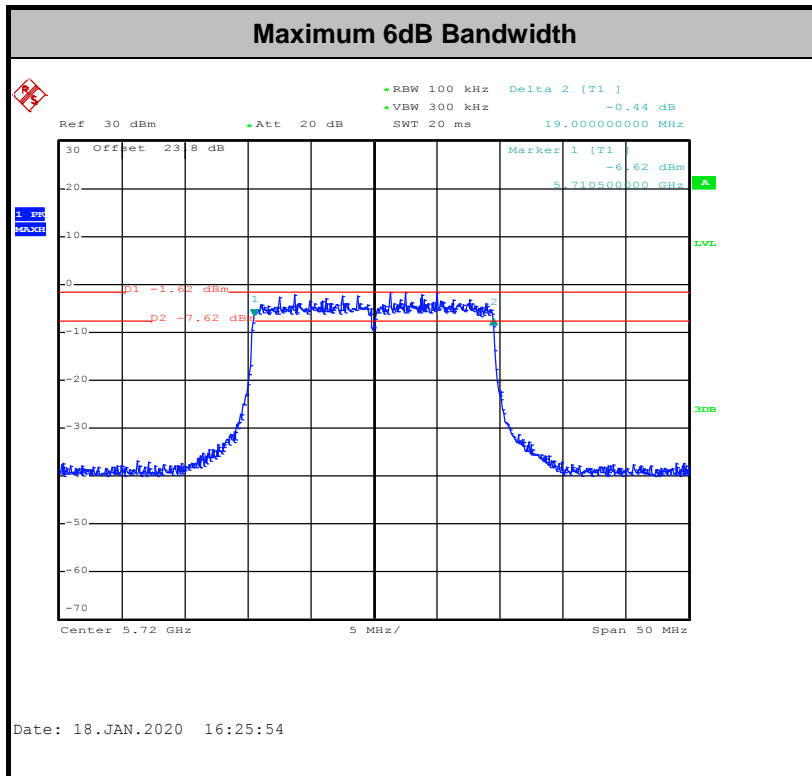

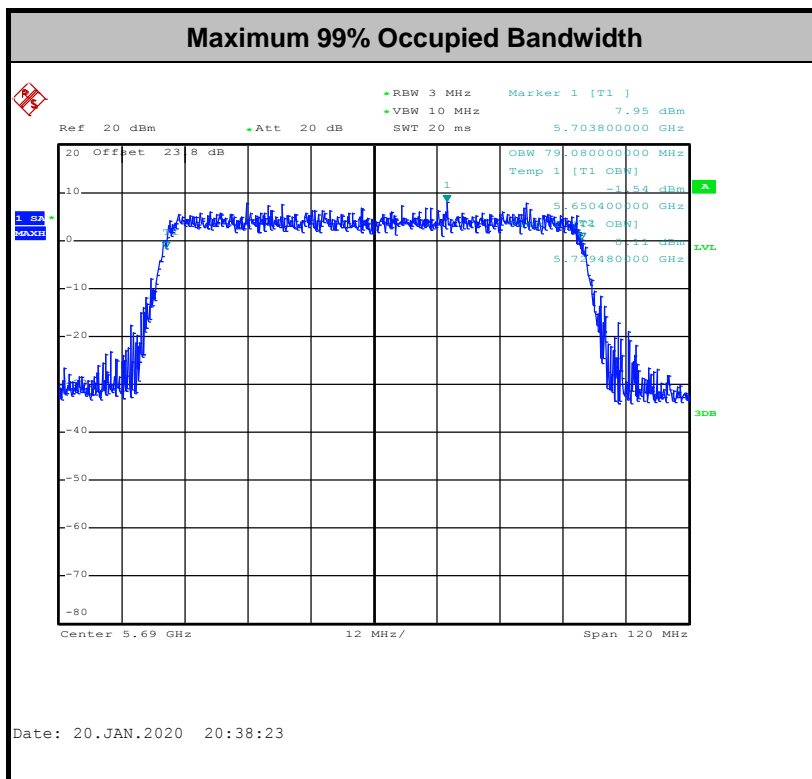
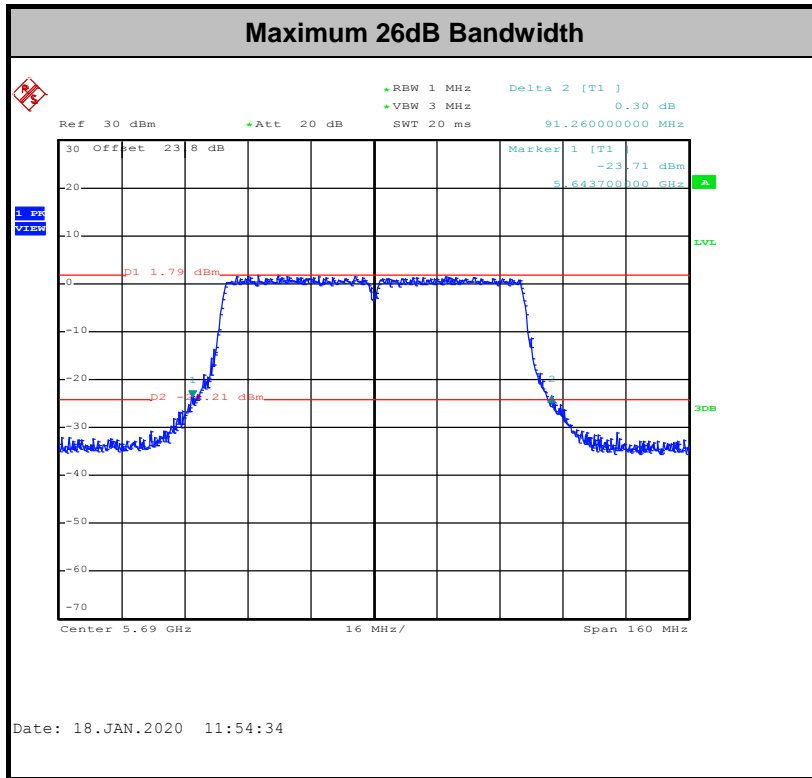

Note: The occupied channel bandwidth is maintained within the band of operation for all of the modulations.



3.2 Maximum Conducted Output Power Measurement

3.2.1 Limit of Maximum Conducted Output Power

<FCC 14-30 CFR 15.407>

For the 5.15–5.25 GHz bands:

- For mobile and portable client devices in the 5.15–5.25 GHz band, the maximum conducted output power over the frequency band of operation shall not exceed 250 mW. For an indoor access point operating in the band 5.15-5.25 GHz, the maximum conducted output power over the frequency band of operation shall not exceed 1 W.

For the 5.25–5.725 GHz bands:

- The maximum conducted output power over the frequency bands of operation shall not exceed the lesser of 250 mW or $11 \text{ dBm} + 10 \log B$, where B is the 26 dB emission bandwidth in megahertz.

For Straddle Channel, according to KDB 789033 D02 General UNII Test Procedures New Rules v02r01, if the power and PSD of the devices are uniform and comply with the lower limits specified for the U-NII-2 bands, a single measurement over the entire emission bandwidth can be performed to show compliance.

If transmitting antennas of directional gain greater than 6 dBi are used, the peak output power shall be reduced by the amount in dB that the directional gain of the antenna exceeds 6 dBi.

Note that U-NII-2 band, devices with a maximum e.i.r.p. greater than 500 mW shall implement TPC in order to have the capability to operate at least 6 dB below the maximum permitted e.i.r.p. of 1 W.

3.2.2 Measuring Instruments

See list of measuring equipment of this test report.

3.2.3 Test Procedures

The testing follows Method PM-G of FCC KDB 789033 D02 General UNII Test Procedures New Rules v02r01.

Method PM-G (Measurement using an RF average power meter):

1. Measurement is performed using a wideband RF power meter.
2. The EUT is configured to transmit at its maximum power control level.
3. Measure the average power of the transmitter
4. Since the measurement is made only during the ON time of the transmitter, no duty cycle correction factor is required.

For Straddle Channel, according to KDB 789033 D02 General UNII Test Procedures New Rules v02r01, if the power and PSD of the devices are uniform and comply with the lower limits specified for the U-NII-2 bands, a single measurement over the entire emission bandwidth can be performed to show compliance.

3.2.4 Test Setup

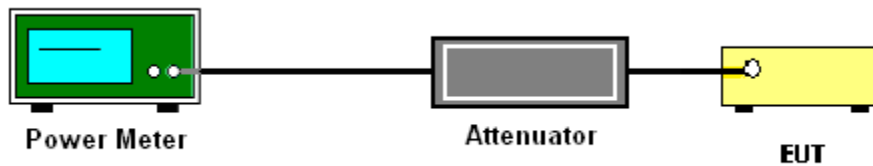

3.2.5 Test Result of Maximum Conducted Output Power

Please refer to Appendix A.



3.3 Power Spectral Density Measurement

3.3.1 Limit of Power Spectral Density

<FCC 14-30 CFR 15.407>

For the 5.15–5.25 GHz bands:

For mobile and portable client devices in the 5.15–5.25 GHz band, the maximum power spectral density shall not exceed 11 dBm in any 1.0 MHz band. For an indoor access point operating in the band 5.15-5.25 GHz, the maximum power spectral density shall not exceed 17 dBm in any 1.0 MHz band.

For the 5.25–5.725 GHz bands:

The maximum power spectral density shall not exceed 11 dBm in any 1.0 MHz band.

For Straddle Channel, according to KDB 789033 D02 General UNII Test Procedures New Rules v02r01, if the power and PSD of the devices are uniform and comply with the lower limits specified for the U-NII-2 bands, a single measurement over the entire emission bandwidth can be performed to show compliance.

If transmitting antennas of directional gain greater than 6 dBi are used, the peak output power shall be reduced by the amount in dB that the directional gain of the antenna exceeds 6 dBi.

3.3.2 Measuring Instruments

See list of measuring equipment of this test report.

3.3.3 Test Procedures

The testing follows FCC KDB 789033 D02 General UNII Test Procedures New Rules v02r01. Section F) Maximum power spectral density.

Method SA-3

(power averaging (rms) detection with max hold):

- Set span to encompass the entire emission bandwidth (EBW) of the signal.
- Set RBW = 1 MHz.
- Set VBW \geq 3 MHz
- Number of points in sweep \geq 2 Span / RBW.
- Sweep time \leq (number of points in sweep) \times T, when duty cycle is less than 98 percent where T is the minimum transmission duration over which the transmitter is on and is transmitting at its maximum power control level for the tested mode of operation.
- Detector = power averaging (rms).
- Trace mode = max hold.
- Allow max hold to run for at least 60 seconds, or longer as needed to allow the trace to stabilize.

1. The RF output of EUT was connected to the spectrum analyzer by a low loss cable.
2. Each plot has already offset with cable loss, and attenuator loss. Measure the PPSD and record it.
3. For MIMO mode, calculation method follows FCC KDB 662911 D01 Multiple Transmitter Output v02r01.

Method (a): Measure and sum the spectra across the outputs.

The total final Power Spectral Density is from a device with 2 transmitter outputs. The spectrum measurements of the individual outputs are all performed with the same span and number of points; the spectrum value in the first spectral bin of output 1 is summed with that in the first spectral bin of output 2 to obtain the value for the first frequency bin of the summed spectrum.

3.3.4 Test Setup

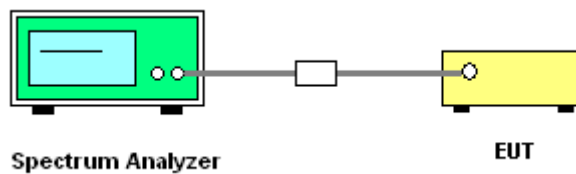

3.3.5 Test Result of Power Spectral Density

Please refer to Appendix A.

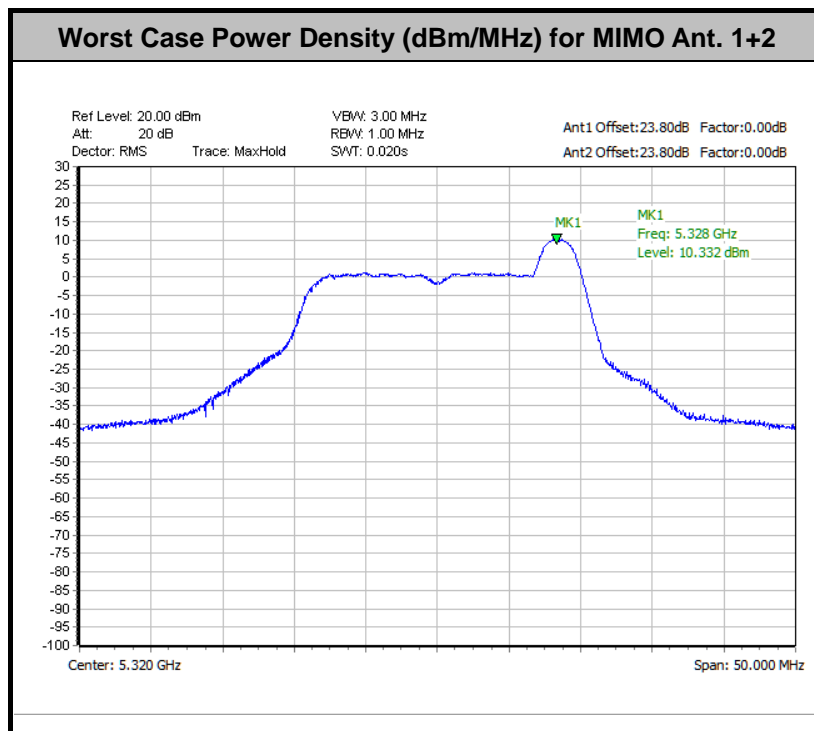



3.4 Unwanted Emissions Measurement

This section is to measure unwanted emissions through radiated measurement for band edge spurious emissions and out of band emissions measurement.

3.4.1 Limit of Unwanted Emissions

- (1) For transmitters operating in the 5150-5250 MHz band: all emissions outside of the 5150-5350 MHz band shall not exceed an EIRP of -27dBm/MHz.

For transmitters operating in the 5250-5350 MHz band: all emissions outside of the 5150-5350 MHz band shall not exceed an EIRP of -27 dBm/MHz. Devices operating in the 5250-5350 MHz band that generate emissions in the 5150-5250 MHz band must meet all applicable technical requirements for operation in the 5150-5250 MHz band (including indoor use) or alternatively meet an out-of-band emission EIRP limit of -27 dBm/MHz in the 5150-5250 MHz band.

For transmitters operating in the 5470-5600 MHz and 5650-5725MHz band: all emissions outside of the 5470-5600 MHz and 5650-5725MHz band shall not exceed an EIRP of -27 dBm/MHz.

- (2) Unwanted spurious emissions fallen in restricted bands shall comply with the general field strength limits as below table:

Frequency (MHz)	Field Strength (microvolts/meter)	Measurement Distance (meters)
0.009 – 0.490	2400/F(kHz)	300
0.490 – 1.705	24000/F(kHz)	30
1.705 – 30.0	30	30
30 – 88	100	3
88 – 216	150	3
216 - 960	200	3
Above 960	500	3

Note: The following formula is used to convert the EIRP to field strength.

$$E = \frac{1000000\sqrt{30P}}{3} \text{ } \mu\text{V/m, where P is the eirp (Watts)}$$



EIRP (dBm)	Field Strength at 3m (dBμV/m)
- 27	68.3

(3) KDB789033 D02 v02r01 G)2)c)

- (i) Sections 15.407(b)(1-3) specifies the unwanted emissions limit for the U-NII-1 and U-NII-2 bands. As specified, emissions above 1000 MHz that are outside of the restricted bands are subject to a peak emission limit of -27 dBm/MHz.
- (ii) Section 15.407(b)(4) specifies the unwanted emissions limit for the U-NII-3 band. A band emissions mask is specified in Section 15.407(b)(4)(i). The emission limits are based on the use of a peak detector.

3.4.2 Measuring Instruments

See list of measuring equipment of this test report.

3.4.3 Test Procedures

1. The testing follows FCC KDB 789033 D02 General UNII Test Procedures New Rules v02r01. Section G) Unwanted emissions measurement.

(1) Procedure for Unwanted Emissions Measurements Below 1000MHz

- RBW = 120 kHz
- VBW = 300 kHz
- Detector = Peak
- Trace mode = max hold

(2) Procedure for Peak Unwanted Emissions Measurements Above 1000 MHz

- RBW = 1 MHz
- VBW ≥ 3 MHz
- Detector = Peak
- Sweep time = auto
- Trace mode = max hold

(3) Procedures for Average Unwanted Emissions Measurements Above 1000MHz

- RBW = 1 MHz
- VBW = 10 Hz, when duty cycle is no less than 98 percent.
- VBW ≥ 1/T, when duty cycle is less than 98 percent where T is the minimum transmission duration over which the transmitter is on and is transmitting at its maximum power control level for the tested mode of operation.



2. The EUT was placed on a turntable with 0.8 meter for frequency below 1GHz and 1.5 meter for frequency above 1GHz respectively above ground.
3. The EUT was set 3 meters from the interference receiving antenna which was mounted on the top of a variable height antenna tower.
4. The antenna is a broadband antenna and its height is adjusted between one meter and four meters above ground to find the maximum value of the field strength for both horizontal polarization and vertical polarization of the antenna.
5. For each suspected emission, the EUT was arranged to its worst case and then adjust the antenna tower (from 1 m to 4 m) and turntable (from 0 degree to 360 degrees) to find the maximum reading.
6. For testing below 1GHz, if the emission level of the EUT in peak mode was 3 dB lower than the limit specified, then peak values of EUT will be reported, otherwise, the emissions will be repeated one by one using the CISPR quasi-peak method and reported.
7. For testing above 1GHz, the emission level of the EUT in peak mode was 20dB lower than average limit (that means the emission level in average mode also complies with the limit in average mode), then peak values of EUT will be reported, otherwise, the emissions will be measured in average mode again and reported.

3.4.4 Test Setup

For radiated emissions below 30MHz

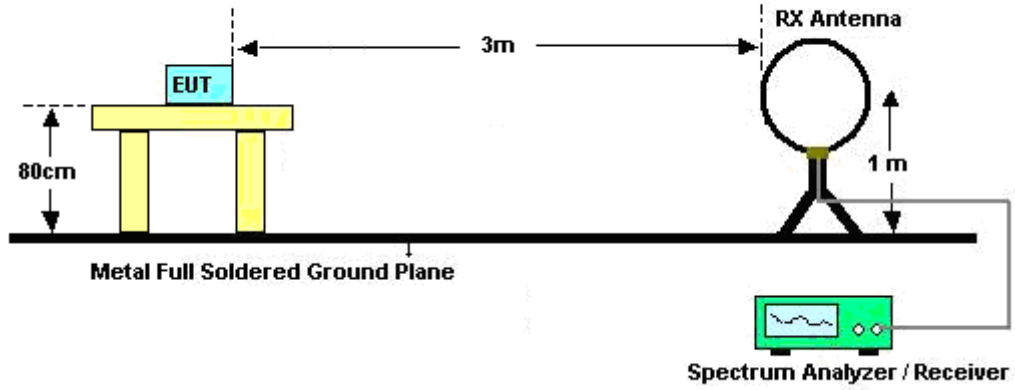

For radiated emissions from 30MHz to 1GHz

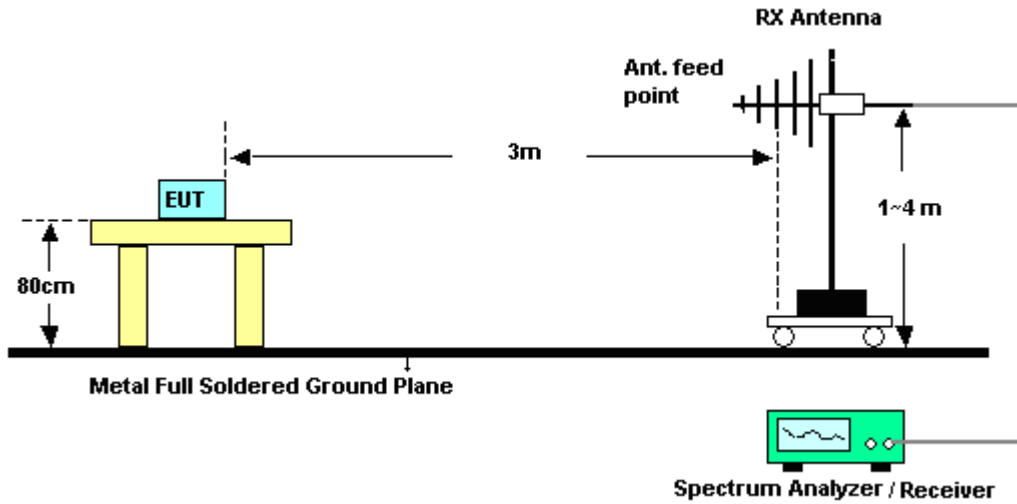

For radiated emissions from 1GHz to 18GHz

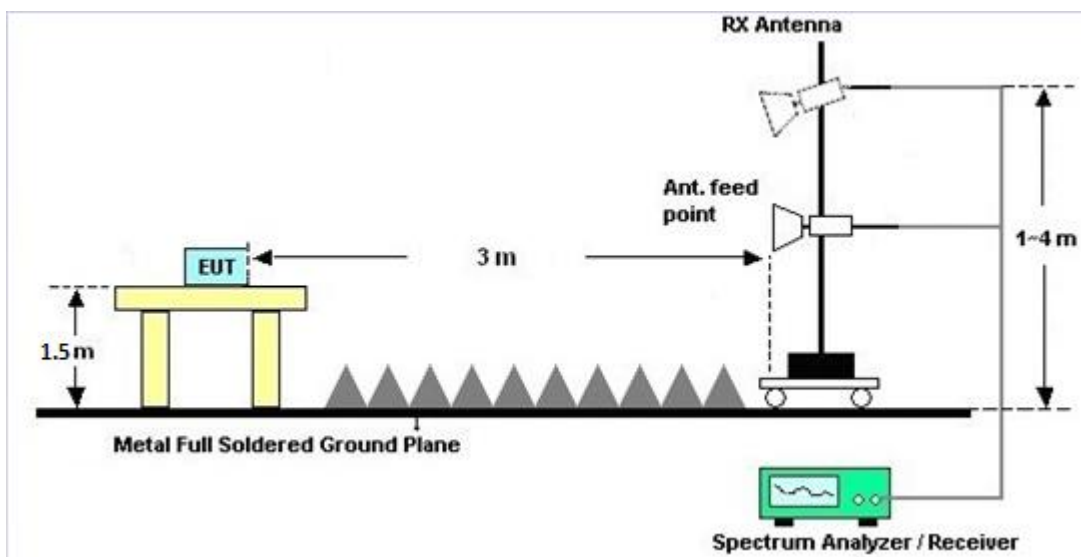

For radiated emissions from 18GHz~40GHz

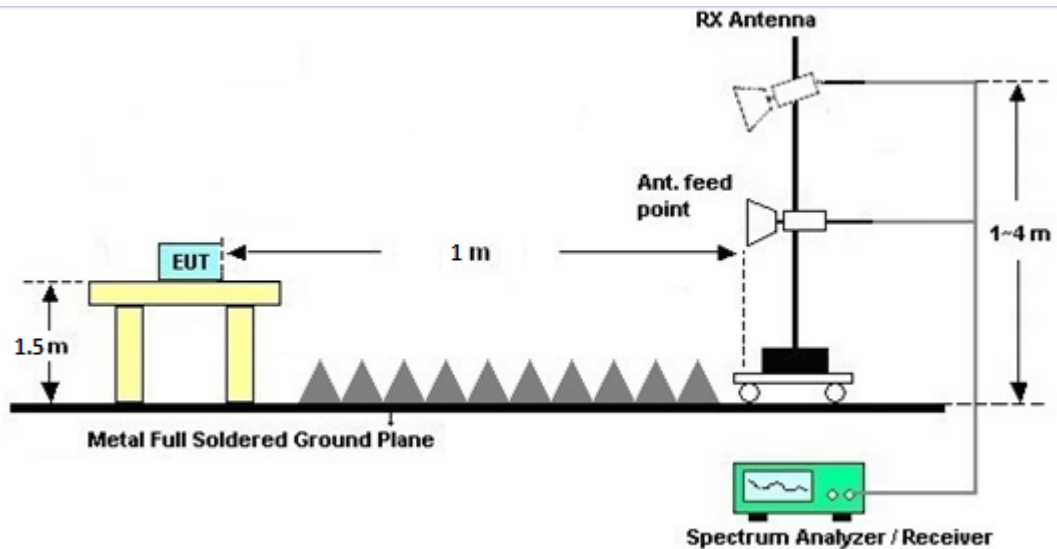

3.4.5 Test Results of Radiated Spurious Emissions (9 kHz ~ 30 MHz)

The low frequency, which started from 9 kHz to 30MHz, was pre-scanned and the result which was 20dB lower than the limit line was not reported.

There is a comparison data of both open-field test site and alternative test site - semi-Anechoic chamber according to 414788 D01 Radiated Test Site v01r01, and the result came out very similar.

3.4.6 Test Result of Radiated Spurious at Band Edges

Please refer to Appendix C and D.

3.4.7 Duty Cycle

Please refer to Appendix E.

3.4.8 Test Result of Radiated Spurious Emissions (30MHz ~ 10th Harmonic)

Please refer to Appendix C and D.



3.5 AC Conducted Emission Measurement

3.5.1 Limit of AC Conducted Emission

For equipment that is designed to be connected to the public utility (AC) power line, the radio frequency voltage that is conducted back onto the AC power line on any frequency or frequencies within the band 150 kHz to 30 MHz shall not exceed the limits in the following table.

Frequency of emission (MHz)	Conducted limit (dB μ V)	
	Quasi-peak	Average
0.15-0.5	66 to 56*	56 to 46*
0.5-5	56	46
5-30	60	50

*Decreases with the logarithm of the frequency.

3.5.2 Measuring Instruments

See list of measuring equipment of this test report.

3.5.3 Test Procedures

1. The EUT was placed 0.4 meter from the conducting wall of the shielding room was kept at least 80 centimeters from any other grounded conducting surface.
2. Connect EUT to the power mains through a line impedance stabilization network (LISN).
3. All the support units are connecting to the other LISN.
4. The LISN provides 50 ohm coupling impedance for the measuring instrument.
5. The FCC states that a 50 ohm, 50 microhenry LISN should be used.
6. Both sides of AC line were checked for maximum conducted interference.
7. The frequency range from 150 kHz to 30 MHz was searched.
8. Set the test-receiver system to Peak Detect Function and specified bandwidth with Maximum Hold Mode.

3.5.4 Test Setup

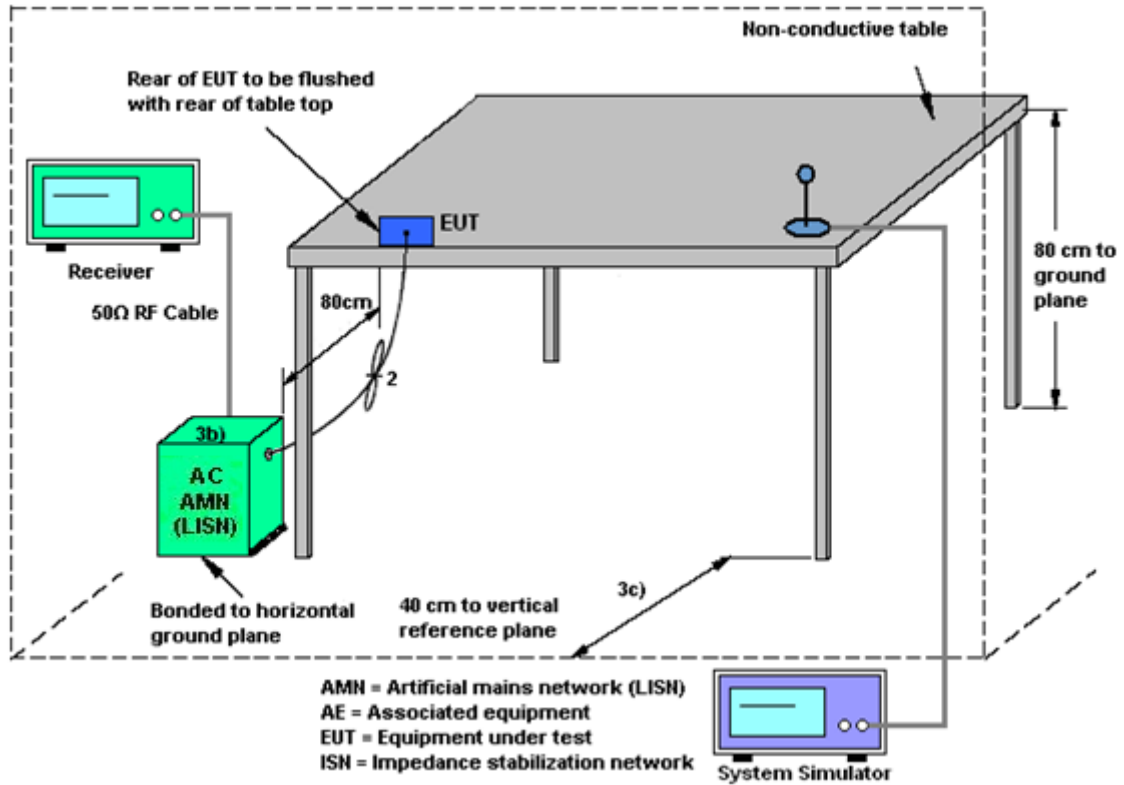

3.5.5 Test Result of AC Conducted Emission

Please refer to Appendix B.



3.6 Automatically Discontinue Transmission

3.6.1 Limit of Automatically Discontinue Transmission

The device shall automatically discontinue transmission in case of either absence of information to transmit or operational failure. These provisions are not intended to preclude the transmission of control or signaling information or the use of repetitive codes used by certain digital technologies to complete frame or burst intervals. Applicants shall include in their application for equipment authorization to describe how this requirement is met.

3.6.2 Measuring Instruments

See list of measuring equipment of this test report.

3.6.3 Test Result of Automatically Discontinue Transmission

EUT is verified this characteristic during the function check of normal sample associated with an access point:

- A. Information start: make EUT supply information to the access point.
- B. Information stop: stop supplying information to the access point.

While the EUT is not transmitting any information, the EUT can automatically discontinue transmission and become standby mode for power saving.

- C. Information start: make EUT supply information to the access point again.

The EUT can detect the controlling signal of ACK message transmitting from remote device and verify whether it shall resend or discontinue transmission.

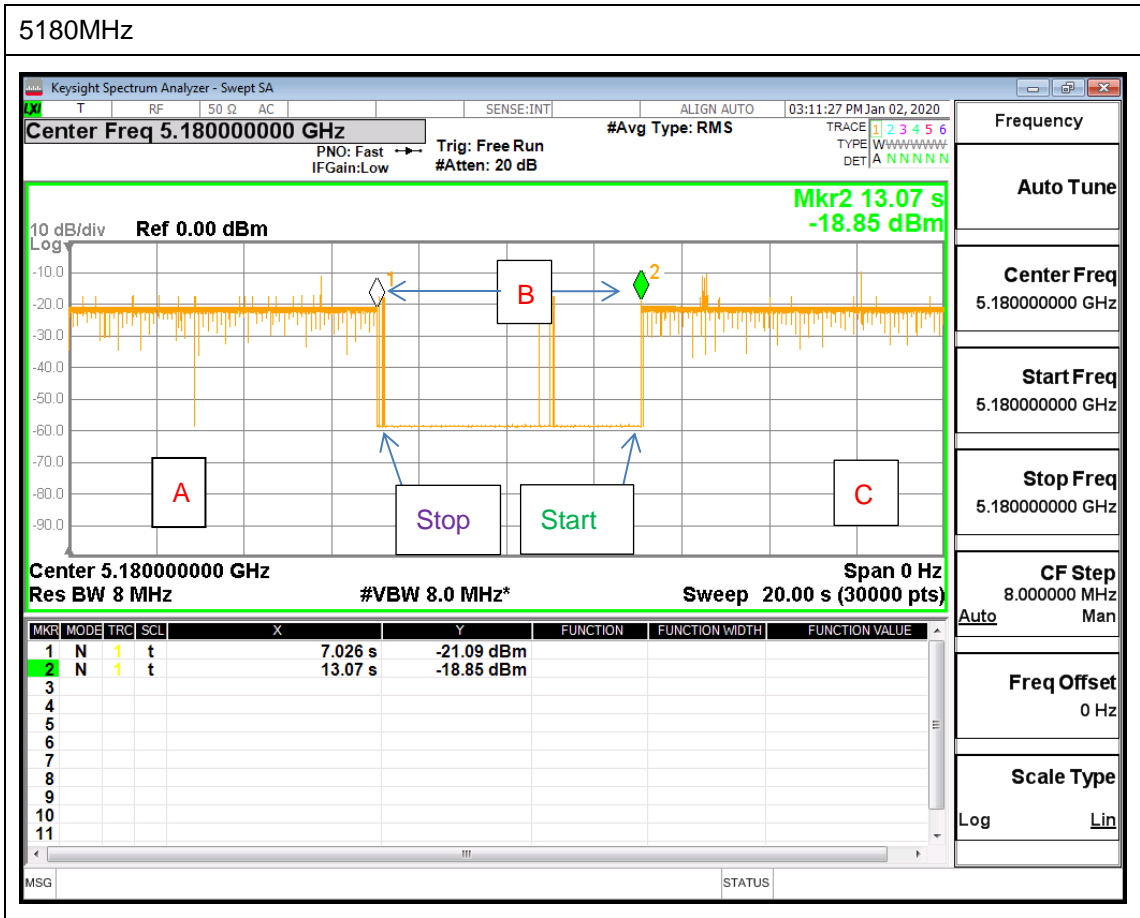

Note : The control / signalling information during the period B is precluded.



3.7 Antenna Requirements

3.7.1 Standard Applicable

If transmitting antenna directional gain is greater than 6 dBi, both the peak transmit power and the peak power spectral density shall be reduced by the amount in dB that the directional gain of the antenna exceeds 6 dBi.

3.7.2 Antenna Anti-Replacement Construction

An embedded-in antenna design is used.

3.7.3 Antenna Gain

<CDD Modes >

FCC KDB 662911 D01 Multiple Transmitter Output v02r01

For CDD transmissions, directional gain is calculated as

Directional gain = GANT + Array Gain, where Array Gain is as follows.

For power spectral density (PSD) measurements on all devices,

Array Gain = 10 log(NANT/NSS=1) dB.

For power measurements on IEEE 802.11 devices,

Array Gain = 0 dB (i.e., no array gain) for NANT ≤ 4.

Directional gain may be calculated by using the formulas applicable to equal gain antennas with GANT set equal to the gain of the antenna having the highest gain;

The EUT supports CDD mode.

For power, the directional gain GANT is set equal to the antenna having the highest gain, i.e., F)2)f)i).

For PSD, the directional gain calculation is following F)2)f)ii) of KDB 662911 D01 v02r01.

The power and PSD limit should be modified if the directional gain of EUT is over 6 dBi,

The directional gain “DG” is calculated as following table.

<CDD Modes>						
			DG	DG	Power	PSD
	Ant. 1	Ant. 2	for	for	Limit	Limit
	(dBi)	(dBi)	Power	PSD	Reduction	Reduction
	(dBi)	(dBi)	(dBi)	(dBi)	(dB)	(dB)
Band I	-1.90	-6.10	-1.90	-0.74	0.00	0.00
Band II	-2.00	-6.70	-2.00	-1.03	0.00	0.00
Band III	-4.10	-4.40	-4.10	-1.24	0.00	0.00

Power limit reduction = Composite gain – 6dBi, (min = 0)

PSD limit reduction = Composite gain + PSD Array gain – 6dBi, (min = 0)



4 List of Measuring Equipment

Instrument	Manufacturer	Model No.	Serial No.	Characteristics	Calibration Date	Test Date	Due Date	Remark
Loop Antenna	Rohde & Schwarz	HFH2-Z2	100488	9 kHz~30 MHz	Dec. 26, 2019	Jan. 04, 2020~ Jan. 31, 2020	Dec. 25, 2020	Radiation (03CH16-HY)
Bilog Antenna	TESEQ	CBL6111D&0 0802N1D01N- 06	47020&06	30MHz to 1GHz	Oct. 13, 2019	Jan. 04, 2020~ Jan. 31, 2020	Oct. 12, 2020	Radiation (03CH16-HY)
Horn Antenna	SCHWARZBE CK	BBHA 9120 D	9120D-152 2	1G~18GHz	Sep. 19, 2019	Jan. 04, 2020~ Jan. 31, 2020	Sep. 18, 2020	Radiation (03CH16-HY)
Amplifier	SONOMA	310N	371607	9kHz~1000MHz	Oct. 01, 2019	Jan. 04, 2020~ Jan. 31, 2020	Sep. 30, 2020	Radiation (03CH16-HY)
Preamplifier	Jet-Power	JPA0118-55-3 03	171000180 0054001	1GHz~18GHz	May 19, 2019	Jan. 04, 2020~ Jan. 31, 2020	May 18, 2020	Radiation (03CH16-HY)
Preamplifier	EMEC	EMC184045B	980192	18GHz ~40GHz	Jul. 10, 2019	Jan. 04, 2020~ Jan. 31, 2020	Jul. 09, 2020	Radiation (03CH16-HY)
Preamplifier	Keysight	83017A	MY532702 64	1GHz~26.5GHz	Dec. 11, 2019	Jan. 04, 2020~ Jan. 31, 2020	Dec. 10, 2020	Radiation (03CH16-HY)
EMI Test Receiver	Keysight	N9038A (MXE)	MY554201 70	20MHz~8.4GHz	Mar. 08, 2019	Jan. 04, 2020~ Jan. 31, 2020	Mar. 07, 2020	Radiation (03CH16-HY)
Spectrum Analyzer	Agilent	E4446A	MY501801 36	3Hz~44GHz	Apr. 29, 2019	Jan. 04, 2020~ Jan. 31, 2020	Apr. 28, 2020	Radiation (03CH16-HY)
RF Cable	HUBER + SUHNER	SUCOFLEX 104	MY11680/ 4PE	NA	Aug. 30, 2019	Jan. 04, 2020~ Jan. 31, 2020	Aug. 29, 2020	Radiation (03CH16-HY)
RF Cable	HUBER + SUHNER	SUCOFLEX 104	MY11688/ 4PE	NA	Aug. 30, 2019	Jan. 04, 2020~ Jan. 31, 2020	Aug. 29, 2020	Radiation (03CH16-HY)
RF Cable	HUBER + SUHNER	SUCOFLEX 102	EC-A5-300 -5757	NA	Aug. 30, 2019	Jan. 04, 2020~ Jan. 31, 2020	Aug. 29, 2020	Radiation (03CH16-HY)
RF Cable	HUBER + SUHNER	SUCOFLEX 102	505134/2	30MHz~40GHz	Feb. 26, 2019	Jan. 04, 2020~ Jan. 31, 2020	Feb. 25, 2020	Radiation (03CH16-HY)
RF Cable	HUBER + SUHNER	SUCOFLEX 102	800740/2	30MHz~40GHz	Feb. 26, 2019	Jan. 04, 2020~ Jan. 31, 2020	Feb. 25, 2020	Radiation (03CH16-HY)
SHF-EHF Horn Antenna	SCHWARZBE CK	BBHA 9170	BBHA9170 576	18GHz~40GHz	May 14, 2019	Jan. 04, 2020~ Jan. 31, 2020	May 13, 2020	Radiation (03CH16-HY)
Preamplifier	EMEC	EM18G40G	060715	18GHz~40GHz	Dec. 13, 2019	Jan. 04, 2020~ Jan. 31, 2020	Dec.12.2020	Radiation (03CH16-HY)
Hygrometer	TECPEL	DTM-303B	TP161243	N/A	Jun. 17, 2019	Jan. 04, 2020~ Jan. 31, 2020	Jun. 16, 2020	Radiation (03CH16-HY)
Software	Audix	E3 6.2009-8-24	RK-001136	N/A	N/A	Jan. 04, 2020~ Jan. 31, 2020	N/A	Radiation (03CH16-HY)
Filter	Wainwright	WLK4-1000-1 530-8000-40S S	SN11	1.53G Low Pass	Sep. 15, 2019	Jan. 07, 2020~ Jan. 13, 2020	Sep. 14, 2020	Radiation (03CH16-HY)
Filter	Wainwright	WHKX8-5872. 5-6750-18000 -40SS	SN3	6.75GHz High Pass	Sep. 16, 2019	Jan. 07, 2020~ Jan. 13, 2020	Sep. 15, 2020	Radiation (03CH16-HY)



Instrument	Manufacturer	Model No.	Serial No.	Characteristics	Calibration Date	Test Date	Due Date	Remark
Hygrometer	Testo	608-H2	41410069	N/A	Jun. 17, 2019	Dec. 19, 2019~ Feb. 19, 2020	Jun. 16, 2020	Conducted (TH05-HY)
Power Sensor	DARE	RPR3006W	13I00030S NO32	9kHz~6GHz	Dec. 17, 2019	Dec. 19, 2019~ Feb. 19, 2020	Dec. 16, 2020	Conducted (TH05-HY)
Spectrum Analyzer	Rohde & Schwarz	FSP40	100055	9kHz-40GHz	Aug. 14, 2019	Dec. 19, 2019~ Feb. 19, 2020	Aug. 13, 2020	Conducted (TH05-HY)
Signal Analyzer	Rohde & Schwarz	FSV40	101566	10Hz~40GHz	Jul. 15, 2019	Dec. 19, 2019~ Feb. 19, 2020	Jul. 14, 2020	Conducted (TH05-HY)
Switch Box & RF Cable	Burgeon	ETF-058	EC120838 2	N/A	Mar. 27, 2019	Dec. 19, 2019~ Feb. 19, 2020	Mar. 26, 2020	Conducted (TH05-HY)
AC Power Source	ChainTek	APC-1000W	N/A	N/A	N/A	Dec. 26, 2019~ Jan. 16, 2020	N/A	Conduction (CO05-HY)
EMI Test Receiver	Rohde & Schwarz	ESR3	102388	9kHz~3.6GHz	Nov. 15, 2019	Dec. 26, 2019~ Jan. 16, 2020	Nov. 14, 2020	Conduction (CO05-HY)
Hygrometer	Testo	608-H1	34913912	N/A	Mar. 19, 2019	Dec. 26, 2019~ Jan. 16, 2020	Mar. 18, 2020	Conduction (CO05-HY)
LISN	Rohde & Schwarz	ENV216	100081	9kHz~30MHz	Nov. 15, 2019	Dec. 26, 2019~ Jan. 16, 2020	Nov. 14, 2020	Conduction (CO05-HY)
Software	Rohde & Schwarz	EMC32 V10.30	N/A	N/A	N/A	Dec. 26, 2019~ Jan. 16, 2020	N/A	Conduction (CO05-HY)
LF Cable	HUBER + SUHNER	RG-214/U	LF01	N/A	Dec. 31, 2018	Dec. 26, 2019	Dec. 30, 2019	Conduction (CO05-HY)
LF Cable	HUBER + SUHNER	RG-214/U	LF01	N/A	Jan. 02, 2020	Jan. 16, 2020	Jan. 01, 2021	Conduction (CO05-HY)
Pulse Limiter	Rohde & Schwarz	ESH3-Z2	100851	N/A	Dec. 31, 2018	Dec. 26, 2019	Dec. 30, 2019	Conduction (CO05-HY)
Pulse Limiter	Rohde & Schwarz	ESH3-Z2	100851	N/A	Jan. 02, 2020	Jan. 16, 2020	Jan. 01, 2021	Conduction (CO05-HY)



5 Uncertainty of Evaluation

Uncertainty of Conducted Emission Measurement (150kHz ~ 30MHz)

Measuring Uncertainty for a Level of Confidence of 95% ($U = 2Uc(y)$)	2.0
---	-----

Uncertainty of Radiated Emission Measurement (30 MHz ~ 1000 MHz)

Measuring Uncertainty for a Level of Confidence of 95% ($U = 2Uc(y)$)	4.9
---	-----

Uncertainty of Radiated Emission Measurement (1000 MHz ~ 18000 MHz)

Measuring Uncertainty for a Level of Confidence of 95% ($U = 2Uc(y)$)	6.7
---	-----

Uncertainty of Radiated Emission Measurement (18000 MHz ~ 40000 MHz)

Measuring Uncertainty for a Level of Confidence of 95% ($U = 2Uc(y)$)	3.9
---	-----

Appendix A. Test Result of Conducted Test Items

Test Engineer:	Derek Hsu and Shiming Liu	Temperature:	21~25	°C
Test Date:	2019/12/19~2020/1/25	Relative Humidity:	51~54	%

TEST RESULTS DATA
26dB and 99% OBW

Band I MIMO													
Mod.	Data Rate	NTX	CH.	Freq. (MHz)	99% Bandwidth (MHz)		26 dB Bandwidth (MHz)		IC 99% Bandwidth Power Limit (dBm)		IC 99% Bandwidth EIRP Limit (dBm)		Note
					Ant 1	Ant 2	Ant 1	Ant 2	Ant 1	Ant 2	Ant 1	Ant 2	
11a	6Mbps	2	36	5180	16.80	16.75	27.40	26.70	-	-	22.24	22.24	
11a	6Mbps	2	44	5220	16.90	16.75	26.65	26.50	-	-	22.24	22.24	
11a	6Mbps	2	48	5240	16.80	16.80	27.45	26.45	-	-	22.25	22.25	
HT20	MCS0	2	36	5180	17.90	17.80	26.90	26.85	-	-	22.50	22.50	
HT20	MCS0	2	44	5220	17.90	17.80	27.40	26.30	-	-	22.50	22.50	
HT20	MCS0	2	48	5240	17.90	17.80	27.35	26.70	-	-	22.50	22.50	
HT40	MCS0	2	38	5190	36.90	36.90	48.55	48.79	-	-	23.01	23.01	
HT40	MCS0	2	46	5230	36.80	36.80	48.60	49.14	-	-	23.01	23.01	
VHT80	MCS0	2	42	5210	77.52	77.40	92.62	89.92	-	-	23.01	23.01	

TEST RESULTS DATA
Average Power Table

FCC Band I single antenna												
Mod.	Data Rate	NTX	CH.	Freq. (MHz)	Average Conducted Power (dBm)			FCC Conducted Power Limit (dBm)		DG (dBi)		Pass/Fail
					Ant 1	Ant 2	SUM	Ant 1	Ant 2	Ant 1	Ant 2	
11a	6Mbps	1	36	5180	11.20	11.40		24.00	24.00	-1.90	-6.10	Pass
11a	6Mbps	1	44	5220	11.20	11.10		24.00	24.00	-1.90	-6.10	Pass
11a	6Mbps	1	48	5240	11.40	11.30		24.00	24.00	-1.90	-6.10	Pass
HT20	MCS0	1	36	5180	11.10	11.30		24.00	24.00	-1.90	-6.10	Pass
HT20	MCS0	1	44	5220	11.10	11.10		24.00	24.00	-1.90	-6.10	Pass
HT20	MCS0	1	48	5240	11.30	11.40		24.00	24.00	-1.90	-6.10	Pass
HT40	MCS0	1	38	5190	11.10	11.40		24.00	24.00	-1.90	-6.10	Pass
HT40	MCS0	1	46	5230	11.20	11.30		24.00	24.00	-1.90	-6.10	Pass
VHT20	MCS0	1	36	5180	11.00	11.20		24.00	24.00	-1.90	-6.10	Pass
VHT20	MCS0	1	44	5220	11.00	11.00		24.00	24.00	-1.90	-6.10	Pass
VHT20	MCS0	1	48	5240	11.20	11.30		24.00	24.00	-1.90	-6.10	Pass
VHT40	MCS0	1	38	5190	11.00	11.30		24.00	24.00	-1.90	-6.10	Pass
VHT40	MCS0	1	46	5230	11.10	11.10		24.00	24.00	-1.90	-6.10	Pass
VHT80	MCS0	1	42	5210	11.10	11.10		24.00	24.00	-1.90	-6.10	Pass

FCC Band I MIMO												
Mod.	Data Rate	NTX	CH.	Freq. (MHz)	Average Conducted Power (dBm)			FCC Conducted Power Limit (dBm)		DG (dBi)		Pass/Fail
					Ant 1	Ant 2	SUM	Ant 1	Ant 2	Ant 1	Ant 2	
11a	6Mbps	2	36	5180	11.20	11.40	14.31	24.00	24.00	-1.90	-1.90	Pass
11a	6Mbps	2	44	5220	11.20	11.10	14.16	24.00	24.00	-1.90	-1.90	Pass
11a	6Mbps	2	48	5240	11.40	11.40	14.41	24.00	24.00	-1.90	-1.90	Pass
HT20	MCS0	2	36	5180	11.10	11.40	14.26	24.00	24.00	-1.90	-1.90	Pass
HT20	MCS0	2	44	5220	11.10	11.10	14.11	24.00	24.00	-1.90	-1.90	Pass
HT20	MCS0	2	48	5240	11.30	11.40	14.36	24.00	24.00	-1.90	-1.90	Pass
HT40	MCS0	2	38	5190	11.20	11.40	14.31	24.00	24.00	-1.90	-1.90	Pass
HT40	MCS0	2	46	5230	11.20	11.30	14.26	24.00	24.00	-1.90	-1.90	Pass
VHT20	MCS0	2	36	5180	11.00	11.30	14.16	24.00	24.00	-1.90	-1.90	Pass
VHT20	MCS0	2	44	5220	11.00	11.00	14.01	24.00	24.00	-1.90	-1.90	Pass
VHT20	MCS0	2	48	5240	11.20	11.30	14.26	24.00	24.00	-1.90	-1.90	Pass
VHT40	MCS0	2	38	5190	11.00	11.30	14.16	24.00	24.00	-1.90	-1.90	Pass
VHT40	MCS0	2	46	5230	11.10	11.10	14.11	24.00	24.00	-1.90	-1.90	Pass
VHT80	MCS0	2	42	5210	11.10	11.10	14.11	24.00	24.00	-1.90	-1.90	Pass

TEST RESULTS DATA
Power Spectral Density

FCC Band I MIMO												
Mod.	Data Rate	NTX	CH.	Freq. (MHz)	Average Power Density (dBm/MHz)			Average PSD Limit (dBm/MHz)		DG (dBi)		Pass /Fail
					Ant 1	Ant 2	SUM	Ant 1	Ant 2	Ant 1	Ant 2	
11a	6Mbps	2	36	5180			4.05	11.00	-0.74		Pass	
11a	6Mbps	2	44	5220			4.16	11.00	-0.74		Pass	
11a	6Mbps	2	48	5240			4.12	11.00	-0.74		Pass	
HT20	MCS0	2	36	5180			3.74	11.00	-0.74		Pass	
HT20	MCS0	2	44	5220			4.04	11.00	-0.74		Pass	
HT20	MCS0	2	48	5240			4.26	11.00	-0.74		Pass	
HT40	MCS0	2	38	5190			0.66	11.00	-0.74		Pass	
HT40	MCS0	2	46	5230			0.98	11.00	-0.74		Pass	
VHT80	MCS0	2	42	5210			-3.17	11.00	-0.74		Pass	

TEST RESULTS DATA
26dB and 99% OBW

Band II MIMO															
Mod.	Data Rate	NTX	CH.	Freq. (MHz)	99% Bandwidth (MHz)		26 dB Bandwidth (MHz)		IC 99% Bandwidth Power Limit (dBm)		IC 99% Bandwidth EIRP Limit (dBm)		FCC 26dB Bandwidth Power Limit (dBm)		Note
					Ant 1	Ant 2	Ant 1	Ant 2	Ant 1	Ant 2	Ant 1	Ant 2	Ant 1	Ant 2	
11a	6Mbps	2	52	5260	16.85	16.75	27.40	27.05	23.24		29.24		23.98		
11a	6Mbps	2	60	5300	16.85	16.80	27.35	26.40	23.25		29.25		23.98		
11a	6Mbps	2	64	5320	16.85	16.75	27.45	27.00	23.24		29.24		23.98		
HT20	MCS0	2	52	5260	17.90	17.85	27.10	27.05	23.52		29.52		23.98		
HT20	MCS0	2	60	5300	17.90	17.80	26.70	26.65	23.50		29.50		23.98		
HT20	MCS0	2	64	5320	17.85	17.85	26.60	26.29	23.52		29.52		23.98		
HT40	MCS0	2	54	5270	36.80	37.00	48.42	48.42	23.98		30.00		23.98		
HT40	MCS0	2	62	5310	37.00	36.80	48.73	48.83	23.98		30.00		23.98		
VHT80	MCS0	2	58	5290	77.40	77.64	91.04	90.95	23.98		30.00		23.98		

TEST RESULTS DATA
Average Power Table

FCC Band II single antenna													
Mod.	Data Rate	NTX	CH.	Freq. (MHz)	Average Conducted Power (dBm)			FCC Conducted Power Limit (dBm)		DG (dBi)		EIRP Power Limit (dBm)	Pass/Fail
					Ant 1	Ant 2	SUM	Ant 1	Ant 2	Ant 1	Ant 2		
11a	6Mbps	1	52	5260	11.30	11.00		23.98	23.98	-2.00	-6.70	30	Pass
11a	6Mbps	1	60	5300	11.20	11.20		23.98	23.98	-2.00	-6.70	30	Pass
11a	6Mbps	1	64	5320	11.20	11.30		23.98	23.98	-2.00	-6.70	30	Pass
HT20	MCS0	1	52	5260	11.20	11.10		23.98	23.98	-2.00	-6.70	30	Pass
HT20	MCS0	1	60	5300	11.30	11.10		23.98	23.98	-2.00	-6.70	30	Pass
HT20	MCS0	1	64	5320	11.10	11.20		23.98	23.98	-2.00	-6.70	30	Pass
HT40	MCS0	1	54	5270	11.10	11.30		23.98	23.98	-2.00	-6.70	30	Pass
HT40	MCS0	1	62	5310	11.20	11.20		23.98	23.98	-2.00	-6.70	30	Pass
VHT20	MCS0	1	52	5260	11.10	11.00		23.98	23.98	-2.00	-6.70	30	Pass
VHT20	MCS0	1	60	5300	11.20	11.00		23.98	23.98	-2.00	-6.70	30	Pass
VHT20	MCS0	1	64	5320	11.00	11.10		23.98	23.98	-2.00	-6.70	30	Pass
VHT40	MCS0	1	54	5270	11.00	11.20		23.98	23.98	-2.00	-6.70	30	Pass
VHT40	MCS0	1	62	5310	11.10	11.10		23.98	23.98	-2.00	-6.70	30	Pass
VHT80	MCS0	1	58	5290	11.00	11.40		23.98	23.98	-2.00	-6.70	30	Pass

FCC Band II MIMO													
Mod.	Data Rate	NTX	CH.	Freq. (MHz)	Average Conducted Power (dBm)			FCC Conducted Power Limit (dBm)		DG (dBi)		EIRP Power Limit (dBm)	Pass/Fail
					Ant 1	Ant 2	SUM	Ant 1	Ant 2	Ant 1	Ant 2		
11a	6Mbps	2	52	5260	11.30	11.00	14.16	23.98	23.98	-2.00	-6.70	30	Pass
11a	6Mbps	2	60	5300	11.20	11.30	14.26	23.98	23.98	-2.00	-6.70	30	Pass
11a	6Mbps	2	64	5320	11.20	11.40	14.31	23.98	23.98	-2.00	-6.70	30	Pass
HT20	MCS0	2	52	5260	11.20	11.10	14.16	23.98	23.98	-2.00	-6.70	30	Pass
HT20	MCS0	2	60	5300	11.30	11.20	14.26	23.98	23.98	-2.00	-6.70	30	Pass
HT20	MCS0	2	64	5320	11.20	11.40	14.31	23.98	23.98	-2.00	-6.70	30	Pass
HT40	MCS0	2	54	5270	11.20	11.30	14.26	23.98	23.98	-2.00	-6.70	30	Pass
HT40	MCS0	2	62	5310	11.30	11.40	14.36	23.98	23.98	-2.00	-6.70	30	Pass
VHT20	MCS0	2	52	5260	11.10	11.00	14.06	23.98	23.98	-2.00	-6.70	30	Pass
VHT20	MCS0	2	60	5300	11.20	11.00	14.11	23.98	23.98	-2.00	-6.70	30	Pass
VHT20	MCS0	2	64	5320	11.10	11.30	14.21	23.98	23.98	-2.00	-6.70	30	Pass
VHT40	MCS0	2	54	5270	11.10	11.30	14.21	23.98	23.98	-2.00	-6.70	30	Pass
VHT40	MCS0	2	62	5310	11.20	11.30	14.26	23.98	23.98	-2.00	-6.70	30	Pass
VHT80	MCS0	2	58	5290	11.00	11.40	14.21	23.98	23.98	-2.00	-6.70	30	Pass

TEST RESULTS DATA
Power Spectral Density

Band II MIMO												
Mod.	Data Rate	NTX	CH.	Freq. (MHz)	Average Power Density (dBm/MHz)			Average PSD Limit (dBm/MHz)		DG (dBi)		Pass /Fail
					Ant 1	Ant 2	SUM	Ant 1	Ant 2	Ant 1	Ant 2	
11a	6Mbps	2	52	5260			3.87	11.00	-1.03		Pass	
11a	6Mbps	2	60	5300			3.73	11.00	-1.03		Pass	
11a	6Mbps	2	64	5320			3.95	11.00	-1.03		Pass	
HT20	MCS0	2	52	5260			4.06	11.00	-1.03		Pass	
HT20	MCS0	2	60	5300			3.88	11.00	-1.03		Pass	
HT20	MCS0	2	64	5320			4.26	11.00	-1.03		Pass	
HT40	MCS0	2	54	5270			0.55	11.00	-1.03		Pass	
HT40	MCS0	2	62	5310			0.48	11.00	-1.03		Pass	
VHT80	MCS0	2	58	5290			-3.27	11.00	-1.03		Pass	

TEST RESULTS DATA
26dB and 99% OBW

Band III MIMO																
Mod.	Data Rate	NTX	CH.	Freq. (MHz)	99% Bandwidth In U-NII 2C (MHz)		26 dB Bandwidth In U-NII 2C (MHz)		IC 99% Bandwidth Power Limit (dBm)		IC 99% Bandwidth EIRP Limit (dBm)		FCC 26dB Bandwidth Power Limit (dBm)		6 dB Bandwidth for Straddle Channel (MHz)	
					Ant 1	Ant 2	Ant 1	Ant 2	Ant 1	Ant 2	Ant 1	Ant 2	Ant 1	Ant 2	Ant 1	Ant 2
11a	6Mbps	2	100	5500	16.90	16.75	27.25	26.50	23.24		29.24		23.98		----	----
11a	6Mbps	2	116	5580	16.80	16.70	27.15	26.55	23.23		29.23		23.98		----	----
11a	6Mbps	2	140	5700	16.80	16.70	27.15	26.45	23.23		29.23		23.98		----	----
HT20	MCS0	2	100	5500	17.90	17.85	26.85	26.55	23.52		29.52		23.98		----	----
HT20	MCS0	2	116	5580	17.85	17.85	26.83	26.65	23.52		29.52		23.98		----	----
HT20	MCS0	2	140	5700	17.85	17.85	27.05	26.64	23.52		29.52		23.98		----	----
HT40	MCS0	2	102	5510	36.80	36.90	48.73	48.72	23.98		30.00		23.98		----	----
HT40	MCS0	2	110	5550	36.80	36.90	48.65	48.54	23.98		30.00		23.98		----	----
HT40	MCS0	2	134	5670	36.80	36.80	47.96	48.24	23.98		30.00		23.98		----	----
VHT80	MCS0	2	106	5530	77.40	77.64	93.32	90.06	23.98		30.00		23.98		----	----
VHT80	MCS0	2	122	5610	77.52	77.64	91.21	90.74	23.98		30.00		23.98		----	----

Band III straddle channel MIMO																
Mod.	Data Rate	NTX	CH.	Freq. (MHz)	99% Bandwidth In U-NII 2C (MHz)		26 dB Bandwidth In U-NII 2C (MHz)		IC 99% Bandwidth Power Limit (dBm)		IC 99% Bandwidth EIRP Limit (dBm)		FCC 26dB Bandwidth Power Limit (dBm)		6 dB Bandwidth for Straddle Channel (MHz)	
					Ant 1	Ant 2	Ant 1	Ant 2	Ant 1	Ant 2	Ant 1	Ant 2	Ant 1	Ant 2	Ant 1	Ant 2
11a	6Mbps	2	144	5720	13.45	13.40	18.70	18.35	22.27		28.27		23.64		3.15	3.15
HT20	MCS0	2	144	5720	13.95	13.95	18.60	18.20	22.45		28.45		23.60		3.75	3.75
HT40	MCS0	2	142	5710	33.40	33.50	38.98	38.66	23.98		30.00		23.98		3.09	3.18
VHT80	MCS0	2	138	5690	74.00	73.76	80.76	81.30	23.98		30.00		23.98		3.24	3.24

TEST RESULTS DATA
Average Power Table

FCC Band III single antenna													
Mod.	Data Rate	NTX	CH.	Freq. (MHz)	Average Conducted Power (dBm)			FCC Conducted Power Limit (dBm)		DG (dBi)		EIRP Power Limit (dBm)	Pass/Fail
					Ant 1	Ant 2	SUM	Ant 1	Ant 2	Ant 1	Ant 2		
11a	6Mbps	1	100	5500	11.00	11.10		23.98	23.98	-4.10	-4.40	30	Pass
11a	6Mbps	1	116	5580	11.20	11.30		23.98	23.98	-4.10	-4.40	30	Pass
11a	6Mbps	1	140	5700	11.10	11.20		23.98	23.98	-4.10	-4.40	30	Pass
HT20	MCS0	1	100	5500	11.40	11.10		23.98	23.98	-4.10	-4.40	30	Pass
HT20	MCS0	1	116	5580	11.20	11.30		23.98	23.98	-4.10	-4.40	30	Pass
HT20	MCS0	1	140	5700	11.20	11.20		23.98	23.98	-4.10	-4.40	30	Pass
HT40	MCS0	1	102	5510	11.40	11.20		23.98	23.98	-4.10	-4.40	30	Pass
HT40	MCS0	1	110	5550	11.30	11.10		23.98	23.98	-4.10	-4.40	30	Pass
HT40	MCS0	1	134	5670	11.30	11.10		23.98	23.98	-4.10	-4.40	30	Pass
VHT20	MCS0	1	100	5500	11.30	11.00		23.98	23.98	-4.10	-4.40	30	Pass
VHT20	MCS0	1	116	5580	11.10	11.20		23.98	23.98	-4.10	-4.40	30	Pass
VHT20	MCS0	1	140	5700	11.10	11.10		23.98	23.98	-4.10	-4.40	30	Pass
VHT40	MCS0	1	102	5510	11.30	11.10		23.98	23.98	-4.10	-4.40	30	Pass
VHT40	MCS0	1	110	5550	11.20	11.00		23.98	23.98	-4.10	-4.40	30	Pass
VHT40	MCS0	1	134	5670	11.20	11.00		23.98	23.98	-4.10	-4.40	30	Pass
VHT80	MCS0	1	106	5530	11.30	11.40		23.98	23.98	-4.10	-4.40	30	Pass
VHT80	MCS0	1	122	5610	11.10	11.10		23.98	23.98	-4.10	-4.40	30	Pass

FCC Band III MIMO													
Mod.	Data Rate	NTX	CH.	Freq. (MHz)	Average Conducted Power (dBm)			FCC Conducted Power Limit (dBm)		DG (dBi)		EIRP Power Limit (dBm)	Pass/Fail
					Ant 1	Ant 2	SUM	Ant 1	Ant 2	Ant 1	Ant 2		
11a	6Mbps	2	100	5500	11.10	11.10	14.11	23.98		-4.10	30	Pass	
11a	6Mbps	2	116	5580	11.30	11.40	14.36	23.98		-4.10	30	Pass	
11a	6Mbps	2	140	5700	11.20	11.30	14.26	23.98		-4.10	30	Pass	
HT20	MCS0	2	100	5500	11.40	11.20	14.31	23.98		-4.10	30	Pass	
HT20	MCS0	2	116	5580	11.20	11.30	14.26	23.98		-4.10	30	Pass	
HT20	MCS0	2	140	5700	11.20	11.20	14.21	23.98		-4.10	30	Pass	
HT40	MCS0	2	102	5510	11.40	11.20	14.31	23.98		-4.10	30	Pass	
HT40	MCS0	2	110	5550	11.30	11.10	14.21	23.98		-4.10	30	Pass	
HT40	MCS0	2	134	5670	11.30	11.10	14.21	23.98		-4.10	30	Pass	
VHT20	MCS0	2	100	5500	11.30	11.10	14.21	23.98		-4.10	30	Pass	
VHT20	MCS0	2	116	5580	11.10	11.20	14.16	23.98		-4.10	30	Pass	
VHT20	MCS0	2	140	5700	11.10	11.10	14.11	23.98		-4.10	30	Pass	
VHT40	MCS0	2	102	5510	11.30	11.10	14.21	23.98		-4.10	30	Pass	
VHT40	MCS0	2	110	5550	11.20	11.00	14.11	23.98		-4.10	30	Pass	
VHT40	MCS0	2	134	5670	11.20	11.00	14.11	23.98		-4.10	30	Pass	
VHT80	MCS0	2	106	5530	11.30	11.40	14.36	23.98		-4.10	30	Pass	
VHT80	MCS0	2	122	5610	11.10	11.10	14.11	23.98		-4.10	30	Pass	

FCC Band III straddle channel single antenna													
Mod.	Data Rate	NTX	CH.	Freq. (MHz)	Average Conducted Power (dBm)			FCC Conducted Power Limit (dBm)		DG (dBi)		EIRP Power Limit (dBm)	Pass/Fail
					Ant 1	Ant 2	SUM	Ant 1	Ant 2	Ant 1	Ant 2		
11a	6Mbps	1	144	5720	11.10	11.10		23.98	23.98	-4.10	-4.40	30	Pass
HT20	MCS0	1	144	5720	11.10	11.10		23.98	23.98	-4.10	-4.40	30	Pass
HT40	MCS0	1	142	5710	11.20	11.10		23.98	23.98	-4.10	-4.40	30	Pass
VHT20	MCS0	1	144	5720	11.00	11.00		23.98	23.98	-4.10	-4.40	30	Pass
VHT40	MCS0	1	142	5710	11.10	11.00		23.98	23.98	-4.10	-4.40	30	Pass
VHT80	MCS0	1	138	5690	11.20	11.10		23.98	23.98	-4.10	-4.40	30	Pass

FCC Band III straddle channel MIMO													
Mod.	Data Rate	NTX	CH.	Freq. (MHz)	Average Conducted Power (dBm)			FCC Conducted Power Limit (dBm)		DG (dBi)		EIRP Power Limit (dBm)	Pass/Fail
					Ant 1	Ant 2	SUM	Ant 1	Ant 2	Ant 1	Ant 2		
11a	6Mbps	2	144	5720	11.10	11.10	14.11	23.64		-4.10		30	Pass
HT20	MCS0	2	144	5720	11.10	11.10	14.11	23.60		-4.10		30	Pass
HT40	MCS0	2	142	5710	11.20	11.10	14.16	23.98		-4.10		30	Pass
VHT20	MCS0	2	144	5720	11.00	11.00	14.01	23.98		-4.10		30	Pass
VHT40	MCS0	2	142	5710	11.10	11.00	14.06	23.98		-4.10		30	Pass
VHT80	MCS0	2	138	5690	11.20	11.10	14.16	23.98		-4.10		30	Pass

TEST RESULTS DATA
Power Spectral Density

Band III MIMO												
Mod.	Data Rate	NTX	CH.	Freq. (MHz)	Average Power Density (dBm/MHz)			Average PSD Limit (dBm/MHz)		DG (dBi)		Pass /Fail
					Ant 1	Ant 2	SUM	Ant 1	Ant 2	Ant 1	Ant 2	
11a	6Mbps	2	100	5500			3.54	11.00	-1.24		Pass	
11a	6Mbps	2	116	5580			4.07	11.00	-1.24		Pass	
11a	6Mbps	2	140	5700			3.45	11.00	-1.24		Pass	
HT20	MCS0	2	100	5500			3.58	11.00	-1.24		Pass	
HT20	MCS0	2	116	5580			3.79	11.00	-1.24		Pass	
HT20	MCS0	2	140	5700			3.44	11.00	-1.24		Pass	
HT40	MCS0	2	102	5510			0.12	11.00	-1.24		Pass	
HT40	MCS0	2	110	5550			0.45	11.00	-1.24		Pass	
HT40	MCS0	2	134	5670			0.12	11.00	-1.24		Pass	
VHT80	MCS0	2	106	5530			-3.46	11.00	-1.24		Pass	
VHT80	MCS0	2	122	5610			-3.54	11.00	-1.24		Pass	

Band III straddle channel MIMO												
Mod.	Data Rate	NTX	CH.	Freq. (MHz)	Average Power Density (dBm/MHz)			Average PSD Limit (dBm/MHz)		DG (dBi)		Pass /Fail
					Ant 1	Ant 2	SUM	Ant 1	Ant 2	Ant 1	Ant 2	
11a	6Mbps	2	144	5720			3.14	11.00	-1.24		Pass	
HT20	MCS0	2	144	5720			3.18	11.00	-1.24		Pass	
HT40	MCS0	2	142	5710			0.09	11.00	-1.24		Pass	
VHT80	MCS0	2	138	5690			-3.56	11.00	-1.24		Pass	

TEST RESULTS DATA
26dB and 99% OBW

Band I MIMO														
Mod.	Data Rate	NTx	CH.	Freq. (MHz)	RU Config	99% Bandwidth (MHz)		26 dB Bandwidth (MHz)		IC 99% Bandwidth Power Limit (dBm)		IC 99% Bandwidth EIRP Limit (dBm)		Note
						Ant 1	Ant 2	Ant 1	Ant 2	Ant 1	Ant 2	Ant 1	Ant 2	
HE20	MCS0	2	36	5180	Full	19.15	19.15	25.95	25.95	-	-	22.82		
HE20	MCS0	2	36	5180	26/0	18.60	18.55	22.10	21.50	-	-	22.68		
HE20	MCS0	2	36	5180	52/37	18.30	18.45	24.20	24.65	-	-	22.62		
HE20	MCS0	2	36	5180	106/53	18.35	18.40	25.00	27.30	-	-	22.64		
HE20	MCS0	2	44	5220	Full	19.05	19.10	26.90	26.90	-	-	22.80		
HE20	MCS0	2	48	5240	Full	19.10	19.10	25.30	26.25	-	-	22.81		
HE20	MCS0	2	48	5240	26/8	18.75	18.45	22.50	21.35	-	-	22.66		
HE20	MCS0	2	48	5240	52/40	18.35	18.35	23.45	24.25	-	-	22.64		
HE20	MCS0	2	48	5240	106/54	18.30	18.25	24.95	26.55	-	-	22.61		
HE40	MCS0	2	38	5190	Full	38.30	38.30	45.82	46.75	-	-	23.01		
HE40	MCS0	2	38	5190	242/61	37.80	38.20	45.18	56.52	-	-	23.01		
HE40	MCS0	2	46	5230	Full	38.30	38.30	46.69	46.26	-	-	23.01		
HE40	MCS0	2	46	5230	242/62	37.90	38.00	46.45	46.08	-	-	23.01		
HE80	MCS0	2	42	5210	Full	79.08	78.96	87.04	88.00	-	-	23.01		
HE80	MCS0	2	42	5210	484/65	78.00	78.24	94.90	97.23	-	-	23.01		

TEST RESULTS DATA
Average Power Table

FCC Band I single antenna														
Mod.	Data Rate	NTX	CH.	Freq. (MHz)	RU Config	Average Conducted Power (dBm)			FCC Conducted Power Limit (dBm)		DG (dBi)			Pass/Fail
						Ant 1	Ant 2	SUM	Ant 1	Ant 2	Ant 1	Ant 2		
HE20	MCS0	1	36	5180	Full	11.30	11.30		24.00	24.00	-1.90	-6.10		Pass
HE20	MCS0	1	36	5180	26/0	8.80	8.60		24.00	24.00	-1.90	-6.10		Pass
HE20	MCS0	1	36	5180	52/37	11.30	11.30		24.00	24.00	-1.90	-6.10		Pass
HE20	MCS0	1	36	5180	106/53	11.10	11.30		24.00	24.00	-1.90	-6.10		Pass
HE20	MCS0	1	44	5220	Full	11.30	11.20		24.00	24.00	-1.90	-6.10		Pass
HE20	MCS0	1	44	5220	26/4	8.60	8.60		24.00	24.00	-1.90	-6.10		Pass
HE20	MCS0	1	44	5220	52/39	11.30	11.20		24.00	24.00	-1.90	-6.10		Pass
HE20	MCS0	1	44	5220	106/53	11.30	11.30		24.00	24.00	-1.90	-6.10		Pass
HE20	MCS0	1	48	5240	Full	11.20	11.30		24.00	24.00	-1.90	-6.10		Pass
HE20	MCS0	1	48	5240	26/8	8.60	8.70		24.00	24.00	-1.90	-6.10		Pass
HE20	MCS0	1	48	5240	52/40	11.10	11.30		24.00	24.00	-1.90	-6.10		Pass
HE20	MCS0	1	48	5240	106/54	11.10	11.20		24.00	24.00	-1.90	-6.10		Pass
HE40	MCS0	1	38	5190	Full	11.30	11.20		24.00	24.00	-1.90	-6.10		Pass
HE40	MCS0	1	38	5190	242/61	11.10	11.10		24.00	24.00	-1.90	-6.10		Pass
HE40	MCS0	1	46	5230	Full	11.30	11.10		24.00	24.00	-1.90	-6.10		Pass
HE40	MCS0	1	46	5230	242/62	11.20	11.30		24.00	24.00	-1.90	-6.10		Pass
HE80	MCS0	1	42	5210	Full	11.30	11.30		24.00	24.00	-1.90	-6.10		Pass
HE80	MCS0	1	42	5210	484/65	11.20	11.30		24.00	24.00	-1.90	-6.10		Pass

FCC Band I MIMO														
Mod.	Data Rate	NTX	CH.	Freq. (MHz)	RU Config	Average Conducted Power (dBm)			FCC Conducted Power Limit (dBm)		DG (dBi)			Pass/Fail
						Ant 1	Ant 2	SUM	Ant 1	Ant 2	Ant 1	Ant 2		
HE20	MCS0	2	36	5180	Full	11.40	11.40	14.41	24.00		-1.90		Pass	
HE20	MCS0	2	36	5180	26/0	8.90	8.70	11.81	24.00		-1.90		Pass	
HE20	MCS0	2	36	5180	52/37	11.40	11.40	14.41	24.00		-1.90		Pass	
HE20	MCS0	2	36	5180	106/53	11.20	11.40	14.31	24.00		-1.90		Pass	
HE20	MCS0	2	44	5220	Full	11.40	11.30	14.36	24.00		-1.90		Pass	
HE20	MCS0	2	44	5220	26/4	8.70	8.70	11.71	24.00		-1.90		Pass	
HE20	MCS0	2	44	5220	52/39	11.40	11.30	14.36	24.00		-1.90		Pass	
HE20	MCS0	2	44	5220	106/53	11.40	11.40	14.41	24.00		-1.90		Pass	
HE20	MCS0	2	48	5240	Full	11.30	11.40	14.36	24.00		-1.90		Pass	
HE20	MCS0	2	48	5240	26/8	8.70	8.80	11.76	24.00		-1.90		Pass	
HE20	MCS0	2	48	5240	52/40	11.20	11.40	14.31	24.00		-1.90		Pass	
HE20	MCS0	2	48	5240	106/54	11.20	11.30	14.26	24.00		-1.90		Pass	
HE40	MCS0	2	38	5190	Full	11.40	11.30	14.36	24.00		-1.90		Pass	
HE40	MCS0	2	38	5190	242/61	11.20	11.20	14.21	24.00		-1.90		Pass	
HE40	MCS0	2	46	5230	Full	11.40	11.20	14.31	24.00		-1.90		Pass	
HE40	MCS0	2	46	5230	242/62	11.30	11.40	14.36	24.00		-1.90		Pass	
HE80	MCS0	2	42	5210	Full	11.40	11.40	14.41	24.00		-1.90		Pass	
HE80	MCS0	2	42	5210	484/65	11.30	11.40	14.36	24.00		-1.90		Pass	

TEST RESULTS DATA
Power Spectral Density

FCC Band I MIMO													
Mod.	Data Rate	NTX	CH.	Freq. (MHz)	RU Config	Average Power Density (dBm/MHz)			Average PSD Limit (dBm/MHz)		DG (dBi)		Pass /Fail
						Ant 1	Ant 2	SUM	Ant 1	Ant 2	Ant 1	Ant 2	
HE20	MCS0	2	36	5180	Full			2.71	11.00		-0.74	Pass	
HE20	MCS0	2	36	5180	26/0			9.63	11.00		-0.74	Pass	
HE20	MCS0	2	36	5180	52/37			9.59	11.00		-0.74	Pass	
HE20	MCS0	2	36	5180	106/53			6.21	11.00		-0.74	Pass	
HE20	MCS0	2	44	5220	Full			3.03	11.00		-0.74	Pass	
HE20	MCS0	2	44	5220	26/4			8.74	11.00		-0.74	Pass	
HE20	MCS0	2	44	5220	52/39			9.77	11.00		-0.74	Pass	
HE20	MCS0	2	44	5220	106/53			7.01	11.00		-0.74	Pass	
HE20	MCS0	2	48	5240	Full			2.86	11.00		-0.74	Pass	
HE20	MCS0	2	48	5240	26/8			9.67	11.00		-0.74	Pass	
HE20	MCS0	2	48	5240	52/40			10.13	11.00		-0.74	Pass	
HE20	MCS0	2	48	5240	106/54			6.92	11.00		-0.74	Pass	
HE40	MCS0	2	38	5190	Full			-0.31	11.00		-0.74	Pass	
HE40	MCS0	2	38	5190	242/61			1.74	11.00		-0.74	Pass	
HE40	MCS0	2	46	5230	Full			-0.28	11.00		-0.74	Pass	
HE40	MCS0	2	46	5230	242/62			2.50	11.00		-0.74	Pass	
HE80	MCS0	2	42	5210	Full			-1.99	11.00		-0.74	Pass	
HE80	MCS0	2	42	5210	484/65			0.01	11.00		-0.74	Pass	

TEST RESULTS DATA
26dB and 99% OBW

Band II MIMO																
Mod.	Data Rate	NTx	CH.	Freq. (MHz)	RU Config	99% Bandwidth (MHz)		26 dB Bandwidth (MHz)		IC 99% Bandwidth Power Limit (dBm)		IC 99% Bandwidth EIRP Limit (dBm)		FCC 26dB Bandwidth Power Limit (dBm)		Note
						Ant 1	Ant 2	Ant 1	Ant 2	Ant 1	Ant 2	Ant 1	Ant 2	Ant 1	Ant 2	
HE20	MCS0	2	52	5260	Full	19.10	19.10	26.20	26.65	23.81	29.81	23.98				
HE20	MCS0	2	52	5260	26/0	18.55	18.50	22.20	21.85	23.67	29.67	23.98				
HE20	MCS0	2	52	5260	52/37	18.25	18.30	23.25	25.10	23.61	29.61	23.98				
HE20	MCS0	2	52	5260	106/53	18.35	18.30	25.40	26.80	23.62	29.62	23.98				
HE20	MCS0	2	60	5300	Full	19.10	19.10	25.50	25.95	23.81	29.81	23.98				
HE20	MCS0	2	64	5320	Full	19.10	19.15	25.70	25.40	23.81	29.81	23.98				
HE20	MCS0	2	64	5320	26/8	18.80	18.35	22.80	21.20	23.64	29.64	23.98				
HE20	MCS0	2	64	5320	52/40	18.45	18.30	23.85	24.90	23.62	29.62	23.98				
HE20	MCS0	2	64	5320	106/54	18.50	18.30	25.00	26.10	23.62	29.62	23.98				
HE40	MCS0	2	54	5270	Full	38.20	38.30	46.66	46.37	23.98	30.00	23.98				
HE40	MCS0	2	54	5270	242/61	37.80	37.80	45.48	46.08	23.98	30.00	23.98				
HE40	MCS0	2	62	5310	Full	38.30	38.20	47.39	45.46	23.98	30.00	23.98				
HE40	MCS0	2	62	5310	242/62	37.90	38.00	46.57	46.08	23.98	30.00	23.98				
HE80	MCS0	2	58	5290	Full	79.20	78.96	87.04	86.72	23.98	30.00	23.98				
HE80	MCS0	2	58	5290	484/66	79.08	78.12	96.48	97.68	23.98	30.00	23.98				

TEST RESULTS DATA
Average Power Table

FCC Band II single antenna														
Mod.	Data Rate	NTX	CH.	Freq. (MHz)	RU Config	Average Conducted Power (dBm)			FCC Conducted Power Limit (dBm)		DG (dBi)		EIRP Power Limit (dBm)	Pass/Fail
						Ant 1	Ant 2	SUM	Ant 1	Ant 2	Ant 1	Ant 2		
HE20	MCS0	1	52	5260	Full	11.30	11.10		23.98	23.98	-2.00	-6.70	30	Pass
HE20	MCS0	1	52	5260	26/0	8.70	8.80		23.98	23.98	-2.00	-6.70	30	Pass
HE20	MCS0	1	52	5260	52/37	11.30	11.30		23.98	23.98	-2.00	-6.70	30	Pass
HE20	MCS0	1	52	5260	106/53	11.20	11.20		23.98	23.98	-2.00	-6.70	30	Pass
HE20	MCS0	1	60	5300	Full	11.30	11.30		23.98	23.98	-2.00	-6.70	30	Pass
HE20	MCS0	1	60	5300	26/4	8.80	8.80		23.98	23.98	-2.00	-6.70	30	Pass
HE20	MCS0	1	60	5300	52/39	11.30	11.30		23.98	23.98	-2.00	-6.70	30	Pass
HE20	MCS0	1	60	5300	106/54	11.30	11.30		23.98	23.98	-2.00	-6.70	30	Pass
HE20	MCS0	1	64	5320	Full	11.20	11.10		23.98	23.98	-2.00	-6.70	30	Pass
HE20	MCS0	1	64	5320	26/8	8.80	8.70		23.98	23.98	-2.00	-6.70	30	Pass
HE20	MCS0	1	64	5320	52/40	11.10	11.20		23.98	23.98	-2.00	-6.70	30	Pass
HE20	MCS0	1	64	5320	106/54	11.10	11.30		23.98	23.98	-2.00	-6.70	30	Pass
HE40	MCS0	1	54	5270	Full	11.20	11.10		23.98	23.98	-2.00	-6.70	30	Pass
HE40	MCS0	1	54	5270	242/61	11.30	11.10		23.98	23.98	-2.00	-6.70	30	Pass
HE40	MCS0	1	62	5310	Full	11.10	11.20		23.98	23.98	-2.00	-6.70	30	Pass
HE40	MCS0	1	62	5310	242/62	11.10	11.20		23.98	23.98	-2.00	-6.70	30	Pass
HE80	MCS0	1	58	5290	Full	11.30	11.20		23.98	23.98	-2.00	-6.70	30	Pass
HE80	MCS0	1	58	5290	484/66	11.30	11.30		23.98	23.98	-2.00	-6.70	30	Pass

FCC Band II MIMO														
Mod.	Data Rate	NTX	CH.	Freq. (MHz)	RU Config	Average Conducted Power (dBm)			FCC Conducted Power Limit (dBm)		DG (dBi)		EIRP Power Limit (dBm)	Pass/Fail
						Ant 1	Ant 2	SUM	Ant 1	Ant 2	Ant 1	Ant 2		
HE20	MCS0	2	52	5260	Full	11.40	11.20	14.31	23.98	23.98	-2.00	-2.00	30	Pass
HE20	MCS0	2	52	5260	26/0	8.80	8.90	11.86	23.98	23.98	-2.00	-2.00	30	Pass
HE20	MCS0	2	52	5260	52/37	11.40	11.40	14.41	23.98	23.98	-2.00	-2.00	30	Pass
HE20	MCS0	2	52	5260	106/53	11.30	11.30	14.31	23.98	23.98	-2.00	-2.00	30	Pass
HE20	MCS0	2	60	5300	Full	11.40	11.40	14.41	23.98	23.98	-2.00	-2.00	30	Pass
HE20	MCS0	2	60	5300	26/4	8.90	8.90	11.91	23.98	23.98	-2.00	-2.00	30	Pass
HE20	MCS0	2	60	5300	52/39	11.40	11.40	14.41	23.98	23.98	-2.00	-2.00	30	Pass
HE20	MCS0	2	60	5300	106/54	11.40	11.40	14.41	23.98	23.98	-2.00	-2.00	30	Pass
HE20	MCS0	2	64	5320	Full	11.30	11.20	14.26	23.98	23.98	-2.00	-2.00	30	Pass
HE20	MCS0	2	64	5320	26/8	8.90	8.80	11.86	23.98	23.98	-2.00	-2.00	30	Pass
HE20	MCS0	2	64	5320	52/40	11.20	11.30	14.26	23.98	23.98	-2.00	-2.00	30	Pass
HE20	MCS0	2	64	5320	106/54	11.20	11.40	14.31	23.98	23.98	-2.00	-2.00	30	Pass
HE40	MCS0	2	54	5270	Full	11.30	11.20	14.26	23.98	23.98	-2.00	-2.00	30	Pass
HE40	MCS0	2	54	5270	242/61	11.40	11.20	14.31	23.98	23.98	-2.00	-2.00	30	Pass
HE40	MCS0	2	62	5310	Full	11.20	11.30	14.26	23.98	23.98	-2.00	-2.00	30	Pass
HE40	MCS0	2	62	5310	242/62	11.20	11.30	14.26	23.98	23.98	-2.00	-2.00	30	Pass
HE80	MCS0	2	58	5290	Full	11.40	11.30	14.36	23.98	23.98	-2.00	-2.00	30	Pass
HE80	MCS0	2	58	5290	484/66	11.40	11.40	14.41	23.98	23.98	-2.00	-2.00	30	Pass

TEST RESULTS DATA
Power Spectral Density

Band II MIMO													
Mod.	Data Rate	NTX	CH.	Freq. (MHz)	RU Config	Average Power Density (dBm/MHz)			Average PSD Limit (dBm/MHz)		DG (dBi)		Pass /Fail
						Ant 1	Ant 2	SUM	Ant 1	Ant 2	Ant 1	Ant 2	
HE20	MCS0	2	52	5260	Full			3.03	11.00		-1.03		Pass
HE20	MCS0	2	52	5260	26/0			10.29	11.00		-1.03		Pass
HE20	MCS0	2	52	5260	52/37			9.97	11.00		-1.03		Pass
HE20	MCS0	2	52	5260	106/53			6.28	11.00		-1.03		Pass
HE20	MCS0	2	60	5300	Full			2.88	11.00		-1.03		Pass
HE20	MCS0	2	60	5300	26/4			9.37	11.00		-1.03		Pass
HE20	MCS0	2	60	5300	52/39			10.11	11.00		-1.03		Pass
HE20	MCS0	2	60	5300	106/54			6.41	11.00		-1.03		Pass
HE20	MCS0	2	64	5320	Full			2.99	11.00		-1.03		Pass
HE20	MCS0	2	64	5320	26/8			10.33	11.00		-1.03		Pass
HE20	MCS0	2	64	5320	52/40			10.16	11.00		-1.03		Pass
HE20	MCS0	2	64	5320	106/54			6.53	11.00		-1.03		Pass
HE40	MCS0	2	54	5270	Full			-0.18	11.00		-1.03		Pass
HE40	MCS0	2	54	5270	242/61			2.61	11.00		-1.03		Pass
HE40	MCS0	2	62	5310	Full			0.02	11.00		-1.03		Pass
HE40	MCS0	2	62	5310	242/62			2.86	11.00		-1.03		Pass
HE80	MCS0	2	58	5290	Full			-2.16	11.00		-1.03		Pass
HE80	MCS0	2	58	5290	484/66			0.32	11.00		-1.03		Pass

TEST RESULTS DATA
26dB and 99% OBW

Band III MIMO																	
Mod.	Data Rate	N _{TX}	CH.	Freq. (MHz)	RU Config	99% Bandwidth In U-NII 2C (MHz)		26 dB Bandwidth In U-NII 2C (MHz)		IC 99% Bandwidth Power Limit (dBm)		IC 99% Bandwidth EIRP Limit (dBm)		FCC 26dB Bandwidth Power Limit (dBm)		6 dB Bandwidth for Straddle Channel (MHz)	
						Ant 1	Ant 2	Ant 1	Ant 2	Ant 1	Ant 2	Ant 1	Ant 2	Ant 1	Ant 2	Ant 1	Ant 2
HE20	MCS0	2	100	5500	Full	19.15	19.10	25.15	26.15	23.81	29.81	23.98	----	----			
HE20	MCS0	2	100	5500	26/0	18.50	18.50	22.00	21.60	23.67	29.67	23.98	----	----			
HE20	MCS0	2	100	5500	52/37	18.40	18.40	23.30	26.75	23.65	29.65	23.98	----	----			
HE20	MCS0	2	100	5500	106/53	18.30	18.30	25.70	27.00	23.62	29.62	23.98	----	----			
HE20	MCS0	2	116	5580	Full	19.05	19.10	25.63	26.55	23.80	29.80	23.98	----	----			
HE20	MCS0	2	140	5700	Full	19.10	19.10	26.35	27.00	23.81	29.81	23.98	----	----			
HE20	MCS0	2	140	5700	26/8	18.55	18.40	22.70	21.30	23.65	29.65	23.98	----	----			
HE20	MCS0	2	140	5700	52/40	18.45	18.40	23.80	24.60	23.65	29.65	23.98	----	----			
HE20	MCS0	2	140	5700	106/54	18.50	18.40	26.05	27.15	23.65	29.65	23.98	----	----			
HE40	MCS0	2	102	5510	Full	38.30	38.30	44.34	46.32	23.98	30.00	23.98	----	----			
HE40	MCS0	2	102	5510	242/61	37.70	37.80	45.36	47.16	23.98	30.00	23.98	----	----			
HE40	MCS0	2	110	5550	Full	38.30	38.20	47.17	47.22	23.98	30.00	23.98	----	----			
HE40	MCS0	2	134	5670	Full	38.30	38.50	46.08	46.75	23.98	30.00	23.98	----	----			
HE40	MCS0	2	134	5670	242/62	37.90	37.90	46.87	68.45	23.98	30.00	23.98	----	----			
HE80	MCS0	2	106	5530	Full	78.96	79.08	88.18	85.44	23.98	30.00	23.98	----	----			
HE80	MCS0	2	106	5530	484/65	78.48	78.12	88.32	93.44	23.98	30.00	23.98	----	----			
HE80	MCS0	2	122	5610	Full	78.96	79.20	88.72	87.47	23.98	30.00	23.98	----	----			
HE80	MCS0	2	122	5610	484/66	78.72	78.72	94.80	96.00	23.98	30.00	23.98	----	----			

Band III straddle channel MIMO																	
Mod.	Data Rate	N _{TX}	CH.	Freq. (MHz)	RU Config	99% Bandwidth In U-NII 2C (MHz)		26 dB Bandwidth In U-NII 2C (MHz)		IC 99% Bandwidth Power Limit (dBm)		IC 99% Bandwidth EIRP Limit (dBm)		FCC 26dB Bandwidth Power Limit (dBm)		6 dB Bandwidth for Straddle Channel (MHz)	
						Ant 1	Ant 2	Ant 1	Ant 2	Ant 1	Ant 2	Ant 1	Ant 2	Ant 1	Ant 2	Ant 1	Ant 2
HE20	MCS0	2	144	5720	Full	14.60	14.60	18.05	17.90	22.64	28.64	23.53	4.5	4.45			
HE40	MCS0	2	142	5710	Full	34.20	34.20	38.40	38.40	23.98	30.00	23.98	4	3.9			
HE40	MCS0	2	142	5710	242/62	33.40	33.70	37.86	49.74	23.98	30.00	23.98	3.99	3.99			
HE80	MCS0	2	138	5690	Full	74.60	74.60	78.86	79.26	23.98	30.00	23.98	3.88	3.9			
HE80	MCS0	2	138	5690	484/66	74.12	73.52	83.54	86.20	23.98	30.00	23.98	3.88	4.04			

TEST RESULTS DATA
Average Power Table

FCC Band III single antenna														
Mod.	Data Rate	NTX	CH.	Freq. (MHz)	RU Config	Average Conducted Power (dBm)			FCC Conducted Power Limit (dBm)		DG (dBi)		EIRP Power Limit (dBm)	Pass/Fail
						Ant 1	Ant 2	SUM	Ant 1	Ant 2	Ant 1	Ant 2		
HE20	MCS0	1	100	5500	Full	11.20	11.20		23.98	23.98	-4.10	-4.40	30	Pass
HE20	MCS0	1	100	5500	26/0	8.60	8.70		23.98	23.98	-4.10	-4.40	30	Pass
HE20	MCS0	1	100	5500	52/37	11.20	11.10		23.98	23.98	-4.10	-4.40	30	Pass
HE20	MCS0	1	100	5500	106/53	11.10	11.10		23.98	23.98	-4.10	-4.40	30	Pass
HE20	MCS0	1	116	5580	Full	11.10	11.10		23.98	23.98	-4.10	-4.40	30	Pass
HE20	MCS0	1	116	5580	26/4	8.60	8.80		23.98	23.98	-4.10	-4.40	30	Pass
HE20	MCS0	1	116	5580	52/38	11.20	11.10		23.98	23.98	-4.10	-4.40	30	Pass
HE20	MCS0	1	116	5580	106/53	11.10	11.20		23.98	23.98	-4.10	-4.40	30	Pass
HE20	MCS0	1	140	5700	Full	11.10	11.10		23.98	23.98	-4.10	-4.40	30	Pass
HE20	MCS0	1	140	5700	26/8	8.80	8.80		23.98	23.98	-4.10	-4.40	30	Pass
HE20	MCS0	1	140	5700	52/40	11.10	11.10		23.98	23.98	-4.10	-4.40	30	Pass
HE20	MCS0	1	140	5700	106/54	11.10	11.10		23.98	23.98	-4.10	-4.40	30	Pass
HE40	MCS0	1	102	5510	Full	11.20	11.30		23.98	23.98	-4.10	-4.40	30	Pass
HE40	MCS0	1	102	5510	242/61	9.40	9.60		23.98	23.98	-4.10	-4.40	30	Pass
HE40	MCS0	1	110	5550	Full	11.30	11.10		23.98	23.98	-4.10	-4.40	30	Pass
HE40	MCS0	1	110	5550	242/61	11.30	11.20		23.98	23.98	-4.10	-4.40	30	Pass
HE40	MCS0	1	134	5670	Full	11.20	11.30		23.98	23.98	-4.10	-4.40	30	Pass
HE40	MCS0	1	134	5670	242/62	11.20	11.30		23.98	23.98	-4.10	-4.40	30	Pass
HE80	MCS0	1	106	5530	Full	11.20	11.30		23.98	23.98	-4.10	-4.40	30	Pass
HE80	MCS0	1	106	5530	484/65	10.50	10.90		23.98	23.98	-4.10	-4.40	30	Pass
HE80	MCS0	1	122	5610	Full	11.30	11.30		23.98	23.98	-4.10	-4.40	30	Pass
HE80	MCS0	1	122	5610	484/66	11.10	11.20		23.98	23.98	-4.10	-4.40	30	Pass

FCC Band III MIMO														
Mod.	Data Rate	NTX	CH.	Freq. (MHz)	RU Config	Average Conducted Power (dBm)			FCC Conducted Power Limit (dBm)		DG (dBi)		EIRP Power Limit (dBm)	Pass/Fail
						Ant 1	Ant 2	SUM	Ant 1	Ant 2	Ant 1	Ant 2		
HE20	MCS0	2	100	5500	Full	11.30	11.30	14.31	23.98		-4.10	30	Pass	
HE20	MCS0	2	100	5500	26/0	8.70	8.80	11.76	23.98		-4.10	30	Pass	
HE20	MCS0	2	100	5500	52/37	11.30	11.20	14.26	23.98		-4.10	30	Pass	
HE20	MCS0	2	100	5500	106/53	11.20	11.20	14.21	23.98		-4.10	30	Pass	
HE20	MCS0	2	116	5580	Full	11.20	11.20	14.21	23.98		-4.10	30	Pass	
HE20	MCS0	2	116	5580	26/4	8.70	8.90	11.81	23.98		-4.10	30	Pass	
HE20	MCS0	2	116	5580	52/38	11.30	11.20	14.26	23.98		-4.10	30	Pass	
HE20	MCS0	2	116	5580	106/53	11.20	11.30	14.26	23.98		-4.10	30	Pass	
HE20	MCS0	2	140	5700	Full	11.20	11.20	14.21	23.98		-4.10	30	Pass	
HE20	MCS0	2	140	5700	26/8	8.90	8.90	11.91	23.98		-4.10	30	Pass	
HE20	MCS0	2	140	5700	52/40	11.20	11.20	14.21	23.98		-4.10	30	Pass	
HE20	MCS0	2	140	5700	106/54	11.20	11.20	14.21	23.98		-4.10	30	Pass	
HE40	MCS0	2	102	5510	Full	11.30	11.40	14.36	23.98		-4.10	30	Pass	
HE40	MCS0	2	102	5510	242/61	9.50	9.80	12.66	23.98		-4.10	30	Pass	
HE40	MCS0	2	110	5550	Full	11.40	11.20	14.31	23.98		-4.10	30	Pass	
HE40	MCS0	2	110	5550	242/61	11.40	11.30	14.36	23.98		-4.10	30	Pass	
HE40	MCS0	2	134	5670	Full	11.30	11.40	14.36	23.98		-4.10	30	Pass	
HE40	MCS0	2	134	5670	242/62	11.30	11.40	14.36	23.98		-4.10	30	Pass	
HE80	MCS0	2	106	5530	Full	11.30	11.40	14.36	23.98		-4.10	30	Pass	
HE80	MCS0	2	106	5530	484/65	10.70	11.00	13.86	23.98		-4.10	30	Pass	
HE80	MCS0	2	122	5610	Full	11.40	11.40	14.41	23.98		-4.10	30	Pass	
HE80	MCS0	2	122	5610	484/66	11.20	11.30	14.26	23.98		-4.10	30	Pass	

FCC Band III straddle channel single antenna														
Mod.	Data Rate	NTX	CH.	Freq. (MHz)	RU Config	Average Conducted Power (dBm)			FCC Conducted Power Limit (dBm)		DG (dBi)		EIRP Power Limit (dBm)	Pass/Fail
						Ant 1	Ant 2	SUM	Ant 1	Ant 2	Ant 1	Ant 2		
HE20	MCS0	1	144	5720	Full	11.20	11.10		23.98	23.98	-4.10	-4.40	30	Pass
HE20	MCS0	1	144	5720	26/8	8.60	8.80		23.98	23.98	-4.10	-4.40	30	Pass
HE20	MCS0	1	144	5720	52/40	11.20	11.30		23.98	23.98	-4.10	-4.40	30	Pass
HE20	MCS0	1	144	5720	106/54	11.20	11.10		23.98	23.98	-4.10	-4.40	30	Pass
HE40	MCS0	1	142	5710	Full	11.10	11.30		23.98	23.98	-4.10	-4.40	30	Pass
HE40	MCS0	1	142	5710	242/62	11.10	11.30		23.98	23.98	-4.10	-4.40	30	Pass
HE80	MCS0	1	138	5690	Full	11.10	11.10		23.98	23.98	-4.10	-4.40	30	Pass
HE80	MCS0	1	138	5690	484/66	11.10	11.20		23.98	23.98	-4.10	-4.40	30	Pass

FCC Band III straddle channel MIMO														
Mod.	Data Rate	NTX	CH.	Freq. (MHz)	RU Config	Average Conducted Power (dBm)			FCC Conducted Power Limit (dBm)		DG (dBi)		EIRP Power Limit (dBm)	Pass/Fail
						Ant 1	Ant 2	SUM	Ant 1	Ant 2	Ant 1	Ant 2		
HE20	MCS0	2	144	5720	Full	11.30	11.20	14.26	23.53		-4.10		30	Pass
HE20	MCS0	2	144	5720	26/8	8.70	8.90	11.81	22.64		-4.10		30	Pass
HE20	MCS0	2	144	5720	52/40	11.30	11.40	14.36	23.14		-4.10		30	Pass
HE20	MCS0	2	144	5720	106/54	11.30	11.20	14.26	23.39		-4.10		30	Pass
HE40	MCS0	2	142	5710	Full	11.20	11.40	14.31	23.98		-4.10		30	Pass
HE40	MCS0	2	142	5710	242/62	11.20	11.40	14.31	23.98		-4.10		30	Pass
HE80	MCS0	2	138	5690	Full	11.40	11.40	14.41	23.98		-4.10		30	Pass
HE80	MCS0	2	138	5690	484/66	11.40	11.40	14.41	23.98		-4.10		30	Pass

TEST RESULTS DATA
Power Spectral Density

Band III MIMO													
Mod.	Data Rate	NTX	CH.	Freq. (MHz)	RU Config	Average Power Density (dBm/MHz)			Average PSD Limit (dBm/MHz)		DG (dBi)		Pass /Fail
						Ant 1	Ant 2	SUM	Ant 1	Ant 2	Ant 1	Ant 2	
HE20	MCS0	2	100	5500	Full			2.67	11.00		-1.24	Pass	
HE20	MCS0	2	100	5500	26/0			9.70	11.00		-1.24	Pass	
HE20	MCS0	2	100	5500	52/37			9.92	11.00		-1.24	Pass	
HE20	MCS0	2	100	5500	106/53			6.12	11.00		-1.24	Pass	
HE20	MCS0	2	116	5580	Full			2.48	11.00		-1.24	Pass	
HE20	MCS0	2	116	5580	26/4			9.55	11.00		-1.24	Pass	
HE20	MCS0	2	116	5580	52/38			10.01	11.00		-1.24	Pass	
HE20	MCS0	2	116	5580	106/53			6.22	11.00		-1.24	Pass	
HE20	MCS0	2	140	5700	Full			2.89	11.00		-1.24	Pass	
HE20	MCS0	2	140	5700	26/8			10.11	11.00		-1.24	Pass	
HE20	MCS0	2	140	5700	52/40			10.12	11.00		-1.24	Pass	
HE20	MCS0	2	140	5700	106/54			6.26	11.00		-1.24	Pass	
HE40	MCS0	2	102	5510	Full			-0.28	11.00		-1.24	Pass	
HE40	MCS0	2	102	5510	242/61			3.45	11.00		-1.24	Pass	
HE40	MCS0	2	110	5550	Full			-0.20	11.00		-1.24	Pass	
HE40	MCS0	2	110	5550	242/61			3.56	11.00		-1.24	Pass	
HE40	MCS0	2	134	5670	Full			-0.35	11.00		-1.24	Pass	
HE40	MCS0	2	134	5670	242/62			3.18	11.00		-1.24	Pass	
HE80	MCS0	2	106	5530	Full			-1.74	11.00		-1.24	Pass	
HE80	MCS0	2	106	5530	484/65			0.09	11.00		-1.24	Pass	
HE80	MCS0	2	122	5610	Full			-1.81	11.00		-1.24	Pass	
HE80	MCS0	2	122	5610	484/66			0.54	11.00		-1.24	Pass	

Band III straddle channel MIMO													
Mod.	Data Rate	NTX	CH.	Freq. (MHz)	RU Config	Average Power Density (dBm/MHz)			Average PSD Limit (dBm/MHz)		DG (dBi)		Pass /Fail
						Ant 1	Ant 2	SUM	Ant 1	Ant 2	Ant 1	Ant 2	
HE20	MCS0	2	144	5720	Full			2.53	11.00		-1.24	Pass	
HE20	MCS0	2	144	5720	26/8			9.54	11.00		-1.24	Pass	
HE20	MCS0	2	144	5720	52/40			9.81	11.00		-1.24	Pass	
HE20	MCS0	2	144	5720	106/54			6.26	11.00		-1.24	Pass	
HE40	MCS0	2	142	5710	Full			-0.09	11.00		-1.24	Pass	
HE40	MCS0	2	142	5710	242/62			2.59	11.00		-1.24	Pass	
HE80	MCS0	2	138	5690	Full			-2.70	11.00		-1.24	Pass	
HE80	MCS0	2	138	5690	484/66			0.20	11.00		-1.24	Pass	

<Simultaneous Mode>

Test Engineer:	Eric Jeng	Temperature:	21~25	°C
Test Date:	2020/1/15	Relative Humidity:	51~54	%

TEST RESULTS DATA
Average Power Table

FCC Band I single antenna												
Mod.	Data Rate	NTX	CH.	Freq. (MHz)	Average Conducted Power (dBm)			FCC Conducted Power Limit (dBm)		DG (dBi)		Pass/Fail
					Ant 1	Ant 2	SUM	Ant 1	Ant 2	Ant 1	Ant 2	
11a	6Mbps	1	36	5180	9.30	9.20		24.00	24.00	-1.90	-6.10	Pass
11a	6Mbps	1	44	5220	9.30	9.10		24.00	24.00	-1.90	-6.10	Pass
11a	6Mbps	1	48	5240	9.20	9.20		24.00	24.00	-1.90	-6.10	Pass
HT20	MCS0	1	36	5180	9.20	9.10		24.00	24.00	-1.90	-6.10	Pass
HT20	MCS0	1	44	5220	9.20	9.20		24.00	24.00	-1.90	-6.10	Pass
HT20	MCS0	1	48	5240	9.10	9.10		24.00	24.00	-1.90	-6.10	Pass
HT40	MCS0	1	38	5190	9.20	9.40		24.00	24.00	-1.90	-6.10	Pass
HT40	MCS0	1	46	5230	9.20	9.40		24.00	24.00	-1.90	-6.10	Pass
VHT20	MCS0	1	36	5180	9.10	9.00		24.00	24.00	-1.90	-6.10	Pass
VHT20	MCS0	1	44	5220	9.10	9.10		24.00	24.00	-1.90	-6.10	Pass
VHT20	MCS0	1	48	5240	9.00	9.00		24.00	24.00	-1.90	-6.10	Pass
VHT40	MCS0	1	38	5190	9.10	9.30		24.00	24.00	-1.90	-6.10	Pass
VHT40	MCS0	1	46	5230	9.10	9.20		24.00	24.00	-1.90	-6.10	Pass
VHT80	MCS0	1	42	5210	9.40	9.40		24.00	24.00	-1.90	-6.10	Pass

FCC Band I MIMO												
Mod.	Data Rate	NTX	CH.	Freq. (MHz)	Average Conducted Power (dBm)			FCC Conducted Power Limit (dBm)		DG (dBi)		Pass/Fail
					Ant 1	Ant 2	SUM	Ant 1	Ant 2	Ant 1	Ant 2	
11a	6Mbps	2	36	5180	9.10	9.20	12.16	24.00		-1.90		Pass
11a	6Mbps	2	44	5220	9.20	9.20	12.21	24.00		-1.90		Pass
11a	6Mbps	2	48	5240	9.20	9.10	12.16	24.00		-1.90		Pass
HT20	MCS0	2	36	5180	9.20	9.10	12.16	24.00		-1.90		Pass
HT20	MCS0	2	44	5220	9.20	9.20	12.21	24.00		-1.90		Pass
HT20	MCS0	2	48	5240	9.30	9.20	12.26	24.00		-1.90		Pass
HT40	MCS0	2	38	5190	9.30	9.20	12.26	24.00		-1.90		Pass
HT40	MCS0	2	46	5230	9.20	9.10	12.16	24.00		-1.90		Pass
VHT20	MCS0	2	36	5180	9.10	9.00	12.06	24.00		-1.90		Pass
VHT20	MCS0	2	44	5220	9.10	9.10	12.11	24.00		-1.90		Pass
VHT20	MCS0	2	48	5240	9.20	9.10	12.16	24.00		-1.90		Pass
VHT40	MCS0	2	38	5190	9.20	9.10	12.16	24.00		-1.90		Pass
VHT40	MCS0	2	46	5230	9.10	9.00	12.06	24.00		-1.90		Pass
VHT80	MCS0	2	42	5210	9.40	9.50	12.46	24.00		-1.90		Pass

TEST RESULTS DATA
Average Power Table

FCC Band II single antenna													
Mod.	Data Rate	NTX	CH.	Freq. (MHz)	Average Conducted Power (dBm)			FCC Conducted Power Limit (dBm)		DG (dBi)		EIRP Power Limit (dBm)	Pass/Fail
					Ant 1	Ant 2	SUM	Ant 1	Ant 2	Ant 1	Ant 2		
11a	6Mbps	1	52	5260	9.20	9.30		23.98	23.98	-2.00	-6.70	26.99	Pass
11a	6Mbps	1	60	5300	9.10	9.30		23.98	23.98	-2.00	-6.70	26.99	Pass
11a	6Mbps	1	64	5320	9.20	9.20		23.98	23.98	-2.00	-6.70	26.99	Pass
HT20	MCS0	1	52	5260	9.30	9.20		23.98	23.98	-2.00	-6.70	26.99	Pass
HT20	MCS0	1	60	5300	9.20	9.20		23.98	23.98	-2.00	-6.70	26.99	Pass
HT20	MCS0	1	64	5320	9.20	9.10		23.98	23.98	-2.00	-6.70	26.99	Pass
HT40	MCS0	1	54	5270	9.20	9.30		23.98	23.98	-2.00	-6.70	26.99	Pass
HT40	MCS0	1	62	5310	9.10	9.20		23.98	23.98	-2.00	-6.70	26.99	Pass
VHT20	MCS0	1	52	5260	9.20	9.10		23.98	23.98	-2.00	-6.70	26.99	Pass
VHT20	MCS0	1	60	5300	9.10	9.10		23.98	23.98	-2.00	-6.70	26.99	Pass
VHT20	MCS0	1	64	5320	9.10	9.00		23.98	23.98	-2.00	-6.70	26.99	Pass
VHT40	MCS0	1	54	5270	9.10	9.10		23.98	23.98	-2.00	-6.70	26.99	Pass
VHT40	MCS0	1	62	5310	9.00	9.00		23.98	23.98	-2.00	-6.70	26.99	Pass
VHT80	MCS0	1	58	5290	9.20	9.30		23.98	23.98	-2.00	-6.70	26.99	Pass

FCC Band II MIMO													
Mod.	Data Rate	NTX	CH.	Freq. (MHz)	Average Conducted Power (dBm)			FCC Conducted Power Limit (dBm)		DG (dBi)		EIRP Power Limit (dBm)	Pass/Fail
					Ant 1	Ant 2	SUM	Ant 1	Ant 2	Ant 1	Ant 2		
11a	6Mbps	2	52	5260	9.10	9.10	12.11	23.98		-2.00		26.99	Pass
11a	6Mbps	2	60	5300	9.30	9.20	12.26	23.98		-2.00		26.99	Pass
11a	6Mbps	2	64	5320	9.10	9.10	12.11	23.98		-2.00		26.99	Pass
HT20	MCS0	2	52	5260	9.10	9.10	12.11	23.98		-2.00		26.99	Pass
HT20	MCS0	2	60	5300	9.20	9.20	12.21	23.98		-2.00		26.99	Pass
HT20	MCS0	2	64	5320	9.20	9.10	12.16	23.98		-2.00		26.99	Pass
HT40	MCS0	2	54	5270	9.30	9.30	12.31	23.98		-2.00		26.99	Pass
HT40	MCS0	2	62	5310	9.20	9.20	12.21	23.98		-2.00		26.99	Pass
VHT20	MCS0	2	52	5260	9.00	9.00	12.01	23.98		-2.00		26.99	Pass
VHT20	MCS0	2	60	5300	9.10	9.10	12.11	23.98		-2.00		26.99	Pass
VHT20	MCS0	2	64	5320	9.10	9.00	12.06	23.98		-2.00		26.99	Pass
VHT40	MCS0	2	54	5270	9.20	9.20	12.21	23.98		-2.00		26.99	Pass
VHT40	MCS0	2	62	5310	9.10	9.10	12.11	23.98		-2.00		26.99	Pass
VHT80	MCS0	2	58	5290	9.30	9.40	12.36	23.98		-2.00		26.99	Pass

TEST RESULTS DATA
Average Power Table

FCC Band III single antenna													
Mod.	Data Rate	NTX	CH.	Freq. (MHz)	Average Conducted Power (dBm)			FCC Conducted Power Limit (dBm)		DG (dBi)		EIRP Power Limit (dBm)	Pass/Fail
					Ant 1	Ant 2	SUM	Ant 1	Ant 2	Ant 1	Ant 2		
11a	6Mbps	1	100	5500	9.20	9.30		23.98	23.98	-4.10	-4.40	26.99	Pass
11a	6Mbps	1	116	5580	9.30	9.30		23.98	23.98	-4.10	-4.40	26.99	Pass
11a	6Mbps	1	140	5700	9.20	9.20		23.98	23.98	-4.10	-4.40	26.99	Pass
HT20	MCS0	1	100	5500	9.40	9.20		23.98	23.98	-4.10	-4.40	26.99	Pass
HT20	MCS0	1	116	5580	9.40	9.30		23.98	23.98	-4.10	-4.40	26.99	Pass
HT20	MCS0	1	140	5700	9.30	9.20		23.98	23.98	-4.10	-4.40	26.99	Pass
HT40	MCS0	1	102	5510	9.50	9.10		23.98	23.98	-4.10	-4.40	26.99	Pass
HT40	MCS0	1	110	5550	9.40	9.20		23.98	23.98	-4.10	-4.40	26.99	Pass
HT40	MCS0	1	134	5670	9.40	9.10		23.98	23.98	-4.10	-4.40	26.99	Pass
VHT20	MCS0	1	100	5500	9.30	9.10		23.98	23.98	-4.10	-4.40	26.99	Pass
VHT20	MCS0	1	116	5580	9.30	9.20		23.98	23.98	-4.10	-4.40	26.99	Pass
VHT20	MCS0	1	140	5700	9.20	9.10		23.98	23.98	-4.10	-4.40	26.99	Pass
VHT40	MCS0	1	102	5510	9.40	9.00		23.98	23.98	-4.10	-4.40	26.99	Pass
VHT40	MCS0	1	110	5550	9.30	9.10		23.98	23.98	-4.10	-4.40	26.99	Pass
VHT40	MCS0	1	134	5670	9.30	9.00		23.98	23.98	-4.10	-4.40	26.99	Pass
VHT80	MCS0	1	106	5530	9.30	9.30		23.98	23.98	-4.10	-4.40	26.99	Pass
VHT80	MCS0	1	122	5610	9.30	9.40		23.98	23.98	-4.10	-4.40	26.99	Pass

FCC Band III MIMO													
Mod.	Data Rate	NTX	CH.	Freq. (MHz)	Average Conducted Power (dBm)			FCC Conducted Power Limit (dBm)		DG (dBi)		EIRP Power Limit (dBm)	Pass/Fail
					Ant 1	Ant 2	SUM	Ant 1	Ant 2	Ant 1	Ant 2		
11a	6Mbps	2	100	5500	9.30	9.30	12.31	23.98		-4.10		26.99	Pass
11a	6Mbps	2	116	5580	9.30	9.30	12.31	23.98		-4.10		26.99	Pass
11a	6Mbps	2	140	5700	9.30	9.30	12.31	23.98		-4.10		26.99	Pass
HT20	MCS0	2	100	5500	9.30	9.20	12.26	23.98		-4.10		26.99	Pass
HT20	MCS0	2	116	5580	9.20	9.30	12.26	23.98		-4.10		26.99	Pass
HT20	MCS0	2	140	5700	9.30	9.20	12.26	23.98		-4.10		26.99	Pass
HT40	MCS0	2	102	5510	9.30	9.40	12.36	23.98		-4.10		26.99	Pass
HT40	MCS0	2	110	5550	9.40	9.30	12.36	23.98		-4.10		26.99	Pass
HT40	MCS0	2	134	5670	9.40	9.30	12.36	23.98		-4.10		26.99	Pass
VHT20	MCS0	2	100	5500	9.20	9.10	12.16	23.98		-4.10		26.99	Pass
VHT20	MCS0	2	116	5580	9.10	9.20	12.16	23.98		-4.10		26.99	Pass
VHT20	MCS0	2	140	5700	9.20	9.10	12.16	23.98		-4.10		26.99	Pass
VHT40	MCS0	2	102	5510	9.20	9.30	12.26	23.98		-4.10		26.99	Pass
VHT40	MCS0	2	110	5550	9.30	9.20	12.26	23.98		-4.10		26.99	Pass
VHT40	MCS0	2	134	5670	9.30	9.20	12.26	23.98		-4.10		26.99	Pass
VHT80	MCS0	2	106	5530	9.40	9.40	12.41	23.98		-4.10		26.99	Pass
VHT80	MCS0	2	122	5610	9.40	9.50	12.46	23.98		-4.10		26.99	Pass

FCC Band III straddle channel single antenna													
Mod.	Data Rate	NTX	CH.	Freq. (MHz)	Average Conducted Power (dBm)			FCC Conducted Power Limit (dBm)		DG (dBi)		EIRP Power Limit (dBm)	Pass/Fail
					Ant 1	Ant 2	SUM	Ant 1	Ant 2	Ant 1	Ant 2		
11a	6Mbps	1	144	5720	9.30	9.30		23.98	23.98	-4.10	-4.40	26.99	Pass
HT20	MCS0	1	144	5720	9.30	9.30		23.98	23.98	-4.10	-4.40	26.99	Pass
HT40	MCS0	1	142	5710	9.40	9.40		23.98	23.98	-4.10	-4.40	26.99	Pass
VHT20	MCS0	1	144	5720	9.20	9.20		23.98	23.98	-4.10	-4.40	26.99	Pass
VHT40	MCS0	1	142	5710	9.30	9.30		23.98	23.98	-4.10	-4.40	26.99	Pass
VHT80	MCS0	1	138	5690	9.40	9.30		23.98	23.98	-4.10	-4.40	26.99	Pass

FCC Band III straddle channel MIMO													
Mod.	Data Rate	NTX	CH.	Freq. (MHz)	Average Conducted Power (dBm)			FCC Conducted Power Limit (dBm)		DG (dBi)		EIRP Power Limit (dBm)	Pass/Fail
					Ant 1	Ant 2	SUM	Ant 1	Ant 2	Ant 1	Ant 2		
11a	6Mbps	2	144	5720	9.20	9.30	12.26	23.98		-4.10		26.99	Pass
HT20	MCS0	2	144	5720	9.30	9.40	12.36	23.98		-4.10		26.99	Pass
HT40	MCS0	2	142	5710	9.30	9.40	12.36	23.98		-4.10		26.99	Pass
VHT20	MCS0	2	144	5720	9.20	9.30	12.26	23.98		-4.10		26.99	Pass
VHT40	MCS0	2	142	5710	9.30	9.30	12.31	23.98		-4.10		26.99	Pass
VHT80	MCS0	2	138	5690	9.40	9.40	12.41	23.98		-4.10		26.99	Pass

TEST RESULTS DATA
Average Power Table

FCC Band I single antenna													
Mod.	Data Rate	NTX	CH.	Freq. (MHz)	RU Config	Average Conducted Power (dBm)			FCC Conducted Power Limit (dBm)		DG (dBi)		Pass/Fail
						Ant 1	Ant 2	SUM	Ant 1	Ant 2	Ant 1	Ant 2	
HE20	MCS0	1	36	5180	Full	9.40	9.40		24.00	24.00	-1.90	-6.10	Pass
HE20	MCS0	1	44	5220	Full	9.40	9.30		24.00	24.00	-1.90	-6.10	Pass
HE20	MCS0	1	48	5240	Full	9.30	9.40		24.00	24.00	-1.90	-6.10	Pass
HE40	MCS0	1	38	5190	Full	9.30	9.10		24.00	24.00	-1.90	-6.10	Pass
HE40	MCS0	1	46	5230	Full	9.40	9.30		24.00	24.00	-1.90	-6.10	Pass
HE80	MCS0	1	42	5210	Full	9.40	9.40		24.00	24.00	-1.90	-6.10	Pass

FCC Band I MIMO													
Mod.	Data Rate	NTX	CH.	Freq. (MHz)	RU Config	Average Conducted Power (dBm)			FCC Conducted Power Limit (dBm)		DG (dBi)		Pass/Fail
						Ant 1	Ant 2	SUM	Ant 1	Ant 2	Ant 1	Ant 2	
HE20	MCS0	2	36	5180	Full	9.50	9.40	12.46	24.00	24.00	-1.90	-1.90	Pass
HE20	MCS0	2	44	5220	Full	9.50	9.40	12.46	24.00	24.00	-1.90	-1.90	Pass
HE20	MCS0	2	48	5240	Full	9.40	9.50	12.46	24.00	24.00	-1.90	-1.90	Pass
HE40	MCS0	2	38	5190	Full	9.40	9.20	12.31	24.00	24.00	-1.90	-1.90	Pass
HE40	MCS0	2	46	5230	Full	9.50	9.40	12.46	24.00	24.00	-1.90	-1.90	Pass
HE80	MCS0	2	42	5210	Full	9.40	9.50	12.46	24.00	24.00	-1.90	-1.90	Pass

TEST RESULTS DATA
Average Power Table

FCC Band II single antenna														
Mod.	Data Rate	NTX	CH.	Freq. (MHz)	RU Config	Average Conducted Power (dBm)			FCC Conducted Power Limit (dBm)		DG (dBi)		EIRP Power Limit (dBm)	Pass/Fail
						Ant 1	Ant 2	SUM	Ant 1	Ant 2	Ant 1	Ant 2		
HE20	MCS0	1	52	5260	Full	9.40	9.40		23.98	23.98	-2.00	-6.70	26.99	Pass
HE20	MCS0	1	60	5300	Full	9.20	9.40		23.98	23.98	-2.00	-6.70	26.99	Pass
HE20	MCS0	1	64	5320	Full	9.20	9.40		23.98	23.98	-2.00	-6.70	26.99	Pass
HE40	MCS0	1	54	5270	Full	9.30	9.40		23.98	23.98	-2.00	-6.70	26.99	Pass
HE40	MCS0	1	62	5310	Full	9.40	9.20		23.98	23.98	-2.00	-6.70	26.99	Pass
HE80	MCS0	1	58	5290	Full	9.20	9.30		23.98	23.98	-2.00	-6.70	26.99	Pass

FCC Band II MIMO														
Mod.	Data Rate	NTX	CH.	Freq. (MHz)	RU Config	Average Conducted Power (dBm)			FCC Conducted Power Limit (dBm)		DG (dBi)		EIRP Power Limit (dBm)	Pass/Fail
						Ant 1	Ant 2	SUM	Ant 1	Ant 2	Ant 1	Ant 2		
HE20	MCS0	2	52	5260	Full	9.50	9.40	12.46	23.98	23.98	-2.00	-6.70	26.99	Pass
HE20	MCS0	2	60	5300	Full	9.30	9.50	12.41	23.98	23.98	-2.00	-6.70	26.99	Pass
HE20	MCS0	2	64	5320	Full	9.30	9.50	12.41	23.98	23.98	-2.00	-6.70	26.99	Pass
HE40	MCS0	2	54	5270	Full	9.40	9.50	12.46	23.98	23.98	-2.00	-6.70	26.99	Pass
HE40	MCS0	2	62	5310	Full	9.50	9.30	12.41	23.98	23.98	-2.00	-6.70	26.99	Pass
HE80	MCS0	2	58	5290	Full	9.30	9.40	12.36	23.98	23.98	-2.00	-6.70	26.99	Pass

TEST RESULTS DATA
Average Power Table

FCC Band III single antenna														
Mod.	Data Rate	NTX	CH.	Freq. (MHz)	RU Config	Average Conducted Power (dBm)			FCC Conducted Power Limit (dBm)		DG (dBi)		EIRP Power Limit (dBm)	Pass/Fail
						Ant 1	Ant 2	SUM	Ant 1	Ant 2	Ant 1	Ant 2		
HE20	MCS0	1	100	5500	Full	9.10	9.20		23.98	23.98	-4.10	-4.40	26.99	Pass
HE20	MCS0	1	116	5580	Full	9.10	9.20		23.98	23.98	-4.10	-4.40	26.99	Pass
HE20	MCS0	1	140	5700	Full	9.10	9.20		23.98	23.98	-4.10	-4.40	26.99	Pass
HE40	MCS0	1	102	5510	Full	9.40	9.30		23.98	23.98	-4.10	-4.40	26.99	Pass
HE40	MCS0	1	110	5550	Full	9.30	9.10		23.98	23.98	-4.10	-4.40	26.99	Pass
HE40	MCS0	1	134	5670	Full	9.30	9.30		23.98	23.98	-4.10	-4.40	26.99	Pass
HE80	MCS0	1	106	5530	Full	9.40	9.40		23.98	23.98	-4.10	-4.40	26.99	Pass
HE80	MCS0	1	122	5610	Full	9.20	9.10		23.98	23.98	-4.10	-4.40	26.99	Pass

FCC Band III MIMO														
Mod.	Data Rate	NTX	CH.	Freq. (MHz)	RU Config	Average Conducted Power (dBm)			FCC Conducted Power Limit (dBm)		DG (dBi)		EIRP Power Limit (dBm)	Pass/Fail
						Ant 1	Ant 2	SUM	Ant 1	Ant 2	Ant 1	Ant 2		
HE20	MCS0	2	100	5500	Full	9.20	9.30	12.26	23.98	23.98	-4.10	-4.40	26.99	Pass
HE20	MCS0	2	116	5580	Full	9.20	9.30	12.26	23.98	23.98	-4.10	-4.40	26.99	Pass
HE20	MCS0	2	140	5700	Full	9.20	9.30	12.26	23.98	23.98	-4.10	-4.40	26.99	Pass
HE40	MCS0	2	102	5510	Full	9.50	9.40	12.46	23.98	23.98	-4.10	-4.40	26.99	Pass
HE40	MCS0	2	110	5550	Full	9.40	9.20	12.41	23.98	23.98	-4.10	-4.40	26.99	Pass
HE40	MCS0	2	134	5670	Full	9.40	9.40	12.41	23.98	23.98	-4.10	-4.40	26.99	Pass
HE80	MCS0	2	106	5530	Full	9.50	9.40	12.46	23.98	23.98	-4.10	-4.40	26.99	Pass
HE80	MCS0	2	122	5610	Full	9.30	9.20	12.26	23.98	23.98	-4.10	-4.40	26.99	Pass

FCC Band III straddle channel single antenna														
Mod.	Data Rate	NTX	CH.	Freq. (MHz)	RU Config	Average Conducted Power (dBm)			FCC Conducted Power Limit (dBm)		DG (dBi)		EIRP Power Limit (dBm)	Pass/Fail
						Ant 1	Ant 2	SUM	Ant 1	Ant 2	Ant 1	Ant 2		
HE20	MCS0	1	144	5720	Full	9.20	9.30		23.98	23.98	-4.10	-4.40	26.99	Pass
HE40	MCS0	1	142	5710	Full	9.40	9.40		23.98	23.98	-4.10	-4.40	26.99	Pass
HE80	MCS0	1	138	5690	Full	9.10	9.30		23.98	23.98	-4.10	-4.40	26.99	Pass

FCC Band III straddle channel MIMO														
Mod.	Data Rate	NTX	CH.	Freq. (MHz)	RU Config	Average Conducted Power (dBm)			FCC Conducted Power Limit (dBm)		DG (dBi)		EIRP Power Limit (dBm)	Pass/Fail
						Ant 1	Ant 2	SUM	Ant 1	Ant 2	Ant 1	Ant 2		
HE20	MCS0	2	144	5720	Full	9.30	9.40	12.36	23.98	23.98	-4.10	-4.40	26.99	Pass
HE40	MCS0	2	142	5710	Full	9.40	9.50	12.46	23.98	23.98	-4.10	-4.40	26.99	Pass
HE80	MCS0	2	138	5690	Full	9.20	9.40	12.31	23.98	23.98	-4.10	-4.40	26.99	Pass



Appendix B. AC Conducted Emission Test Results

Test Engineer :	Howard Huang and Tom Lee	Temperature :	22~25°C
		Relative Humidity :	45~52%

EUT Information

Report NO : 901542-02
 Test Mode : Mode 1
 Test Voltage : 120Vac/60Hz
 Phase : Line

Full Spectrum

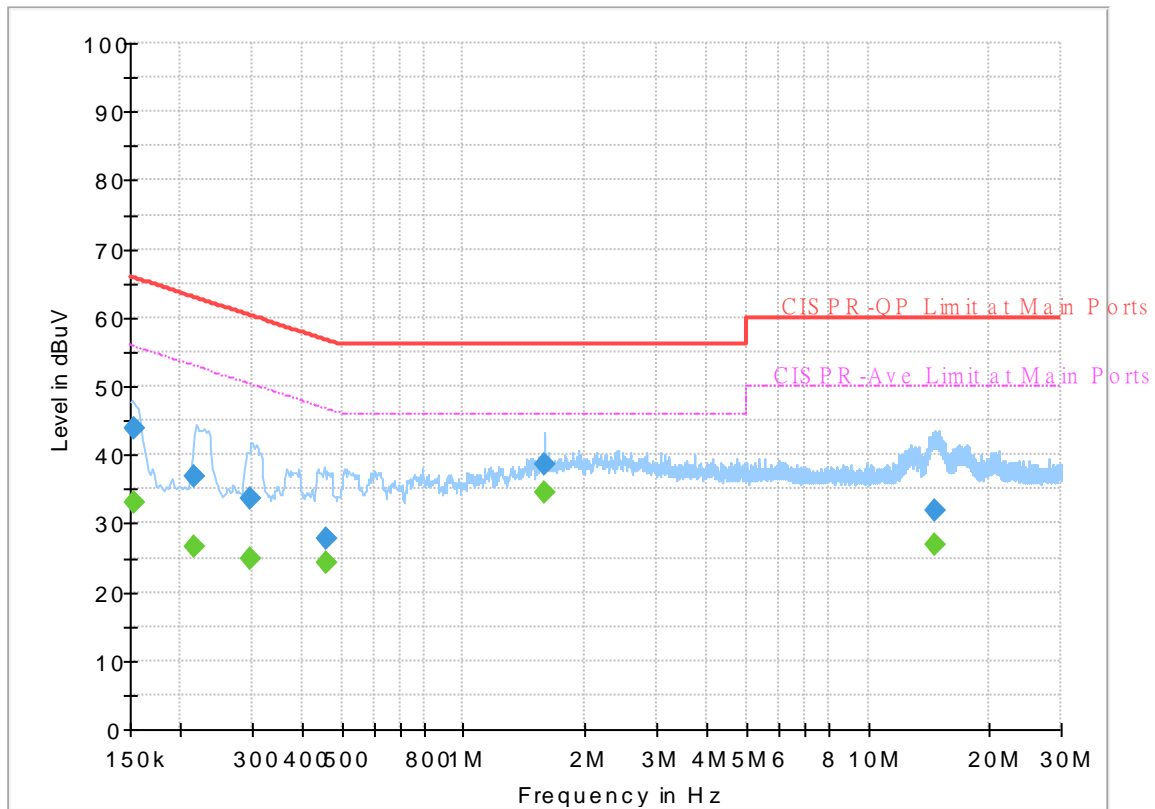

Final_Result

Frequency (MHz)	QuasiPeak (dBuV)	CAverage (dBuV)	Limit (dBuV)	Margin (dB)	Line	Filter	Corr. (dB)
0.153983	---	32.96	55.78	22.82	L1	OFF	19.5
0.153983	43.93	---	65.78	21.85	L1	OFF	19.5
0.217140	---	26.61	52.93	26.32	L1	OFF	19.5
0.217140	36.89	---	62.93	26.04	L1	OFF	19.5
0.298140	---	24.80	50.29	25.49	L1	OFF	19.5
0.298140	33.59	---	60.29	26.70	L1	OFF	19.5
0.455640	---	24.15	46.77	22.62	L1	OFF	19.5
0.455640	27.74	---	56.77	29.03	L1	OFF	19.5
1.585680	---	34.36	46.00	11.64	L1	OFF	19.6
1.585680	38.52	---	56.00	17.48	L1	OFF	19.6
14.581050	---	26.96	50.00	23.04	L1	OFF	20.0
14.581050	31.96	---	60.00	28.04	L1	OFF	20.0

EUT Information

Report NO : 901542-02
 Test Mode : Mode 1
 Test Voltage : 120Vac/60Hz
 Phase : Neutral

Full Spectrum

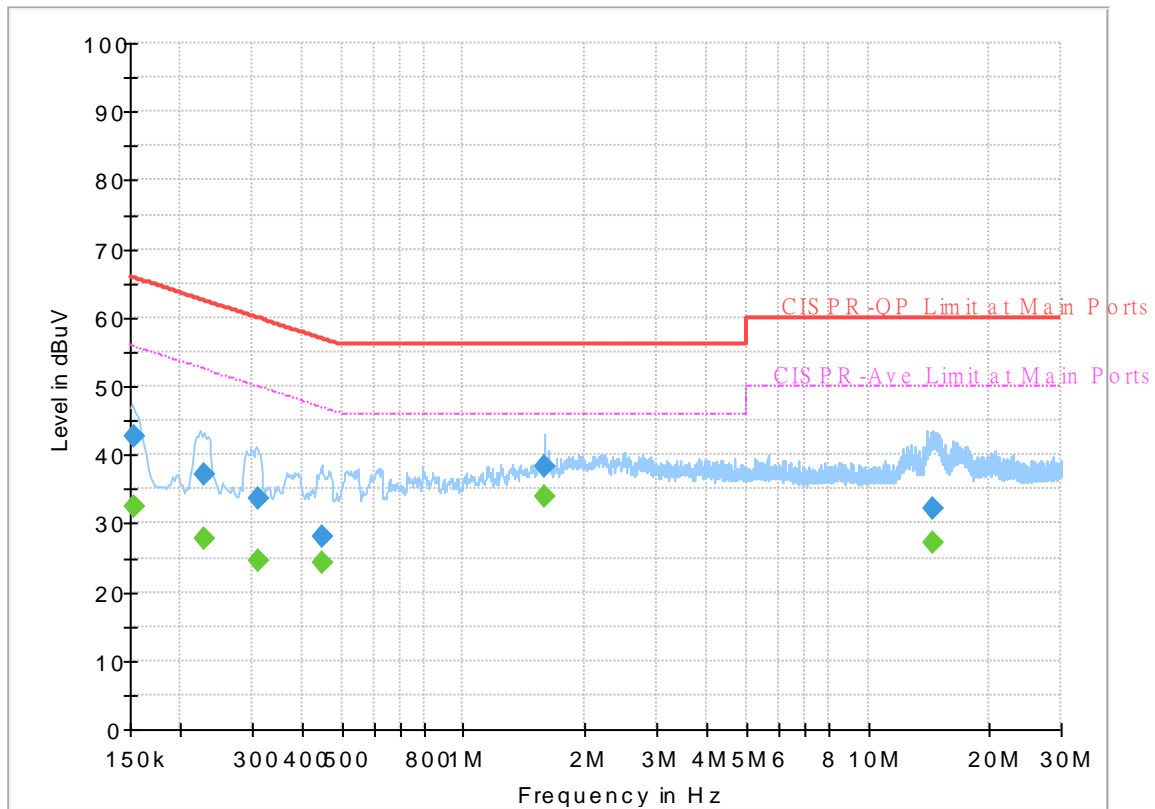

Final Result

Frequency (MHz)	QuasiPeak (dBuV)	CAverage (dBuV)	Limit (dBuV)	Margin (dB)	Line	Filter	Corr. (dB)
0.153443	---	32.48	55.81	23.33	N	OFF	19.5
0.153443	42.79	---	65.81	23.02	N	OFF	19.5
0.228750	---	27.92	52.50	24.58	N	OFF	19.5
0.228750	37.28	---	62.50	25.22	N	OFF	19.5
0.309930	---	24.62	49.97	25.35	N	OFF	19.5
0.309930	33.71	---	59.97	26.26	N	OFF	19.5
0.449250	---	24.39	46.89	22.50	N	OFF	19.5
0.449250	28.07	---	56.89	28.82	N	OFF	19.5
1.585590	---	34.00	46.00	12.00	N	OFF	19.6
1.585590	38.20	---	56.00	17.80	N	OFF	19.6
14.532000	---	27.10	50.00	22.90	N	OFF	20.1
14.532000	32.12	---	60.00	27.88	N	OFF	20.1

EUT Information

Report NO : 9O1542-02
 Test Mode : Mode 2
 Test Voltage : 120Vac/60Hz
 Phase : Line

Full Spectrum

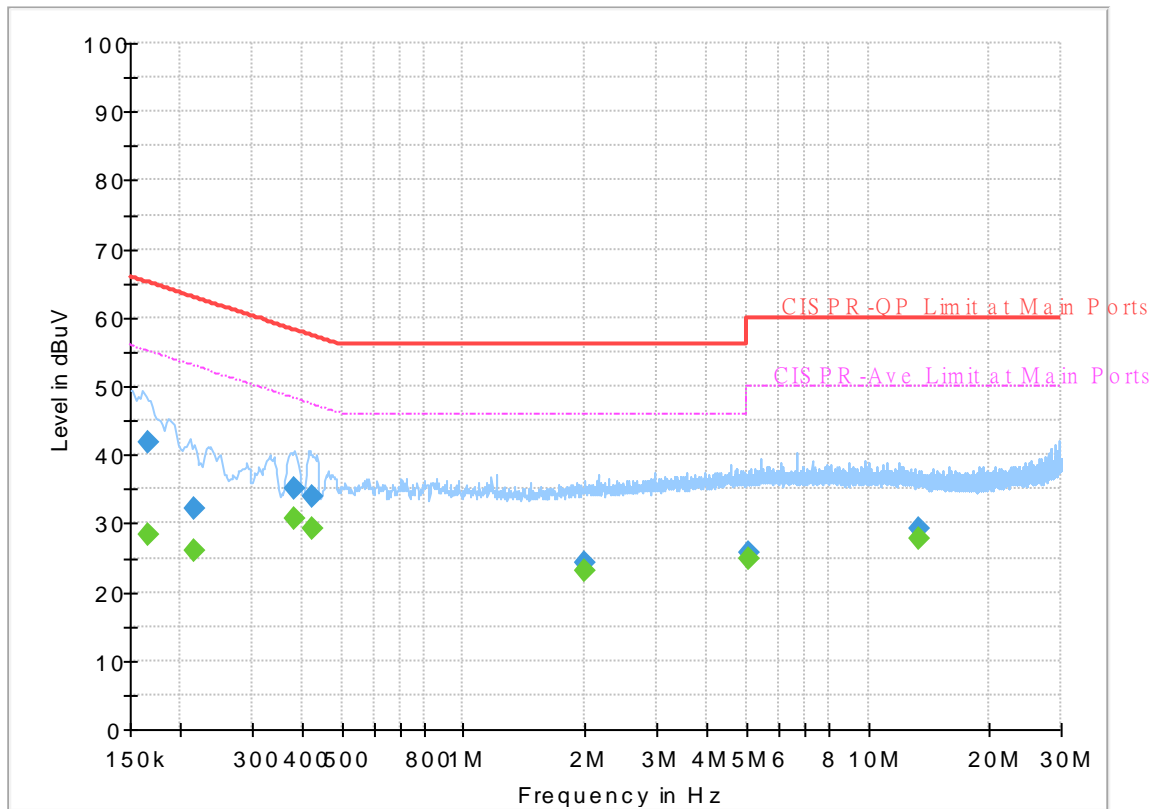

Final_Result

Frequency (MHz)	QuasiPeak (dBuV)	CAverage (dBuV)	Limit (dBuV)	Margin (dB)	Line	Filter	Corr. (dB)
0.165750	---	28.47	55.17	26.70	L1	OFF	19.5
0.165750	41.92	---	65.17	23.25	L1	OFF	19.5
0.215250	---	26.01	53.00	26.99	L1	OFF	19.5
0.215250	32.09	---	63.00	30.91	L1	OFF	19.5
0.382740	---	30.69	48.22	17.53	L1	OFF	19.5
0.382740	35.14	---	58.22	23.08	L1	OFF	19.5
0.422250	---	29.28	47.40	18.12	L1	OFF	19.5
0.422250	33.95	---	57.40	23.45	L1	OFF	19.5
1.983750	---	23.19	46.00	22.81	L1	OFF	19.6
1.983750	24.28	---	56.00	31.72	L1	OFF	19.6
5.068500	---	24.80	50.00	25.20	L1	OFF	19.7
5.068500	25.70	---	60.00	34.30	L1	OFF	19.7
13.325550	---	27.80	50.00	22.20	L1	OFF	20.1
13.325550	29.38	---	60.00	30.62	L1	OFF	20.1

EUT Information

Report NO : 901542-02
 Test Mode : Mode 2
 Test Voltage : 120Vac/60Hz
 Phase : Neutral

Full Spectrum

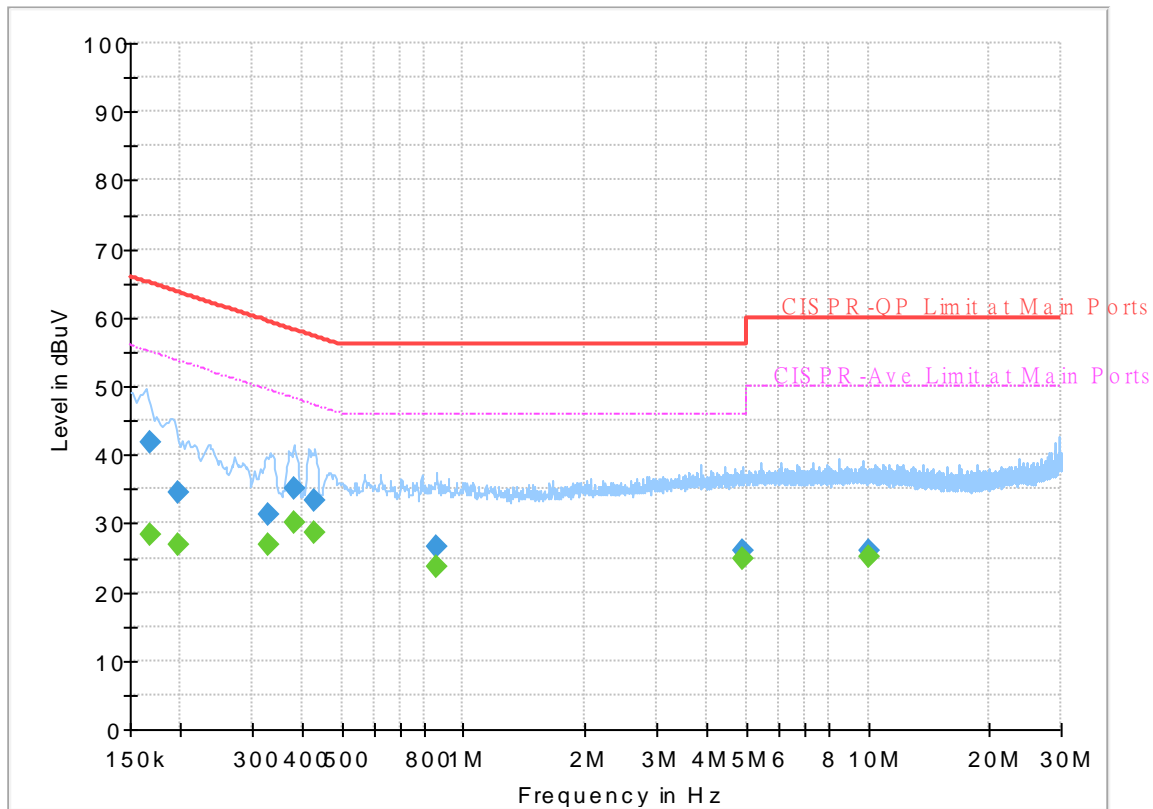

Final_Result

Frequency (MHz)	QuasiPeak (dBuV)	CAverage (dBuV)	Limit (dBuV)	Margin (dB)	Line	Filter	Corr. (dB)
0.168000	---	28.50	55.06	26.56	N	OFF	19.6
0.168000	41.69	---	65.06	23.37	N	OFF	19.6
0.197250	---	26.91	53.73	26.82	N	OFF	19.6
0.197250	34.44	---	63.73	29.29	N	OFF	19.6
0.328470	---	27.01	49.49	22.48	N	OFF	19.6
0.328470	31.17	---	59.49	28.32	N	OFF	19.6
0.383370	---	30.05	48.21	18.16	N	OFF	19.6
0.383370	35.04	---	58.21	23.17	N	OFF	19.6
0.427920	---	28.63	47.29	18.66	N	OFF	19.6
0.427920	33.29	---	57.29	24.00	N	OFF	19.6
0.854610	---	23.65	46.00	22.35	N	OFF	19.6
0.854610	26.48	---	56.00	29.52	N	OFF	19.6
4.920000	---	24.89	46.00	21.11	N	OFF	19.8
4.920000	25.95	---	56.00	30.05	N	OFF	19.8
10.068720	---	25.20	50.00	24.80	N	OFF	20.1
10.068720	26.15	---	60.00	33.85	N	OFF	20.1



Appendix C. Radiated Spurious Emission

Test Engineer :	Jacky Hung, CR Liro and Andy Yang	Temperature :	20~25°C
		Relative Humidity :	50~60%

Band 1 - 5150~5250MHz
WIFI 802.11a (Band Edge @ 3m)

WIFI	Note	Frequency	Level	Over	Limit	Read	Antenna	Path	Preamp	Ant	Table	Peak	Pol.
Ant.				Limit	Line	Level	Factor	Loss	Factor	Pos	Pos	Avg.	
1+2		(MHz)	(dBµV/m)	(dB)	(dBµV/m)	(dBµV)	(dB/m)	(dB)	(dB)	(cm)	(deg)	(P/A)	(H/V)
802.11a CH 36 5180MHz		5133.9	53.87	-20.13	74	38.68	31.73	12.3	28.84	100	60	P	H
		5088.66	42.22	-11.78	54	27.01	31.78	12.24	28.81	100	60	A	H
	*	5180	104.88	-	-	89.81	31.58	12.36	28.87	100	60	P	H
	*	5180	96.95	-	-	81.88	31.58	12.36	28.87	100	60	A	H
		5146.64	53.76	-20.24	74	38.58	31.71	12.32	28.85	100	311	P	V
		5090.48	42.22	-11.78	54	27.01	31.78	12.24	28.81	100	311	A	V
	*	5180	102.21	-	-	87.14	31.58	12.36	28.87	100	311	P	V
	*	5180	94.56	-	-	79.49	31.58	12.36	28.87	100	311	A	V
802.11a CH 44 5220MHz		5041.86	54.48	-19.52	74	39.41	31.67	12.18	28.78	100	59	P	H
		5086.32	42.25	-11.75	54	27.05	31.77	12.24	28.81	100	59	A	H
	*	5220	105.15	-	-	90.22	31.42	12.41	28.9	100	59	P	H
	*	5220	97.22	-	-	82.29	31.42	12.41	28.9	100	59	A	H
		5442.64	52.76	-21.24	74	37.57	31.57	12.66	29.04	100	59	P	H
		5449.36	41.65	-12.35	54	26.43	31.6	12.67	29.05	100	59	A	H
		5122.2	54.56	-19.44	74	39.35	31.76	12.28	28.83	100	143	P	V
		5087.62	42.17	-11.83	54	26.96	31.78	12.24	28.81	100	143	A	V
	*	5220	101.84	-	-	86.91	31.42	12.41	28.9	100	143	P	V
	*	5220	93.87	-	-	78.94	31.42	12.41	28.9	100	143	A	V
		5391.12	53.14	-20.86	74	38.22	31.36	12.57	29.01	100	143	P	V
		5455.24	41.59	-12.41	54	26.35	31.61	12.68	29.05	100	143	A	V



802.11a CH 48 5240MHz		5112.32	53.78	-20.22	74	38.55	31.78	12.27	28.82	100	59	P	H
		5087.88	42.25	-11.75	54	27.04	31.78	12.24	28.81	100	59	A	H
	*	5240	104.86	-	-	90	31.34	12.43	28.91	100	59	P	H
	*	5240	96.69	-	-	81.83	31.34	12.43	28.91	100	59	A	H
		5445.72	53.14	-20.86	74	37.93	31.58	12.67	29.04	100	59	P	H
		5449.92	41.67	-12.33	54	26.45	31.6	12.67	29.05	100	59	A	H
		5133.64	53.88	-20.12	74	38.69	31.73	12.3	28.84	100	143	P	V
		5081.9	42.14	-11.86	54	26.95	31.76	12.23	28.8	100	143	A	V
	*	5240	102.03	-	-	87.17	31.34	12.43	28.91	100	143	P	V
	*	5240	94	-	-	79.14	31.34	12.43	28.91	100	143	A	V
		5433.68	53.25	-20.75	74	38.12	31.53	12.64	29.04	100	143	P	V
		5443.48	41.59	-12.41	54	26.4	31.57	12.66	29.04	100	143	A	V
Remark	<ol style="list-style-type: none"> 1. No other spurious found. 2. All results are PASS against Peak and Average limit line. 												



Band 1 5150~5250MHz
WIFI 802.11a (Harmonic @ 3m)

WIFI Ant. 1+2	Note	Frequency (MHz)	Level (dBμV/m)	Over Limit (dB)	Limit Line (dBμV/m)	Read Level (dBμV)	Antenna Factor (dB/m)	Path Loss (dB)	Preamp Factor (dB)	Ant Pos (cm)	Table Pos (deg)	Peak Avg. (P/A)	Pol. (H/V)	
802.11a CH 36 5180MHz		10360	49	-19.2	68.2	49.48	39.64	19.17	59.29	100	0	P	H	
		15540	46.97	-27.03	74	44.6	37.94	24.38	59.95	100	0	P	H	
													H	
													H	
			10360	49.54	-18.66	68.2	50.02	39.64	19.17	59.29	100	0	P	V
			15540	47.32	-26.68	74	44.95	37.94	24.38	59.95	100	0	P	V
														V
														V
802.11a CH 44 5220MHz		10440	47.37	-20.83	68.2	47.53	39.88	19.29	59.33	100	0	P	H	
		15660	45.47	-28.53	74	43.51	37.46	24.38	59.88	100	0	P	H	
													H	
													H	
			10440	47.57	-20.63	68.2	47.73	39.88	19.29	59.33	100	0	P	V
			15660	45.42	-28.58	74	43.46	37.46	24.38	59.88	100	0	P	V
														V
														V
802.11a CH 48 5240MHz		10480	47.98	-20.22	68.2	48.02	39.96	19.35	59.35	100	0	P	H	
		15720	46.45	-27.55	74	44.62	37.3	24.37	59.84	100	0	P	H	
													H	
													H	
			10480	47.75	-20.45	68.2	47.79	39.96	19.35	59.35	100	0	P	V
			15720	46.76	-27.24	74	44.93	37.3	24.37	59.84	100	0	P	V
														V
														V
Remark	1. No other spurious found. 2. All results are PASS against Peak and Average limit line.													



Band 1 5150~5250MHz
WIFI 802.11n HT20 (Band Edge @ 3m)

WIFI Ant. 1+2	Note	Frequency (MHz)	Level (dBμV/m)	Over Limit (dB)	Limit Line (dBμV/m)	Read Level (dBμV)	Antenna Factor (dB/m)	Path Loss (dB)	Preamp Factor (dB)	Ant Pos (cm)	Table Pos (deg)	Peak Avg. (P/A)	Pol. (H/V)	
802.11n HT20 CH 36 5180MHz		5083.46	54.43	-19.57	74	39.24	31.77	12.23	28.81	100	60	P	H	
		5089.7	42.15	-11.85	54	26.94	31.78	12.24	28.81	100	60	A	H	
	*	5180	103.98	-	-	88.91	31.58	12.36	28.87	100	60	P	H	
	*	5180	94.44	-	-	79.37	31.58	12.36	28.87	100	60	A	H	
													H	
														H
			5106.6	53.69	-20.31	74	38.46	31.79	12.26	28.82	100	317	P	V
			5100.62	42.17	-11.83	54	26.93	31.8	12.26	28.82	100	317	A	V
	*		5180	101.97	-	-	86.9	31.58	12.36	28.87	100	317	P	V
	*		5180	92.65	-	-	77.58	31.58	12.36	28.87	100	317	A	V
														V
														V
802.11n HT20 CH 44 5220MHz		5115.18	53.58	-20.42	74	38.36	31.77	12.28	28.83	100	59	P	H	
		5087.88	42.16	-11.84	54	26.95	31.78	12.24	28.81	100	59	A	H	
	*	5220	104.68	-	-	89.75	31.42	12.41	28.9	100	59	P	H	
	*	5220	94.48	-	-	79.55	31.42	12.41	28.9	100	59	A	H	
			5389.16	54.29	-19.71	74	39.37	31.36	12.57	29.01	100	59	P	H
			5442.08	41.59	-12.41	54	26.4	31.57	12.66	29.04	100	59	A	H
			5080.6	53.42	-20.58	74	38.23	31.76	12.23	28.8	100	143	P	V
			5087.1	42.07	-11.93	54	26.87	31.77	12.24	28.81	100	143	A	V
	*		5220	101.21	-	-	86.28	31.42	12.41	28.9	100	143	P	V
	*		5220	91.25	-	-	76.32	31.42	12.41	28.9	100	143	A	V
			5414.64	52.89	-21.11	74	37.84	31.46	12.61	29.02	100	143	P	V
			5441.24	41.57	-12.43	54	26.39	31.56	12.66	29.04	100	143	A	V



802.11n HT20 CH 48 5240MHz		5100.1	53.56	-20.44	74	38.32	31.8	12.26	28.82	100	58	P	H
		5095.16	42.16	-11.84	54	26.93	31.79	12.25	28.81	100	58	A	H
	*	5240	104.38	-	-	89.52	31.34	12.43	28.91	100	58	P	H
	*	5240	93.99	-	-	79.13	31.34	12.43	28.91	100	58	A	H
		5432.84	53.79	-20.21	74	38.66	31.53	12.64	29.04	100	58	P	H
		5456.64	41.63	-12.37	54	26.38	31.61	12.69	29.05	100	58	A	H
		5102.96	53.74	-20.26	74	38.51	31.79	12.26	28.82	100	144	P	V
		5090.48	42.14	-11.86	54	26.93	31.78	12.24	28.81	100	144	A	V
	*	5240	101.53	-	-	86.67	31.34	12.43	28.91	100	144	P	V
	*	5240	91.32	-	-	76.46	31.34	12.43	28.91	100	144	A	V
		5458.04	53.13	-20.87	74	37.87	31.62	12.69	29.05	100	144	P	V
	5449.36	41.53	-12.47	54	26.31	31.6	12.67	29.05	100	144	A	V	
Remark	1. No other spurious found. 2. All results are PASS against Peak and Average limit line.												



Band 1 5150~5250MHz
WIFI 802.11n HT20 (Harmonic @ 3m)

WIFI Ant. 1+2	Note	Frequency (MHz)	Level (dBμV/m)	Over Limit (dB)	Limit Line (dBμV/m)	Read Level (dBμV)	Antenna Factor (dB/m)	Path Loss (dB)	Preamp Factor (dB)	Ant Pos (cm)	Table Pos (deg)	Peak Avg. (P/A)	Pol. (H/V)	
802.11n HT20 CH 36 5180MHz		10360	48.14	-20.06	68.2	48.62	39.64	19.17	59.29	100	0	P	H	
		15540	46.51	-27.49	74	44.14	37.94	24.38	59.95	100	0	P	H	
													H	
													H	
			10360	47.92	-20.28	68.2	48.4	39.64	19.17	59.29	100	0	P	V
			15540	45.87	-28.13	74	43.5	37.94	24.38	59.95	100	0	P	V
														V
802.11n HT20 CH 44 5220MHz		10440	47.31	-20.89	68.2	47.47	39.88	19.29	59.33	100	0	P	H	
		15660	45.63	-28.37	74	43.67	37.46	24.38	59.88	100	0	P	H	
													H	
													H	
			10440	47.15	-21.05	68.2	47.31	39.88	19.29	59.33	100	0	P	V
			15660	46.12	-27.88	74	44.16	37.46	24.38	59.88	100	0	P	V
														V
802.11n HT20 CH 48 5240MHz		10480	47.89	-20.31	68.2	47.93	39.96	19.35	59.35	100	0	P	H	
		15720	46.64	-27.36	74	44.81	37.3	24.37	59.84	100	0	P	H	
													H	
													H	
			10480	47.97	-20.23	68.2	48.01	39.96	19.35	59.35	100	0	P	V
			15720	46.12	-27.88	74	44.29	37.3	24.37	59.84	100	0	P	V
														V
Remark	1. No other spurious found.													
	2. All results are PASS against Peak and Average limit line.													



Band 1 5150~5250MHz
WIFI 802.11n HT40 (Band Edge @ 3m)

WIFI Ant. 1+2	Note	Frequency (MHz)	Level (dBμV/m)	Over Limit (dB)	Limit Line (dBμV/m)	Read Level (dBμV)	Antenna Factor (dB/m)	Path Loss (dB)	Preamp Factor (dB)	Ant Pos (cm)	Table Pos (deg)	Peak Avg. (P/A)	Pol. (H/V)
802.11n HT40 CH 38 5190MHz		5100.1	54	-20	74	38.76	31.8	12.26	28.82	100	59	P	H
		5150	42.32	-11.68	54	27.15	31.7	12.32	28.85	100	59	A	H
	*	5190	100.16	-	-	85.12	31.54	12.38	28.88	100	59	P	H
	*	5190	91.5	-	-	76.46	31.54	12.38	28.88	100	59	A	H
		5414.08	54.27	-19.73	74	39.22	31.46	12.61	29.02	100	59	P	H
		5454.96	41.54	-12.46	54	26.3	31.61	12.68	29.05	100	59	A	H
		5059.02	53.07	-20.93	74	37.94	31.72	12.2	28.79	100	315	P	V
		5150	42.15	-11.85	54	26.98	31.7	12.32	28.85	100	315	A	V
	*	5190	98.17	-	-	83.13	31.54	12.38	28.88	100	315	P	V
	*	5190	89.88	-	-	74.84	31.54	12.38	28.88	100	315	A	V
		5455.24	53.83	-20.17	74	38.59	31.61	12.68	29.05	100	315	P	V
		5441.24	41.47	-12.53	54	26.29	31.56	12.66	29.04	100	315	A	V
802.11n HT40 CH 46 5230MHz		5048.36	54.53	-19.47	74	39.43	31.69	12.19	28.78	101	59	P	H
		5089.7	42.17	-11.83	54	26.96	31.78	12.24	28.81	101	59	A	H
	*	5230	100.51	-	-	85.61	31.38	12.42	28.9	101	59	P	H
	*	5230	91.56	-	-	76.66	31.38	12.42	28.9	101	59	A	H
		5439.28	53.41	-20.59	74	38.24	31.56	12.65	29.04	101	59	P	H
		5445.16	41.59	-12.41	54	26.38	31.58	12.67	29.04	101	59	A	H
		5048.62	54.31	-19.69	74	39.21	31.69	12.19	28.78	100	317	P	V
		5094.64	42.15	-11.85	54	26.92	31.79	12.25	28.81	100	317	A	V
	*	5230	97.68	-	-	82.78	31.38	12.42	28.9	100	317	P	V
	*	5230	88.93	-	-	74.03	31.38	12.42	28.9	100	317	A	V
	5453	53.21	-20.79	74	37.97	31.61	12.68	29.05	100	317	P	V	
	5456.64	41.52	-12.48	54	26.27	31.61	12.69	29.05	100	317	A	V	
Remark	1. No other spurious found. 2. All results are PASS against Peak and Average limit line.												



Band 1 5150~5250MHz
WIFI 802.11n HT40 (Harmonic @ 3m)

WIFI Ant. 1+2	Note	Frequency (MHz)	Level (dBμV/m)	Over Limit (dB)	Limit Line (dBμV/m)	Read Level (dBμV)	Antenna Factor (dB/m)	Path Loss (dB)	Preamp Factor (dB)	Ant Pos (cm)	Table Pos (deg)	Peak Avg. (P/A)	Pol. (H/V)	
802.11n HT40 CH 38 5190MHz		10380	47.75	-20.45	68.2	48.13	39.72	19.2	59.3	100	0	P	H	
		15570	45	-29	74	42.74	37.82	24.38	59.94	100	0	P	H	
													H	
													H	
			10380	46.85	-21.35	68.2	47.23	39.72	19.2	59.3	100	0	P	V
			15570	44.33	-29.67	74	42.07	37.82	24.38	59.94	100	0	P	V
														V
802.11n HT40 CH 46 5230MHz		10460	47.85	-20.35	68.2	47.95	39.92	19.32	59.34	100	0	P	H	
		15690	45.11	-28.89	74	43.26	37.34	24.37	59.86	100	0	P	H	
													H	
													H	
			10460	46.62	-21.58	68.2	46.72	39.92	19.32	59.34	100	0	P	V
			15690	47.11	-26.89	74	45.26	37.34	24.37	59.86	100	0	P	V
														V
Remark	1. No other spurious found.													
	2. All results are PASS against Peak and Average limit line.													



**Band 1 5150~5250MHz
WIFI 802.11ac VHT80 (Band Edge @ 3m)**

WIFI Ant. 1+2	Note	Frequency (MHz)	Level (dBμV/m)	Over Limit (dB)	Limit Line (dBμV/m)	Read Level (dBμV)	Antenna Factor (dB/m)	Path Loss (dB)	Preamp Factor (dB)	Ant Pos (cm)	Table Pos (deg)	Peak Avg. (P/A)	Pol. (H/V)
802.11ac VHT80 CH 42 5210MHz		5029.9	54	-20	74	38.99	31.62	12.16	28.77	101	58	P	H
		5147.42	42.52	-11.48	54	27.34	31.71	12.32	28.85	101	58	A	H
	*	5210	98.07	-	-	83.1	31.46	12.4	28.89	101	58	P	H
	*	5210	89.02	-	-	74.05	31.46	12.4	28.89	101	58	A	H
		5358.92	53.25	-20.75	74	38.46	31.24	12.54	28.99	101	58	P	H
		5438.72	41.63	-12.37	54	26.47	31.55	12.65	29.04	101	58	A	H
		5108.42	53.68	-20.32	74	38.45	31.78	12.27	28.82	101	304	P	V
		5147.42	42.33	-11.67	54	27.15	31.71	12.32	28.85	101	304	A	V
	*	5210	95.26	-	-	80.29	31.46	12.4	28.89	101	304	P	V
	*	5210	85.89	-	-	70.92	31.46	12.4	28.89	101	304	A	V
		5433.96	53.49	-20.51	74	38.35	31.54	12.64	29.04	101	304	P	V
		5445.72	41.52	-12.48	54	26.31	31.58	12.67	29.04	101	304	A	V
Remark	1. No other spurious found. 2. All results are PASS against Peak and Average limit line.												



**Band 1 5150~5250MHz
WIFI 802.11ac VHT80 (Harmonic @ 3m)**

WIFI Ant. 1+2	Note	Frequency (MHz)	Level (dBμV/m)	Over Limit (dB)	Limit Line (dBμV/m)	Read Level (dBμV)	Antenna Factor (dB/m)	Path Loss (dB)	Preamp Factor (dB)	Ant Pos (cm)	Table Pos (deg)	Peak Avg. (P/A)	Pol. (H/V)
802.11ac VHT80		10420	46.87	-21.33	68.2	47.09	39.84	19.26	59.32	100	0	P	H
		15630	45.21	-28.79	74	43.16	37.58	24.37	59.9	100	0	P	H
													H
													H
5210MHz	CH 42	10420	46.2	-22	68.2	46.42	39.84	19.26	59.32	100	0	P	V
		15630	46.14	-27.86	74	44.09	37.58	24.37	59.9	100	0	P	V
													V
													V
Remark	1. No other spurious found. 2. All results are PASS against Peak and Average limit line.												



Band 2 - 5250~5350MHz
WIFI 802.11a (Band Edge @ 3m)

WIFI	Note	Frequency	Level	Over	Limit	Read	Antenna	Path	Preamp	Ant	Table	Peak	Pol.
Ant.				Limit	Line	Level	Factor	Loss	Factor	Pos	Pos	Avg.	
1+2		(MHz)	(dBµV/m)	(dB)	(dBµV/m)	(dBµV)	(dB/m)	(dB)	(dB)	(cm)	(deg)	(P/A)	(H/V)
802.11a CH 52 5260MHz		5094.18	54.26	-19.74	74	39.03	31.79	12.25	28.81	101	60	P	H
		5096.9	41.95	-12.05	54	26.72	31.79	12.25	28.81	101	60	A	H
	*	5260	104.78	-	-	89.95	31.3	12.45	28.92	101	60	P	H
	*	5260	96.74	-	-	81.91	31.3	12.45	28.92	101	60	A	H
		5351.04	54.04	-19.96	74	39.29	31.2	12.53	28.98	101	60	P	H
		5446.56	41.47	-12.53	54	26.25	31.59	12.67	29.04	101	60	A	H
		5024.14	52.71	-21.29	74	37.73	31.6	12.15	28.77	101	144	P	V
		5096.22	41.87	-12.13	54	26.64	31.79	12.25	28.81	101	144	A	V
	*	5260	101.56	-	-	86.73	31.3	12.45	28.92	101	144	P	V
	*	5260	93.96	-	-	79.13	31.3	12.45	28.92	101	144	A	V
		5397.12	53.01	-20.99	74	38.05	31.39	12.58	29.01	101	144	P	V
		5446.8	41.36	-12.64	54	26.14	31.59	12.67	29.04	101	144	A	V
802.11a CH 60 5300MHz		5141.78	53.65	-20.35	74	38.46	31.72	12.31	28.84	101	59	P	H
		5089.42	41.92	-12.08	54	26.71	31.78	12.24	28.81	101	59	A	H
	*	5300	105.06	-	-	90.22	31.3	12.49	28.95	101	59	P	H
	*	5300	96.94	-	-	82.1	31.3	12.49	28.95	101	59	A	H
		5444.64	53.75	-20.25	74	38.55	31.58	12.66	29.04	101	59	P	H
		5457.12	41.56	-12.44	54	26.31	31.61	12.69	29.05	101	59	A	H
		5053.72	53.56	-20.44	74	38.45	31.71	12.19	28.79	100	144	P	V
		5096.56	41.87	-12.13	54	26.64	31.79	12.25	28.81	100	144	A	V
	*	5300	101.85	-	-	87.01	31.3	12.49	28.95	100	144	P	V
	*	5300	93.92	-	-	79.08	31.3	12.49	28.95	100	144	A	V
		5366.16	53.51	-20.49	74	38.69	31.26	12.55	28.99	100	144	P	V
		5446.32	41.41	-12.59	54	26.19	31.59	12.67	29.04	100	144	A	V



802.11a CH 64 5320MHz	*	5320	104.51	-	-	89.71	31.26	12.5	28.96	101	58	P	H
	*	5320	96.42	-	-	81.62	31.26	12.5	28.96	101	58	A	H
		5434.4	53.66	-20.34	74	38.51	31.54	12.65	29.04	101	58	P	H
		5457.28	41.53	-12.47	54	26.28	31.61	12.69	29.05	101	58	A	H
													H
													H
	*	5320	101.61	-	-	86.81	31.26	12.5	28.96	109	144	P	V
	*	5320	93.72	-	-	78.92	31.26	12.5	28.96	109	144	A	V
		5444.96	53.55	-20.45	74	38.34	31.58	12.67	29.04	109	144	P	V
		5453.28	41.38	-12.62	54	26.14	31.61	12.68	29.05	109	144	A	V
													V
													V
Remark	1. No other spurious found. 2. All results are PASS against Peak and Average limit line.												



Band 2 5250~5350MHz
WIFI 802.11a (Harmonic @ 3m)

WIFI Ant. 1+2	Note	Frequency (MHz)	Level (dBμV/m)	Over Limit (dB)	Limit Line (dBμV/m)	Read Level (dBμV)	Antenna Factor (dB/m)	Path Loss (dB)	Preamp Factor (dB)	Ant Pos (cm)	Table Pos (deg)	Peak Avg. (P/A)	Pol. (H/V)	
802.11a CH 52 5260MHz		10520	45.67	-22.53	68.2	45.65	40	19.42	59.4	100	0	P	H	
		15780	43.27	-30.73	74	41.4	37.3	24.37	59.8	100	0	P	H	
													H	
													H	
			10520	46.22	-21.98	68.2	46.2	40	19.42	59.4	100	0	P	V
			15780	43.28	-30.72	74	41.41	37.3	24.37	59.8	100	0	P	V
														V
														V
802.11a CH 60 5300MHz		10600	46.27	-27.73	74	46.31	40	19.54	59.58	100	0	P	H	
		15900	43.93	-30.07	74	42.19	37.1	24.36	59.72	100	0	P	H	
													H	
													H	
			10600	46.38	-27.62	74	46.42	40	19.54	59.58	100	0	P	V
			15900	43.67	-30.33	74	41.93	37.1	24.36	59.72	100	0	P	V
														V
														V
802.11a CH 64 5320MHz		10640	46.4	-27.6	74	46.47	40	19.6	59.67	100	0	P	H	
		15960	43.99	-30.01	74	42.28	37.04	24.36	59.69	100	0	P	H	
													H	
													H	
			10640	46.57	-27.43	74	46.64	40	19.6	59.67	100	0	P	V
			15960	44.19	-29.81	74	42.48	37.04	24.36	59.69	100	0	P	V
														V
														V
Remark	1. No other spurious found. 2. All results are PASS against Peak and Average limit line.													



Band 2 5250~5350MHz
WIFI 802.11n HT20 (Band Edge @ 3m)

WIFI Ant. 1+2	Note	Frequency (MHz)	Level (dBμV/m)	Over Limit (dB)	Limit Line (dBμV/m)	Read Level (dBμV)	Antenna Factor (dB/m)	Path Loss (dB)	Preamp Factor (dB)	Ant Pos (cm)	Table Pos (deg)	Peak Avg. (P/A)	Pol. (H/V)
802.11n HT20 CH 52 5260MHz		5139.4	53.26	-20.74	74	38.07	31.72	12.31	28.84	100	61	P	H
		5094.86	42.56	-11.44	54	27.33	31.79	12.25	28.81	100	61	A	H
	*	5260	104.65	-	-	89.82	31.3	12.45	28.92	100	61	P	H
	*	5260	95.25	-	-	80.42	31.3	12.45	28.92	100	61	A	H
		5355.6	53.36	-20.64	74	38.58	31.22	12.54	28.98	100	61	P	H
		5452.8	41.93	-12.07	54	26.69	31.61	12.68	29.05	100	61	A	H
		5131.24	53.69	-20.31	74	38.49	31.74	12.3	28.84	101	318	P	V
		5096.56	42.42	-11.58	54	27.19	31.79	12.25	28.81	101	318	A	V
	*	5260	100.91	-	-	86.08	31.3	12.45	28.92	101	318	P	V
	*	5260	91.11	-	-	76.28	31.3	12.45	28.92	101	318	A	V
		5406.72	53.53	-20.47	74	38.53	31.43	12.59	29.02	101	318	P	V
		5455.2	41.7	-12.3	54	26.46	31.61	12.68	29.05	101	318	A	V
802.11n HT20 CH 60 5300MHz		5111.86	53.98	-20.02	74	38.75	31.78	12.27	28.82	100	59	P	H
		5090.44	42.4	-11.6	54	27.19	31.78	12.24	28.81	100	59	A	H
	*	5300	104.93	-	-	90.09	31.3	12.49	28.95	100	59	P	H
	*	5300	95.57	-	-	80.73	31.3	12.49	28.95	100	59	A	H
		5416.32	53.9	-20.1	74	38.84	31.47	12.61	29.02	100	59	P	H
		5455.92	41.96	-12.04	54	26.71	31.61	12.69	29.05	100	59	A	H
		5083.98	53.38	-20.62	74	38.19	31.77	12.23	28.81	113	318	P	V
		5096.56	42.32	-11.68	54	27.09	31.79	12.25	28.81	113	318	A	V
	*	5300	100.47	-	-	85.63	31.3	12.49	28.95	113	318	P	V
	*	5300	91.39	-	-	76.55	31.3	12.49	28.95	113	318	A	V
	5439.84	53.29	-20.71	74	38.11	31.56	12.66	29.04	113	318	P	V	
	5448.48	41.69	-12.31	54	26.48	31.59	12.67	29.05	113	318	A	V	



802.11n HT20 CH 64 5320MHz	*	5320	105.32	-	-	90.52	31.26	12.5	28.96	100	60	P	H
	*	5320	95.72	-	-	80.92	31.26	12.5	28.96	100	60	A	H
		5351.36	54.07	-19.93	74	39.31	31.21	12.53	28.98	100	60	P	H
		5455.84	41.89	-12.11	54	26.64	31.61	12.69	29.05	100	60	A	H
													H
													H
	*	5320	99.24	-	-	84.44	31.26	12.5	28.96	100	314	P	V
	*	5320	90.18	-	-	75.38	31.26	12.5	28.96	100	314	A	V
		5426.72	53.04	-20.96	74	37.93	31.51	12.63	29.03	100	314	P	V
		5445.12	41.65	-12.35	54	26.44	31.58	12.67	29.04	100	314	A	V
													V
												V	
Remark	1. No other spurious found. 2. All results are PASS against Peak and Average limit line.												



Band 2 5250~5350MHz
WIFI 802.11n HT20 (Harmonic @ 3m)

WIFI Ant. 1+2	Note	Frequency (MHz)	Level (dBμV/m)	Over Limit (dB)	Limit Line (dBμV/m)	Read Level (dBμV)	Antenna Factor (dB/m)	Path Loss (dB)	Preamp Factor (dB)	Ant Pos (cm)	Table Pos (deg)	Peak Avg. (P/A)	Pol. (H/V)	
802.11n HT20 CH 52 5260MHz		10520	45.94	-22.26	68.2	45.92	40	19.42	59.4	100	0	P	H	
		15780	44.06	-29.94	74	42.19	37.3	24.37	59.8	100	0	P	H	
													H	
													H	
			10520	45.36	-22.84	68.2	45.34	40	19.42	59.4	100	0	P	V
			15780	43.29	-30.71	74	41.42	37.3	24.37	59.8	100	0	P	V
														V
802.11n HT20 CH 60 5300MHz		10600	45.92	-28.08	74	45.96	40	19.54	59.58	100	0	P	H	
		15900	43.33	-30.67	74	41.59	37.1	24.36	59.72	100	0	P	H	
													H	
													H	
			10600	46.08	-27.92	74	46.12	40	19.54	59.58	100	0	P	V
			15900	43.65	-30.35	74	41.91	37.1	24.36	59.72	100	0	P	V
														V
802.11n HT20 CH 64 5320MHz		10640	49.55	-24.45	74	49.62	40	19.6	59.67	100	0	P	H	
		15960	46.38	-27.62	74	44.67	37.04	24.36	59.69	100	0	P	H	
													H	
													H	
			10640	49.14	-24.86	74	49.21	40	19.6	59.67	100	0	P	V
			15960	45.85	-28.15	74	44.14	37.04	24.36	59.69	100	0	P	V
														V
Remark	1. No other spurious found.													
	2. All results are PASS against Peak and Average limit line.													



Band 2 5250~5350MHz
WIFI 802.11n HT40 (Band Edge @ 3m)

WIFI Ant. 1+2	Note	Frequency (MHz)	Level (dBμV/m)	Over Limit (dB)	Limit Line (dBμV/m)	Read Level (dBμV)	Antenna Factor (dB/m)	Path Loss (dB)	Preamp Factor (dB)	Ant Pos (cm)	Table Pos (deg)	Peak Avg. (P/A)	Pol. (H/V)
802.11n HT40 CH 54 5270MHz		5093.84	53.54	-20.46	74	38.31	31.79	12.25	28.81	100	60	P	H
		5092.82	42.3	-11.7	54	27.07	31.79	12.25	28.81	100	60	A	H
	*	5270	101.25	-	-	86.42	31.3	12.46	28.93	100	60	P	H
	*	5270	91.8	-	-	76.97	31.3	12.46	28.93	100	60	A	H
		5382.96	53.38	-20.62	74	38.49	31.33	12.56	29	100	60	P	H
		5445.36	41.77	-12.23	54	26.56	31.58	12.67	29.04	100	60	A	H
		5058.14	54.05	-19.95	74	38.92	31.72	12.2	28.79	102	319	P	V
		5095.88	42.27	-11.73	54	27.04	31.79	12.25	28.81	102	319	A	V
	*	5270	97.15	-	-	82.32	31.3	12.46	28.93	102	319	P	V
	*	5270	88.17	-	-	73.34	31.3	12.46	28.93	102	319	A	V
		5445.12	54.38	-19.62	74	39.17	31.58	12.67	29.04	102	319	P	V
		5446.8	41.61	-12.39	54	26.39	31.59	12.67	29.04	102	319	A	V
802.11n HT40 CH 62 5310MHz		5063.24	54.43	-19.57	74	39.28	31.73	12.21	28.79	100	59	P	H
		5096.9	42.25	-11.75	54	27.02	31.79	12.25	28.81	100	59	A	H
	*	5310	101.04	-	-	86.22	31.28	12.49	28.95	100	59	P	H
	*	5310	91.73	-	-	76.91	31.28	12.49	28.95	100	59	A	H
		5455.44	52.63	-21.37	74	37.38	31.61	12.69	29.05	100	59	P	H
		5350.08	41.89	-12.11	54	27.14	31.2	12.53	28.98	100	59	A	H
		5134.3	53.22	-20.78	74	38.03	31.73	12.3	28.84	106	147	P	V
		5095.54	42.07	-11.93	54	26.84	31.79	12.25	28.81	106	147	A	V
	*	5310	97.74	-	-	82.92	31.28	12.49	28.95	106	147	P	V
	*	5310	88.74	-	-	73.92	31.28	12.49	28.95	106	147	A	V
	5395.44	53.09	-20.91	74	38.14	31.38	12.58	29.01	106	147	P	V	
	5452.32	41.59	-12.41	54	26.36	31.6	12.68	29.05	106	147	A	V	
Remark	1. No other spurious found. 2. All results are PASS against Peak and Average limit line.												



**Band 2 5250~5350MHz
WIFI 802.11n HT40 (Harmonic @ 3m)**

WIFI Ant. 1+2	Note	Frequency (MHz)	Level (dBμV/m)	Over Limit (dB)	Limit Line (dBμV/m)	Read Level (dBμV)	Antenna Factor (dB/m)	Path Loss (dB)	Preamp Factor (dB)	Ant Pos (cm)	Table Pos (deg)	Peak Avg. (P/A)	Pol. (H/V)	
802.11n HT40 CH 54 5270MHz		10540	47.61	-20.59	68.2	47.61	40	19.45	59.45	100	0	P	H	
		15810	44.86	-29.14	74	42.99	37.28	24.37	59.78	100	0	P	H	
													H	
													H	
			10540	48.28	-19.92	68.2	48.28	40	19.45	59.45	100	0	P	V
			15810	45.58	-28.42	74	43.71	37.28	24.37	59.78	100	0	P	V
														V
802.11n HT40 CH 62 5310MHz		10620	47.89	-26.11	74	47.95	40	19.57	59.63	100	0	P	H	
		15930	45.82	-28.18	74	44.08	37.07	24.37	59.7	100	0	P	H	
													H	
													H	
			10620	47.95	-26.05	74	48.01	40	19.57	59.63	100	0	P	V
			15930	45.21	-28.79	74	43.47	37.07	24.37	59.7	100	0	P	V
														V
Remark	1. No other spurious found.													
	2. All results are PASS against Peak and Average limit line.													



**Band 2 5250~5350MHz
WIFI 802.11ac VHT80 (Band Edge @ 3m)**

WIFI Ant. 1+2	Note	Frequency (MHz)	Level (dBμV/m)	Over Limit (dB)	Limit Line (dBμV/m)	Read Level (dBμV)	Antenna Factor (dB/m)	Path Loss (dB)	Preamp Factor (dB)	Ant Pos (cm)	Table Pos (deg)	Peak Avg. (P/A)	Pol. (H/V)
802.11ac VHT80 CH 58 5290MHz		5146.88	53.73	-20.27	74	38.55	31.71	12.32	28.85	100	58	P	H
		5094.52	42.19	-11.81	54	26.96	31.79	12.25	28.81	100	58	A	H
	*	5290	98.85	-	-	84.01	31.3	12.48	28.94	100	58	P	H
	*	5290	89.38	-	-	74.54	31.3	12.48	28.94	100	58	A	H
		5400.48	53.33	-20.67	74	38.36	31.4	12.58	29.01	100	58	P	H
		5350.32	42.22	-11.78	54	27.47	31.2	12.53	28.98	100	58	A	H
		5102.68	53.62	-20.38	74	38.39	31.79	12.26	28.82	102	144	P	V
		5092.14	42.17	-11.83	54	26.96	31.78	12.24	28.81	102	144	A	V
	*	5290	95.26	-	-	80.42	31.3	12.48	28.94	102	144	P	V
	*	5290	86.38	-	-	71.54	31.3	12.48	28.94	102	144	A	V
		5352	53.49	-20.51	74	38.73	31.21	12.53	28.98	102	144	P	V
		5350.32	41.72	-12.28	54	26.97	31.2	12.53	28.98	102	144	A	V
Remark	1. No other spurious found. 2. All results are PASS against Peak and Average limit line.												



**Band 2 5250~5350MHz
WIFI 802.11ac VHT80 (Harmonic @ 3m)**

WIFI Ant. 1+2	Note	Frequency (MHz)	Level (dBμV/m)	Over Limit (dB)	Limit Line (dBμV/m)	Read Level (dBμV)	Antenna Factor (dB/m)	Path Loss (dB)	Preamp Factor (dB)	Ant Pos (cm)	Table Pos (deg)	Peak Avg. (P/A)	Pol. (H/V)	
802.11ac VHT80 CH 58 5290MHz		10580	47.17	-21.03	68.2	47.2	40	19.51	59.54	100	0	P	H	
		15870	45.43	-28.57	74	43.64	37.16	24.37	59.74	100	0	P	H	
													H	
													H	
			10580	47.48	-20.72	68.2	47.51	40	19.51	59.54	100	0	P	V
			15870	45.32	-28.68	74	43.53	37.16	24.37	59.74	100	0	P	V
														V
Remark	1. No other spurious found. 2. All results are PASS against Peak and Average limit line.													



Band 3 - 5470~5725MHz
WIFI 802.11a (Band Edge @ 3m)

WIFI	Note	Frequency	Level	Over	Limit	Read	Antenna	Path	Preamp	Ant	Table	Peak	Pol.	
Ant.				Limit	Line	Level	Factor	Loss	Factor	Pos	Pos	Avg.		
1+2		(MHz)	(dBµV/m)	(dB)	(dBµV/m)	(dBµV)	(dB/m)	(dB)	(dB)	(cm)	(deg)	(P/A)	(H/V)	
802.11a CH 100 5500MHz		5390.48	54.51	-19.49	74	39.59	31.36	12.57	29.01	101	61	P	H	
		5464.56	52.62	-15.58	68.2	37.35	31.63	12.7	29.06	101	61	P	H	
		5453.68	41.54	-12.46	54	26.3	31.61	12.68	29.05	101	61	A	H	
	*	5500	104.86	-	-	89.47	31.7	12.77	29.08	101	61	P	H	
	*	5500	96.52	-	-	81.13	31.7	12.77	29.08	101	61	A	H	
														H
			5423.6	54.22	-19.78	74	39.14	31.49	12.62	29.03	305	99	P	V
			5465.2	52.96	-15.24	68.2	37.69	31.63	12.7	29.06	305	99	P	V
			5449.36	41.49	-12.51	54	26.27	31.6	12.67	29.05	305	99	A	V
	*		5500	103.72	-	-	88.33	31.7	12.77	29.08	305	99	P	V
	*		5500	95.25	-	-	79.86	31.7	12.77	29.08	305	99	A	V
														V
802.11a CH 116 5580MHz		5382.4	53.89	-20.11	74	39	31.33	12.56	29	100	61	P	H	
		5466.64	53.62	-14.58	68.2	38.34	31.63	12.71	29.06	100	61	P	H	
		5456.08	41.67	-12.33	54	26.42	31.61	12.69	29.05	100	61	A	H	
	*	5580	105.5	-	-	89.9	31.74	12.92	29.06	100	61	P	H	
	*	5580	97.56	-	-	81.96	31.74	12.92	29.06	100	61	A	H	
			5747.99	54.27	-13.93	68.2	38.1	31.99	13.2	29.02	100	61	P	H
			5431.84	53.15	-20.85	74	38.02	31.53	12.64	29.04	297	95	P	V
			5463.28	52.18	-16.02	68.2	36.91	31.63	12.7	29.06	297	95	P	V
			5454.64	41.55	-12.45	54	26.31	31.61	12.68	29.05	297	95	A	V
	*		5580	103.95	-	-	88.35	31.74	12.92	29.06	297	95	P	V
	*		5580	96.21	-	-	80.61	31.74	12.92	29.06	297	95	A	V
			5725.31	54.16	-14.04	68.2	38.13	31.9	13.16	29.03	297	95	P	V



802.11a CH 140 5700MHz	*	5700	106.03	-	-	90.14	31.8	13.12	29.03	100	62	P	H
	*	5700	98	-	-	82.11	31.8	13.12	29.03	100	62	A	H
		5764.36	54.81	-13.39	68.2	38.58	32.03	13.22	29.02	100	62	P	H
													H
													H
													H
	*	5700	104.57	-	-	88.68	31.8	13.12	29.03	302	96	P	V
	*	5700	96.14	-	-	80.25	31.8	13.12	29.03	302	96	A	V
		5731.08	54.25	-13.95	68.2	38.18	31.92	13.17	29.02	302	96	P	V
													V
													V
													V
Remark	1. No other spurious found. 2. All results are PASS against Peak and Average limit line.												



Band 3 - 5470~5725MHz
WIFI 802.11a (Harmonic @ 3m)

WIFI Ant. 1+2	Note	Frequency (MHz)	Level (dBμV/m)	Over Limit (dB)	Limit Line (dBμV/m)	Read Level (dBμV)	Antenna Factor (dB/m)	Path Loss (dB)	Preamp Factor (dB)	Ant Pos (cm)	Table Pos (deg)	Peak Avg. (P/A)	Pol. (H/V)	
802.11a CH 100 5500MHz		11000	48.79	-25.21	74	48.74	40.4	20.13	60.48	100	0	P	H	
		16500	47.9	-20.3	68.2	42.82	38.8	25.22	58.94	100	0	P	H	
													H	
													H	
			11000	47.57	-26.43	74	47.52	40.4	20.13	60.48	100	0	P	V
			16500	47.8	-20.4	68.2	42.72	38.8	25.22	58.94	100	0	P	V
														V
														V
802.11a CH 116 5580MHz		11160	47.05	-26.95	74	47.34	39.98	20.3	60.57	100	0	P	H	
		16740	49.43	-18.77	68.2	42.38	39.8	25.63	58.38	100	0	P	H	
													H	
													H	
			11160	47.45	-26.55	74	47.74	39.98	20.3	60.57	100	0	P	V
			16740	49.63	-18.57	68.2	42.58	39.8	25.63	58.38	100	0	P	V
														V
														V
802.11a CH 140 5700MHz		11400	47.65	-26.35	74	47.68	40.1	20.57	60.7	100	0	P	H	
		17100	50.03	-18.17	68.2	40.89	40.3	26.25	57.41	100	0	P	H	
													H	
													H	
			11400	48.18	-25.82	74	48.21	40.1	20.57	60.7	100	0	P	V
			17100	49.99	-18.21	68.2	40.85	40.3	26.25	57.41	100	0	P	V
														V
														V
Remark	1. No other spurious found. 2. All results are PASS against Peak and Average limit line.													



Band 3 - 5470~5725MHz
WIFI 802.11n HT20 (Band Edge @ 3m)

WIFI Ant. 1+2	Note	Frequency (MHz)	Level (dBμV/m)	Over Limit (dB)	Limit Line (dBμV/m)	Read Level (dBμV)	Antenna Factor (dB/m)	Path Loss (dB)	Preamp Factor (dB)	Ant Pos (cm)	Table Pos (deg)	Peak Avg. (P/A)	Pol. (H/V)	
802.11n HT20 CH 100 5500MHz		5441.68	53.64	-20.36	74	38.45	31.57	12.66	29.04	100	60	P	H	
		5464.88	53.26	-14.94	68.2	37.99	31.63	12.7	29.06	100	60	P	H	
		5457.68	41.61	-12.39	54	26.35	31.62	12.69	29.05	100	60	A	H	
	*	5500	105.16	-	-	89.77	31.7	12.77	29.08	100	60	P	H	
	*	5500	95.39	-	-	80	31.7	12.77	29.08	100	60	A	H	
														H
			5415.76	53.83	-20.17	74	38.78	31.46	12.61	29.02	342	96	P	V
			5468.56	52.57	-15.63	68.2	37.28	31.64	12.71	29.06	342	96	P	V
			5455.12	41.54	-12.46	54	26.3	31.61	12.68	29.05	342	96	A	V
	*	5500	102.22	-	-	86.83	31.7	12.77	29.08	342	96	P	V	
	*	5500	92.44	-	-	77.05	31.7	12.77	29.08	342	96	A	V	
														V
802.11n HT20 CH 116 5580MHz		5446.72	53.4	-20.6	74	38.18	31.59	12.67	29.04	101	61	P	H	
		5466.64	53.21	-14.99	68.2	37.93	31.63	12.71	29.06	101	61	P	H	
		5450.56	41.48	-12.52	54	26.25	31.6	12.68	29.05	101	61	A	H	
	*	5580	106.1	-	-	90.5	31.74	12.92	29.06	101	61	P	H	
	*	5580	97.07	-	-	81.47	31.74	12.92	29.06	101	61	A	H	
			5744.525	54.11	-14.09	68.2	37.96	31.98	13.19	29.02	101	61	P	H
			5360.8	53.02	-20.98	74	38.23	31.24	12.54	28.99	107	183	P	V
			5463.52	52.48	-15.72	68.2	37.21	31.63	12.7	29.06	107	183	P	V
			5454.4	41.39	-12.61	54	26.15	31.61	12.68	29.05	107	183	A	V
	*	5580	102.67	-	-	87.07	31.74	12.92	29.06	107	183	P	V	
	*	5580	92.81	-	-	77.21	31.74	12.92	29.06	107	183	A	V	
			5764.37	53.77	-14.43	68.2	37.54	32.03	13.22	29.02	107	183	P	V



802.11n HT20 CH 140 5700MHz	*	5700	106.35	-	-	90.46	31.8	13.12	29.03	101	62	P	H
	*	5700	97.2	-	-	81.31	31.8	13.12	29.03	101	62	A	H
		5730.52	55.18	-13.02	68.2	39.11	31.92	13.17	29.02	101	62	P	H
													H
													H
													H
	*	5700	102.39	-	-	86.5	31.8	13.12	29.03	109	179	P	V
	*	5700	92.5	-	-	76.61	31.8	13.12	29.03	109	179	A	V
		5738.28	54.59	-13.61	68.2	38.48	31.95	13.18	29.02	109	179	P	V
													V
												V	
												V	
Remark	1. No other spurious found. 2. All results are PASS against Peak and Average limit line.												



Band 3 - 5470~5725MHz
WIFI 802.11n HT20 (Harmonic @ 3m)

WIFI Ant. 1+2	Note	Frequency (MHz)	Level (dBμV/m)	Over Limit (dB)	Limit Line (dBμV/m)	Read Level (dBμV)	Antenna Factor (dB/m)	Path Loss (dB)	Preamp Factor (dB)	Ant Pos (cm)	Table Pos (deg)	Peak Avg. (P/A)	Pol. (H/V)	
802.11n HT20 CH 100 5500MHz		11000	49.7	-24.3	74	49.65	40.4	20.13	60.48	100	0	P	H	
		16500	47.75	-20.45	68.2	42.67	38.8	25.22	58.94	100	0	P	H	
													H	
													H	
			11000	48.43	-25.57	74	48.38	40.4	20.13	60.48	100	0	P	V
			16500	48.45	-19.75	68.2	43.37	38.8	25.22	58.94	100	0	P	V
														V
														V
802.11n HT20 CH 116 5580MHz		11160	47.38	-26.62	74	47.67	39.98	20.3	60.57	100	0	P	H	
		16740	49.8	-18.4	68.2	42.75	39.8	25.63	58.38	100	0	P	H	
													H	
													H	
			11160	47.52	-26.48	74	47.81	39.98	20.3	60.57	100	0	P	V
			16740	49.51	-18.69	68.2	42.46	39.8	25.63	58.38	100	0	P	V
														V
														V
802.11n HT20 CH 140 5700MHz		11400	47.06	-26.94	74	47.09	40.1	20.57	60.7	100	0	P	H	
		17100	49.38	-18.82	68.2	40.24	40.3	26.25	57.41	100	0	P	H	
													H	
													H	
			11400	47.02	-26.98	74	47.05	40.1	20.57	60.7	100	0	P	V
			17100	50.34	-17.86	68.2	41.2	40.3	26.25	57.41	100	0	P	V
														V
														V
Remark	1. No other spurious found. 2. All results are PASS against Peak and Average limit line.													



Band 3 - 5470~5725MHz
WIFI 802.11n HT40 (Band Edge @ 3m)

WIFI Ant. 1+2	Note	Frequency (MHz)	Level (dBμV/m)	Over Limit (dB)	Limit Line (dBμV/m)	Read Level (dBμV)	Antenna Factor (dB/m)	Path Loss (dB)	Preamp Factor (dB)	Ant Pos (cm)	Table Pos (deg)	Peak Avg. (P/A)	Pol. (H/V)
802.11n HT40 CH 102 5510MHz		5376.88	53.57	-20.43	74	38.7	31.31	12.56	29	100	59	P	H
		5462.08	53.16	-15.04	68.2	37.89	31.62	12.7	29.05	100	59	P	H
		5458	41.52	-12.48	54	26.26	31.62	12.69	29.05	100	59	A	H
	*	5510	101.99	-	-	86.56	31.72	12.79	29.08	100	59	P	H
	*	5510	92.48	-	-	77.05	31.72	12.79	29.08	100	59	A	H
		5742.95	53.61	-14.59	68.2	37.47	31.97	13.19	29.02	100	59	P	H
		5390.8	53.78	-20.22	74	38.86	31.36	12.57	29.01	101	181	P	V
		5464.48	52.73	-15.47	68.2	37.46	31.63	12.7	29.06	101	181	P	V
		5459.2	41.44	-12.56	54	26.18	31.62	12.69	29.05	101	181	A	V
	*	5510	98.78	-	-	83.35	31.72	12.79	29.08	101	181	P	V
	*	5510	89.85	-	-	74.42	31.72	12.79	29.08	101	181	A	V
		5736.335	54.43	-13.77	68.2	38.32	31.95	13.18	29.02	101	181	P	V
802.11n HT40 CH 110 5550MHz		5414.08	54.19	-19.81	74	39.14	31.46	12.61	29.02	101	64	P	H
		5462.32	52.1	-16.1	68.2	36.84	31.62	12.7	29.06	101	64	P	H
		5449.6	41.52	-12.48	54	26.3	31.6	12.67	29.05	101	64	A	H
	*	5550	102.82	-	-	87.23	31.8	12.86	29.07	101	64	P	H
	*	5550	93.18	-	-	77.59	31.8	12.86	29.07	101	64	A	H
		5735.39	53.78	-14.42	68.2	37.68	31.94	13.18	29.02	101	64	P	H
		5424.16	52.8	-21.2	74	37.7	31.5	12.63	29.03	102	180	P	V
		5469.04	53.05	-15.15	68.2	37.76	31.64	12.71	29.06	102	180	P	V
		5456.08	41.43	-12.57	54	26.18	31.61	12.69	29.05	102	180	A	V
	*	5550	98.08	-	-	82.49	31.8	12.86	29.07	102	180	P	V
	*	5550	89.54	-	-	73.95	31.8	12.86	29.07	102	180	A	V
		5751.14	53.96	-14.24	68.2	37.78	32	13.2	29.02	102	180	P	V



802.11n HT40 CH 134 5670MHz		5456.75	53.2	-20.8	74	37.95	31.61	12.69	29.05	100	60	P	H
		5462.35	51.9	-16.3	68.2	36.64	31.62	12.7	29.06	100	60	P	H
		5457.1	41.45	-12.55	54	26.2	31.61	12.69	29.05	100	60	A	H
	*	5670	103.52	-	-	87.75	31.74	13.07	29.04	100	60	P	H
	*	5670	94.26	-	-	78.49	31.74	13.07	29.04	100	60	A	H
		5739.45	55.02	-13.18	68.2	38.9	31.96	13.18	29.02	100	60	P	H
		5450.8	52.96	-21.04	74	37.73	31.6	12.68	29.05	100	178	P	V
		5463.75	52.56	-15.64	68.2	37.29	31.63	12.7	29.06	100	178	P	V
		5459.2	41.43	-12.57	54	26.17	31.62	12.69	29.05	100	178	A	V
	*	5670	98.56	-	-	82.79	31.74	13.07	29.04	100	178	P	V
	*	5670	90.07	-	-	74.3	31.74	13.07	29.04	100	178	A	V
		5743.125	54.01	-14.19	68.2	37.87	31.97	13.19	29.02	100	178	P	V
Remark	1. No other spurious found. 2. All results are PASS against Peak and Average limit line.												



**Band 3 - 5470~5725MHz
WIFI 802.11n HT40 (Harmonic @ 3m)**

WIFI Ant. 1+2	Note	Frequency (MHz)	Level (dBμV/m)	Over Limit (dB)	Limit Line (dBμV/m)	Read Level (dBμV)	Antenna Factor (dB/m)	Path Loss (dB)	Preamp Factor (dB)	Ant Pos (cm)	Table Pos (deg)	Peak Avg. (P/A)	Pol. (H/V)
802.11n HT40 CH 102 5510MHz		11020	48.4	-25.6	74	48.4	40.34	20.15	60.49	100	0	P	H
		16530	47.06	-21.14	68.2	41.71	38.95	25.27	58.87	100	0	P	H
													H
													H
		11020	48.25	-25.75	74	48.25	40.34	20.15	60.49	100	0	P	V
		16530	47.35	-20.85	68.2	42	38.95	25.27	58.87	100	0	P	V
													V
													V
802.11n HT40 CH 110 5550MHz		11100	47.95	-26.05	74	48.15	40.1	20.24	60.54	100	0	P	H
		16650	48.16	-20.04	68.2	41.83	39.45	25.47	58.59	100	0	P	H
													H
													H
		11100	47.89	-26.11	74	48.09	40.1	20.24	60.54	100	0	P	V
		16650	47.98	-20.22	68.2	41.65	39.45	25.47	58.59	100	0	P	V
													V
													V
802.11n HT40 CH 134 5670MHz		11340	46.97	-27.03	74	47.22	39.92	20.5	60.67	100	0	P	H
		17010	49.83	-18.37	68.2	40.89	40.57	26.1	57.73	100	0	P	H
													H
													H
		11340	47.92	-26.08	74	48.17	39.92	20.5	60.67	100	0	P	V
		17010	50.75	-17.45	68.2	41.81	40.57	26.1	57.73	100	0	P	V
													V
													V
Remark	1. No other spurious found. 2. All results are PASS against Peak and Average limit line.												



Band 3 - 5470~5725MHz
WIFI 802.11ac VHT80 (Band Edge @ 3m)

WIFI Ant. 1+2	Note	Frequency (MHz)	Level (dBμV/m)	Over Limit (dB)	Limit Line (dBμV/m)	Read Level (dBμV)	Antenna Factor (dB/m)	Path Loss (dB)	Preamp Factor (dB)	Ant Pos (cm)	Table Pos (deg)	Peak Avg. (P/A)	Pol. (H/V)
802.11ac VHT80 CH 106 5530MHz		5454.16	54.3	-19.7	74	39.06	31.61	12.68	29.05	101	62	P	H
		5464.24	52.86	-15.34	68.2	37.59	31.63	12.7	29.06	101	62	P	H
		5458.72	42.03	-11.97	54	26.77	31.62	12.69	29.05	101	62	A	H
	*	5530	100.28	-	-	84.76	31.76	12.83	29.07	101	62	P	H
	*	5530	90.89	-	-	75.37	31.76	12.83	29.07	101	62	A	H
		5734.76	54.28	-13.92	68.2	38.18	31.94	13.18	29.02	101	62	P	H
		5423.44	53.63	-20.37	74	38.55	31.49	12.62	29.03	107	182	P	V
		5465.68	54.5	-13.7	68.2	39.23	31.63	12.7	29.06	107	182	P	V
		5458.48	41.65	-12.35	54	26.39	31.62	12.69	29.05	107	182	A	V
	*	5530	95.09	-	-	79.57	31.76	12.83	29.07	107	182	P	V
	*	5530	86.43	-	-	70.91	31.76	12.83	29.07	107	182	A	V
		5747.36	54.59	-13.61	68.2	38.42	31.99	13.2	29.02	107	182	P	V
802.11ac VHT80 CH 122 5610MHz		5405.92	54.07	-19.93	74	39.08	31.42	12.59	29.02	100	62	P	H
		5460.4	53.96	-14.24	68.2	38.7	31.62	12.69	29.05	100	62	P	H
		5456.08	41.56	-12.44	54	26.31	31.61	12.69	29.05	100	62	A	H
	*	5610	101.24	-	-	85.61	31.7	12.98	29.05	100	62	P	H
	*	5610	92.07	-	-	76.44	31.7	12.98	29.05	100	62	A	H
		5736.65	54.49	-13.71	68.2	38.38	31.95	13.18	29.02	100	62	P	H
		5359.12	53.18	-20.82	74	38.39	31.24	12.54	28.99	108	185	P	V
		5464	52.06	-16.14	68.2	36.79	31.63	12.7	29.06	108	185	P	V
		5455.6	41.25	-12.75	54	26	31.61	12.69	29.05	108	185	A	V
	*	5610	95.88	-	-	80.25	31.7	12.98	29.05	108	185	P	V
	*	5610	86.31	-	-	70.68	31.7	12.98	29.05	108	185	A	V
		5751.77	53.54	-14.66	68.2	37.36	32	13.2	29.02	108	185	P	V
Remark	1. No other spurious found. 2. All results are PASS against Peak and Average limit line.												



**Band 3 5470~5725MHz
WIFI 802.11ac VHT80 (Harmonic @ 3m)**

WIFI Ant. 1+2	Note	Frequency (MHz)	Level (dBμV/m)	Over Limit (dB)	Limit Line (dBμV/m)	Read Level (dBμV)	Antenna Factor (dB/m)	Path Loss (dB)	Preamp Factor (dB)	Ant Pos (cm)	Table Pos (deg)	Peak Avg. (P/A)	Pol. (H/V)
802.11ac VHT80		11060	47.56	-26.44	74	47.65	40.22	20.2	60.51	100	0	P	H
		16590	48.44	-19.76	68.2	42.55	39.25	25.37	58.73	100	0	P	H
													H
													H
CH 106 5530MHz		11060	48.21	-25.79	74	48.3	40.22	20.2	60.51	100	0	P	V
		16590	48.3	-19.9	68.2	42.41	39.25	25.37	58.73	100	0	P	V
													V
													V
802.11ac VHT80		11220	47.06	-26.94	74	47.41	39.88	20.37	60.6	100	0	P	H
		16830	49.66	-18.54	68.2	41.8	40.25	25.78	58.17	100	0	P	H
													H
													H
CH 122 5610MHz		11220	47.76	-26.24	74	48.11	39.88	20.37	60.6	100	0	P	V
		16830	48.6	-19.6	68.2	40.74	40.25	25.78	58.17	100	0	P	V
													V
													V
Remark	1. No other spurious found. 2. All results are PASS against Peak and Average limit line.												



Band 3 - Straddle Channel
WIFI 802.11a (Band Edge @ 3m)

WIFI	Note	Frequency	Level	Over	Limit	Read	Antenna	Path	Preamp	Ant	Table	Peak	Pol.
Ant.				Limit	Line	Level	Factor	Loss	Factor	Pos	Pos	Avg.	
1+2		(MHz)	(dBµV/m)	(dB)	(dBµV/m)	(dBµV)	(dB/m)	(dB)	(dB)	(cm)	(deg)	(P/A)	(H/V)
802.11a CH 144 5720MHz		5426.44	54.37	-19.63	74	39.26	31.51	12.63	29.03	101	61	P	H
		5460.76	53.65	-14.55	68.2	38.38	31.62	12.7	29.05	101	61	P	H
		5455.69	41.65	-12.35	54	26.4	31.61	12.69	29.05	101	61	A	H
	*	5720	105.81	-	-	89.81	31.88	13.15	29.03	101	61	P	H
	*	5720	97.83	-	-	81.83	31.88	13.15	29.03	101	61	A	H
		5912.75	56.99	-11.21	68.2	40.37	32.25	13.35	28.98	101	61	P	H
		5373.01	54.73	-19.27	74	39.89	31.29	12.55	29	301	96	P	V
		5466.61	53.45	-14.75	68.2	38.17	31.63	12.71	29.06	301	96	P	V
		5447.5	41.56	-12.44	54	26.35	31.59	12.67	29.05	301	96	A	V
	*	5720	103.3	-	-	87.3	31.88	13.15	29.03	301	96	P	V
	*	5720	95.38	-	-	79.38	31.88	13.15	29.03	301	96	A	V
		5873.75	57.48	-10.72	68.2	41	32.15	13.32	28.99	301	96	P	V
Remark	1. No other spurious found. 2. All results are PASS against Peak and Average limit line.												



**Band 3 - Straddle Channel
WIFI 802.11a (Harmonic @ 3m)**

WIFI Ant. 1+2	Note	Frequency (MHz)	Level (dBμV/m)	Over Limit (dB)	Limit Line (dBμV/m)	Read Level (dBμV)	Antenna Factor (dB/m)	Path Loss (dB)	Preamp Factor (dB)	Ant Pos (cm)	Table Pos (deg)	Peak Avg. (P/A)	Pol. (H/V)	
802.11a CH 144 5720MHz		11440	47.93	-26.07	74	47.95	40.1	20.61	60.73	100	0	P	H	
		17160	49.8	-18.4	68.2	40.1	40.54	26.35	57.19	100	0	P	H	
													H	
													H	
			11440	47.69	-26.31	74	47.71	40.1	20.61	60.73	100	0	P	V
			17160	49.91	-18.29	68.2	40.21	40.54	26.35	57.19	100	0	P	V
														V
														V
Remark	1. No other spurious found. 2. All results are PASS against Peak and Average limit line.													



**Band 3 - Straddle Channel
WIFI 802.11n HT20 (Band Edge @ 3m)**

WIFI Ant. 1+2	Note	Frequency (MHz)	Level (dBμV/m)	Over Limit (dB)	Limit Line (dBμV/m)	Read Level (dBμV)	Antenna Factor (dB/m)	Path Loss (dB)	Preamp Factor (dB)	Ant Pos (cm)	Table Pos (deg)	Peak Avg. (P/A)	Pol. (H/V)
802.11n HT20 CH 144 5720MHz		5455.69	54.36	-19.64	74	39.11	31.61	12.69	29.05	101	61	P	H
		5469.34	54.82	-13.38	68.2	39.53	31.64	12.71	29.06	101	61	P	H
		5457.25	41.52	-12.48	54	26.27	31.61	12.69	29.05	101	61	A	H
	*	5720	106.21	-	-	90.21	31.88	13.15	29.03	101	61	P	H
	*	5720	97.25	-	-	81.25	31.88	13.15	29.03	101	61	A	H
		5885.5	56.87	-11.33	68.2	40.36	32.17	13.33	28.99	101	61	P	H
		5384.32	55.45	-18.55	74	40.54	31.34	12.57	29	102	176	P	V
		5465.83	55.02	-13.18	68.2	39.74	31.63	12.71	29.06	102	176	P	V
		5450.62	41.41	-12.59	54	26.18	31.6	12.68	29.05	102	176	A	V
	*	5720	101.04	-	-	85.04	31.88	13.15	29.03	102	176	P	V
	*	5720	92.5	-	-	76.5	31.88	13.15	29.03	102	176	A	V
		5926.5	57.52	-10.68	68.2	40.83	32.31	13.36	28.98	102	176	P	V
Remark	1. No other spurious found. 2. All results are PASS against Peak and Average limit line.												



**Band 3 - Straddle Channel
WIFI 802.11n HT20 (Harmonic @ 3m)**

WIFI Ant. 1+2	Note	Frequency (MHz)	Level (dBμV/m)	Over Limit (dB)	Limit Line (dBμV/m)	Read Level (dBμV)	Antenna Factor (dB/m)	Path Loss (dB)	Preamp Factor (dB)	Ant Pos (cm)	Table Pos (deg)	Peak Avg. (P/A)	Pol. (H/V)	
802.11n HT20 CH 144 5720MHz		11440	48.07	-25.93	74	48.09	40.1	20.61	60.73	100	0	P	H	
		17160	49.68	-18.52	68.2	39.98	40.54	26.35	57.19	100	0	P	H	
													H	
													H	
			11440	47.5	-26.5	74	47.52	40.1	20.61	60.73	100	0	P	V
			17160	50.19	-18.01	68.2	40.49	40.54	26.35	57.19	100	0	P	V
														V
Remark	1. No other spurious found. 2. All results are PASS against Peak and Average limit line.													



**Band 3 - Straddle Channel
WIFI 802.11n HT40 (Band Edge @ 3m)**

WIFI Ant. 1+2	Note	Frequency (MHz)	Level (dBμV/m)	Over Limit (dB)	Limit Line (dBμV/m)	Read Level (dBμV)	Antenna Factor (dB/m)	Path Loss (dB)	Preamp Factor (dB)	Ant Pos (cm)	Table Pos (deg)	Peak Avg. (P/A)	Pol. (H/V)
802.11n HT40 CH 142 5710MHz		5454.52	54.48	-19.52	74	39.24	31.61	12.68	29.05	100	63	P	H
		5467	53.82	-14.38	68.2	38.54	31.63	12.71	29.06	100	63	P	H
		5456.86	41.45	-12.55	54	26.2	31.61	12.69	29.05	100	63	A	H
	*	5710	103.52	-	-	87.57	31.84	13.14	29.03	100	63	P	H
	*	5710	94.63	-	-	78.68	31.84	13.14	29.03	100	63	A	H
		5858.75	57.12	-11.08	68.2	40.67	32.12	13.32	28.99	100	63	P	H
		5439.31	54.8	-19.2	74	39.63	31.56	12.65	29.04	340	106	P	V
		5460.37	54.3	-13.9	68.2	39.04	31.62	12.69	29.05	340	106	P	V
		5457.25	41.37	-12.63	54	26.12	31.61	12.69	29.05	340	106	A	V
	*	5710	98.52	-	-	82.57	31.84	13.14	29.03	340	106	P	V
	*	5710	89.57	-	-	73.62	31.84	13.14	29.03	340	106	A	V
		5924.25	56.92	-11.28	68.2	40.25	32.3	13.35	28.98	340	106	P	V
Remark	1. No other spurious found. 2. All results are PASS against Peak and Average limit line.												



**Band 3 - Straddle Channel
WIFI 802.11n HT40 (Harmonic @ 3m)**

WIFI Ant. 1+2	Note	Frequency (MHz)	Level (dBμV/m)	Over Limit (dB)	Limit Line (dBμV/m)	Read Level (dBμV)	Antenna Factor (dB/m)	Path Loss (dB)	Preamp Factor (dB)	Ant Pos (cm)	Table Pos (deg)	Peak Avg. (P/A)	Pol. (H/V)	
802.11n HT40 CH 142 5710MHz		11420	47.55	-26.45	74	47.58	40.1	20.59	60.72	100	0	P	H	
		17130	49.86	-18.34	68.2	40.44	40.42	26.3	57.3	100	0	P	H	
													H	
													H	
			11420	47.35	-26.65	74	47.38	40.1	20.59	60.72	100	0	P	V
			17130	49.55	-18.65	68.2	40.13	40.42	26.3	57.3	100	0	P	V
														V
Remark	1. No other spurious found. 2. All results are PASS against Peak and Average limit line.													



**Band 3 - Straddle Channel
WIFI 802.11ac VHT80 (Band Edge @ 3m)**

WIFI Ant. 1+2	Note	Frequency (MHz)	Level (dBμV/m)	Over Limit (dB)	Limit Line (dBμV/m)	Read Level (dBμV)	Antenna Factor (dB/m)	Path Loss (dB)	Preamp Factor (dB)	Ant Pos (cm)	Table Pos (deg)	Peak Avg. (P/A)	Pol. (H/V)
802.11ac VHT80 CH 138 5690MHz		5435.02	54.53	-19.47	74	39.38	31.54	12.65	29.04	101	61	P	H
		5467.39	53.82	-14.38	68.2	38.54	31.63	12.71	29.06	101	61	P	H
		5447.11	41.43	-12.57	54	26.22	31.59	12.67	29.05	101	61	A	H
	*	5690	101.44	-	-	85.59	31.78	13.1	29.03	101	61	P	H
	*	5690	92.21	-	-	76.36	31.78	13.1	29.03	101	61	A	H
		5858.75	57.01	-11.19	68.2	40.56	32.12	13.32	28.99	101	61	P	H
		5446.33	54.69	-19.31	74	39.47	31.59	12.67	29.04	107	178	P	V
		5470	54.89	-13.31	68.2	39.6	31.64	12.71	29.06	107	178	P	V
		5445.94	41.33	-12.67	54	26.12	31.58	12.67	29.04	107	178	A	V
	*	5690	94.95	-	-	79.1	31.78	13.1	29.03	107	178	P	V
	*	5690	86.49	-	-	70.64	31.78	13.1	29.03	107	178	A	V
		5929.5	56.63	-11.57	68.2	39.93	32.32	13.36	28.98	107	178	P	V
Remark	1. No other spurious found. 2. All results are PASS against Peak and Average limit line.												



**Band 3 - Straddle Channel
WIFI 802.11ac VHT80 (Harmonic @ 3m)**

WIFI Ant. 1+2	Note	Frequency (MHz)	Level (dBμV/m)	Over Limit (dB)	Limit Line (dBμV/m)	Read Level (dBμV)	Antenna Factor (dB/m)	Path Loss (dB)	Preamp Factor (dB)	Ant Pos (cm)	Table Pos (deg)	Peak Avg. (P/A)	Pol. (H/V)
802.11ac VHT80		11380	47.55	-26.45	74	47.66	40.04	20.54	60.69	100	0	P	H
		17070	50.5	-17.7	68.2	41.43	40.39	26.2	57.52	100	0	P	H
													H
													H
CH 138 5690MHz		11380	47.59	-26.41	74	47.7	40.04	20.54	60.69	100	0	P	V
		17070	50.36	-17.84	68.2	41.29	40.39	26.2	57.52	100	0	P	V
													V
													V
Remark	1. No other spurious found. 2. All results are PASS against Peak and Average limit line.												



Band 1 - 5150~5250MHz

WIFI 802.11ax HE20 Full RU (242 Tone) (Band Edge @ 3m)

WIFI	Note	Frequency	Level	Over	Limit	Read	Antenna	Path	Preamp	Ant	Table	Peak	Pol.
Ant.				Limit	Line	Level	Factor	Loss	Factor	Pos	Pos	Avg.	
1+2		(MHz)	(dBμV/m)	(dB)	(dBμV/m)	(dBμV)	(dB/m)	(dB)	(dB)	(cm)	(deg)	(P/A)	(H/V)
802.11ax HE20 Full RU (242 Tone) CH 36 5180MHz		5096.98	53.84	-20.16	74	38.61	31.79	12.25	28.81	100	60	P	H
		5087.1	42.36	-11.64	54	27.16	31.77	12.24	28.81	100	60	A	H
	*	5180	104.49	-	-	89.42	31.58	12.36	28.87	100	60	P	H
	*	5180	94.12	-	-	79.05	31.58	12.36	28.87	100	60	A	H
		5148.72	54.31	-19.69	74	39.14	31.7	12.32	28.85	101	320	P	V
		5099.32	42.3	-11.7	54	27.07	31.8	12.25	28.82	101	320	A	V
	*	5180	104.74	-	-	89.67	31.58	12.36	28.87	101	320	P	V
	*	5180	93.76	-	-	78.69	31.58	12.36	28.87	101	320	A	V
802.11ax HE20 Full RU (242 Tone) CH 44 5220MHz		5057.98	53.47	-20.53	74	38.34	31.72	12.2	28.79	100	61	P	H
		5080.86	42.24	-11.76	54	27.05	31.76	12.23	28.8	100	61	A	H
	*	5220	105.26	-	-	90.33	31.42	12.41	28.9	100	61	P	H
	*	5220	93.67	-	-	78.74	31.42	12.41	28.9	100	61	A	H
		5451.88	52.57	-21.43	74	37.34	31.6	12.68	29.05	100	61	P	H
		5439.56	41.62	-12.38	54	26.44	31.56	12.66	29.04	100	61	A	H
		5021.84	53.5	-20.5	74	38.52	31.59	12.15	28.76	101	320	P	V
		5092.3	42.25	-11.75	54	27.04	31.78	12.24	28.81	101	320	A	V
	*	5220	103.75	-	-	88.82	31.42	12.41	28.9	101	320	P	V
	*	5220	92.69	-	-	77.76	31.42	12.41	28.9	101	320	A	V
	5384.12	54.24	-19.76	74	39.34	31.34	12.56	29	101	320	P	V	
	5458.32	41.55	-12.45	54	26.29	31.62	12.69	29.05	101	320	A	V	



802.11ax HE20 Full RU (242 Tone) CH 48 5240MHz		5144.56	53.69	-20.31	74	38.51	31.71	12.32	28.85	100	60	P	H
		5089.7	42.24	-11.76	54	27.03	31.78	12.24	28.81	100	60	A	H
	*	5240	104.38	-	-	89.52	31.34	12.43	28.91	100	60	P	H
	*	5240	93.41	-	-	78.55	31.34	12.43	28.91	100	60	A	H
		5446	54.32	-19.68	74	39.11	31.58	12.67	29.04	100	60	P	H
		5445.44	41.65	-12.35	54	26.44	31.58	12.67	29.04	100	60	A	H
		5063.18	53.81	-20.19	74	38.66	31.73	12.21	28.79	100	144	P	V
		5098.8	42.1	-11.9	54	26.87	31.8	12.25	28.82	100	144	A	V
	*	5240	103.77	-	-	88.91	31.34	12.43	28.91	100	144	P	V
	*	5240	91.9	-	-	77.04	31.34	12.43	28.91	100	144	A	V
		5394.2	52.96	-21.04	74	38.02	31.38	12.57	29.01	100	144	P	V
		5447.12	41.51	-12.49	54	26.3	31.59	12.67	29.05	100	144	A	V
Remark	1. No other spurious found. 2. All results are PASS against Peak and Average limit line.												



Band 1 5150~5250MHz

WIFI 802.11ax HE20 Full RU (242 Tone) (Harmonic @ 3m)

WIFI Ant. 1+2	Note	Frequency (MHz)	Level (dBμV/m)	Over Limit (dB)	Limit Line (dBμV/m)	Read Level (dBμV)	Antenna Factor (dB/m)	Path Loss (dB)	Preamp Factor (dB)	Ant Pos (cm)	Table Pos (deg)	Peak Avg. (P/A)	Pol. (H/V)	
802.11ax HE20 Full RU (242 Tone) CH 36 5180MHz		10360	48.5	-19.7	68.2	48.98	39.64	19.17	59.29	100	0	P	H	
		15540	46.83	-27.17	74	44.46	37.94	24.38	59.95	100	0	P	H	
													H	
													H	
			10360	51.39	-16.81	68.2	51.87	39.64	19.17	59.29	100	0	P	V
			15540	46.65	-27.35	74	44.28	37.94	24.38	59.95	100	0	P	V
802.11ax HE20 Full RU (242 Tone) CH 44 5220MHz		10440	47.38	-20.82	68.2	47.54	39.88	19.29	59.33	100	0	P	H	
		15660	45.48	-28.52	74	43.52	37.46	24.38	59.88	100	0	P	H	
													H	
													H	
			10440	47.83	-20.37	68.2	47.99	39.88	19.29	59.33	100	0	P	V
			15660	44.96	-29.04	74	43	37.46	24.38	59.88	100	0	P	V
802.11ax HE20 Full RU (242 Tone) CH 48 5240MHz		10480	47.33	-20.87	68.2	47.37	39.96	19.35	59.35	100	0	P	H	
		15720	45.54	-28.46	74	43.71	37.3	24.37	59.84	100	0	P	H	
													H	
													H	
			10480	48.09	-20.11	68.2	48.13	39.96	19.35	59.35	100	0	P	V
			15720	45.95	-28.05	74	44.12	37.3	24.37	59.84	100	0	P	V
Remark	1. No other spurious found.													
	2. All results are PASS against Peak and Average limit line.													



Band 1 5150~5250MHz

WIFI 802.11ax HE20 Partial RU (26 Tone) (Band Edge @ 3m)

WIFI Ant. 1+2	Note	Frequency (MHz)	Level (dBμV/m)	Over Limit (dB)	Limit Line (dBμV/m)	Read Level (dBμV)	Antenna Factor (dB/m)	Path Loss (dB)	Preamp Factor (dB)	Ant Pos (cm)	Table Pos (deg)	Peak Avg. (P/A)	Pol. (H/V)	
802.11ax HE20 Partial RU (26 Tone) 26/0 RU CH 36 5180MHz		5086.84	55.47	-18.53	74	40.27	31.77	12.24	28.81	328	42	P	H	
		5094.12	43.05	-10.95	54	27.82	31.79	12.25	28.81	328	42	A	H	
	*	5180	112.27	-	-	97.2	31.58	12.36	28.87	328	42	P	H	
	*	5180	102.92	-	-	87.85	31.58	12.36	28.87	328	42	A	H	
													H	
														H
			5081.9	55.05	-18.95	74	39.86	31.76	12.23	28.8	301	333	P	V
			5095.42	43.07	-10.93	54	27.84	31.79	12.25	28.81	301	333	A	V
	*		5180	110.02	-	-	94.95	31.58	12.36	28.87	301	333	P	V
	*		5180	100.72	-	-	85.65	31.58	12.36	28.87	301	333	A	V
														V
														V
Remark	1. No other spurious found. 2. All results are PASS against Peak and Average limit line.													



Band 1 5150~5250MHz

WIFI 802.11ax HE20 Partial RU (26 Tone) (Harmonic @ 3m)

WIFI Ant. 1+2	Note	Frequency (MHz)	Level (dBμV/m)	Over Limit (dB)	Limit Line (dBμV/m)	Read Level (dBμV)	Antenna Factor (dB/m)	Path Loss (dB)	Preamp Factor (dB)	Ant Pos (cm)	Table Pos (deg)	Peak Avg. (P/A)	Pol. (H/V)	
802.11ax HE20 Partial RU (26 Tone) 26/0 RU CH 36 5180MHz		10344	56.56	-11.64	68.2	57.11	39.58	19.15	59.28	100	0	P	H	
		15514	48.46	-25.54	74	46.01	38.04	24.38	59.97	100	0	P	H	
													H	
													H	
			10344	54.54	-13.66	68.2	55.09	39.58	19.15	59.28	100	0	P	V
			15514	49.92	-24.08	74	47.47	38.04	24.38	59.97	100	0	P	V
														V
														V
Remark	1. No other spurious found. 2. All results are PASS against Peak and Average limit line.													



Band 1 5150~5250MHz

WIFI 802.11ax HE20 Partial RU (52 Tone) (Band Edge @ 3m)

WIFI Ant. 1+2	Note	Frequency (MHz)	Level (dBμV/m)	Over Limit (dB)	Limit Line (dBμV/m)	Read Level (dBμV)	Antenna Factor (dB/m)	Path Loss (dB)	Preamp Factor (dB)	Ant Pos (cm)	Table Pos (deg)	Peak Avg. (P/A)	Pol. (H/V)	
802.11ax HE20 Partial RU (52 Tone) 52/37 RU CH 36 5180MHz		5064.22	55.07	-18.93	74	39.92	31.73	12.21	28.79	360	44	P	H	
		5097.5	43.12	-10.88	54	27.88	31.8	12.25	28.81	360	44	A	H	
	*	5180	112.3	-	-	97.23	31.58	12.36	28.87	360	44	P	H	
	*	5180	101.86	-	-	86.79	31.58	12.36	28.87	360	44	A	H	
													H	
														H
			5132.86	54.95	-19.05	74	39.76	31.73	12.3	28.84	302	333	P	V
			5094.9	43.07	-10.93	54	27.84	31.79	12.25	28.81	302	333	A	V
	*		5180	109.48	-	-	94.41	31.58	12.36	28.87	302	333	P	V
	*		5180	100.21	-	-	85.14	31.58	12.36	28.87	302	333	A	V
														V
														V
Remark	1. No other spurious found. 2. All results are PASS against Peak and Average limit line.													



Band 1 5150~5250MHz

WIFI 802.11ax HE20 Partial RU (52 Tone) (Harmonic @ 3m)

WIFI Ant. 1+2	Note	Frequency (MHz)	Level (dBμV/m)	Over Limit (dB)	Limit Line (dBμV/m)	Read Level (dBμV)	Antenna Factor (dB/m)	Path Loss (dB)	Preamp Factor (dB)	Ant Pos (cm)	Table Pos (deg)	Peak Avg. (P/A)	Pol. (H/V)	
802.11ax HE20 Partial RU (52 Tone) 52/37 RU CH 36 5180MHz		10344	54.35	-13.85	68.2	54.9	39.58	19.15	59.28	100	0	P	H	
		15514	48.27	-25.73	74	45.82	38.04	24.38	59.97	100	0	P	H	
													H	
													H	
			10344	51.62	-16.58	68.2	52.17	39.58	19.15	59.28	100	0	P	V
			15514	46.6	-27.4	74	44.15	38.04	24.38	59.97	100	0	P	V
														V
														V
Remark	1. No other spurious found. 2. All results are PASS against Peak and Average limit line.													



Band 1 5150~5250MHz

WIFI 802.11ax HE20 Partial RU (106 Tone) (Band Edge @ 3m)

WIFI Ant. 1+2	Note	Frequency (MHz)	Level (dBμV/m)	Over Limit (dB)	Limit Line (dBμV/m)	Read Level (dBμV)	Antenna Factor (dB/m)	Path Loss (dB)	Preamp Factor (dB)	Ant Pos (cm)	Table Pos (deg)	Peak Avg. (P/A)	Pol. (H/V)	
802.11ax HE20 Partial RU (106 Tone) 106/53 RU CH 36 5180MHz		5019.24	55.52	-18.48	74	40.55	31.58	12.15	28.76	341	55	P	H	
		5100.36	43.07	-10.93	54	27.83	31.8	12.26	28.82	341	55	A	H	
	*	5180	109.22	-	-	94.15	31.58	12.36	28.87	341	55	P	H	
	*	5180	98.55	-	-	83.48	31.58	12.36	28.87	341	55	A	H	
													H	
														H
			5099.84	55.3	-18.7	74	40.07	31.8	12.25	28.82	297	332	P	V
			5096.72	42.91	-11.09	54	27.68	31.79	12.25	28.81	297	332	A	V
	*		5180	106.35	-	-	91.28	31.58	12.36	28.87	297	332	P	V
	*		5180	97.12	-	-	82.05	31.58	12.36	28.87	297	332	A	V
													V	
													V	
Remark	1. No other spurious found. 2. All results are PASS against Peak and Average limit line.													



Band 1 5150~5250MHz

WIFI 802.11ax HE20 Partial RU (106 Tone) (Harmonic @ 3m)

WIFI Ant. 1+2	Note	Frequency (MHz)	Level (dBμV/m)	Over Limit (dB)	Limit Line (dBμV/m)	Read Level (dBμV)	Antenna Factor (dB/m)	Path Loss (dB)	Preamp Factor (dB)	Ant Pos (cm)	Table Pos (deg)	Peak Avg. (P/A)	Pol. (H/V)	
802.11ax HE20 Partial RU (106 Tone) 106/53 RU CH 36 5180MHz		10355	52.69	-15.51	68.2	53.19	39.62	19.17	59.29	100	0	P	H	
		15540	45.88	-28.12	74	43.51	37.94	24.38	59.95	100	0	P	H	
													H	
													H	
			10344	53.77	-14.43	68.2	54.32	39.58	19.15	59.28	100	0	P	V
			15540	46.89	-27.11	74	44.52	37.94	24.38	59.95	100	0	P	V
														V
														V
Remark	1. No other spurious found. 2. All results are PASS against Peak and Average limit line.													



Band 1 5150~5250MHz

WIFI 802.11ax HE40 Full RU (484 Tone) (Band Edge @ 3m)

WIFI Ant. 1+2	Note	Frequency (MHz)	Level (dBμV/m)	Over Limit (dB)	Limit Line (dBμV/m)	Read Level (dBμV)	Antenna Factor (dB/m)	Path Loss (dB)	Preamp Factor (dB)	Ant Pos (cm)	Table Pos (deg)	Peak Avg. (P/A)	Pol. (H/V)
802.11ax HE40 Full RU (484 Tone) CH 38 5190MHz		5137.02	54.77	-19.23	74	39.58	31.73	12.3	28.84	100	61	P	H
		5150	42.75	-11.25	54	27.58	31.7	12.32	28.85	100	61	A	H
	*	5190	102.16	-	-	87.09	31.57	12.37	28.87	100	61	P	H
	*	5190	91.46	-	-	76.42	31.54	12.38	28.88	100	61	A	H
		5453.28	52.53	-21.47	74	37.29	31.61	12.68	29.05	100	61	P	H
		5460	41.53	-12.47	54	38.55	31.71	12.32	28.85	102	320	A	H
		5145.34	53.73	-20.27	74	38.55	31.71	12.32	28.85	102	320	P	V
		5150	42.75	-11.25	54	27.58	31.7	12.32	28.85	102	320	A	V
	*	5190	102.31	-	-	87.27	31.54	12.38	28.88	102	320	P	V
	*	5190	91.2	-	-	76.16	31.54	12.38	28.88	102	320	A	V
		5400.36	53.14	-20.86	74	38.17	31.4	12.58	29.01	102	320	P	V
		5454.96	41.44	-12.56	54	26.2	31.61	12.68	29.05	102	320	A	V
802.11ax HE40 Full RU (484 Tone) CH 46 5230MHz		5142.74	54.24	-19.76	74	39.06	31.71	12.31	28.84	100	60	P	H
		5081.12	42.15	-11.85	54	26.96	31.76	12.23	28.8	100	60	A	H
	*	5230	101	-	-	86.1	31.38	12.42	28.9	100	60	P	H
	*	5230	90.66	-	-	75.76	31.38	12.42	28.9	100	60	A	H
		5377.68	52.65	-21.35	74	37.78	31.31	12.56	29	100	60	P	H
		5446.28	41.59	-12.41	54	26.37	31.59	12.67	29.04	100	60	A	H
		5084.24	54.41	-19.59	74	39.22	31.77	12.23	28.81	100	319	P	V
		5090.22	42.15	-11.85	54	26.94	31.78	12.24	28.81	100	319	A	V
	*	5230	100.51	-	-	85.61	31.38	12.42	28.9	100	319	P	V
	*	5230	89.8	-	-	74.9	31.38	12.42	28.9	100	319	A	V
	5360.32	52.51	-21.49	74	37.72	31.24	12.54	28.99	100	319	P	V	
	5454.68	41.47	-12.53	54	26.23	31.61	12.68	29.05	100	319	A	V	
Remark	1. No other spurious found. 2. All results are PASS against Peak and Average limit line.												



Band 1 5150~5250MHz

WIFI 802.11ax HE40 Full RU (484 Tone) (Harmonic @ 3m)

WIFI Ant. 1+2	Note	Frequency (MHz)	Level (dBμV/m)	Over Limit (dB)	Limit Line (dBμV/m)	Read Level (dBμV)	Antenna Factor (dB/m)	Path Loss (dB)	Preamp Factor (dB)	Ant Pos (cm)	Table Pos (deg)	Peak Avg. (P/A)	Pol. (H/V)	
802.11ax HE40 Full RU (484 Tone) CH 38 5190MHz		10380	47.46	-20.74	68.2	47.84	39.72	19.2	59.3	100	0	P	H	
		15570	45.37	-28.63	74	43.11	37.82	24.38	59.94	100	0	P	H	
													H	
													H	
			10380	47.4	-20.8	68.2	47.78	39.72	19.2	59.3	100	0	P	V
			15570	46.32	-27.68	74	44.06	37.82	24.38	59.94	100	0	P	V
802.11ax HE40 Full RU (484 Tone) CH 46 5230MHz		10460	47.26	-20.94	68.2	47.36	39.92	19.32	59.34	100	0	P	H	
		15690	45.49	-28.51	74	43.64	37.34	24.37	59.86	100	0	P	H	
													H	
													H	
			10460	47.69	-20.51	68.2	47.79	39.92	19.32	59.34	100	0	P	V
			15690	45.19	-28.81	74	43.34	37.34	24.37	59.86	100	0	P	V
Remark	1. No other spurious found.													
	2. All results are PASS against Peak and Average limit line.													



Band 1 5150~5250MHz

WIFI 802.11ax HE40 Partial RU (242 Tone) (Band Edge @ 3m)

WIFI Ant. 1+2	Note	Frequency (MHz)	Level (dBμV/m)	Over Limit (dB)	Limit Line (dBμV/m)	Read Level (dBμV)	Antenna Factor (dB/m)	Path Loss (dB)	Preamp Factor (dB)	Ant Pos (cm)	Table Pos (deg)	Peak Avg. (P/A)	Pol. (H/V)
802.11ax HE40 Partial RU (242 Tone) 242/61 CH 38 5190MHz		5149.5	65.66	-8.34	74	50.49	31.7	12.32	28.85	300	58	P	H
		5150	43.15	-10.85	54	27.98	31.7	12.32	28.85	300	58	A	H
	*	5190	104.27	-	-	89.23	31.54	12.38	28.88	300	58	P	H
	*	5190	92.64	-	-	77.6	31.54	12.38	28.88	300	58	A	H
		5425	55.11	-18.89	74	40.01	31.5	12.63	29.03	300	58	P	H
		5459.44	42.31	-11.69	54	27.05	31.62	12.69	29.05	300	58	A	H
		5148.98	65.41	-8.59	74	50.24	31.7	12.32	28.85	302	312	P	V
		5148.72	43.2	-10.8	54	28.03	31.7	12.32	28.85	302	312	A	V
	*	5190	103.19	-	-	88.15	31.54	12.38	28.88	302	312	P	V
	*	5190	92.36	-	-	77.32	31.54	12.38	28.88	302	312	A	V
		5440.12	55.01	-18.99	74	39.83	31.56	12.66	29.04	302	312	P	V
		5457.76	42.33	-11.67	54	27.07	31.62	12.69	29.05	302	312	A	V
Remark	1. No other spurious found. 2. All results are PASS against Peak and Average limit line.												



Band 1 5150~5250MHz

WIFI 802.11ax HE40 Partial RU (242 Tone) (Harmonic @ 3m)

WIFI Ant. 1+2	Note	Frequency (MHz)	Level (dBμV/m)	Over Limit (dB)	Limit Line (dBμV/m)	Read Level (dBμV)	Antenna Factor (dB/m)	Path Loss (dB)	Preamp Factor (dB)	Ant Pos (cm)	Table Pos (deg)	Peak Avg. (P/A)	Pol. (H/V)	
802.11ax HE40 Partial RU (484 Tone) 242/61CH 38 5190MHz		10380	46.95	-21.25	68.2	47.33	39.72	19.2	59.3	100	0	P	H	
		15570	45.99	-28.01	74	43.73	37.82	24.38	59.94	100	0	P	H	
													H	
													H	
			10380	46.73	-21.47	68.2	47.11	39.72	19.2	59.3	100	0	P	V
			15570	46.24	-27.76	74	43.98	37.82	24.38	59.94	100	0	P	V
														V
														V
Remark	1. No other spurious found. 2. All results are PASS against Peak and Average limit line.													



Band 1 5150~5250MHz

WIFI 802.11ax HE80 Full RU (996 Tone) (Band Edge @ 3m)

WIFI Ant. 1+2	Note	Frequency (MHz)	Level (dBμV/m)	Over Limit (dB)	Limit Line (dBμV/m)	Read Level (dBμV)	Antenna Factor (dB/m)	Path Loss (dB)	Preamp Factor (dB)	Ant Pos (cm)	Table Pos (deg)	Peak Avg. (P/A)	Pol. (H/V)
802.11ax HE80 Full RU (996 Tone) CH 42 5210MHz		5136.76	54.58	-19.42	74	39.39	31.73	12.3	28.84	100	62	P	H
		5148.72	43.02	-10.98	54	27.85	31.7	12.32	28.85	100	62	A	H
	*	5210	99.31	-	-	84.34	31.46	12.4	28.89	100	62	P	H
	*	5210	88.11	-	-	73.14	31.46	12.4	28.89	100	62	A	H
		5445.44	53.65	-20.35	74	38.44	31.58	12.67	29.04	100	62	P	H
		5445.72	41.44	-12.56	54	26.23	31.58	12.67	29.04	100	62	A	H
		5099.84	53.56	-20.44	74	38.33	31.8	12.25	28.82	100	320	P	V
		5148.98	42.97	-11.03	54	27.8	31.7	12.32	28.85	100	320	A	V
	*	5210	98.5	-	-	83.53	31.46	12.4	28.89	100	320	P	V
	*	5210	87.61	-	-	72.64	31.46	12.4	28.89	100	320	A	V
		5383.84	52.68	-21.32	74	37.78	31.34	12.56	29	100	320	P	V
		5456.08	41.34	-12.66	54	26.09	31.61	12.69	29.05	100	320	A	V
Remark	1. No other spurious found. 2. All results are PASS against Peak and Average limit line.												



Band 1 5150~5250MHz

WIFI 802.11ax HE80 Full RU (996 Tone) (Harmonic @ 3m)

WIFI Ant. 1+2	Note	Frequency (MHz)	Level (dBμV/m)	Over Limit (dB)	Limit Line (dBμV/m)	Read Level (dBμV)	Antenna Factor (dB/m)	Path Loss (dB)	Preamp Factor (dB)	Ant Pos (cm)	Table Pos (deg)	Peak Avg. (P/A)	Pol. (H/V)	
802.11ax HE80 Full RU (996 Tone) CH 42 5210MHz		10420	46.86	-21.34	68.2	47.08	39.84	19.26	59.32	100	0	P	H	
		15630	46.17	-27.83	74	44.12	37.58	24.37	59.9	100	0	P	H	
													H	
													H	
			10420	47.59	-20.61	68.2	47.81	39.84	19.26	59.32	100	0	P	V
			15630	46.25	-27.75	74	44.2	37.58	24.37	59.9	100	0	P	V
													V	
													V	
Remark	1. No other spurious found. 2. All results are PASS against Peak and Average limit line.													



Band 1 5150~5250MHz

WIFI 802.11ax HE80 Partial RU (484 Tone) (Band Edge @ 3m)

WIFI Ant. 1+2	Note	Frequency (MHz)	Level (dBμV/m)	Over Limit (dB)	Limit Line (dBμV/m)	Read Level (dBμV)	Antenna Factor (dB/m)	Path Loss (dB)	Preamp Factor (dB)	Ant Pos (cm)	Table Pos (deg)	Peak Avg. (P/A)	Pol. (H/V)
802.11ax HE80 Partial RU (484 Tone) 484/65 RU CH 42 5210MHz		5147.42	62.1	-11.9	74	46.92	31.71	12.32	28.85	300	53	P	H
		5148.2	42.43	-11.57	54	27.26	31.7	12.32	28.85	300	53	A	H
	*	5210	101.99	-	-	87.02	31.46	12.4	28.89	300	53	P	H
	*	5210	87.43	-	-	72.46	31.46	12.4	28.89	300	53	A	H
		5433.4	54.09	-19.91	74	38.96	31.53	12.64	29.04	300	53	P	H
		5447.12	41.78	-12.22	54	26.57	31.59	12.67	29.05	300	53	A	H
		5148.2	62.51	-11.49	74	47.34	31.7	12.32	28.85	265	314	P	V
		5149.24	42.54	-11.46	54	27.37	31.7	12.32	28.85	265	314	A	V
	*	5210	100.78	-	-	85.81	31.46	12.4	28.89	265	314	P	V
	*	5210	84.74	-	-	69.77	31.46	12.4	28.89	265	314	A	V
		5410.72	54.79	-19.21	74	39.77	31.44	12.6	29.02	265	314	P	V
		5456.64	41.69	-12.31	54	26.44	31.61	12.69	29.05	265	314	A	V
Remark	1. No other spurious found. 2. All results are PASS against Peak and Average limit line.												



Band 1 5150~5250MHz

WIFI 802.11ax HE80 Full RU (996 Tone) (Harmonic @ 3m)

WIFI Ant. 1+2	Note	Frequency (MHz)	Level (dBμV/m)	Over Limit (dB)	Limit Line (dBμV/m)	Read Level (dBμV)	Antenna Factor (dB/m)	Path Loss (dB)	Preamp Factor (dB)	Ant Pos (cm)	Table Pos (deg)	Peak Avg. (P/A)	Pol. (H/V)	
802.11ax HE80 Partial RU (484 Tone) 484/65 RU CH 42 5210MHz		10420	47.24	-20.96	68.2	47.46	39.84	19.26	59.32	100	0	P	H	
		15630	45.91	-28.09	74	43.86	37.58	24.37	59.9	100	0	P	H	
													H	
													H	
			10420	47.06	-21.14	68.2	47.28	39.84	19.26	59.32	100	0	P	V
			15630	46.09	-27.91	74	44.04	37.58	24.37	59.9	100	0	P	V
														V
														V
Remark	1. No other spurious found. 2. All results are PASS against Peak and Average limit line.													



Band 2 - 5250~5350MHz

WIFI 802.11ax HE20 Full RU (242 Tone) (Band Edge @ 3m)

WIFI	Note	Frequency	Level	Over	Limit	Read	Antenna	Path	Preamp	Ant	Table	Peak	Pol.
Ant.				Limit	Line	Level	Factor	Loss	Factor	Pos	Pos	Avg.	
1+2		(MHz)	(dBμV/m)	(dB)	(dBμV/m)	(dBμV)	(dB/m)	(dB)	(dB)	(cm)	(deg)	(P/A)	(H/V)
802.11ax HE20 Full RU (242 Tone) CH 52 5260MHz		5075.14	53.22	-20.78	74	38.05	31.75	12.22	28.8	100	62	P	H
		5089.42	42.25	-11.75	54	27.04	31.78	12.24	28.81	100	62	A	H
	*	5260	104.55	-	-	89.72	31.3	12.45	28.92	100	62	P	H
	*	5260	93.56	-	-	78.73	31.3	12.45	28.92	100	62	A	H
		5383.92	53.91	-20.09	74	39.01	31.34	12.56	29	100	62	P	H
		5447.52	41.67	-12.33	54	26.46	31.59	12.67	29.05	100	62	A	H
		5093.16	53.15	-20.85	74	37.92	31.79	12.25	28.81	110	145	P	V
		5089.42	42.18	-11.82	54	26.97	31.78	12.24	28.81	110	145	A	V
	*	5260	102.94	-	-	88.11	31.3	12.45	28.92	110	145	P	V
	*	5260	91.92	-	-	77.09	31.3	12.45	28.92	110	145	A	V
		5457.84	53.1	-20.9	74	37.84	31.62	12.69	29.05	110	145	P	V
		5444.88	41.54	-12.46	54	26.33	31.58	12.67	29.04	110	145	A	V
802.11ax HE20 Full RU (242 Tone) CH 60 5300MHz		5018.36	53.84	-20.16	74	38.89	31.57	12.14	28.76	100	63	P	H
		5087.38	42.14	-11.86	54	26.94	31.77	12.24	28.81	100	63	A	H
	*	5300	104.87	-	-	90.03	31.3	12.49	28.95	100	63	P	H
	*	5300	94.26	-	-	79.42	31.3	12.49	28.95	100	63	A	H
		5456.16	53.84	-20.16	74	38.59	31.61	12.69	29.05	100	63	P	H
		5448.72	41.7	-12.3	54	26.49	31.59	12.67	29.05	100	63	A	H
		5126.48	53.45	-20.55	74	38.24	31.75	12.29	28.83	100	145	P	V
		5094.52	42.02	-11.98	54	26.79	31.79	12.25	28.81	100	145	A	V
	*	5300	102.69	-	-	87.85	31.3	12.49	28.95	100	145	P	V
	*	5300	91.68	-	-	76.84	31.3	12.49	28.95	100	145	A	V
		5426.88	53.05	-20.95	74	37.94	31.51	12.63	29.03	100	145	P	V
		5458.08	41.54	-12.46	54	26.28	31.62	12.69	29.05	100	145	A	V



802.11ax HE20 Full RU (242 Tone) CH 64 5320MHz	*	5320	104	-	-	89.2	31.26	12.5	28.96	100	62	P	H
	*	5320	93.25	-	-	78.45	31.26	12.5	28.96	100	62	A	H
		5372.48	53.14	-20.86	74	38.3	31.29	12.55	29	100	62	P	H
		5459.36	41.63	-12.37	54	26.37	31.62	12.69	29.05	100	62	A	H
													H
													H
	*	5320	101.68	-	-	86.88	31.26	12.5	28.96	102	145	P	V
	*	5320	90.52	-	-	75.72	31.26	12.5	28.96	102	145	A	V
		5438.72	53.51	-20.49	74	38.35	31.55	12.65	29.04	102	145	P	V
		5452.32	41.52	-12.48	54	26.29	31.6	12.68	29.05	102	145	A	V
												V	
												V	
Remark	1. No other spurious found. 2. All results are PASS against Peak and Average limit line.												



Band 3 - 5470~5725MHz

WIFI 802.11ax HE20 Full RU (242 Tone) (Harmonic @ 3m)

WIFI Ant. 1+2	Note	Frequency (MHz)	Level (dBμV/m)	Over Limit (dB)	Limit Line (dBμV/m)	Read Level (dBμV)	Antenna Factor (dB/m)	Path Loss (dB)	Preamp Factor (dB)	Ant Pos (cm)	Table Pos (deg)	Peak Avg. (P/A)	Pol. (H/V)
802.11ax HE20 Full RU (242 Tone) CH 52 5260MHz		10520	48.13	-20.07	68.2	48.11	40	19.42	59.4	100	0	P	H
		15780	44.36	-29.64	74	42.49	37.3	24.37	59.8	100	0	P	H
													H
													H
		10520	47.34	-20.86	68.2	47.32	40	19.42	59.4	100	0	P	V
		15780	45.11	-28.89	74	43.24	37.3	24.37	59.8	100	0	P	V
													V
													V
802.11ax HE20 Full RU (242 Tone) CH 60 5300MHz		10600	49.76	-24.24	74	49.8	40	19.54	59.58	100	0	P	H
		15900	44.67	-29.33	74	42.93	37.1	24.36	59.72	100	0	P	H
													H
													H
		10600	47.95	-26.05	74	47.99	40	19.54	59.58	100	0	P	V
		15900	44.62	-29.38	74	42.88	37.1	24.36	59.72	100	0	P	V
													V
													V
802.11ax HE20 Full RU (242 Tone) CH 64 5320MHz		10640	47.18	-26.82	74	47.25	40	19.6	59.67	100	0	P	H
		15960	45.61	-28.39	74	43.9	37.04	24.36	59.69	100	0	P	H
													H
													H
		10640	47.36	-26.64	74	47.43	40	19.6	59.67	100	0	P	V
		15960	44.68	-29.32	74	42.97	37.04	24.36	59.69	100	0	P	V
													V
													V
Remark	1. No other spurious found. 2. All results are PASS against Peak and Average limit line.												



Band 2 - 5250~5350MHz

WIFI 802.11ax HE20 Partial RU (26 Tone) (Band Edge @ 3m)

WIFI Ant. 1+2	Note	Frequency (MHz)	Level (dBμV/m)	Over Limit (dB)	Limit Line (dBμV/m)	Read Level (dBμV)	Antenna Factor (dB/m)	Path Loss (dB)	Preamp Factor (dB)	Ant Pos (cm)	Table Pos (deg)	Peak Avg. (P/A)	Pol. (H/V)	
802.11ax HE20 Partial RU (26 Tone) 26/8 RU CH 64 5320MHz	*	5320	108.72	-	-	93.92	31.26	12.5	28.96	266	40	P	H	
	*	5320	98.99	-	-	84.19	31.26	12.5	28.96	266	40	A	H	
		5367.2	53.77	-20.23	74	38.94	31.27	12.55	28.99	266	40	P	H	
		5452.32	41.55	-12.45	54	26.32	31.6	12.68	29.05	266	40	A	H	
													H	
														H
	*	5320	108.17	-	-	93.37	31.26	12.5	28.96	298	329	P	V	
	*	5320	98.16	-	-	83.36	31.26	12.5	28.96	298	329	A	V	
		5449.28	53.98	-20.02	74	38.76	31.6	12.67	29.05	298	329	P	V	
		5452.32	41.57	-12.43	54	26.34	31.6	12.68	29.05	298	329	A	V	
														V
														V
Remark	1. No other spurious found. 2. All results are PASS against Peak and Average limit line.													



Band 2 5250~5350MHz

WIFI 802.11ax HE20 Partial RU (26 Tone) (Harmonic @ 3m)

WIFI Ant. 1+2	Note	Frequency (MHz)	Level (dBμV/m)	Over Limit (dB)	Limit Line (dBμV/m)	Read Level (dBμV)	Antenna Factor (dB/m)	Path Loss (dB)	Preamp Factor (dB)	Ant Pos (cm)	Table Pos (deg)	Peak Avg. (P/A)	Pol. (H/V)	
802.11ax HE20 Partial RU (26 Tone) 26/8 RU CH 64 5320MHz		10652	54.97	-19.03	74	55.06	40	19.61	59.7	200	49	P	H	
		10652	41.65	-12.35	54	41.74	40	19.61	59.7	200	49	A	H	
		15965	45.15	-28.85	74	43.44	37.03	24.36	59.68	100	0	P	H	
													H	
			10652	49.1	-24.9	74	49.19	40	19.61	59.7	100	0	P	V
			15965	44.59	-29.41	74	42.88	37.03	24.36	59.68	100	0	P	V
														V
														V
Remark	1. No other spurious found. 2. All results are PASS against Peak and Average limit line.													



Band 2 - 5250~5350MHz

WIFI 802.11ax HE20 Partial RU (52 Tone) (Band Edge @ 3m)

WIFI Ant. 1+2	Note	Frequency (MHz)	Level (dBμV/m)	Over Limit (dB)	Limit Line (dBμV/m)	Read Level (dBμV)	Antenna Factor (dB/m)	Path Loss (dB)	Preamp Factor (dB)	Ant Pos (cm)	Table Pos (deg)	Peak Avg. (P/A)	Pol. (H/V)	
802.11ax HE20 Partial RU (52 Tone) 52/40 RU CH 64 5320MHz	*	5320	110.33	-	-	95.53	31.26	12.5	28.96	262	44	P	H	
	*	5320	98.86	-	-	84.06	31.26	12.5	28.96	262	44	A	H	
		5373.76	53.53	-20.47	74	38.67	31.3	12.56	29	262	44	P	H	
		5448.16	41.57	-12.43	54	26.36	31.59	12.67	29.05	262	44	A	H	
													H	
														H
	*	5320	108.71	-	-	93.91	31.26	12.5	28.96	297	339	P	V	
	*	5320	97.79	-	-	82.99	31.26	12.5	28.96	297	339	A	V	
		5441.28	54.19	-19.81	74	39	31.57	12.66	29.04	297	339	P	V	
		5456.32	41.56	-12.44	54	26.31	31.61	12.69	29.05	297	339	A	V	
													V	
													V	
Remark	1. No other spurious found. 2. All results are PASS against Peak and Average limit line.													



Band 2 5250~5350MHz

WIFI 802.11ax HE20 Partial RU (26 Tone) (Harmonic @ 3m)

WIFI Ant. 1+2	Note	Frequency (MHz)	Level (dBμV/m)	Over Limit (dB)	Limit Line (dBμV/m)	Read Level (dBμV)	Antenna Factor (dB/m)	Path Loss (dB)	Preamp Factor (dB)	Ant Pos (cm)	Table Pos (deg)	Peak Avg. (P/A)	Pol. (H/V)	
802.11ax HE20 Partial RU (52 Tone) 52/40 RU CH 64 5320MHz		10652	55.17	-18.83	74	55.26	40	19.61	59.7	200	49	P	H	
		10652	42.09	-11.91	54	42.18	40	19.61	59.7	200	49	A	H	
		15965	45.33	-28.67	74	43.62	37.03	24.36	59.68	100	0	P	H	
													H	
			10652	48.86	-25.14	74	48.95	40	19.61	59.7	100	0	P	V
			15965	44.66	-29.34	74	42.95	37.03	24.36	59.68	100	0	P	V
														V
														V
Remark	1. No other spurious found. 2. All results are PASS against Peak and Average limit line.													



Band 2 - 5250~5350MHz

WIFI 802.11ax HE20 Partial RU (106 Tone) (Band Edge @ 3m)

WIFI Ant. 1+2	Note	Frequency (MHz)	Level (dBμV/m)	Over Limit (dB)	Limit Line (dBμV/m)	Read Level (dBμV)	Antenna Factor (dB/m)	Path Loss (dB)	Preamp Factor (dB)	Ant Pos (cm)	Table Pos (deg)	Peak Avg. (P/A)	Pol. (H/V)
802.11ax HE20 Partial RU (106 Tone) 106/54 RU CH 64 5320MHz	*	5320	108	-	-	93.2	31.26	12.5	28.96	262	46	P	H
	*	5320	96.26	-	-	81.46	31.26	12.5	28.96	262	46	A	H
		5415.68	54.35	-19.65	74	39.3	31.46	12.61	29.02	262	46	P	H
		5457.6	41.59	-12.41	54	26.33	31.62	12.69	29.05	262	46	A	H
													H
													H
	*	5320	106.87	-	-	92.07	31.26	12.5	28.96	297	343	P	V
	*	5320	95.11	-	-	80.31	31.26	12.5	28.96	297	343	A	V
		5408.96	53.25	-20.75	74	38.23	31.44	12.6	29.02	297	343	P	V
		5455.36	41.58	-12.42	54	26.33	31.61	12.69	29.05	297	343	A	V
												V	
												V	
Remark	1. No other spurious found. 2. All results are PASS against Peak and Average limit line.												



Band 2 5250~5350MHz

WIFI 802.11ax HE20 Partial RU (106 Tone) (Harmonic @ 3m)

WIFI Ant. 1+2	Note	Frequency (MHz)	Level (dBμV/m)	Over Limit (dB)	Limit Line (dBμV/m)	Read Level (dBμV)	Antenna Factor (dB/m)	Path Loss (dB)	Preamp Factor (dB)	Ant Pos (cm)	Table Pos (deg)	Peak Avg. (P/A)	Pol. (H/V)	
802.11ax HE20 Partial RU (106 Tone) 106/54 RU CH 64 5320MHz		10652	48.88	-25.12	74	48.97	40	19.61	59.7	100	0	P	H	
		15965	44.72	-29.28	74	43.01	37.03	24.36	59.68	100	0	P	H	
													H	
													H	
			10652	49.25	-24.75	74	49.34	40	19.61	59.7	100	0	P	V
			15965	46.47	-27.53	74	44.76	37.03	24.36	59.68	100	0	P	V
														V
														V
Remark	1. No other spurious found. 2. All results are PASS against Peak and Average limit line.													



Band 2 5250~5350MHz

WIFI 802.11ax HE40 Full RU (484 Tone) (Band Edge @ 3m)

WIFI Ant. 1+2	Note	Frequency (MHz)	Level (dBμV/m)	Over Limit (dB)	Limit Line (dBμV/m)	Read Level (dBμV)	Antenna Factor (dB/m)	Path Loss (dB)	Preamp Factor (dB)	Ant Pos (cm)	Table Pos (deg)	Peak Avg. (P/A)	Pol. (H/V)
802.11ax HE40 Full RU (484 Tone) CH 54 5270MHz		5087.72	53.84	-20.16	74	38.63	31.78	12.24	28.81	101	62	P	H
		5099.62	42.01	-11.99	54	26.78	31.8	12.25	28.82	101	62	A	H
	*	5270	101.53	-	-	86.7	31.3	12.46	28.93	101	62	P	H
	*	5270	90.52	-	-	75.69	31.3	12.46	28.93	101	62	A	H
		5400.48	53.12	-20.88	74	38.15	31.4	12.58	29.01	101	62	P	H
		5456.64	41.56	-12.44	54	26.31	31.61	12.69	29.05	101	62	A	H
		5099.96	52.75	-21.25	74	37.52	31.8	12.25	28.82	109	145	P	V
		5098.6	41.94	-12.06	54	26.71	31.8	12.25	28.82	109	145	A	V
	*	5270	100.04	-	-	85.21	31.3	12.46	28.93	109	145	P	V
	*	5270	89	-	-	74.17	31.3	12.46	28.93	109	145	A	V
		5449.68	53.63	-20.37	74	38.41	31.6	12.67	29.05	109	145	P	V
		5457.36	41.41	-12.59	54	26.16	31.61	12.69	29.05	109	145	A	V
802.11ax HE40 Full RU (484 Tone) CH 62 5310MHz		5137.36	53.69	-20.31	74	38.49	31.73	12.31	28.84	100	61	P	H
		5089.42	41.95	-12.05	54	26.74	31.78	12.24	28.81	100	61	A	H
	*	5310	100.88	-	-	86.06	31.28	12.49	28.95	100	61	P	H
	*	5310	90.32	-	-	75.5	31.28	12.49	28.95	100	61	A	H
		5447.28	54.96	-19.04	74	39.75	31.59	12.67	29.05	100	61	P	H
		5453.52	41.55	-12.45	54	26.31	31.61	12.68	29.05	100	61	A	H
		5091.12	53.3	-20.7	74	38.09	31.78	12.24	28.81	100	145	P	V
		5095.54	41.92	-12.08	54	26.69	31.79	12.25	28.81	100	145	A	V
	*	5310	98.68	-	-	83.86	31.28	12.49	28.95	100	145	P	V
	*	5310	88.01	-	-	73.19	31.28	12.49	28.95	100	145	A	V
	5363.28	53.22	-20.78	74	38.41	31.25	12.55	28.99	100	145	P	V	
	5448.72	41.43	-12.57	54	26.22	31.59	12.67	29.05	100	145	A	V	
Remark	1. No other spurious found. 2. All results are PASS against Peak and Average limit line.												



Band 2 5250~5350MHz

WIFI 802.11ax HE40 Full RU (484 Tone) (Harmonic @ 3m)

WIFI Ant. 1+2	Note	Frequency (MHz)	Level (dBμV/m)	Over Limit (dB)	Limit Line (dBμV/m)	Read Level (dBμV)	Antenna Factor (dB/m)	Path Loss (dB)	Preamp Factor (dB)	Ant Pos (cm)	Table Pos (deg)	Peak Avg. (P/A)	Pol. (H/V)	
802.11ax HE40 Full RU (484 Tone) CH 54 5270MHz		10540	46.45	-21.75	68.2	46.45	40	19.45	59.45	100	0	P	H	
		15810	45.41	-28.59	74	43.54	37.28	24.37	59.78	100	0	P	H	
													H	
													H	
			10540	46.69	-21.51	68.2	46.69	40	19.45	59.45	100	0	P	V
			15810	44.54	-29.46	74	42.67	37.28	24.37	59.78	100	0	P	V
802.11ax HE40 Full RU (484 Tone) CH 62 5310MHz		10620	47.68	-26.32	74	47.74	40	19.57	59.63	100	0	P	H	
		15930	46.18	-27.82	74	44.44	37.07	24.37	59.7	100	0	P	H	
													H	
													H	
			10620	48.72	-25.28	74	48.78	40	19.57	59.63	100	0	P	V
			15930	45.54	-28.46	74	43.8	37.07	24.37	59.7	100	0	P	V
Remark	1. No other spurious found.													
	2. All results are PASS against Peak and Average limit line.													



Band 2 5250~5350MHz

WIFI 802.11ax HE40 Partial RU (242 Tone) (Band Edge @ 3m)

WIFI Ant. 1+2	Note	Frequency (MHz)	Level (dBμV/m)	Over Limit (dB)	Limit Line (dBμV/m)	Read Level (dBμV)	Antenna Factor (dB/m)	Path Loss (dB)	Preamp Factor (dB)	Ant Pos (cm)	Table Pos (deg)	Peak Avg. (P/A)	Pol. (H/V)
802.11ax HE40 Partial RU (242 Tone) 242/62 RU CH 62 5310MHz		5090.78	54.73	-19.27	74	39.52	31.78	12.24	28.81	277	46	P	H
		5096.22	42.44	-11.56	54	27.21	31.79	12.25	28.81	277	46	A	H
	*	5310	103.32	-	-	88.5	31.28	12.49	28.95	277	46	P	H
	*	5310	91.68	-	-	76.86	31.28	12.49	28.95	277	46	A	H
		5351.52	58.73	-15.27	74	43.97	31.21	12.53	28.98	277	46	P	H
		5456.4	41.79	-12.21	54	26.54	31.61	12.69	29.05	277	46	A	H
		5073.78	54.05	-19.95	74	38.88	31.75	12.22	28.8	298	340	P	V
		5100.3	42.31	-11.69	54	27.07	31.8	12.26	28.82	298	340	A	V
	*	5310	102.5	-	-	87.68	31.28	12.49	28.95	298	340	P	V
	*	5310	90.64	-	-	75.82	31.28	12.49	28.95	298	340	A	V
		5350.08	59.58	-14.42	74	44.83	31.2	12.53	28.98	298	340	P	V
		5456.4	41.78	-12.22	54	26.53	31.61	12.69	29.05	298	340	A	V
Remark	1. No other spurious found. 2. All results are PASS against Peak and Average limit line.												



Band 2 5250~5350MHz

WIFI 802.11ax HE40 Partial RU (242 Tone) (Harmonic @ 3m)

WIFI Ant. 1+2	Note	Frequency (MHz)	Level (dBμV/m)	Over Limit (dB)	Limit Line (dBμV/m)	Read Level (dBμV)	Antenna Factor (dB/m)	Path Loss (dB)	Preamp Factor (dB)	Ant Pos (cm)	Table Pos (deg)	Peak Avg. (P/A)	Pol. (H/V)	
802.11ax HE40 Partial RU (242 Tone) 242/62 RU CH 62 5310MHz		10641	49.44	-24.56	74	49.52	40	19.6	59.68	100	0	P	H	
		15954	45.74	-28.26	74	44.02	37.05	24.36	59.69	100	0	P	H	
													H	
													H	
			10641	48.79	-25.21	74	48.87	40	19.6	59.68	100	0	P	V
			15954	47.14	-26.86	74	45.42	37.05	24.36	59.69	100	0	P	V
														V
														V
Remark	1. No other spurious found. 2. All results are PASS against Peak and Average limit line.													



Band 2 5250~5350MHz

WIFI 802.11ax HE80 Full RU (996 Tone) (Band Edge @ 3m)

WIFI Ant. 1+2	Note	Frequency (MHz)	Level (dBμV/m)	Over Limit (dB)	Limit Line (dBμV/m)	Read Level (dBμV)	Antenna Factor (dB/m)	Path Loss (dB)	Preamp Factor (dB)	Ant Pos (cm)	Table Pos (deg)	Peak Avg. (P/A)	Pol. (H/V)
802.11ax HE80 Full RU (996 Tone) CH 58 5290MHz		5096.9	54.03	-19.97	74	38.8	31.79	12.25	28.81	100	62	P	H
		5092.48	41.94	-12.06	54	26.73	31.78	12.24	28.81	100	62	A	H
	*	5290	98.96	-	-	84.12	31.3	12.48	28.94	100	62	P	H
	*	5290	88.26	-	-	73.42	31.3	12.48	28.94	100	62	A	H
		5451.84	54.7	-19.3	74	39.47	31.6	12.68	29.05	100	62	P	H
		5446.56	41.57	-12.43	54	26.35	31.59	12.67	29.04	100	62	A	H
		5098.6	53.03	-20.97	74	37.8	31.8	12.25	28.82	100	146	P	V
		5087.38	41.85	-12.15	54	26.65	31.77	12.24	28.81	100	146	A	V
	*	5290	96.78	-	-	81.94	31.3	12.48	28.94	100	146	P	V
	*	5290	86.49	-	-	71.65	31.3	12.48	28.94	100	146	A	V
		5379.84	53.31	-20.69	74	38.43	31.32	12.56	29	100	146	P	V
		5453.04	41.38	-12.62	54	26.14	31.61	12.68	29.05	100	146	A	V
Remark	1. No other spurious found. 2. All results are PASS against Peak and Average limit line.												



**Band 2 5250~5350MHz
WIFI 802.11ac VHT80 (Harmonic @ 3m)**

WIFI Ant. 1+2	Note	Frequency (MHz)	Level (dBμV/m)	Over Limit (dB)	Limit Line (dBμV/m)	Read Level (dBμV)	Antenna Factor (dB/m)	Path Loss (dB)	Preamp Factor (dB)	Ant Pos (cm)	Table Pos (deg)	Peak Avg. (P/A)	Pol. (H/V)	
802.11ax HE80 Full RU (996 Tone) CH 58 5290MHz		10580	46.74	-21.46	68.2	46.77	40	19.51	59.54	100	0	P	H	
		15870	45.37	-28.63	74	43.58	37.16	24.37	59.74	100	0	P	H	
													H	
													H	
			10580	47.34	-20.86	68.2	47.37	40	19.51	59.54	100	0	P	V
			15870	44.93	-29.07	74	43.14	37.16	24.37	59.74	100	0	P	V
													V	
													V	
Remark	1. No other spurious found. 2. All results are PASS against Peak and Average limit line.													



Band 2 5250~5350MHz

WIFI 802.11ax HE80 Partial RU (484 Tone) (Band Edge @ 3m)

WIFI Ant. 1+2	Note	Frequency (MHz)	Level (dBμV/m)	Over Limit (dB)	Limit Line (dBμV/m)	Read Level (dBμV)	Antenna Factor (dB/m)	Path Loss (dB)	Preamp Factor (dB)	Ant Pos (cm)	Table Pos (deg)	Peak Avg. (P/A)	Pol. (H/V)
802.11ax HE80 Partial RU (242 Tone) 484/66 RU CH 58 5290MHz		5083.98	54.89	-19.11	74	39.7	31.77	12.23	28.81	266	43	P	H
		5085	42.41	-11.59	54	27.22	31.77	12.23	28.81	266	43	A	H
	*	5290	101.68	-	-	86.84	31.3	12.48	28.94	266	43	P	H
	*	5290	87.36	-	-	72.52	31.3	12.48	28.94	266	43	A	H
		5353.68	63.87	-10.13	74	49.1	31.21	12.54	28.98	266	43	P	H
		5457.12	41.76	-12.24	54	26.51	31.61	12.69	29.05	266	43	A	H
		5092.82	54.51	-19.49	74	39.28	31.79	12.25	28.81	299	343	P	V
		5085.68	42.24	-11.76	54	27.04	31.77	12.24	28.81	299	343	A	V
	*	5290	99.93	-	-	85.09	31.3	12.48	28.94	299	343	P	V
	*	5290	85.14	-	-	70.3	31.3	12.48	28.94	299	343	A	V
		5368.8	62.53	-11.47	74	47.69	31.28	12.55	28.99	299	343	P	V
		5458.08	41.66	-12.34	54	26.4	31.62	12.69	29.05	299	343	A	V
Remark	1. No other spurious found. 2. All results are PASS against Peak and Average limit line.												



Band 2 5250~5350MHz

WIFI 802.11ax HE80 Partial RU (484 Tone) (Harmonic @ 3m)

WIFI Ant. 1+2	Note	Frequency (MHz)	Level (dBμV/m)	Over Limit (dB)	Limit Line (dBμV/m)	Read Level (dBμV)	Antenna Factor (dB/m)	Path Loss (dB)	Preamp Factor (dB)	Ant Pos (cm)	Table Pos (deg)	Peak Avg. (P/A)	Pol. (H/V)	
802.11ax HE80 Partial RU (242 Tone) 484/66 RU CH 58 5290MHz		10580	47.13	-21.07	68.2	47.16	40	19.51	59.54	100	0	P	H	
		15870	45.26	-28.74	74	43.47	37.16	24.37	59.74	100	0	P	H	
													H	
													H	
			10580	47.22	-20.98	68.2	47.25	40	19.51	59.54	100	0	P	V
			15870	45.26	-28.74	74	43.47	37.16	24.37	59.74	100	0	P	V
														V
														V
Remark	1. No other spurious found. 2. All results are PASS against Peak and Average limit line.													



Band 3 - 5470~5725MHz

WIFI 802.11ax HE20 Full RU (242 Tone) (Band Edge @ 3m)

WIFI	Note	Frequency	Level	Over	Limit	Read	Antenna	Path	Preamp	Ant	Table	Peak	Pol.	
Ant.				Limit	Line	Level	Factor	Loss	Factor	Pos	Pos	Avg.		
1+2		(MHz)	(dBμV/m)	(dB)	(dBμV/m)	(dBμV)	(dB/m)	(dB)	(dB)	(cm)	(deg)	(P/A)	(H/V)	
802.11ax HE20 Full RU (242 Tone) CH 100 5500MHz		5416.72	53.96	-20.04	74	38.91	31.47	12.61	29.03	101	61	P	H	
		5465.52	53.4	-14.8	68.2	38.13	31.63	12.7	29.06	101	61	P	H	
		5447.44	41.82	-12.18	54	26.61	31.59	12.67	29.05	101	61	A	H	
	*	5500	105.55	-	-	90.16	31.7	12.77	29.08	101	61	P	H	
	*	5500	95.41	-	-	80.02	31.7	12.77	29.08	101	61	A	H	
														H
		5450	54.02	-19.98	74	38.79	31.6	12.68	29.05	101	97	P	V	
		5467.76	54.47	-13.73	68.2	39.18	31.64	12.71	29.06	101	97	P	V	
		5455.76	41.78	-12.22	54	26.53	31.61	12.69	29.05	101	97	A	V	
	*	5500	104.32	-	-	88.93	31.7	12.77	29.08	101	97	P	V	
	*	5500	92.73	-	-	77.34	31.7	12.77	29.08	101	97	A	V	
													V	
802.11ax HE20 Full RU (242 Tone) CH 116 5580MHz		5444.32	53.58	-20.42	74	38.38	31.58	12.66	29.04	101	62	P	H	
		5467.84	51.99	-16.21	68.2	36.7	31.64	12.71	29.06	101	62	P	H	
		5456.8	42.08	-11.92	54	26.83	31.61	12.69	29.05	101	62	A	H	
	*	5580	107.63	-	-	92.03	31.74	12.92	29.06	101	62	P	H	
	*	5580	97.37	-	-	81.77	31.74	12.92	29.06	101	62	A	H	
		5762.48	54.59	-13.61	68.2	38.37	32.02	13.22	29.02	101	62	P	H	
		5376.88	53.79	-20.21	74	38.92	31.31	12.56	29	100	98	P	V	
		5464.96	53.02	-15.18	68.2	37.75	31.63	12.7	29.06	100	98	P	V	
		5450.56	42.02	-11.98	54	26.79	31.6	12.68	29.05	100	98	A	V	
	*	5580	104.85	-	-	89.25	31.74	12.92	29.06	100	98	P	V	
	*	5580	94.12	-	-	78.52	31.74	12.92	29.06	100	98	A	V	
	5732.24	54.94	-13.26	68.2	38.86	31.93	13.17	29.02	100	98	P	V		



802.11ax HE20 Full RU (242 Tone) CH 140 5700MHz	*	5700	106.28	-	-	90.39	31.8	13.12	29.03	102	61	P	H
	*	5700	96.04	-	-	80.15	31.8	13.12	29.03	102	61	A	H
		5732.04	55.3	-12.9	68.2	39.22	31.93	13.17	29.02	102	61	P	H
													H
													H
													H
	*	5700	104.06	-	-	88.17	31.8	13.12	29.03	101	94	P	V
	*	5700	92.75	-	-	76.86	31.8	13.12	29.03	101	94	A	V
		5757.56	55.79	-12.41	68.2	39.58	32.02	13.21	29.02	101	94	P	V
													V
												V	
												V	
Remark	1. No other spurious found. 2. All results are PASS against Peak and Average limit line.												



Band 3 - 5470~5725MHz

WIFI 802.11ax HE20 Full RU (242 Tone) (Harmonic @ 3m)

WIFI Ant. 1+2	Note	Frequency (MHz)	Level (dBμV/m)	Over Limit (dB)	Limit Line (dBμV/m)	Read Level (dBμV)	Antenna Factor (dB/m)	Path Loss (dB)	Preamp Factor (dB)	Ant Pos (cm)	Table Pos (deg)	Peak Avg. (P/A)	Pol. (H/V)	
802.11ax HE20 Full RU (242 Tone) CH 100 5500MHz		11000	48.31	-25.69	74	48.26	40.4	20.13	60.48	100	0	P	H	
		16500	47.57	-20.63	68.2	42.49	38.8	25.22	58.94	100	0	P	H	
													H	
													H	
			11000	48.12	-25.88	74	48.07	40.4	20.13	60.48	100	0	P	V
			16500	47.42	-20.78	68.2	42.34	38.8	25.22	58.94	100	0	P	V
														V
														V
802.11ax HE20 Full RU (242 Tone) CH 116 5580MHz		11160	47.1	-26.9	74	47.39	39.98	20.3	60.57	100	0	P	H	
		16740	49.22	-18.98	68.2	42.17	39.8	25.63	58.38	100	0	P	H	
													H	
													H	
			11160	48.24	-25.76	74	48.53	39.98	20.3	60.57	100	0	P	V
			16740	48.83	-19.37	68.2	41.78	39.8	25.63	58.38	100	0	P	V
														V
														V
802.11ax HE20 Full RU (242 Tone) CH 140 5700MHz		11400	46.77	-27.23	74	46.8	40.1	20.57	60.7	100	0	P	H	
		17100	48.91	-19.29	68.2	39.77	40.3	26.25	57.41	100	0	P	H	
													H	
													H	
			11400	47.41	-26.59	74	47.44	40.1	20.57	60.7	100	0	P	V
			17100	48.96	-19.24	68.2	39.82	40.3	26.25	57.41	100	0	P	V
														V
														V
Remark	1. No other spurious found. 2. All results are PASS against Peak and Average limit line.													



Band 3 - 5470~5725MHz

WIFI 802.11ax HE20 Partial RU (26 Tone) (Band Edge @ 3m)

WIFI Ant. 1+2	Note	Frequency (MHz)	Level (dBμV/m)	Over Limit (dB)	Limit Line (dBμV/m)	Read Level (dBμV)	Antenna Factor (dB/m)	Path Loss (dB)	Preamp Factor (dB)	Ant Pos (cm)	Table Pos (deg)	Peak Avg. (P/A)	Pol. (H/V)	
802.11ax HE20 Partial RU (26 Tone) 26/0 RU CH 100 5500MHz		5386.8	54.01	-19.99	74	39.1	31.35	12.57	29.01	329	311	P	H	
		5468.56	53.05	-15.15	68.2	37.76	31.64	12.71	29.06	329	311	P	H	
		5459.44	41.73	-12.27	54	26.47	31.62	12.69	29.05	329	311	A	H	
	*	5500	108.6	-	-	93.21	31.7	12.77	29.08	329	311	P	H	
	*	5500	98.14	-	-	82.75	31.7	12.77	29.08	329	311	A	H	
														H
			5436.72	54.09	-19.91	74	38.93	31.55	12.65	29.04	136	348	P	V
			5467.76	53.21	-14.99	68.2	37.92	31.64	12.71	29.06	136	348	P	V
			5459.6	41.76	-12.24	54	26.5	31.62	12.69	29.05	136	348	A	V
	*	5500	112.29	-	-	96.9	31.7	12.77	29.08	136	348	P	V	
	*	5500	101.13	-	-	85.74	31.7	12.77	29.08	136	348	A	V	
														V
802.11ax HE20 Partial RU (26 Tone) 26/8 RU CH 140 5700MHz	*	5700	106.36	-	-	90.47	31.8	13.12	29.03	204	286	P	H	
	*	5700	97.38	-	-	81.49	31.8	13.12	29.03	204	286	A	H	
		5759.64	54.67	-13.53	68.2	38.45	32.02	13.22	29.02	204	286	P	H	
														H
														H
														H
	*	5700	108.78	-	-	92.89	31.8	13.12	29.03	245	319	P	V	
	*	5700	99.28	-	-	83.39	31.8	13.12	29.03	245	319	A	V	
		5752.76	54.75	-13.45	68.2	38.56	32.01	13.2	29.02	245	319	P	V	
														V
														V
														V
Remark	1. No other spurious found. 2. All results are PASS against Peak and Average limit line.													



Band 3 - 5470~5725MHz

WIFI 802.11ax HE20 Partial RU (26 Tone) (Harmonic @ 3m)

WIFI Ant. 1+2	Note	Frequency (MHz)	Level (dBμV/m)	Over Limit (dB)	Limit Line (dBμV/m)	Read Level (dBμV)	Antenna Factor (dB/m)	Path Loss (dB)	Preamp Factor (dB)	Ant Pos (cm)	Table Pos (deg)	Peak Avg. (P/A)	Pol. (H/V)	
802.11ax HE20 Partial RU (26 Tone) 26/0 RU CH 100 5500MHz		10982	52.74	-21.26	74	52.68	40.4	20.1	60.44	318	348	P	H	
		10982	40.05	-13.95	54	39.99	40.4	20.1	60.44	318	348	A	H	
		16473	47.42	-20.78	68.2	42.62	38.61	25.17	58.98	100	0	P	H	
													H	
		10982	50.67	-23.33	74	50.61	40.4	20.1	60.44	361	348	P	V	
		10982	39.32	-14.68	54	39.26	40.4	20.1	60.44	361	348	A	V	
		16473	47.4	-20.8	68.2	42.6	38.61	25.17	58.98	100	0	P	V	
														V
802.11ax HE20 Partial RU (26 Tone) 26/8 RU CH 140 5700MHz		11400	49.17	-24.83	74	49.2	40.1	20.57	60.7	100	0	P	H	
		17100	50.38	-17.82	68.2	41.24	40.3	26.25	57.41	100	0	P	H	
													H	
													H	
		11400	47.92	-26.08	74	47.95	40.1	20.57	60.7	100	0	P	V	
		17100	49.9	-18.3	68.2	40.76	40.3	26.25	57.41	100	0	P	V	
														V
														V
Remark	1. No other spurious found. 2. All results are PASS against Peak and Average limit line.													



Band 3 - 5470~5725MHz

WIFI 802.11ax HE20 Partial RU (52 Tone) (Band Edge @ 3m)

WIFI Ant. 1+2	Note	Frequency (MHz)	Level (dBμV/m)	Over Limit (dB)	Limit Line (dBμV/m)	Read Level (dBμV)	Antenna Factor (dB/m)	Path Loss (dB)	Preamp Factor (dB)	Ant Pos (cm)	Table Pos (deg)	Peak Avg. (P/A)	Pol. (H/V)	
802.11ax HE20 Partial RU (52 Tone) 52/37 RU CH 100 5500MHz		5377.68	53.89	-20.11	74	39.02	31.31	12.56	29	312	313	P	H	
		5463.28	53.24	-14.96	68.2	37.97	31.63	12.7	29.06	312	313	P	H	
		5454.64	41.56	-12.44	54	26.32	31.61	12.68	29.05	312	313	A	H	
	*	5500	109.28	-	-	93.89	31.7	12.77	29.08	312	313	P	H	
	*	5500	98.49	-	-	83.1	31.7	12.77	29.08	312	313	A	H	
														H
			5408.24	53.99	-20.01	74	38.98	31.43	12.6	29.02	166	316	P	V
			5469.84	53.44	-14.76	68.2	38.15	31.64	12.71	29.06	166	316	P	V
			5452.56	41.57	-12.43	54	26.33	31.61	12.68	29.05	166	316	A	V
	*		5500	112.04	-	-	96.65	31.7	12.77	29.08	166	316	P	V
	*		5500	101.05	-	-	85.66	31.7	12.77	29.08	166	316	A	V
														V
802.11ax HE20 Partial RU (26 Tone) 52/40 RU CH 140 5700MHz	*	5700	108.35	-	-	92.46	31.8	13.12	29.03	208	286	P	H	
	*	5700	97.34	-	-	81.45	31.8	13.12	29.03	208	286	A	H	
			5726.52	55.05	-13.15	68.2	39.01	31.91	13.16	29.03	208	286	P	H
														H
														H
														H
	*		5700	110.47	-	-	94.58	31.8	13.12	29.03	247	319	P	V
	*		5700	99.41	-	-	83.52	31.8	13.12	29.03	247	319	A	V
			5726.2	55.24	-12.96	68.2	39.21	31.9	13.16	29.03	247	319	P	V
														V
													V	
													V	
Remark	1. No other spurious found. 2. All results are PASS against Peak and Average limit line.													



Band 3 - 5470~5725MHz

WIFI 802.11ax HE20 Partial RU (52 Tone) (Harmonic @ 3m)

WIFI Ant. 1+2	Note	Frequency (MHz)	Level (dBμV/m)	Over Limit (dB)	Limit Line (dBμV/m)	Read Level (dBμV)	Antenna Factor (dB/m)	Path Loss (dB)	Preamp Factor (dB)	Ant Pos (cm)	Table Pos (deg)	Peak Avg. (P/A)	Pol. (H/V)	
802.11ax HE20 Partial RU (52 Tone) 52/37 RU CH 100 5500MHz		10982	56.13	-17.87	74	56.07	40.4	20.1	60.44	300	355	P	H	
		10982	42.8	-11.2	54	42.74	40.4	20.1	60.44	300	355	A	H	
		16471	49.12	-19.08	68.2	44.33	38.6	25.17	58.98	100	0	P	H	
													H	
		10982	55.91	-18.09	74	55.85	40.4	20.1	60.44	350	344	P	V	
		10982	41.74	-12.26	54	41.68	40.4	20.1	60.44	350	344	A	V	
		16471	48.49	-19.71	68.2	43.7	38.6	25.17	58.98	100	0	P	V	
														V
802.11ax HE20 Partial RU (52 Tone) 52/40 RU CH 140 5700MHz		11400	46.94	-27.06	74	46.97	40.1	20.57	60.7	100	0	P	H	
		17100	49.31	-18.89	68.2	40.17	40.3	26.25	57.41	100	0	P	H	
													H	
													H	
		11400	46.88	-27.12	74	46.91	40.1	20.57	60.7	100	0	P	V	
		17100	50.26	-17.94	68.2	41.12	40.3	26.25	57.41	100	0	P	V	
														V
														V
Remark	1. No other spurious found. 2. All results are PASS against Peak and Average limit line.													



Band 3 - 5470~5725MHz

WIFI 802.11ax HE20 Partial RU (106 Tone) (Band Edge @ 3m)

WIFI Ant. 1+2	Note	Frequency (MHz)	Level (dBμV/m)	Over Limit (dB)	Limit Line (dBμV/m)	Read Level (dBμV)	Antenna Factor (dB/m)	Path Loss (dB)	Preamp Factor (dB)	Ant Pos (cm)	Table Pos (deg)	Peak Avg. (P/A)	Pol. (H/V)	
802.11ax HE20 Partial RU (106 Tone) 106/53 RU CH 100 5500MHz		5420.88	54.1	-19.9	74	39.03	31.48	12.62	29.03	310	314	P	H	
		5468.88	53.92	-14.28	68.2	38.63	31.64	12.71	29.06	310	314	P	H	
		5456.72	41.56	-12.44	54	26.31	31.61	12.69	29.05	310	314	A	H	
	*	5500	105.86	-	-	90.47	31.7	12.77	29.08	310	314	P	H	
	*	5500	94.81	-	-	79.42	31.7	12.77	29.08	310	314	A	H	
														H
			5415.44	55.77	-18.23	74	40.72	31.46	12.61	29.02	156	317	P	V
			5461.2	53.43	-14.77	68.2	38.16	31.62	12.7	29.05	156	317	P	V
			5457.36	41.6	-12.4	54	26.35	31.61	12.69	29.05	156	317	A	V
		*	5500	108.65	-	-	93.26	31.7	12.77	29.08	156	317	P	V
	*	5500	98.02	-	-	82.63	31.7	12.77	29.08	156	317	A	V	
													V	
802.11ax HE20 Partial RU (106 Tone) 106/54 RU CH 140 5700MHz		5700	104.14	-	-	88.25	31.8	13.12	29.03	203	286	P	H	
		5700	93.49	-	-	77.6	31.8	13.12	29.03	203	286	A	H	
		5725.56	56.34	-11.86	68.2	40.31	31.9	13.16	29.03	203	286	P	H	
													H	
													H	
													H	
		*	5700	106.4	-	-	90.51	31.8	13.12	29.03	247	319	P	V
		*	5700	95.95	-	-	80.06	31.8	13.12	29.03	247	319	A	V
			5735.4	55.58	-12.62	68.2	39.48	31.94	13.18	29.02	247	319	P	V
														V
													V	
													V	
Remark	1. No other spurious found. 2. All results are PASS against Peak and Average limit line.													



Band 3 - 5470~5725MHz

WIFI 802.11ax HE20 Partial RU (26 Tone) (Harmonic @ 3m)

WIFI Ant. 1+2	Note	Frequency (MHz)	Level (dBμV/m)	Over Limit (dB)	Limit Line (dBμV/m)	Read Level (dBμV)	Antenna Factor (dB/m)	Path Loss (dB)	Preamp Factor (dB)	Ant Pos (cm)	Table Pos (deg)	Peak Avg. (P/A)	Pol. (H/V)
802.11ax HE20 Partial RU (106 Tone) 106/53 RU CH 100 5500MHz		10982	51.11	-22.89	74	51.05	40.4	20.1	60.44	300	355	P	H
		10982	40.92	-13.08	54	40.86	40.4	20.1	60.44	300	355	A	H
		16500	47.45	-20.75	68.2	42.37	38.8	25.22	58.94	100	0	P	H
													H
		10982	48.85	-25.15	74	48.79	40.4	20.1	60.44	100	0	P	V
		16500	47.85	-20.35	68.2	42.77	38.8	25.22	58.94	100	0	P	V
													V
													V
802.11ax HE20 Partial RU (106 Tone) 53/54 RU CH 140 5700MHz		11400	46.55	-27.45	74	46.58	40.1	20.57	60.7	100	0	P	H
		17100	49.87	-18.33	68.2	40.73	40.3	26.25	57.41	100	0	P	H
													H
													H
		11400	46.95	-27.05	74	46.98	40.1	20.57	60.7	100	0	P	V
		17100	49.23	-18.97	68.2	40.09	40.3	26.25	57.41	100	0	P	V
													V
													V
Remark	1. No other spurious found. 2. All results are PASS against Peak and Average limit line.												



Band 3 - 5470~5725MHz

WIFI 802.11ax HE40 Full RU (242 Tone) (Band Edge @ 3m)

WIFI Ant. 1+2	Note	Frequency (MHz)	Level (dBμV/m)	Over Limit (dB)	Limit Line (dBμV/m)	Read Level (dBμV)	Antenna Factor (dB/m)	Path Loss (dB)	Preamp Factor (dB)	Ant Pos (cm)	Table Pos (deg)	Peak Avg. (P/A)	Pol. (H/V)
802.11ax HE40 Full RU (484 Tone) CH 102 5510MHz		5441.92	54.27	-19.73	74	39.08	31.57	12.66	29.04	101	62	P	H
		5467.6	54.07	-14.13	68.2	38.78	31.64	12.71	29.06	101	62	P	H
		5459.2	42.16	-11.84	54	26.9	31.62	12.69	29.05	101	62	A	H
	*	5510	104.59	-	-	89.16	31.72	12.79	29.08	101	62	P	H
	*	5510	93.67	-	-	78.24	31.72	12.79	29.08	101	62	A	H
		5748.62	54.1	-14.1	68.2	37.93	31.99	13.2	29.02	101	62	P	H
		5361.04	53.83	-20.17	74	39.04	31.24	12.54	28.99	101	94	P	V
		5460.4	54.41	-13.79	68.2	39.15	31.62	12.69	29.05	101	94	P	V
		5459.92	41.92	-12.08	54	26.66	31.62	12.69	29.05	101	94	A	V
	*	5510	99.17	-	-	83.74	31.72	12.79	29.08	101	94	P	V
	*	5510	89.65	-	-	74.22	31.72	12.79	29.08	101	94	A	V
		5762.795	54.21	-13.99	68.2	37.98	32.03	13.22	29.02	101	94	P	V
802.11ax HE40 Full RU (484 Tone) CH 110 5550MHz		5397.28	54.79	-19.21	74	39.83	31.39	12.58	29.01	101	61	P	H
		5465.44	53.5	-14.7	68.2	38.23	31.63	12.7	29.06	101	61	P	H
		5455.12	41.88	-12.12	54	26.64	31.61	12.68	29.05	101	61	A	H
	*	5550	104.49	-	-	88.9	31.8	12.86	29.07	101	61	P	H
	*	5550	93.86	-	-	78.27	31.8	12.86	29.07	101	61	A	H
		5754.605	53.57	-14.63	68.2	37.37	32.01	13.21	29.02	101	61	P	H
		5451.28	54.28	-19.72	74	39.05	31.6	12.68	29.05	101	94	P	V
		5465.2	54.69	-13.51	68.2	39.42	31.63	12.7	29.06	101	94	P	V
		5456.32	41.77	-12.23	54	26.52	31.61	12.69	29.05	101	94	A	V
	*	5550	100.26	-	-	84.67	31.8	12.86	29.07	101	94	P	V
	*	5550	89.82	-	-	74.23	31.8	12.86	29.07	101	94	A	V
		5727.515	55.61	-12.59	68.2	39.57	31.91	13.16	29.03	101	94	P	V



802.11ax HE40 Full RU (484 Tone) CH 134 5670MHz		5350	53.31	-20.69	74	38.56	31.2	12.53	28.98	101	63	P	H
		5469.7	52.53	-15.67	68.2	37.24	31.64	12.71	29.06	101	63	P	H
		5456.4	42.05	-11.95	54	26.8	31.61	12.69	29.05	101	63	A	H
	*	5670	104.58	-	-	88.81	31.74	13.07	29.04	101	63	P	H
	*	5670	94.3	-	-	78.53	31.74	13.07	29.04	101	63	A	H
		5747.675	54.35	-13.85	68.2	38.18	31.99	13.2	29.02	101	63	P	H
		5454.3	53.72	-20.28	74	38.48	31.61	12.68	29.05	105	93	P	V
		5465.15	52.95	-15.25	68.2	37.68	31.63	12.7	29.06	105	93	P	V
		5453.25	41.99	-12.01	54	26.75	31.61	12.68	29.05	105	93	A	V
	*	5670	101.61	-	-	85.84	31.74	13.07	29.04	105	93	P	V
	*	5670	90.94	-	-	75.17	31.74	13.07	29.04	105	93	A	V
		5762.55	54.93	-13.27	68.2	38.7	32.03	13.22	29.02	105	93	P	V
Remark	1. No other spurious found. 2. All results are PASS against Peak and Average limit line.												



Band 3 - 5470~5725MHz

WIFI 802.11ax HE40 Full RU (242 Tone) (Harmonic @ 3m)

WIFI Ant. 1+2	Note	Frequency (MHz)	Level (dBμV/m)	Over Limit (dB)	Limit Line (dBμV/m)	Read Level (dBμV)	Antenna Factor (dB/m)	Path Loss (dB)	Preamp Factor (dB)	Ant Pos (cm)	Table Pos (deg)	Peak Avg. (P/A)	Pol. (H/V)	
802.11ax HE40 Full RU (484 Tone) CH 102 5510MHz		11020	48.42	-25.58	74	48.42	40.34	20.15	60.49	100	0	P	H	
		16530	47.61	-20.59	68.2	42.26	38.95	25.27	58.87	100	0	P	H	
													H	
													H	
		11020	48.33	-25.67	74	48.33	40.34	20.15	60.49	100	0	P	V	
		16530	46.54	-21.66	68.2	41.19	38.95	25.27	58.87	100	0	P	V	
														V
														V
802.11ax HE40 Full RU (484 Tone) CH 110 5550MHz		11100	48.54	-25.46	74	48.74	40.1	20.24	60.54	100	0	P	H	
		16650	47.56	-20.64	68.2	41.23	39.45	25.47	58.59	100	0	P	H	
													H	
													H	
		11100	48.36	-25.64	74	48.56	40.1	20.24	60.54	100	0	P	V	
		16650	47.66	-20.54	68.2	41.33	39.45	25.47	58.59	100	0	P	V	
														V
														V
802.11ax HE40 Full RU (484 Tone) CH 134 5670MHz		11340	47.15	-26.85	74	47.4	39.92	20.5	60.67	100	0	P	H	
		17010	49.38	-18.82	68.2	40.44	40.57	26.1	57.73	100	0	P	H	
													H	
													H	
		11340	47.36	-26.64	74	47.61	39.92	20.5	60.67	100	0	P	V	
		17010	49.23	-18.97	68.2	40.29	40.57	26.1	57.73	100	0	P	V	
														V
														V
Remark	1. No other spurious found. 2. All results are PASS against Peak and Average limit line.													



Band 3 - 5470~5725MHz

WIFI 802.11ax HE40 Partial RU (242 Tone) (Band Edge @ 3m)

WIFI Ant. 1+2	Note	Frequency (MHz)	Level (dBμV/m)	Over Limit (dB)	Limit Line (dBμV/m)	Read Level (dBμV)	Antenna Factor (dB/m)	Path Loss (dB)	Preamp Factor (dB)	Ant Pos (cm)	Table Pos (deg)	Peak Avg. (P/A)	Pol. (H/V)
802.11ax HE40 Partial RU (242 Tone) 242/61 CH 102 5510MHz		5384.32	54.66	-19.34	74	39.75	31.34	12.57	29	329	302	P	H
		5469.76	62.2	-6	68.2	46.91	31.64	12.71	29.06	329	302	P	H
		5455.36	41.56	-12.44	54	26.31	31.61	12.69	29.05	329	302	A	H
	*	5510	100.87	-	-	85.44	31.72	12.79	29.08	329	302	P	H
	*	5510	88.78	-	-	73.35	31.72	12.79	29.08	329	302	A	H
		5728.775	54.76	-13.44	68.2	38.7	31.92	13.17	29.03	329	302	P	H
		5459.68	56.97	-17.03	74	41.71	31.62	12.69	29.05	141	322	P	V
		5469.76	64.08	-4.12	68.2	48.79	31.64	12.71	29.06	141	322	P	V
		5458.48	41.57	-12.43	54	26.31	31.62	12.69	29.05	141	322	A	V
	*	5510	103.9	-	-	88.47	31.72	12.79	29.08	141	322	P	V
	*	5510	92.43	-	-	77	31.72	12.79	29.08	141	322	A	V
		5740.43	54.97	-13.23	68.2	38.85	31.96	13.18	29.02	141	322	P	V
802.11ax HE40 Partial RU (242 Tone) 242/62 CH 134 5670MHz		5459.2	53.5	-20.5	74	38.24	31.62	12.69	29.05	201	285	P	H
		5463.75	53.61	-14.59	68.2	38.34	31.63	12.7	29.06	201	285	P	H
		5456.75	41.53	-12.47	54	26.28	31.61	12.69	29.05	201	285	A	H
	*	5670	102.04	-	-	86.27	31.74	13.07	29.04	201	285	P	H
	*	5670	89.88	-	-	74.11	31.74	13.07	29.04	201	285	A	H
		5741.2	57.41	-10.79	68.2	41.28	31.96	13.19	29.02	201	285	P	H
		5445.55	54.07	-19.93	74	38.86	31.58	12.67	29.04	260	320	P	V
		5466.9	54.15	-14.05	68.2	38.87	31.63	12.71	29.06	260	320	P	V
		5456.4	41.54	-12.46	54	26.29	31.61	12.69	29.05	260	320	A	V
	*	5670	103.31	-	-	87.54	31.74	13.07	29.04	260	320	P	V
	*	5670	90.8	-	-	75.03	31.74	13.07	29.04	260	320	A	V
		5741.375	55.96	-12.24	68.2	39.82	31.97	13.19	29.02	260	320	P	V
Remark	1. No other spurious found. 2. All results are PASS against Peak and Average limit line.												



Band 3 - 5470~5725MHz

WIFI 802.11ax HE40 Partial RU (242 Tone) (Harmonic @ 3m)

WIFI Ant. 1+2	Note	Frequency (MHz)	Level (dBμV/m)	Over Limit (dB)	Limit Line (dBμV/m)	Read Level (dBμV)	Antenna Factor (dB/m)	Path Loss (dB)	Preamp Factor (dB)	Ant Pos (cm)	Table Pos (deg)	Peak Avg. (P/A)	Pol. (H/V)
802.11ax HE40 Partial RU (242 Tone) 242/61 CH 102 5510MHz		10982	55.11	-18.89	74	55.05	40.4	20.1	60.44	300	355	P	H
		10982	41.62	-12.38	54	41.56	40.4	20.1	60.44	300	355	A	H
		16471	48.58	-19.62	68.2	43.79	38.6	25.17	58.98	100	0	P	H
													H
		10982	49.18	-24.82	74	49.12	40.4	20.1	60.44	100	0	P	V
		16471	48.01	-20.19	68.2	43.22	38.6	25.17	58.98	100	0	P	V
													V
													V
802.11ax HE40 Partial RU (242 Tone) 242/62 CH 134 5670MHz		11378	53.66	-20.34	74	53.78	40.03	20.54	60.69	300	360	P	H
		11378	40.95	-13.05	54	41.07	40.03	20.54	60.69	300	360	A	H
		17075	50.77	-17.43	68.2	41.68	40.38	26.21	57.5	100	0	P	H
													H
		11378	49.17	-24.83	74	49.29	40.03	20.54	60.69	100	0	P	V
		17075	49.54	-18.66	68.2	40.45	40.38	26.21	57.5	100	0	P	V
													V
													V
Remark	1. No other spurious found. 2. All results are PASS against Peak and Average limit line.												



Band 3 - 5470~5725MHz

WIFI 802.11ax HE80 Full RU (996 Tone) (Band Edge @ 3m)

WIFI Ant. 1+2	Note	Frequency (MHz)	Level (dBμV/m)	Over Limit (dB)	Limit Line (dBμV/m)	Read Level (dBμV)	Antenna Factor (dB/m)	Path Loss (dB)	Preamp Factor (dB)	Ant Pos (cm)	Table Pos (deg)	Peak Avg. (P/A)	Pol. (H/V)
802.11ax HE80 Full RU (996 Tone) CH 106 5530MHz		5415.04	54.7	-19.3	74	39.65	31.46	12.61	29.02	100	61	P	H
		5469.04	53.59	-14.61	68.2	38.3	31.64	12.71	29.06	100	61	P	H
		5459.92	43.21	-10.79	54	27.95	31.62	12.69	29.05	100	61	A	H
	*	5530	101.51	-	-	85.99	31.76	12.83	29.07	100	61	P	H
	*	5530	90.87	-	-	75.35	31.76	12.83	29.07	100	61	A	H
		5757.125	55.29	-12.91	68.2	39.09	32.01	13.21	29.02	100	61	P	H
		5458.72	54.03	-19.97	74	38.77	31.62	12.69	29.05	101	95	P	V
		5465.44	54.88	-13.32	68.2	39.61	31.63	12.7	29.06	101	95	P	V
		5459.68	42.54	-11.46	54	27.28	31.62	12.69	29.05	101	95	A	V
	*	5530	97.38	-	-	81.86	31.76	12.83	29.07	101	95	P	V
	*	5530	87.4	-	-	71.88	31.76	12.83	29.07	101	95	A	V
		5727.515	55.03	-13.17	68.2	38.99	31.91	13.16	29.03	101	95	P	V
802.11ax HE80 Full RU (996 Tone) CH 122 5610MHz		5434.72	54.04	-19.96	74	38.89	31.54	12.65	29.04	100	62	P	H
		5466.4	52.75	-15.45	68.2	37.47	31.63	12.71	29.06	100	62	P	H
		5456.8	41.95	-12.05	54	26.7	31.61	12.69	29.05	100	62	A	H
	*	5610	103.17	-	-	87.54	31.7	12.98	29.05	100	62	P	H
	*	5610	91.82	-	-	76.19	31.7	12.98	29.05	100	62	A	H
		5751.77	55.38	-12.82	68.2	39.2	32	13.2	29.02	100	62	P	H
		5394.4	53.92	-20.08	74	38.98	31.38	12.57	29.01	100	95	P	V
		5465.44	54.18	-14.02	68.2	38.91	31.63	12.7	29.06	100	95	P	V
		5457.28	41.81	-12.19	54	26.56	31.61	12.69	29.05	100	95	A	V
	*	5610	98.82	-	-	83.19	31.7	12.98	29.05	100	95	P	V
*	5610	87.86	-	-	72.23	31.7	12.98	29.05	100	95	A	V	
	5738.54	55.93	-12.27	68.2	39.82	31.95	13.18	29.02	100	95	P	V	
Remark	1. No other spurious found. 2. All results are PASS against Peak and Average limit line.												



Band 3 5470~5725MHz
WIFI 802.11ac VHT80 (Harmonic @ 3m)

WIFI Ant. 1+2	Note	Frequency (MHz)	Level (dBμV/m)	Over Limit (dB)	Limit Line (dBμV/m)	Read Level (dBμV)	Antenna Factor (dB/m)	Path Loss (dB)	Preamp Factor (dB)	Ant Pos (cm)	Table Pos (deg)	Peak Avg. (P/A)	Pol. (H/V)	
802.11ax HE80 Full RU (996 Tone) CH 106 5530MHz		11060	47.81	-26.19	74	47.9	40.22	20.2	60.51	100	0	P	H	
		16590	48.49	-19.71	68.2	42.6	39.25	25.37	58.73	100	0	P	H	
													H	
													H	
			11060	48.74	-25.26	74	48.83	40.22	20.2	60.51	100	0	P	V
			16590	49.22	-18.98	68.2	43.33	39.25	25.37	58.73	100	0	P	V
														V
802.11ax HE80 Full RU (996 Tone) CH 122 5610MHz		11220	48.27	-25.73	74	48.62	39.88	20.37	60.6	100	0	P	H	
		16830	50.92	-17.28	68.2	43.06	40.25	25.78	58.17	100	0	P	H	
													H	
													H	
			11220	47.47	-26.53	74	47.82	39.88	20.37	60.6	100	0	P	V
			16830	49.76	-18.44	68.2	41.9	40.25	25.78	58.17	100	0	P	V
														V
Remark	1. No other spurious found.													
	2. All results are PASS against Peak and Average limit line.													



Band 3 - 5470~5725MHz

WIFI 802.11ax HE80 Partial RU (484 Tone) (Band Edge @ 3m)

WIFI Ant. 1+2	Note	Frequency (MHz)	Level (dBμV/m)	Over Limit (dB)	Limit Line (dBμV/m)	Read Level (dBμV)	Antenna Factor (dB/m)	Path Loss (dB)	Preamp Factor (dB)	Ant Pos (cm)	Table Pos (deg)	Peak Avg. (P/A)	Pol. (H/V)
802.11ax HE80 Partial RU (484 Tone) 484/65 RU CH 106 5530MHz		5440.24	59.96	-14.04	74	44.78	31.56	12.66	29.04	329	296	P	H
		5467.12	61.99	-6.21	68.2	46.71	31.63	12.71	29.06	329	296	P	H
		5447.2	41.56	-12.44	54	26.35	31.59	12.67	29.05	329	296	A	H
	*	5530	99.54	-	-	84.02	31.76	12.83	29.07	329	296	P	H
	*	5530	84.29	-	-	68.77	31.76	12.83	29.07	329	296	A	H
		5751.14	54.78	-13.42	68.2	38.6	32	13.2	29.02	329	296	P	H
		5440.48	61.44	-12.56	74	46.26	31.56	12.66	29.04	133	321	P	V
		5468.08	63.96	-4.24	68.2	48.67	31.64	12.71	29.06	133	321	P	V
		5441.44	41.74	-12.26	54	26.55	31.57	12.66	29.04	133	321	A	V
	*	5530	102.39	-	-	86.87	31.76	12.83	29.07	133	321	P	V
	*	5530	87.34	-	-	71.82	31.76	12.83	29.07	133	321	A	V
		5736.965	54.83	-13.37	68.2	38.72	31.95	13.18	29.02	133	321	P	V
802.11ax HE80 Partial RU (484 Tone) 484/66 RU CH 122 5610MHz		5408.56	54.63	-19.37	74	39.62	31.43	12.6	29.02	185	309	P	H
		5468.8	54.66	-13.54	68.2	39.37	31.64	12.71	29.06	185	309	P	H
		5457.04	41.66	-12.34	54	26.41	31.61	12.69	29.05	185	309	A	H
	*	5610	100.26	-	-	84.63	31.7	12.98	29.05	185	309	P	H
	*	5610	85.83	-	-	70.2	31.7	12.98	29.05	185	309	A	H
		5731.61	55.17	-13.03	68.2	39.09	31.93	13.17	29.02	185	309	P	H
		5423.44	54.38	-19.62	74	39.3	31.49	12.62	29.03	163	317	P	V
		5463.28	54.28	-13.92	68.2	39.01	31.63	12.7	29.06	163	317	P	V
		5455.36	41.6	-12.4	54	26.35	31.61	12.69	29.05	163	317	A	V
	*	5610	99.37	-	-	83.74	31.7	12.98	29.05	163	317	P	V
	*	5610	85.51	-	-	69.88	31.7	12.98	29.05	163	317	A	V
		5757.755	54.3	-13.9	68.2	38.09	32.02	13.21	29.02	163	317	P	V
Remark	1. No other spurious found. 2. All results are PASS against Peak and Average limit line.												



Band 3 5470~5725MHz

WIFI 802.11ax HE80 Partial RU (484 Tone) (Harmonic @ 3m)

WIFI Ant. 1+2	Note	Frequency (MHz)	Level (dBμV/m)	Over Limit (dB)	Limit Line (dBμV/m)	Read Level (dBμV)	Antenna Factor (dB/m)	Path Loss (dB)	Preamp Factor (dB)	Ant Pos (cm)	Table Pos (deg)	Peak Avg. (P/A)	Pol. (H/V)	
802.11ax HE80 Partial RU (484 Tone) 484/65 RU CH 106 5530MHz		11060	48.38	-25.62	74	48.47	40.22	20.2	60.51	100	0	P	H	
		16590	49.37	-18.83	68.2	43.48	39.25	25.37	58.73	100	0	P	H	
													H	
													H	
			11060	47.98	-26.02	74	48.07	40.22	20.2	60.51	100	0	P	V
			16590	48.59	-19.61	68.2	42.7	39.25	25.37	58.73	100	0	P	V
														V
														V
802.11ax HE80 Partial RU (484 Tone) 484/66 RU CH 122 5610MHz		11235	47.17	-26.83	74	47.52	39.87	20.39	60.61	100	0	P	H	
		16830	50.06	-18.14	68.2	42.2	40.25	25.78	58.17	100	0	P	H	
													H	
													H	
			11235	49.13	-24.87	74	49.48	39.87	20.39	60.61	100	0	P	V
			16830	49.77	-18.43	68.2	41.91	40.25	25.78	58.17	100	0	P	V
														V
														V
Remark	1. No other spurious found. 2. All results are PASS against Peak and Average limit line.													



Band 3 - Straddle Channel

WIFI 802.11ax HE20 Full RU (242 Tone) (Band Edge @ 3m)

WIFI	Note	Frequency	Level	Over	Limit	Read	Antenna	Path	Preamp	Ant	Table	Peak	Pol.
Ant.				Limit	Line	Level	Factor	Loss	Factor	Pos	Pos	Avg.	
1+2		(MHz)	(dBµV/m)	(dB)	(dBµV/m)	(dBµV)	(dB/m)	(dB)	(dB)	(cm)	(deg)	(P/A)	(H/V)
802.11ax HE20 Full RU (242 Tone) CH 144 5720MHz		5435.41	55.17	-18.83	74	40.02	31.54	12.65	29.04	100	61	P	H
		5461.15	54.16	-14.04	68.2	38.89	31.62	12.7	29.05	100	61	P	H
		5459.98	41.54	-12.46	54	26.28	31.62	12.69	29.05	100	61	A	H
	*	5720	108.57	-	-	92.57	31.88	13.15	29.03	100	61	P	H
	*	5720	97.13	-	-	81.13	31.88	13.15	29.03	100	61	A	H
		5945	56.76	-11.44	68.2	39.98	32.38	13.37	28.97	100	61	P	H
		5379.64	55.5	-18.5	74	40.62	31.32	12.56	29	106	178	P	V
		5470	53.78	-14.42	68.2	38.49	31.64	12.71	29.06	106	178	P	V
		5455.3	41.5	-12.5	54	26.25	31.61	12.69	29.05	106	178	A	V
	*	5720	105.2	-	-	89.2	31.88	13.15	29.03	106	178	P	V
*	5720	94.25	-	-	78.25	31.88	13.15	29.03	106	178	A	V	
		5948.75	57.46	-10.74	68.2	40.66	32.4	13.37	28.97	106	178	P	V
Remark	1. No other spurious found. 2. All results are PASS against Peak and Average limit line.												



Band 3 - Straddle Channel

WIFI 802.11ax HE20 Full RU (242 Tone) (Harmonic @ 3m)

WIFI Ant. 1+2	Note	Frequency (MHz)	Level (dBμV/m)	Over Limit (dB)	Limit Line (dBμV/m)	Read Level (dBμV)	Antenna Factor (dB/m)	Path Loss (dB)	Preamp Factor (dB)	Ant Pos (cm)	Table Pos (deg)	Peak Avg. (P/A)	Pol. (H/V)	
802.11ax HE20 Full RU (242 Tone) CH 144 5720MHz		11440	47.47	-26.53	74	47.49	40.1	20.61	60.73	100	0	P	H	
		17160	50.2	-18	68.2	40.5	40.54	26.35	57.19	100	0	P	H	
													H	
													H	
			11440	47.85	-26.15	74	47.87	40.1	20.61	60.73	100	0	P	V
			17160	50.24	-17.96	68.2	40.54	40.54	26.35	57.19	100	0	P	V
													V	
													V	
Remark	1. No other spurious found. 2. All results are PASS against Peak and Average limit line.													



Band 3 - Straddle Channel
WIFI 802.11ax HE40 Full RU (484 Tone) (Band Edge @ 3m)

WIFI Ant. 1+2	Note	Frequency (MHz)	Level (dBμV/m)	Over Limit (dB)	Limit Line (dBμV/m)	Read Level (dBμV)	Antenna Factor (dB/m)	Path Loss (dB)	Preamp Factor (dB)	Ant Pos (cm)	Table Pos (deg)	Peak Avg. (P/A)	Pol. (H/V)
802.11ax HE40 Full RU (484 Tone) CH 142 5710MHz		5424.1	54.57	-19.43	74	39.47	31.5	12.63	29.03	100	62	P	H
		5463.49	55.27	-12.93	68.2	40	31.63	12.7	29.06	100	62	P	H
		5452.96	41.53	-12.47	54	26.29	31.61	12.68	29.05	100	62	A	H
	*	5710	104.48	-	-	88.53	31.84	13.14	29.03	100	62	P	H
	*	5710	93.94	-	-	77.99	31.84	13.14	29.03	100	62	A	H
		5943.5	57.65	-10.55	68.2	40.88	32.37	13.37	28.97	100	62	P	H
		5360.14	54.17	-19.83	74	39.38	31.24	12.54	28.99	104	178	P	V
		5463.49	54.75	-13.45	68.2	39.48	31.63	12.7	29.06	104	178	P	V
		5454.13	41.45	-12.55	54	26.21	31.61	12.68	29.05	104	178	A	V
	*	5710	101.66	-	-	85.71	31.84	13.14	29.03	104	178	P	V
	*	5710	91.07	-	-	75.12	31.84	13.14	29.03	104	178	A	V
		5899.5	56.15	-12.05	68.2	39.59	32.2	13.34	28.98	104	178	P	V
Remark	1. No other spurious found. 2. All results are PASS against Peak and Average limit line.												



Band 3 - Straddle Channel

WIFI 802.11ax HE40 Full RU (484 Tone) (Harmonic @ 3m)

WIFI Ant. 1+2	Note	Frequency (MHz)	Level (dBμV/m)	Over Limit (dB)	Limit Line (dBμV/m)	Read Level (dBμV)	Antenna Factor (dB/m)	Path Loss (dB)	Preamp Factor (dB)	Ant Pos (cm)	Table Pos (deg)	Peak Avg. (P/A)	Pol. (H/V)	
802.11n HT40 CH 142 5710MHz		11420	47.5	-26.5	74	47.53	40.1	20.59	60.72	100	0	P	H	
		17130	50.85	-17.35	68.2	41.43	40.42	26.3	57.3	100	0	P	H	
													H	
													H	
			11420	46.9	-27.1	74	46.93	40.1	20.59	60.72	100	0	P	V
			17130	50.05	-18.15	68.2	40.63	40.42	26.3	57.3	100	0	P	V
														V
Remark	1. No other spurious found. 2. All results are PASS against Peak and Average limit line.													



**Band 3 - Straddle Channel
WIFI 802.11ax HE80 Full RU (996 Tone) (Band Edge @ 3m)**

WIFI Ant. 1+2	Note	Frequency (MHz)	Level (dBμV/m)	Over Limit (dB)	Limit Line (dBμV/m)	Read Level (dBμV)	Antenna Factor (dB/m)	Path Loss (dB)	Preamp Factor (dB)	Ant Pos (cm)	Table Pos (deg)	Peak Avg. (P/A)	Pol. (H/V)
802.11ax HE80 Full RU (996 Tone) CH 138 5690MHz		5431.9	55.29	-18.71	74	40.16	31.53	12.64	29.04	100	63	P	H
		5461.93	54.33	-13.87	68.2	39.06	31.62	12.7	29.05	100	63	P	H
		5456.86	41.6	-12.4	54	26.35	31.61	12.69	29.05	100	63	A	H
	*	5690	102.81	-	-	86.96	31.78	13.1	29.03	100	63	P	H
	*	5690	91.72	-	-	75.87	31.78	13.1	29.03	100	63	A	H
		5869	57.1	-11.1	68.2	40.63	32.14	13.32	28.99	100	63	P	H
		5358.97	54.51	-19.49	74	39.72	31.24	12.54	28.99	109	180	P	V
		5469.73	54.06	-14.14	68.2	38.77	31.64	12.71	29.06	109	180	P	V
		5456.47	41.46	-12.54	54	26.21	31.61	12.69	29.05	109	180	A	V
	*	5690	98.92	-	-	83.07	31.78	13.1	29.03	109	180	P	V
	*	5690	88.83	-	-	72.98	31.78	13.1	29.03	109	180	A	V
		5908.75	56.44	-11.76	68.2	39.83	32.24	13.35	28.98	109	180	P	V
Remark	1. No other spurious found. 2. All results are PASS against Peak and Average limit line.												



Band 3 - Straddle Channel

WIFI 802.11ax HE80 Full RU (996 Tone) (Harmonic @ 3m)

WIFI Ant. 1+2	Note	Frequency (MHz)	Level (dBμV/m)	Over Limit (dB)	Limit Line (dBμV/m)	Read Level (dBμV)	Antenna Factor (dB/m)	Path Loss (dB)	Preamp Factor (dB)	Ant Pos (cm)	Table Pos (deg)	Peak Avg. (P/A)	Pol. (H/V)	
802.11n HT80 CH 138 5690MHz		11380	47.91	-26.09	74	48.02	40.04	20.54	60.69	100	0	P	H	
		17070	51.32	-16.88	68.2	42.25	40.39	26.2	57.52	100	0	P	H	
													H	
													H	
			11380	48.29	-25.71	74	48.4	40.04	20.54	60.69	100	0	P	V
			17070	50.47	-17.73	68.2	41.4	40.39	26.2	57.52	100	0	P	V
														V
Remark	1. No other spurious found. 2. All results are PASS against Peak and Average limit line.													



**Emission above 18GHz
5GHz WIFI 802.11ax HE40 (SHF)**

WIFI	Note	Frequency	Level	Over	Limit	Read	Antenna	Path	Preamp	Ant	Table	Peak	Pol.	
Ant.				Limit	Line	Level	Factor	Loss	Factor	Pos	Pos	Avg.		
1		(MHz)	(dBμV/m)	(dB)	(dBμV/m)	(dBμV)	(dB/m)	(dB)	(dB)	(cm)	(deg)	(P/A)	(H/V)	
802.11ax HE40 SHF		23610	41.81	-32.19	74	42.24	39.85	13.02	53.3	150	0	P	H	
		39780	49.85	-24.15	74	39.53	45.01	19.96	54.65	150	0	P	H	
													H	
													H	
													H	
													H	
			23522	41.65	-26.55	68.2	42.19	39.73	13.03	53.3	150	0	P	V
			39890	49.89	-24.11	74	39.14	45.06	20.17	54.48	150	0	P	V
														V
														V
														V
														V
Remark	1. No other spurious found. 2. All results are PASS against limit line.													



Emission below 1GHz

WIFI 802.11ax HE40 Partial RU (242 Tone) (LF @ 3m)

WIFI	Note	Frequency	Level	Over	Limit	Read	Antenna	Path	Preamp	Ant	Table	Peak	Pol.	
Ant.				Limit	Line	Level	Factor	Loss	Factor	Pos	Pos	Avg.		
1+2		(MHz)	(dBμV/m)	(dB)	(dBμV/m)	(dBμV)	(dB/m)	(dB)	(dB)	(cm)	(deg)	(P/A)	(H/V)	
802.11ax HE40 Partial RU (242 Tone) 242/61 LF		30.97	22.39	-17.61	40	29.57	24.09	0.94	32.21	-	-	P	H	
		103.72	29.16	-14.34	43.5	43.39	16.29	1.73	32.25	-	-	P	H	
		183.26	26.79	-16.71	43.5	41.96	14.78	2.36	32.31	-	-	P	H	
		214.3	28.16	-15.34	43.5	42.79	15.17	2.53	32.33	-	-	P	H	
		785.63	32.28	-13.72	46	31.73	28.07	4.82	32.34	-	-	P	H	
		957.32	34.26	-11.74	46	29.26	30.91	5.33	31.24	100	0	P	H	
	Remark	1. No other spurious found. 2. All results are PASS against limit line.												



<WPC Mode>

Band 3 - 5470~5725MHz

WIFI 802.11ax HE40 Partial RU (242 Tone) (Band Edge @ 3m)

WIFI	Note	Frequency	Level	Over	Limit	Read	Antenna	Path	Preamp	Ant	Table	Peak	Pol.
Ant.				Limit	Line	Level	Factor	Loss	Factor	Pos	Pos	Avg.	
1+2		(MHz)	(dBμV/m)	(dB)	(dBμV/m)	(dBμV)	(dB/m)	(dB)	(dB)	(cm)	(deg)	(P/A)	(H/V)
802.11ax HE40 Partial RU (242 Tone) 242/61 CH 102 5510MHz		5404.96	54.31	-19.69	74	39.32	31.42	12.59	29.02	301	33	P	H
		5470	58.28	-9.92	68.2	42.99	31.64	12.71	29.06	301	33	P	H
		5454.16	41.42	-12.58	54	26.18	31.61	12.68	29.05	301	33	A	H
	*	5510	98.65			83.22	31.72	12.79	29.08	301	33	P	H
	*	5510	86.04			70.61	31.72	12.79	29.08	301	33	A	H
		5764.685	54.74	-13.46	68.2	38.51	32.03	13.22	29.02	301	33	P	H
		5459.92	56.49	-17.51	74	41.23	31.62	12.69	29.05	107	166	P	V
		5469.52	61.76	-6.44	68.2	46.47	31.64	12.71	29.06	107	166	P	V
		5459.92	41.51	-12.49	54	26.25	31.62	12.69	29.05	107	166	A	V
	*	5510	103.36			87.93	31.72	12.79	29.08	107	166	P	V
	*	5510	91.05			75.62	31.72	12.79	29.08	107	166	A	V
		5740.115	55.21	-12.99	68.2	39.09	31.96	13.18	29.02	107	166	P	V
Remark	1. No other spurious found. 2. All results are PASS against Peak and Average limit line.												



Band 3 - 5470~5725MHz

WIFI 802.11ax HE40 Partial RU (242 Tone) (Harmonic @ 3m)

WIFI Ant. 1+2	Note	Frequency (MHz)	Level (dBμV/m)	Over Limit (dB)	Limit Line (dBμV/m)	Read Level (dBμV)	Antenna Factor (dB/m)	Path Loss (dB)	Preamp Factor (dB)	Ant Pos (cm)	Table Pos (deg)	Peak Avg. (P/A)	Pol. (H/V)	
802.11ax HE40 Partial RU (242 Tone) 242/61 CH 102 5510MHz		11020	47.32	-26.68	74	47.32	40.34	20.15	60.49	100	0	P	H	
		16530	47.29	-20.91	68.2	41.94	38.95	25.27	58.87	100	0	P	H	
												P	H	
													H	
			11020	47.57	-26.43	74	47.57	40.34	20.15	60.49	100	0	P	V
			16530	47.57	-20.63	68.2	42.22	38.95	25.27	58.87	100	0	P	V
														V
														V
Remark	1. No other spurious found. 2. All results are PASS against Peak and Average limit line.													



Emission below 1GHz

WIFI 802.11ax HE40 Partial RU (242 Tone) (LF @ 3m)

WIFI	Note	Frequency	Level	Over	Limit	Read	Antenna	Path	Preamp	Ant	Table	Peak	Pol.	
Ant.				Limit	Line	Level	Factor	Loss	Factor	Pos	Pos	Avg.		
1+2		(MHz)	(dBμV/m)	(dB)	(dBμV/m)	(dBμV)	(dB/m)	(dB)	(dB)	(cm)	(deg)	(P/A)	(H/V)	
802.11ax HE40 Partial RU (242 Tone) LF		71.71	26.3	-13.7	40	44.9	12.31	1.44	32.35	-	-	P	H	
		145.43	28.65	-14.85	43.5	41.65	17.16	2.12	32.28	-	-	P	H	
		213.33	26.55	-16.95	43.5	41.17	15.18	2.53	32.33	-	-	P	H	
		431.58	26.37	-19.63	46	32.14	22.85	3.6	32.17	-	-	P	H	
		741.01	31.23	-14.77	46	30.75	28.04	4.68	32.24	-	-	P	H	
		957.32	34.49	-11.51	46	29.49	30.91	5.32	31.24	100	0	P	H	
			32.91	28.58	-11.42	40	36.86	22.99	0.96	32.23	100	314	QP	V
			181.32	26.82	-16.68	43.5	41.94	14.84	2.35	32.31	-	-	P	V
			431.58	27.8	-18.2	46	33.57	22.85	3.6	32.17	-	-	P	V
			739.07	31.25	-14.75	46	30.83	27.99	4.67	32.24	-	-	P	V
			920.46	33.27	-12.73	46	30.27	29.47	5.22	31.68	-	-	P	V
		954.41	33.85	-12.15	46	28.95	30.86	5.32	31.28	-	-	P	V	
Remark	1. No other spurious found. 2. All results are PASS against limit line.													



Note symbol

*	Fundamental Frequency which can be ignored. However, the level of any unwanted emissions shall not exceed the level of the fundamental frequency.
!	Test result is over limit line.
P/A	Peak or Average
H/V	Horizontal or Vertical



A calculation example for radiated spurious emission is shown as below:

WIFI	Note	Frequency	Level	Over	Limit	Read	Antenna	Path	Preamp	Ant	Table	Peak	Pol.
Ant.				Limit	Line	Level	Factor	Loss	Factor	Pos	Pos	Avg.	
1+2		(MHz)	(dBμV/m)	(dB)	(dBμV/m)	(dBμV)	(dB/m)	(dB)	(dB)	(cm)	(deg)	(P/A)	(H/V)
802.11b		2390	55.45	-18.55	74	54.51	32.22	4.58	35.86	103	308	P	H
CH 01													
2412MHz		2390	43.54	-10.46	54	42.6	32.22	4.58	35.86	103	308	A	H

1. Path Loss(dB) = Cable loss(dB) + Filter loss(dB) + Attenuator loss(dB)
2. Level(dBμV/m) = Antenna Factor(dB/m) + Path Loss(dB) + Read Level(dBμV) - Preamp Factor(dB)
3. Over Limit(dB) = Level(dBμV/m) – Limit Line(dBμV/m)

For Peak Limit @ 2390MHz:

1. Level(dBμV/m)
= Antenna Factor(dB/m) + Path Loss(dB) + Read Level(dBμV) - Preamp Factor(dB)
= 32.22(dB/m) + 4.58(dB) + 54.51(dBμV) – 35.86 (dB)
= 55.45 (dBμV/m)
2. Over Limit(dB)
= Level(dBμV/m) – Limit Line(dBμV/m)
= 55.45(dBμV/m) – 74(dBμV/m)
= -18.55(dB)

For Average Limit @ 2390MHz:

1. Level(dBμV/m)
= Antenna Factor(dB/m) + Path Loss(dB) + Read Level(dBμV) - Preamp Factor(dB)
= 32.22(dB/m) + 4.58(dB) + 42.6(dBμV) – 35.86 (dB)
= 43.54 (dBμV/m)
2. Over Limit(dB) = Level(dBμV/m) – Limit Line(dBμV/m)
= 43.54(dBμV/m) – 54(dBμV/m)
= -10.46(dB)

Both peak and average measured complies with the limit line, so test result is “PASS”.



Appendix D. Radiated Spurious Emission

Test Engineer :	Jacky Hung, CR Liro and Andy Yang	Temperature :	20~25°C
		Relative Humidity :	50~60%

Note symbol

-L	Low channel location
-R	High channel location

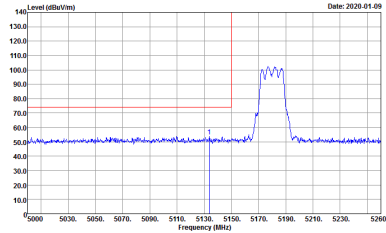
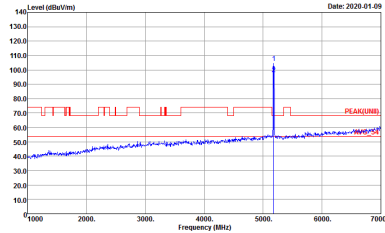
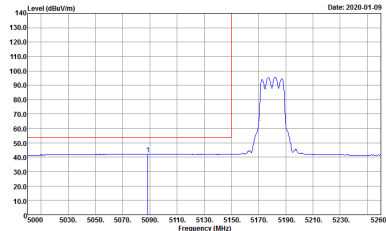

Band 1 - 5150~5250MHz
WIFI 802.11a (Band Edge @ 3m)

WIFI	Band 1 5150~5250MHz Band Edge @ 3m	
ANT	802.11a CH36 5180MHz	
1+2	Horizontal	Fundamental
<p align="center">Peak</p>	 <p>Site : 03CH16-1FY Condition : PEAK_BE_74 3m 91200_1522 HORIZONTAL : RBW:1000.000KHz VBW:3000.000KHz SWT:Auto Detector : Peak Project : 901542-02</p>	 <p>Site : 03CH16-1FY Condition : PEAK(LINII) 3m 91200_1522 HORIZONTAL : RBW:1000.000KHz VBW:3000.000KHz SWT:Auto Detector : Peak Project : 901542-02</p>
<p align="center">Avg.</p>	 <p>Site : 03CH16-1FY Condition : AVG_BE_54 3m 91200_1522 HORIZONTAL : RBW:1000.000KHz VBW:3000.000KHz SWT:Auto Detector : Peak Project : 901542-02</p>	<p align="center">Left blank</p>



WIFI	Band 1 5150~5250MHz Band Edge @ 3m	
ANT	802.11a CH36 5180MHz	
1+2	Vertical	Fundamental
Peak	<p>Site : 03CH16-HY Condition : PEAK_BE_74 3m 91200_1522 VERTICAL RBW:1000.000KHz VBW:3000.000KHz SWT:Auto Detector : Peak Project : 901542-02</p>	<p>Site : 03CH16-HY Condition : PEAK(UNII) 3m 91200_1522 VERTICAL RBW:1000.000KHz VBW:3000.000KHz SWT:Auto Detector : Peak Project : 901542-02</p>
Avg.	<p>Site : 03CH16-HY Condition : AVG_BE_54 3m 91200_1522 VERTICAL RBW:1000.000KHz VBW:3000.000KHz SWT:Auto Detector : Peak Project : 901542-02</p>	Left blank



WIFI	Band 1 5150~5250MHz Band Edge @ 3m	
ANT	802.11a CH44 5220MHz - L	
1+2	Horizontal	Fundamental
Peak	<p>Site : 03CH16-HY Condition : PEAK_BE_74 3m 91200_1522 HORIZONTAL RBW:1000.000KHz VBW:3000.000KHz SWT:Auto Detector : Peak Project : 901542-02</p>	<p>Site : 03CH16-HY Condition : PEAK(UNII) 3m 91200_1522 HORIZONTAL RBW:1000.000KHz VBW:3000.000KHz SWT:Auto Detector : Peak Project : 901542-02</p>
Avg.	<p>Site : 03CH16-HY Condition : AVG_BE_54 3m 91200_1522 HORIZONTAL RBW:1000.000KHz VBW:3000.000KHz SWT:Auto Detector : Peak Project : 901542-02</p>	Left blank

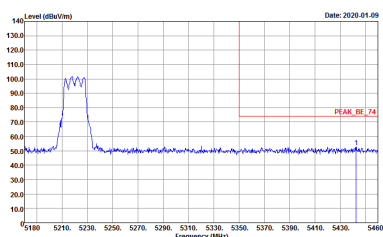
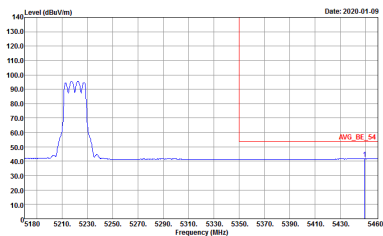

WIFI	Band 1 5150~5250MHz Band Edge @ 3m	
ANT	802.11a CH44 5220MHz - R	
1+2	Horizontal	Fundamental
<p>Peak</p>	 <p>Site : 03CH16-HY Condition : PEAK_BE_74 3m 91200_1522 HORIZONTAL RBW:1000.000kHz VBW:3000.000kHz SWT:Auto Detector : Peak Project : 901542-02</p>	<p>Left blank</p>
<p>Avg.</p>	 <p>Site : 03CH16-HY Condition : AVG_BE_54 3m 91200_1522 HORIZONTAL RBW:1000.000kHz VBW:0.0100kHz SWT:Auto Detector : Peak Project : 901542-02</p>	<p>Left blank</p>



WIFI	Band 1 5150~5250MHz Band Edge @ 3m	
ANT	802.11a CH44 5220MHz - L	
1+2	Vertical	Fundamental
Peak	<p>Site : 03CH16-HY Condition : PEAK_BE_74 3m 91200_1522 VERTICAL RBW:1000.000KHz VBW:3000.000KHz SWT:Auto Detector : Peak Project : 901542-02</p>	<p>Site : 03CH16-HY Condition : PEAK(UNII) 3m 91200_1522 VERTICAL RBW:1000.000KHz VBW:3000.000KHz SWT:Auto Detector : Peak Project : 901542-02</p>
Avg.	<p>Site : 03CH16-HY Condition : AVG_BE_54 3m 91200_1522 VERTICAL RBW:1000.000KHz VBW:3000.000KHz SWT:Auto Detector : Peak Project : 901542-02</p>	Left blank

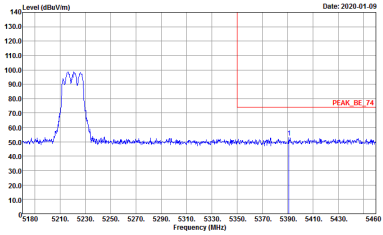
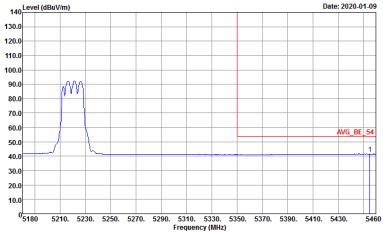

WIFI	Band 1 5150~5250MHz Band Edge @ 3m	
ANT	802.11a CH44 5220MHz - R	
1+2	Vertical	Fundamental
<p>Peak</p>	 <p>Site : 03CH16-HY Condition : PEAK_BE_74 3m 91200_1522 VERTICAL RBW:1000.000kHz VBW:3000.000kHz SWF:Auto Detector : Peak Project : 901542-02</p>	<p>Left blank</p>
<p>Avg.</p>	 <p>Site : 03CH16-HY Condition : AVG_BE_54 3m 91200_1522 VERTICAL RBW:1000.000kHz VBW:3000.000kHz SWF:Auto Detector : Peak Project : 901542-02</p>	<p>Left blank</p>

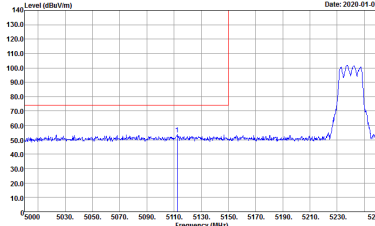
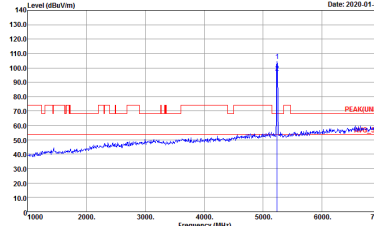
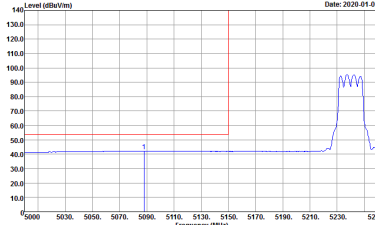

WIFI	Band 1 5150~5250MHz Band Edge @ 3m	
ANT	802.11a CH48 5240MHz - L	
1+2	Horizontal	Fundamental
Peak	 <p>Site : 03CH16-HY Condition : PEAK_BE_74 3m 91200_1522 HORIZONTAL RBW:1000.000KHz VBW:3000.000KHz SWT:Auto Detector : Peak Project : 901542-02</p>	 <p>Site : 03CH16-HY Condition : PEAK(UNII) 3m 91200_1522 HORIZONTAL RBW:1000.000KHz VBW:3000.000KHz SWT:Auto Detector : Peak Project : 901542-02</p>
Avg.	 <p>Site : 03CH16-HY Condition : AVG_BE_54 3m 91200_1522 HORIZONTAL RBW:1000.000KHz VBW:3000.000KHz SWT:Auto Detector : Peak Project : 901542-02</p>	Left blank

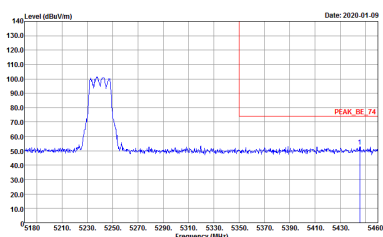
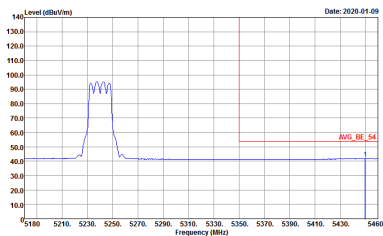

WIFI	Band 1 5150~5250MHz Band Edge @ 3m	
ANT	802.11a CH48 5240MHz - R	
1+2	Horizontal	Fundamental
<p>Peak</p>	 <p>Site : 03CH16-HY Condition : PEAK_BE_74 3m 91200_1522 HORIZONTAL RBW:1000.000kHz VBW:3000.000kHz SWT:Auto Detector : Peak Project : 901542-02</p>	<p>Left blank</p>
<p>Avg.</p>	 <p>Site : 03CH16-HY Condition : AVG_BE_54 3m 91200_1522 HORIZONTAL RBW:1000.000kHz VBW:3000.000kHz SWT:Auto Detector : Peak Project : 901542-02</p>	<p>Left blank</p>



WIFI	Band 1 5150~5250MHz Band Edge @ 3m	
ANT	802.11a CH48 5240MHz - L	
1+2	Vertical	Fundamental
Peak	<p>Site : 03CH16-HY Condition : PEAK_BE_74 3m 91200_1522 VERTICAL RBW:1000.000KHz VBW:3000.000KHz SWT:Auto Detector : Peak Project : 901542-02</p>	<p>Site : 03CH16-HY Condition : PEAK(UNII) 3m 91200_1522 VERTICAL RBW:1000.000KHz VBW:3000.000KHz SWT:Auto Detector : Peak Project : 901542-02</p>
Avg.	<p>Site : 03CH16-HY Condition : AVG_BE_54 3m 91200_1522 VERTICAL RBW:1000.000KHz VBW:3000.000KHz SWT:Auto Detector : Peak Project : 901542-02</p>	Left blank



WIFI	Band 1 5150~5250MHz Band Edge @ 3m	
ANT	802.11a CH48 5240MHz - R	
1+2	Vertical	Fundamental
<p>Peak</p>	<p>Site : 03CH16-HY Condition : PEAK_BE_74 3m 91200_1522 VERTICAL RBW:1000.000kHz VBW:3000.000kHz SWF:Auto Detector : Peak Project : 901542-02</p>	<p>Left blank</p>
<p>Avg.</p>	<p>Site : 03CH16-HY Condition : AVG_BE_54 3m 91200_1522 VERTICAL RBW:1000.000kHz VBW:3000.000kHz SWF:Auto Detector : Peak Project : 901542-02</p>	<p>Left blank</p>

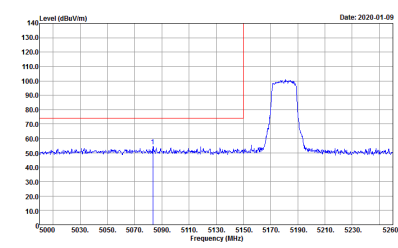
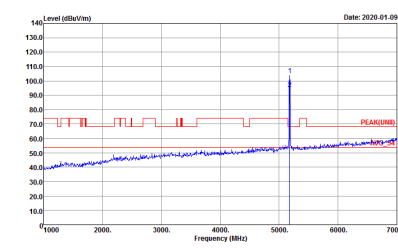
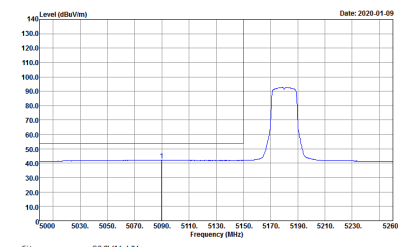

Band 1 5150~5250MHz
WIFI 802.11n HT20 (Band Edge @ 3m)

WIFI	Band 1 5150~5250MHz Band Edge @ 3m	
ANT	802.11n HT20 CH36 5180MHz	
1+2	Horizontal	Fundamental
<p align="center">Peak</p>	 <p>Date: 2020-01-09</p> <p>Site : 03CH16-HY Condition : PEAK_BE_74 3m 91200_1522 HORIZONTAL : RBW:1000.000KHz VBW:3000.000KHz SWT:Auto Detector : Peak Project : 901542-02</p>	 <p>Date: 2020-01-09</p> <p>Site : 03CH16-HY Condition : PEAK(UNIT) 3m 91200_1522 HORIZONTAL : RBW:1000.000KHz VBW:3000.000KHz SWT:Auto Detector : Peak Project : 901542-02</p>
<p align="center">Avg.</p>	 <p>Date: 2020-01-09</p> <p>Site : 03CH16-HY Condition : AVG_BE_54 3m 91200_1522 HORIZONTAL : RBW:1000.000KHz VBW:0.010KHz SWT:Auto Detector : Peak Project : 901542-02</p>	<p align="center">Left blank</p>



WIFI	Band 1 5150~5250MHz Band Edge @ 3m	
ANT	802.11n HT20 CH36 5180MHz	
1+2	Vertical	Fundamental
Peak	<p>Site : 03CH16-HY Condition : PEAK_BE_74 3m 91200_1522 VERTICAL RBW:1000.000KHz VBW:3000.000KHz SWT:Auto Detector : Peak Project : 901542-02</p>	<p>Site : 03CH16-HY Condition : PEAK(UNII) 3m 91200_1522 VERTICAL RBW:1000.000KHz VBW:3000.000KHz SWT:Auto Detector : Peak Project : 901542-02</p>
Avg.	<p>Site : 03CH16-HY Condition : AVG_BE_54 3m 91200_1522 VERTICAL RBW:1000.000KHz VBW:3000.000KHz SWT:Auto Detector : Peak Project : 901542-02</p>	Left blank

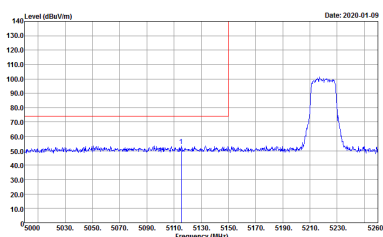
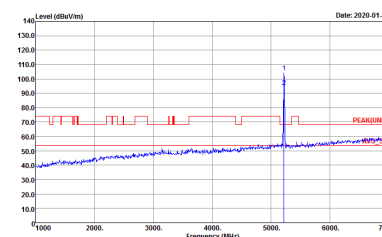
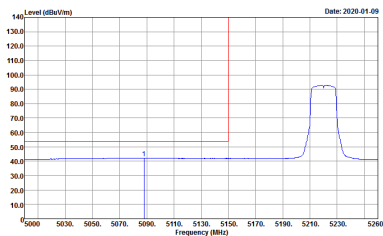

WIFI	Band 1 5150~5250MHz Band Edge @ 3m	
ANT	802.11n HT20 CH44 5220MHz - L	
1+2	Horizontal	Fundamental
Peak	 <p>Site : 03CH16-HY Condition : PEAK_BE_74 3m 91200_1522 HORIZONTAL RBW:1000.000KHz VBW:3000.000KHz SWT:Auto Detector : Peak Project : 901542-02</p>	 <p>Site : 03CH16-HY Condition : PEAK(UNII) 3m 91200_1522 HORIZONTAL RBW:1000.000KHz VBW:3000.000KHz SWT:Auto Detector : Peak Project : 901542-02</p>
Avg.	 <p>Site : 03CH16-HY Condition : AVG_BE_54 3m 91200_1522 HORIZONTAL RBW:1000.000KHz VBW:3000.000KHz SWT:Auto Detector : Peak Project : 901542-02</p>	Left blank

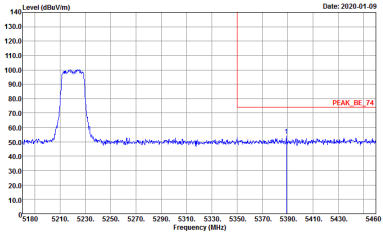
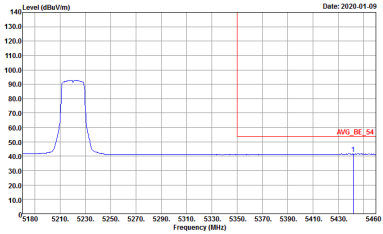

WIFI	Band 1 5150~5250MHz Band Edge @ 3m	
ANT	802.11n HT20 CH44 5220MHz - R	
1+2	Horizontal	Fundamental
<p>Peak</p>	 <p>Site : 03CH16-HY Condition : PEAK_BE_74 3m 91200_1522 HORIZONTAL RBW:1000.000kHz VBW:3000.000kHz SWT:Auto Detector : Peak Project : 901542-02</p>	<p>Left blank</p>
<p>Avg.</p>	 <p>Site : 03CH16-HY Condition : AVG_BE_54 3m 91200_1522 HORIZONTAL RBW:1000.000kHz VBW:3000.000kHz SWT:Auto Detector : Peak Project : 901542-02</p>	<p>Left blank</p>



WIFI	Band 1 5150~5250MHz Band Edge @ 3m	
ANT	802.11n HT20 CH44 5220MHz - L	
1+2	Vertical	Fundamental
Peak	<p>Site : 03CH16-HY Condition : PEAK_BE_74 3m 91200_1522 VERTICAL RBW:1000.000KHz VBW:3000.000KHz SWT:Auto Detector : Peak Project : 901542-02</p>	<p>Site : 03CH16-HY Condition : PEAK(UNII) 3m 91200_1522 VERTICAL RBW:1000.000KHz VBW:3000.000KHz SWT:Auto Detector : Peak Project : 901542-02</p>
Avg.	<p>Site : 03CH16-HY Condition : AVG_BE_54 3m 91200_1522 VERTICAL RBW:1000.000KHz VBW:3000.000KHz SWT:Auto Detector : Peak Project : 901542-02</p>	Left blank

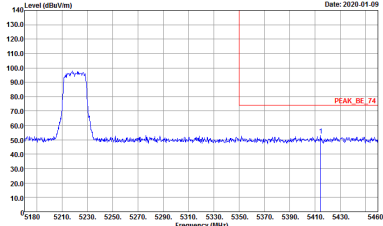
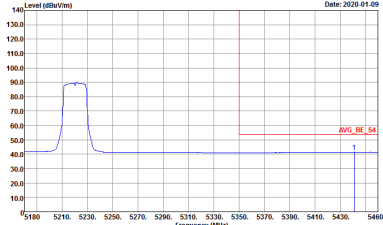

WIFI	Band 1 5150~5250MHz Band Edge @ 3m	
ANT	802.11n HT20 CH44 5220MHz - R	
1+2	Vertical	Fundamental
<p>Peak</p>	 <p>Site : 03CH16-HY Condition : PEAK_BE_74 3m 91200_1522 VERTICAL RBW:1000.000kHz VBW:3000.000kHz SWF:Auto Detector : Peak Project : 901542-02</p>	<p>Left blank</p>
<p>Avg.</p>	 <p>Site : 03CH16-HY Condition : AVG_BE_54 3m 91200_1522 VERTICAL RBW:1000.000kHz VBW:3000.000kHz SWF:Auto Detector : Peak Project : 901542-02</p>	<p>Left blank</p>

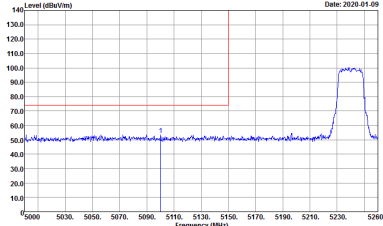
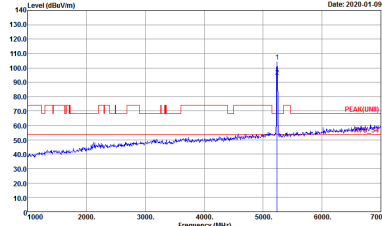
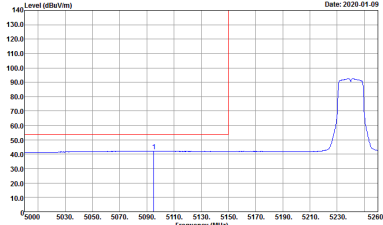

WIFI	Band 1 5150~5250MHz Band Edge @ 3m	
ANT	802.11n HT20 CH48 5240MHz - L	
1+2	Horizontal	Fundamental
<p>Peak</p>	 <p>Site : 03CH16-HY Condition : PEAK_BE_74 3m 91200_1522 HORIZONTAL RBW:1000.000kHz VBW:3000.000kHz SWT:Auto Detector : Peak Project : 901542-02</p>	 <p>Site : 03CH16-HY Condition : PEAK(UNII) 3m 91200_1522 HORIZONTAL RBW:1000.000kHz VBW:3000.000kHz SWT:Auto Detector : Peak Project : 901542-02</p>
<p>Avg.</p>	 <p>Site : 03CH16-HY Condition : AVG_BE_54 3m 91200_1522 HORIZONTAL RBW:1000.000kHz VBW:3000.000kHz SWT:Auto Detector : Peak Project : 901542-02</p>	<p>Left blank</p>



WIFI	Band 1 5150~5250MHz Band Edge @ 3m	
ANT	802.11n HT20 CH48 5240MHz - R	
1+2	Horizontal	Fundamental
<p>Peak</p>	<p>Site : 03CH16-HY Condition : PEAK_BE_74 3m 91200_1522 HORIZONTAL RBW:1000.000kHz VBW:3000.000kHz SWT:Auto Detector : Peak Project : 901542-02</p>	<p>Left blank</p>
<p>Avg.</p>	<p>Site : 03CH16-HY Condition : AVG_BE_54 3m 91200_1522 HORIZONTAL RBW:1000.000kHz VBW:0.0100kHz SWT:Auto Detector : Peak Project : 901542-02</p>	<p>Left blank</p>



WIFI	Band 1 5150~5250MHz Band Edge @ 3m	
ANT	802.11n HT20 CH48 5240MHz - L	
1+2	Vertical	Fundamental
Peak	<p>Site : 03CH16-HY Condition : PEAK_BE_74 3m 91200_1522 VERTICAL RBW:1000.000KHz VBW:3000.000KHz SWT:Auto Detector : Peak Project : 901542-02</p>	<p>Site : 03CH16-HY Condition : PEAK(UNII) 3m 91200_1522 VERTICAL RBW:1000.000KHz VBW:3000.000KHz SWT:Auto Detector : Peak Project : 901542-02</p>
Avg.	<p>Site : 03CH16-HY Condition : AVG_BE_54 3m 91200_1522 VERTICAL RBW:1000.000KHz VBW:3000.000KHz SWT:Auto Detector : Peak Project : 901542-02</p>	Left blank

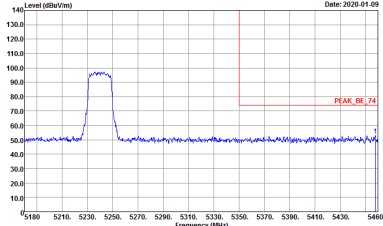
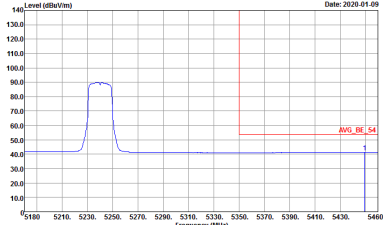

WIFI	Band 1 5150~5250MHz Band Edge @ 3m	
ANT	802.11n HT20 CH48 5240MHz - R	
1+2	Vertical	Fundamental
<p>Peak</p>	 <p>Site : 03CH16-HY Condition : PEAK_BE_74 3m 91200_1522 VERTICAL RBW:1000.000kHz VBW:3000.000kHz SWF:Auto Detector : Peak Project : 901542-02</p>	<p>Left blank</p>
<p>Avg.</p>	 <p>Site : 03CH16-HY Condition : AVG_BE_54 3m 91200_1522 VERTICAL RBW:1000.000kHz VBW:0.010kHz SWF:Auto Detector : Peak Project : 901542-02</p>	<p>Left blank</p>

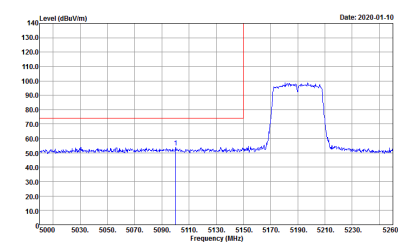
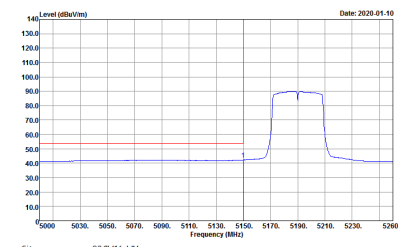

Band 1 5150~5250MHz
WIFI 802.11n HT40 (Band Edge @ 3m)

WIFI	Band 1 5150~5250MHz Band Edge @ 3m	
ANT	802.11n HT40 CH38 5190MHz - L	
1+2	Horizontal	Fundamental
Peak	 <p>Site : 03CH16-HY Condition : PEAK_BE_74 3m 91200_1522 HORIZONTAL : RBW:1000.000kHz VBW:3000.000kHz SWF:Auto Detector : Peak Project : 901542-02</p>	 <p>Site : 03CH16-HY Condition : PEAK(UNIT) 3m 91200_1522 HORIZONTAL : RBW:1000.000kHz VBW:3000.000kHz SWF:Auto Detector : Peak Project : 901542-02</p>
Avg.	 <p>Site : 03CH16-HY Condition : AVG_BE_54 3m 91200_1522 HORIZONTAL : RBW:1000.000kHz VBW:0.010kHz SWF:Auto Detector : Peak Project : 901542-02</p>	Left blank

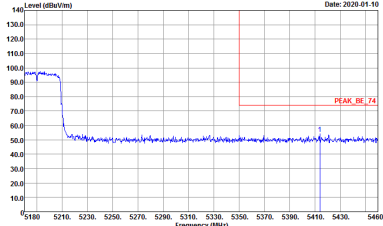
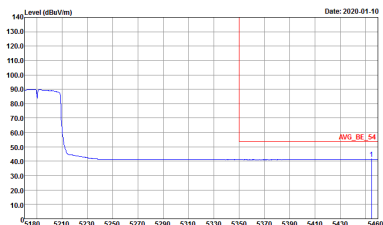

WIFI	Band 1 5150~5250MHz Band Edge @ 3m	
ANT	802.11n HT40 CH38 5190MHz - R	
1+2	Horizontal	Fundamental
<p>Peak</p>	 <p>Site : 03CH16-HY Condition : PEAK_BE_74 3m 91200_1522 HORIZONTAL RBW:1000.000kHz VBW:3000.000kHz SWT:Auto Detector : Peak Project : 901542-02</p>	<p>Left blank</p>
<p>Avg.</p>	 <p>Site : 03CH16-HY Condition : AVG_BE_54 3m 91200_1522 HORIZONTAL RBW:1000.000kHz VBW:0.0100kHz SWT:Auto Detector : Peak Project : 901542-02</p>	<p>Left blank</p>



WIFI	Band 1 5150~5250MHz Band Edge @ 3m	
ANT	802.11n HT40 CH38 5190MHz - L	
1+2	Vertical	Fundamental
Peak	<p>Site : 03CH16-HY Condition : PEAK_BE_74 3m 91200_1522 VERTICAL RBW:1000.000KHz VBW:3000.000KHz SWT:Auto Detector : Peak Project : 901542-02</p>	<p>Site : 03CH16-HY Condition : PEAK(UNII) 3m 91200_1522 VERTICAL RBW:1000.000KHz VBW:3000.000KHz SWT:Auto Detector : Peak Project : 901542-02</p>
Avg.	<p>Site : 03CH16-HY Condition : AVG_BE_54 3m 91200_1522 VERTICAL RBW:1000.000KHz VBW:3000.000KHz SWT:Auto Detector : Peak Project : 901542-02</p>	Left blank

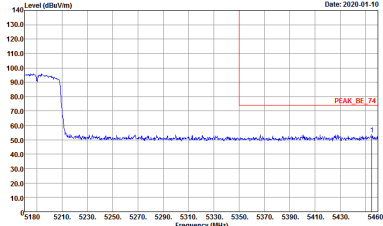
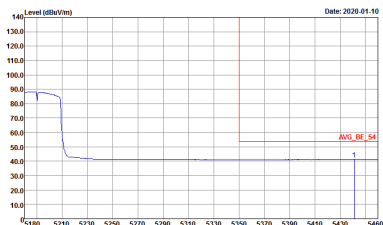

WIFI	Band 1 5150~5250MHz Band Edge @ 3m	
ANT	802.11n HT40 CH38 5190MHz - R	
1+2	Vertical	Fundamental
<p>Peak</p>	 <p>Site : 03CH16-HY Condition : PEAK_BE_74 3m 91200_1522 VERTICAL RBW:1000.000KHz VBW:3000.000KHz SWF:Auto Detector : Peak Project : 901542-02</p>	<p>Left blank</p>
<p>Avg.</p>	 <p>Site : 03CH16-HY Condition : AVG_BE_54 3m 91200_1522 VERTICAL RBW:1000.000KHz VBW:3000.000KHz SWF:Auto Detector : Peak Project : 901542-02</p>	<p>Left blank</p>



WIFI	Band 1 5150~5250MHz Band Edge @ 3m	
ANT	802.11n HT40 CH46 5230MHz - L	
1+2	Horizontal	Fundamental
Peak	 <p>Site : 03CH16-HY Condition : PEAK_BE_74 3m 91200_1522 HORIZONTAL RBW:1000.000KHz VBW:3000.000KHz SWT:Auto Detector : Peak Project : 901542-02</p>	 <p>Site : 03CH16-HY Condition : PEAK(UNII) 3m 91200_1522 HORIZONTAL RBW:1000.000KHz VBW:3000.000KHz SWT:Auto Detector : Peak Project : 901542-02</p>
Avg.	 <p>Site : 03CH16-HY Condition : AVG_BE_54 3m 91200_1522 HORIZONTAL RBW:1000.000KHz VBW:3000.000KHz SWT:Auto Detector : Peak Project : 901542-02</p>	Left blank

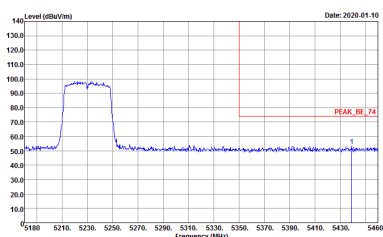
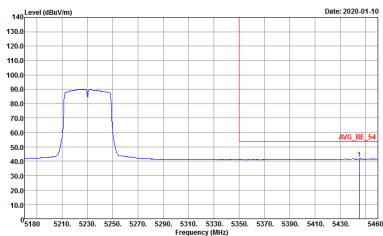

WIFI	Band 1 5150~5250MHz Band Edge @ 3m	
ANT	802.11n HT40 CH46 5230MHz - R	
1+2	Horizontal	Fundamental
<p>Peak</p>	 <p>Site : 03CH16-HY Condition : PEAK_BE_74 3m 91200_1522 HORIZONTAL RBW:1000.000kHz VBW:3000.000kHz SWF:Auto Detector : Peak Project : 901542-02</p>	<p>Left blank</p>
<p>Avg.</p>	 <p>Site : 03CH16-HY Condition : AVG_BE_54 3m 91200_1522 HORIZONTAL RBW:1000.000kHz VBW:0.0100kHz SWF:Auto Detector : Peak Project : 901542-02</p>	<p>Left blank</p>



WIFI	Band 1 5150~5250MHz Band Edge @ 3m	
ANT	802.11n HT40 CH46 5230MHz - L	
1+2	Vertical	Fundamental
Peak	<p>Site : 03CH16-HY Condition : PEAK_BE_74 3m 91200_1522 VERTICAL RBW:1000.000KHz VBW:3000.000KHz SWT:Auto Detector : Peak Project : 901542-02</p>	<p>Site : 03CH16-HY Condition : PEAK(UNII) 3m 91200_1522 VERTICAL RBW:1000.000KHz VBW:3000.000KHz SWT:Auto Detector : Peak Project : 901542-02</p>
Avg.	<p>Site : 03CH16-HY Condition : AVG_BE_54 3m 91200_1522 VERTICAL RBW:1000.000KHz VBW:3000.000KHz SWT:Auto Detector : Peak Project : 901542-02</p>	Left blank

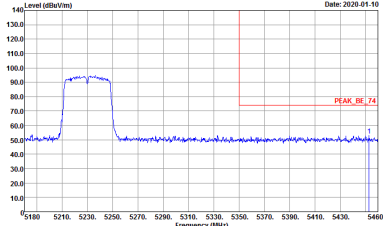
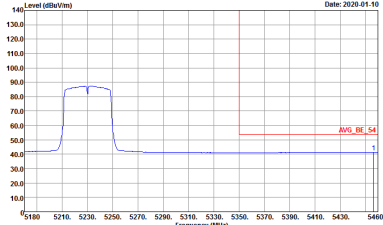

WIFI	Band 1 5150~5250MHz Band Edge @ 3m	
ANT	802.11n HT40 CH46 5230MHz - R	
1+2	Vertical	Fundamental
<p>Peak</p>	 <p>Site : 03CH16-HY Condition : PEAK_BE_74 3m 91200_1522 VERTICAL RBW:1000.000kHz VBW:3000.000kHz SWF:Auto Detector : Peak Project : 901542-02</p>	<p>Left blank</p>
<p>Avg.</p>	 <p>Site : 03CH16-HY Condition : AVG_BE_54 3m 91200_1522 VERTICAL RBW:1000.000kHz VBW:3000.000kHz SWF:Auto Detector : Peak Project : 901542-02</p>	<p>Left blank</p>

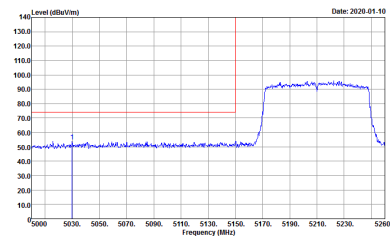
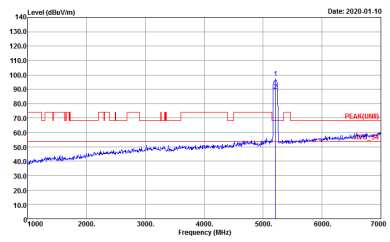
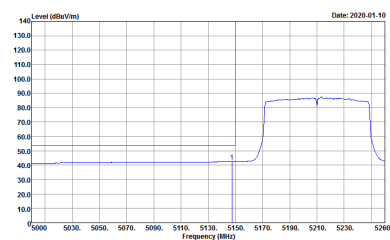

Band 1 5150~5250MHz
WIFI 802.11ac VHT80 (Band Edge @ 3m)

WIFI	Band 1 5150~5250MHz Band Edge @ 3m	
ANT	802.11ac VHT80 CH42 5210MHz - L	
1+2	Horizontal	Fundamental
<p>Peak</p>	 <p>Site : 03CH16-HY Condition : PEAK_BE_74 3m 91200_1522 HORIZONTAL Detector : Peak Project : 901542-02</p>	 <p>Site : 03CH16-HY Condition : PEAK(UNIT) 3m 91200_1522 HORIZONTAL Detector : Peak Project : 901542-02</p>
<p>Avg.</p>	 <p>Site : 03CH16-HY Condition : AVG_BE_54 3m 91200_1522 HORIZONTAL Detector : Peak Project : 901542-02</p>	<p>Left blank</p>

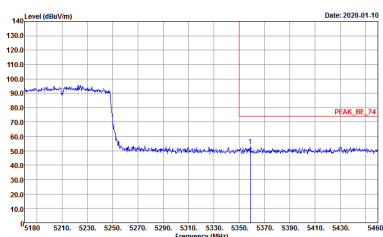
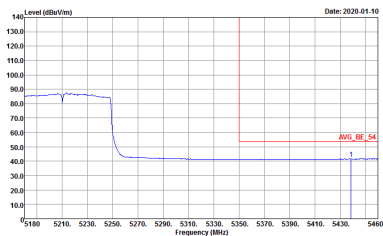

WIFI	Band 1 5150~5250MHz Band Edge @ 3m	
ANT	802.11ac VHT80 CH42 5210MHz - R	
1+2	Horizontal	Fundamental
<p>Peak</p>	 <p>Site : 03CH16-HY Condition : PEAK_BE_74 3m 91200_1522 HORIZONTAL RBW:1000.000KHz VBW:3000.000KHz SWT:Auto Detector : Peak Project : 901542-02</p>	<p>Left blank</p>
<p>Avg.</p>	 <p>Site : 03CH16-HY Condition : AVG_BE_54 3m 91200_1522 HORIZONTAL RBW:1000.000KHz VBW:0.0100KHz SWT:Auto Detector : Peak Project : 901542-02</p>	<p>Left blank</p>



WIFI	Band 1 5150~5250MHz Band Edge @ 3m	
ANT	802.11ac VHT80 CH42 5210MHz - L	
1+2	Vertical	Fundamental
Peak	<p>Site : 03CH16-HY Condition : PEAK_BE_74 3m 91200_1522 VERTICAL RBW:1000.000KHz VBW:3000.000KHz SWT:Auto Detector : Peak Project : 901542-02</p>	<p>Site : 03CH16-HY Condition : PEAK(UNII) 3m 91200_1522 VERTICAL RBW:1000.000KHz VBW:3000.000KHz SWT:Auto Detector : Peak Project : 901542-02</p>
Avg.	<p>Site : 03CH16-HY Condition : AVG_BE_54 3m 91200_1522 VERTICAL RBW:1000.000KHz VBW:3000.000KHz SWT:Auto Detector : Peak Project : 901542-02</p>	Left blank

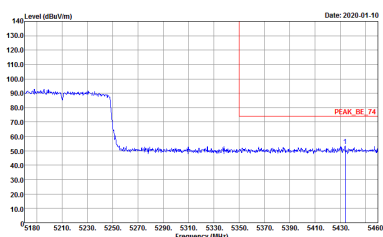
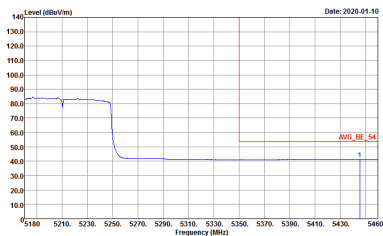

WIFI	Band 1 5150~5250MHz Band Edge @ 3m	
ANT	802.11ac VHT80 CH42 5210MHz - R	
1+2	Vertical	Fundamental
<p>Peak</p>	 <p>Site : 03CH16-HY Condition : PEAK_BE_74 3m 91200_1522 VERTICAL RBW:1000.000kHz VBW:3000.000kHz SWF:Auto Detector : Peak Project : 901542-02</p>	<p>Left blank</p>
<p>Avg.</p>	 <p>Site : 03CH16-HY Condition : AVG_BE_54 3m 91200_1522 VERTICAL RBW:1000.000kHz VBW:3000.000kHz SWF:Auto Detector : Peak Project : 901542-02</p>	<p>Left blank</p>



Band 1 - 5150~5250MHz
WIFI 802.11a (Harmonic @ 3m)

Table with 2 columns: Horizontal and Vertical. Rows include WIFI, ANT, 1+2, and Peak/Avg. Each cell contains a spectral plot of Level (dBuV/m) vs Frequency (MHz) with associated metadata.



WIFI	Band 1 5150~5250MHz Harmonic @ 3m	
ANT	802.11a CH44 5220MHz	
1+2	Horizontal	Vertical
Peak Avg.	<p>Site : 03CH16-HY Condition : PEAK(UNII) 3m 9120D_1522 HORIZONTAL Detector : Peak Project : 901542-02</p>	<p>Site : 03CH16-HY Condition : PEAK(UNII) 3m 9120D_1522 VERTICAL Detector : Peak Project : 901542-02</p>



WIFI	Band 1 5150~5250MHz Harmonic @ 3m	
ANT	802.11a CH48 5240MHz	
1+2	Horizontal	Vertical
Peak Avg.	<p>Site : 03CH16-HY Condition : PEAK(UNII) 3m 91200_1522 HORIZONTAL Detector : Peak Project : 901542-02</p>	<p>Site : 03CH16-HY Condition : PEAK(UNII) 3m 91200_1522 VERTICAL Detector : Peak Project : 901542-02</p>



**Band 1 5150~5250MHz
WIFI 802.11n HT20 (Harmonic @ 3m)**

WIFI	Band 1 5150~5250MHz Harmonic @ 3m	
ANT	802.11n HT20 CH36 5180MHz	
1+2	Horizontal	Vertical
Peak Avg.	<p>Site : 03CH16-HY Condition : PEAK(UNIT) 3m 91200_1522 HORIZONTAL Detector : Peak Project : 901542-02</p>	<p>Site : 03CH16-HY Condition : PEAK(UNIT) 3m 91200_1522 VERTICAL Detector : Peak Project : 901542-02</p>



WIFI	Band 1 5150~5250MHz Harmonic @ 3m	
ANT	802.11n HT20 CH44 5220MHz	
1+2	Horizontal	Vertical
Peak Avg.	<p>Site : 03CH16-HY Condition : PEAK(UNII) 3m 9120D_1522 HORIZONTAL Detector : Peak Project : 901542-02</p>	<p>Site : 03CH16-HY Condition : PEAK(UNII) 3m 9120D_1522 VERTICAL Detector : Peak Project : 901542-02</p>



WIFI	Band 1 5150~5250MHz Harmonic @ 3m	
ANT	802.11n HT20 CH48 5240MHz	
1+2	Horizontal	Vertical
Peak Avg.	<p>Site : 03CH16-HY Condition : PEAK(UNII) 3m 91200_1522 HORIZONTAL Detector : Peak Project : 901542-02</p>	<p>Site : 03CH16-HY Condition : PEAK(UNII) 3m 91200_1522 VERTICAL Detector : Peak Project : 901542-02</p>



Band 1 5150~5250MHz
WIFI 802.11n HT40 (Harmonic @ 3m)

Table with 2 columns: Horizontal and Vertical. Each column contains a graph of Level (dBuV/m) vs Frequency (MHz) and associated metadata like Site, Condition, Detector, and Project.



WIFI	Band 1 5150~5250MHz Harmonic @ 3m	
ANT	802.11n HT40 CH46 5230MHz	
1+2	Horizontal	Vertical
Peak Avg.	<p>Site : 03CH16-HY Condition : PEAK(UNII) 3m 91200_1522 HORIZONTAL Detector : Peak Project : 901542-02</p>	<p>Site : 03CH16-HY Condition : PEAK(UNII) 3m 91200_1522 VERTICAL Detector : Peak Project : 901542-02</p>



**Band 1 5150~5250MHz
WIFI 802.11ac VHT80 (Harmonic @ 3m)**

WIFI	Band 1 5150~5250MHz Harmonic @ 3m	
ANT	802.11ac VHT80 CH42 5210MHz	
1+2	Horizontal	Vertical
Peak Avg.	<p>Site : 03CH16-HY Condition : PEAK(UNIT) 3m 91200_1522 HORIZONTAL Detector : Peak Project : 901542-02</p>	<p>Site : 03CH16-HY Condition : PEAK(UNIT) 3m 91200_1522 VERTICAL Detector : Peak Project : 901542-02</p>



Band 2 - 5250~5350MHz
WIFI 802.11a (Band Edge @ 3m)

WIFI	Band 2 5250~5350MHz Band Edge @ 3m	
ANT	802.11a CH52 5260MHz - L	
1+2	Horizontal	Fundamental
Peak	<p>Site : 03CH16-1FY Condition : PEAK_BE_74 3m 91200_1522 HORIZONTAL Detector : Peak Project : 901542-02</p>	<p>Site : 03CH16-1FY Condition : PEAK(LINII) 3m 91200_1522 HORIZONTAL Detector : Peak Project : 901542-02</p>
Avg.	<p>Site : 03CH16-1FY Condition : AVG_BE_54 3m 91200_1522 HORIZONTAL Detector : Peak Project : 901542-02</p>	Left blank



WIFI	Band 2 5250~5350MHz Band Edge @ 3m	
ANT	802.11a CH52 5260MHz - R	
1+2	Horizontal	Fundamental
<p>Peak</p>	<p>Site : 03CH16-HY Condition : PEAK_BE_74 3m 91200_1522 HORIZONTAL RBW:1000.000KHz VBW:3000.000KHz SWT:Auto Detector : Peak Project : 901542-02</p>	<p>Left blank</p>
<p>Avg.</p>	<p>Site : 03CH16-HY Condition : AVG_BE_54 3m 91200_1522 HORIZONTAL RBW:1000.000KHz VBW:3000.000KHz SWT:Auto Detector : Peak Project : 901542-02</p>	<p>Left blank</p>



WIFI	Band 2 5250~5350MHz Band Edge @ 3m	
ANT	802.11a CH52 5260MHz - L	
1+2	Vertical	Fundamental
Peak	<p>Site : 03CH16-HY Condition : PEAK_BE_74 3m 91200_1522 VERTICAL RBW:1000.000KHz VBW:3000.000KHz SWT:Auto Detector : Peak Project : 901542-02</p>	<p>Site : 03CH16-HY Condition : PEAK(UNII) 3m 91200_1522 VERTICAL RBW:1000.000KHz VBW:3000.000KHz SWT:Auto Detector : Peak Project : 901542-02</p>
Avg.	<p>Site : 03CH16-HY Condition : AVG_BE_54 3m 91200_1522 VERTICAL RBW:1000.000KHz VBW:3000.000KHz SWT:Auto Detector : Peak Project : 901542-02</p>	Left blank

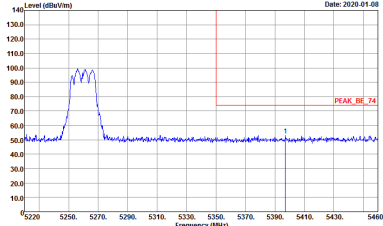
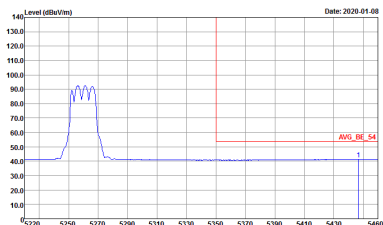

WIFI	Band 2 5250~5350MHz Band Edge @ 3m	
ANT	802.11a CH52 5260MHz - R	
1+2	Vertical	Fundamental
<p>Peak</p>	 <p>Site : 03CH16-HY Condition : PEAK_BE_74 3m 91200_1522 VERTICAL : RBW:1000.000KHz VBW:3000.000KHz SWT:Auto Detector : Peak Project : 901542-02</p>	<p>Left blank</p>
<p>Avg.</p>	 <p>Site : 03CH16-HY Condition : AVG_BE_54 3m 91200_1522 VERTICAL : RBW:1000.000KHz VBW:3000.000KHz SWT:Auto Detector : Peak Project : 901542-02</p>	<p>Left blank</p>

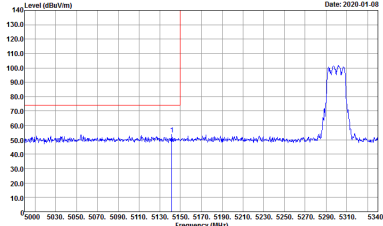
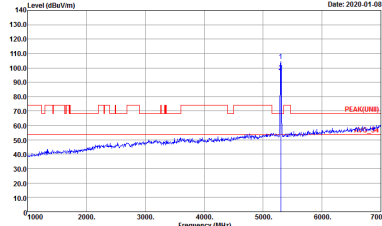
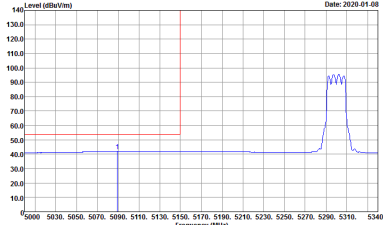

WIFI	Band 2 5250~5350MHz Band Edge @ 3m	
ANT	802.11a CH60 5300MHz - L	
1+2	Horizontal	Fundamental
Peak	 <p>Site : 03CH16-HY Condition : PEAK_BE_74 3m 91200_1522 HORIZONTAL RBW:1000.000kHz VBW:3000.000kHz SWT:Auto Detector : Peak Project : 901542-02</p>	 <p>Site : 03CH16-HY Condition : PEAK(UNII) 3m 91200_1522 HORIZONTAL RBW:1000.000kHz VBW:3000.000kHz SWT:Auto Detector : Peak Project : 901542-02</p>
Avg.	 <p>Site : 03CH16-HY Condition : AVG_BE_54 3m 91200_1522 HORIZONTAL RBW:1000.000kHz VBW:3000.000kHz SWT:Auto Detector : Peak Project : 901542-02</p>	Left blank

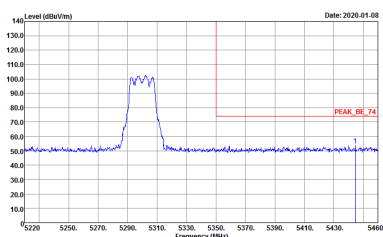
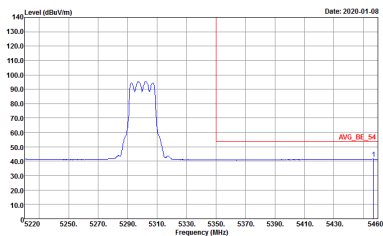

WIFI	Band 2 5250~5350MHz Band Edge @ 3m	
ANT	802.11a CH60 5300MHz - R	
1+2	Horizontal	Fundamental
<p>Peak</p>	 <p>Site : 03CH16-HY Condition : PEAK_BE_74 3m 91200_1522 HORIZONTAL RBW:1000.000kHz VBW:3000.000kHz SWT:Auto Detector : Peak Project : 901542-02</p>	<p>Left blank</p>
<p>Avg.</p>	 <p>Site : 03CH16-HY Condition : AVG_BE_54 3m 91200_1522 HORIZONTAL RBW:1000.000kHz VBW:3000.000kHz SWT:Auto Detector : Peak Project : 901542-02</p>	<p>Left blank</p>



WIFI	Band 2 5250~5350MHz Band Edge @ 3m	
ANT	802.11a CH60 5300MHz - L	
1+2	Vertical	Fundamental
Peak	<p>Site : 03CH16-HY Condition : PEAK_BE_74 3m 91200_1522 VERTICAL RBW:1000.000KHz VBW:3000.000KHz SWT:Auto Detector : Peak Project : 901542-02</p>	<p>Site : 03CH16-HY Condition : PEAK(UNII) 3m 91200_1522 VERTICAL RBW:1000.000KHz VBW:3000.000KHz SWT:Auto Detector : Peak Project : 901542-02</p>
Avg.	<p>Site : 03CH16-HY Condition : AVG_BE_54 3m 91200_1522 VERTICAL RBW:1000.000KHz VBW:3000.000KHz SWT:Auto Detector : Peak Project : 901542-02</p>	Left blank

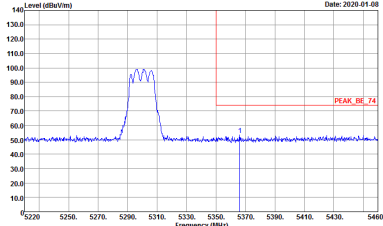
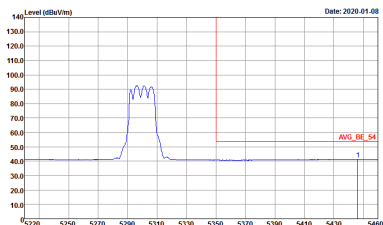

WIFI	Band 2 5250~5350MHz Band Edge @ 3m	
ANT	802.11a CH60 5300MHz - R	
1+2	Vertical	Fundamental
<p>Peak</p>	 <p>Date: 2020-01-08</p> <p>Site : 03CH16-HY Condition : PEAK_BE_74 3m 91200_1522 VERTICAL RBW:1000.000kHz VBW:3000.000kHz SWF:Auto Detector : Peak Project : 901542-02</p>	<p>Left blank</p>
<p>Avg.</p>	 <p>Date: 2020-01-08</p> <p>Site : 03CH16-HY Condition : AVG_BE_54 3m 91200_1522 VERTICAL RBW:1000.000kHz VBW:3000.000kHz SWF:Auto Detector : Peak Project : 901542-02</p>	<p>Left blank</p>



WIFI	Band 2 5250~5350MHz Band Edge @ 3m	
ANT	802.11a CH64 5320MHz	
1+2	Horizontal	Fundamental
Peak	<p>Site : 03CH16-HY Condition : PEAK_BE_74 3m 91200_1522 HORIZONTAL RBW:1000.000KHz VBW:3000.000KHz SWT:Auto Detector : Peak Project : 901542-02</p>	<p>Site : 03CH16-HY Condition : PEAK(UNII) 3m 91200_1522 HORIZONTAL RBW:1000.000KHz VBW:3000.000KHz SWT:Auto Detector : Peak Project : 901542-02</p>
Avg.	<p>Site : 03CH16-HY Condition : AVG_BE_54 3m 91200_1522 HORIZONTAL RBW:1000.000KHz VBW:3000.000KHz SWT:Auto Detector : Peak Project : 901542-02</p>	Left blank



WIFI	Band 2 5250~5350MHz Band Edge @ 3m	
ANT	802.11a CH64 5320MHz	
1+2	Vertical	Fundamental
Peak	<p>Site : 03CH16-HY Condition : PEAK_BE_74 3m 91200_1522 VERTICAL RBW:1000.000KHz VBW:3000.000KHz SWT:Auto Detector : Peak Project : 901542-02</p>	<p>Site : 03CH16-HY Condition : PEAK(UNII) 3m 91200_1522 VERTICAL RBW:1000.000KHz VBW:3000.000KHz SWT:Auto Detector : Peak Project : 901542-02</p>
Avg.	<p>Site : 03CH16-HY Condition : AVG_BE_54 3m 91200_1522 VERTICAL RBW:1000.000KHz VBW:3000.000KHz SWT:Auto Detector : Peak Project : 901542-02</p>	Left blank

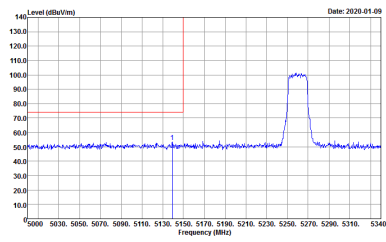
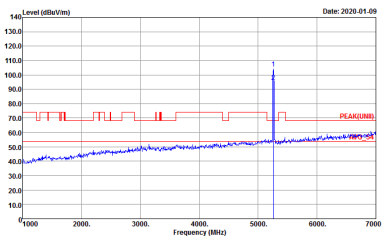
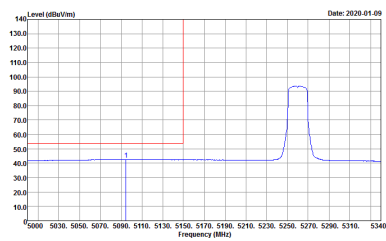

Band 2 5250~5350MHz
WIFI 802.11n HT20 (Band Edge @ 3m)

WIFI	Band 2 5250~5350MHz Band Edge @ 3m	
ANT	802.11n HT20 CH52 5260MHz - L	
1+2	Horizontal	Fundamental
Peak	 <p>Site : 03CH16-HY Condition : PEAK_BE_74 3m 91200_1522 HORIZONTAL RBW:1000.000kHz VBW:3000.000kHz SWT:Auto Detector : Peak Project : 901542-02</p>	 <p>Site : 03CH16-HY Condition : PEAK(UNIT) 3m 91200_1522 HORIZONTAL RBW:1000.000kHz VBW:3000.000kHz SWT:Auto Detector : Peak Project : 901542-02</p>
Avg.	 <p>Site : 03CH16-HY Condition : AVG_BE_54 3m 91200_1522 HORIZONTAL RBW:1000.000kHz VBW:0.010kHz SWT:Auto Detector : Peak Project : 901542-02</p>	Left blank

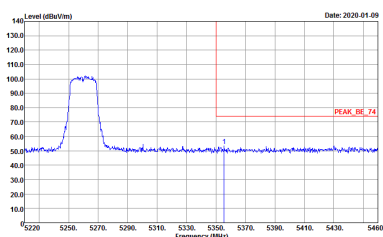
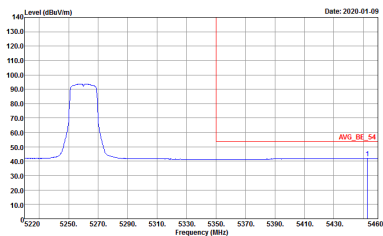

WIFI	Band 2 5250~5350MHz Band Edge @ 3m	
ANT	802.11n HT20 CH52 5260MHz - R	
1+2	Horizontal	Fundamental
<p>Peak</p>	 <p>Site : 03CH16-HY Condition : PEAK_BE_74 3m 91200_1522 HORIZONTAL RBW:1000.000KHz VBW:3000.000KHz SWT:Auto Detector : Peak Project : 901542-02</p>	<p>Left blank</p>
<p>Avg.</p>	 <p>Site : 03CH16-HY Condition : AVG_BE_54 3m 91200_1522 HORIZONTAL RBW:1000.000KHz VBW:3000.000KHz SWT:Auto Detector : Peak Project : 901542-02</p>	<p>Left blank</p>



WIFI	Band 2 5250~5350MHz Band Edge @ 3m	
ANT	802.11n HT20 CH52 5260MHz - L	
1+2	Vertical	Fundamental
Peak	<p>Site : 03CH16-HY Condition : PEAK_BE_74 3m 91200_1522 VERTICAL RBW:1000.000KHz VBW:3000.000KHz SWT:Auto Detector : Peak Project : 901542-02</p>	<p>Site : 03CH16-HY Condition : PEAK(UNII) 3m 91200_1522 VERTICAL RBW:1000.000KHz VBW:3000.000KHz SWT:Auto Detector : Peak Project : 901542-02</p>
Avg.	<p>Site : 03CH16-HY Condition : AVG_BE_54 3m 91200_1522 VERTICAL RBW:1000.000KHz VBW:3000.000KHz SWT:Auto Detector : Peak Project : 901542-02</p>	Left blank



WIFI	Band 2 5250~5350MHz Band Edge @ 3m	
ANT	802.11n HT20 CH52 5260MHz - R	
1+2	Vertical	Fundamental
<p>Peak</p>	<p>Site : 03CH16-HY Condition : PEAK_BE_74 3m 91200_1522 VERTICAL RBW:1000.000kHz VBW:3000.000kHz SWT:Auto Detector : Peak Project : 901542-02</p>	<p>Left blank</p>
<p>Avg.</p>	<p>Site : 03CH16-HY Condition : AVG_BE_54 3m 91200_1522 VERTICAL RBW:1000.000kHz VBW:3000.000kHz SWT:Auto Detector : Peak Project : 901542-02</p>	<p>Left blank</p>

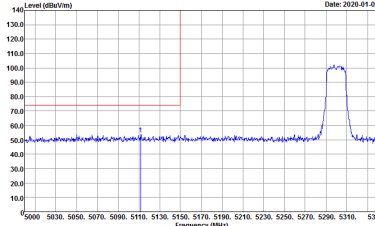
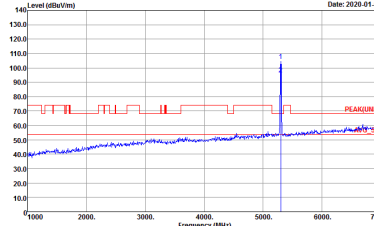
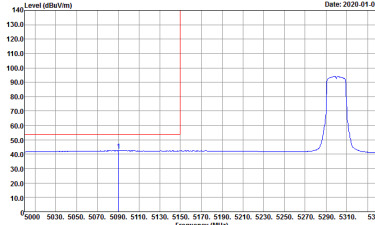

WIFI	Band 2 5250~5350MHz Band Edge @ 3m	
ANT	802.11n HT20 CH60 5300MHz - L	
1+2	Horizontal	Fundamental
Peak	 <p>Site : 03CH16-HY Condition : PEAK_BE_74 3m 91200_1522 HORIZONTAL RBW:1000.000KHz VBW:3000.000KHz SWT:Auto Detector : Peak Project : 901542-02</p>	 <p>Site : 03CH16-HY Condition : PEAK(UNII) 3m 91200_1522 HORIZONTAL RBW:1000.000KHz VBW:3000.000KHz SWT:Auto Detector : Peak Project : 901542-02</p>
Avg.	 <p>Site : 03CH16-HY Condition : AVG_BE_54 3m 91200_1522 HORIZONTAL RBW:1000.000KHz VBW:3000.000KHz SWT:Auto Detector : Peak Project : 901542-02</p>	Left blank

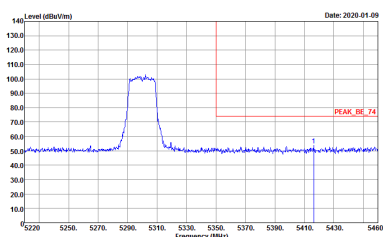
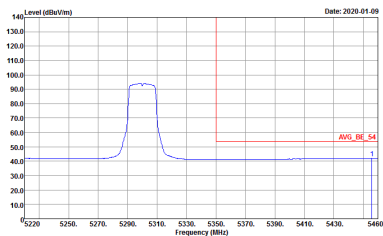

WIFI	Band 2 5250~5350MHz Band Edge @ 3m	
ANT	802.11n HT20 CH60 5300MHz - R	
1+2	Horizontal	Vertical
<p>Peak</p>	 <p>Site : 03CH16-HY Condition : PEAK_BE_74 3m 91200_1522 HORIZONTAL RBW:1000.000KHz VBW:3000.000KHz SWT:Auto Detector : Peak Project : 901542-02</p>	<p>Left blank</p>
<p>Avg.</p>	 <p>Site : 03CH16-HY Condition : AVG_BE_54 3m 91200_1522 HORIZONTAL RBW:1000.000KHz VBW:3000.000KHz SWT:Auto Detector : Peak Project : 901542-02</p>	<p>Left blank</p>

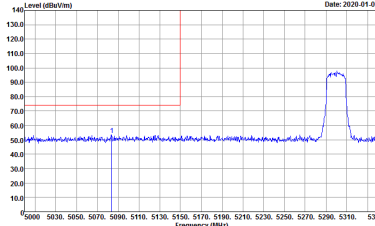
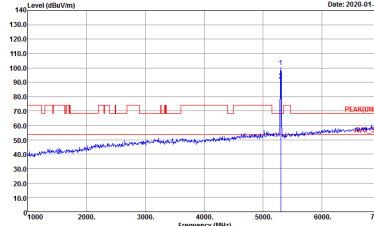
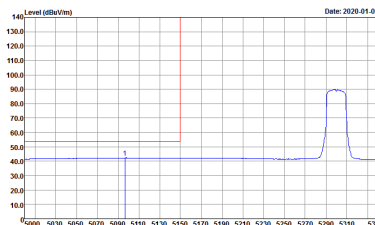

WIFI	Band 2 5250~5350MHz Band Edge @ 3m	
ANT	802.11n HT20 CH60 5300MHz - L	
1+2	Vertical	Fundamental
Peak	 <p>Site : 03CH16-HY Condition : PEAK_BE_74 3m 91200_1522 VERTICAL RBW:1000.000KHz VBW:3000.000KHz SWT:Auto Detector : Peak Project : 901542-02</p>	 <p>Site : 03CH16-HY Condition : PEAK(UNII) 3m 91200_1522 VERTICAL RBW:1000.000KHz VBW:3000.000KHz SWT:Auto Detector : Peak Project : 901542-02</p>
Avg.	 <p>Site : 03CH16-HY Condition : AVG_BE_54 3m 91200_1522 VERTICAL RBW:1000.000KHz VBW:3000.000KHz SWT:Auto Detector : Peak Project : 901542-02</p>	Left blank

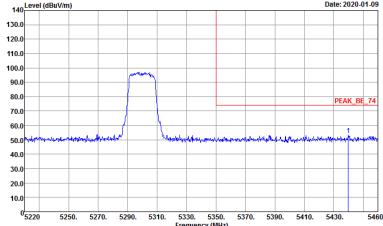
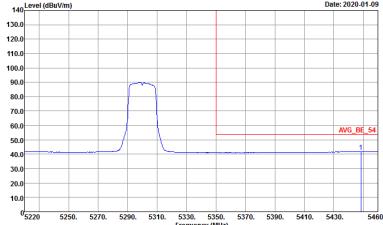

WIFI	Band 2 5250~5350MHz Band Edge @ 3m	
ANT	802.11n HT20 CH60 5300MHz - R	
1+2	Vertical	Fundamental
<p>Peak</p>	 <p>Site : 03CH16-HY Condition : PEAK_BE_74 3m 91200_1522 VERTICAL RBW:1000.000kHz VBW:3000.000kHz SWF:Auto Detector : Peak Project : 901542-02</p>	<p>Left blank</p>
<p>Avg.</p>	 <p>Site : 03CH16-HY Condition : AVG_BE_54 3m 91200_1522 VERTICAL RBW:1000.000kHz VBW:3000.000kHz SWF:Auto Detector : Peak Project : 901542-02</p>	<p>Left blank</p>



WIFI	Band 2 5250~5350MHz Band Edge @ 3m	
ANT	802.11n HT20 CH64 5320MHz	
1+2	Horizontal	Fundamental
<p>Peak</p>	<p>Site : 03CH16-HY Condition : PEAK_BE_74 3m 91200_1522 HORIZONTAL RBW:1000.000KHz VBW:3000.000KHz SWT:Auto Detector : Peak Project : 901542-02</p>	<p>Site : 03CH16-HY Condition : PEAK(UNII) 3m 91200_1522 HORIZONTAL RBW:1000.000KHz VBW:3000.000KHz SWT:Auto Detector : Peak Project : 901542-02</p>
<p>Avg.</p>	<p>Site : 03CH16-HY Condition : AVG_BE_54 3m 91200_1522 HORIZONTAL RBW:1000.000KHz VBW:3000.000KHz SWT:Auto Detector : Peak Project : 901542-02</p>	<p>Left blank</p>



WIFI	Band 2 5250~5350MHz Band Edge @ 3m	
ANT	802.11n HT20 CH64 5320MHz	
1+2	Vertical	Fundamental
Peak	 <p>Site : 03CH16-HY Condition : PEAK_BE_74 3m 91200_1522 VERTICAL RBW:1000.000KHz VBW:3000.000KHz SWT:Auto Detector : Peak Project : 901542-02</p>	 <p>Site : 03CH16-HY Condition : PEAK(UNII) 3m 91200_1522 VERTICAL RBW:1000.000KHz VBW:3000.000KHz SWT:Auto Detector : Peak Project : 901542-02</p>
Avg.	 <p>Site : 03CH16-HY Condition : AVG_BE_54 3m 91200_1522 VERTICAL RBW:1000.000KHz VBW:3000.000KHz SWT:Auto Detector : Peak Project : 901542-02</p>	Left blank

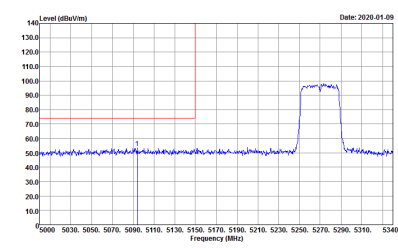
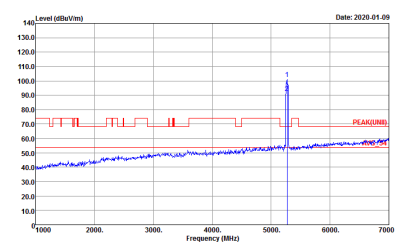
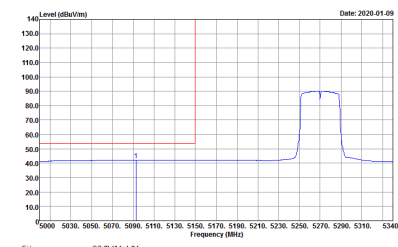

Band 2 5250~5350MHz
WIFI 802.11n HT40 (Band Edge @ 3m)

WIFI	Band 2 5250~5350MHz Band Edge @ 3m	
ANT	802.11n HT40 CH54 5270MHz - L	
1+2	Horizontal	Fundamental
Peak	 <p>Site : 03CH16-HY Condition : PEAK_BE_74 3m 91200_1522 HORIZONTAL Detector : Peak Project : 901542-02</p>	 <p>Site : 03CH16-HY Condition : PEAK(UNIT) 3m 91200_1522 HORIZONTAL Detector : Peak Project : 901542-02</p>
Avg.	 <p>Site : 03CH16-HY Condition : AVG_BE_54 3m 91200_1522 HORIZONTAL Detector : Peak Project : 901542-02</p>	Left blank



WIFI	Band 2 5250~5350MHz Band Edge @ 3m	
ANT	802.11n HT40 CH54 5270 MHz - R	
1+2	Horizontal	Fundamental
<p>Peak</p>	<p>Site : 03CH16-HY Condition : PEAK_BE_74 3m 91200_1522 HORIZONTAL RBW:1000.000kHz VBW:3000.000kHz SWT:Auto Detector : Peak Project : 901542-02</p>	<p>Left blank</p>
<p>Avg.</p>	<p>Site : 03CH16-HY Condition : AVG_BE_54 3m 91200_1522 HORIZONTAL RBW:1000.000kHz VBW:0.0100kHz SWT:Auto Detector : Peak Project : 901542-02</p>	<p>Left blank</p>

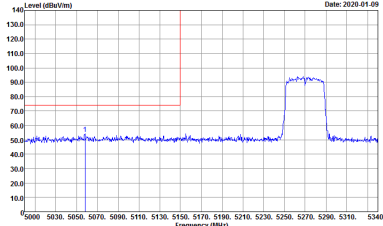
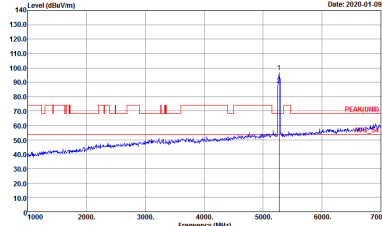
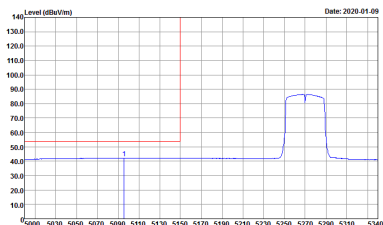

WIFI	Band 2 5250~5350MHz Band Edge @ 3m	
ANT	802.11n HT40 CH54 5270MHz - L	
1+2	Vertical	Vertical
Peak	 <p>Site : 03CH16-HY Condition : PEAK_BE_74 3m 91200_1522 VERTICAL RBW:1000.000KHz VBW:3000.000KHz SWT:Auto Detector : Peak Project : 901542-02</p>	 <p>Site : 03CH16-HY Condition : PEAK(UNII) 3m 91200_1522 VERTICAL RBW:1000.000KHz VBW:3000.000KHz SWT:Auto Detector : Peak Project : 901542-02</p>
Avg.	 <p>Site : 03CH16-HY Condition : AVG_BE_54 3m 91200_1522 VERTICAL RBW:1000.000KHz VBW:3000.000KHz SWT:Auto Detector : Peak Project : 901542-02</p>	Left blank

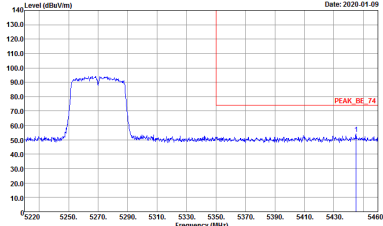
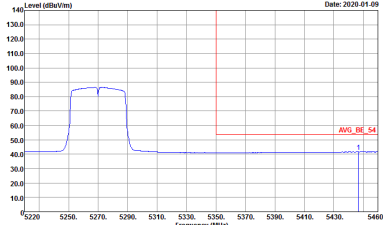

WIFI	Band 2 5250~5350MHz Band Edge @ 3m	
ANT	802.11n HT40 CH54 5270MHz - R	
1+2	Vertical	Vertical
<p>Peak</p>	 <p>Site : 03CH16-HY Condition : PEAK_BE_74 3m 91200_1522 VERTICAL RBW:1000.000kHz VBW:3000.000kHz SWF:Auto Detector : Peak Project : 901542-02</p>	<p>Left blank</p>
<p>Avg.</p>	 <p>Site : 03CH16-HY Condition : AVG_BE_54 3m 91200_1522 VERTICAL RBW:1000.000kHz VBW:0.0100kHz SWF:Auto Detector : Peak Project : 901542-02</p>	<p>Left blank</p>

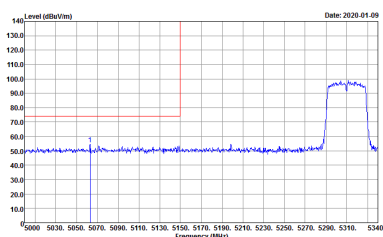
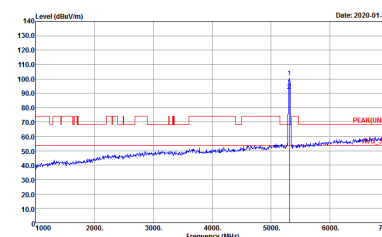
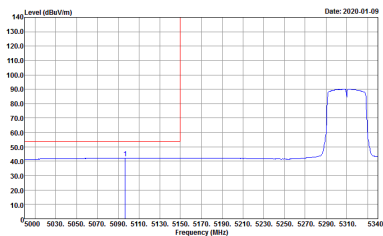

WIFI	Band 2 5250~5350MHz Band Edge @ 3m	
ANT	802.11n HT40 CH62 5310MHz - L	
1+2	Horizontal	Fundamental
Peak	 <p>Site : 03CH16-HY Condition : PEAK_BE_74 3m 91200_1522 HORIZONTAL RBW:1000.000KHz VBW:3000.000KHz SWT:Auto Detector : Peak Project : 901542-02</p>	 <p>Site : 03CH16-HY Condition : PEAK(UNII) 3m 91200_1522 HORIZONTAL RBW:1000.000KHz VBW:3000.000KHz SWT:Auto Detector : Peak Project : 901542-02</p>
Avg.	 <p>Site : 03CH16-HY Condition : AVG_BE_54 3m 91200_1522 HORIZONTAL RBW:1000.000KHz VBW:3000.000KHz SWT:Auto Detector : Peak Project : 901542-02</p>	Left blank

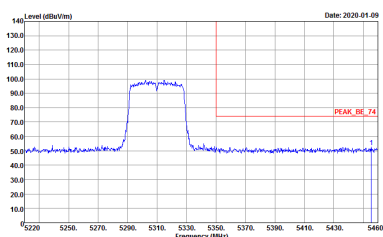
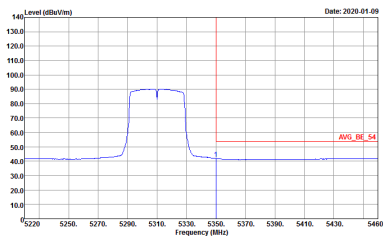

WIFI	Band 2 5250~5350MHz Band Edge @ 3m	
ANT	802.11n HT40 CH62 5310MHz - R	
1+2	Horizontal	Fundamental
<p>Peak</p>	 <p>Site : 03CH16-HY Condition : PEAK_BE_74 3m 91200_1522 HORIZONTAL RBW:1000.000kHz VBW:3000.000kHz SWT:Auto Detector : Peak Project : 901542-02</p>	<p>Left blank</p>
<p>Avg.</p>	 <p>Site : 03CH16-HY Condition : AVG_BE_54 3m 91200_1522 HORIZONTAL RBW:1000.000kHz VBW:0.0100kHz SWT:Auto Detector : Peak Project : 901542-02</p>	<p>Left blank</p>



WIFI	Band 2 5250~5350MHz Band Edge @ 3m	
ANT	802.11n HT40 CH62 5310MHz - L	
1+2	Vertical	Fundamental
Peak	<p>Site : 03CH16-HY Condition : PEAK_BE_74 3m 91200_1522 VERTICAL RBW:1000.000KHz VBW:3000.000KHz SWT:Auto Detector : Peak Project : 901542-02</p>	<p>Site : 03CH16-HY Condition : PEAK(UNII) 3m 91200_1522 VERTICAL RBW:1000.000KHz VBW:3000.000KHz SWT:Auto Detector : Peak Project : 901542-02</p>
Avg.	<p>Site : 03CH16-HY Condition : AVG_BE_54 3m 91200_1522 VERTICAL RBW:1000.000KHz VBW:3000.000KHz SWT:Auto Detector : Peak Project : 901542-02</p>	Left blank

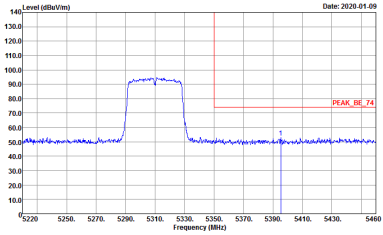
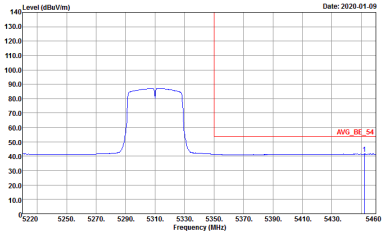

WIFI	Band 2 5250~5350MHz Band Edge @ 3m	
ANT	802.11n HT40 CH62 5310MHz - R	
1+2	Vertical	Fundamental
<p>Peak</p>	 <p>Site : 03CH16-HY Condition : PEAK_BE_74 3m 91200_1522 VERTICAL RBW:1000.000kHz VBW:3000.000kHz SWT:Auto Detector : Peak Project : 901542-02</p>	<p>Left blank</p>
<p>Avg.</p>	 <p>Site : 03CH16-HY Condition : AVG_BE_54 3m 91200_1522 VERTICAL RBW:1000.000kHz VBW:3000.000kHz SWT:Auto Detector : Peak Project : 901542-02</p>	<p>Left blank</p>