



FCC RADIO TEST REPORT

FCC ID : PY7-07452G
Equipment : GSM/WCDMA/LTE/5G Phone with BT, DTS/UNII a/b/g/n/ac/ax, GPS, WPC and NFC
Brand Name : Sony
Applicant : Sony Corporation
1-7-1 Konan Minato-ku Tokyo, 108-0075 Japan
Manufacturer : Sony Corporation
1-7-1 Konan Minato-ku Tokyo, 108-0075 Japan
Standard : FCC Part 15 Subpart C §15.225

The product was received on Mar. 02, 2021 and testing was started from Mar. 04, 2021 and completed on Mar. 06, 2021. We, Sporton International Inc. EMC & Wireless Communications Laboratory, would like to declare that the tested sample has been evaluated in accordance with the test procedures and has been in compliance with the applicable technical standards.

The test results in this report apply exclusively to the tested model / sample. Without written approval of Sporton International Inc. EMC & Wireless Communications Laboratory, the test report shall not be reproduced except in full.

Reviewed by: Louis Wu

Sporton International Inc. EMC & Wireless Communications Laboratory

No. 52, Huaya 1st Rd., Guishan Dist., Taoyuan City 333, Taiwan (R.O.C.)



Table of Contents

History of this test report..... 3

Summary of Test Result..... 4

1. General Description 5

 1.1 Product Feature of Equipment Under Test 5

 1.2 Modification of EUT 5

 1.3 Testing Location 6

 1.4 Applicable Standards..... 6

2. Test Configuration of Equipment Under Test..... 7

 2.1 Descriptions of Test Mode 7

 2.2 Connection Diagram of Test System 8

 2.3 Table for Supporting Units 9

 2.4 EUT Operation Test Setup 9

3. Test Results 10

 3.1 AC Power Line Conducted Emissions Measurement 10

 3.2 20dB and 99% OBW Spectrum Bandwidth Measurement..... 12

 3.3 Frequency Stability Measurement 13

 3.4 Field Strength of Fundamental Emissions and Mask Measurement..... 14

 3.5 Radiated Emissions Measurement 16

 3.6 Antenna Requirements..... 19

4. List of Measuring Equipment 20

5. Uncertainty of Evaluation 22

Appendix A. Test Results of Conducted Emission Test

Appendix B. Test Results of Conducted Test Items

 B1. Test Result of 20dB Spectrum Bandwidth

 B2. Test Result of Frequency Stability

Appendix C. Test Results of Radiated Test Items

 C1. Test Result of Field Strength of Fundamental Emissions

 C2. Results of Radiated Emissions (9 kHz~30MHz)

 C3. Results of Radiated Emissions (30MHz~1GHz)



History of this test report

Report No.	Version	Description	Issued Date
FR0D2212D	01	Initial issue of report	Apr. 09, 2021



Summary of Test Result

Report Clause	Ref Std. Clause	Test Items	Result (PASS/FAIL)	Remark
3.1	15.207	AC Power Line Conducted Emissions	Pass	Under limit 15.92 dB at 0.571MHz
3.2	15.215(c)	20dB Spectrum Bandwidth	Pass	-
	2.1049	99% OBW Spectrum Bandwidth	Reporting only	-
3.3	15.225(e)	Frequency Stability	Pass	-
3.4	15.225(a)(b)(c)	Field Strength of Fundamental Emissions	Pass	Max level 18.45 dB μ V/m at 13.560 MHz
3.5	15.225(d) 15.209	Radiated Spurious Emissions	Pass	Under limit 3.22 dB at 40.680MHz
3.6	15.203	Antenna Requirements	Pass	-

Declaration of Conformity:

The test results with all measurement uncertainty excluded are presented in accordance with the regulation limits or requirements declared by manufacturers.

Comments and Explanations:

The declared of product specification for EUT presented in the report are provided by the manufacturer, and the manufacturer takes all the responsibilities for the accuracy of product specification.

Reviewed by: Wii Chang

Report Producer: Tina Chuang



1. General Description

1.1 Product Feature of Equipment Under Test

GSM/WCDMA/LTE, Bluetooth, DTS/UNII a/b/g/n/ac/ax, NFC, WPC/WPT, and GNSS.

Standards-related Product Specification	
Antenna Type	Loop Antenna

Remark: The above EUT's information was declared by manufacturer. Please refer to Comments and Explanations in report summary.

EUT Information List			
HW Version	SW Version	S/N	Performed Test Item
A	0.694	QV7200UM6T	Conducted Emission
		QV7200GG6T	
		QV7200UM6T	Radiated Spurious Emission RF Conducted Measurement

Accessory List	
AC Adapter	Model Name : XQZ-UC1
	S/N : 0020W51300095 (for Radiated Spurious Emission) 0020W51300024 (for Conducted Emission)
Earphone	Model Name : MH750
	S/N : N/A
Bluetooth Earphone	Model Name : SBH82D
	S/N : N/A
USB Cable	Model Name : XQZ-UB1
	S/N : N/A

Note:

- Above EUT list used are electrically identical per declared by manufacturer.
- Above the accessories list are used to exercise the EUT during test, and the serial number of each type of accessories is listed in each section of this report.
- For other wireless features of this EUT, test report will be issued separately.

1.2 Modification of EUT

No modifications are made to the EUT during all test items.



1.3 Testing Location

Test Site	Sporton International Inc. EMC & Wireless Communications Laboratory		
Test Site Location	No.52, Huaya 1st Rd., Guishan Dist., Taoyuan City 333, Taiwan (R.O.C.) TEL: +886-3-327-3456 FAX: +886-3-328-4978		
Test Site No.	Sporton Site No.		
	TH03-HY	CO05-HY	03CH07-HY
Test Engineer	Oscar Chi	Tom Lee	Stan Hsieh, Ken Wu
Temperature	22~24	23~26	23~25
Relative Humidity	53~55	40~50	52~56

Note: The test site complies with ANSI C63.4 2014 requirement.

FCC designation No.: TW1190

1.4 Applicable Standards

According to the specifications of the manufacturer, the EUT must comply with the requirements of the following standards:

- ♦ FCC Part 15 Subpart C §15.225
- ♦ FCC KDB 414788 D01 Radiated Test Site v01r01
- ♦ ANSI C63.10-2013

Remark:

1. All test items were verified and recorded according to the standards and without any deviation during the test.
2. The TAF code is not including all the FCC KDB listed without accreditation.
3. This EUT has also been tested and complied with the requirements of FCC Part 15, Subpart B, recorded in a separate test report.



2. Test Configuration of Equipment Under Test

2.1 Descriptions of Test Mode

Investigation has been done on all the possible configurations.

The following table is a list of the test modes shown in this test report.

Test Items	
AC Power Line Conducted Emissions	Field Strength of Fundamental Emissions
20dB Spectrum Bandwidth	Frequency Stability
Radiated Emissions 9kHz~30MHz	Radiated Emissions 30MHz~1GHz

The NFC test is performed with app “NFC PRBS Test Mode” installed in the mobile phone. It can enable continuous transmission with type F tag respectively.

The EUT pre-scanned in four NFC type, A, B, F, V. The worst type (type F) was recorded in this report. Pre-scanned tests, X, Y, Z in three orthogonal panels to determine the final configuration (Z plane as worst plane) from all possible combinations.

Test Cases	
AC Conducted Emission	Mode 1 :NFC Tx + Bluetooth Link + WLAN (2.4GHz) Link + SD Card + USB Cable (Charging from AC Adapter) + Earphone + Battery

2.2 Connection Diagram of Test System

<AC Conducted Emissions>

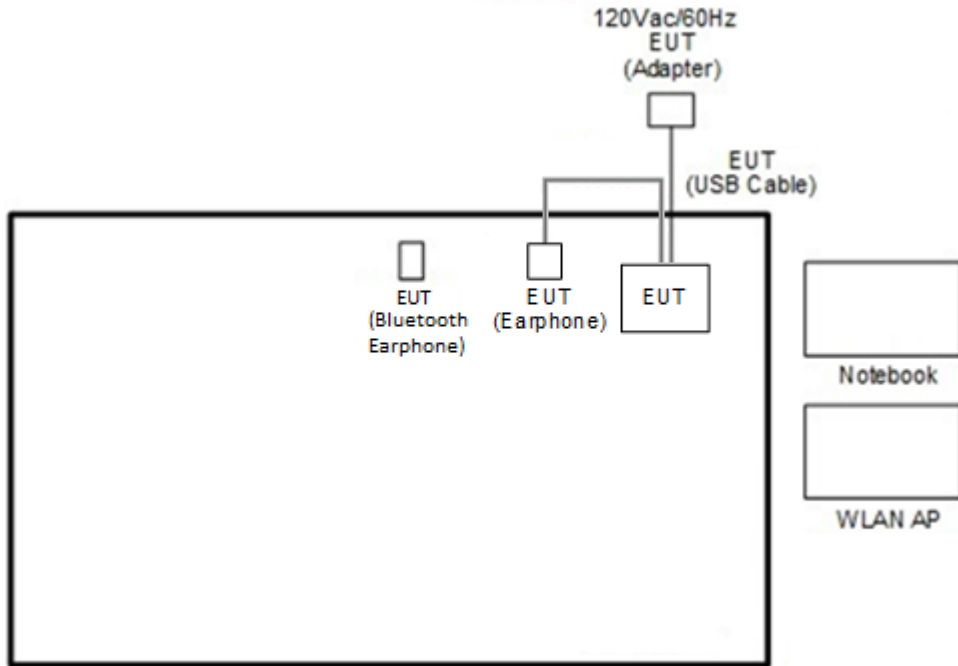

<For Radiated Emissions Measurement with Tx Tool>

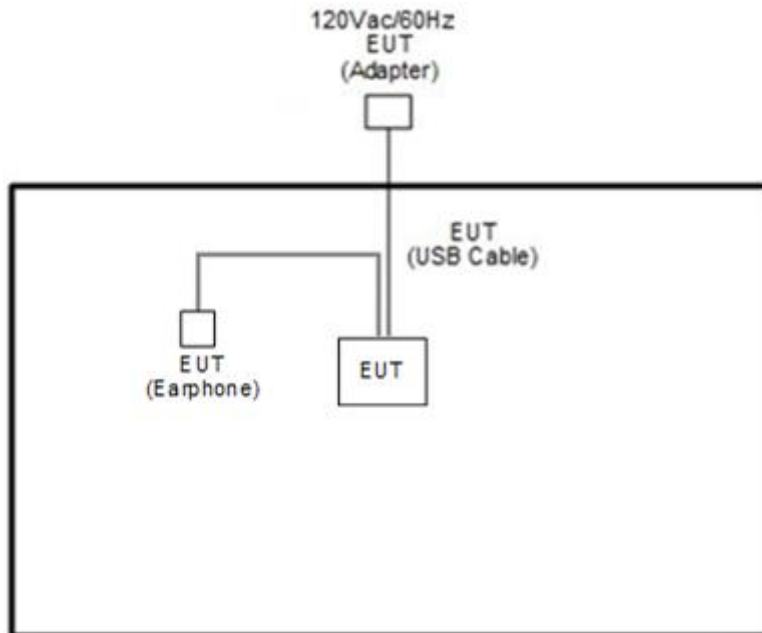

<For Radiated Emissions Measurement with NFC Card>

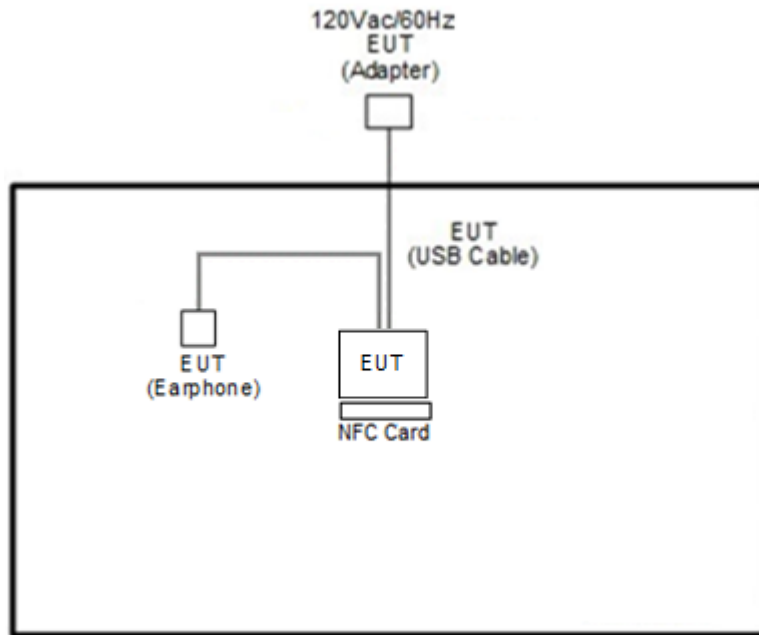

2.3 Table for Supporting Units

Item	Equipment	Brand Name	Model Name	FCC ID	Data Cable	Power Cord
1.	WLAN AP	ASUS	RT-AC66U	MSQ-RTAC66U	N/A	Unshielded, 1.8 m
2.	SD Card	SanDisk	MicroSD HC	FCC DoC	N/A	N/A
3.	Notebook	Dell	Latitude 3400	FCC DOC	N/A	AC I/P : Unshielded, 1.2m DC O/P : Shielded, 1.8m
4.	NFC Card	N/A	N/A	N/A	N/A	N/A

2.4 EUT Operation Test Setup

The EUT was programmed to be in continuously transmitting mode.

The ancillary equipment, NFC card, is used to make the EUT (NFC) continuously transmitting signal (Power Level: Default) at 13.56MHz and is placed around 2 cm gap to the EUT.

The RF test items, utility “NFC PRBS Test Mode” was installed in Notebook which was programmed in order to make the EUT get into the engineering modes to provide channel selection, power level (Power setting: Default), data rate (Type F Bit Rate: 424kbps) and the application type and for continuous transmitting signals.



3. Test Results

3.1 AC Power Line Conducted Emissions Measurement

3.1.1 Limit of AC Conducted Emission

For equipment that is designed to be connected to the public utility (AC) power line, the radio frequency voltage that is conducted back onto the AC power line on any frequency or frequencies within the band 150 kHz to 30 MHz shall not exceed the limits in the following table.

Frequency of Emission (MHz)	Conducted Limit (dBµV)	
	Quasi-Peak	Average
0.15-0.5	66 to 56*	56 to 46*
0.5-5	56	46
5-30	60	50

*Decreases with the logarithm of the frequency.

For terminal test result, the testing follows FCC KDB 174176.

3.1.2 Measuring Instruments

See list of measuring equipment of this test report.

3.1.3 Test Procedures

1. The EUT was placed 0.4 meter from the conducting wall of the shielding room, and it was kept at least 80 centimeters from any other grounded conducting surface.
2. Connect EUT to the power mains through a line impedance stabilization network (LISN).
3. All the support units are connecting to the other LISN.
4. The LISN provides 50 ohm coupling impedance for the measuring instrument.
5. The FCC states that a 50 ohm, 50 microhenry LISN shall be used.
6. Both sides of AC line were checked for maximum conducted interference.
7. The frequency range from 150 kHz to 30 MHz was searched.
8. Set the test-receiver system to Peak Detect Function and specified bandwidth (IF Bandwidth = 9kHz) with Maximum Hold Mode. Then measurement is also conducted by Average Detector and Quasi-Peak Detector Function respectively.

3.1.4 Test setup

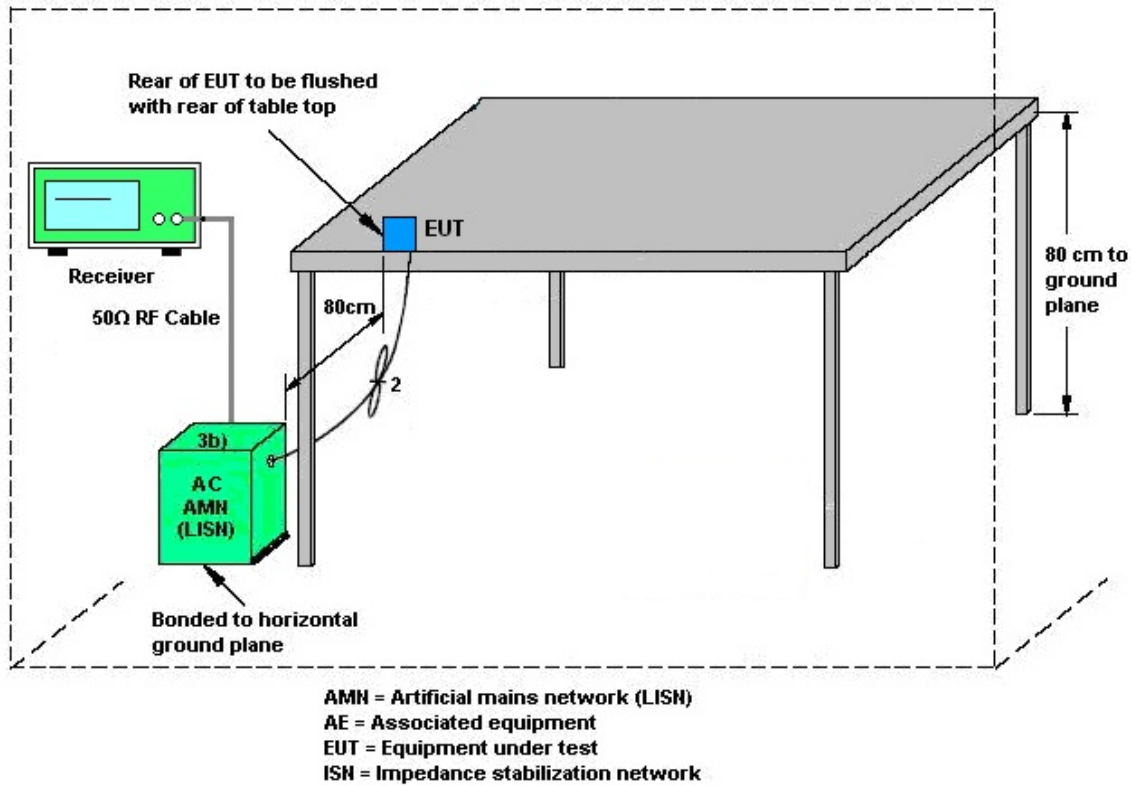

3.1.5 Test Result of AC Conducted Emission

Please refer to Appendix A.

Note:

(1) with antenna

Remark: 13.560MHz is the NFC RF fundamental signal.

(2) with dummy load

Remark: Only the fundamental NFC signal needs to be retested per C63.4.

3.2 20dB and 99% OBW Spectrum Bandwidth Measurement

3.2.1 Limit

Intentional radiators must be designed to ensure that the 20 dB and 99% emission bandwidth in the specific band 13.553~13.567 MHz.

3.2.2 Measuring Instruments

See list of measuring instruments of this test report.

3.2.3 Test Procedures

1. The spectrum analyzer connected via a receive antenna placed near the EUT in peak Max Hold Mode.
2. The resolution bandwidth of 1 kHz and the video bandwidth of 3 kHz were used.
3. Measured the spectrum width with power higher than 20 dB below carrier.
4. Measured the 99% OBW.

3.2.4 Test Setup

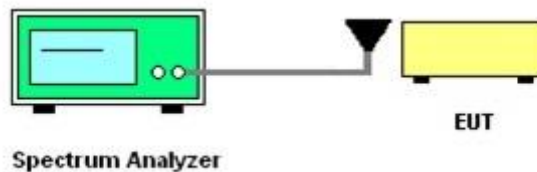

3.2.5 Test Result of Conducted Test Items

Please refer to Appendix B.

3.3 Frequency Stability Measurement

3.3.1 Limit

The frequency tolerance of the carrier signal shall be maintained within +/- 0.01% (100ppm) of the operating frequency over a temperature variation of -20 degrees to +50 degrees C at normal supply voltage, and for a variation in the primary supply voltage from 85% to 115% of the rated supply voltage at a temperature of 20 degrees C. For battery operated equipment, the equipment tests shall be performed by using a new battery.

3.3.2 Measuring Instruments

See list of measuring instruments of this test report.

3.3.3 Test Procedures

1. The spectrum analyzer connected via a receive antenna placed near the EUT.
2. EUT has transmitted signal and fixed channelize.
3. Set the spectrum analyzer span to view the entire emissions bandwidth.
4. Set RBW = 1 kHz, VBW = 3 kHz with peak detector and maxhold settings.
5. The f_c is declaring of channel frequency. Then the frequency error formula is $(f_c - f) / f_c \times 10^6$ ppm and the limit is less than ± 100 ppm.
6. Extreme temperature rule is -20°C~50°C.

3.3.4 Test Setup

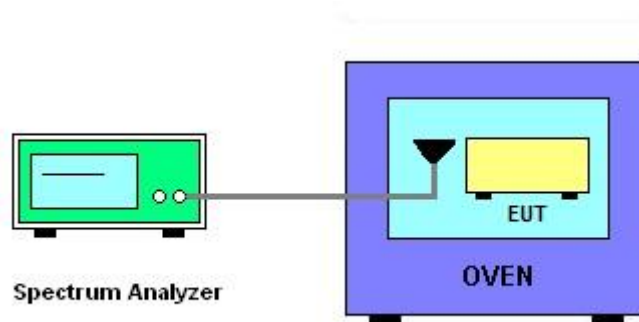

3.3.5 Test Result of Conducted Test Items

Please refer to Appendix B.



3.4 Field Strength of Fundamental Emissions and Mask Measurement

3.4.1 Limit

Rules and specifications	FCC CFR 47 Part 15 section 15.225			
Description	Compliance with the spectrum mask is tested with RBW set to 9kHz.			
Freq. of Emission (MHz)	Field Strength ($\mu\text{V/m}$) at 30m	Field Strength ($\text{dB}\mu\text{V/m}$) at 30m	Field Strength ($\text{dB}\mu\text{V/m}$) at 10m	Field Strength ($\text{dB}\mu\text{V/m}$) at 3m
1.705~13.110	30	29.5	48.58	69.5
13.110~13.410	106	40.5	59.58	80.5
13.410~13.553	334	50.5	69.58	90.5
13.553~13.567	15848	84.0	103.08	124.0
13.567~13.710	334	50.5	69.58	90.5
13.710~14.010	106	40.5	59.58	80.5
14.010~30.000	30	29.5	48.58	69.5

Remark:

1. The field strength test result is in 3m test distance, follow test rules the test data use distance extrapolation factor and reported in this report at 30m test result.
2. Distance extrapolation factor = $40 \log(\text{specific distance} / \text{test distance})$ (dB)

3.4.2 Measuring Instruments

See list of measuring instruments of this test report.

3.4.3 Test Procedures

1. Configure the EUT according to ANSI C63.10. The EUT was placed on the top of the turntable 0.8 meter above ground. The phase center of the loop receiving antenna mounted antenna tower was placed 3 meters far away from the turntable.
 2. Power on the EUT and all the supporting units. The turntable was rotated by 360 degrees to determine the position of the highest radiation.
 3. The height of the receiving antenna was fixed at one meter above ground to find the maximum emissions field strength.
 4. For Fundamental emissions, use the receiver to measure QP reading.
 5. When the radiated emissions limits are expressed in terms of the average value of the emissions, and pulsed operation is employed, the measurement field strength shall be determined by averaging over one complete pulse train, including blanking intervals, as long as the pulse train does not exceed 0.1 seconds. As an alternative (provided the transmitter operates for longer than 0.1 seconds) or in cases where the pulse train exceeds 0.1 seconds, the measured field strength shall be determined from the average absolute voltage during a 0.1 second interval during which the field strength is at its maximum value.
 6. Compliance with the spectrum mask is tested with RBW set to 9 kHz.
- Note: Emission level (dB μ V/m) = 20 log Emission level (μ V/m).

3.4.4 Test Setup

For radiated test below 30MHz

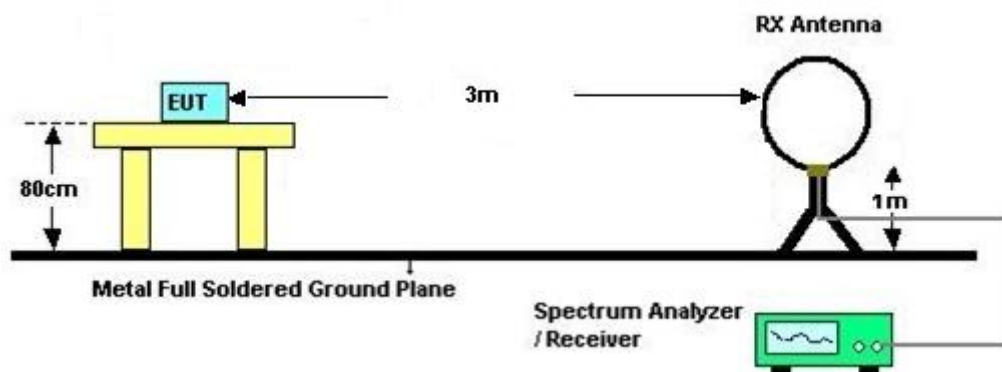

3.4.5 Test Result of Field Strength of Fundamental Emissions and Mask

Please refer to Appendix C.



3.5 Radiated Emissions Measurement

3.5.1 Limit

The field strength of any emissions which appear outside of 13.110 ~14.010MHz band shall not exceed the general radiated emissions limits.

Frequencies (MHz)	Field Strength (µV/m)	Measurement Distance (meters)
0.009~0.490	2400/F(kHz)	300
0.490~1.705	24000/F(kHz)	30
1.705~30.0	30	30
30~88	100	3
88~216	150	3
216~960	200	3
Above 960	500	3

3.5.2 Measuring Instruments

See list of measuring instruments of this test report.

3.5.3 Measuring Instrument Setting

The following table is the setting of receiver:

Receiver Parameter	Setting
Attenuation	Auto
Frequency Range: 9kHz~150kHz	RBW 200Hz for QP
Frequency Range: 150kHz~30MHz	RBW 9kHz for QP
Frequency Range: 30MHz~1000MHz	RBW 120kHz for Peak

Note: The emission limits shown in the above table are based on measurements employing a CISPR quasi-peak detector except for the frequency bands 9-90 kHz and 110-490 kHz. Radiated emission limits in these two bands are based on measurements employing an average detector.



3.5.4 Test Procedures

1. Configure the EUT according to ANSI C63.10. The EUT was placed on the top of the turntable 0.8 meter above ground. The phase center of the receiving antenna mounted on the top of a height-variable antenna tower was placed 3 meters far away from the turntable.
2. Power on the EUT and all the supporting units. The turntable was rotated by 360 degrees to determine the position of the highest radiation.
3. The height of the broadband receiving antenna was varied between one meter and four meters above ground to find the maximum emissions field strength of both horizontal and vertical polarization.
4. For each suspected emissions, the antenna tower was scan (from 1 M to 4 M) and then the turntable was rotated (from 0 degree to 360 degrees) to find the maximum reading.
5. Set the test-receiver system to Peak or CISPR quasi-peak Detect Function with specified bandwidth under Maximum Hold Mode.
6. When the radiated emissions limits are expressed in terms of the average value of the emissions, and pulsed operation is employed, the measurement field strength shall be determined by averaging over one complete pulse train, including blanking intervals, as long as the pulse train does not exceed 0.1 seconds. As an alternative (provided the transmitter operates for longer than 0.1 seconds) or in cases where the pulse train exceeds 0.1 seconds, the measured field strength shall be determined from the average absolute voltage during a 0.1 second interval during which the field strength is at its maximum value.
7. In case the emission is lower than 30 MHz, loop antenna has to be used for measurement and the recorded data shall be QP measured by receiver.

3.5.5 Test Setup

For radiated test below 30MHz

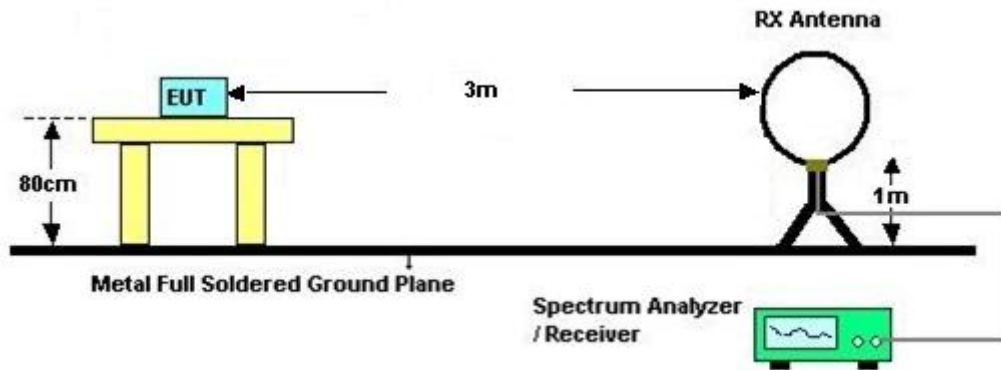

For radiated test above 30MHz

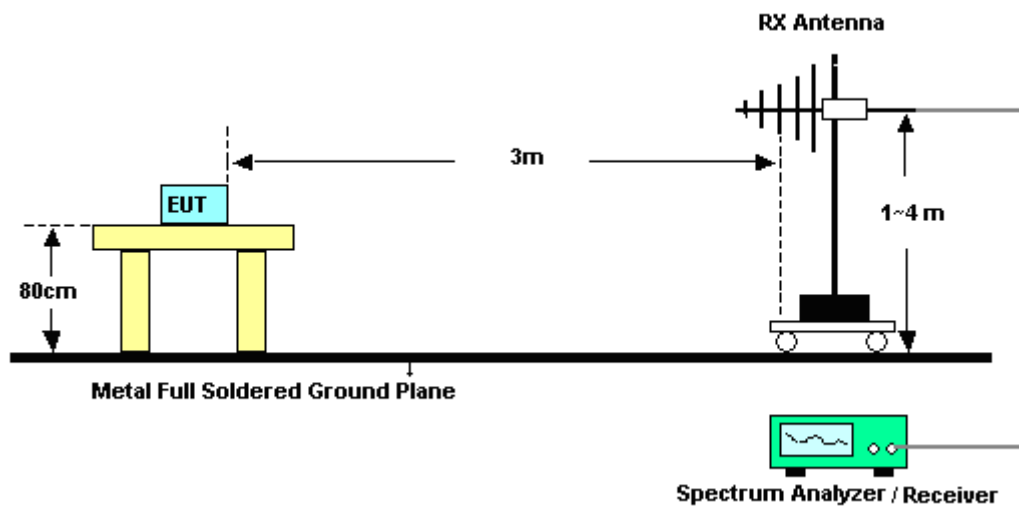

3.5.6 Test Result of Radiated Emissions Measurement

Please refer to Appendix C.

Remark:

1. There is a comparison data of both open-field test site and alternative test site - semi-Anechoic chamber according to 414788 D01 Radiated Test Site v01r01, and the result came out very similar.
2. According to C63.10 radiated Test, the EUT pre-scanned horizontal, vertical, and ground-parallel three polarization's, the worst case is horizontal & vertical polarization, test data of two mode was reported.



3.6 Antenna Requirements

3.6.1 Standard Applicable

Except for special regulations, the Low-power Radio-frequency Devices must not be equipped with any jacket for installing an antenna with extension cable. An intentional radiator shall be designed to ensure that no antenna other than that furnished by the responsible party shall be used with the device. The use of a permanently attached antenna or of an antenna that uses a unique coupling to the intentional radiator shall be considered sufficient to comply with the provisions of this Section. The manufacturer may design the unit so that the user can replace a broken antenna, but the use of a standard antenna jack or electrical connector is prohibited.

The use of a permanently attached antenna or of an antenna that uses a unique coupling to the intentional radiator shall be considered sufficient to comply with the rule.

3.6.2 Antenna Anti-Replacement Construction

An embedded-in antenna design is used.



4. List of Measuring Equipment

Instrument	Brand Name	Model No.	Serial No.	Characteristics	Calibration Date	Test Date	Due Date	Remark
AC Power Source	ChainTek	APC-1000W	N/A	N/A	N/A	Mar. 04, 2021	N/A	Conduction (CO05-HY)
EMI Test Receiver	Rohde & Schwarz	ESR3	102388	9kHz~3.6GHz	Nov. 30, 2020	Mar. 04, 2021	Nov. 29, 2021	Conduction (CO05-HY)
Hygrometer	Testo	608-H1	34913912	N/A	Nov. 18, 2020	Mar. 04, 2021	Nov. 17, 2021	Conduction (CO05-HY)
LISN	Rohde & Schwarz	ENV216	100081	9kHz~30MHz	Nov. 16, 2020	Mar. 04, 2021	Nov. 15, 2021	Conduction (CO05-HY)
Software	Rohde & Schwarz	EMC32 V10.30	N/A	N/A	N/A	Mar. 04, 2021	N/A	Conduction (CO05-HY)
LISN Cable	MVE	RG-400	260260	N/A	Dec. 31, 2020	Mar. 04, 2021	Dec. 30, 2021	Conduction (CO05-HY)
Pulse Limiter	Rohde & Schwarz	ESH3-Z2	100851	N/A	Feb. 25, 2021	Mar. 04, 2021	Feb. 24, 2022	Conduction (CO05-HY)
Bilog Antenna	TESEQ	CBL 6111D & 00800N1D01 N-06	35419 & 03	30MHz~1GHz	Apr. 29, 2020	Mar. 05, 2021~ Mar. 06, 2021	Apr. 28, 2021	Radiation (03CH07-HY)
Preamplifier	COM-POWER	PA-103A	161241	10MHz~1GHz	May 19, 2020	Mar. 05, 2021~ Mar. 06, 2021	May 18, 2021	Radiation (03CH07-HY)
RF Cable	HUBER + SUHNER	SUCOFLEX 104	MY24971/4,	9kHz~18GHz	Feb. 24, 2021	Mar. 05, 2021~ Mar. 06, 2021	Feb. 23, 2022	Radiation (03CH07-HY)
RF Cable	HUBER + SUHNER	SUCOFLEX 104	MY28655/4,	9kHz~18GHz	Feb. 24, 2021	Mar. 05, 2021~ Mar. 06, 2021	Feb. 23, 2022	Radiation (03CH07-HY)
RF Cable	HUBER + SUHNER	SUCOFLEX 104	MY15682/4	30MHz~18GHz	Feb. 24, 2021	Mar. 05, 2021~ Mar. 06, 2021	Feb. 23, 2022	Radiation (03CH07-HY)
Controller	ChainTek	Chaintek 3000	N/A	Control Turn table	N/A	Mar. 05, 2021~ Mar. 06, 2021	N/A	Radiation (03CH07-HY)
Controller	Max-Full	MF7802	MF780208368	Control Ant Mast	N/A	Mar. 05, 2021~ Mar. 06, 2021	N/A	Radiation (03CH07-HY)
Antenna Mast	Max-Full	MFA520BS	N/A	1m~4m	N/A	Mar. 05, 2021~ Mar. 06, 2021	N/A	Radiation (03CH07-HY)
Turn Table	ChainTek	Chaintek 3000	N/A	0~360 Degree	N/A	Mar. 05, 2021~ Mar. 06, 2021	N/A	Radiation (03CH07-HY)
USB Data Logger	TECPEL	TR-32	HE17XB2495	N/A	N/A	Mar. 05, 2021~ Mar. 06, 2021	N/A	Radiation (03CH07-HY)
EMI Test Receiver	Agilent	N9038A(MXE)	MY53290053	20Hz~26.5GHz	May 21, 2020	Mar. 05, 2021~ Mar. 06, 2021	May 20, 2021	Radiation (03CH07-HY)
Software	Audix	E3 6.2009-8-24	N/A	N/A	N/A	Mar. 05, 2021~ Mar. 06, 2021	N/A	Radiation (03CH07-HY)
Loop Antenna	Rohde & Schwarz	HFH2-Z2	100315	9 kHz~30 MHz	Jan. 04, 2021	Mar. 05, 2021~ Mar. 06, 2021	Jan. 03, 2022	Radiation (03CH07-HY)



Instrument	Brand Name	Model No.	Serial No.	Characteristics	Calibration Date	Test Date	Due Date	Remark
AC Power Source	AC POWER	AFC-500W	F10407001 1	50Hz~60Hz	Apr. 09, 2020	Mar. 05, 2021	Apr. 08, 2021	Conducted (TH03-HY)
Hygrometer	Testo	608-H1	34913904	N/A	Jul. 27, 2020	Mar. 05, 2021	Jul. 26, 2021	Conducted (TH03-HY)
Spectrum Analyzer	Rohde & Schwarz	FSP30	101329	9kHz~30GHz	Sep. 03, 2020	Mar. 05, 2021	Sep. 02, 2021	Conducted (TH03-HY)
Temperature Chamber	ESPEC	SH-641	92013720	-40°C ~90°C	Sep. 14, 2020	Mar. 05, 2021	Sep. 13, 2021	Conducted (TH03-HY)



5. Uncertainty of Evaluation

Uncertainty of Conducted Emission Measurement (150 kHz ~ 30 MHz)

Measuring Uncertainty for a Level of Confidence of 95% ($U = 2Uc(y)$)	2.3
---	-----

Uncertainty of Radiated Emission Measurement (9 kHz ~ 30 MHz)

Measuring Uncertainty for a Level of Confidence of 95% ($U = 2Uc(y)$)	2.9
---	-----

Uncertainty of Radiated Emission Measurement (30 MHz ~ 1000 MHz)

Measuring Uncertainty for a Level of Confidence of 95% ($U = 2Uc(y)$)	4.7
---	-----



Appendix A. Test Results of Conducted Emission Test

Test Engineer :	Tom Lee	Temperature :	23~26°C
		Relative Humidity :	40~50%

Original

Report NO : 0D2212
 Test Mode : Mode 1
 Test Voltage : 120Vac/60Hz
 Phase : Line

Full Spectrum

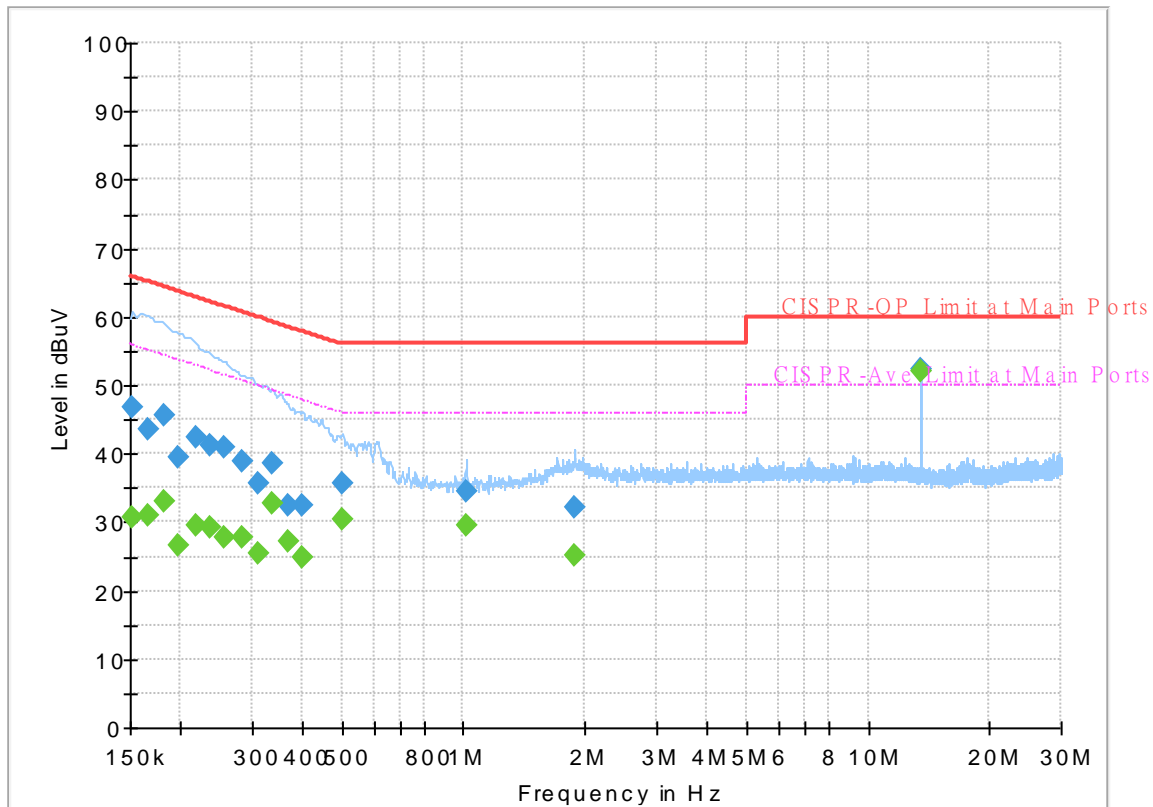

Final_Result

Frequency (MHz)	QuasiPeak (dBuV)	CAverage (dBuV)	Limit (dBuV)	Margin (dB)	Line	Filter	Corr. (dB)
0.152250	---	30.64	55.88	25.24	L1	OFF	19.7
0.152250	46.86	---	65.88	19.02	L1	OFF	19.7
0.165750	---	31.09	55.17	24.08	L1	OFF	19.7
0.165750	43.52	---	65.17	21.65	L1	OFF	19.7
0.181500	---	33.02	54.42	21.40	L1	OFF	19.7
0.181500	45.50	---	64.42	18.92	L1	OFF	19.7
0.197250	---	26.61	53.73	27.12	L1	OFF	19.7
0.197250	39.37	---	63.73	24.36	L1	OFF	19.7
0.217500	---	29.40	52.91	23.51	L1	OFF	19.7
0.217500	42.31	---	62.91	20.60	L1	OFF	19.7
0.237750	---	29.35	52.17	22.82	L1	OFF	19.7
0.237750	41.15	---	62.17	21.02	L1	OFF	19.7
0.255750	---	27.64	51.57	23.93	L1	OFF	19.7
0.255750	41.02	---	61.57	20.55	L1	OFF	19.7
0.285000	---	27.75	50.67	22.92	L1	OFF	19.7
0.285000	38.81	---	60.67	21.86	L1	OFF	19.7
0.309750	---	25.47	49.98	24.51	L1	OFF	19.7
0.309750	35.70	---	59.98	24.28	L1	OFF	19.7
0.336750	---	32.84	49.28	16.44	L1	OFF	19.7
0.336750	38.49	---	59.28	20.79	L1	OFF	19.7
0.368250	---	27.11	48.54	21.43	L1	OFF	19.7

0.368250	32.54	---	58.54	26.00	L1	OFF	19.7
0.399750	---	24.83	47.86	23.03	L1	OFF	19.7
0.399750	32.59	---	57.86	25.27	L1	OFF	19.7
0.503250	---	30.48	46.00	15.52	L1	OFF	19.9
0.503250	35.57	---	56.00	20.43	L1	OFF	19.9
1.016250	---	29.62	46.00	16.38	L1	OFF	20.3
1.016250	34.44	---	56.00	21.56	L1	OFF	20.3
1.882500	---	25.19	46.00	20.81	L1	OFF	20.2
1.882500	32.16	---	56.00	23.84	L1	OFF	20.2
13.560000	---	52.16	50.00	-2.16	L1	OFF	20.3
13.560000	52.39	---	60.00	7.61	L1	OFF	20.3

Report NO : 0D2212
 Test Mode : Mode 1
 Test Voltage : 120Vac/60Hz
 Phase : Neutral

Full Spectrum

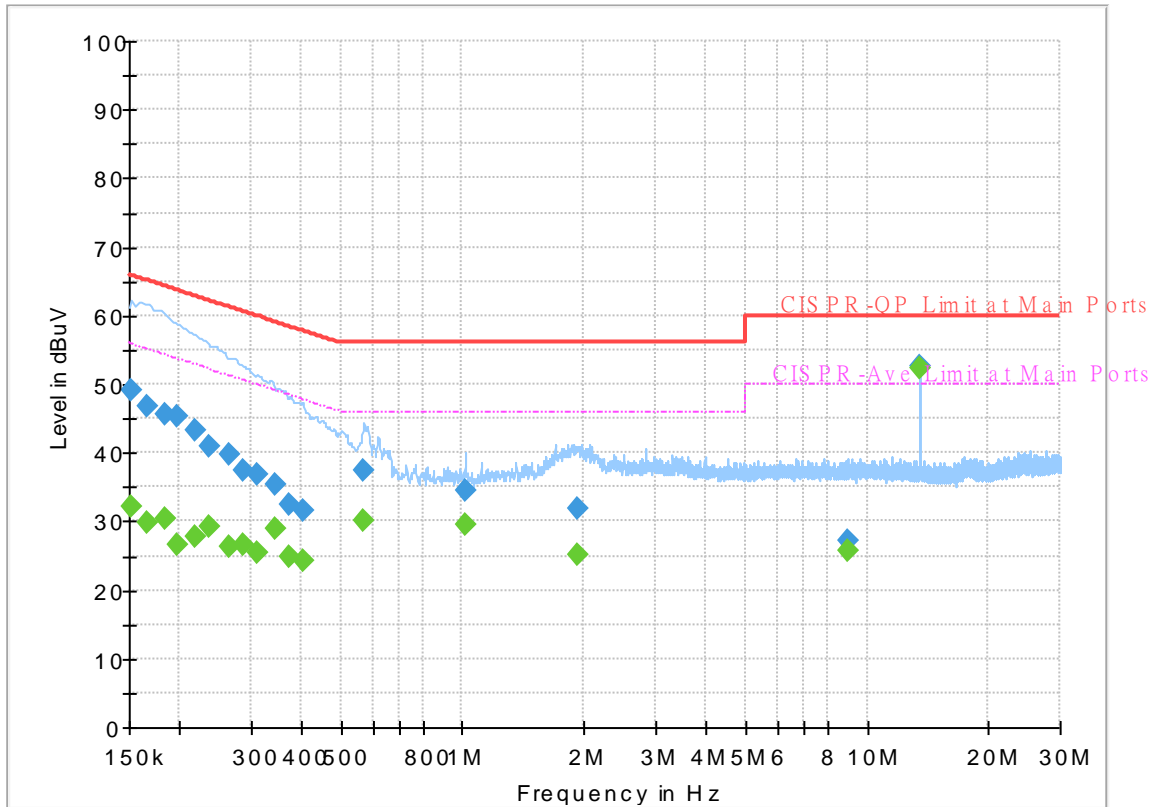

Final_Result

Frequency (MHz)	QuasiPeak (dBuV)	CAverage (dBuV)	Limit (dBuV)	Margin (dB)	Line	Filter	Corr. (dB)
0.152250	---	32.22	55.88	23.66	N	OFF	19.7
0.152250	49.03	---	65.88	16.85	N	OFF	19.7
0.165750	---	29.80	55.17	25.37	N	OFF	19.7
0.165750	46.87	---	65.17	18.30	N	OFF	19.7
0.183750	---	30.34	54.31	23.97	N	OFF	19.7
0.183750	45.59	---	64.31	18.72	N	OFF	19.7
0.197250	---	26.58	53.73	27.15	N	OFF	19.7
0.197250	45.28	---	63.73	18.45	N	OFF	19.7
0.217500	---	27.78	52.91	25.13	N	OFF	19.7
0.217500	43.19	---	62.91	19.72	N	OFF	19.7
0.237750	---	29.16	52.17	23.01	N	OFF	19.8
0.237750	40.89	---	62.17	21.28	N	OFF	19.8
0.264750	---	26.28	51.28	25.00	N	OFF	19.8
0.264750	39.88	---	61.28	21.40	N	OFF	19.8
0.287250	---	26.68	50.60	23.92	N	OFF	19.8
0.287250	37.42	---	60.60	23.18	N	OFF	19.8
0.309750	---	25.45	49.98	24.53	N	OFF	19.8
0.309750	36.89	---	59.98	23.09	N	OFF	19.8
0.343500	---	28.86	49.12	20.26	N	OFF	19.8
0.343500	35.52	---	59.12	23.60	N	OFF	19.8
0.372750	---	24.92	48.44	23.52	N	OFF	19.8

0.372750	32.45	---	58.44	25.99	N	OFF	19.8
0.402000	---	24.29	47.81	23.52	N	OFF	19.8
0.402000	31.59	---	57.81	26.22	N	OFF	19.8
0.570750	---	30.08	46.00	15.92	N	OFF	20.0
0.570750	37.34	---	56.00	18.66	N	OFF	20.0
1.016250	---	29.62	46.00	16.38	N	OFF	20.3
1.016250	34.42	---	56.00	21.58	N	OFF	20.3
1.918500	---	25.26	46.00	20.74	N	OFF	20.3
1.918500	31.99	---	56.00	24.01	N	OFF	20.3
8.938500	---	25.63	50.00	24.37	N	OFF	20.2
8.938500	27.07	---	60.00	32.93	N	OFF	20.2
13.560000	---	52.44	50.00	-2.44	N	OFF	20.4
13.560000	52.67	---	60.00	7.33	N	OFF	20.4

Terminal

Report NO : 0D2212
 Test Mode : Mode 1
 Test Voltage : 120Vac/60Hz
 Phase : Line

Full Spectrum

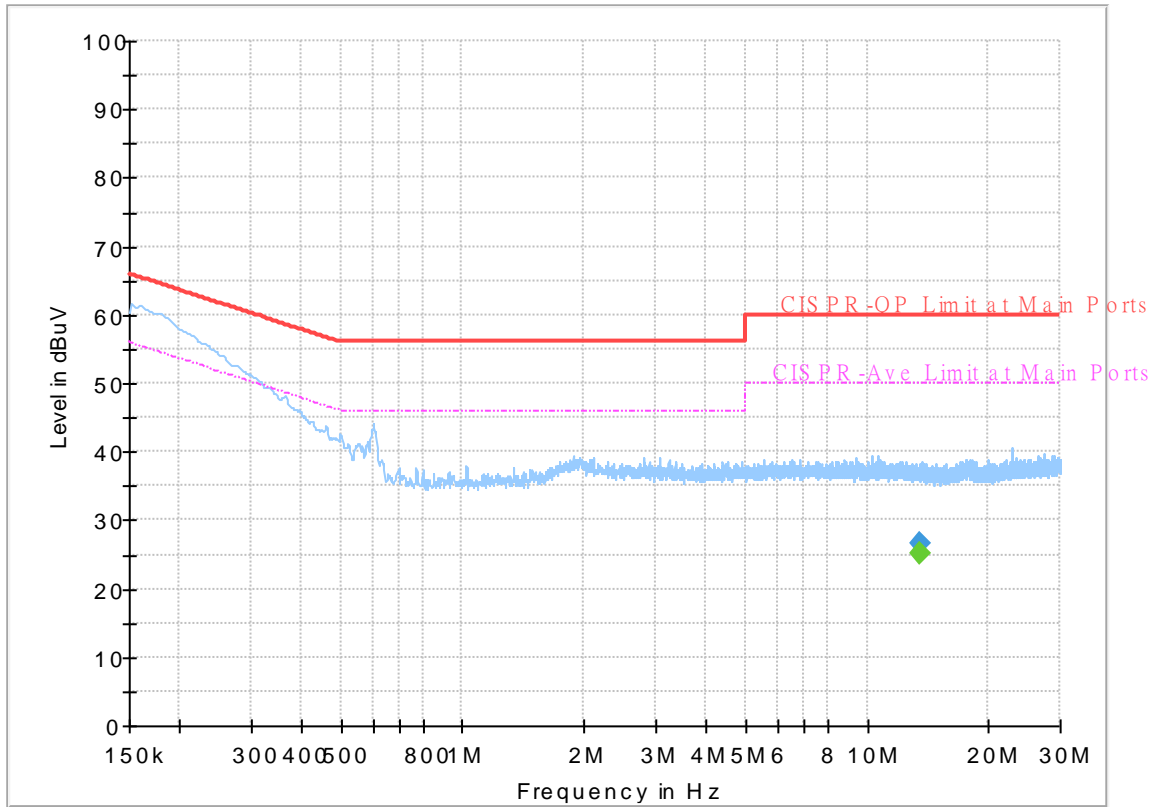

Final_Result

Frequency (MHz)	QuasiPeak (dBuV)	CAverage (dBuV)	Limit (dBuV)	Margin (dB)	Line	Filter	Corr. (dB)
13.560000	---	25.13	50.00	24.87	L1	OFF	20.3
13.560000	26.56	---	60.00	33.44	L1	OFF	20.3

Report NO : 0D2212
 Test Mode : Mode 1
 Test Voltage : 120Vac/60Hz
 Phase : Neutral

Full Spectrum

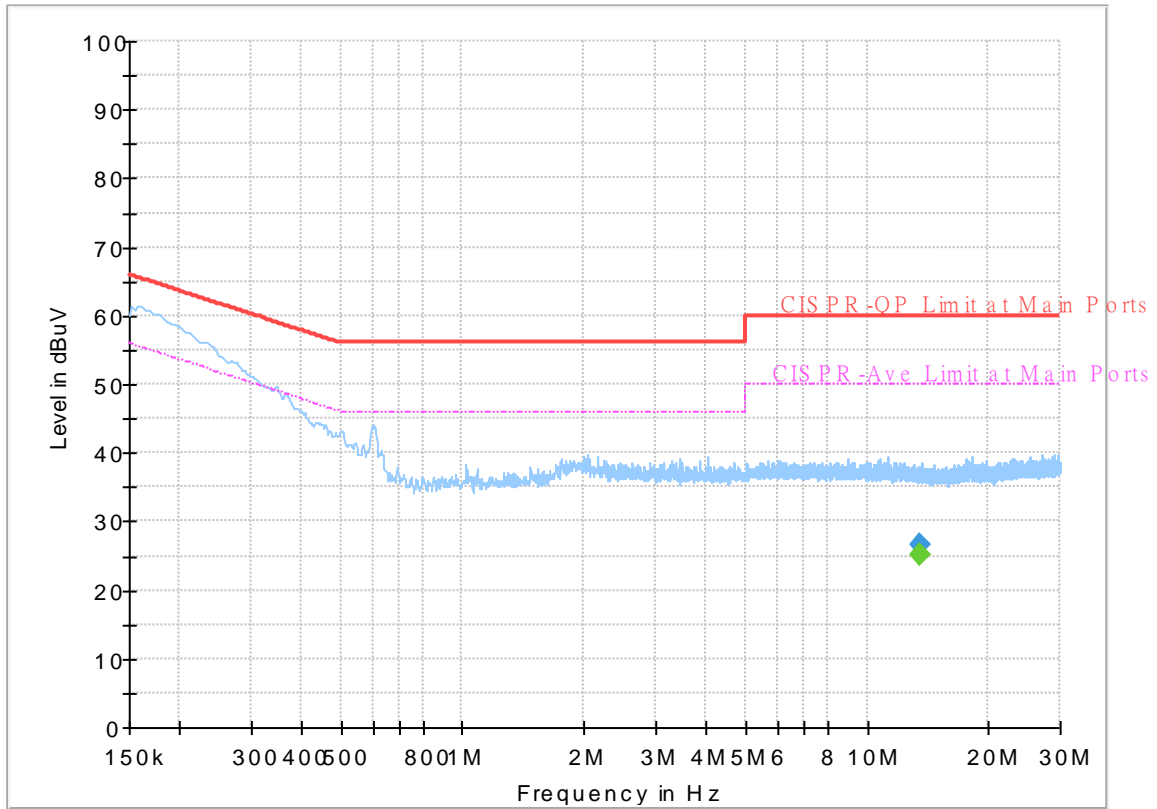

Final_Result

Frequency (MHz)	QuasiPeak (dBuV)	CAverage (dBuV)	Limit (dBuV)	Margin (dB)	Line	Filter	Corr. (dB)
13.555500	---	25.16	50.00	24.84	N	OFF	20.4
13.555500	26.64	---	60.00	33.36	N	OFF	20.4



Appendix B. Test Results of Conducted Test Items

B1. Test Result of 20dB Spectrum Bandwidth

Test mode	NFC Tx	Test Frequency (MHz)	13.56
20dB Bandwidth (kHz)	2.640	99% OccupiedBW(kHz)	2.260
Frequency range (MHz)	$f_L > 13.553$	13.55858	Test Result
	$f_H < 13.567$	13.56122	Complies

Remark: Because the measured signal is CW adjusting the RBW per C63.10 would not be practical since measured bandwidth will always follow the RBW and the result will be approximately twice the RBW.



B2. Test Result of Frequency Stability

Voltage vs. Frequency Stability		Temperature vs. Frequency Stability		
Voltage (Vac)	Measurement Frequency (MHz)	Temperature (°C)	Time	Measurement Frequency (MHz)
120	13.559900	-20	0	13.560060
102	13.559900		2	13.560060
138	13.559900		5	13.560060
			10	13.560070
		-10	0	13.560040
			2	13.560040
			5	13.560060
			10	13.560060
		0	0	13.560020
			2	13.560020
			5	13.560020
			10	13.560020
		10	0	13.559940
			2	13.559960
			5	13.559980
			10	13.559980
		20	0	13.559900
			2	13.559900
			5	13.559900
			10	13.559900
		30	0	13.559880
			2	13.559880
			5	13.559900
			10	13.559880
		40	0	13.559870
			2	13.559860
			5	13.559860
			10	13.559870



Voltage vs. Frequency Stability		Temperature vs. Frequency Stability		
Voltage (Vac)	Measurement Frequency (MHz)	Temperature (°C)	Time	Measurement Frequency (MHz)
		50	0	13.559940
			2	13.559900
			5	13.559880
			10	13.559870
Max.Deviation (MHz)	-0.000100	Max.Deviation (MHz)		-0.000140
Max.Deviation (ppm)	-7.3746	Max.Deviation (ppm)		-10.3245
Limit	FS < ±100 ppm	Limit		FS < ±100 ppm
Test Result	PASS	Test Result		PASS



Appendix C. Test Results of Radiated Test Items

C1. Test Result of Field Strength of Fundamental Emissions

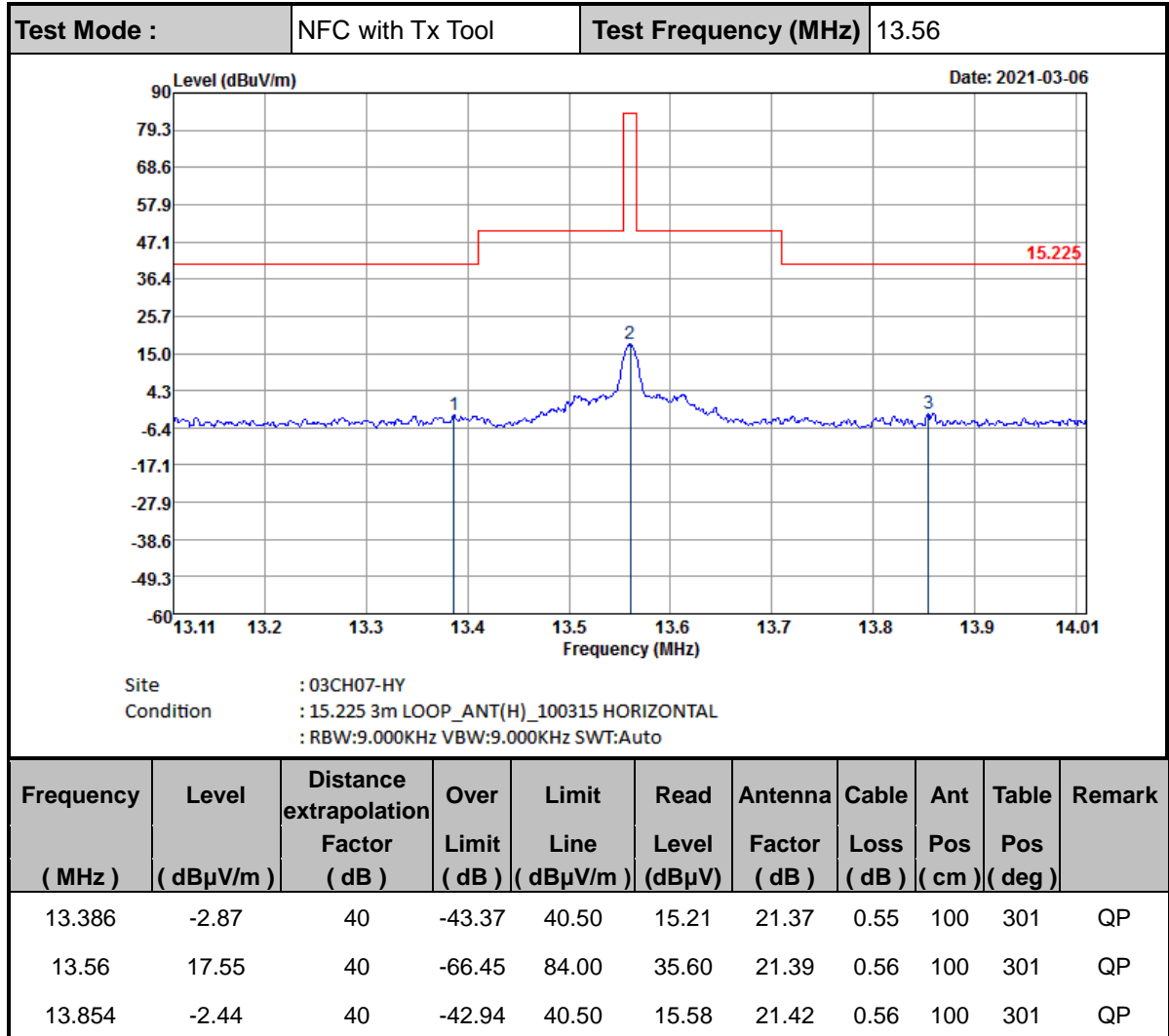



Test Mode :	NFC with Tx Tool	Test Frequency (MHz)	13.56
-------------	------------------	----------------------	-------

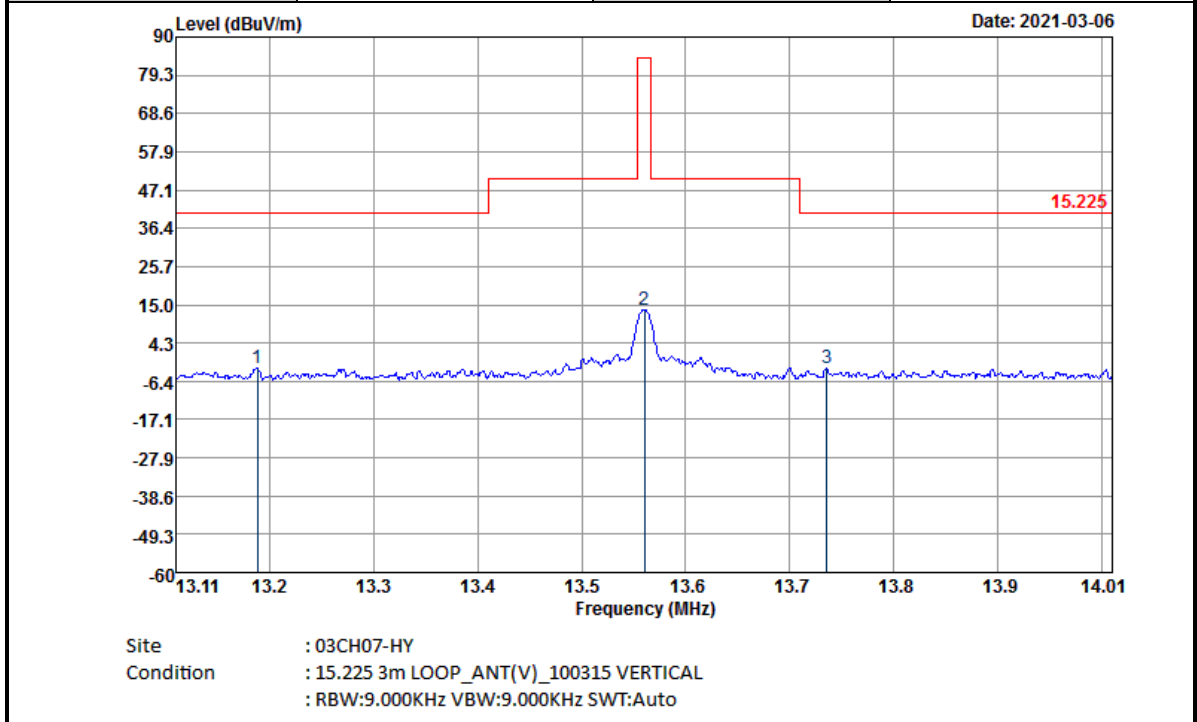

Frequency (MHz)	Level (dBμV/m)	Distance extrapolation Factor (dB)	Over Limit (dB)	Limit Line (dBμV/m)	Read Level (dBμV)	Antenna Factor (dB)	Cable Loss (dB)	Ant Pos (cm)	Table Pos (deg)	Remark
13.188	-2.69	40	-43.19	40.50	15.41	21.35	0.55	100	48	QP
13.56	13.65	40	-70.35	84.00	31.70	21.39	0.56	100	48	QP
13.736	-2.81	40	-43.31	40.50	15.22	21.41	0.56	100	48	QP



Test Mode :	NFC with NFC Card	Test Frequency (MHz)	13.56
-------------	-------------------	----------------------	-------

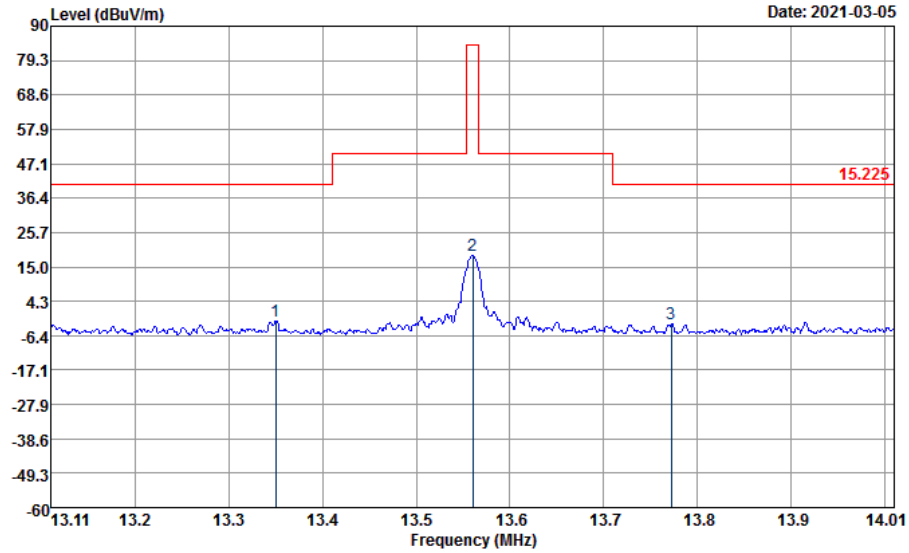

Site : 03CH07-HY
 Condition : 15.225 3m LOOP_ANT(H)_100315 HORIZONTAL
 : RBW:9.000KHz VBW:9.000KHz SWT:Auto

Frequency (MHz)	Level (dB μ V/m)	Distance extrapolation Factor (dB)	Over Limit (dB)	Limit Line (dB μ V/m)	Read Level (dB μ V)	Antenna Factor (dB)	Cable Loss (dB)	Ant Pos (cm)	Table Pos (deg)	Remark
13.35	-1.79	40	-42.29	40.50	16.29	21.37	0.55	100	0	QP
13.56	18.45	40	-65.55	84.00	36.50	21.39	0.56	100	0	QP
13.772	-2.91	40	-43.41	40.50	15.12	21.41	0.56	100	0	QP



Test Mode :	NFC with NFC Card	Test Frequency (MHz)	13.56
-------------	-------------------	----------------------	-------

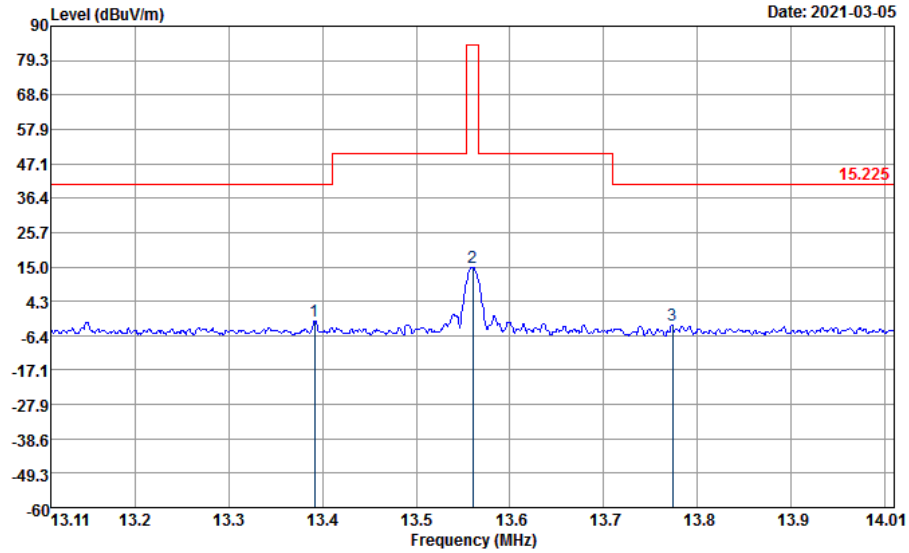

Site : 03CH07-HY
 Condition : 15.225 3m LOOP_ANT(V)_100315 VERTICAL
 : RBW:9.000KHz VBW:9.000KHz SWT:Auto

Frequency (MHz)	Level (dB μ V/m)	Distance extrapolation Factor (dB)	Over Limit (dB)	Limit Line (dB μ V/m)	Read Level (dB μ V)	Antenna Factor (dB)	Cable Loss (dB)	Ant Pos (cm)	Table Pos (deg)	Remark
13.392	-1.75	40	-42.25	40.50	16.33	21.37	0.55	100	263	QP
13.56	14.89	40	-69.11	84.00	32.94	21.39	0.56	100	263	QP
13.773	-3.36	40	-43.86	40.50	14.67	21.41	0.56	100	263	QP

C2. Results of Radiated Spurious Emissions (9 kHz~30MHz)

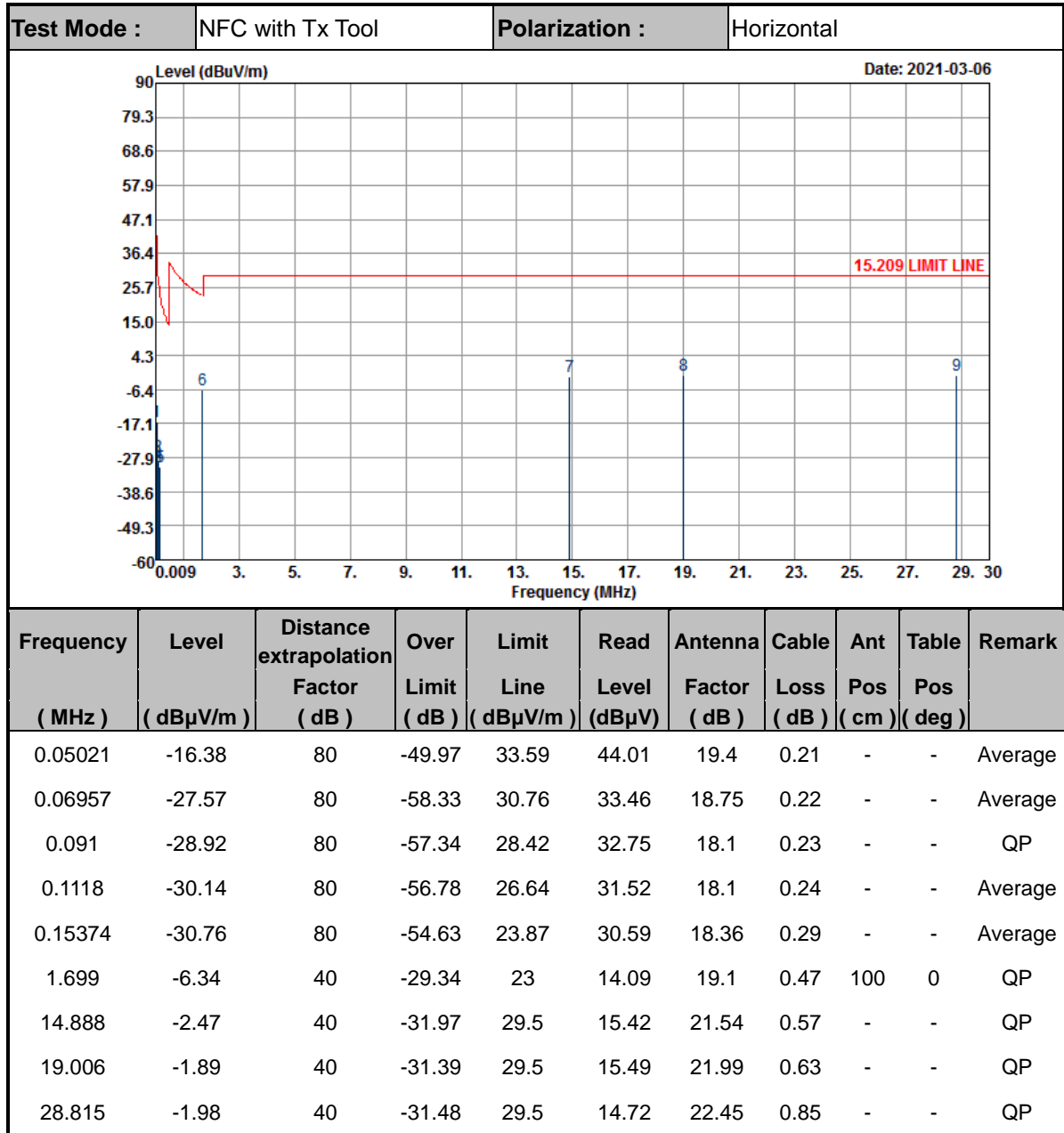

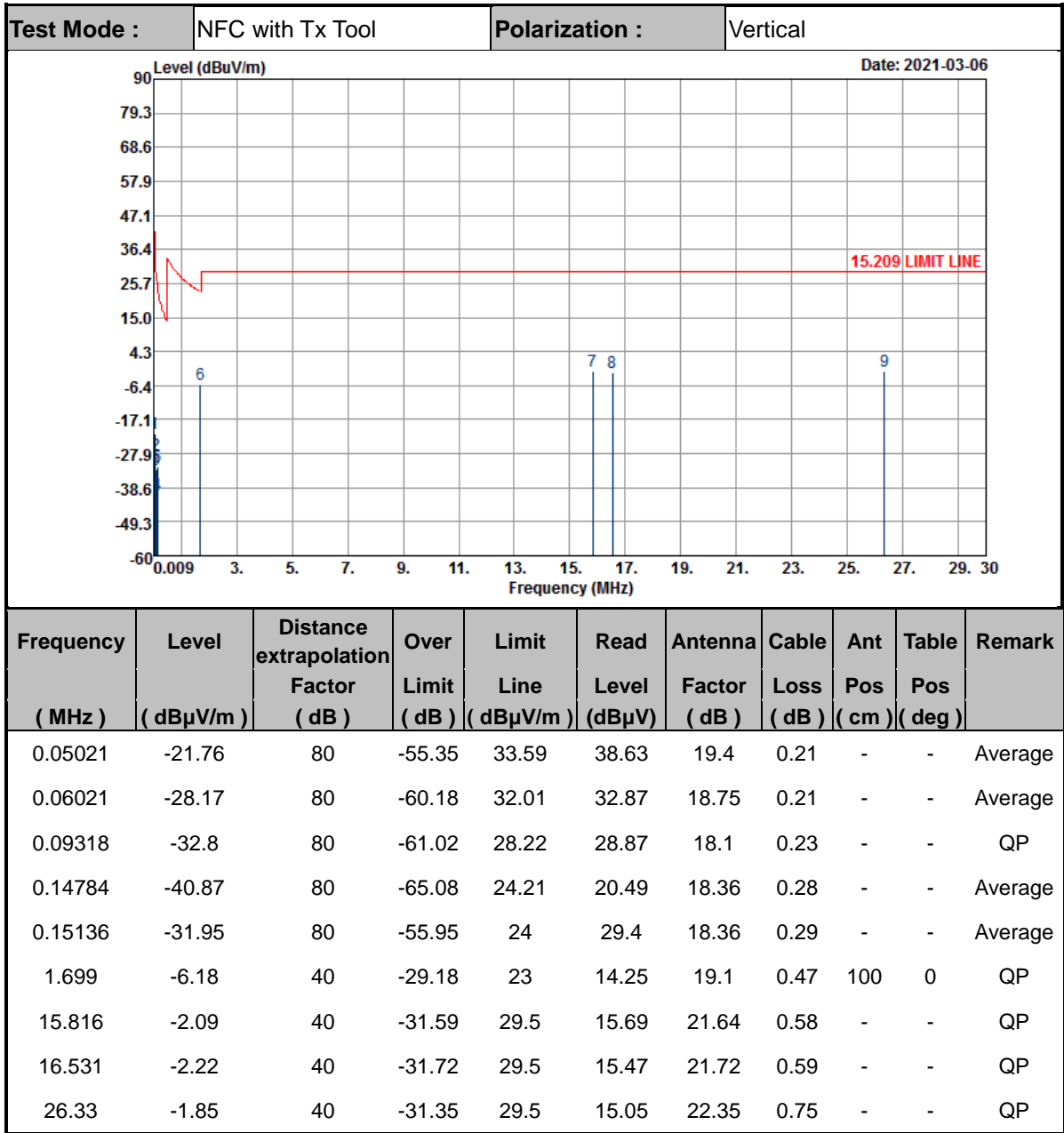

Note:

1. The amplitude of spurious emissions which are attenuated by more than 20dB below the permissible value has no need to be reported.
2. Distance extrapolation factor = 40 log (specific distance / test distance) (dB)
3. Limit line = specific limits (dBμV) + distance extrapolation factor



Test Mode:	NFC with NFC Card	Polarization :	Horizontal
-------------------	-------------------	-----------------------	------------

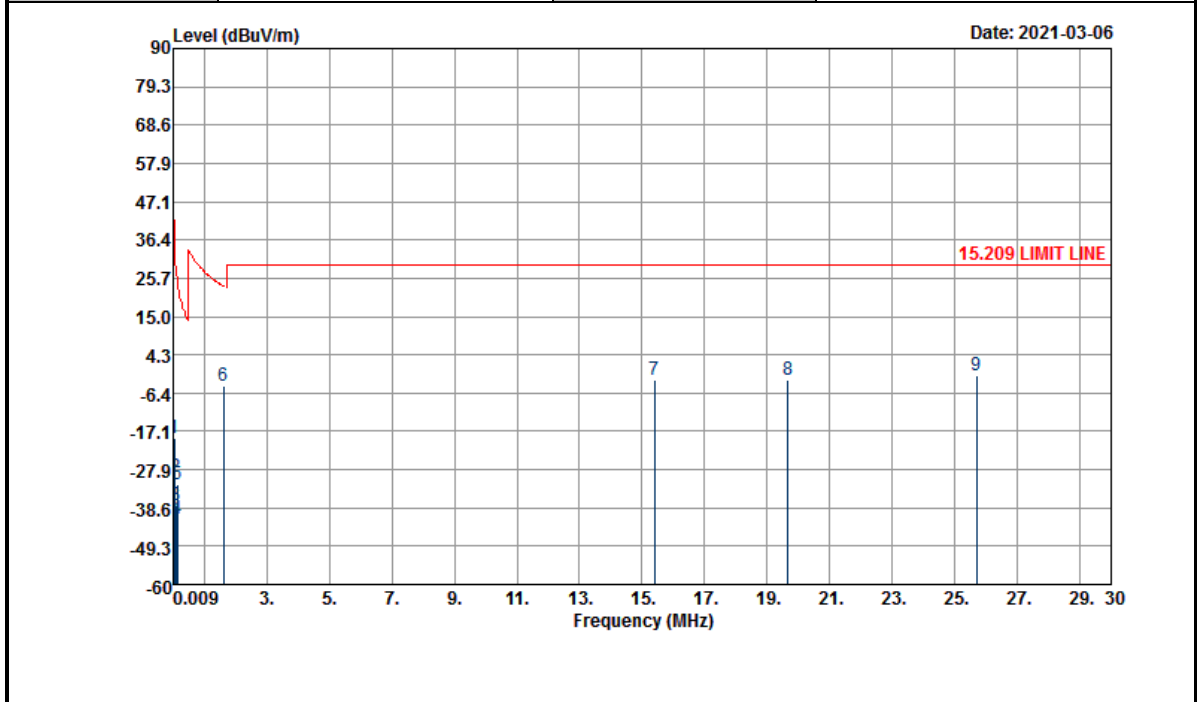

Frequency (MHz)	Level (dB μ V/m)	Distance extrapolation Factor (dB)	Over Limit (dB)	Limit Line (dB μ V/m)	Read Level (dB μ V)	Antenna Factor (dB)	Cable Loss (dB)	Ant Pos (cm)	Table Pos (deg)	Remark
0.05016	-19.23	80	-52.83	33.6	41.16	19.4	0.21	-	-	Average
0.06273	-30.08	80	-61.73	31.65	30.96	18.75	0.21	-	-	Average
0.0934	-37.83	80	-66.03	28.2	23.84	18.1	0.23	-	-	QP
0.11196	-41.7	80	-68.32	26.62	19.96	18.1	0.24	-	-	Average
0.15102	-31.84	80	-55.86	24.02	29.51	18.36	0.29	-	-	Average
1.624	-4.54	40	-27.93	23.39	15.89	19.1	0.47	100	0	QP
15.392	-2.6	40	-32.1	29.5	15.23	21.59	0.58	-	-	QP
19.672	-2.59	40	-32.09	29.5	14.71	22.06	0.64	-	-	QP
25.69	-1.52	40	-31.02	29.5	15.43	22.33	0.72	-	-	QP

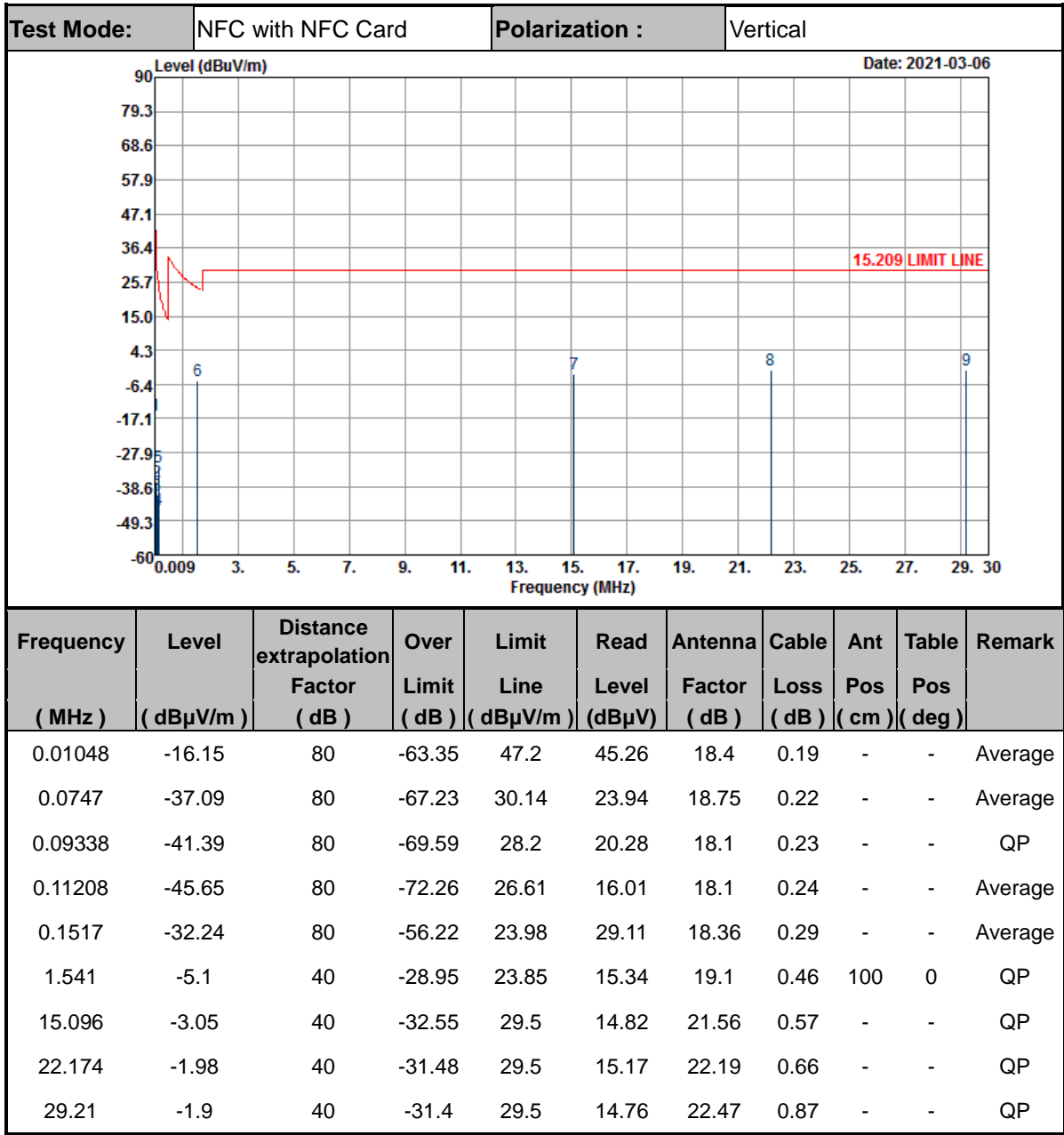

Note:

1. The amplitude of spurious emissions which are attenuated by more than 20dB below the permissible value has no need to be reported.
2. Distance extrapolation factor = 40 log (specific distance / test distance) (dB)
3. Limit line = specific limits (dBμV) + distance extrapolation factor



C3. Results of Radiated Spurious Emissions (30MHz~1GHz)

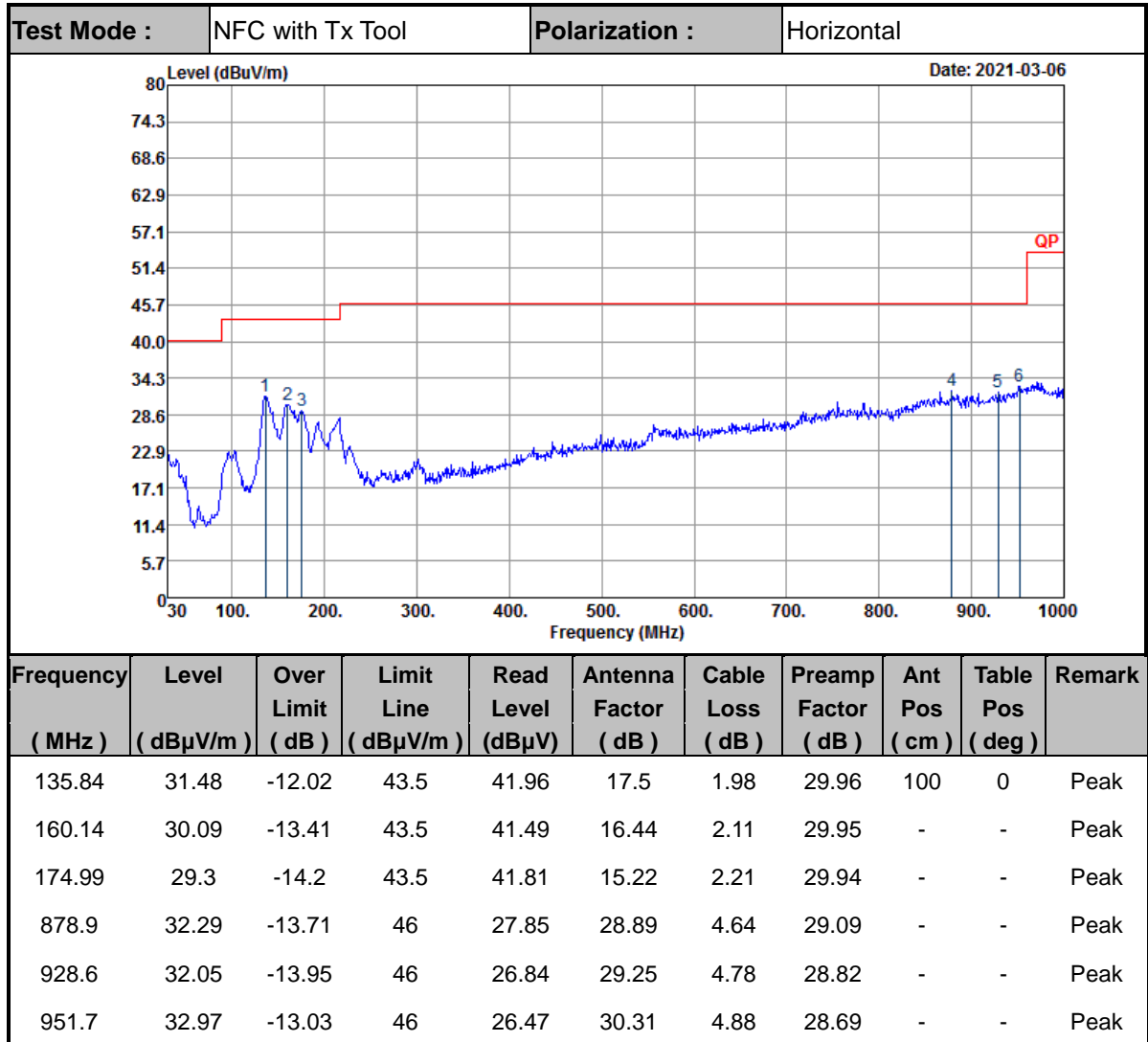

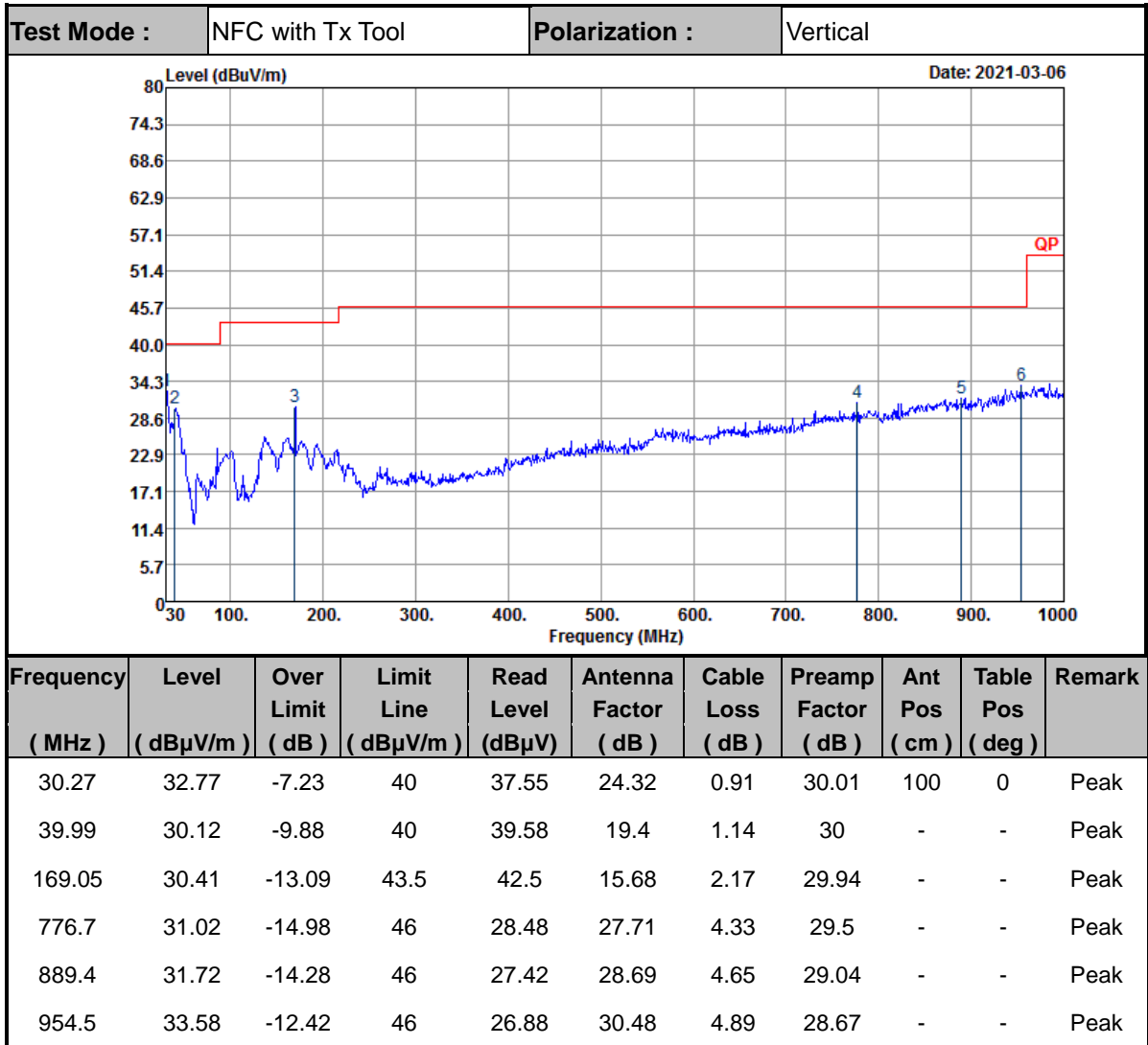

Note:

1. The amplitude of spurious emissions which are attenuated by more than 20dB below the permissible value has no need to be reported.
2. Emission level (dBμV/m) = 20 log Emission level (μV/m).
3. Corrected Reading: Antenna Factor + Cable Loss + Read Level - Preamp Factor= Level.

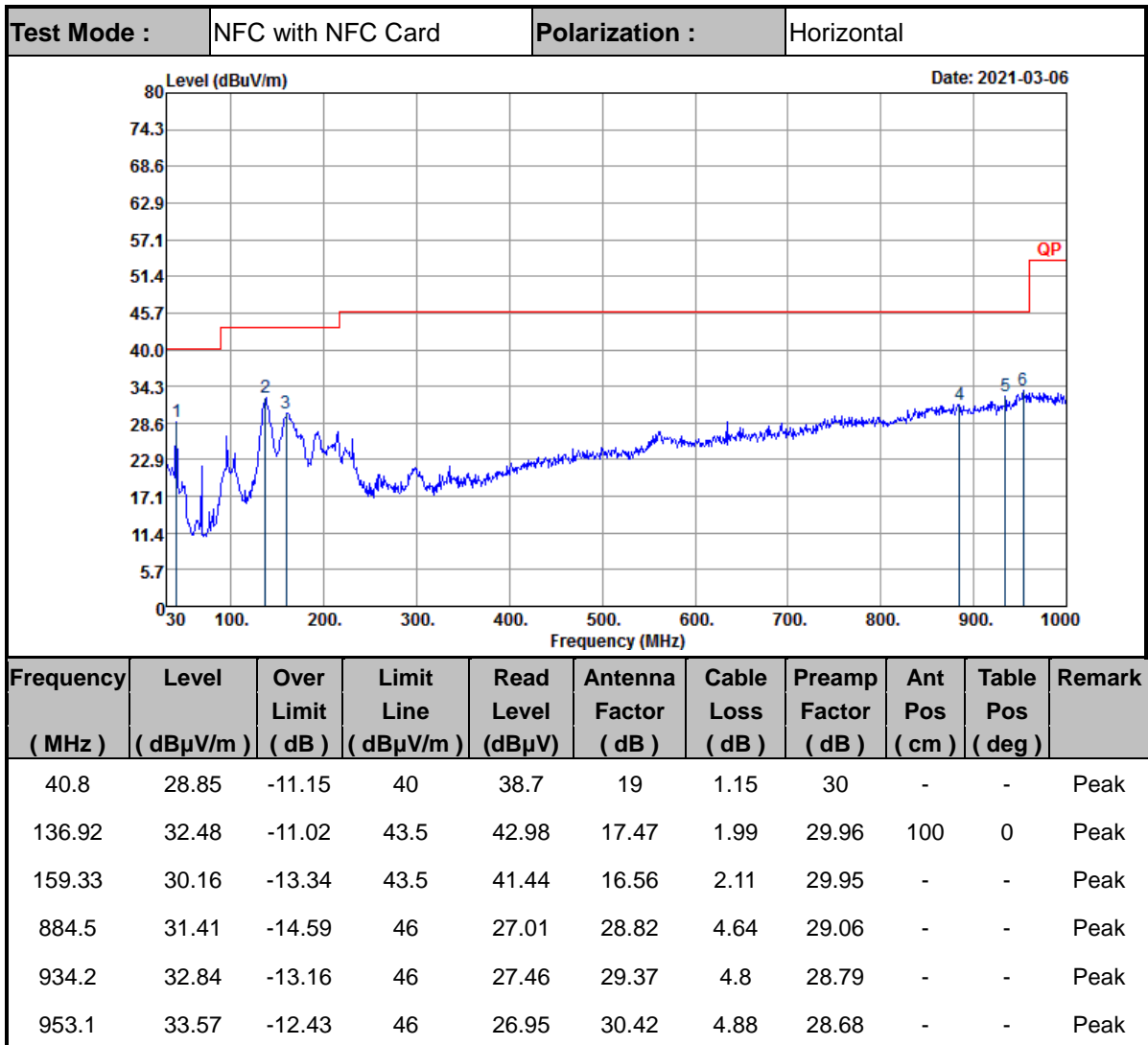

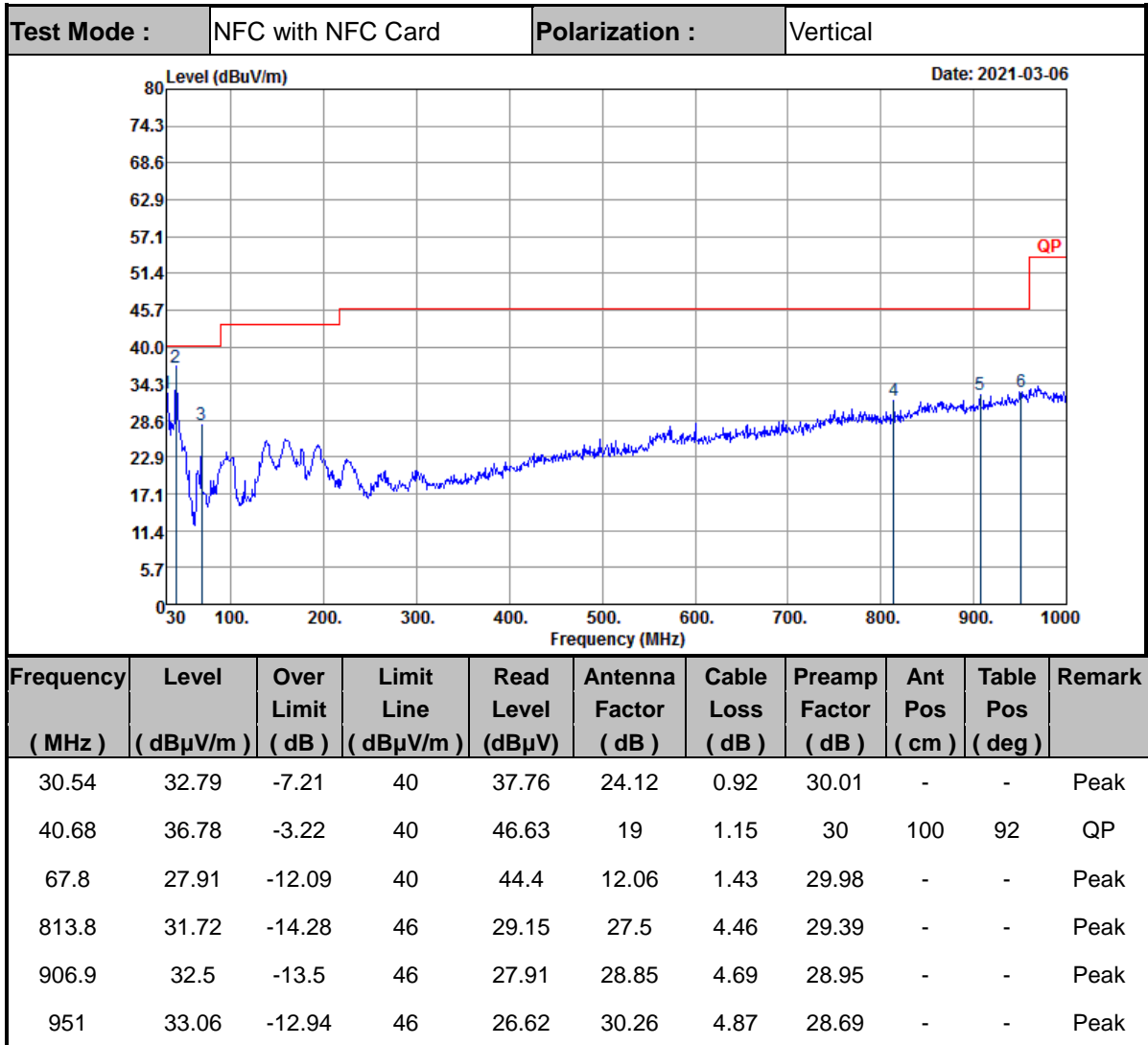

Note:

1. The amplitude of spurious emissions which are attenuated by more than 20dB below the permissible value has no need to be reported.
2. Emission level (dBμV/m) = 20 log Emission level (μV/m).
3. Corrected Reading: Antenna Factor + Cable Loss + Read Level - Preamp Factor= Level.

————THE END————