



FCC RF Test Report

APPLICANT : Sony Mobile Communications Inc.
EQUIPMENT : GSM/WCDMA/LTE Phone+Bluetooth,
DTS/UNII a/b/g/n and NFC
BRAND NAME : Sony
FCC ID : PY7-84773W
STANDARD : FCC Part 15 Subpart C §15.247
CLASSIFICATION : (DTS) Digital Transmission System

The product was received on Sep. 22, 2016 and testing was completed on Nov. 02, 2016. We, SPORTON INTERNATIONAL INC., would like to declare that the tested sample has been evaluated in accordance with the test procedures and has been in compliance with the applicable technical standards.

The test results in this report apply exclusively to the tested model / sample. Without written approval of SPORTON INTERNATIONAL INC., the test report shall not be reproduced except in full.

Reviewed by: Joseph Lin / Supervisor

Approved by: Jones Tsai / Manager



SPORTON INTERNATIONAL INC.

No. 52, Hwa Ya 1st Rd., Hwa Ya Technology Park, Kwei-Shan District, Tao Yuan City, Taiwan, R.O.C.



TABLE OF CONTENTS

REVISION HISTORY..... 3

SUMMARY OF TEST RESULT 4

1 GENERAL DESCRIPTION 5

 1.1 Applicant 5

 1.2 Manufacturer 5

 1.3 Product Feature of Equipment Under Test 5

 1.4 Modification of EUT 6

 1.5 Testing Location 7

 1.6 Applicable Standards 7

2 TEST CONFIGURATION OF EQUIPMENT UNDER TEST 8

 2.1 Carrier Frequency and Channel 8

 2.2 Test Mode 9

 2.3 Connection Diagram of Test System 10

 2.4 Support Unit used in test configuration and system 11

 2.5 EUT Operation Test Setup 11

 2.6 Measurement Results Explanation Example 11

3 TEST RESULT 12

 3.1 6dB and 99% Bandwidth Measurement 12

 3.2 Output Power Measurement 14

 3.3 Power Spectral Density Measurement 15

 3.4 Conducted Band Edges and Spurious Emission Measurement 17

 3.5 Radiated Band Edges and Spurious Emission Measurement 27

 3.6 AC Conducted Emission Measurement 31

 3.7 Antenna Requirements 35

4 LIST OF MEASURING EQUIPMENT 36

5 UNCERTAINTY OF EVALUATION 38

APPENDIX A. CONDUCTED TEST RESULTS

APPENDIX B. RADIATED SPURIOUS EMISSION

APPENDIX C. RADIATED SPURIOUS EMISSION PLOTS

APPENDIX D. DUTY CYCLE PLOTS



REVISION HISTORY

REPORT NO.	VERSION	DESCRIPTION	ISSUED DATE
FR692208-01C	Rev. 01	Initial issue of report	Feb. 06, 2017



SUMMARY OF TEST RESULT

Report Section	FCC Rule	Description	Limit	Result	Remark
3.1	15.247(a)(2)	6dB Bandwidth	$\geq 0.5\text{MHz}$	Pass	-
3.1	-	99% Bandwidth	-	Pass	-
3.2	15.247(b)	Power Output Measurement	$\leq 30\text{dBm}$	Pass	-
3.3	15.247(e)	Power Spectral Density	$\leq 8\text{dBm}/3\text{kHz}$	Pass	-
3.4	15.247(d)	Conducted Band Edges	$\leq 20\text{dBc}$	Pass	-
		Conducted Spurious Emission		Pass	-
3.5	15.247(d)	Radiated Band Edges and Radiated Spurious Emission	15.209(a) & 15.247(d)	Pass	Under limit 3.43 dB at 738.200 MHz
3.6	15.207	AC Conducted Emission	15.207(a)	Pass	Under limit 14.10 dB at 0.462 MHz
3.7	15.203 & 15.247(b)	Antenna Requirement	N/A	Pass	-



1 General Description

1.1 Applicant

Sony Mobile Communications Inc.

4-12-3 Higashi-Shinagawa, Shinagawa-ku, Tokyo, 140-0002, Japan

1.2 Manufacturer

Sony Mobile Communications Inc.

4-12-3 Higashi-Shinagawa, Shinagawa-ku, Tokyo, 140-0002, Japan

1.3 Product Feature of Equipment Under Test

GSM/WCDMA/LTE, Bluetooth, DTS/UNII, a/b/g/n, GPS, and NFC

Standards-related Product Specification	
Antenna Type / Gain	PIFA Antenna type with gain -0.80 dBi

EUT Information List			
HW Version	SW Version	S/N	Performed Test Item
A	0.85	RQ3002HXPA	RF conducted measurement
		RQ3002HWLU	Radiated Spurious Emission
		RQ3002HWM1	Conducted Emission



Accessory List	
AC Adapter 1	Model No. : UCH20
	S/N :
	1215W48600011 (for radiated spurious emission) 1215W48600039 (for conducted emission)
Earphone 1	Model No. : MH410c
	S/N:
	1632A86300007A6 (for radiated spurious emission) 1632A8640000088 (for conducted emission)
USB Cable	Model No. : UCB20
	S/N :
	1625A912000332E (for radiated spurious emission) 1625A91900007E2 (for conducted emission)

Note:

1. Above EUT list and accessory list used are electrically identical per declared by manufacturer.
2. Above the accessories list are used to exercise the EUT during test.
3. For other wireless features of this EUT, test report will be issued separately.

1.4 Modification of EUT

No modifications are made to the EUT during all test items.



1.5 Testing Location

Sporton Lab is accredited to ISO 17025 by Taiwan Accreditation Foundation (TAF code : 1190) and the FCC designation No. TW1022 under the FCC 2.948(e) by Mutual Recognition Agreement (MRA) in FCC Test.

Test Site	SPORTON INTERNATIONAL INC.	
Test Site Location	No. 52, Hwa Ya 1 st Rd., Hwa Ya Technology Park, Kwei-Shan District, Tao Yuan City, Taiwan, R.O.C. TEL: +886-3-327-3456 FAX: +886-3-328-4978	
Test Site No.	Sporton Site No.	
	TH05-HY	CO05-HY

Note: The test site complies with ANSI C63.4 2014 requirement.

Test Site	SPORTON INTERNATIONAL INC.	
Test Site Location	No.58, Aly. 75, Ln. 564, Wenhua 3rd Rd. Guishan Dist, Taoyuan City, Taiwan (R.O.C.) TEL: +886-3-327-0868 FAX: +886-3-327-0855	
Test Site No.	Sporton Site No.	
	03CH12-HY	

Note: The test site complies with ANSI C63.4 2014 requirement.

1.6 Applicable Standards

According to the specifications of the manufacturer, the EUT must comply with the requirements of the following standards:

- ♦ FCC Part 15 Subpart C §15.247
- ♦ FCC KDB Publication No. 558074 D01 DTS Meas. Guidance v03r05
- ♦ ANSI C63.10-2013

Remark:

1. All test items were verified and recorded according to the standards and without any deviation during the test.
2. This EUT has also been tested and complied with the requirements of FCC Part 15, Subpart B, recorded in a separate test report.



2 Test Configuration of Equipment Under Test

The EUT has been associated with peripherals and configuration operated in a manner tended to maximize its emission characteristics in a typical application. Frequency range investigated: conducted emission (150 kHz to 30 MHz) and radiated emission (9 kHz to the 10th harmonic of the highest fundamental frequency or to 40 GHz, whichever is lower). For radiated measurement, pre-scanned in three orthogonal panels, X, Y, Z. The worst cases (Z plane) were recorded in this report.

2.1 Carrier Frequency and Channel

Frequency Band	Channel	Freq. (MHz)	Channel	Freq. (MHz)
2400-2483.5 MHz	1	2412	7	2442
	2	2417	8	2447
	3	2422	9	2452
	4	2427	10	2457
	5	2432	11	2462
	6	2437	-	-



2.2 Test Mode

Final test mode of conducted test items and radiated spurious emissions are considering the modulation and worse data rates as below table.

Modulation	Data Rate
802.11b	1 Mbps
802.11g	6 Mbps
802.11n HT20	MCS0

Test Cases	
AC Conducted Emission	Mode 1 : GSM1900 Idle + Bluetooth Link + WLAN (2.4GHz) Link + MP3 + Earphone 1 + Battery + USB Cable (Charging from Adapter 1)

2.3 Connection Diagram of Test System

<WLAN Tx Mode>

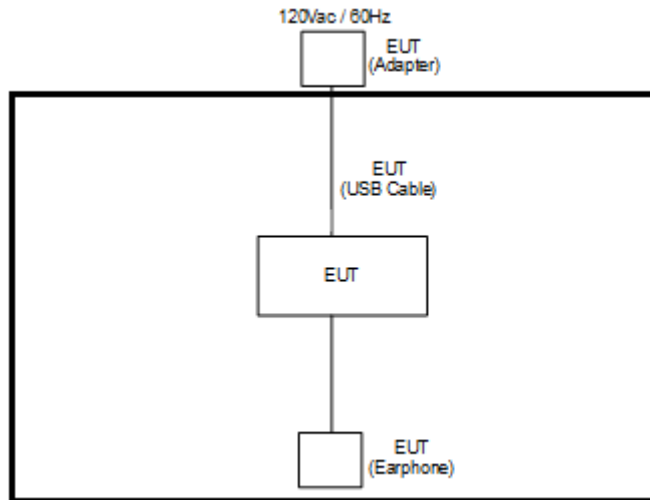

<AC Conducted Emission Mode>

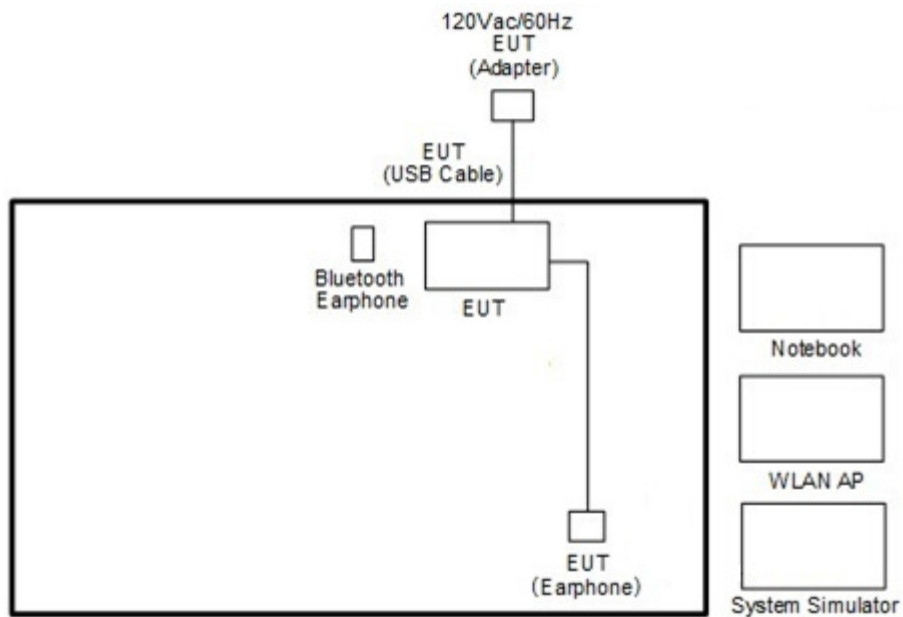



2.4 Support Unit used in test configuration and system

Item	Equipment	Trade Name	Model Name	FCC ID	Data Cable	Power Cord
1.	System Simulator	Anritsu	MT8820C	N/A	N/A	Unshielded, 1.8 m
2.	WLAN AP	ASUS	RT-AC66U	MSQ-RTAC66U	N/A	Unshielded, 1.8m
3.	Notebook	DELL	Latitude E6320	FCC DoC/ Contains FCC ID: QDS-BRCM1054	N/A	AC I/P: Unshielded, 1.2 m DC O/P: Shielded, 1.8 m
4.	Bluetooth Earphone	Sony	SBH20	PY7-RD0010	N/A	N/A
5.	SD Card	SanDisk	MicroSD HC	FCC DoC	N/A	N/A

2.5 EUT Operation Test Setup

For RF test items, an engineering test program was provided and enabled to make EUT transmitting signals.

2.6 Measurement Results Explanation Example

For all conducted test items:

The offset level is set in the spectrum analyzer to compensate the RF cable loss and attenuator factor between EUT conducted output port and spectrum analyzer. With the offset compensation, the spectrum analyzer reading level is exactly the EUT RF output level.

Example :

The spectrum analyzer offset is derived from RF cable loss and attenuator factor.

Offset = RF cable loss + attenuator factor.

Following shows an offset computation example with cable loss 4.2 dB and 10dB attenuator.

$$\begin{aligned}
 \text{Offset(dB)} &= \text{RF cable loss(dB)} + \text{attenuator factor(dB)}. \\
 &= 4.2 + 10 = 14.2 \text{ (dB)}
 \end{aligned}$$

3 Test Result

3.1 6dB and 99% Bandwidth Measurement

3.1.1 Limit of 6dB and 99% Bandwidth

The minimum 6 dB bandwidth shall be at least 500 kHz.

3.1.2 Measuring Instruments

The measuring equipment is listed in the section 4 of this test report.

3.1.3 Test Procedures

1. The testing follows FCC KDB Publication No. 558074 DTS D01 Meas. Guidance v03r05.
2. The RF output of EUT was connected to the spectrum analyzer by RF cable and attenuator. The path loss was compensated to the results for each measurement.
3. Set to the maximum power setting and enable the EUT transmit continuously.
4. Make the measurement with the spectrum analyzer's resolution bandwidth (RBW) = 100 kHz. Set the Video bandwidth (VBW) = 300 kHz. In order to make an accurate measurement. The 6 dB bandwidth must be greater than 500 kHz.
5. For 99% Bandwidth Measurement, the spectrum analyzer's resolution bandwidth (RBW) = 1MHz and set the Video bandwidth (VBW) = 3MHz.
6. Measure and record the results in the test report.

3.1.4 Test Setup





3.1.5 Test Result of 6dB and 99% Occupied Bandwidth

Please refer to Appendix A.

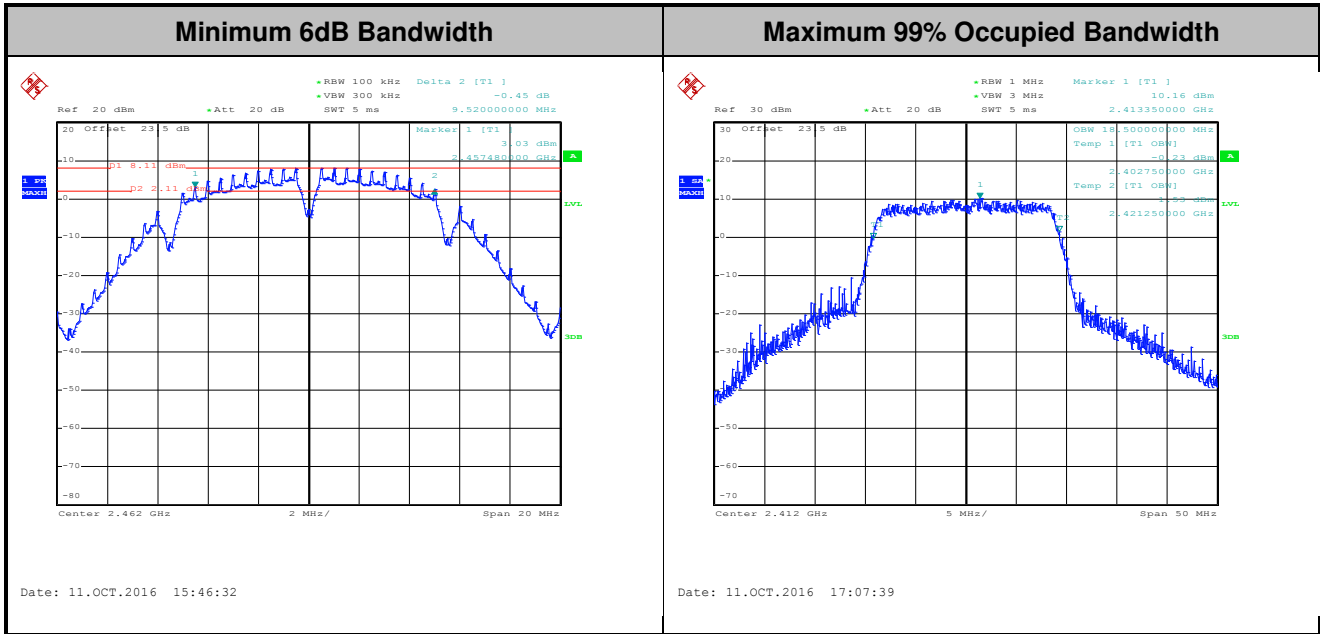

Note : The occupied channel bandwidth is maintained within the band of operation for all of the modulations.

3.2 Output Power Measurement

3.2.1 Limit of Output Power

For systems using digital modulation in the 2400-2483.5MHz, the limit for peak output power is 30dBm. If transmitting antenna of directional gain greater than 6dBi are used the peak output power from the intentional radiator shall be reduced below the above stated value by the amount in dB that the directional gain of the antenna exceeds 6 dBi. In case of point-to-point operation, the limit has to be reduced by 1dB for every 3dB that the directional gain of the antenna exceeds 6dBi.

3.2.2 Measuring Instruments

The measuring equipment is listed in the section 4 of this test report.

3.2.3 Test Procedures

1. The testing follows the Measurement Procedure of FCC KDB No. 558074 DTS D01 Meas. Guidance v03r05 section 9.1.2 PKPM1 Peak power meter method.
2. The RF output of EUT was connected to the power meter by RF cable and attenuator. The path loss was compensated to the results for each measurement.
3. Set to the maximum power setting and enable the EUT transmit continuously.
4. Measure the conducted output power and record the results in the test report.

3.2.4 Test Setup

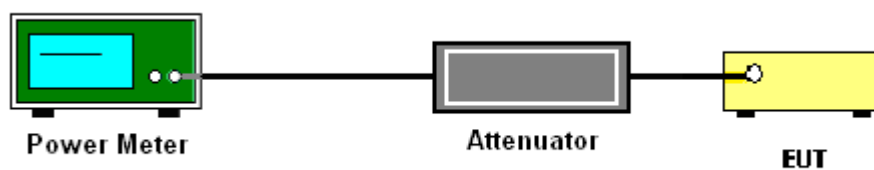

3.2.5 Test Result of Peak Output Power

Please refer to Appendix A.

3.2.6 Test Result of Average output Power (Reporting Only)

Please refer to Appendix A.

3.3 Power Spectral Density Measurement

3.3.1 Limit of Power Spectral Density

The peak power spectral density shall not be greater than 8dBm in any 3kHz band at any time interval of continuous transmission.

3.3.2 Measuring Instruments

The measuring equipment is listed in the section 4 of this test report.

3.3.3 Test Procedures

1. The testing follows Measurement Procedure 10.2 Method PKPSD of FCC KDB Publication No. 558074 D01 DTS Meas. Guidance v03r05
2. The RF output of EUT was connected to the spectrum analyzer by RF cable and attenuator. The path loss was compensated to the results for each measurement.
3. Set to the maximum power setting and enable the EUT transmit continuously.
4. Make the measurement with the spectrum analyzer's resolution bandwidth (RBW) = 3 kHz. Video bandwidth VBW = 10 kHz In order to make an accurate measurement, set the span to 1.5 times DTS Channel Bandwidth. (6dB BW)
5. Detector = peak, Sweep time = auto couple, Trace mode = max hold, Allow trace to fully stabilize. Use the peak marker function to determine the maximum power level.
6. Measure and record the results in the test report.

3.3.4 Test Setup





3.3.5 Test Result of Power Spectral Density

Please refer to Appendix A.

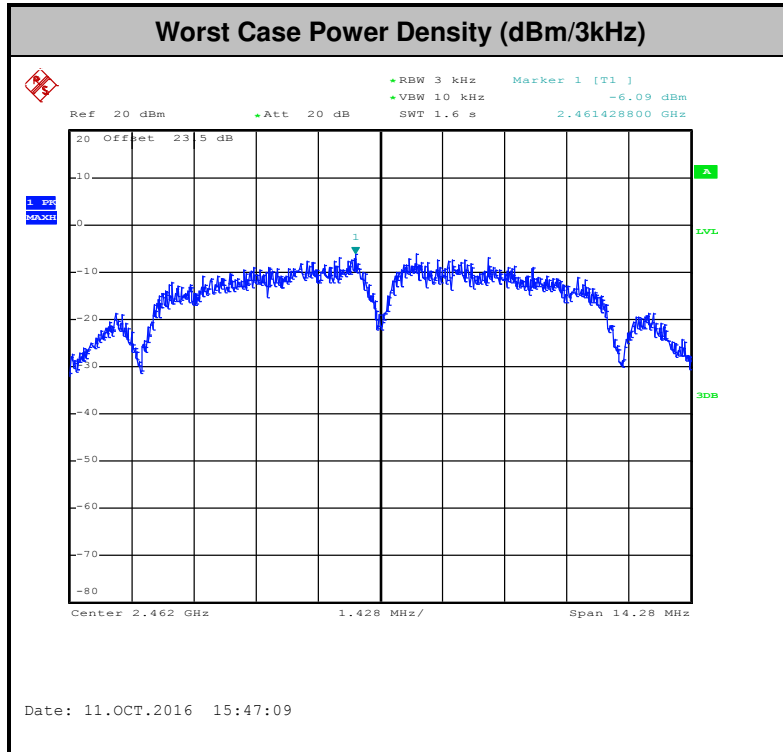

3.4 Conducted Band Edges and Spurious Emission Measurement

3.4.1 Limit of Conducted Band Edges and Spurious Emission Measurement

In any 100 kHz bandwidth outside of the authorized frequency band, the emissions which fall in the non-restricted bands shall be attenuated at least 20 dB / 30dB relative to the maximum PSD level in 100 kHz by RF conducted measurement and radiated emissions which fall in the restricted bands, as defined in Section 15.205(a), must also comply with the radiated emission limits specified in Section 15.209(a).

3.4.2 Measuring Instruments

The measuring equipment is listed in the section 4 of this test report.

3.4.3 Test Procedures

1. The testing follows FCC KDB Publication No. 558074 D01 DTS Meas. Guidance v03r05.
2. The RF output of EUT was connected to the spectrum analyzer by RF cable and attenuator. The path loss was compensated to the results for each measurement.
3. Set to the maximum power setting and enable the EUT transmit continuously.
4. Set RBW = 100 kHz, VBW=300 kHz, Peak Detector. Unwanted Emissions measured in any 100 kHz bandwidth outside of the authorized frequency band shall be attenuated by at least 20 dB relative to the maximum in-band peak PSD level in 100 kHz when maximum peak conducted output power procedure is used. If the transmitter complies with the conducted power limits based on the use of RMS averaging over a time interval, the attenuation required under this paragraph shall be 30 dB instead of 20 dB per 15.247(d).
5. Measure and record the results in the test report.
6. The RF fundamental frequency should be excluded against the limit line in the operating frequency band.

3.4.4 Test Setup

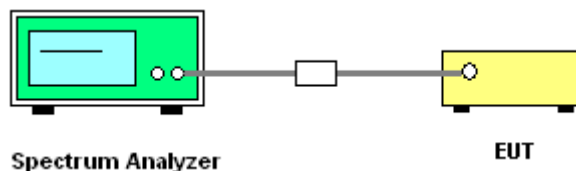



3.4.5 Test Result of Conducted Band Edges and Spurious Emission

Test Mode :	802.11b	Temperature :	21~25°C
Test Band :	2.4GHz Low	Relative Humidity :	51~54%
Test Channel :	01	Test Engineer :	Tommy Lee

WLAN 802.11b Channel 01

100kHz PSD reference Level	Low Channel Plot
-----------------------------------	-------------------------

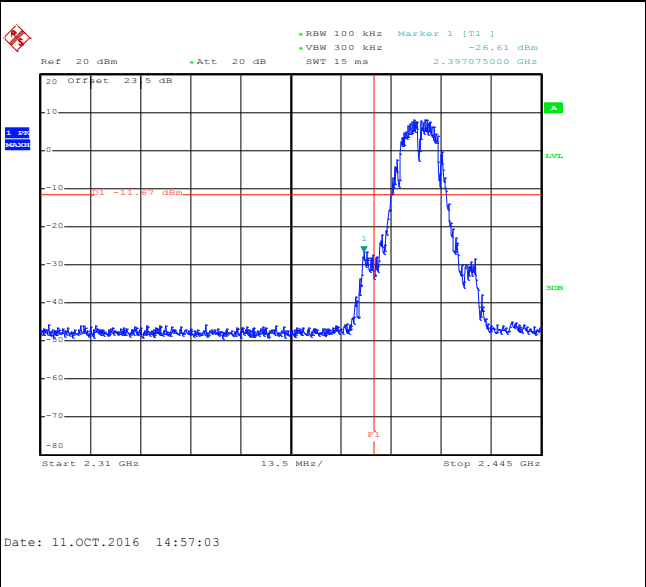
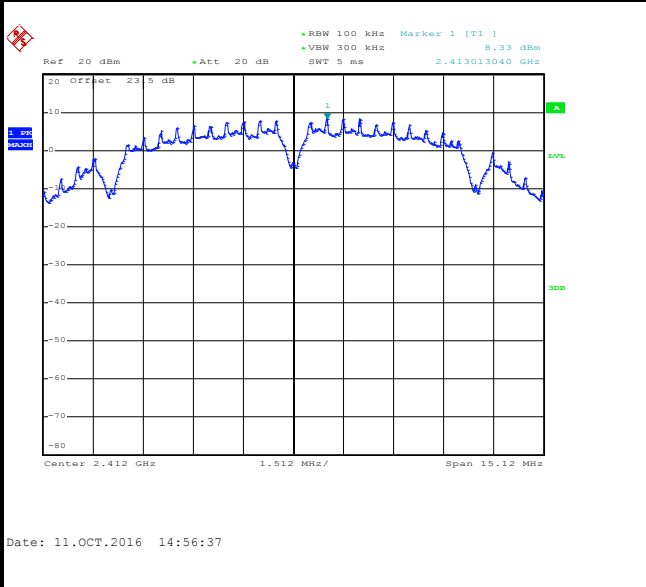

Spurious Emission 30MHz~3GHz

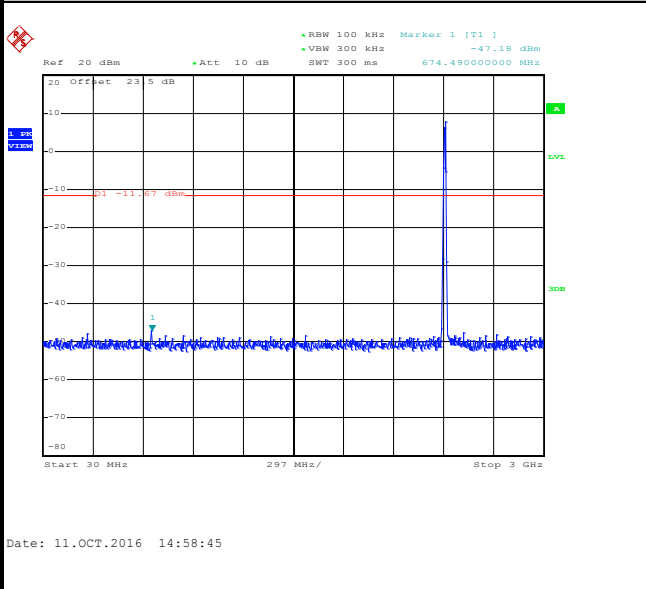

Spurious Emission 2GHz~25GHz

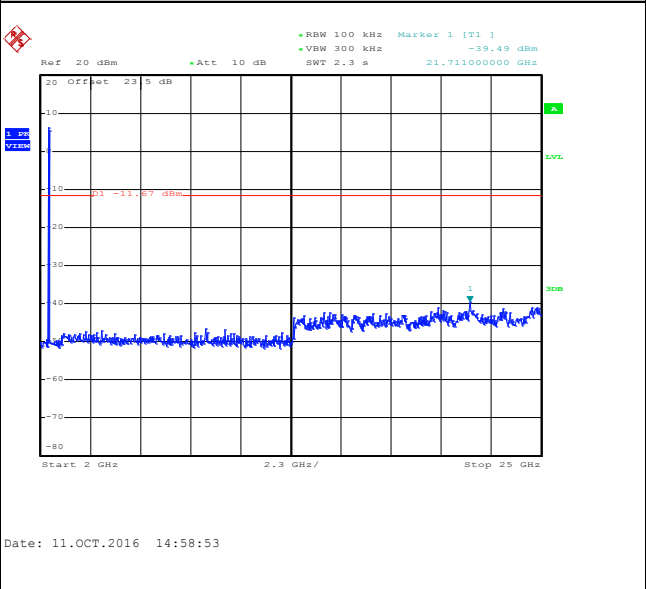



Test Mode :	802.11b	Temperature :	21~25
Test Band :	2.4GHz Mid	Relative Humidity :	51~54
Test Channel :	06	Test Engineer :	Tommy Lee

WLAN 802.11b Channel 06

100kHz PSD reference Level

Mid Channel Plot

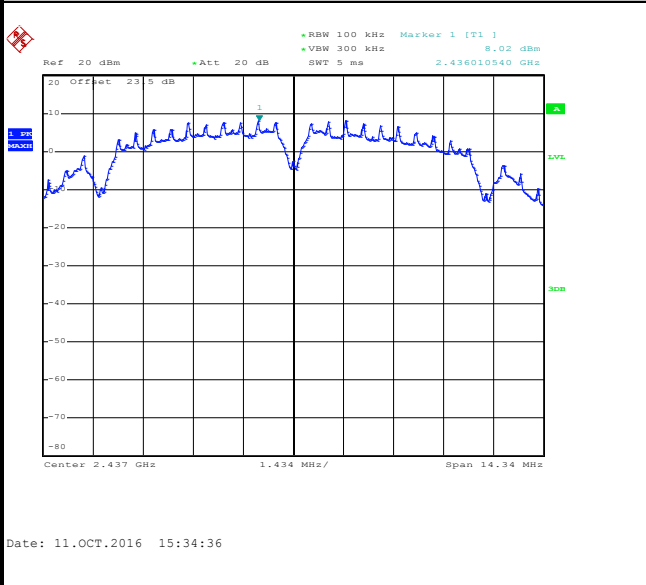

Spurious Emission 30MHz~3GHz

Spurious Emission 2GHz~25GHz

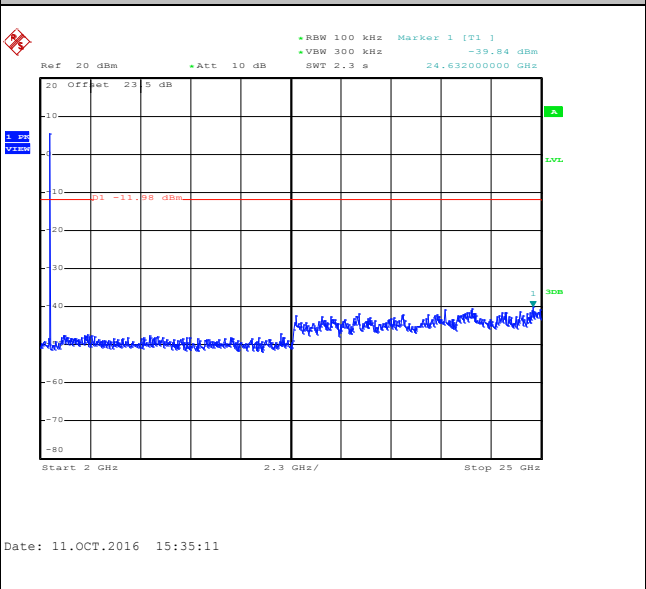
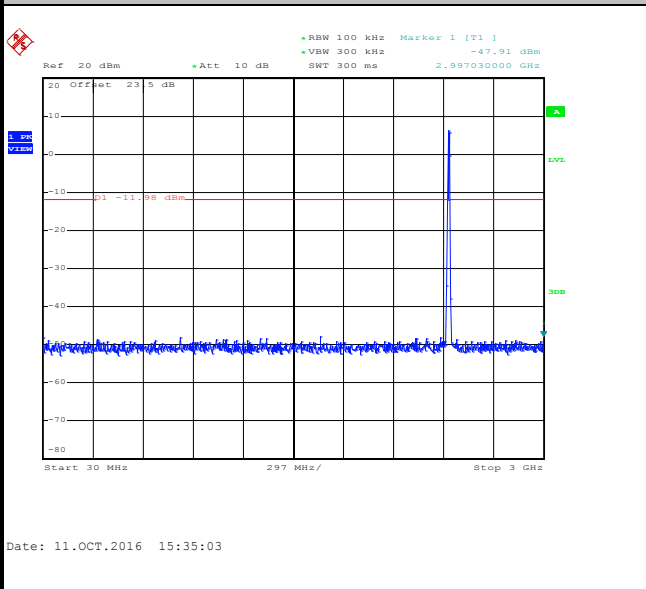



Test Mode :	802.11b	Temperature :	21~25
Test Band :	2.4GHz High	Relative Humidity :	51~54
Test Channel :	11	Test Engineer :	Tommy Lee

WLAN 802.11b Channel 11

100kHz PSD reference Level

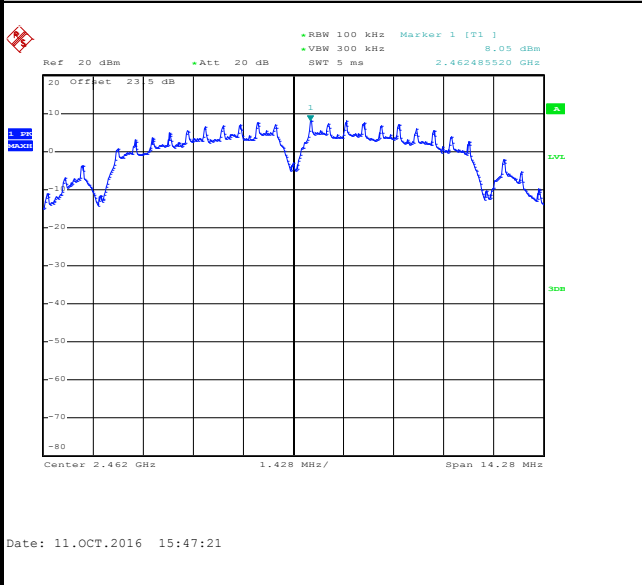

High Channel Plot

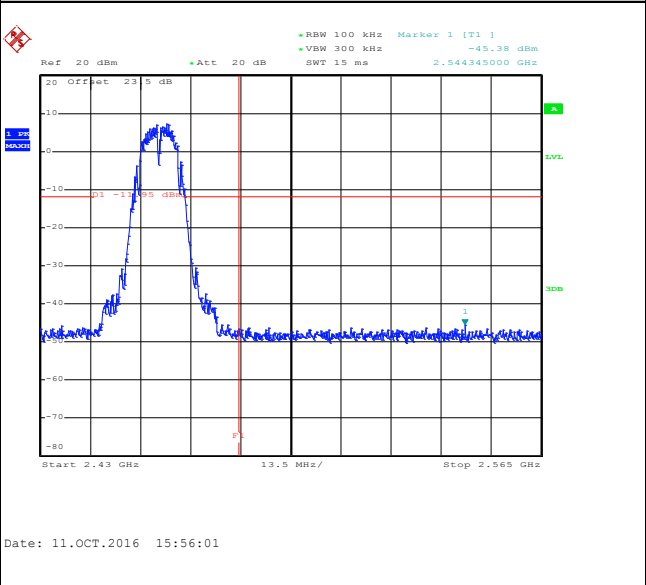

Spurious Emission 30MHz~3GHz

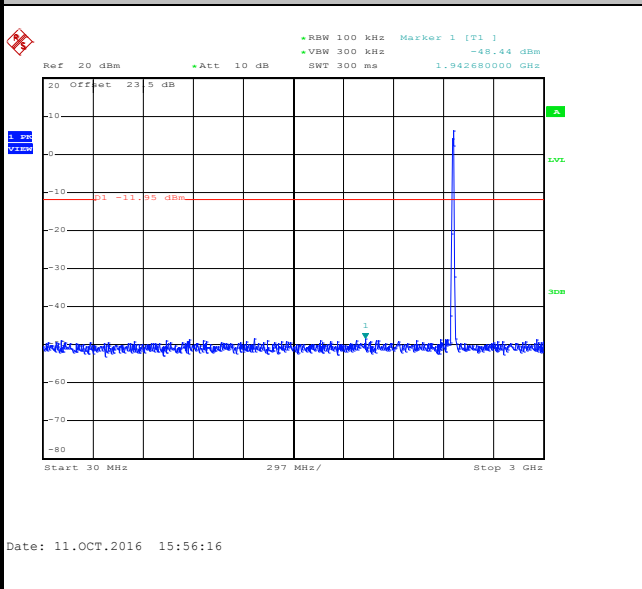

Spurious Emission 2GHz~25GHz

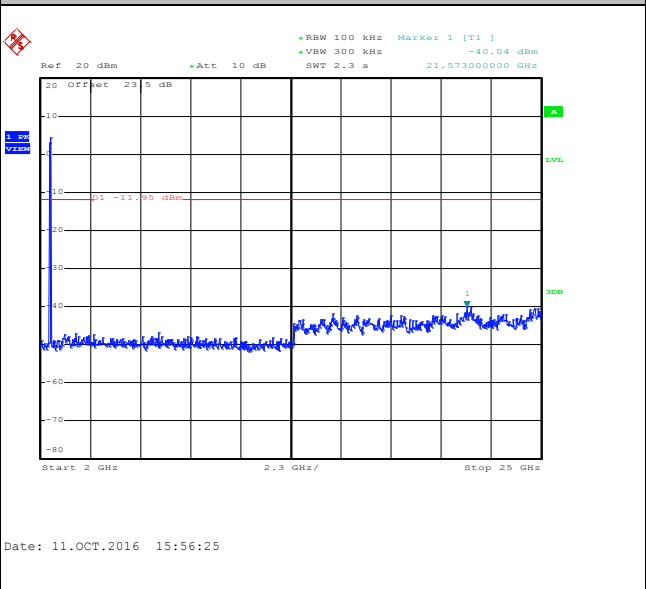



Test Mode :	802.11g	Temperature :	21~25
Test Band :	2.4GHz Low	Relative Humidity :	51~54
Test Channel :	01	Test Engineer :	Tommy Lee

WLAN 802.11g Channel 01

100kHz PSD reference Level

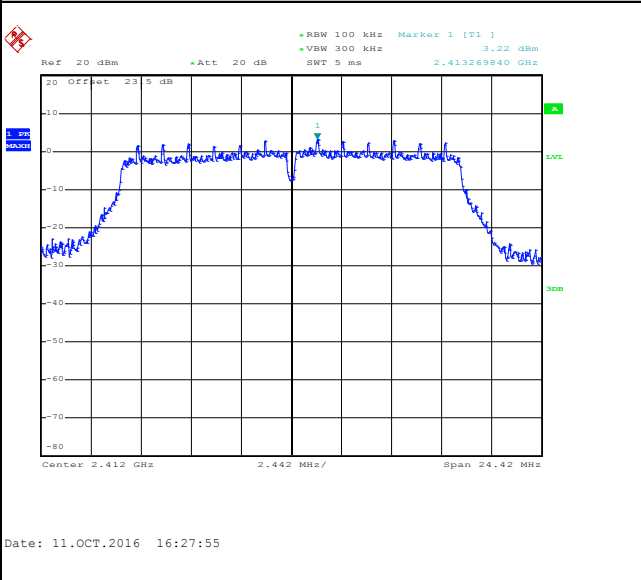

Low Channel Plot

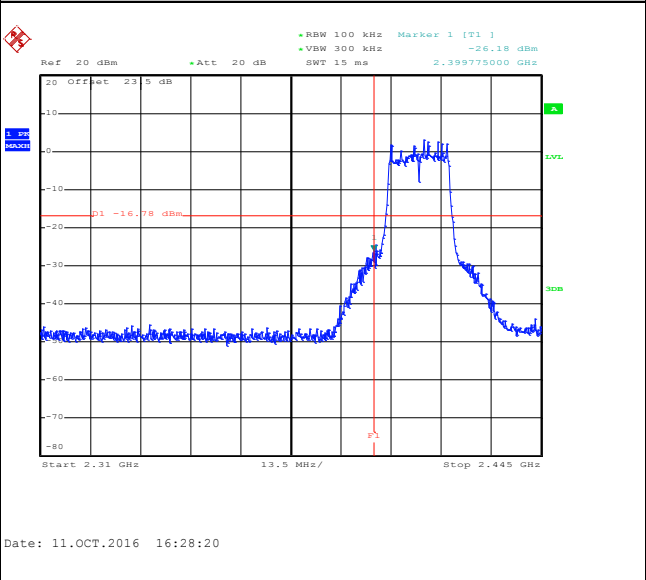

Spurious Emission 30MHz~3GHz

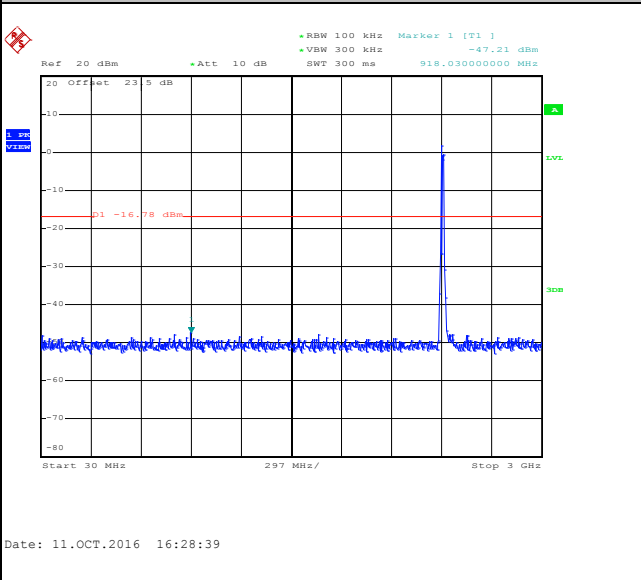

Spurious Emission 2GHz~25GHz

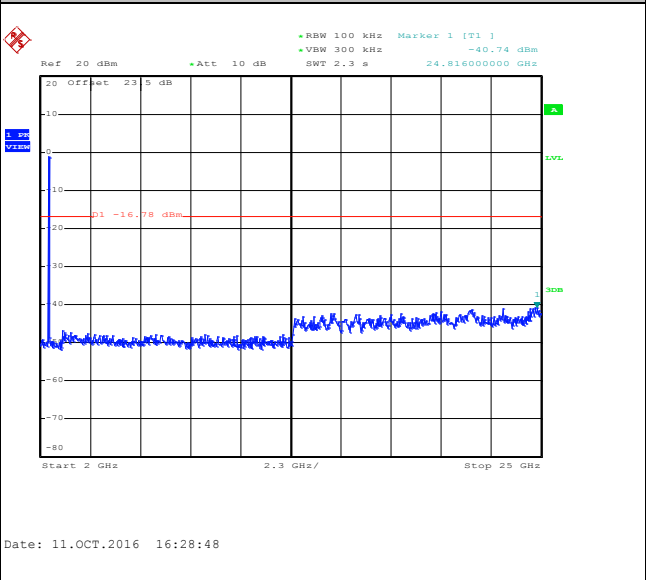



Test Mode :	802.11g	Temperature :	21~25
Test Band :	2.4GHz Mid	Relative Humidity :	51~54
Test Channel :	06	Test Engineer :	Tommy Lee

WLAN 802.11g Channel 06

100kHz PSD reference Level

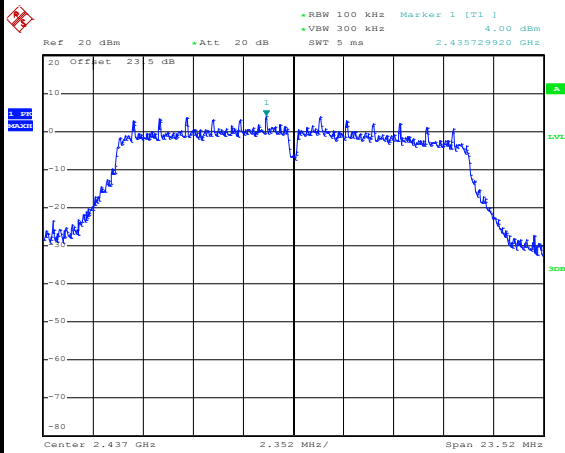

Date: 11.OCT.2016 16:37:51

Mid Channel Plot

Spurious Emission 30MHz~3GHz

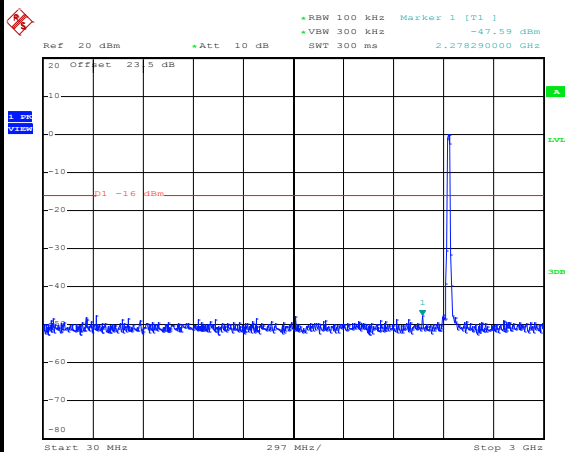

Date: 11.OCT.2016 16:38:07

Spurious Emission 2GHz~25GHz

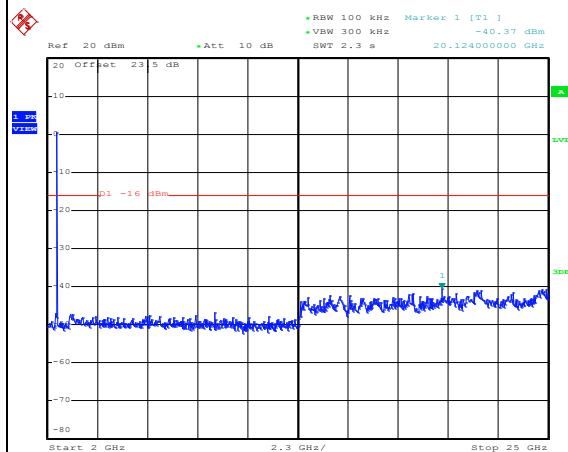

Date: 11.OCT.2016 16:38:16



Test Mode :	802.11g	Temperature :	21~25
Test Band :	2.4GHz High	Relative Humidity :	51~54
Test Channel :	11	Test Engineer :	Tommy Lee

WLAN 802.11g Channel 11

100kHz PSD reference Level

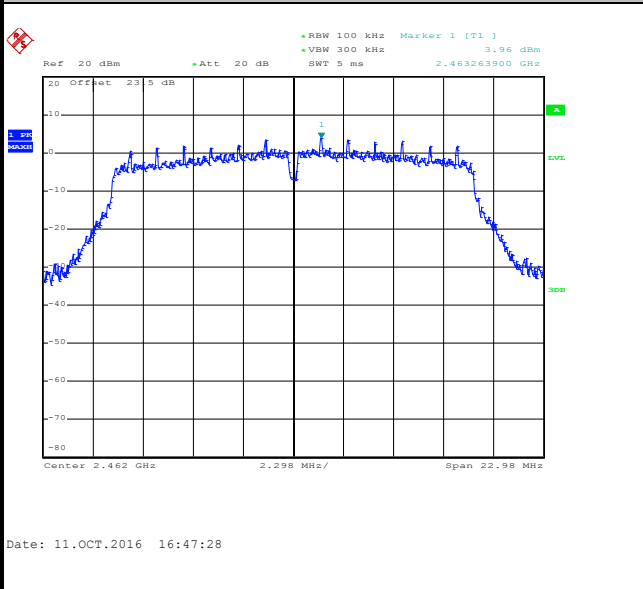

High Channel Plot

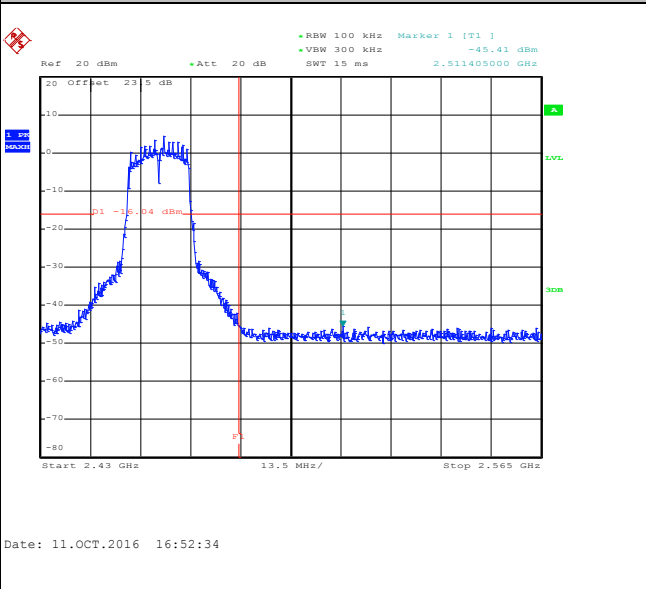

Spurious Emission 30MHz~3GHz

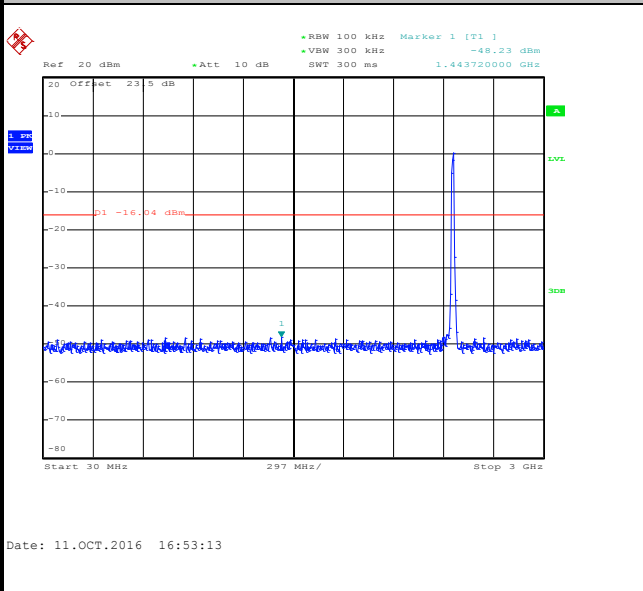

Spurious Emission 2GHz~25GHz

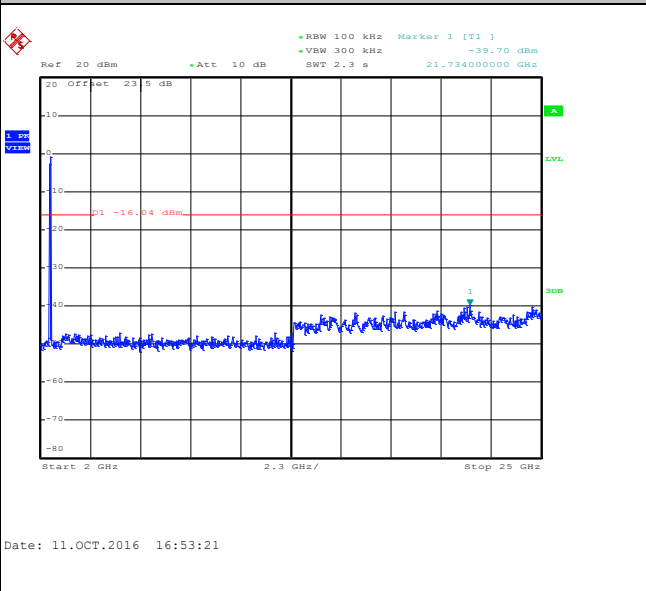



Test Mode :	802.11n HT20	Temperature :	21~25
Test Band :	2.4GHz Low	Relative Humidity :	51~54
Test Channel :	01	Test Engineer :	Tommy Lee

WLAN 802.11n HT20 Channel 01

100kHz PSD reference Level

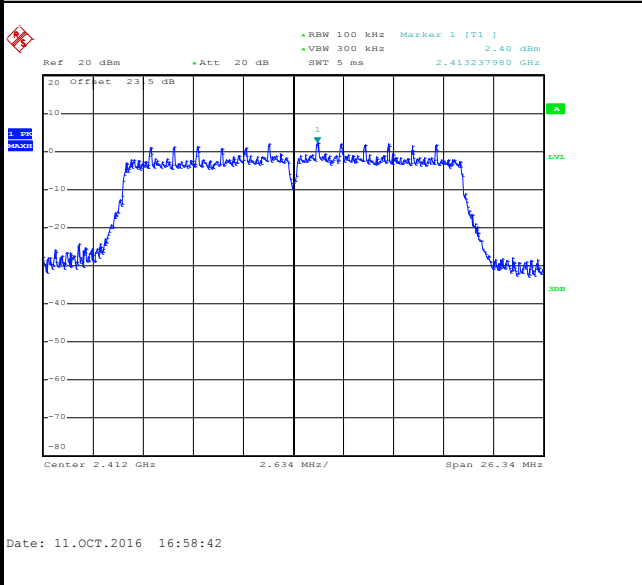

Low Channel Plot

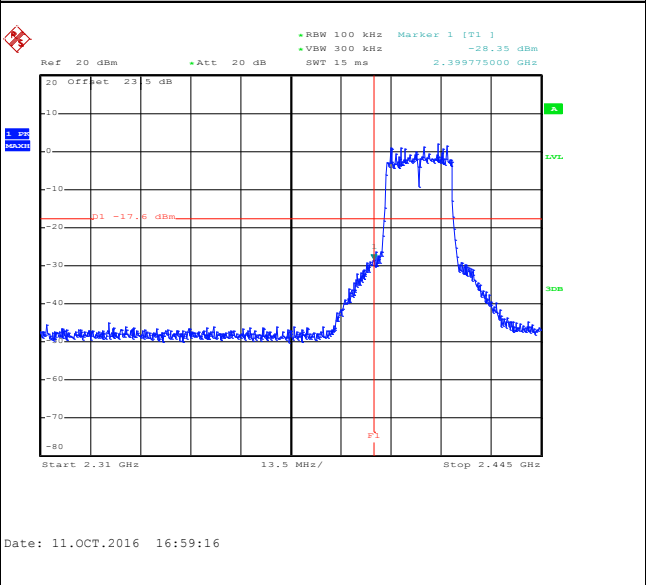

Spurious Emission 30MHz~3GHz

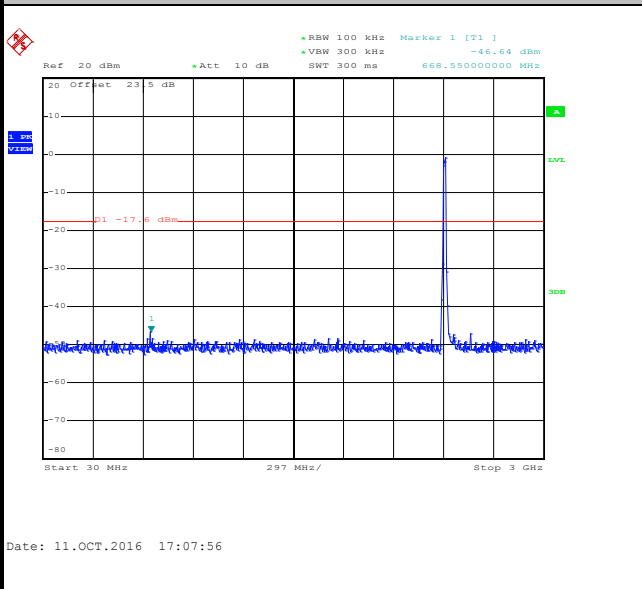

Spurious Emission 2GHz~25GHz

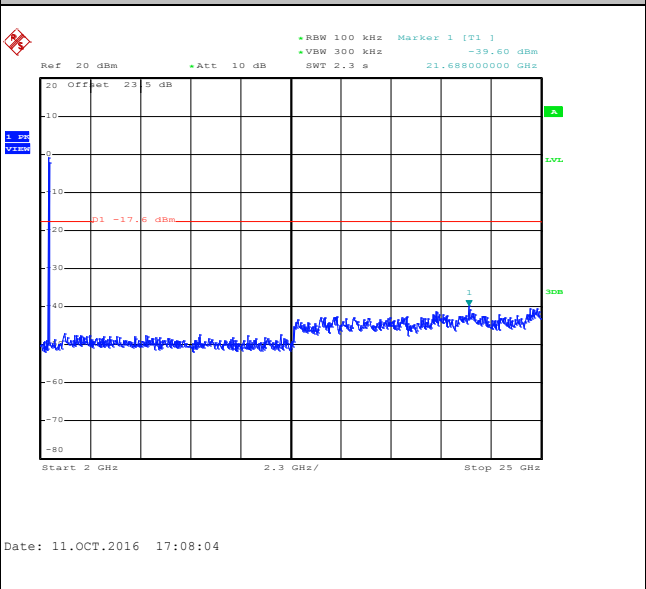



Test Mode :	802.11n HT20	Temperature :	21~25
Test Band :	2.4GHz Mid	Relative Humidity :	51~54
Test Channel :	06	Test Engineer :	Tommy Lee

WLAN 802.11n HT20 Channel 06

100kHz PSD reference Level

Mid Channel Plot

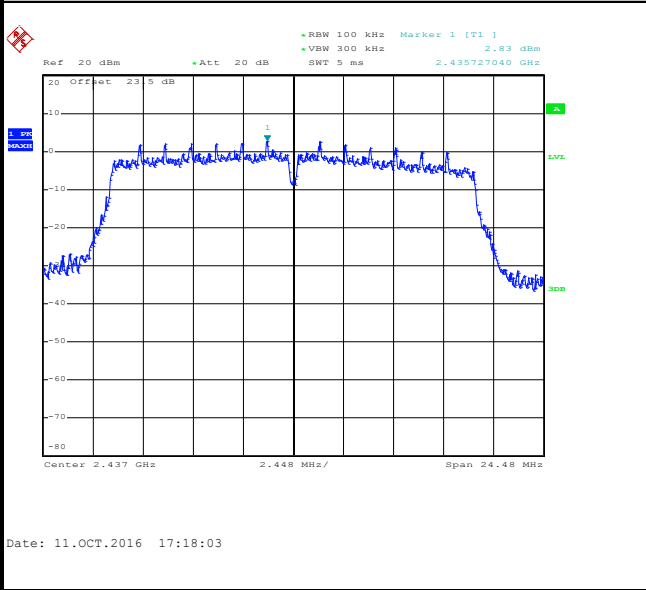

Spurious Emission 30MHz~3GHz

Spurious Emission 2GHz~25GHz

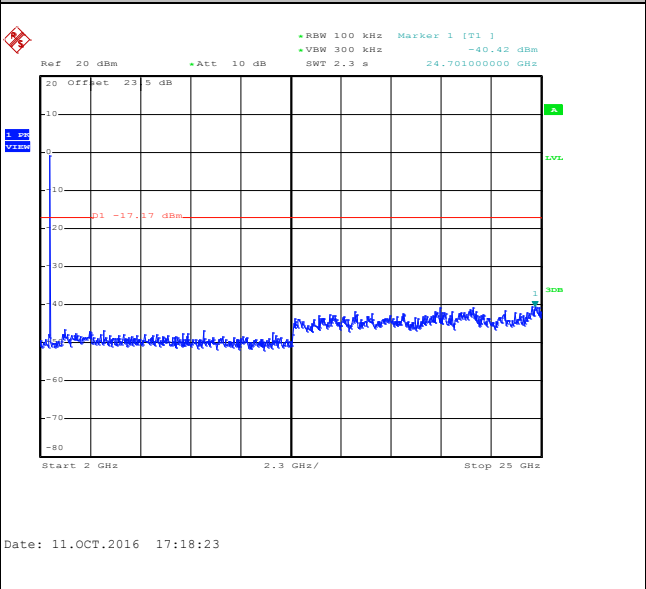
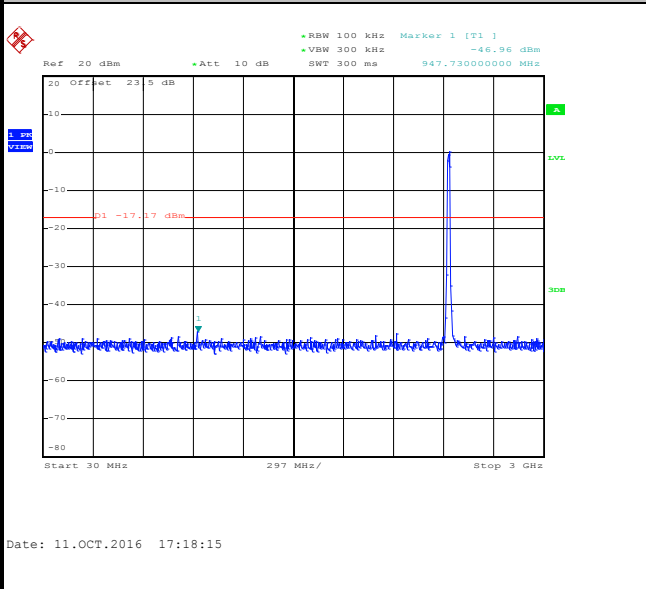



Test Mode :	802.11n HT20	Temperature :	21~25
Test Band :	2.4GHz High	Relative Humidity :	51~54
Test Channel :	11	Test Engineer :	Tommy Lee

WLAN 802.11n HT20 Channel 11

100kHz PSD reference Level

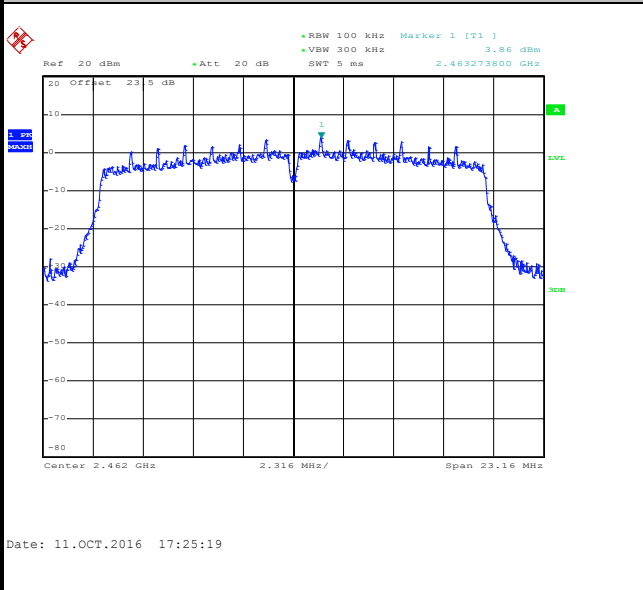

High Channel Plot

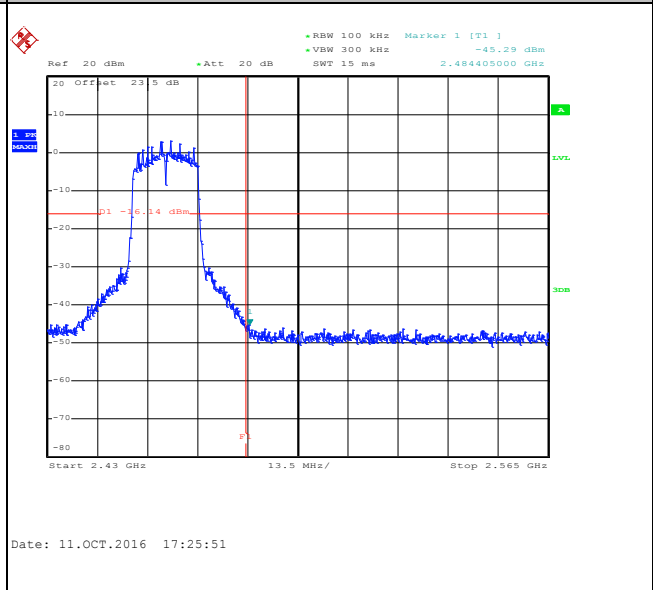

Spurious Emission 30MHz~3GHz

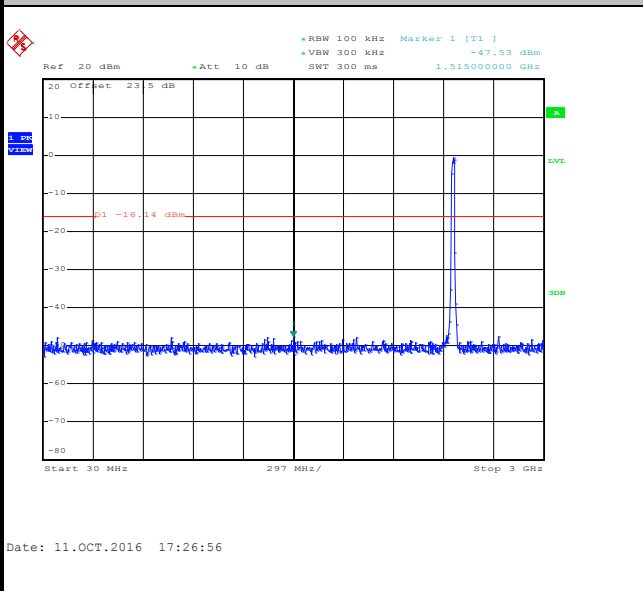

Spurious Emission 2GHz~25GHz

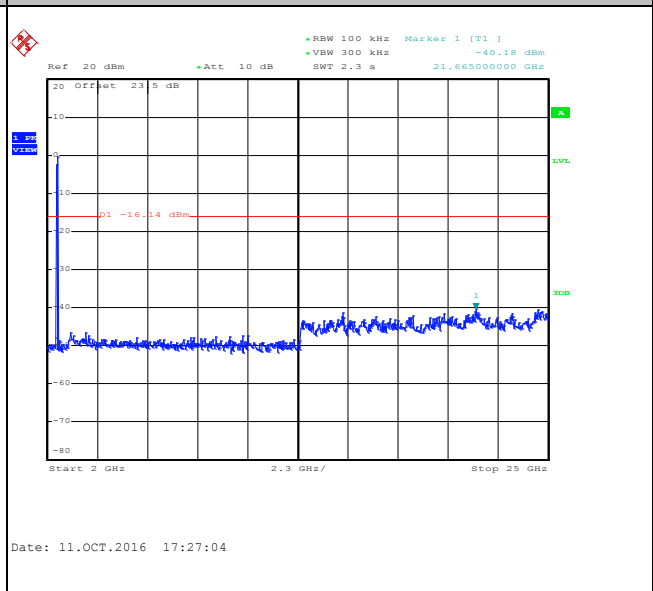



3.5 Radiated Band Edges and Spurious Emission Measurement

3.5.1 Limit of Radiated band edge and Spurious Emission Measurement

In any 100 kHz bandwidth outside the intentional radiator frequency band, all harmonics/spurious must be at least 20 dB below the highest emission level within the authorized band. If the output power of this device was measured by spectrum analyzer, the attenuation under this paragraph shall be 30 dB instead of 20 dB. In addition, radiated emissions which fall in the restricted bands must also comply with the FCC section 15.209 limits as below.

Frequency (MHz)	Field Strength (microvolts/meter)	Measurement Distance (meters)
0.009 – 0.490	2400/F(kHz)	300
0.490 – 1.705	24000/F(kHz)	30
1.705 – 30.0	30	30
30 – 88	100	3
88 – 216	150	3
216 - 960	200	3
Above 960	500	3

3.5.2 Measuring Instruments

The measuring equipment is listed in the section 4 of this test report.



3.5.3 Test Procedures

1. The testing follows FCC KDB Publication No. 558074 D01 DTS Meas. Guidance v03r05.
2. The EUT was arranged to its worst case and then tune the antenna tower (from 1 m to 4 m) and turntable (from 0 degree to 360 degrees) to find the maximum reading. A pre-amp and a high pass filter are used for the test in order to get better signal level.
3. The EUT was placed on a turntable with 0.8 meter for frequency below 1GHz and 1.5 meter for frequency above 1GHz respectively above ground.
4. The EUT was set 3 meters from the interference receiving antenna, which was mounted on the top of a variable height antenna tower.
5. Corrected Reading: Antenna Factor + Cable Loss + Read Level - Preamp Factor = Level
6. For measurement below 1GHz, If the emission level of the EUT measured by the peak detector is 3 dB lower than the applicable limit, the peak emission level will be reported. Otherwise, the emission measurement will be repeated using the quasi-peak detector and reported.
7. Use the following spectrum analyzer settings:
 - (1) Span shall wide enough to fully capture the emission being measured;
 - (2) Set RBW=100 kHz for $f < 1$ GHz; VBW \geq RBW; Sweep = auto; Detector function = peak; Trace = max hold;
 - (3) Set RBW = 1 MHz, VBW= 3MHz for $f \geq 1$ GHz for peak measurement.
For average measurement:
 - VBW = 10 Hz, when duty cycle is no less than 98 percent.
 - VBW $\geq 1/T$, when duty cycle is less than 98 percent where T is the minimum transmission duration over which the transmitter is on and is transmitting at its maximum power control level for the tested mode of operation.

3.5.4 Test Setup

For radiated emissions below 30MHz

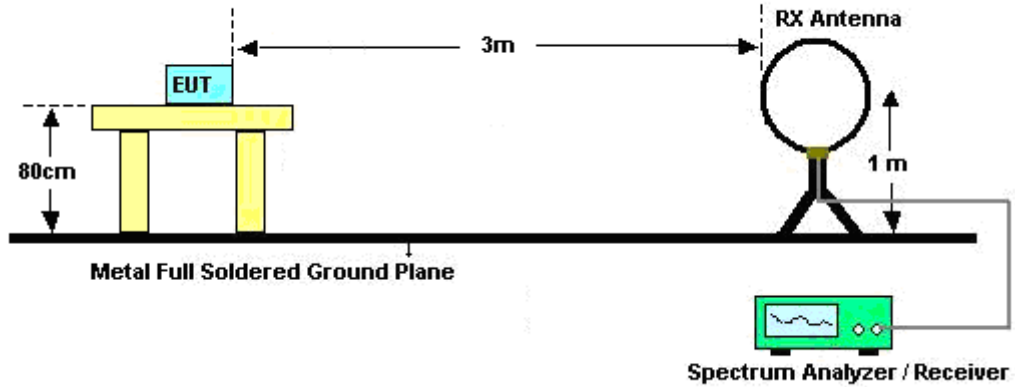

For radiated emissions from 30MHz to 1GHz

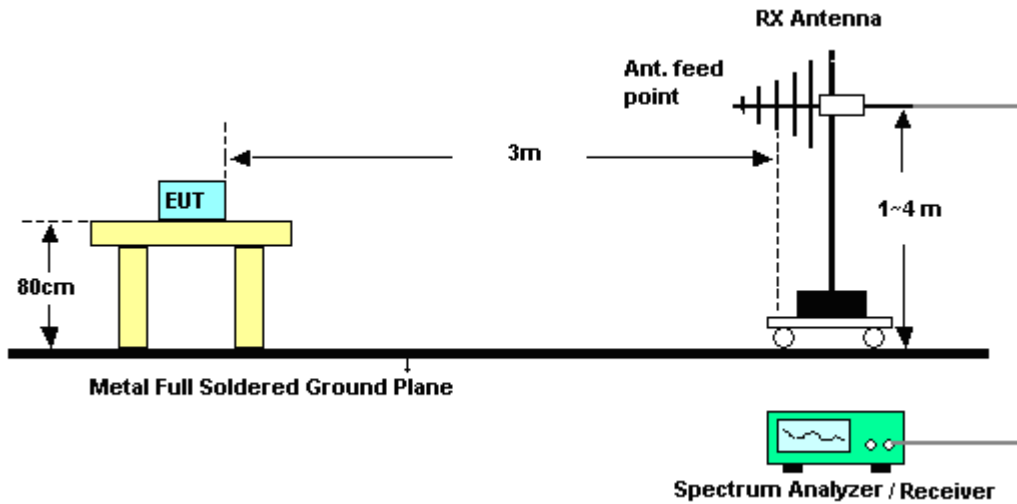

For radiated emissions above 1GHz

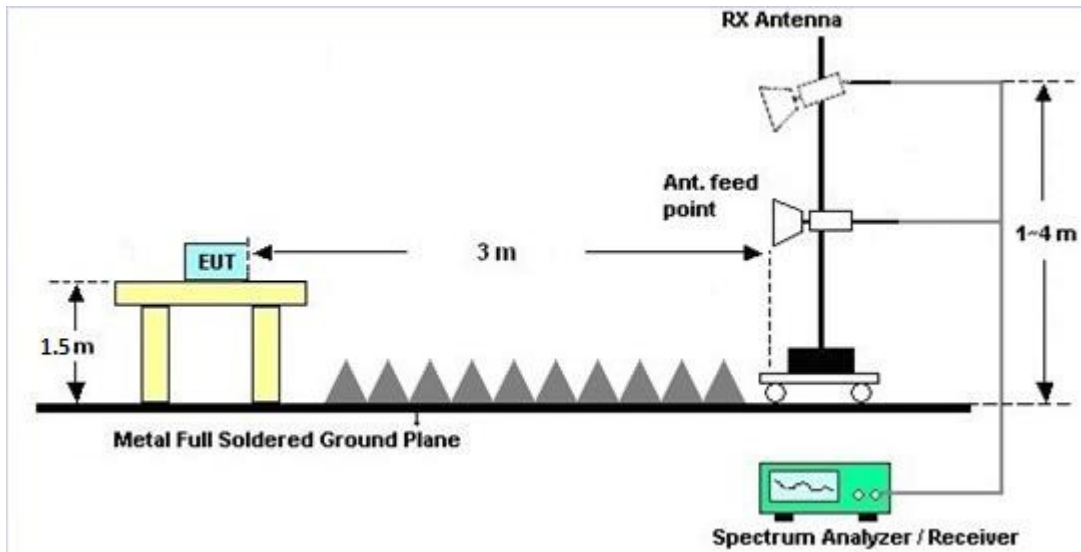

3.5.5 Test Results of Radiated Spurious Emissions (9kHz ~ 30MHz)

The low frequency, which started from 9 kHz to 30MHz, was pre-scanned and the result which was 20dB lower than the limit line per 15.31(o) was not reported.

3.5.6 Test Result of Radiated Spurious at Band Edges

Please refer to Appendix B and C.

3.5.7 Duty Cycle

Please refer to Appendix D.

3.5.8 Test Result of Radiated Spurious Emission (30MHz ~ 10th Harmonic)

Please refer to Appendix B and C.



3.6 AC Conducted Emission Measurement

3.6.1 Limit of AC Conducted Emission

For equipment that is designed to be connected to the public utility (AC) power line, the radio frequency voltage that is conducted back onto the AC power line on any frequency or frequencies within the band 150 kHz to 30 MHz shall not exceed the limits in the following table.

Frequency of Emission (MHz)	Conducted Limit (dBµV)	
	Quasi-Peak	Average
0.15-0.5	66 to 56*	56 to 46*
0.5-5	56	46
5-30	60	50

*Decreases with the logarithm of the frequency.

3.6.2 Measuring Instruments

The measuring equipment is listed in the section 4 of this test report.

3.6.3 Test Procedures

1. The EUT was placed 0.4 meter from the conducting wall of the shielding room, and it was kept at least 80 centimeters from any other grounded conducting surface.
2. Connect EUT to the power mains through a line impedance stabilization network (LISN).
3. All the support units are connecting to the other LISN.
4. The LISN provides 50 ohm coupling impedance for the measuring instrument.
5. The FCC states that a 50 ohm, 50 microhenry LISN should be used.
6. Both sides of AC line were checked for maximum conducted interference.
7. The frequency range from 150 kHz to 30 MHz was searched.
8. Set the test-receiver system to Peak Detect Function and specified bandwidth (IF bandwidth = 9kHz) with Maximum Hold Mode.

3.6.4 Test Setup

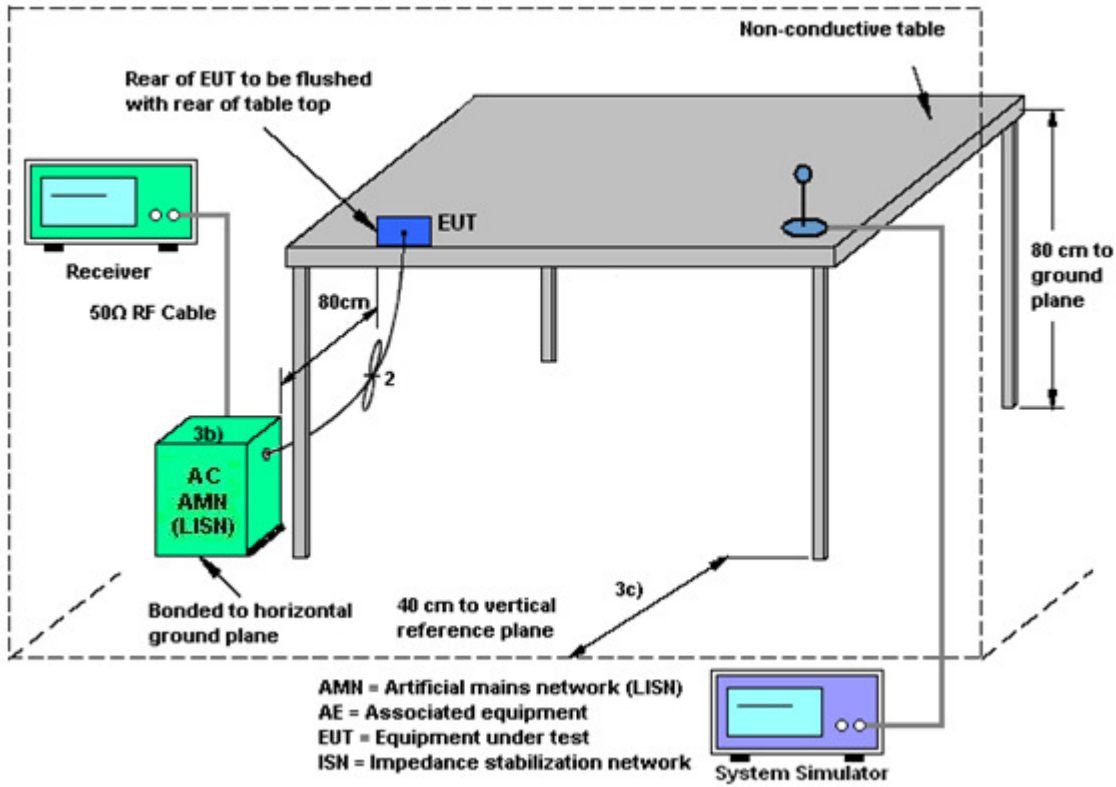

3.6.5 Test Result of AC Conducted Emission

Test Mode :	Mode 1	Temperature :	21~23°C
Test Engineer :	Arthur Hsieh	Relative Humidity :	51~53%
Test Voltage :	120Vac / 60Hz	Phase :	Line
Function Type :	GSM1900 Idle + Bluetooth Link + WLAN (2.4GHz) Link + MP3 + Earphone 1 + Battery + USB Cable (Charging from Adapter 1)		

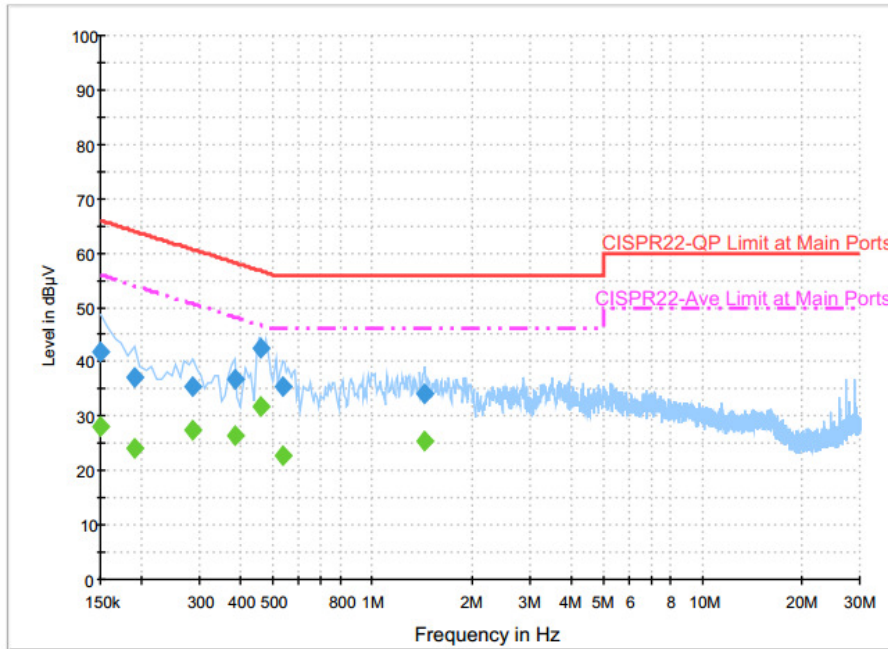

Final Result : Quasi-Peak

Frequency (MHz)	Quasi-Peak (dBµV)	Filter	Line	Corr. (dB)	Margin (dB)	Limit (dBµV)
0.150000	41.9	Off	L1	19.6	24.1	66.0
0.190000	37.0	Off	L1	19.6	27.0	64.0
0.286000	35.4	Off	L1	19.6	25.2	60.6
0.382000	36.7	Off	L1	19.6	21.5	58.2
0.462000	42.6	Off	L1	19.6	14.1	56.7
0.534000	35.5	Off	L1	19.6	20.5	56.0
1.446000	34.0	Off	L1	19.7	22.0	56.0

Final Result : Average

Frequency (MHz)	Average (dBµV)	Filter	Line	Corr. (dB)	Margin (dB)	Limit (dBµV)
0.150000	28.1	Off	L1	19.6	27.9	56.0
0.190000	24.1	Off	L1	19.6	29.9	54.0
0.286000	27.3	Off	L1	19.6	23.3	50.6
0.382000	26.3	Off	L1	19.6	21.9	48.2
0.462000	31.8	Off	L1	19.6	14.9	46.7
0.534000	22.7	Off	L1	19.6	23.3	46.0
1.446000	25.5	Off	L1	19.7	20.5	46.0



Test Mode :	Mode 1	Temperature :	21~23°C
Test Engineer :	Arthur Hsieh	Relative Humidity :	51~53%
Test Voltage :	120Vac / 60Hz	Phase :	Neutral
Function Type :	GSM1900 Idle + Bluetooth Link + WLAN (2.4GHz) Link + MP3 + Earphone 1 + Battery + USB Cable (Charging from Adapter 1)		

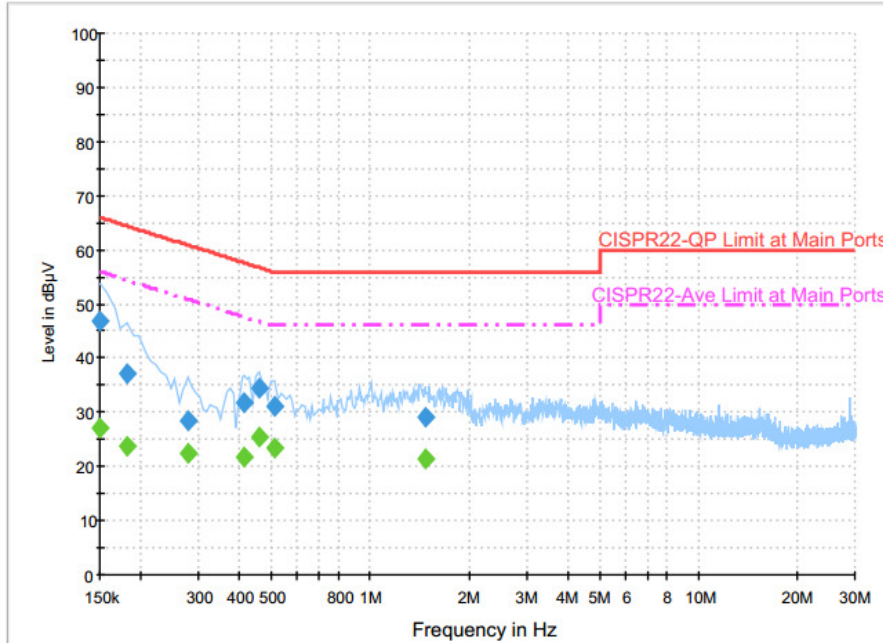

Final Result : Quasi-Peak

Frequency (MHz)	Quasi-Peak (dBµV)	Filter	Line	Corr. (dB)	Margin (dB)	Limit (dBµV)
0.150000	46.9	Off	N	19.6	19.1	66.0
0.182000	37.0	Off	N	19.6	27.4	64.4
0.278000	28.3	Off	N	19.6	32.6	60.9
0.414000	31.8	Off	N	19.6	25.8	57.6
0.462000	34.3	Off	N	19.6	22.4	56.7
0.510000	31.2	Off	N	19.6	24.8	56.0
1.470000	29.1	Off	N	19.6	26.9	56.0

Final Result : Average

Frequency (MHz)	Average (dBµV)	Filter	Line	Corr. (dB)	Margin (dB)	Limit (dBµV)
0.150000	27.2	Off	N	19.6	28.8	56.0
0.182000	23.6	Off	N	19.6	30.8	54.4
0.278000	22.3	Off	N	19.6	28.6	50.9
0.414000	21.8	Off	N	19.6	25.8	47.6
0.462000	25.5	Off	N	19.6	21.2	46.7
0.510000	23.4	Off	N	19.6	22.6	46.0
1.470000	21.3	Off	N	19.6	24.7	46.0



3.7 Antenna Requirements

3.7.1 Standard Applicable

If directional gain of transmitting antennas is greater than 6dBi, the power shall be reduced by the same level in dB comparing to gain minus 6dBi. For the fixed point-to-point operation, the power shall be reduced by one dB for every 3 dB that the directional gain of the antenna exceeds 6 dBi. The use of a permanently attached antenna or of an antenna that uses a unique coupling to the intentional radiator shall be considered sufficient to comply with the FCC rule.

3.7.2 Antenna Anti-Replacement Construction

An embedded-in antenna design is used.

3.7.3 Antenna Gain

The antenna peak gain of EUT is less than 6 dBi. Therefore, it is not necessary to reduce maximum peak output power limit.



4 List of Measuring Equipment

Instrument	Manufacturer	Model No.	Serial No.	Characteristics	Calibration Date	Test Date	Due Date	Remark
Spectrum Analyzer	Rohde & Schwarz	FSP40	100057	9kHz-40GHz	Nov. 23, 2015	Oct. 06, 2016 ~ Nov. 02, 2016	Nov. 22, 2016	Conducted (TH05-HY)
Power Meter	Anritsu	ML2495A	1240001	300MHz~40GHz	Sep. 07, 2016	Oct. 06, 2016 ~ Nov. 02, 2016	Sep. 06, 2017	Conducted (TH05-HY)
Power Sensor	Anritsu	MA2411B	1207349	300MHz~40GHz	Sep. 07, 2016	Oct. 06, 2016 ~ Nov. 02, 2016	Sep. 06, 2017	Conducted (TH05-HY)
Hygrometer	Testo	608-H2	41410069	N/A	Aug. 28, 2016	Oct. 06, 2016 ~ Nov. 02, 2016	Aug. 27, 2017	Conducted (TH05-HY)
RF Cable	HUBER + SUHNER	SUCOFLEX 104	MY842095 21	1GHz~26GHz	Dec. 03, 2015	Oct. 06, 2016 ~ Nov. 02, 2016	Dec. 02, 2016	Conducted (TH05-HY)
AC Power Source	ChainTek	APC-1000W	N/A	N/A	N/A	Oct. 11, 2016	N/A	Conduction (CO05-HY)
EMI Test Receiver	Rohde & Schwarz	ESCI 7	100724	9kHz~7GHz	Aug. 30, 2016	Oct. 11, 2016	Aug. 29, 2017	Conduction (CO05-HY)
Hygrometer	Testo	608-H1	34913912	N/A	Apr. 19, 2016	Oct. 11, 2016	Apr. 18, 2017	Conduction (CO05-HY)
LISN	Rohde & Schwarz	ENV216	100080	9kHz~30MHz	Dec. 02, 2015	Oct. 11, 2016	Dec. 01, 2016	Conduction (CO05-HY)
LF Cable	HUBER + SUHNER	RG-214/U	LF01	N/A	Jan. 06, 2016	Oct. 11, 2016	Jan. 05, 2017	Conduction (CO05-HY)
Test Software	N/A	EMC32	8.40.0	N/A	N/A	Oct. 11, 2016	N/A	Conduction (CO05-HY)
Loop Antenna	Rohde & Schwarz	HFH2-Z2	100315	9 kHz~30 MHz	Sep. 02, 2015	Oct. 06, 2016 ~ Oct. 11, 2016	Sep. 01, 2017	Radiation (03CH12-HY)
Amplifier	SONOMA	310N	187312	9kHz~1GHz	Nov. 20, 2015	Oct. 06, 2016 ~ Oct. 11, 2016	Nov. 19, 2016	Radiation (03CH12-HY)
Bilog Antenna	TESEQ	CBL 6111D&N-6-06	35414&AT-N0602	30MHz~1GHz	Nov. 17, 2015	Oct. 06, 2016 ~ Oct. 11, 2016	Nov. 16, 2016	Radiation (03CH12-HY)
Horn Antenna	SCHWARZBECK	BBHA 9120D	9120D-1328	1GHz ~ 18GHz	Nov. 02, 2015	Oct. 06, 2016 ~ Oct. 11, 2016	Nov. 01, 2016	Radiation (03CH12-HY)
SHF-EHF Horn Antenna	SCHWARZBECK	BBHA 9170	BBHA9170576	18GHz ~ 40GHz	Apr. 15, 2016	Oct. 06, 2016 ~ Oct. 11, 2016	Apr. 14, 2017	Radiation (03CH12-HY)
EMI Test Receiver	Rohde & Schwarz	ESU26	100390	20Hz~26.5GHz	Dec. 21, 2015	Oct. 06, 2016 ~ Oct. 11, 2016	Dec. 20, 2016	Radiation (03CH12-HY)
Spectrum Analyzer	Agilent	N9030A	MY52350276	3Hz~44GHz	Mar. 21, 2016	Oct. 06, 2016 ~ Oct. 11, 2016	Mar. 20, 2017	Radiation (03CH12-HY)
Preamplifier	MITEQ	TTA0204	1872107	2GHz~40GHz	Feb. 15, 2016	Oct. 06, 2016 ~ Oct. 11, 2016	Feb. 14, 2017	Radiation (03CH12-HY)
Preamplifier	MITEQ	AMF-7D-0010 1800-30-10P	1815698	1GHz~18GHz	Dec. 14, 2015	Oct. 06, 2016 ~ Oct. 11, 2016	Dec. 13, 2016	Radiation (03CH12-HY)
Preamplifier	Keysight	83017A	MY53270148	1GHz~26.5GHz	Jan. 30, 2016	Oct. 06, 2016 ~ Oct. 11, 2016	Jan. 29, 2017	Radiation (03CH12-HY)



Instrument	Manufacturer	Model No.	Serial No.	Characteristics	Calibration Date	Test Date	Due Date	Remark
Hygrometer	TECPEL	DTM-303B	TP140349	N/A	Nov. 17, 2015	Oct. 06, 2016 ~ Oct. 11, 2016	Nov. 16, 2016	Radiation (03CH12-HY)
RF Cable	HUBER + SUHNER	SUCOFLEX 104	MY24958/ 4,MY2865 3/4,MY983 9/4PE	26GHz~40GHz	Jan. 12, 2016	Oct. 06, 2016 ~ Oct. 11, 2016	Jan. 11, 2017	Radiation (03CH12-HY)
RF Cable	HUBER + SUHNER	SUCOFLEX 104	MY24958/ 4,MY2865 3/4,MY983 9/4PE	1GHz~26GHz	Jan. 12, 2016	Oct. 06, 2016 ~ Oct. 11, 2016	Jan. 11, 2017	Radiation (03CH12-HY)
RF Cable	HUBER + SUHNER	SUCOFLEX 104	MY24958/ 4,MY2865 3/4,MY983 9/4PE	30MHz~1GHz	Jan. 12, 2016	Oct. 06, 2016 ~ Oct. 11, 2016	Jan. 11, 2017	Radiation (03CH12-HY)
RF Cable	HUBER + SUHNER	SUCOFLEX 104	MY24958/ 4,MY2865 3/4,MY983 9/4PE	9K~30MHz	Jan. 12, 2016	Oct. 06, 2016 ~ Oct. 11, 2016	Jan. 11, 2017	Radiation (03CH12-HY)
Controller	EMEC	EM1000	N/A	Control Turn table & Ant Mast	N/A	Oct. 06, 2016 ~ Oct. 11, 2016	N/A	Radiation (03CH12-HY)
Antenna Mast	EMEC	AM-BS-4500- B	N/A	1m~4m	N/A	Oct. 06, 2016 ~ Oct. 11, 2016	N/A	Radiation (03CH12-HY)
Turn Table	EMEC	TT2000	N/A	0~360 Degree	N/A	Oct. 06, 2016 ~ Oct. 11, 2016	N/A	Radiation (03CH12-HY)
Test Software	Audix	E3	6.2009-8-2 4	N/A	N/A	Oct. 06, 2016 ~ Oct. 11, 2016	N/A	Radiation (03CH12-HY)
Filter	Wainwright	WLKS1200-8 SS	SN3	1.2G Low Pass	Oct. 28, 2015	Oct. 06, 2016 ~ Oct. 11, 2016	Oct. 27, 2016	Radiation (03CH12-HY)
Filter	Microwave	H3G018G1	SN477220	3.0G High Pass	Oct. 28, 2015	Oct. 06, 2016 ~ Oct. 11, 2016	Oct. 27, 2016	Radiation (03CH12-HY)



5 Uncertainty of Evaluation

Uncertainty of Conducted Emission Measurement (150 kHz ~ 30 MHz)

Measuring Uncertainty for a Level of Confidence of 95% ($U = 2Uc(y)$)	2.70
---	------

Uncertainty of Radiated Emission Measurement (30 MHz ~ 1000 MHz)

Measuring Uncertainty for a Level of Confidence of 95% ($U = 2Uc(y)$)	5.10
---	------

Uncertainty of Radiated Emission Measurement (1000 MHz ~ 18000 MHz)

Measuring Uncertainty for a Level of Confidence of 95% ($U = 2Uc(y)$)	5.20
---	------

Uncertainty of Radiated Emission Measurement (18000 MHz ~ 40000 MHz)

Measuring Uncertainty for a Level of Confidence of 95% ($U = 2Uc(y)$)	4.70
---	------



Appendix A. Conducted Test Results

A1 - DTS Part

Test Engineer:	Tommy Lee	Temperature:	21~25	°C
Test Date:	2016/10/6~11/02	Relative Humidity:	51~54	%

TEST RESULTS DATA
6dB and 99% Occupied Bandwidth

2.4GHz Band								
Mod.	Data Rate	N _{TX}	CH.	Freq. (MHz)	99% Occupied BW (MHz)	6dB BW (MHz)	6dB BW Limit (MHz)	Pass/Fail
11b	1Mbps	1	1	2412	13.45	10.08	0.50	Pass
11b	1Mbps	1	6	2437	12.85	9.56	0.50	Pass
11b	1Mbps	1	11	2462	12.55	9.52	0.50	Pass
11g	6Mbps	1	1	2412	17.90	16.28	0.50	Pass
11g	6Mbps	1	6	2437	17.55	15.68	0.50	Pass
11g	6Mbps	1	11	2462	17.35	15.32	0.50	Pass
HT20	MCS0	1	1	2412	18.50	17.56	0.50	Pass
HT20	MCS0	1	6	2437	18.35	16.32	0.50	Pass
HT20	MCS0	1	11	2462	18.15	15.44	0.50	Pass

TEST RESULTS DATA
Peak Power Table

2.4GHz Band										
Mod.	Data Rate	N _{TX}	CH.	Freq. (MHz)	Peak Conducted Power (dBm)	Conducted Power Limit (dBm)	DG (dBi)	EIRP Power (dBm)	EIRP Power Limit (dBm)	Pass /Fail
11b	1Mbps	1	1	2412	19.23	30.00	-4.70	14.53	36.00	Pass
11b	1Mbps	1	6	2437	19.33	30.00	-4.70	14.63	36.00	Pass
11b	1Mbps	1	11	2462	19.21	30.00	-4.70	14.51	36.00	Pass
11g	6Mbps	1	1	2412	21.62	30.00	-4.70	16.92	36.00	Pass
11g	6Mbps	1	6	2437	22.37	30.00	-4.70	17.67	36.00	Pass
11g	6Mbps	1	11	2462	22.87	30.00	-4.70	18.17	36.00	Pass
HT20	MCS0	1	1	2412	21.51	30.00	-4.70	16.81	36.00	Pass
HT20	MCS0	1	6	2437	21.91	30.00	-4.70	17.21	36.00	Pass
HT20	MCS0	1	11	2462	22.35	30.00	-4.70	17.65	36.00	Pass

TEST RESULTS DATA
Average Power Table
(Reporting Only)

2.4GHz Band						
Mod.	Data Rate	N _{TX}	CH.	Freq. (MHz)	Duty Factor (dB)	Average Conducted Power (dBm)
11b	1Mbps	1	1	2412	0.00	16.36
11b	1Mbps	1	6	2437	0.00	16.41
11b	1Mbps	1	11	2462	0.00	16.27
11g	6Mbps	1	1	2412	0.15	13.88
11g	6Mbps	1	6	2437	0.15	14.63
11g	6Mbps	1	11	2462	0.15	14.81
HT20	MCS0	1	1	2412	0.13	13.04
HT20	MCS0	1	6	2437	0.13	13.42
HT20	MCS0	1	11	2462	0.13	13.89

TEST RESULTS DATA
Peak Power Density

2.4GHz Band								
Mod.	Data Rate	N _{TX}	CH.	Freq. (MHz)	Peak PSD (dBm /3kHz)	DG (dBi)	Peak PSD Limit (dBm /3kHz)	Pass/Fail
11b	1Mbps	1	1	2412	-6.33	-4.70	8.00	Pass
11b	1Mbps	1	6	2437	-6.36	-4.70	8.00	Pass
11b	1Mbps	1	11	2462	-6.09	-4.70	8.00	Pass
11g	6Mbps	1	1	2412	-12.18	-4.70	8.00	Pass
11g	6Mbps	1	6	2437	-10.30	-4.70	8.00	Pass
11g	6Mbps	1	11	2462	-11.44	-4.70	8.00	Pass
HT20	MCS0	1	1	2412	-12.33	-4.70	8.00	Pass
HT20	MCS0	1	6	2437	-11.48	-4.70	8.00	Pass
HT20	MCS0	1	11	2462	-11.13	-4.70	8.00	Pass



Appendix B. Radiated Spurious Emission

Test Engineer :	Peter Chiu, Karl Hou, Nick Yu, and Citta Ke	Temperature :	21~23°C
		Relative Humidity :	54~58%

2.4GHz 2400~2483.5MHz

WIFI 802.11b (Band Edge @ 3m)

WIFI Ant. 1	Note	Frequency (MHz)	Level (dBμV/m)	Over Limit (dB)	Limit Line (dBμV/m)	Read Level (dBμV)	Antenna Factor (dB/m)	Cable Loss (dB)	Preamp Factor (dB)	Ant Pos (cm)	Table Pos (deg)	Peak Avg. (P/A)	Pol. (H/V)	
802.11b CH 01 2412MHz		2389.8	56.51	-17.49	74	53.5	27.05	7.45	31.49	284	59	P	H	
		2390	44.22	-9.78	54	41.21	27.05	7.45	31.49	284	59	A	H	
	*	2412	99.16	-	-	96.11	27.09	7.45	31.49	284	59	P	H	
	*	2412	94.6	-	-	91.55	27.09	7.45	31.49	284	59	A	H	
													H	
														H
			2354.205	57.13	-16.87	74	54.29	26.97	7.37	31.5	298	238	P	V
			2390	45.39	-8.61	54	42.38	27.05	7.45	31.49	298	238	A	V
	*		2412	106.52	-	-	103.47	27.09	7.45	31.49	298	238	P	V
	*		2412	101.78	-	-	98.73	27.09	7.45	31.49	298	238	A	V
														V
														V
802.11b CH 06 2437MHz		2383.92	56.2	-17.8	74	53.23	27.01	7.45	31.49	310	137	P	H	
		2381.96	43.83	-10.17	54	40.86	27.01	7.45	31.49	310	137	A	H	
	*	2437	99.5	-	-	96.31	27.18	7.49	31.48	310	137	P	H	
	*	2437	95.09	-	-	91.9	27.18	7.49	31.48	310	137	A	H	
			2499.72	56.73	-17.27	74	53.36	27.3	7.53	31.46	310	137	P	H
			2494.75	44.04	-9.96	54	40.67	27.3	7.53	31.46	310	137	A	H
			2338.56	56.44	-17.56	74	53.72	26.93	7.3	31.51	369	234	P	V
			2389.94	43.94	-10.06	54	40.93	27.05	7.45	31.49	369	234	A	V
	*		2437	106.24	-	-	103.05	27.18	7.49	31.48	369	234	P	V
	*		2437	101.85	-	-	98.66	27.18	7.49	31.48	369	234	A	V
			2487.12	56.22	-17.78	74	52.9	27.26	7.53	31.47	369	234	P	V
			2499.72	44.08	-9.92	54	40.71	27.3	7.53	31.46	369	234	A	V



802.11b CH 11 2462MHz	*	2462	98.66	-	-	95.38	27.22	7.53	31.47	386	64	P	H
	*	2462	94.36	-	-	91.08	27.22	7.53	31.47	386	64	A	H
		2496.64	56.32	-17.68	74	52.95	27.3	7.53	31.46	386	64	P	H
		2497.72	44.08	-9.92	54	40.71	27.3	7.53	31.46	386	64	A	H
													H
													H
	*	2462	105.87	-	-	102.59	27.22	7.53	31.47	360	235	P	V
	*	2462	101.6	-	-	98.32	27.22	7.53	31.47	360	235	A	V
		2486	56.12	-17.88	74	52.8	27.26	7.53	31.47	360	235	P	V
		2483.52	44.14	-9.86	54	40.82	27.26	7.53	31.47	360	235	A	V
													V
													V
Remark	1. No other spurious found. 2. All results are PASS against Peak and Average limit line.												



2.4GHz 2400~2483.5MHz

WIFI 802.11b (Harmonic @ 3m)

WIFI Ant. 1	Note	Frequency (MHz)	Level (dBμV/m)	Over Limit (dB)	Limit Line (dBμV/m)	Read Level (dBμV)	Antenna Factor (dB/m)	Cable Loss (dB)	Preamp Factor (dB)	Ant Pos (cm)	Table Pos (deg)	Peak Avg. (P/A)	Pol. (H/V)
802.11b CH 01 2412MHz		4824	45.69	-28.31	74	61.83	31.26	10.74	58.14	100	0	P	H
													H
													H
													H
		4824	46.54	-27.46	74	62.68	31.26	10.74	58.14	100	0	P	V
													V
													V
802.11b CH 06 2437MHz		4872	38.47	-35.53	74	54.35	31.33	10.89	58.1	100	0	P	H
		7311	42.5	-31.5	74	51.34	36.07	14.18	59.09	100	0	P	H
													H
													H
		4872	39.96	-34.04	74	55.84	31.33	10.89	58.1	100	0	P	V
		7311	43.19	-30.81	74	52.03	36.07	14.18	59.09	100	0	P	V
													V
802.11b CH 11 2462MHz		4926	41.07	-32.93	74	56.69	31.4	11.04	58.06	100	0	P	H
		7386	43.02	-30.98	74	51.58	36.31	14.27	59.14	100	0	P	H
													H
													H
		4926	41.94	-32.06	74	57.56	31.4	11.04	58.06	100	0	P	V
		7386	42.34	-31.66	74	50.9	36.31	14.27	59.14	100	0	P	V
													V
Remark	1. No other spurious found.												
	2. All results are PASS against Peak and Average limit line.												



2.4GHz 2400~2483.5MHz
WIFI 802.11g (Band Edge @ 3m)

WIFI Ant. 1	Note	Frequency (MHz)	Level (dBμV/m)	Over Limit (dB)	Limit Line (dBμV/m)	Read Level (dBμV)	Antenna Factor (dB/m)	Cable Loss (dB)	Preamp Factor (dB)	Ant Pos (cm)	Table Pos (deg)	Peak Avg. (P/A)	Pol. (H/V)	
802.11g CH 01 2412MHz		2389.275	57.29	-16.71	74	54.28	27.05	7.45	31.49	392	59	P	H	
		2390	46.42	-7.58	54	43.41	27.05	7.45	31.49	392	59	A	H	
	*	2412	100.82	-	-	97.77	27.09	7.45	31.49	392	59	P	H	
	*	2412	91.03	-	-	87.98	27.09	7.45	31.49	392	59	A	H	
													H	
													H	
			2389.8	66	-8	74	62.99	27.05	7.45	31.49	372	262	P	V
			2389.905	50.26	-3.74	54	47.25	27.05	7.45	31.49	372	262	A	V
	*		2412	105.94	-	-	102.89	27.09	7.45	31.49	372	262	P	V
	*		2412	96.24	-	-	93.19	27.09	7.45	31.49	372	262	A	V
													V	
													V	
802.11g CH 06 2437MHz		2345.42	56	-18	74	53.2	26.93	7.37	31.5	337	65	P	H	
		2383.5	44.66	-9.34	54	41.69	27.01	7.45	31.49	337	65	A	H	
	*	2437	102.78	-	-	99.59	27.18	7.49	31.48	337	65	P	H	
	*	2437	92.74	-	-	89.55	27.18	7.49	31.48	337	65	A	H	
			2487.89	56.04	-17.96	74	52.68	27.3	7.53	31.47	337	65	P	H
			2484.6	44.82	-9.18	54	41.5	27.26	7.53	31.47	337	65	A	H
			2360.96	55.78	-18.22	74	52.94	26.97	7.37	31.5	375	240	P	V
			2389.38	44.92	-9.08	54	41.91	27.05	7.45	31.49	375	240	A	V
	*		2437	106.49	-	-	103.3	27.18	7.49	31.48	375	240	P	V
	*		2437	96.83	-	-	93.64	27.18	7.49	31.48	375	240	A	V
			2483.9	56.75	-17.25	74	53.43	27.26	7.53	31.47	375	240	P	V
			2483.5	45.14	-8.86	54	41.82	27.26	7.53	31.47	375	240	A	V



802.11g CH 11 2462MHz	*	2462	103.39	-	-	100.11	27.22	7.53	31.47	361	226	P	H
	*	2462	92.77	-	-	89.49	27.22	7.53	31.47	361	226	A	H
		2486.2	56.56	-17.44	74	53.24	27.26	7.53	31.47	361	226	P	H
		2483.72	45.14	-8.86	54	41.82	27.26	7.53	31.47	361	226	A	H
													H
													H
	*	2462	109.12	-	-	105.84	27.22	7.53	31.47	100	79	P	V
	*	2462	98.49	-	-	95.21	27.22	7.53	31.47	100	79	A	V
		2483.72	58.49	-15.51	74	55.17	27.26	7.53	31.47	100	79	P	V
		2483.52	46.59	-7.41	54	43.27	27.26	7.53	31.47	100	79	A	V
													V
													V
Remark	1. No other spurious found. 2. All results are PASS against Peak and Average limit line.												



2.4GHz 2400~2483.5MHz

WIFI 802.11g (Harmonic @ 3m)

WIFI Ant. 1	Note	Frequency (MHz)	Level (dBμV/m)	Over Limit (dB)	Limit Line (dBμV/m)	Read Level (dBμV)	Antenna Factor (dB/m)	Cable Loss (dB)	Preamp Factor (dB)	Ant Pos (cm)	Table Pos (deg)	Peak Avg. (P/A)	Pol. (H/V)	
802.11g CH 01 2412MHz		4824	39.23	-34.77	74	55.37	31.26	10.74	58.14	100	0	P	H	
													H	
													H	
													H	
			4824	42.82	-31.18	74	58.96	31.26	10.74	58.14	100	0	P	V
														V
														V
802.11g CH 06 2437MHz		4872	37.42	-36.58	74	53.3	31.33	10.89	58.1	100	0	P	H	
		7311	42.88	-31.12	74	51.72	36.07	14.18	59.09	100	0	P	H	
													H	
													H	
			4874	38.43	-35.57	74	54.31	31.33	10.89	58.1	100	0	P	V
			7308	42.43	-31.57	74	51.27	36.07	14.18	59.09	100	0	P	V
														V
802.11g CH 11 2462MHz		4926	39.33	-34.67	74	54.95	31.4	11.04	58.06	100	0	P	H	
		7386	43.1	-30.9	74	51.66	36.31	14.27	59.14	100	0	P	H	
													H	
													H	
			4924	40.26	-33.74	74	55.88	31.4	11.04	58.06	100	0	P	V
			7386	43.45	-30.55	74	52.01	36.31	14.27	59.14	100	0	P	V
														V
Remark	1. No other spurious found.													
	2. All results are PASS against Peak and Average limit line.													



2.4GHz 2400~2483.5MHz
WIFI 802.11n HT20 (Band Edge @ 3m)

WIFI Ant. 1	Note	Frequency (MHz)	Level (dBμV/m)	Over Limit (dB)	Limit Line (dBμV/m)	Read Level (dBμV)	Antenna Factor (dB/m)	Cable Loss (dB)	Preamp Factor (dB)	Ant Pos (cm)	Table Pos (deg)	Peak Avg. (P/A)	Pol. (H/V)	
802.11n HT20 CH 01 2412MHz		2389.38	60.41	-13.59	74	57.4	27.05	7.45	31.49	356	54	P	H	
		2389.905	45.71	-8.29	54	42.7	27.05	7.45	31.49	356	54	A	H	
	*	2412	94.58	-	-	91.53	27.09	7.45	31.49	356	54	P	H	
	*	2412	85.32	-	-	82.27	27.09	7.45	31.49	356	54	A	H	
													H	
													H	
			2389.8	66.34	-7.66	74	63.33	27.05	7.45	31.49	339	234	P	V
			2390	50.06	-3.94	54	47.05	27.05	7.45	31.49	339	234	A	V
		*	2412	103.85	-	-	100.8	27.09	7.45	31.49	339	234	P	V
		*	2412	94.04	-	-	90.99	27.09	7.45	31.49	339	234	A	V
													V	
													V	
802.11n HT20 CH 06 2437MHz		2349.9	56.11	-17.89	74	53.31	26.93	7.37	31.5	344	138	P	H	
		2371.04	44.64	-9.36	54	41.75	27.01	7.37	31.49	344	138	A	H	
	*	2437	97.4	-	-	94.21	27.18	7.49	31.48	344	138	P	H	
	*	2437	87.56	-	-	84.37	27.18	7.49	31.48	344	138	A	H	
			2488.87	56.44	-17.56	74	53.08	27.3	7.53	31.47	344	138	P	H
			2498.67	44.87	-9.13	54	41.5	27.3	7.53	31.46	344	138	A	H
			2388.82	56.16	-17.84	74	53.15	27.05	7.45	31.49	300	239	P	V
			2388.26	44.89	-9.11	54	41.88	27.05	7.45	31.49	300	239	A	V
		*	2437	104.99	-	-	101.8	27.18	7.49	31.48	300	239	P	V
		*	2437	95.33	-	-	92.14	27.18	7.49	31.48	300	239	A	V
		2499.09	56.28	-17.72	74	52.91	27.3	7.53	31.46	300	239	P	V	
		2483.55	45.07	-8.93	54	41.75	27.26	7.53	31.47	300	239	A	V	



802.11n HT20 CH 11 2462MHz	*	2462	97.62	-	-	94.34	27.22	7.53	31.47	379	134	P	H
	*	2462	87.62	-	-	84.34	27.22	7.53	31.47	379	134	A	H
		2485.6	57.08	-16.92	74	53.76	27.26	7.53	31.47	379	134	P	H
		2484.44	44.88	-9.12	54	41.56	27.26	7.53	31.47	379	134	A	H
													H
													H
	*	2462	106.58	-	-	103.3	27.22	7.53	31.47	362	252	P	V
	*	2462	97	-	-	93.72	27.22	7.53	31.47	362	252	A	V
		2483.8	60.05	-13.95	74	56.73	27.26	7.53	31.47	362	252	P	V
		2483.64	46.43	-7.57	54	43.11	27.26	7.53	31.47	362	252	A	V
													V
												V	
Remark	1. No other spurious found. 2. All results are PASS against Peak and Average limit line.												



2.4GHz 2400~2483.5MHz

WIFI 802.11n HT20 (Harmonic @ 3m)

WIFI Ant. 1	Note	Frequency (MHz)	Level (dBμV/m)	Over Limit (dB)	Limit Line (dBμV/m)	Read Level (dBμV)	Antenna Factor (dB/m)	Cable Loss (dB)	Preamp Factor (dB)	Ant Pos (cm)	Table Pos (deg)	Peak Avg. (P/A)	Pol. (H/V)	
802.11n HT20 CH 01 2412MHz		4824	39.37	-34.63	74	55.51	31.26	10.74	58.14	100	0	P	H	
													H	
													H	
													H	
			4824	40.32	-33.68	74	56.46	31.26	10.74	58.14	100	0	P	V
														V
														V
802.11n HT20 CH 06 2437MHz		4872	37.47	-36.53	74	53.35	31.33	10.89	58.1	100	0	P	H	
													H	
			7308	42.29	-31.71	74	51.13	36.07	14.18	59.09	100	0	P	H
														H
			4874	38.06	-35.94	74	53.94	31.33	10.89	58.1	100	0	P	V
			7308	43.01	-30.99	74	51.85	36.07	14.18	59.09	100	0	P	V
														V
802.11n HT20 CH 11 2462MHz		4926	38.17	-35.83	74	53.79	31.4	11.04	58.06	100	0	P	H	
													H	
			7386	42.87	-31.13	74	51.43	36.31	14.27	59.14	100	0	P	H
														H
			4924	38.53	-35.47	74	54.15	31.4	11.04	58.06	100	0	P	V
			7386	43.28	-30.72	74	51.84	36.31	14.27	59.14	100	0	P	V
														V
Remark	1. No other spurious found.													
	2. All results are PASS against Peak and Average limit line.													



2.4GHz 2400~2483.5MHz

Emission below 1GHz

2.4GHz WIFI 802.11b (LF)

WIFI Ant.	Note	Frequency	Level	Over Limit	Limit Line	Read Level	Antenna Factor	Cable Loss	Preamp Factor	Ant Pos	Table Pos	Peak Avg.	Pol.	
1		(MHz)	(dBμV/m)	(dB)	(dBμV/m)	(dBμV)	(dB/m)	(dB)	(dB)	(cm)	(deg)	(P/A)	(H/V)	
2.4GHz 802.11b LF		32.7	25.45	-14.55	40	32.99	24.14	0.78	32.46	-	-	P	H	
		137.46	28.38	-15.12	43.5	41.45	17.92	1.43	32.42	-	-	P	H	
		159.06	24.78	-18.72	43.5	38.5	16.95	1.75	32.42	-	-	P	H	
		656.3	26.6	-19.4	46	29.13	26.27	3.61	32.41	-	-	P	H	
		774.6	28.81	-17.19	46	29.09	28	3.97	32.25	-	-	P	H	
		941.9	32.16	-13.84	46	28.23	30.38	4.75	31.2	100	0	P	H	
														H
														H
														H
														H
														H
			30	30.77	-9.23	40	36.75	25.7	0.78	32.46	100	0	P	V
			40.53	30.3	-9.7	40	42.24	19.74	0.78	32.46	-	-	P	V
			160.41	24.25	-19.25	43.5	38.02	16.9	1.75	32.42	-	-	P	V
			746.6	32.12	-13.88	46	32.82	27.64	3.97	32.31	-	-	P	V
			902	31.41	-14.59	46	29.11	29.25	4.6	31.55	-	-	P	V
			981.8	31.89	-22.11	54	28.28	30.54	3.92	30.85	-	-	P	V
														V
													V	
													V	
													V	
													V	
													V	
Remark	1. No other spurious found. 2. All results are PASS against limit line.													



Emission below 1GHz

2.4GHz WIFI 802.11g (LF)

WIFI	Note	Frequency	Level	Over	Limit	Read	Antenna	Cable	Preamp	Ant	Table	Peak	Pol.	
Ant.				Limit	Line	Level	Factor	Loss	Factor	Pos	Pos	Avg.		
1		(MHz)	(dBμV/m)	(dB)	(dBμV/m)	(dBμV)	(dB/m)	(dB)	(dB)	(cm)	(deg)	(P/A)	(H/V)	
2.4GHz 802.11g LF		67.53	25.89	-14.11	40	44.98	12.3	1.06	32.45	-	-	P	H	
		137.46	27.73	-15.77	43.5	40.8	17.92	1.43	32.42	-	-	P	H	
		159.06	24.4	-19.1	43.5	38.12	16.95	1.75	32.42	-	-	P	H	
		746.6	28.56	-17.44	46	29.26	27.64	3.97	32.31	-	-	P	H	
		794.9	28.74	-17.26	46	28.57	28.24	4.14	32.21	-	-	P	H	
		953.8	32.3	-13.7	46	28.05	30.59	4.75	31.09	100	0	P	H	
														H
														H
														H
														H
														H
														H
			36.75	30.08	-9.92	40	39.78	21.98	0.78	32.46	100	0	P	V
			61.32	22.57	-17.43	40	42.01	11.95	1.06	32.45	-	-	P	V
			159.6	23.79	-19.71	43.5	37.56	16.9	1.75	32.42	-	-	P	V
			726.3	27.17	-18.83	46	28.41	27.23	3.89	32.36	-	-	P	V
			857.2	29.73	-16.27	46	28.34	28.95	4.28	31.84	-	-	P	V
			945.4	32.4	-13.6	46	28.33	30.49	4.75	31.17	-	-	P	V
														V
														V
													V	
													V	
													V	
													V	
Remark	1. No other spurious found. 2. All results are PASS against limit line.													



Emission below 1GHz

2.4GHz WIFI 802.11n HT20 (LF)

WIFI	Note	Frequency	Level	Over	Limit	Read	Antenna	Cable	Preamp	Ant	Table	Peak	Pol.	
Ant.				Limit	Line	Level	Factor	Loss	Factor	Pos	Pos	Avg.		
1		(MHz)	(dBμV/m)	(dB)	(dBμV/m)	(dBμV)	(dB/m)	(dB)	(dB)	(cm)	(deg)	(P/A)	(H/V)	
2.4GHz 802.11n HT20 LF		103.17	22.71	-20.79	43.5	37.28	16.43	1.43	32.43	-	-	P	H	
		141.78	26.5	-17	43.5	39.36	17.81	1.75	32.42	-	-	P	H	
		158.79	24.82	-18.68	43.5	38.54	16.95	1.75	32.42	-	-	P	H	
		468.7	29.31	-16.69	46	35.03	23.59	3.08	32.39	-	-	P	H	
		746.6	30.1	-15.9	46	30.8	27.64	3.97	32.31	-	-	P	H	
		939.1	31.7	-14.3	46	28.03	30.3	4.6	31.23	100	0	P	H	
														H
														H
														H
														H
														H
														H
														H
			30	29.69	-10.31	40	35.67	25.7	0.78	32.46	-	-	P	V
			68.61	25.36	-14.64	40	44.4	12.35	1.06	32.45	-	-	P	V
			158.25	24.14	-19.36	43.5	37.81	17	1.75	32.42	-	-	P	V
			738.2	42.57	-3.43	46	43.55	27.46	3.89	32.33	100	0	P	V
			909.7	30.63	-15.37	46	28.04	29.47	4.6	31.48	-	-	P	V
			973.4	32.99	-21.01	54	28.62	30.55	4.75	30.93	-	-	P	V
													V	
													V	
													V	
													V	
													V	
													V	
Remark	1. No other spurious found. 2. All results are PASS against limit line.													



Note symbol

*	Fundamental Frequency which can be ignored. However, the level of any unwanted emissions shall not exceed the level of the fundamental frequency.
!	Test result is over limit line.
P/A	Peak or Average
H/V	Horizontal or Vertical



A calculation example for radiated spurious emission is shown as below:

WIFI	Note	Frequency	Level	Over	Limit	Read	Antenna	Cable	Preamp	Ant	Table	Peak	Pol.
Ant.				Limit	Line	Level	Factor	Loss	Factor	Pos	Pos	Avg.	
1		(MHz)	(dBμV/m)	(dB)	(dBμV/m)	(dBμV)	(dB/m)	(dB)	(dB)	(cm)	(deg)	(P/A)	(H/V)
802.11b		2390	55.45	-18.55	74	54.51	32.22	4.58	35.86	103	308	P	H
CH 01													
2412MHz		2390	43.54	-10.46	54	42.6	32.22	4.58	35.86	103	308	A	H

- Level(dBμV/m) =
Antenna Factor(dB/m) + Cable Loss(dB) + Read Level(dBμV) - Preamp Factor(dB)
- Over Limit(dB) = Level(dBμV/m) – Limit Line(dBμV/m)

For Peak Limit @ 2390MHz:

- Level(dBμV/m)
= Antenna Factor(dB/m) + Cable Loss(dB) + Read Level(dBμV) - Preamp Factor(dB)
= 32.22(dB/m) + 4.58(dB) + 54.51(dBμV) – 35.86 (dB)
= 55.45 (dBμV/m)
- Over Limit(dB)
= Level(dBμV/m) – Limit Line(dBμV/m)
= 55.45(dBμV/m) – 74(dBμV/m)
= -18.55(dB)

For Average Limit @ 2390MHz:

- Level(dBμV/m)
= Antenna Factor(dB/m) + Cable Loss(dB) + Read Level(dBμV) - Preamp Factor(dB)
= 32.22(dB/m) + 4.58(dB) + 42.6(dBμV) – 35.86 (dB)
= 43.54 (dBμV/m)
- Over Limit(dB)
= Level(dBμV/m) – Limit Line(dBμV/m)
= 43.54(dBμV/m) – 54(dBμV/m)
= -10.46(dB)

Both peak and average measured complies with the limit line, so test result is “PASS”.



Appendix C. Radiated Spurious Emission Plots

Test Engineer :	Peter Chiu, Karl Hou, Nick Yu, and Citta Ke	Temperature :	21~23°C
		Relative Humidity :	54~58%

Note symbol

-L	Low channel location
-R	High channel location



2.4GHz 2400~2483.5MHz

WIFI 802.11b (Band Edge @ 3m)

WIFI	2.4GHz 2400~2483.5MHz Band Edge @ 3m	
ANT	802.11b CH01 2412MHz	
1	Horizontal	Fundamental
Peak	<p>Site : 03CH12-HY Condition : PEAK_BE_74 3m HORN_9120D_1328 HORIZONTAL</p>	<p>Site : 03CH12-HY Condition : PEAK_74 3m HORN_9120D_1328 HORIZONTAL</p>
Avg.	<p>Site : 03CH12-HY Condition : AVG_BE_54 3m HORN_9120D_1328 HORIZONTAL</p>	<p>Site : 03CH12-HY Condition : AVG_54 3m HORN_9120D_1328 HORIZONTAL</p>



WIFI	2.4GHz 2400~2483.5MHz Band Edge @ 3m	
ANT	802.11b CH01 2412MHz	
1	Vertical	Fundamental
Peak		
Avg.		



WIFI	2.4GHz 2400~2483.5MHz Band Edge @ 3m	
ANT	802.11b CH06 2437MHz - L	
1	Horizontal	Fundamental
Peak	<p>Site Condition : 03CH12-HY : PEAK_BE_74 3m HORN_9120D_1328 HORIZONTAL</p>	<p>Site Condition : 03CH12-HY : PEAK_74 3m HORN_9120D_1328 HORIZONTAL</p>
Avg.	<p>Site Condition : 03CH12-HY : AVG_BE_54 3m HORN_9120D_1328 HORIZONTAL</p>	<p>Site Condition : 03CH12-HY : AVG_54 3m HORN_9120D_1328 HORIZONTAL</p>



WIFI	2.4GHz 2400~2483.5MHz Band Edge @ 3m	
ANT	802.11b CH06 2437MHz - R	
1	Horizontal	Fundamental
Peak	<p>Site Condition : 03CH12-HY : PEAK_BE_74 3m HORN_9120D_1328 HORIZONTAL</p>	Left blank
Avg.	<p>Site Condition : 03CH12-HY : AVG_BE_54 3m HORN_9120D_1328 HORIZONTAL</p>	Left blank



WIFI	2.4GHz 2400~2483.5MHz Band Edge @ 3m	
ANT	802.11b CH06 2437MHz - L	
1	Vertical	Fundamental
Peak	<p>Site : 03CH12-HY Condition : PEAK_BE_74.3m HORN_9120D_1328 VERTICAL</p>	<p>Site : 03CH12-HY Condition : PEAK_74.3m HORN_9120D_1328 VERTICAL</p>
Avg.	<p>Site : 03CH12-HY Condition : AVG_BE_54.3m HORN_9120D_1328 VERTICAL</p>	<p>Site : 03CH12-HY Condition : AVG_54.3m HORN_9120D_1328 VERTICAL</p>



WIFI	2.4GHz 2400~2483.5MHz Band Edge @ 3m	
ANT	802.11b CH06 2437MHz - R	
1	Vertical	Fundamental
<p>Peak</p>	<p>Date: 2016-10-07</p> <p>Site Condition : 03CH12-HY : PEAK_BE_74 3m HORN_9120D_1328 VERTICAL</p>	<p>Left blank</p>
<p>Avg.</p>	<p>Date: 2016-10-07</p> <p>Site Condition : 03CH12-HY : AVG_BE_54 3m HORN_9120D_1328 VERTICAL</p>	<p>Left blank</p>



WIFI	2.4GHz 2400~2483.5MHz Band Edge @ 3m	
ANT	802.11b CH11 2462MHz	
1	Horizontal	Fundamental
Peak	<p>Date: 2016-10-07</p> <p>Site Condition : 03CH12-HY : PEAK_BE_74 3m HORN_9120D_1328 HORIZONTAL</p>	<p>Date: 2016-10-07</p> <p>Site Condition : 03CH12-HY : PEAK_74 3m HORN_9120D_1328 HORIZONTAL</p>
Avg.	<p>Date: 2016-10-07</p> <p>Site Condition : 03CH12-HY : AVG_BE_54 3m HORN_9120D_1328 HORIZONTAL</p>	<p>Date: 2016-10-07</p> <p>Site Condition : 03CH12-HY : AVG_54 3m HORN_9120D_1328 HORIZONTAL</p>

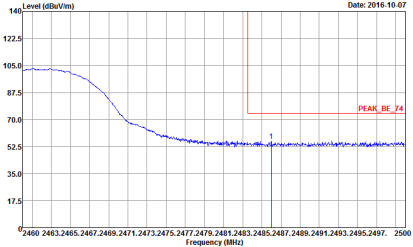
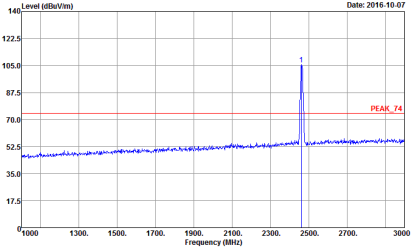
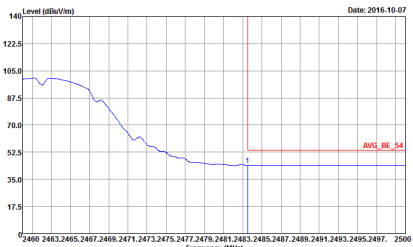
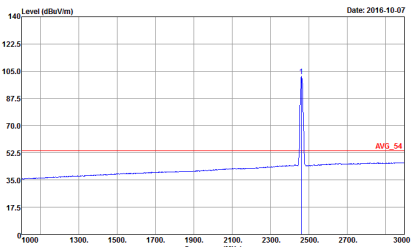

WIFI	2.4GHz 2400~2483.5MHz Band Edge @ 3m	
ANT	802.11b CH11 2462MHz	
1	<p style="text-align: center;">Vertical</p> <p>Peak</p>  <p>Site : 03CH12-HY Condition : PEAK_BE_74 3m HORN_9120D_1328 VERTICAL</p>	<p style="text-align: center;">Fundamental</p>  <p>Site : 03CH12-HY Condition : PEAK_74 3m HORN_9120D_1328 VERTICAL</p>
Avg.	 <p>Site : 03CH12-HY Condition : AVG_BE_54 3m HORN_9120D_1328 VERTICAL</p>	 <p>Site : 03CH12-HY Condition : AVG_54 3m HORN_9120D_1328 VERTICAL</p>



2.4GHz 2400~2483.5MHz

WIFI 802.11g (Band Edge @ 3m)

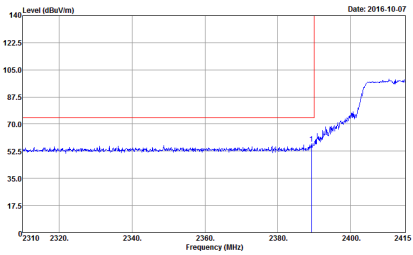
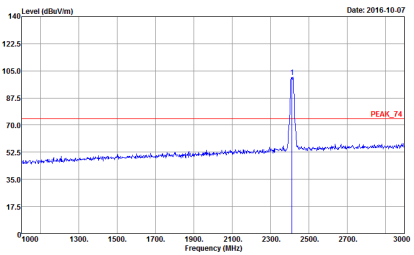
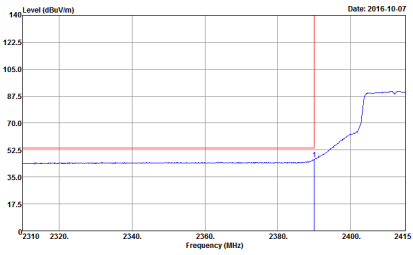
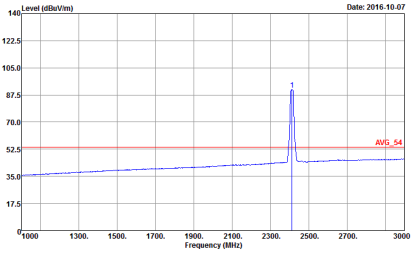
WIFI	2.4GHz 2400~2483.5MHz Band Edge @ 3m	
ANT	802.11g CH01 2412MHz	
1	Horizontal	Fundamental
Peak	 <p>Level (dBuV/m) vs Frequency (MHz) plot showing a peak at approximately 2412 MHz. The y-axis ranges from 17.5 to 140 dBuV/m, and the x-axis ranges from 2310 to 2415 MHz. A red horizontal line is drawn at approximately 70 dBuV/m. The plot is dated 2016-10-07.</p> <p>Site Condition : 03CH12-HY : PEAK_BE_74 3m HORN_9120D_1328 HORIZONTAL</p>	 <p>Level (dBuV/m) vs Frequency (MHz) plot showing a sharp peak at approximately 2412 MHz. The y-axis ranges from 17.5 to 140 dBuV/m, and the x-axis ranges from 1900 to 3000 MHz. A red horizontal line is drawn at approximately 70 dBuV/m. The plot is dated 2016-10-07.</p> <p>Site Condition : 03CH12-HY : PEAK_74 3m HORN_9120D_1328 HORIZONTAL</p>
Avg.	 <p>Level (dBuV/m) vs Frequency (MHz) plot showing the average level. The y-axis ranges from 17.5 to 140 dBuV/m, and the x-axis ranges from 2310 to 2415 MHz. A red horizontal line is drawn at approximately 52.5 dBuV/m. The plot is dated 2016-10-07.</p> <p>Site Condition : 03CH12-HY : AVG_BE_54 3m HORN_9120D_1328 HORIZONTAL</p>	 <p>Level (dBuV/m) vs Frequency (MHz) plot showing the average level. The y-axis ranges from 17.5 to 140 dBuV/m, and the x-axis ranges from 1900 to 3000 MHz. A red horizontal line is drawn at approximately 52.5 dBuV/m. The plot is dated 2016-10-07.</p> <p>Site Condition : 03CH12-HY : AVG_54 3m HORN_9120D_1328 HORIZONTAL</p>

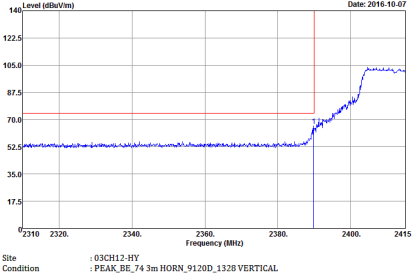
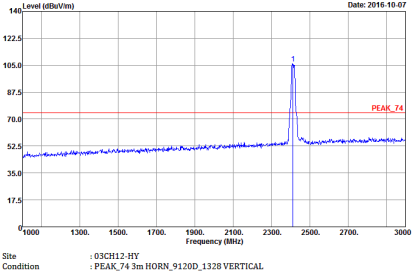
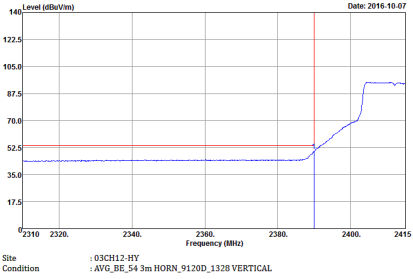
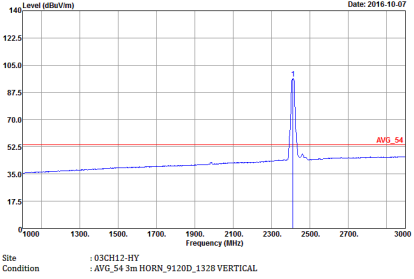

WIFI	2.4GHz 2400~2483.5MHz Band Edge @ 3m	
ANT	802.11g CH01 2412MHz	
1	Vertical	Fundamental
Peak		
Avg.		



WIFI	2.4GHz 2400~2483.5MHz Band Edge @ 3m	
ANT	802.11g CH06 2437MHz - L	
1	Horizontal	Fundamental
Peak	<p>Date: 2016-10-07</p> <p>Site Condition : 03CH12-HY : PEAK_BE_74 3m HORN_9120D_1328 HORIZONTAL</p>	<p>Date: 2016-10-07</p> <p>Site Condition : 03CH12-HY : PEAK_74 3m HORN_9120D_1328 HORIZONTAL</p>
Avg.	<p>Date: 2016-10-07</p> <p>Site Condition : 03CH12-HY : AVG_BE_54 3m HORN_9120D_1328 HORIZONTAL</p>	<p>Date: 2016-10-07</p> <p>Site Condition : 03CH12-HY : AVG_54 3m HORN_9120D_1328 HORIZONTAL</p>

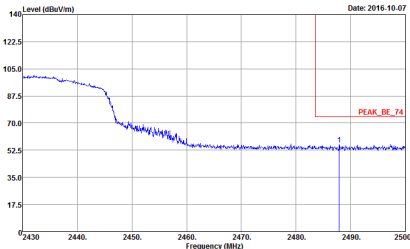
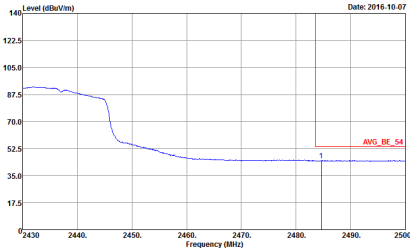

WIFI	2.4GHz 2400~2483.5MHz Band Edge @ 3m	
ANT	802.11g CH06 2437MHz - R	
1	Horizontal	Fundamental
Peak	 <p>Date: 2016-10-07</p> <p>Site Condition : 03CH12-HY : PEAK_BE_74 3m HORN_9120D_1328 HORIZONTAL</p>	Left blank
Avg.	 <p>Date: 2016-10-07</p> <p>Site Condition : 03CH12-HY : AVG_BE_54 3m HORN_9120D_1328 HORIZONTAL</p>	Left blank

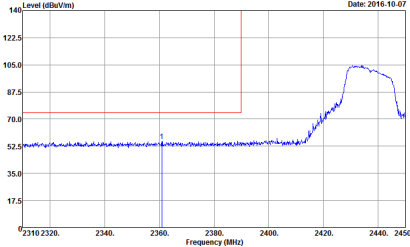
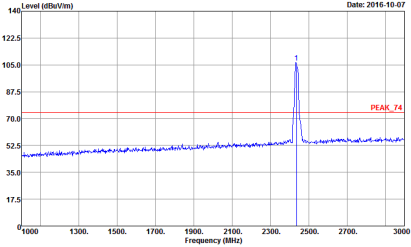
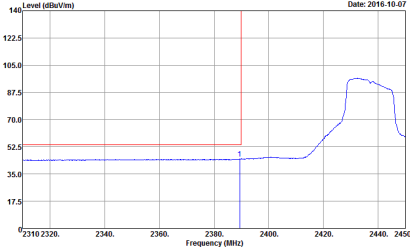
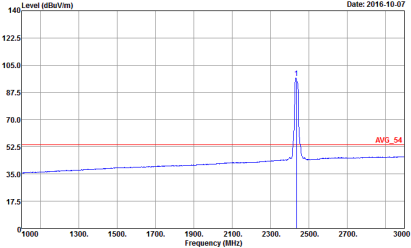

WIFI	2.4GHz 2400~2483.5MHz Band Edge @ 3m	
ANT	802.11g CH06 2437MHz - L	
1	Vertical	Fundamental
Peak	 <p>Date: 2016-10-07</p> <p>Site Condition : 03CH12-HY : PEAK_BE_74 3m HORN_9120D_1328 VERTICAL</p>	 <p>Date: 2016-10-07</p> <p>Site Condition : 03CH12-HY : PEAK_74 3m HORN_9120D_1328 VERTICAL</p>
Avg.	 <p>Date: 2016-10-07</p> <p>Site Condition : 03CH12-HY : AVG_BE_54 3m HORN_9120D_1328 VERTICAL</p>	 <p>Date: 2016-10-07</p> <p>Site Condition : 03CH12-HY : AVG_54 3m HORN_9120D_1328 VERTICAL</p>



WIFI	2.4GHz 2400~2483.5MHz Band Edge @ 3m	
ANT	802.11g CH06 2437MHz - R	
1	Vertical	Fundamental
Peak	<p>Site Condition : 03CH12-HY : PEAK_BE_74 3m HORN_9120D_1328 VERTICAL</p>	Left Blank
Avg.	<p>Site Condition : 03CH12-HY : AVG_BE_54 3m HORN_9120D_1328 VERTICAL</p>	Left Blank

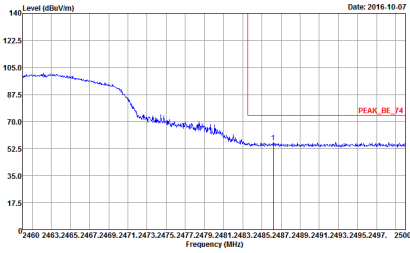
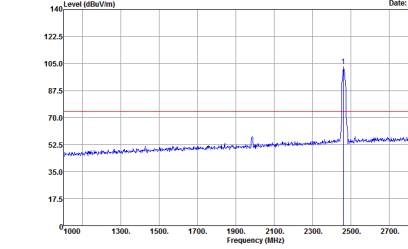
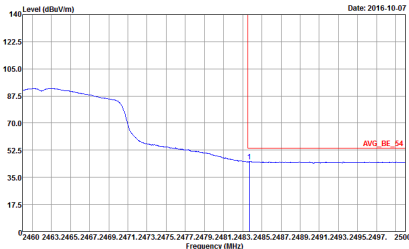
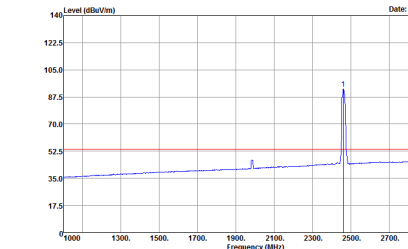

WIFI	2.4GHz 2400~2483.5MHz Band Edge @ 3m	
ANT	802.11g CH11 2462MHz	
1	Horizontal	Fundamental
Peak	 <p>Site Condition : 03CH12-HY : PEAK_BE_74 3m HORN_9120D_1328 HORIZONTAL</p>	 <p>Site Condition : 03CH12-HY : PEAK_74 3m HORN_9120D_1328 HORIZONTAL</p>
Avg.	 <p>Site Condition : 03CH12-HY : AVG_BE_54 3m HORN_9120D_1328 HORIZONTAL</p>	 <p>Site Condition : 03CH12-HY : AVG_54 3m HORN_9120D_1328 HORIZONTAL</p>

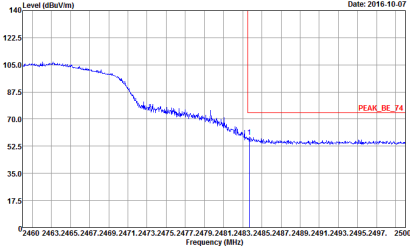
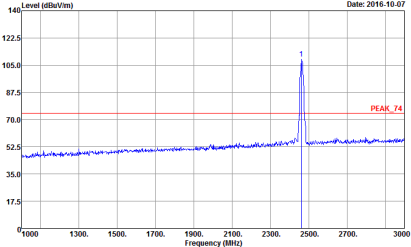
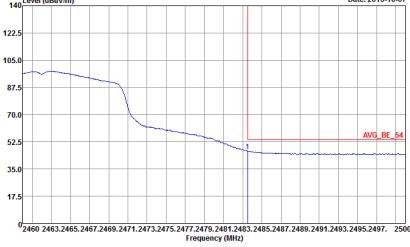
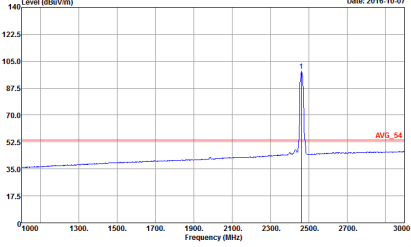

WIFI	2.4GHz 2400~2483.5MHz Band Edge @ 3m	
ANT	802.11g CH11 2462MHz	
1	Vertical	Fundamental
Peak	 <p>Level (dBuV/m) vs Frequency (MHz) plot showing a peak at 2462 MHz. The y-axis ranges from 17.5 to 140 dBuV/m, and the x-axis ranges from 2460 to 2500 MHz. A red line indicates the peak level at approximately 75 dBuV/m.</p> <p>Site : 03CH12-HY Condition : PEAK_BE_74 3m HORN_9120D_1328 VERTICAL</p>	 <p>Level (dBuV/m) vs Frequency (MHz) plot showing a sharp peak at 2462 MHz. The y-axis ranges from 17.5 to 140 dBuV/m, and the x-axis ranges from 1000 to 3000 MHz. A red line indicates the peak level at approximately 75 dBuV/m.</p> <p>Site : 03CH12-HY Condition : PEAK_74 3m HORN_9120D_1328 VERTICAL</p>
Avg.	 <p>Level (dBuV/m) vs Frequency (MHz) plot showing the average spectrum. The y-axis ranges from 17.5 to 140 dBuV/m, and the x-axis ranges from 2460 to 2500 MHz. A red line indicates the average level at approximately 55 dBuV/m.</p> <p>Site : 03CH12-HY Condition : AVG_BE_54 3m HORN_9120D_1328 VERTICAL</p>	 <p>Level (dBuV/m) vs Frequency (MHz) plot showing the average spectrum with a sharp peak at 2462 MHz. The y-axis ranges from 17.5 to 140 dBuV/m, and the x-axis ranges from 1000 to 3000 MHz. A red line indicates the average level at approximately 55 dBuV/m.</p> <p>Site : 03CH12-HY Condition : AVG_54 3m HORN_9120D_1328 VERTICAL</p>



2.4GHz 2400~2483.5MHz

WIFI 802.11n HT20 (Band Edge @ 3m)

WIFI	2.4GHz 2400~2483.5MHz Band Edge @ 3m	
ANT	802.11n HT20 CH01 2412MHz	
1	Horizontal	Fundamental
Peak	<p>Site : 03CH12-HY Condition : PEAK_BE_74 3m HORN_9120D_1328 HORIZONTAL</p>	<p>Site : 03CH12-HY Condition : PEAK_74 3m HORN_9120D_1328 HORIZONTAL</p>
Avg.	<p>Site : 03CH12-HY Condition : AVG_BE_54 3m HORN_9120D_1328 HORIZONTAL</p>	<p>Site : 03CH12-HY Condition : AVG_54 3m HORN_9120D_1328 HORIZONTAL</p>

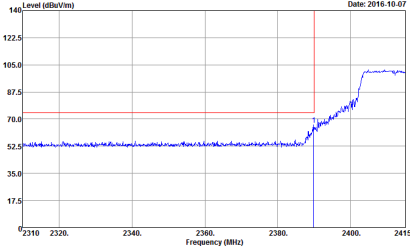
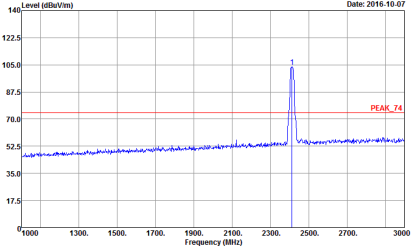
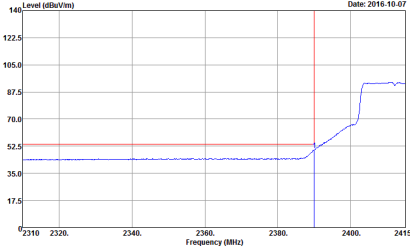
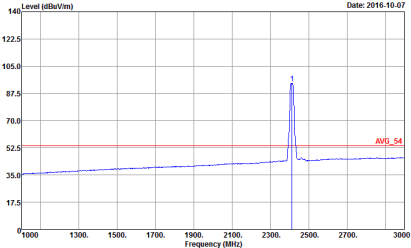

WIFI	2.4GHz 2400~2483.5MHz Band Edge @ 3m	
ANT	802.11n HT20 CH01 2412MHz	
1	Vertical	Fundamental
Peak	 <p>Level (dBuV/m) vs Frequency (MHz) plot showing a peak at approximately 2412 MHz. The y-axis ranges from 17.5 to 140 dBuV/m, and the x-axis ranges from 2310 to 2415 MHz. A red vertical line marks the peak frequency. Date: 2016-10-07.</p> <p>Site : 03CH12-HY Condition : PEAK_BE_74 3m HORN_9120D_1328 VERTICAL</p>	 <p>Level (dBuV/m) vs Frequency (MHz) plot showing a peak at approximately 2412 MHz. The y-axis ranges from 17.5 to 140 dBuV/m, and the x-axis ranges from 1900 to 3000 MHz. A red vertical line marks the peak frequency. Date: 2016-10-07.</p> <p>Site : 03CH12-HY Condition : PEAK_74 3m HORN_9120D_1328 VERTICAL</p>
Avg.	 <p>Level (dBuV/m) vs Frequency (MHz) plot showing the average spectrum. The y-axis ranges from 17.5 to 140 dBuV/m, and the x-axis ranges from 2310 to 2415 MHz. A red vertical line marks the peak frequency. Date: 2016-10-07.</p> <p>Site : 03CH12-HY Condition : AVG_BE_54 3m HORN_9120D_1328 VERTICAL</p>	 <p>Level (dBuV/m) vs Frequency (MHz) plot showing the average spectrum. The y-axis ranges from 17.5 to 140 dBuV/m, and the x-axis ranges from 1900 to 3000 MHz. A red vertical line marks the peak frequency. Date: 2016-10-07.</p> <p>Site : 03CH12-HY Condition : AVG_54 3m HORN_9120D_1328 VERTICAL</p>



WIFI	2.4GHz 2400~2483.5MHz Band Edge @ 3m	
ANT	802.11n HT20 CH06 2437MHz - L	
1	Horizontal	Fundamental
Peak	<p>Level (dBuV/m) vs Frequency (MHz) plot for Peak Horizontal. The plot shows a signal level around 52.5 dBuV/m from 2310 to 2420 MHz, rising to a peak of approximately 90 dBuV/m at 2437 MHz, and then falling back to 52.5 dBuV/m by 2450 MHz. A red horizontal line is drawn at 70.0 dBuV/m. The date is 2016-10-07.</p> <p>Site : 03CH12-HY Condition : PEAK_BE_74 3m HORN_9120D_1328 HORIZONTAL</p>	<p>Level (dBuV/m) vs Frequency (MHz) plot for Peak Fundamental. The plot shows a signal level around 52.5 dBuV/m from 1000 to 2400 MHz, with a sharp peak at 2437 MHz reaching approximately 105 dBuV/m. A red horizontal line is drawn at 70.0 dBuV/m. The date is 2016-10-07.</p> <p>Site : 03CH12-HY Condition : PEAK_74 3m HORN_9120D_1328 HORIZONTAL</p>
Avg.	<p>Level (dBuV/m) vs Frequency (MHz) plot for Avg Horizontal. The plot shows a signal level around 52.5 dBuV/m from 2310 to 2420 MHz, rising to a peak of approximately 85 dBuV/m at 2437 MHz, and then falling back to 52.5 dBuV/m by 2450 MHz. A red horizontal line is drawn at 52.5 dBuV/m. The date is 2016-10-07.</p> <p>Site : 03CH12-HY Condition : AVG_BE_54 3m HORN_9120D_1328 HORIZONTAL</p>	<p>Level (dBuV/m) vs Frequency (MHz) plot for Avg Fundamental. The plot shows a signal level around 52.5 dBuV/m from 1000 to 2400 MHz, with a sharp peak at 2437 MHz reaching approximately 90 dBuV/m. A red horizontal line is drawn at 52.5 dBuV/m. The date is 2016-10-07.</p> <p>Site : 03CH12-HY Condition : AVG_54 3m HORN_9120D_1328 HORIZONTAL</p>



WIFI	2.4GHz 2400~2483.5MHz Band Edge @ 3m	
ANT	802.11n HT20 CH06 2437MHz - R	
1	Horizontal	Fundamental
Peak	<p>Site Condition : 03CH12-HY : PEAK_BE_74 3m HORN_9120D_1328 HORIZONTAL</p>	Left blank
Avg.	<p>Site Condition : 03CH12-HY : AVG_BE_54 3m HORN_9120D_1328 HORIZONTAL</p>	Left blank



WIFI	2.4GHz 2400~2483.5MHz Band Edge @ 3m	
ANT	802.11n HT20 CH06 2437MHz - L	
1	Vertical	Fundamental
Peak	<p>Site Condition : 03CH12-HY : PEAK_BE_74 3m HORN_9120D_1328 VERTICAL</p>	<p>Site Condition : 03CH12-HY : PEAK_74 3m HORN_9120D_1328 VERTICAL</p>
Avg.	<p>Site Condition : 03CH12-HY : AVG_BE_54 3m HORN_9120D_1328 VERTICAL</p>	<p>Site Condition : 03CH12-HY : AVG_54 3m HORN_9120D_1328 VERTICAL</p>



WIFI	2.4GHz 2400~2483.5MHz Band Edge @ 3m	
ANT	802.11n HT20 CH06 2437MHz - R	
1	Vertical	Fundamental
<p>Peak</p>	<p>Date: 2016-10-07</p> <p>Site Condition : 03CH12-HY : PEAK_BE_74 3m HORN_9120D_1328 VERTICAL</p>	<p>Left Blank</p>
<p>Avg.</p>	<p>Date: 2016-10-07</p> <p>Site Condition : 03CH12-HY : AVG_BE_54 3m HORN_9120D_1328 VERTICAL</p>	<p>Left Blank</p>



WIFI	2.4GHz 2400~2483.5MHz Band Edge @ 3m	
ANT	802.11n HT20 CH11 2462MHz	
1	Horizontal	Fundamental
Peak	<p>Site Condition : 03CH12-HY : PEAK_BE_74 3m HORN_9120D_1328 HORIZONTAL</p>	<p>Site Condition : 03CH12-HY : PEAK_74 3m HORN_9120D_1328 HORIZONTAL</p>
Avg.	<p>Site Condition : 03CH12-HY : AVG_BE_54 3m HORN_9120D_1328 HORIZONTAL</p>	<p>Site Condition : 03CH12-HY : AVG_54 3m HORN_9120D_1328 HORIZONTAL</p>

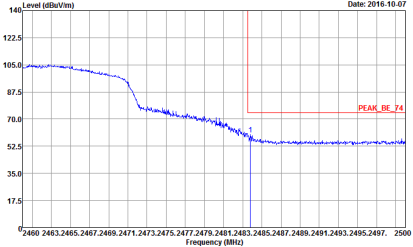
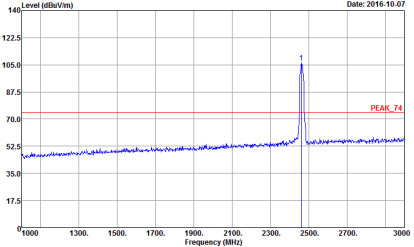
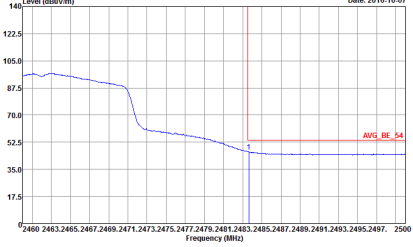
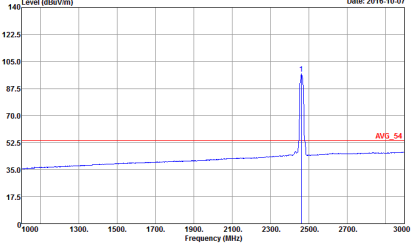

WIFI	2.4GHz 2400~2483.5MHz Fundamental @ 3m	
ANT	802.11n HT20 CH11 2462MHz	
1	Vertical	Fundamental
Peak	 <p>Date: 2016-10-07</p> <p>Site Condition : 03CH12-HY : PEAK_BE_74 3m HORN_9120D_1328 VERTICAL</p>	 <p>Date: 2016-10-07</p> <p>Site Condition : 03CH12-HY : PEAK_74 3m HORN_9120D_1328 VERTICAL</p>
Avg.	 <p>Date: 2016-10-07</p> <p>Site Condition : 03CH12-HY : AVG_BE_54 3m HORN_9120D_1328 VERTICAL</p>	 <p>Date: 2016-10-07</p> <p>Site Condition : 03CH12-HY : AVG_54 3m HORN_9120D_1328 VERTICAL</p>



2.4GHz 2400~2483.5MHz

WIFI 802.11b (Harmonic @ 3m)

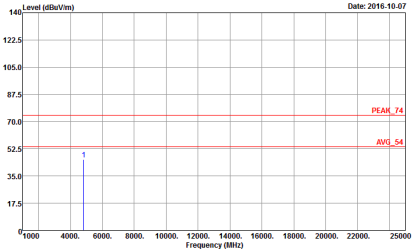
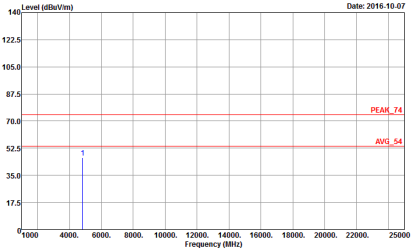
WIFI	2.4GHz 2400~2483.5MHz Harmonic @ 3m	
ANT	802.11b CH01 2412MHz	
1	Horizontal	Vertical
<p>Peak</p> <p>Avg.</p>	 <p>Site Condition : 03CH12-HY : PEAK_74 3m HORN_9120D_1328 HORIZONTAL</p>	 <p>Site Condition : 03CH12-HY : PEAK_74 3m HORN_9120D_1328 VERTICAL</p>

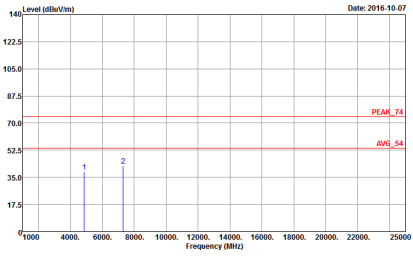
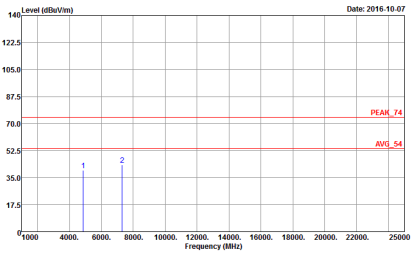

WIFI	2.4GHz 2400~2483.5MHz Harmonic @ 3m	
ANT	802.11b CH06 2437MHz	
1	Horizontal	Vertical
<p>Peak</p> <p>Avg.</p>	 <p>Site Condition : 03CH12-HY : PEAK_74 3m HORN_9120D_1328 HORIZONTAL</p>	 <p>Site Condition : 03CH12-HY : PEAK_74 3m HORN_9120D_1328 VERTICAL</p>



WIFI	2.4GHz 2400~2483.5MHz Harmonic @ 3m	
ANT	802.11b CH11 2462MHz	
1	Horizontal	Vertical
Peak Avg.	<p>Site Condition : 03CH12-HY : PEAK_74 3m HORN_9120D_1328 HORIZONTAL</p>	<p>Site Condition : 03CH12-HY : PEAK_74 3m HORN_9120D_1328 VERTICAL</p>



2.4GHz 2400~2483.5MHz

WIFI 802.11g (Harmonic @ 3m)

WIFI	2.4GHz 2400~2483.5MHz Harmonic @ 3m	
ANT	802.11g CH01 2412MHz	
1	Horizontal	Vertical
Peak Avg.	<p>Site Condition : 03CH12-HY : PEAK_74 3m HORN_9120D_1328 HORIZONTAL</p>	<p>Site Condition : 03CH12-HY : PEAK_74 3m HORN_9120D_1328 VERTICAL</p>



WIFI	2.4GHz 2400~2483.5MHz Harmonic @ 3m	
ANT	802.11g CH06 2437MHz	
1	Horizontal	Vertical
Peak Avg.	<p>Site Condition : 03CH12-HY : PEAK_74 3m HORN_9120D_1328 HORIZONTAL</p>	<p>Site Condition : 03CH12-HY : PEAK_74 3m HORN_9120D_1328 VERTICAL</p>

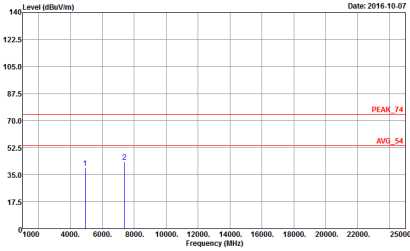
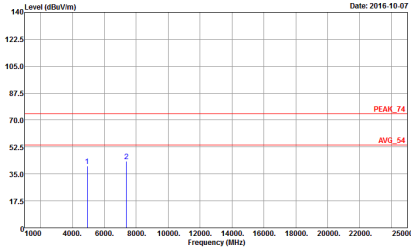

WIFI	2.4GHz 2400~2483.5MHz Harmonic @ 3m	
ANT	802.11g CH11 2462MHz	
1	Horizontal	Vertical
<p>Peak</p> <p>Avg.</p>	 <p>Site Condition : 03CH12-HY : PEAK_74 3m HORN_9120D_1328 HORIZONTAL</p>	 <p>Site Condition : 03CH12-HY : PEAK_74 3m HORN_9120D_1328 VERTICAL</p>



2.4GHz 2400~2483.5MHz

WIFI 802.11n HT20 (Harmonic @ 3m)

WIFI	2.4GHz 2400~2483.5MHz Harmonic @ 3m	
ANT	802.11n HT20 CH01 2412MHz	
1	Horizontal	Vertical
Peak Avg.	<p>Site Condition : 03CH12-HY : PEAK_74 3m HORN_9120D_1328 HORIZONTAL</p>	<p>Site Condition : 03CH12-HY : PEAK_74 3m HORN_9120D_1328 VERTICAL</p>

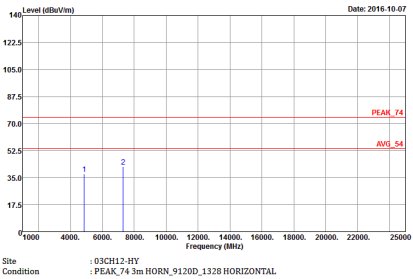
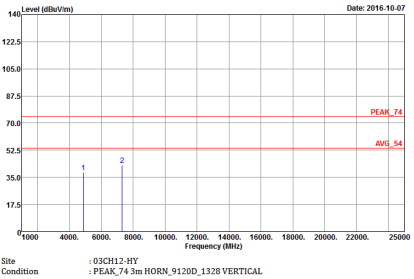

WIFI	2.4GHz 2400~2483.5MHz Harmonic @ 3m	
ANT	802.11n HT20 CH06 2437MHz	
1	Horizontal	Vertical
<p>Peak</p> <p>Avg.</p>		

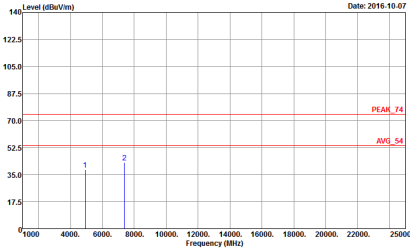
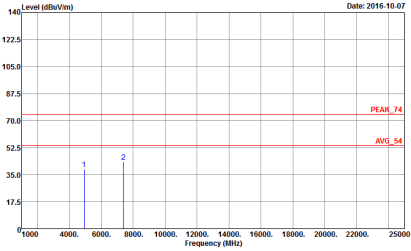

WIFI	2.4GHz 2400~2483.5MHz Harmonic @ 3m	
ANT	802.11n HT20 CH11 2462MHz	
1	Horizontal	Vertical
<p>Peak</p> <p>Avg.</p>	 <p>Site Condition : 03CH12-HY : PEAK_74 3m HORN_9120D_1328 HORIZONTAL</p>	 <p>Site Condition : 03CH12-HY : PEAK_74 3m HORN_9120D_1328 VERTICAL</p>



Emission below 1GHz

2.4GHz WIFI 802.11b (LF)

WIFI	2.4GHz 2400~2483.5MHz	
ANT	802.11b LF	
1	Horizontal	Vertical
<p>QP / Peak</p>	<p>Site : 03CH12-HY Condition : QP 3m BILOG_6111D_37059 HORIZONTAL</p>	<p>Site : 03CH12-HY Condition : QP 3m BILOG_6111D_37059 VERTICAL</p>



2.4GHz 2400~2483.5MHz

Emission below 1GHz

2.4GHz WIFI 802.11g (LF)

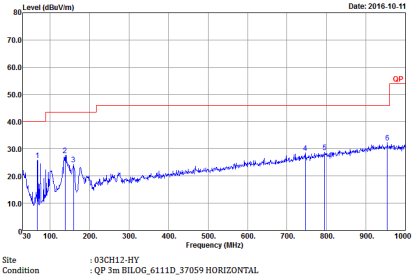
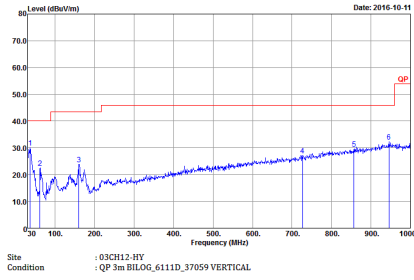
WIFI	2.4GHz 2400~2483.5MHz	
ANT	802.11g LF	
1	Horizontal	Vertical
QP / Peak		



2.4GHz 2400~2483.5MHz

Emission below 1GHz

2.4GHz WIFI 802.11n HT20 (LF)

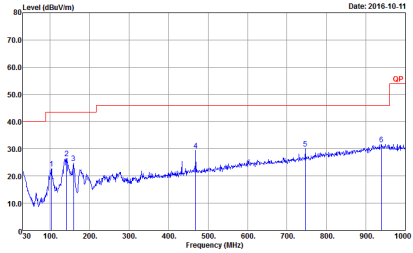
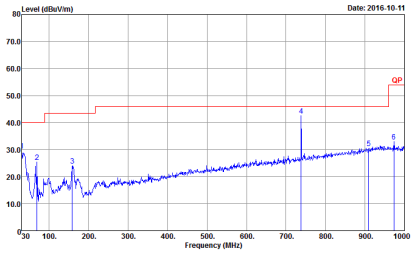
WIFI	2.4GHz 2400~2483.5MHz	
ANT	802.11n HT20 LF	
1	Horizontal	Vertical
<p>QP / Peak</p>	 <p>Site Condition : 03CH12-HY : QP 3m BILOG_6111D_37059 HORIZONTAL</p>	 <p>Site Condition : 03CH12-HY : QP 3m BILOG_6111D_37059 VERTICAL</p>



Appendix D. Duty Cycle Plots

Band	Duty Cycle(%)	T(us)	1/T(kHz)	VBW Setting
802.11b	100.00	-	-	10Hz
802.11g	96.53	1390.00	0.72	1kHz
2.4GHz 802.11n HT20	97.02	0.77	1kHz	

802.11b

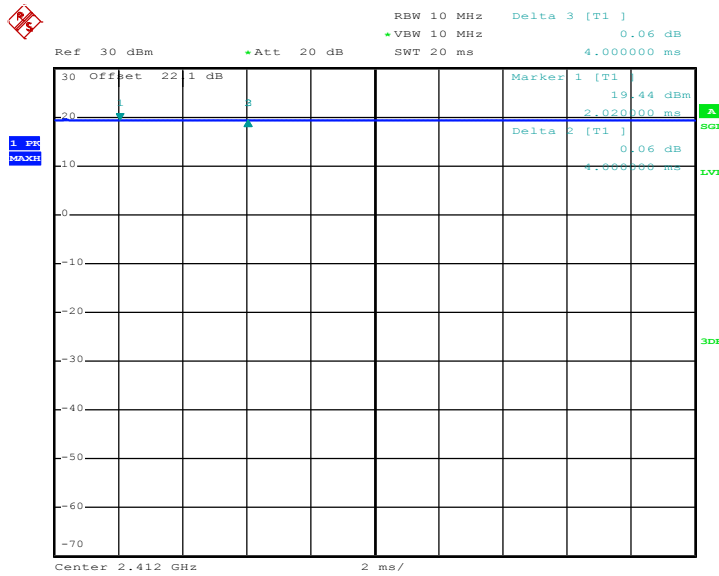

Date: 6.OCT.2016 10:14:23



802.11g

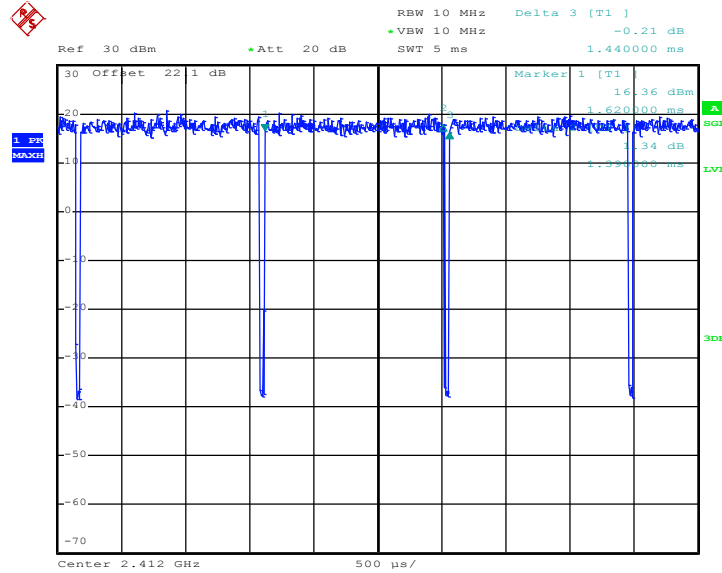

Date: 6.OCT.2016 10:10:21

2.4GHz 802.11n HT20

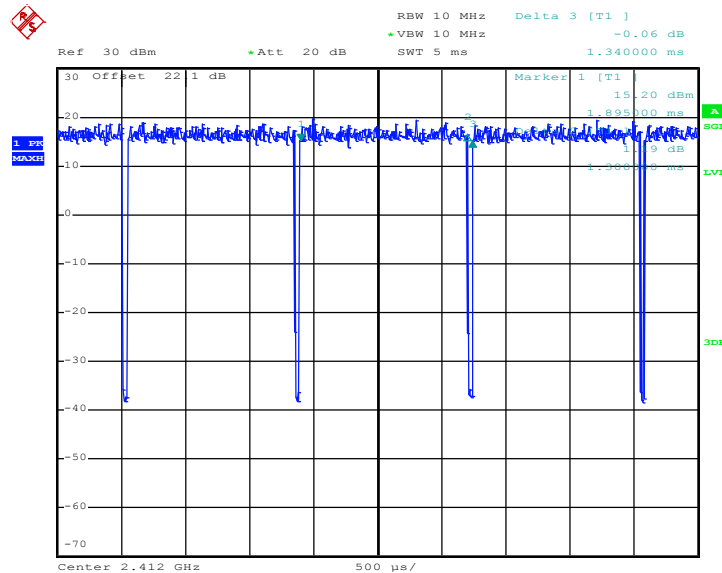

Date: 6.OCT.2016 10:25:49