



# FCC RF Test Report

**APPLICANT** : Sony Mobile Communications Inc.  
**EQUIPMENT** : GSM/WCDMA/LTE Phone+Bluetooth,  
DTS/UNII a/b/g/n and NFC  
**BRAND NAME** : Sony  
**FCC ID** : PY7-84773W  
**STANDARD** : FCC Part 15 Subpart C §15.247  
**CLASSIFICATION** : (DTS) Digital Transmission System

The product was received on Sep. 22, 2016 and testing was completed on Nov. 28, 2016. We, SPORTON INTERNATIONAL INC., would like to declare that the tested sample has been evaluated in accordance with the test procedures and has been in compliance with the applicable technical standards.

The test results in this report apply exclusively to the tested model / sample. Without written approval of SPORTON INTERNATIONAL INC., the test report shall not be reproduced except in full.

Reviewed by: Joseph Lin / Supervisor

Approved by: Jones Tsai / Manager



## **SPORTON INTERNATIONAL INC.**

**No. 52, Hwa Ya 1<sup>st</sup> Rd., Hwa Ya Technology Park, Kwei-Shan District, Tao Yuan City, Taiwan, R.O.C.**

SPORTON INTERNATIONAL INC.

TEL : 886-3-327-3456

FAX : 886-3-328-4978

FCC ID : PY7-84773W

Page Number : 1 of 39

Report Issued Date : Feb. 14, 2017

Report Version : Rev. 02

Report Template No.: BU5-FR15CBT4.0 Version 1.3



# TABLE OF CONTENTS

**REVISION HISTORY..... 3**

**SUMMARY OF TEST RESULT ..... 4**

**1 GENERAL DESCRIPTION..... 5**

    1.1 Applicant ..... 5

    1.2 Manufacturer..... 5

    1.3 Product Feature of Equipment Under Test..... 5

    1.4 Modification of EUT ..... 6

    1.5 Testing Location ..... 7

    1.6 Applicable Standards..... 7

**2 TEST CONFIGURATION OF EQUIPMENT UNDER TEST..... 8**

    2.1 Carrier Frequency Channel ..... 8

    2.2 Descriptions of Test Mode ..... 9

    2.3 Test Mode ..... 9

    2.4 Connection Diagram of Test System ..... 10

    2.5 Support Unit used in test configuration and system ..... 11

    2.6 EUT Operation Test Setup ..... 11

    2.7 Measurement Results Explanation Example..... 11

**3 TEST RESULT ..... 12**

    3.1 6dB and 99% Bandwidth Measurement ..... 12

    3.2 Peak Output Power Measurement ..... 17

    3.3 Power Spectral Density Measurement ..... 18

    3.4 Conducted Band Edges and Spurious Emission Measurement ..... 23

    3.5 Radiated Band Edges and Spurious Emission Measurement ..... 28

    3.6 AC Conducted Emission Measurement..... 32

    3.7 Antenna Requirements ..... 36

**4 LIST OF MEASURING EQUIPMENT ..... 37**

**5 UNCERTAINTY OF EVALUATION..... 39**

**APPENDIX A. CONDUCTED TEST RESULTS**

**APPENDIX B. RADIATED SPURIOUS EMISSION**

**APPENDIX C. RADIATED SPURIOUS EMISSION PLOTS**

**APPENDIX D. DUTY CYCLE PLOTS**





### SUMMARY OF TEST RESULT

Report Section	FCC Rule	Description	Limit	Result	Remark
3.1	15.247(a)(2)	6dB Bandwidth	$\geq 0.5\text{MHz}$	Pass	-
3.1	-	99% Bandwidth	-	Pass	-
3.2	15.247(b)(3)	Peak Output Power	$\leq 30\text{dBm}$	Pass	-
3.3	15.247(e)	Power Spectral Density	$\leq 8\text{dBm}/3\text{kHz}$	Pass	-
3.4	15.247(d)	Conducted Band Edges and Spurious Emission	$\leq 20\text{dBc}$	Pass	-
3.5	15.247(d)	Radiated Band Edges and Spurious Emission	15.209(a) & 15.247(d)	Pass	Under limit 7.57 dB at 30.810 MHz
3.6	15.207	AC Conducted Emission	15.207(a)	Pass	Under limit 14.10 dB at 0.462 MHz
3.7	15.203 & 15.247(b)	Antenna Requirement	N/A	Pass	-



# 1 General Description

## 1.1 Applicant

**Sony Mobile Communications Inc.**

4-12-3 Higashi-Shinagawa, Shinagawa-ku, Tokyo, 140-0002, Japan

## 1.2 Manufacturer

**Sony Mobile Communications Inc.**

4-12-3 Higashi-Shinagawa, Shinagawa-ku, Tokyo, 140-0002, Japan

## 1.3 Product Feature of Equipment Under Test

GSM/WCDMA/LTE, Bluetooth, DTS/UNII, a/b/g/n, GPS, and NFC

Standards-related Product Specification	
Antenna Type / Gain	PIFA Antenna type with gain -0.80 dBi

EUT Information List			
HW Version	SW Version	S/N	Performed Test Item
A	0.85	RQ3002J3KX	RF conducted measurement Radiated Spurious Emission
		RQ3002HWM1	Conducted Emission



Accessory List	
<b>AC Adapter 1</b>	Model No. : UCH20
	S/N :
	1215W48600011 (for radiated spurious emission) 1215W48600039 (for conducted emission)
<b>Earphone 1</b>	Model No. : MH410c
	S/N:
	1632A86300007A6 (for radiated spurious emission) 1632A8640000088 (for conducted emission)
<b>USB Cable</b>	Model No. : UCB20
	S/N :
	1625A912000332E (for radiated spurious emission) 1625A91900007E2 (for conducted emission)

**Note:**

1. Above EUT list and accessory list used are electrically identical per declared by manufacturer.
2. Above the accessories list are used to exercise the EUT during test.
3. For other wireless features of this EUT, test report will be issued separately.

### 1.4 Modification of EUT

No modifications are made to the EUT during all test items.



### 1.5 Testing Location

Sporton Lab is accredited to ISO 17025 by Taiwan Accreditation Foundation (TAF code : 1190) and the FCC designation No. TW1022 under the FCC 2.948(e) by Mutual Recognition Agreement (MRA) in FCC Test.

<b>Test Site</b>	SPORTON INTERNATIONAL INC.	
<b>Test Site Location</b>	No. 52, Hwa Ya 1 <sup>st</sup> Rd., Hwa Ya Technology Park, Kwei-Shan District, Tao Yuan City, Taiwan, R.O.C. TEL: +886-3-327-3456 FAX: +886-3-328-4978	
<b>Test Site No.</b>	<b>Sporton Site No.</b>	
	TH05-HY	CO05-HY

**Note:** The test site complies with ANSI C63.4 2014 requirement.

<b>Test Site</b>	SPORTON INTERNATIONAL INC.	
<b>Test Site Location</b>	No.58, Aly. 75, Ln. 564, Wenhua 3rd Rd. Guishan Dist, Taoyuan City, Taiwan (R.O.C.) TEL: +886-3-327-0868 FAX: +886-3-327-0855	
<b>Test Site No.</b>	<b>Sporton Site No.</b>	
	03CH12-HY	

**Note:** The test site complies with ANSI C63.4 2014 requirement.

### 1.6 Applicable Standards

According to the specifications of the manufacturer, the EUT must comply with the requirements of the following standards:

- ♦ FCC Part 15 Subpart C §15.247
- ♦ FCC KDB Publication No. 558074 D01 DTS Meas. Guidance v03r05
- ♦ ANSI C63.10-2013

**Remark:**

1. All test items were verified and recorded according to the standards and without any deviation during the test.
2. This EUT has also been tested and complied with the requirements of FCC Part 15, Subpart B, recorded in a separate test report.



## 2 Test Configuration of Equipment Under Test

### 2.1 Carrier Frequency Channel

Frequency Band	Channel	Freq. (MHz)	Channel	Freq. (MHz)
2400-2483.5 MHz	0	2402	21	2444
	1	2404	22	2446
	2	2406	23	2448
	3	2408	24	2450
	4	2410	25	2452
	5	2412	26	2454
	6	2414	27	2456
	7	2416	28	2458
	8	2418	29	2460
	9	2420	30	2462
	10	2422	31	2464
	11	2424	32	2466
	12	2426	33	2468
	13	2428	34	2470
	14	2430	35	2472
	15	2432	36	2474
	16	2434	37	2476
	17	2436	38	2478
	18	2438	39	2480
	19	2440	-	-
20	2442	-	-	





## 2.2 Descriptions of Test Mode

The RF output power was recorded in the following table:

Channel	Frequency	Bluetooth – LE RF Output Power	
		Data Rate / Modulation	
		GFSK	
		1Mbps	
Ch00	2402MHz	0.84 dBm	
Ch19	2440MHz	1.86 dBm	
Ch39	2480MHz	0.90 dBm	

- a. The EUT has been associated with peripherals and configuration operated in a manner tended to maximize its emission characteristics in a typical application. Frequency range investigated: conduction (150 kHz to 30 MHz), radiation (9 kHz to the 10th harmonic of the highest fundamental frequency or to 40 GHz, whichever is lower). Pre-scanned tests, X, Y, Z in three orthogonal panels to determine the final configuration (X plane as worst plane) from all possible combinations.
- b. AC power line Conducted Emission was tested under maximum output power.

## 2.3 Test Mode

The following summary table is showing all test modes to demonstrate in compliance with the standard.

Summary table of Test Cases	
Test Item	Data Rate / Modulation
	Bluetooth – LE / GFSK
Conducted TCs	Mode 1: Bluetooth Tx CH00_2402 MHz_1Mbps Mode 2: Bluetooth Tx CH19_2440 MHz_1Mbps Mode 3: Bluetooth Tx CH39_2480 MHz_1Mbps
Radiated TCs	Mode 1: Bluetooth Tx CH00_2402 MHz_1Mbps Mode 2: Bluetooth Tx CH19_2440 MHz_1Mbps Mode 3: Bluetooth Tx CH39_2480 MHz_1Mbps
AC Conducted Emission	Mode 1: GSM1900 Idle + Bluetooth Link + WLAN (2.4GHz) Link + MP3 + Earphone 1 + Battery + USB Cable (Charging from Adapter 1)

## 2.4 Connection Diagram of Test System

<Bluetooth – LE Tx Mode>

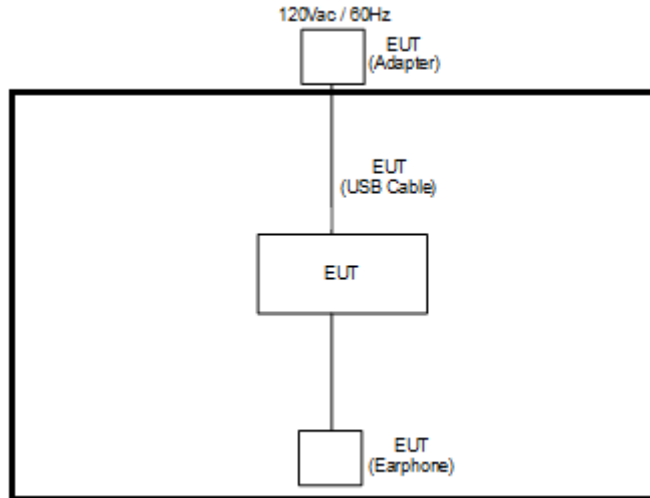

<AC Conducted Emission Mode>

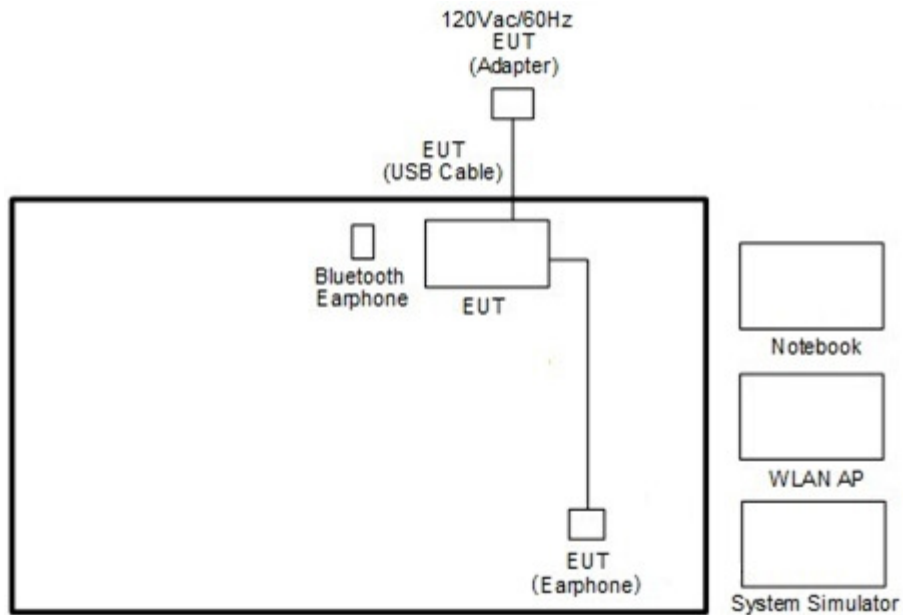



## 2.5 Support Unit used in test configuration and system

Item	Equipment	Trade Name	Model Name	FCC ID	Data Cable	Power Cord
1.	System Simulator	Anritsu	MT8820C	N/A	N/A	Unshielded, 1.8 m
2.	WLAN AP	ASUS	RT-AC66U	MSQ-RTAC66U	N/A	Unshielded, 1.8m
3.	Notebook	DELL	Latitude E6320	FCC DoC/ Contains FCC ID: QDS-BRCM1054	N/A	AC I/P: Unshielded, 1.2 m DC O/P: Shielded, 1.8 m
4.	Bluetooth Earphone	Sony	SBH20	PY7-RD0010	N/A	N/A
5.	SD Card	SanDisk	MicroSD HC	FCC DoC	N/A	N/A

## 2.6 EUT Operation Test Setup

For RF test items, an engineering test program was provided and enabled to make EUT transmitting signals.

## 2.7 Measurement Results Explanation Example

For all conducted test items:

The offset level is set in the spectrum analyzer to compensate the RF cable loss and attenuator factor between EUT conducted output port and spectrum analyzer. With the offset compensation, the spectrum analyzer reading level is exactly the EUT RF output level.

Example :

The spectrum analyzer offset is derived from RF cable loss and attenuator factor.

*Offset = RF cable loss + attenuator factor.*

Following shows an offset computation example with cable loss 4.2 dB and 10dB attenuator.

$$\begin{aligned}
 \text{Offset(dB)} &= \text{RF cable loss(dB)} + \text{attenuator factor(dB)}. \\
 &= 4.2 + 10 = 14.2 \text{ (dB)}
 \end{aligned}$$

### 3 Test Result

#### 3.1 6dB and 99% Bandwidth Measurement

##### 3.1.1 Limit of 6dB and 99% Bandwidth

The minimum 6 dB bandwidth shall be at least 500 kHz.

##### 3.1.2 Measuring Instruments

The section 4.0 of List of Measuring Equipment of this test report is used for test.

##### 3.1.3 Test Procedures

1. The testing follows FCC KDB Publication No. 558074 D01 DTS Meas. Guidance v03r05.
2. The RF output of EUT was connected to the spectrum analyzer by RF cable and attenuator. The path loss was compensated to the results for each measurement.
3. Set to the maximum power setting and enable the EUT transmit continuously.
4. Make the measurement with the spectrum analyzer's resolution bandwidth (RBW) = 100 kHz. Set the Video bandwidth (VBW) = 300 kHz. In order to make an accurate measurement. The 6 dB bandwidth must be greater than 500 kHz.
5. For 99% Bandwidth Measurement, the spectrum analyzer's resolution bandwidth (RBW) is set 30kHz and set the Video bandwidth (VBW) = 100kHz.
6. Measure and record the results in the test report.

##### 3.1.4 Test Setup



##### 3.1.5 Test Result of 6dB Bandwidth

Test data refer to Appendix A.



6 dB Bandwidth Plot on Channel 00

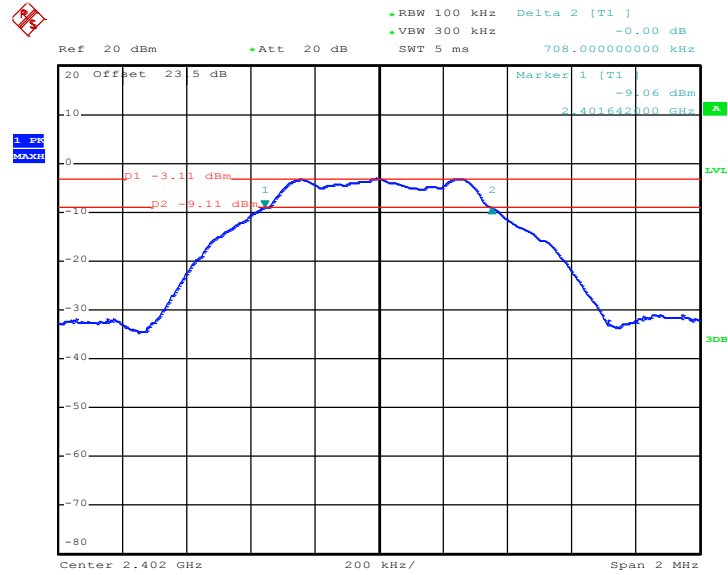

Date: 20.NOV.2016 15:31:49

6 dB Bandwidth Plot on Channel 19

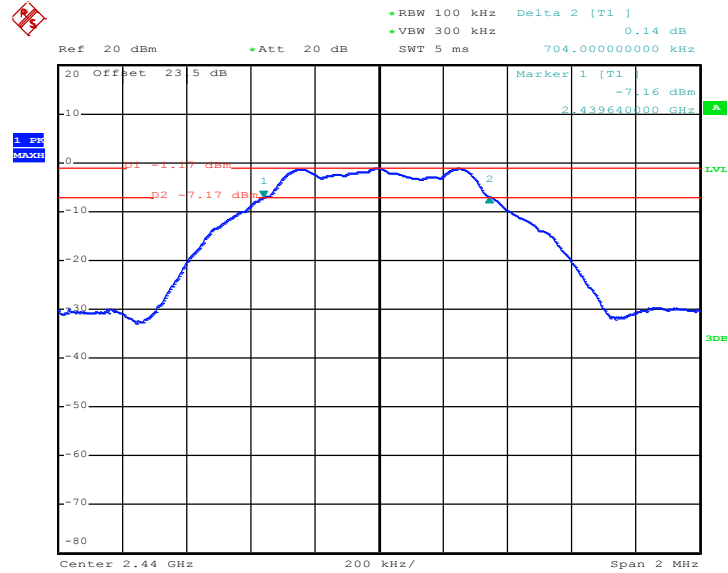

Date: 20.NOV.2016 15:36:14



6 dB Bandwidth Plot on Channel 39

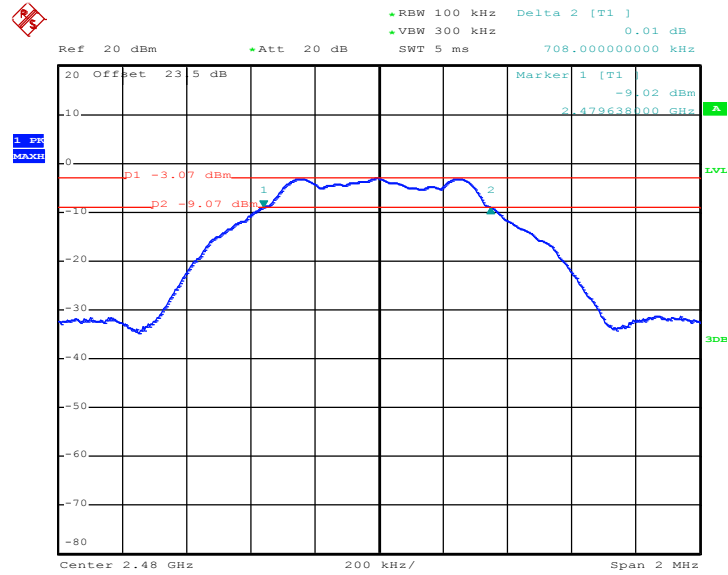

Date: 20.NOV.2016 15:40:03



### 3.1.6 Test Result of 99% Occupied Bandwidth

Test data refer to Appendix A.

99% Bandwidth Plot on Channel 00

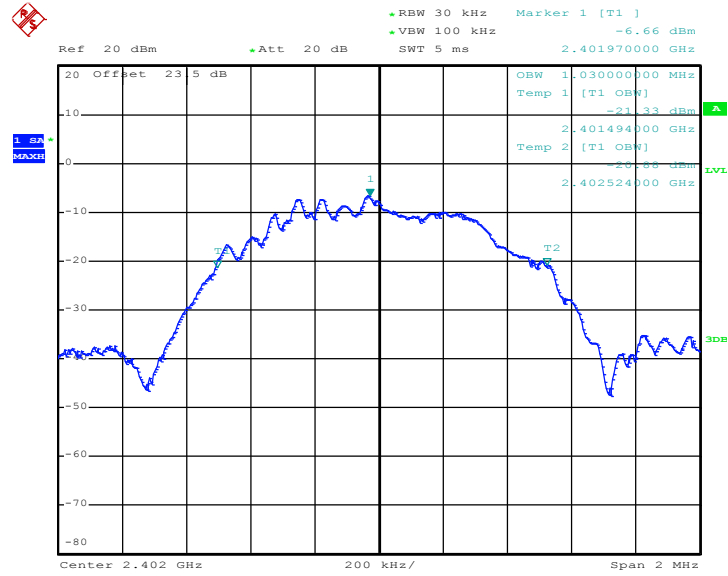

Date: 20.NOV.2016 15:33:46



99% Occupied Bandwidth Plot on Channel 19

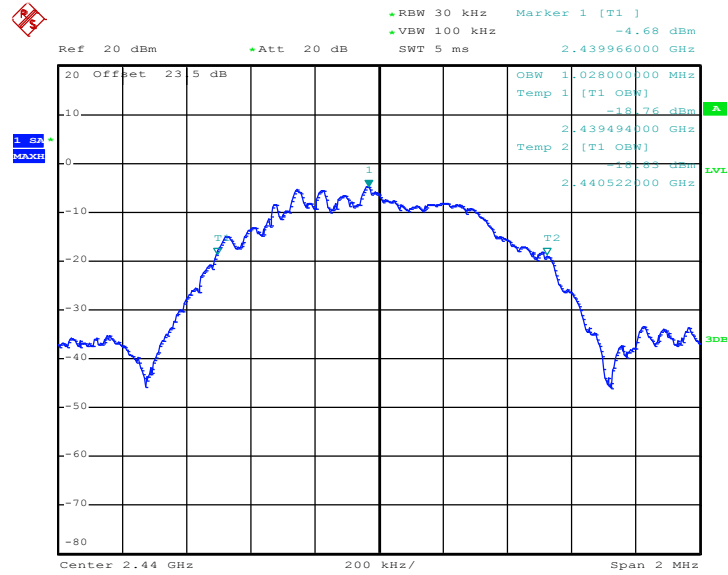

Date: 20.NOV.2016 15:38:13

99% Occupied Bandwidth Plot on Channel 39

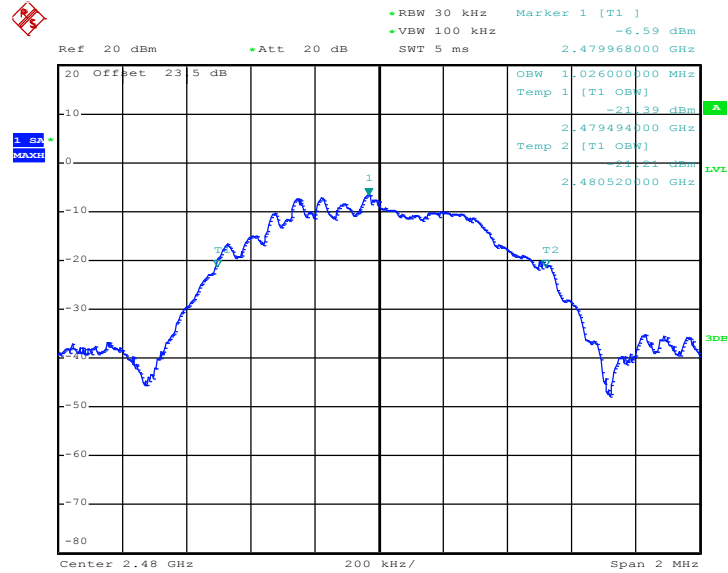

Date: 20.NOV.2016 15:41:37

Note: The occupied channel bandwidth is maintained within the band of operation for all of the modulations.



## 3.2 Peak Output Power Measurement

### 3.2.1 Limit of Peak Output Power

For systems using digital modulation in the 2400-2483.5MHz, the limit for peak output power is 30dBm. If transmitting antenna of directional gain greater than 6dBi is used, the peak output power from the intentional radiator shall be reduced below the above stated value by the amount in dB that the directional gain of the antenna exceeds 6 dBi. In case of point-to-point operation, the limit has to be reduced by 1dB for every 3dB that the directional gain of the antenna exceeds 6dBi.

### 3.2.2 Measuring Instruments

The section 4.0 of List of Measuring Equipment of this test report is used for test.

### 3.2.3 Test Procedures

1. The testing follows the Measurement Procedure of FCC KDB No. 558074 DTS D01 Meas. Guidance v03r05 section 9.1.2 PKPM1 Peak power meter method.
2. The RF output of EUT was connected to the power meter by RF cable and attenuator. The path loss was compensated to the results for each measurement.
3. Set to the maximum power setting and enable the EUT transmit continuously.
4. Measure the conducted output power and record the results in the test report.

### 3.2.4 Test Setup

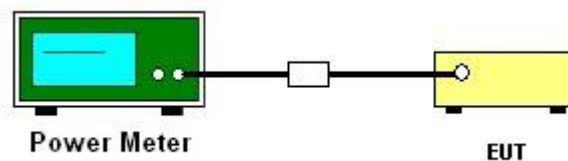

### 3.2.5 Test Result of Peak Output Power

Test data refers to Appendix A.

### 3.3 Power Spectral Density Measurement

#### 3.3.1 Limit of Power Spectral Density

The peak power spectral density shall not be greater than 8dBm in any 3kHz band at any time interval of continuous transmission.

#### 3.3.2 Measuring Instruments

The section 4.0 of List of Measuring Equipment of this test report is used for test.

#### 3.3.3 Test Procedures

1. The testing follows Measurement Procedure 10.2 Method PKPSD of FCC KDB Publication No. 558074 D01 DTS Meas. Guidance v03r05
2. The RF output of EUT was connected to the spectrum analyzer by RF cable and attenuator. The path loss was compensated to the results for each measurement.
3. Set to the maximum power setting and enable the EUT transmit continuously.
4. Make the measurement with the spectrum analyzer's resolution bandwidth (RBW) = 3 kHz. Video bandwidth VBW = 10 kHz In order to make an accurate measurement, set the span to 1.5 times DTS Channel Bandwidth. (6dB BW)
5. Detector = peak, Sweep time = auto couple, Trace mode = max hold, Allow trace to fully stabilize. Use the peak marker function to determine the maximum power level.
6. Measure and record the results in the test report.
7. The Measured power density (dBm)/ 100kHz is a reference level and used as 20dBc down limit line for Conducted Band Edges and Conducted Spurious Emission.

#### 3.3.4 Test Setup

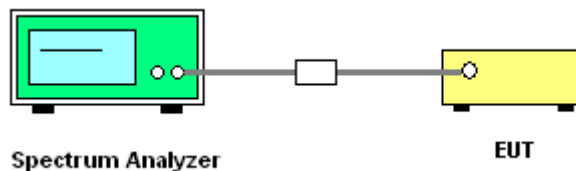

#### 3.3.5 Test Result of Power Spectral Density

Test data refers to Appendix A.



### 3.3.6 Test Result of Power Spectral Density Plots (100kHz)

PSD 100kHz Plot on Channel 00

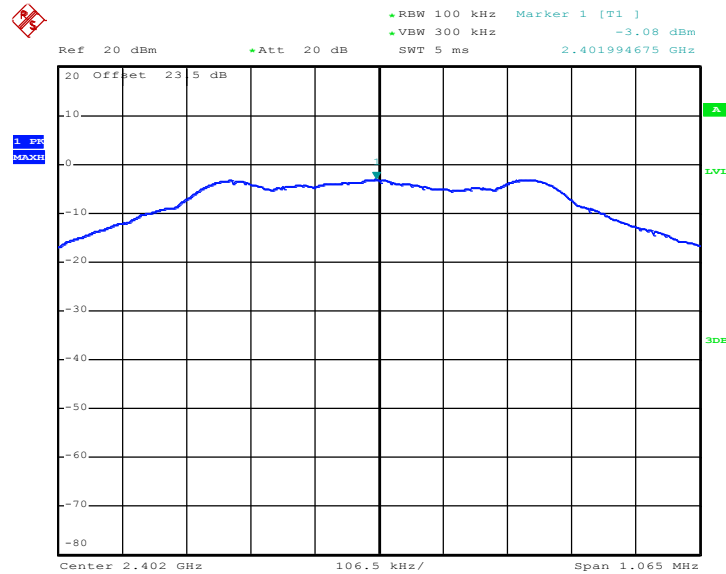

Date: 20.NOV.2016 15:32:35

PSD 100kHz Plot on Channel 19

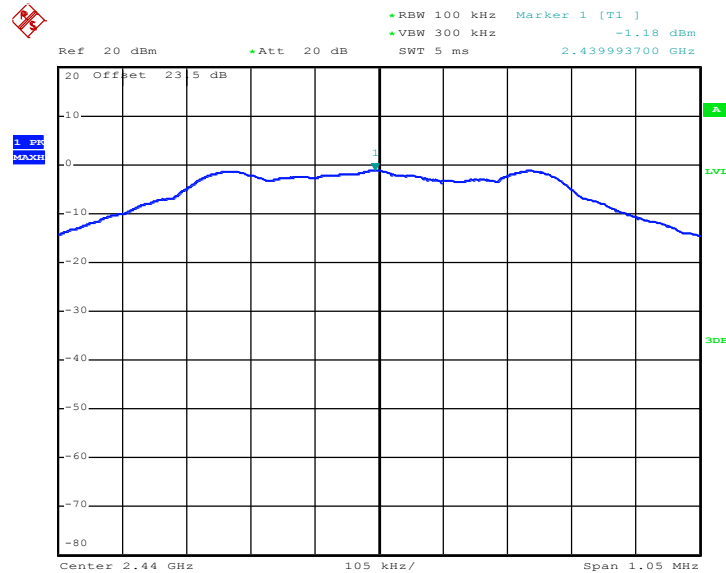

Date: 20.NOV.2016 15:36:55



PSD 100kHz Plot on Channel 39

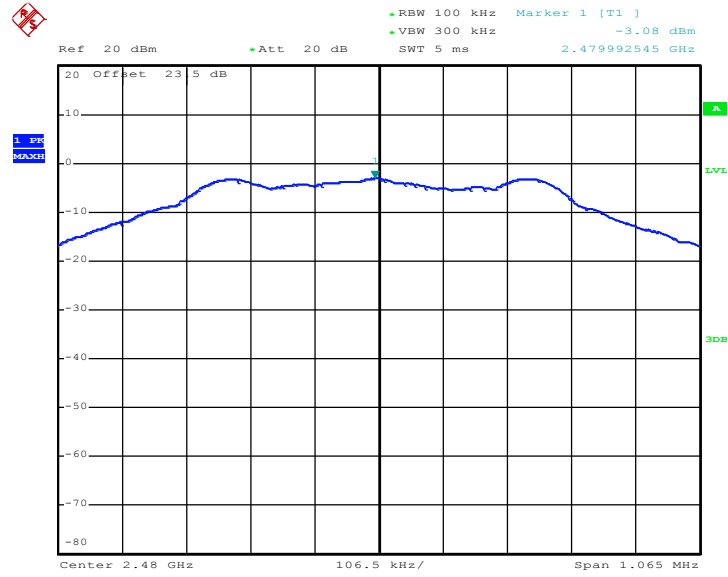

Date: 20.NOV.2016 15:40:42



### 3.3.7 Test Result of Power Spectral Density Plots (3kHz)

PSD 3kHz Plot on Channel 00

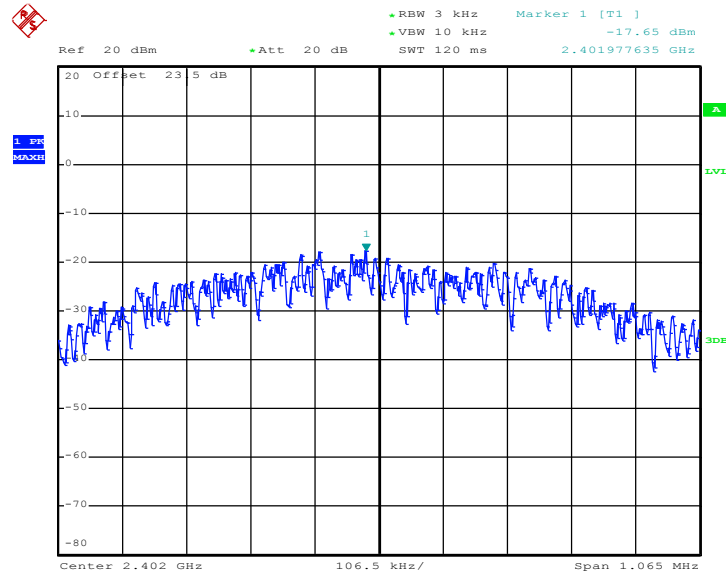

Date: 20.NOV.2016 15:32:18

PSD 3kHz Plot on Channel 19

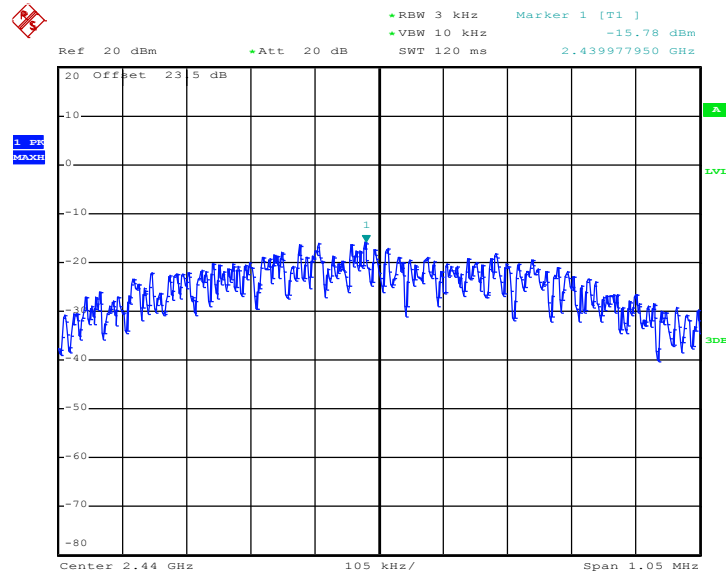

Date: 20.NOV.2016 15:36:42



PSD 3kHz Plot on Channel 39

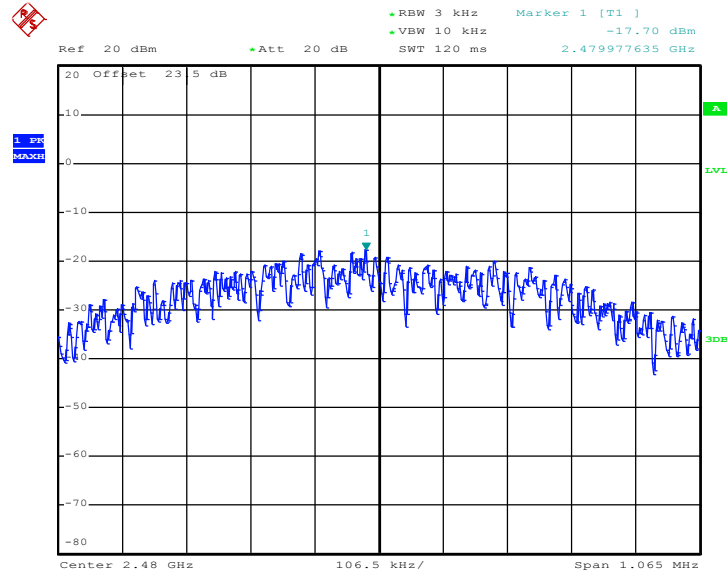

Date: 20.NOV.2016 15:40:28

## 3.4 Conducted Band Edges and Spurious Emission Measurement

### 3.4.1 Limit of Conducted Band Edges and Spurious Emission

All harmonics/spurious must be at least 20 dB down from the highest emission level within the authorized band.

### 3.4.2 Measuring Instruments

The section 4.0 of List of Measuring Equipment of this test report is used for test.

### 3.4.3 Test Procedure

1. The testing follows FCC KDB Publication No. 558074 D01 DTS Meas. Guidance v03r05.
2. The RF output of EUT was connected to the spectrum analyzer by RF cable and attenuator. The path loss was compensated to the results for each measurement.
3. Set to the maximum power setting and enable the EUT transmit continuously.
4. Set RBW = 100 kHz, VBW=300 kHz, Peak Detector. Unwanted Emissions measured in any 100 kHz bandwidth outside of the authorized frequency band shall be attenuated by at least 20 dB relative to the maximum in-band peak PSD level in 100 kHz when maximum peak conducted output power procedure is used. If the transmitter complies with the conducted power limits based on the use of RMS averaging over a time interval, the attenuation required under this paragraph shall be 30 dB instead of 20 dB per 15.247(d).
5. Measure and record the results in the test report.
6. The RF fundamental frequency should be excluded against the limit line in the operating frequency band.

### 3.4.4 Test Setup

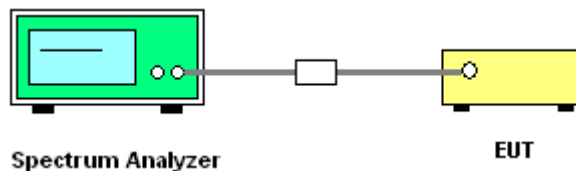



### 3.4.5 Test Result of Conducted Band Edges Plots

#### Low Band Edge Plot on Channel 00

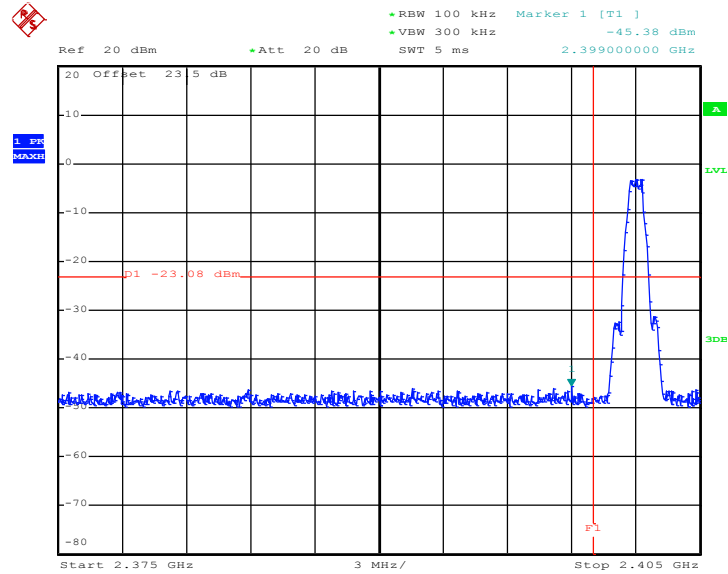

Date: 20.NOV.2016 15:33:03

#### High Band Edge Plot on Channel 39

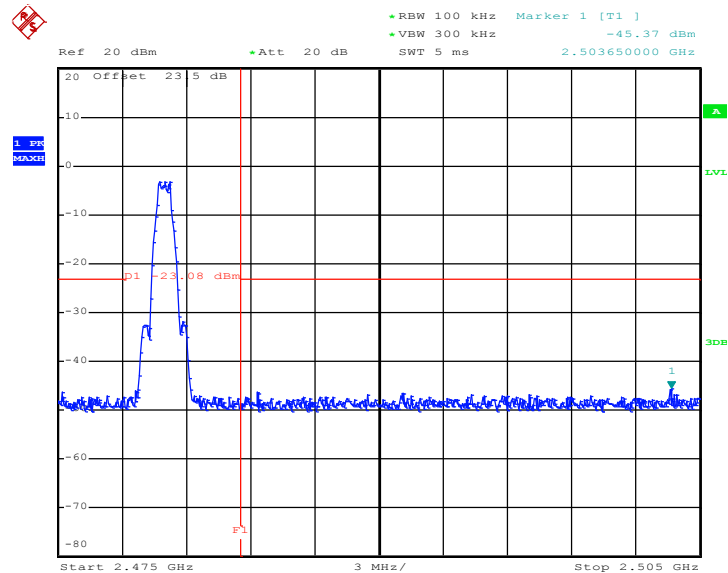

Date: 20.NOV.2016 15:41:00







### Conducted Spurious Emission Plot on Bluetooth LE 1Mbps GFSK Channel 19

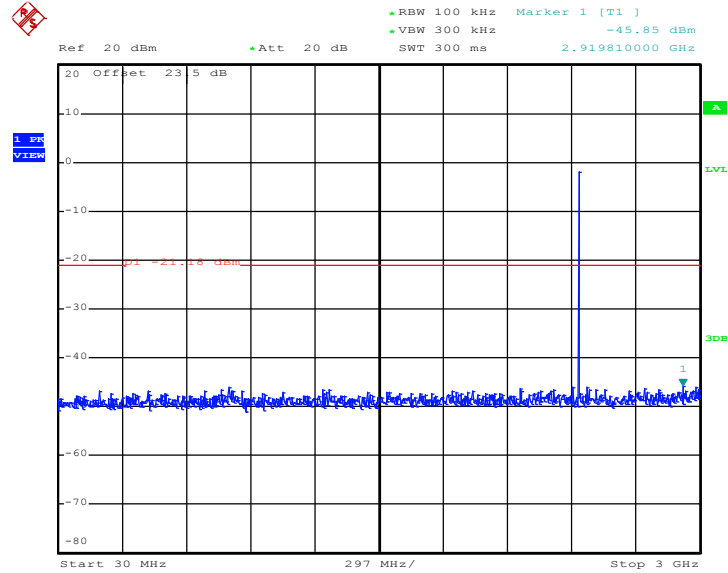

Date: 20.NOV.2016 15:37:33

### Conducted Spurious Emission Plot on Bluetooth LE 1Mbps GFSK Channel 19

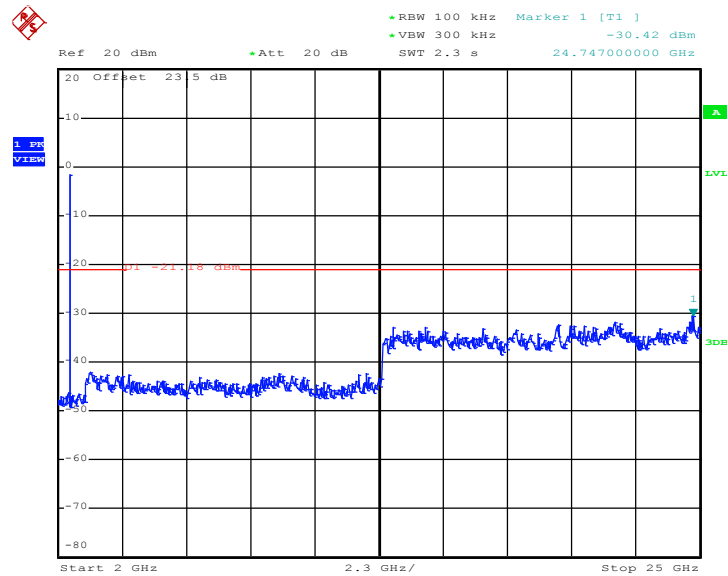

Date: 20.NOV.2016 15:37:41



### Conducted Spurious Emission Plot on Bluetooth LE 1Mbps GFSK Channel 39

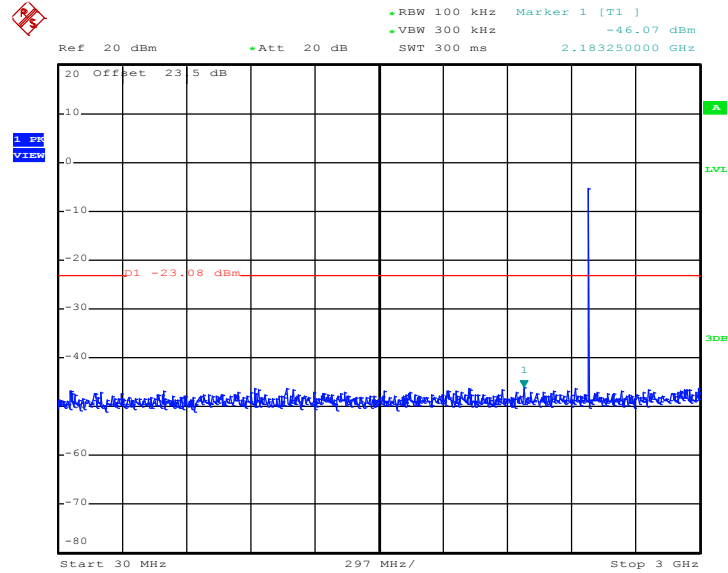

Date: 20.NOV.2016 15:41:12

### Conducted Spurious Emission Plot on Bluetooth LE 1Mbps GFSK Channel 39

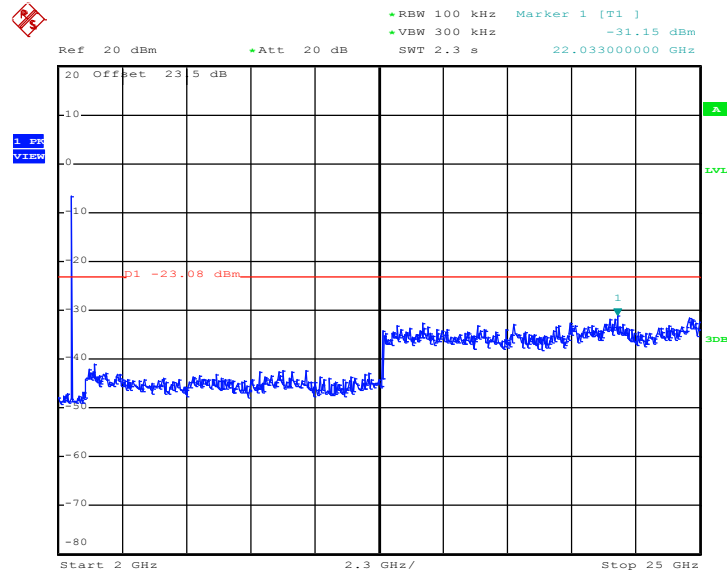

Date: 20.NOV.2016 15:41:21



### 3.5 Radiated Band Edges and Spurious Emission Measurement

#### 3.5.1 Limit of Radiated Band Edges and Spurious Emission

In any 100 kHz bandwidth outside the intentional radiator frequency band, all harmonics/spurious must be at least 20 dB below the highest emission level within the authorized band. If the output power of this device was measured by spectrum analyzer, the attenuation under this paragraph shall be 30 dB instead of 20 dB. In addition, radiated emissions which fall in the restricted bands must also comply with the FCC section 15.209 limits as below.

Frequency (MHz)	Field Strength (microvolts/meter)	Measurement Distance (meters)
0.009 – 0.490	2400/F(kHz)	300
0.490 – 1.705	24000/F(kHz)	30
1.705 – 30.0	30	30
30 – 88	100	3
88 – 216	150	3
216 - 960	200	3
Above 960	500	3

#### 3.5.2 Measuring Instruments

The section 4.0 of List of Measuring Equipment of this test report is used for test.



### 3.5.3 Test Procedures

1. The testing follows FCC KDB Publication No. 558074 D01 DTS Meas. Guidance v03r05.
2. The EUT was arranged to its worst case and then tune the antenna tower (from 1 m to 4 m) and turntable (from 0 degree to 360 degrees) to find the maximum reading. A pre-amp and a high pass filter are used for the test in order to get better signal level.
3. The EUT was placed on a turntable with 0.8 meter for frequency below 1GHz and 1.5 meter for frequency above 1GHz respectively above ground.
4. The EUT was set 3 meters from the interference receiving antenna, which was mounted on the top of a variable height antenna tower.
5. Corrected Reading: Antenna Factor + Cable Loss + Read Level - Preamp Factor = Level
6. For measurement below 1GHz, If the emission level of the EUT measured by the peak detector is 3 dB lower than the applicable limit, the peak emission level will be reported. Otherwise, the emission measurement will be repeated using the quasi-peak detector and reported.
7. Use the following spectrum analyzer settings:
  - (1) Span shall wide enough to fully capture the emission being measured;
  - (2) Set RBW=100 kHz for  $f < 1$  GHz; VBW  $\geq$  RBW; Sweep = auto; Detector function = peak; Trace = max hold;
  - (3) Set RBW = 1 MHz, VBW= 3MHz for  $f \geq 1$  GHz for peak measurement.  
For average measurement:
    - VBW = 10 Hz, when duty cycle is no less than 98 percent.
    - VBW  $\geq 1/T$ , when duty cycle is less than 98 percent where T is the minimum transmission duration over which the transmitter is on and is transmitting at its maximum power control level for the tested mode of operation.

### 3.5.4 Test Setup

For radiated emissions below 30MHz

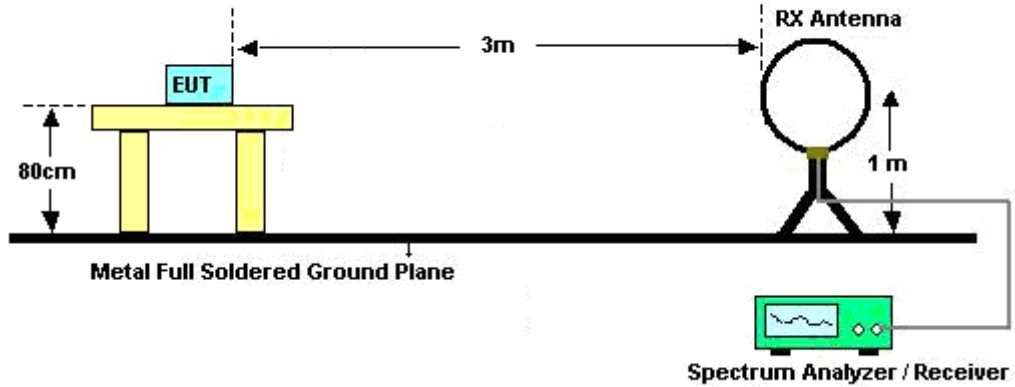

For radiated emissions from 30MHz to 1GHz

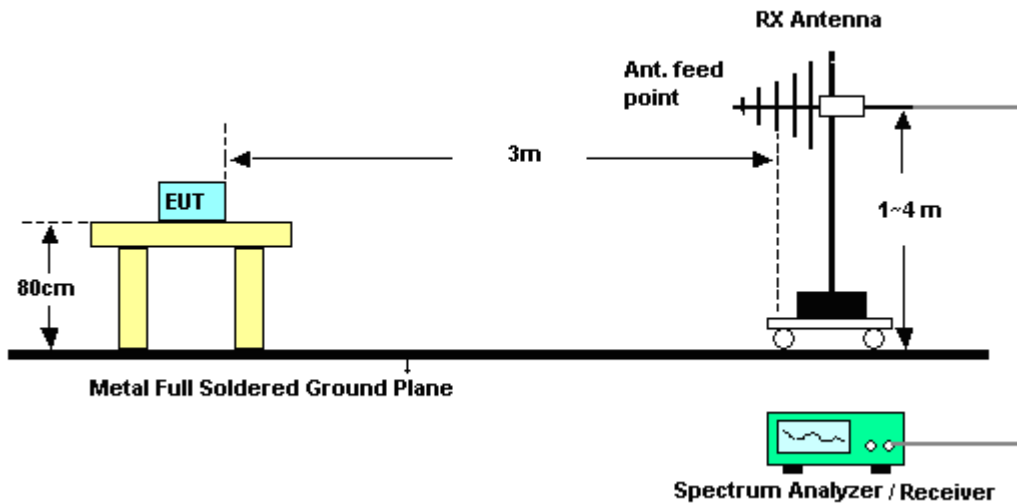

For radiated emissions above 1GHz

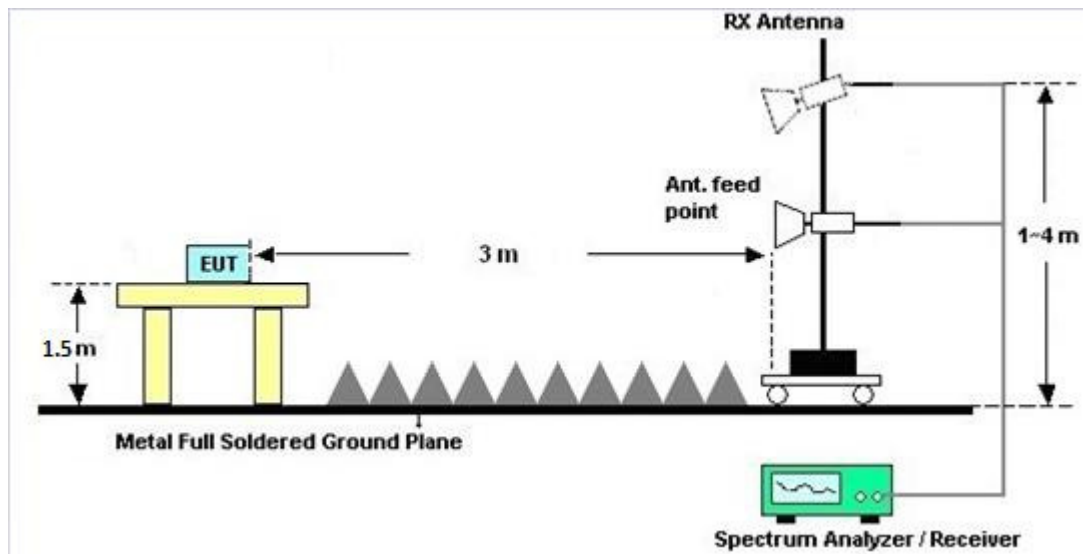

### 3.5.5 Test Results of Radiated Spurious Emissions (9 kHz ~ 30 MHz)

The low frequency, which started from 9 kHz to 30MHz, was pre-scanned and the result which was 20dB lower than the limit line per 15.31(o) was not reported.

### 3.5.6 Test Result of Radiated Spurious at Band Edges

Please refer to Appendix B and C.

### 3.5.7 Duty Cycle

Please refer to Appendix D.

### 3.5.8 Test Result of Radiated Spurious Emission (30MHz ~ 10th Harmonic)

Please refer to Appendix B and C.



### 3.6 AC Conducted Emission Measurement

#### 3.6.1 Limit of AC Conducted Emission

For equipment that is designed to be connected to the public utility (AC) power line, the radio frequency voltage that is conducted back onto the AC power line on any frequency or frequencies within the band 150 kHz to 30 MHz shall not exceed the limits in the following table.

Frequency of emission (MHz)	Conducted limit (dB $\mu$ V)	
	Quasi-peak	Average
0.15-0.5	66 to 56*	56 to 46*
0.5-5	56	46
5-30	60	50

\*Decreases with the logarithm of the frequency.

#### 3.6.2 Measuring Instruments

The section 4.0 of List of Measuring Equipment of this test report is used for test.

#### 3.6.3 Test Procedures

1. The EUT was placed 0.4 meter from the conducting wall of the shielding room was kept at least 80 centimeters from any other grounded conducting surface.
2. Connect EUT to the power mains through a line impedance stabilization network (LISN).
3. All the support units are connecting to the other LISN.
4. The LISN provides 50 ohm coupling impedance for the measuring instrument.
5. The FCC states that a 50 ohm, 50 microhenry LISN should be used.
6. Both sides of AC line were checked for maximum conducted interference.
7. The frequency range from 150 kHz to 30 MHz was searched.
8. Set the test-receiver system to Peak Detect Function and specified bandwidth (IF Bandwidth = 9kHz) with Maximum Hold Mode. Then measurement is also conducted by Average Detector and Quasi-Peak Detector Function respectively.



### 3.6.4 Test Setup

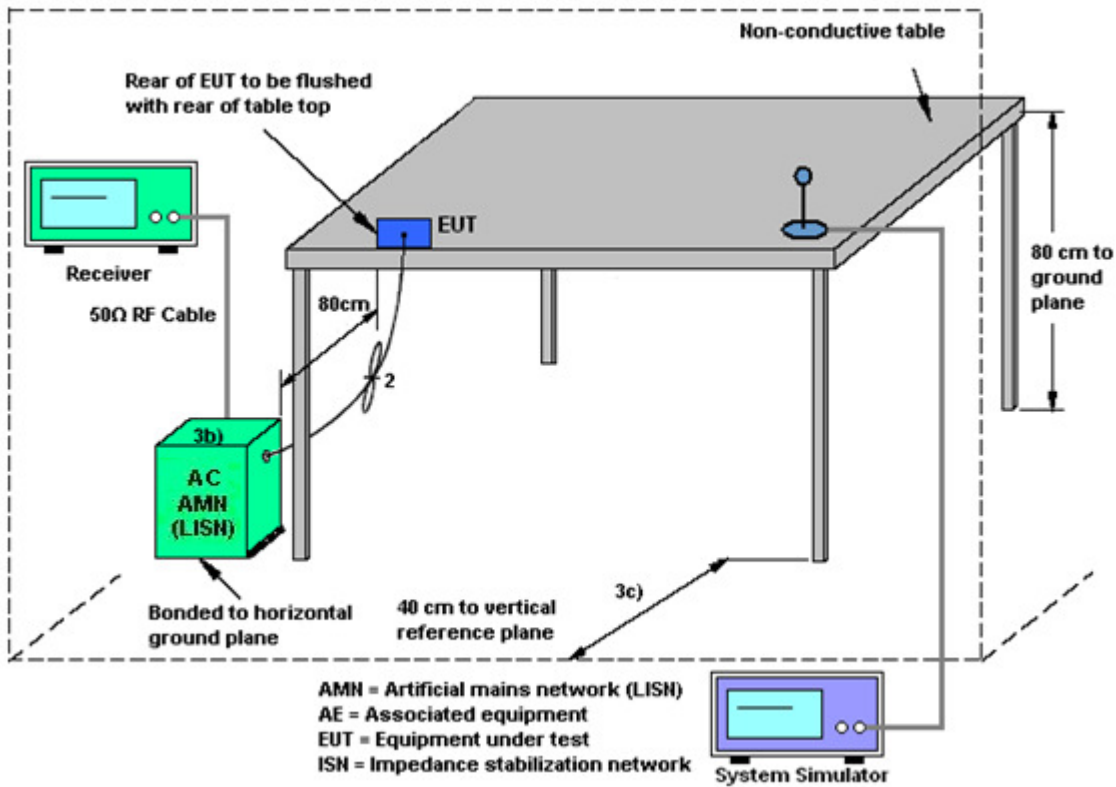



3.6.5 Test Result of AC Conducted Emission

Test Mode :	Mode 1	Temperature :	21~23°C
Test Engineer :	Arthur Hsieh	Relative Humidity :	51~53%
Test Voltage :	120Vac / 60Hz	Phase :	Line
Function Type :	GSM1900 Idle + Bluetooth Link + WLAN (2.4GHz) Link + MP3 + Earphone 1 + Battery + USB Cable (Charging from Adapter 1)		

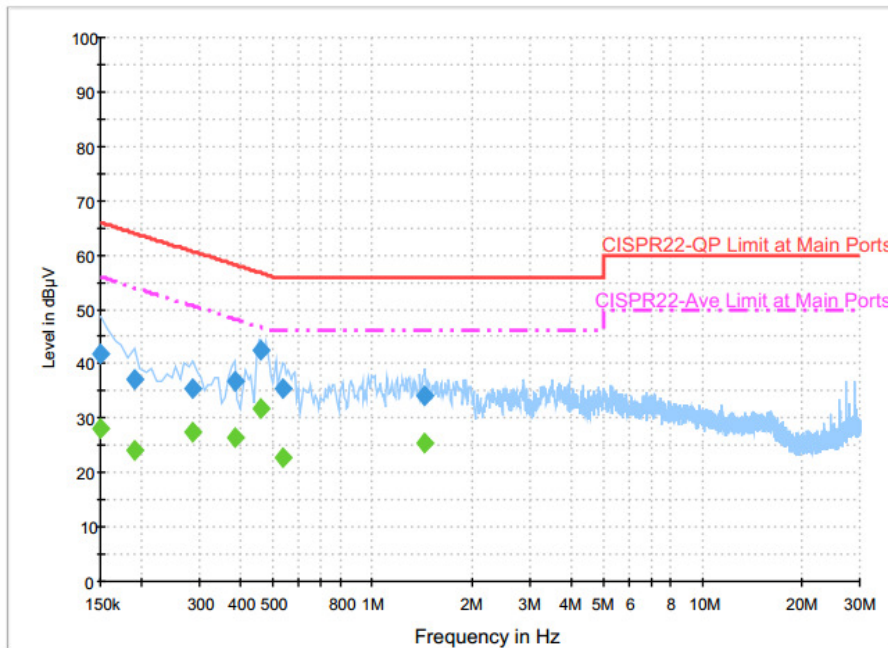

Final Result : Quasi-Peak

Frequency (MHz)	Quasi-Peak (dBµV)	Filter	Line	Corr. (dB)	Margin (dB)	Limit (dBµV)
0.150000	41.9	Off	L1	19.6	24.1	66.0
0.190000	37.0	Off	L1	19.6	27.0	64.0
0.286000	35.4	Off	L1	19.6	25.2	60.6
0.382000	36.7	Off	L1	19.6	21.5	58.2
0.462000	42.6	Off	L1	19.6	14.1	56.7
0.534000	35.5	Off	L1	19.6	20.5	56.0
1.446000	34.0	Off	L1	19.7	22.0	56.0

Final Result : Average

Frequency (MHz)	Average (dBµV)	Filter	Line	Corr. (dB)	Margin (dB)	Limit (dBµV)
0.150000	28.1	Off	L1	19.6	27.9	56.0
0.190000	24.1	Off	L1	19.6	29.9	54.0
0.286000	27.3	Off	L1	19.6	23.3	50.6
0.382000	26.3	Off	L1	19.6	21.9	48.2
0.462000	31.8	Off	L1	19.6	14.9	46.7
0.534000	22.7	Off	L1	19.6	23.3	46.0
1.446000	25.5	Off	L1	19.7	20.5	46.0



Test Mode :	Mode 1	Temperature :	21~23°C
Test Engineer :	Arthur Hsieh	Relative Humidity :	51~53%
Test Voltage :	120Vac / 60Hz	Phase :	Neutral
Function Type :	GSM1900 Idle + Bluetooth Link + WLAN (2.4GHz) Link + MP3 + Earphone 1 + Battery + USB Cable (Charging from Adapter 1)		

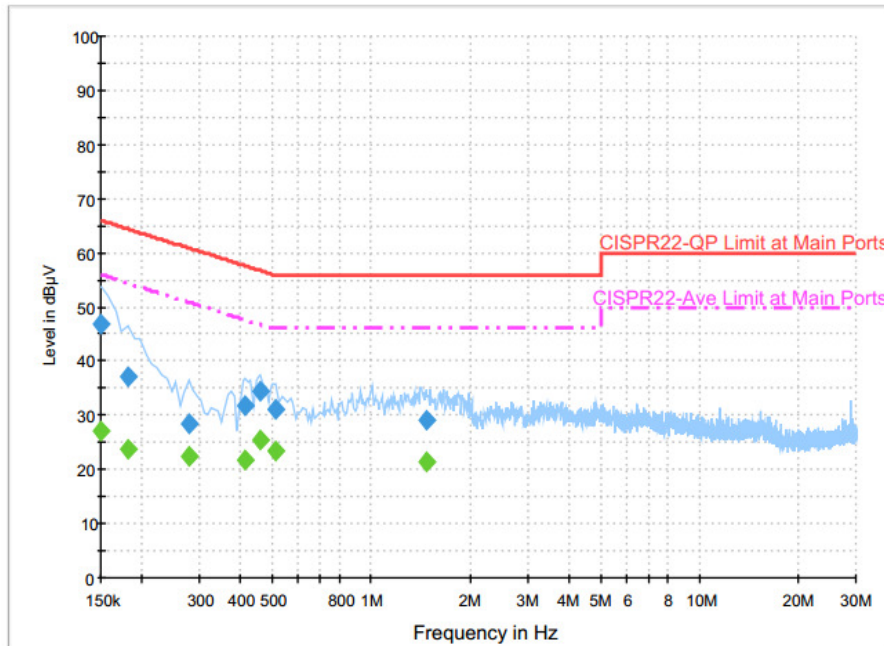

**Final Result : Quasi-Peak**

Frequency (MHz)	Quasi-Peak (dBµV)	Filter	Line	Corr. (dB)	Margin (dB)	Limit (dBµV)
0.150000	46.9	Off	N	19.6	19.1	66.0
0.182000	37.0	Off	N	19.6	27.4	64.4
0.278000	28.3	Off	N	19.6	32.6	60.9
0.414000	31.8	Off	N	19.6	25.8	57.6
0.462000	34.3	Off	N	19.6	22.4	56.7
0.510000	31.2	Off	N	19.6	24.8	56.0
1.470000	29.1	Off	N	19.6	26.9	56.0

**Final Result : Average**

Frequency (MHz)	Average (dBµV)	Filter	Line	Corr. (dB)	Margin (dB)	Limit (dBµV)
0.150000	27.2	Off	N	19.6	28.8	56.0
0.182000	23.6	Off	N	19.6	30.8	54.4
0.278000	22.3	Off	N	19.6	28.6	50.9
0.414000	21.8	Off	N	19.6	25.8	47.6
0.462000	25.5	Off	N	19.6	21.2	46.7
0.510000	23.4	Off	N	19.6	22.6	46.0
1.470000	21.3	Off	N	19.6	24.7	46.0



## **3.7 Antenna Requirements**

### **3.7.1 Standard Applicable**

If directional gain of transmitting antennas is greater than 6dBi, the power shall be reduced by the same level in dB comparing to gain minus 6dBi. The use of a permanently attached antenna or of an antenna that uses a unique coupling to the intentional radiator shall be considered sufficient to comply with the FCC rule.

### **3.7.2 Antenna Anti-Replacement Construction**

An embedded-in antenna design is used.

### **3.7.3 Antenna Gain**

The antenna peak gain of EUT is less than 6 dBi. Therefore, it is not necessary to reduce maximum peak output power limit.



## 4 List of Measuring Equipment

Instrument	Manufacturer	Model No.	Serial No.	Characteristics	Calibration Date	Test Date	Due Date	Remark
Spectrum Analyzer	Rohde & Schwarz	FSP40	100055	9kHz~40GHz	Jun. 17, 2016	Oct. 06, 2016 ~ Nov. 25, 2016	Jun. 16, 2017	Conducted (TH05-HY)
Power Meter	Anritsu	ML2495A	1240001	300MHz~40GHz	Sep. 07, 2016	Oct. 06, 2016 ~ Nov. 25, 2016	Sep. 06, 2017	Conducted (TH05-HY)
Power Meter	Agilent	E4416A	GB41292344	300MHz~40GHz	Jan. 08, 2016	Oct. 06, 2016 ~ Nov. 25, 2016	Jan. 07, 2017	Conducted (TH05-HY)
Power Sensor	Agilent	E9327A	US40441548	300MHz~40GHz	Jan. 07, 2016	Oct. 06, 2016 ~ Nov. 25, 2016	Jan. 06, 2017	Conducted (TH05-HY)
Hygrometer	Testo	608-H2	41410069	N/A	Aug. 28, 2016	Oct. 06, 2016 ~ Nov. 25, 2016	Aug. 27, 2017	Conducted (TH05-HY)
RF Cable	HUBER + SUHNER	SUCOFLEX 104	MY84209521	1GHz~26GHz	Dec. 03, 2015	Oct. 06, 2016 ~ Nov. 25, 2016	Dec. 02, 2016	Conducted (TH05-HY)
AC Power Source	ChainTek	APC-1000W	N/A	N/A	N/A	Oct. 11, 2016	N/A	Conduction (CO05-HY)
EMI Test Receiver	Rohde & Schwarz	ESCI 7	100724	9kHz~7GHz	Aug. 30, 2016	Oct. 11, 2016	Aug. 29, 2017	Conduction (CO05-HY)
Hygrometer	Testo	608-H1	34913912	N/A	Apr. 19, 2016	Oct. 11, 2016	Apr. 18, 2017	Conduction (CO05-HY)
LISN	Rohde & Schwarz	ENV216	100080	9kHz~30MHz	Dec. 02, 2015	Oct. 11, 2016	Dec. 01, 2016	Conduction (CO05-HY)
LF Cable	HUBER + SUHNER	RG-214/U	LF01	N/A	Jan. 06, 2016	Oct. 11, 2016	Jan. 05, 2017	Conduction (CO05-HY)
Test Software	N/A	EMC32	8.40.0	N/A	N/A	Oct. 11, 2016	N/A	Conduction (CO05-HY)
Loop Antenna	Rohde & Schwarz	HFH2-Z2	100315	9 kHz~30 MHz	Sep. 02, 2015	Nov. 22, 2016 ~ Nov. 28, 2016	Sep. 01, 2017	Radiation (03CH12-HY)
Amplifier	SONOMA	310N	187312	9kHz~1GHz	Nov. 10, 2016	Nov. 22, 2016~ Nov. 28, 2016	Nov. 09, 2017	Radiation (03CH12-HY)
Bilog Antenna	TESEQ	CBL 6111D&N-6-06	35414&AT-N0602	30MHz~1GHz	Oct. 15, 2016	Nov. 22, 2016~ Nov. 28, 2016	Oct. 14, 2017	Radiation (03CH12-HY)
Horn Antenna	SCHWARZBECK	BBHA 9120D	9120D-1328	1GHz ~ 18GHz	Oct. 25, 2016	Nov. 22, 2016~ Nov. 28, 2016	Oct. 24, 2017	Radiation (03CH12-HY)
SHF-EHF Horn Antenna	SCHWARZBECK	BBHA 9170	BBHA9170576	18GHz ~ 40GHz	Apr. 15, 2016	Nov. 22, 2016 ~ Nov. 28, 2016	Apr. 14, 2017	Radiation (03CH12-HY)
EMI Test Receiver	Rohde & Schwarz	ESU26	100390	20Hz~26.5GHz	Dec. 21, 2015	Nov. 22, 2016 ~ Nov. 28, 2016	Dec. 20, 2016	Radiation (03CH12-HY)



Instrument	Manufacturer	Model No.	Serial No.	Characteristics	Calibration Date	Test Date	Due Date	Remark
Spectrum Analyzer	Agilent	N9030A	MY523502 76	3Hz~44GHz	Mar. 21, 2016	Nov. 22, 2016 ~ Nov. 28, 2016	Mar. 20, 2017	Radiation (03CH12-HY)
Preamplifier	MITEQ	TTA0204	1872107	2GHz~40GHz	Feb. 15, 2016	Nov. 22, 2016 ~ Nov. 28, 2016	Feb. 14, 2017	Radiation (03CH12-HY)
Preamplifier	MITEQ	AMF-7D-0010 1800-30-10P	1815698	1GHz~18GHz	Dec. 14, 2015	Nov. 22, 2016 ~ Nov. 28, 2016	Dec. 13, 2016	Radiation (03CH12-HY)
Preamplifier	Keysight	83017A	MY532701 48	1GHz~26.5GHz	Jan. 30, 2016	Nov. 22, 2016 ~ Nov. 28, 2016	Jan. 29, 2017	Radiation (03CH12-HY)
Hygrometer	TECEP	DTM-303B	TP140349	N/A	Nov. 14, 2016	Nov. 22, 2016 ~ Nov. 28, 2016	Nov. 13, 2017	Radiation (03CH12-HY)
RF Cable	HUBER + SUHNER	SUCOFLEX 104	MY24958/ 4,MY2865 3/4,MY983 9/4PE	26GHz~40GHz	Jan. 12, 2016	Nov. 22, 2016 ~ Nov. 28, 2016	Jan. 11, 2017	Radiation (03CH12-HY)
RF Cable	HUBER + SUHNER	SUCOFLEX 104	MY24958/ 4,MY2865 3/4,MY983 9/4PE	1GHz~26GHz	Jan. 12, 2016	Nov. 22, 2016 ~ Nov. 28, 2016	Jan. 11, 2017	Radiation (03CH12-HY)
RF Cable	HUBER + SUHNER	SUCOFLEX 104	MY24958/ 4,MY2865 3/4,MY983 9/4PE	30MHz~1GHz	Jan. 12, 2016	Nov. 22, 2016 ~ Nov. 28, 2016	Jan. 11, 2017	Radiation (03CH12-HY)
RF Cable	HUBER + SUHNER	SUCOFLEX 104	MY24958/ 4,MY2865 3/4,MY983 9/4PE	9K~30MHz	Jan. 12, 2016	Nov. 22, 2016 ~ Nov. 28, 2016	Jan. 11, 2017	Radiation (03CH12-HY)
Controller	EMEC	EM1000	N/A	Control Turn table & Ant Mast	N/A	Nov. 22, 2016 ~ Nov. 28, 2016	N/A	Radiation (03CH12-HY)
Antenna Mast	EMEC	AM-BS-4500- B	N/A	1m~4m	N/A	Nov. 22, 2016 ~ Nov. 28, 2016	N/A	Radiation (03CH12-HY)
Turn Table	EMEC	TT2000	N/A	0~360 Degree	N/A	Nov. 22, 2016 ~ Nov. 28, 2016	N/A	Radiation (03CH12-HY)
Test Software	Audix	E3	6.2009-8-2 4	N/A	N/A	Nov. 22, 2016 ~ Nov. 28, 2016	N/A	Radiation (03CH12-HY)
Filter	Wainwright	WLKS1200-1 2SS	SN2	1.2G Low Pass	Sep. 19, 2016	Nov. 22, 2016 ~ Nov. 28, 2016	Sep. 18, 2017	Radiation (03CH12-HY)
Filter	Microwave	H3G018G1	SN477220	3.0G High Pass	Aug. 25, 2016	Nov. 22, 2016 ~ Nov. 28, 2016	Aug. 24, 2017	Radiation (03CH12-HY)



## 5 Uncertainty of Evaluation

### Uncertainty of Conducted Emission Measurement (150 kHz ~ 30 MHz)

Measuring Uncertainty for a Level of Confidence of 95% ( $U = 2Uc(y)$ )	2.70
---	------

### Uncertainty of Radiated Emission Measurement (30 MHz ~ 1000 MHz)

Measuring Uncertainty for a Level of Confidence of 95% ( $U = 2Uc(y)$ )	5.10
---	------

### Uncertainty of Radiated Emission Measurement (1000 MHz ~ 18000 MHz)

Measuring Uncertainty for a Level of Confidence of 95% ( $U = 2Uc(y)$ )	5.20
---	------

### Uncertainty of Radiated Emission Measurement (18000 MHz ~ 40000 MHz)

Measuring Uncertainty for a Level of Confidence of 95% ( $U = 2Uc(y)$ )	4.70
---	------



## **Appendix A. Conducted Test Results**



**Bluetooth Low Energy**

Test Engineer:	Tommy Lee	Temperature:	21~25	°C
Test Date:	2016/10/06~11/25	Relative Humidity:	51~54	%

**TEST RESULTS DATA**  
**6dB and 99% Occupied Bandwidth**

Mod.	Data Rate	NTX	CH.	Freq. (MHz)	99% Occupied BW (MHz)	6dB BW (MHz)	6dB BW Limit (MHz)	Pass/Fail
BLE	1Mbps	1	0	2402	1.030	0.708	0.50	Pass
BLE	1Mbps	1	19	2440	1.028	0.704	0.50	Pass
BLE	1Mbps	1	39	2480	1.026	0.708	0.50	Pass

**TEST RESULTS DATA**  
**Peak Power Table**

Mod.	Data Rate	NTX	CH.	Freq. (MHz)	Peak Conducted Power (dBm)	Conducted Power Limit (dBm)	DG (dBi)	EIRP Power (dBm)	EIRP Power Limit (dBm)	Pass /Fail
BLE	1Mbps	1	0	2402	0.84	30.00	-0.80	0.04	36.00	Pass
BLE	1Mbps	1	19	2440	1.86	30.00	-0.80	1.06	36.00	Pass
BLE	1Mbps	1	39	2480	0.90	30.00	-0.80	0.10	36.00	Pass

**TEST RESULTS DATA**  
**Average Power Table**  
**(Reporting Only)**

Mod.	Data Rate	NTX	CH.	Freq. (MHz)	Duty Factor (dB)	Average Conducted Power (dBm)
BLE	1Mbps	1	0	2402	2.18	-1.98
BLE	1Mbps	1	19	2440	2.18	-0.29
BLE	1Mbps	1	39	2480	2.18	-1.93

**TEST RESULTS DATA**  
**Peak Power Density**

Mod.	Data Rate	NTX	CH.	Freq. (MHz)	Peak PSD (dBm /100kHz)	Peak PSD (dBm /3kHz)	DG (dBi)	Peak PSD Limit (dBm /3kHz)	Pass/Fail
BLE	1Mbps	1	0	2402	-3.08	-17.65	-0.80	8.00	Pass
BLE	1Mbps	1	19	2440	-1.18	-15.78	-0.80	8.00	Pass
BLE	1Mbps	1	39	2480	-3.08	-17.70	-0.80	8.00	Pass

Note: PSD (dBm/ 100kHz) is a reference level used for Conducted Band Edges and Conducted Spurious Emission 20dBc limit.



## Appendix B. Radiated Spurious Emission

Test Engineer :	Peter Chiu, Karl Hou, Nick Yu, and Citta Ke	Temperature :	21~23°C
		Relative Humidity :	54~58%

2.4GHz 2400~2483.5MHz

BLE (Band Edge @ 3m)

BLE	Note	Frequency ( MHz )	Level ( dBμV/m )	Over Limit ( dB )	Limit Line ( dBμV/m )	Read Level ( dBμV )	Antenna Factor ( dB/m )	Cable Loss ( dB )	Preamp Factor ( dB )	Ant Pos ( cm )	Table Pos ( deg )	Peak Avg. (P/A)	Pol. (H/V)	
BLE CH 00 2402MHz		2354.415	53.74	-20.26	74	50.91	26.96	7.37	31.5	106	274	P	H	
		2348.85	43.31	-10.69	54	40.49	26.95	7.37	31.5	106	274	A	H	
	*	2402	93.65	-	-	90.58	27.11	7.45	31.49	106	274	P	H	
	*	2402	92.7	-	-	89.63	27.11	7.45	31.49	106	274	A	H	
													H	
														H
			2314.725	54.5	-19.5	74	51.87	26.84	7.3	31.51	281	280	P	V
			2389.485	43.24	-10.76	54	40.21	27.07	7.45	31.49	281	280	A	V
	*		2402	88.78	-	-	85.71	27.11	7.45	31.49	281	280	P	V
	*		2402	86.53	-	-	83.46	27.11	7.45	31.49	281	280	A	V
														V
														V
BLE CH 19 2440MHz		2352.14	54.35	-19.65	74	51.52	26.96	7.37	31.5	108	275	P	H	
		2389.8	43.29	-10.71	54	40.26	27.07	7.45	31.49	108	275	A	H	
	*	2440	95.69	-	-	92.46	27.22	7.49	31.48	108	275	P	H	
	*	2440	93.79	-	-	90.56	27.22	7.49	31.48	108	275	A	H	
			2484.18	54.25	-19.75	74	50.84	27.35	7.53	31.47	108	275	P	H
			2494.47	43.64	-10.36	54	40.19	27.38	7.53	31.46	108	275	A	H
			2359	54.28	-19.72	74	51.43	26.98	7.37	31.5	270	276	P	V
			2370.48	43.19	-10.81	54	40.3	27.01	7.37	31.49	270	276	A	V
	*		2440	90.66	-	-	87.43	27.22	7.49	31.48	270	276	P	V
	*		2440	89.69	-	-	86.46	27.22	7.49	31.48	270	276	A	V
			2489.99	54.14	-19.86	74	50.71	27.37	7.53	31.47	270	276	P	V
			2499.86	43.63	-10.37	54	40.16	27.4	7.53	31.46	270	276	A	V



<b>BLE CH 39 2480MHz</b>	*	2480	93.52	-	-	90.12	27.34	7.53	31.47	100	274	P	H
	*	2480	90.14	-	-	86.74	27.34	7.53	31.47	100	274	A	H
		2496.84	54.82	-19.18	74	51.36	27.39	7.53	31.46	100	274	P	H
		2493.08	43.63	-10.37	54	40.18	27.38	7.53	31.46	100	274	A	H
													H
													H
	*	2480	88.04	-	-	84.64	27.34	7.53	31.47	197	284	P	V
	*	2480	86.89	-	-	83.49	27.34	7.53	31.47	197	284	A	V
		2499	56.43	-17.57	74	52.96	27.4	7.53	31.46	197	284	P	V
		2485.16	43.56	-10.44	54	40.14	27.36	7.53	31.47	197	284	A	V
													V
													V
<b>Remark</b>	<ol style="list-style-type: none"> <li>1. No other spurious found.</li> <li>2. All results are PASS against Peak and Average limit line.</li> </ol>												



2.4GHz 2400~2483.5MHz

BLE (Harmonic @ 3m)

BLE	Note	Frequency ( MHz )	Level ( dBμV/m )	Over Limit ( dB )	Limit Line ( dBμV/m )	Read Level ( dBμV )	Antenna Factor ( dB/m )	Cable Loss ( dB )	Preamp Factor ( dB )	Ant Pos ( cm )	Table Pos ( deg )	Peak Avg. ( P/A )	Pol. ( H/V )	
BLE CH 00 2402MHz		4804	38.62	-35.38	74	54.03	32.15	10.59	58.15	100	0	P	H	
													H	
													H	
													H	
			4804	38.06	-35.94	74	53.47	32.15	10.59	58.15	100	0	P	V
														V
														V
BLE CH 19 2440MHz		4880	38.51	-35.49	74	53.44	32.28	10.89	58.1	100	0	P	H	
		7320	42.42	-31.58	74	50.34	37	14.18	59.1	100	0	P	H	
													H	
													H	
			4880	38.37	-35.63	74	53.3	32.28	10.89	58.1	100	0	P	V
			7320	44.02	-29.98	74	51.94	37	14.18	59.1	100	0	P	V
														V
BLE CH 39 2480MHz		4960	39.17	-34.83	74	53.58	32.43	11.19	58.03	100	0	P	H	
		7440	44.17	-29.83	74	51.69	37.33	14.32	59.17	100	0	P	H	
													H	
													H	
			4960	38.36	-35.64	74	52.77	32.43	11.19	58.03	100	0	P	V
			7440	43.45	-30.55	74	50.97	37.33	14.32	59.17	100	0	P	V
														V
Remark	1. No other spurious found.													
	2. All results are PASS against Peak and Average limit line.													



Emission below 1GHz

2.4GHz BLE (LF)

BLE	Note	Frequency	Level	Over	Limit	Read	Antenna	Cable	Preamp	Ant	Table	Peak	Pol.	
		( MHz )	( dBμV/m )	( dB )	( dBμV/m )	( dBμV )	( dB/m )	( dB )	( dB )	( cm )	( deg )	( P/A )	( H/V )	
2.4GHz BLE LF		100.47	21.97	-21.53	43.5	36.86	16.11	1.43	32.43			P	H	
		150.96	29.56	-13.94	43.5	42.78	17.45	1.75	32.42	100	0	P	H	
		238.44	25.92	-20.08	46	38.92	17.51	1.83	32.34			P	H	
		513.5	25.2	-20.8	46	30.28	24.13	3.19	32.4			P	H	
		659.1	27.16	-18.84	46	29.88	26.08	3.61	32.41			P	H	
		867.7	31.06	-14.94	46	29.67	28.71	4.45	31.77			P	H	
														H
														H
														H
														H
														H
														H
			30.81	32.43	-7.57	40	38.85	25.26	0.78	32.46	100	0	P	V
			84.81	27.62	-12.38	40	44.75	14.25	1.06	32.44			P	V
			150.96	24.31	-19.19	43.5	37.53	17.45	1.75	32.42			P	V
			444.2	24.29	-21.71	46	30.78	23	2.89	32.38			P	V
			484.1	24.3	-21.7	46	29.91	23.71	3.08	32.4			P	V
			715.1	31.18	-14.82	46	32.92	26.75	3.89	32.38			P	V
														V
														V
													V	
													V	
													V	
													V	
Remark	1. No other spurious found. 2. All results are PASS against limit line.													



**Note symbol**

*	<b>Fundamental Frequency</b> which can be ignored. However, the level of any unwanted emissions shall not exceed the level of the fundamental frequency.
!	Test result is <b>over limit</b> line.
P/A	<b>Peak</b> or <b>Average</b>
H/V	<b>Horizontal</b> or <b>Vertical</b>



A calculation example for radiated spurious emission is shown as below:

WIFI	Note	Frequency	Level	Over	Limit	Read	Antenna	Cable	Preamp	Ant	Table	Peak	Pol.
Ant.				Limit	Line	Level	Factor	Loss	Factor	Pos	Pos	Avg.	
1+2		( MHz )	( dBμV/m )	( dB )	( dBμV/m )	( dBμV )	( dB/m )	( dB )	( dB )	( cm )	( deg )	( P/A )	( H/V )
802.11b		2390	55.45	-18.55	74	54.51	32.22	4.58	35.86	103	308	P	H
CH 01													
2412MHz		2390	43.54	-10.46	54	42.6	32.22	4.58	35.86	103	308	A	H

- Level(dBμV/m) =  
Antenna Factor(dB/m) + Cable Loss(dB) + Read Level(dBμV) - Preamp Factor(dB)
- Over Limit(dB) = Level(dBμV/m) – Limit Line(dBμV/m)

**For Peak Limit @ 2390MHz:**

- Level(dBμV/m)  
= Antenna Factor(dB/m) + Cable Loss(dB) + Read Level(dBμV) - Preamp Factor(dB)  
= 32.22(dB/m) + 4.58(dB) + 54.51(dBμV) – 35.86 (dB)  
= 55.45 (dBμV/m)
- Over Limit(dB)  
= Level(dBμV/m) – Limit Line(dBμV/m)  
= 55.45(dBμV/m) – 74(dBμV/m)  
= -18.55(dB)

**For Average Limit @ 2390MHz:**

- Level(dBμV/m)  
= Antenna Factor(dB/m) + Cable Loss(dB) + Read Level(dBμV) - Preamp Factor(dB)  
= 32.22(dB/m) + 4.58(dB) + 42.6(dBμV) – 35.86 (dB)  
= 43.54 (dBμV/m)
- Over Limit(dB)  
= Level(dBμV/m) – Limit Line(dBμV/m)  
= 43.54(dBμV/m) – 54(dBμV/m)  
= -10.46(dB)

**Both peak and average measured complies with the limit line, so test result is “PASS”.**



## Appendix C. Radiated Spurious Emission

<b>Test Engineer :</b>	Peter Chiu, Karl Hou, Nick Yu, and Citta Ke	<b>Temperature :</b>	21~23°C
		<b>Relative Humidity :</b>	54~58%

### Note symbol

-L	Low channel location
-R	High channel location





2.4GHz 2400~2483.5MHz

BLE (Band Edge @ 3m)

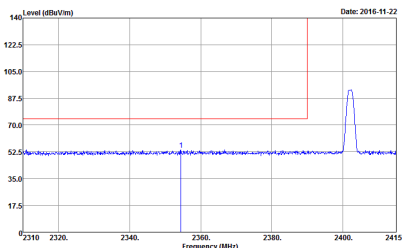
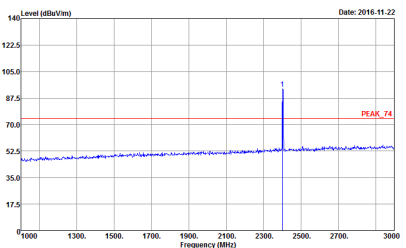
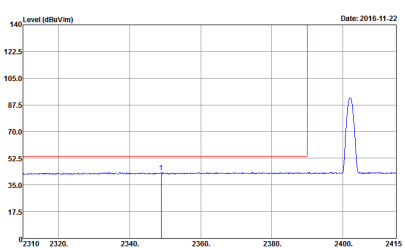
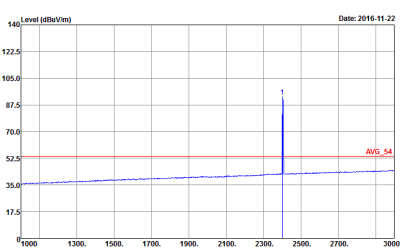
BLE	2.4GHz 2400~2483.5MHz Band Edge @ 3m	
ANT	BLE CH00 2402MHz	
1	Horizontal	Fundamental
Peak	 <p>Site Condition : 03CH12-HY : PEAK_BE_74 3m HORN_9120D_1328 HORIZONTAL</p>	 <p>Site Condition : 03CH12-HY : PEAK_74 3m HORN_9120D_1328 HORIZONTAL</p>
Avg.	 <p>Site Condition : 03CH12-HY : AVG_BE_54 3m HORN_9120D_1328 HORIZONTAL</p>	 <p>Site Condition : 03CH12-HY : AVG_54 3m HORN_9120D_1328 HORIZONTAL</p>



BLE	2.4GHz 2400~2483.5MHz Band Edge @ 3m	
ANT	BLE CH00 2402MHz	
1	Vertical	Fundamental
Peak	<p>Site Condition : 03CH12-HY : PEAK_BE_74 3m HORN_9120D_1328 VERTICAL</p>	<p>Site Condition : 03CH12-HY : PEAK_74 3m HORN_9120D_1328 VERTICAL</p>
Avg	<p>Site Condition : 03CH12-HY : AVG_BE_54 3m HORN_9120D_1328 VERTICAL</p>	<p>Site Condition : 03CH12-HY : AVG_54 3m HORN_9120D_1328 VERTICAL</p>



BLE	2.4GHz 2400~2483.5MHz Band Edge @ 3m	
ANT	BLE CH19 2440MHz - L	
1	Horizontal	Fundamental
Peak	<p>Site Condition : 03CH12-HY : PEAK_BE_74 3m HORN_9120D_1328 HORIZONTAL</p>	<p>Site Condition : 03CH12-HY : PEAK_74 3m HORN_9120D_1328 HORIZONTAL</p>
Avg.	<p>Site Condition : 03CH12-HY : AVG_BE_54 3m HORN_9120D_1328 HORIZONTAL</p>	<p>Site Condition : 03CH12-HY : AVG_54 3m HORN_9120D_1328 HORIZONTAL</p>

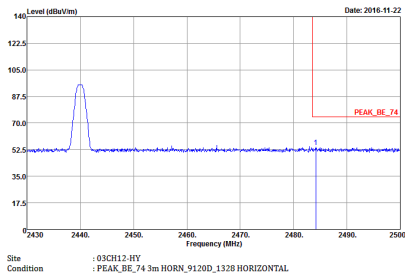
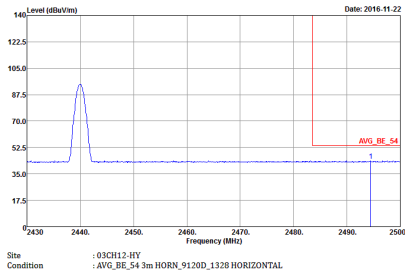

BLE	2.4GHz 2400~2483.5MHz Band Edge @ 3m	
ANT	BLE CH19 2440MHz - R	
1	Horizontal	Fundamental
Peak		Left blank
Avg.		Left blank

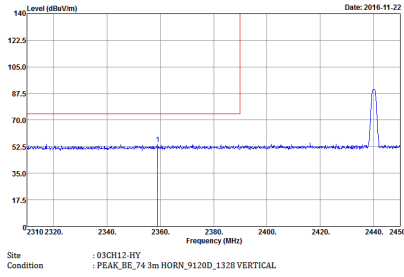
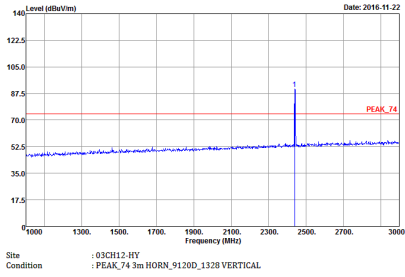
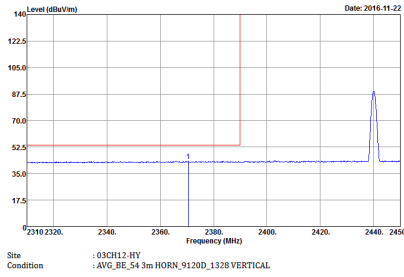
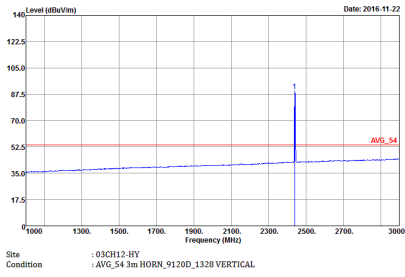

BLE	2.4GHz 2400~2483.5MHz Band Edge @ 3m	
ANT	BLE CH19 2440MHz - L	
1	Vertical	Fundamental
Peak	 <p>Site Condition : 03CH12-HY : PEAK_BE_74 3m HORN_9120D_1328 VERTICAL</p>	 <p>Site Condition : 03CH12-HY : PEAK_74 3m HORN_9120D_1328 VERTICAL</p>
Avg.	 <p>Site Condition : 03CH12-HY : AVG_BE_54 3m HORN_9120D_1328 VERTICAL</p>	 <p>Site Condition : 03CH12-HY : AVG_54 3m HORN_9120D_1328 VERTICAL</p>

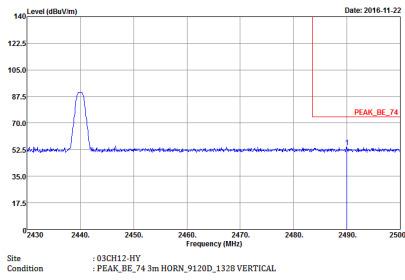
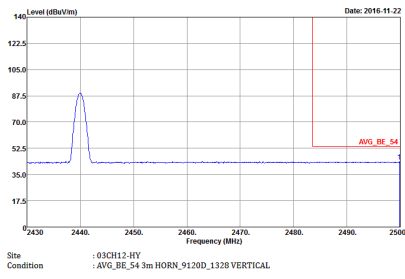

BLE	2.4GHz 2400~2483.5MHz Band Edge @ 3m	
ANT	BLE CH19 2440MHz - R	
1	Vertical	Fundamental
Peak	 <p>Site Condition : 03CH12-HY : PEAK_BE_74 3m HORN_9120D_1328 VERTICAL</p>	Left blank
Avg.	 <p>Site Condition : 03CH12-HY : AVG_BE_54 3m HORN_9120D_1328 VERTICAL</p>	Left blank



BLE	2.4GHz 2400~2483.5MHz Band Edge @ 3m	
ANT	BLE CH39 2480MHz	
1	Horizontal	Fundamental
Peak	<p>Site Condition : 03CH12-HY : PEAK_BE_74 3m HORN_9120D_1328 HORIZONTAL</p>	<p>Site Condition : 03CH12-HY : PEAK_74 3m HORN_9120D_1328 HORIZONTAL</p>
Avg.	<p>Site Condition : 03CH12-HY : AVG_BE_54 3m HORN_9120D_1328 HORIZONTAL</p>	<p>Site Condition : 03CH12-HY : AVG_54 3m HORN_9120D_1328 HORIZONTAL</p>



BLE	2.4GHz 2400~2483.5MHz Band Edge @ 3m	
ANT	BLE CH39 2480MHz	
1	Vertical	Fundamental
Peak	<p>Site Condition : 03CH12-HY : PEAK_BE_74 3m HORN_9120D_1328 VERTICAL</p>	<p>Site Condition : 03CH12-HY : PEAK_74 3m HORN_9120D_1328 VERTICAL</p>
Avg.	<p>Site Condition : 03CH12-HY : AVG_BE_54 3m HORN_9120D_1328 VERTICAL</p>	<p>Site Condition : 03CH12-HY : AVG_54 3m HORN_9120D_1328 VERTICAL</p>





2.4GHz 2400~2483.5MHz

BLE (Harmonic @ 3m)

BLE	2.4GHz 2400~2483.5MHz Harmonic @ 3m	
ANT	BLE CH00 2402MHz	
1	Horizontal	Vertical
<p>Peak Avg.</p>	<p>Site Condition : 03CH12-HY : PEAK_74 3m HORN_9120D_1328 HORIZONTAL</p>	<p>Site Condition : 03CH12-HY : PEAK_74 3m HORN_9120D_1328 VERTICAL</p>



BLE	2.4GHz 2400~2483.5MHz Harmonic @ 3m	
ANT	BLE CH19 2440MHz	
1	Horizontal	Vertical
Peak Avg.	<p>Site Condition : 03CH12-HY : PEAK_74 3m HORN_9120D_1328 HORIZONTAL</p>	<p>Site Condition : 03CH12-HY : PEAK_74 3m HORN_9120D_1328 VERTICAL</p>

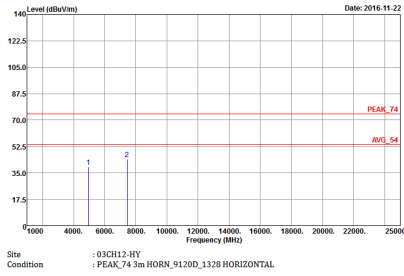
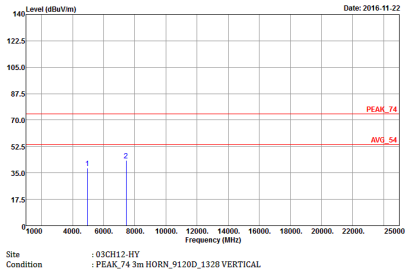

BLE	2.4GHz 2400~2483.5MHz Harmonic @ 3m	
ANT	BLE CH39 2480MHz	
1	Horizontal	Vertical
Peak	 <p>Horizontal spectrum plot showing Level (dBuV/m) vs Frequency (MHz). The plot includes two peaks labeled 1 and 2. The y-axis ranges from 0 to 140 dBuV/m, and the x-axis ranges from 0 to 25000 MHz. Two horizontal lines are present: PEAK_74 at approximately 75 dBuV/m and AVG_54 at approximately 55 dBuV/m. The date is 2016-11-22.</p> <p>Site Condition : 03CH12-HY : PEAK_74 3m HORN_9120D_1328 HORIZONTAL</p>	 <p>Vertical spectrum plot showing Level (dBuV/m) vs Frequency (MHz). The plot includes two peaks labeled 1 and 2. The y-axis ranges from 0 to 140 dBuV/m, and the x-axis ranges from 0 to 25000 MHz. Two horizontal lines are present: PEAK_74 at approximately 75 dBuV/m and AVG_54 at approximately 55 dBuV/m. The date is 2016-11-22.</p> <p>Site Condition : 03CH12-HY : PEAK_74 3m HORN_9120D_1328 VERTICAL</p>



Emission below 1GHz

2.4GHz BLE (LF)

BLE	2.4GHz 2400~2483.5MHz	
ANT	BLE LF	
1	Horizontal	Vertical
QP / Peak	<p>Site : 03CH12-HY Condition : QP 3m BILOG_6111D_37059 HORIZONTAL</p>	<p>Site : 03CH12-HY Condition : QP 3m BILOG_6111D_37059 VERTICAL</p>



## Appendix D. Duty Cycle Plots

Band	Duty Cycle(%)	T(us)	1/T(kHz)	VBW Setting
Bluetooth -LE	66.5	380	2.63	3kHz

### Bluetooth - LE

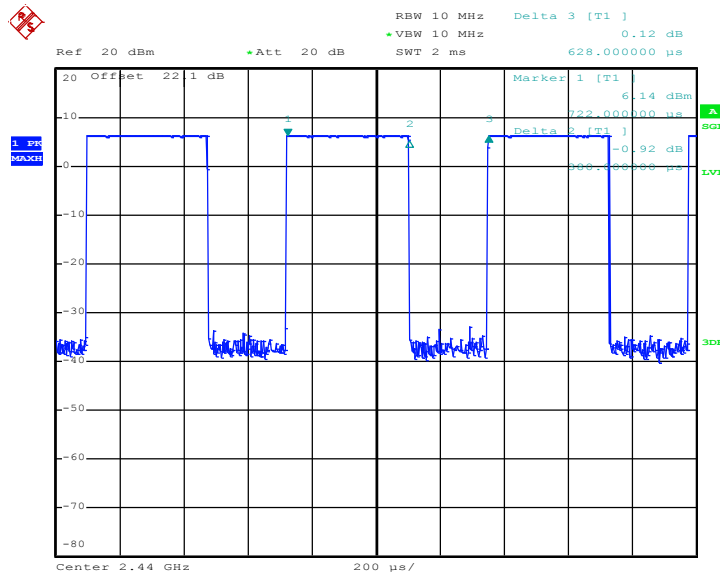

Date: 6.OCT.2016 15:56:07