



Accredited by the Swiss Accreditation Service (SAS)
 The Swiss Accreditation Service is one of the signatories to the EA
 Multilateral Agreement for the recognition of calibration certificates

Accreditation No.: **SCS 0108**

Client **Element**

Certificate No **EX-7639_Nov22**

CALIBRATION CERTIFICATE

Object **EX3DV4 - SN:7639**

Calibration procedure(s) **QA CAL-01.v9, QA CAL-12.v9, QA CAL-14.v6, QA CAL-23.v5, QA CAL-25.v7**
 Calibration procedure for dosimetric E-field probes

Calibration date **November 14, 2022**

This calibration certificate documents the traceability to national standards, which realize the physical units of measurements (SI).
 The measurements and the uncertainties with confidence probability are given on the following pages and are part of the certificate.

All calibrations have been conducted in the closed laboratory facility: environment temperature (22 ± 3) °C and humidity < 70%.

Calibration Equipment used (M&TE critical for calibration)

ATM
 12/6/22

| Primary Standards | ID | Cal Date (Certificate No.) | Scheduled Calibration |
|----------------------------|------------------|-----------------------------------|-----------------------|
| Power meter NRP | SN: 104778 | 04-Apr-22 (No. 217-03525/03524) | Apr-23 |
| Power sensor NRP-Z91 | SN: 103244 | 04-Apr-22 (No. 217-03524) | Apr-23 |
| OCP DAK-3.5 (weighted) | SN: 1249 | 20-Oct-22 (OCP-DAK3.5-1249_Oct22) | Oct-23 |
| OCP DAK-12 | SN: 1016 | 20-Oct-22 (OCP-DAK12-1016_Oct22) | Oct-23 |
| Reference 20 dB Attenuator | SN: CC2552 (20x) | 04-Apr-22 (No. 217-03527) | Apr-23 |
| DAE4 | SN: 660 | 10-Oct-22 (No. DAE4-660_Oct22) | Oct-23 |
| Reference Probe ES3DV2 | SN: 3013 | 27-Dec-21 (No. ES3-3013_Dec21) | Dec-22 |

| Secondary Standards | ID | Check Date (in house) | Scheduled Check |
|-------------------------|------------------|-----------------------------------|------------------------|
| Power meter E4419B | SN: GB41293874 | 06-Apr-16 (in house check Jun-22) | In house check: Jun-24 |
| Power sensor E4412A | SN: MY41498087 | 06-Apr-16 (in house check Jun-22) | In house check: Jun-24 |
| Power sensor E4412A | SN: 000110210 | 06-Apr-16 (in house check Jun-22) | In house check: Jun-24 |
| RF generator HP 8648C | SN: US3642U01700 | 04-Aug-99 (in house check Jun-22) | In house check: Jun-24 |
| Network Analyzer E8358A | SN: US41080477 | 31-Mar-14 (in house check Oct-22) | In house check: Oct-24 |

| | Name | Function | Signature |
|---------------|-----------------|-----------------------|-----------|
| Calibrated by | Jeffrey Katzman | Laboratory Technician | |
| Approved by | Sven Kühn | Technical Manager | |

Issued: November 18, 2022

This calibration certificate shall not be reproduced except in full without written approval of the laboratory.

Calibration Laboratory of

Schmid & Partner
Engineering AG

Zeughausstrasse 43, 8004 Zurich, Switzerland



S Schweizerischer Kalibrierdienst
C Service suisse d'étalonnage
S Servizio svizzero di taratura
S Swiss Calibration Service

Accredited by the Swiss Accreditation Service (SAS)

The Swiss Accreditation Service is one of the signatories to the EA
Multilateral Agreement for the recognition of calibration certificates

Accreditation No.: **SCS 0108**

Glossary

| | |
|--------------------------|--|
| TSL | tissue simulating liquid |
| NORM _{x,y,z} | sensitivity in free space |
| ConvF | sensitivity in TSL / NORM _{x,y,z} |
| DCP | diode compression point |
| CF | crest factor (1/duty_cycle) of the RF signal |
| A, B, C, D | modulation dependent linearization parameters |
| Polarization φ | φ rotation around probe axis |
| Polarization ϑ | ϑ rotation around an axis that is in the plane normal to probe axis (at measurement center), i.e., $\vartheta = 0$ is normal to probe axis |
| Connector Angle | information used in DASYS system to align probe sensor X to the robot coordinate system |

Calibration is Performed According to the Following Standards:

- IEC/IEEE 62209-1528, "Measurement Procedure For The Assessment Of Specific Absorption Rate Of Human Exposure To Radio Frequency Fields From Hand-Held And Body-Worn Wireless Communication Devices – Part 1528: Human Models, Instrumentation And Procedures (Frequency Range of 4 MHz to 10 GHz)", October 2020.
- KDB 865664, "SAR Measurement Requirements for 100 MHz to 6 GHz"

Methods Applied and Interpretation of Parameters:

- NORM_{x,y,z}**: Assessed for E-field polarization $\vartheta = 0$ ($f \leq 900$ MHz in TEM-cell; $f > 1800$ MHz: R22 waveguide). NORM_{x,y,z} are only intermediate values, i.e., the uncertainties of NORM_{x,y,z} does not affect the E²-field uncertainty inside TSL (see below ConvF).
- NORM(f)_{x,y,z}** = NORM_{x,y,z} * frequency_response (see Frequency Response Chart). This linearization is implemented in DASYS4 software versions later than 4.2. The uncertainty of the frequency response is included in the stated uncertainty of ConvF.
- DCP_{x,y,z}**: DCP are numerical linearization parameters assessed based on the data of power sweep with CW signal. DCP does not depend on frequency nor media.
- PAR**: PAR is the Peak to Average Ratio that is not calibrated but determined based on the signal characteristics
- A_{x,y,z}; B_{x,y,z}; C_{x,y,z}; D_{x,y,z}; VR_{x,y,z}; A, B, C, D** are numerical linearization parameters assessed based on the data of power sweep for specific modulation signal. The parameters do not depend on frequency nor media. VR is the maximum calibration range expressed in RMS voltage across the diode.
- ConvF and Boundary Effect Parameters**: Assessed in flat phantom using E-field (or Temperature Transfer Standard for $f \leq 800$ MHz) and inside waveguide using analytical field distributions based on power measurements for $f > 800$ MHz. The same setups are used for assessment of the parameters applied for boundary compensation (alpha, depth) of which typical uncertainty values are given. These parameters are used in DASYS4 software to improve probe accuracy close to the boundary. The sensitivity in TSL corresponds to NORM_{x,y,z} * ConvF whereby the uncertainty corresponds to that given for ConvF. A frequency dependent ConvF is used in DASYS version 4.4 and higher which allows extending the validity from ± 50 MHz to ± 100 MHz.
- Spherical isotropy (3D deviation from isotropy)**: in a field of low gradients realized using a flat phantom exposed by a patch antenna.
- Sensor Offset**: The sensor offset corresponds to the offset of virtual measurement center from the probe tip (on probe axis). No tolerance required.
- Connector Angle**: The angle is assessed using the information gained by determining the NORM_x (no uncertainty required).

Parameters of Probe: EX3DV4 - SN:7639

Basic Calibration Parameters

| | Sensor X | Sensor Y | Sensor Z | Unc ($k = 2$) |
|---|----------|----------|----------|-----------------|
| Norm ($\mu\text{V}/(\text{V}/\text{m})^2$) ^A | 0.63 | 0.63 | 0.63 | $\pm 10.1\%$ |
| DCP (mV) ^B | 111.5 | 112.0 | 110.4 | $\pm 4.7\%$ |

Calibration Results for Modulation Response

| UID | Communication System Name | | A dB | B dB $\sqrt{\mu\text{V}}$ | C | D dB | VR mV | Max dev. | Max Unc ^E $k = 2$ |
|-------|-----------------------------|---|---------|------------------------------|-------|---------|----------|-------------|------------------------------------|
| 0 | CW | X | 0.00 | 0.00 | 1.00 | 0.00 | 162.6 | $\pm 3.0\%$ | $\pm 4.7\%$ |
| | | Y | 0.00 | 0.00 | 1.00 | | 148.7 | | |
| | | Z | 0.00 | 0.00 | 1.00 | | 160.5 | | |
| 10352 | Pulse Waveform (200Hz, 10%) | X | 1.38 | 60.00 | 6.02 | 10.00 | 60.0 | $\pm 3.3\%$ | $\pm 9.6\%$ |
| | | Y | 1.60 | 60.86 | 6.26 | | 60.0 | | |
| | | Z | 1.85 | 62.33 | 7.54 | | 60.0 | | |
| 10353 | Pulse Waveform (200Hz, 20%) | X | 0.86 | 60.00 | 4.93 | 6.99 | 80.0 | $\pm 2.6\%$ | $\pm 9.6\%$ |
| | | Y | 0.89 | 60.00 | 4.87 | | 80.0 | | |
| | | Z | 0.85 | 60.00 | 5.46 | | 80.0 | | |
| 10354 | Pulse Waveform (200Hz, 40%) | X | 0.19 | 137.07 | 0.00 | 3.98 | 95.0 | $\pm 2.8\%$ | $\pm 9.6\%$ |
| | | Y | 0.52 | 60.00 | 3.78 | | 95.0 | | |
| | | Z | 4.00 | 68.00 | 7.00 | | 95.0 | | |
| 10355 | Pulse Waveform (200Hz, 60%) | X | 8.83 | 157.69 | 19.63 | 2.22 | 120.0 | $\pm 1.9\%$ | $\pm 9.6\%$ |
| | | Y | 12.11 | 155.03 | 1.83 | | 120.0 | | |
| | | Z | 10.78 | 155.68 | 9.61 | | 120.0 | | |
| 10387 | QPSK Waveform, 1 MHz | X | 0.46 | 60.66 | 9.66 | 1.00 | 150.0 | $\pm 4.8\%$ | $\pm 9.6\%$ |
| | | Y | 0.45 | 61.71 | 10.71 | | 150.0 | | |
| | | Z | 0.47 | 60.89 | 10.00 | | 150.0 | | |
| 10388 | QPSK Waveform, 10 MHz | X | 1.15 | 63.11 | 12.16 | 0.00 | 150.0 | $\pm 1.3\%$ | $\pm 9.6\%$ |
| | | Y | 1.19 | 64.60 | 12.82 | | 150.0 | | |
| | | Z | 1.29 | 64.71 | 13.02 | | 150.0 | | |
| 10396 | 64-QAM Waveform, 100 kHz | X | 1.67 | 64.33 | 15.75 | 3.01 | 150.0 | $\pm 0.9\%$ | $\pm 9.6\%$ |
| | | Y | 1.76 | 65.29 | 16.04 | | 150.0 | | |
| | | Z | 1.70 | 64.54 | 15.73 | | 150.0 | | |
| 10399 | 64-QAM Waveform, 40 MHz | X | 2.78 | 65.75 | 14.53 | 0.00 | 150.0 | $\pm 2.7\%$ | $\pm 9.6\%$ |
| | | Y | 2.70 | 65.89 | 14.62 | | 150.0 | | |
| | | Z | 2.79 | 65.83 | 14.62 | | 150.0 | | |
| 10414 | WLAN CCDF, 64-QAM, 40 MHz | X | 3.84 | 65.59 | 14.89 | 0.00 | 150.0 | $\pm 4.7\%$ | $\pm 9.6\%$ |
| | | Y | 3.83 | 66.42 | 15.23 | | 150.0 | | |
| | | Z | 3.83 | 65.60 | 14.93 | | 150.0 | | |

Note: For details on UID parameters see Appendix

The reported uncertainty of measurement is stated as the standard uncertainty of measurement multiplied by the coverage factor $k=2$, which for a normal distribution corresponds to a coverage probability of approximately 95%.

^A The uncertainties of Norm X,Y,Z do not affect the E^2 -field uncertainty inside TSL (see Pages 5 and 6).

^B Linearization parameter uncertainty for maximum specified field strength.

^E Uncertainty is determined using the max. deviation from linear response applying rectangular distribution and is expressed for the square of the field value.

Parameters of Probe: EX3DV4 - SN:7639**Sensor Model Parameters**

| | C1 fF | C2 fF | α V⁻¹ | T1 ms V⁻² | T2 ms V⁻¹ | T3 ms | T4 V⁻² | T5 V⁻¹ | T6 |
|---|------------------------|------------------------|---|---------------------------------------|---------------------------------------|------------------------|------------------------------------|------------------------------------|-----------|
| x | 11.2 | 80.48 | 32.67 | 5.42 | 0.00 | 4.93 | 0.51 | 0.00 | 1.01 |
| y | 9.1 | 63.53 | 31.38 | 6.37 | 0.00 | 4.90 | 0.61 | 0.00 | 1.00 |
| z | 11.1 | 79.56 | 32.55 | 6.14 | 0.00 | 4.97 | 0.67 | 0.00 | 1.01 |

Other Probe Parameters

| | |
|---|------------|
| Sensor Arrangement | Triangular |
| Connector Angle | -79.1° |
| Mechanical Surface Detection Mode | enabled |
| Optical Surface Detection Mode | disabled |
| Probe Overall Length | 337 mm |
| Probe Body Diameter | 10 mm |
| Tip Length | 9 mm |
| Tip Diameter | 2.5 mm |
| Probe Tip to Sensor X Calibration Point | 1 mm |
| Probe Tip to Sensor Y Calibration Point | 1 mm |
| Probe Tip to Sensor Z Calibration Point | 1 mm |
| Recommended Measurement Distance from Surface | 1.4 mm |

Note: Measurement distance from surface can be increased to 3–4 mm for an *Area Scan* job.

Parameters of Probe: EX3DV4 - SN:7639**Calibration Parameter Determined in Head Tissue Simulating Media**

| f (MHz) ^C | Relative Permittivity ^F | Conductivity ^F (S/m) | ConvF X | ConvF Y | ConvF Z | Alpha ^G | Depth ^G (mm) | Unc (k = 2) |
|----------------------|------------------------------------|---------------------------------|---------|---------|---------|--------------------|-------------------------|-------------|
| 750 | 41.9 | 0.89 | 10.71 | 10.71 | 10.71 | 0.56 | 0.80 | ±12.0% |
| 835 | 41.5 | 0.90 | 10.75 | 10.75 | 10.75 | 0.45 | 0.80 | ±12.0% |
| 1750 | 40.1 | 1.37 | 9.30 | 9.30 | 9.30 | 0.37 | 0.86 | ±12.0% |
| 1900 | 40.0 | 1.40 | 9.12 | 9.12 | 9.12 | 0.33 | 0.86 | ±12.0% |
| 2300 | 39.5 | 1.67 | 8.90 | 8.90 | 8.90 | 0.29 | 0.90 | ±12.0% |
| 2450 | 39.2 | 1.80 | 8.62 | 8.62 | 8.62 | 0.34 | 0.90 | ±12.0% |
| 2600 | 39.0 | 1.96 | 8.33 | 8.33 | 8.33 | 0.40 | 0.90 | ±12.0% |

^C Frequency validity above 300 MHz of ±100 MHz only applies for DASY v4.4 and higher (see Page 2), else it is restricted to ±50 MHz. The uncertainty is the RSS of the ConvF uncertainty at calibration frequency and the uncertainty for the indicated frequency band. Frequency validity below 300 MHz is ±10, 25, 40, 50 and 70 MHz for ConvF assessments at 30, 64, 128, 150 and 220 MHz respectively. Validity of ConvF assessed at 6 MHz is 4–9 MHz, and ConvF assessed at 13 MHz is 9–19 MHz. Above 5 GHz frequency validity can be extended to ±110 MHz.

^F At frequencies below 3 GHz, the validity of tissue parameters (ϵ and σ) can be relaxed to ±10% if liquid compensation formula is applied to measured SAR values. At frequencies above 3 GHz, the validity of tissue parameters (ϵ and σ) is restricted to ±5%. The uncertainty is the RSS of the ConvF uncertainty for indicated target tissue parameters.

^G Alpha/Depth are determined during calibration. SPEAG warrants that the remaining deviation due to the boundary effect after compensation is always less than ±1% for frequencies below 3 GHz and below ±2% for frequencies between 3–6 GHz at any distance larger than half the probe tip diameter from the boundary.

Parameters of Probe: EX3DV4 - SN:7639

Calibration Parameter Determined in Body Tissue Simulating Media

| f (MHz) ^C | Relative Permittivity ^F | Conductivity ^F (S/m) | ConvF X | ConvF Y | ConvF Z | Alpha ^G | Depth ^G (mm) | Unc (k = 2) |
|----------------------|------------------------------------|---------------------------------|---------|---------|---------|--------------------|-------------------------|-------------|
| 750 | 55.5 | 0.96 | 10.83 | 10.83 | 10.83 | 0.33 | 1.01 | ±12.0% |
| 835 | 55.2 | 0.97 | 10.60 | 10.60 | 10.60 | 0.41 | 0.93 | ±12.0% |
| 1750 | 53.4 | 1.49 | 9.36 | 9.36 | 9.36 | 0.42 | 0.86 | ±12.0% |
| 1900 | 53.3 | 1.52 | 8.96 | 8.96 | 8.96 | 0.44 | 0.86 | ±12.0% |
| 2300 | 52.9 | 1.81 | 8.95 | 8.95 | 8.95 | 0.43 | 0.90 | ±12.0% |
| 2450 | 52.7 | 1.95 | 8.78 | 8.78 | 8.78 | 0.41 | 0.90 | ±12.0% |
| 2600 | 52.5 | 2.16 | 8.48 | 8.48 | 8.48 | 0.32 | 0.90 | ±12.0% |

^C Frequency validity above 300 MHz of ±100 MHz only applies for DASY v4.4 and higher (see Page 2), else it is restricted to ±50 MHz. The uncertainty is the RSS of the ConvF uncertainty at calibration frequency and the uncertainty for the indicated frequency band. Frequency validity below 300 MHz is ±10, 25, 40, 50 and 70 MHz for ConvF assessments at 30, 64, 128, 150 and 220 MHz respectively. Validity of ConvF assessed at 6 MHz is 4–9 MHz, and ConvF assessed at 13 MHz is 9–19 MHz. Above 5 GHz frequency validity can be extended to ±110 MHz.

^F At frequencies below 3 GHz, the validity of tissue parameters (ϵ and σ) can be relaxed to ±10% if liquid compensation formula is applied to measured SAR values. At frequencies above 3 GHz, the validity of tissue parameters (ϵ and σ) is restricted to ±5%. The uncertainty is the RSS of the ConvF uncertainty for indicated target tissue parameters.

^G Alpha/Depth are determined during calibration. SPEAG warrants that the remaining deviation due to the boundary effect after compensation is always less than ±1% for frequencies below 3 GHz and below ±2% for frequencies between 3–6 GHz at any distance larger than half the probe tip diameter from the boundary.

Frequency Response of E-Field

(TEM-Cell:ifi110 EXX, Waveguide:R22)

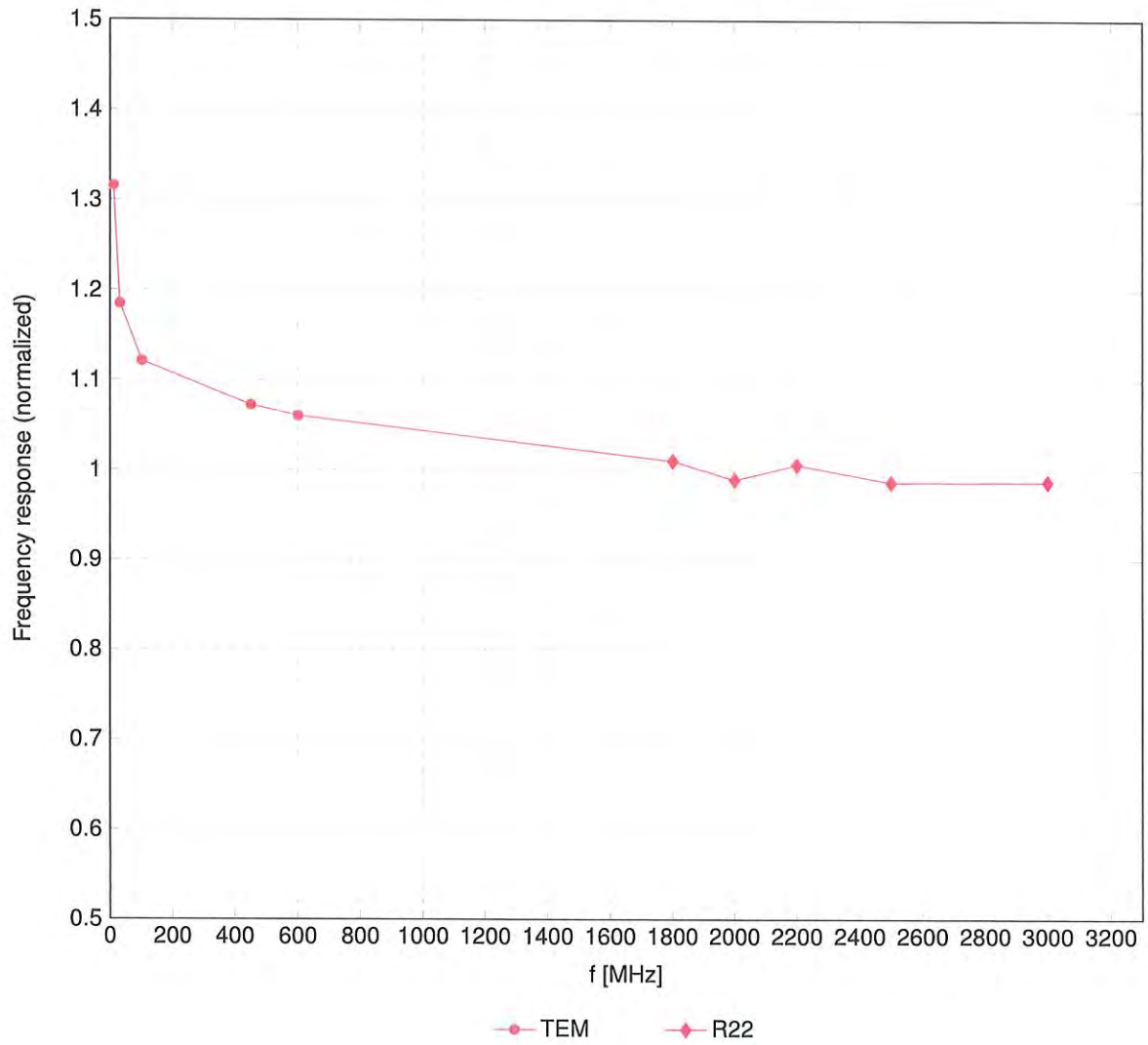

Uncertainty of Frequency Response of E-field: $\pm 6.3\%$ (k=2)

Receiving Pattern (ϕ), $\vartheta = 0^\circ$

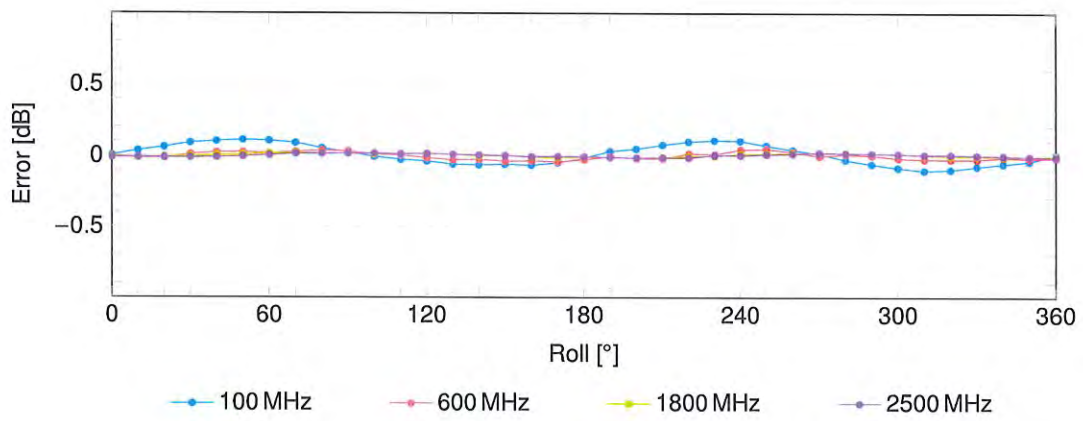
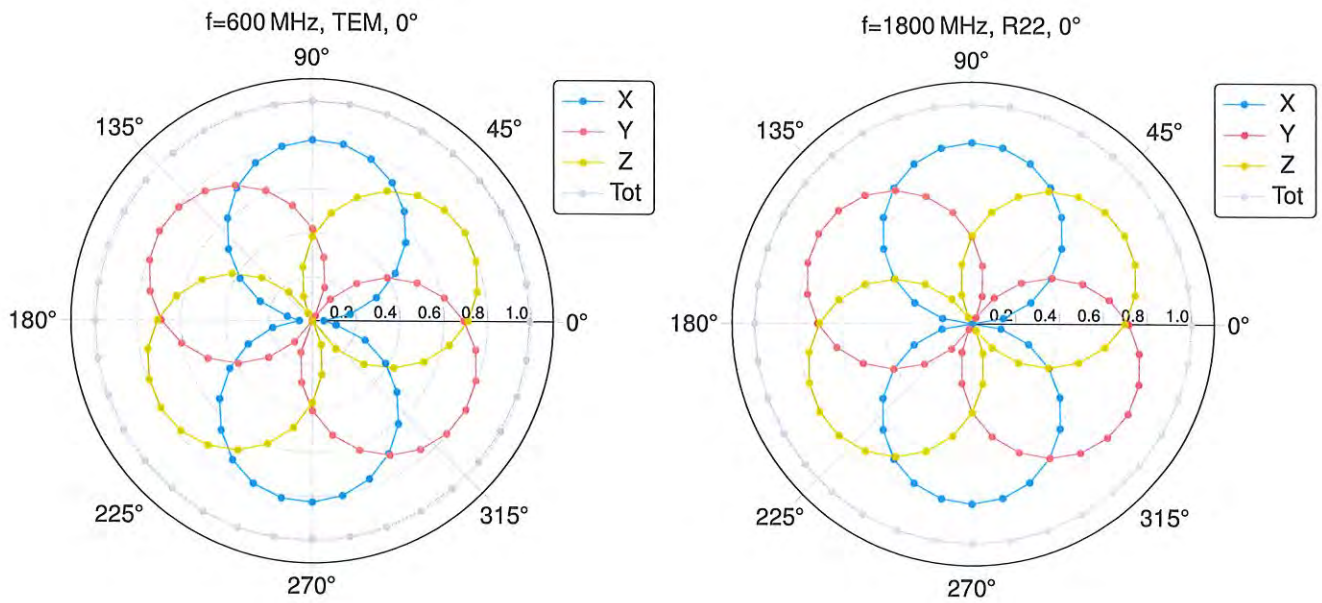

Uncertainty of Axial Isotropy Assessment: $\pm 0.5\%$ ($k=2$)

Dynamic Range $f(\text{SAR}_{\text{head}})$

(TEM cell, $f_{\text{eval}} = 1900\text{MHz}$)

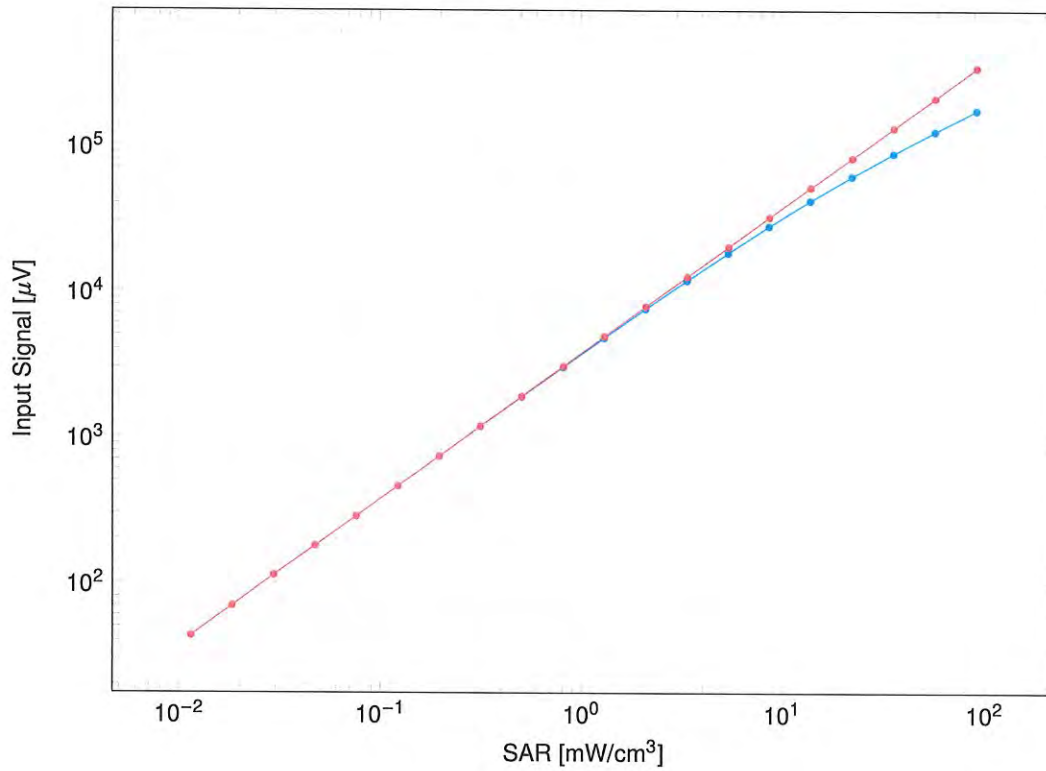

— not compensated — compensated

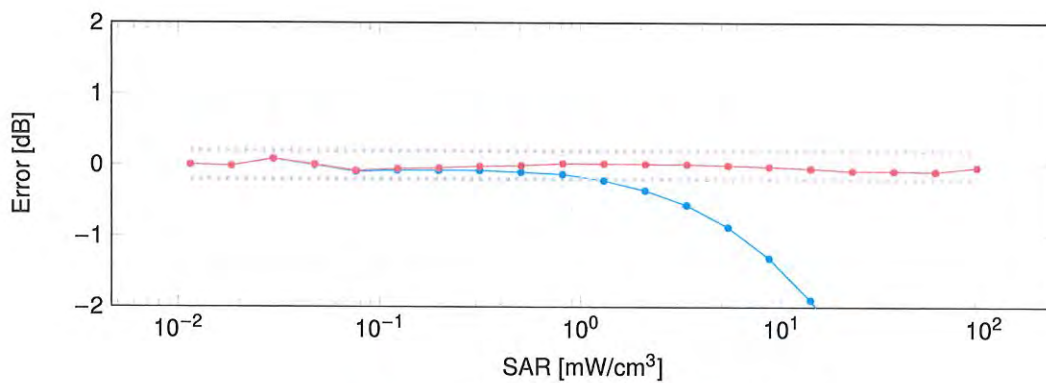

— not compensated — compensated

Uncertainty of Linearity Assessment: $\pm 0.6\%$ ($k=2$)

Conversion Factor Assessment

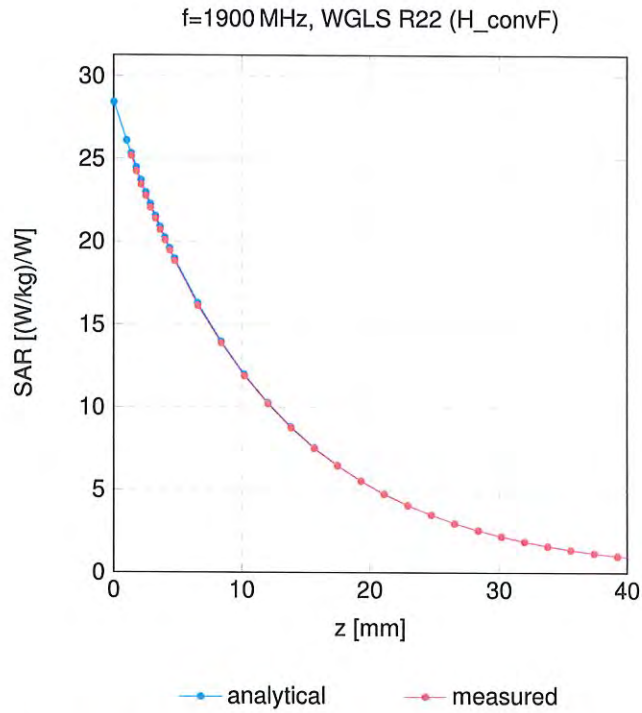

Deviation from Isotropy in Liquid

Error (ϕ, θ), f = 900MHz

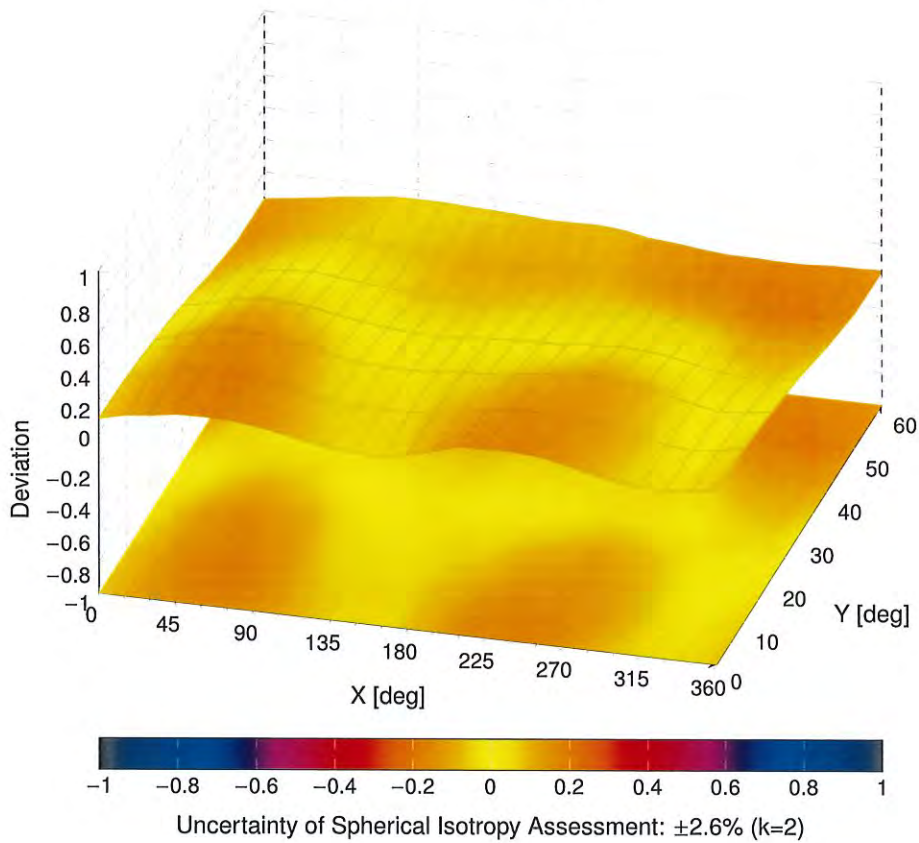

Appendix: Modulation Calibration Parameters

| UID | Rev | Communication System Name | Group | PAR (dB) | Unc ^E k = 2 |
|-------|-----|---|-----------|----------|------------------------|
| 0 | | CW | CW | 0.00 | ±4.7 |
| 10010 | CAB | SAR Validation (Square, 100 ms, 10 ms) | Test | 10.00 | ±9.6 |
| 10011 | CAC | UMTS-FDD (WCDMA) | WCDMA | 2.91 | ±9.6 |
| 10012 | CAB | IEEE 802.11b WiFi 2.4 GHz (DSSS, 1 Mbps) | WLAN | 1.87 | ±9.6 |
| 10013 | CAB | IEEE 802.11g WiFi 2.4 GHz (DSSS-OFDM, 6 Mbps) | WLAN | 9.46 | ±9.6 |
| 10021 | DAC | GSM-FDD (TDMA, GMSK) | GSM | 9.39 | ±9.6 |
| 10023 | DAC | GPRS-FDD (TDMA, GMSK, TN 0) | GSM | 9.57 | ±9.6 |
| 10024 | DAC | GPRS-FDD (TDMA, GMSK, TN 0-1) | GSM | 6.56 | ±9.6 |
| 10025 | DAC | EDGE-FDD (TDMA, 8PSK, TN 0) | GSM | 12.62 | ±9.6 |
| 10026 | DAC | EDGE-FDD (TDMA, 8PSK, TN 0-1) | GSM | 9.55 | ±9.6 |
| 10027 | DAC | GPRS-FDD (TDMA, GMSK, TN 0-1-2) | GSM | 4.80 | ±9.6 |
| 10028 | DAC | GPRS-FDD (TDMA, GMSK, TN 0-1-2-3) | GSM | 3.55 | ±9.6 |
| 10029 | DAC | EDGE-FDD (TDMA, 8PSK, TN 0-1-2) | GSM | 7.78 | ±9.6 |
| 10030 | CAA | IEEE 802.15.1 Bluetooth (GFSK, DH1) | Bluetooth | 5.30 | ±9.6 |
| 10031 | CAA | IEEE 802.15.1 Bluetooth (GFSK, DH3) | Bluetooth | 1.87 | ±9.6 |
| 10032 | CAA | IEEE 802.15.1 Bluetooth (GFSK, DH5) | Bluetooth | 1.16 | ±9.6 |
| 10033 | CAA | IEEE 802.15.1 Bluetooth (PI/4-DQPSK, DH1) | Bluetooth | 7.74 | ±9.6 |
| 10034 | CAA | IEEE 802.15.1 Bluetooth (PI/4-DQPSK, DH3) | Bluetooth | 4.53 | ±9.6 |
| 10035 | CAA | IEEE 802.15.1 Bluetooth (PI/4-DQPSK, DH5) | Bluetooth | 3.83 | ±9.6 |
| 10036 | CAA | IEEE 802.15.1 Bluetooth (8-DPSK, DH1) | Bluetooth | 8.01 | ±9.6 |
| 10037 | CAA | IEEE 802.15.1 Bluetooth (8-DPSK, DH3) | Bluetooth | 4.77 | ±9.6 |
| 10038 | CAA | IEEE 802.15.1 Bluetooth (8-DPSK, DH5) | Bluetooth | 4.10 | ±9.6 |
| 10039 | CAB | CDMA2000 (1xRTT, RC1) | CDMA2000 | 4.57 | ±9.6 |
| 10042 | CAB | IS-54 / IS-136 FDD (TDMA/FDM, PI/4-DQPSK, Halfrate) | AMPS | 7.78 | ±9.6 |
| 10044 | CAA | IS-91/EIA/TIA-553 FDD (FDMA, FM) | AMPS | 0.00 | ±9.6 |
| 10048 | CAA | DECT (TDD, TDMA/FDM, GFSK, Full Slot, 24) | DECT | 13.80 | ±9.6 |
| 10049 | CAA | DECT (TDD, TDMA/FDM, GFSK, Double Slot, 12) | DECT | 10.79 | ±9.6 |
| 10056 | CAA | UMTS-TDD (TD-SCDMA, 1.28 Mcps) | TD-SCDMA | 11.01 | ±9.6 |
| 10058 | DAC | EDGE-FDD (TDMA, 8PSK, TN 0-1-2-3) | GSM | 6.52 | ±9.6 |
| 10059 | CAB | IEEE 802.11b WiFi 2.4 GHz (DSSS, 2 Mbps) | WLAN | 2.12 | ±9.6 |
| 10060 | CAB | IEEE 802.11b WiFi 2.4 GHz (DSSS, 5.5 Mbps) | WLAN | 2.83 | ±9.6 |
| 10061 | CAB | IEEE 802.11b WiFi 2.4 GHz (DSSS, 11 Mbps) | WLAN | 3.60 | ±9.6 |
| 10062 | CAD | IEEE 802.11a/h WiFi 5 GHz (OFDM, 6 Mbps) | WLAN | 8.68 | ±9.6 |
| 10063 | CAD | IEEE 802.11a/h WiFi 5 GHz (OFDM, 9 Mbps) | WLAN | 8.63 | ±9.6 |
| 10064 | CAD | IEEE 802.11a/h WiFi 5 GHz (OFDM, 12 Mbps) | WLAN | 9.09 | ±9.6 |
| 10065 | CAD | IEEE 802.11a/h WiFi 5 GHz (OFDM, 18 Mbps) | WLAN | 9.00 | ±9.6 |
| 10066 | CAD | IEEE 802.11a/h WiFi 5 GHz (OFDM, 24 Mbps) | WLAN | 9.38 | ±9.6 |
| 10067 | CAD | IEEE 802.11a/h WiFi 5 GHz (OFDM, 36 Mbps) | WLAN | 10.12 | ±9.6 |
| 10068 | CAD | IEEE 802.11a/h WiFi 5 GHz (OFDM, 48 Mbps) | WLAN | 10.24 | ±9.6 |
| 10069 | CAD | IEEE 802.11a/h WiFi 5 GHz (OFDM, 54 Mbps) | WLAN | 10.56 | ±9.6 |
| 10071 | CAB | IEEE 802.11g WiFi 2.4 GHz (DSSS/OFDM, 9 Mbps) | WLAN | 9.83 | ±9.6 |
| 10072 | CAB | IEEE 802.11g WiFi 2.4 GHz (DSSS/OFDM, 12 Mbps) | WLAN | 9.62 | ±9.6 |
| 10073 | CAB | IEEE 802.11g WiFi 2.4 GHz (DSSS/OFDM, 18 Mbps) | WLAN | 9.94 | ±9.6 |
| 10074 | CAB | IEEE 802.11g WiFi 2.4 GHz (DSSS/OFDM, 24 Mbps) | WLAN | 10.30 | ±9.6 |
| 10075 | CAB | IEEE 802.11g WiFi 2.4 GHz (DSSS/OFDM, 36 Mbps) | WLAN | 10.77 | ±9.6 |
| 10076 | CAB | IEEE 802.11g WiFi 2.4 GHz (DSSS/OFDM, 48 Mbps) | WLAN | 10.94 | ±9.6 |
| 10077 | CAB | IEEE 802.11g WiFi 2.4 GHz (DSSS/OFDM, 54 Mbps) | WLAN | 11.00 | ±9.6 |
| 10081 | CAB | CDMA2000 (1xRTT, RC3) | CDMA2000 | 3.97 | ±9.6 |
| 10082 | CAB | IS-54 / IS-136 FDD (TDMA/FDM, PI/4-DQPSK, Fullrate) | AMPS | 4.77 | ±9.6 |
| 10090 | DAC | GPRS-FDD (TDMA, GMSK, TN 0-4) | GSM | 6.56 | ±9.6 |
| 10097 | CAC | UMTS-FDD (HSDPA) | WCDMA | 3.98 | ±9.6 |
| 10098 | CAC | UMTS-FDD (HSUPA, Subtest 2) | WCDMA | 3.98 | ±9.6 |
| 10099 | DAC | EDGE-FDD (TDMA, 8PSK, TN 0-4) | GSM | 9.55 | ±9.6 |
| 10100 | CAF | LTE-FDD (SC-FDMA, 100% RB, 20 MHz, QPSK) | LTE-FDD | 5.67 | ±9.6 |
| 10101 | CAF | LTE-FDD (SC-FDMA, 100% RB, 20 MHz, 16-QAM) | LTE-FDD | 6.42 | ±9.6 |
| 10102 | CAF | LTE-FDD (SC-FDMA, 100% RB, 20 MHz, 64-QAM) | LTE-FDD | 6.60 | ±9.6 |
| 10103 | CAH | LTE-TDD (SC-FDMA, 100% RB, 20 MHz, QPSK) | LTE-TDD | 9.29 | ±9.6 |
| 10104 | CAH | LTE-TDD (SC-FDMA, 100% RB, 20 MHz, 16-QAM) | LTE-TDD | 9.97 | ±9.6 |
| 10105 | CAH | LTE-TDD (SC-FDMA, 100% RB, 20 MHz, 64-QAM) | LTE-TDD | 10.01 | ±9.6 |
| 10108 | CAH | LTE-FDD (SC-FDMA, 100% RB, 10 MHz, QPSK) | LTE-FDD | 5.80 | ±9.6 |
| 10109 | CAH | LTE-FDD (SC-FDMA, 100% RB, 10 MHz, 16-QAM) | LTE-FDD | 6.43 | ±9.6 |
| 10110 | CAH | LTE-FDD (SC-FDMA, 100% RB, 5 MHz, QPSK) | LTE-FDD | 5.75 | ±9.6 |
| 10111 | CAH | LTE-FDD (SC-FDMA, 100% RB, 5 MHz, 16-QAM) | LTE-FDD | 6.44 | ±9.6 |

| UID | Rev | Communication System Name | Group | PAR (dB) | Unc ^E k = 2 |
|-------|-----|--|---------|----------|------------------------|
| 10112 | CAH | LTE-FDD (SC-FDMA, 100% RB, 10 MHz, 64-QAM) | LTE-FDD | 6.59 | ±9.6 |
| 10113 | CAH | LTE-FDD (SC-FDMA, 100% RB, 5 MHz, 64-QAM) | LTE-FDD | 6.62 | ±9.6 |
| 10114 | CAD | IEEE 802.11n (HT Greenfield, 13.5 Mbps, BPSK) | WLAN | 8.10 | ±9.6 |
| 10115 | CAD | IEEE 802.11n (HT Greenfield, 81 Mbps, 16-QAM) | WLAN | 8.46 | ±9.6 |
| 10116 | CAD | IEEE 802.11n (HT Greenfield, 135 Mbps, 64-QAM) | WLAN | 8.15 | ±9.6 |
| 10117 | CAD | IEEE 802.11n (HT Mixed, 13.5 Mbps, BPSK) | WLAN | 8.07 | ±9.6 |
| 10118 | CAD | IEEE 802.11n (HT Mixed, 81 Mbps, 16-QAM) | WLAN | 8.59 | ±9.6 |
| 10119 | CAD | IEEE 802.11n (HT Mixed, 135 Mbps, 64-QAM) | WLAN | 8.13 | ±9.6 |
| 10140 | CAF | LTE-FDD (SC-FDMA, 100% RB, 15 MHz, 16-QAM) | LTE-FDD | 6.49 | ±9.6 |
| 10141 | CAF | LTE-FDD (SC-FDMA, 100% RB, 15 MHz, 64-QAM) | LTE-FDD | 6.53 | ±9.6 |
| 10142 | CAF | LTE-FDD (SC-FDMA, 100% RB, 3 MHz, QPSK) | LTE-FDD | 5.73 | ±9.6 |
| 10143 | CAF | LTE-FDD (SC-FDMA, 100% RB, 3 MHz, 16-QAM) | LTE-FDD | 6.35 | ±9.6 |
| 10144 | CAF | LTE-FDD (SC-FDMA, 100% RB, 3 MHz, 64-QAM) | LTE-FDD | 6.65 | ±9.6 |
| 10145 | CAG | LTE-FDD (SC-FDMA, 100% RB, 1.4 MHz, QPSK) | LTE-FDD | 5.76 | ±9.6 |
| 10146 | CAG | LTE-FDD (SC-FDMA, 100% RB, 1.4 MHz, 16-QAM) | LTE-FDD | 6.41 | ±9.6 |
| 10147 | CAG | LTE-FDD (SC-FDMA, 100% RB, 1.4 MHz, 64-QAM) | LTE-FDD | 6.72 | ±9.6 |
| 10149 | CAF | LTE-FDD (SC-FDMA, 50% RB, 20 MHz, 16-QAM) | LTE-FDD | 6.42 | ±9.6 |
| 10150 | CAF | LTE-FDD (SC-FDMA, 50% RB, 20 MHz, 64-QAM) | LTE-FDD | 6.60 | ±9.6 |
| 10151 | CAH | LTE-TDD (SC-FDMA, 50% RB, 20 MHz, QPSK) | LTE-TDD | 9.28 | ±9.6 |
| 10152 | CAH | LTE-TDD (SC-FDMA, 50% RB, 20 MHz, 16-QAM) | LTE-TDD | 9.92 | ±9.6 |
| 10153 | CAH | LTE-TDD (SC-FDMA, 50% RB, 20 MHz, 64-QAM) | LTE-TDD | 10.05 | ±9.6 |
| 10154 | CAH | LTE-FDD (SC-FDMA, 50% RB, 10 MHz, QPSK) | LTE-FDD | 5.75 | ±9.6 |
| 10155 | CAH | LTE-FDD (SC-FDMA, 50% RB, 10 MHz, 16-QAM) | LTE-FDD | 6.43 | ±9.6 |
| 10156 | CAH | LTE-FDD (SC-FDMA, 50% RB, 5 MHz, QPSK) | LTE-FDD | 5.79 | ±9.6 |
| 10157 | CAH | LTE-FDD (SC-FDMA, 50% RB, 5 MHz, 16-QAM) | LTE-FDD | 6.49 | ±9.6 |
| 10158 | CAH | LTE-FDD (SC-FDMA, 50% RB, 10 MHz, 64-QAM) | LTE-FDD | 6.62 | ±9.6 |
| 10159 | CAH | LTE-FDD (SC-FDMA, 50% RB, 5 MHz, 64-QAM) | LTE-FDD | 6.56 | ±9.6 |
| 10160 | CAF | LTE-FDD (SC-FDMA, 50% RB, 15 MHz, QPSK) | LTE-FDD | 5.82 | ±9.6 |
| 10161 | CAF | LTE-FDD (SC-FDMA, 50% RB, 15 MHz, 16-QAM) | LTE-FDD | 6.43 | ±9.6 |
| 10162 | CAF | LTE-FDD (SC-FDMA, 50% RB, 15 MHz, 64-QAM) | LTE-FDD | 6.58 | ±9.6 |
| 10166 | CAG | LTE-FDD (SC-FDMA, 50% RB, 1.4 MHz, QPSK) | LTE-FDD | 5.46 | ±9.6 |
| 10167 | CAG | LTE-FDD (SC-FDMA, 50% RB, 1.4 MHz, 16-QAM) | LTE-FDD | 6.21 | ±9.6 |
| 10168 | CAG | LTE-FDD (SC-FDMA, 50% RB, 1.4 MHz, 64-QAM) | LTE-FDD | 6.79 | ±9.6 |
| 10169 | CAF | LTE-FDD (SC-FDMA, 1 RB, 20 MHz, QPSK) | LTE-FDD | 5.73 | ±9.6 |
| 10170 | CAF | LTE-FDD (SC-FDMA, 1 RB, 20 MHz, 16-QAM) | LTE-FDD | 6.52 | ±9.6 |
| 10171 | AAF | LTE-FDD (SC-FDMA, 1 RB, 20 MHz, 64-QAM) | LTE-FDD | 6.49 | ±9.6 |
| 10172 | CAH | LTE-TDD (SC-FDMA, 1 RB, 20 MHz, QPSK) | LTE-TDD | 9.21 | ±9.6 |
| 10173 | CAH | LTE-TDD (SC-FDMA, 1 RB, 20 MHz, 16-QAM) | LTE-TDD | 9.48 | ±9.6 |
| 10174 | CAH | LTE-TDD (SC-FDMA, 1 RB, 20 MHz, 64-QAM) | LTE-TDD | 10.25 | ±9.6 |
| 10175 | CAH | LTE-FDD (SC-FDMA, 1 RB, 10 MHz, QPSK) | LTE-FDD | 5.72 | ±9.6 |
| 10176 | CAH | LTE-FDD (SC-FDMA, 1 RB, 10 MHz, 16-QAM) | LTE-FDD | 6.52 | ±9.6 |
| 10177 | CAJ | LTE-FDD (SC-FDMA, 1 RB, 5 MHz, QPSK) | LTE-FDD | 5.73 | ±9.6 |
| 10178 | CAH | LTE-FDD (SC-FDMA, 1 RB, 5 MHz, 16-QAM) | LTE-FDD | 6.52 | ±9.6 |
| 10179 | CAH | LTE-FDD (SC-FDMA, 1 RB, 10 MHz, 64-QAM) | LTE-FDD | 6.50 | ±9.6 |
| 10180 | CAH | LTE-FDD (SC-FDMA, 1 RB, 5 MHz, 64-QAM) | LTE-FDD | 6.50 | ±9.6 |
| 10181 | CAF | LTE-FDD (SC-FDMA, 1 RB, 15 MHz, QPSK) | LTE-FDD | 5.72 | ±9.6 |
| 10182 | CAF | LTE-FDD (SC-FDMA, 1 RB, 15 MHz, 16-QAM) | LTE-FDD | 6.52 | ±9.6 |
| 10183 | AAE | LTE-FDD (SC-FDMA, 1 RB, 15 MHz, 64-QAM) | LTE-FDD | 6.50 | ±9.6 |
| 10184 | CAF | LTE-FDD (SC-FDMA, 1 RB, 3 MHz, QPSK) | LTE-FDD | 5.73 | ±9.6 |
| 10185 | CAF | LTE-FDD (SC-FDMA, 1 RB, 3 MHz, 16-QAM) | LTE-FDD | 6.51 | ±9.6 |
| 10186 | AAF | LTE-FDD (SC-FDMA, 1 RB, 3 MHz, 64-QAM) | LTE-FDD | 6.50 | ±9.6 |
| 10187 | CAG | LTE-FDD (SC-FDMA, 1 RB, 1.4 MHz, QPSK) | LTE-FDD | 5.73 | ±9.6 |
| 10188 | CAG | LTE-FDD (SC-FDMA, 1 RB, 1.4 MHz, 16-QAM) | LTE-FDD | 6.52 | ±9.6 |
| 10189 | AAG | LTE-FDD (SC-FDMA, 1 RB, 1.4 MHz, 64-QAM) | LTE-FDD | 6.50 | ±9.6 |
| 10193 | CAD | IEEE 802.11n (HT Greenfield, 6.5 Mbps, BPSK) | WLAN | 8.09 | ±9.6 |
| 10194 | CAD | IEEE 802.11n (HT Greenfield, 39 Mbps, 16-QAM) | WLAN | 8.12 | ±9.6 |
| 10195 | CAD | IEEE 802.11n (HT Greenfield, 65 Mbps, 64-QAM) | WLAN | 8.21 | ±9.6 |
| 10196 | CAD | IEEE 802.11n (HT Mixed, 6.5 Mbps, BPSK) | WLAN | 8.10 | ±9.6 |
| 10197 | CAD | IEEE 802.11n (HT Mixed, 39 Mbps, 16-QAM) | WLAN | 8.13 | ±9.6 |
| 10198 | CAD | IEEE 802.11n (HT Mixed, 65 Mbps, 64-QAM) | WLAN | 8.27 | ±9.6 |
| 10219 | CAD | IEEE 802.11n (HT Mixed, 7.2 Mbps, BPSK) | WLAN | 8.03 | ±9.6 |
| 10220 | CAD | IEEE 802.11n (HT Mixed, 43.3 Mbps, 16-QAM) | WLAN | 8.13 | ±9.6 |
| 10221 | CAD | IEEE 802.11n (HT Mixed, 72.2 Mbps, 64-QAM) | WLAN | 8.27 | ±9.6 |
| 10222 | CAD | IEEE 802.11n (HT Mixed, 15 Mbps, BPSK) | WLAN | 8.06 | ±9.6 |
| 10223 | CAD | IEEE 802.11n (HT Mixed, 90 Mbps, 16-QAM) | WLAN | 8.48 | ±9.6 |
| 10224 | CAD | IEEE 802.11n (HT Mixed, 150 Mbps, 64-QAM) | WLAN | 8.08 | ±9.6 |

| UID | Rev | Communication System Name | Group | PAR (dB) | Unc ^E k = 2 |
|-------|-----|--|----------|----------|------------------------|
| 10225 | CAC | UMTS-FDD (HSPA+) | WCDMA | 5.97 | ±9.6 |
| 10226 | CAC | LTE-TDD (SC-FDMA, 1 RB, 1.4 MHz, 16-QAM) | LTE-TDD | 9.49 | ±9.6 |
| 10227 | CAC | LTE-TDD (SC-FDMA, 1 RB, 1.4 MHz, 64-QAM) | LTE-TDD | 10.26 | ±9.6 |
| 10228 | CAC | LTE-TDD (SC-FDMA, 1 RB, 1.4 MHz, QPSK) | LTE-TDD | 9.22 | ±9.6 |
| 10229 | CAE | LTE-TDD (SC-FDMA, 1 RB, 3 MHz, 16-QAM) | LTE-TDD | 9.48 | ±9.6 |
| 10230 | CAE | LTE-TDD (SC-FDMA, 1 RB, 3 MHz, 64-QAM) | LTE-TDD | 10.25 | ±9.6 |
| 10231 | CAE | LTE-TDD (SC-FDMA, 1 RB, 3 MHz, QPSK) | LTE-TDD | 9.19 | ±9.6 |
| 10232 | CAH | LTE-TDD (SC-FDMA, 1 RB, 5 MHz, 16-QAM) | LTE-TDD | 9.48 | ±9.6 |
| 10233 | CAH | LTE-TDD (SC-FDMA, 1 RB, 5 MHz, 64-QAM) | LTE-TDD | 10.25 | ±9.6 |
| 10234 | CAH | LTE-TDD (SC-FDMA, 1 RB, 5 MHz, QPSK) | LTE-TDD | 9.21 | ±9.6 |
| 10235 | CAH | LTE-TDD (SC-FDMA, 1 RB, 10 MHz, 16-QAM) | LTE-TDD | 9.48 | ±9.6 |
| 10236 | CAH | LTE-TDD (SC-FDMA, 1 RB, 10 MHz, 64-QAM) | LTE-TDD | 10.25 | ±9.6 |
| 10237 | CAH | LTE-TDD (SC-FDMA, 1 RB, 10 MHz, QPSK) | LTE-TDD | 9.21 | ±9.6 |
| 10238 | CAG | LTE-TDD (SC-FDMA, 1 RB, 15 MHz, 16-QAM) | LTE-TDD | 9.48 | ±9.6 |
| 10239 | CAG | LTE-TDD (SC-FDMA, 1 RB, 15 MHz, 64-QAM) | LTE-TDD | 10.25 | ±9.6 |
| 10240 | CAG | LTE-TDD (SC-FDMA, 1 RB, 15 MHz, QPSK) | LTE-TDD | 9.21 | ±9.6 |
| 10241 | CAC | LTE-TDD (SC-FDMA, 50% RB, 1.4 MHz, 16-QAM) | LTE-TDD | 9.82 | ±9.6 |
| 10242 | CAC | LTE-TDD (SC-FDMA, 50% RB, 1.4 MHz, 64-QAM) | LTE-TDD | 9.86 | ±9.6 |
| 10243 | CAC | LTE-TDD (SC-FDMA, 50% RB, 1.4 MHz, QPSK) | LTE-TDD | 9.46 | ±9.6 |
| 10244 | CAE | LTE-TDD (SC-FDMA, 50% RB, 3 MHz, 16-QAM) | LTE-TDD | 10.06 | ±9.6 |
| 10245 | CAE | LTE-TDD (SC-FDMA, 50% RB, 3 MHz, 64-QAM) | LTE-TDD | 10.06 | ±9.6 |
| 10246 | CAE | LTE-TDD (SC-FDMA, 50% RB, 3 MHz, QPSK) | LTE-TDD | 9.30 | ±9.6 |
| 10247 | CAH | LTE-TDD (SC-FDMA, 50% RB, 5 MHz, 16-QAM) | LTE-TDD | 9.91 | ±9.6 |
| 10248 | CAH | LTE-TDD (SC-FDMA, 50% RB, 5 MHz, 64-QAM) | LTE-TDD | 10.09 | ±9.6 |
| 10249 | CAH | LTE-TDD (SC-FDMA, 50% RB, 5 MHz, QPSK) | LTE-TDD | 9.29 | ±9.6 |
| 10250 | CAH | LTE-TDD (SC-FDMA, 50% RB, 10 MHz, 16-QAM) | LTE-TDD | 9.81 | ±9.6 |
| 10251 | CAH | LTE-TDD (SC-FDMA, 50% RB, 10 MHz, 64-QAM) | LTE-TDD | 10.17 | ±9.6 |
| 10252 | CAH | LTE-TDD (SC-FDMA, 50% RB, 10 MHz, QPSK) | LTE-TDD | 9.24 | ±9.6 |
| 10253 | CAG | LTE-TDD (SC-FDMA, 50% RB, 15 MHz, 16-QAM) | LTE-TDD | 9.90 | ±9.6 |
| 10254 | CAG | LTE-TDD (SC-FDMA, 50% RB, 15 MHz, 64-QAM) | LTE-TDD | 10.14 | ±9.6 |
| 10255 | CAG | LTE-TDD (SC-FDMA, 50% RB, 15 MHz, QPSK) | LTE-TDD | 9.20 | ±9.6 |
| 10256 | CAC | LTE-TDD (SC-FDMA, 100% RB, 1.4 MHz, 16-QAM) | LTE-TDD | 9.96 | ±9.6 |
| 10257 | CAC | LTE-TDD (SC-FDMA, 100% RB, 1.4 MHz, 64-QAM) | LTE-TDD | 10.08 | ±9.6 |
| 10258 | CAC | LTE-TDD (SC-FDMA, 100% RB, 1.4 MHz, QPSK) | LTE-TDD | 9.34 | ±9.6 |
| 10259 | CAE | LTE-TDD (SC-FDMA, 100% RB, 3 MHz, 16-QAM) | LTE-TDD | 9.98 | ±9.6 |
| 10260 | CAE | LTE-TDD (SC-FDMA, 100% RB, 3 MHz, 64-QAM) | LTE-TDD | 9.97 | ±9.6 |
| 10261 | CAE | LTE-TDD (SC-FDMA, 100% RB, 3 MHz, QPSK) | LTE-TDD | 9.24 | ±9.6 |
| 10262 | CAH | LTE-TDD (SC-FDMA, 100% RB, 5 MHz, 16-QAM) | LTE-TDD | 9.83 | ±9.6 |
| 10263 | CAH | LTE-TDD (SC-FDMA, 100% RB, 5 MHz, 64-QAM) | LTE-TDD | 10.16 | ±9.6 |
| 10264 | CAH | LTE-TDD (SC-FDMA, 100% RB, 5 MHz, QPSK) | LTE-TDD | 9.23 | ±9.6 |
| 10265 | CAH | LTE-TDD (SC-FDMA, 100% RB, 10 MHz, 16-QAM) | LTE-TDD | 9.92 | ±9.6 |
| 10266 | CAH | LTE-TDD (SC-FDMA, 100% RB, 10 MHz, 64-QAM) | LTE-TDD | 10.07 | ±9.6 |
| 10267 | CAH | LTE-TDD (SC-FDMA, 100% RB, 10 MHz, QPSK) | LTE-TDD | 9.30 | ±9.6 |
| 10268 | CAG | LTE-TDD (SC-FDMA, 100% RB, 15 MHz, 16-QAM) | LTE-TDD | 10.06 | ±9.6 |
| 10269 | CAG | LTE-TDD (SC-FDMA, 100% RB, 15 MHz, 64-QAM) | LTE-TDD | 10.13 | ±9.6 |
| 10270 | CAG | LTE-TDD (SC-FDMA, 100% RB, 15 MHz, QPSK) | LTE-TDD | 9.58 | ±9.6 |
| 10274 | CAC | UMTS-FDD (HSUPA, Subtest 5, 3GPP Rel8.10) | WCDMA | 4.87 | ±9.6 |
| 10275 | CAC | UMTS-FDD (HSUPA, Subtest 5, 3GPP Rel8.4) | WCDMA | 3.96 | ±9.6 |
| 10277 | CAA | PHS (QPSK) | PHS | 11.81 | ±9.6 |
| 10278 | CAA | PHS (QPSK, BW 884 MHz, Roll-off 0.5) | PHS | 11.81 | ±9.6 |
| 10279 | CAA | PHS (QPSK, BW 884 MHz, Roll-off 0.38) | PHS | 12.18 | ±9.6 |
| 10290 | AAB | CDMA2000, RC1, SO55, Full Rate | CDMA2000 | 3.91 | ±9.6 |
| 10291 | AAB | CDMA2000, RC3, SO55, Full Rate | CDMA2000 | 3.46 | ±9.6 |
| 10292 | AAB | CDMA2000, RC3, SO32, Full Rate | CDMA2000 | 3.39 | ±9.6 |
| 10293 | AAB | CDMA2000, RC3, SO3, Full Rate | CDMA2000 | 3.50 | ±9.6 |
| 10295 | AAB | CDMA2000, RC1, SO3, 1/8th Rate 25 fr. | CDMA2000 | 12.49 | ±9.6 |
| 10297 | AAE | LTE-FDD (SC-FDMA, 50% RB, 20 MHz, QPSK) | LTE-FDD | 5.81 | ±9.6 |
| 10298 | AAE | LTE-FDD (SC-FDMA, 50% RB, 3 MHz, QPSK) | LTE-FDD | 5.72 | ±9.6 |
| 10299 | AAE | LTE-FDD (SC-FDMA, 50% RB, 3 MHz, 16-QAM) | LTE-FDD | 6.39 | ±9.6 |
| 10300 | AAE | LTE-FDD (SC-FDMA, 50% RB, 3 MHz, 64-QAM) | LTE-FDD | 6.60 | ±9.6 |
| 10301 | AAA | IEEE 802.16e WiMAX (29:18, 5 ms, 10 MHz, QPSK, PUSC) | WiMAX | 12.03 | ±9.6 |
| 10302 | AAA | IEEE 802.16e WiMAX (29:18, 5 ms, 10 MHz, QPSK, PUSC, 3 CTRL symbols) | WiMAX | 12.57 | ±9.6 |
| 10303 | AAA | IEEE 802.16e WiMAX (31:15, 5 ms, 10 MHz, 64QAM, PUSC) | WiMAX | 12.52 | ±9.6 |
| 10304 | AAA | IEEE 802.16e WiMAX (29:18, 5 ms, 10 MHz, 64QAM, PUSC) | WiMAX | 11.86 | ±9.6 |
| 10305 | AAA | IEEE 802.16e WiMAX (31:15, 10 ms, 10 MHz, 64QAM, PUSC, 15 symbols) | WiMAX | 15.24 | ±9.6 |
| 10306 | AAA | IEEE 802.16e WiMAX (29:18, 10 ms, 10 MHz, 64QAM, PUSC, 18 symbols) | WiMAX | 14.67 | ±9.6 |

| UID | Rev | Communication System Name | Group | PAR (dB) | Unc ^E k = 2 |
|-------|-----|---|----------|----------|------------------------|
| 10307 | AAA | IEEE 802.16e WiMAX (29:18, 10 ms, 10 MHz, QPSK, PUSC, 18 symbols) | WiMAX | 14.49 | ±9.6 |
| 10308 | AAA | IEEE 802.16e WiMAX (29:18, 10 ms, 10 MHz, 16QAM, PUSC) | WiMAX | 14.46 | ±9.6 |
| 10309 | AAA | IEEE 802.16e WiMAX (29:18, 10 ms, 10 MHz, 16QAM, AMC 2x3, 18 symbols) | WiMAX | 14.58 | ±9.6 |
| 10310 | AAA | IEEE 802.16e WiMAX (29:18, 10 ms, 10 MHz, QPSK, AMC 2x3, 18 symbols) | WiMAX | 14.57 | ±9.6 |
| 10311 | AAE | LTE-FDD (SC-FDMA, 100% RB, 15 MHz, QPSK) | LTE-FDD | 6.06 | ±9.6 |
| 10313 | AAA | iDEN 1:3 | iDEN | 10.51 | ±9.6 |
| 10314 | AAA | iDEN 1:6 | iDEN | 13.48 | ±9.6 |
| 10315 | AAB | IEEE 802.11b WiFi 2.4 GHz (DSSS, 1 Mbps, 96pc duty cycle) | WLAN | 1.71 | ±9.6 |
| 10316 | AAB | IEEE 802.11g WiFi 2.4 GHz (ERP-OFDM, 6 Mbps, 96pc duty cycle) | WLAN | 8.36 | ±9.6 |
| 10317 | AAD | IEEE 802.11a WiFi 5 GHz (OFDM, 6 Mbps, 96pc duty cycle) | WLAN | 8.36 | ±9.6 |
| 10352 | AAA | Pulse Waveform (200Hz, 10%) | Generic | 10.00 | ±9.6 |
| 10353 | AAA | Pulse Waveform (200Hz, 20%) | Generic | 6.99 | ±9.6 |
| 10354 | AAA | Pulse Waveform (200Hz, 40%) | Generic | 3.98 | ±9.6 |
| 10355 | AAA | Pulse Waveform (200Hz, 60%) | Generic | 2.22 | ±9.6 |
| 10356 | AAA | Pulse Waveform (200Hz, 80%) | Generic | 0.97 | ±9.6 |
| 10387 | AAA | QPSK Waveform, 1 MHz | Generic | 5.10 | ±9.6 |
| 10388 | AAA | QPSK Waveform, 10 MHz | Generic | 5.22 | ±9.6 |
| 10396 | AAA | 64-QAM Waveform, 100 kHz | Generic | 6.27 | ±9.6 |
| 10399 | AAA | 64-QAM Waveform, 40 MHz | Generic | 6.27 | ±9.6 |
| 10400 | AAE | IEEE 802.11ac WiFi (20 MHz, 64-QAM, 99pc duty cycle) | WLAN | 8.37 | ±9.6 |
| 10401 | AAE | IEEE 802.11ac WiFi (40 MHz, 64-QAM, 99pc duty cycle) | WLAN | 8.60 | ±9.6 |
| 10402 | AAE | IEEE 802.11ac WiFi (80 MHz, 64-QAM, 99pc duty cycle) | WLAN | 8.53 | ±9.6 |
| 10403 | AAB | CDMA2000 (1xEV-DO, Rev. 0) | CDMA2000 | 3.76 | ±9.6 |
| 10404 | AAB | CDMA2000 (1xEV-DO, Rev. A) | CDMA2000 | 3.77 | ±9.6 |
| 10406 | AAB | CDMA2000, RC3, SQ32, SCH0, Full Rate | CDMA2000 | 5.22 | ±9.6 |
| 10410 | AAH | LTE-TDD (SC-FDMA, 1 RB, 10 MHz, QPSK, UL Subframe=2,3,4,7,8,9, Subframe Conf=4) | LTE-TDD | 7.82 | ±9.6 |
| 10414 | AAA | WLAN CCDF, 64-QAM, 40 MHz | Generic | 8.54 | ±9.6 |
| 10415 | AAA | IEEE 802.11b WiFi 2.4 GHz (DSSS, 1 Mbps, 99pc duty cycle) | WLAN | 1.54 | ±9.6 |
| 10416 | AAA | IEEE 802.11g WiFi 2.4 GHz (ERP-OFDM, 6 Mbps, 99pc duty cycle) | WLAN | 8.23 | ±9.6 |
| 10417 | AAC | IEEE 802.11a/h WiFi 5 GHz (OFDM, 6 Mbps, 99pc duty cycle) | WLAN | 8.23 | ±9.6 |
| 10418 | AAA | IEEE 802.11g WiFi 2.4 GHz (DSSS-OFDM, 6 Mbps, 99pc duty cycle, Long preamble) | WLAN | 8.14 | ±9.6 |
| 10419 | AAA | IEEE 802.11g WiFi 2.4 GHz (DSSS-OFDM, 6 Mbps, 99pc duty cycle, Short preamble) | WLAN | 8.19 | ±9.6 |
| 10422 | AAC | IEEE 802.11n (HT Greenfield, 7.2 Mbps, BPSK) | WLAN | 8.32 | ±9.6 |
| 10423 | AAC | IEEE 802.11n (HT Greenfield, 43.3 Mbps, 16-QAM) | WLAN | 8.47 | ±9.6 |
| 10424 | AAC | IEEE 802.11n (HT Greenfield, 72.2 Mbps, 64-QAM) | WLAN | 8.40 | ±9.6 |
| 10425 | AAC | IEEE 802.11n (HT Greenfield, 15 Mbps, BPSK) | WLAN | 8.41 | ±9.6 |
| 10426 | AAC | IEEE 802.11n (HT Greenfield, 90 Mbps, 16-QAM) | WLAN | 8.45 | ±9.6 |
| 10427 | AAC | IEEE 802.11n (HT Greenfield, 150 Mbps, 64-QAM) | WLAN | 8.41 | ±9.6 |
| 10430 | AAE | LTE-FDD (OFDMA, 5 MHz, E-TM 3.1) | LTE-FDD | 8.28 | ±9.6 |
| 10431 | AAE | LTE-FDD (OFDMA, 10 MHz, E-TM 3.1) | LTE-FDD | 8.38 | ±9.6 |
| 10432 | AAD | LTE-FDD (OFDMA, 15 MHz, E-TM 3.1) | LTE-FDD | 8.34 | ±9.6 |
| 10433 | AAD | LTE-FDD (OFDMA, 20 MHz, E-TM 3.1) | LTE-FDD | 8.34 | ±9.6 |
| 10434 | AAB | W-CDMA (BS Test Model 1, 64 DPCH) | WCDMA | 8.60 | ±9.6 |
| 10435 | AAG | LTE-TDD (SC-FDMA, 1 RB, 20 MHz, QPSK, UL Subframe=2,3,4,7,8,9) | LTE-TDD | 7.82 | ±9.6 |
| 10447 | AAE | LTE-FDD (OFDMA, 5 MHz, E-TM 3.1, Clipping 44%) | LTE-FDD | 7.56 | ±9.6 |
| 10448 | AAE | LTE-FDD (OFDMA, 10 MHz, E-TM 3.1, Clipping 44%) | LTE-FDD | 7.53 | ±9.6 |
| 10449 | AAD | LTE-FDD (OFDMA, 15 MHz, E-TM 3.1, Clipping 44%) | LTE-FDD | 7.51 | ±9.6 |
| 10450 | AAD | LTE-FDD (OFDMA, 20 MHz, E-TM 3.1, Clipping 44%) | LTE-FDD | 7.48 | ±9.6 |
| 10451 | AAB | W-CDMA (BS Test Model 1, 64 DPCH, Clipping 44%) | WCDMA | 7.59 | ±9.6 |
| 10453 | AAE | Validation (Square, 10 ms, 1 ms) | Test | 10.00 | ±9.6 |
| 10456 | AAC | IEEE 802.11ac WiFi (160 MHz, 64-QAM, 99pc duty cycle) | WLAN | 8.63 | ±9.6 |
| 10457 | AAB | UMTS-FDD (DC-HSDPA) | WCDMA | 6.62 | ±9.6 |
| 10458 | AAA | CDMA2000 (1xEV-DO, Rev. B, 2 carriers) | CDMA2000 | 6.55 | ±9.6 |
| 10459 | AAA | CDMA2000 (1xEV-DO, Rev. B, 3 carriers) | CDMA2000 | 8.25 | ±9.6 |
| 10460 | AAB | UMTS-FDD (WCDMA, AMR) | WCDMA | 2.39 | ±9.6 |
| 10461 | AAC | LTE-TDD (SC-FDMA, 1 RB, 1.4 MHz, QPSK, UL Subframe=2,3,4,7,8,9) | LTE-TDD | 7.82 | ±9.6 |
| 10462 | AAC | LTE-TDD (SC-FDMA, 1 RB, 1.4 MHz, 16-QAM, UL Subframe=2,3,4,7,8,9) | LTE-TDD | 8.30 | ±9.6 |
| 10463 | AAC | LTE-TDD (SC-FDMA, 1 RB, 1.4 MHz, 64-QAM, UL Subframe=2,3,4,7,8,9) | LTE-TDD | 8.56 | ±9.6 |
| 10464 | AAD | LTE-TDD (SC-FDMA, 1 RB, 3 MHz, QPSK, UL Subframe=2,3,4,7,8,9) | LTE-TDD | 7.82 | ±9.6 |
| 10465 | AAD | LTE-TDD (SC-FDMA, 1 RB, 3 MHz, 16-QAM, UL Subframe=2,3,4,7,8,9) | LTE-TDD | 8.32 | ±9.6 |
| 10466 | AAD | LTE-TDD (SC-FDMA, 1 RB, 3 MHz, 64-QAM, UL Subframe=2,3,4,7,8,9) | LTE-TDD | 8.57 | ±9.6 |
| 10467 | AAG | LTE-TDD (SC-FDMA, 1 RB, 5 MHz, QPSK, UL Subframe=2,3,4,7,8,9) | LTE-TDD | 7.82 | ±9.6 |
| 10468 | AAG | LTE-TDD (SC-FDMA, 1 RB, 5 MHz, 16-QAM, UL Subframe=2,3,4,7,8,9) | LTE-TDD | 8.32 | ±9.6 |
| 10469 | AAG | LTE-TDD (SC-FDMA, 1 RB, 5 MHz, 64-QAM, UL Subframe=2,3,4,7,8,9) | LTE-TDD | 8.56 | ±9.6 |
| 10470 | AAG | LTE-TDD (SC-FDMA, 1 RB, 10 MHz, QPSK, UL Subframe=2,3,4,7,8,9) | LTE-TDD | 7.82 | ±9.6 |
| 10471 | AAG | LTE-TDD (SC-FDMA, 1 RB, 10 MHz, 16-QAM, UL Subframe=2,3,4,7,8,9) | LTE-TDD | 8.32 | ±9.6 |

| UID | Rev | Communication System Name | Group | PAR (dB) | Unc ^E k = 2 |
|-------|-----|--|---------|----------|------------------------|
| 10472 | AAG | LTE-TDD (SC-FDMA, 1 RB, 10 MHz, 64-QAM, UL Subframe=2,3,4,7,8,9) | LTE-TDD | 8.57 | ±9.6 |
| 10473 | AAF | LTE-TDD (SC-FDMA, 1 RB, 15 MHz, QPSK, UL Subframe=2,3,4,7,8,9) | LTE-TDD | 7.82 | ±9.6 |
| 10474 | AAF | LTE-TDD (SC-FDMA, 1 RB, 15 MHz, 16-QAM, UL Subframe=2,3,4,7,8,9) | LTE-TDD | 8.32 | ±9.6 |
| 10475 | AAF | LTE-TDD (SC-FDMA, 1 RB, 15 MHz, 64-QAM, UL Subframe=2,3,4,7,8,9) | LTE-TDD | 8.57 | ±9.6 |
| 10477 | AAG | LTE-TDD (SC-FDMA, 1 RB, 20 MHz, 16-QAM, UL Subframe=2,3,4,7,8,9) | LTE-TDD | 8.32 | ±9.6 |
| 10478 | AAG | LTE-TDD (SC-FDMA, 1 RB, 20 MHz, 64-QAM, UL Subframe=2,3,4,7,8,9) | LTE-TDD | 8.57 | ±9.6 |
| 10479 | AAC | LTE-TDD (SC-FDMA, 50% RB, 1.4 MHz, QPSK, UL Subframe=2,3,4,7,8,9) | LTE-TDD | 7.74 | ±9.6 |
| 10480 | AAC | LTE-TDD (SC-FDMA, 50% RB, 1.4 MHz, 16-QAM, UL Subframe=2,3,4,7,8,9) | LTE-TDD | 8.18 | ±9.6 |
| 10481 | AAC | LTE-TDD (SC-FDMA, 50% RB, 1.4 MHz, 64-QAM, UL Subframe=2,3,4,7,8,9) | LTE-TDD | 8.45 | ±9.6 |
| 10482 | AAD | LTE-TDD (SC-FDMA, 50% RB, 3 MHz, QPSK, UL Subframe=2,3,4,7,8,9) | LTE-TDD | 7.71 | ±9.6 |
| 10483 | AAD | LTE-TDD (SC-FDMA, 50% RB, 3 MHz, 16-QAM, UL Subframe=2,3,4,7,8,9) | LTE-TDD | 8.39 | ±9.6 |
| 10484 | AAD | LTE-TDD (SC-FDMA, 50% RB, 3 MHz, 64-QAM, UL Subframe=2,3,4,7,8,9) | LTE-TDD | 8.47 | ±9.6 |
| 10485 | AAG | LTE-TDD (SC-FDMA, 50% RB, 5 MHz, QPSK, UL Subframe=2,3,4,7,8,9) | LTE-TDD | 7.59 | ±9.6 |
| 10486 | AAG | LTE-TDD (SC-FDMA, 50% RB, 5 MHz, 16-QAM, UL Subframe=2,3,4,7,8,9) | LTE-TDD | 8.38 | ±9.6 |
| 10487 | AAG | LTE-TDD (SC-FDMA, 50% RB, 5 MHz, 64-QAM, UL Subframe=2,3,4,7,8,9) | LTE-TDD | 8.60 | ±9.6 |
| 10488 | AAG | LTE-TDD (SC-FDMA, 50% RB, 10 MHz, QPSK, UL Subframe=2,3,4,7,8,9) | LTE-TDD | 7.70 | ±9.6 |
| 10489 | AAG | LTE-TDD (SC-FDMA, 50% RB, 10 MHz, 16-QAM, UL Subframe=2,3,4,7,8,9) | LTE-TDD | 8.31 | ±9.6 |
| 10490 | AAG | LTE-TDD (SC-FDMA, 50% RB, 10 MHz, 64-QAM, UL Subframe=2,3,4,7,8,9) | LTE-TDD | 8.54 | ±9.6 |
| 10491 | AAF | LTE-TDD (SC-FDMA, 50% RB, 15 MHz, QPSK, UL Subframe=2,3,4,7,8,9) | LTE-TDD | 7.74 | ±9.6 |
| 10492 | AAF | LTE-TDD (SC-FDMA, 50% RB, 15 MHz, 16-QAM, UL Subframe=2,3,4,7,8,9) | LTE-TDD | 8.41 | ±9.6 |
| 10493 | AAF | LTE-TDD (SC-FDMA, 50% RB, 15 MHz, 64-QAM, UL Subframe=2,3,4,7,8,9) | LTE-TDD | 8.55 | ±9.6 |
| 10494 | AAG | LTE-TDD (SC-FDMA, 50% RB, 20 MHz, QPSK, UL Subframe=2,3,4,7,8,9) | LTE-TDD | 7.74 | ±9.6 |
| 10495 | AAG | LTE-TDD (SC-FDMA, 50% RB, 20 MHz, 16-QAM, UL Subframe=2,3,4,7,8,9) | LTE-TDD | 8.37 | ±9.6 |
| 10496 | AAG | LTE-TDD (SC-FDMA, 50% RB, 20 MHz, 64-QAM, UL Subframe=2,3,4,7,8,9) | LTE-TDD | 8.54 | ±9.6 |
| 10497 | AAC | LTE-TDD (SC-FDMA, 100% RB, 1.4 MHz, QPSK, UL Subframe=2,3,4,7,8,9) | LTE-TDD | 7.67 | ±9.6 |
| 10498 | AAC | LTE-TDD (SC-FDMA, 100% RB, 1.4 MHz, 16-QAM, UL Subframe=2,3,4,7,8,9) | LTE-TDD | 8.40 | ±9.6 |
| 10499 | AAC | LTE-TDD (SC-FDMA, 100% RB, 1.4 MHz, 64-QAM, UL Subframe=2,3,4,7,8,9) | LTE-TDD | 8.68 | ±9.6 |
| 10500 | AAD | LTE-TDD (SC-FDMA, 100% RB, 3 MHz, QPSK, UL Subframe=2,3,4,7,8,9) | LTE-TDD | 7.67 | ±9.6 |
| 10501 | AAD | LTE-TDD (SC-FDMA, 100% RB, 3 MHz, 16-QAM, UL Subframe=2,3,4,7,8,9) | LTE-TDD | 8.44 | ±9.6 |
| 10502 | AAD | LTE-TDD (SC-FDMA, 100% RB, 3 MHz, 64-QAM, UL Subframe=2,3,4,7,8,9) | LTE-TDD | 8.52 | ±9.6 |
| 10503 | AAG | LTE-TDD (SC-FDMA, 100% RB, 5 MHz, QPSK, UL Subframe=2,3,4,7,8,9) | LTE-TDD | 7.72 | ±9.6 |
| 10504 | AAG | LTE-TDD (SC-FDMA, 100% RB, 5 MHz, 16-QAM, UL Subframe=2,3,4,7,8,9) | LTE-TDD | 8.31 | ±9.6 |
| 10505 | AAG | LTE-TDD (SC-FDMA, 100% RB, 5 MHz, 64-QAM, UL Subframe=2,3,4,7,8,9) | LTE-TDD | 8.54 | ±9.6 |
| 10506 | AAG | LTE-TDD (SC-FDMA, 100% RB, 10 MHz, QPSK, UL Subframe=2,3,4,7,8,9) | LTE-TDD | 7.74 | ±9.6 |
| 10507 | AAG | LTE-TDD (SC-FDMA, 100% RB, 10 MHz, 16-QAM, UL Subframe=2,3,4,7,8,9) | LTE-TDD | 8.36 | ±9.6 |
| 10508 | AAG | LTE-TDD (SC-FDMA, 100% RB, 10 MHz, 64-QAM, UL Subframe=2,3,4,7,8,9) | LTE-TDD | 8.55 | ±9.6 |
| 10509 | AAF | LTE-TDD (SC-FDMA, 100% RB, 15 MHz, QPSK, UL Subframe=2,3,4,7,8,9) | LTE-TDD | 7.99 | ±9.6 |
| 10510 | AAF | LTE-TDD (SC-FDMA, 100% RB, 15 MHz, 16-QAM, UL Subframe=2,3,4,7,8,9) | LTE-TDD | 8.49 | ±9.6 |
| 10511 | AAF | LTE-TDD (SC-FDMA, 100% RB, 15 MHz, 64-QAM, UL Subframe=2,3,4,7,8,9) | LTE-TDD | 8.51 | ±9.6 |
| 10512 | AAG | LTE-TDD (SC-FDMA, 100% RB, 20 MHz, QPSK, UL Subframe=2,3,4,7,8,9) | LTE-TDD | 7.74 | ±9.6 |
| 10513 | AAG | LTE-TDD (SC-FDMA, 100% RB, 20 MHz, 16-QAM, UL Subframe=2,3,4,7,8,9) | LTE-TDD | 8.42 | ±9.6 |
| 10514 | AAG | LTE-TDD (SC-FDMA, 100% RB, 20 MHz, 64-QAM, UL Subframe=2,3,4,7,8,9) | LTE-TDD | 8.45 | ±9.6 |
| 10515 | AAA | IEEE 802.11b WiFi 2.4 GHz (DSSS, 2 Mbps, 99pc duty cycle) | WLAN | 1.58 | ±9.6 |
| 10516 | AAA | IEEE 802.11b WiFi 2.4 GHz (DSSS, 5.5 Mbps, 99pc duty cycle) | WLAN | 1.57 | ±9.6 |
| 10517 | AAA | IEEE 802.11b WiFi 2.4 GHz (DSSS, 11 Mbps, 99pc duty cycle) | WLAN | 1.58 | ±9.6 |
| 10518 | AAC | IEEE 802.11a/h WiFi 5 GHz (OFDM, 9 Mbps, 99pc duty cycle) | WLAN | 8.23 | ±9.6 |
| 10519 | AAC | IEEE 802.11a/h WiFi 5 GHz (OFDM, 12 Mbps, 99pc duty cycle) | WLAN | 8.39 | ±9.6 |
| 10520 | AAC | IEEE 802.11a/h WiFi 5 GHz (OFDM, 18 Mbps, 99pc duty cycle) | WLAN | 8.12 | ±9.6 |
| 10521 | AAC | IEEE 802.11a/h WiFi 5 GHz (OFDM, 24 Mbps, 99pc duty cycle) | WLAN | 7.97 | ±9.6 |
| 10522 | AAC | IEEE 802.11a/h WiFi 5 GHz (OFDM, 36 Mbps, 99pc duty cycle) | WLAN | 8.45 | ±9.6 |
| 10523 | AAC | IEEE 802.11a/h WiFi 5 GHz (OFDM, 48 Mbps, 99pc duty cycle) | WLAN | 8.08 | ±9.6 |
| 10524 | AAC | IEEE 802.11a/h WiFi 5 GHz (OFDM, 54 Mbps, 99pc duty cycle) | WLAN | 8.27 | ±9.6 |
| 10525 | AAC | IEEE 802.11ac WiFi (20 MHz, MCS0, 99pc duty cycle) | WLAN | 8.36 | ±9.6 |
| 10526 | AAC | IEEE 802.11ac WiFi (20 MHz, MCS1, 99pc duty cycle) | WLAN | 8.42 | ±9.6 |
| 10527 | AAC | IEEE 802.11ac WiFi (20 MHz, MCS2, 99pc duty cycle) | WLAN | 8.21 | ±9.6 |
| 10528 | AAC | IEEE 802.11ac WiFi (20 MHz, MCS3, 99pc duty cycle) | WLAN | 8.36 | ±9.6 |
| 10529 | AAC | IEEE 802.11ac WiFi (20 MHz, MCS4, 99pc duty cycle) | WLAN | 8.36 | ±9.6 |
| 10531 | AAC | IEEE 802.11ac WiFi (20 MHz, MCS6, 99pc duty cycle) | WLAN | 8.43 | ±9.6 |
| 10532 | AAC | IEEE 802.11ac WiFi (20 MHz, MCS7, 99pc duty cycle) | WLAN | 8.29 | ±9.6 |
| 10533 | AAC | IEEE 802.11ac WiFi (20 MHz, MCS8, 99pc duty cycle) | WLAN | 8.38 | ±9.6 |
| 10534 | AAC | IEEE 802.11ac WiFi (40 MHz, MCS0, 99pc duty cycle) | WLAN | 8.45 | ±9.6 |
| 10535 | AAC | IEEE 802.11ac WiFi (40 MHz, MCS1, 99pc duty cycle) | WLAN | 8.45 | ±9.6 |
| 10536 | AAC | IEEE 802.11ac WiFi (40 MHz, MCS2, 99pc duty cycle) | WLAN | 8.32 | ±9.6 |
| 10537 | AAC | IEEE 802.11ac WiFi (40 MHz, MCS3, 99pc duty cycle) | WLAN | 8.44 | ±9.6 |
| 10538 | AAC | IEEE 802.11ac WiFi (40 MHz, MCS4, 99pc duty cycle) | WLAN | 8.54 | ±9.6 |
| 10540 | AAC | IEEE 802.11ac WiFi (40 MHz, MCS6, 99pc duty cycle) | WLAN | 8.39 | ±9.6 |

| UID | Rev | Communication System Name | Group | PAR (dB) | Unc ^E k = 2 |
|-------|-----|---|-------|----------|------------------------|
| 10541 | AAC | IEEE 802.11ac WiFi (40 MHz, MCS7, 99pc duty cycle) | WLAN | 8.46 | ±9.6 |
| 10542 | AAC | IEEE 802.11ac WiFi (40 MHz, MCS8, 99pc duty cycle) | WLAN | 8.65 | ±9.6 |
| 10543 | AAC | IEEE 802.11ac WiFi (40 MHz, MCS9, 99pc duty cycle) | WLAN | 8.65 | ±9.6 |
| 10544 | AAC | IEEE 802.11ac WiFi (80 MHz, MCS0, 99pc duty cycle) | WLAN | 8.47 | ±9.6 |
| 10545 | AAC | IEEE 802.11ac WiFi (80 MHz, MCS1, 99pc duty cycle) | WLAN | 8.55 | ±9.6 |
| 10546 | AAC | IEEE 802.11ac WiFi (80 MHz, MCS2, 99pc duty cycle) | WLAN | 8.35 | ±9.6 |
| 10547 | AAC | IEEE 802.11ac WiFi (80 MHz, MCS3, 99pc duty cycle) | WLAN | 8.49 | ±9.6 |
| 10548 | AAC | IEEE 802.11ac WiFi (80 MHz, MCS4, 99pc duty cycle) | WLAN | 8.37 | ±9.6 |
| 10550 | AAC | IEEE 802.11ac WiFi (80 MHz, MCS6, 99pc duty cycle) | WLAN | 8.38 | ±9.6 |
| 10551 | AAC | IEEE 802.11ac WiFi (80 MHz, MCS7, 99pc duty cycle) | WLAN | 8.50 | ±9.6 |
| 10552 | AAC | IEEE 802.11ac WiFi (80 MHz, MCS8, 99pc duty cycle) | WLAN | 8.42 | ±9.6 |
| 10553 | AAC | IEEE 802.11ac WiFi (80 MHz, MCS9, 99pc duty cycle) | WLAN | 8.45 | ±9.6 |
| 10554 | AAD | IEEE 802.11ac WiFi (160 MHz, MCS0, 99pc duty cycle) | WLAN | 8.48 | ±9.6 |
| 10555 | AAD | IEEE 802.11ac WiFi (160 MHz, MCS1, 99pc duty cycle) | WLAN | 8.47 | ±9.6 |
| 10556 | AAD | IEEE 802.11ac WiFi (160 MHz, MCS2, 99pc duty cycle) | WLAN | 8.50 | ±9.6 |
| 10557 | AAD | IEEE 802.11ac WiFi (160 MHz, MCS3, 99pc duty cycle) | WLAN | 8.52 | ±9.6 |
| 10558 | AAD | IEEE 802.11ac WiFi (160 MHz, MCS4, 99pc duty cycle) | WLAN | 8.61 | ±9.6 |
| 10560 | AAD | IEEE 802.11ac WiFi (160 MHz, MCS6, 99pc duty cycle) | WLAN | 8.73 | ±9.6 |
| 10561 | AAD | IEEE 802.11ac WiFi (160 MHz, MCS7, 99pc duty cycle) | WLAN | 8.56 | ±9.6 |
| 10562 | AAD | IEEE 802.11ac WiFi (160 MHz, MCS8, 99pc duty cycle) | WLAN | 8.69 | ±9.6 |
| 10563 | AAD | IEEE 802.11ac WiFi (160 MHz, MCS9, 99pc duty cycle) | WLAN | 8.77 | ±9.6 |
| 10564 | AAA | IEEE 802.11g WiFi 2.4 GHz (DSSS-OFDM, 9 Mbps, 99pc duty cycle) | WLAN | 8.25 | ±9.6 |
| 10565 | AAA | IEEE 802.11g WiFi 2.4 GHz (DSSS-OFDM, 12 Mbps, 99pc duty cycle) | WLAN | 8.45 | ±9.6 |
| 10566 | AAA | IEEE 802.11g WiFi 2.4 GHz (DSSS-OFDM, 18 Mbps, 99pc duty cycle) | WLAN | 8.13 | ±9.6 |
| 10567 | AAA | IEEE 802.11g WiFi 2.4 GHz (DSSS-OFDM, 24 Mbps, 99pc duty cycle) | WLAN | 8.00 | ±9.6 |
| 10568 | AAA | IEEE 802.11g WiFi 2.4 GHz (DSSS-OFDM, 36 Mbps, 99pc duty cycle) | WLAN | 8.37 | ±9.6 |
| 10569 | AAA | IEEE 802.11g WiFi 2.4 GHz (DSSS-OFDM, 48 Mbps, 99pc duty cycle) | WLAN | 8.10 | ±9.6 |
| 10570 | AAA | IEEE 802.11g WiFi 2.4 GHz (DSSS-OFDM, 54 Mbps, 99pc duty cycle) | WLAN | 8.30 | ±9.6 |
| 10571 | AAA | IEEE 802.11b WiFi 2.4 GHz (DSSS, 1 Mbps, 90pc duty cycle) | WLAN | 1.99 | ±9.6 |
| 10572 | AAA | IEEE 802.11b WiFi 2.4 GHz (DSSS, 2 Mbps, 90pc duty cycle) | WLAN | 1.99 | ±9.6 |
| 10573 | AAA | IEEE 802.11b WiFi 2.4 GHz (DSSS, 5.5 Mbps, 90pc duty cycle) | WLAN | 1.98 | ±9.6 |
| 10574 | AAA | IEEE 802.11b WiFi 2.4 GHz (DSSS, 11 Mbps, 90pc duty cycle) | WLAN | 1.98 | ±9.6 |
| 10575 | AAA | IEEE 802.11g WiFi 2.4 GHz (DSSS-OFDM, 6 Mbps, 90pc duty cycle) | WLAN | 8.59 | ±9.6 |
| 10576 | AAA | IEEE 802.11g WiFi 2.4 GHz (DSSS-OFDM, 9 Mbps, 90pc duty cycle) | WLAN | 8.60 | ±9.6 |
| 10577 | AAA | IEEE 802.11g WiFi 2.4 GHz (DSSS-OFDM, 12 Mbps, 90pc duty cycle) | WLAN | 8.70 | ±9.6 |
| 10578 | AAA | IEEE 802.11g WiFi 2.4 GHz (DSSS-OFDM, 18 Mbps, 90pc duty cycle) | WLAN | 8.49 | ±9.6 |
| 10579 | AAA | IEEE 802.11g WiFi 2.4 GHz (DSSS-OFDM, 24 Mbps, 90pc duty cycle) | WLAN | 8.36 | ±9.6 |
| 10580 | AAA | IEEE 802.11g WiFi 2.4 GHz (DSSS-OFDM, 36 Mbps, 90pc duty cycle) | WLAN | 8.76 | ±9.6 |
| 10581 | AAA | IEEE 802.11g WiFi 2.4 GHz (DSSS-OFDM, 48 Mbps, 90pc duty cycle) | WLAN | 8.35 | ±9.6 |
| 10582 | AAA | IEEE 802.11g WiFi 2.4 GHz (DSSS-OFDM, 54 Mbps, 90pc duty cycle) | WLAN | 8.67 | ±9.6 |
| 10583 | AAC | IEEE 802.11a/h WiFi 5 GHz (OFDM, 6 Mbps, 90pc duty cycle) | WLAN | 8.59 | ±9.6 |
| 10584 | AAC | IEEE 802.11a/h WiFi 5 GHz (OFDM, 9 Mbps, 90pc duty cycle) | WLAN | 8.60 | ±9.6 |
| 10585 | AAC | IEEE 802.11a/h WiFi 5 GHz (OFDM, 12 Mbps, 90pc duty cycle) | WLAN | 8.70 | ±9.6 |
| 10586 | AAC | IEEE 802.11a/h WiFi 5 GHz (OFDM, 18 Mbps, 90pc duty cycle) | WLAN | 8.49 | ±9.6 |
| 10587 | AAC | IEEE 802.11a/h WiFi 5 GHz (OFDM, 24 Mbps, 90pc duty cycle) | WLAN | 8.36 | ±9.6 |
| 10588 | AAC | IEEE 802.11a/h WiFi 5 GHz (OFDM, 36 Mbps, 90pc duty cycle) | WLAN | 8.76 | ±9.6 |
| 10589 | AAC | IEEE 802.11a/h WiFi 5 GHz (OFDM, 48 Mbps, 90pc duty cycle) | WLAN | 8.35 | ±9.6 |
| 10590 | AAC | IEEE 802.11a/h WiFi 5 GHz (OFDM, 54 Mbps, 90pc duty cycle) | WLAN | 8.67 | ±9.6 |
| 10591 | AAC | IEEE 802.11n (HT Mixed, 20 MHz, MCS0, 90pc duty cycle) | WLAN | 8.63 | ±9.6 |
| 10592 | AAC | IEEE 802.11n (HT Mixed, 20 MHz, MCS1, 90pc duty cycle) | WLAN | 8.79 | ±9.6 |
| 10593 | AAC | IEEE 802.11n (HT Mixed, 20 MHz, MCS2, 90pc duty cycle) | WLAN | 8.64 | ±9.6 |
| 10594 | AAC | IEEE 802.11n (HT Mixed, 20 MHz, MCS3, 90pc duty cycle) | WLAN | 8.74 | ±9.6 |
| 10595 | AAC | IEEE 802.11n (HT Mixed, 20 MHz, MCS4, 90pc duty cycle) | WLAN | 8.74 | ±9.6 |
| 10596 | AAC | IEEE 802.11n (HT Mixed, 20 MHz, MCS5, 90pc duty cycle) | WLAN | 8.71 | ±9.6 |
| 10597 | AAC | IEEE 802.11n (HT Mixed, 20 MHz, MCS6, 90pc duty cycle) | WLAN | 8.72 | ±9.6 |
| 10598 | AAC | IEEE 802.11n (HT Mixed, 20 MHz, MCS7, 90pc duty cycle) | WLAN | 8.50 | ±9.6 |
| 10599 | AAC | IEEE 802.11n (HT Mixed, 40 MHz, MCS0, 90pc duty cycle) | WLAN | 8.79 | ±9.6 |
| 10600 | AAC | IEEE 802.11n (HT Mixed, 40 MHz, MCS1, 90pc duty cycle) | WLAN | 8.88 | ±9.6 |
| 10601 | AAC | IEEE 802.11n (HT Mixed, 40 MHz, MCS2, 90pc duty cycle) | WLAN | 8.82 | ±9.6 |
| 10602 | AAC | IEEE 802.11n (HT Mixed, 40 MHz, MCS3, 90pc duty cycle) | WLAN | 8.94 | ±9.6 |
| 10603 | AAC | IEEE 802.11n (HT Mixed, 40 MHz, MCS4, 90pc duty cycle) | WLAN | 9.03 | ±9.6 |
| 10604 | AAC | IEEE 802.11n (HT Mixed, 40 MHz, MCS5, 90pc duty cycle) | WLAN | 8.76 | ±9.6 |
| 10605 | AAC | IEEE 802.11n (HT Mixed, 40 MHz, MCS6, 90pc duty cycle) | WLAN | 8.97 | ±9.6 |
| 10606 | AAC | IEEE 802.11n (HT Mixed, 40 MHz, MCS7, 90pc duty cycle) | WLAN | 8.82 | ±9.6 |
| 10607 | AAC | IEEE 802.11ac WiFi (20 MHz, MCS0, 90pc duty cycle) | WLAN | 8.64 | ±9.6 |
| 10608 | AAC | IEEE 802.11ac WiFi (20 MHz, MCS1, 90pc duty cycle) | WLAN | 8.77 | ±9.6 |

| UID | Rev | Communication System Name | Group | PAR (dB) | Unc ^E $k = 2$ |
|-------|-----|--|-----------|----------|--------------------------|
| 10609 | AAC | IEEE 802.11ac WiFi (20 MHz, MCS2, 90pc duty cycle) | WLAN | 8.57 | ±9.6 |
| 10610 | AAC | IEEE 802.11ac WiFi (20 MHz, MCS3, 90pc duty cycle) | WLAN | 8.78 | ±9.6 |
| 10611 | AAC | IEEE 802.11ac WiFi (20 MHz, MCS4, 90pc duty cycle) | WLAN | 8.70 | ±9.6 |
| 10612 | AAC | IEEE 802.11ac WiFi (20 MHz, MCS5, 90pc duty cycle) | WLAN | 8.77 | ±9.6 |
| 10613 | AAC | IEEE 802.11ac WiFi (20 MHz, MCS6, 90pc duty cycle) | WLAN | 8.94 | ±9.6 |
| 10614 | AAC | IEEE 802.11ac WiFi (20 MHz, MCS8, 90pc duty cycle) | WLAN | 8.59 | ±9.6 |
| 10615 | AAC | IEEE 802.11ac WiFi (20 MHz, MCS8, 90pc duty cycle) | WLAN | 8.82 | ±9.6 |
| 10616 | AAC | IEEE 802.11ac WiFi (40 MHz, MCS0, 90pc duty cycle) | WLAN | 8.82 | ±9.6 |
| 10617 | AAC | IEEE 802.11ac WiFi (40 MHz, MCS1, 90pc duty cycle) | WLAN | 8.81 | ±9.6 |
| 10618 | AAC | IEEE 802.11ac WiFi (40 MHz, MCS2, 90pc duty cycle) | WLAN | 8.58 | ±9.6 |
| 10619 | AAC | IEEE 802.11ac WiFi (40 MHz, MCS3, 90pc duty cycle) | WLAN | 8.86 | ±9.6 |
| 10620 | AAC | IEEE 802.11ac WiFi (40 MHz, MCS4, 90pc duty cycle) | WLAN | 8.87 | ±9.6 |
| 10621 | AAC | IEEE 802.11ac WiFi (40 MHz, MCS5, 90pc duty cycle) | WLAN | 8.77 | ±9.6 |
| 10622 | AAC | IEEE 802.11ac WiFi (40 MHz, MCS6, 90pc duty cycle) | WLAN | 8.68 | ±9.6 |
| 10623 | AAC | IEEE 802.11ac WiFi (40 MHz, MCS7, 90pc duty cycle) | WLAN | 8.82 | ±9.6 |
| 10624 | AAC | IEEE 802.11ac WiFi (40 MHz, MCS8, 90pc duty cycle) | WLAN | 8.96 | ±9.6 |
| 10625 | AAC | IEEE 802.11ac WiFi (40 MHz, MCS9, 90pc duty cycle) | WLAN | 8.96 | ±9.6 |
| 10626 | AAC | IEEE 802.11ac WiFi (80 MHz, MCS0, 90pc duty cycle) | WLAN | 8.83 | ±9.6 |
| 10627 | AAC | IEEE 802.11ac WiFi (80 MHz, MCS1, 90pc duty cycle) | WLAN | 8.88 | ±9.6 |
| 10628 | AAC | IEEE 802.11ac WiFi (80 MHz, MCS2, 90pc duty cycle) | WLAN | 8.71 | ±9.6 |
| 10629 | AAC | IEEE 802.11ac WiFi (80 MHz, MCS3, 90pc duty cycle) | WLAN | 8.85 | ±9.6 |
| 10630 | AAC | IEEE 802.11ac WiFi (80 MHz, MCS4, 90pc duty cycle) | WLAN | 8.72 | ±9.6 |
| 10631 | AAC | IEEE 802.11ac WiFi (80 MHz, MCS5, 90pc duty cycle) | WLAN | 8.81 | ±9.6 |
| 10632 | AAC | IEEE 802.11ac WiFi (80 MHz, MCS6, 90pc duty cycle) | WLAN | 8.74 | ±9.6 |
| 10633 | AAC | IEEE 802.11ac WiFi (80 MHz, MCS7, 90pc duty cycle) | WLAN | 8.83 | ±9.6 |
| 10634 | AAC | IEEE 802.11ac WiFi (80 MHz, MCS8, 90pc duty cycle) | WLAN | 8.80 | ±9.6 |
| 10635 | AAC | IEEE 802.11ac WiFi (80 MHz, MCS9, 90pc duty cycle) | WLAN | 8.81 | ±9.6 |
| 10636 | AAD | IEEE 802.11ac WiFi (160 MHz, MCS0, 90pc duty cycle) | WLAN | 8.83 | ±9.6 |
| 10637 | AAD | IEEE 802.11ac WiFi (160 MHz, MCS1, 90pc duty cycle) | WLAN | 8.79 | ±9.6 |
| 10638 | AAD | IEEE 802.11ac WiFi (160 MHz, MCS2, 90pc duty cycle) | WLAN | 8.86 | ±9.6 |
| 10639 | AAD | IEEE 802.11ac WiFi (160 MHz, MCS3, 90pc duty cycle) | WLAN | 8.85 | ±9.6 |
| 10640 | AAD | IEEE 802.11ac WiFi (160 MHz, MCS4, 90pc duty cycle) | WLAN | 8.98 | ±9.6 |
| 10641 | AAD | IEEE 802.11ac WiFi (160 MHz, MCS5, 90pc duty cycle) | WLAN | 9.06 | ±9.6 |
| 10642 | AAD | IEEE 802.11ac WiFi (160 MHz, MCS6, 90pc duty cycle) | WLAN | 9.06 | ±9.6 |
| 10643 | AAD | IEEE 802.11ac WiFi (160 MHz, MCS7, 90pc duty cycle) | WLAN | 8.89 | ±9.6 |
| 10644 | AAD | IEEE 802.11ac WiFi (160 MHz, MCS8, 90pc duty cycle) | WLAN | 9.05 | ±9.6 |
| 10645 | AAD | IEEE 802.11ac WiFi (160 MHz, MCS9, 90pc duty cycle) | WLAN | 9.11 | ±9.6 |
| 10646 | AAH | LTE-TDD (SC-FDMA, 1 RB, 5 MHz, QPSK, UL Subframe=2,7) | LTE-TDD | 11.96 | ±9.6 |
| 10647 | AAG | LTE-TDD (SC-FDMA, 1 RB, 20 MHz, QPSK, UL Subframe=2,7) | LTE-TDD | 11.96 | ±9.6 |
| 10648 | AAA | CDMA2000 (1x Advanced) | CDMA2000 | 3.45 | ±9.6 |
| 10652 | AAF | LTE-TDD (OFDMA, 5 MHz, E-TM 3.1, Clipping 44%) | LTE-TDD | 6.91 | ±9.6 |
| 10653 | AAF | LTE-TDD (OFDMA, 10 MHz, E-TM 3.1, Clipping 44%) | LTE-TDD | 7.42 | ±9.6 |
| 10654 | AAE | LTE-TDD (OFDMA, 15 MHz, E-TM 3.1, Clipping 44%) | LTE-TDD | 6.96 | ±9.6 |
| 10655 | AAF | LTE-TDD (OFDMA, 20 MHz, E-TM 3.1, Clipping 44%) | LTE-TDD | 7.21 | ±9.6 |
| 10658 | AAB | Pulse Waveform (200Hz, 10%) | Test | 10.00 | ±9.6 |
| 10659 | AAB | Pulse Waveform (200Hz, 20%) | Test | 6.99 | ±9.6 |
| 10660 | AAB | Pulse Waveform (200Hz, 40%) | Test | 3.98 | ±9.6 |
| 10661 | AAB | Pulse Waveform (200Hz, 60%) | Test | 2.22 | ±9.6 |
| 10662 | AAB | Pulse Waveform (200Hz, 80%) | Test | 0.97 | ±9.6 |
| 10670 | AAA | Bluetooth Low Energy | Bluetooth | 2.19 | ±9.6 |
| 10671 | AAC | IEEE 802.11ax (20 MHz, MCS0, 90pc duty cycle) | WLAN | 9.09 | ±9.6 |
| 10672 | AAC | IEEE 802.11ax (20 MHz, MCS1, 90pc duty cycle) | WLAN | 8.57 | ±9.6 |
| 10673 | AAC | IEEE 802.11ax (20 MHz, MCS2, 90pc duty cycle) | WLAN | 8.78 | ±9.6 |
| 10674 | AAC | IEEE 802.11ax (20 MHz, MCS3, 90pc duty cycle) | WLAN | 8.74 | ±9.6 |
| 10675 | AAC | IEEE 802.11ax (20 MHz, MCS4, 90pc duty cycle) | WLAN | 8.90 | ±9.6 |
| 10676 | AAC | IEEE 802.11ax (20 MHz, MCS5, 90pc duty cycle) | WLAN | 8.77 | ±9.6 |
| 10677 | AAC | IEEE 802.11ax (20 MHz, MCS6, 90pc duty cycle) | WLAN | 8.73 | ±9.6 |
| 10678 | AAC | IEEE 802.11ax (20 MHz, MCS7, 90pc duty cycle) | WLAN | 8.78 | ±9.6 |
| 10679 | AAC | IEEE 802.11ax (20 MHz, MCS8, 90pc duty cycle) | WLAN | 8.89 | ±9.6 |
| 10680 | AAC | IEEE 802.11ax (20 MHz, MCS9, 90pc duty cycle) | WLAN | 8.80 | ±9.6 |
| 10681 | AAC | IEEE 802.11ax (20 MHz, MCS10, 90pc duty cycle) | WLAN | 8.62 | ±9.6 |
| 10682 | AAC | IEEE 802.11ax (20 MHz, MCS11, 90pc duty cycle) | WLAN | 8.83 | ±9.6 |
| 10683 | AAC | IEEE 802.11ax (20 MHz, MCS0, 99pc duty cycle) | WLAN | 8.42 | ±9.6 |
| 10684 | AAC | IEEE 802.11ax (20 MHz, MCS1, 99pc duty cycle) | WLAN | 8.26 | ±9.6 |
| 10685 | AAC | IEEE 802.11ax (20 MHz, MCS2, 99pc duty cycle) | WLAN | 8.33 | ±9.6 |
| 10686 | AAC | IEEE 802.11ax (20 MHz, MCS3, 99pc duty cycle) | WLAN | 8.28 | ±9.6 |

| UID | Rev | Communication System Name | Group | PAR (dB) | Unc ^E $k = 2$ |
|-------|-----|--|-------|----------|--------------------------|
| 10687 | AAC | IEEE 802.11ax (20 MHz, MCS4, 99pc duty cycle) | WLAN | 8.45 | ±9.6 |
| 10688 | AAC | IEEE 802.11ax (20 MHz, MCS5, 99pc duty cycle) | WLAN | 8.29 | ±9.6 |
| 10689 | AAC | IEEE 802.11ax (20 MHz, MCS6, 99pc duty cycle) | WLAN | 8.55 | ±9.6 |
| 10690 | AAC | IEEE 802.11ax (20 MHz, MCS7, 99pc duty cycle) | WLAN | 8.29 | ±9.6 |
| 10691 | AAC | IEEE 802.11ax (20 MHz, MCS8, 99pc duty cycle) | WLAN | 8.25 | ±9.6 |
| 10692 | AAC | IEEE 802.11ax (20 MHz, MCS9, 99pc duty cycle) | WLAN | 8.29 | ±9.6 |
| 10693 | AAC | IEEE 802.11ax (20 MHz, MCS10, 99pc duty cycle) | WLAN | 8.25 | ±9.6 |
| 10694 | AAC | IEEE 802.11ax (20 MHz, MCS11, 99pc duty cycle) | WLAN | 8.57 | ±9.6 |
| 10695 | AAC | IEEE 802.11ax (40 MHz, MCS0, 90pc duty cycle) | WLAN | 8.78 | ±9.6 |
| 10696 | AAC | IEEE 802.11ax (40 MHz, MCS1, 90pc duty cycle) | WLAN | 8.91 | ±9.6 |
| 10697 | AAC | IEEE 802.11ax (40 MHz, MCS2, 90pc duty cycle) | WLAN | 8.61 | ±9.6 |
| 10698 | AAC | IEEE 802.11ax (40 MHz, MCS3, 90pc duty cycle) | WLAN | 8.89 | ±9.6 |
| 10699 | AAC | IEEE 802.11ax (40 MHz, MCS4, 90pc duty cycle) | WLAN | 8.82 | ±9.6 |
| 10700 | AAC | IEEE 802.11ax (40 MHz, MCS5, 90pc duty cycle) | WLAN | 8.73 | ±9.6 |
| 10701 | AAC | IEEE 802.11ax (40 MHz, MCS6, 90pc duty cycle) | WLAN | 8.86 | ±9.6 |
| 10702 | AAC | IEEE 802.11ax (40 MHz, MCS7, 90pc duty cycle) | WLAN | 8.70 | ±9.6 |
| 10703 | AAC | IEEE 802.11ax (40 MHz, MCS8, 90pc duty cycle) | WLAN | 8.82 | ±9.6 |
| 10704 | AAC | IEEE 802.11ax (40 MHz, MCS9, 90pc duty cycle) | WLAN | 8.56 | ±9.6 |
| 10705 | AAC | IEEE 802.11ax (40 MHz, MCS10, 90pc duty cycle) | WLAN | 8.69 | ±9.6 |
| 10706 | AAC | IEEE 802.11ax (40 MHz, MCS11, 90pc duty cycle) | WLAN | 8.66 | ±9.6 |
| 10707 | AAC | IEEE 802.11ax (40 MHz, MCS0, 99pc duty cycle) | WLAN | 8.32 | ±9.6 |
| 10708 | AAC | IEEE 802.11ax (40 MHz, MCS1, 99pc duty cycle) | WLAN | 8.55 | ±9.6 |
| 10709 | AAC | IEEE 802.11ax (40 MHz, MCS2, 99pc duty cycle) | WLAN | 8.33 | ±9.6 |
| 10710 | AAC | IEEE 802.11ax (40 MHz, MCS3, 99pc duty cycle) | WLAN | 8.29 | ±9.6 |
| 10711 | AAC | IEEE 802.11ax (40 MHz, MCS4, 99pc duty cycle) | WLAN | 8.39 | ±9.6 |
| 10712 | AAC | IEEE 802.11ax (40 MHz, MCS5, 99pc duty cycle) | WLAN | 8.67 | ±9.6 |
| 10713 | AAC | IEEE 802.11ax (40 MHz, MCS6, 99pc duty cycle) | WLAN | 8.33 | ±9.6 |
| 10714 | AAC | IEEE 802.11ax (40 MHz, MCS7, 99pc duty cycle) | WLAN | 8.26 | ±9.6 |
| 10715 | AAC | IEEE 802.11ax (40 MHz, MCS8, 99pc duty cycle) | WLAN | 8.45 | ±9.6 |
| 10716 | AAC | IEEE 802.11ax (40 MHz, MCS9, 99pc duty cycle) | WLAN | 8.30 | ±9.6 |
| 10717 | AAC | IEEE 802.11ax (40 MHz, MCS10, 99pc duty cycle) | WLAN | 8.48 | ±9.6 |
| 10718 | AAC | IEEE 802.11ax (40 MHz, MCS11, 99pc duty cycle) | WLAN | 8.24 | ±9.6 |
| 10719 | AAC | IEEE 802.11ax (80 MHz, MCS0, 90pc duty cycle) | WLAN | 8.81 | ±9.6 |
| 10720 | AAC | IEEE 802.11ax (80 MHz, MCS1, 90pc duty cycle) | WLAN | 8.87 | ±9.6 |
| 10721 | AAC | IEEE 802.11ax (80 MHz, MCS2, 90pc duty cycle) | WLAN | 8.76 | ±9.6 |
| 10722 | AAC | IEEE 802.11ax (80 MHz, MCS3, 90pc duty cycle) | WLAN | 8.55 | ±9.6 |
| 10723 | AAC | IEEE 802.11ax (80 MHz, MCS4, 90pc duty cycle) | WLAN | 8.70 | ±9.6 |
| 10724 | AAC | IEEE 802.11ax (80 MHz, MCS5, 90pc duty cycle) | WLAN | 8.90 | ±9.6 |
| 10725 | AAC | IEEE 802.11ax (80 MHz, MCS6, 90pc duty cycle) | WLAN | 8.74 | ±9.6 |
| 10726 | AAC | IEEE 802.11ax (80 MHz, MCS7, 90pc duty cycle) | WLAN | 8.72 | ±9.6 |
| 10727 | AAC | IEEE 802.11ax (80 MHz, MCS8, 90pc duty cycle) | WLAN | 8.66 | ±9.6 |
| 10728 | AAC | IEEE 802.11ax (80 MHz, MCS9, 90pc duty cycle) | WLAN | 8.65 | ±9.6 |
| 10729 | AAC | IEEE 802.11ax (80 MHz, MCS10, 90pc duty cycle) | WLAN | 8.64 | ±9.6 |
| 10730 | AAC | IEEE 802.11ax (80 MHz, MCS11, 90pc duty cycle) | WLAN | 8.67 | ±9.6 |
| 10731 | AAC | IEEE 802.11ax (80 MHz, MCS0, 99pc duty cycle) | WLAN | 8.42 | ±9.6 |
| 10732 | AAC | IEEE 802.11ax (80 MHz, MCS1, 99pc duty cycle) | WLAN | 8.46 | ±9.6 |
| 10733 | AAC | IEEE 802.11ax (80 MHz, MCS2, 99pc duty cycle) | WLAN | 8.40 | ±9.6 |
| 10734 | AAC | IEEE 802.11ax (80 MHz, MCS3, 99pc duty cycle) | WLAN | 8.25 | ±9.6 |
| 10735 | AAC | IEEE 802.11ax (80 MHz, MCS4, 99pc duty cycle) | WLAN | 8.33 | ±9.6 |
| 10736 | AAC | IEEE 802.11ax (80 MHz, MCS5, 99pc duty cycle) | WLAN | 8.27 | ±9.6 |
| 10737 | AAC | IEEE 802.11ax (80 MHz, MCS6, 99pc duty cycle) | WLAN | 8.36 | ±9.6 |
| 10738 | AAC | IEEE 802.11ax (80 MHz, MCS7, 99pc duty cycle) | WLAN | 8.42 | ±9.6 |
| 10739 | AAC | IEEE 802.11ax (80 MHz, MCS8, 99pc duty cycle) | WLAN | 8.29 | ±9.6 |
| 10740 | AAC | IEEE 802.11ax (80 MHz, MCS9, 99pc duty cycle) | WLAN | 8.48 | ±9.6 |
| 10741 | AAC | IEEE 802.11ax (80 MHz, MCS10, 99pc duty cycle) | WLAN | 8.40 | ±9.6 |
| 10742 | AAC | IEEE 802.11ax (80 MHz, MCS11, 99pc duty cycle) | WLAN | 8.43 | ±9.6 |
| 10743 | AAC | IEEE 802.11ax (160 MHz, MCS0, 90pc duty cycle) | WLAN | 8.94 | ±9.6 |
| 10744 | AAC | IEEE 802.11ax (160 MHz, MCS1, 90pc duty cycle) | WLAN | 9.16 | ±9.6 |
| 10745 | AAC | IEEE 802.11ax (160 MHz, MCS2, 90pc duty cycle) | WLAN | 8.93 | ±9.6 |
| 10746 | AAC | IEEE 802.11ax (160 MHz, MCS3, 90pc duty cycle) | WLAN | 9.11 | ±9.6 |
| 10747 | AAC | IEEE 802.11ax (160 MHz, MCS4, 90pc duty cycle) | WLAN | 9.04 | ±9.6 |
| 10748 | AAC | IEEE 802.11ax (160 MHz, MCS5, 90pc duty cycle) | WLAN | 8.93 | ±9.6 |
| 10749 | AAC | IEEE 802.11ax (160 MHz, MCS6, 90pc duty cycle) | WLAN | 8.90 | ±9.6 |
| 10750 | AAC | IEEE 802.11ax (160 MHz, MCS7, 90pc duty cycle) | WLAN | 8.79 | ±9.6 |
| 10751 | AAC | IEEE 802.11ax (160 MHz, MCS8, 90pc duty cycle) | WLAN | 8.82 | ±9.6 |
| 10752 | AAC | IEEE 802.11ax (160 MHz, MCS9, 90pc duty cycle) | WLAN | 8.81 | ±9.6 |

| UID | Rev | Communication System Name | Group | PAR (dB) | Unc ^E $k = 2$ |
|-------|-----|---|---------------|----------|--------------------------|
| 10753 | AAC | IEEE 802.11ax (160 MHz, MCS10, 90pc duty cycle) | WLAN | 9.00 | ±9.6 |
| 10754 | AAC | IEEE 802.11ax (160 MHz, MCS11, 90pc duty cycle) | WLAN | 8.94 | ±9.6 |
| 10755 | AAC | IEEE 802.11ax (160 MHz, MCS0, 99pc duty cycle) | WLAN | 8.64 | ±9.6 |
| 10756 | AAC | IEEE 802.11ax (160 MHz, MCS1, 99pc duty cycle) | WLAN | 8.77 | ±9.6 |
| 10757 | AAC | IEEE 802.11ax (160 MHz, MCS2, 99pc duty cycle) | WLAN | 8.77 | ±9.6 |
| 10758 | AAC | IEEE 802.11ax (160 MHz, MCS3, 99pc duty cycle) | WLAN | 8.69 | ±9.6 |
| 10759 | AAC | IEEE 802.11ax (160 MHz, MCS4, 99pc duty cycle) | WLAN | 8.58 | ±9.6 |
| 10760 | AAC | IEEE 802.11ax (160 MHz, MCS5, 99pc duty cycle) | WLAN | 8.49 | ±9.6 |
| 10761 | AAC | IEEE 802.11ax (160 MHz, MCS6, 99pc duty cycle) | WLAN | 8.58 | ±9.6 |
| 10762 | AAC | IEEE 802.11ax (160 MHz, MCS7, 99pc duty cycle) | WLAN | 8.49 | ±9.6 |
| 10763 | AAC | IEEE 802.11ax (160 MHz, MCS8, 99pc duty cycle) | WLAN | 8.53 | ±9.6 |
| 10764 | AAC | IEEE 802.11ax (160 MHz, MCS9, 99pc duty cycle) | WLAN | 8.54 | ±9.6 |
| 10765 | AAC | IEEE 802.11ax (160 MHz, MCS10, 99pc duty cycle) | WLAN | 8.54 | ±9.6 |
| 10766 | AAC | IEEE 802.11ax (160 MHz, MCS11, 99pc duty cycle) | WLAN | 8.51 | ±9.6 |
| 10767 | AAE | 5G NR (CP-OFDM, 1 RB, 5 MHz, QPSK, 15 kHz) | 5G NR FR1 TDD | 7.99 | ±9.6 |
| 10768 | AAD | 5G NR (CP-OFDM, 1 RB, 10 MHz, QPSK, 15 kHz) | 5G NR FR1 TDD | 8.01 | ±9.6 |
| 10769 | AAD | 5G NR (CP-OFDM, 1 RB, 15 MHz, QPSK, 15 kHz) | 5G NR FR1 TDD | 8.01 | ±9.6 |
| 10770 | AAD | 5G NR (CP-OFDM, 1 RB, 20 MHz, QPSK, 15 kHz) | 5G NR FR1 TDD | 8.02 | ±9.6 |
| 10771 | AAD | 5G NR (CP-OFDM, 1 RB, 25 MHz, QPSK, 15 kHz) | 5G NR FR1 TDD | 8.02 | ±9.6 |
| 10772 | AAD | 5G NR (CP-OFDM, 1 RB, 30 MHz, QPSK, 15 kHz) | 5G NR FR1 TDD | 8.23 | ±9.6 |
| 10773 | AAD | 5G NR (CP-OFDM, 1 RB, 40 MHz, QPSK, 15 kHz) | 5G NR FR1 TDD | 8.03 | ±9.6 |
| 10774 | AAD | 5G NR (CP-OFDM, 1 RB, 50 MHz, QPSK, 15 kHz) | 5G NR FR1 TDD | 8.02 | ±9.6 |
| 10775 | AAD | 5G NR (CP-OFDM, 50% RB, 5 MHz, QPSK, 15 kHz) | 5G NR FR1 TDD | 8.31 | ±9.6 |
| 10776 | AAD | 5G NR (CP-OFDM, 50% RB, 10 MHz, QPSK, 15 kHz) | 5G NR FR1 TDD | 8.30 | ±9.6 |
| 10777 | AAC | 5G NR (CP-OFDM, 50% RB, 15 MHz, QPSK, 15 kHz) | 5G NR FR1 TDD | 8.30 | ±9.6 |
| 10778 | AAD | 5G NR (CP-OFDM, 50% RB, 20 MHz, QPSK, 15 kHz) | 5G NR FR1 TDD | 8.34 | ±9.6 |
| 10779 | AAC | 5G NR (CP-OFDM, 50% RB, 25 MHz, QPSK, 15 kHz) | 5G NR FR1 TDD | 8.42 | ±9.6 |
| 10780 | AAD | 5G NR (CP-OFDM, 50% RB, 30 MHz, QPSK, 15 kHz) | 5G NR FR1 TDD | 8.38 | ±9.6 |
| 10781 | AAD | 5G NR (CP-OFDM, 50% RB, 40 MHz, QPSK, 15 kHz) | 5G NR FR1 TDD | 8.38 | ±9.6 |
| 10782 | AAD | 5G NR (CP-OFDM, 50% RB, 50 MHz, QPSK, 15 kHz) | 5G NR FR1 TDD | 8.43 | ±9.6 |
| 10783 | AAE | 5G NR (CP-OFDM, 100% RB, 5 MHz, QPSK, 15 kHz) | 5G NR FR1 TDD | 8.31 | ±9.6 |
| 10784 | AAD | 5G NR (CP-OFDM, 100% RB, 10 MHz, QPSK, 15 kHz) | 5G NR FR1 TDD | 8.29 | ±9.6 |
| 10785 | AAD | 5G NR (CP-OFDM, 100% RB, 15 MHz, QPSK, 15 kHz) | 5G NR FR1 TDD | 8.40 | ±9.6 |
| 10786 | AAD | 5G NR (CP-OFDM, 100% RB, 20 MHz, QPSK, 15 kHz) | 5G NR FR1 TDD | 8.35 | ±9.6 |
| 10787 | AAD | 5G NR (CP-OFDM, 100% RB, 25 MHz, QPSK, 15 kHz) | 5G NR FR1 TDD | 8.44 | ±9.6 |
| 10788 | AAD | 5G NR (CP-OFDM, 100% RB, 30 MHz, QPSK, 15 kHz) | 5G NR FR1 TDD | 8.39 | ±9.6 |
| 10789 | AAD | 5G NR (CP-OFDM, 100% RB, 40 MHz, QPSK, 15 kHz) | 5G NR FR1 TDD | 8.37 | ±9.6 |
| 10790 | AAD | 5G NR (CP-OFDM, 100% RB, 50 MHz, QPSK, 15 kHz) | 5G NR FR1 TDD | 8.39 | ±9.6 |
| 10791 | AAE | 5G NR (CP-OFDM, 1 RB, 5 MHz, QPSK, 30 kHz) | 5G NR FR1 TDD | 7.83 | ±9.6 |
| 10792 | AAD | 5G NR (CP-OFDM, 1 RB, 10 MHz, QPSK, 30 kHz) | 5G NR FR1 TDD | 7.92 | ±9.6 |
| 10793 | AAD | 5G NR (CP-OFDM, 1 RB, 15 MHz, QPSK, 30 kHz) | 5G NR FR1 TDD | 7.95 | ±9.6 |
| 10794 | AAD | 5G NR (CP-OFDM, 1 RB, 20 MHz, QPSK, 30 kHz) | 5G NR FR1 TDD | 7.82 | ±9.6 |
| 10795 | AAD | 5G NR (CP-OFDM, 1 RB, 25 MHz, QPSK, 30 kHz) | 5G NR FR1 TDD | 7.84 | ±9.6 |
| 10796 | AAD | 5G NR (CP-OFDM, 1 RB, 30 MHz, QPSK, 30 kHz) | 5G NR FR1 TDD | 7.82 | ±9.6 |
| 10797 | AAD | 5G NR (CP-OFDM, 1 RB, 40 MHz, QPSK, 30 kHz) | 5G NR FR1 TDD | 8.01 | ±9.6 |
| 10798 | AAD | 5G NR (CP-OFDM, 1 RB, 50 MHz, QPSK, 30 kHz) | 5G NR FR1 TDD | 7.89 | ±9.6 |
| 10799 | AAD | 5G NR (CP-OFDM, 1 RB, 60 MHz, QPSK, 30 kHz) | 5G NR FR1 TDD | 7.93 | ±9.6 |
| 10801 | AAD | 5G NR (CP-OFDM, 1 RB, 80 MHz, QPSK, 30 kHz) | 5G NR FR1 TDD | 7.89 | ±9.6 |
| 10802 | AAD | 5G NR (CP-OFDM, 1 RB, 90 MHz, QPSK, 30 kHz) | 5G NR FR1 TDD | 7.87 | ±9.6 |
| 10803 | AAD | 5G NR (CP-OFDM, 1 RB, 100 MHz, QPSK, 30 kHz) | 5G NR FR1 TDD | 7.93 | ±9.6 |
| 10805 | AAD | 5G NR (CP-OFDM, 50% RB, 10 MHz, QPSK, 30 kHz) | 5G NR FR1 TDD | 8.34 | ±9.6 |
| 10806 | AAD | 5G NR (CP-OFDM, 50% RB, 15 MHz, QPSK, 30 kHz) | 5G NR FR1 TDD | 8.37 | ±9.6 |
| 10809 | AAD | 5G NR (CP-OFDM, 50% RB, 30 MHz, QPSK, 30 kHz) | 5G NR FR1 TDD | 8.34 | ±9.6 |
| 10810 | AAD | 5G NR (CP-OFDM, 50% RB, 40 MHz, QPSK, 30 kHz) | 5G NR FR1 TDD | 8.34 | ±9.6 |
| 10812 | AAD | 5G NR (CP-OFDM, 50% RB, 60 MHz, QPSK, 30 kHz) | 5G NR FR1 TDD | 8.35 | ±9.6 |
| 10817 | AAE | 5G NR (CP-OFDM, 100% RB, 5 MHz, QPSK, 30 kHz) | 5G NR FR1 TDD | 8.35 | ±9.6 |
| 10818 | AAD | 5G NR (CP-OFDM, 100% RB, 10 MHz, QPSK, 30 kHz) | 5G NR FR1 TDD | 8.34 | ±9.6 |
| 10819 | AAD | 5G NR (CP-OFDM, 100% RB, 15 MHz, QPSK, 30 kHz) | 5G NR FR1 TDD | 8.33 | ±9.6 |
| 10820 | AAD | 5G NR (CP-OFDM, 100% RB, 20 MHz, QPSK, 30 kHz) | 5G NR FR1 TDD | 8.30 | ±9.6 |
| 10821 | AAD | 5G NR (CP-OFDM, 100% RB, 25 MHz, QPSK, 30 kHz) | 5G NR FR1 TDD | 8.41 | ±9.6 |
| 10822 | AAD | 5G NR (CP-OFDM, 100% RB, 30 MHz, QPSK, 30 kHz) | 5G NR FR1 TDD | 8.41 | ±9.6 |
| 10823 | AAD | 5G NR (CP-OFDM, 100% RB, 40 MHz, QPSK, 30 kHz) | 5G NR FR1 TDD | 8.36 | ±9.6 |
| 10824 | AAD | 5G NR (CP-OFDM, 100% RB, 50 MHz, QPSK, 30 kHz) | 5G NR FR1 TDD | 8.39 | ±9.6 |
| 10825 | AAD | 5G NR (CP-OFDM, 100% RB, 60 MHz, QPSK, 30 kHz) | 5G NR FR1 TDD | 8.41 | ±9.6 |
| 10827 | AAD | 5G NR (CP-OFDM, 100% RB, 80 MHz, QPSK, 30 kHz) | 5G NR FR1 TDD | 8.42 | ±9.6 |
| 10828 | AAD | 5G NR (CP-OFDM, 100% RB, 90 MHz, QPSK, 30 kHz) | 5G NR FR1 TDD | 8.43 | ±9.6 |

| UID | Rev | Communication System Name | Group | PAR (dB) | Unc ^E $k = 2$ |
|-------|-----|--|---------------|----------|--------------------------|
| 10829 | AAD | 5G NR (CP-OFDM, 100% RB, 100 MHz, QPSK, 30 kHz) | 5G NR FR1 TDD | 8.40 | ±9.6 |
| 10830 | AAD | 5G NR (CP-OFDM, 1 RB, 10 MHz, QPSK, 60 kHz) | 5G NR FR1 TDD | 7.63 | ±9.6 |
| 10831 | AAD | 5G NR (CP-OFDM, 1 RB, 15 MHz, QPSK, 60 kHz) | 5G NR FR1 TDD | 7.73 | ±9.6 |
| 10832 | AAD | 5G NR (CP-OFDM, 1 RB, 20 MHz, QPSK, 60 kHz) | 5G NR FR1 TDD | 7.74 | ±9.6 |
| 10833 | AAD | 5G NR (CP-OFDM, 1 RB, 25 MHz, QPSK, 60 kHz) | 5G NR FR1 TDD | 7.70 | ±9.6 |
| 10834 | AAD | 5G NR (CP-OFDM, 1 RB, 30 MHz, QPSK, 60 kHz) | 5G NR FR1 TDD | 7.75 | ±9.6 |
| 10835 | AAD | 5G NR (CP-OFDM, 1 RB, 40 MHz, QPSK, 60 kHz) | 5G NR FR1 TDD | 7.70 | ±9.6 |
| 10836 | AAD | 5G NR (CP-OFDM, 1 RB, 50 MHz, QPSK, 60 kHz) | 5G NR FR1 TDD | 7.66 | ±9.6 |
| 10837 | AAD | 5G NR (CP-OFDM, 1 RB, 60 MHz, QPSK, 60 kHz) | 5G NR FR1 TDD | 7.68 | ±9.6 |
| 10839 | AAD | 5G NR (CP-OFDM, 1 RB, 80 MHz, QPSK, 60 kHz) | 5G NR FR1 TDD | 7.70 | ±9.6 |
| 10840 | AAD | 5G NR (CP-OFDM, 1 RB, 90 MHz, QPSK, 60 kHz) | 5G NR FR1 TDD | 7.67 | ±9.6 |
| 10841 | AAD | 5G NR (CP-OFDM, 1 RB, 100 MHz, QPSK, 60 kHz) | 5G NR FR1 TDD | 7.71 | ±9.6 |
| 10843 | AAD | 5G NR (CP-OFDM, 50% RB, 15 MHz, QPSK, 60 kHz) | 5G NR FR1 TDD | 8.49 | ±9.6 |
| 10844 | AAD | 5G NR (CP-OFDM, 50% RB, 20 MHz, QPSK, 60 kHz) | 5G NR FR1 TDD | 8.34 | ±9.6 |
| 10846 | AAD | 5G NR (CP-OFDM, 50% RB, 30 MHz, QPSK, 60 kHz) | 5G NR FR1 TDD | 8.41 | ±9.6 |
| 10854 | AAD | 5G NR (CP-OFDM, 100% RB, 10 MHz, QPSK, 60 kHz) | 5G NR FR1 TDD | 8.34 | ±9.6 |
| 10855 | AAD | 5G NR (CP-OFDM, 100% RB, 15 MHz, QPSK, 60 kHz) | 5G NR FR1 TDD | 8.36 | ±9.6 |
| 10856 | AAD | 5G NR (CP-OFDM, 100% RB, 20 MHz, QPSK, 60 kHz) | 5G NR FR1 TDD | 8.37 | ±9.6 |
| 10857 | AAD | 5G NR (CP-OFDM, 100% RB, 25 MHz, QPSK, 60 kHz) | 5G NR FR1 TDD | 8.35 | ±9.6 |
| 10858 | AAD | 5G NR (CP-OFDM, 100% RB, 30 MHz, QPSK, 60 kHz) | 5G NR FR1 TDD | 8.36 | ±9.6 |
| 10859 | AAD | 5G NR (CP-OFDM, 100% RB, 40 MHz, QPSK, 60 kHz) | 5G NR FR1 TDD | 8.34 | ±9.6 |
| 10860 | AAD | 5G NR (CP-OFDM, 100% RB, 50 MHz, QPSK, 60 kHz) | 5G NR FR1 TDD | 8.41 | ±9.6 |
| 10861 | AAD | 5G NR (CP-OFDM, 100% RB, 60 MHz, QPSK, 60 kHz) | 5G NR FR1 TDD | 8.40 | ±9.6 |
| 10863 | AAD | 5G NR (CP-OFDM, 100% RB, 80 MHz, QPSK, 60 kHz) | 5G NR FR1 TDD | 8.41 | ±9.6 |
| 10864 | AAD | 5G NR (CP-OFDM, 100% RB, 90 MHz, QPSK, 60 kHz) | 5G NR FR1 TDD | 8.37 | ±9.6 |
| 10865 | AAD | 5G NR (CP-OFDM, 100% RB, 100 MHz, QPSK, 60 kHz) | 5G NR FR1 TDD | 8.41 | ±9.6 |
| 10866 | AAD | 5G NR (DFT-s-OFDM, 1 RB, 100 MHz, QPSK, 30 kHz) | 5G NR FR1 TDD | 5.68 | ±9.6 |
| 10868 | AAD | 5G NR (DFT-s-OFDM, 100% RB, 100 MHz, QPSK, 30 kHz) | 5G NR FR1 TDD | 5.89 | ±9.6 |
| 10869 | AAE | 5G NR (DFT-s-OFDM, 1 RB, 100 MHz, QPSK, 120 kHz) | 5G NR FR2 TDD | 5.75 | ±9.6 |
| 10870 | AAE | 5G NR (DFT-s-OFDM, 100% RB, 100 MHz, QPSK, 120 kHz) | 5G NR FR2 TDD | 5.86 | ±9.6 |
| 10871 | AAE | 5G NR (DFT-s-OFDM, 1 RB, 100 MHz, 16QAM, 120 kHz) | 5G NR FR2 TDD | 5.75 | ±9.6 |
| 10872 | AAE | 5G NR (DFT-s-OFDM, 100% RB, 100 MHz, 16QAM, 120 kHz) | 5G NR FR2 TDD | 6.52 | ±9.6 |
| 10873 | AAE | 5G NR (DFT-s-OFDM, 1 RB, 100 MHz, 64QAM, 120 kHz) | 5G NR FR2 TDD | 6.61 | ±9.6 |
| 10874 | AAE | 5G NR (DFT-s-OFDM, 100% RB, 100 MHz, 64QAM, 120 kHz) | 5G NR FR2 TDD | 6.65 | ±9.6 |
| 10875 | AAE | 5G NR (CP-OFDM, 1 RB, 100 MHz, QPSK, 120 kHz) | 5G NR FR2 TDD | 7.78 | ±9.6 |
| 10876 | AAE | 5G NR (CP-OFDM, 100% RB, 100 MHz, QPSK, 120 kHz) | 5G NR FR2 TDD | 8.39 | ±9.6 |
| 10877 | AAE | 5G NR (CP-OFDM, 1 RB, 100 MHz, 16QAM, 120 kHz) | 5G NR FR2 TDD | 7.95 | ±9.6 |
| 10878 | AAE | 5G NR (CP-OFDM, 100% RB, 100 MHz, 16QAM, 120 kHz) | 5G NR FR2 TDD | 8.41 | ±9.6 |
| 10879 | AAE | 5G NR (CP-OFDM, 1 RB, 100 MHz, 64QAM, 120 kHz) | 5G NR FR2 TDD | 8.12 | ±9.6 |
| 10880 | AAE | 5G NR (CP-OFDM, 100% RB, 100 MHz, 64QAM, 120 kHz) | 5G NR FR2 TDD | 8.38 | ±9.6 |
| 10881 | AAE | 5G NR (DFT-s-OFDM, 1 RB, 50 MHz, QPSK, 120 kHz) | 5G NR FR2 TDD | 5.75 | ±9.6 |
| 10882 | AAE | 5G NR (DFT-s-OFDM, 100% RB, 50 MHz, QPSK, 120 kHz) | 5G NR FR2 TDD | 5.96 | ±9.6 |
| 10883 | AAE | 5G NR (DFT-s-OFDM, 1 RB, 50 MHz, 16QAM, 120 kHz) | 5G NR FR2 TDD | 6.57 | ±9.6 |
| 10884 | AAE | 5G NR (DFT-s-OFDM, 100% RB, 50 MHz, 16QAM, 120 kHz) | 5G NR FR2 TDD | 6.53 | ±9.6 |
| 10885 | AAE | 5G NR (DFT-s-OFDM, 1 RB, 50 MHz, 64QAM, 120 kHz) | 5G NR FR2 TDD | 6.61 | ±9.6 |
| 10886 | AAE | 5G NR (DFT-s-OFDM, 100% RB, 50 MHz, 64QAM, 120 kHz) | 5G NR FR2 TDD | 6.65 | ±9.6 |
| 10887 | AAE | 5G NR (CP-OFDM, 1 RB, 50 MHz, QPSK, 120 kHz) | 5G NR FR2 TDD | 7.78 | ±9.6 |
| 10888 | AAE | 5G NR (CP-OFDM, 100% RB, 50 MHz, QPSK, 120 kHz) | 5G NR FR2 TDD | 8.35 | ±9.6 |
| 10889 | AAE | 5G NR (CP-OFDM, 1 RB, 50 MHz, 16QAM, 120 kHz) | 5G NR FR2 TDD | 8.02 | ±9.6 |
| 10890 | AAE | 5G NR (CP-OFDM, 100% RB, 50 MHz, 16QAM, 120 kHz) | 5G NR FR2 TDD | 8.40 | ±9.6 |
| 10891 | AAE | 5G NR (CP-OFDM, 1 RB, 50 MHz, 64QAM, 120 kHz) | 5G NR FR2 TDD | 8.13 | ±9.6 |
| 10892 | AAE | 5G NR (CP-OFDM, 100% RB, 50 MHz, 64QAM, 120 kHz) | 5G NR FR2 TDD | 8.41 | ±9.6 |
| 10897 | AAC | 5G NR (DFT-s-OFDM, 1 RB, 5 MHz, QPSK, 30 kHz) | 5G NR FR1 TDD | 5.66 | ±9.6 |
| 10898 | AAB | 5G NR (DFT-s-OFDM, 1 RB, 10 MHz, QPSK, 30 kHz) | 5G NR FR1 TDD | 5.67 | ±9.6 |
| 10899 | AAB | 5G NR (DFT-s-OFDM, 1 RB, 15 MHz, QPSK, 30 kHz) | 5G NR FR1 TDD | 5.67 | ±9.6 |
| 10900 | AAB | 5G NR (DFT-s-OFDM, 1 RB, 20 MHz, QPSK, 30 kHz) | 5G NR FR1 TDD | 5.68 | ±9.6 |
| 10901 | AAB | 5G NR (DFT-s-OFDM, 1 RB, 25 MHz, QPSK, 30 kHz) | 5G NR FR1 TDD | 5.68 | ±9.6 |
| 10902 | AAB | 5G NR (DFT-s-OFDM, 1 RB, 30 MHz, QPSK, 30 kHz) | 5G NR FR1 TDD | 5.68 | ±9.6 |
| 10903 | AAB | 5G NR (DFT-s-OFDM, 1 RB, 40 MHz, QPSK, 30 kHz) | 5G NR FR1 TDD | 5.68 | ±9.6 |
| 10904 | AAB | 5G NR (DFT-s-OFDM, 1 RB, 50 MHz, QPSK, 30 kHz) | 5G NR FR1 TDD | 5.68 | ±9.6 |
| 10905 | AAB | 5G NR (DFT-s-OFDM, 1 RB, 60 MHz, QPSK, 30 kHz) | 5G NR FR1 TDD | 5.68 | ±9.6 |
| 10906 | AAB | 5G NR (DFT-s-OFDM, 1 RB, 80 MHz, QPSK, 30 kHz) | 5G NR FR1 TDD | 5.68 | ±9.6 |
| 10907 | AAC | 5G NR (DFT-s-OFDM, 50% RB, 5 MHz, QPSK, 30 kHz) | 5G NR FR1 TDD | 5.78 | ±9.6 |
| 10908 | AAB | 5G NR (DFT-s-OFDM, 50% RB, 10 MHz, QPSK, 30 kHz) | 5G NR FR1 TDD | 5.93 | ±9.6 |
| 10909 | AAB | 5G NR (DFT-s-OFDM, 50% RB, 15 MHz, QPSK, 30 kHz) | 5G NR FR1 TDD | 5.96 | ±9.6 |
| 10910 | AAB | 5G NR (DFT-s-OFDM, 50% RB, 20 MHz, QPSK, 30 kHz) | 5G NR FR1 TDD | 5.83 | ±9.6 |

| UID | Rev | Communication System Name | Group | PAR (dB) | Unc ^E $k = 2$ |
|-------|-----|---|---------------|----------|--------------------------|
| 10911 | AAB | 5G NR (DFT-s-OFDM, 50% RB, 25 MHz, QPSK, 30 kHz) | 5G NR FR1 TDD | 5.93 | ±9.6 |
| 10912 | AAB | 5G NR (DFT-s-OFDM, 50% RB, 30 MHz, QPSK, 30 kHz) | 5G NR FR1 TDD | 5.84 | ±9.6 |
| 10913 | AAB | 5G NR (DFT-s-OFDM, 50% RB, 40 MHz, QPSK, 30 kHz) | 5G NR FR1 TDD | 5.84 | ±9.6 |
| 10914 | AAB | 5G NR (DFT-s-OFDM, 50% RB, 50 MHz, QPSK, 30 kHz) | 5G NR FR1 TDD | 5.85 | ±9.6 |
| 10915 | AAB | 5G NR (DFT-s-OFDM, 50% RB, 60 MHz, QPSK, 30 kHz) | 5G NR FR1 TDD | 5.83 | ±9.6 |
| 10916 | AAB | 5G NR (DFT-s-OFDM, 50% RB, 80 MHz, QPSK, 30 kHz) | 5G NR FR1 TDD | 5.87 | ±9.6 |
| 10917 | AAB | 5G NR (DFT-s-OFDM, 50% RB, 100 MHz, QPSK, 30 kHz) | 5G NR FR1 TDD | 5.94 | ±9.6 |
| 10918 | AAC | 5G NR (DFT-s-OFDM, 100% RB, 5 MHz, QPSK, 30 kHz) | 5G NR FR1 TDD | 5.86 | ±9.6 |
| 10919 | AAB | 5G NR (DFT-s-OFDM, 100% RB, 10 MHz, QPSK, 30 kHz) | 5G NR FR1 TDD | 5.86 | ±9.6 |
| 10920 | AAB | 5G NR (DFT-s-OFDM, 100% RB, 15 MHz, QPSK, 30 kHz) | 5G NR FR1 TDD | 5.87 | ±9.6 |
| 10921 | AAB | 5G NR (DFT-s-OFDM, 100% RB, 20 MHz, QPSK, 30 kHz) | 5G NR FR1 TDD | 5.84 | ±9.6 |
| 10922 | AAB | 5G NR (DFT-s-OFDM, 100% RB, 25 MHz, QPSK, 30 kHz) | 5G NR FR1 TDD | 5.82 | ±9.6 |
| 10923 | AAB | 5G NR (DFT-s-OFDM, 100% RB, 30 MHz, QPSK, 30 kHz) | 5G NR FR1 TDD | 5.84 | ±9.6 |
| 10924 | AAB | 5G NR (DFT-s-OFDM, 100% RB, 40 MHz, QPSK, 30 kHz) | 5G NR FR1 TDD | 5.84 | ±9.6 |
| 10925 | AAB | 5G NR (DFT-s-OFDM, 100% RB, 50 MHz, QPSK, 30 kHz) | 5G NR FR1 TDD | 5.95 | ±9.6 |
| 10926 | AAB | 5G NR (DFT-s-OFDM, 100% RB, 60 MHz, QPSK, 30 kHz) | 5G NR FR1 TDD | 5.84 | ±9.6 |
| 10927 | AAB | 5G NR (DFT-s-OFDM, 100% RB, 80 MHz, QPSK, 30 kHz) | 5G NR FR1 TDD | 5.94 | ±9.6 |
| 10928 | AAC | 5G NR (DFT-s-OFDM, 1 RB, 5 MHz, QPSK, 15 kHz) | 5G NR FR1 FDD | 5.52 | ±9.6 |
| 10929 | AAC | 5G NR (DFT-s-OFDM, 1 RB, 10 MHz, QPSK, 15 kHz) | 5G NR FR1 FDD | 5.52 | ±9.6 |
| 10930 | AAC | 5G NR (DFT-s-OFDM, 1 RB, 15 MHz, QPSK, 15 kHz) | 5G NR FR1 FDD | 5.52 | ±9.6 |
| 10931 | AAC | 5G NR (DFT-s-OFDM, 1 RB, 20 MHz, QPSK, 15 kHz) | 5G NR FR1 FDD | 5.51 | ±9.6 |
| 10932 | AAC | 5G NR (DFT-s-OFDM, 1 RB, 25 MHz, QPSK, 15 kHz) | 5G NR FR1 FDD | 5.51 | ±9.6 |
| 10933 | AAC | 5G NR (DFT-s-OFDM, 1 RB, 30 MHz, QPSK, 15 kHz) | 5G NR FR1 FDD | 5.51 | ±9.6 |
| 10934 | AAC | 5G NR (DFT-s-OFDM, 1 RB, 40 MHz, QPSK, 15 kHz) | 5G NR FR1 FDD | 5.51 | ±9.6 |
| 10935 | AAD | 5G NR (DFT-s-OFDM, 1 RB, 50 MHz, QPSK, 15 kHz) | 5G NR FR1 FDD | 5.51 | ±9.6 |
| 10936 | AAC | 5G NR (DFT-s-OFDM, 50% RB, 5 MHz, QPSK, 15 kHz) | 5G NR FR1 FDD | 5.90 | ±9.6 |
| 10937 | AAC | 5G NR (DFT-s-OFDM, 50% RB, 10 MHz, QPSK, 15 kHz) | 5G NR FR1 FDD | 5.77 | ±9.6 |
| 10938 | AAC | 5G NR (DFT-s-OFDM, 50% RB, 15 MHz, QPSK, 15 kHz) | 5G NR FR1 FDD | 5.90 | ±9.6 |
| 10939 | AAC | 5G NR (DFT-s-OFDM, 50% RB, 20 MHz, QPSK, 15 kHz) | 5G NR FR1 FDD | 5.82 | ±9.6 |
| 10940 | AAC | 5G NR (DFT-s-OFDM, 50% RB, 25 MHz, QPSK, 15 kHz) | 5G NR FR1 FDD | 5.89 | ±9.6 |
| 10941 | AAC | 5G NR (DFT-s-OFDM, 50% RB, 30 MHz, QPSK, 15 kHz) | 5G NR FR1 FDD | 5.83 | ±9.6 |
| 10942 | AAC | 5G NR (DFT-s-OFDM, 50% RB, 40 MHz, QPSK, 15 kHz) | 5G NR FR1 FDD | 5.85 | ±9.6 |
| 10943 | AAD | 5G NR (DFT-s-OFDM, 50% RB, 50 MHz, QPSK, 15 kHz) | 5G NR FR1 FDD | 5.95 | ±9.6 |
| 10944 | AAC | 5G NR (DFT-s-OFDM, 100% RB, 5 MHz, QPSK, 15 kHz) | 5G NR FR1 FDD | 5.81 | ±9.6 |
| 10945 | AAC | 5G NR (DFT-s-OFDM, 100% RB, 10 MHz, QPSK, 15 kHz) | 5G NR FR1 FDD | 5.85 | ±9.6 |
| 10946 | AAC | 5G NR (DFT-s-OFDM, 100% RB, 15 MHz, QPSK, 15 kHz) | 5G NR FR1 FDD | 5.83 | ±9.6 |
| 10947 | AAC | 5G NR (DFT-s-OFDM, 100% RB, 20 MHz, QPSK, 15 kHz) | 5G NR FR1 FDD | 5.87 | ±9.6 |
| 10948 | AAC | 5G NR (DFT-s-OFDM, 100% RB, 25 MHz, QPSK, 15 kHz) | 5G NR FR1 FDD | 5.94 | ±9.6 |
| 10949 | AAC | 5G NR (DFT-s-OFDM, 100% RB, 30 MHz, QPSK, 15 kHz) | 5G NR FR1 FDD | 5.87 | ±9.6 |
| 10950 | AAC | 5G NR (DFT-s-OFDM, 100% RB, 40 MHz, QPSK, 15 kHz) | 5G NR FR1 FDD | 5.94 | ±9.6 |
| 10951 | AAD | 5G NR (DFT-s-OFDM, 100% RB, 50 MHz, QPSK, 15 kHz) | 5G NR FR1 FDD | 5.92 | ±9.6 |
| 10952 | AAA | 5G NR DL (CP-OFDM, TM 3.1, 5 MHz, 64-QAM, 15 kHz) | 5G NR FR1 FDD | 8.25 | ±9.6 |
| 10953 | AAA | 5G NR DL (CP-OFDM, TM 3.1, 10 MHz, 64-QAM, 15 kHz) | 5G NR FR1 FDD | 8.15 | ±9.6 |
| 10954 | AAA | 5G NR DL (CP-OFDM, TM 3.1, 15 MHz, 64-QAM, 15 kHz) | 5G NR FR1 FDD | 8.23 | ±9.6 |
| 10955 | AAA | 5G NR DL (CP-OFDM, TM 3.1, 20 MHz, 64-QAM, 15 kHz) | 5G NR FR1 FDD | 8.42 | ±9.6 |
| 10956 | AAA | 5G NR DL (CP-OFDM, TM 3.1, 5 MHz, 64-QAM, 30 kHz) | 5G NR FR1 FDD | 8.14 | ±9.6 |
| 10957 | AAA | 5G NR DL (CP-OFDM, TM 3.1, 10 MHz, 64-QAM, 30 kHz) | 5G NR FR1 FDD | 8.31 | ±9.6 |
| 10958 | AAA | 5G NR DL (CP-OFDM, TM 3.1, 15 MHz, 64-QAM, 30 kHz) | 5G NR FR1 FDD | 8.61 | ±9.6 |
| 10959 | AAA | 5G NR DL (CP-OFDM, TM 3.1, 20 MHz, 64-QAM, 30 kHz) | 5G NR FR1 FDD | 8.33 | ±9.6 |
| 10960 | AAC | 5G NR DL (CP-OFDM, TM 3.1, 5 MHz, 64-QAM, 15 kHz) | 5G NR FR1 TDD | 9.32 | ±9.6 |
| 10961 | AAB | 5G NR DL (CP-OFDM, TM 3.1, 10 MHz, 64-QAM, 15 kHz) | 5G NR FR1 TDD | 9.36 | ±9.6 |
| 10962 | AAB | 5G NR DL (CP-OFDM, TM 3.1, 15 MHz, 64-QAM, 15 kHz) | 5G NR FR1 TDD | 9.40 | ±9.6 |
| 10963 | AAB | 5G NR DL (CP-OFDM, TM 3.1, 20 MHz, 64-QAM, 15 kHz) | 5G NR FR1 TDD | 9.55 | ±9.6 |
| 10964 | AAC | 5G NR DL (CP-OFDM, TM 3.1, 5 MHz, 64-QAM, 30 kHz) | 5G NR FR1 TDD | 9.29 | ±9.6 |
| 10965 | AAB | 5G NR DL (CP-OFDM, TM 3.1, 10 MHz, 64-QAM, 30 kHz) | 5G NR FR1 TDD | 9.37 | ±9.6 |
| 10966 | AAB | 5G NR DL (CP-OFDM, TM 3.1, 15 MHz, 64-QAM, 30 kHz) | 5G NR FR1 TDD | 9.55 | ±9.6 |
| 10967 | AAB | 5G NR DL (CP-OFDM, TM 3.1, 20 MHz, 64-QAM, 30 kHz) | 5G NR FR1 TDD | 9.42 | ±9.6 |
| 10968 | AAB | 5G NR DL (CP-OFDM, TM 3.1, 100 MHz, 64-QAM, 30 kHz) | 5G NR FR1 TDD | 9.49 | ±9.6 |
| 10972 | AAB | 5G NR (CP-OFDM, 1 RB, 20 MHz, QPSK, 15 kHz) | 5G NR FR1 TDD | 11.59 | ±9.6 |
| 10973 | AAB | 5G NR (DFT-s-OFDM, 1 RB, 100 MHz, QPSK, 30 kHz) | 5G NR FR1 TDD | 9.06 | ±9.6 |
| 10974 | AAB | 5G NR (CP-OFDM, 100% RB, 100 MHz, 256-QAM, 30 kHz) | 5G NR FR1 TDD | 10.28 | ±9.6 |
| 10978 | AAA | ULLA BDR | ULLA | 1.16 | ±9.6 |
| 10979 | AAA | ULLA HDR4 | ULLA | 8.58 | ±9.6 |
| 10980 | AAA | ULLA HDR8 | ULLA | 10.32 | ±9.6 |
| 10981 | AAA | ULLA HDRp4 | ULLA | 3.19 | ±9.6 |
| 10982 | AAA | ULLA HDRp8 | ULLA | 3.43 | ±9.6 |

| UID | Rev | Communication System Name | Group | PAR (dB) | Unc ^E $k = 2$ |
|-------|-----|--|---------------|----------|--------------------------|
| 10983 | AAA | 5G NR DL (CP-OFDM, TM 3.1, 40 MHz, 64-QAM, 15 kHz) | 5G NR FR1 TDD | 9.31 | ±9.6 |
| 10984 | AAA | 5G NR DL (CP-OFDM, TM 3.1, 50 MHz, 64-QAM, 15 kHz) | 5G NR FR1 TDD | 9.42 | ±9.6 |
| 10985 | AAA | 5G NR DL (CP-OFDM, TM 3.1, 40 MHz, 64-QAM, 30 kHz) | 5G NR FR1 TDD | 9.54 | ±9.6 |
| 10986 | AAA | 5G NR DL (CP-OFDM, TM 3.1, 50 MHz, 64-QAM, 30 kHz) | 5G NR FR1 TDD | 9.50 | ±9.6 |
| 10987 | AAA | 5G NR DL (CP-OFDM, TM 3.1, 60 MHz, 64-QAM, 30 kHz) | 5G NR FR1 TDD | 9.53 | ±9.6 |
| 10988 | AAA | 5G NR DL (CP-OFDM, TM 3.1, 70 MHz, 64-QAM, 30 kHz) | 5G NR FR1 TDD | 9.38 | ±9.6 |
| 10989 | AAA | 5G NR DL (CP-OFDM, TM 3.1, 80 MHz, 64-QAM, 30 kHz) | 5G NR FR1 TDD | 9.33 | ±9.6 |
| 10990 | AAA | 5G NR DL (CP-OFDM, TM 3.1, 90 MHz, 64-QAM, 30 kHz) | 5G NR FR1 TDD | 9.52 | ±9.6 |

^E Uncertainty is determined using the max. deviation from linear response applying rectangular distribution and is expressed for the square of the field value.



Accredited by the Swiss Accreditation Service (SAS)
The Swiss Accreditation Service is one of the signatories to the EA
Multilateral Agreement for the recognition of calibration certificates

Accreditation No.: **SCS 0108**

Client **Element** Certificate No **EX-7410_Jul22**

CALIBRATION CERTIFICATE

Object **EX3DV4 - SN:7410** BIN ✓
07-22-22

Calibration procedure(s) **QA CAL-01.v9, QA CAL-12.v9, QA CAL-14.v6, QA CAL-23.v5,
QA CAL-25.v7
Calibration procedure for dosimetric E-field probes**

Calibration date **July 19, 2022**

This calibration certificate documents the traceability to national standards, which realize the physical units of measurements (SI).
The measurements and the uncertainties with confidence probability are given on the following pages and are part of the certificate.

All calibrations have been conducted in the closed laboratory facility: environment temperature (22±3) °C and humidity < 70%.

Calibration Equipment used (M&TE critical for calibration)

| Primary Standards | ID | Cal Date (Certificate No.) | Scheduled Calibration |
|----------------------------|------------------|-----------------------------------|-----------------------|
| Power meter NRP | SN: 104778 | 04-Apr-22 (No. 217-03525/03524) | Apr-23 |
| Power sensor NRP-Z91 | SN: 103244 | 04-Apr-22 (No. 217-03524) | Apr-23 |
| OCP DAK-3.5 (weighted) | SN: 1249 | 20-Oct-21 (OCP-DAK3.5-1249_Oct21) | Oct-22 |
| OCP DAK-12 | SN: 1016 | 20-Oct-21 (OCP-DAK12-1016_Oct21) | Oct-22 |
| Reference 20 dB Attenuator | SN: CC2552 (20x) | 04-Apr-22 (No. 217-03527) | Apr-23 |
| DAE4 | SN: 660 | 13-Oct-21 (No. DAE4-660_Oct21) | Oct-22 |
| Reference Probe ES3DV2 | SN: 3013 | 27-Dec-21 (No. ES3-3013_Dec21) | Dec-22 |

| Secondary Standards | ID | Check Date (in house) | Scheduled Check |
|-------------------------|------------------|-----------------------------------|------------------------|
| Power meter E4419B | SN: GB41293874 | 06-Apr-16 (in house check Jun-22) | In house check: Jun-24 |
| Power sensor E4412A | SN: MY41498087 | 06-Apr-16 (in house check Jun-22) | In house check: Jun-24 |
| Power sensor E4412A | SN: 000110210 | 06-Apr-16 (in house check Jun-22) | In house check: Jun-24 |
| RF generator HP 8648C | SN: US3642U01700 | 04-Aug-99 (in house check Jun-22) | In house check: Jun-24 |
| Network Analyzer E8358A | SN: US41080477 | 31-Mar-14 (in house check Oct-20) | In house check: Oct-22 |

| | | | |
|---------------|--------------------------------|--|---|
| Calibrated by | Name Jeffrey Katzman | Function Laboratory Technician | Signature  |
| Approved by | Name Niels Kuster | Function Quality Manager | |

Issued: July 20, 2022

This calibration certificate shall not be reproduced except in full without written approval of the laboratory.



Accredited by the Swiss Accreditation Service (SAS)
The Swiss Accreditation Service is one of the signatories to the EA
Multilateral Agreement for the recognition of calibration certificates

Accreditation No.: **SCS 0108**

Glossary

| | |
|------------------------|--|
| TSL | tissue simulating liquid |
| NORM _{x,y,z} | sensitivity in free space |
| ConvF | sensitivity in TSL / NORM _{x,y,z} |
| DCP | diode compression point |
| CF | crest factor (1/duty_cycle) of the RF signal |
| A, B, C, D | modulation dependent linearization parameters |
| Polarization φ | φ rotation around probe axis |
| Polarization θ | θ rotation around an axis that is in the plane normal to probe axis (at measurement center), i.e., $\theta = 0$ is normal to probe axis |
| Connector Angle | information used in DASY system to align probe sensor X to the robot coordinate system |

Calibration is Performed According to the Following Standards:

- IEC/IEEE 62209-1528, "Measurement Procedure For The Assessment Of Specific Absorption Rate Of Human Exposure To Radio Frequency Fields From Hand-Held And Body-Worn Wireless Communication Devices – Part 1528: Human Models, Instrumentation And Procedures (Frequency Range of 4 MHz to 10 GHz)", October 2020.
- KDB 865664, "SAR Measurement Requirements for 100 MHz to 6 GHz"

Methods Applied and Interpretation of Parameters:

- NORM_{x,y,z}**: Assessed for E-field polarization $\theta = 0$ ($f \leq 900$ MHz in TEM-cell; $f > 1800$ MHz: R22 waveguide). NORM_{x,y,z} are only intermediate values, i.e., the uncertainties of NORM_{x,y,z} does not affect the E²-field uncertainty inside TSL (see below ConvF).
- NORM(f)_{x,y,z}** = NORM_{x,y,z} * frequency_response (see Frequency Response Chart). This linearization is implemented in DASY4 software versions later than 4.2. The uncertainty of the frequency response is included in the stated uncertainty of ConvF.
- DCP_{x,y,z}**: DCP are numerical linearization parameters assessed based on the data of power sweep with CW signal. DCP does not depend on frequency nor media.
- PAR**: PAR is the Peak to Average Ratio that is not calibrated but determined based on the signal characteristics
- A_{x,y,z}; B_{x,y,z}; C_{x,y,z}; D_{x,y,z}; VR_{x,y,z}**: A, B, C, D are numerical linearization parameters assessed based on the data of power sweep for specific modulation signal. The parameters do not depend on frequency nor media. VR is the maximum calibration range expressed in RMS voltage across the diode.
- ConvF and Boundary Effect Parameters**: Assessed in flat phantom using E-field (or Temperature Transfer Standard for $f \leq 800$ MHz) and inside waveguide using analytical field distributions based on power measurements for $f > 800$ MHz. The same setups are used for assessment of the parameters applied for boundary compensation (alpha, depth) of which typical uncertainty values are given. These parameters are used in DASY4 software to improve probe accuracy close to the boundary. The sensitivity in TSL corresponds to NORM_{x,y,z} * ConvF whereby the uncertainty corresponds to that given for ConvF. A frequency dependent ConvF is used in DASY version 4.4 and higher which allows extending the validity from ± 50 MHz to ± 100 MHz.
- Spherical isotropy (3D deviation from isotropy)**: in a field of low gradients realized using a flat phantom exposed by a patch antenna.
- Sensor Offset**: The sensor offset corresponds to the offset of virtual measurement center from the probe tip (on probe axis). No tolerance required.
- Connector Angle**: The angle is assessed using the information gained by determining the NORM_x (no uncertainty required).

Parameters of Probe: EX3DV4 - SN:7410

Basic Calibration Parameters

| | Sensor X | Sensor Y | Sensor Z | Unc (k = 2) |
|---|----------|----------|----------|-------------|
| Norm ($\mu\text{V}/(\text{V}/\text{m})^2$) ^A | 0.41 | 0.46 | 0.43 | ±10.1% |
| DCP (mV) ^B | 100.3 | 99.4 | 98.9 | ±4.7% |

Calibration Results for Modulation Response

| UID | Communication System Name | | A dB | B dB $\sqrt{\mu\text{V}}$ | C | D dB | VR mV | Max dev. | Max Unc ^E k = 2 |
|-------|-----------------------------|---|---------|------------------------------|-------|---------|----------|-------------|----------------------------------|
| 0 | CW | X | 0.00 | 0.00 | 1.00 | 0.00 | 169.5 | ±3.3% | ±4.7% |
| | | Y | 0.00 | 0.00 | 1.00 | | 155.3 | | |
| | | Z | 0.00 | 0.00 | 1.00 | | 145.7 | | |
| 10352 | Pulse Waveform (200Hz, 10%) | X | 5.80 | 74.36 | 13.84 | 10.00 | 60.0 | ±3.3% | ±9.6% |
| | | Y | 20.00 | 88.86 | 18.95 | | 60.0 | | |
| | | Z | 20.00 | 89.13 | 19.25 | | 60.0 | | |
| 10353 | Pulse Waveform (200Hz, 20%) | X | 20.00 | 86.64 | 16.50 | 6.99 | 80.0 | ±2.1% | ±9.6% |
| | | Y | 20.00 | 91.21 | 18.85 | | 80.0 | | |
| | | Z | 20.00 | 90.42 | 18.78 | | 80.0 | | |
| 10354 | Pulse Waveform (200Hz, 40%) | X | 20.00 | 87.84 | 15.82 | 3.98 | 95.0 | ±1.2% | ±9.6% |
| | | Y | 20.00 | 96.01 | 19.55 | | 95.0 | | |
| | | Z | 20.00 | 93.94 | 19.17 | | 95.0 | | |
| 10355 | Pulse Waveform (200Hz, 60%) | X | 20.00 | 89.27 | 15.38 | 2.22 | 120.0 | ±1.1% | ±9.6% |
| | | Y | 20.00 | 93.63 | 16.98 | | 120.0 | | |
| | | Z | 20.00 | 98.33 | 19.91 | | 120.0 | | |
| 10387 | QPSK Waveform, 1 MHz | X | 1.70 | 67.69 | 15.61 | 1.00 | 150.0 | ±2.7% | ±9.6% |
| | | Y | 1.57 | 65.91 | 14.47 | | 150.0 | | |
| | | Z | 1.77 | 66.87 | 15.56 | | 150.0 | | |
| 10388 | QPSK Waveform, 10 MHz | X | 2.26 | 68.90 | 16.29 | 0.00 | 150.0 | ±0.8% | ±9.6% |
| | | Y | 2.13 | 67.61 | 15.34 | | 150.0 | | |
| | | Z | 2.40 | 69.18 | 16.34 | | 150.0 | | |
| 10396 | 64-QAM Waveform, 100 kHz | X | 2.60 | 69.49 | 18.54 | 3.01 | 150.0 | ±0.8% | ±9.6% |
| | | Y | 2.50 | 68.02 | 17.62 | | 150.0 | | |
| | | Z | 2.83 | 70.05 | 18.74 | | 150.0 | | |
| 10399 | 64-QAM Waveform, 40 MHz | X | 3.51 | 67.45 | 16.03 | 0.00 | 150.0 | ±2.3% | ±9.6% |
| | | Y | 3.46 | 67.01 | 15.64 | | 150.0 | | |
| | | Z | 3.62 | 67.62 | 16.11 | | 150.0 | | |
| 10414 | WLAN CCDF, 64-QAM, 40 MHz | X | 4.81 | 65.82 | 15.71 | 0.00 | 150.0 | ±4.0% | ±9.6% |
| | | Y | 4.83 | 65.72 | 15.55 | | 150.0 | | |
| | | Z | 4.99 | 65.94 | 15.78 | | 150.0 | | |

Note: For details on UID parameters see Appendix

The reported uncertainty of measurement is stated as the standard uncertainty of measurement multiplied by the coverage factor k=2, which for a normal distribution corresponds to a coverage probability of approximately 95%.

^A The uncertainties of Norm X,Y,Z do not affect the E²-field uncertainty inside TSL (see Pages 5 and 6).

^B Linearization parameter uncertainty for maximum specified field strength.

^E Uncertainty is determined using the max. deviation from linear response applying rectangular distribution and is expressed for the square of the field value.

Parameters of Probe: EX3DV4 - SN:7410**Sensor Model Parameters**

| | C1 fF | C2 fF | α V ⁻¹ | T1 msV ⁻² | T2 msV ⁻¹ | T3 ms | T4 V ⁻² | T5 V ⁻¹ | T6 |
|---|----------|----------|-----------------------------|-------------------------|-------------------------|----------|-----------------------|-----------------------|------|
| x | 39.5 | 296.56 | 35.96 | 11.02 | 0.00 | 5.04 | 0.71 | 0.24 | 1.01 |
| y | 42.5 | 321.39 | 36.23 | 8.49 | 0.00 | 5.09 | 0.00 | 0.40 | 1.01 |
| z | 50.3 | 380.27 | 36.40 | 12.72 | 0.00 | 5.08 | 0.53 | 0.35 | 1.01 |

Other Probe Parameters

| | |
|---|------------|
| Sensor Arrangement | Triangular |
| Connector Angle | -178.8° |
| Mechanical Surface Detection Mode | enabled |
| Optical Surface Detection Mode | disabled |
| Probe Overall Length | 337 mm |
| Probe Body Diameter | 10 mm |
| Tip Length | 9 mm |
| Tip Diameter | 2.5 mm |
| Probe Tip to Sensor X Calibration Point | 1 mm |
| Probe Tip to Sensor Y Calibration Point | 1 mm |
| Probe Tip to Sensor Z Calibration Point | 1 mm |
| Recommended Measurement Distance from Surface | 1.4 mm |

Note: Measurement distance from surface can be increased to 3–4 mm for an *Area Scan* job.

Parameters of Probe: EX3DV4 - SN:7410

Calibration Parameter Determined in Head Tissue Simulating Media

| f (MHz) ^C | Relative Permittivity ^F | Conductivity ^F (S/m) | ConvF X | ConvF Y | ConvF Z | Alpha ^G | Depth ^G (mm) | Unc (k = 2) |
|----------------------|------------------------------------|---------------------------------|---------|---------|---------|--------------------|-------------------------|-------------|
| 750 | 41.9 | 0.89 | 10.06 | 10.06 | 10.06 | 0.58 | 0.80 | ±12.0% |
| 835 | 41.5 | 0.90 | 9.60 | 9.60 | 9.60 | 0.41 | 1.02 | ±12.0% |
| 1750 | 40.1 | 1.37 | 8.34 | 8.34 | 8.34 | 0.40 | 0.86 | ±12.0% |
| 1900 | 40.0 | 1.40 | 8.04 | 8.04 | 8.04 | 0.41 | 0.86 | ±12.0% |
| 2300 | 39.5 | 1.67 | 7.89 | 7.89 | 7.89 | 0.30 | 0.90 | ±12.0% |
| 2450 | 39.2 | 1.80 | 7.46 | 7.46 | 7.46 | 0.38 | 0.90 | ±12.0% |
| 2600 | 39.0 | 1.96 | 7.33 | 7.33 | 7.33 | 0.45 | 0.90 | ±12.0% |
| 3300 | 38.2 | 2.71 | 7.18 | 7.18 | 7.18 | 0.35 | 1.35 | ±14.0% |
| 3500 | 37.9 | 2.91 | 7.04 | 7.04 | 7.04 | 0.35 | 1.35 | ±14.0% |
| 3700 | 37.7 | 3.12 | 6.98 | 6.98 | 6.98 | 0.35 | 1.35 | ±14.0% |
| 3900 | 37.5 | 3.32 | 6.59 | 6.59 | 6.59 | 0.45 | 1.60 | ±14.0% |
| 4100 | 37.2 | 3.53 | 6.52 | 6.52 | 6.52 | 0.45 | 1.60 | ±14.0% |

^C Frequency validity above 300 MHz of ±100MHz only applies for DASY v4.4 and higher (see Page 2), else it is restricted to ±50 MHz. The uncertainty is the RSS of the ConvF uncertainty at calibration frequency and the uncertainty for the indicated frequency band. Frequency validity below 300 MHz is ±10, 25, 40, 50 and 70 MHz for ConvF assessments at 30, 64, 128, 150 and 220MHz respectively. Validity of ConvF assessed at 6 MHz is 4–9MHz, and ConvF assessed at 13 MHz is 9–19 MHz. Above 5 GHz frequency validity can be extended to ±110 MHz.

^F At frequencies up to 6 GHz, the validity of tissue parameters (ϵ and σ) can be relaxed to ±10% if liquid compensation formula is applied to measured SAR values. The uncertainty is the RSS of the ConvF uncertainty for indicated target tissue parameters.

^G Alpha/Depth are determined during calibration. SPEAG warrants that the remaining deviation due to the boundary effect after compensation is always less than ±1% for frequencies below 3 GHz and below ±2% for frequencies between 3–6 GHz at any distance larger than half the probe tip diameter from the boundary.

Parameters of Probe: EX3DV4 - SN:7410

Calibration Parameter Determined in Body Tissue Simulating Media

| f (MHz) ^C | Relative Permittivity ^F | Conductivity ^F (S/m) | ConvF X | ConvF Y | ConvF Z | Alpha ^G | Depth ^G (mm) | Unc (k = 2) |
|----------------------|------------------------------------|---------------------------------|---------|---------|---------|--------------------|-------------------------|-------------|
| 750 | 55.5 | 0.96 | 10.00 | 10.00 | 10.00 | 0.45 | 0.87 | ±12.0% |
| 835 | 55.2 | 0.97 | 9.81 | 9.81 | 9.81 | 0.47 | 0.80 | ±12.0% |
| 1750 | 53.4 | 1.49 | 8.14 | 8.14 | 8.14 | 0.36 | 0.86 | ±12.0% |
| 1900 | 53.3 | 1.52 | 7.82 | 7.82 | 7.82 | 0.40 | 0.86 | ±12.0% |
| 2300 | 52.9 | 1.81 | 7.69 | 7.69 | 7.69 | 0.41 | 0.90 | ±12.0% |
| 2450 | 52.7 | 1.95 | 7.52 | 7.52 | 7.52 | 0.43 | 0.90 | ±12.0% |
| 2600 | 52.5 | 2.16 | 7.45 | 7.45 | 7.45 | 0.36 | 0.90 | ±12.0% |
| 3300 | 51.6 | 3.08 | 6.72 | 6.72 | 6.72 | 0.40 | 1.35 | ±14.0% |
| 3500 | 51.3 | 3.31 | 6.65 | 6.65 | 6.65 | 0.40 | 1.35 | ±14.0% |
| 3700 | 51.0 | 3.55 | 6.45 | 6.45 | 6.45 | 0.40 | 1.35 | ±14.0% |
| 3900 | 50.8 | 3.78 | 6.37 | 6.37 | 6.37 | 0.40 | 1.70 | ±14.0% |
| 4100 | 50.5 | 4.01 | 6.01 | 6.01 | 6.01 | 0.40 | 1.70 | ±14.0% |

^C Frequency validity above 300 MHz of ±100 MHz only applies for DASY v4.4 and higher (see Page 2), else it is restricted to ±50 MHz. The uncertainty is the RSS of the ConvF uncertainty at calibration frequency and the uncertainty for the indicated frequency band. Frequency validity below 300 MHz is ±10, 25, 40, 50 and 70 MHz for ConvF assessments at 30, 64, 128, 150 and 220 MHz respectively. Validity of ConvF assessed at 6 MHz is 4–9 MHz, and ConvF assessed at 13 MHz is 9–19 MHz. Above 5 GHz frequency validity can be extended to ±110 MHz.

^F At frequencies up to 6 GHz, the validity of tissue parameters (ϵ and σ) can be relaxed to ±10% if liquid compensation formula is applied to measured SAR values. The uncertainty is the RSS of the ConvF uncertainty for indicated target tissue parameters.

^G Alpha/Depth are determined during calibration. SPEAG warrants that the remaining deviation due to the boundary effect after compensation is always less than ±1% for frequencies below 3 GHz and below ±2% for frequencies between 3–6 GHz at any distance larger than half the probe tip diameter from the boundary.

Frequency Response of E-Field (TEM-Cell:ifi110 EXX, Waveguide:R22)

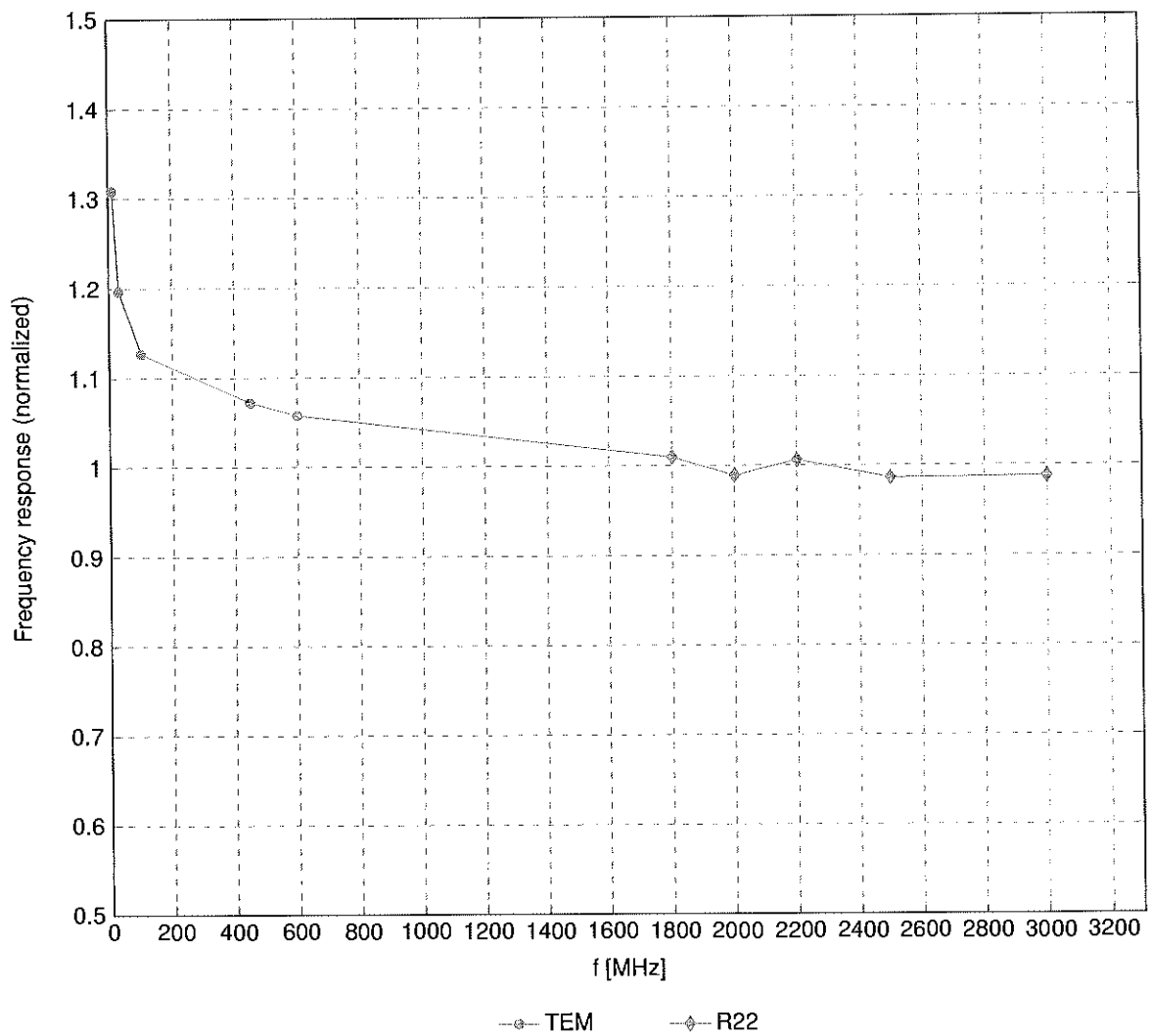

Uncertainty of Frequency Response of E-field: $\pm 6.3\%$ (k=2)

Receiving Pattern (ϕ), $\theta = 0^\circ$

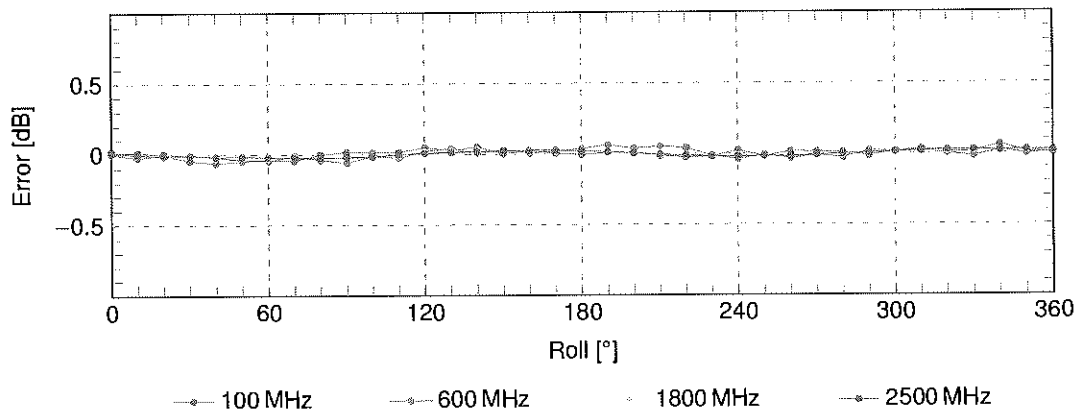
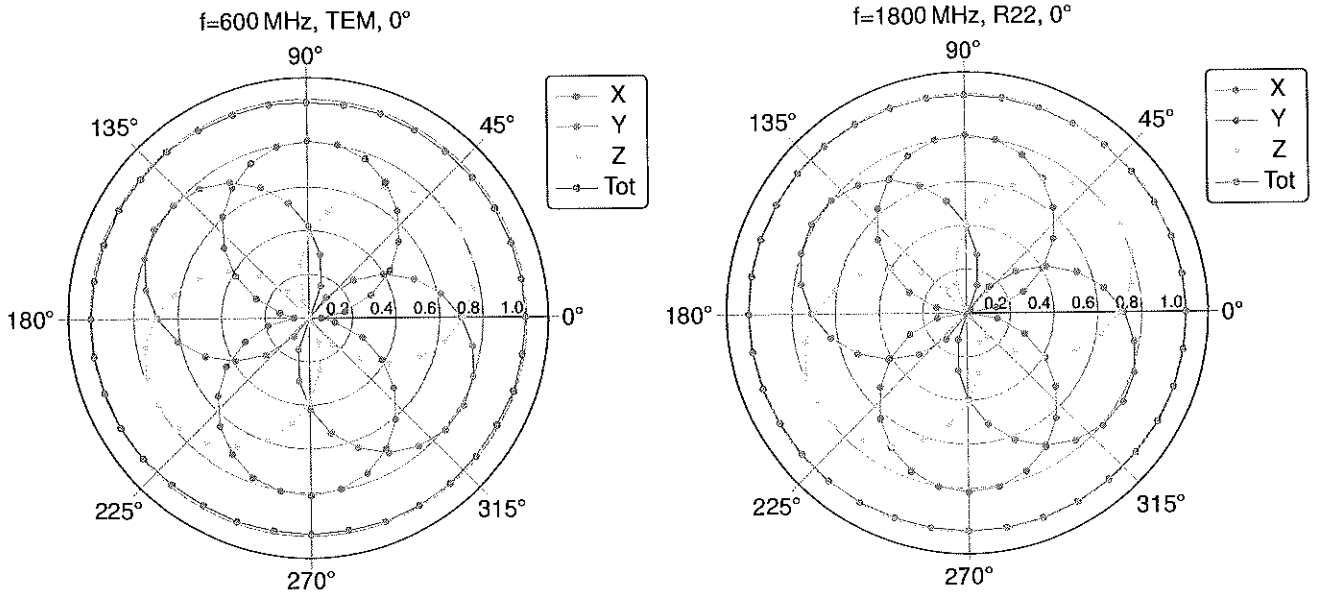

Uncertainty of Axial Isotropy Assessment: $\pm 0.5\%$ ($k=2$)

Dynamic Range $f(\text{SAR}_{\text{head}})$

(TEM cell, $f_{\text{eval}} = 1900\text{MHz}$)

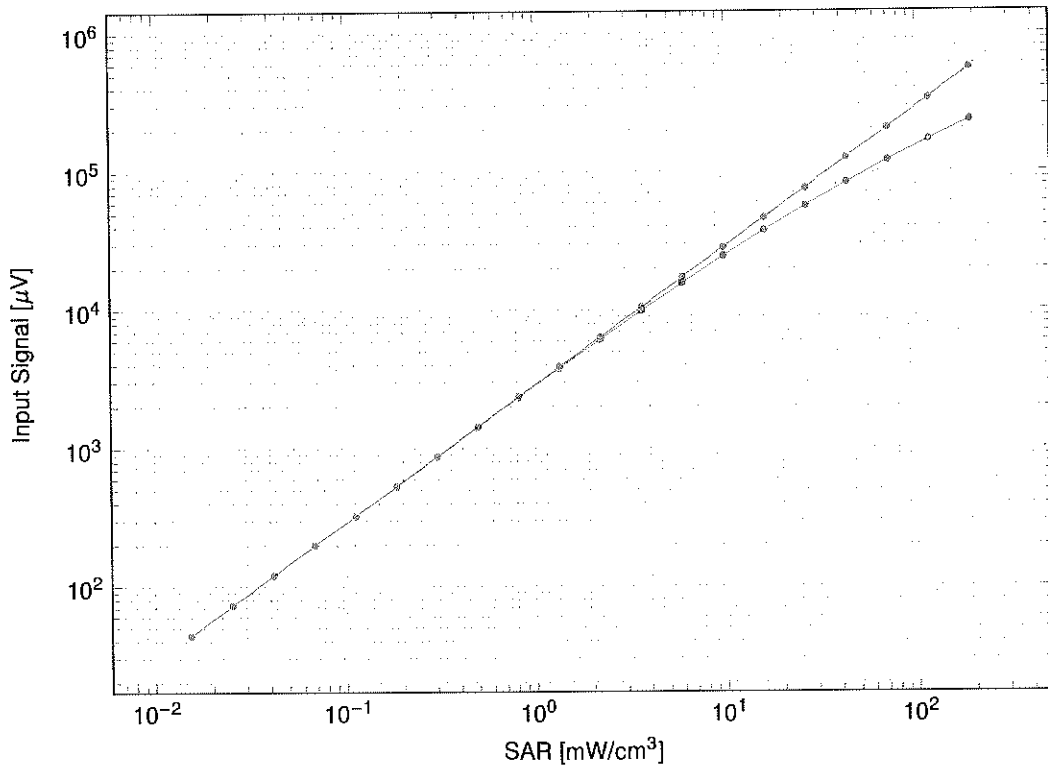

○ not compensated □ compensated

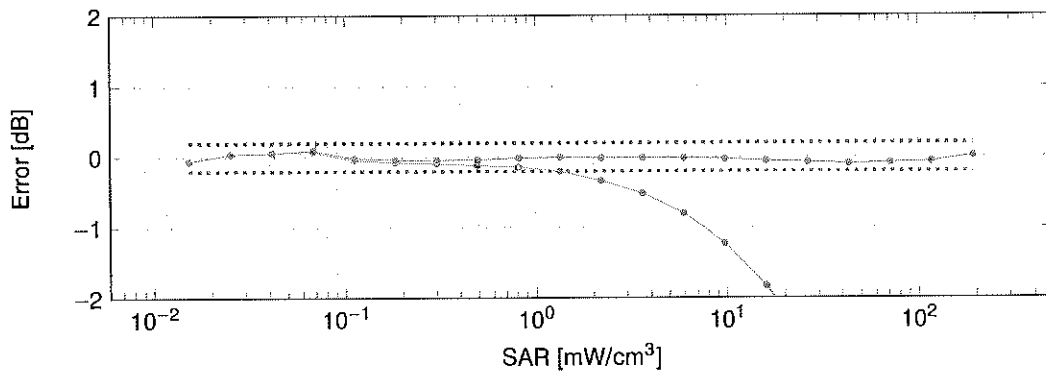

○ not compensated □ compensated

Uncertainty of Linearity Assessment: $\pm 0.6\%$ ($k=2$)

Conversion Factor Assessment

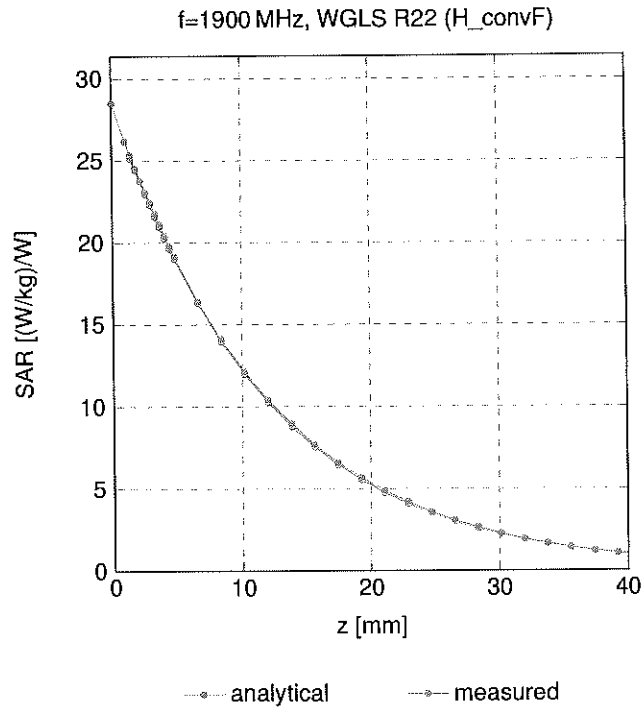

Deviation from Isotropy in Liquid

Error (ϕ, θ), f = 900 MHz

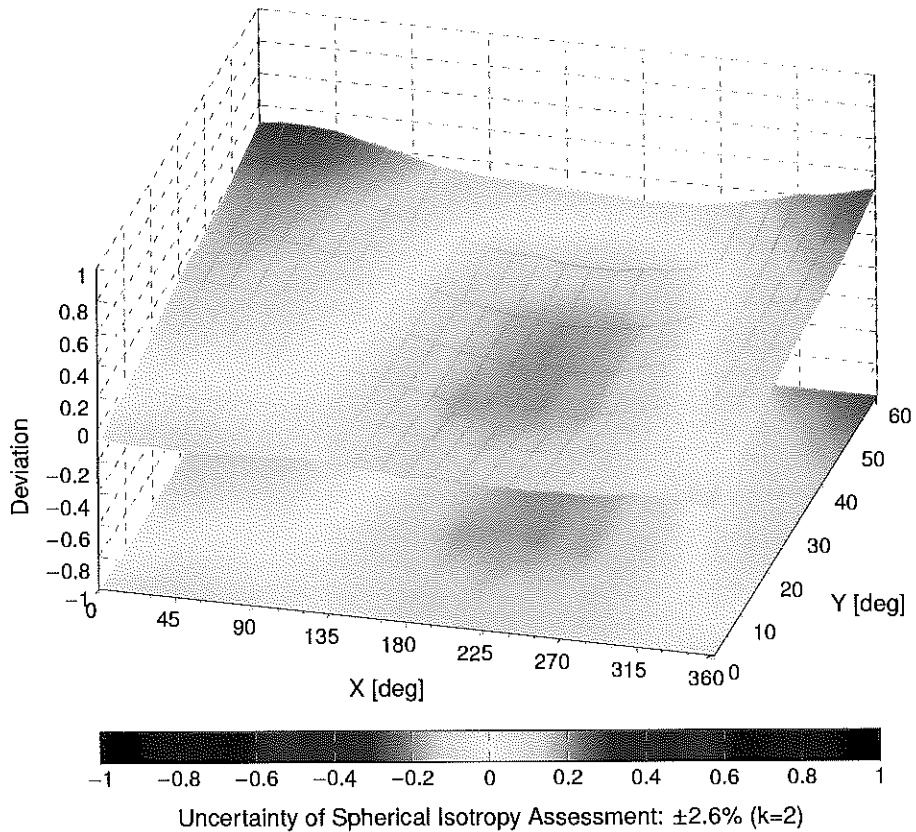

Appendix: Modulation Calibration Parameters

| UID | Rev | Communication System Name | Group | PAR (dB) | Unc ^E k = 2 |
|-------|-----|---|-----------|----------|------------------------|
| 0 | | CW | CW | 0.00 | ±4.7 |
| 10010 | CAA | SAR Validation (Square, 100 ms, 10 ms) | Test | 10.00 | ±9.6 |
| 10011 | CAB | UMTS-FDD (WCDMA) | WCDMA | 2.91 | ±9.6 |
| 10012 | CAB | IEEE 802.11b WiFi 2.4 GHz (DSSS, 1 Mbps) | WLAN | 1.87 | ±9.6 |
| 10013 | CAB | IEEE 802.11g WiFi 2.4 GHz (DSSS-OFDM, 6 Mbps) | WLAN | 9.46 | ±9.6 |
| 10021 | DAC | GSM-FDD (TDMA, GMSK) | GSM | 9.39 | ±9.6 |
| 10023 | DAC | GPRS-FDD (TDMA, GMSK, TN 0) | GSM | 9.57 | ±9.6 |
| 10024 | DAC | GPRS-FDD (TDMA, GMSK, TN 0-1) | GSM | 6.56 | ±9.6 |
| 10025 | DAC | EDGE-FDD (TDMA, 8PSK, TN 0) | GSM | 12.62 | ±9.6 |
| 10026 | DAC | EDGE-FDD (TDMA, 8PSK, TN 0-1) | GSM | 9.55 | ±9.6 |
| 10027 | DAC | GPRS-FDD (TDMA, GMSK, TN 0-1-2) | GSM | 4.80 | ±9.6 |
| 10028 | DAC | GPRS-FDD (TDMA, GMSK, TN 0-1-2-3) | GSM | 3.55 | ±9.6 |
| 10029 | DAC | EDGE-FDD (TDMA, 8PSK, TN 0-1-2) | GSM | 7.78 | ±9.6 |
| 10030 | CAA | IEEE 802.15.1 Bluetooth (GFSK, DH1) | Bluetooth | 5.30 | ±9.6 |
| 10031 | CAA | IEEE 802.15.1 Bluetooth (GFSK, DH3) | Bluetooth | 1.87 | ±9.6 |
| 10032 | CAA | IEEE 802.15.1 Bluetooth (GFSK, DH5) | Bluetooth | 1.16 | ±9.6 |
| 10033 | CAA | IEEE 802.15.1 Bluetooth (PI/4-DQPSK, DH1) | Bluetooth | 7.74 | ±9.6 |
| 10034 | CAA | IEEE 802.15.1 Bluetooth (PI/4-DQPSK, DH3) | Bluetooth | 4.53 | ±9.6 |
| 10035 | CAA | IEEE 802.15.1 Bluetooth (PI/4-DQPSK, DH5) | Bluetooth | 3.83 | ±9.6 |
| 10036 | CAA | IEEE 802.15.1 Bluetooth (8-DPSK, DH1) | Bluetooth | 8.01 | ±9.6 |
| 10037 | CAA | IEEE 802.15.1 Bluetooth (8-DPSK, DH3) | Bluetooth | 4.77 | ±9.6 |
| 10038 | CAA | IEEE 802.15.1 Bluetooth (8-DPSK, DH5) | Bluetooth | 4.10 | ±9.6 |
| 10039 | CAB | CDMA2000 (1xRTT, RC1) | CDMA2000 | 4.57 | ±9.6 |
| 10042 | CAB | IS-54 / IS-136 FDD (TDMA/FDM, PI/4-DQPSK, Halfrate) | AMPS | 7.78 | ±9.6 |
| 10044 | CAA | IS-91/EIA/TIA-553 FDD (FDMA, FM) | AMPS | 0.00 | ±9.6 |
| 10048 | CAA | DECT (TDD, TDMA/FDM, GFSK, Full Slot, 24) | DECT | 13.80 | ±9.6 |
| 10049 | CAA | DECT (TDD, TDMA/FDM, GFSK, Double Slot, 12) | DECT | 10.79 | ±9.6 |
| 10056 | CAA | UMTS-TDD (TD-SCDMA, 1.28 Mcps) | TD-SCDMA | 11.01 | ±9.6 |
| 10058 | DAC | EDGE-FDD (TDMA, 8PSK, TN 0-1-2-3) | GSM | 6.52 | ±9.6 |
| 10059 | CAB | IEEE 802.11b WiFi 2.4 GHz (DSSS, 2 Mbps) | WLAN | 2.12 | ±9.6 |
| 10060 | CAB | IEEE 802.11b WiFi 2.4 GHz (DSSS, 5.5 Mbps) | WLAN | 2.83 | ±9.6 |
| 10061 | CAB | IEEE 802.11b WiFi 2.4 GHz (DSSS, 11 Mbps) | WLAN | 3.60 | ±9.6 |
| 10062 | CAD | IEEE 802.11a/h WiFi 5 GHz (OFDM, 6 Mbps) | WLAN | 8.68 | ±9.6 |
| 10063 | CAD | IEEE 802.11a/h WiFi 5 GHz (OFDM, 9 Mbps) | WLAN | 8.63 | ±9.6 |
| 10064 | CAD | IEEE 802.11a/h WiFi 5 GHz (OFDM, 12 Mbps) | WLAN | 9.09 | ±9.6 |
| 10065 | CAD | IEEE 802.11a/h WiFi 5 GHz (OFDM, 18 Mbps) | WLAN | 9.00 | ±9.6 |
| 10066 | CAD | IEEE 802.11a/h WiFi 5 GHz (OFDM, 24 Mbps) | WLAN | 9.38 | ±9.6 |
| 10067 | CAD | IEEE 802.11a/h WiFi 5 GHz (OFDM, 36 Mbps) | WLAN | 10.12 | ±9.6 |
| 10068 | CAD | IEEE 802.11a/h WiFi 5 GHz (OFDM, 48 Mbps) | WLAN | 10.24 | ±9.6 |
| 10069 | CAD | IEEE 802.11a/h WiFi 5 GHz (OFDM, 54 Mbps) | WLAN | 10.56 | ±9.6 |
| 10071 | CAB | IEEE 802.11g WiFi 2.4 GHz (DSSS/OFDM, 9 Mbps) | WLAN | 9.83 | ±9.6 |
| 10072 | CAB | IEEE 802.11g WiFi 2.4 GHz (DSSS/OFDM, 12 Mbps) | WLAN | 9.62 | ±9.6 |
| 10073 | CAB | IEEE 802.11g WiFi 2.4 GHz (DSSS/OFDM, 18 Mbps) | WLAN | 9.94 | ±9.6 |
| 10074 | CAB | IEEE 802.11g WiFi 2.4 GHz (DSSS/OFDM, 24 Mbps) | WLAN | 10.30 | ±9.6 |
| 10075 | CAB | IEEE 802.11g WiFi 2.4 GHz (DSSS/OFDM, 36 Mbps) | WLAN | 10.77 | ±9.6 |
| 10076 | CAB | IEEE 802.11g WiFi 2.4 GHz (DSSS/OFDM, 48 Mbps) | WLAN | 10.94 | ±9.6 |
| 10077 | CAB | IEEE 802.11g WiFi 2.4 GHz (DSSS/OFDM, 54 Mbps) | WLAN | 11.00 | ±9.6 |
| 10081 | CAB | CDMA2000 (1xRTT, RC3) | CDMA2000 | 3.97 | ±9.6 |
| 10082 | CAB | IS-54 / IS-136 FDD (TDMA/FDM, PI/4-DQPSK, Fullrate) | AMPS | 4.77 | ±9.6 |
| 10090 | DAC | GPRS-FDD (TDMA, GMSK, TN 0-4) | GSM | 6.56 | ±9.6 |
| 10097 | CAC | UMTS-FDD (HSDPA) | WCDMA | 3.98 | ±9.6 |
| 10098 | DAC | UMTS-FDD (HSUPA, Subtest 2) | WCDMA | 3.98 | ±9.6 |
| 10099 | CAC | EDGE-FDD (TDMA, 8PSK, TN 0-4) | GSM | 9.55 | ±9.6 |
| 10100 | CAC | LTE-FDD (SC-FDMA, 100% RB, 20 MHz, QPSK) | LTE-FDD | 5.67 | ±9.6 |
| 10101 | CAB | LTE-FDD (SC-FDMA, 100% RB, 20 MHz, 16-QAM) | LTE-FDD | 6.42 | ±9.6 |
| 10102 | CAB | LTE-FDD (SC-FDMA, 100% RB, 20 MHz, 64-QAM) | LTE-FDD | 6.60 | ±9.6 |
| 10103 | DAC | LTE-TDD (SC-FDMA, 100% RB, 20 MHz, QPSK) | LTE-TDD | 9.29 | ±9.6 |
| 10104 | CAE | LTE-TDD (SC-FDMA, 100% RB, 20 MHz, 16-QAM) | LTE-TDD | 9.97 | ±9.6 |
| 10105 | CAE | LTE-TDD (SC-FDMA, 100% RB, 20 MHz, 64-QAM) | LTE-TDD | 10.01 | ±9.6 |
| 10108 | CAE | LTE-FDD (SC-FDMA, 100% RB, 10 MHz, QPSK) | LTE-FDD | 5.80 | ±9.6 |
| 10109 | CAG | LTE-FDD (SC-FDMA, 100% RB, 10 MHz, 16-QAM) | LTE-FDD | 6.43 | ±9.6 |
| 10110 | CAG | LTE-FDD (SC-FDMA, 100% RB, 5 MHz, QPSK) | LTE-FDD | 5.75 | ±9.6 |
| 10111 | CAG | LTE-FDD (SC-FDMA, 100% RB, 5 MHz, 16-QAM) | LTE-FDD | 6.44 | ±9.6 |

| UID | Rev | Communication System Name | Group | PAR (dB) | Unc ^E k = 2 |
|-------|-----|--|---------|----------|------------------------|
| 10112 | CAG | LTE-FDD (SC-FDMA, 100% RB, 10 MHz, 64-QAM) | LTE-FDD | 6.59 | ±9.6 |
| 10113 | CAG | LTE-FDD (SC-FDMA, 100% RB, 5 MHz, 64-QAM) | LTE-FDD | 6.62 | ±9.6 |
| 10114 | CAG | IEEE 802.11n (HT Greenfield, 13.5 Mbps, BPSK) | WLAN | 8.10 | ±9.6 |
| 10115 | CAG | IEEE 802.11n (HT Greenfield, 81 Mbps, 16-QAM) | WLAN | 8.46 | ±9.6 |
| 10116 | CAG | IEEE 802.11n (HT Greenfield, 135 Mbps, 64-QAM) | WLAN | 8.15 | ±9.6 |
| 10117 | CAG | IEEE 802.11n (HT Mixed, 13.5 Mbps, BPSK) | WLAN | 8.07 | ±9.6 |
| 10118 | CAD | IEEE 802.11n (HT Mixed, 81 Mbps, 16-QAM) | WLAN | 8.59 | ±9.6 |
| 10119 | CAD | IEEE 802.11n (HT Mixed, 135 Mbps, 64-QAM) | WLAN | 8.13 | ±9.6 |
| 10140 | CAD | LTE-FDD (SC-FDMA, 100% RB, 15 MHz, 16-QAM) | LTE-FDD | 6.49 | ±9.6 |
| 10141 | CAD | LTE-FDD (SC-FDMA, 100% RB, 15 MHz, 64-QAM) | LTE-FDD | 6.53 | ±9.6 |
| 10142 | CAD | LTE-FDD (SC-FDMA, 100% RB, 3 MHz, QPSK) | LTE-FDD | 5.73 | ±9.6 |
| 10143 | CAD | LTE-FDD (SC-FDMA, 100% RB, 3 MHz, 16-QAM) | LTE-FDD | 6.35 | ±9.6 |
| 10144 | CAC | LTE-FDD (SC-FDMA, 100% RB, 3 MHz, 64-QAM) | LTE-FDD | 6.65 | ±9.6 |
| 10145 | CAC | LTE-FDD (SC-FDMA, 100% RB, 1.4 MHz, QPSK) | LTE-FDD | 5.76 | ±9.6 |
| 10146 | CAG | LTE-FDD (SC-FDMA, 100% RB, 1.4 MHz, 16-QAM) | LTE-FDD | 6.41 | ±9.6 |
| 10147 | CAC | LTE-FDD (SC-FDMA, 100% RB, 1.4 MHz, 64-QAM) | LTE-FDD | 6.72 | ±9.6 |
| 10149 | CAE | LTE-FDD (SC-FDMA, 50% RB, 20 MHz, 16-QAM) | LTE-FDD | 6.42 | ±9.6 |
| 10150 | CAE | LTE-FDD (SC-FDMA, 50% RB, 20 MHz, 64-QAM) | LTE-FDD | 6.60 | ±9.6 |
| 10151 | CAE | LTE-TDD (SC-FDMA, 50% RB, 20 MHz, QPSK) | LTE-TDD | 9.28 | ±9.6 |
| 10152 | CAE | LTE-TDD (SC-FDMA, 50% RB, 20 MHz, 16-QAM) | LTE-TDD | 9.92 | ±9.6 |
| 10153 | CAE | LTE-TDD (SC-FDMA, 50% RB, 20 MHz, 64-QAM) | LTE-TDD | 10.05 | ±9.6 |
| 10154 | CAF | LTE-FDD (SC-FDMA, 50% RB, 10 MHz, QPSK) | LTE-FDD | 5.75 | ±9.6 |
| 10155 | CAF | LTE-FDD (SC-FDMA, 50% RB, 10 MHz, 16-QAM) | LTE-FDD | 6.43 | ±9.6 |
| 10156 | CAF | LTE-FDD (SC-FDMA, 50% RB, 5 MHz, QPSK) | LTE-FDD | 5.79 | ±9.6 |
| 10157 | CAE | LTE-FDD (SC-FDMA, 50% RB, 5 MHz, 16-QAM) | LTE-FDD | 6.49 | ±9.6 |
| 10158 | CAE | LTE-FDD (SC-FDMA, 50% RB, 10 MHz, 64-QAM) | LTE-FDD | 6.62 | ±9.6 |
| 10159 | CAG | LTE-FDD (SC-FDMA, 50% RB, 5 MHz, 64-QAM) | LTE-FDD | 6.56 | ±9.6 |
| 10160 | CAG | LTE-FDD (SC-FDMA, 50% RB, 15 MHz, QPSK) | LTE-FDD | 5.82 | ±9.6 |
| 10161 | CAG | LTE-FDD (SC-FDMA, 50% RB, 15 MHz, 16-QAM) | LTE-FDD | 6.43 | ±9.6 |
| 10162 | CAG | LTE-FDD (SC-FDMA, 50% RB, 15 MHz, 64-QAM) | LTE-FDD | 6.58 | ±9.6 |
| 10166 | CAG | LTE-FDD (SC-FDMA, 50% RB, 1.4 MHz, QPSK) | LTE-FDD | 5.46 | ±9.6 |
| 10167 | CAG | LTE-FDD (SC-FDMA, 50% RB, 1.4 MHz, 16-QAM) | LTE-FDD | 6.21 | ±9.6 |
| 10168 | CAG | LTE-FDD (SC-FDMA, 50% RB, 1.4 MHz, 64-QAM) | LTE-FDD | 6.79 | ±9.6 |
| 10169 | CAG | LTE-FDD (SC-FDMA, 1 RB, 20 MHz, QPSK) | LTE-FDD | 5.73 | ±9.6 |
| 10170 | CAG | LTE-FDD (SC-FDMA, 1 RB, 20 MHz, 16-QAM) | LTE-FDD | 6.52 | ±9.6 |
| 10171 | CAE | LTE-FDD (SC-FDMA, 1 RB, 20 MHz, 64-QAM) | LTE-FDD | 6.49 | ±9.6 |
| 10172 | CAE | LTE-TDD (SC-FDMA, 1 RB, 20 MHz, QPSK) | LTE-TDD | 9.21 | ±9.6 |
| 10173 | CAE | LTE-TDD (SC-FDMA, 1 RB, 20 MHz, 16-QAM) | LTE-TDD | 9.48 | ±9.6 |
| 10174 | CAF | LTE-TDD (SC-FDMA, 1 RB, 20 MHz, 64-QAM) | LTE-TDD | 10.25 | ±9.6 |
| 10175 | CAF | LTE-FDD (SC-FDMA, 1 RB, 10 MHz, QPSK) | LTE-FDD | 5.72 | ±9.6 |
| 10176 | CAF | LTE-FDD (SC-FDMA, 1 RB, 10 MHz, 16-QAM) | LTE-FDD | 6.52 | ±9.6 |
| 10177 | CAE | LTE-FDD (SC-FDMA, 1 RB, 5 MHz, QPSK) | LTE-FDD | 5.73 | ±9.6 |
| 10178 | CAE | LTE-FDD (SC-FDMA, 1 RB, 5 MHz, 16-QAM) | LTE-FDD | 6.52 | ±9.6 |
| 10179 | AAE | LTE-FDD (SC-FDMA, 1 RB, 10 MHz, 64-QAM) | LTE-FDD | 6.50 | ±9.6 |
| 10180 | CAG | LTE-FDD (SC-FDMA, 1 RB, 5 MHz, 64-QAM) | LTE-FDD | 6.50 | ±9.6 |
| 10181 | CAG | LTE-FDD (SC-FDMA, 1 RB, 15 MHz, QPSK) | LTE-FDD | 5.72 | ±9.6 |
| 10182 | CAG | LTE-FDD (SC-FDMA, 1 RB, 15 MHz, 16-QAM) | LTE-FDD | 6.52 | ±9.6 |
| 10183 | CAG | LTE-FDD (SC-FDMA, 1 RB, 15 MHz, 64-QAM) | LTE-FDD | 6.50 | ±9.6 |
| 10184 | CAG | LTE-FDD (SC-FDMA, 1 RB, 3 MHz, QPSK) | LTE-FDD | 5.73 | ±9.6 |
| 10185 | CAI | LTE-FDD (SC-FDMA, 1 RB, 3 MHz, 16-QAM) | LTE-FDD | 6.51 | ±9.6 |
| 10186 | CAG | LTE-FDD (SC-FDMA, 1 RB, 3 MHz, 64-QAM) | LTE-FDD | 6.50 | ±9.6 |
| 10187 | CAG | LTE-FDD (SC-FDMA, 1 RB, 1.4 MHz, QPSK) | LTE-FDD | 5.73 | ±9.6 |
| 10188 | CAG | LTE-FDD (SC-FDMA, 1 RB, 1.4 MHz, 16-QAM) | LTE-FDD | 6.52 | ±9.6 |
| 10189 | CAE | LTE-FDD (SC-FDMA, 1 RB, 1.4 MHz, 64-QAM) | LTE-FDD | 6.50 | ±9.6 |
| 10193 | CAE | IEEE 802.11n (HT Greenfield, 6.5 Mbps, BPSK) | WLAN | 8.09 | ±9.6 |
| 10194 | AAD | IEEE 802.11n (HT Greenfield, 39 Mbps, 16-QAM) | WLAN | 8.12 | ±9.6 |
| 10195 | CAE | IEEE 802.11n (HT Greenfield, 65 Mbps, 64-QAM) | WLAN | 8.21 | ±9.6 |
| 10196 | CAE | IEEE 802.11n (HT Mixed, 6.5 Mbps, BPSK) | WLAN | 8.10 | ±9.6 |
| 10197 | AAE | IEEE 802.11n (HT Mixed, 39 Mbps, 16-QAM) | WLAN | 8.13 | ±9.6 |
| 10198 | CAF | IEEE 802.11n (HT Mixed, 65 Mbps, 64-QAM) | WLAN | 8.27 | ±9.6 |
| 10219 | CAF | IEEE 802.11n (HT Mixed, 7.2 Mbps, BPSK) | WLAN | 8.03 | ±9.6 |
| 10220 | AAF | IEEE 802.11n (HT Mixed, 43.3 Mbps, 16-QAM) | WLAN | 8.13 | ±9.6 |
| 10221 | CAC | IEEE 802.11n (HT Mixed, 72.2 Mbps, 64-QAM) | WLAN | 8.27 | ±9.6 |
| 10222 | CAC | IEEE 802.11n (HT Mixed, 15 Mbps, BPSK) | WLAN | 8.06 | ±9.6 |
| 10223 | CAD | IEEE 802.11n (HT Mixed, 90 Mbps, 16-QAM) | WLAN | 8.48 | ±9.6 |
| 10224 | CAD | IEEE 802.11n (HT Mixed, 150 Mbps, 64-QAM) | WLAN | 8.08 | ±9.6 |

| UID | Rev | Communication System Name | Group | PAR (dB) | Unc ^F k = 2 |
|-------|-----|---|----------|----------|------------------------|
| 10225 | CAD | UMTS-FDD (HSPA+) | WCDMA | 5.97 | ±9.6 |
| 10226 | CAD | LTE-TDD (SC-FDMA, 1 RB, 1.4 MHz, 16-QAM) | LTE-TDD | 9.49 | ±9.6 |
| 10227 | CAD | LTE-TDD (SC-FDMA, 1 RB, 1.4 MHz, 64-QAM) | LTE-TDD | 10.26 | ±9.6 |
| 10228 | CAD | LTE-TDD (SC-FDMA, 1 RB, 1.4 MHz, QPSK) | LTE-TDD | 9.22 | ±9.6 |
| 10229 | DAC | LTE-TDD (SC-FDMA, 1 RB, 3 MHz, 16-QAM) | LTE-TDD | 9.48 | ±9.6 |
| 10230 | CAC | LTE-TDD (SC-FDMA, 1 RB, 3 MHz, 64-QAM) | LTE-TDD | 10.25 | ±9.6 |
| 10231 | CAC | LTE-TDD (SC-FDMA, 1 RB, 3 MHz, QPSK) | LTE-TDD | 9.19 | ±9.6 |
| 10232 | CAD | LTE-TDD (SC-FDMA, 1 RB, 5 MHz, 16-QAM) | LTE-TDD | 9.48 | ±9.6 |
| 10233 | CAD | LTE-TDD (SC-FDMA, 1 RB, 5 MHz, 64-QAM) | LTE-TDD | 10.25 | ±9.6 |
| 10234 | CAD | LTE-TDD (SC-FDMA, 1 RB, 5 MHz, QPSK) | LTE-TDD | 9.21 | ±9.6 |
| 10235 | CAD | LTE-TDD (SC-FDMA, 1 RB, 10 MHz, 16-QAM) | LTE-TDD | 9.48 | ±9.6 |
| 10236 | CAD | LTE-TDD (SC-FDMA, 1 RB, 10 MHz, 64-QAM) | LTE-TDD | 10.25 | ±9.6 |
| 10237 | CAD | LTE-TDD (SC-FDMA, 1 RB, 10 MHz, QPSK) | LTE-TDD | 9.21 | ±9.6 |
| 10238 | CAB | LTE-TDD (SC-FDMA, 1 RB, 15 MHz, 16-QAM) | LTE-TDD | 9.48 | ±9.6 |
| 10239 | CAB | LTE-TDD (SC-FDMA, 1 RB, 15 MHz, 64-QAM) | LTE-TDD | 10.25 | ±9.6 |
| 10240 | CAB | LTE-TDD (SC-FDMA, 1 RB, 15 MHz, QPSK) | LTE-TDD | 9.21 | ±9.6 |
| 10241 | CAB | LTE-TDD (SC-FDMA, 50% RB, 1.4 MHz, 16-QAM) | LTE-TDD | 9.82 | ±9.6 |
| 10242 | CAD | LTE-TDD (SC-FDMA, 50% RB, 1.4 MHz, 64-QAM) | LTE-TDD | 9.86 | ±9.6 |
| 10243 | CAD | LTE-TDD (SC-FDMA, 50% RB, 1.4 MHz, QPSK) | LTE-TDD | 9.46 | ±9.6 |
| 10244 | CAD | LTE-TDD (SC-FDMA, 50% RB, 3 MHz, 16-QAM) | LTE-TDD | 10.06 | ±9.6 |
| 10245 | CAG | LTE-TDD (SC-FDMA, 50% RB, 3 MHz, 64-QAM) | LTE-TDD | 10.06 | ±9.6 |
| 10246 | CAG | LTE-TDD (SC-FDMA, 50% RB, 3 MHz, QPSK) | LTE-TDD | 9.30 | ±9.6 |
| 10247 | CAG | LTE-TDD (SC-FDMA, 50% RB, 5 MHz, 16-QAM) | LTE-TDD | 9.91 | ±9.6 |
| 10248 | CAG | LTE-TDD (SC-FDMA, 50% RB, 5 MHz, 64-QAM) | LTE-TDD | 10.09 | ±9.6 |
| 10249 | CAG | LTE-TDD (SC-FDMA, 50% RB, 5 MHz, QPSK) | LTE-TDD | 9.29 | ±9.6 |
| 10250 | CAG | LTE-TDD (SC-FDMA, 50% RB, 10 MHz, 16-QAM) | LTE-TDD | 9.81 | ±9.6 |
| 10251 | CAF | LTE-TDD (SC-FDMA, 50% RB, 10 MHz, 64-QAM) | LTE-TDD | 10.17 | ±9.6 |
| 10252 | CAF | LTE-TDD (SC-FDMA, 50% RB, 10 MHz, QPSK) | LTE-TDD | 9.24 | ±9.6 |
| 10253 | CAF | LTE-TDD (SC-FDMA, 50% RB, 15 MHz, 16-QAM) | LTE-TDD | 9.90 | ±9.6 |
| 10254 | CAB | LTE-TDD (SC-FDMA, 50% RB, 15 MHz, 64-QAM) | LTE-TDD | 10.14 | ±9.6 |
| 10255 | CAB | LTE-TDD (SC-FDMA, 50% RB, 15 MHz, QPSK) | LTE-TDD | 9.20 | ±9.6 |
| 10256 | CAB | LTE-TDD (SC-FDMA, 100% RB, 1.4 MHz, 16-QAM) | LTE-TDD | 9.96 | ±9.6 |
| 10257 | CAD | LTE-TDD (SC-FDMA, 100% RB, 1.4 MHz, 64-QAM) | LTE-TDD | 10.08 | ±9.6 |
| 10258 | CAD | LTE-TDD (SC-FDMA, 100% RB, 1.4 MHz, QPSK) | LTE-TDD | 9.34 | ±9.6 |
| 10259 | CAD | LTE-TDD (SC-FDMA, 100% RB, 3 MHz, 16-QAM) | LTE-TDD | 9.98 | ±9.6 |
| 10260 | CAG | LTE-TDD (SC-FDMA, 100% RB, 3 MHz, 64-QAM) | LTE-TDD | 9.97 | ±9.6 |
| 10261 | CAG | LTE-TDD (SC-FDMA, 100% RB, 3 MHz, QPSK) | LTE-TDD | 9.24 | ±9.6 |
| 10262 | CAG | LTE-TDD (SC-FDMA, 100% RB, 5 MHz, 16-QAM) | LTE-TDD | 9.83 | ±9.6 |
| 10263 | CAG | LTE-TDD (SC-FDMA, 100% RB, 5 MHz, 64-QAM) | LTE-TDD | 10.16 | ±9.6 |
| 10264 | CAG | LTE-TDD (SC-FDMA, 100% RB, 5 MHz, QPSK) | LTE-TDD | 9.23 | ±9.6 |
| 10265 | CAG | LTE-TDD (SC-FDMA, 100% RB, 10 MHz, 16-QAM) | LTE-TDD | 9.92 | ±9.6 |
| 10266 | CAF | LTE-TDD (SC-FDMA, 100% RB, 10 MHz, 64-QAM) | LTE-TDD | 10.07 | ±9.6 |
| 10267 | CAF | LTE-TDD (SC-FDMA, 100% RB, 10 MHz, QPSK) | LTE-TDD | 9.30 | ±9.6 |
| 10268 | CAF | LTE-TDD (SC-FDMA, 100% RB, 15 MHz, 16-QAM) | LTE-TDD | 10.06 | ±9.6 |
| 10269 | CAB | LTE-TDD (SC-FDMA, 100% RB, 15 MHz, 64-QAM) | LTE-TDD | 10.13 | ±9.6 |
| 10270 | CAB | LTE-TDD (SC-FDMA, 100% RB, 15 MHz, QPSK) | LTE-TDD | 9.58 | ±9.6 |
| 10274 | CAB | UMTS-FDD (HSUPA, Subtest 5, 3GPP Rel8.10) | WCDMA | 4.87 | ±9.6 |
| 10275 | CAD | UMTS-FDD (HSUPA, Subtest 5, 3GPP Rel8.4) | WCDMA | 3.96 | ±9.6 |
| 10277 | CAD | PHS (QPSK) | PHS | 11.81 | ±9.6 |
| 10278 | CAD | PHS (QPSK, BW 884 MHz, Rolloff 0.5) | PHS | 11.81 | ±9.6 |
| 10279 | CAG | PHS (QPSK, BW 884 MHz, Rolloff 0.38) | PHS | 12.18 | ±9.6 |
| 10290 | CAG | CDMA2000, RC1, SO55, Full Rate | CDMA2000 | 3.91 | ±9.6 |
| 10291 | CAG | CDMA2000, RC3, SO55, Full Rate | CDMA2000 | 3.46 | ±9.6 |
| 10292 | CAG | CDMA2000, RC3, SO32, Full Rate | CDMA2000 | 3.39 | ±9.6 |
| 10293 | CAG | CDMA2000, RC3, SO3, Full Rate | CDMA2000 | 3.50 | ±9.6 |
| 10295 | CAG | CDMA2000, RC1, SO3, 1/8th Rate 25 fr. | CDMA2000 | 12.49 | ±9.6 |
| 10297 | CAF | LTE-FDD (SC-FDMA, 50% RB, 20 MHz, QPSK) | LTE-FDD | 5.81 | ±9.6 |
| 10298 | CAF | LTE-FDD (SC-FDMA, 50% RB, 3 MHz, QPSK) | LTE-FDD | 5.72 | ±9.6 |
| 10299 | CAF | LTE-FDD (SC-FDMA, 50% RB, 3 MHz, 16-QAM) | LTE-FDD | 6.39 | ±9.6 |
| 10300 | CAC | LTE-FDD (SC-FDMA, 50% RB, 3 MHz, 64-QAM) | LTE-FDD | 6.60 | ±9.6 |
| 10301 | CAC | IEEE 802.16e WiMAX (29:18, 5 ms, 10 MHz, QPSK, PUSC) | WiMAX | 12.03 | ±9.6 |
| 10302 | CAB | IEEE 802.16e WiMAX (29:18, 5 ms, 10 MHz, QPSK, PUSC, 3CTRL) | WiMAX | 12.57 | ±9.6 |
| 10303 | CAB | IEEE 802.16e WiMAX (31:15, 5 ms, 10 MHz, 64QAM, PUSC) | WiMAX | 12.52 | ±9.6 |
| 10304 | CAA | IEEE 802.16e WiMAX (29:18, 5 ms, 10 MHz, 64QAM, PUSC) | WiMAX | 11.86 | ±9.6 |
| 10305 | CAA | IEEE 802.16e WiMAX (31:15, 10 ms, 10 MHz, 64QAM, PUSC) | WiMAX | 15.24 | ±9.6 |
| 10306 | CAA | IEEE 802.16e WiMAX (29:18, 10 ms, 10 MHz, 64QAM, PUSC) | WiMAX | 14.67 | ±9.6 |

| UID | Rev | Communication System Name | Group | PAR (dB) | Unc ^E k = 2 |
|-------|-----|--|----------|----------|------------------------|
| 10307 | AAB | IEEE 802.16e WiMAX (29:18, 10 ms, 10 MHz, QPSK, PUSC) | WiMAX | 14.49 | ±9.6 |
| 10308 | AAB | IEEE 802.16e WiMAX (29:18, 10 ms, 10 MHz, 16QAM, PUSC) | WiMAX | 14.46 | ±9.6 |
| 10309 | AAB | IEEE 802.16e WiMAX (29:18, 10 ms, 10 MHz, 16QAM, AMC 2x3) | WiMAX | 14.58 | ±9.6 |
| 10310 | AAB | IEEE 802.16e WiMAX (29:18, 10 ms, 10 MHz, QPSK, AMC 2x3) | WiMAX | 14.57 | ±9.6 |
| 10311 | AAB | LTE-FDD (SC-FDMA, 100% RB, 15 MHz, QPSK) | LTE-FDD | 6.06 | ±9.6 |
| 10313 | AAD | iDEN 1:3 | iDEN | 10.51 | ±9.6 |
| 10314 | AAD | iDEN 1:6 | iDEN | 13.48 | ±9.6 |
| 10315 | AAD | IEEE 802.11b WiFi 2.4 GHz (DSSS, 1 Mbps, 96pc dc) | WLAN | 1.71 | ±9.6 |
| 10316 | AAD | IEEE 802.11g WiFi 2.4 GHz (ERP-OFDM, 6 Mbps, 96pc dc) | WLAN | 8.36 | ±9.6 |
| 10317 | AAA | IEEE 802.11a WiFi 5 GHz (OFDM, 6 Mbps, 96pc dc) | WLAN | 8.36 | ±9.6 |
| 10352 | AAA | Pulse Waveform (200 Hz, 10%) | Generic | 10.00 | ±9.6 |
| 10353 | AAA | Pulse Waveform (200 Hz, 20%) | Generic | 6.99 | ±9.6 |
| 10354 | AAA | Pulse Waveform (200 Hz, 40%) | Generic | 3.98 | ±9.6 |
| 10355 | AAA | Pulse Waveform (200 Hz, 60%) | Generic | 2.22 | ±9.6 |
| 10356 | AAA | Pulse Waveform (200 Hz, 80%) | Generic | 0.97 | ±9.6 |
| 10387 | AAA | QPSK Waveform, 1 MHz | Generic | 5.10 | ±9.6 |
| 10388 | AAA | QPSK Waveform, 10 MHz | Generic | 5.22 | ±9.6 |
| 10396 | AAA | 64-QAM Waveform, 100 kHz | Generic | 6.27 | ±9.6 |
| 10399 | AAA | 64-QAM Waveform, 40 MHz | Generic | 6.27 | ±9.6 |
| 10400 | AAD | IEEE 802.11ac WiFi (20 MHz, 64-QAM, 99pc dc) | WLAN | 8.37 | ±9.6 |
| 10401 | AAA | IEEE 802.11ac WiFi (40 MHz, 64-QAM, 99pc dc) | WLAN | 8.60 | ±9.6 |
| 10402 | AAA | IEEE 802.11ac WiFi (80 MHz, 64-QAM, 99pc dc) | WLAN | 8.53 | ±9.6 |
| 10403 | AAB | CDMA2000 (1xEV-DO, Rev. 0) | CDMA2000 | 3.76 | ±9.6 |
| 10404 | AAB | CDMA2000 (1xEV-DO, Rev. A) | CDMA2000 | 3.77 | ±9.6 |
| 10406 | AAD | CDMA2000, RC3, SC32, SCH0, Full Rate | CDMA2000 | 5.22 | ±9.6 |
| 10410 | AAA | LTE-TDD (SC-FDMA, 1 RB, 10 MHz, QPSK, UL Sub=2,3,4,7,8,9) | LTE-TDD | 7.82 | ±9.6 |
| 10414 | AAA | WLAN CCDF, 64-QAM, 40 MHz | Generic | 8.54 | ±9.6 |
| 10415 | AAA | IEEE 802.11b WiFi 2.4 GHz (DSSS, 1 Mbps, 99pc dc) | WLAN | 1.54 | ±9.6 |
| 10416 | AAA | IEEE 802.11g WiFi 2.4 GHz (ERP-OFDM, 6 Mbps, 99pc dc) | WLAN | 8.23 | ±9.6 |
| 10417 | AAA | IEEE 802.11a/h WiFi 5 GHz (OFDM, 6 Mbps, 99pc dc) | WLAN | 8.23 | ±9.6 |
| 10418 | AAA | IEEE 802.11g WiFi 2.4 GHz (DSSS-OFDM, 6 Mbps, 99pc, Long) | WLAN | 8.14 | ±9.6 |
| 10419 | AAA | IEEE 802.11g WiFi 2.4 GHz (DSSS-OFDM, 6 Mbps, 99pc, Short) | WLAN | 8.19 | ±9.6 |
| 10422 | AAA | IEEE 802.11n (HT Greenfield, 7.2 Mbps, BPSK) | WLAN | 8.32 | ±9.6 |
| 10423 | AAA | IEEE 802.11n (HT Greenfield, 43.3 Mbps, 16-QAM) | WLAN | 8.47 | ±9.6 |
| 10424 | AAE | IEEE 802.11n (HT Greenfield, 72.2 Mbps, 64-QAM) | WLAN | 8.40 | ±9.6 |
| 10425 | AAE | IEEE 802.11n (HT Greenfield, 15 Mbps, BPSK) | WLAN | 8.41 | ±9.6 |
| 10426 | AAE | IEEE 802.11n (HT Greenfield, 90 Mbps, 16-QAM) | WLAN | 8.45 | ±9.6 |
| 10427 | AAB | IEEE 802.11n (HT Greenfield, 150 Mbps, 64-QAM) | WLAN | 8.41 | ±9.6 |
| 10430 | AAB | LTE-FDD (OFDMA, 5 MHz, E-TM 3.1) | LTE-FDD | 8.28 | ±9.6 |
| 10431 | AAC | LTE-FDD (OFDMA, 10 MHz, E-TM 3.1) | LTE-FDD | 8.38 | ±9.6 |
| 10432 | AAB | LTE-FDD (OFDMA, 15 MHz, E-TM 3.1) | LTE-FDD | 8.34 | ±9.6 |
| 10433 | AAC | LTE-FDD (OFDMA, 20 MHz, E-TM 3.1) | LTE-FDD | 8.34 | ±9.6 |
| 10434 | AAG | W-CDMA (BS Test Model 1, 64 DPCH) | WCDMA | 8.60 | ±9.6 |
| 10435 | AAA | LTE-TDD (SC-FDMA, 1 RB, 20 MHz, QPSK, UL Sub) | LTE-TDD | 7.82 | ±9.6 |
| 10447 | AAA | LTE-FDD (OFDMA, 5 MHz, E-TM 3.1, Clipping 44%) | LTE-FDD | 7.56 | ±9.6 |
| 10448 | AAA | LTE-FDD (OFDMA, 10 MHz, E-TM 3.1, Clipping 44%) | LTE-FDD | 7.53 | ±9.6 |
| 10449 | AAC | LTE-FDD (OFDMA, 15 MHz, E-TM 3.1, Clipping 44%) | LTE-FDD | 7.51 | ±9.6 |
| 10450 | AAA | LTE-FDD (OFDMA, 20 MHz, E-TM 3.1, Clipping 44%) | LTE-FDD | 7.48 | ±9.6 |
| 10451 | AAA | W-CDMA (BS Test Model 1, 64 DPCH, Clipping 44%) | WCDMA | 7.59 | ±9.6 |
| 10453 | AAC | Validation (Square, 10 ms, 1 ms) | Test | 10.00 | ±9.6 |
| 10456 | AAC | IEEE 802.11ac WiFi (160 MHz, 64-QAM, 99pc dc) | WLAN | 8.63 | ±9.6 |
| 10457 | AAC | UMTS-FDD (DC-HSDPA) | WCDMA | 6.62 | ±9.6 |
| 10458 | AAC | CDMA2000 (1xEV-DO, Rev. B, 2 carriers) | CDMA2000 | 6.55 | ±9.6 |
| 10459 | AAC | CDMA2000 (1xEV-DO, Rev. B, 3 carriers) | CDMA2000 | 8.25 | ±9.6 |
| 10460 | AAC | UMTS-FDD (WCDMA, AMR) | WCDMA | 2.39 | ±9.6 |
| 10461 | AAC | LTE-TDD (SC-FDMA, 1 RB, 1.4 MHz, QPSK, UL Sub) | LTE-TDD | 7.82 | ±9.6 |
| 10462 | AAC | LTE-TDD (SC-FDMA, 1 RB, 1.4 MHz, 16-QAM, UL Sub) | LTE-TDD | 8.30 | ±9.6 |
| 10463 | AAD | LTE-TDD (SC-FDMA, 1 RB, 1.4 MHz, 64-QAM, UL Sub) | LTE-TDD | 8.56 | ±9.6 |
| 10464 | AAD | LTE-TDD (SC-FDMA, 1 RB, 3 MHz, QPSK, UL Sub) | LTE-TDD | 7.82 | ±9.6 |
| 10465 | AAC | LTE-TDD (SC-FDMA, 1 RB, 3 MHz, 16-QAM, UL Sub) | LTE-TDD | 8.32 | ±9.6 |
| 10466 | AAC | LTE-TDD (SC-FDMA, 1 RB, 3 MHz, 64-QAM, UL Sub) | LTE-TDD | 8.57 | ±9.6 |
| 10467 | AAA | LTE-TDD (SC-FDMA, 1 RB, 5 MHz, QPSK, UL Sub) | LTE-TDD | 7.82 | ±9.6 |
| 10468 | AAF | LTE-TDD (SC-FDMA, 1 RB, 5 MHz, 16-QAM, UL Sub) | LTE-TDD | 8.32 | ±9.6 |
| 10469 | AAD | LTE-TDD (SC-FDMA, 1 RB, 5 MHz, 64-QAM, UL Sub) | LTE-TDD | 8.56 | ±9.6 |
| 10470 | AAD | LTE-TDD (SC-FDMA, 1 RB, 10 MHz, QPSK, UL Sub) | LTE-TDD | 7.82 | ±9.6 |
| 10471 | AAC | LTE-TDD (SC-FDMA, 1 RB, 10 MHz, 16-QAM, UL Sub) | LTE-TDD | 8.32 | ±9.6 |

| UID | Rev | Communication System Name | Group | PAR (dB) | Unc ^E k = 2 |
|-------|-----|---|---------|----------|------------------------|
| 10472 | AAC | LTE-TDD (SC-FDMA, 1 RB, 10 MHz, 64-QAM, UL Sub) | LTE-TDD | 8.57 | ±9.6 |
| 10473 | AAA | LTE-TDD (SC-FDMA, 1 RB, 15 MHz, QPSK, UL Sub) | LTE-TDD | 7.82 | ±9.6 |
| 10474 | AAC | LTE-TDD (SC-FDMA, 1 RB, 15 MHz, 16-QAM, UL Sub) | LTE-TDD | 8.32 | ±9.6 |
| 10475 | AAD | LTE-TDD (SC-FDMA, 1 RB, 15 MHz, 64-QAM, UL Sub) | LTE-TDD | 8.57 | ±9.6 |
| 10477 | AAC | LTE-TDD (SC-FDMA, 1 RB, 20 MHz, 16-QAM, UL Sub) | LTE-TDD | 8.32 | ±9.6 |
| 10478 | AAC | LTE-TDD (SC-FDMA, 1 RB, 20 MHz, 64-QAM, UL Sub) | LTE-TDD | 8.57 | ±9.6 |
| 10479 | AAC | LTE-TDD (SC-FDMA, 50% RB, 1.4 MHz, QPSK, UL Sub) | LTE-TDD | 7.74 | ±9.6 |
| 10480 | AAA | LTE-TDD (SC-FDMA, 50% RB, 1.4 MHz, 16-QAM, UL Sub) | LTE-TDD | 8.18 | ±9.6 |
| 10481 | AAA | LTE-TDD (SC-FDMA, 50% RB, 1.4 MHz, 64-QAM, UL Sub) | LTE-TDD | 8.45 | ±9.6 |
| 10482 | AAA | LTE-TDD (SC-FDMA, 50% RB, 3 MHz, QPSK, UL Sub) | LTE-TDD | 7.71 | ±9.6 |
| 10483 | AAA | LTE-TDD (SC-FDMA, 50% RB, 3 MHz, 16-QAM, Sub) | LTE-TDD | 8.39 | ±9.6 |
| 10484 | AAB | LTE-TDD (SC-FDMA, 50% RB, 3 MHz, 64-QAM, UL Sub) | LTE-TDD | 8.47 | ±9.6 |
| 10485 | AAB | LTE-TDD (SC-FDMA, 50% RB, 5 MHz, QPSK, UL Sub) | LTE-TDD | 7.59 | ±9.6 |
| 10486 | AAB | LTE-TDD (SC-FDMA, 50% RB, 5 MHz, 16-QAM, UL Sub) | LTE-TDD | 8.38 | ±9.6 |
| 10487 | AAC | LTE-TDD (SC-FDMA, 50% RB, 5 MHz, 64-QAM, UL Sub) | LTE-TDD | 8.60 | ±9.6 |
| 10488 | AAC | LTE-TDD (SC-FDMA, 50% RB, 10 MHz, QPSK, UL Sub) | LTE-TDD | 7.70 | ±9.6 |
| 10489 | AAC | LTE-TDD (SC-FDMA, 50% RB, 10 MHz, 16-QAM, UL Sub) | LTE-TDD | 8.31 | ±9.6 |
| 10490 | AAF | LTE-TDD (SC-FDMA, 50% RB, 10 MHz, 64-QAM, UL Sub) | LTE-TDD | 8.54 | ±9.6 |
| 10491 | AAF | LTE-TDD (SC-FDMA, 50% RB, 15 MHz, QPSK, UL Sub) | LTE-TDD | 7.74 | ±9.6 |
| 10492 | AAF | LTE-TDD (SC-FDMA, 50% RB, 15 MHz, 16-QAM, UL Sub) | LTE-TDD | 8.41 | ±9.6 |
| 10493 | AAF | LTE-TDD (SC-FDMA, 50% RB, 15 MHz, 64-QAM, UL Sub) | LTE-TDD | 8.55 | ±9.6 |
| 10494 | AAF | LTE-TDD (SC-FDMA, 50% RB, 20 MHz, QPSK, UL Sub) | LTE-TDD | 7.74 | ±9.6 |
| 10495 | AAF | LTE-TDD (SC-FDMA, 50% RB, 20 MHz, 16-QAM, UL Sub) | LTE-TDD | 8.37 | ±9.6 |
| 10496 | AAE | LTE-TDD (SC-FDMA, 50% RB, 20 MHz, 64-QAM, UL Sub) | LTE-TDD | 8.54 | ±9.6 |
| 10497 | AAE | LTE-TDD (SC-FDMA, 100% RB, 1.4 MHz, QPSK, UL Sub) | LTE-TDD | 7.67 | ±9.6 |
| 10498 | AAE | LTE-TDD (SC-FDMA, 100% RB, 1.4 MHz, 16-QAM, UL Sub) | LTE-TDD | 8.40 | ±9.6 |
| 10499 | AAC | LTE-TDD (SC-FDMA, 100% RB, 1.4 MHz, 64-QAM, UL Sub) | LTE-TDD | 8.68 | ±9.6 |
| 10500 | AAF | LTE-TDD (SC-FDMA, 100% RB, 3 MHz, QPSK, UL Sub) | LTE-TDD | 7.67 | ±9.6 |
| 10501 | AAF | LTE-TDD (SC-FDMA, 100% RB, 3 MHz, 16-QAM, UL Sub) | LTE-TDD | 8.44 | ±9.6 |
| 10502 | AAB | LTE-TDD (SC-FDMA, 100% RB, 3 MHz, 64-QAM, UL Sub) | LTE-TDD | 8.52 | ±9.6 |
| 10503 | AAB | LTE-TDD (SC-FDMA, 100% RB, 5 MHz, QPSK, UL Sub) | LTE-TDD | 7.72 | ±9.6 |
| 10504 | AAB | LTE-TDD (SC-FDMA, 100% RB, 5 MHz, 16-QAM, UL Sub) | LTE-TDD | 8.31 | ±9.6 |
| 10505 | AAC | LTE-TDD (SC-FDMA, 100% RB, 5 MHz, 64-QAM, UL Sub) | LTE-TDD | 8.54 | ±9.6 |
| 10506 | AAC | LTE-TDD (SC-FDMA, 100% RB, 10 MHz, QPSK, UL Sub) | LTE-TDD | 7.74 | ±9.6 |
| 10507 | AAC | LTE-TDD (SC-FDMA, 100% RB, 10 MHz, 16-QAM, UL Sub) | LTE-TDD | 8.36 | ±9.6 |
| 10508 | AAF | LTE-TDD (SC-FDMA, 100% RB, 10 MHz, 64-QAM, UL Sub) | LTE-TDD | 8.55 | ±9.6 |
| 10509 | AAF | LTE-TDD (SC-FDMA, 100% RB, 15 MHz, QPSK, UL Sub) | LTE-TDD | 7.99 | ±9.6 |
| 10510 | AAF | LTE-TDD (SC-FDMA, 100% RB, 15 MHz, 16-QAM, UL Sub) | LTE-TDD | 8.49 | ±9.6 |
| 10511 | AAF | LTE-TDD (SC-FDMA, 100% RB, 15 MHz, 64-QAM, UL Sub) | LTE-TDD | 8.51 | ±9.6 |
| 10512 | AAF | LTE-TDD (SC-FDMA, 100% RB, 20 MHz, QPSK, UL Sub) | LTE-TDD | 7.74 | ±9.6 |
| 10513 | AAF | LTE-TDD (SC-FDMA, 100% RB, 20 MHz, 16-QAM, UL Sub) | LTE-TDD | 8.42 | ±9.6 |
| 10514 | AAE | LTE-TDD (SC-FDMA, 100% RB, 20 MHz, 64-QAM, UL Sub) | LTE-TDD | 8.45 | ±9.6 |
| 10515 | AAE | IEEE 802.11b WiFi 2.4 GHz (DSSS, 2 Mbps, 99pc dc) | WLAN | 1.58 | ±9.6 |
| 10516 | AAE | IEEE 802.11b WiFi 2.4 GHz (DSSS, 5.5 Mbps, 99pc dc) | WLAN | 1.57 | ±9.6 |
| 10517 | AAF | IEEE 802.11b WiFi 2.4 GHz (DSSS, 11 Mbps, 99pc dc) | WLAN | 1.58 | ±9.6 |
| 10518 | AAF | IEEE 802.11a/h WiFi 5 GHz (OFDM, 9 Mbps, 99pc dc) | WLAN | 8.23 | ±9.6 |
| 10519 | AAF | IEEE 802.11a/h WiFi 5 GHz (OFDM, 12 Mbps, 99pc dc) | WLAN | 8.39 | ±9.6 |
| 10520 | AAB | IEEE 802.11a/h WiFi 5 GHz (OFDM, 18 Mbps, 99pc dc) | WLAN | 8.12 | ±9.6 |
| 10521 | AAB | IEEE 802.11a/h WiFi 5 GHz (OFDM, 24 Mbps, 99pc dc) | WLAN | 7.97 | ±9.6 |
| 10522 | AAB | IEEE 802.11a/h WiFi 5 GHz (OFDM, 36 Mbps, 99pc dc) | WLAN | 8.45 | ±9.6 |
| 10523 | AAC | IEEE 802.11a/h WiFi 5 GHz (OFDM, 48 Mbps, 99pc dc) | WLAN | 8.08 | ±9.6 |
| 10524 | AAC | IEEE 802.11a/h WiFi 5 GHz (OFDM, 54 Mbps, 99pc dc) | WLAN | 8.27 | ±9.6 |
| 10525 | AAC | IEEE 802.11ac WiFi (20 MHz, MCS0, 99pc dc) | WLAN | 8.36 | ±9.6 |
| 10526 | AAF | IEEE 802.11ac WiFi (20 MHz, MCS1, 99pc dc) | WLAN | 8.42 | ±9.6 |
| 10527 | AAF | IEEE 802.11ac WiFi (20 MHz, MCS2, 99pc dc) | WLAN | 8.21 | ±9.6 |
| 10528 | AAF | IEEE 802.11ac WiFi (20 MHz, MCS3, 99pc dc) | WLAN | 8.36 | ±9.6 |
| 10529 | AAF | IEEE 802.11ac WiFi (20 MHz, MCS4, 99pc dc) | WLAN | 8.36 | ±9.6 |
| 10531 | AAF | IEEE 802.11ac WiFi (20 MHz, MCS6, 99pc dc) | WLAN | 8.43 | ±9.6 |
| 10532 | AAF | IEEE 802.11ac WiFi (20 MHz, MCS7, 99pc dc) | WLAN | 8.29 | ±9.6 |
| 10533 | AAE | IEEE 802.11ac WiFi (20 MHz, MCS8, 99pc dc) | WLAN | 8.38 | ±9.6 |
| 10534 | AAE | IEEE 802.11ac WiFi (40 MHz, MCS0, 99pc dc) | WLAN | 8.45 | ±9.6 |
| 10535 | AAE | IEEE 802.11ac WiFi (40 MHz, MCS1, 99pc dc) | WLAN | 8.45 | ±9.6 |
| 10536 | AAF | IEEE 802.11ac WiFi (40 MHz, MCS2, 99pc dc) | WLAN | 8.32 | ±9.6 |
| 10537 | AAF | IEEE 802.11ac WiFi (40 MHz, MCS3, 99pc dc) | WLAN | 8.44 | ±9.6 |
| 10538 | AAF | IEEE 802.11ac WiFi (40 MHz, MCS4, 99pc dc) | WLAN | 8.54 | ±9.6 |
| 10540 | AAA | IEEE 802.11ac WiFi (40 MHz, MCS6, 99pc dc) | WLAN | 8.39 | ±9.6 |

| UID | Rev | Communication System Name | Group | PAR (dB) | Unc ^F k = 2 |
|-------|-----|---|-------|----------|------------------------|
| 10541 | AAA | IEEE 802.11ac WiFi (40 MHz, MCS7, 99pc dc) | WLAN | 8.46 | ±9.6 |
| 10542 | AAA | IEEE 802.11ac WiFi (40 MHz, MCS8, 99pc dc) | WLAN | 8.65 | ±9.6 |
| 10543 | AAC | IEEE 802.11ac WiFi (40 MHz, MCS9, 99pc dc) | WLAN | 8.65 | ±9.6 |
| 10544 | AAC | IEEE 802.11ac WiFi (80 MHz, MCS0, 99pc dc) | WLAN | 8.47 | ±9.6 |
| 10545 | AAC | IEEE 802.11ac WiFi (80 MHz, MCS1, 99pc dc) | WLAN | 8.55 | ±9.6 |
| 10546 | AAC | IEEE 802.11ac WiFi (80 MHz, MCS2, 99pc dc) | WLAN | 8.35 | ±9.6 |
| 10547 | AAC | IEEE 802.11ac WiFi (80 MHz, MCS3, 99pc dc) | WLAN | 8.49 | ±9.6 |
| 10548 | AAC | IEEE 802.11ac WiFi (80 MHz, MCS4, 99pc dc) | WLAN | 8.37 | ±9.6 |
| 10550 | AAC | IEEE 802.11ac WiFi (80 MHz, MCS6, 99pc dc) | WLAN | 8.38 | ±9.6 |
| 10551 | AAC | IEEE 802.11ac WiFi (80 MHz, MCS7, 99pc dc) | WLAN | 8.50 | ±9.6 |
| 10552 | AAC | IEEE 802.11ac WiFi (80 MHz, MCS8, 99pc dc) | WLAN | 8.42 | ±9.6 |
| 10553 | AAC | IEEE 802.11ac WiFi (80 MHz, MCS9, 99pc dc) | WLAN | 8.45 | ±9.6 |
| 10554 | AAC | IEEE 802.11ac WiFi (160 MHz, MCS0, 99pc dc) | WLAN | 8.48 | ±9.6 |
| 10555 | AAC | IEEE 802.11ac WiFi (160 MHz, MCS1, 99pc dc) | WLAN | 8.47 | ±9.6 |
| 10556 | AAC | IEEE 802.11ac WiFi (160 MHz, MCS2, 99pc dc) | WLAN | 8.50 | ±9.6 |
| 10557 | AAC | IEEE 802.11ac WiFi (160 MHz, MCS3, 99pc dc) | WLAN | 8.52 | ±9.6 |
| 10558 | AAC | IEEE 802.11ac WiFi (160 MHz, MCS4, 99pc dc) | WLAN | 8.61 | ±9.6 |
| 10560 | AAC | IEEE 802.11ac WiFi (160 MHz, MCS6, 99pc dc) | WLAN | 8.73 | ±9.6 |
| 10561 | AAC | IEEE 802.11ac WiFi (160 MHz, MCS7, 99pc dc) | WLAN | 8.56 | ±9.6 |
| 10562 | AAC | IEEE 802.11ac WiFi (160 MHz, MCS8, 99pc dc) | WLAN | 8.69 | ±9.6 |
| 10563 | AAC | IEEE 802.11ac WiFi (160 MHz, MCS9, 99pc dc) | WLAN | 8.77 | ±9.6 |
| 10564 | AAC | IEEE 802.11g WiFi 2.4 GHz (DSSS-OFDM, 9 Mbps, 99pc dc) | WLAN | 8.25 | ±9.6 |
| 10565 | AAC | IEEE 802.11g WiFi 2.4 GHz (DSSS-OFDM, 12 Mbps, 99pc dc) | WLAN | 8.45 | ±9.6 |
| 10566 | AAC | IEEE 802.11g WiFi 2.4 GHz (DSSS-OFDM, 18 Mbps, 99pc dc) | WLAN | 8.13 | ±9.6 |
| 10567 | AAC | IEEE 802.11g WiFi 2.4 GHz (DSSS-OFDM, 24 Mbps, 99pc dc) | WLAN | 8.00 | ±9.6 |
| 10568 | AAC | IEEE 802.11g WiFi 2.4 GHz (DSSS-OFDM, 36 Mbps, 99pc dc) | WLAN | 8.37 | ±9.6 |
| 10569 | AAC | IEEE 802.11g WiFi 2.4 GHz (DSSS-OFDM, 48 Mbps, 99pc dc) | WLAN | 8.10 | ±9.6 |
| 10570 | AAC | IEEE 802.11g WiFi 2.4 GHz (DSSS-OFDM, 54 Mbps, 99pc dc) | WLAN | 8.30 | ±9.6 |
| 10571 | AAC | IEEE 802.11b WiFi 2.4 GHz (DSSS, 1 Mbps, 90pc dc) | WLAN | 1.99 | ±9.6 |
| 10572 | AAC | IEEE 802.11b WiFi 2.4 GHz (DSSS, 2 Mbps, 90pc dc) | WLAN | 1.99 | ±9.6 |
| 10573 | AAC | IEEE 802.11b WiFi 2.4 GHz (DSSS, 5.5 Mbps, 90pc dc) | WLAN | 1.98 | ±9.6 |
| 10574 | AAC | IEEE 802.11b WiFi 2.4 GHz (DSSS, 11 Mbps, 90pc dc) | WLAN | 1.98 | ±9.6 |
| 10575 | AAC | IEEE 802.11g WiFi 2.4 GHz (DSSS-OFDM, 6 Mbps, 90pc dc) | WLAN | 8.59 | ±9.6 |
| 10576 | AAC | IEEE 802.11g WiFi 2.4 GHz (DSSS-OFDM, 9 Mbps, 90pc dc) | WLAN | 8.60 | ±9.6 |
| 10577 | AAC | IEEE 802.11g WiFi 2.4 GHz (DSSS-OFDM, 12 Mbps, 90pc dc) | WLAN | 8.70 | ±9.6 |
| 10578 | AAD | IEEE 802.11g WiFi 2.4 GHz (DSSS-OFDM, 18 Mbps, 90pc dc) | WLAN | 8.49 | ±9.6 |
| 10579 | AAD | IEEE 802.11g WiFi 2.4 GHz (DSSS-OFDM, 24 Mbps, 90pc dc) | WLAN | 8.36 | ±9.6 |
| 10580 | AAD | IEEE 802.11g WiFi 2.4 GHz (DSSS-OFDM, 36 Mbps, 90pc dc) | WLAN | 8.76 | ±9.6 |
| 10581 | AAD | IEEE 802.11g WiFi 2.4 GHz (DSSS-OFDM, 48 Mbps, 90pc dc) | WLAN | 8.35 | ±9.6 |
| 10582 | AAD | IEEE 802.11g WiFi 2.4 GHz (DSSS-OFDM, 54 Mbps, 90pc dc) | WLAN | 8.67 | ±9.6 |
| 10583 | AAD | IEEE 802.11a/h WiFi 5 GHz (OFDM, 6 Mbps, 90pc dc) | WLAN | 8.59 | ±9.6 |
| 10584 | AAD | IEEE 802.11a/h WiFi 5 GHz (OFDM, 9 Mbps, 90pc dc) | WLAN | 8.60 | ±9.6 |
| 10585 | AAD | IEEE 802.11a/h WiFi 5 GHz (OFDM, 12 Mbps, 90pc dc) | WLAN | 8.70 | ±9.6 |
| 10586 | AAD | IEEE 802.11a/h WiFi 5 GHz (OFDM, 18 Mbps, 90pc dc) | WLAN | 8.49 | ±9.6 |
| 10587 | AAA | IEEE 802.11a/h WiFi 5 GHz (OFDM, 24 Mbps, 90pc dc) | WLAN | 8.36 | ±9.6 |
| 10588 | AAA | IEEE 802.11a/h WiFi 5 GHz (OFDM, 36 Mbps, 90pc dc) | WLAN | 8.76 | ±9.6 |
| 10589 | AAA | IEEE 802.11a/h WiFi 5 GHz (OFDM, 48 Mbps, 90pc dc) | WLAN | 8.35 | ±9.6 |
| 10590 | AAA | IEEE 802.11a/h WiFi 5 GHz (OFDM, 54 Mbps, 90pc dc) | WLAN | 8.67 | ±9.6 |
| 10591 | AAA | IEEE 802.11n (HT Mixed, 20 MHz, MCS0, 90pc dc) | WLAN | 8.63 | ±9.6 |
| 10592 | AAA | IEEE 802.11n (HT Mixed, 20 MHz, MCS1, 90pc dc) | WLAN | 8.79 | ±9.6 |
| 10593 | AAA | IEEE 802.11n (HT Mixed, 20 MHz, MCS2, 90pc dc) | WLAN | 8.64 | ±9.6 |
| 10594 | AAA | IEEE 802.11n (HT Mixed, 20 MHz, MCS3, 90pc dc) | WLAN | 8.74 | ±9.6 |
| 10595 | AAA | IEEE 802.11n (HT Mixed, 20 MHz, MCS4, 90pc dc) | WLAN | 8.74 | ±9.6 |
| 10596 | AAA | IEEE 802.11n (HT Mixed, 20 MHz, MCS5, 90pc dc) | WLAN | 8.71 | ±9.6 |
| 10597 | AAA | IEEE 802.11n (HT Mixed, 20 MHz, MCS6, 90pc dc) | WLAN | 8.72 | ±9.6 |
| 10598 | AAA | IEEE 802.11n (HT Mixed, 20 MHz, MCS7, 90pc dc) | WLAN | 8.50 | ±9.6 |
| 10599 | AAA | IEEE 802.11n (HT Mixed, 40 MHz, MCS0, 90pc dc) | WLAN | 8.79 | ±9.6 |
| 10600 | AAA | IEEE 802.11n (HT Mixed, 40 MHz, MCS1, 90pc dc) | WLAN | 8.88 | ±9.6 |
| 10601 | AAA | IEEE 802.11n (HT Mixed, 40 MHz, MCS2, 90pc dc) | WLAN | 8.82 | ±9.6 |
| 10602 | AAA | IEEE 802.11n (HT Mixed, 40 MHz, MCS3, 90pc dc) | WLAN | 8.94 | ±9.6 |
| 10603 | AAA | IEEE 802.11n (HT Mixed, 40 MHz, MCS4, 90pc dc) | WLAN | 9.03 | ±9.6 |
| 10604 | AAA | IEEE 802.11n (HT Mixed, 40 MHz, MCS5, 90pc dc) | WLAN | 8.76 | ±9.6 |
| 10605 | AAA | IEEE 802.11n (HT Mixed, 40 MHz, MCS6, 90pc dc) | WLAN | 8.97 | ±9.6 |
| 10606 | AAC | IEEE 802.11n (HT Mixed, 40 MHz, MCS7, 90pc dc) | WLAN | 8.82 | ±9.6 |
| 10607 | AAC | IEEE 802.11ac WiFi (20 MHz, MCS0, 90pc dc) | WLAN | 8.64 | ±9.6 |
| 10608 | AAC | IEEE 802.11ac WiFi (20 MHz, MCS1, 90pc dc) | WLAN | 8.77 | ±9.6 |

| UID | Rev | Communication System Name | Group | PAR (dB) | Unc ^F k = 2 |
|-------|-----|---|-----------|----------|------------------------|
| 10609 | AAC | IEEE 802.11ac WiFi (20 MHz, MCS2, 90pc dc) | WLAN | 8.57 | ±9.6 |
| 10610 | AAC | IEEE 802.11ac WiFi (20 MHz, MCS3, 90pc dc) | WLAN | 8.78 | ±9.6 |
| 10611 | AAC | IEEE 802.11ac WiFi (20 MHz, MCS4, 90pc dc) | WLAN | 8.70 | ±9.6 |
| 10612 | AAC | IEEE 802.11ac WiFi (20 MHz, MCS5, 90pc dc) | WLAN | 8.77 | ±9.6 |
| 10613 | AAC | IEEE 802.11ac WiFi (20 MHz, MCS6, 90pc dc) | WLAN | 8.94 | ±9.6 |
| 10614 | AAC | IEEE 802.11ac WiFi (20 MHz, MCS7, 90pc dc) | WLAN | 8.59 | ±9.6 |
| 10615 | AAC | IEEE 802.11ac WiFi (20 MHz, MCS8, 90pc dc) | WLAN | 8.82 | ±9.6 |
| 10616 | AAC | IEEE 802.11ac WiFi (40 MHz, MCS0, 90pc dc) | WLAN | 8.82 | ±9.6 |
| 10617 | AAC | IEEE 802.11ac WiFi (40 MHz, MCS1, 90pc dc) | WLAN | 8.81 | ±9.6 |
| 10618 | AAC | IEEE 802.11ac WiFi (40 MHz, MCS2, 90pc dc) | WLAN | 8.58 | ±9.6 |
| 10619 | AAC | IEEE 802.11ac WiFi (40 MHz, MCS3, 90pc dc) | WLAN | 8.86 | ±9.6 |
| 10620 | AAC | IEEE 802.11ac WiFi (40 MHz, MCS4, 90pc dc) | WLAN | 8.87 | ±9.6 |
| 10621 | AAC | IEEE 802.11ac WiFi (40 MHz, MCS5, 90pc dc) | WLAN | 8.77 | ±9.6 |
| 10622 | AAC | IEEE 802.11ac WiFi (40 MHz, MCS6, 90pc dc) | WLAN | 8.68 | ±9.6 |
| 10623 | AAC | IEEE 802.11ac WiFi (40 MHz, MCS7, 90pc dc) | WLAN | 8.82 | ±9.6 |
| 10624 | AAC | IEEE 802.11ac WiFi (40 MHz, MCS8, 90pc dc) | WLAN | 8.96 | ±9.6 |
| 10625 | AAC | IEEE 802.11ac WiFi (40 MHz, MCS9, 90pc dc) | WLAN | 8.96 | ±9.6 |
| 10626 | AAC | IEEE 802.11ac WiFi (80 MHz, MCS0, 90pc dc) | WLAN | 8.83 | ±9.6 |
| 10627 | AAC | IEEE 802.11ac WiFi (80 MHz, MCS1, 90pc dc) | WLAN | 8.88 | ±9.6 |
| 10628 | AAC | IEEE 802.11ac WiFi (80 MHz, MCS2, 90pc dc) | WLAN | 8.71 | ±9.6 |
| 10629 | AAC | IEEE 802.11ac WiFi (80 MHz, MCS3, 90pc dc) | WLAN | 8.85 | ±9.6 |
| 10630 | AAC | IEEE 802.11ac WiFi (80 MHz, MCS4, 90pc dc) | WLAN | 8.72 | ±9.6 |
| 10631 | AAC | IEEE 802.11ac WiFi (80 MHz, MCS5, 90pc dc) | WLAN | 8.81 | ±9.6 |
| 10632 | AAC | IEEE 802.11ac WiFi (80 MHz, MCS6, 90pc dc) | WLAN | 8.74 | ±9.6 |
| 10633 | AAC | IEEE 802.11ac WiFi (80 MHz, MCS7, 90pc dc) | WLAN | 8.83 | ±9.6 |
| 10634 | AAC | IEEE 802.11ac WiFi (80 MHz, MCS8, 90pc dc) | WLAN | 8.80 | ±9.6 |
| 10635 | AAC | IEEE 802.11ac WiFi (80 MHz, MCS9, 90pc dc) | WLAN | 8.81 | ±9.6 |
| 10636 | AAC | IEEE 802.11ac WiFi (160 MHz, MCS0, 90pc dc) | WLAN | 8.83 | ±9.6 |
| 10637 | AAC | IEEE 802.11ac WiFi (160 MHz, MCS1, 90pc dc) | WLAN | 8.79 | ±9.6 |
| 10638 | AAC | IEEE 802.11ac WiFi (160 MHz, MCS2, 90pc dc) | WLAN | 8.86 | ±9.6 |
| 10639 | AAC | IEEE 802.11ac WiFi (160 MHz, MCS3, 90pc dc) | WLAN | 8.85 | ±9.6 |
| 10640 | AAC | IEEE 802.11ac WiFi (160 MHz, MCS4, 90pc dc) | WLAN | 8.98 | ±9.6 |
| 10641 | AAC | IEEE 802.11ac WiFi (160 MHz, MCS5, 90pc dc) | WLAN | 9.06 | ±9.6 |
| 10642 | AAC | IEEE 802.11ac WiFi (160 MHz, MCS6, 90pc dc) | WLAN | 9.06 | ±9.6 |
| 10643 | AAC | IEEE 802.11ac WiFi (160 MHz, MCS7, 90pc dc) | WLAN | 8.89 | ±9.6 |
| 10644 | AAC | IEEE 802.11ac WiFi (160 MHz, MCS8, 90pc dc) | WLAN | 9.05 | ±9.6 |
| 10645 | AAC | IEEE 802.11ac WiFi (160 MHz, MCS9, 90pc dc) | WLAN | 9.11 | ±9.6 |
| 10646 | AAC | LTE-TDD (SC-FDMA, 1 RB, 5 MHz, QPSK, UL Sub=2,7) | LTE-TDD | 11.96 | ±9.6 |
| 10647 | AAC | LTE-TDD (SC-FDMA, 1 RB, 20 MHz, QPSK, UL Sub=2,7) | LTE-TDD | 11.96 | ±9.6 |
| 10648 | AAC | CDMA2000 (1x Advanced) | CDMA2000 | 3.45 | ±9.6 |
| 10652 | AAC | LTE-TDD (OFDMA, 5 MHz, E-TM 3.1, Clipping 44%) | LTE-TDD | 6.91 | ±9.6 |
| 10653 | AAC | LTE-TDD (OFDMA, 10 MHz, E-TM 3.1, Clipping 44%) | LTE-TDD | 7.42 | ±9.6 |
| 10654 | AAC | LTE-TDD (OFDMA, 15 MHz, E-TM 3.1, Clipping 44%) | LTE-TDD | 6.96 | ±9.6 |
| 10655 | AAC | LTE-TDD (OFDMA, 20 MHz, E-TM 3.1, Clipping 44%) | LTE-TDD | 7.21 | ±9.6 |
| 10658 | AAC | Pulse Waveform (200 Hz, 10%) | Test | 10.00 | ±9.6 |
| 10659 | AAC | Pulse Waveform (200 Hz, 20%) | Test | 6.99 | ±9.6 |
| 10660 | AAC | Pulse Waveform (200 Hz, 40%) | Test | 3.98 | ±9.6 |
| 10661 | AAC | Pulse Waveform (200 Hz, 60%) | Test | 2.22 | ±9.6 |
| 10662 | AAC | Pulse Waveform (200 Hz, 80%) | Test | 0.97 | ±9.6 |
| 10670 | AAC | Bluetooth Low Energy | Bluetooth | 2.19 | ±9.6 |
| 10671 | AAD | IEEE 802.11ax (20 MHz, MCS0, 90pc dc) | WLAN | 9.09 | ±9.6 |
| 10672 | AAD | IEEE 802.11ax (20 MHz, MCS1, 90pc dc) | WLAN | 8.57 | ±9.6 |
| 10673 | AAD | IEEE 802.11ax (20 MHz, MCS2, 90pc dc) | WLAN | 8.78 | ±9.6 |
| 10674 | AAD | IEEE 802.11ax (20 MHz, MCS3, 90pc dc) | WLAN | 8.74 | ±9.6 |
| 10675 | AAD | IEEE 802.11ax (20 MHz, MCS4, 90pc dc) | WLAN | 8.90 | ±9.6 |
| 10676 | AAD | IEEE 802.11ax (20 MHz, MCS5, 90pc dc) | WLAN | 8.77 | ±9.6 |
| 10677 | AAD | IEEE 802.11ax (20 MHz, MCS6, 90pc dc) | WLAN | 8.73 | ±9.6 |
| 10678 | AAD | IEEE 802.11ax (20 MHz, MCS7, 90pc dc) | WLAN | 8.78 | ±9.6 |
| 10679 | AAD | IEEE 802.11ax (20 MHz, MCS8, 90pc dc) | WLAN | 8.89 | ±9.6 |
| 10680 | AAD | IEEE 802.11ax (20 MHz, MCS9, 90pc dc) | WLAN | 8.80 | ±9.6 |
| 10681 | AAG | IEEE 802.11ax (20 MHz, MCS10, 90pc dc) | WLAN | 8.62 | ±9.6 |
| 10682 | AAF | IEEE 802.11ax (20 MHz, MCS11, 90pc dc) | WLAN | 8.83 | ±9.6 |
| 10683 | AAA | IEEE 802.11ax (20 MHz, MCS0, 99pc dc) | WLAN | 8.42 | ±9.6 |
| 10684 | AAC | IEEE 802.11ax (20 MHz, MCS1, 99pc dc) | WLAN | 8.26 | ±9.6 |
| 10685 | AAC | IEEE 802.11ax (20 MHz, MCS2, 99pc dc) | WLAN | 8.33 | ±9.6 |
| 10686 | AAC | IEEE 802.11ax (20 MHz, MCS3, 99pc dc) | WLAN | 8.28 | ±9.6 |

| UID | Rev | Communication System Name | Group | PAR (dB) | Unc ^E k = 2 |
|-------|-----|--|-------|----------|------------------------|
| 10687 | AAE | IEEE 802.11ax (20 MHz, MCS4, 99pc dc) | WLAN | 8.45 | ±9.6 |
| 10688 | AAE | IEEE 802.11ax (20 MHz, MCS5, 99pc dc) | WLAN | 8.29 | ±9.6 |
| 10689 | AAD | IEEE 802.11ax (20 MHz, MCS6, 99pc dc) | WLAN | 8.55 | ±9.6 |
| 10690 | AAE | IEEE 802.11ax (20 MHz, MCS7, 99pc dc) | WLAN | 8.29 | ±9.6 |
| 10691 | AAB | IEEE 802.11ax (20 MHz, MCS8, 99pc dc) | WLAN | 8.25 | ±9.6 |
| 10692 | AAA | IEEE 802.11ax (20 MHz, MCS9, 99pc dc) | WLAN | 8.29 | ±9.6 |
| 10693 | AAA | IEEE 802.11ax (20 MHz, MCS10, 99pc dc) | WLAN | 8.25 | ±9.6 |
| 10694 | AAA | IEEE 802.11ax (20 MHz, MCS11, 99pc dc) | WLAN | 8.57 | ±9.6 |
| 10695 | AAA | IEEE 802.11ax (40 MHz, MCS0, 90pc dc) | WLAN | 8.78 | ±9.6 |
| 10696 | AAA | IEEE 802.11ax (40 MHz, MCS1, 90pc dc) | WLAN | 8.91 | ±9.6 |
| 10697 | AAA | IEEE 802.11ax (40 MHz, MCS2, 90pc dc) | WLAN | 8.61 | ±9.6 |
| 10698 | AAA | IEEE 802.11ax (40 MHz, MCS3, 90pc dc) | WLAN | 8.89 | ±9.6 |
| 10699 | AAA | IEEE 802.11ax (40 MHz, MCS4, 90pc dc) | WLAN | 8.82 | ±9.6 |
| 10700 | AAA | IEEE 802.11ax (40 MHz, MCS5, 90pc dc) | WLAN | 8.73 | ±9.6 |
| 10701 | AAA | IEEE 802.11ax (40 MHz, MCS6, 90pc dc) | WLAN | 8.86 | ±9.6 |
| 10702 | AAA | IEEE 802.11ax (40 MHz, MCS7, 90pc dc) | WLAN | 8.70 | ±9.6 |
| 10703 | AAA | IEEE 802.11ax (40 MHz, MCS8, 90pc dc) | WLAN | 8.82 | ±9.6 |
| 10704 | AAA | IEEE 802.11ax (40 MHz, MCS9, 90pc dc) | WLAN | 8.56 | ±9.6 |
| 10705 | AAA | IEEE 802.11ax (40 MHz, MCS10, 90pc dc) | WLAN | 8.69 | ±9.6 |
| 10706 | AAC | IEEE 802.11ax (40 MHz, MCS11, 90pc dc) | WLAN | 8.66 | ±9.6 |
| 10707 | AAC | IEEE 802.11ax (40 MHz, MCS0, 99pc dc) | WLAN | 8.32 | ±9.6 |
| 10708 | AAC | IEEE 802.11ax (40 MHz, MCS1, 99pc dc) | WLAN | 8.55 | ±9.6 |
| 10709 | AAC | IEEE 802.11ax (40 MHz, MCS2, 99pc dc) | WLAN | 8.33 | ±9.6 |
| 10710 | AAC | IEEE 802.11ax (40 MHz, MCS3, 99pc dc) | WLAN | 8.29 | ±9.6 |
| 10711 | AAC | IEEE 802.11ax (40 MHz, MCS4, 99pc dc) | WLAN | 8.39 | ±9.6 |
| 10712 | AAC | IEEE 802.11ax (40 MHz, MCS5, 99pc dc) | WLAN | 8.67 | ±9.6 |
| 10713 | AAC | IEEE 802.11ax (40 MHz, MCS6, 99pc dc) | WLAN | 8.33 | ±9.6 |
| 10714 | AAC | IEEE 802.11ax (40 MHz, MCS7, 99pc dc) | WLAN | 8.26 | ±9.6 |
| 10715 | AAC | IEEE 802.11ax (40 MHz, MCS8, 99pc dc) | WLAN | 8.45 | ±9.6 |
| 10716 | AAC | IEEE 802.11ax (40 MHz, MCS9, 99pc dc) | WLAN | 8.30 | ±9.6 |
| 10717 | AAC | IEEE 802.11ax (40 MHz, MCS10, 99pc dc) | WLAN | 8.48 | ±9.6 |
| 10718 | AAC | IEEE 802.11ax (40 MHz, MCS11, 99pc dc) | WLAN | 8.24 | ±9.6 |
| 10719 | AAC | IEEE 802.11ax (80 MHz, MCS0, 90pc dc) | WLAN | 8.81 | ±9.6 |
| 10720 | AAC | IEEE 802.11ax (80 MHz, MCS1, 90pc dc) | WLAN | 8.87 | ±9.6 |
| 10721 | AAC | IEEE 802.11ax (80 MHz, MCS2, 90pc dc) | WLAN | 8.76 | ±9.6 |
| 10722 | AAC | IEEE 802.11ax (80 MHz, MCS3, 90pc dc) | WLAN | 8.55 | ±9.6 |
| 10723 | AAC | IEEE 802.11ax (80 MHz, MCS4, 90pc dc) | WLAN | 8.70 | ±9.6 |
| 10724 | AAC | IEEE 802.11ax (80 MHz, MCS5, 90pc dc) | WLAN | 8.90 | ±9.6 |
| 10725 | AAC | IEEE 802.11ax (80 MHz, MCS6, 90pc dc) | WLAN | 8.74 | ±9.6 |
| 10726 | AAC | IEEE 802.11ax (80 MHz, MCS7, 90pc dc) | WLAN | 8.72 | ±9.6 |
| 10727 | AAC | IEEE 802.11ax (80 MHz, MCS8, 90pc dc) | WLAN | 8.66 | ±9.6 |
| 10728 | AAC | IEEE 802.11ax (80 MHz, MCS9, 90pc dc) | WLAN | 8.65 | ±9.6 |
| 10729 | AAC | IEEE 802.11ax (80 MHz, MCS10, 90pc dc) | WLAN | 8.64 | ±9.6 |
| 10730 | AAC | IEEE 802.11ax (80 MHz, MCS11, 90pc dc) | WLAN | 8.67 | ±9.6 |
| 10731 | AAC | IEEE 802.11ax (80 MHz, MCS0, 99pc dc) | WLAN | 8.42 | ±9.6 |
| 10732 | AAC | IEEE 802.11ax (80 MHz, MCS1, 99pc dc) | WLAN | 8.46 | ±9.6 |
| 10733 | AAC | IEEE 802.11ax (80 MHz, MCS2, 99pc dc) | WLAN | 8.40 | ±9.6 |
| 10734 | AAC | IEEE 802.11ax (80 MHz, MCS3, 99pc dc) | WLAN | 8.25 | ±9.6 |
| 10735 | AAC | IEEE 802.11ax (80 MHz, MCS4, 99pc dc) | WLAN | 8.33 | ±9.6 |
| 10736 | AAC | IEEE 802.11ax (80 MHz, MCS5, 99pc dc) | WLAN | 8.27 | ±9.6 |
| 10737 | AAC | IEEE 802.11ax (80 MHz, MCS6, 99pc dc) | WLAN | 8.36 | ±9.6 |
| 10738 | AAC | IEEE 802.11ax (80 MHz, MCS7, 99pc dc) | WLAN | 8.42 | ±9.6 |
| 10739 | AAC | IEEE 802.11ax (80 MHz, MCS8, 99pc dc) | WLAN | 8.29 | ±9.6 |
| 10740 | AAC | IEEE 802.11ax (80 MHz, MCS9, 99pc dc) | WLAN | 8.48 | ±9.6 |
| 10741 | AAC | IEEE 802.11ax (80 MHz, MCS10, 99pc dc) | WLAN | 8.40 | ±9.6 |
| 10742 | AAC | IEEE 802.11ax (80 MHz, MCS11, 99pc dc) | WLAN | 8.43 | ±9.6 |
| 10743 | AAC | IEEE 802.11ax (160 MHz, MCS0, 90pc dc) | WLAN | 8.94 | ±9.6 |
| 10744 | AAC | IEEE 802.11ax (160 MHz, MCS1, 90pc dc) | WLAN | 9.16 | ±9.6 |
| 10745 | AAC | IEEE 802.11ax (160 MHz, MCS2, 90pc dc) | WLAN | 8.93 | ±9.6 |
| 10746 | AAC | IEEE 802.11ax (160 MHz, MCS3, 90pc dc) | WLAN | 9.11 | ±9.6 |
| 10747 | AAC | IEEE 802.11ax (160 MHz, MCS4, 90pc dc) | WLAN | 9.04 | ±9.6 |
| 10748 | AAC | IEEE 802.11ax (160 MHz, MCS5, 90pc dc) | WLAN | 8.93 | ±9.6 |
| 10749 | AAC | IEEE 802.11ax (160 MHz, MCS6, 90pc dc) | WLAN | 8.90 | ±9.6 |
| 10750 | AAC | IEEE 802.11ax (160 MHz, MCS7, 90pc dc) | WLAN | 8.79 | ±9.6 |
| 10751 | AAC | IEEE 802.11ax (160 MHz, MCS8, 90pc dc) | WLAN | 8.82 | ±9.6 |
| 10752 | AAC | IEEE 802.11ax (160 MHz, MCS9, 90pc dc) | WLAN | 8.81 | ±9.6 |

| UID | Rev | Communication System Name | Group | PAR (dB) | Unc ^E k = 2 |
|-------|-----|--|---------------|----------|------------------------|
| 10753 | AAC | IEEE 802.11ax (160 MHz, MCS10, 90pc dc) | WLAN | 9.00 | ±9.6 |
| 10754 | AAC | IEEE 802.11ax (160 MHz, MCS11, 90pc dc) | WLAN | 8.94 | ±9.6 |
| 10755 | AAC | IEEE 802.11ax (160 MHz, MCS0, 99pc dc) | WLAN | 8.64 | ±9.6 |
| 10756 | AAC | IEEE 802.11ax (160 MHz, MCS1, 99pc dc) | WLAN | 8.77 | ±9.6 |
| 10757 | AAC | IEEE 802.11ax (160 MHz, MCS2, 99pc dc) | WLAN | 8.77 | ±9.6 |
| 10758 | AAC | IEEE 802.11ax (160 MHz, MCS3, 99pc dc) | WLAN | 8.69 | ±9.6 |
| 10759 | AAC | IEEE 802.11ax (160 MHz, MCS4, 99pc dc) | WLAN | 8.58 | ±9.6 |
| 10760 | AAC | IEEE 802.11ax (160 MHz, MCS5, 99pc dc) | WLAN | 8.49 | ±9.6 |
| 10761 | AAC | IEEE 802.11ax (160 MHz, MCS6, 99pc dc) | WLAN | 8.58 | ±9.6 |
| 10762 | AAC | IEEE 802.11ax (160 MHz, MCS7, 99pc dc) | WLAN | 8.49 | ±9.6 |
| 10763 | AAC | IEEE 802.11ax (160 MHz, MCS8, 99pc dc) | WLAN | 8.53 | ±9.6 |
| 10764 | AAC | IEEE 802.11ax (160 MHz, MCS9, 99pc dc) | WLAN | 8.54 | ±9.6 |
| 10765 | AAC | IEEE 802.11ax (160 MHz, MCS10, 99pc dc) | WLAN | 8.54 | ±9.6 |
| 10766 | AAC | IEEE 802.11ax (160 MHz, MCS11, 99pc dc) | WLAN | 8.51 | ±9.6 |
| 10767 | AAC | 5G NR (CP-OFDM, 1 RB, 5MHz, QPSK, 15 kHz) | 5G NR FR1 TDD | 7.99 | ±9.6 |
| 10768 | AAC | 5G NR (CP-OFDM, 1 RB, 10 MHz, QPSK, 15 kHz) | 5G NR FR1 TDD | 8.01 | ±9.6 |
| 10769 | AAC | 5G NR (CP-OFDM, 1 RB, 15 MHz, QPSK, 15 kHz) | 5G NR FR1 TDD | 8.01 | ±9.6 |
| 10770 | AAC | 5G NR (CP-OFDM, 1 RB, 20 MHz, QPSK, 15 kHz) | 5G NR FR1 TDD | 8.02 | ±9.6 |
| 10771 | AAC | 5G NR (CP-OFDM, 1 RB, 25 MHz, QPSK, 15 kHz) | 5G NR FR1 TDD | 8.02 | ±9.6 |
| 10772 | AAC | 5G NR (CP-OFDM, 1 RB, 30 MHz, QPSK, 15 kHz) | 5G NR FR1 TDD | 8.23 | ±9.6 |
| 10773 | AAC | 5G NR (CP-OFDM, 1 RB, 40 MHz, QPSK, 15 kHz) | 5G NR FR1 TDD | 8.03 | ±9.6 |
| 10774 | AAC | 5G NR (CP-OFDM, 1 RB, 50 MHz, QPSK, 15 kHz) | 5G NR FR1 TDD | 8.02 | ±9.6 |
| 10775 | AAC | 5G NR (CP-OFDM, 50% RB, 5 MHz, QPSK, 15 kHz) | 5G NR FR1 TDD | 8.31 | ±9.6 |
| 10776 | AAC | 5G NR (CP-OFDM, 50% RB, 10 MHz, QPSK, 15 kHz) | 5G NR FR1 TDD | 8.30 | ±9.6 |
| 10777 | AAC | 5G NR (CP-OFDM, 50% RB, 15 MHz, QPSK, 15 kHz) | 5G NR FR1 TDD | 8.30 | ±9.6 |
| 10778 | AAC | 5G NR (CP-OFDM, 50% RB, 20 MHz, QPSK, 15 kHz) | 5G NR FR1 TDD | 8.34 | ±9.6 |
| 10779 | AAC | 5G NR (CP-OFDM, 50% RB, 25 MHz, QPSK, 15 kHz) | 5G NR FR1 TDD | 8.42 | ±9.6 |
| 10780 | AAC | 5G NR (CP-OFDM, 50% RB, 30 MHz, QPSK, 15 kHz) | 5G NR FR1 TDD | 8.38 | ±9.6 |
| 10781 | AAC | 5G NR (CP-OFDM, 50% RB, 40 MHz, QPSK, 15 kHz) | 5G NR FR1 TDD | 8.38 | ±9.6 |
| 10782 | AAC | 5G NR (CP-OFDM, 50% RB, 50 MHz, QPSK, 15 kHz) | 5G NR FR1 TDD | 8.43 | ±9.6 |
| 10783 | AAC | 5G NR (CP-OFDM, 100% RB, 5 MHz, QPSK, 15 kHz) | 5G NR FR1 TDD | 8.31 | ±9.6 |
| 10784 | AAC | 5G NR (CP-OFDM, 100% RB, 10 MHz, QPSK, 15 kHz) | 5G NR FR1 TDD | 8.29 | ±9.6 |
| 10785 | AAC | 5G NR (CP-OFDM, 100% RB, 15 MHz, QPSK, 15 kHz) | 5G NR FR1 TDD | 8.40 | ±9.6 |
| 10786 | AAC | 5G NR (CP-OFDM, 100% RB, 20 MHz, QPSK, 15 kHz) | 5G NR FR1 TDD | 8.35 | ±9.6 |
| 10787 | AAC | 5G NR (CP-OFDM, 100% RB, 25 MHz, QPSK, 15 kHz) | 5G NR FR1 TDD | 8.44 | ±9.6 |
| 10788 | AAC | 5G NR (CP-OFDM, 100% RB, 30 MHz, QPSK, 15 kHz) | 5G NR FR1 TDD | 8.39 | ±9.6 |
| 10789 | AAC | 5G NR (CP-OFDM, 100% RB, 40 MHz, QPSK, 15 kHz) | 5G NR FR1 TDD | 8.37 | ±9.6 |
| 10790 | AAC | 5G NR (CP-OFDM, 100% RB, 50 MHz, QPSK, 15 kHz) | 5G NR FR1 TDD | 8.39 | ±9.6 |
| 10791 | AAC | 5G NR (CP-OFDM, 1 RB, 5 MHz, QPSK, 30 kHz) | 5G NR FR1 TDD | 7.83 | ±9.6 |
| 10792 | AAC | 5G NR (CP-OFDM, 1 RB, 10 MHz, QPSK, 30 kHz) | 5G NR FR1 TDD | 7.92 | ±9.6 |
| 10793 | AAC | 5G NR (CP-OFDM, 1 RB, 15 MHz, QPSK, 30 kHz) | 5G NR FR1 TDD | 7.95 | ±9.6 |
| 10794 | AAC | 5G NR (CP-OFDM, 1 RB, 20 MHz, QPSK, 30 kHz) | 5G NR FR1 TDD | 7.82 | ±9.6 |
| 10795 | AAC | 5G NR (CP-OFDM, 1 RB, 25 MHz, QPSK, 30 kHz) | 5G NR FR1 TDD | 7.84 | ±9.6 |
| 10796 | AAC | 5G NR (CP-OFDM, 1 RB, 30 MHz, QPSK, 30 kHz) | 5G NR FR1 TDD | 7.82 | ±9.6 |
| 10797 | AAC | 5G NR (CP-OFDM, 1 RB, 40 MHz, QPSK, 30 kHz) | 5G NR FR1 TDD | 8.01 | ±9.6 |
| 10798 | AAC | 5G NR (CP-OFDM, 1 RB, 50 MHz, QPSK, 30 kHz) | 5G NR FR1 TDD | 7.89 | ±9.6 |
| 10799 | AAC | 5G NR (CP-OFDM, 1 RB, 60 MHz, QPSK, 30 kHz) | 5G NR FR1 TDD | 7.93 | ±9.6 |
| 10801 | AAC | 5G NR (CP-OFDM, 1 RB, 80 MHz, QPSK, 30 kHz) | 5G NR FR1 TDD | 7.89 | ±9.6 |
| 10802 | AAC | 5G NR (CP-OFDM, 1 RB, 90 MHz, QPSK, 30 kHz) | 5G NR FR1 TDD | 7.87 | ±9.6 |
| 10803 | AAE | 5G NR (CP-OFDM, 1 RB, 100 MHz, QPSK, 30 kHz) | 5G NR FR1 TDD | 7.93 | ±9.6 |
| 10805 | AAD | 5G NR (CP-OFDM, 50% RB, 10 MHz, QPSK, 30 kHz) | 5G NR FR1 TDD | 8.34 | ±9.6 |
| 10806 | AAD | 5G NR (CP-OFDM, 50% RB, 15 MHz, QPSK, 30 kHz) | 5G NR FR1 TDD | 8.37 | ±9.6 |
| 10809 | AAD | 5G NR (CP-OFDM, 50% RB, 30 MHz, QPSK, 30 kHz) | 5G NR FR1 TDD | 8.34 | ±9.6 |
| 10810 | AAD | 5G NR (CP-OFDM, 50% RB, 40 MHz, QPSK, 30 kHz) | 5G NR FR1 TDD | 8.34 | ±9.6 |
| 10812 | AAD | 5G NR (CP-OFDM, 50% RB, 60 MHz, QPSK, 30 kHz) | 5G NR FR1 TDD | 8.35 | ±9.6 |
| 10817 | AAD | 5G NR (CP-OFDM, 100% RB, 5 MHz, QPSK, 30 kHz) | 5G NR FR1 TDD | 8.35 | ±9.6 |
| 10818 | AAD | 5G NR (CP-OFDM, 100% RB, 10 MHz, QPSK, 30 kHz) | 5G NR FR1 TDD | 8.34 | ±9.6 |
| 10819 | AAD | 5G NR (CP-OFDM, 100% RB, 15 MHz, QPSK, 30 kHz) | 5G NR FR1 TDD | 8.33 | ±9.6 |
| 10820 | AAD | 5G NR (CP-OFDM, 100% RB, 20 MHz, QPSK, 30 kHz) | 5G NR FR1 TDD | 8.30 | ±9.6 |
| 10821 | AAC | 5G NR (CP-OFDM, 100% RB, 25 MHz, QPSK, 30 kHz) | 5G NR FR1 TDD | 8.41 | ±9.6 |
| 10822 | AAD | 5G NR (CP-OFDM, 100% RB, 30 MHz, QPSK, 30 kHz) | 5G NR FR1 TDD | 8.41 | ±9.6 |
| 10823 | AAC | 5G NR (CP-OFDM, 100% RB, 40 MHz, QPSK, 30 kHz) | 5G NR FR1 TDD | 8.36 | ±9.6 |
| 10824 | AAD | 5G NR (CP-OFDM, 100% RB, 50 MHz, QPSK, 30 kHz) | 5G NR FR1 TDD | 8.39 | ±9.6 |
| 10825 | AAD | 5G NR (CP-OFDM, 100% RB, 60 MHz, QPSK, 30 kHz) | 5G NR FR1 TDD | 8.41 | ±9.6 |
| 10827 | AAD | 5G NR (CP-OFDM, 100% RB, 80 MHz, QPSK, 30 kHz) | 5G NR FR1 TDD | 8.42 | ±9.6 |
| 10828 | AAE | 5G NR (CP-OFDM, 100% RB, 90 MHz, QPSK, 30 kHz) | 5G NR FR1 TDD | 8.43 | ±9.6 |

| UID | Rev | Communication System Name | Group | PAR (dB) | Unc ^F k = 2 |
|-------|-----|--|---------------|----------|------------------------|
| 10829 | AAD | 5G NR (CP-OFDM, 100% RB, 100 MHz, QPSK, 30 kHz) | 5G NR FR1 TDD | 8.40 | ±9.6 |
| 10830 | AAD | 5G NR (CP-OFDM, 1 RB, 10 MHz, QPSK, 60 kHz) | 5G NR FR1 TDD | 7.63 | ±9.6 |
| 10831 | AAD | 5G NR (CP-OFDM, 1 RB, 15 MHz, QPSK, 60 kHz) | 5G NR FR1 TDD | 7.73 | ±9.6 |
| 10832 | AAD | 5G NR (CP-OFDM, 1 RB, 20 MHz, QPSK, 60 kHz) | 5G NR FR1 TDD | 7.74 | ±9.6 |
| 10833 | AAD | 5G NR (CP-OFDM, 1 RB, 25 MHz, QPSK, 60 kHz) | 5G NR FR1 TDD | 7.70 | ±9.6 |
| 10834 | AAD | 5G NR (CP-OFDM, 1 RB, 30 MHz, QPSK, 60 kHz) | 5G NR FR1 TDD | 7.75 | ±9.6 |
| 10835 | AAD | 5G NR (CP-OFDM, 1 RB, 40 MHz, QPSK, 60 kHz) | 5G NR FR1 TDD | 7.70 | ±9.6 |
| 10836 | AAE | 5G NR (CP-OFDM, 1 RB, 50 MHz, QPSK, 60 kHz) | 5G NR FR1 TDD | 7.66 | ±9.6 |
| 10837 | AAD | 5G NR (CP-OFDM, 1 RB, 60 MHz, QPSK, 60 kHz) | 5G NR FR1 TDD | 7.68 | ±9.6 |
| 10839 | AAD | 5G NR (CP-OFDM, 1 RB, 80 MHz, QPSK, 60 kHz) | 5G NR FR1 TDD | 7.70 | ±9.6 |
| 10840 | AAD | 5G NR (CP-OFDM, 1 RB, 90 MHz, QPSK, 60 kHz) | 5G NR FR1 TDD | 7.67 | ±9.6 |
| 10841 | AAD | 5G NR (CP-OFDM, 1 RB, 100 MHz, QPSK, 60 kHz) | 5G NR FR1 TDD | 7.71 | ±9.6 |
| 10843 | AAD | 5G NR (CP-OFDM, 50% RB, 15 MHz, QPSK, 60 kHz) | 5G NR FR1 TDD | 8.49 | ±9.6 |
| 10844 | AAD | 5G NR (CP-OFDM, 50% RB, 20 MHz, QPSK, 60 kHz) | 5G NR FR1 TDD | 8.34 | ±9.6 |
| 10846 | AAD | 5G NR (CP-OFDM, 50% RB, 30 MHz, QPSK, 60 kHz) | 5G NR FR1 TDD | 8.41 | ±9.6 |
| 10854 | AAD | 5G NR (CP-OFDM, 100% RB, 10 MHz, QPSK, 60 kHz) | 5G NR FR1 TDD | 8.34 | ±9.6 |
| 10855 | AAD | 5G NR (CP-OFDM, 100% RB, 15 MHz, QPSK, 60 kHz) | 5G NR FR1 TDD | 8.36 | ±9.6 |
| 10856 | AAD | 5G NR (CP-OFDM, 100% RB, 20 MHz, QPSK, 60 kHz) | 5G NR FR1 TDD | 8.37 | ±9.6 |
| 10857 | AAD | 5G NR (CP-OFDM, 100% RB, 25 MHz, QPSK, 60 kHz) | 5G NR FR1 TDD | 8.35 | ±9.6 |
| 10858 | AAD | 5G NR (CP-OFDM, 100% RB, 30 MHz, QPSK, 60 kHz) | 5G NR FR1 TDD | 8.36 | ±9.6 |
| 10859 | AAD | 5G NR (CP-OFDM, 100% RB, 40 MHz, QPSK, 60 kHz) | 5G NR FR1 TDD | 8.34 | ±9.6 |
| 10860 | AAD | 5G NR (CP-OFDM, 100% RB, 50 MHz, QPSK, 60 kHz) | 5G NR FR1 TDD | 8.41 | ±9.6 |
| 10861 | AAD | 5G NR (CP-OFDM, 100% RB, 60 MHz, QPSK, 60 kHz) | 5G NR FR1 TDD | 8.40 | ±9.6 |
| 10863 | AAD | 5G NR (CP-OFDM, 100% RB, 80 MHz, QPSK, 60 kHz) | 5G NR FR1 TDD | 8.41 | ±9.6 |
| 10864 | AAE | 5G NR (CP-OFDM, 100% RB, 90 MHz, QPSK, 60 kHz) | 5G NR FR1 TDD | 8.37 | ±9.6 |
| 10865 | AAD | 5G NR (CP-OFDM, 100% RB, 100 MHz, QPSK, 60 kHz) | 5G NR FR1 TDD | 8.41 | ±9.6 |
| 10866 | AAD | 5G NR (DFT-s-OFDM, 1 RB, 100 MHz, QPSK, 30 kHz) | 5G NR FR1 TDD | 5.68 | ±9.6 |
| 10868 | AAD | 5G NR (DFT-s-OFDM, 100% RB, 100 MHz, QPSK, 30 kHz) | 5G NR FR1 TDD | 5.89 | ±9.6 |
| 10869 | AAD | 5G NR (DFT-s-OFDM, 1 RB, 100 MHz, QPSK, 120 kHz) | 5G NR FR2 TDD | 5.75 | ±9.6 |
| 10870 | AAD | 5G NR (DFT-s-OFDM, 100% RB, 100 MHz, QPSK, 120 kHz) | 5G NR FR2 TDD | 5.86 | ±9.6 |
| 10871 | AAD | 5G NR (DFT-s-OFDM, 1 RB, 100 MHz, 16QAM, 120 kHz) | 5G NR FR2 TDD | 5.75 | ±9.6 |
| 10872 | AAD | 5G NR (DFT-s-OFDM, 100% RB, 100 MHz, 16QAM, 120 kHz) | 5G NR FR2 TDD | 6.52 | ±9.6 |
| 10873 | AAD | 5G NR (DFT-s-OFDM, 1 RB, 100 MHz, 64QAM, 120 kHz) | 5G NR FR2 TDD | 6.61 | ±9.6 |
| 10874 | AAD | 5G NR (DFT-s-OFDM, 100% RB, 100 MHz, 64QAM, 120 kHz) | 5G NR FR2 TDD | 6.65 | ±9.6 |
| 10875 | AAD | 5G NR (CP-OFDM, 1 RB, 100 MHz, QPSK, 120 kHz) | 5G NR FR2 TDD | 7.78 | ±9.6 |
| 10876 | AAD | 5G NR (CP-OFDM, 100% RB, 100 MHz, QPSK, 120 kHz) | 5G NR FR2 TDD | 8.39 | ±9.6 |
| 10877 | AAD | 5G NR (CP-OFDM, 1 RB, 100 MHz, 16QAM, 120 kHz) | 5G NR FR2 TDD | 7.95 | ±9.6 |
| 10878 | AAD | 5G NR (CP-OFDM, 100% RB, 100 MHz, 16QAM, 120 kHz) | 5G NR FR2 TDD | 8.41 | ±9.6 |
| 10879 | AAD | 5G NR (CP-OFDM, 1 RB, 100 MHz, 64QAM, 120 kHz) | 5G NR FR2 TDD | 8.12 | ±9.6 |
| 10880 | AAD | 5G NR (CP-OFDM, 100% RB, 100 MHz, 64QAM, 120 kHz) | 5G NR FR2 TDD | 8.38 | ±9.6 |
| 10881 | AAD | 5G NR (DFT-s-OFDM, 1 RB, 50 MHz, QPSK, 120 kHz) | 5G NR FR2 TDD | 5.75 | ±9.6 |
| 10882 | AAD | 5G NR (DFT-s-OFDM, 100% RB, 50 MHz, QPSK, 120 kHz) | 5G NR FR2 TDD | 5.96 | ±9.6 |
| 10883 | AAD | 5G NR (DFT-s-OFDM, 1 RB, 50 MHz, 16QAM, 120 kHz) | 5G NR FR2 TDD | 6.57 | ±9.6 |
| 10884 | AAD | 5G NR (DFT-s-OFDM, 100% RB, 50 MHz, 16QAM, 120 kHz) | 5G NR FR2 TDD | 6.53 | ±9.6 |
| 10885 | AAD | 5G NR (DFT-s-OFDM, 1 RB, 50 MHz, 64QAM, 120 kHz) | 5G NR FR2 TDD | 6.61 | ±9.6 |
| 10886 | AAD | 5G NR (DFT-s-OFDM, 100% RB, 50 MHz, 64QAM, 120 kHz) | 5G NR FR2 TDD | 6.65 | ±9.6 |
| 10887 | AAD | 5G NR (CP-OFDM, 1 RB, 50 MHz, QPSK, 120 kHz) | 5G NR FR2 TDD | 7.78 | ±9.6 |
| 10888 | AAD | 5G NR (CP-OFDM, 100% RB, 50 MHz, QPSK, 120 kHz) | 5G NR FR2 TDD | 8.35 | ±9.6 |
| 10889 | AAD | 5G NR (CP-OFDM, 1 RB, 50 MHz, 16QAM, 120 kHz) | 5G NR FR2 TDD | 8.02 | ±9.6 |
| 10890 | AAD | 5G NR (CP-OFDM, 100% RB, 50 MHz, 16QAM, 120 kHz) | 5G NR FR2 TDD | 8.40 | ±9.6 |
| 10891 | AAD | 5G NR (CP-OFDM, 1 RB, 50 MHz, 64QAM, 120 kHz) | 5G NR FR2 TDD | 8.13 | ±9.6 |
| 10892 | AAD | 5G NR (CP-OFDM, 100% RB, 50 MHz, 64QAM, 120 kHz) | 5G NR FR2 TDD | 8.41 | ±9.6 |
| 10897 | AAD | 5G NR (DFT-s-OFDM, 1 RB, 5 MHz, QPSK, 30 kHz) | 5G NR FR1 TDD | 5.66 | ±9.6 |
| 10898 | AAD | 5G NR (DFT-s-OFDM, 1 RB, 10 MHz, QPSK, 30 kHz) | 5G NR FR1 TDD | 5.67 | ±9.6 |
| 10899 | AAD | 5G NR (DFT-s-OFDM, 1 RB, 15 MHz, QPSK, 30 kHz) | 5G NR FR1 TDD | 5.67 | ±9.6 |
| 10900 | AAD | 5G NR (DFT-s-OFDM, 1 RB, 20 MHz, QPSK, 30 kHz) | 5G NR FR1 TDD | 5.68 | ±9.6 |
| 10901 | AAD | 5G NR (DFT-s-OFDM, 1 RB, 25 MHz, QPSK, 30 kHz) | 5G NR FR1 TDD | 5.68 | ±9.6 |
| 10902 | AAD | 5G NR (DFT-s-OFDM, 1 RB, 30 MHz, QPSK, 30 kHz) | 5G NR FR1 TDD | 5.68 | ±9.6 |
| 10903 | AAD | 5G NR (DFT-s-OFDM, 1 RB, 40 MHz, QPSK, 30 kHz) | 5G NR FR1 TDD | 5.68 | ±9.6 |
| 10904 | AAD | 5G NR (DFT-s-OFDM, 1 RB, 50 MHz, QPSK, 30 kHz) | 5G NR FR1 TDD | 5.68 | ±9.6 |
| 10905 | AAD | 5G NR (DFT-s-OFDM, 1 RB, 60 MHz, QPSK, 30 kHz) | 5G NR FR1 TDD | 5.68 | ±9.6 |
| 10906 | AAD | 5G NR (DFT-s-OFDM, 1 RB, 80 MHz, QPSK, 30 kHz) | 5G NR FR1 TDD | 5.68 | ±9.6 |
| 10907 | AAD | 5G NR (DFT-s-OFDM, 50% RB, 5 MHz, QPSK, 30 kHz) | 5G NR FR1 TDD | 5.78 | ±9.6 |
| 10908 | AAD | 5G NR (DFT-s-OFDM, 50% RB, 10 MHz, QPSK, 30 kHz) | 5G NR FR1 TDD | 5.93 | ±9.6 |
| 10909 | AAD | 5G NR (DFT-s-OFDM, 50% RB, 15 MHz, QPSK, 30 kHz) | 5G NR FR1 TDD | 5.96 | ±9.6 |
| 10910 | AAD | 5G NR (DFT-s-OFDM, 50% RB, 20 MHz, QPSK, 30 kHz) | 5G NR FR1 TDD | 5.83 | ±9.6 |

| UID | Rev | Communication System Name | Group | PAR (dB) | Unc ^E k = 2 |
|-------|-----|---|---------------|----------|------------------------|
| 10911 | AAD | 5G NR (DFT-s-OFDM, 50% RB, 25 MHz, QPSK, 30 kHz) | 5G NR FR1 TDD | 5.93 | ±9.6 |
| 10912 | AAD | 5G NR (DFT-s-OFDM, 50% RB, 30 MHz, QPSK, 30 kHz) | 5G NR FR1 TDD | 5.84 | ±9.6 |
| 10913 | AAD | 5G NR (DFT-s-OFDM, 50% RB, 40 MHz, QPSK, 30 kHz) | 5G NR FR1 TDD | 5.84 | ±9.6 |
| 10914 | AAD | 5G NR (DFT-s-OFDM, 50% RB, 50 MHz, QPSK, 30 kHz) | 5G NR FR1 TDD | 5.85 | ±9.6 |
| 10915 | AAD | 5G NR (DFT-s-OFDM, 50% RB, 60 MHz, QPSK, 30 kHz) | 5G NR FR1 TDD | 5.83 | ±9.6 |
| 10916 | AAD | 5G NR (DFT-s-OFDM, 50% RB, 80 MHz, QPSK, 30 kHz) | 5G NR FR1 TDD | 5.87 | ±9.6 |
| 10917 | AAD | 5G NR (DFT-s-OFDM, 50% RB, 100 MHz, QPSK, 30 kHz) | 5G NR FR1 TDD | 5.94 | ±9.6 |
| 10918 | AAD | 5G NR (DFT-s-OFDM, 100% RB, 5 MHz, QPSK, 30 kHz) | 5G NR FR1 TDD | 5.86 | ±9.6 |
| 10919 | AAD | 5G NR (DFT-s-OFDM, 100% RB, 10 MHz, QPSK, 30 kHz) | 5G NR FR1 TDD | 5.86 | ±9.6 |
| 10920 | AAD | 5G NR (DFT-s-OFDM, 100% RB, 15 MHz, QPSK, 30 kHz) | 5G NR FR1 TDD | 5.87 | ±9.6 |
| 10921 | AAD | 5G NR (DFT-s-OFDM, 100% RB, 20 MHz, QPSK, 30 kHz) | 5G NR FR1 TDD | 5.84 | ±9.6 |
| 10922 | AAD | 5G NR (DFT-s-OFDM, 100% RB, 25 MHz, QPSK, 30 kHz) | 5G NR FR1 TDD | 5.82 | ±9.6 |
| 10923 | AAD | 5G NR (DFT-s-OFDM, 100% RB, 30 MHz, QPSK, 30 kHz) | 5G NR FR1 TDD | 5.84 | ±9.6 |
| 10924 | AAD | 5G NR (DFT-s-OFDM, 100% RB, 40 MHz, QPSK, 30 kHz) | 5G NR FR1 TDD | 5.84 | ±9.6 |
| 10925 | AAD | 5G NR (DFT-s-OFDM, 100% RB, 50 MHz, QPSK, 30 kHz) | 5G NR FR1 TDD | 5.95 | ±9.6 |
| 10926 | AAD | 5G NR (DFT-s-OFDM, 100% RB, 60 MHz, QPSK, 30 kHz) | 5G NR FR1 TDD | 5.84 | ±9.6 |
| 10927 | AAD | 5G NR (DFT-s-OFDM, 100% RB, 80 MHz, QPSK, 30 kHz) | 5G NR FR1 TDD | 5.94 | ±9.6 |
| 10928 | AAD | 5G NR (DFT-s-OFDM, 1 RB, 5 MHz, QPSK, 15 kHz) | 5G NR FR1 FDD | 5.52 | ±9.6 |
| 10929 | AAD | 5G NR (DFT-s-OFDM, 1 RB, 10 MHz, QPSK, 15 kHz) | 5G NR FR1 FDD | 5.52 | ±9.6 |
| 10930 | AAD | 5G NR (DFT-s-OFDM, 1 RB, 15 MHz, QPSK, 15 kHz) | 5G NR FR1 FDD | 5.52 | ±9.6 |
| 10931 | AAD | 5G NR (DFT-s-OFDM, 1 RB, 20 MHz, QPSK, 15 kHz) | 5G NR FR1 FDD | 5.51 | ±9.6 |
| 10932 | AAB | 5G NR (DFT-s-OFDM, 1 RB, 25 MHz, QPSK, 15 kHz) | 5G NR FR1 FDD | 5.51 | ±9.6 |
| 10933 | AAA | 5G NR (DFT-s-OFDM, 1 RB, 30 MHz, QPSK, 15 kHz) | 5G NR FR1 FDD | 5.51 | ±9.6 |
| 10934 | AAA | 5G NR (DFT-s-OFDM, 1 RB, 40 MHz, QPSK, 15 kHz) | 5G NR FR1 FDD | 5.51 | ±9.6 |
| 10935 | AAA | 5G NR (DFT-s-OFDM, 1 RB, 50 MHz, QPSK, 15 kHz) | 5G NR FR1 FDD | 5.51 | ±9.6 |
| 10936 | AAC | 5G NR (DFT-s-OFDM, 50% RB, 5 MHz, QPSK, 15 kHz) | 5G NR FR1 FDD | 5.90 | ±9.6 |
| 10937 | AAB | 5G NR (DFT-s-OFDM, 50% RB, 10 MHz, QPSK, 15 kHz) | 5G NR FR1 FDD | 5.77 | ±9.6 |
| 10938 | AAB | 5G NR (DFT-s-OFDM, 50% RB, 15 MHz, QPSK, 15 kHz) | 5G NR FR1 FDD | 5.90 | ±9.6 |
| 10939 | AAB | 5G NR (DFT-s-OFDM, 50% RB, 20 MHz, QPSK, 15 kHz) | 5G NR FR1 FDD | 5.82 | ±9.6 |
| 10940 | AAB | 5G NR (DFT-s-OFDM, 50% RB, 25 MHz, QPSK, 15 kHz) | 5G NR FR1 FDD | 5.89 | ±9.6 |
| 10941 | AAB | 5G NR (DFT-s-OFDM, 50% RB, 30 MHz, QPSK, 15 kHz) | 5G NR FR1 FDD | 5.83 | ±9.6 |
| 10942 | AAB | 5G NR (DFT-s-OFDM, 50% RB, 40 MHz, QPSK, 15 kHz) | 5G NR FR1 FDD | 5.85 | ±9.6 |
| 10943 | AAB | 5G NR (DFT-s-OFDM, 50% RB, 50 MHz, QPSK, 15 kHz) | 5G NR FR1 FDD | 5.95 | ±9.6 |
| 10944 | AAB | 5G NR (DFT-s-OFDM, 100% RB, 5 MHz, QPSK, 15 kHz) | 5G NR FR1 FDD | 5.81 | ±9.6 |
| 10945 | AAB | 5G NR (DFT-s-OFDM, 100% RB, 10 MHz, QPSK, 15 kHz) | 5G NR FR1 FDD | 5.85 | ±9.6 |
| 10946 | AAC | 5G NR (DFT-s-OFDM, 100% RB, 15 MHz, QPSK, 15 kHz) | 5G NR FR1 FDD | 5.83 | ±9.6 |
| 10947 | AAB | 5G NR (DFT-s-OFDM, 100% RB, 20 MHz, QPSK, 15 kHz) | 5G NR FR1 FDD | 5.87 | ±9.6 |
| 10948 | AAB | 5G NR (DFT-s-OFDM, 100% RB, 25 MHz, QPSK, 15 kHz) | 5G NR FR1 FDD | 5.94 | ±9.6 |
| 10949 | AAB | 5G NR (DFT-s-OFDM, 100% RB, 30 MHz, QPSK, 15 kHz) | 5G NR FR1 FDD | 5.87 | ±9.6 |
| 10950 | AAB | 5G NR (DFT-s-OFDM, 100% RB, 40 MHz, QPSK, 15 kHz) | 5G NR FR1 FDD | 5.94 | ±9.6 |
| 10951 | AAB | 5G NR (DFT-s-OFDM, 100% RB, 50 MHz, QPSK, 15 kHz) | 5G NR FR1 FDD | 5.92 | ±9.6 |
| 10952 | AAB | 5G NR DL (CP-OFDM, TM 3.1, 5 MHz, 64-QAM, 15 kHz) | 5G NR FR1 FDD | 8.25 | ±9.6 |
| 10953 | AAB | 5G NR DL (CP-OFDM, TM 3.1, 10 MHz, 64-QAM, 15 kHz) | 5G NR FR1 FDD | 8.15 | ±9.6 |
| 10954 | AAB | 5G NR DL (CP-OFDM, TM 3.1, 15 MHz, 64-QAM, 15 kHz) | 5G NR FR1 FDD | 8.23 | ±9.6 |
| 10955 | AAB | 5G NR DL (CP-OFDM, TM 3.1, 20 MHz, 64-QAM, 15 kHz) | 5G NR FR1 FDD | 8.42 | ±9.6 |
| 10956 | AAB | 5G NR DL (CP-OFDM, TM 3.1, 5 MHz, 64-QAM, 30 kHz) | 5G NR FR1 FDD | 8.14 | ±9.6 |
| 10957 | AAC | 5G NR DL (CP-OFDM, TM 3.1, 10 MHz, 64-QAM, 30 kHz) | 5G NR FR1 FDD | 8.31 | ±9.6 |
| 10958 | AAB | 5G NR DL (CP-OFDM, TM 3.1, 15 MHz, 64-QAM, 30 kHz) | 5G NR FR1 FDD | 8.61 | ±9.6 |
| 10959 | AAB | 5G NR DL (CP-OFDM, TM 3.1, 20 MHz, 64-QAM, 30 kHz) | 5G NR FR1 FDD | 8.33 | ±9.6 |
| 10960 | AAB | 5G NR DL (CP-OFDM, TM 3.1, 5 MHz, 64-QAM, 15 kHz) | 5G NR FR1 TDD | 9.32 | ±9.6 |
| 10961 | AAB | 5G NR DL (CP-OFDM, TM 3.1, 10 MHz, 64-QAM, 15 kHz) | 5G NR FR1 TDD | 9.36 | ±9.6 |
| 10962 | AAB | 5G NR DL (CP-OFDM, TM 3.1, 15 MHz, 64-QAM, 15 kHz) | 5G NR FR1 TDD | 9.40 | ±9.6 |
| 10963 | AAB | 5G NR DL (CP-OFDM, TM 3.1, 20 MHz, 64-QAM, 15 kHz) | 5G NR FR1 TDD | 9.55 | ±9.6 |
| 10964 | AAB | 5G NR DL (CP-OFDM, TM 3.1, 5 MHz, 64-QAM, 30 kHz) | 5G NR FR1 TDD | 9.29 | ±9.6 |
| 10965 | AAB | 5G NR DL (CP-OFDM, TM 3.1, 10 MHz, 64-QAM, 30 kHz) | 5G NR FR1 TDD | 9.37 | ±9.6 |
| 10966 | AAB | 5G NR DL (CP-OFDM, TM 3.1, 15 MHz, 64-QAM, 30 kHz) | 5G NR FR1 TDD | 9.55 | ±9.6 |
| 10967 | AAB | 5G NR DL (CP-OFDM, TM 3.1, 20 MHz, 64-QAM, 30 kHz) | 5G NR FR1 TDD | 9.42 | ±9.6 |
| 10968 | AAB | 5G NR DL (CP-OFDM, TM 3.1, 100 MHz, 64-QAM, 30 kHz) | 5G NR FR1 TDD | 9.49 | ±9.6 |
| 10972 | AAB | 5G NR (CP-OFDM, 1 RB, 20 MHz, QPSK, 15 kHz) | 5G NR FR1 TDD | 11.59 | ±9.6 |
| 10973 | AAB | 5G NR (DFT-s-OFDM, 1 RB, 100 MHz, QPSK, 30 kHz) | 5G NR FR1 TDD | 9.06 | ±9.6 |
| 10974 | AAB | 5G NR (CP-OFDM, 100% RB, 100 MHz, 256-QAM, 30 kHz) | 5G NR FR1 TDD | 10.28 | ±9.6 |
| 10978 | AAA | ULLA BDR | ULLA | 2.23 | ±9.6 |
| 10979 | AAA | ULLA HDR4 | ULLA | 7.02 | ±9.6 |
| 10980 | AAA | ULLA HDR8 | ULLA | 8.82 | ±9.6 |
| 10981 | AAA | ULLA HDRp4 | ULLA | 1.50 | ±9.6 |
| 10982 | AAA | ULLA HDRp8 | ULLA | 1.44 | ±9.6 |

| UID | Rev | Communication System Name | Group | PAR (dB) | Unc ^E k = 2 |
|-------|-----|--|---------------|----------|------------------------|
| 10983 | AAA | 5G NR DL (CP-OFDM, TM 3.1, 40 MHz, 64-QAM, 15 kHz) | 5G NR FR1 TDD | 9.31 | ±9.6 |
| 10984 | AAA | 5G NR DL (CP-OFDM, TM 3.1, 50 MHz, 64-QAM, 15 kHz) | 5G NR FR1 TDD | 9.42 | ±9.6 |
| 10985 | AAA | 5G NR DL (CP-OFDM, TM 3.1, 40 MHz, 64-QAM, 30 kHz) | 5G NR FR1 TDD | 9.54 | ±9.6 |
| 10986 | AAA | 5G NR DL (CP-OFDM, TM 3.1, 50 MHz, 64-QAM, 30 kHz) | 5G NR FR1 TDD | 9.50 | ±9.6 |
| 10987 | AAA | 5G NR DL (CP-OFDM, TM 3.1, 60 MHz, 64-QAM, 30 kHz) | 5G NR FR1 TDD | 9.53 | ±9.6 |
| 10988 | AAA | 5G NR DL (CP-OFDM, TM 3.1, 70 MHz, 64-QAM, 30 kHz) | 5G NR FR1 TDD | 9.38 | ±9.6 |
| 10989 | AAA | 5G NR DL (CP-OFDM, TM 3.1, 80 MHz, 64-QAM, 30 kHz) | 5G NR FR1 TDD | 9.33 | ±9.6 |
| 10990 | AAA | 5G NR DL (CP-OFDM, TM 3.1, 90 MHz, 64-QAM, 30 kHz) | 5G NR FR1 TDD | 9.52 | ±9.6 |

^E Uncertainty is determined using the max. deviation from linear response applying rectangular distribution and is expressed for the square of the field value.