

HEARING AID COMPATIBILITY

Applicant Name:
 SONY CORPORATION
 1-7-1 Konan Minato-ku
 Tokyo, 108-0075, Japan

Date of Testing:
 2/14/2023 – 2/27/2023
Test Site/Location:
 Element Washington DC LLC,
 Columbia, MD, USA
Test Report Serial No.:
 1M2302060006-07.PY7
Date of Issue:
 4/14/2023

FCC ID:	PY7-84558E
APPLICANT:	SONY CORPORATION

Scope of Test: Audio Band Magnetic Testing (T-Coil)
Application Type: Certification
FCC Rule Part(s): CFR §20.19(b)
HAC Standard: ANSI C63.19-2011
 285076 D01 HAC Guidance v06r02
 285076 D02 T-Coil testing for CMRS IP v04

DUT Type: Portable Handset
Model: 84558E
Test Device Serial No.: Pre-Production Sample [S/N: 03VFX]

C63.19-2011 HAC Category:	T4 (SIGNAL TO NOISE CATEGORY)
----------------------------------	--------------------------------------

This wireless portable device has been shown to be hearing-aid compatible under the above rated category, specified in ANSI/IEEE Std. C63.19-2011 and has been tested in accordance with the specified measurement procedures. Test results reported herein relate only to the item(s) tested. Hearing-Aid Compatibility is based on the assumption that all production units will be designed electrically identical to the device tested in this report. North American Bands only.

I attest to the accuracy of data. All measurements reported herein were performed by me or were made under my supervision and are correct to the best of my knowledge and belief. I assume full responsibility for the completeness of these measurements and vouch for the qualifications of all persons taking them.

 RJ Ortanez
 Executive Vice President



FCC ID: PY7-84558E		HAC (T-COIL) TEST REPORT	Approved by: Managing Director
Filename: 1M2302060006-07.PY7	Test Dates: 2/14/2023 – 2/27/2023	DUT Type: Portable Handset	Page 1 of 84

REV 4.2.M
11/29/2022

TABLE OF CONTENTS

1.	INTRODUCTION	3
2.	DUT DESCRIPTION.....	4
3.	ANSI C63.19-2011 PERFORMANCE CATEGORIES	6
4.	METHOD OF MEASUREMENT	8
5.	VOLTE TEST SYSTEM SETUP AND DUT CONFIGURATION	18
6.	OTT VOIP TEST SYSTEM AND DUT CONFIGURATION	22
7.	FCC 3G MEASUREMENTS	32
8.	T-COIL TEST SUMMARY	33
9.	MEASUREMENT UNCERTAINTY	47
10.	EQUIPMENT LIST	48
11.	TEST DATA	49
12.	CALIBRATION CERTIFICATES.....	72
13.	CONCLUSION.....	79
14.	REFERENCES	80
15.	TEST SETUP PHOTOGRAPHS	82

FCC ID: PY7-84558E		HAC (T-COIL) TEST REPORT	Approved by: Managing Director
Filename: 1M2302060006-07.PY7	Test Dates: 2/14/2023 – 2/27/2023	DUT Type: Portable Handset	Page 2 of 84

REV 4.2.M

11/29/2022

1. INTRODUCTION

On July 10, 2003, the Federal Communications Commission (FCC) adopted new rules requiring wireless manufacturers and service providers to provide digital wireless phones that are compatible with hearing aids. The FCC has modified the exemption for wireless phones under the Hearing Aid Compatibility Act of 1998 (HAC Act) in WT Docket 01-309 RM-8658¹ to extend the benefits of wireless telecommunications to individuals with hearing disabilities. These benefits encompass business, social and emergency communications, which increase the value of the wireless network for everyone. An estimated more than 10% of the population in the United States show signs of hearing impairment and of that fraction, almost 80% use hearing aids. Approximately 500 million people worldwide and 30 million people in the United States suffer from hearing loss.

Compatibility Tests Involved:

The standard calls for wireless communications devices to be measured for:

- RF Electric-field emissions
- T-coil mode, magnetic-signal strength in the audio band
- T-coil mode, magnetic-signal frequency response through the audio band
- T-coil mode, magnetic-signal and noise articulation index

The hearing aid must be measured for:

- RF immunity in microphone mode
- RF immunity in T-coil mode

In the following tests and results, this report includes the evaluation for a wireless communications device.

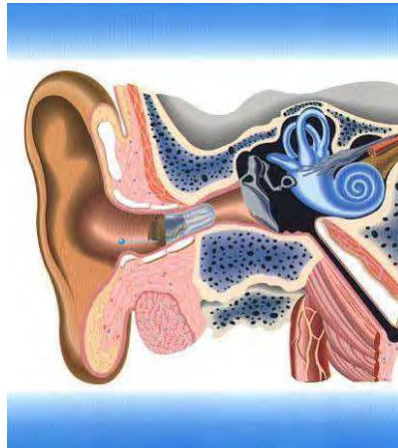



Figure 1-1 Hearing Aid *in-vitu*

¹ FCC Rule & Order, WT Docket 01-309 RM-8658

FCC ID: PY7-84558E		HAC (T-COIL) TEST REPORT	Approved by: Managing Director
Filename: 1M2302060006-07.PY7	Test Dates: 2/14/2023 – 2/27/2023	DUT Type: Portable Handset	Page 3 of 84

REV 4.2.M
11/29/2022

2. DUT DESCRIPTION

FCC ID: PY7-84558E
Applicant: SONY CORPORATION
1-7-1 Konan Minato-ku
Tokyo, 108-0075, Japan
Model: 84558E
Serial Number: 03VFX
HW Version: A
SW Version: 0.621
Antenna: Internal Antenna
DUT Type: Portable Handset

I. LTE Band Selection

This device supports LTE capabilities with overlapping transmission frequency ranges. When the supported frequency range of an LTE band falls completely within an LTE band with a larger transmission frequency range, both LTE bands have the same target power (or the band with the larger transmission frequency range has a higher target power), and both LTE bands share the same transmission path and signal characteristics, hearing-aid compatibility compliance was only assessed for the band with the larger transmission frequency range. However, overlapped LTE bands which are anchor bands for dual connectivity (EN-DC) scenarios between LTE and NR were evaluated as independent LTE bands.

FCC ID: PY7-84558E	 element	HAC (T-COIL) TEST REPORT	Approved by: Managing Director
Filename: 1M2302060006-07.PY7	Test Dates: 2/14/2023 – 2/27/2023	DUT Type: Portable Handset	Page 4 of 84

REV 4.2.M
11/29/2022

**Table 2-1
PY7-84558E HAC Air Interfaces**

Air-Interface	Band (MHz)	Type Transport	HAC Tested	Simultaneous But Not Tested	Name of Voice Service	Audio Codec Evaluated
GSM	850	VO	Yes	Yes: WIFI or BT	CMRS Voice ¹	EFR
	1900					
	GPRS/EDGE	VD	Yes	Yes: WIFI or BT	Google Meet ²	Google Meet: OPUS
UMTS	850	VD	Yes	Yes: WIFI or BT	CMRS Voice ¹	NB AMR, WB AMR
	1700					
	1900					
	HSPA	VD	Yes	Yes: WIFI or BT	Google Meet ²	Google Meet: OPUS
LTE (FDD)	680 (B71)	VD	Yes ³	Yes: NR, WIFI or BT	VoLTE ¹ , Google Meet ²	VoLTE: NB AMR, WB AMR, EVS Google Meet: OPUS
	700 (B12)		Yes			
	700 (B17)					
	780 (B13)					
	850 (B5)					
	1700 (B4)					
	1700 (B66)					
	1900 (B2)					
	1900 (B25)					
2300 (B30)						
LTE (TDD)	2600 (B41)	VD	Yes	Yes: NR, WIFI or BT	VoLTE ¹ , Google Meet ²	VoLTE: NB AMR, WB AMR, EVS Google Meet: OPUS
	3600 (B48)					
NR (FDD)	680 (n71)	VD	Yes ^{3,4}	Yes: LTE, WIFI or BT	Google Meet ²	Google Meet: OPUS
	850 (n5)		Yes ⁴			
	1700 (n66)					
	1900 (n2)					
	1900 (n25)					
2300 (n30)						
NR (TDD)	2600 (n41)	VD	Yes ⁴	Yes: LTE, WIFI or BT	Google Meet ²	Google Meet: OPUS
	3500 (n77, DoD)					
	3700 (n77)					
WIFI	2450	VD	Yes	Yes: GSM, UMTS, LTE, or NR	Google Meet ²	Google Meet: OPUS
	5200 (U-NII 1)					
	5300 (U-NII 2A)					
	5500 (U-NII 2C)		Yes ⁵			
	5800 (U-NII 3)					
	6175 (U-NII 5)					
	6475 (U-NII 6)					
	6700 (U-NII 7)					
7000 (U-NII 8)	No ⁶					
BT	2450	DT	No	Yes: GSM, UMTS, LTE, or NR	N/A	N/A

Type Transport
VO = Voice Only
DT = Digital Data - Not intended for Voice Services
VD = CMRS and/or IP Voice over Data Transport

Notes:
1. Reference level in accordance with 7.4.2.1 of ANSI C63.19-2011 and July 2012 C63 VoLTE Interpretation.
2. Reference level is -20dBm0 in accordance with FCC KDB 285076 D02
3. LTE B71 and NR n71, while outside the scope of ANSI C63.19 and FCC HAC regulations, were additionally tested according to the existing HAC procedures with currently available test equipment.
4. DFT-s-OFDM Waveform and NR TDD was evaluated using an interim procedure outlined in Section 6.II.4 due to equipment limitations.
5. WIFI U-NII band 5 was evaluated for operations which are entirely below 6 GHz. Operations partially or entirely above 6 GHz were not evaluated due to equipment limitations and being outside of the current scope of ANSI C63.19 and FCC HAC regulations.
6. WIFI U-NII bands 6 through 8 were not evaluated due to equipment limitations and being outside the scope of ANSI C63.19 and FCC HAC regulations.

FCC ID: PY7-84558E		HAC (T-COIL) TEST REPORT	Approved by: Managing Director
Filename: 1M2302060006-07.PY7	Test Dates: 2/14/2023 – 2/27/2023	DUT Type: Portable Handset	Page 5 of 84

REV 4.2.M
11/29/2022

3. ANSI C63.19-2011 PERFORMANCE CATEGORIES

I. MAGNETIC COUPLING

Axial and Radial Field Intensity

All orientations of the magnetic field, in the axial and radial position along the measurement plane shall be ≥ -18 dB(A/m) at 1 kHz in a 1/3 octave band filter per §8.3.1.

Frequency Response

The frequency response of the axial component of the magnetic field shall follow the response curve specified in EIA RS-504-1983, over the frequency range 300 Hz – 3000 Hz per §8.3.2.

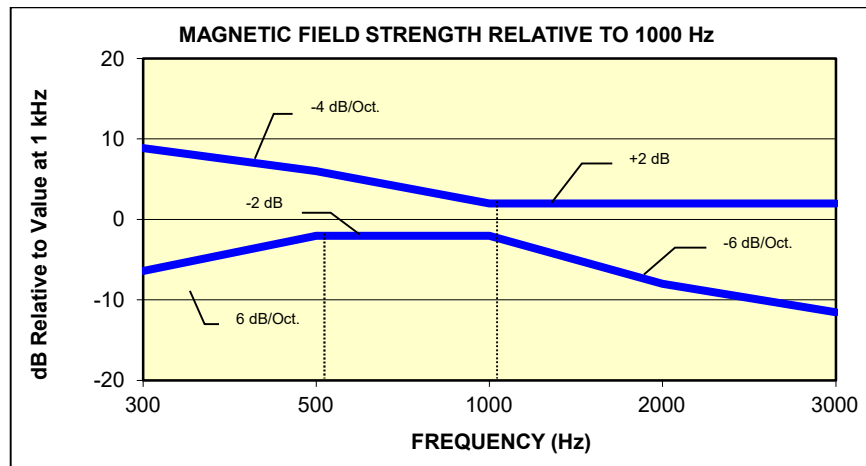

Figure 3-1
Magnetic field frequency response for Wireless Devices with an axial field ≤ -15 dB(A/m) at 1 kHz

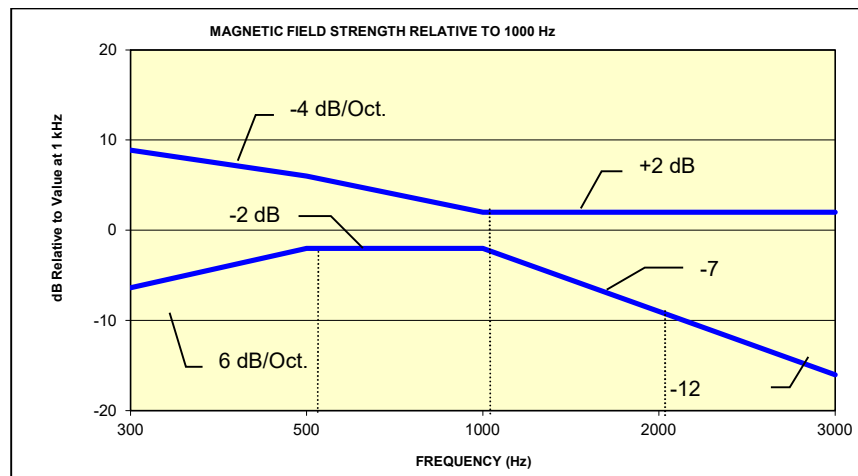



Figure 3-2
Magnetic Field frequency response for wireless devices with an axial field that exceeds -15 dB(A/m) at 1 kHz

FCC ID: PY7-84558E		HAC (T-COIL) TEST REPORT	Approved by: Managing Director
Filename: 1M2302060006-07.PY7	Test Dates: 2/14/2023 – 2/27/2023	DUT Type: Portable Handset	Page 6 of 84

REV 4.2.M
11/29/2022

Signal Quality

The table below provides the signal quality requirement for the intended audio magnetic signal from a wireless device. Only the RF immunity of the hearing aid is measured in T-coil mode. It is assumed that a hearing aid can have no immunity to an interference signal in the audio band, which is the intended reception band for this mode. The only criterion that can be measured is the RF immunity in T-coil mode. This is measured using the same procedure as the audio coupling mode at the same levels.

The signal quality of the axial and radial components of the magnetic field was used to determine the T-coil mode category.

Category	Telephone RF Parameters
	Wireless Device Signal Quality [(Signal + Noise)-to-noise ratio in dB]
T1	0 to 10 dB
T2	10 to 20 dB
T3	20 to 30 dB
T4	> 30 dB

Table 3-1
Magnetic Coupling Parameters

Note: The FCC limit for SNNR is 20dB and the test data margins will indicate a margin from the FCC limit for compliance.

FCC ID: PY7-84558E	 element	HAC (T-COIL) TEST REPORT	Approved by: Managing Director
Filename: 1M2302060006-07.PY7	Test Dates: 2/14/2023 – 2/27/2023	DUT Type: Portable Handset	Page 7 of 84

REV 4.2.M
11/29/2022

4. METHOD OF MEASUREMENT

I. Test Setup

The equipment was connected as shown in an RF-shielded chamber:

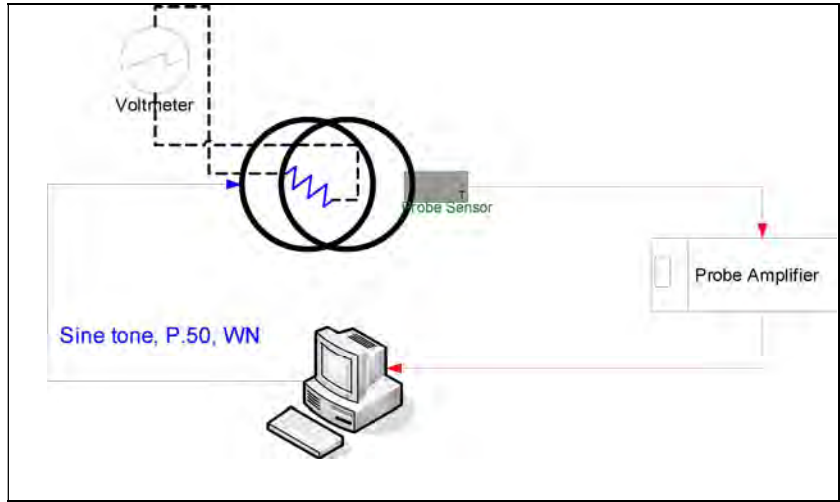

Figure 4-1
Validation Setup with Helmholtz Coil

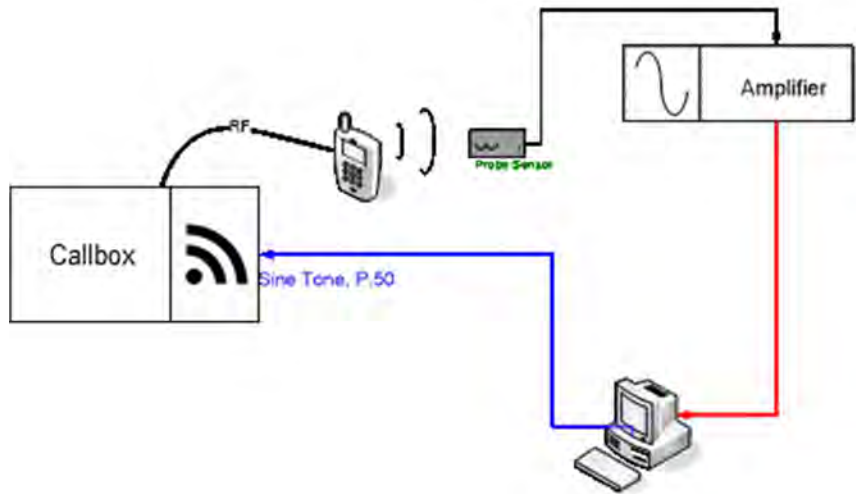



Figure 4-2
T-Coil Test Setup

FCC ID: PY7-84558E		HAC (T-COIL) TEST REPORT	Approved by: Managing Director
Filename: 1M2302060006-07.PY7	Test Dates: 2/14/2023 – 2/27/2023	DUT Type: Portable Handset	Page 8 of 84

REV 4.2.M
11/29/2022

II. Scanning Mechanism

Manufacturer:	TEM
Accuracy:	± 0.83 cm/meter
Minimum Step Size:	0.1 mm
Maximum speed	6.1 cm/sec
Line Voltage:	115 VAC
Line Frequency:	60 Hz
Material Composite:	Delrin (Acetal)
Data Control:	Parallel Port
Dynamic Range (X-Y-Z):	45 x 31.75 x 47 cm
Dimensions:	36" x 25" x 38"
Operating Area:	36" x 49" x 55"
Reflections:	< -20 dB (in anechoic chamber)

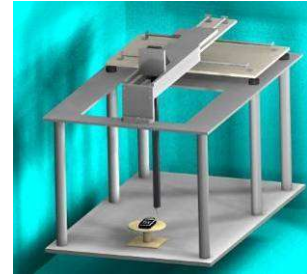

Figure 4-3
RF Near-Field Scanner

III. ITU-T P.50 Artificial Voice

Manufacturer:	ITU-T
Active Frequency Range:	100 Hz – 8 kHz
Stimulus Type:	Male and Female, no spaces
Single Sample Duration:	20.96 seconds
Activity Level:	100%

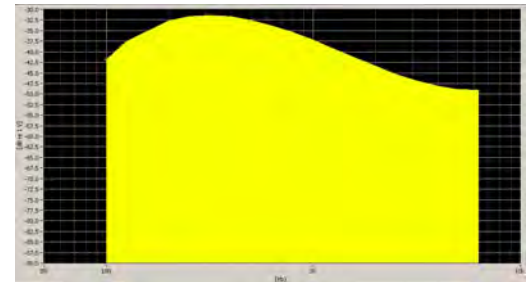

Figure 4-4
Spectral Characteristic of full P.50

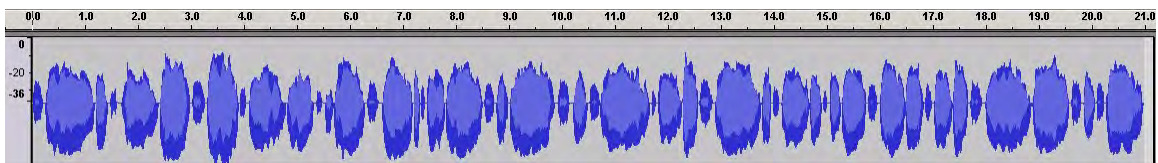

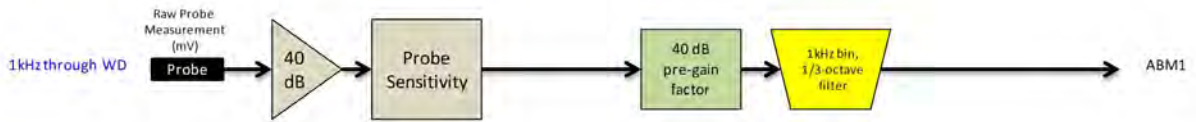

Figure 4-5
Temporal Characteristic of full P.50

FCC ID: PY7-84558E		HAC (T-COIL) TEST REPORT	Approved by: Managing Director
Filename: 1M2302060006-07.PY7	Test Dates: 2/14/2023 – 2/27/2023	DUT Type: Portable Handset	Page 9 of 84

REV 4.2.M
11/29/2022

ABM1 Measurement Block Diagram:



ABM2 Measurement Block Diagram:

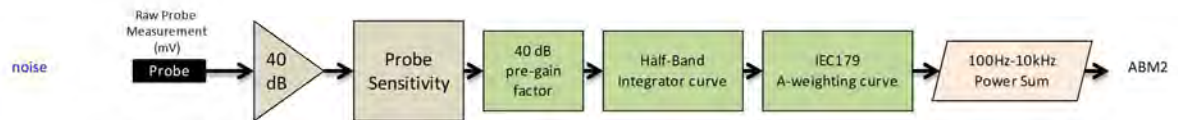

Figure 4-6 Magnetic Measurement Processing Steps

IV. Test Procedure

1. Ambient Noise Check per C63.19 §7.3.1
 - a. Ambient interference was monitored using a Real-Time Analyzer between 100-10,000 Hz with 1/3 octave filtering.
 - b. “A-weighting” and Half-Band Integration was applied to the measurements.
 - c. Since this measurement was measured in the same method as ABM2 measurements, this level was verified to be more than 10 dB below the lowest measurement signal (which is the highest ABM2 measurement for a T4 WD). Therefore the maximum noise level for a T4 WD with an ABM1 = -18 dBA/m is:

$$-18 - 30 - 10 = -58 \text{ dBA/m}$$
2. Measurement System Validation (See Figure 4-1)
 - a. The measurement system including the probe, pre-amplifier and acquisition system were validated as an entire system to ensure the reliability of test measurements.
 - b. ABM1 Validation
 The magnetic field at the center of the Helmholtz coil is given by the equation (per C63.19 Annex D.10.1):

$$H_c = \frac{NI}{r\sqrt{1.25^3}} = \frac{N\left(\frac{V}{R}\right)}{r\sqrt{1.25^3}}$$

Where H_c = magnetic field strength in amperes per meter

N = number of turns per coil

For Helmholtz Coil SN: SBI 1052, $N=20$; $r=0.13\text{m}$; $R=10.193\Omega$ and using $V=29\text{mV}$:

$$H_c = \frac{20 \cdot \left(\frac{0.029}{10.193}\right)}{0.13 \cdot \sqrt{1.25^3}} = 0.316 \text{ A/m} \approx -10 \text{ dB(A/m)}$$

Therefore a pure tone of 1kHz was applied into the coils such that 29mV was observed across the resistor. The voltmeter used for measurement was verified to be capable of measurements in the audio band range. This theoretically generates an expected field of -10 dB(A/m) in the center of the Helmholtz coil which was used to validate the probe

FCC ID: PY7-84558E		HAC (T-COIL) TEST REPORT	Approved by: Managing Director
Filename: 1M2302060006-07.PY7	Test Dates: 2/14/2023 – 2/27/2023	DUT Type: Portable Handset	Page 10 of 84

REV 4.2.M
11/29/2022

measurement at -10dB(A/m). This was verified to be within ± 0.5 dB of the -10dB(A/m) value (see Page 45).

c. Frequency Response Validation

The frequency response through the Helmholtz Coil was verified to be within 0.5 dB relative to 1kHz, between 300 – 3000 Hz using the P.50 signal as shown below:

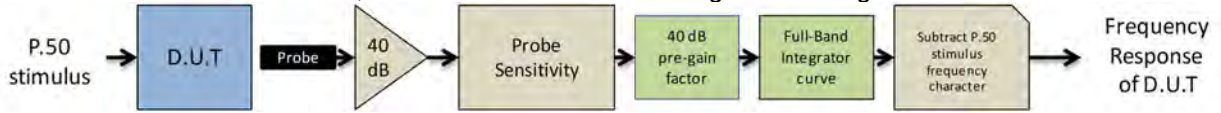

Figure 4-7 Frequency Response Validation

d. ABM2 Measurement Validation

WD noise measurements are filtered with A-weighting and Half-Band Integration over a frequency range of 100Hz – 10kHz to process ABM2 measurements. Below is the verification of the system processing A-weighting and Half-Band integration between system input to output within 0.5 dB of the theoretical result:

**Table 4-1
ABM2 Frequency Response Validation**

f (Hz)	HBI, A - Measured (dB re 1kHz)	HBI, A - Theoretical (dB re 1kHz)	dB Var.
100	-16.180	-16.170	-0.010
125	-13.257	-13.250	-0.007
160	-10.347	-10.340	-0.007
200	-8.017	-8.010	-0.007
250	-5.925	-5.920	-0.005
315	-4.045	-4.040	-0.005
400	-2.405	-2.400	-0.005
500	-1.212	-1.210	-0.002
630	-0.349	-0.350	0.001
800	0.071	0.070	0.001
1000	0.000	0.000	0.000
1250	-0.503	-0.500	-0.003
1600	-1.513	-1.510	-0.003
2000	-2.778	-2.780	0.002
2500	-4.316	-4.320	0.004
3150	-6.166	-6.170	0.004
4000	-8.322	-8.330	0.008
5000	-10.573	-10.590	0.017
6300	-13.178	-13.200	0.022
8000	-16.241	-16.270	0.029
10000	-19.495	-19.520	0.025

FCC ID: PY7-84558E		HAC (T-COIL) TEST REPORT	Approved by: Managing Director
Filename: 1M2302060006-07.PY7	Test Dates: 2/14/2023 – 2/27/2023	DUT Type: Portable Handset	Page 11 of 84

REV 4.2.M
11/29/2022

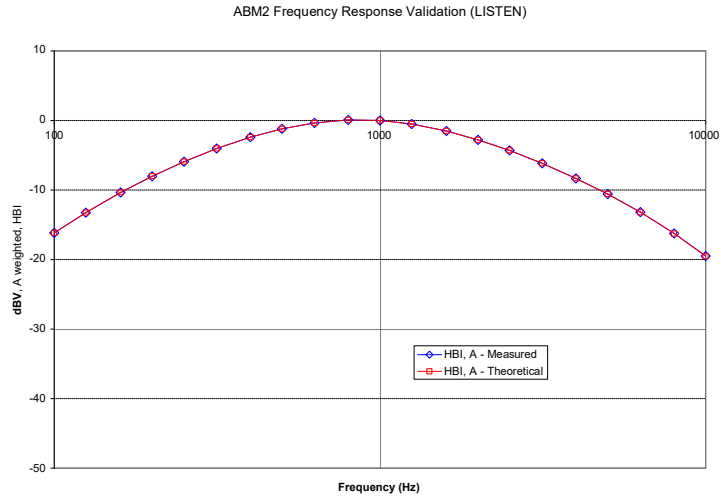

Figure 4-8
ABM2 Frequency Response Validation

The ABM2 result is a power sum from 100Hz to 10kHz with half-band integration and A-weighting. To verify the power sum measurement, a power sum over the full band was measured and verified to track with the source level (See Figure 4-9). Therefore the setup in this step was used to verify the power sum post-processing for ABM2 measurements. See below block diagram:

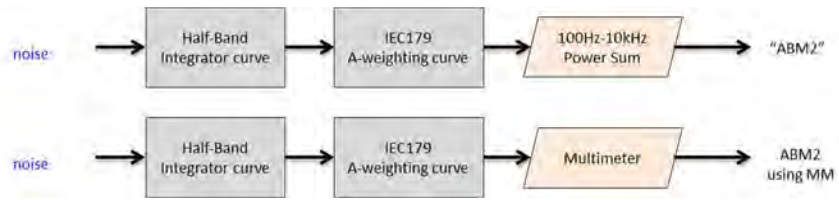

Figure 4-9
ABM2 Validation Block Diagram

The power summed output results for a known input were compared to the multi-meter results to verify any deviation in the post-processing implemented with the power-sum.

Table 4-2
ABM2 Power Sum Validation

WN Input (dBV)	Power Sum (dBV)	Multimeter-Full (dBV)	Dev (dB)
-60	-60.36	-60.2	0.16
-50	-50.19	-50.13	0.06
-40	-40.14	-40.03	0.11
-30	-30.13	-30.01	0.12
-20	-20.12	-20	0.12
-10	-10.14	-10	0.14

FCC ID: PY7-84558E		HAC (T-COIL) TEST REPORT	Approved by: Managing Director
Filename: 1M2302060006-07.PY7	Test Dates: 2/14/2023 – 2/27/2023	DUT Type: Portable Handset	Page 12 of 84

REV 4.2.M
11/29/2022

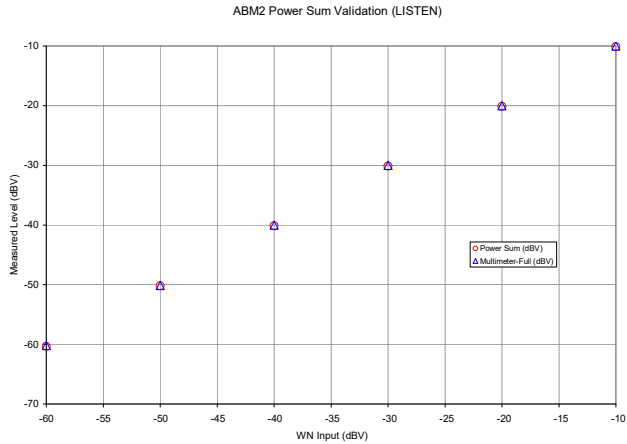

Figure 4-10
ABM2 Power Sum Validation

3. Measurement Test Setup

a. Fine scan above the WD (TEM)

- i. A multitone signal was applied to the handset such that the phone acoustic output was stable within 1dB over the probe settling time and with the acoustic output level at the C63.19 specified levels (below). The measurement step size was in 2 mm increments at a distance of 10 mm between the surface of the wireless device as shown below (note that in Figure 4-12, the grid is not to scale but merely a graphical representation of the coordinate system in use):

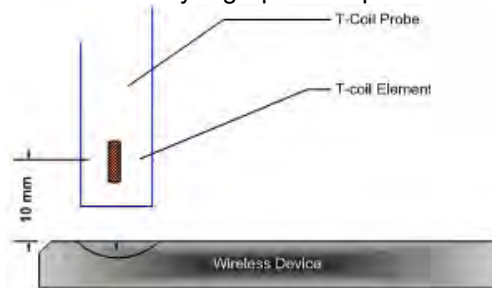

Figure 4-11
Measurement Distance

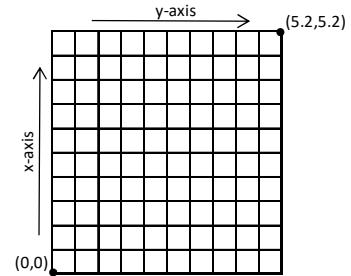

Figure 4-12
Measurement Grid

- ii. After scanning, the planar field maximum point was determined. The position of the probe was moved to this location to setup the test using the SoundCheck system.
 - iii. These steps were repeated for all T-coil orientations (axial and radial) per Figure 4-14 after a T-coil orientation was fully measured with the SoundCheck system.
- b. Speech Signal Setup to Base Station Simulator
- i. C63.19 Table 7-1 states audio reference input levels for various technologies:

Standard	Technology	Input Level (dBm0)
TIA/EIA/IS-2000	CDMA	-18
J-STD-007	GSM (217)	-16
T1/T1P1/3GPP	UMTS (WCDMA)	-16
IDEN™	TDMA (22 and 11 Hz)	-18

FCC ID: PY7-84558E		HAC (T-COIL) TEST REPORT	Approved by: Managing Director
Filename: 1M2302060006-07.PY7	Test Dates: 2/14/2023 – 2/27/2023	DUT Type: Portable Handset	Page 13 of 84

REV 4.2.M
11/29/2022

- ii. See Section 5 for more information regarding CMW500 audio level settings for Voice Over LTE (VoLTE) testing.
 - iii. See Section 6 for more information regarding audio level settings for Over-The-Top (OTT) Voice Over IP (VoIP) Testing.
 - c. Real-Time Analyzer (RTA)
 - i. The Real-Time Analyzer was configured to analyze measurements using 1/3 Octave band weighted filtering.
 - d. WD Radio Configuration Selection
 - i. The device was chosen to be tested in the worst-case ABM2 condition (See Section 7 for more information regarding worst-case configurations for UMTS. LTE configuration information can be found in Section 5 and 6. NR configuration information can be found in Section 6. WIFI configuration information can be found in Section 6.)
 - ii. Supported GSM vocoders were investigated for the worst-case ABM2 condition. GSM-EFR was deemed the worst-case condition for the GSM air interface.
- 4. Signal Quality Data Analysis
 - a. Narrow-band Magnetic Intensity
 - i. The standard specifies a 1kHz 1/3 octave band minimum field intensity for a sine tone. The ABM1 measurements were evaluated at 1kHz with 1/3 octave band filtering over an averaged period of 10 seconds.
 - b. Frequency Response
 - i. The appropriate frequency response curve was measured to curves in Figure 3-1 or Figure 3-2 between 300 – 3000 Hz using digital linear averaging (limit lines chosen according to measurement found in step 4a). A linear average over 3x the length of the artificial voice signal (3x sampling) was performed. A 10 second delay was configured in the measurement process of the stimulus to ensure handset vocoder latency effects and echo cancellation devices (if any) were appropriately stabilized during measurements.
 - ii. The appropriate post-processing was applied according to the system processing chain illustrated in Figure 4-7. All R10 frequencies were plotted with respect to 0dB at 1kHz value and aligned with respect to the EIA-504 mask.
 - iii. The margin is represented by the closest measured data point on the curve to the EIA-504 limit lines, in dB.
 - c. Signal Quality Index
 - i. Ensuring the WD was at maximum RF power, maximum volume, backlight off, display on, maximum contrast setting, keypad lights on (when possible) with no audio signal through the vocoder, the WD was measured over at least 100 Hz – 10,000 Hz, maximized over 5 seconds with a 50ms sample time for the ABM2 measurement (5 second time period is used in noise measurements under standards such as IEEE 269, etc.).
 - ii. After applying half-band integration and A-weighting to the result, a power sum was applied over each 1/3 octave bandwidth frequency for an ABM2 value.
 - iii. This result was subtracted from the ABM1 result in step a, to obtain the Signal Quality.

FCC ID: PY7-84558E		HAC (T-COIL) TEST REPORT	Approved by: Managing Director
Filename: 1M2302060006-07.PY7	Test Dates: 2/14/2023 – 2/27/2023	DUT Type: Portable Handset	Page 14 of 84

REV 4.2.M
11/29/2022

V. Test Setup

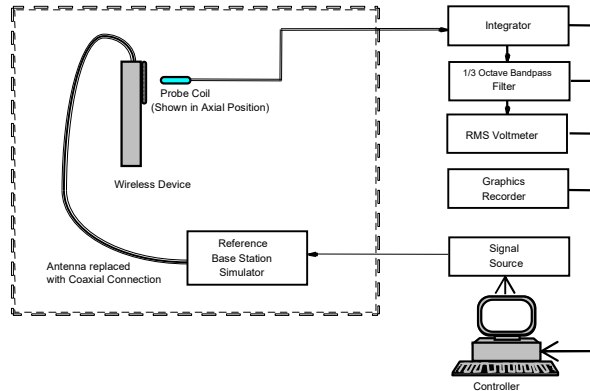

Figure 4-13
Audio Magnetic Field Test Setup

Environmental conditions such as temperature and relative humidity are monitored to ensure there are no impacts on system specifications. Proper voltage and power line frequency conditions are maintained with three phase power sources. Environmental noise and reflections are monitored through system checks.

VI. Deviation from C63.19 Test Procedure

Non-conducted RF connection due to inaccessible RF ports.

VII. Air Interface Technologies Tested

All air interfaces which support voice capabilities over a managed CMRS or pre-installed OTT VoIP applications were tested for T-coil unless otherwise noted. See Table 2-1 for more details regarding which modes were tested.

FCC ID: PY7-84558E		HAC (T-COIL) TEST REPORT	Approved by: Managing Director
Filename: 1M2302060006-07.PY7	Test Dates: 2/14/2023 – 2/27/2023	DUT Type: Portable Handset	Page 15 of 84

REV 4.2.M

11/29/2022

VIII. Wireless Device Channels and Frequencies

1. 2G/3G Modes

The frequencies listed in the table below are those that lie in the center of the bands used for cellular telephony. Low, middle and high channels were tested in each band for FCC compliance evaluation to ensure the maximum emission is captured across the entire band. Only middle channels were evaluated for data modes.

**Table 4-3
Center Channels and Frequencies**

Test frequencies & associated channels	
Channel	Frequency (MHz)
Cellular 850	
190 (GSM)	836.60
4183 (UMTS)	836.60
AWS 1750	
1412 (UMTS)	1730.40
PCS 1900	
661 (GSM)	1880
9400 (UMTS)	1880

2. 4G (LTE) Modes

The middle channel for every band and bandwidth combination was tested for each probe orientation. The band and bandwidth combination from each probe orientation resulting in the worst-case SNNR was additionally tested using low and high channels for that band and bandwidth combination. Low-mid and mid-high channels were additionally tested for LTE TDD. The middle channels and supported bandwidths from the worst-case bands according to Tables 6-6 and 6-7 were additionally evaluated with OTT VoIP for each probe orientation. See Tables 8-4 to 8-20 as well as 8-21 and 8-22 for LTE bandwidths and channels.

3. 5G (NR) Modes

The middle channel and supported bandwidths from the worst-case NR FDD band according to Table 6-11 was evaluated with OTT VoIP for each probe orientation. NR TDD was additionally evaluated with OTT VoIP for each probe orientation according to Table 6-12. The band and bandwidth combination from each probe orientation resulting in the worst-case SNNR was additionally tested using low and high channels for that band and bandwidth combination. Low-mid and mid-high channels were additionally tested for NR TDD. See Tables 8-25 and 8-26 for NR bandwidths and channels.

4. WIFI

The middle channel for each IEEE 802.11 standard was tested for each probe orientation. The 2.4GHz IEEE 802.11 standard from each probe orientation resulting in the worst-case SNNR was additionally tested using low and high channels. The 5GHz IEEE 802.11 standard from each probe orientation resulting in the worst-case SNNR was additionally tested on higher U-NII bands as well as applicable low and high channels. See Tables 8-28 to 8-32 for WIFI standards and channels.

FCC ID: PY7-84558E		HAC (T-COIL) TEST REPORT	Approved by: Managing Director
Filename: 1M2302060006-07.PY7	Test Dates: 2/14/2023 – 2/27/2023	DUT Type: Portable Handset	Page 16 of 84

REV 4.2.M
11/29/2022

IX. Test Flow

The flow diagram below was followed (From C63.19):

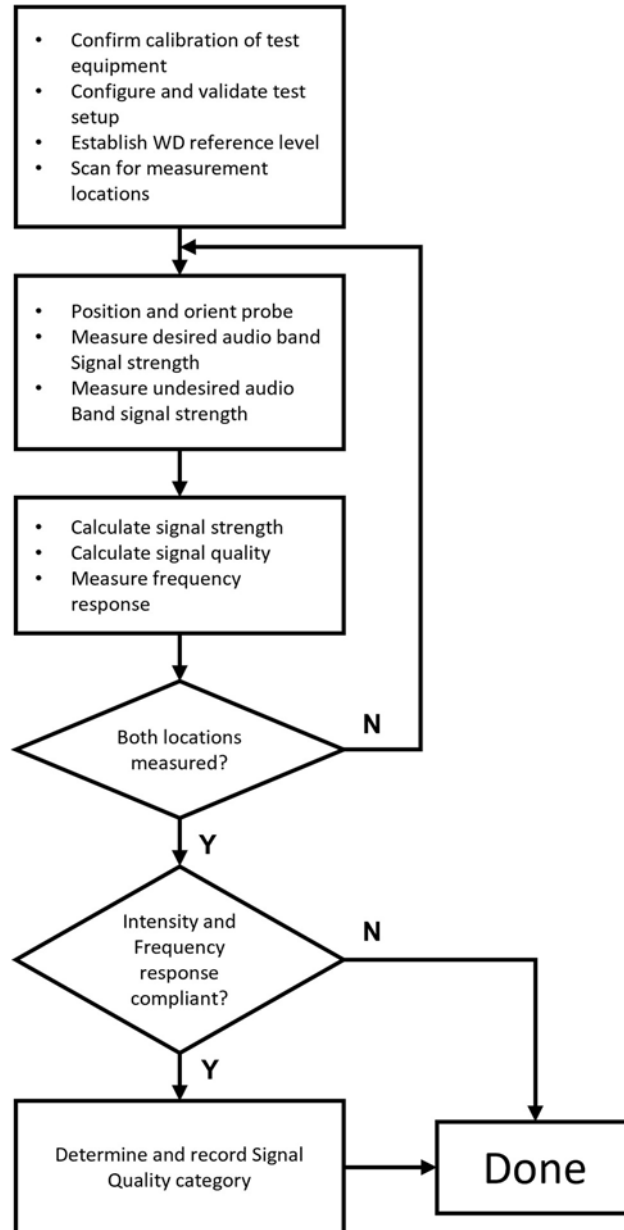



Figure 4-14
C63.19 T-Coil Signal Test Process

FCC ID: PY7-84558E		HAC (T-COIL) TEST REPORT	Approved by: Managing Director
Filename: 1M2302060006-07.PY7	Test Dates: 2/14/2023 – 2/27/2023	DUT Type: Portable Handset	Page 17 of 84

REV 4.2.M
11/29/2022

5. VOLTE TEST SYSTEM SETUP AND DUT CONFIGURATION

I. Test System Setup for VoLTE over IMS T-coil Testing

1. Equipment Setup

The general test setup used for VoLTE over IMS is shown below. The callbox used when performing VoLTE over IMS T-coil measurements is a CMW500. The Data Application Unit (DAU) of the CMW500 was used to simulate the IP Multimedia Subsystem (IMS) server.

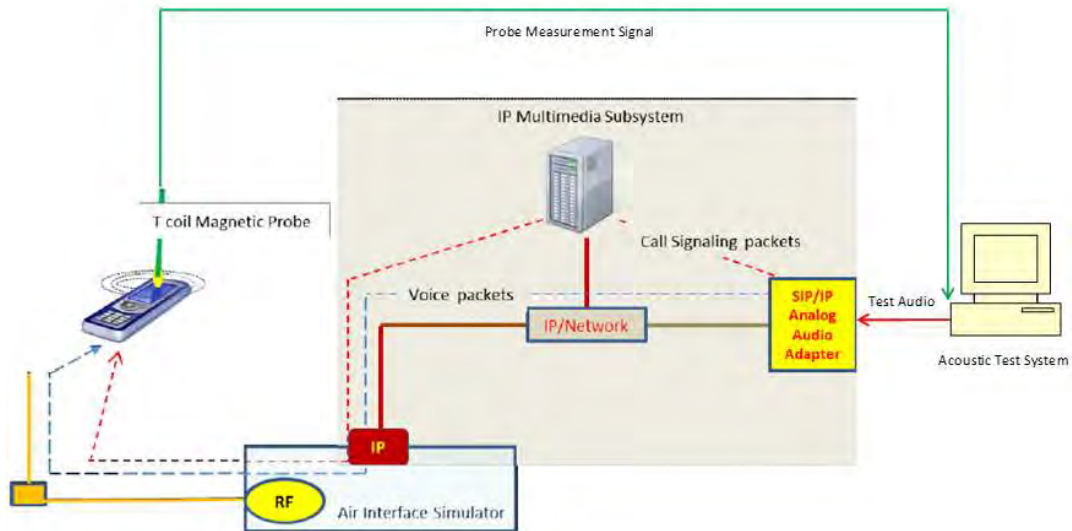



Figure 5-1
Test Setup for VoLTE over IMS T-Coil Measurements

2. Audio Level Settings

According to the July 2012 interpretations by the C63 Committee regarding the appropriate audio levels to be used for VoLTE over IMS T-coil testing, -16dBm0 shall be used for the normal speech input level*. The CMW500 base station simulator was manually configured to ensure that the settings for speech input and full scale levels resulted in the -16dBm0 speech input level to the DUT for the VoLTE over IMS connection.

* http://c63.org/documents/misc/posting/new_interpretations.htm

FCC ID: PY7-84558E		HAC (T-COIL) TEST REPORT	Approved by: Managing Director
Filename: 1M2302060006-07.PY7	Test Dates: 2/14/2023 – 2/27/2023	DUT Type: Portable Handset	Page 18 of 84

REV 4.2.M
11/29/2022

II. DUT Configuration for VoLTE over IMS T-coil Testing

1. Radio Configuration

An investigation was performed to determine the modulation and RB configuration to be used for testing. The effects of modulation and RB configuration were found to be independent of band and bandwidth; therefore, only one band and bandwidth were used for this investigation. 16QAM, 1RB, 50%RB offset was used for the testing as the worst-case configuration for the handset. See below table for SNNR comparison between different radio configurations:

Table 5-1
VoLTE over IMS SNNR by Radio Configuration

Band	Frequency [MHz]	Channel	Bandwidth [MHz]	Modulation	RB Size	RB Offset	ABM1 [dB(A/m)]	ABM2 [dB(A/m)]	SNNR [dB]
66	1750.0	132322	20	QPSK	1	0	0.07	-45.68	45.75
66	1750.0	132322	20	QPSK	1	50	-0.27	-45.33	45.06
66	1750.0	132322	20	QPSK	1	99	-0.34	-45.27	44.93
66	1750.0	132322	20	QPSK	50	0	-0.24	-45.34	45.10
66	1750.0	132322	20	QPSK	50	25	-0.08	-45.02	44.94
66	1750.0	132322	20	QPSK	50	50	0.06	-45.25	45.31
66	1750.0	132322	20	QPSK	100	0	0.15	-46.01	46.16
66	1750.0	132322	20	16QAM	1	0	0.15	-43.47	43.62
66	1750.0	132322	20	16QAM	1	50	0.09	-43.00	43.09
66	1750.0	132322	20	16QAM	1	99	0.14	-43.50	43.64
66	1750.0	132322	20	16QAM	50	0	0.05	-44.49	44.54
66	1750.0	132322	20	16QAM	50	25	0.22	-45.07	45.29
66	1750.0	132322	20	16QAM	50	50	-0.13	-45.10	44.97
66	1750.0	132322	20	16QAM	100	0	0.00	-44.86	44.86
66	1750.0	132322	20	64QAM	1	0	-0.26	-44.83	44.57
66	1750.0	132322	20	64QAM	1	50	0.52	-43.45	43.97
66	1750.0	132322	20	64QAM	1	99	0.14	-44.25	44.39
66	1750.0	132322	20	64QAM	50	0	0.10	-46.24	46.34
66	1750.0	132322	20	64QAM	50	25	-0.13	-45.35	45.22
66	1750.0	132322	20	64QAM	50	50	-0.02	-45.53	45.51
66	1750.0	132322	20	64QAM	100	0	-0.32	-45.09	44.77

2. Codec Configuration

An investigation was performed to determine the audio codec configuration to be used for testing. The effects of codec configuration were found to be independent of radio configuration; therefore, only one radio configuration was used for this investigation. The WB AMR 6.60kbps setting was used for the audio codec on the CMW500 for VoLTE over IMS T-coil testing. See below table for comparisons between different codecs and codec data rates:

Table 5-2
AMR Codec Investigation – VoLTE over IMS

Codec Setting:	WB AMR 23.85kbps	WB AMR 6.60kbps	NB AMR 12.2kbps	NB AMR 4.75kbps	Orientation	Band / BW	Channel
ABM1 (dBA/m)	1.15	0.06	2.10	1.85	Axial	LTE Band 66 20MHz	132322
ABM2 (dBA/m)	-43.04	-42.60	-43.41	-42.74			
Frequency Response	Pass	Pass	Pass	Pass			
S+N/N (dB)	44.19	42.66	45.51	44.59			

FCC ID: PY7-84558E		HAC (T-COIL) TEST REPORT	Approved by: Managing Director
Filename: 1M2302060006-07.PY7	Test Dates: 2/14/2023 – 2/27/2023	DUT Type: Portable Handset	Page 19 of 84

REV 4.2.M
11/29/2022

Table 5-3
EVS Codec Investigation - VoLTE over IMS

Codec Setting:	EVS Primary SWB 13.2kbps	EVS Primary SWB 9.6kbps	EVS Primary WB 13.2kbps	EVS Primary WB 5.9kbps	EVS Primary NB 13.2kbps	EVS Primary NB 5.9kbps	Orientation	Band / BW	Channel
ABM1 (dBA/m)	2.62	0.62	2.01	0.90	3.14	2.49	Axial	LTE Band 66 20MHz	132322
ABM2 (dBA/m)	-42.20	-42.16	-42.61	-42.26	-42.60	-42.72			
Frequency Response	Pass	Pass	Pass	Pass	Pass	Pass			
S+N/N (dB)	44.82	42.78	44.62	43.16	45.74	45.21			

- Mute on; Backlight off; Max Volume; Max Contrast
- TPC = "Max Power"

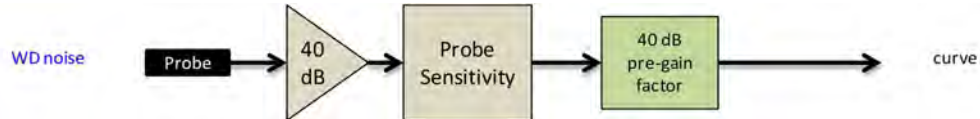

Figure 5-2
Audio Band Magnetic Curve Measurement Block Diagram

3. LTE TDD Uplink-Downlink Configuration Investigation for VoLTE over IMS

An investigation was performed to determine the worst-case Uplink-Downlink configuration for VoLTE over IMS T-Coil testing.

Per 3GPP TS 36.211, the total frame length for each TDD radio frame of length $T_f = 307200 \cdot T_s = 10$ ms, where T_s is a number of time units equal to $1/(15000 \times 2048)$ seconds. Additionally, each radio frame consists of 10 subframes, each of length $30720 \cdot T_s = 1$ ms, and subframes can be designated as uplink (U), downlink (D), or special subframe (S), depending on the Uplink-Downlink configuration as indicated in Table 4.2-2 of 3GPP TS 36.211. In the transmission duty factor calculation, the special subframe configuration with the shortest UpPTS duration within the special subframe is used and will be applied for measurement. From 3GPP TS 36.211 Table 4.2-1, the shortest UpPTS is $2192 \cdot T_s$ which occurs in the normal cyclic prefix and special subframe configuration 4.

See table below outlining the calculated transmission duty cycles for each Uplink-Downlink configuration:

Table 5-4
Uplink-Downlink Configurations for Type 2 Frame Structures

Uplink-downlink configuration	Downlink-to-Uplink Switch-point periodicity	Subframe number										Calculated Transmission Duty Cycle (%)
		0	1	2	3	4	5	6	7	8	9	
0	5 ms	D	S	U	U	U	D	S	U	U	U	61.4%
1	5 ms	D	S	U	U	D	D	S	U	U	D	41.4%
2	5 ms	D	S	U	D	D	D	S	U	D	D	21.4%
3	10 ms	D	S	U	U	U	D	D	D	D	D	30.7%
4	10 ms	D	S	U	U	D	D	D	D	D	D	20.7%
5	10 ms	D	S	U	D	D	D	D	D	D	D	10.7%
6	5 ms	D	S	U	U	U	D	S	U	U	D	51.4%

FCC ID: PY7-84558E		HAC (T-COIL) TEST REPORT	Approved by: Managing Director
Filename: 1M2302060006-07.PY7	Test Dates: 2/14/2023 – 2/27/2023	DUT Type: Portable Handset	Page 20 of 84

REV 4.2.M
11/29/2022

a. Power Class 3 Uplink-Downlink Configuration Investigation

Power Class 3 was evaluated with the following radio configuration: channel 40620, 20MHz BW, 16QAM, 1RB, 50%RB offset. For Power Class 3, all configurations (0-6) are supported. The configuration which resulted in the worst SNNR was used for full testing. Uplink-Downlink configuration 2 was used as the worst-case configuration for Power Class 3 VoLTE over IMS T-Coil testing. See table below for the SNNR comparison between each Uplink-Downlink configuration:

**Table 5-5
Power Class 3 VoLTE over IMS SNNR by UL-DL Configuration**

Frequency [MHz]	Channel	Bandwidth [MHz]	Modulation	RB Size	RB Offset	UL-DL Configuration	ABM1 [dB(A/m)]	ABM2 [dB(A/m)]	SNNR [dB]
2593.0	40620	20	16QAM	1	50	0	0.35	-37.15	37.50
2593.0	40620	20	16QAM	1	50	1	-0.21	-37.41	37.20
2593.0	40620	20	16QAM	1	50	2	0.11	-36.89	37.00
2593.0	40620	20	16QAM	1	50	3	0.33	-39.73	40.06
2593.0	40620	20	16QAM	1	50	4	0.10	-39.47	39.57
2593.0	40620	20	16QAM	1	50	5	-0.07	-39.26	39.19
2593.0	40620	20	16QAM	1	50	6	0.36	-37.04	37.40

b. Conclusion

Per the investigations above, UL-DL Configuration 2 was used to evaluate Power Class 3 VoLTE over IMS.

4. LTE EN-DC Configuration for VoLTE

VoLTE may be transported over 5G NR sub 6GHz bands. Therefore, additional analysis was performed to confirm that all EN-DC operations are passing. See Table 5-6 below for the results of this analysis.

**Table 5-6
VoLTE (during EN-DC) SNNR by LTE & NR Band**

Combination	LTE							NR							ABM1 [dB(A/m)]	ABM2 [dB(A/m)]	SNNR [dB]	
	LTE Band	LTE Bandwidth [MHz]	LTE Channel	LTE Frequency [MHz]	Modulation	LTE # RB	LTE RB Offset	NR Band	NR Bandwidth [MHz]	NR Channel	NR Frequency [MHz]	Waveform	Modulation	SCC UL# RB				SCC UL RB Offset
LTE Band 66 EN-DC	LTE B66	20	132322	1745.0	16QAM	1	50	n2	20	376000	1880.0	CP-OFDM	16QAM	1	1	0.03	-42.43	42.46
LTE Band 66 EN-DC	LTE B66	20	132322	1745.0	16QAM	1	50	n41	100	518598	2593.0	CP-OFDM	16QAM	1	1	0.03	-37.35	37.38
LTE Band 66 EN-DC	LTE B66	20	132322	1745.0	16QAM	1	50	n30	10	462000	2310.0	CP-OFDM	16QAM	1	1	0.03	-42.29	42.32
LTE Band 66 EN-DC	LTE B66	20	132322	1745.0	16QAM	1	50	n25	20	376500	1882.5	CP-OFDM	16QAM	1	1	0.03	-43.65	43.68
LTE Band 2 EN-DC	LTE B2	20	18900	1880.0	16QAM	1	25	n66	20	349000	1745.0	CP-OFDM	16QAM	1	1	-0.04	-43.74	43.70
LTE Band 2 EN-DC	LTE B2	20	18900	1880.0	16QAM	1	50	n30	10	462000	2310.0	CP-OFDM	16QAM	1	1	-0.04	-45.30	45.26
LTE Band 2 EN-DC	LTE B2	20	18900	1880.0	16QAM	1	25	n41	100	518598	2593.0	CP-OFDM	16QAM	1	1	-0.04	-35.07	35.03
LTE Band 30 EN-DC	LTE B30	10	27710	2310.0	16QAM	1	25	n66	20	349000	1745.0	CP-OFDM	16QAM	1	1	0.18	-38.67	38.85
LTE Band 30 EN-DC	LTE B30	10	27710	2310.0	16QAM	1	25	n2	20	376000	1880.0	CP-OFDM	16QAM	1	1	0.18	-38.85	39.03

FCC ID: PY7-84558E		HAC (T-COIL) TEST REPORT	Approved by: Managing Director
Filename: 1M2302060006-07.PY7	Test Dates: 2/14/2023 – 2/27/2023	DUT Type: Portable Handset	Page 21 of 84

REV 4.2.M
11/29/2022

6. OTT VOIP TEST SYSTEM AND DUT CONFIGURATION

I. Test System Setup for OTT VoIP T-Coil Testing

1. OTT VoIP Application

Google Meet is a pre-installed application on the DUT which allows for VoIP calls in a held-to-ear scenario. Meet uses the OPUS audio codec and supports a bitrate range of 6kb/s to 75kb/s. All air interfaces capable of a data connection were evaluated with Google Meet.

2. Equipment Setup

A CMW500 callbox was used to perform OTT VoIP T-coil measurements. The Data Application Unit (DAU) of the CMW500 was connected to the internet and allowed for an IP data connection on the DUT. An auxiliary VoIP unit was used to initiate an OTT VoIP call to the DUT. The auxiliary VoIP unit allowed for the configuration and monitoring of the OTT VoIP codec bitrate during a call. Both high and low bitrate settings were evaluated in to determine the worst-case configuration.

3. Audio Level Settings

According to KDB 285076 D02, the average speech level of -20dBm0 shall be used for protocols not specifically listed in Table 7.1 of ANSI C63.19-2011 or the ANSI C63.19-2011 VoLTE interpretation². The auxiliary VoIP unit allowed for monitoring the signal input level to ensure that the settings for speech input and full scale levels resulted in the -20dBm0 speech input level to the DUT for the OTT VoIP call.

II. DUT Configuration for OTT VoIP T-Coil Testing

1. Codec Configuration

An investigation was performed for each applicable data mode to determine the audio codec configuration to be used for testing. The effects of codec configuration were found to be independent of radio configuration; therefore, only one radio configuration for each applicable data mode was used for these investigations. The 75kbps codec setting was used for the audio codec on the auxiliary VoIP unit for OTT VoIP T-Coil testing. See below tables for comparisons between codec data rates on all applicable data modes:

Table 6-1
Codec Investigation – OTT VoIP (EDGE)

Codec Setting:	75kbps	6kbps	Orientation	Channel
ABM1 (dBA/m)	1.05	0.97	Axial	661
ABM2 (dBA/m)	-42.87	-43.15		
Frequency Response	Pass	Pass		
S+N/N (dB)	43.92	44.12		

² FCC Office of Engineering and Technology KDB, "285076 D02 T-Coil Testing for CMRS IP v04," February 23, 2022

FCC ID: PY7-84558E		HAC (T-COIL) TEST REPORT	Approved by: Managing Director
Filename: 1M2302060006-07.PY7	Test Dates: 2/14/2023 – 2/27/2023	DUT Type: Portable Handset	Page 22 of 84

REV 4.2.M
11/29/2022

**Table 6-2
Codec Investigation – OTT VoIP (HSPA)**

Codec Setting:	75kbps	6kbps	Orientation	Channel
ABM1 (dBA/m)	1.06	0.80	Axial	9400
ABM2 (dBA/m)	-47.99	-48.76		
Frequency Response	Pass	Pass		
S+N/N (dB)	49.05	49.56		

**Table 6-3
Codec Investigation – OTT VoIP (LTE)**

Codec Setting:	75kbps	6kbps	Orientation	Band / BW	Channel
ABM1 (dBA/m)	0.97	1.24	Axial	LTE Band 66 20MHz	132322
ABM2 (dBA/m)	-44.19	-44.11			
Frequency Response	Pass	Pass			
S+N/N (dB)	45.16	45.35			

**Table 6-4
Codec Investigation – OTT VoIP (NR)**

Codec Setting:	75kbps	6kbps	Orientation	Band / BW	Channel
ABM1 (dBA/m)	0.99	1.20	Axial	NR n66 20MHz	349000
ABM2 (dBA/m)	-44.31	-45.75			
Frequency Response	Pass	Pass			
S+N/N (dB)	45.30	46.95			

FCC ID: PY7-84558E		HAC (T-COIL) TEST REPORT	Approved by: Managing Director
Filename: 1M2302060006-07.PY7	Test Dates: 2/14/2023 – 2/27/2023	DUT Type: Portable Handset	Page 23 of 84

REV 4.2.M
11/29/2022

**Table 6-5
Codec Investigation – OTT VoIP (WIFI)**

Codec Setting:	75kbps	6kbps	Orientation	Band	Standard	Channel
ABM1 (dBA/m)	1.22	1.52	Axial	2.4GHz	IEEE 802.11 b	6
ABM2 (dBA/m)	-47.04	-48.03				
Frequency Response	Pass	Pass				
S+N/N (dB)	48.26	49.55				

- Mute on; Backlight off; Max Volume; Max Contrast
- Radio Configurations can be found in Section 8.II.F

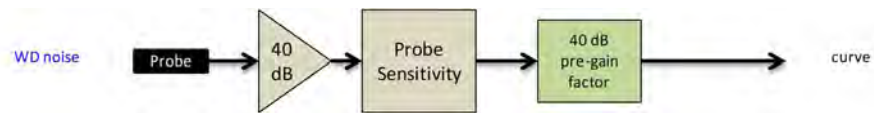

**Figure 6-1
Audio Band Magnetic Curve Measurement Block Diagram**

FCC ID: PY7-84558E		HAC (T-COIL) TEST REPORT	Approved by: Managing Director
Filename: 1M2302060006-07.PY7	Test Dates: 2/14/2023 – 2/27/2023	DUT Type: Portable Handset	Page 24 of 84

REV 4.2.M
11/29/2022

2. Radio Configuration for OTT VoIP (LTE)

An investigation was performed to determine the worst-case LTE FDD band to be used for OTT VoIP testing. LTE FDD Band 25 was used for the testing as the worst-case configuration for the handset. See below table for SNNR comparison between different LTE FDD bands:

Table 6-6
OTT VoIP (LTE FDD) SNNR by LTE Band

Band	Frequency [MHz]	Channel	Bandwidth [MHz]	Modulation	RB Size	RB Offset	ABM1 [dB(A/m)]	ABM2 [dB(A/m)]	SNNR [dB]
71	680.5	133297	20	16QAM	1	50	0.89	-45.52	46.41
12	707.5	23095	10	16QAM	1	25	0.91	-45.96	46.87
12 - SUB	707.5	23095	10	16QAM	1	25	0.75	-46.24	46.99
13	782.0	23230	10	16QAM	1	25	0.84	-45.73	46.57
13 - SUB	782.0	23230	10	16QAM	1	25	0.71	-46.17	46.88
5	836.5	20525	10	16QAM	1	25	0.92	-45.82	46.74
5 - SUB	836.5	20525	10	16QAM	1	25	0.75	-45.46	46.21
4	1732.5	20175	20	16QAM	1	50	0.93	-43.63	44.56
66	1745.0	132322	20	16QAM	1	50	0.92	-43.99	44.91
2	1880.0	18900	20	16QAM	1	50	0.92	-43.42	44.34
25	1882.5	26365	20	16QAM	1	50	0.93	-43.31	44.24
30	2310.0	27710	10	16QAM	1	25	0.94	-44.43	45.37

An investigation was performed to determine the worst-case LTE TDD band to be used for OTT VoIP testing. LTE TDD Band 41 (PC3) was used for the testing as the worst-case configuration for the handset. See below table for SNNR comparison between different LTE TDD bands:

Table 6-7
OTT VoIP (LTE TDD) SNNR by LTE Band

Band	Frequency [MHz]	Channel	Bandwidth [MHz]	Modulation	RB Size	RB Offset	ABM1 [dB(A/m)]	ABM2 [dB(A/m)]	SNNR [dB]
41 (PC3)	2593.0	40620	20	16QAM	1	50	0.79	-37.37	38.16
48	3625.0	55990	20	16QAM	1	50	0.87	-41.18	42.05
48 - SUB	3625.0	55990	20	16QAM	1	50	0.73	-40.02	40.75

3. LTE EN-DC Configuration for OTT VoIP

LTE EN-DC using the Sub Antenna was evaluated to ensure compliance. See Table 6-8 below for the results of this analysis.

Table 6-8
OTT VoIP (LTE FDD EN-DC) SNNR by LTE Band

Combination	LTE							NR							ABM1 [dB(A/m)]	ABM2 [dB(A/m)]	SNNR [dB]	
	LTE Band	LTE Bandwidth [MHz]	LTE Channel	LTE Frequency [MHz]	Modulation	LTE # RB	LTE RB Offset	NR Band	NR Bandwidth [MHz]	NR Channel	NR Frequency [MHz]	Waveform	Modulation	SCC UL# RB				SCC UL RB Offset
LTE Band 66 EN-DC	LTE B66	20	132322	1745.0	16QAM	1	50	n2	20	376000	1880.0	CP-OFDM	16QAM	1	1	0.91	-42.43	43.34
LTE Band 66 EN-DC	LTE B66	20	132322	1745.0	16QAM	1	50	n41	100	518598	2593.0	CP-OFDM	16QAM	1	1	0.92	-37.35	38.27
LTE Band 66 EN-DC	LTE B66	20	132322	1745.0	16QAM	1	50	n30	10	462000	2310.0	CP-OFDM	16QAM	1	1	0.87	-42.29	43.16
LTE Band 66 EN-DC	LTE B66	20	132322	1745.0	16QAM	1	50	n25	20	376500	1882.5	CP-OFDM	16QAM	1	1	0.92	-43.65	44.57
LTE Band 2 EN-DC	LTE B2	20	18900	1880.0	16QAM	1	25	n66	20	349000	1745.0	CP-OFDM	16QAM	1	1	0.85	-43.74	44.59
LTE Band 2 EN-DC	LTE B2	20	18900	1880.0	16QAM	1	50	n30	10	462000	2310.0	CP-OFDM	16QAM	1	1	1.03	-45.30	46.33
LTE Band 2 EN-DC	LTE B2	20	18900	1880.0	16QAM	1	25	n41	100	518598	2593.0	CP-OFDM	16QAM	1	1	0.87	-35.07	35.94
LTE Band 30 EN-DC	LTE B30	10	27710	2310.0	16QAM	1	25	n66	20	349000	1745.0	CP-OFDM	16QAM	1	1	0.81	-38.67	39.48
LTE Band 30 EN-DC	LTE B30	10	27710	2310.0	16QAM	1	25	n2	20	376000	1880.0	CP-OFDM	16QAM	1	1	0.83	-38.85	39.68

FCC ID: PY7-84558E		HAC (T-COIL) TEST REPORT	Approved by: Managing Director
Filename: 1M2302060006-07.PY7	Test Dates: 2/14/2023 – 2/27/2023	DUT Type: Portable Handset	Page 25 of 84

REV 4.2.M
11/29/2022

4. Interim Procedure for evaluation OTT VoIP (NR)

The following procedure is used to evaluate OTT VoIP (NR) given equipment limitations.

- a. This procedure is applicable for OTT VoIP (NR) voice calls that use the same protocol, codec(s), and reference level as OTT VoIP (LTE) (i.e. -20dBm0).
- b. Establish the $ABM1_{NR}$ value by using the $ABM1_{LTE}$ magnetic intensity for an LTE call using a correlating LTE band through existing procedures and test equipment.
- c. Establish an $ABM2_{NR}$ value using factory test mode (FTM) to simulate a NR connection for the desired NR band and channel under test.
- d. The following information is documented in Section 9:
 - i. $ABM2_{LTE}$ and $ABM2_{NR}$ for respective tests.
 - ii. Calculate SNNR:
 1. $ABM1 = ABM1_{LTE}$
 2. $ABM2 = ABM2_{NR}$
 3. $SNNR_{NR} = [ABM1_{LTE} - ABM2_{NR}] - 3dB$
 - a. A 3dB margin is built in to ensure conservative results with this interim procedure.

The above is only applicable for OTT VoIP scenarios, this device does not support VoNR over IMS.

The manufacturer has confirmed the handset as designed is expected to exhibit similar audio intensity levels between an OTT VoIP call placed over a 4G LTE and a 5G Sub-6GHz data connection.

Note: The green highlighted text is approved by FCC under the TCB PAG Re-Use Policy 388624 D01.

FCC ID: PY7-84558E		HAC (T-COIL) TEST REPORT	Approved by: Managing Director
Filename: 1M2302060006-07.PY7	Test Dates: 2/14/2023 – 2/27/2023	DUT Type: Portable Handset	Page 26 of 84

REV 4.2.M
11/29/2022

5. Radio Configuration for OTT VoIP (NR)

An investigation was performed to determine the waveform, modulation, and RB configuration to be used for testing. Due to equipment limitations, the procedure outlined in 6.II.4 was used to evaluate the SNNR for DFT-s-OFDM radio configuration in Table 6-10. CP-OFDM was evaluated with a callbox. CP-OFDM, 16QAM, 1RB, 99%RB offset was used for the testing as the worst-case configuration for the handset. See below table for SNNR comparison between different radio configurations:

**Table 6-9
NR OTT VoIP SNNR by Radio Configuration (CP-OFDM)**

Band	Frequency [MHz]	Channel	Bandwidth [MHz]	Waveform	Modulation	RB Size	RB Offset	ABM _{1LTE} [dB/(A/m)]	ABM _{2NR} [dB/(A/m)]	SNNR _{NR} [dB]
n66	1745.0	349000	20	CP-OFDM	QPSK	1	1	0.95	-44.59	45.54
n66	1745.0	349000	20	CP-OFDM	QPSK	1	53	0.97	-44.59	45.56
n66	1745.0	349000	20	CP-OFDM	QPSK	1	104	0.73	-43.87	44.60
n66	1745.0	349000	20	CP-OFDM	QPSK	53	0	0.81	-45.10	45.91
n66	1745.0	349000	20	CP-OFDM	QPSK	53	26	0.85	-46.08	46.93
n66	1745.0	349000	20	CP-OFDM	QPSK	53	53	0.82	-45.56	46.38
n66	1745.0	349000	20	CP-OFDM	QPSK	106	0	0.87	-45.73	46.60
n66	1745.0	349000	20	CP-OFDM	16QAM	1	1	0.87	-44.53	45.40
n66	1745.0	349000	20	CP-OFDM	16QAM	1	53	0.85	-44.45	45.30
n66	1745.0	349000	20	CP-OFDM	16QAM	1	104	0.87	-42.53	43.40
n66	1745.0	349000	20	CP-OFDM	16QAM	53	0	0.86	-45.71	46.57
n66	1745.0	349000	20	CP-OFDM	16QAM	53	26	0.90	-45.34	46.24
n66	1745.0	349000	20	CP-OFDM	16QAM	53	53	0.86	-45.85	46.71
n66	1745.0	349000	20	CP-OFDM	16QAM	106	0	0.91	-45.51	46.42
n66	1745.0	349000	20	CP-OFDM	64QAM	1	1	0.90	-43.11	44.01
n66	1745.0	349000	20	CP-OFDM	64QAM	1	53	0.92	-44.51	45.43
n66	1745.0	349000	20	CP-OFDM	64QAM	1	104	0.92	-45.06	45.98
n66	1745.0	349000	20	CP-OFDM	64QAM	53	0	0.90	-45.28	46.18
n66	1745.0	349000	20	CP-OFDM	64QAM	53	26	0.91	-45.37	46.28
n66	1745.0	349000	20	CP-OFDM	64QAM	53	53	0.92	-45.72	46.64
n66	1745.0	349000	20	CP-OFDM	64QAM	106	0	0.91	-43.96	44.87
n66	1745.0	349000	20	CP-OFDM	256QAM	1	1	0.90	-44.45	45.35
n66	1745.0	349000	20	CP-OFDM	256QAM	1	53	0.93	-45.44	46.37
n66	1745.0	349000	20	CP-OFDM	256QAM	1	104	0.91	-44.96	45.87
n66	1745.0	349000	20	CP-OFDM	256QAM	53	0	0.91	-45.33	46.24
n66	1745.0	349000	20	CP-OFDM	256QAM	53	26	0.92	-45.35	46.27
n66	1745.0	349000	20	CP-OFDM	256QAM	53	53	0.91	-45.64	46.55
n66	1745.0	349000	20	CP-OFDM	256QAM	106	0	0.91	-45.50	46.41

FCC ID: PY7-84558E		HAC (T-COIL) TEST REPORT	Approved by: Managing Director
Filename: 1M2302060006-07.PY7	Test Dates: 2/14/2023 – 2/27/2023	DUT Type: Portable Handset	Page 27 of 84

REV 4.2.M

11/29/2022

Table 6-10
NR OTT VoIP SNNR by Radio Configuration (DFT-s-OFDM)

Band	Frequency [MHz]	Channel	Bandwidth [MHz]	Waveform	Modulation	RB Size	RB Offset	ABM _{1LTE} [dB(A/m)]	ABM _{2NR} [dB(A/m)]	SNNR _{NR} [dB]
n66	1745.0	349000	20	DFT-s-OFDM	π/2-BPSK	1	1	0.73	-45.76	46.49
n66	1745.0	349000	20	DFT-s-OFDM	π/2-BPSK	1	53	0.73	-45.65	46.38
n66	1745.0	349000	20	DFT-s-OFDM	π/2-BPSK	1	104	0.73	-47.75	48.48
n66	1745.0	349000	20	DFT-s-OFDM	π/2-BPSK	50	0	0.73	-48.82	49.55
n66	1745.0	349000	20	DFT-s-OFDM	π/2-BPSK	50	28	0.73	-47.67	48.40
n66	1745.0	349000	20	DFT-s-OFDM	π/2-BPSK	50	53	0.73	-48.04	48.77
n66	1745.0	349000	20	DFT-s-OFDM	π/2-BPSK	100	0	0.73	-48.12	48.85
n66	1745.0	349000	20	DFT-s-OFDM	QPSK	1	1	0.73	-47.36	48.09
n66	1745.0	349000	20	DFT-s-OFDM	QPSK	1	53	0.73	-47.40	48.13
n66	1745.0	349000	20	DFT-s-OFDM	QPSK	1	104	0.73	-47.26	47.99
n66	1745.0	349000	20	DFT-s-OFDM	QPSK	50	0	0.73	-48.63	49.36
n66	1745.0	349000	20	DFT-s-OFDM	QPSK	50	28	0.73	-48.69	49.42
n66	1745.0	349000	20	DFT-s-OFDM	QPSK	50	53	0.73	-48.25	48.98
n66	1745.0	349000	20	DFT-s-OFDM	QPSK	100	0	0.73	-47.89	48.62
n66	1745.0	349000	20	DFT-s-OFDM	16QAM	1	1	0.73	-47.20	47.93
n66	1745.0	349000	20	DFT-s-OFDM	16QAM	1	53	0.73	-46.00	46.73
n66	1745.0	349000	20	DFT-s-OFDM	16QAM	1	104	0.73	-45.52	46.25
n66	1745.0	349000	20	DFT-s-OFDM	16QAM	50	0	0.73	-48.37	49.10
n66	1745.0	349000	20	DFT-s-OFDM	16QAM	50	28	0.73	-48.35	49.08
n66	1745.0	349000	20	DFT-s-OFDM	16QAM	50	53	0.73	-49.15	49.88
n66	1745.0	349000	20	DFT-s-OFDM	16QAM	100	0	0.73	-49.06	49.79
n66	1745.0	349000	20	DFT-s-OFDM	64QAM	1	1	0.73	-46.92	47.65
n66	1745.0	349000	20	DFT-s-OFDM	64QAM	1	53	0.73	-46.30	47.03
n66	1745.0	349000	20	DFT-s-OFDM	64QAM	1	104	0.73	-45.51	46.24
n66	1745.0	349000	20	DFT-s-OFDM	64QAM	50	0	0.73	-47.61	48.34
n66	1745.0	349000	20	DFT-s-OFDM	64QAM	50	28	0.73	-47.23	47.96
n66	1745.0	349000	20	DFT-s-OFDM	64QAM	50	53	0.73	-48.40	49.13
n66	1745.0	349000	20	DFT-s-OFDM	64QAM	100	0	0.73	-48.88	49.61
n66	1745.0	349000	20	DFT-s-OFDM	256QAM	1	1	0.73	-46.86	47.59
n66	1745.0	349000	20	DFT-s-OFDM	256QAM	1	53	0.73	-47.04	47.77
n66	1745.0	349000	20	DFT-s-OFDM	256QAM	1	104	0.73	-46.62	47.35
n66	1745.0	349000	20	DFT-s-OFDM	256QAM	50	0	0.73	-47.31	48.04
n66	1745.0	349000	20	DFT-s-OFDM	256QAM	50	28	0.73	-48.68	49.41
n66	1745.0	349000	20	DFT-s-OFDM	256QAM	50	53	0.73	-47.92	48.65
n66	1745.0	349000	20	DFT-s-OFDM	256QAM	100	0	0.73	-48.81	49.54

An investigation was performed to determine the worst-case NR FDD band to be used for OTT VoIP testing. NR n66 was used for the testing as the worst-case configuration for the handset. See below table for SNNR comparison between different NR FDD bands:

Table 6-11
OTT VoIP (NR FDD) SNNR by Band

Band	Frequency [MHz]	Channel	Bandwidth [MHz]	Waveform	Modulation	RB Size	RB Offset	ABM _{1LTE} [dB(A/m)]	ABM _{2NR} [dB(A/m)]	SNNR _{NR} [dB]
n71	680.5	136100	20	CP-OFDM	16QAM	1	104	0.82	-44.93	45.75
n5	836.5	167300	20	CP-OFDM	16QAM	1	104	0.82	-43.97	44.79
n5 - SUB	836.5	167300	20	CP-OFDM	16QAM	1	104	0.71	-43.72	44.43
n66	1745.0	349000	20	CP-OFDM	16QAM	1	104	0.77	-42.89	43.66
n2	1880.0	376000	20	CP-OFDM	16QAM	1	104	0.77	-43.02	43.79
n25	1882.5	376500	20	CP-OFDM	16QAM	1	104	0.79	-44.10	44.89
n30	2310.0	462000	10	CP-OFDM	16QAM	1	50	0.80	-46.07	46.87

An investigation was performed to determine the worst-case NR TDD band to be used for OTT VoIP testing. NR n77 (PC2) - SUB was used for the testing as the worst-case configuration for the handset. See below table for SNNR comparison between different NR TDD bands:

Table 6-12
OTT VoIP (NR TDD) SNNR by Band

Band	Frequency [MHz]	Channel	Bandwidth [MHz]	Waveform	Modulation	RB Size	RB Offset	ABM _{1LTE} [dB(A/m)]	ABM _{2NR} [dB(A/m)]	SNNR _{NR} [dB]
n41 (PC2)	2592.99	518598	100	CP-OFDM	16QAM	1	271	0.79	-41.28	42.07
n77 (DoD, PC2)	3500.0	633334	100	CP-OFDM	16QAM	1	271	0.73	-42.00	42.73
n77 (DoD, PC2) - SUB	3500.0	633334	100	CP-OFDM	16QAM	1	271	0.73	-40.67	41.40
n77 (PC2)	3840.00	656000	100	CP-OFDM	16QAM	1	271	0.73	-42.39	43.12
n77 (PC2) - SUB	3840.00	656000	100	CP-OFDM	16QAM	1	271	0.73	-40.33	41.06

FCC ID: PY7-84558E		HAC (T-COIL) TEST REPORT	Approved by: Managing Director
Filename: 1M2302060006-07.PY7	Test Dates: 2/14/2023 – 2/27/2023	DUT Type: Portable Handset	Page 28 of 84

NR TDD UL MIMO was evaluated to ensure compliance. Therefore, additional analysis was performed to confirm that all UL MIMO operations are passing. See below table for SNNR comparison between different NR TDD UL MIMO bands:

Table 6-13
OTT VoIP (NR UL MIMO) SNNR by Band

Combination	Band	Bandwidth [MHz]	Channel	Frequency [MHz]	Waveform	Modulation	RB Size	RB Offset	ABM1 [dB(A/m)]	ABM2 [dB(A/m)]	SNNR [dB]
UL MIMO n41	NR n41	100	518598	2593.0	CP-OFDM	16QAM	1	271	0.79	-36.23	37.02
UL MIMO n77_DoD	NR n77	100	633334	3500.0	CP-OFDM	16QAM	1	271	0.73	-39.85	40.58
UL MIMO n77_C	NR n77	100	656000	3840.0	CP-OFDM	16QAM	1	271	0.73	-38.75	39.48

6. Radio Configuration for OTT VoIP (WIFI)

An investigation was performed on all applicable data rates and modulations to determine the radio configuration to be used for testing. See tables below for SNNR comparison between radio configurations in each IEEE 802.11 standard:

Table 6-14
IEEE 802.11b SNNR by Radio Configuration

Mode	Channel	Modulation	Data Rate [Mbps]	ABM1 [dB(A/m)]	ABM2 [dB(A/m)]	SNNR [dB]
IEEE 802.11b	6	DSSS	1	1.05	-47.34	48.39
IEEE 802.11b	6	DSSS	2	1.01	-46.90	47.91
IEEE 802.11b	6	CCK	5.5	1.00	-46.20	47.20
IEEE 802.11b	6	CCK	11	0.98	-46.16	47.14

Table 6-15
IEEE 802.11g/a SNNR by Radio Configuration

Mode	Channel	Modulation	Data Rate [Mbps]	ABM1 [dB(A/m)]	ABM2 [dB(A/m)]	SNNR [dB]
IEEE 802.11g	6	BPSK	6	0.96	-47.44	48.40
IEEE 802.11g	6	BPSK	9	0.96	-47.17	48.13
IEEE 802.11g	6	QPSK	12	0.91	-46.20	47.11
IEEE 802.11g	6	QPSK	18	0.93	-45.88	46.81
IEEE 802.11g	6	16QAM	24	0.80	-46.61	47.41
IEEE 802.11g	6	16QAM	36	0.83	-46.20	47.03
IEEE 802.11g	6	64QAM	48	0.93	-46.87	47.80
IEEE 802.11g	6	64QAM	54	0.89	-46.78	47.67

FCC ID: PY7-84558E		HAC (T-COIL) TEST REPORT	Approved by: Managing Director
Filename: 1M2302060006-07.PY7	Test Dates: 2/14/2023 – 2/27/2023	DUT Type: Portable Handset	Page 29 of 84

REV 4.2.M
11/29/2022

Table 6-16
IEEE 802.11n/ac 20MHz BW SNNR by Radio Configuration

Mode	Bandwidth [MHz]	Channel	Modulation	MCS Index	ABM1 [dB(A/m)]	ABM2 [dB(A/m)]	SNNR [dB]
IEEE 802.11n	20	40	BPSK	0	0.93	-46.63	47.56
IEEE 802.11n	20	40	QPSK	1	0.91	-49.02	49.93
IEEE 802.11n	20	40	QPSK	2	0.88	-48.62	49.50
IEEE 802.11n	20	40	16QAM	3	0.90	-48.30	49.20
IEEE 802.11n	20	40	16QAM	4	0.91	-48.73	49.64
IEEE 802.11n	20	40	64QAM	5	0.87	-47.85	48.72
IEEE 802.11n	20	40	64QAM	6	0.87	-46.80	47.67
IEEE 802.11n	20	40	64QAM	7	0.87	-47.93	48.80
IEEE 802.11ac	20	40	256QAM	8	0.78	-47.21	47.99

Table 6-17
IEEE 802.11ax SU 20MHz BW SNNR by Radio Configuration

Mode	Bandwidth [MHz]	Channel	Modulation	MCS Index	ABM1 [dB(A/m)]	ABM2 [dB(A/m)]	SNNR [dB]
IEEE 802.11ax SU	20	40	BPSK	0	0.99	-45.85	46.84
IEEE 802.11ax SU	20	40	QPSK	1	1.01	-46.86	47.87
IEEE 802.11ax SU	20	40	QPSK	2	1.00	-46.31	47.31
IEEE 802.11ax SU	20	40	16QAM	3	0.99	-46.72	47.71
IEEE 802.11ax SU	20	40	16QAM	4	1.02	-47.17	48.19
IEEE 802.11ax SU	20	40	64QAM	5	1.03	-46.34	47.37
IEEE 802.11ax SU	20	40	64QAM	6	0.99	-45.79	46.78
IEEE 802.11ax SU	20	40	64QAM	7	1.02	-46.77	47.79
IEEE 802.11ax SU	20	40	256QAM	8	1.02	-47.06	48.08
IEEE 802.11ax SU	20	40	256QAM	9	1.02	-46.88	47.90
IEEE 802.11ax SU	20	40	1024QAM	10	1.02	-46.86	47.88
IEEE 802.11ax SU	20	40	1024QAM	11	1.01	-46.41	47.42

Table 6-18
IEEE 802.11ax RU 20MHz BW SNNR by Radio Configuration

Mode	Bandwidth [MHz]	Channel	Modulation	MCS Index	RU Index	ABM1 [dB(A/m)]	ABM2 [dB(A/m)]	SNNR [dB]
IEEE 802.11ax RU	20	40	64QAM	6	0	0.98	-47.98	48.96
IEEE 802.11ax RU	20	40	64QAM	6	8	0.98	-47.86	48.84
IEEE 802.11ax RU	20	40	64QAM	6	37	0.94	-47.39	48.33
IEEE 802.11ax RU	20	40	64QAM	6	40	0.99	-47.73	48.72
IEEE 802.11ax RU	20	40	64QAM	6	53	0.97	-47.68	48.65
IEEE 802.11ax RU	20	40	64QAM	6	54	0.97	-46.81	47.78
IEEE 802.11ax RU	20	40	64QAM	6	61	0.97	-47.23	48.20

FCC ID: PY7-84558E		HAC (T-COIL) TEST REPORT		Approved by: Managing Director
Filename: 1M2302060006-07.PY7	Test Dates: 2/14/2023 – 2/27/2023	DUT Type: Portable Handset		Page 30 of 84

REV 4.2.M
11/29/2022

Table 6-19
IEEE 802.11n/ac 40MHz BW SNNR by Radio Configuration

Mode	Bandwidth [MHz]	Channel	Modulation	MCS Index	ABM1 [dB(A/m)]	ABM2 [dB(A/m)]	SNNR [dB]
IEEE 802.11n	40	38	BPSK	0	0.76	-47.76	48.52
IEEE 802.11n	40	38	QPSK	1	0.84	-47.75	48.59
IEEE 802.11n	40	38	QPSK	2	0.85	-47.37	48.22
IEEE 802.11n	40	38	16QAM	3	0.86	-48.14	49.00
IEEE 802.11n	40	38	16QAM	4	0.85	-47.01	47.86
IEEE 802.11n	40	38	64QAM	5	0.84	-47.97	48.81
IEEE 802.11n	40	38	64QAM	6	0.86	-46.69	47.55
IEEE 802.11n	40	38	64QAM	7	0.85	-47.43	48.28
IEEE 802.11ac	40	38	256QAM	8	0.83	-47.54	48.37
IEEE 802.11ac	40	38	256QAM	9	0.80	-47.33	48.13

Table 6-20
IEEE 802.11ax SU 40MHz BW SNNR by Radio Configuration

Mode	Bandwidth [MHz]	Channel	Modulation	MCS Index	ABM1 [dB(A/m)]	ABM2 [dB(A/m)]	SNNR [dB]
IEEE 802.11ax SU	40	38	BPSK	0	0.74	-47.07	47.81
IEEE 802.11ax SU	40	38	QPSK	1	0.88	-46.81	47.69
IEEE 802.11ax SU	40	38	QPSK	2	0.92	-47.24	48.16
IEEE 802.11ax SU	40	38	16QAM	3	0.89	-47.26	48.15
IEEE 802.11ax SU	40	38	16QAM	4	0.92	-47.26	48.18
IEEE 802.11ax SU	40	38	64QAM	5	0.84	-46.68	47.52
IEEE 802.11ax SU	40	38	64QAM	6	0.93	-46.69	47.62
IEEE 802.11ax SU	40	38	64QAM	7	0.87	-45.72	46.59
IEEE 802.11ax SU	40	38	256QAM	8	0.91	-46.80	47.71
IEEE 802.11ax SU	40	38	256QAM	9	0.92	-46.20	47.12
IEEE 802.11ax SU	40	38	1024QAM	10	0.92	-47.28	48.20
IEEE 802.11ax SU	40	38	1024QAM	11	0.90	-46.94	47.84

Table 6-21
IEEE 802.11ax RU 40MHz BW SNNR by Radio Configuration

Mode	Bandwidth [MHz]	Channel	Modulation	MCS Index	RU Index	ABM1 [dB(A/m)]	ABM2 [dB(A/m)]	SNNR [dB]
IEEE 802.11ax RU	40	38	64QAM	7	0	0.89	-48.20	49.09
IEEE 802.11ax RU	40	38	64QAM	7	17	0.93	-48.26	49.19
IEEE 802.11ax RU	40	38	64QAM	7	37	0.91	-47.81	48.72
IEEE 802.11ax RU	40	38	64QAM	7	44	0.91	-47.67	48.58
IEEE 802.11ax RU	40	38	64QAM	7	53	0.88	-47.81	48.69
IEEE 802.11ax RU	40	38	64QAM	7	56	0.91	-47.54	48.45
IEEE 802.11ax RU	40	38	64QAM	7	61	1.01	-48.55	49.56
IEEE 802.11ax RU	40	38	64QAM	7	62	1.01	-47.51	48.52
IEEE 802.11ax RU	40	38	64QAM	7	65	0.99	-48.46	49.45

FCC ID: PY7-84558E		HAC (T-COIL) TEST REPORT	Approved by: Managing Director
Filename: 1M2302060006-07.PY7	Test Dates: 2/14/2023 – 2/27/2023	DUT Type: Portable Handset	Page 31 of 84

REV 4.2.M
11/29/2022

7. FCC 3G MEASUREMENTS

I. UMTS Test Configurations

WB AMR 6.60kbps, 13.6kbps SRB was used for the testing as the worst-case configuration for the handset.

**Table 7-1
Codec Investigation - UMTS**

Codec Setting:	WB AMR 23.85kbps	WB AMR 6.60kbps	NB AMR 12.2kbps	NB AMR 4.75kbps	Orientation	Channel
ABM1 (dBA/m)	1.15	0.20	2.10	2.16	Axial	9400
ABM2 (dBA/m)	-45.11	-45.60	-45.09	-45.46		
Frequency Response	Pass	Pass	Pass	Pass		
S+N/N (dB)	46.26	45.80	47.19	47.62		

- Mute on; Backlight off; Max Volume; Max Contrast
- TPC="All 1s"

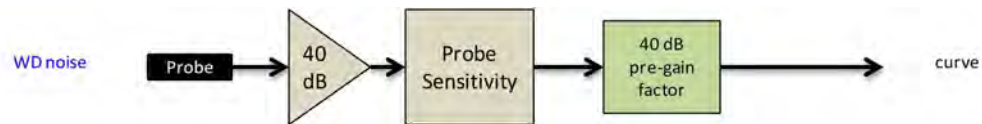

**Figure 7-1
Audio Band Magnetic Curve Measurement Block Diagram**

FCC ID: PY7-84558E	element	HAC (T-COIL) TEST REPORT	Approved by: Managing Director
Filename: 1M2302060006-07.PY7	Test Dates: 2/14/2023 – 2/27/2023	DUT Type: Portable Handset	Page 32 of 84

REV 4.2.M
11/29/2022

8. T-COIL TEST SUMMARY

**Table 8-1
Consolidated Tabled Results**

		Freq. Response Margin		Magnetic Intensity Verdict		FCC SNNR Verdict		Margin from FCC Limit (dB)	C63.19-2011 Rating
		8.3.2		8.3.1		8.3.4			
		Axial	Radial	Axial	Radial	Axial	Radial		
C63.19 Section									
GSM	Cellular	PASS	NA	PASS	PASS	PASS	PASS	-13.15	T4
	PCS	PASS	NA	PASS	PASS	PASS	PASS		
EDGE (OTT VoIP)	Cellular	PASS	NA	PASS	PASS	PASS	PASS	-14.36	T4
	PCS	PASS	NA	PASS	PASS	PASS	PASS		
UMTS	Cellular	PASS	NA	PASS	PASS	PASS	PASS	-21.17	T4
	AWS	PASS	NA	PASS	PASS	PASS	PASS		
	PCS	PASS	NA	PASS	PASS	PASS	PASS		
HSPA (OTT VoIP)	Cellular	PASS	NA	PASS	PASS	PASS	PASS	-23.10	T4
	AWS	PASS	NA	PASS	PASS	PASS	PASS		
	PCS	PASS	NA	PASS	PASS	PASS	PASS		
LTE FDD	B71	PASS	NA	PASS	PASS	PASS	PASS	-16.68	T4
	B12	PASS	NA	PASS	PASS	PASS	PASS		
	B13	PASS	NA	PASS	PASS	PASS	PASS		
	B5	PASS	NA	PASS	PASS	PASS	PASS		
	B4	PASS	NA	PASS	PASS	PASS	PASS		
	B66	PASS	NA	PASS	PASS	PASS	PASS		
	B2	PASS	NA	PASS	PASS	PASS	PASS		
	B25	PASS	NA	PASS	PASS	PASS	PASS		
B30	PASS	NA	PASS	PASS	PASS	PASS			
LTE FDD (OTT VoIP)	B25	PASS	NA	PASS	PASS	PASS	PASS	-18.89	T4
LTE TDD	B41 (PC3)	PASS	NA	PASS	PASS	PASS	PASS	-11.38	T4
	B48	PASS	NA	PASS	PASS	PASS	PASS		
LTE TDD (OTT VoIP)	B41 (PC3)	PASS	NA	PASS	PASS	PASS	PASS	-11.07	T4
NR FDD (OTT VoIP)	n66	PASS	NA	PASS	PASS	PASS	PASS	-16.62	T4
NR TDD (OTT VoIP)	n77 (PC2) - SUB	NA	NA	PASS	PASS	PASS	PASS	-11.52	T4
WLAN (OTT VoIP)	IEEE 802.11b	PASS	NA	PASS	PASS	PASS	PASS	-16.63	T4
	IEEE 802.11g	PASS	NA	PASS	PASS	PASS	PASS		
	IEEE 802.11n	PASS	NA	PASS	PASS	PASS	PASS		
	IEEE 802.11ax SU	PASS	NA	PASS	PASS	PASS	PASS		
	IEEE 802.11ax RU	PASS	NA	PASS	PASS	PASS	PASS		
U-NII (OTT VoIP)	IEEE 802.11a	PASS	NA	PASS	PASS	PASS	PASS	-15.70	T4
	IEEE 802.11n	PASS	NA	PASS	PASS	PASS	PASS		
	IEEE 802.11ac	PASS	NA	PASS	PASS	PASS	PASS		
	IEEE 802.11ax SU	PASS	NA	PASS	PASS	PASS	PASS		
	IEEE 802.11ax RU	PASS	NA	PASS	PASS	PASS	PASS		

FCC ID: PY7-84558E	element	HAC (T-COIL) TEST REPORT	Approved by: Managing Director
Filename: 1M2302060006-07.PY7	Test Dates: 2/14/2023 – 2/27/2023	DUT Type: Portable Handset	Page 33 of 84

REV 4.2.M
11/29/2022

I. Raw Handset Data

Table 8-2
Raw Data Results for GSM

Mode	Orientation	Channel	ABM1 [dB(A/m)]	ABM2 [dB(A/m)]	Ambient Noise [dB(A/m)]	Frequency Response Margin (dB)	S+N/N (dB)	FCC Limit (dB)	Margin from FCC Limit (dB)	C63.19-2011 Rating	Test Coordinates
GSM850	Axial	128	2.03	-40.45	-59.03	1.42	42.48	20.00	-22.48	T4	1.8, 2.8
		190	2.19	-39.26		1.44	41.45	20.00	-21.45	T4	
		251	2.09	-39.41		1.47	41.50	20.00	-21.50	T4	
	Radial	128	-4.19	-38.32	-58.54	N/A	34.13	20.00	-14.13	T4	2.0, 3.6
		190	-4.19	-37.34			33.15	20.00	-13.15	T4	
		251	-4.38	-37.62			33.24	20.00	-13.24	T4	
GSM1900	Axial	512	2.29	-41.90	-59.03	1.42	44.19	20.00	-24.19	T4	1.8, 2.8
		661	2.06	-40.67		1.46	42.73	20.00	-22.73	T4	
		810	2.48	-40.12		1.42	42.60	20.00	-22.60	T4	
	Radial	512	-4.35	-38.82	-58.54	N/A	34.47	20.00	-14.47	T4	2.0, 3.6
		661	-4.24	-38.03			33.79	20.00	-13.79	T4	
		810	-4.21	-37.85			33.64	20.00	-13.64	T4	

Table 8-3
Raw Data Results for UMTS

Mode	Orientation	Channel	ABM1 [dB(A/m)]	ABM2 [dB(A/m)]	Ambient Noise [dB(A/m)]	Frequency Response Margin (dB)	S+N/N (dB)	FCC Limit (dB)	Margin from FCC Limit (dB)	C63.19-2011 Rating	Test Coordinates
UMTS V	Axial	4132	0.13	-46.51	-59.03	2.00	46.64	20.00	-26.64	T4	1.8, 2.8
		4183	0.02	-45.84		2.00	45.86	20.00	-25.86	T4	
		4233	0.11	-46.65		2.00	46.76	20.00	-26.76	T4	
	Radial	4132	-6.73	-48.64	-58.54	N/A	41.91	20.00	-21.91	T4	2.0, 3.6
		4183	-6.49	-48.59			42.10	20.00	-22.10	T4	
		4233	-6.60	-48.50			41.90	20.00	-21.90	T4	
UMTS IV	Axial	1312	0.08	-46.71	-59.03	2.00	46.79	20.00	-26.79	T4	1.8, 2.8
		1412	0.37	-45.36		2.00	45.73	20.00	-25.73	T4	
		1513	2.00	-43.97		2.00	45.97	20.00	-25.97	T4	
	Radial	1312	-6.47	-47.64	-58.54	N/A	41.17	20.00	-21.17	T4	2.0, 3.6
		1412	-6.66	-48.16			41.50	20.00	-21.50	T4	
		1513	-6.62	-49.00			42.38	20.00	-22.38	T4	
UMTS II	Axial	9262	0.03	-46.05	-59.03	1.88	46.08	20.00	-26.08	T4	1.8, 2.8
		9400	-0.15	-45.93		2.00	45.78	20.00	-25.78	T4	
		9538	0.07	-45.04		2.00	45.11	20.00	-25.11	T4	
	Radial	9262	-6.61	-48.33	-58.54	N/A	41.72	20.00	-21.72	T4	2.0, 3.6
		9400	-6.24	-48.03			41.79	20.00	-21.79	T4	
		9538	-6.48	-48.23			41.75	20.00	-21.75	T4	

Table 8-4
Raw Data Results for LTE B71

Mode	Orientation	Bandwidth	Channel	ABM1 [dB(A/m)]	ABM2 [dB(A/m)]	Ambient Noise [dB(A/m)]	Frequency Response Margin (dB)	S+N/N (dB)	FCC Limit (dB)	Margin from FCC Limit (dB)	C63.19-2011 Rating	Test Coordinates
LTE Band 71	Axial	20MHz	133297	0.46	-42.11	-59.03	2.00	42.57	20.00	-22.57	T4	1.8, 2.8
		15MHz	133297	0.12	-42.69		2.00	42.81	20.00	-22.81	T4	
		10MHz	133297	-0.12	-42.54		2.00	42.42	20.00	-22.42	T4	
		5MHz	133297	0.17	-42.55		2.00	42.72	20.00	-22.72	T4	
	Radial	20MHz	133297	-6.83	-46.16	-58.54	N/A	39.33	20.00	-19.33	T4	2.0, 3.6
		15MHz	133297	-6.97	-46.80			39.83	20.00	-19.83	T4	
		10MHz	133297	-6.82	-46.03			39.21	20.00	-19.21	T4	
		5MHz	133297	-6.77	-46.70			39.93	20.00	-19.93	T4	

FCC ID: PY7-84558E		HAC (T-COIL) TEST REPORT	Approved by: Managing Director
Filename: 1M2302060006-07.PY7	Test Dates: 2/14/2023 – 2/27/2023	DUT Type: Portable Handset	Page 34 of 84

REV 4.2.M
11/29/2022

**Table 8-5
Raw Data Results for LTE B12**

Mode	Orientation	Bandwidth	Channel	ABM1 [dB(A/m)]	ABM2 [dB(A/m)]	Ambient Noise [dB(A/m)]	Frequency Response Margin (dB)	S+N/N (dB)	FCC Limit (dB)	Margin from FCC Limit (dB)	C63.19-2011 Rating	Test Coordinates
LTE Band 12	Axial	10MHz	23095	0.19	-43.73	-59.03	2.00	43.92	20.00	-23.92	T4	1.8, 2.8
		5MHz	23095	0.00	-44.68		2.00	44.68	20.00	-24.68	T4	
		3MHz	23095	0.13	-43.68		2.00	43.81	20.00	-23.81	T4	
		1.4MHz	23095	0.16	-44.47		2.00	44.63	20.00	-24.63	T4	
	Radial	10MHz	23095	-6.72	-47.26	-58.54	N/A	40.54	20.00	-20.54	T4	2.0, 3.6
		5MHz	23095	-6.76	-47.42			40.66	20.00	-20.66	T4	
		3MHz	23095	-6.71	-48.43			41.72	20.00	-21.72	T4	
		1.4MHz	23095	-6.55	-47.12			40.57	20.00	-20.57	T4	

**Table 8-6
Raw Data Results for LTE B12 - SUB**

Mode	Orientation	Bandwidth	Channel	ABM1 [dB(A/m)]	ABM2 [dB(A/m)]	Ambient Noise [dB(A/m)]	Frequency Response Margin (dB)	S+N/N (dB)	FCC Limit (dB)	Margin from FCC Limit (dB)	C63.19-2011 Rating	Test Coordinates
LTE Band 12	Axial	10MHz	23095	-0.27	-43.72	-58.47	2.00	43.45	20.00	-23.45	T4	1.8, 2.8
		5MHz	23095	-0.35	-43.20		1.99	42.85	20.00	-22.85	T4	
		3MHz	23095	0.17	-43.34		2.00	43.51	20.00	-23.51	T4	
		1.4MHz	23095	-0.02	-44.44		1.93	44.42	20.00	-24.42	T4	
	Radial	10MHz	23095	-6.61	-46.31	-58.54	N/A	39.70	20.00	-19.70	T4	2.0, 3.6
		5MHz	23095	-6.82	-46.91			40.09	20.00	-20.09	T4	
		3MHz	23095	-6.88	-47.18			40.30	20.00	-20.30	T4	
		1.4MHz	23095	-6.96	-46.55			39.59	20.00	-19.59	T4	

**Table 8-7
Raw Data Results for LTE B13**

Mode	Orientation	Bandwidth	Channel	ABM1 [dB(A/m)]	ABM2 [dB(A/m)]	Ambient Noise [dB(A/m)]	Frequency Response Margin (dB)	S+N/N (dB)	FCC Limit (dB)	Margin from FCC Limit (dB)	C63.19-2011 Rating	Test Coordinates
LTE Band 13	Axial	10MHz	23230	-0.03	-44.04	-59.03	2.00	44.01	20.00	-24.01	T4	1.8, 2.8
		5MHz	23230	-0.01	-44.65		2.00	44.64	20.00	-24.64	T4	
	Radial	10MHz	23230	-6.85	-47.44	-58.54	N/A	40.59	20.00	-20.59	T4	2.0, 3.6
		5MHz	23230	-7.02	-47.53			40.51	20.00	-20.51	T4	

**Table 8-8
Raw Data Results for LTE B13 - SUB**

Mode	Orientation	Bandwidth	Channel	ABM1 [dB(A/m)]	ABM2 [dB(A/m)]	Ambient Noise [dB(A/m)]	Frequency Response Margin (dB)	S+N/N (dB)	FCC Limit (dB)	Margin from FCC Limit (dB)	C63.19-2011 Rating	Test Coordinates
LTE Band 13	Axial	10MHz	23230	-0.16	-46.31	-58.47	1.87	46.15	20.00	-26.15	T4	1.8, 2.8
		5MHz	23230	-0.15	-47.24		2.00	47.09	20.00	-27.09	T4	
	Radial	10MHz	23230	-6.62	-45.88	-58.54	N/A	39.26	20.00	-19.26	T4	2.0, 3.6
		5MHz	23230	-6.92	-45.95			39.03	20.00	-19.03	T4	

**Table 8-9
Raw Data Results for LTE B5**

Mode	Orientation	Bandwidth	Channel	ABM1 [dB(A/m)]	ABM2 [dB(A/m)]	Ambient Noise [dB(A/m)]	Frequency Response Margin (dB)	S+N/N (dB)	FCC Limit (dB)	Margin from FCC Limit (dB)	C63.19-2011 Rating	Test Coordinates
LTE Band 5	Axial	10MHz	20525	-0.24	-43.49	-58.47	2.00	43.25	20.00	-23.25	T4	1.8, 2.8
		5MHz	20525	-0.25	-43.02		1.97	42.77	20.00	-22.77	T4	
		3MHz	20525	-0.16	-43.40		2.00	43.24	20.00	-23.24	T4	
		1.4MHz	20525	0.01	-42.80		2.00	42.81	20.00	-22.81	T4	
	Radial	10MHz	20525	-6.99	-45.87	-58.54	N/A	38.88	20.00	-18.88	T4	2.0, 3.6
		5MHz	20525	-6.78	-46.65			39.87	20.00	-19.87	T4	
		3MHz	20525	-6.68	-46.25			39.57	20.00	-19.57	T4	
		1.4MHz	20525	-6.97	-46.30			39.33	20.00	-19.33	T4	

FCC ID: PY7-84558E		HAC (T-COIL) TEST REPORT	Approved by: Managing Director
Filename: 1M2302060006-07.PY7	Test Dates: 2/14/2023 – 2/27/2023	DUT Type: Portable Handset	Page 35 of 84

REV 4.2.M
11/29/2022

Unless otherwise specified, no part of this report may be reproduced or utilized in any part, form or by any means, electronic or mechanical, including photocopying and microfilm, without permission in writing from Element. If you have any questions about this or have an enquiry about obtaining additional rights to this report or assembly of contents thereof, please contact CT.INFO@ELEMENT.COM.

Table 8-10
Raw Data Results for LTE B5 - SUB

Mode	Orientation	Bandwidth	Channel	ABM1 [dB(A/m)]	ABM2 [dB(A/m)]	Ambient Noise [dB(A/m)]	Frequency Response Margin (dB)	S+N/N (dB)	FCC Limit (dB)	Margin from FCC Limit (dB)	C63.19-2011 Rating	Test Coordinates
LTE Band 5	Axial	10MHz	20525	0.23	-43.78	-58.47	2.00	44.01	20.00	-24.01	T4	1.8, 2.8
		5MHz	20525	0.01	-44.23		2.00	44.24	20.00	-24.24	T4	
		3MHz	20525	0.10	-44.53		2.00	44.63	20.00	-24.63	T4	
		1.4MHz	20525	0.45	-44.02		2.00	44.47	20.00	-24.47	T4	
	Radial	10MHz	20525	-6.69	-45.62	-58.54	N/A	38.93	20.00	-18.93	T4	2.0, 3.6
		5MHz	20525	-6.82	-44.98			38.16	20.00	-18.16	T4	
		3MHz	20525	-6.97	-45.68			38.71	20.00	-18.71	T4	
		1.4MHz	20525	-6.93	-45.60			38.67	20.00	-18.67	T4	

Table 8-11
Raw Data Results for LTE B66

Mode	Orientation	Bandwidth	Channel	ABM1 [dB(A/m)]	ABM2 [dB(A/m)]	Ambient Noise [dB(A/m)]	Frequency Response Margin (dB)	S+N/N (dB)	FCC Limit (dB)	Margin from FCC Limit (dB)	C63.19-2011 Rating	Test Coordinates
LTE Band 66	Axial	20MHz	132322	0.03	-42.65	-59.03	2.00	42.68	20.00	-22.68	T4	1.8, 2.8
		15MHz	132322	0.06	-42.37		2.00	42.43	20.00	-22.43	T4	
		10MHz	132322	0.50	-42.08		2.00	42.58	20.00	-22.58	T4	
		5MHz	132322	0.04	-42.43		2.00	42.47	20.00	-22.47	T4	
		3MHz	132322	0.00	-42.63		2.00	42.63	20.00	-22.63	T4	
		1.4MHz	132322	-0.11	-42.64		2.00	42.53	20.00	-22.53	T4	
	Radial	20MHz	132322	-6.83	-45.11	-58.54	N/A	38.28	20.00	-18.28	T4	2.0, 3.6
		15MHz	132322	-6.71	-45.56			38.85	20.00	-18.85	T4	
		10MHz	132322	-6.78	-45.37			38.59	20.00	-18.59	T4	
		5MHz	132322	-6.92	-45.11			38.19	20.00	-18.19	T4	
		3MHz	132322	-6.80	-45.27			38.47	20.00	-18.47	T4	
		1.4MHz	132322	-6.65	-44.78			38.13	20.00	-18.13	T4	

Table 8-12
Raw Data Results for LTE B4

Mode	Orientation	Bandwidth	Channel	ABM1 [dB(A/m)]	ABM2 [dB(A/m)]	Ambient Noise [dB(A/m)]	Frequency Response Margin (dB)	S+N/N (dB)	FCC Limit (dB)	Margin from FCC Limit (dB)	C63.19-2011 Rating	Test Coordinates
LTE Band 4	Axial	20MHz	20175	-0.17	-41.77	-58.47	1.98	41.60	20.00	-21.60	T4	1.8, 2.8
		15MHz	20175	-0.19	-41.66		1.97	41.47	20.00	-21.47	T4	
		10MHz	20175	-0.20	-41.08		2.00	40.88	20.00	-20.88	T4	
		5MHz	20175	-0.20	-41.75		2.00	41.55	20.00	-21.55	T4	
		3MHz	20175	-0.14	-41.80		2.00	41.66	20.00	-21.66	T4	
		1.4MHz	20393	0.10	-41.62		2.00	41.72	20.00	-21.72	T4	
	Radial	1.4MHz	20175	-0.32	-41.02	2.00	40.70	20.00	-20.70	T4	2.0, 3.6	
		1.4MHz	19957	0.24	-41.53	2.00	41.77	20.00	-21.77	T4		
		20MHz	20175	-6.73	-44.74	-58.54	N/A	38.01	20.00	-18.01		T4
		15MHz	20175	-6.61	-45.22			38.61	20.00	-18.61		T4
		10MHz	20175	-6.70	-44.42			37.72	20.00	-17.72		T4
		5MHz	20175	-6.57	-44.57			38.00	20.00	-18.00		T4
3MHz	20175	-6.64	-44.94	38.30	20.00			-18.30	T4			
1.4MHz	20175	-6.91	-44.71	37.80	20.00			-17.80	T4			

Table 8-13
Raw Data Results for LTE B25

Mode	Orientation	Bandwidth	Channel	ABM1 [dB(A/m)]	ABM2 [dB(A/m)]	Ambient Noise [dB(A/m)]	Frequency Response Margin (dB)	S+N/N (dB)	FCC Limit (dB)	Margin from FCC Limit (dB)	C63.19-2011 Rating	Test Coordinates
LTE Band 25	Axial	20MHz	26365	0.22	-44.26	-59.03	2.00	44.48	20.00	-24.48	T4	1.8, 2.8
		15MHz	26365	-0.04	-43.50		1.98	43.46	20.00	-23.46	T4	
		10MHz	26365	0.19	-43.23		1.96	43.42	20.00	-23.42	T4	
		5MHz	26365	0.40	-43.67		2.00	44.07	20.00	-24.07	T4	
		3MHz	26365	0.17	-43.87		1.98	44.04	20.00	-24.04	T4	
		1.4MHz	26365	0.38	-44.54		2.00	44.92	20.00	-24.92	T4	
	Radial	20MHz	26365	-6.79	-43.85	-58.54	N/A	37.06	20.00	-17.06	T4	2.0, 3.6
		15MHz	26365	-6.74	-44.41			37.67	20.00	-17.67	T4	
		10MHz	26365	-6.80	-44.20			37.40	20.00	-17.40	T4	
		5MHz	26365	-6.99	-44.21			37.22	20.00	-17.22	T4	
		3MHz	26365	-6.99	-44.26			37.27	20.00	-17.27	T4	
		1.4MHz	26365	-6.92	-44.49			37.57	20.00	-17.57	T4	

FCC ID: PY7-84558E		HAC (T-COIL) TEST REPORT	Approved by: Managing Director
Filename: 1M2302060006-07.PY7	Test Dates: 2/14/2023 – 2/27/2023	DUT Type: Portable Handset	Page 36 of 84

REV 4.2.M
11/29/2022

Unless otherwise specified, no part of this report may be reproduced or utilized in any part, form or by any means, electronic or mechanical, including photocopying and microfilm, without permission in writing from Element. If you have any questions about this or have an enquiry about obtaining additional rights to this report or assembly of contents thereof, please contact CT.INFO@ELEMENT.COM.

Table 8-14
Raw Data Results for LTE B2

Mode	Orientation	Bandwidth	Channel	ABM1 [dB(A/m)]	ABM2 [dB(A/m)]	Ambient Noise [dB(A/m)]	Frequency Response Margin (dB)	S+N/N (dB)	FCC Limit (dB)	Margin from FCC Limit (dB)	C63.19-2011 Rating	Test Coordinates
LTE Band 2	Axial	20MHz	18900	-0.04	-41.64	-58.47	2.00	41.60	20.00	-21.60	T4	1.8, 2.8
		15MHz	18900	0.14	-42.18		2.00	42.32	20.00	-22.32	T4	
		10MHz	18900	-0.12	-41.69		2.00	41.57	20.00	-21.57	T4	
		5MHz	18900	-0.11	-41.49		2.00	41.38	20.00	-21.38	T4	
		3MHz	18900	0.20	-41.11		2.00	41.31	20.00	-21.31	T4	
		1.4MHz	18900	-0.27	-41.51		2.00	41.24	20.00	-21.24	T4	
	Radial	20MHz	19100	-6.76	-43.60	-58.54	N/A	36.84	20.00	-16.84	T4	2.0, 3.6
		20MHz	18900	-6.66	-43.44			36.78	20.00	-16.78	T4	
		20MHz	18700	-6.82	-43.50			36.68	20.00	-16.68	T4	
		15MHz	18900	-6.67	-44.54			37.87	20.00	-17.87	T4	
		10MHz	18900	-6.50	-44.21			37.71	20.00	-17.71	T4	
		5MHz	18900	-6.84	-44.23			37.39	20.00	-17.39	T4	
		3MHz	18900	-6.75	-44.20			37.45	20.00	-17.45	T4	
		1.4MHz	18900	-6.83	-44.27			37.44	20.00	-17.44	T4	

Table 8-15
Raw Data Results for LTE B30

Mode	Orientation	Bandwidth	Channel	ABM1 [dB(A/m)]	ABM2 [dB(A/m)]	Ambient Noise [dB(A/m)]	Frequency Response Margin (dB)	S+N/N (dB)	FCC Limit (dB)	Margin from FCC Limit (dB)	C63.19-2011 Rating	Test Coordinates
LTE Band 30	Axial	10MHz	27710	0.18	-44.11	-59.03	2.00	44.29	20.00	-24.29	T4	1.8, 2.8
		5MHz	27710	0.16	-43.35		2.00	43.51	20.00	-23.51	T4	
	Radial	10MHz	27710	-6.79	-44.36	-58.54	N/A	37.57	20.00	-17.57	T4	2.0, 3.6
		5MHz	27710	-6.98	-44.35			37.37	20.00	-17.37	T4	

Table 8-16
Raw Data Results for LTE B41 Power Class 3

Mode	Orientation	Bandwidth	Channel	ABM1 [dB(A/m)]	ABM2 [dB(A/m)]	Ambient Noise [dB(A/m)]	Frequency Response Margin (dB)	S+N/N (dB)	FCC Limit (dB)	Margin from FCC Limit (dB)	C63.19-2011 Rating	Test Coordinates
LTE Band 41 (PC3)	Axial	20MHz	41490	0.31	-36.37	-58.47	1.90	36.68	20.00	-16.68	T4	1.8, 2.8
		20MHz	41055	0.09	-35.71		1.79	35.80	20.00	-15.80	T4	
		20MHz	40620	0.34	-36.98		2.00	37.32	20.00	-17.32	T4	
		20MHz	40185	0.07	-37.20		1.91	37.27	20.00	-17.27	T4	
		20MHz	39750	0.24	-36.34		1.84	36.58	20.00	-16.58	T4	
		15MHz	40620	0.09	-38.02		1.93	38.11	20.00	-18.11	T4	
		10MHz	40620	0.00	-37.40		2.00	37.40	20.00	-17.40	T4	
		5MHz	40620	0.05	-37.77		1.95	37.82	20.00	-17.82	T4	
	Radial	20MHz	41490	-6.74	-39.36	-58.54	N/A	32.62	20.00	-12.62	T4	2.0, 3.6
		20MHz	41055	-6.62	-38.00			31.38	20.00	-11.38	T4	
		20MHz	40620	-6.67	-39.40			32.73	20.00	-12.73	T4	
		20MHz	40185	-6.59	-38.83			32.24	20.00	-12.24	T4	
		20MHz	39750	-6.90	-38.39			31.49	20.00	-11.49	T4	
		15MHz	40620	-6.85	-40.30			33.45	20.00	-13.45	T4	
		10MHz	40620	-7.04	-40.15			33.11	20.00	-13.11	T4	
		5MHz	40620	-6.83	-40.94			34.11	20.00	-14.11	T4	

Table 8-17
Raw Data Results for LTE B48

Mode	Orientation	Bandwidth	Channel	ABM1 [dB(A/m)]	ABM2 [dB(A/m)]	Ambient Noise [dB(A/m)]	Frequency Response Margin (dB)	S+N/N (dB)	FCC Limit (dB)	Margin from FCC Limit (dB)	C63.19-2011 Rating	Test Coordinates
LTE Band 48	Axial	20MHz	55990	0.34	-40.29	-58.47	1.91	40.63	20.00	-20.63	T4	1.8, 2.8
		15MHz	55990	0.45	-41.40		1.75	41.85	20.00	-21.85	T4	
		10MHz	55990	-0.15	-40.11		1.88	39.96	20.00	-19.96	T4	
		5MHz	55990	-0.21	-41.19		1.95	40.98	20.00	-20.98	T4	
	Radial	20MHz	55990	-6.62	-42.98	-58.54	N/A	36.36	20.00	-16.36	T4	2.0, 3.6
		15MHz	55990	-6.72	-44.22			37.50	20.00	-17.50	T4	
		10MHz	55990	-6.69	-44.45			37.76	20.00	-17.76	T4	
		5MHz	55990	-6.76	-46.32			39.56	20.00	-19.56	T4	

FCC ID: PY7-84558E		HAC (T-COIL) TEST REPORT	Approved by: Managing Director
Filename: 1M2302060006-07.PY7	Test Dates: 2/14/2023 – 2/27/2023	DUT Type: Portable Handset	Page 37 of 84

REV 4.2.M

11/29/2022

Unless otherwise specified, no part of this report may be reproduced or utilized in any part, form or by any means, electronic or mechanical, including photocopying and microfilm, without permission in writing from Element. If you have any questions about this or have an enquiry about obtaining additional rights to this report or assembly of contents thereof, please contact CT.INFO@ELEMENT.COM.

Table 8-18
Raw Data Results for LTE B48 - SUB

Mode	Orientation	Bandwidth	Channel	ABM1 [dB(A/m)]	ABM2 [dB(A/m)]	Ambient Noise [dB(A/m)]	Frequency Response Margin (dB)	S+N/N (dB)	FCC Limit (dB)	Margin from FCC Limit (dB)	C63.19-2011 Rating	Test Coordinates
LTE Band 48	Axial	20MHz	55990	-0.35	-39.83	-58.47	1.81	39.48	20.00	-19.48	T4	1.8, 2.8
		15MHz	55990	-0.10	-40.47		1.87	40.37	20.00	-20.37	T4	
		10MHz	55990	-0.07	-40.73		1.79	40.66	20.00	-20.66	T4	
		5MHz	55990	0.10	-41.15		1.87	41.25	20.00	-21.25	T4	
		20MHz	55990	-6.98	-42.35		N/A	35.37	20.00	-15.37	T4	
	15MHz	55990	-7.07	-43.03	35.96	20.00		-15.96	T4			
	10MHz	55990	-7.03	-42.62	35.59	20.00		-15.59	T4			
	5MHz	55990	-6.71	-43.73	37.02	20.00		-17.02	T4			
	20MHz	55990	-6.98	-42.35	35.37	20.00		-15.37	T4			
	Radial	15MHz	55990	-7.07	-43.03	-58.54	N/A	35.96	20.00	-15.96	T4	2.0, 3.6
10MHz		55990	-7.03	-42.62	35.59			20.00	-15.59	T4		
5MHz		55990	-6.71	-43.73	37.02			20.00	-17.02	T4		
20MHz		55990	-6.98	-42.35	35.37			20.00	-15.37	T4		
15MHz		55990	-7.07	-43.03	35.96			20.00	-15.96	T4		

Table 8-19
Raw Data Results for EDGE (OTT VoIP)

Mode	Orientation	Channel	ABM1 [dB(A/m)]	ABM2 [dB(A/m)]	Ambient Noise [dB(A/m)]	Frequency Response Margin (dB)	S+N/N (dB)	FCC Limit (dB)	Margin from FCC Limit (dB)	C63.19-2011 Rating	Test Coordinates
EDGE850	Axial	190	1.09	-40.77	-58.47	1.12	41.86	20.00	-21.86	T4	1.8, 2.8
	Radial	190	-5.87	-40.23	-58.46	N/A	34.36	20.00	-14.36	T4	2.0, 3.6
EDGE1900	Axial	661	1.10	-42.81	-58.47	0.95	43.91	20.00	-23.91	T4	1.8, 2.8
	Radial	661	-6.02	-40.46	-58.46	N/A	34.44	20.00	-14.44	T4	2.0, 3.6

Table 8-20
Raw Data Results for HSPA (OTT VoIP)

Mode	Orientation	Channel	ABM1 [dB(A/m)]	ABM2 [dB(A/m)]	Ambient Noise [dB(A/m)]	Frequency Response Margin (dB)	S+N/N (dB)	FCC Limit (dB)	Margin from FCC Limit (dB)	C63.19-2011 Rating	Test Coordinates
HSPA V	Axial	4183	1.18	-46.86	-58.47	1.21	48.04	20.00	-28.04	T4	1.8, 2.8
	Radial	4183	-5.70	-48.89	-58.46	N/A	43.19	20.00	-23.19	T4	2.0, 3.6
HSPA IV	Axial	1412	1.18	-47.81	-58.47	1.17	48.99	20.00	-28.99	T4	1.8, 2.8
	Radial	1412	-5.73	-49.02	-58.46	N/A	43.29	20.00	-23.29	T4	2.0, 3.6
HSPA II	Axial	9400	1.17	-47.62	-58.47	1.15	48.79	20.00	-28.79	T4	1.8, 2.8
	Radial	9400	-5.68	-48.78	-58.46	N/A	43.10	20.00	-23.10	T4	2.0, 3.6

Table 8-21
Raw Data Results for LTE FDD B25 (OTT VoIP)

Mode	Orientation	Bandwidth	Channel	ABM1 [dB(A/m)]	ABM2 [dB(A/m)]	Ambient Noise [dB(A/m)]	Frequency Response Margin (dB)	S+N/N (dB)	FCC Limit (dB)	Margin from FCC Limit (dB)	C63.19-2011 Rating	Test Coordinates
LTE Band 25	Axial	20MHz	26365	0.78	-43.67	-58.47	1.11	44.45	20.00	-24.45	T4	1.8, 2.8
		15MHz	26365	0.81	-43.94		1.14	44.75	20.00	-24.75	T4	
		10MHz	26640	0.86	-43.38		1.19	44.24	20.00	-24.24	T4	
		10MHz	26365	0.88	-42.66		1.13	43.54	20.00	-23.54	T4	
		10MHz	26090	0.88	-43.42		1.17	44.30	20.00	-24.30	T4	
		5MHz	26365	0.82	-43.29		1.16	44.11	20.00	-24.11	T4	
		3MHz	26365	0.88	-44.04		1.13	44.92	20.00	-24.92	T4	
		1.4MHz	26365	0.80	-43.54		1.15	44.34	20.00	-24.34	T4	
		Radial	20MHz	26365	-5.72		-45.11	-58.46	N/A	39.39	20.00	
	15MHz		26365	-5.75	-45.56	39.81	20.00			-19.81	T4	
	10MHz		26640	-5.73	-44.95	39.22	20.00			-19.22	T4	
	10MHz		26365	-5.72	-44.61	38.89	20.00			-18.89	T4	
	10MHz		26090	-5.72	-45.09	39.37	20.00			-19.37	T4	
	5MHz		26365	-5.71	-45.31	39.60	20.00			-19.60	T4	
	3MHz		26365	-5.83	-45.11	39.28	20.00			-19.28	T4	
	1.4MHz		26365	-5.80	-45.35	39.55	20.00			-19.55	T4	

FCC ID: PY7-84558E		HAC (T-COIL) TEST REPORT	Approved by: Managing Director
Filename: 1M2302060006-07.PY7	Test Dates: 2/14/2023 – 2/27/2023	DUT Type: Portable Handset	Page 38 of 84

REV 4.2.M
11/29/2022

Table 8-22
Raw Data Results for LTE TDD B41 (PC3) (OTT VoIP)

Mode	Orientation	Bandwidth	Channel	ABM1 [dB(A/m)]	ABM2 [dB(A/m)]	Ambient Noise [dB(A/m)]	Frequency Response Margin (dB)	S+N/N (dB)	FCC Limit (dB)	Margin from FCC Limit (dB)	C63.19-2011 Rating	Test Coordinates
LTE Band 41 (PC3)	Axial	20MHz	41490	0.75	-37.17	-58.47	1.29	37.92	20.00	-17.92	T4	1.8, 2.8
		20MHz	41055	0.82	-36.25		1.04	37.07	20.00	-17.07	T4	
		20MHz	40620	0.77	-37.09		1.09	37.86	20.00	-17.86	T4	
		20MHz	40185	0.76	-37.72		1.05	38.48	20.00	-18.48	T4	
		20MHz	39750	0.75	-36.69		0.98	37.44	20.00	-17.44	T4	
		15MHz	40620	0.76	-38.26		0.95	39.02	20.00	-19.02	T4	
		10MHz	40620	0.76	-37.97		1.09	38.73	20.00	-18.73	T4	
		5MHz	40620	0.74	-37.93		1.03	38.67	20.00	-18.67	T4	
	Radial	20MHz	41490	-5.97	-38.11	-58.54	N/A	32.14	20.00	-12.14	T4	2.0, 3.6
		20MHz	41055	-5.97	-37.62			31.65	20.00	-11.65	T4	
		20MHz	40620	-5.92	-38.33			32.41	20.00	-12.41	T4	
		20MHz	40185	-5.99	-38.70			32.71	20.00	-12.71	T4	
		20MHz	39750	-6.02	-37.09			31.07	20.00	-11.07	T4	
		15MHz	40620	-5.97	-39.15			33.18	20.00	-13.18	T4	
		10MHz	40620	-6.00	-38.91			32.91	20.00	-12.91	T4	
		5MHz	40620	-5.97	-38.95			32.98	20.00	-12.98	T4	

Table 8-23
Raw Data Results for NR FDD n66 (OTT VoIP)

Mode	Orientation	Bandwidth	Channel	ABM1 [dB(A/m)]	ABM2 [dB(A/m)]	Ambient Noise [dB(A/m)]	Frequency Response Margin (dB)	S+N/N (dB)	FCC Limit (dB)	Margin from FCC Limit (dB)	C63.19-2011 Rating	Test Coordinates
NR n66	Axial	20MHz	349000	0.92	-43.00	-59.27	1.06	43.92	20.00	-23.92	T4	1.8, 2.8
		15MHz	354500	0.89	-43.86		1.17	44.75	20.00	-24.75	T4	
		15MHz	349000	0.96	-42.43		0.94	43.39	20.00	-23.39	T4	
		15MHz	343500	0.84	-41.66		1.23	42.50	20.00	-22.50	T4	
		10MHz	349000	0.92	-43.17		1.07	44.09	20.00	-24.09	T4	
		5MHz	349000	0.87	-44.34		1.08	45.21	20.00	-25.21	T4	
	Radial	20MHz	354000	-5.72	-43.05	-59.52	N/A	37.33	20.00	-17.33	T4	2.0, 3.6
		20MHz	349000	-5.66	-42.28			36.62	20.00	-16.62	T4	
		20MHz	344000	-5.70	-44.26			38.56	20.00	-18.56	T4	
		15MHz	349000	-5.64	-42.72			37.08	20.00	-17.08	T4	
		10MHz	349000	-5.71	-44.88			39.17	20.00	-19.17	T4	
		5MHz	349000	-5.68	-45.89			40.21	20.00	-20.21	T4	

Table 8-24
Raw Data Results for NR TDD n77 (PC2) - SUB (OTT VoIP)

Mode	Orientation	Bandwidth	Channel	ABM1 _{LTE} [dB(A/m)]	ABM2 _{NR} [dB(A/m)]	Ambient Noise [dB(A/m)]	Frequency Response Margin (dB)	S+N/N _{NR} (dB)	S+N/N _{NR} - 3 dB (dB)	FCC Limit (dB)	Margin from FCC Limit (dB)	C63.19-2011 Rating	Test Coordinates				
NR n77 (PC2) - SUB	Axial	100MHz	662000	0.97	-40.89	-58.89	N/A	41.86	38.86	20.00	-18.86	T4	1.8, 2.8				
		100MHz	659000	0.97	-40.50			41.47	38.47	20.00	-18.47	T4					
		100MHz	656000	0.97	-40.46			41.43	38.43	20.00	-18.43	T4					
		100MHz	653000	0.97	-40.71			41.68	38.68	20.00	-18.68	T4					
		100MHz	650000	0.97	-40.05			41.02	38.02	20.00	-18.02	T4					
		80MHz	656000	0.97	-41.01			41.98	38.98	20.00	-18.98	T4					
		60MHz	656000	0.97	-41.26			42.23	39.23	20.00	-19.23	T4					
		40MHz	656000	0.97	-41.84			42.81	39.81	20.00	-19.81	T4					
		30MHz	656000	0.97	-41.71			42.68	39.68	20.00	-19.68	T4					
		20MHz	656000	0.97	-40.49			41.46	38.46	20.00	-18.46	T4					
		Radial	100MHz	656000	-5.69			-41.00	-58.54	N/A	35.31	32.31		20.00	-12.31	T4	2.0, 3.6
			80MHz	656000	-5.69			-40.53			34.84	31.84		20.00	-11.84	T4	
	60MHz		663332	-5.69	-42.03	36.34	33.34	20.00			-13.34	T4					
	60MHz		659666	-5.69	-41.48	35.79	32.79	20.00			-12.79	T4					
	60MHz		656000	-5.69	-40.21	34.52	31.52	20.00			-11.52	T4					
	60MHz		652334	-5.69	-41.46	35.77	32.77	20.00			-12.77	T4					
	60MHz		648668	-5.69	-41.44	35.75	32.75	20.00			-12.75	T4					
	40MHz		656000	-5.69	-42.68	36.99	33.99	20.00			-13.99	T4					
	30MHz		656000	-5.69	-42.41	36.72	33.72	20.00			-13.72	T4					
	20MHz		656000	-5.69	-42.07	36.38	33.38	20.00			-13.38	T4					

FCC ID: PY7-84558E		HAC (T-COIL) TEST REPORT	Approved by: Managing Director
Filename: 1M2302060006-07.PY7	Test Dates: 2/14/2023 – 2/27/2023	DUT Type: Portable Handset	Page 39 of 84

REV 4.2.M
11/29/2022

Unless otherwise specified, no part of this report may be reproduced or utilized in any part, form or by any means, electronic or mechanical, including photocopying and microfilm, without permission in writing from Element. If you have any questions about this or have an enquiry about obtaining additional rights to this report or assembly of contents thereof, please contact CT.INFO@ELEMENT.COM.

Table 8-25
Raw Data Results for LTE TDD B48 (OTT VoIP – Additional Measurements for NR)

Mode	Orientation	Bandwidth	Channel	ABM1 _{LTE} [dB(A/m)]	ABM2 _{NR} [dB(A/m)]	Ambient Noise [dB(A/m)]	Frequency Response Margin (dB)	S+N/N _{LTE} (dB)	S+N/N _{NR} - 3 dB (dB)	FCC Limit (dB)	Margin from FCC Limit (dB)	C63.19-2011 Rating	Test Coordinates
LTE Band 48	Axial	20MHz	55990	0.97	N/A	-58.89	N/A	43.20	N/A	20.00	-23.20	T4	1.8, 2.8
	Radial	20MHz	55990	-5.69		-58.54		36.16		20.00	-16.16	T4	2.0, 3.6

Table 8-26
Raw Data Results for 2.4GHz WIFI (OTT VoIP)

Mode	Orientation	Channel	ABM1 [dB(A/m)]	ABM2 [dB(A/m)]	Ambient Noise [dB(A/m)]	Frequency Response Margin (dB)	S+N/N (dB)	FCC Limit (dB)	Margin from FCC Limit (dB)	C63.19-2011 Rating	Test Coordinates
IEEE 802.11b	Axial	6	0.87	-46.70	-58.47	1.11	47.57	20.00	-27.57	T4	1.8, 2.8
		1	-5.86	-42.80			36.94	20.00	-16.94	T4	2.0, 3.6
	Radial	6	-5.85	-42.48	-58.46	N/A	36.63	20.00	-16.63	T4	
		11	-5.76	-43.48			37.72	20.00	-17.72	T4	
IEEE 802.11g	Axial	6	0.86	-46.66	-58.47	1.15	47.52	20.00	-27.52	T4	1.8, 2.8
	Radial	6	-5.82	-42.93	-58.46	N/A	37.11	20.00	-17.11	T4	2.0, 3.6
IEEE 802.11n	Axial	6	1.00	-47.11	-58.47	1.11	48.11	20.00	-28.11	T4	1.8, 2.8
	Radial	6	-5.78	-43.57	-58.46	N/A	37.79	20.00	-17.79	T4	2.0, 3.6
IEEE 802.11ax SU	Axial	1	0.93	-46.78	-58.47	1.01	47.71	20.00	-27.71	T4	1.8, 2.8
		6	0.98	-46.27			47.25	20.00	-27.25	T4	
		11	0.86	-47.43			48.29	20.00	-28.29	T4	
	Radial	6	-5.91	-43.21	-58.46	N/A	37.30	20.00	-17.30	T4	2.0, 3.6
IEEE 802.11ax RU	Axial	6	0.99	-47.79	-58.47	1.03	48.78	20.00	-28.78	T4	1.8, 2.8
	Radial	6	-5.91	-44.04	-58.46	N/A	38.13	20.00	-18.13	T4	2.0, 3.6

Table 8-27
Raw Data Results for 5GHz WIFI IEEE 802.11a (OTT VoIP)

Mode	Orientation	Bandwidth	U-NII	Channel	ABM1 [dB(A/m)]	ABM2 [dB(A/m)]	Ambient Noise [dB(A/m)]	Frequency Response Margin (dB)	S+N/N (dB)	FCC Limit (dB)	Margin from FCC Limit (dB)	C63.19-2011 Rating	Test Coordinates
IEEE 802.11a	Axial	20MHz	1	40	0.83	-48.43	-58.47	1.09	49.26	20.00	-29.26	T4	1.8, 2.8
	Radial	20MHz	1	36	-5.79	-42.49	-58.46	N/A	36.70	20.00	-16.70	T4	2.0, 3.6
		20MHz	1	40	-6.05	-41.75			35.70	20.00	-15.70	T4	
		20MHz	1	48	-5.81	-43.09			37.28	20.00	-17.28	T4	
		20MHz	2A	56	-5.79	-42.44			36.65	20.00	-16.65	T4	
		20MHz	2C	116	-5.92	-42.05			36.13	20.00	-16.13	T4	
		20MHz	3	157	-5.80	-42.71			36.91	20.00	-16.91	T4	

Table 8-28
Raw Data Results for 5GHz WIFI IEEE 802.11n (OTT VoIP)

Mode	Orientation	Bandwidth	U-NII	Channel	ABM1 [dB(A/m)]	ABM2 [dB(A/m)]	Ambient Noise [dB(A/m)]	Frequency Response Margin (dB)	S+N/N (dB)	FCC Limit (dB)	Margin from FCC Limit (dB)	C63.19-2011 Rating	Test Coordinates
IEEE 802.11n	Axial	40MHz	1	38	0.80	-46.97	-58.47	1.03	47.77	20.00	-27.77	T4	1.8, 2.8
		20MHz	1	40	0.71	-46.53		0.99	47.24	20.00	-27.24	T4	
	Radial	40MHz	1	38	-5.83	-43.06	-58.46	N/A	37.23	20.00	-17.23	T4	2.0, 3.6
		20MHz	1	40	-5.80	-42.09			36.29	20.00	-16.29	T4	

Table 8-29
Raw Data Results for 5GHz WIFI IEEE 802.11ac (OTT VoIP)

Mode	Orientation	Bandwidth	U-NII	Channel	ABM1 [dB(A/m)]	ABM2 [dB(A/m)]	Ambient Noise [dB(A/m)]	Frequency Response Margin (dB)	S+N/N (dB)	FCC Limit (dB)	Margin from FCC Limit (dB)	C63.19-2011 Rating	Test Coordinates
IEEE 802.11ac	Axial	40MHz	1	38	0.89	-47.39	-58.47	1.03	48.28	20.00	-28.28	T4	1.8, 2.8
		20MHz	1	40	0.90	-47.59		0.95	48.49	20.00	-28.49	T4	
	Radial	40MHz	1	38	-5.81	-43.12	-58.46	N/A	37.31	20.00	-17.31	T4	2.0, 3.6
		20MHz	1	40	-5.92	-42.00			36.08	20.00	-16.08	T4	

FCC ID: PY7-84558E		HAC (T-COIL) TEST REPORT	Approved by: Managing Director
Filename: 1M2302060006-07.PY7	Test Dates: 2/14/2023 – 2/27/2023	DUT Type: Portable Handset	Page 40 of 84

REV 4.2.M
11/29/2022

Table 8-30
Raw Data Results for 5GHz WIFI IEEE 802.11ax (OTT VoIP)

Mode	Orientation	Bandwidth	U-NII	Channel	ABM1 [dB(A/m)]	ABM2 [dB(A/m)]	Ambient Noise [dB(A/m)]	Frequency Response Margin (dB)	S+N/N (dB)	FCC Limit (dB)	Margin from FCC Limit (dB)	C63.19-2011 Rating	Test Coordinates				
IEEE 802.11ax SU	Axial	40MHz	1	38	0.77	-45.69	-58.47	1.05	46.46	20.00	-26.46	T4	1.8, 2.8				
		40MHz	1	46	0.99	-46.63		0.94	47.62	20.00	-27.62	T4					
		20MHz	1	40	0.81	-46.36		1.00	47.17	20.00	-27.17	T4					
		40MHz	2A	54	1.02	-46.12		1.00	47.14	20.00	-27.14	T4					
		20MHz	2A	56	0.98	-45.62		0.97	46.60	20.00	-26.60	T4					
		40MHz	2C	110	1.03	-46.07		1.02	47.10	20.00	-27.10	T4					
		20MHz	2C	116	1.01	-46.74		1.01	47.75	20.00	-27.75	T4					
		40MHz	3	151	1.00	-46.08		1.00	47.08	20.00	-27.08	T4					
		20MHz	3	157	0.95	-45.95		0.96	46.90	20.00	-26.90	T4					
		40MHz	5	3	1.06	-47.12		0.84	48.18	20.00	-28.18	T4					
		20MHz	5	1	1.13	-47.13		0.92	48.26	20.00	-28.26	T4					
		IEEE 802.11ax SU	Radial	40MHz	1	38		-5.92	-42.57	-58.46	N/A	36.65		20.00	-16.65	T4	2.0, 3.6
				20MHz	1	40		-5.79	-42.93			37.14		20.00	-17.14	T4	
				40MHz	5	3		-5.71	-44.92			39.21		20.00	-19.21	T4	
20MHz	5			1	-6.11	-45.11	39.00	20.00	-19.00			T4					
IEEE 802.11ax RU	Axial	40MHz	1	38	0.78	-46.90	-58.47	1.02	47.68	20.00	-27.68	T4	1.8, 2.8				
		20MHz	1	40	0.80	-46.57		1.03	47.37	20.00	-27.37	T4					
		40MHz	5	3	1.14	-47.47		0.96	48.61	20.00	-28.61	T4					
		20MHz	5	1	1.14	-47.58		0.93	48.72	20.00	-28.72	T4					
	Radial	40MHz	1	38	-5.91	-42.80	-58.46	N/A	36.89	20.00	-16.89	T4	2.0, 3.6				
		20MHz	1	40	-5.80	-42.63			36.83	20.00	-16.83	T4					
		40MHz	5	3	-5.67	-44.21			38.54	20.00	-18.54	T4					
		20MHz	5	1	-5.94	-44.26			38.32	20.00	-18.32	T4					

II. Test Notes

A. General

1. Phone Condition: Mute on; Backlight off; Max Volume; Max Contrast
2. 'Radial' orientation refers to radial transverse.
3. Hearing Aid Mode (Phone > Settings > Accessibility > Hearing aids) was set to ON for Frequency Response compliance
4. Speech Signal: ITU-T P.50 Artificial Voice
5. Bluetooth and WIFI were disabled while testing 2G/3G/4G/5G modes.
6. Licensed data modes and Bluetooth were disabled while testing WIFI modes.
7. The Margin from FCC limit column indicates a margin from the FCC limit for compliance (T4).

B. GSM

1. Power Configuration: GSM850: PCL=5, GSM1900: PCL=0;
2. Vocoder Configuration: EFR (GSM);

C. UMTS

1. Power Configuration: TPC= "All 1s";
2. Vocoder Configuration: WB AMR 6.60kbps (UMTS);

D. LTE FDD

1. Power Configuration: TPC = "Max Power"
2. Radio Configuration: 16QAM, 1RB, 50%RB offset
3. Vocoder Configuration: WB AMR 6.60kbps
4. The worst-case band and bandwidth combination for each probe orientation is additionally tested on the low and high channels for those combinations. LTE Band 4 at 1.4MHz is the worst-case for the Axial probe orientation. LTE Band 2 at 20MHz is the worst-case for the Radial probe orientation.

E. LTE TDD

1. Power Configuration: TPC = "Max Power"

FCC ID: PY7-84558E	 element	HAC (T-COIL) TEST REPORT	Approved by: Managing Director
Filename: 1M2302060006-07.PY7	Test Dates: 2/14/2023 – 2/27/2023	DUT Type: Portable Handset	Page 41 of 84

REV 4.2.M
11/29/2022

2. Radio Configuration: 16QAM, 1RB, 50%RB offset
3. Power Class 3 Uplink-Downlink configuration: 2
4. Vocoder Configuration: WB AMR 6.60kbps
5. The worst-case band and bandwidth combination for each probe orientation is additionally tested on the low, low-mid, high-mid, and high channels for those combinations. LTE Band 41 (Power Class 3) at 20MHz is the worst-case for both the Axial and Radial probe orientations.

F. OTT VoIP

1. Vocoder Configuration: 75kbps
2. EDGE Configuration
 - a. MCS Index: 7
 - b. Number of TX slots: 2
3. HSPA Configuration:
 - a. Release: 6
 - b. 3GPP 34.121 Subtest 1
4. LTE FDD Configuration:
 - a. Power Configuration: TPC = "Max Power"
 - b. Radio Configuration: 16QAM, 1RB, 50%RB offset
 - c. LTE Band 25 was the worst-case band from Table 6-6 and was used to test both Axial and Radial probe orientations.
 - d. The worst-case band and bandwidth combination for each probe orientation is additionally tested on the low and high channels for those combinations. LTE Band 25 at 10MHz is the worst-case for both the Axial and Radial probe orientation Radial probe orientation.
5. LTE TDD Configuration:
 - a. Power Configuration: TPC = "Max Power"
 - b. Radio Configuration: 16QAM, 1RB, 50%RB offset
 - c. LTE Band 41 (PC3) was the worst-case band from Table 6-7 and was used to test both Axial and Radial probe orientations.
 - d. The worst-case band and bandwidth combination for each probe orientation is additionally tested on the low, low-mid, high-mid, and high channels for those combinations. LTE Band 41 (Power Class 3) at 20MHz is the worst-case for both the Axial and Radial probe orientations.
6. NR FDD Configuration
 - a. Power Configuration: TxAGC is set such that the DUT operates at max power.
 - b. Radio Configuration: CP-OFDM, 16QAM, 1RB, 99%RB offset
 - c. NR n66 was the worst-case band from Table 6-11 and was used to test both Axial and Radial probe orientations.
 - d. The worst-case band and bandwidth combination for each probe orientation is additionally tested on the low and high channels for those combinations. NR n66 at 15MHz is the worst-case for the Axial probe orientation. NR n66 at 20MHz is the worst-case for the Radial probe orientation.
7. NR TDD Configuration
 - a. Power Configuration: TxAGC is set such that the DUT operates at max power.
 - b. Radio Configuration: CP-OFDM, 16QAM, 1RB, 99%RB offset
 - c. Due to equipment limitations, ABM1 measurements were not possible. Therefore, the procedure outlined in Section 6.II.4 was followed to obtain SNNR values. Additionally, Frequency Response measurements were not possible due to equipment limitations.
 - d. NR n77 (PC2) - SUB was the worst-case band from Table 6-12 and was used to test both Axial and Radial probe orientations.
 - e. The worst-case band and bandwidth combination for each probe orientation is additionally tested on the low and high channels for those combinations. NR n77 (PC2) – SUB at

FCC ID: PY7-84558E	 element	HAC (T-COIL) TEST REPORT	Approved by: Managing Director
Filename: 1M2302060006-07.PY7	Test Dates: 2/14/2023 – 2/27/2023	DUT Type: Portable Handset	Page 42 of 84

REV 4.2.M
11/29/2022

100MHz is the worst-case for the Axial probe orientation. NR n77 (PC2) - SUB at 60MHz is the worst-case for the Radial probe orientation.

8. WIFI Configuration:

- a. Radio Configuration
 - i. IEEE 802.11b: CCK, 11Mbps
 - ii. IEEE 802.11g/a: QPSK, 18Mbps
 - iii. IEEE 802.11n/ac 20MHz: BPSK, MCS 0
 - iv. IEEE 802.11ax SU 20MHz: 64QAM, MCS 6
 - v. IEEE 802.11n/ac 40MHz: 64QAM, MCS 6
 - vi. IEEE 802.11ax SU 40MHz: 64QAM, MCS 7
- b. RU Index
 - i. IEEE 802.11ax RU 20MHz: RU Index 54
 - ii. IEEE 802.11ax RU 40MHz: RU Index 56
- c. The worst-case standard for 2.4GHz WIFI in each probe orientation is additionally tested on the low and high channels. IEEE 802.11ax SU is the worst-case for the Axial probe orientation. IEEE 802.11b is the worst-case for the Radial probe orientation.
- d. The worst-case standard for 5GHz WIFI in each probe orientation is additionally tested on higher U-NII bands as well as applicable low and high channels. IEEE 802.11ax SU (U-NII 1) is the worst-case for the Axial probe orientation. IEEE 802.11a 20MHz (U-NII 1) is the worst-case for the Radial probe orientation.
- e. U-NII 5 testing was performed using IEEE 802.11ax, because no other IEEE standard supports U-NII 5 operations.

FCC ID: PY7-84558E		HAC (T-COIL) TEST REPORT	Approved by: Managing Director
Filename: 1M2302060006-07.PY7	Test Dates: 2/14/2023 – 2/27/2023	DUT Type: Portable Handset	Page 43 of 84

REV 4.2.M
11/29/2022

III. 1 kHz Vocoder Application Check

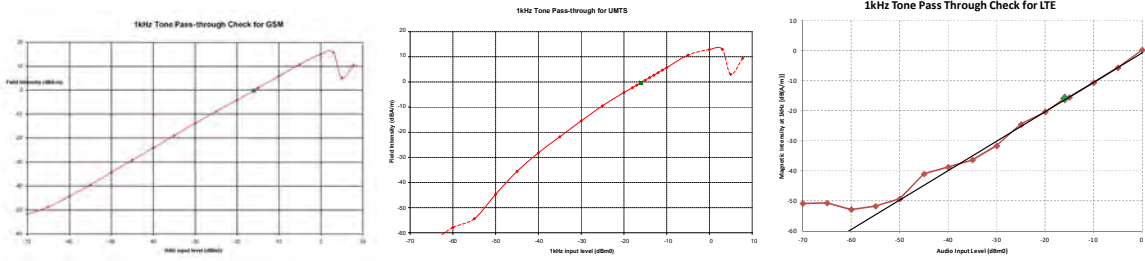

This model was verified to be within the linear region for ABM1 measurements at -16 dBm0 for GSM, UMTS, and VoLTE over IMS. This measurement was taken in the axial configuration above the maximum location.

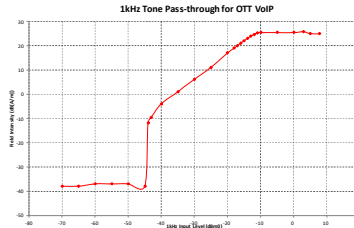

This model was verified to be within the linear region for ABM1 measurements at -20 dBm0 for OTT VoIP. This measurement was taken in the axial configuration above the maximum location.

FCC ID: PY7-84558E		HAC (T-COIL) TEST REPORT	Approved by: Managing Director
Filename: 1M2302060006-07.PY7	Test Dates: 2/14/2023 – 2/27/2023	DUT Type: Portable Handset	Page 44 of 84

REV 4.2.M
11/29/2022

IV. T-Coil Validation Test Results

**Table 8-31
Helmholtz Coil Verification Table of Results – 2/14/2023**

Item	Target	Result	Verdict
Axial			
Magnetic Intensity, -10 dBA/m	-10 ± 0.5 dB	-9.925	PASS
Environmental Noise	< -58 dBA/m	-59.03	PASS
Frequency Response, from limits	> 0 dB	0.80	PASS
Radial			
Magnetic Intensity, -10 dBA/m	-10 ± 0.5 dB	-9.971	PASS
Environmental Noise	< -58 dBA/m	-58.83	PASS
Frequency Response, from limits	> 0 dB	0.80	PASS

**Table 8-32
Helmholtz Coil Verification Table of Results – 2/20/2023**

Item	Target	Result	Verdict
Axial			
Magnetic Intensity, -10 dBA/m	-10 ± 0.5 dB	-9.892	PASS
Environmental Noise	< -58 dBA/m	-58.47	PASS
Frequency Response, from limits	> 0 dB	0.80	PASS
Radial			
Magnetic Intensity, -10 dBA/m	-10 ± 0.5 dB	-9.877	PASS
Environmental Noise	< -58 dBA/m	-58.46	PASS
Frequency Response, from limits	> 0 dB	0.80	PASS

**Table 8-33
Helmholtz Coil Verification Table of Results – 2/27/2023**

Item	Target	Result	Verdict
Axial			
Magnetic Intensity, -10 dBA/m	-10 ± 0.5 dB	-9.986	PASS
Environmental Noise	< -58 dBA/m	-58.89	PASS
Frequency Response, from limits	> 0 dB	0.80	PASS
Radial			
Magnetic Intensity, -10 dBA/m	-10 ± 0.5 dB	-9.960	PASS
Environmental Noise	< -58 dBA/m	-58.54	PASS
Frequency Response, from limits	> 0 dB	0.80	PASS

FCC ID: PY7-84558E		HAC (T-COIL) TEST REPORT	Approved by: Managing Director
Filename: 1M2302060006-07.PY7	Test Dates: 2/14/2023 – 2/27/2023	DUT Type: Portable Handset	Page 45 of 84

REV 4.2.M
11/29/2022

V. ABM1 Magnetic Field Distribution Scan Overlays

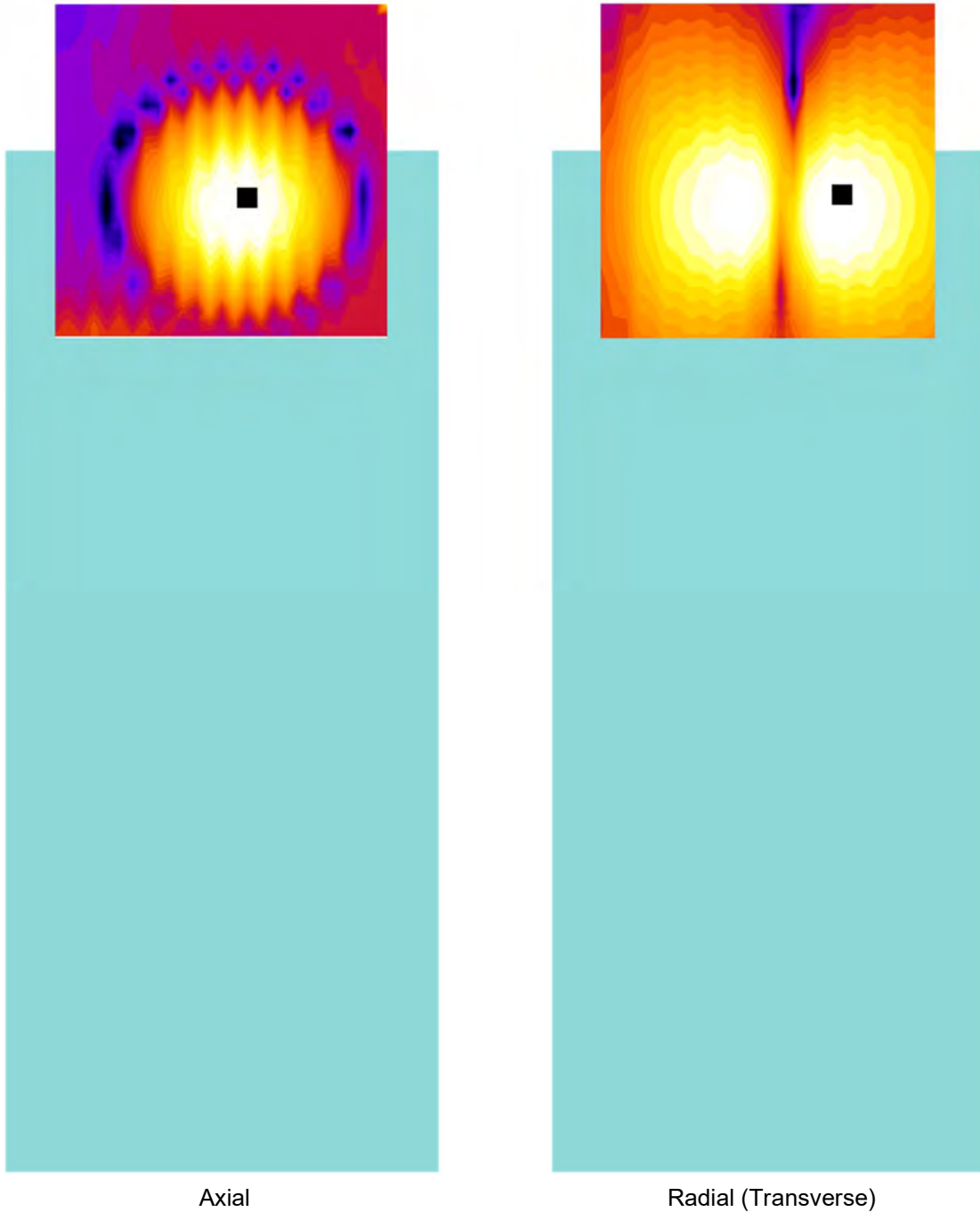

Axial

Radial (Transverse)

**Figure 8-1
T-Coil Scan Overlay Magnetic Field Distributions**

Notes:

1. Final measurement locations are indicated by a cursor on the contour plots.
2. See Test Setup Photographs for actual WD overlay.

FCC ID: PY7-84558E		HAC (T-COIL) TEST REPORT	Approved by: Managing Director
Filename: 1M2302060006-07.PY7	Test Dates: 2/14/2023 – 2/27/2023	DUT Type: Portable Handset	Page 46 of 84

REV 4.2.M
11/29/2022

9. MEASUREMENT UNCERTAINTY

**Table 9-1
Uncertainty Estimation Table**

Contribution	Data +/- %	Data +/- dB	Data Type	Probability distribution	Divisor	Standard uncertainty	Standard Uncertainty (dB)
ABM Noise	7.0%	0.29	Std. Dev.	Normal k=1	1.00	7.0%	
RF Reflections	4.7%	0.20	Specification	Rectangular	1.73	2.7%	
Reference Signal Level	12.2%	0.50	Specification	Rectangular	1.73	7.0%	
Positioning Accuracy	10.0%	0.41	Uncertainty	Rectangular	1.73	5.8%	
Probe Coil Sensitivity	12.2%	0.50	Specification	Rectangular	1.73	7.0%	
Probe Linearity	2.4%	0.10	Std. Dev.	Normal k=1	1.00	2.4%	
Cable Loss	2.8%	0.12	Specification	Rectangular	1.73	1.6%	
Frequency Analyzer	5.0%	0.21	Specification	Rectangular	1.73	2.9%	
System Repeatability	5.0%	0.21	Std. Dev.	Normal k=1	1.00	5.0%	
WD Repeatability	9.0%	0.37	Std. Dev.	Normal k=1	1.00	9.0%	
Positioner Accuracy	1.0%	0.04	Specification	Rectangular	1.73	0.6%	
Combined standard uncertainty, u_c (k=1)						17.7%	0.71
Expanded uncertainty (k=2), 95% confidence level						35.3%	1.31

Notes:

1. Test equipments are calibrated according to techniques outlined in NIS81, NIS3003 and NIST Tech Note 1297.
2. All equipments have traceability according to NIST. Measurement Uncertainties are defined in further detail in NIS 81 and NIST Tech Note 1297 and UKAS M3003.

Measurement uncertainty reflects the quality and accuracy of a measured result as compared to the true value. Such statements are generally required when stating results of measurements so that it is clear to the intended audience that the results may differ when reproduced by different facilities. Measurement results vary due to the measurement uncertainty of the instrumentation, measurement technique, and test engineer. Most uncertainties are calculated using the tolerances of the instrumentation used in the measurement, the measurement setup variability, and the technique used in performing the test. While not generally included, the variability of the equipment under test also figures into the overall measurement uncertainty. Another component of the overall uncertainty is based on the variability of repeated measurements (so-called Type A uncertainty). This may mean that the Hearing Aid compatibility tests may have to be repeated by taking down the test setup and resetting it up so that there are a statistically significant number of repeat measurements to identify the measurement uncertainty. By combining the repeat measurement results with that of the instrumentation chain using the technique contained in NIS 81 and NIS 3003, the overall measurement uncertainty was estimated.

FCC ID: PY7-84558E		HAC (T-COIL) TEST REPORT	Approved by: Managing Director
Filename: 1M2302060006-07.PY7	Test Dates: 2/14/2023 – 2/27/2023	DUT Type: Portable Handset	Page 47 of 84

REV 4.2.M
11/29/2022

10. EQUIPMENT LIST

**Table 10-1
Equipment List**

Manufacturer	Model	Description	Cal Date	Cal Interval	Cal Due	Serial Number
Listen	SoundConnect	Microphone Power Supply	8/10/2022	Biennial	8/10/2024	PS2612
RME	Fireface UC	Soundcheck Acoustic Analyzer External Audio Interface	8/23/2022	Biennial	8/23/2024	23528889
Rohde & Schwarz	CMW500	Wideband Radio Communication Tester	4/8/2022	Annual	4/8/2023	162125
Rohde & Schwarz	CMW500	Radio Communication Tester	8/25/2022	Annual	8/25/2023	140144
Rohde & Schwarz	CMX500	Radio Communication Tester	N/A		N/A	100298
Seekonk	NC-100	Torque Wrench (8" lb)	N/A		N/A	21053
TEM	Axial T-Coil Probe	Axial T-Coil Probe	8/10/2022	Biennial	8/10/2024	TEM-1122
TEM	Radial T-Coil Probe	Radial T-Coil Probe	8/10/2022	Biennial	8/10/2024	TEM-1128
TEM		HAC Positioner	N/A		N/A	N/A
TEM		HAC System Controller with Software	N/A		N/A	N/A
TEM	Helmholtz Coil	Helmholtz Coil	9/15/2022	Biennial	9/15/2024	SBI 1052
YellowTec	YT4211	USB Audio Interface	N/A		N/A	20000365
Control Company	4040	Therm./ Clock/ Humidity Monitor	3/12/2021	Biennial	3/12/2023	210202053
Netgear	XS708E	Ethernet Switch	N/A		N/A	4FU3875C001A8

FCC ID: PY7-84558E	 element	HAC (T-COIL) TEST REPORT	Approved by: Managing Director
Filename: 1M2302060006-07.PY7	Test Dates: 2/14/2023 – 2/27/2023	DUT Type: Portable Handset	Page 48 of 84

REV 4.2.M
11/29/2022

Unless otherwise specified, no part of this report may be reproduced or utilized in any part, form or by any means, electronic or mechanical, including photocopying and microfilm, without permission in writing from Element. If you have any questions about this or have an enquiry about obtaining additional rights to this report or assembly of contents thereof, please contact CT.INFO@ELEMENT.COM.

11. TEST DATA

FCC ID: PY7-84558E	 element	HAC (T-COIL) TEST REPORT	Approved by: Managing Director
Filename: 1M2302060006-07.PY7	Test Dates: 2/14/2023 – 2/27/2023	DUT Type: Portable Handset	Page 49 of 84

REV 4.2.M
11/29/2022



Element Hearing-Aid Compatibility Facility

DUT: HH Coil – SN: SBI 1052

Type: HH Coil
Serial: SBI 1052

Measurement Standard: ANSI C63.19-2011

Equipment:

- Probe: Axial T-Coil Probe – SN: TEM-1122; Calibrated: 8/10/2022
- Helmholtz Coil – SN: SBI 1052; Calibrated: 9/15/2022

Noise Spectrum

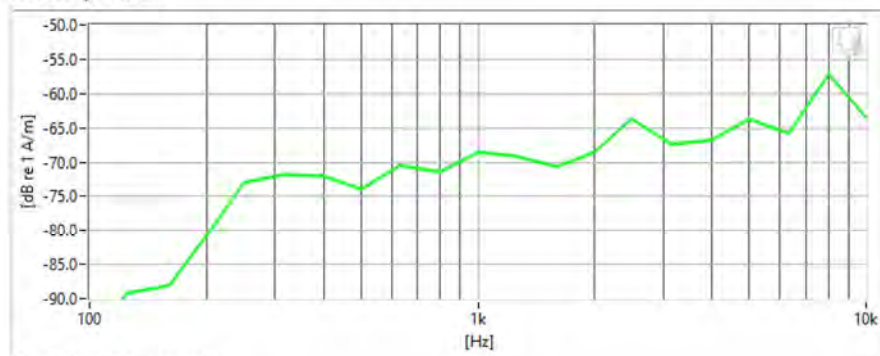

Frequency Response

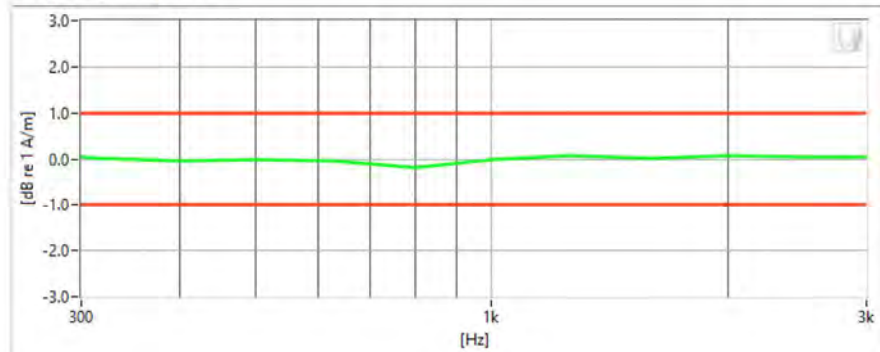

Results

Verification 1kHz Intensity	-9.925 dB	✓	Max/Min	-9.5/-10.5
Verification ABM2	-59.03 dB	✓	Maximum	-58.0
Frequency Response Margin	800m dB	✓	Tolerance curves	Aligned Data

FCC ID: PY7-84558E		HAC (T-COIL) TEST REPORT	Approved by: Managing Director
Filename: 1M2302060006-07.PY7	Test Dates: 2/14/2023 – 2/27/2023	DUT Type: Portable Handset	Page 50 of 84

REV 4.2.M
11/29/2022



Element Hearing-Aid Compatibility Facility

DUT: HH Coil – SN: SBI 1052

Type: HH Coil
Serial: SBI 1052

Measurement Standard: ANSI C63.19-2011

Equipment:

- Probe: Axial T-Coil Probe – SN: TEM-1122; Calibrated: 8/10/2022
- Helmholtz Coil – SN: SBI 1052; Calibrated: 9/15/2022

Noise Spectrum

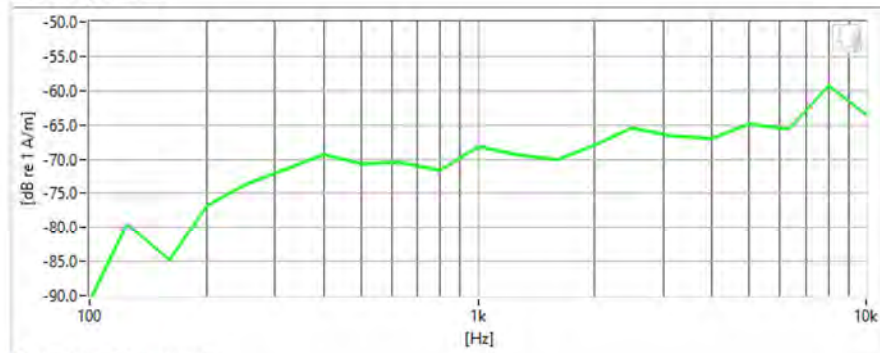

Frequency Response

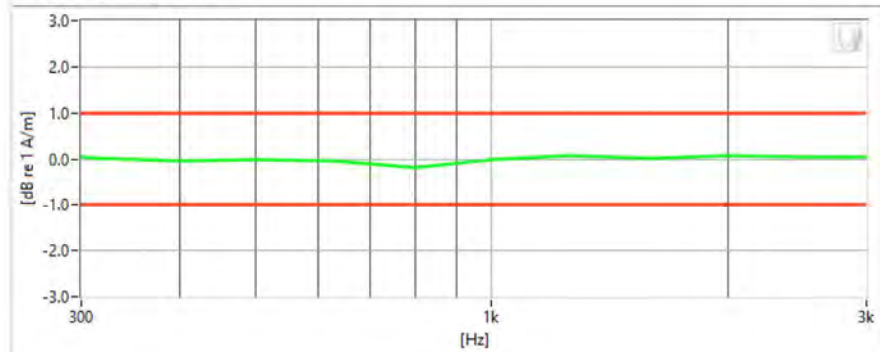

Results

Verification 1kHz Intensity	-9.892 dB	✓	Max/Min	-9.5/-10.5
Verification ABM2	-58.47 dB	✓	Maximum	-58.0
Frequency Response Margin	800m dB	✓	Tolerance curves	Aligned Data

FCC ID: PY7-84558E		HAC (T-COIL) TEST REPORT	Approved by: Managing Director
Filename: 1M2302060006-07.PY7	Test Dates: 2/14/2023 – 2/27/2023	DUT Type: Portable Handset	Page 51 of 84

REV 4.2.M
11/29/2022



Element Hearing-Aid Compatibility Facility

DUT: HH Coil – SN: SBI 1052

Type: HH Coil
Serial: SBI 1052

Measurement Standard: ANSI C63.19-2011

Equipment:

- Probe: Axial T-Coil Probe – SN: TEM-1122; Calibrated: 8/10/2022
- Helmholtz Coil – SN: SBI 1052; Calibrated: 9/15/2022

Noise Spectrum

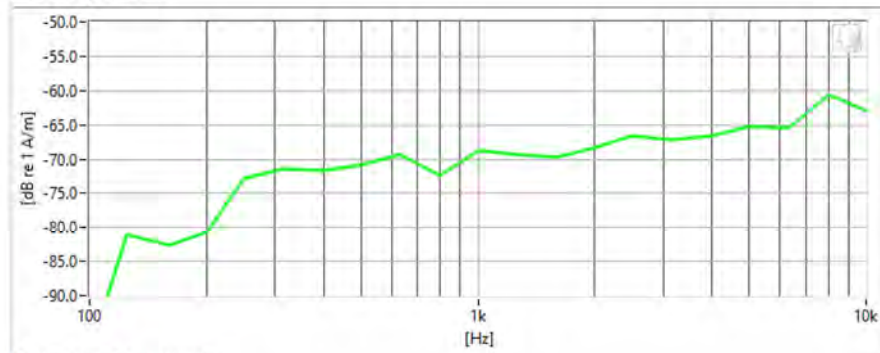

Frequency Response

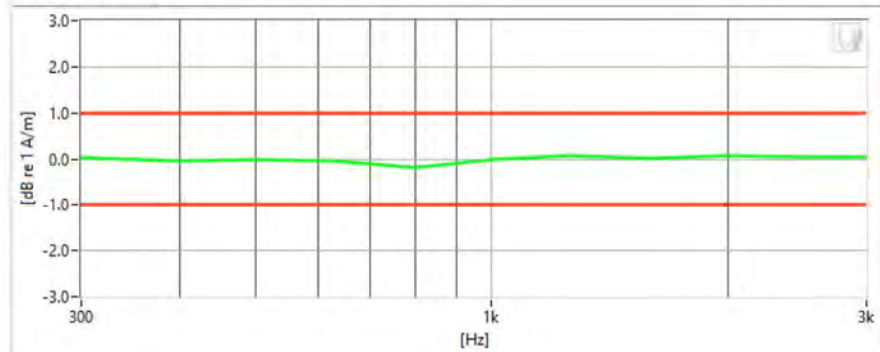

Results

Verification 1kHz Intensity	-9.986 dB	✓	Max/Min	-9.5/-10.5
Verification ABM2	-58.89 dB	✓	Maximum	-58.0
Frequency Response Margin	800m dB	✓	Tolerance curves	Aligned Data

FCC ID: PY7-84558E		HAC (T-COIL) TEST REPORT	Approved by: Managing Director
Filename: 1M2302060006-07.PY7	Test Dates: 2/14/2023 – 2/27/2023	DUT Type: Portable Handset	Page 52 of 84

REV 4.2.M
11/29/2022



Element Hearing-Aid Compatibility Facility

DUT: HH Coil – SN: SBI 1052

Type: HH Coil
Serial: SBI 1052

Measurement Standard: ANSI C63.19-2011

Equipment:

- Probe: Radial T-Coil Probe – SN: TEM-1128; Calibrated: 8/10/2022
- Helmholtz Coil – SN: SBI 1052; Calibrated: 9/15/2022

Noise Spectrum

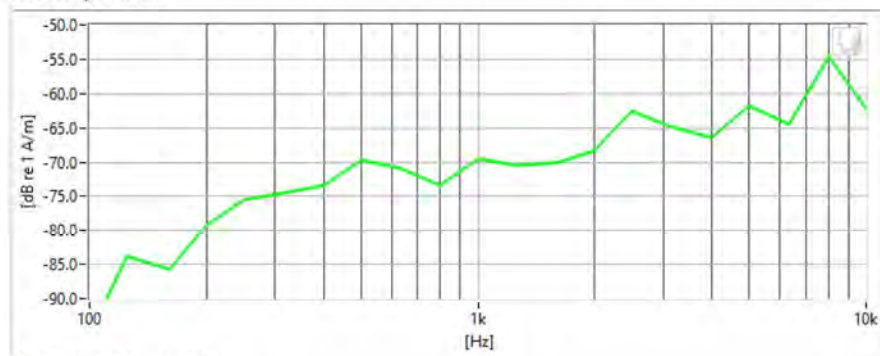

Frequency Response

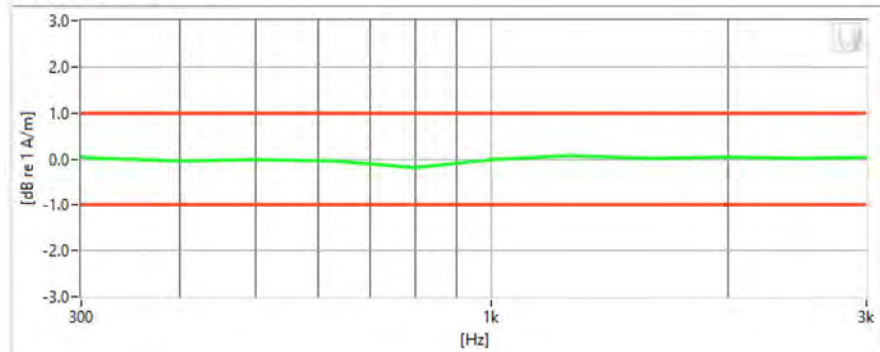

Results

Verification 1kHz Intensity	-9.971 dB	✓	Max/Min	-9.5/-10.5
Verification ABM2	-58.83 dB	✓	Maximum	-58.0
Frequency Response Margin	800m dB	✓	Tolerance curves	Aligned Data

FCC ID: PY7-84558E		HAC (T-COIL) TEST REPORT	Approved by: Managing Director
Filename: 1M2302060006-07.PY7	Test Dates: 2/14/2023 – 2/27/2023	DUT Type: Portable Handset	Page 53 of 84

REV 4.2.M
11/29/2022



Element Hearing-Aid Compatibility Facility

DUT: HH Coil – SN: SBI 1052

Type: HH Coil
Serial: SBI 1052

Measurement Standard: ANSI C63.19-2011

Equipment:

- Probe: Radial T-Coil Probe – SN: TEM-1128; Calibrated: 8/10/2022
- Helmholtz Coil – SN: SBI 1052; Calibrated: 9/15/2022

Noise Spectrum

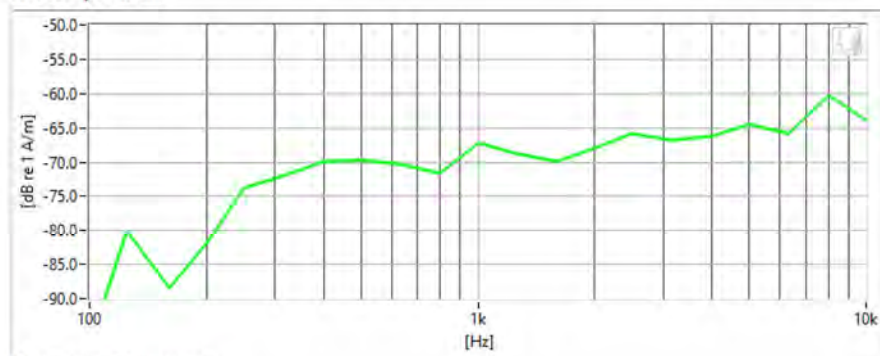

Frequency Response

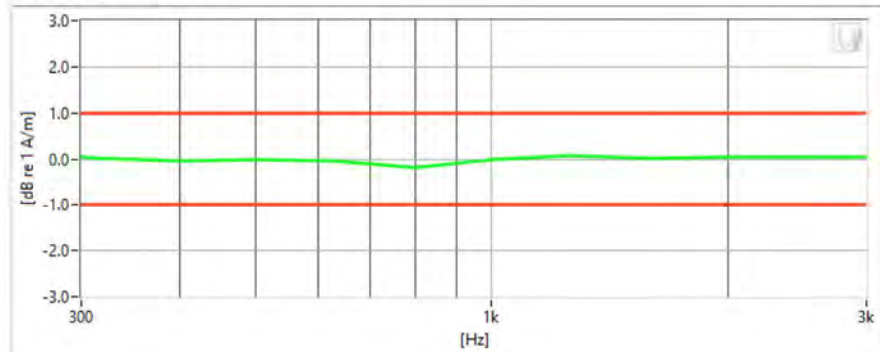

Results

Verification 1kHz Intensity	-9.877 dB	✓	Max/Min	-9.5/-10.5
Verification ABM2	-58.46 dB	✓	Maximum	-58.0
Frequency Response Margin	800m dB	✓	Tolerance curves	Aligned Data

FCC ID: PY7-84558E		HAC (T-COIL) TEST REPORT	Approved by: Managing Director
Filename: 1M2302060006-07.PY7	Test Dates: 2/14/2023 – 2/27/2023	DUT Type: Portable Handset	Page 54 of 84

REV 4.2.M
11/29/2022



Element Hearing-Aid Compatibility Facility

DUT: HH Coil – SN: SBI 1052

Type: HH Coil
Serial: SBI 1052

Measurement Standard: ANSI C63.19-2011

Equipment:

- Probe: Radial T-Coil Probe – SN: TEM-1128; Calibrated: 8/10/2022
- Helmholtz Coil – SN: SBI 1052; Calibrated: 9/15/2022

Noise Spectrum

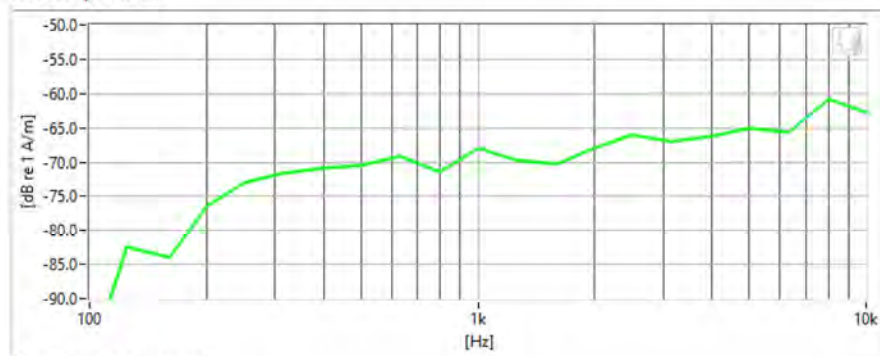

Frequency Response

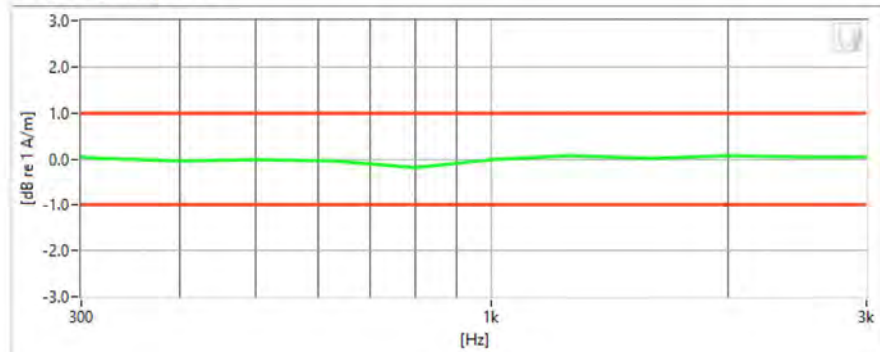

Results

Verification 1kHz Intensity	-9.96 dB	✓	Max/Min	-9.5/-10.5
Verification ABM2	-58.54 dB	✓	Maximum	-58.0
Frequency Response Margin	800m dB	✓	Tolerance curves	Aligned Data

FCC ID: PY7-84558E		HAC (T-COIL) TEST REPORT	Approved by: Managing Director
Filename: 1M2302060006-07.PY7	Test Dates: 2/14/2023 – 2/27/2023	DUT Type: Portable Handset	Page 55 of 84

REV 4.2.M
11/29/2022



Element Hearing-Aid Compatibility Facility

DUT: PY7-84558E

Type: Portable Handset
Serial: 03VFX

Measurement Standard: ANSI C63.19-2011

Equipment:

- Probe: Axial T-Coil Probe – SN: TEM-1122; Calibrated: 8/10/2022

Test Configuration:

- Mode: GSM850
- Channel: 190
- Speech Signal: ITU-T P.50 Artificial Voice

Noise Spectrum

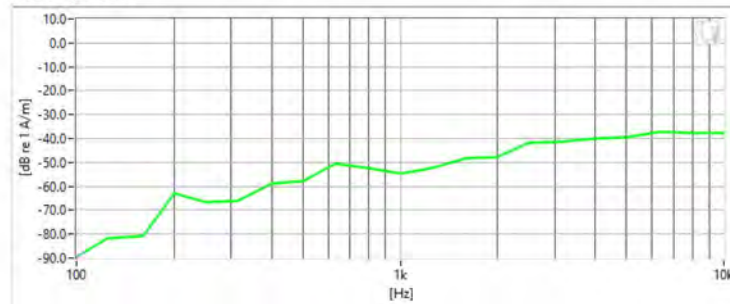

Frequency Response

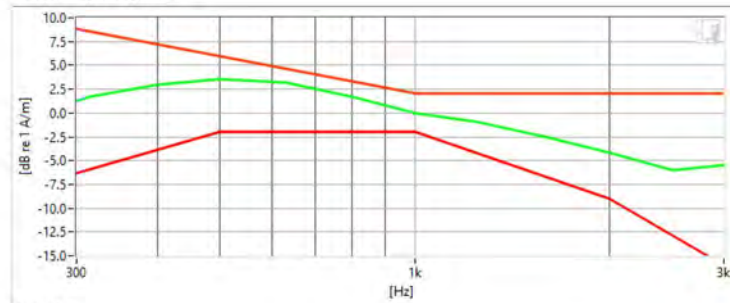

Results

ABM1	2.19 dB	✓	Minimum	-18.0
ABM2	-39.26 dB	✓	Maximum	0.0
SNNR	41.45 dB	✓	Minimum	20.0
Aligned Response - P.50	1.44 dB	✓	Tolerance curves	Aligned Data

FCC ID: PY7-84558E		HAC (T-COIL) TEST REPORT	Approved by: Managing Director
Filename: 1M2302060006-07.PY7	Test Dates: 2/14/2023 – 2/27/2023	DUT Type: Portable Handset	Page 56 of 84

REV 4.2.M
11/29/2022



Element Hearing-Aid Compatibility Facility

DUT: PY7-84558E

Type: Portable Handset
Serial: 03VFX

Measurement Standard: ANSI C63.19-2011

Equipment:

- Probe: Axial T-Coil Probe – SN: TEM-1122; Calibrated: 8/10/2022

Test Configuration:

- Mode: GSM1900
- Channel: 810
- Speech Signal: ITU-T P.50 Artificial Voice

Noise Spectrum

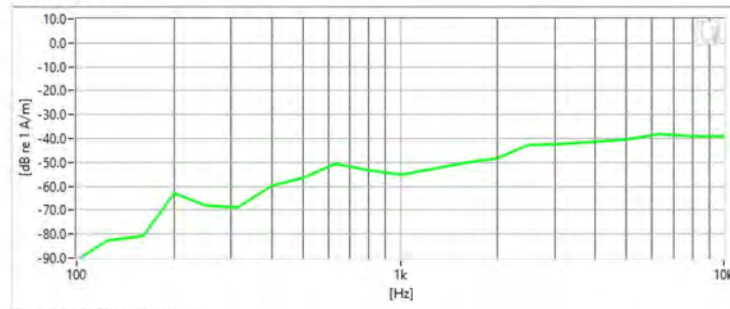

Frequency Response

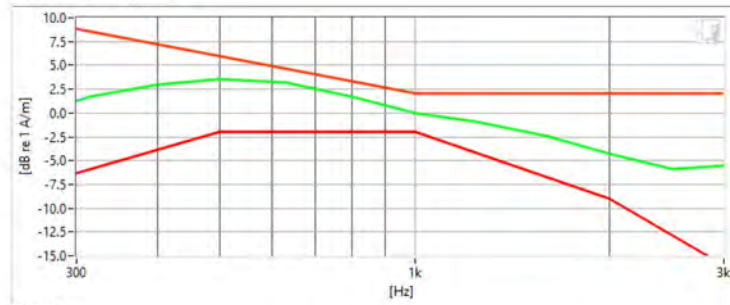

Results

ABM1	2.48 dB	✓	Minimum	-18.0
ABM2	-40.12 dB	✓	Maximum	0
SNNR	42.6 dB	✓	Minimum	20
Aligned Response - P.50	1.42 dB	✓	Tolerance curves	Aligned Data

FCC ID: PY7-84558E		HAC (T-COIL) TEST REPORT	Approved by: Managing Director
Filename: 1M2302060006-07.PY7	Test Dates: 2/14/2023 – 2/27/2023	DUT Type: Portable Handset	Page 57 of 84

REV 4.2.M
11/29/2022



Element Hearing-Aid Compatibility Facility

DUT: PY7-84558E

Type: Portable Handset
Serial: 03VFX

Measurement Standard: ANSI C63.19-2011

Equipment:

- Probe: Axial T-Coil Probe – SN: TEM-1122; Calibrated: 8/10/2022

Test Configuration:

- Mode: UMTS V
- Channel: 4183
- Speech Signal: ITU-T P.50 Artificial Voice

Noise Spectrum

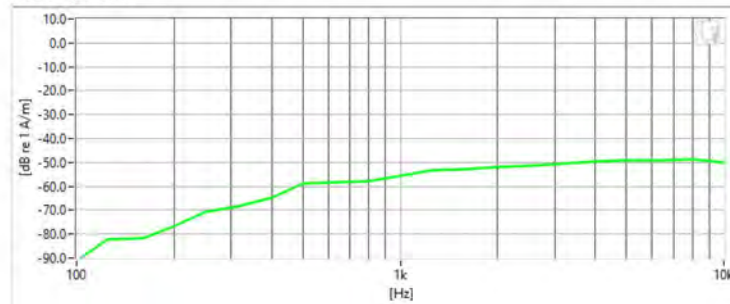

Frequency Response

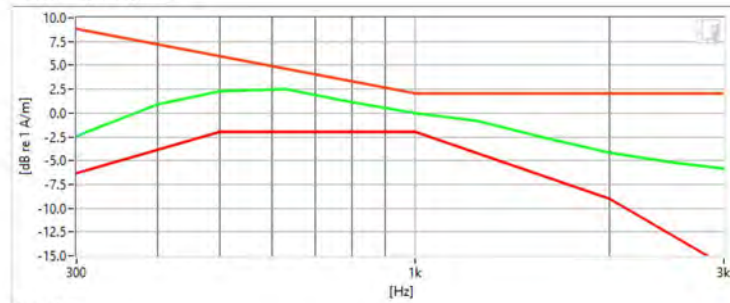

Results

ABM1	20m dB	✓	Minimum	-18.0
ABM2	-45.84 dB	✓	Maximum	0.0
SNNR	45.86 dB	✓	Minimum	20.0
Aligned Response - P.50	2 dB	✓	Tolerance curves	Aligned Data

FCC ID: PY7-84558E		HAC (T-COIL) TEST REPORT	Approved by: Managing Director
Filename: 1M2302060006-07.PY7	Test Dates: 2/14/2023 – 2/27/2023	DUT Type: Portable Handset	Page 58 of 84

REV 4.2.M
11/29/2022



Element Hearing-Aid Compatibility Facility

DUT: PY7-84558E

Type: Portable Handset
Serial: 03VFX

Measurement Standard: ANSI C63.19-2011

Equipment:

- Probe: Axial T-Coil Probe – SN: TEM-1122; Calibrated: 8/10/2022

Test Configuration:

- Mode: UMTS IV
- Channel: 1412
- Speech Signal: ITU-T P.50 Artificial Voice

Noise Spectrum

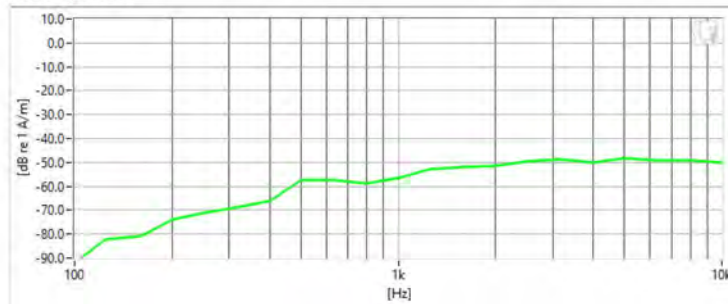

Frequency Response

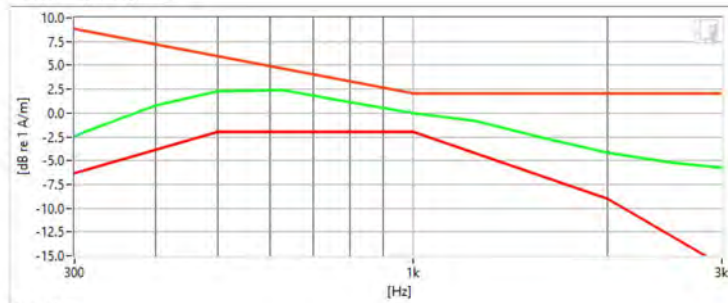

Results

ABM1	370m dB	✓	Minimum	-18.0
ABM2	-45.36 dB	✓	Maximum	0.0
SNNR	45.73 dB	✓	Minimum	20.0
Aligned Response - P.50	2 dB	✓	Tolerance curves	Aligned Data

FCC ID: PY7-84558E		HAC (T-COIL) TEST REPORT	Approved by: Managing Director
Filename: 1M2302060006-07.PY7	Test Dates: 2/14/2023 – 2/27/2023	DUT Type: Portable Handset	Page 59 of 84

REV 4.2.M
11/29/2022



Element Hearing-Aid Compatibility Facility

DUT: PY7-84558E

Type: Portable Handset
Serial: 03VFX

Measurement Standard: ANSI C63.19-2011

Equipment:

- Probe: Axial T-Coil Probe – SN: TEM-1122; Calibrated: 8/10/2022

Test Configuration:

- Mode: UMTS II
- Channel: 9538
- Speech Signal: ITU-T P.50 Artificial Voice

Noise Spectrum

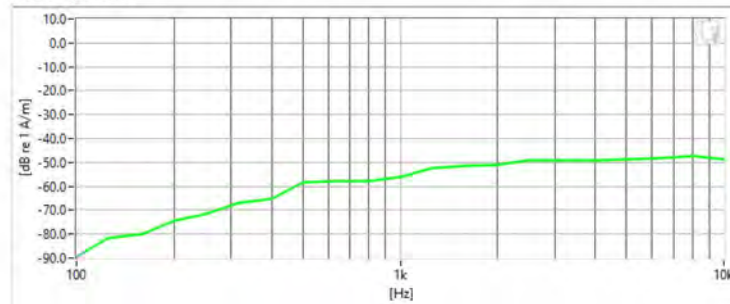

Frequency Response

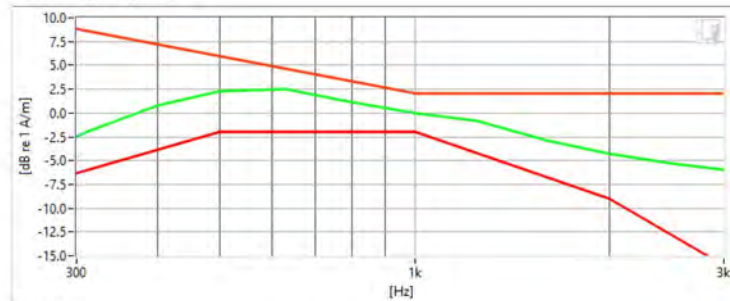

Results

ABM1	70m dB	✓	Minimum	-18.0
ABM2	-45.04 dB	✓	Maximum	0.0
SNNR	45.11 dB	✓	Minimum	20.0
Aligned Response - P.50	2 dB	✓	Tolerance curves	Aligned Data

FCC ID: PY7-84558E		HAC (T-COIL) TEST REPORT	Approved by: Managing Director
Filename: 1M2302060006-07.PY7	Test Dates: 2/14/2023 – 2/27/2023	DUT Type: Portable Handset	Page 60 of 84

REV 4.2.M
11/29/2022



Element Hearing-Aid Compatibility Facility

DUT: PY7-84558E

Type: Portable Handset
Serial: 03VFX

Measurement Standard: ANSI C63.19-2011

Equipment:

- Probe: Axial T-Coil Probe – SN: TEM-1122; Calibrated: 8/10/2022

Test Configuration:

- Mode: LTE FDD Band 4
- Bandwidth: 1.4MHz
- Channel: 20175
- Speech Signal: ITU-T P.50 Artificial Voice

Noise Spectrum

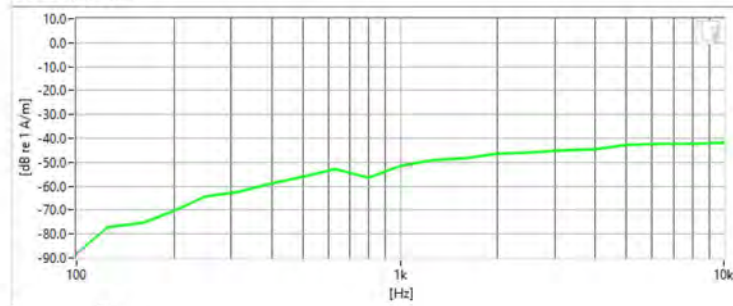

Frequency Response

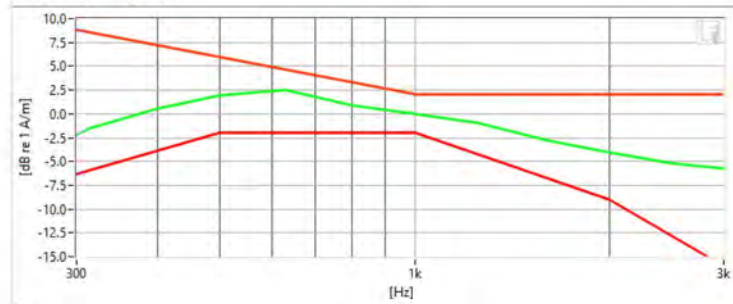

Results

ABM1	-320m dB	✓	Minimum	-18.0
ABM2	-41.01 dB	✓	Maximum	0.0
SNNR	40.7 dB	✓	Minimum	20.0
Aligned Response - P.50	2 dB	✓	Tolerance curves	Aligned Data

FCC ID: PY7-84558E		HAC (T-COIL) TEST REPORT	Approved by: Managing Director
Filename: 1M2302060006-07.PY7	Test Dates: 2/14/2023 – 2/27/2023	DUT Type: Portable Handset	Page 61 of 84

REV 4.2.M
11/29/2022



Element Hearing-Aid Compatibility Facility

DUT: PY7-84558E

Type: Portable Handset
Serial: 03VFX

Measurement Standard: ANSI C63.19-2011

Equipment:

- Probe: Axial T-Coil Probe – SN: TEM-1122; Calibrated: 8/10/2022

Test Configuration:

- Mode: LTE TDD Band 41 (PC3)
- Bandwidth: 20MHz
- Channel: 41055
- Speech Signal: ITU-T P.50 Artificial Voice

Noise Spectrum

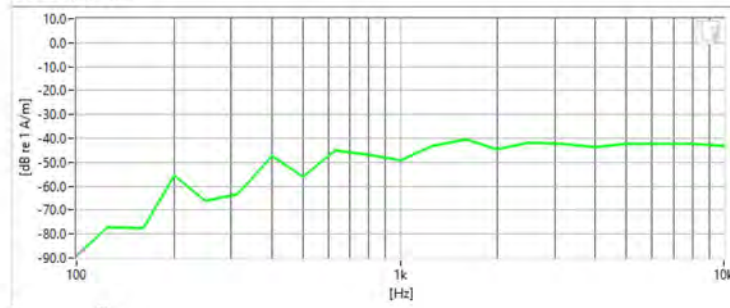

Frequency Response

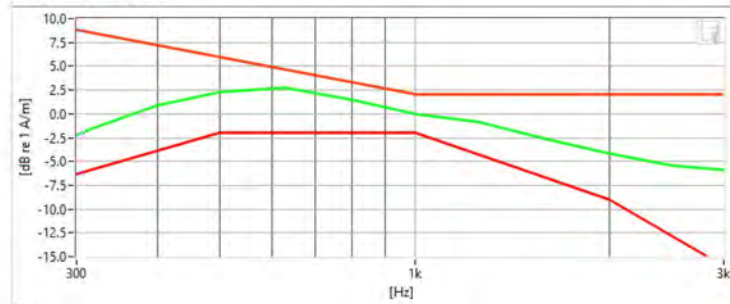

Results

ABM1	90m dB	✓	Minimum	-18.0
ABM2	-35.71 dB	✓	Maximum	0
SNNR	35.8 dB	✓	Minimum	20
Aligned Response - P.50	1.79 dB	✓	Tolerance curves	Aligned Data

FCC ID: PY7-84558E		HAC (T-COIL) TEST REPORT	Approved by: Managing Director
Filename: 1M2302060006-07.PY7	Test Dates: 2/14/2023 – 2/27/2023	DUT Type: Portable Handset	Page 62 of 84

REV 4.2.M
11/29/2022



Element Hearing-Aid Compatibility Facility

DUT: PY7-84558E

Type: Portable Handset
Serial: 03VFX

Measurement Standard: ANSI C63.19-2011

Equipment:

- Probe: Axial T-Coil Probe – SN: TEM-1122; Calibrated: 8/10/2022

Test Configuration:

- VoIP Application: Google Meet
- Mode: LTE TDD Band 41 (PC3)
- Bandwidth: 20MHz
- Channel: 41055
- Speech Signal: ITU-T P.50 Artificial Voice

Noise Spectrum

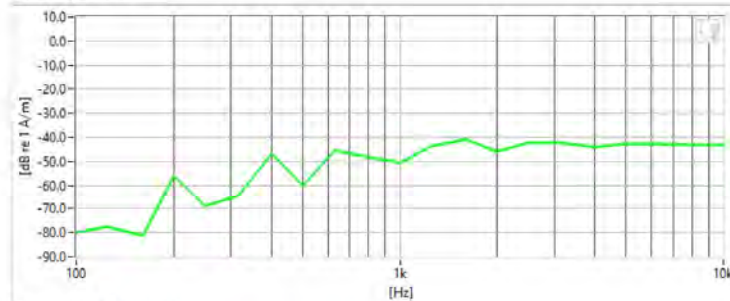

Frequency Response

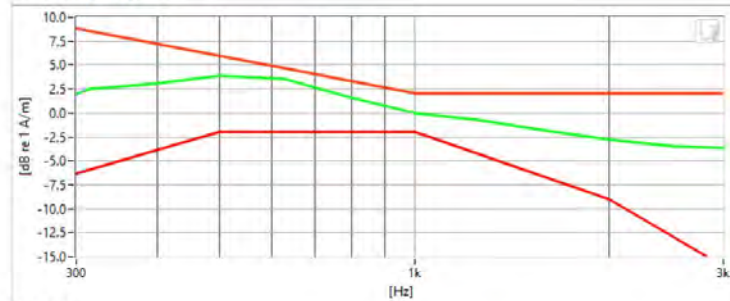

Results

ABM1	820m dB	✓	Minimum	-18.0
ABM2	-36.25 dB	✓	Maximum	0.0
SNNR	37.07 dB	✓	Minimum	20.0
Aligned Response - P.50	1.04 dB	✓	Tolerance curves	Aligned Data

FCC ID: PY7-84558E		HAC (T-COIL) TEST REPORT	Approved by: Managing Director
Filename: 1M2302060006-07.PY7	Test Dates: 2/14/2023 – 2/27/2023	DUT Type: Portable Handset	Page 63 of 84

REV 4.2.M
11/29/2022



Element Hearing-Aid Compatibility Facility

DUT: PY7-84558E

Type: Portable Handset
Serial: 03VFX

Measurement Standard: ANSI C63.19-2011

Equipment:

- Probe: Radial T-Coil Probe – SN: TEM-1128; Calibrated: 8/10/2022

Test Configuration:

- Mode: GSM850
- Channel: 190

Noise Spectrum

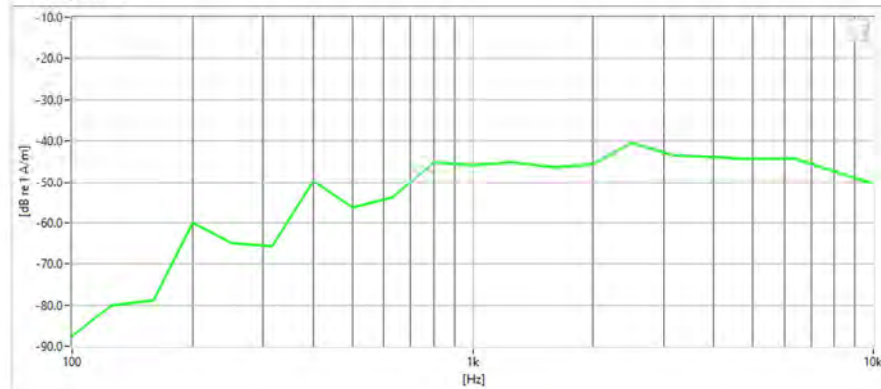

Results

ABM1	-4.19 dB	✓	Minimum	-18.0
ABM2	-37.34 dB	✓	Maximum	0.0
SNNR	33.15 dB	✓	Minimum	20.0

FCC ID: PY7-84558E		HAC (T-COIL) TEST REPORT	Approved by: Managing Director
Filename: 1M2302060006-07.PY7	Test Dates: 2/14/2023 – 2/27/2023	DUT Type: Portable Handset	Page 64 of 84

REV 4.2.M
11/29/2022



Element Hearing-Aid Compatibility Facility

DUT: PY7-84558E

Type: Portable Handset
Serial: 03VFX

Measurement Standard: ANSI C63.19-2011

Equipment:

- Probe: Radial T-Coil Probe – SN: TEM-1128; Calibrated: 8/10/2022

Test Configuration:

- Mode: GSM1900
- Channel: 810

Noise Spectrum

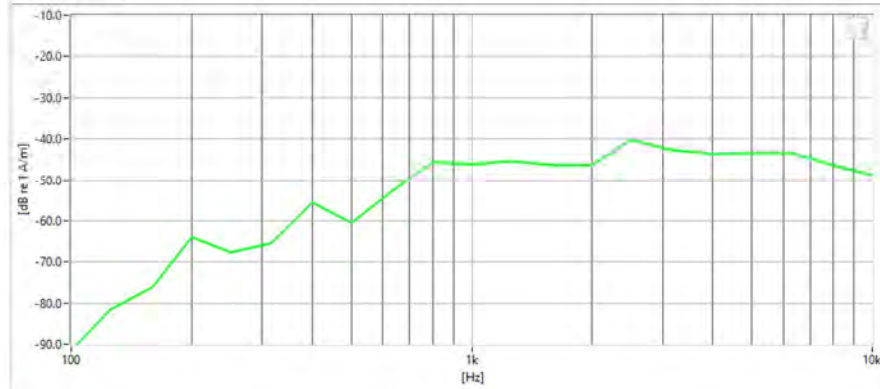

Results

ABM1	-4.21 dB	✓	Minimum	-18.0
ABM2	-37.85 dB	✓	Maximum	0.0
SNNR	33.64 dB	✓	Minimum	20.0

FCC ID: PY7-84558E		HAC (T-COIL) TEST REPORT	Approved by: Managing Director
Filename: 1M2302060006-07.PY7	Test Dates: 2/14/2023 – 2/27/2023	DUT Type: Portable Handset	Page 65 of 84

REV 4.2.M
11/29/2022



Element Hearing-Aid Compatibility Facility

DUT: PY7-84558E

Type: Portable Handset
Serial: 03VFX

Measurement Standard: ANSI C63.19-2011

Equipment:

- Probe: Radial T-Coil Probe – SN: TEM-1128; Calibrated: 8/10/2022

Test Configuration:

- Mode: UMTS V
- Channel: 4233

Noise Spectrum

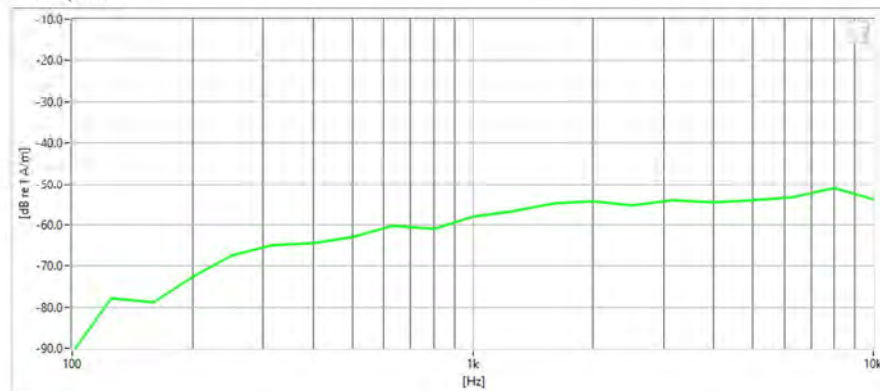

Results

ABM1	-6.6 dB	✓	Minimum	-18.0
ABM2	-48.49 dB	✓	Maximum	0.0
SNNR	41.9 dB	✓	Minimum	20.0

FCC ID: PY7-84558E		HAC (T-COIL) TEST REPORT	Approved by: Managing Director
Filename: 1M2302060006-07.PY7	Test Dates: 2/14/2023 – 2/27/2023	DUT Type: Portable Handset	Page 66 of 84

REV 4.2.M
11/29/2022



Element Hearing-Aid Compatibility Facility

DUT: PY7-84558E

Type: Portable Handset
Serial: 03VFX

Measurement Standard: ANSI C63.19-2011

Equipment:

- Probe: Radial T-Coil Probe – SN: TEM-1128; Calibrated: 8/10/2022

Test Configuration:

- Mode: UMTS IV
- Channel: 1312

Noise Spectrum

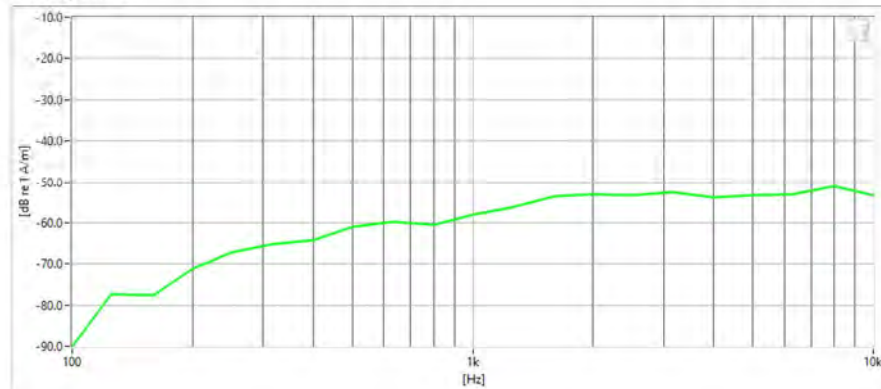

Results

ABM1	-6.47 dB	✓	Minimum	-18.0
ABM2	-47.64 dB	✓	Maximum	0.0
SNNR	41.17 dB	✓	Minimum	20.0

FCC ID: PY7-84558E		HAC (T-COIL) TEST REPORT	Approved by: Managing Director
Filename: 1M2302060006-07.PY7	Test Dates: 2/14/2023 – 2/27/2023	DUT Type: Portable Handset	Page 67 of 84

REV 4.2.M
11/29/2022



Element Hearing-Aid Compatibility Facility

DUT: PY7-84558E

Type: Portable Handset
Serial: 03VFX

Measurement Standard: ANSI C63.19-2011

Equipment:

- Probe: Radial T-Coil Probe – SN: TEM-1128; Calibrated: 8/10/2022

Test Configuration:

- Mode: UMTS II
- Channel: 9262

Noise Spectrum

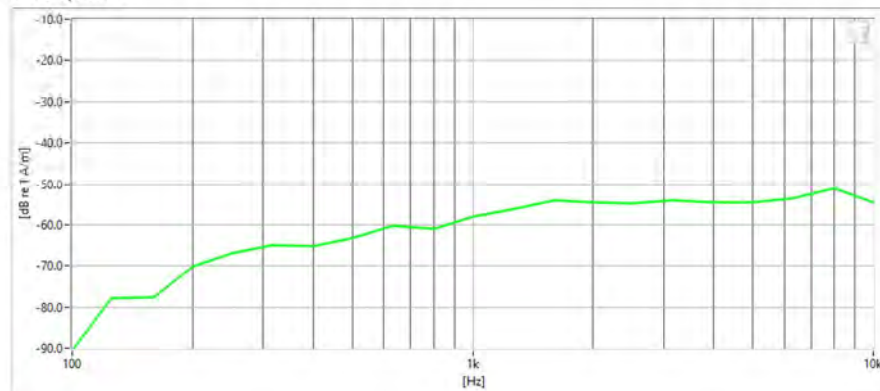

Results

ABM1	-6.61 dB	✓	Minimum	-18.0
ABM2	-48.33 dB	✓	Maximum	0.0
SNNR	41.72 dB	✓	Minimum	20.0

FCC ID: PY7-84558E		HAC (T-COIL) TEST REPORT	Approved by: Managing Director
Filename: 1M2302060006-07.PY7	Test Dates: 2/14/2023 – 2/27/2023	DUT Type: Portable Handset	Page 68 of 84

REV 4.2.M
11/29/2022



Element Hearing-Aid Compatibility Facility

DUT: PY7-84558E

Type: Portable Handset
Serial: 03VFX

Measurement Standard: ANSI C63.19-2011

Equipment:

- Probe: Radial T-Coil Probe – SN: TEM-1128; Calibrated: 8/10/2022

Test Configuration:

- Mode: LTE FDD Band 2
- Bandwidth: 20MHz
- Channel: 18700

Noise Spectrum

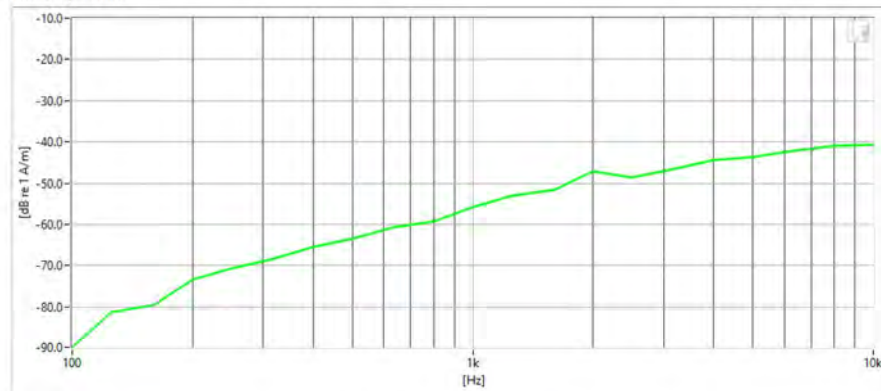

Results

ABM1	-6.82 dB	✓	Minimum	-18.0
ABM2	-43.5 dB	✓	Maximum	0.0
SNNR	36.68 dB	✓	Minimum	20.0

FCC ID: PY7-84558E		HAC (T-COIL) TEST REPORT	Approved by: Managing Director
Filename: 1M2302060006-07.PY7	Test Dates: 2/14/2023 – 2/27/2023	DUT Type: Portable Handset	Page 69 of 84

REV 4.2.M
11/29/2022



Element Hearing-Aid Compatibility Facility

DUT: PY7-84558E

Type: Portable Handset
Serial: 03VFX

Measurement Standard: ANSI C63.19-2011

Equipment:

- Probe: Radial T-Coil Probe – SN: TEM-1128; Calibrated: 8/10/2022

Test Configuration:

- Mode: LTE TDD Band 41 (PC3)
- Bandwidth: 20MHz
- Channel: 41055

Noise Spectrum

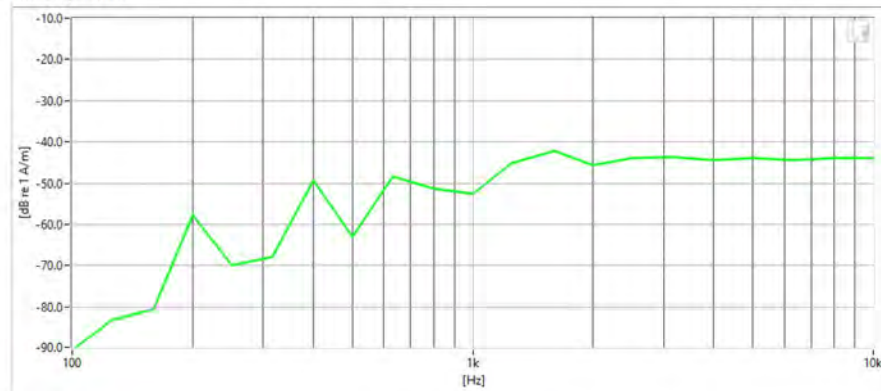

Results

ABM1	-6.62 dB	✓	Minimum	-18.0
ABM2	-37.99 dB	✓	Maximum	0.0
SNNR	31.38 dB	✓	Minimum	20.0

FCC ID: PY7-84558E		HAC (T-COIL) TEST REPORT	Approved by: Managing Director
Filename: 1M2302060006-07.PY7	Test Dates: 2/14/2023 – 2/27/2023	DUT Type: Portable Handset	Page 70 of 84

REV 4.2.M
11/29/2022



Element Hearing-Aid Compatibility Facility

DUT: PY7-84558E

Type: Portable Handset
Serial: 03VFX

Measurement Standard: ANSI C63.19-2011

Equipment:

- Probe: Radial T-Coil Probe – SN: TEM-1128; Calibrated: 8/10/2022

Test Configuration:

- VoIP Application: Google Meet
- Mode: LTE TDD Band 41 (PC3)
- Bandwidth: 20MHz
- Channel: 39750

Noise Spectrum

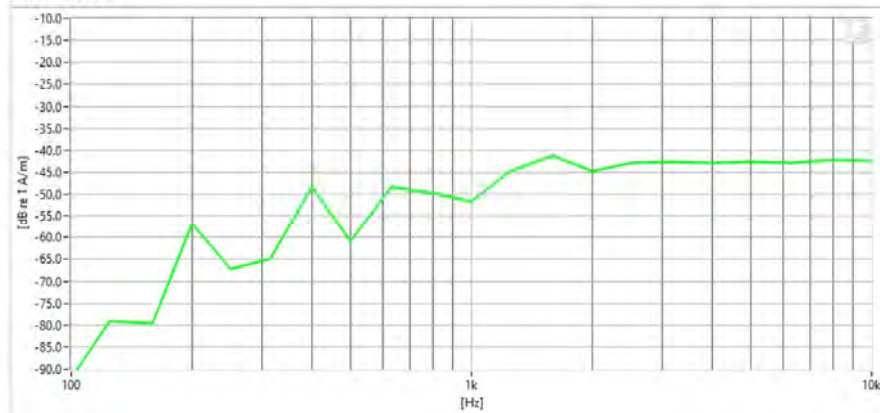

Results

ABM1	-6.02 dB	✓	Minimum	-18.0
ABM2	-37.09 dB	✓	Maximum	0.0
SNNR	31.07 dB	✓	Minimum	20.0

FCC ID: PY7-84558E		HAC (T-COIL) TEST REPORT	Approved by: Managing Director
Filename: 1M2302060006-07.PY7	Test Dates: 2/14/2023 – 2/27/2023	DUT Type: Portable Handset	Page 71 of 84

REV 4.2.M
11/29/2022

12. CALIBRATION CERTIFICATES

FCC ID: PY7-84558E	 element	HAC (T-COIL) TEST REPORT	Approved by: Managing Director
Filename: 1M2302060006-07.PY7	Test Dates: 2/14/2023 – 2/27/2023	DUT Type: Portable Handset	Page 72 of 84

REV 4.2.M

11/29/2022

West Caldwell Calibration Laboratories Inc.
Certificate of Calibration

for

Axial T Coil Probe

Manufactured by: LISTEN INC.
 Model No: AXIAL T COIL PROBE
 Serial No: TEM-1122
 Calibration Recall No: 33271

Submitted By:

Customer: Tae Kim
 Company: Element Materials Technology Washington DC LLC
 Address: 7185 Oakland Mills Road
 Columbia MD 21046

The subject instrument was calibrated to the indicated specification using standards traceable to the SI through the National Institute of Standards and Technology or to accepted values of natural physical constants. This document certifies that the instrument met the following specification upon its return to the submitter.

West Caldwell Calibration Laboratories Procedure No. AXIAL T C LISTE

✓TK
9/2/2022

Upon receipt for Calibration, the instrument was found to be:

Within (X)

tolerance of the indicated specification. See attached Report of Calibration.

The information supplied certifies that the item listed above meets acceptance criteria under the decision rule: $A=(L-(U95))$, where A is the acceptance criteria, L is manufacturer specifications, and U95 is confidence level of 95% at $k=2$. The decision rule has been communicated and approved by customer during contract review. Measurements marked with (*) are not covered by the scope of current A2LA accreditation.

West Caldwell Calibration Laboratories' calibration control system meets the following requirements: ANSI/NCSL Z540-1, ISO 9001, and ISO 17025.

Note: With this Certificate, Report of Calibration is included.

Approved by:

James Zhu

Quality Manager

Calibration Date: 10-Aug-22
 Certificate Issue Date: 01-Sep-22 Rev 2.0
 Certificate No: 33271 - 1

QA Doc. #1051 Rev. 3.0 5/29/20

Certificate Page 1 of 1

ISO/IEC 17025



Calibration Lab. Cert. # 1533.01

West Caldwell Calibration Laboratories, Inc.
 uncompromised calibration
 1575 State Route 96, Victor, NY 14564, U.S.A.

FCC ID: PY7-84558E		HAC (T-COIL) TEST REPORT	Approved by: Managing Director
Filename: 1M2302060006-07.PY7	Test Dates: 2/14/2023 – 2/27/2023	DUT Type: Portable Handset	Page 73 of 84

REV 4.2.M
11/29/2022



REPORT OF CALIBRATION

for

TEM Consulting LP Axial T Coil Probe Model No.: Axial T Coil Probe Serial No.: TEM-1122
 Company: Element Materials Technology Washington D.C. LLC. I. D. No.: XXXX

Calibration results:			
Probe Sensitivity measured with Helmholtz Coil			
<i>Helmholtz Coil;</i>			
the number of turns on each coil;	10	No.	Before & after data same: ...X...
the radius of each coil, in meters;	0.204	m	
the current in the coils, in amperes.;	0.08	A	
<i>Helmholtz Coil Constant;</i>	7.09	A/m/V	Laboratory Environment:
<i>Helmholtz Coil magnetic field;</i>	5.88	A/m	Ambient Temperature: 20.5 °C
			Ambient Humidity: 43.5 % RH
			Ambient Pressure: 99.709 kPa
			Calibration Date: 10-Aug-2022
Probe Sensitivity at	1000	Hz.	Re-calibration Due:
was	-60.15	dBV/A/m	Report Number: 33271 -1
	0.983	mV/A/m	Control Number: 33271
Probe resistance	893	Ohms	
The above listed instrument meets or exceeds the tested manufacturer's specifications.			
This Calibration is traceable through NIST test numbers: ,682636			
The expanded uncertainty of calibration: 0.30dB at 95% confidence level with a coverage factor of k=2.			

Graph represents Probes Frequency Response.

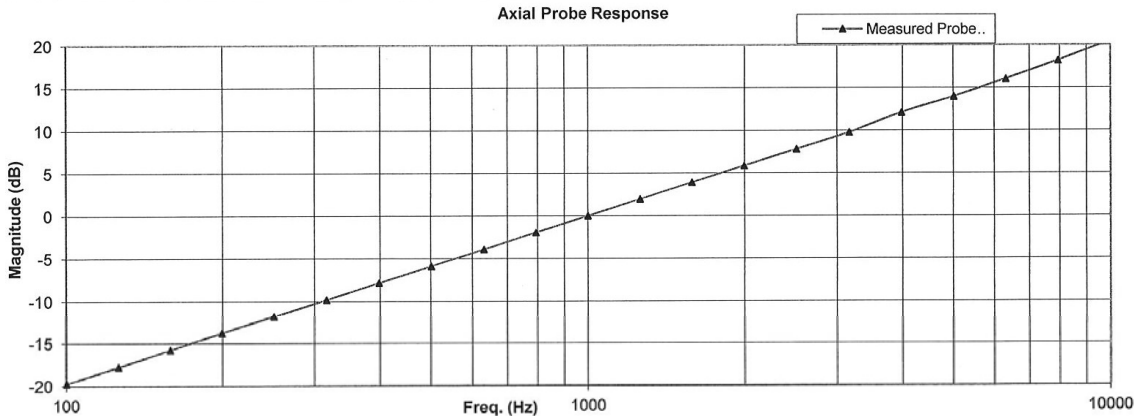

The above listed instrument was checked using calibration procedure documented in West Caldwell Calibration Laboratories Inc. procedure : **Rev. 7.0 Jan. 24, 2014 Doc. # 1038 HCATEMC**
 Calibration was performed by West Caldwell Calibration Laboratories Inc. under Operating Procedures intended to implement the requirements of ANSI/NCCL Z540-1, ISO 9001, and ISO 17025.

Cal. Date: 10-Aug-2022
 Calibrated on WCCL system type 9700

Measurements performed by:

James Zhu
James Zhu
 Rev. 7.0 Jan. 24, 2014 Doc. # 1038 HCATEMC

This document shall not be reproduced, except in full, without the written approval from West Caldwell Cal. Labs. Inc.

FCC ID: PY7-84558E		HAC (T-COIL) TEST REPORT	Approved by: Managing Director
Filename: 1M2302060006-07.PY7	Test Dates: 2/14/2023 – 2/27/2023	DUT Type: Portable Handset	Page 74 of 84

HCATEMC_TEM-1122_Aug-10-2022

West Caldwell Calibration Laboratories Inc.

1575 State Route 96, Victor NY 14564
Tel. (585) 586-3900 FAX (585) 586-4327

Calibration Data Record

TEM Consulting LP Axial T Coil Probe for Model No.: Axial T Coil Probe Serial No.: TEM-1122
Company: Element Materials Technology Washington D.C. LLC.

Test	Function	Tolerance	Measured values		
			Before	Out	Remarks
1.0	Probe Sensitivity at	1000 Hz. dBV/A/m	-60.15		
2.0	Probe Level Linearity	dB			
		6	6.03		
		Ref. (0 dB) 0	0.00		
		-6	-6.03		
		-12	-12.06		
3.0	Probe Frequency Response	Hz			
		100	-19.7		
		126	-17.8		
		158	-15.8		
		200	-13.8		
		251	-11.8		
		316	-9.8		
		398	-7.8		
		501	-5.9		
		631	-3.9		
		794	-2.0		
		Ref. (0 dB) 1000	0.0		
		1259	2.0		
		1585	3.9		
		1995	5.9		
		2512	7.8		
3162	9.8				
3981	12.1				
5012	14.0				
6310	16.0				
7943	18.2				
10000	20.5				

Instruments used for calibration:			Date of Cal.	Traceability No.	Due Date
HP	34401A	S/N US360641	24-Jun-2022	682636	24-Jun-2023
HP	34401A	S/N US361024	24-Jun-2022	682636	24-Jun-2023
HP	33120A	S/N US360437	24-Jun-2022	682636	24-Jun-2023
B&K	2133	S/N 1583254	5-Jul-2022	682636	5-Jul-2023

Cal. Date: 10-Aug-2022
Calibrated on WCCL system type 9700

Tested by: James Zhu

This document shall not be reproduced, except in full, without the written approval from West Caldwell Cal. Labs. Inc.

Rev. 7.0 Jan. 24, 2014 Doc. # 1038 HCATEMC

FCC ID: PY7-84558E		HAC (T-COIL) TEST REPORT	Approved by: Managing Director
Filename: 1M2302060006-07.PY7	Test Dates: 2/14/2023 – 2/27/2023	DUT Type: Portable Handset	Page 75 of 84

West Caldwell Calibration Laboratories Inc.
Certificate of Calibration

for

Radial T Coil Probe

Manufactured by: LISTEN INC.
 Model No: RADIAL T COIL PROBE
 Serial No: TEM-1128
 Calibration Recall No: 33271

Submitted By:

Customer: Tae Kim
 Company: Element Materials Technology Washington DC LLC
 Address: 7185 Oakland Mills Road
 Columbia MD 21046

The subject instrument was calibrated to the indicated specification using standards traceable to the SI through the National Institute of Standards and Technology or to accepted values of natural physical constants. This document certifies that the instrument met the following specification upon its return to the submitter.

West Caldwell Calibration Laboratories Procedure No. RADIAL T LISTE

Upon receipt for Calibration, the instrument was found to be:

Within (X)

✓ TK
9/2/2022

tolerance of the indicated specification. See attached Report of Calibration.

The information supplied certifies that the item listed above meets acceptance criteria under the decision rule: $A=L-(U95)$, where A is the acceptance criteria, L is manufacturer specifications, and U95 is confidence level of 95% at $k=2$. The decision rule has been communicated and approved by customer during contract review. Measurements marked with (*) are not covered by the scope of current A2LA accreditation.

West Caldwell Calibration Laboratories' calibration control system meets the following requirements: ANSI/NCSL Z540-1, ISO 9001, and ISO 17025.

Note: With this Certificate, Report of Calibration is included.

Approved by:



James Zhu

Quality Manager

Calibration Date: 10-Aug-22
 Certificate Issue Date: 01-Sep-22 Rev 2.0
 Certificate No: 33271 - 2

QA Doc. #1051 Rev. 3.0 5/29/20

Certificate Page 1 of 1

ISO/IEC 17025

**West Caldwell
 Calibration
 Laboratories, Inc.**
 uncompromised calibration
 1575 State Route 96, Victor, NY 14564, U.S.A.



Calibration Lab. Cert. # 1533.01

FCC ID: PY7-84558E		HAC (T-COIL) TEST REPORT	Approved by: Managing Director
Filename: 1M2302060006-07.PY7	Test Dates: 2/14/2023 – 2/27/2023	DUT Type: Portable Handset	Page 76 of 84

REV 4.2.M
11/29/2022



REPORT OF CALIBRATION

for

TEM Consulting LP Radial T Coil Probe Model No.: Radial T Coil Probe Serial No.: TEM-1128
 Company: Element Materials Technology Washington D.C. LLC. I. D. No.: XXXX

Calibration results:			
Probe Sensitivity measured with Helmholtz Coil			
<i>Helmholtz Coil;</i>			
the number of turns on each coil;	10	No.	Before & after data same: ...X...
the radius of each coil, in meters;	0.204	m	
the current in the coils, in amperes.;	0.09	A	
<i>Helmholtz Coil Constant;</i>			
	7.09	A/m/V	Laboratory Environment:
<i>Helmholtz Coil magnetic field;</i>			
	5.96	A/m	Ambient Temperature: 20.5 °C
			Ambient Humidity: 43.5 % RH
			Ambient Pressure: 99.709 kPa
			Calibration Date: 10-Aug-2022
Probe Sensitivity at	1000	Hz.	Re-calibration Due:
was	-60.02	dBV/A/m	Report Number: 33271 -2
	0.997	mV/A/m	Control Number: 33271
Probe resistance	902	Ohms	

The above listed instrument meets or exceeds the tested manufacturer's specifications.

This Calibration is traceable through NIST test numbers: ,682636

The expanded uncertainty of calibration: 0.30dB at 95% confidence level with a coverage factor of k=2.

Graph represents Probes Frequency Response.

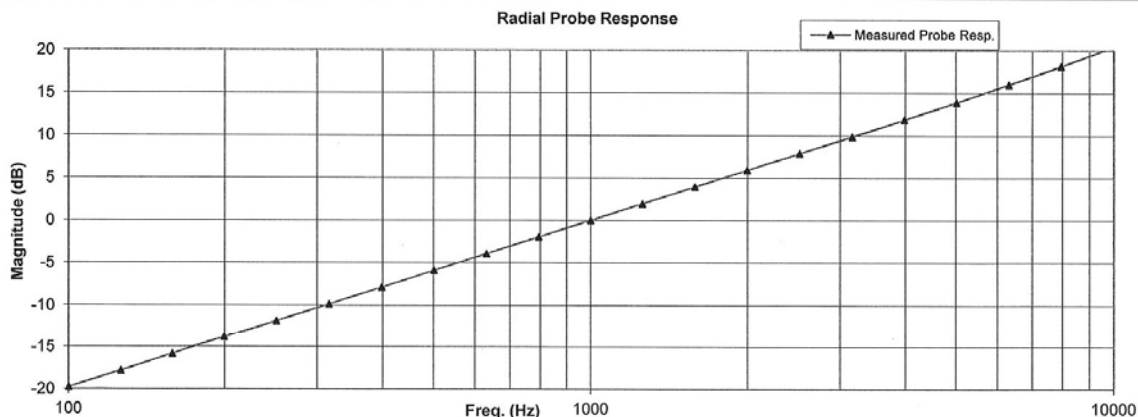

The above listed instrument was checked using calibration procedure documented in West Caldwell Calibration Laboratories Inc. procedure : Rev. 7.0 Jan. 24, 2014 Doc. # 1038 HCRTEMC
 Calibration was performed by West Caldwell Calibration Laboratories Inc. under Operating Procedures intended to implement the requirements of ANSI/NCSL Z540-1, ISO 9001, and ISO 17025.

Cal. Date: 10-Aug-2022
 Calibrated on WCCL system type 9700

Measurements performed by:
James Zhu

This document shall not be reproduced, except in full, without the written approval from West Caldwell Cal. Labs. Inc.

Rev. 7.0 Jan. 24, 2014 Doc. # 1038 HCRTEMC

FCC ID: PY7-84558E		HAC (T-COIL) TEST REPORT	Approved by: Managing Director
Filename: 1M2302060006-07.PY7	Test Dates: 2/14/2023 – 2/27/2023	DUT Type: Portable Handset	Page 77 of 84

HCRTEMC_TEM-1128_Aug-10-2022

West Caldwell Calibration Laboratories Inc.

1575 State Route 96, Victor NY 14564
Tel. (585) 586-3900 FAX (585) 586-4327

Calibration Data Record

TEM Consulting LP Radial T Coil Probe Model No.: Radial T Coil Probe Serial No.: TEM-1128
Company: Element Materials Technology Washington D.C. LLC.

Test	Function	Tolerance		Measured values		
				Before	Out	Remarks
1.0	Probe Sensitivity at	1000 Hz.	dBV/A/m	-60.02		
2.0	Probe Level Linearity	Ref. (0 dB)	dB			
			6	6.03		
			0	0.00		
			-6	-6.03		
			-12	-12.05		
3.0	Probe Frequency Response	Ref. (0 dB)	Hz			
			100	-19.8		
			126	-17.8		
			158	-15.8		
			200	-13.8		
			251	-11.9		
			316	-9.9		
			398	-7.9		
			501	-5.9		
			631	-3.9		
			794	-2.0		
			1000	0.0		
			1259	2.0		
			1585	4.0		
			1995	5.9		
			2512	7.9		
			3162	9.9		
3981	11.9					
5012	13.9					
6310	16.0					
7943	18.2					
10000	20.5					

Instruments used for calibration:			Date of Cal.	Traceability No.	Due Date
HP	34401A	S/N US360641	24-Jun-2022	.682636	24-Jun-2023
HP	34401A	S/N US361024	24-Jun-2022	.682636	24-Jun-2023
HP	33120A	S/N US360437	24-Jun-2022	.682636	24-Jun-2023
B&K	2133	S/N 1583254	5-Jul-2022	.682636	5-Jul-2023

Cal. Date: 10-Aug-2022

Tested by: James Zhu

Calibrated on WCCL system type 9700

This document shall not be reproduced, except in full, without the written approval from West Caldwell Cal. Labs, Inc.

Rev. 7.0 Jan. 24, 2014 Doc. # 1038 HCRTEMC

FCC ID: PY7-84558E		HAC (T-COIL) TEST REPORT	Approved by: Managing Director
Filename: 1M2302060006-07.PY7	Test Dates: 2/14/2023 – 2/27/2023	DUT Type: Portable Handset	Page 78 of 84

REV 4.2.M
11/29/2022

13. CONCLUSION

The measurements indicate that the wireless communications device complies with the HAC limits specified in accordance with the ANSI C63.19 Standard and FCC WT Docket No. 01-309 RM-8658. Precise laboratory measures were taken to assure repeatability of the tests. The tested device complies with the requirements in respect to all parameters specific to the test. The test results and statements relate only to the item(s) tested.

The measurement system and techniques presented in this evaluation are proposed in the ANSI standard as a means of best approximating wireless device compatibility with a hearing-aid. The literature is under continual re-construction.

FCC ID: PY7-84558E		HAC (T-COIL) TEST REPORT	Approved by: Managing Director
Filename: 1M2302060006-07.PY7	Test Dates: 2/14/2023 – 2/27/2023	DUT Type: Portable Handset	Page 79 of 84

REV 4.2.M

11/29/2022

14. REFERENCES

1. ANSI C63.19-2011, American National Standard for Methods of Measurement of Compatibility between Wireless communication devices and Hearing Aids.", New York, NY, IEEE, May 2011
2. FCC Office of Engineering and Technology KDB, "285076 D01 HAC Guidance v06r02," September 19, 2022
3. FCC Office of Engineering and Technology KDB, "285076 D02 T-Coil Testing for CMRS IP v04," February 23, 2022
4. FCC Public Notice DA 06-1215, *Wireless Telecommunications Bureau and Office of Engineering and Technology Clarify Use of Revised Wireless Phone Hearing Aid Compatibility Standard*, June 6, 2006
5. FCC 3G Review Guidance, Laboratory Division OET FCC, May/June 2006
6. Berger, H. S., "Compatibility Between Hearing Aids and Wireless Devices," Electronic Industries Forum, Boston, MA, May, 1997
7. Berger, H. S., "Hearing Aid and Cellular Phone Compatibility: Working Toward Solutions," Wireless Telephones and Hearing Aids: New Challenges for Audiology, Gallaudet University, Washington, D.C., May, 1997 (To be reprinted in the American Journal of Audiology).
8. Berger, H. S., "Hearing Aid Compatibility with Wireless Communications Devices," IEEE International Symposium on Electromagnetic Compatibility, Austin, TX, August, 1997.
9. Bronaugh, E. L., "Simplifying EMI Immunity (Susceptibility) Tests in TEM Cells," in the 1990 IEEE International Symposium on Electromagnetic Compatibility Symposium Record, Washington, D.C., August 1990, pp. 488-491
10. Byrne, D. and Dillon, H., The National Acoustics Laboratory (NAL) New Procedure for Selecting the Gain and Frequency Response of a Hearing Aid, Ear and Hearing 7:257-265, 1986.
11. Crawford, M. L., "Measurement of Electromagnetic Radiation from Electronic Equipment using TEM Transmission Cells," U.S. Department of Commerce, National Bureau of Standards, NBSIR 73-306, Feb. 1973.
12. Crawford, M. L., and Workman, J. L., "Using a TEM Cell for EMC Measurements of Electronic Equipment," U.S. Department of Commerce, National Bureau of Standards. Technical Note 1013, July 1981.
13. EHIMA GSM Project, Development phase, Project Report (1st part) Revision A. Technical-Audiological Laboratory and Telecom Denmark, October 1993.
14. EHIMA GSM Project, Development phase, Part II Project Report. Technical-Audiological Laboratory and Telecom Denmark, June 1994.
15. EHIMA GSM Project Final Report, Hearing Aids and GSM Mobile Telephones: Interference Problems, Methods of Measurement and Levels of Immunity. Technical-Audiological Laboratory and Telecom Denmark, 1995.

FCC ID: PY7-84558E	 element	HAC (T-COIL) TEST REPORT	Approved by: Managing Director
Filename: 1M2302060006-07.PY7	Test Dates: 2/14/2023 – 2/27/2023	DUT Type: Portable Handset	Page 80 of 84

REV 4.2.M
11/29/2022

16. HAMPIS Report, Comparison of Mobile phone electromagnetic near field with an upscaled electromagnetic far field, using hearing aid as reference, 21 October 1999.
17. Hearing Aids/GSM, Report from OTWIDAM, Technical-Audiological Laboratory and Telecom Denmark, April 1993.
18. IEEE 100, The Authoritative Dictionary of IEEE Standards Terms, Seventh Edition.
19. Joyner, K. H., et. al., Interference to Hearing Aids by the New Digital Mobile Telephone System, Global System for Mobile (GSM) Communication Standard, National Acoustic Laboratory, Australian Hearing Series, Sydney 1993.
20. Joyner, K. H., et. al., Interference to Hearing Aids by the Digital Mobile Telephone System, Global System for Mobile Communications (GSM), NAL Report #131, National Acoustic Laboratory, Australian Hearing Series, Sydney, 1995.
21. Kecker, W. T., Crawford, M. L., and Wilson, W. A., "Construction of a Transverse Electromagnetic Cell", U.S. Department of Commerce, National Bureau of Standards, Technical Note 1011, Nov. 1978.
22. Konigstein, D., and Hansen, D., "A New Family of TEM Cells with enlarged bandwidth and Optimized working Volume," in the Proceedings of the 7th International Symposium on EMC, Zurich, Switzerland, March 1987; 50:9, pp. 127-132.
23. Kuk, F., and Hjorstgaard, N. K., "Factors affecting interference from digital cellular telephones," Hearing Journal, 1997; 50:9, pp 32-34.
24. Ma, M. A., and Kanda, M., "Electromagnetic Compatibility and Interference Metrology," U.S. Department of Commerce, National Bureau of Standards, Technical Note 1099, July 1986, pp. 17-43.
25. Ma, M. A., Sreenivashiah, I. , and Chang, D. C., "A Method of Determining the Emission and Susceptibility Levels of Electrically Small Objects Using a TEM Cell," U.S. Department of Commerce, National Bureau of Standards, Technial Note 1040, July 1981.
26. McCandless, G. A., and Lyregaard, P. E., Prescription of Gain/Output (POGO) for Hearing Aids, Hearing Instruments 1:16-21, 1983
27. Skopec, M., "Hearing Aid Electromagnetic Interference from Digital Wireless Telephones, "IEEE Transactions on Rehabilitation Engineering, vol. 6, no. 2, pp. 235-239, June 1998.
28. Technical Report, GSM 05.90, GSM EMC Considerations, European Telecommunications Standards Institute, January 1993.
29. Victorian, T. A., "Digital Cellular Telephone Interference and Hearing Aid Compatibility—an Update," Hearing Journal 1998; 51:10, pp. 53-60
30. Wong, G. S. K., and Embleton, T. F. W., eds., AIP Handbook of Condenser Microphones: Theory, Calibration and Measurements, AIP Press.

FCC ID: PY7-84558E	 element	HAC (T-COIL) TEST REPORT	Approved by: Managing Director
Filename: 1M2302060006-07.PY7	Test Dates: 2/14/2023 – 2/27/2023	DUT Type: Portable Handset	Page 81 of 84

REV 4.2.M
11/29/2022