



# **CERTIFICATION TEST REPORT**

**Report Number. :** 11740661-E5V4

**Applicant :** SONY MOBILE COMMUNICATIONS INC.  
4-12-3 HIGASHI-SHINAGAWA, SHINAGAWA-KU  
TOKYO, 140-0002, JAPAN

**FCC ID :** PY7-81775I

**EUT Description :** GSM/WCDMA/LTE PHONE with BT, DTS/UNII a/b/g/n/ac, GPS & NFC

**Test Standard(s) :** FCC 47 CFR PART 15 SUBPART E (EXCEPT DFS)

**Date Of Issue:**

July 17, 2017

**Prepared by:**

UL Verification Services Inc.  
47173 Benicia Street  
Fremont, CA 94538, U.S.A.  
TEL: (510) 771-1000  
FAX: (510) 661-0888



NVLAP LAB CODE 200065-0

Revision History

<u>Rev.</u>	<u>Issue Date</u>	<u>Revisions</u>	<u>Revised By</u>
V1	06/23/17	Initial Issue	D. Corona
V2	07/10/17	Updated Section 2, 5.2, 5.6, 7, 8 & Corrected 5.2/5.3/5.6 GHz 26dB BW, 99% BW test data table and antenna gain	D. Corona
V3	07/11/17	Updated Section 11.1 Test Procedure	D. Corona
V4	07/17/17	Updated Section 5.6	D. Corona

---

## TABLE OF CONTENTS

<b>1. ATTESTATION OF TEST RESULTS .....</b>	<b>6</b>
<b>2. TEST METHODOLOGY.....</b>	<b>7</b>
<b>3. FACILITIES AND ACCREDITATION .....</b>	<b>7</b>
<b>4. CALIBRATION AND UNCERTAINTY .....</b>	<b>8</b>
4.1. MEASURING INSTRUMENT CALIBRATION.....	8
4.2. SAMPLE CALCULATION.....	8
4.3. MEASUREMENT UNCERTAINTY.....	8
<b>5. EQUIPMENT UNDER TEST .....</b>	<b>9</b>
5.1. DESCRIPTION OF EUT.....	9
5.2. MAXIMUM OUTPUT POWER.....	9
5.3. DESCRIPTION OF AVAILABLE ANTENNAS.....	10
5.4. SOFTWARE AND FIRMWARE.....	10
5.5. LIST OF TEST REDUCTION AND MODES .....	10
5.6. WORST-CASE CONFIGURATION AND MODE .....	11
5.7. DESCRIPTION OF TEST SETUP.....	12
<b>6. TEST AND MEASUREMENT EQUIPMENT .....</b>	<b>15</b>
<b>7. MEASUREMENT METHODS .....</b>	<b>16</b>
<b>8. SUMMARY TABLE.....</b>	<b>17</b>
<b>9. ON TIME, DUTY CYCLE AND MEASUREMENT METHODS.....</b>	<b>18</b>
9.1. ON TIME AND DUTY CYCLE.....	18
<b>10. ANTENNA PORT TEST RESULTS .....</b>	<b>21</b>
10.1. 11a 2TX CDD MIMO MODE IN THE 5.2GHz BAND.....	21
10.1.1. 26 dB BANDWIDTH .....	21
10.1.2. 99% BANDWIDTH.....	25
10.1.3. OUTPUT POWER AND PPSD.....	29
10.2. 11n HT20 2TX CDD MIMO MODE IN THE 5.2GHz BAND.....	35
10.2.1. 26 dB BANDWIDTH .....	35
10.2.2. 99% BANDWIDTH.....	39
10.2.3. OUTPUT POWER AND PPSD.....	43
10.3. 11n HT40 2TX CDD MIMO MODE IN THE 5.2GHz BAND.....	49
10.3.1. 26 dB BANDWIDTH .....	49

---

10.3.2.	99% BANDWIDTH.....	52
10.3.3.	OUTPUT POWER AND PPSD.....	55
10.4.	<i>11ac HT80 2TX CDD MIMO MODE IN THE 5.2GHz BAND</i> .....	60
10.4.1.	26 dB BANDWIDTH .....	60
10.4.2.	99% BANDWIDTH.....	62
10.4.3.	OUTPUT POWER AND PPSD.....	64
10.5.	<i>11a 2TX CDD MIMO MODE IN THE 5.3GHz BAND</i> .....	68
10.5.1.	26 dB BANDWIDTH .....	68
10.5.2.	99% BANDWIDTH.....	72
10.5.3.	OUTPUT POWER AND PPSD.....	76
10.6.	<i>11n HT20 2TX CDD MIMO MODE IN THE 5.3GHz BAND</i> .....	82
10.6.1.	26 dB BANDWIDTH .....	82
10.6.2.	99% BANDWIDTH.....	86
10.6.3.	OUTPUT POWER AND PPSD.....	90
10.7.	<i>11n HT40 2TX CDD MIMO MODE IN THE 5.3GHz BAND</i> .....	96
10.7.1.	26 dB BANDWIDTH .....	96
10.7.2.	99% BANDWIDTH.....	99
10.7.3.	OUTPUT POWER AND PPSD.....	102
10.8.	<i>11ac HT80 2TX CDD MIMO MODE IN THE 5.3GHz BAND</i> .....	107
10.8.1.	26 dB BANDWIDTH .....	107
10.8.2.	99% BANDWIDTH.....	109
10.8.3.	OUTPUT POWER AND PPSD.....	111
10.9.	<i>11a 2TX CDD MIMO MODE IN THE 5.6GHz BAND</i> .....	114
10.9.1.	26 dB BANDWIDTH .....	114
10.9.2.	99% BANDWIDTH.....	120
10.9.3.	OUTPUT POWER AND PPSD.....	126
10.10.	<i>11n HT20 2TX CDD MIMO MODE IN THE 5.6GHz BAND</i> .....	133
10.10.1.	26 dB BANDWIDTH .....	133
10.10.2.	99% BANDWIDTH.....	139
10.10.3.	OUTPUT POWER AND PPSD.....	145
10.11.	<i>11n HT40 2TX CDD MIMO MODE IN THE 5.6GHz BAND</i> .....	152
10.11.1.	26 dB BANDWIDTH .....	152
10.11.2.	99% BANDWIDTH.....	158
10.11.3.	OUTPUT POWER AND PPSD.....	164
10.12.	<i>11ac HT80 2TX CDD MIMO MODE IN THE 5.6GHz BAND</i> .....	171
10.12.1.	26 dB BANDWIDTH .....	171
10.12.2.	99% BANDWIDTH.....	175
10.12.3.	OUTPUT POWER AND PPSD.....	179
10.13.	<i>11a 2TX CDD MIMO MODE IN THE 5.8GHz BAND</i> .....	184
10.13.1.	6 dB BANDWIDTH .....	184
10.13.2.	99% BANDWIDTH.....	188
10.13.3.	OUTPUT POWER AND PSD .....	192
10.14.	<i>11n HT20 2TX CDD MIMO MODE IN THE 5.8GHz BAND</i> .....	197
10.14.1.	6 dB BANDWIDTH .....	197
10.14.2.	99% BANDWIDTH.....	201
10.14.3.	OUTPUT POWER AND PSD .....	205

---

10.15.	11n HT40 2TX CDD MIMO MODE IN THE 5.8GHz BAND .....	210
10.15.1.	6 dB BANDWIDTH .....	210
10.15.2.	99% BANDWIDTH.....	213
10.15.3.	OUTPUT POWER AND PSD .....	216
10.16.	11ac HT80 2TX CDD MIMO MODE IN THE 5.8GHz BAND .....	220
10.16.1.	6 dB BANDWIDTH .....	220
10.16.2.	99% BANDWIDTH.....	222
10.16.3.	OUTPUT POWER AND PSD .....	224
<b>11.</b>	<b>RADIATED TEST RESULTS .....</b>	<b>227</b>
11.1.	LIMITS AND PROCEDURE.....	227
11.1.1.	11a 2TX CDD MIMO MODE IN THE 5.2GHz BAND.....	228
11.1.2.	11n HT20 2TX CDD MIMO MODE IN THE 5.2GHz BAND .....	236
11.1.3.	11n HT40 2TX CDD MIMO MODE IN THE 5.2GHz BAND .....	244
11.1.4.	11ac HT80 2TX CDD MIMO MODE IN THE 5.2GHz BAND .....	250
11.1.5.	11a 2TX CDD MIMO MODE IN THE 5.3GHz BAND.....	254
11.1.6.	11n HT20 2TX CDD MIMO MODE IN THE 5.3GHz BAND .....	262
11.1.7.	11n HT40 2TX CDD MIMO MODE IN THE 5.3GHz BAND .....	270
11.1.8.	11ac HT80 2TX CDD MIMO MODE IN THE 5.3GHz BAND .....	276
11.1.9.	11a 2TX CDD MIMO MODE IN THE 5.6GHz BAND.....	280
11.1.10.	11n HT20 2TX CDD MIMO MODE IN THE 5.6GHz BAND .....	292
11.1.11.	11n HT40 2TX CDD MIMO MODE IN THE 5.6GHz BAND .....	304
11.1.12.	11ac HT80 2TX CDD MIMO MODE IN THE 5.6GHz BAND .....	316
11.1.13.	11a 2TX CDD MIMO MODE IN THE 5.8GHz BAND.....	324
11.1.14.	11n HT20 2TX CDD MIMO MODE IN THE 5.8GHz BAND.....	332
11.1.15.	11n HT40 2TX CDD MIMO MODE IN THE 5.8GHz BAND.....	342
11.1.16.	11ac HT80 2TX CDD MIMO MODE IN THE 5.8GHz BAND .....	350
11.2.	WORST CASE BELOW 30 MHz .....	356
11.3.	WORST-CASE BELOW 1 GHz .....	358
11.4.	WORST-CASE 18 to 26 GHz .....	360
11.5.	WORST-CASE 26 to 40 GHz .....	362
<b>12.</b>	<b>AC POWER LINE CONDUCTED EMISSIONS .....</b>	<b>364</b>
12.1.	SETUP PHOTOS.....	367

# 1. ATTESTATION OF TEST RESULTS

**COMPANY NAME:** SONY MOBILE COMMUNICATIONS INC.  
4-12-3 HIGASHI-SHINAGAWA, SHINAGAWA-KU  
TOKYO, 140-0002, JAPAN

**EUT DESCRIPTION:** GSM/WCDMA/LTE PHONE with BT, DTS/UNII a/b/g/n/ac, GPS & NFC

**SERIAL NUMBER:** CB512DHRYH & CB512DHRXV (CONDUCTED)  
CB512DQZU1 & CB512DQZUN (RADIATED)

**DATE TESTED:** JUNE 6 – 28 , 2017

APPLICABLE STANDARDS	
STANDARD	TEST RESULTS
CFR 47 Part 15 Subpart E	Pass

UL Verification Services Inc. tested the above equipment in accordance with the requirements set forth in the above standards. All indications of Pass/Fail in this report are opinions expressed by UL Verification Services Inc. based on interpretations and/or observations of test results. Measurement Uncertainties were not taken into account and are published for informational purposes only. The test results show that the equipment tested is capable of demonstrating compliance with the requirements as documented in this report.

**Note:** The results documented in this report apply only to the tested sample, under the conditions and modes of operation as described herein. This document may not be altered or revised in any way unless done so by UL Verification Services Inc. and all revisions are duly noted in the revisions section. Any alteration of this document not carried out by UL Verification Services Inc. will constitute fraud and shall nullify the document. This report must not be used by the client to claim product certification, approval, or endorsement by NVLAP, NIST, any agency of the Federal Government, or any agency of any government.

Approved & Released For  
UL Verification Services Inc. By:

Prepared By:



DAN CORONIA  
PROJECT LEAD  
UL VERIFICATION SERVICES INC.

KIYA KEDIDA  
WISE LAB ENGINEER  
UL VERIFICATION SERVICES INC.

## 2. TEST METHODOLOGY

FCC: The tests documented in this report were performed in accordance with FCC CFR 47 Part 2, FCC CFR 47 Part 15, FCC 14-30, FCC KDB 662911 D01 v02r01, FCC KDB 905462 D02 v01r02/D03 v01r01/D06 v01, FCC KDB 789033 D02 v01r04, FCC KDB 644545 D03 v01, ANSI C63.10-2013.

## 3. FACILITIES AND ACCREDITATION

The test sites and measurement facilities used to collect data are located at 47173 and 47266 Benicia Street, Fremont, California, USA. Line conducted emissions are measured only at the 47173 address. The following table identifies which facilities were utilized for radiated emission measurements documented in this report. Specific facilities are also identified in the test results sections.

47173 Benicia Street	47266 Benicia Street
<input checked="" type="checkbox"/> Chamber A(IC: 2324B-1)	<input type="checkbox"/> Chamber D(IC: 22541-1)
<input checked="" type="checkbox"/> Chamber B(IC: 2324B-2)	<input type="checkbox"/> Chamber E(IC: 22541-2)
<input checked="" type="checkbox"/> Chamber C(IC: 2324B-3)	<input type="checkbox"/> Chamber F(IC: 22541-3)
	<input type="checkbox"/> Chamber G(IC: 22541-4)
	<input type="checkbox"/> Chamber H(IC: 22541-5)

The above test sites and facilities are covered under FCC Test Firm Registration # 208313. UL Verification Services Inc. is accredited by NVLAP, Laboratory Code 200065-0. Chambers A through C are covered under Industry Canada company address code 2324B with site numbers 2324B -1 through 2324B-3, respectively. Chambers D through H are covered under Industry Canada company address code 22541 with site numbers 22541 -1 through 22541-5, respectively.

## 4. CALIBRATION AND UNCERTAINTY

### 4.1. MEASURING INSTRUMENT CALIBRATION

The measuring equipment utilized to perform the tests documented in this report has been calibrated in accordance with the manufacturer's recommendations, and is traceable to recognized national standards.

### 4.2. SAMPLE CALCULATION

Where relevant, the following sample calculation is provided:

$$\begin{aligned} \text{Field Strength (dBuV/m)} &= \text{Measured Voltage (dBuV)} + \text{Antenna Factor (dB/m)} + \text{Cable} \\ &\text{Loss (dB)} - \text{Preamp Gain (dB)} \\ 36.5 \text{ dBuV} + 18.7 \text{ dB/m} + 0.6 \text{ dB} - 26.9 \text{ dB} &= 28.9 \text{ dBuV/m} \end{aligned}$$

### 4.3. MEASUREMENT UNCERTAINTY

Where relevant, the following measurement uncertainty levels have been estimated for tests performed on the apparatus:

Where relevant, the following measurement uncertainty levels have been estimated for tests performed on the apparatus:

Parameter	Uncertainty
Worst Case Conducted Disturbance, 9KHz to 0.15 MHz	3.84 dB
Worst Case Conducted Disturbance, 0.15 to 30 MHz	3.65 dB
Worst Case Radiated Disturbance, 9KHz to 30 MHz	3.15 dB
Worst Case Radiated Disturbance, 30 to 1000 MHz	5.36 dB
Worst Case Radiated Disturbance, 1000 to 18000 MHz	4.32 dB
Worst Case Radiated Disturbance, 18000 to 26000 MHz	4.45 dB
Worst Case Radiated Disturbance, 26000 to 40000 MHz	5.24 dB

Uncertainty figures are valid to a confidence level of 95%.



## 5. EQUIPMENT UNDER TEST

### 5.1. DESCRIPTION OF EUT

The EUT is a GSM/WCDMA/LTE Phone with BT, DTS/UNII a/b/g/n/ac, GPS & NFC.

### 5.2. MAXIMUM OUTPUT POWER

The transmitter has a maximum conducted output power as follows:

#### 5.2GHz Band

Frequency Range (MHz)	Mode	Output Power (dBm)	Output Power (mW)
5180 - 5240	802.11a CDD 2TX	15.73	37.41
	802.11n HT20 CDD 2TX	15.80	38.02
5190 - 5230	802.11n HT40 CDD 2TX	15.73	37.41
5210	802.11ac VHT80 CDD 2TX	15.69	37.07

#### 5.3GHz Band

Frequency Range (MHz)	Mode	Output Power (dBm)	Output Power (mW)
5260 - 5320	802.11a CDD 2TX	15.74	37.50
	802.11n HT20 CDD 2TX	15.91	38.99
5270 - 5310	802.11n HT40 CDD 2TX	15.77	37.76
5290	802.11ac VHT80 CDD 2TX	15.99	39.72

#### 5.6GHz Band

Frequency Range (MHz)	Mode	Output Power (dBm)	Output Power (mW)
5500 - 5720	802.11a CDD 2TX	15.91	38.99
5500 - 5720	802.11n HT20 CDD 2TX	16.28	42.46
5510 - 5710	802.11n HT40 CDD 2TX	16.14	41.11
5530-5710	802.11ac VHT80 CDD 2TX	15.72	37.33

#### 5.8GHz Band

Frequency Range (MHz)	Mode	Output Power (dBm)	Output Power (mW)
5745 - 5825	802.11a CDD 2TX	15.63	36.56
5745 - 5825	802.11n HT20 CDD 2TX	15.53	35.73
5755 - 5795	802.11n HT40 CDD 2TX	15.48	35.32
5775	802.11ac VHT80 CDD 2TX	15.27	33.65

### 5.3. DESCRIPTION OF AVAILABLE ANTENNAS

The radio utilizes two integrated antennas, with the following maximum gains:

Frequency (GHz)	Peak Antenna Gain (dBi)	
	Main (Chain 0)	Sub (Chain 1)
5180-5320	-4.4	-6.7
5500-5700	-3.1	-8.4
5725-5850	-3.5	-8.4

### 5.4. SOFTWARE AND FIRMWARE

The firmware installed in the EUT during testing was SONY, s\_atp\_1\_00139\_B\_10\_5.  
 The test utility software used during testing was Tera Term Ver 4.79.

### 5.5. LIST OF TEST REDUCTION AND MODES

Antenna port & Radiated Testing	
Mode	Covered by
802.11a Legacy	802.11a 2TX CDD
802.11HT20 2TX STBC	802.11n HT20 2TX CDD
	802.11n HT20 2TX CDD
802.11ac VHT20 2TX STBC	802.11n HT20 2TX CDD
	802.11n HT20 2TX CDD
802.11n HT40 2TX STBC	802.11n HT40 2TX CDD
	802.11n HT40 2TX CDD
802.11ac VHT40 2TX STBC	802.11n HT40 2TX CDD
	802.11n HT40 2TX CDD
802.11ac VHT80 2TX STBC	802.11ac VHT80 2TX CDD
	802.11ac VHT80 2TX CDD

---

## 5.6. WORST-CASE CONFIGURATION AND MODE

Radiated emission below 1GHz and power line conducted emissions were performed with the EUT set to transmit at the channel with highest output power as worst-case scenario.

The fundamental of the EUT was investigated in three orthogonal orientations X, Y, Z, it was determined that X was worst-case orientations. Therefore, all final radiated testing was performed with the EUT in X orientation.

Worst-case data rates as provided by the client were:

802.11a mode: 6 Mbps  
802.11n HT20 mode: 13 Mbps (MCS8)  
802.11n HT40 mode: 27 Mbps (MCS8)  
802.11ac VHT80 mode: 58.5 Mbps (MCS0)

802.11ac VHT20 and VHT40 mode are different from 802.11nHT20 and HT40 only in control messages and have the same power settings.

The simultaneous mode (SISO 2.4GHz Chain 0 and 5GHz chain 1) was checked and stand-alone (MIMO) 2.4 GHz / 5GHz remain worst case.

## 5.7. DESCRIPTION OF TEST SETUP

### SUPPORT EQUIPMENT

Support Equipment List				
Description	Manufacturer	Model	Serial Number	FCC ID
Laptop	Lenovo	20B7S0A200	PC015REW	NA
AC Adapter	SONY	1300-7137.1	4016W40310044	NA
Headphones	SONY	N/A	N/A	N/A

### I/O CABLES (CONDUCTED TEST)

I/O Cable List						
Cable No	Port	# of identical ports	Connector Type	Cable Type	Cable Length (m)	Remarks
1	Antenna	1	RF	Shielded	0.2	To spectrum Analyzer
2	USB	1	USB	Shielded	1	N/A
3	DC	1	DC	Shielded	0.3	N/A

### I/O CABLES (RADIATED AND CONDUCTED EMISSIONS)

I/O Cable List						
Cable No	Port	# of identical ports	Connector Type	Cable Type	Cable Length (m)	Remarks
1	USB	1	USB	Shielded	3	N/A
2	Audio	1	3.5mm	Shielded	1	N/A

**TEST SETUP**

**CONDCUTED TEST SETUP DIAGRAM**

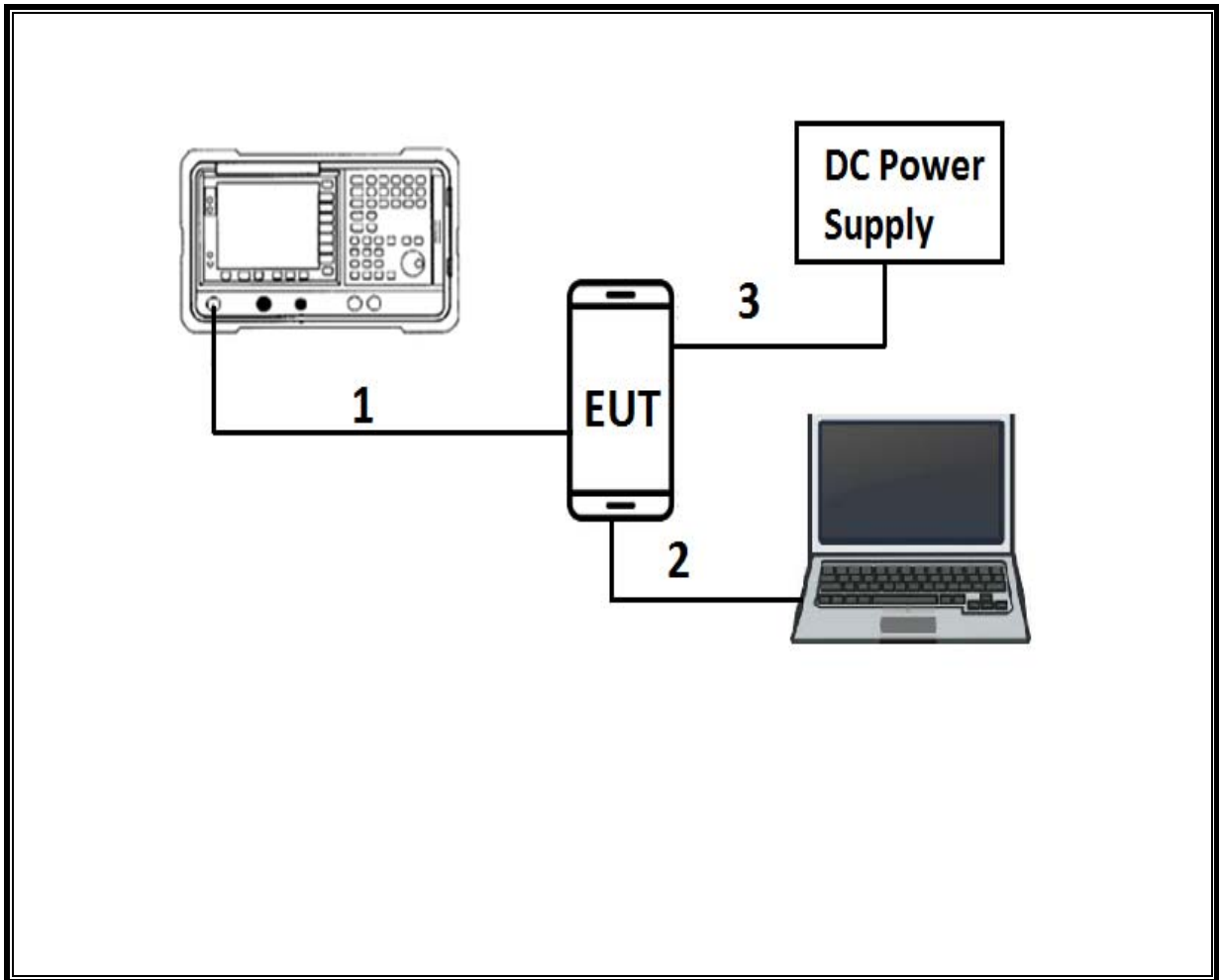

**TEST SETUP**

**RADIATED AND AC LINE CONDUCTED EMISSIONS SETUP DIAGRAM**

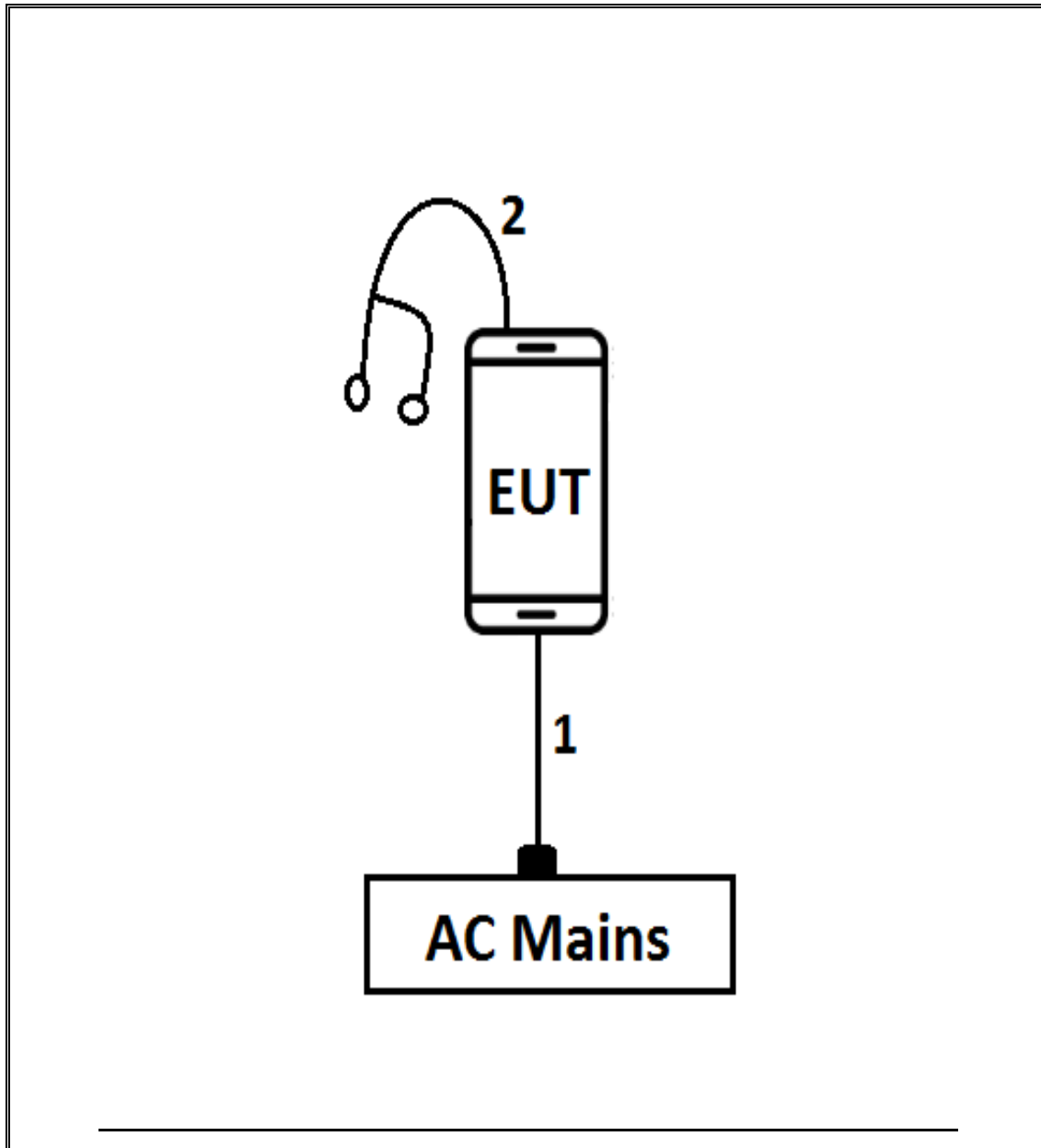

## 6. TEST AND MEASUREMENT EQUIPMENT

The following test and measurement equipment was utilized for the tests documented in this report:

TEST EQUIPMENT LIST				
Description	Manufacturer	Model	Asset	Cal Due
Antenna, Broadband Hybrid, 30MHz to 2000MHz w/4dB Pad	Sunol Sciences Corp.	JB3	T477	06/22/2018
Antenna, Active Loop 9kHz-30MHz	ETS-Lindgren	6502	T1683	02/17/2018
Antenna, Horn 1-18GHz	ETS-Lindgren	3117	T345	03/07/2018
Antenna, Horn 18-26.5GHz	ARA	MWH-1826/B	T449	05/26/2018
Antenna, Horn 26.5 - 40GHz	ARA	MWH-1826/B	T446	05/26/2018
Power Meter, P-series single channel	Agilent (Keysight) Technologies	N1911A	T1264	07/08/2017
Power Sensor, P – series, 50MHz to 18GHz, Wideband	Agilent (Keysight) Technologies	N1921A	T413	06/20/2017
Amplifier, 1-26.5GHz	Agilent (Keysight) Technologies	8449B	T404	07/05/2017
Amplifier, 10kHz-1GHz	Agilent (Keysight) Technologies	8447D	T15	08/26/2017
RF Amplifier	MITEQ	AFS42-00101800-25-S-42	T493	02/15/2018
Spectrum Analyzer, PSA, 3Hz to 26.5GHz	Agilent (Keysight) Technologies	E4440A	T199	07/22/2017
Spectrum Analyzer, PXA, 3Hz to 44GHz	Agilent (Keysight) Technologies	N9030A	T907	01/23/2018
Spectrum Analyzer, PSA, 3Hz to 26.5GHz	Agilent (Keysight) Technologies	E9030A	T905	01/11/2018
LISN	FISCHER	FCC-LISN-50/250-25-2-01	T1310	01/17/2018

Test Software List			
Description	Manufacturer	Model	Version
Radiated Software	UL	UL EMC	Ver 9.5, Apr 26, 2016
Conducted Software	UL	UL EMC	Ver 9.5, May 26, 2015
Antenna Port Software	UL	UL RF	Ver 5.1.1, July 15, 2016

The following test and measurement equipment was utilized for the tests documented in this report:

NOTE: \*testing is completed before equipment calibration expiration date.

## 7. MEASUREMENT METHODS

On Time and Duty Cycle: KDB 789033 D02 v01r04, Section B.

6 dB Emission BW: KDB 789033 D02 v01r04, Section C.2.

26 dB Emission BW: KDB 789033 D02 v01r04, Section C.2.1.

99% Occupied BW: KDB 789033 D02 v01r04, Section D.

Conducted Output Power: KDB 789033 D02 v01r04, Section E.3.b (Method PM-G) and KDB 662911 D01 v02r01.

Power Spectral Density: KDB 789033 D02 v01r04, Section F and KDB 662911 D01 v02r01.

Unwanted emissions in restricted bands: KDB 789033 D02 v01r04, Sections G.3, G.4, G.5, and G.6, and KDB 662911 D01 v02r01.

Unwanted emissions in non-restricted bands: KDB 789033 D02 v01r04, Sections G.3, G.4, and G.5, and KDB 662911 D01 v02r01.

AC Power Line Conducted Emissions: ANSI C63.10-2013, Section 6.2.



## 8. SUMMARY TABLE

FCC Part Section	Test Description	Test Limit	Test Condition	Test Result
§15.407 (a)	Occupied Band width (26dB)	N/A	Conducted	Pass
§15.407	6dB Band width (5.8Ghz)	>500KHz		Pass
§15.407 (a)(1)	TX Cond. Power 5.15-5.25 GHz	<24dBm (FCC) / <23 dBm EIRP or <10+10Log(99% BW) EIRP (IC)		Pass
§15.407 (a)(2)	TX Cond. Power 5.25-5.35 & 5.47-5.725 GHz	<24dBm or <11+10log (OBW) (FCC) / <24 dBm or <11+10Log(99% BW) (IC)		Pass
§15.407 (a)(3)	TX Cond. Power 5.725-5.850 GHz	<30dBm		Pass
§15.407 (a)(1)	PSD (5.15-5.25 GHz)	<11dBm/MHz (FCC) <10 dBm/MHz EIRP (IC)		Pass
§15.407 (a)(2)	PSD (5.3,5.5GHz)	<11dBm/MHz		Pass
§15.407 (a)(3)	PSD (5.8GHz)	<30dBm per 500kHz		Pass
§15.207 (a) §15.407(b) (6)	AC Power Line conducted emissions	Section 10		Pass
§15.407 (b) & 15.209	Radiated Spurious Emission	<54dBuV/m		Radiated

## 9. ON TIME, DUTY CYCLE AND MEASUREMENT METHODS

### 9.1. ON TIME AND DUTY CYCLE

#### LIMITS

None; for reporting purposes only.

#### PROCEDURE

KDB 789033 Zero-Span Spectrum Analyzer Method.

#### RESULTS

Mode	ON Time B (msec)	Period (msec)	Duty Cycle x (linear)	Duty Cycle (%)	Duty Cycle Correction Factor (dB)	1/T Minimum VBW (kHz)
802.11a	2.030	2.145	0.946	94.6%	0.24	0.493
802.11n HT20	2.505	2.625	0.954	95.4%	0.20	0.399
802.11n HT40	1.226	1.343	0.913	91.3%	0.40	0.816
802.11ac VHT80	0.592	0.703	0.842	84.2%	0.75	1.689

**DUTY CYCLE PLOTS**

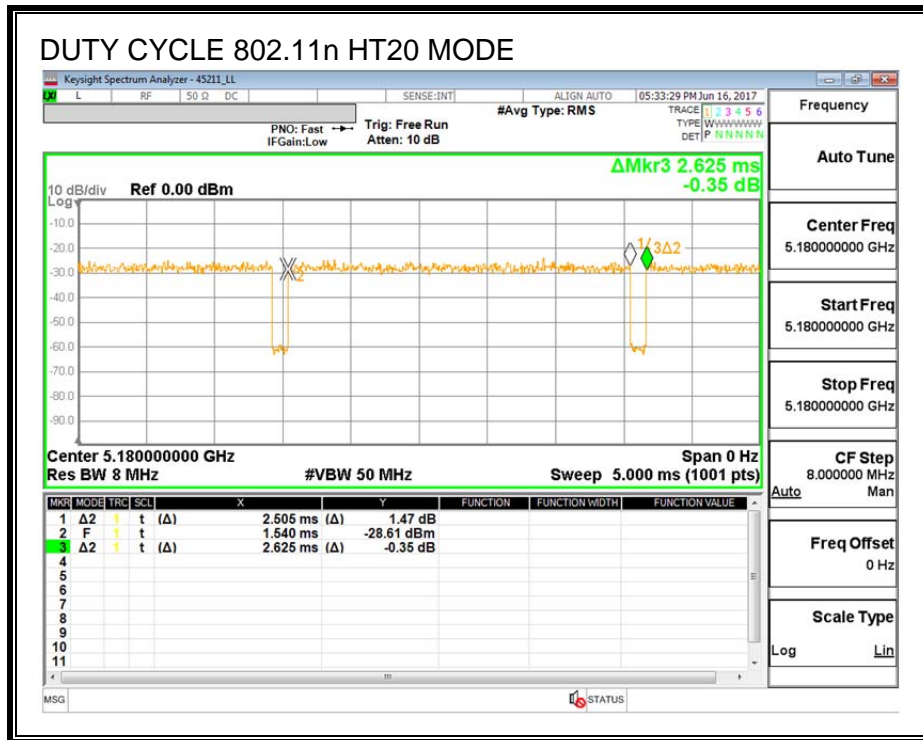
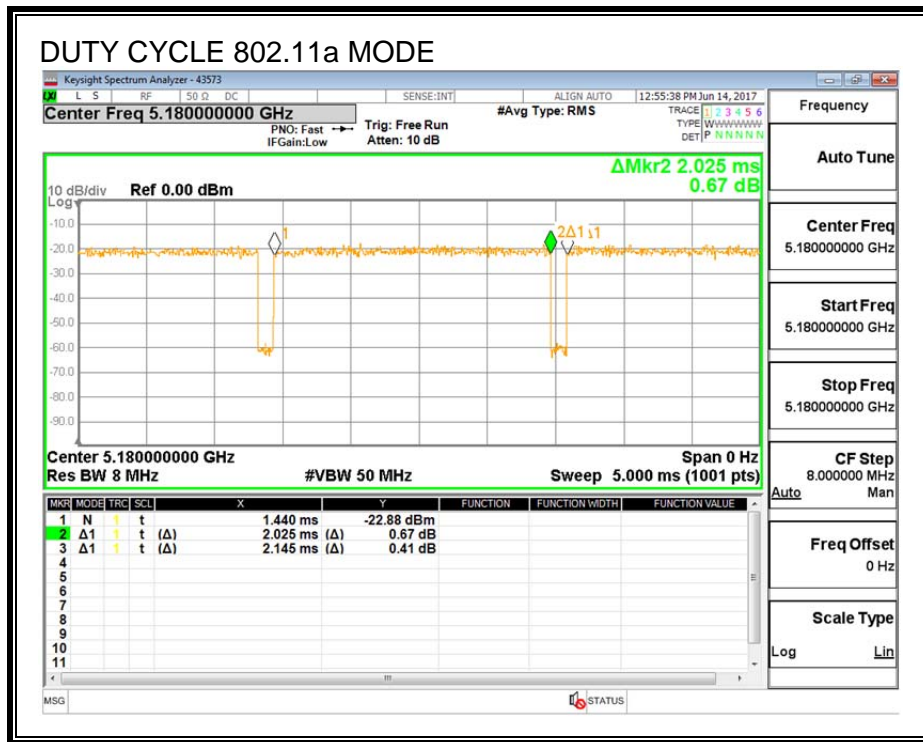

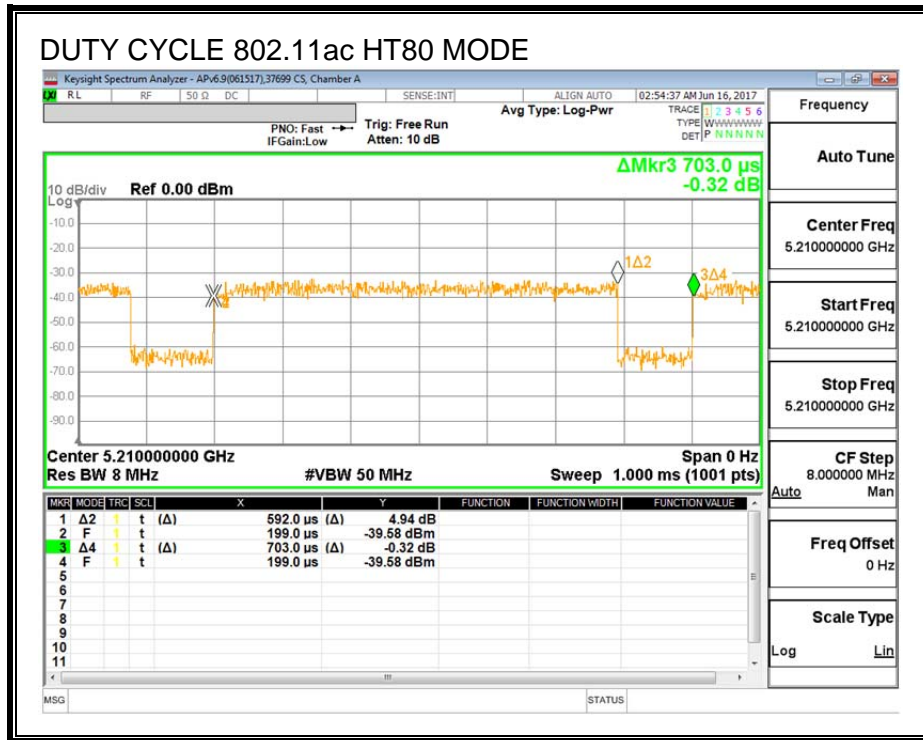
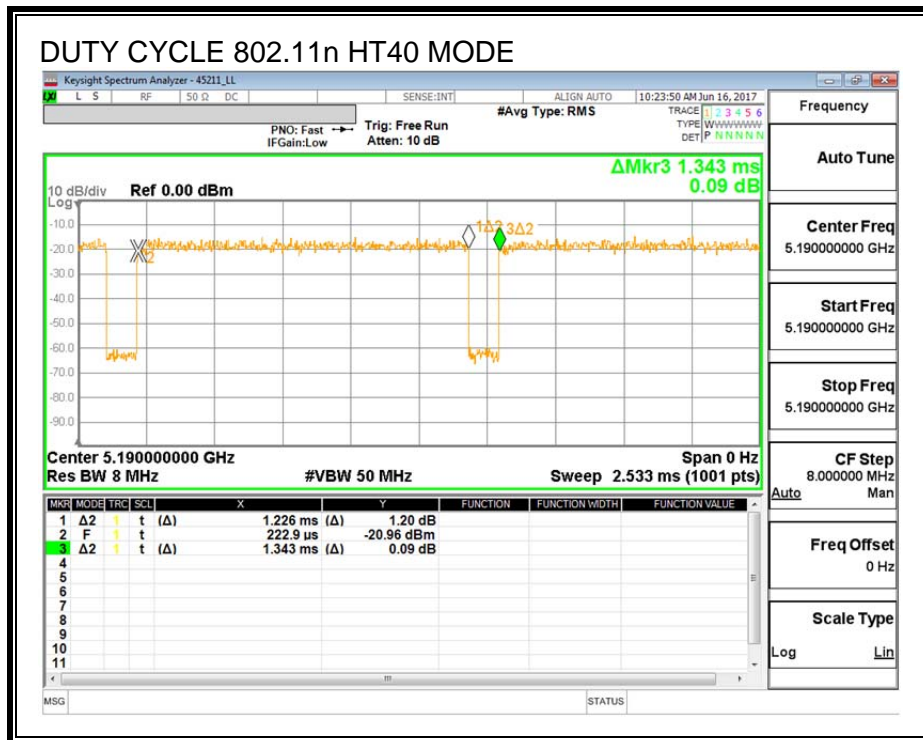

## 10. ANTENNA PORT TEST RESULTS

### 10.1. 11a 2TX CDD MIMO MODE IN THE 5.2GHz BAND

#### 10.1.1. 26 dB BANDWIDTH

##### LIMITS

None; for reporting purposes only.

##### RESULTS

Channel	Frequency	26 dB BW Chain 0 (MHz)	26 dB BW Chain 1 (MHz)
Low	5180	23.70	22.35
Mid	5200	23.65	22.05
High	5240	23.55	22.35

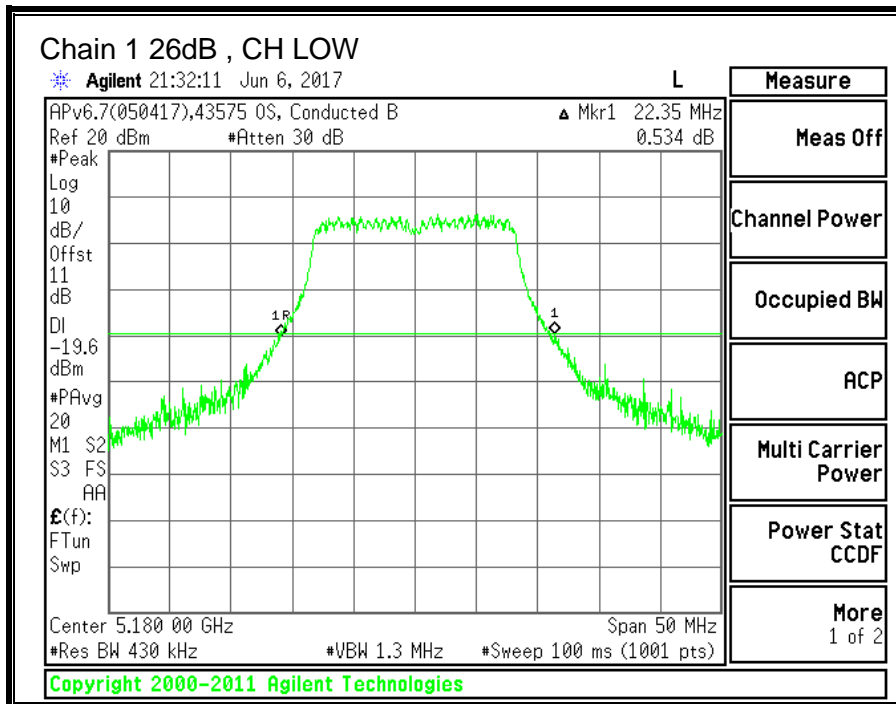
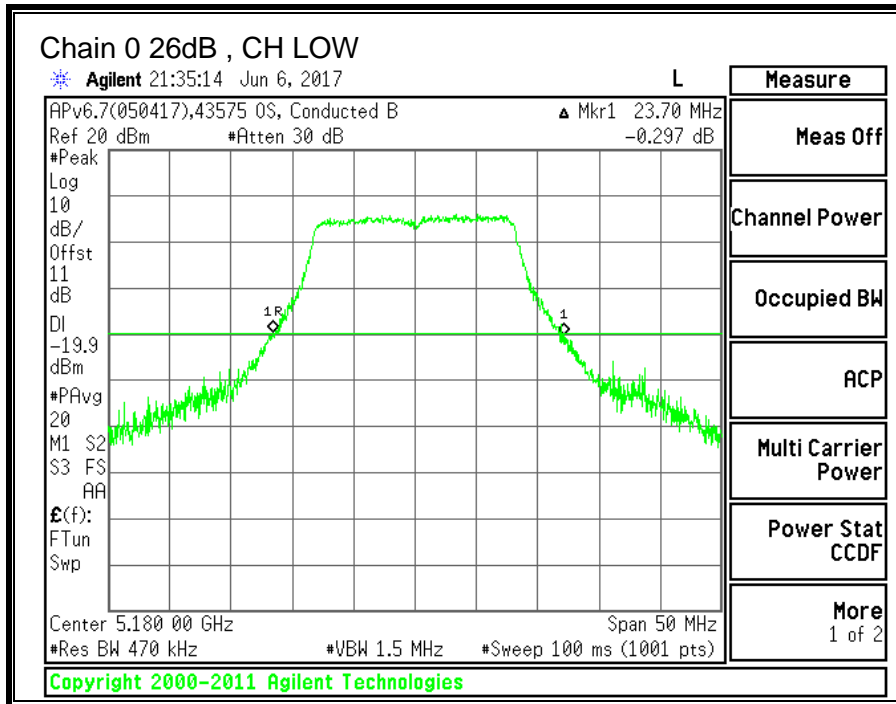

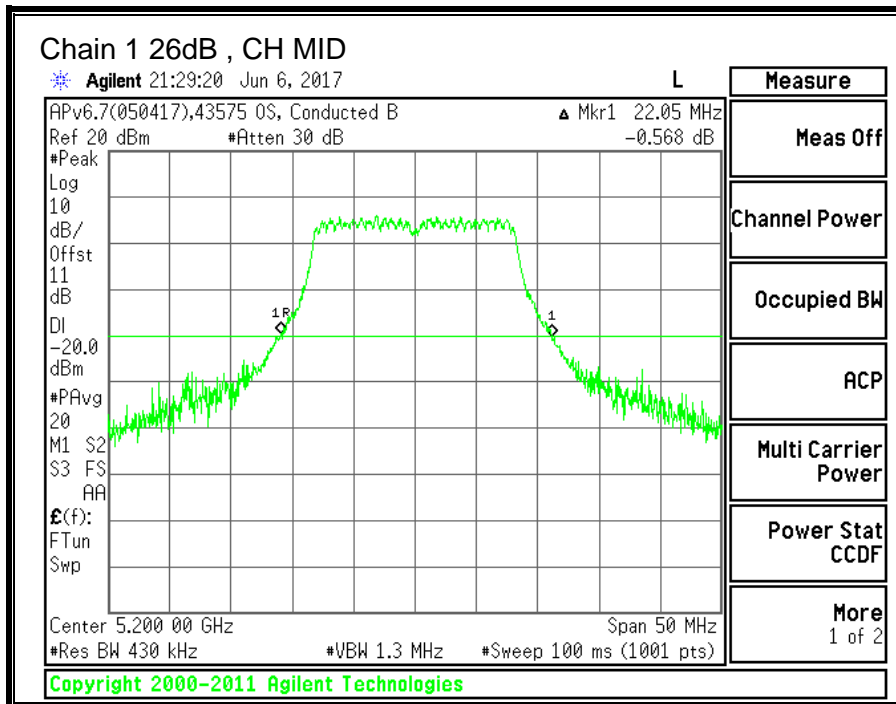
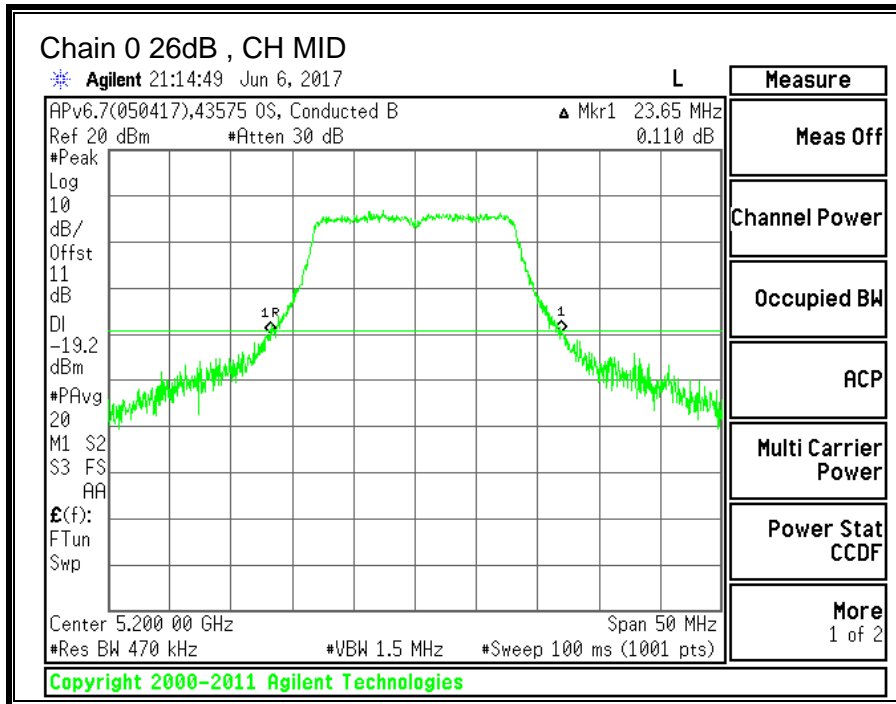

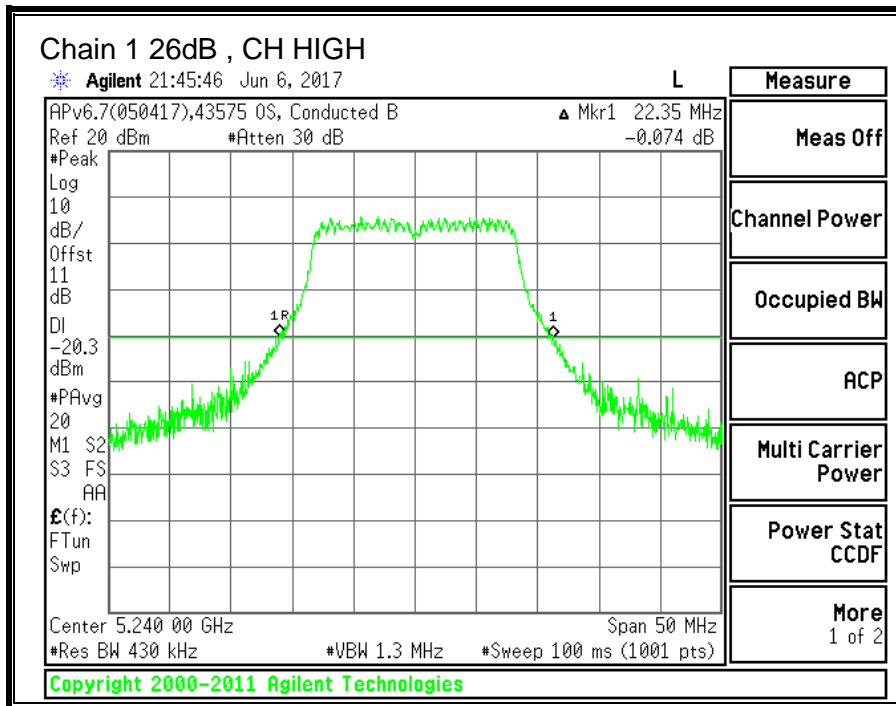
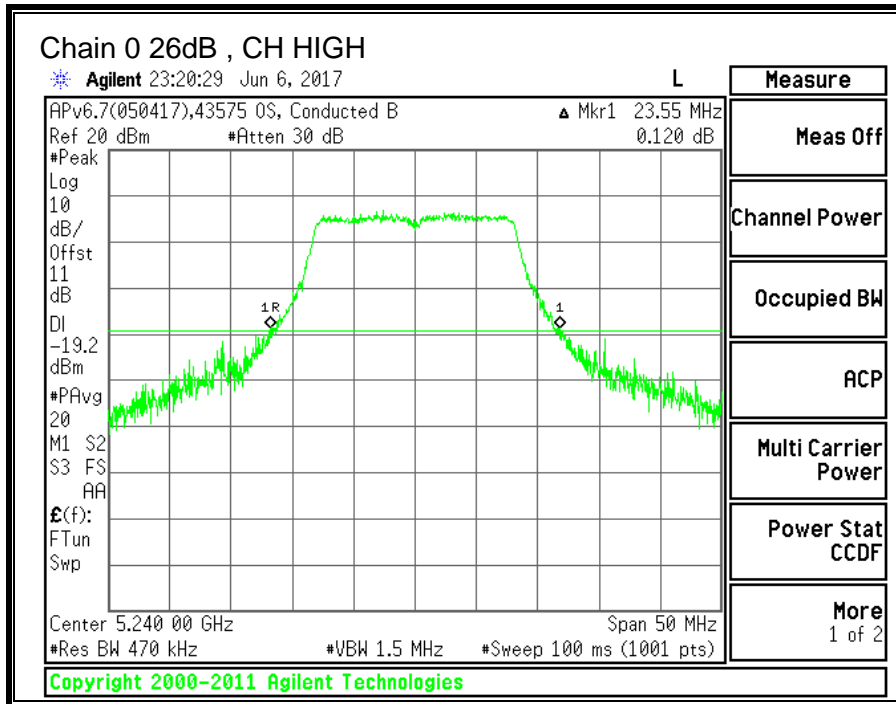



### 10.1.2. 99% BANDWIDTH

#### LIMITS

None; for reporting purposes only.

#### RESULTS

Channel	Frequency	99% BW Chain 0 (MHz)	99% BW Chain 1 (MHz)
Low	5180	16.006	16.337
Mid	5200	16.282	16.487
High	5240	16.529	16.076

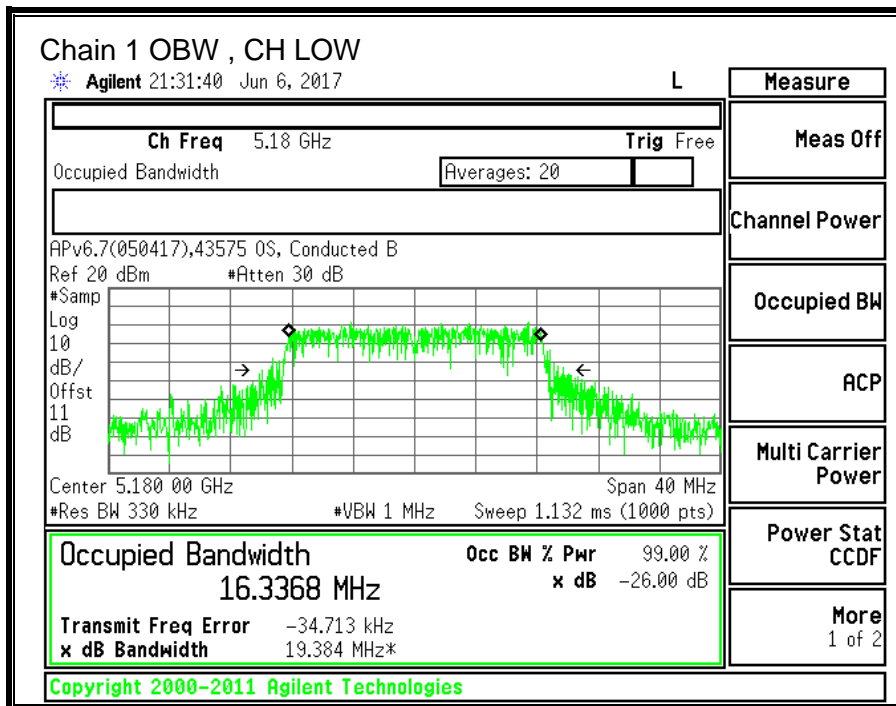
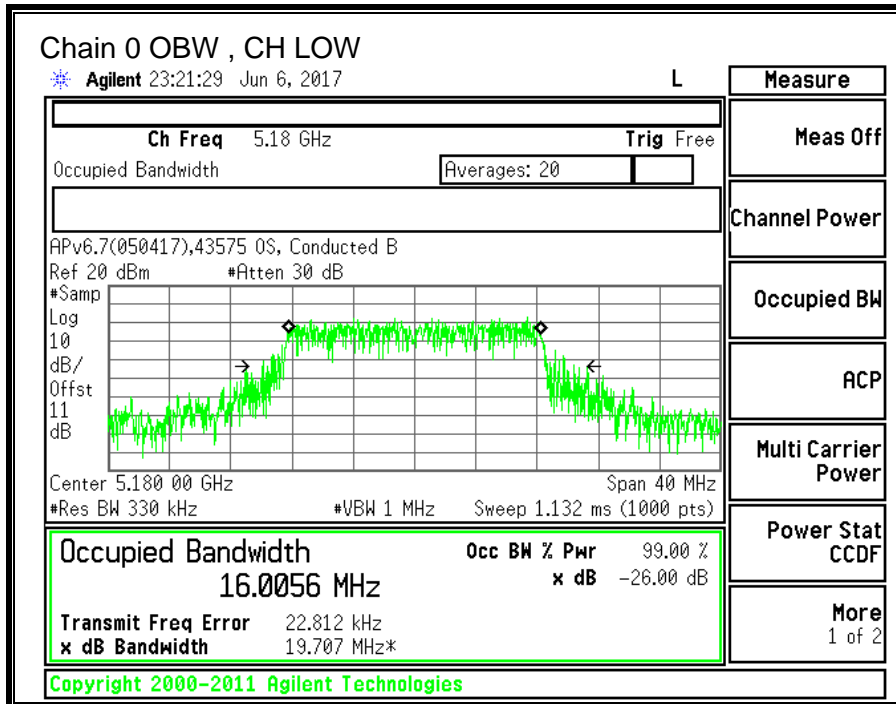

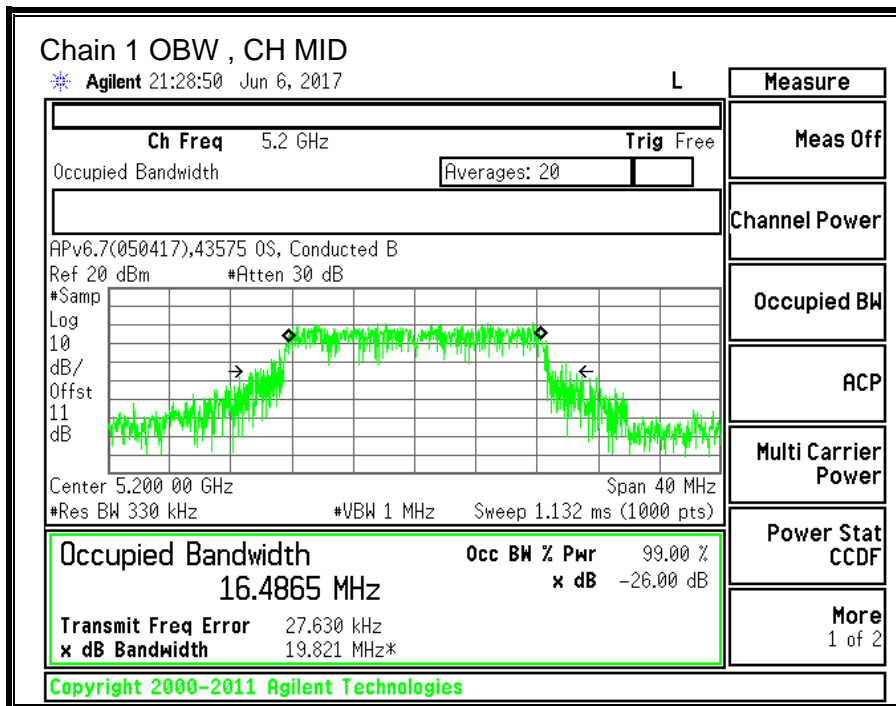
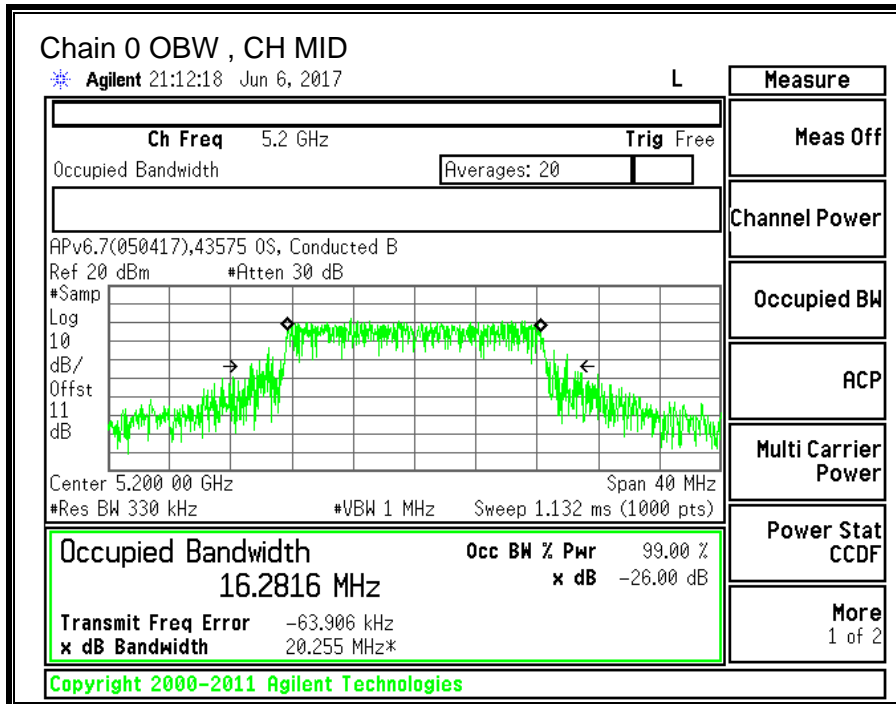

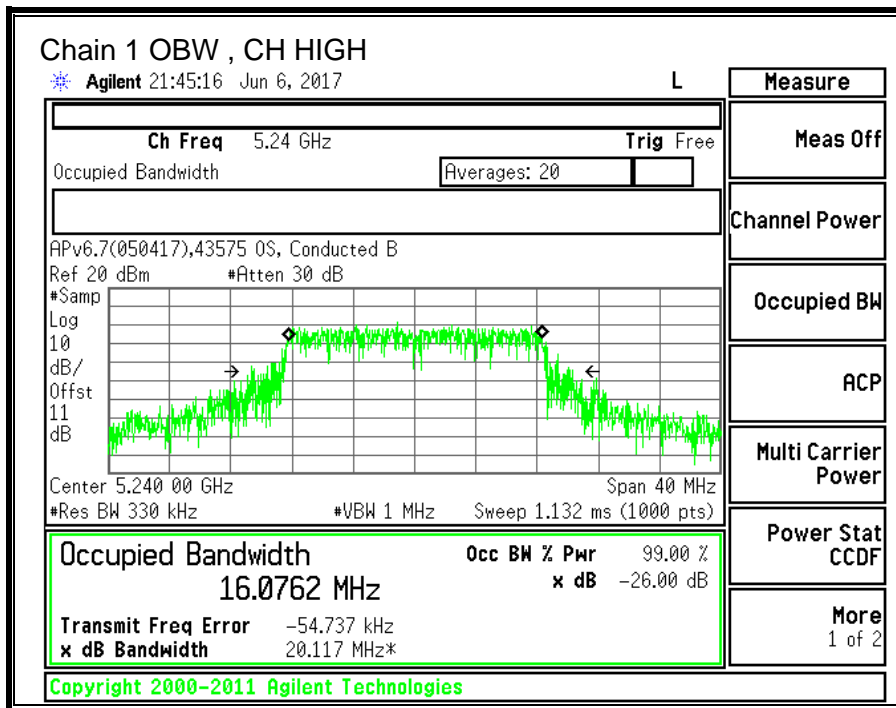
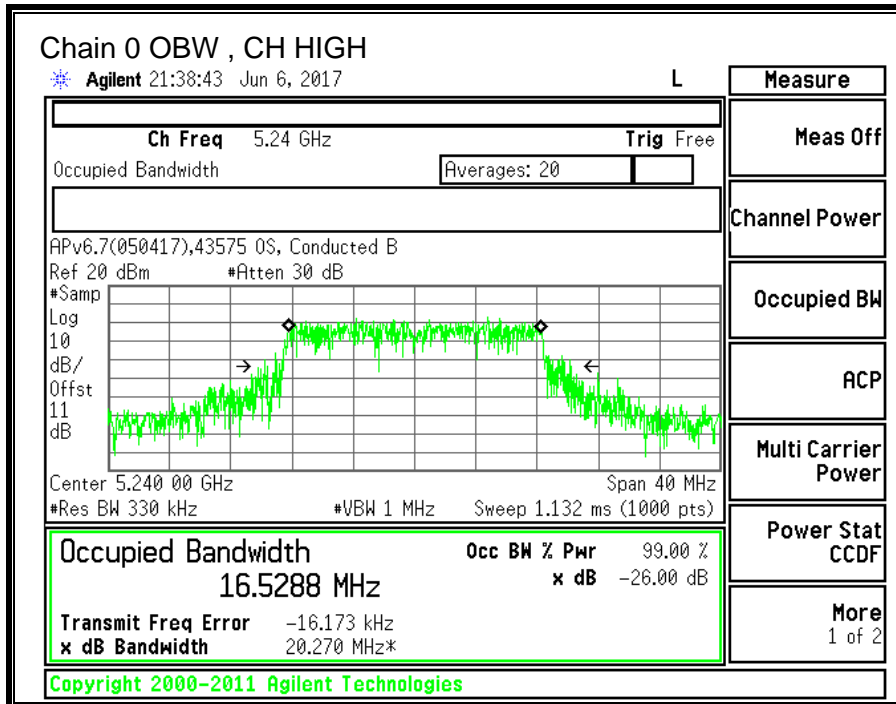

### 10.1.3. OUTPUT POWER AND PPSD

#### **LIMITS**

FCC §15.407 (a) (1)

(i) For an outdoor access point operating in the band 5.15-5.25 GHz, the maximum conducted output power over the frequency band of operation shall not exceed 1 W provided the maximum antenna gain does not exceed 6 dBi. In addition, the maximum power spectral density shall not exceed 17 dBm in any 1 megahertz band. If transmitting antennas of directional gain greater than 6 dBi are used, both the maximum conducted output power and the maximum power spectral density shall be reduced by the amount in dB that the directional gain of the antenna exceeds 6 dBi. The maximum e.i.r.p. at any elevation angle above 30 degrees as measured from the horizon must not exceed 125 mW (21 dBm).

(ii) For an indoor access point operating in the band 5.15-5.25 GHz, the maximum conducted output power over the frequency band of operation shall not exceed 1 W provided the maximum antenna gain does not exceed 6 dBi. In addition, the maximum power spectral density shall not exceed 17 dBm in any 1 megahertz band. If transmitting antennas of directional gain greater than 6 dBi are used, both the maximum conducted output power and the maximum power spectral density shall be reduced by the amount in dB that the directional gain of the antenna exceeds 6 dBi.

(iii) For fixed point-to-point access points operating in the band 5.15-5.25 GHz, the maximum conducted output power over the frequency band of operation shall not exceed 1 W. Fixed point-to-point U-NII devices may employ antennas with directional gain up to 23 dBi without any corresponding reduction in the maximum conducted output power or maximum power spectral density. For fixed point-to-point transmitters that employ a directional antenna gain greater than 23 dBi, a 1 dB reduction in maximum conducted output power and maximum power spectral density is required for each 1 dB of antenna gain in excess of 23 dBi. Fixed, point-to-point operations exclude the use of point-to-multipoint systems, omnidirectional applications, and multiple collocated transmitters transmitting the same information. The operator of the U-NII device, or if the equipment is professionally installed, the installer, is responsible for ensuring that systems employing high gain directional antennas are used exclusively for fixed, point-to-point operations.

(iv) For mobile and portable client devices in the 5.15-5.25 GHz band, the maximum conducted output power over the frequency band of operation shall not exceed 250 mW provided the maximum antenna gain does not exceed 6 dBi. In addition, the maximum power spectral density shall not exceed 11 dBm in any 1 megahertz band. If transmitting antennas of directional gain greater than 6 dBi are used, both the maximum conducted output power and the maximum power spectral density shall be reduced by the amount in dB that the directional gain of the antenna exceeds 6 dBi.

#### **TEST PROCEDURE**

Measurements perform using a wideband gated RF power meter provided that the gate parameters are adjusted such that the power is measured only when the EUT is transmitting at its maximum power control level. Since the measurement is made only during the ON time of the transmitter, no duty cycle correction factor is required.

**DIRECTIONAL ANTENNA GAIN**

For power, the TX chains are uncorrelated and the antenna gain is unequal among the chains. The directional gain is:

**5150-5250 MHz**

<b>Chain 0 Antenna Gain (dBi)</b>	<b>Chain 1 Antenna Gain (dBi)</b>	<b>Uncorrelated Chains Directional Gain (dBi)</b>
-4.40	-6.70	-5.40

For PSD the TX chains are correlated and the antenna gain is unequal among the chains. The directional gain is:

**5150-5250 MHz**

<b>Chain 0 Antenna Gain (dBi)</b>	<b>Chain 1 Antenna Gain (dBi)</b>	<b>Correlated Chains Directional Gain (dBi)</b>
-4.40	-6.70	-2.46

**RESULTS**

<b>ID:</b>	43574	<b>Date:</b>	06/06/17
------------	-------	--------------	----------

**Bandwidth and Antenna Gain**

Channel	Frequency (MHz)	Min 26 dB BW (MHz)	Min 99% BW (MHz)	Directional Gain for Power (dBi)	Directional Gain for PPSD (dBi)
Low	5180	22.35	16.006	-5.40	-2.46
Mid	5200	22.05	16.282	-5.40	-2.46
High	5240	22.35	16.076	-5.40	-2.46

**Limits**

Channel	Frequency (MHz)	FCC Power Limit (dBm)	IC EIRP Limit (dBm)	Max IC Power (dBm)	Power Limit (dBm)	FCC PPSD Limit (dBm)	IC eirp PSD Limit (dBm)	PPSD Limit (dBm)
Low	5180	24.00	22.04	27.44	24.00	11.00	10.00	11.00
Mid	5200	24.00	22.12	27.52	24.00	11.00	10.00	11.00
High	5240	24.00	22.06	27.46	24.00	11.00	10.00	11.00

<b>Duty Cycle CF (dB)</b>	0.24	<b>Included in Calculations of Corr'd PPSD</b>
---------------------------	------	--

**Output Power Results**

Channel	Frequency (MHz)	Chain 0 Meas Power (dBm)	Chain 1 Meas Power (dBm)	Total Corr'd Power (dBm)	Power Limit (dBm)	Power Margin (dB)
Low	5180	13.41	11.91	15.73	24.00	-8.27
Mid	5200	13.38	11.95	15.73	24.00	-8.27
High	5240	13.29	11.85	15.64	24.00	-8.36

**PPSD Results**

Channel	Frequency (MHz)	Chain 0 Meas PPSD (dBm)	Chain 1 Meas PPSD (dBm)	Total Corr'd PPSD (dBm)	PPSD Limit (dBm)	PPSD Margin (dB)
Low	5180	1.810	0.844	4.60	11.00	-6.40
Mid	5200	2.168	0.730	4.76	11.00	-6.24
High	5240	1.575	0.377	4.27	11.00	-6.73

**Note:** the power readings above were measured with gated method, and the measurement was taken only during the ON time. No duty cycle correction was necessary.

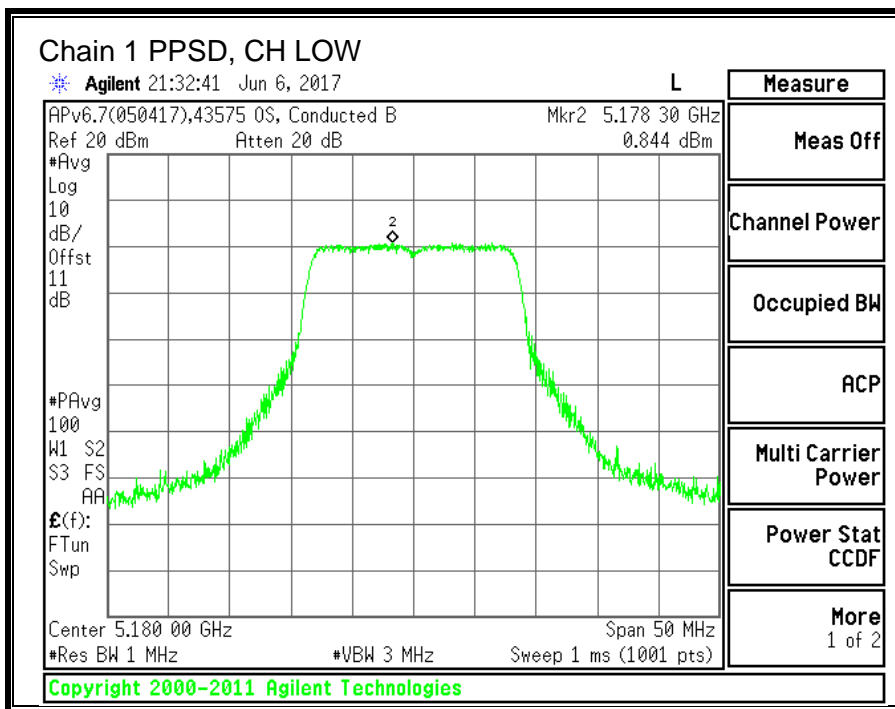
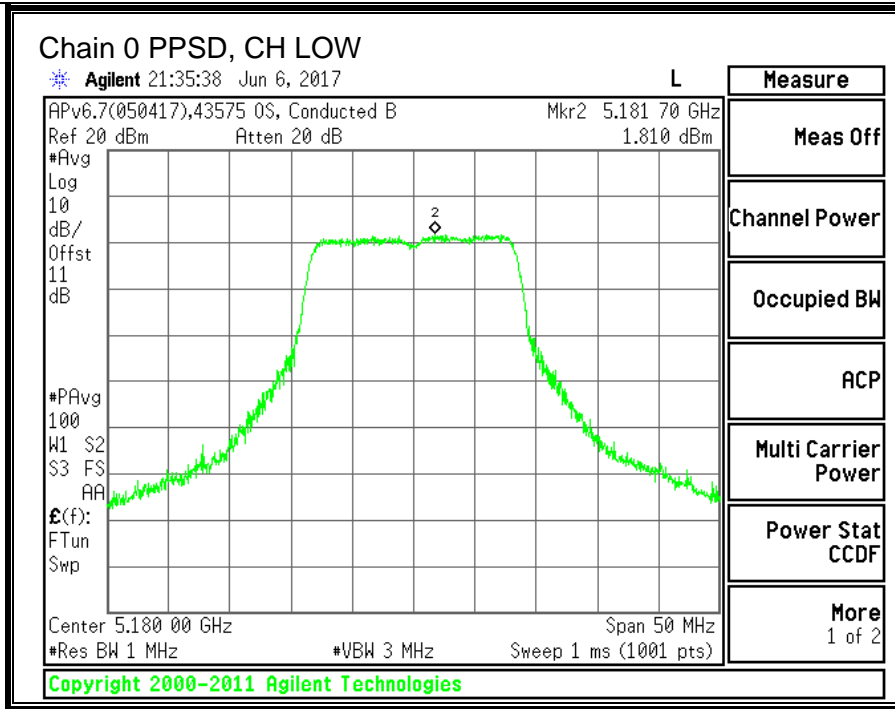



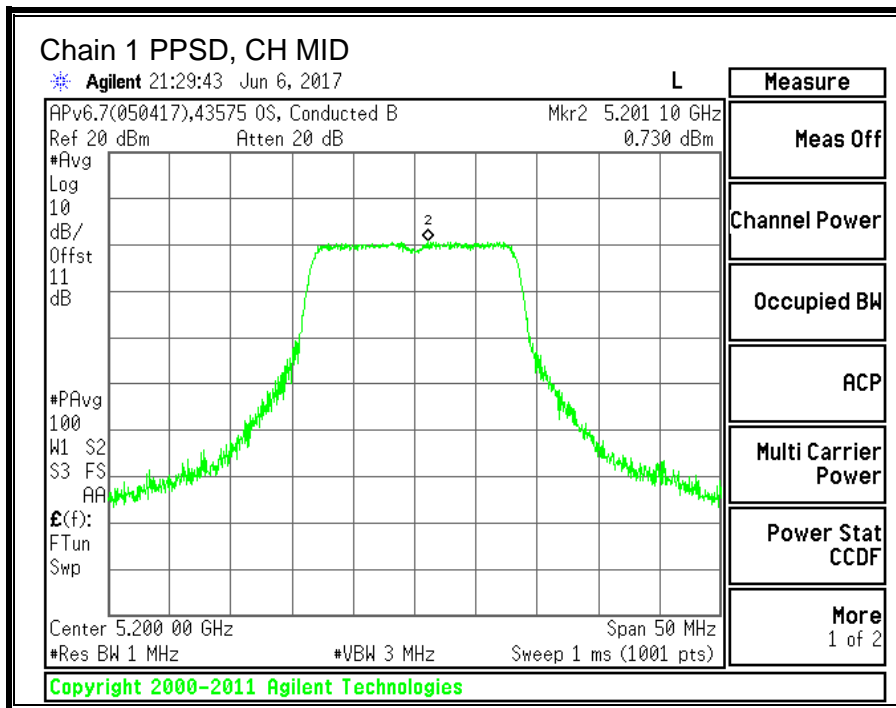
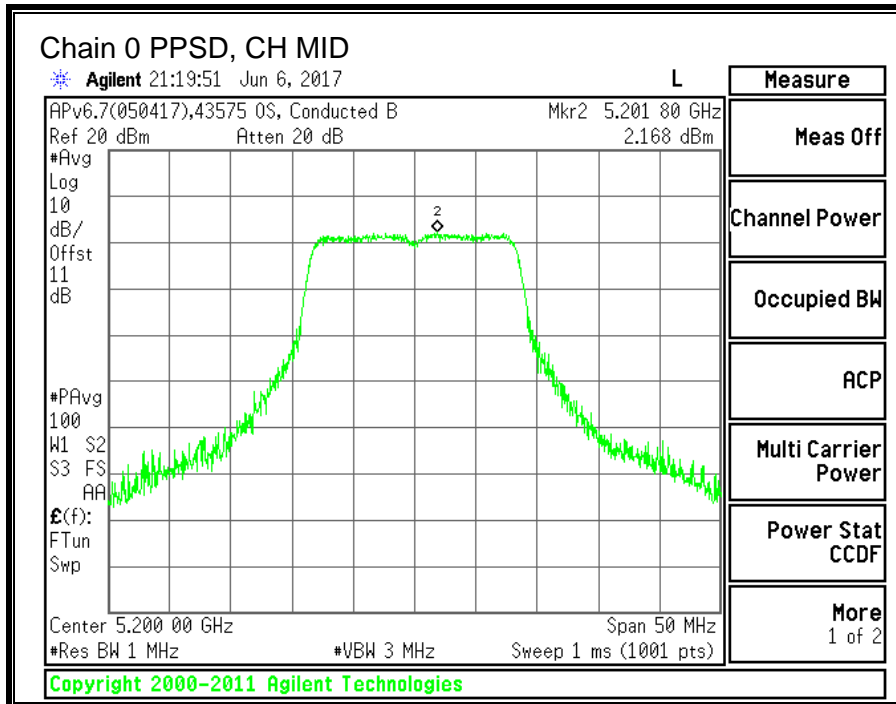

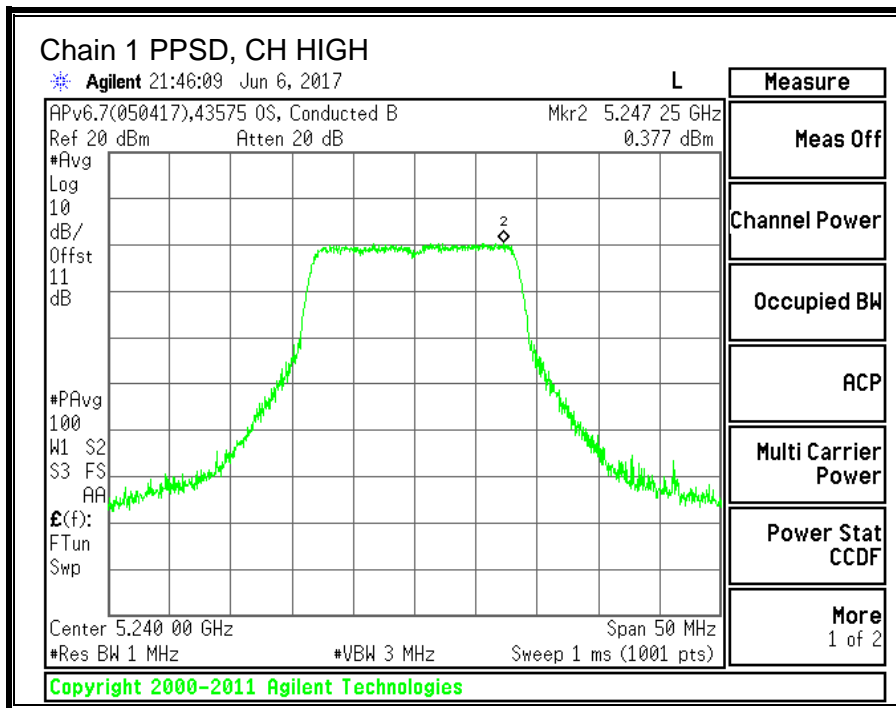
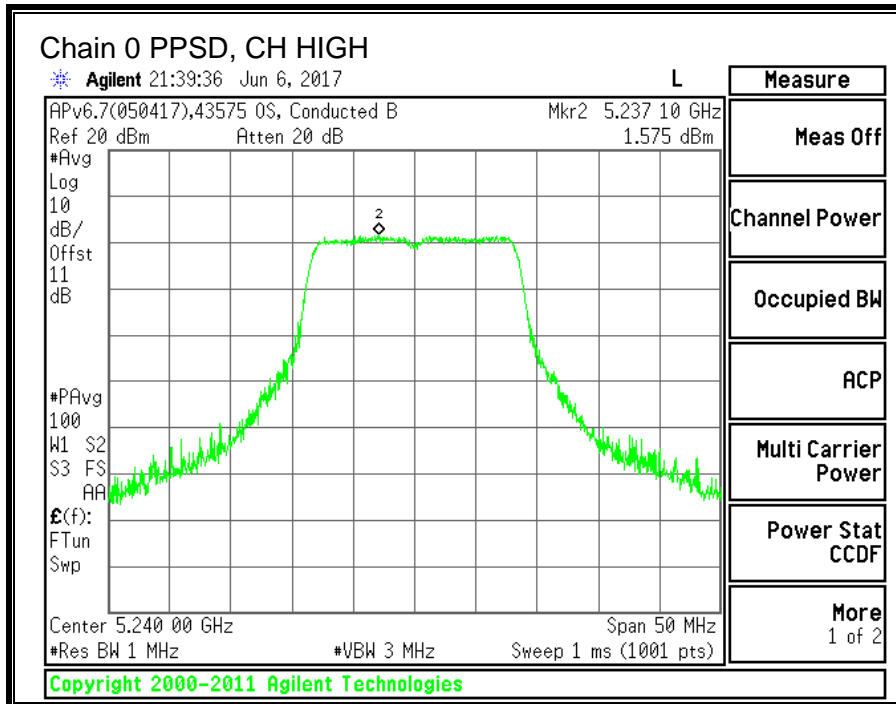

## 10.2. 11n HT20 2TX CDD MIMO MODE IN THE 5.2GHz BAND

### 10.2.1. 26 dB BANDWIDTH

#### LIMITS

None; for reporting purposes only.

#### RESULTS

Channel	Frequency	26 dB BW Chain 0 (MHz)	26 dB BW Chain 1 (MHz)
Low	5180	24.35	23.15
Mid	5200	24.50	23.20
High	5240	24.25	23.10

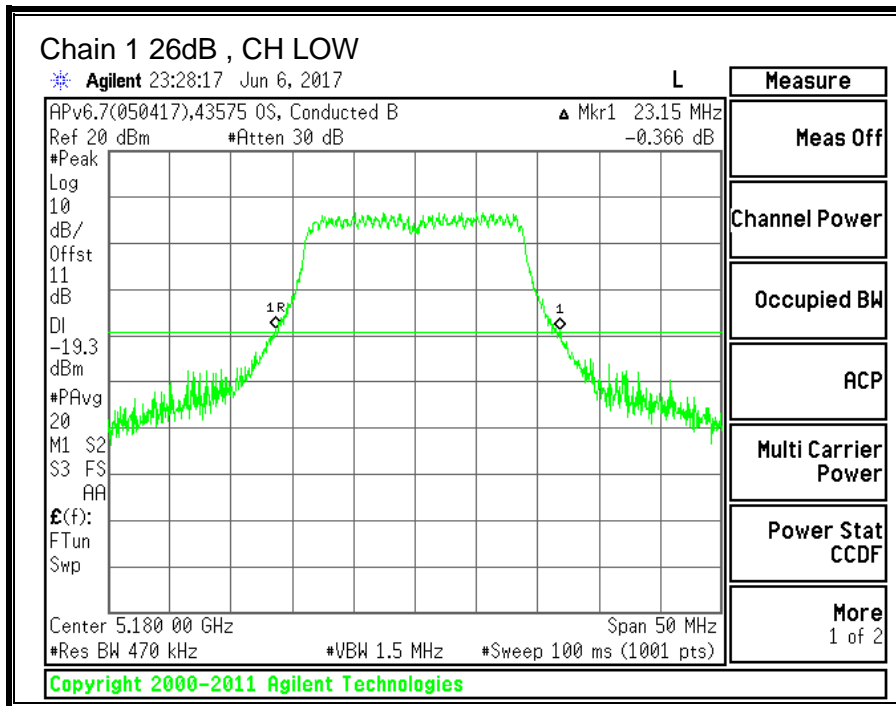
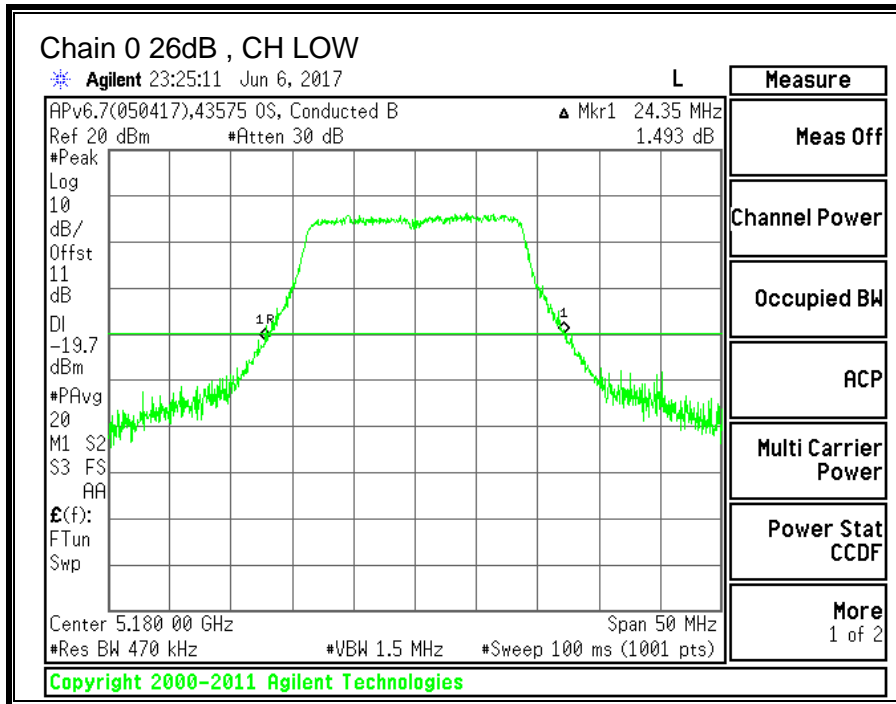

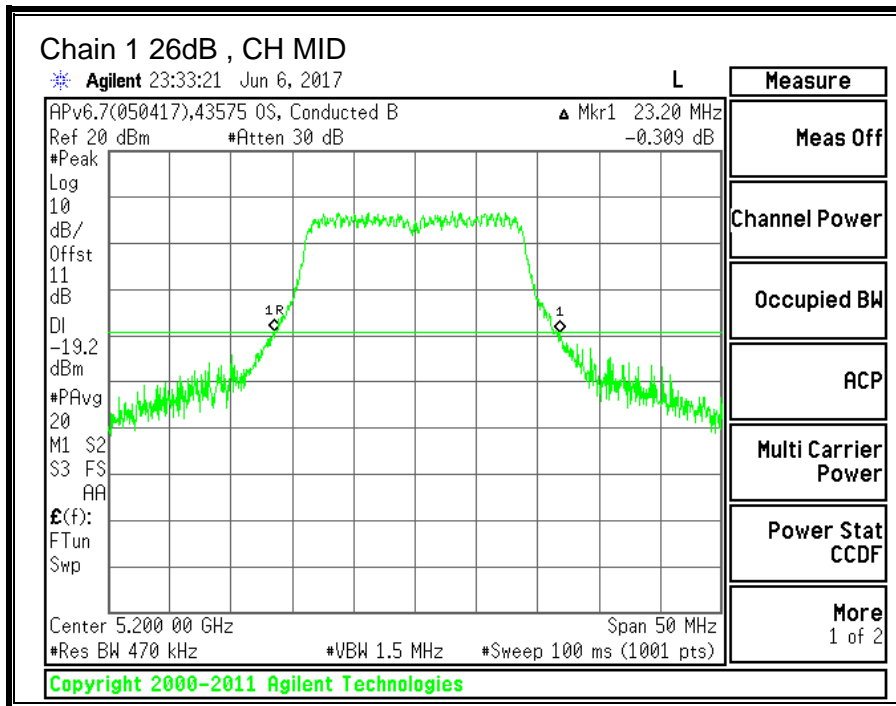
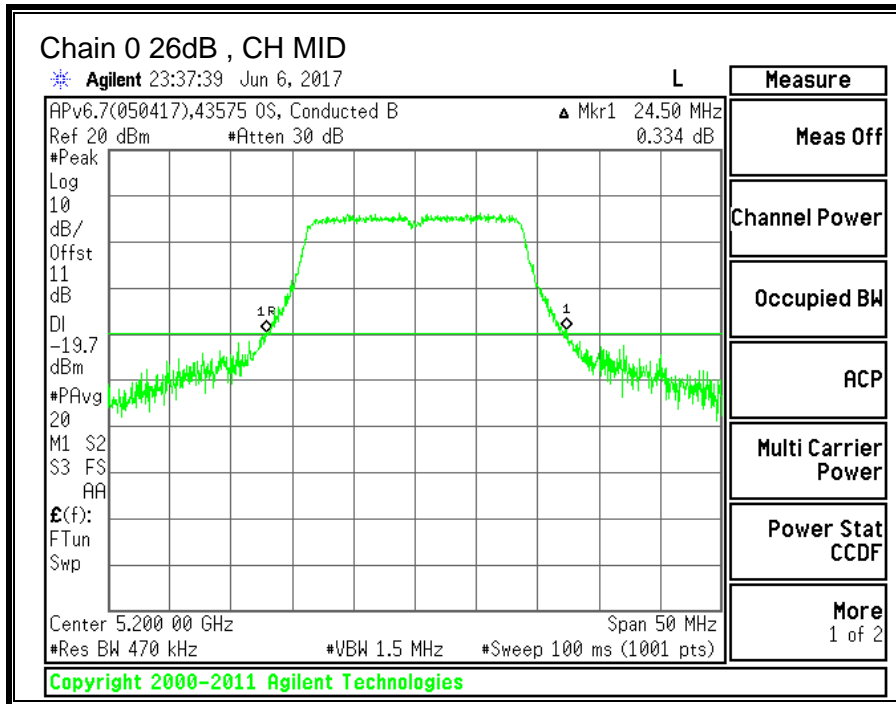

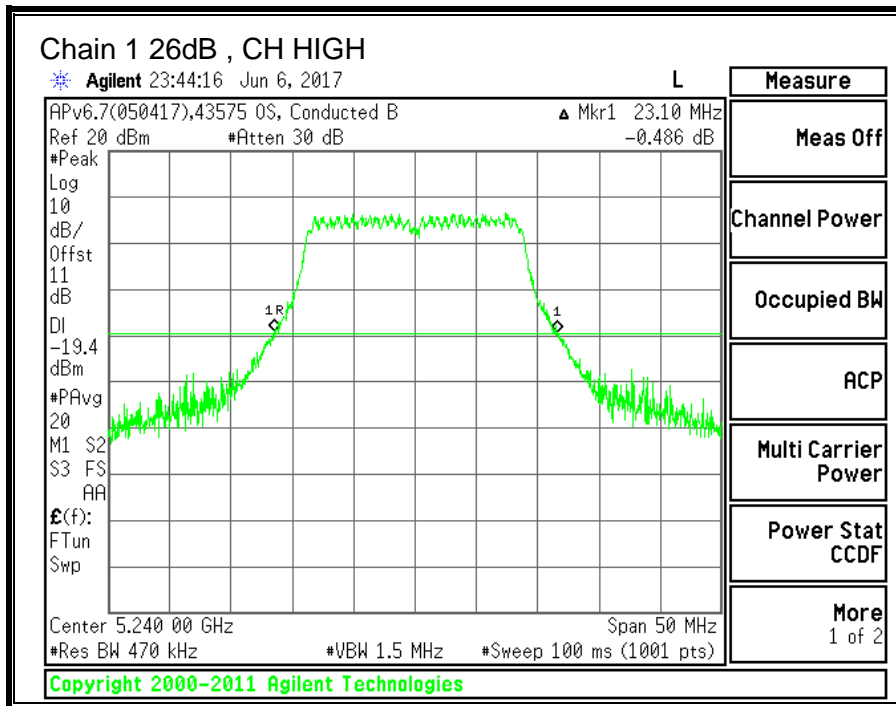
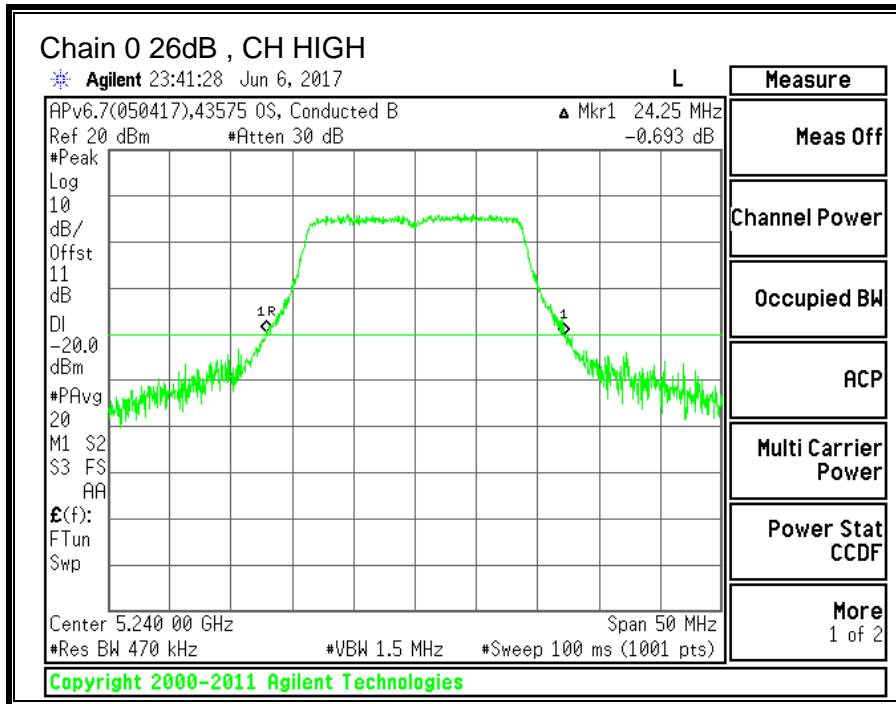

### 10.2.2. 99% BANDWIDTH

#### LIMITS

None; for reporting purposes only.

#### RESULTS

Channel	Frequency	99% BW Chain 0 (MHz)	99% BW Chain 1 (MHz)
Low	5180	17.625	17.307
Mid	5200	17.527	17.197
High	5240	17.469	17.464

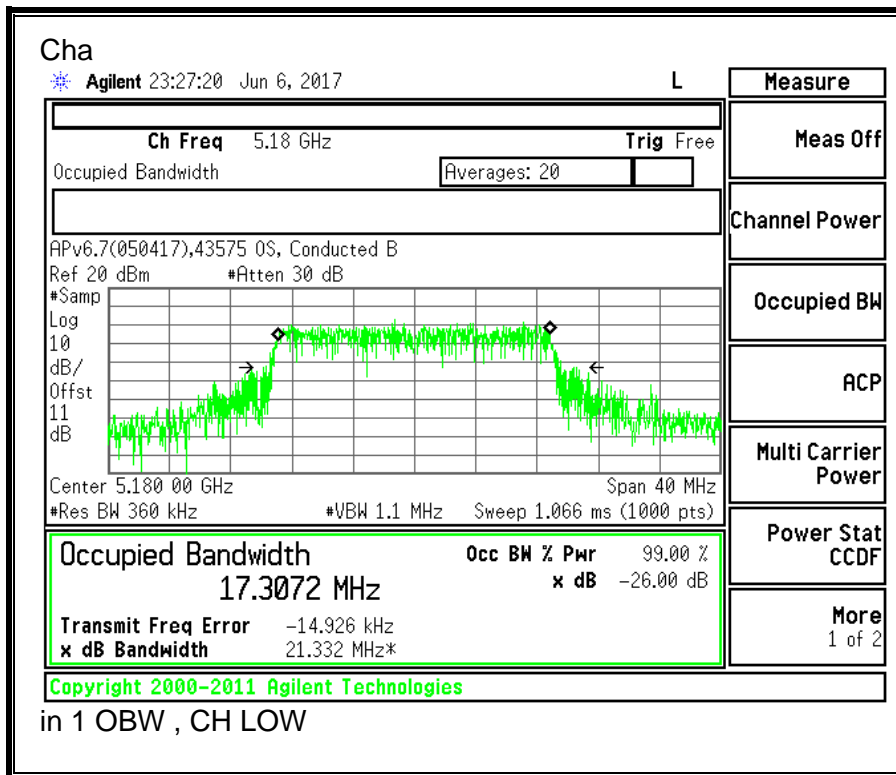
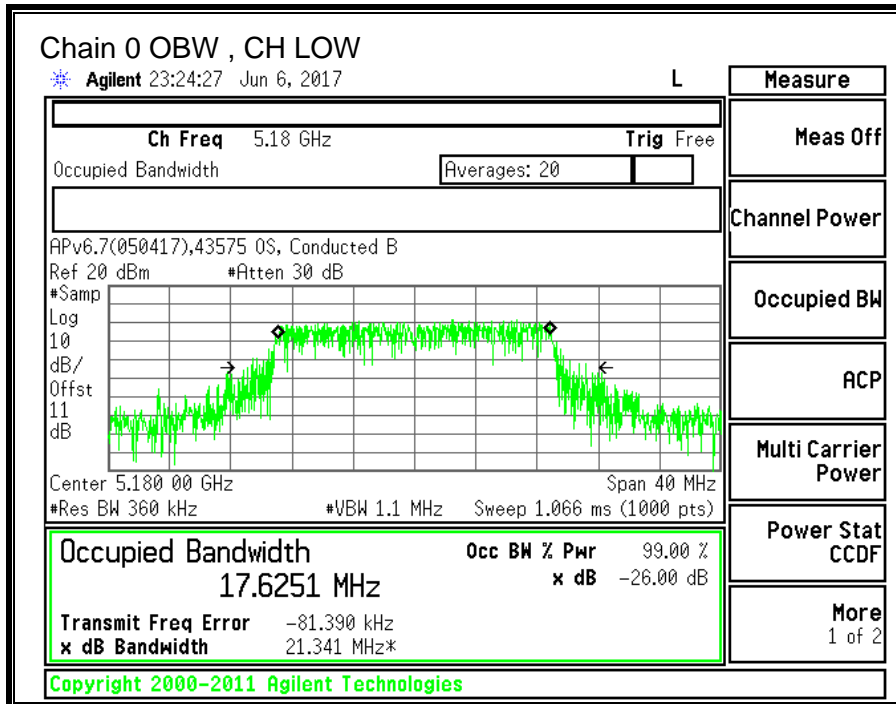



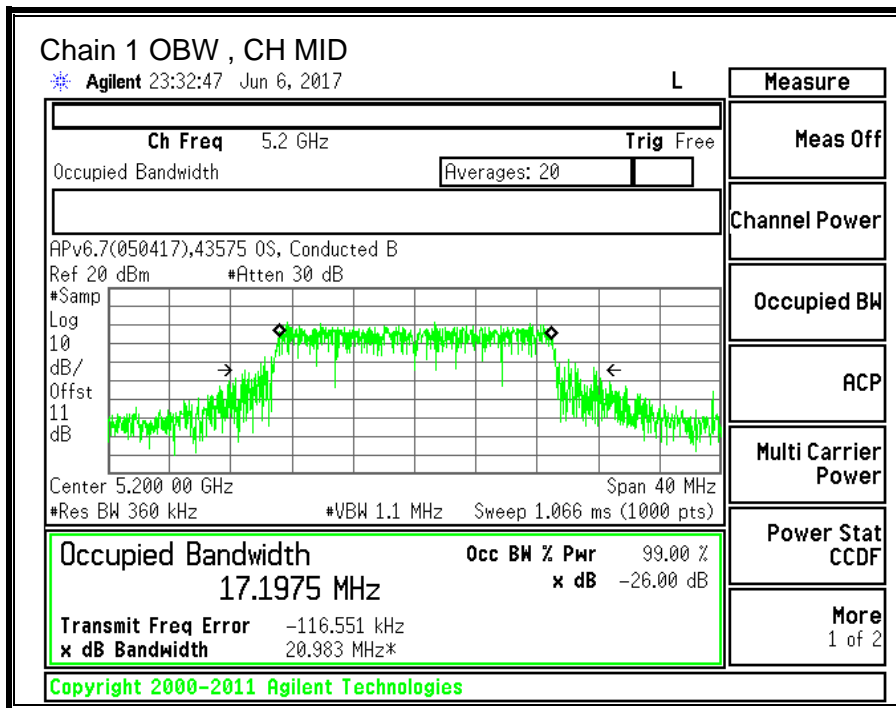
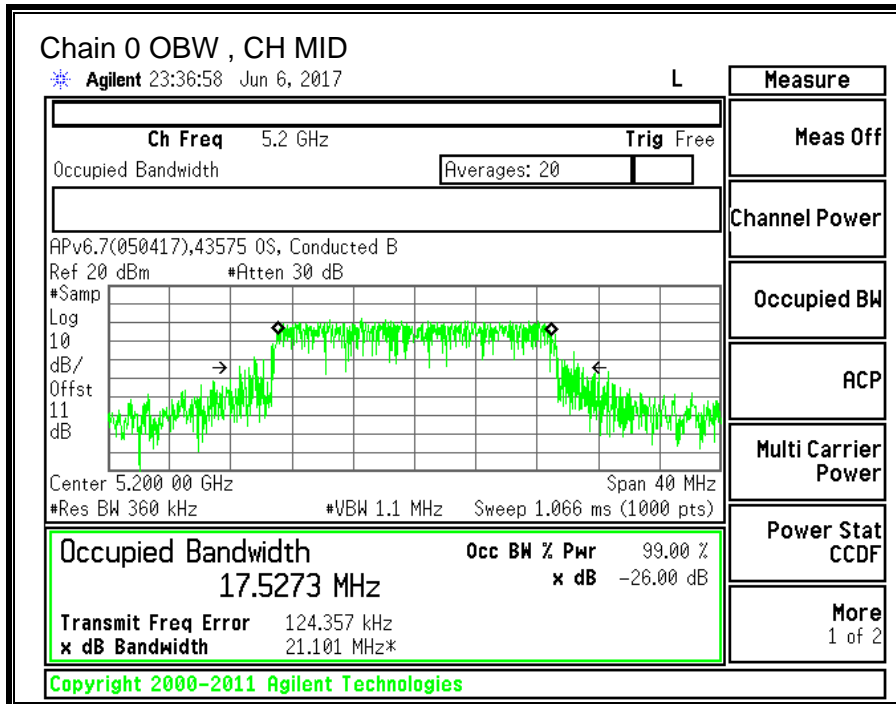

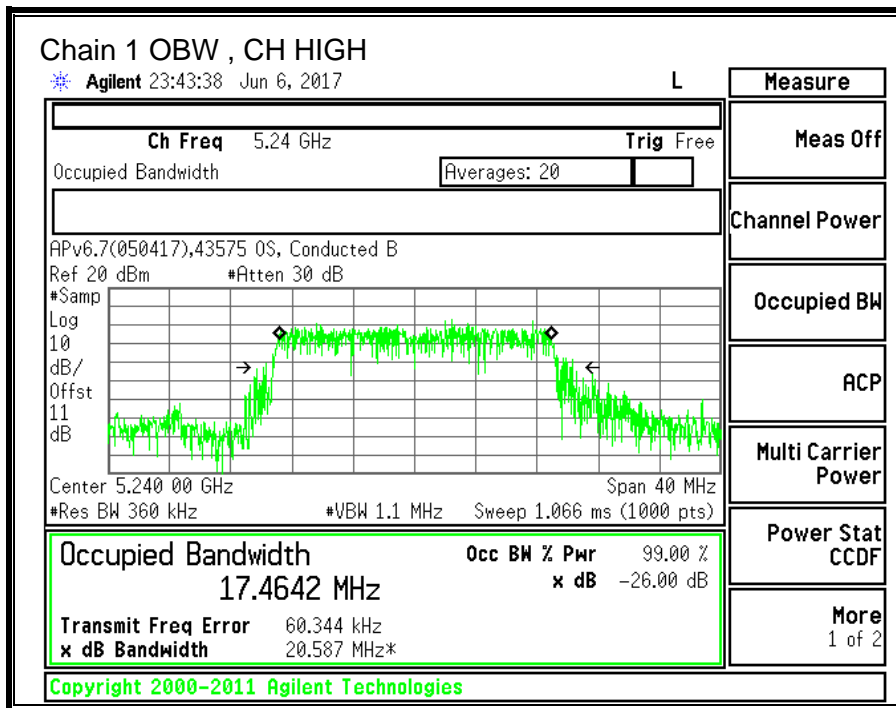
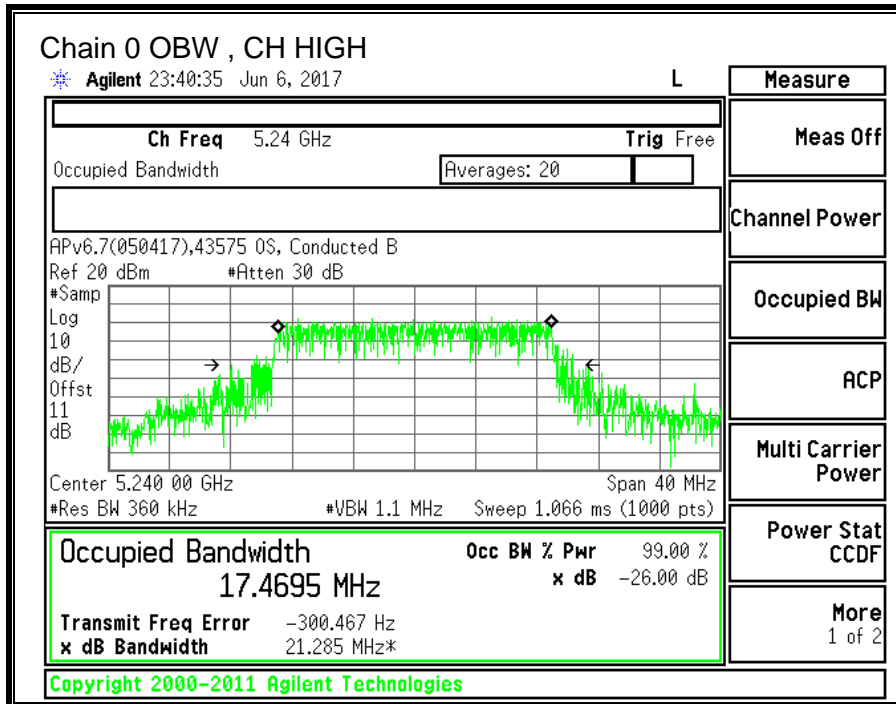

### 10.2.3. OUTPUT POWER AND PPSD

#### **LIMITS**

FCC §15.407 (a) (1)

(i) For an outdoor access point operating in the band 5.15-5.25 GHz, the maximum conducted output power over the frequency band of operation shall not exceed 1 W provided the maximum antenna gain does not exceed 6 dBi. In addition, the maximum power spectral density shall not exceed 17 dBm in any 1 megahertz band. If transmitting antennas of directional gain greater than 6 dBi are used, both the maximum conducted output power and the maximum power spectral density shall be reduced by the amount in dB that the directional gain of the antenna exceeds 6 dBi. The maximum e.i.r.p. at any elevation angle above 30 degrees as measured from the horizon must not exceed 125 mW (21 dBm).

(ii) For an indoor access point operating in the band 5.15-5.25 GHz, the maximum conducted output power over the frequency band of operation shall not exceed 1 W provided the maximum antenna gain does not exceed 6 dBi. In addition, the maximum power spectral density shall not exceed 17 dBm in any 1 megahertz band. If transmitting antennas of directional gain greater than 6 dBi are used, both the maximum conducted output power and the maximum power spectral density shall be reduced by the amount in dB that the directional gain of the antenna exceeds 6 dBi.

(iii) For fixed point-to-point access points operating in the band 5.15-5.25 GHz, the maximum conducted output power over the frequency band of operation shall not exceed 1 W. Fixed point-to-point U-NII devices may employ antennas with directional gain up to 23 dBi without any corresponding reduction in the maximum conducted output power or maximum power spectral density. For fixed point-to-point transmitters that employ a directional antenna gain greater than 23 dBi, a 1 dB reduction in maximum conducted output power and maximum power spectral density is required for each 1 dB of antenna gain in excess of 23 dBi. Fixed, point-to-point operations exclude the use of point-to-multipoint systems, omnidirectional applications, and multiple collocated transmitters transmitting the same information. The operator of the U-NII device, or if the equipment is professionally installed, the installer, is responsible for ensuring that systems employing high gain directional antennas are used exclusively for fixed, point-to-point operations.

(iv) For mobile and portable client devices in the 5.15-5.25 GHz band, the maximum conducted output power over the frequency band of operation shall not exceed 250 mW provided the maximum antenna gain does not exceed 6 dBi. In addition, the maximum power spectral density shall not exceed 11 dBm in any 1 megahertz band. If transmitting antennas of directional gain greater than 6 dBi are used, both the maximum conducted output power and the maximum power spectral density shall be reduced by the amount in dB that the directional gain of the antenna exceeds 6 dBi.

#### **TEST PROCEDURE**

Measurements perform using a wideband gated RF power meter provided that the gate parameters are adjusted such that the power is measured only when the EUT is transmitting at its maximum power control level. Since the measurement is made only during the ON time of the transmitter, no duty cycle correction factor is required.

**DIRECTIONAL ANTENNA GAIN**

For power, the TX chains are uncorrelated and the antenna gain is unequal among the chains. The directional gain is:

**5150-5250 MHz**

<b>Chain 0 Antenna Gain (dBi)</b>	<b>Chain 1 Antenna Gain (dBi)</b>	<b>Uncorrelated Chains Directional Gain (dBi)</b>
-4.40	-6.70	-5.40

For PSD the TX chains are correlated and the antenna gain is unequal among the chains. The directional gain is:

**5150-5250 MHz**

<b>Chain 0 Antenna Gain (dBi)</b>	<b>Chain 1 Antenna Gain (dBi)</b>	<b>Correlated Chains Directional Gain (dBi)</b>
-4.40	-6.70	-2.46

**RESULTS**

<b>ID:</b>	43574	<b>Date:</b>	06/06/17
------------	-------	--------------	----------

**Bandwidth and Antenna Gain**

Channel	Frequency (MHz)	Min 26 dB BW (MHz)	Min 99% BW (MHz)	Directional Gain for Power (dBi)	Directional Gain for PPSD (dBi)
Low	5180	23.15	17.307	-5.40	-2.46
Mid	5200	23.20	17.197	-5.40	-2.46
High	5240	23.10	17.464	-5.40	-2.46

**Limits**

Channel	Frequency (MHz)	FCC Power Limit (dBm)	IC EIRP Limit (dBm)	Max IC Power (dBm)	Power Limit (dBm)	FCC PPSD Limit (dBm)	IC eirp PSD Limit (dBm)	PPSD Limit (dBm)
Low	5180	24.00	22.38	27.78	24.00	11.00	10.00	11.00
Mid	5200	24.00	22.35	27.75	24.00	11.00	10.00	11.00
High	5240	24.00	22.42	27.82	24.00	11.00	10.00	11.00

<b>Duty Cycle CF (dB)</b>	0.20	<b>Included in Calculations of Corr'd PPSD</b>
---------------------------	------	--

**Output Power Results**

Channel	Frequency (MHz)	Chain 0 Meas Power (dBm)	Chain 1 Meas Power (dBm)	Total Corr'd Power (dBm)	Power Limit (dBm)	Power Margin (dB)
Low	5180	13.51	11.92	15.80	24.00	-8.20
Mid	5200	13.37	12.02	15.76	24.00	-8.24
High	5240	13.43	11.96	15.77	24.00	-8.23

**PPSD Results**

Channel	Frequency (MHz)	Chain 0 Meas PPSD (dBm)	Chain 1 Meas PPSD (dBm)	Total Corr'd PPSD (dBm)	PPSD Limit (dBm)	PPSD Margin (dB)
Low	5180	1.759	0.573	4.42	11.00	-6.58
Mid	5200	1.668	0.627	4.39	11.00	-6.61
High	5240	1.807	0.575	4.44	11.00	-6.56

**Note:** the power readings above were measured with gated method, and the measurement was taken only during the ON time. No duty cycle correction was necessary.

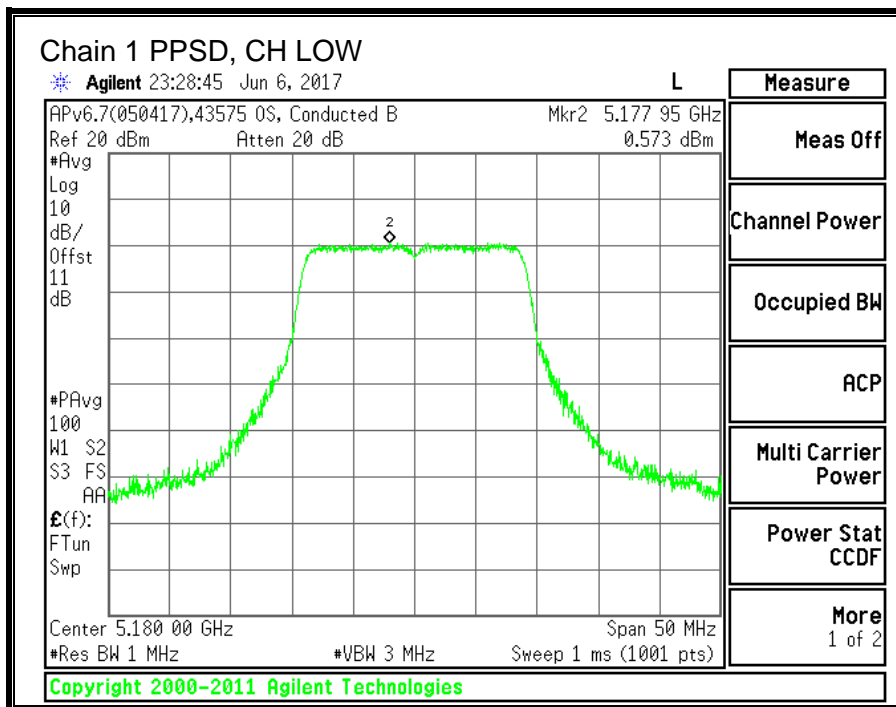
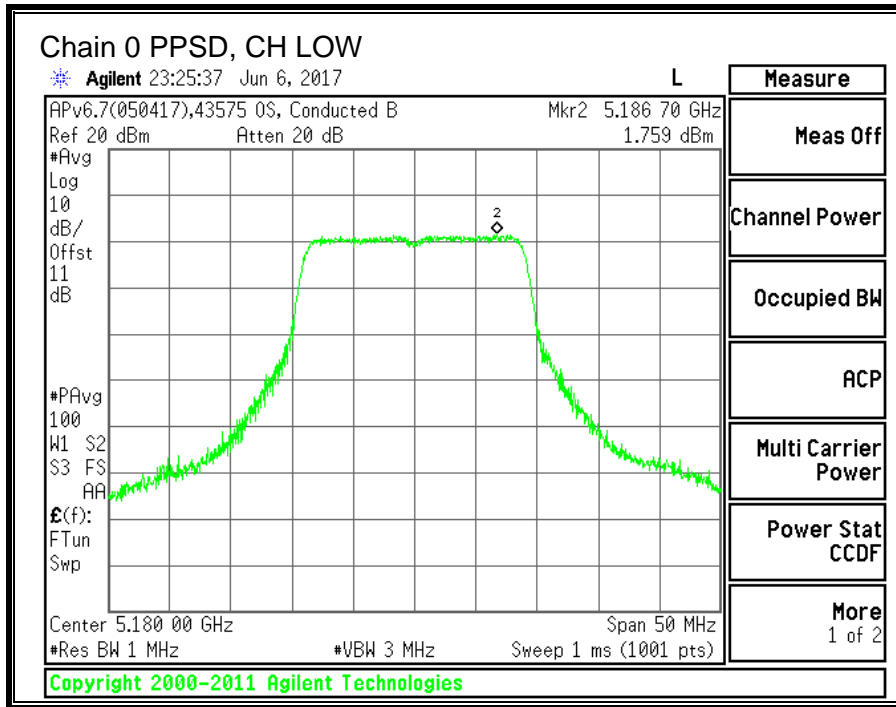

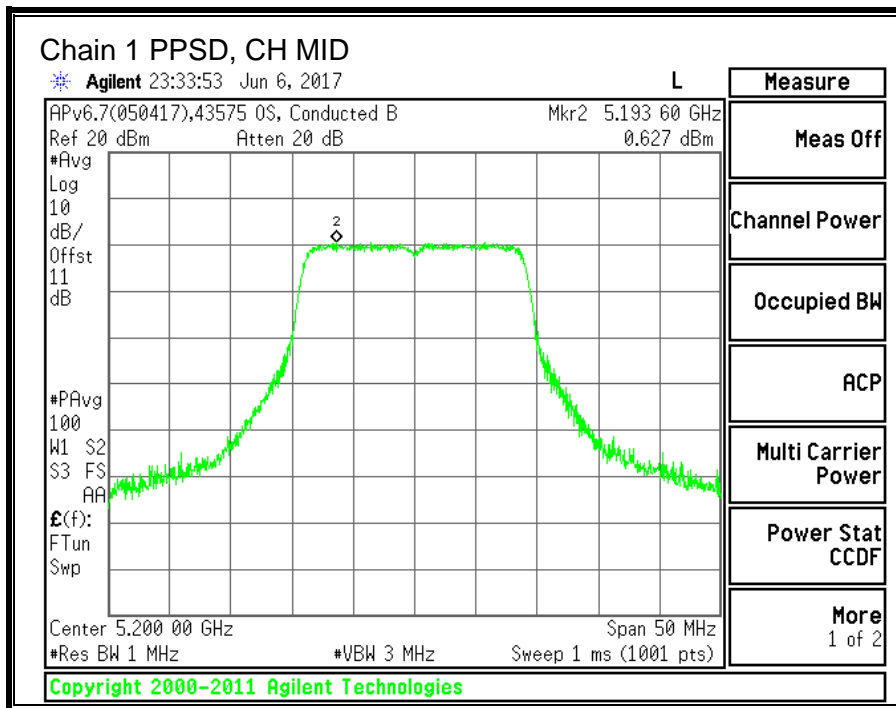
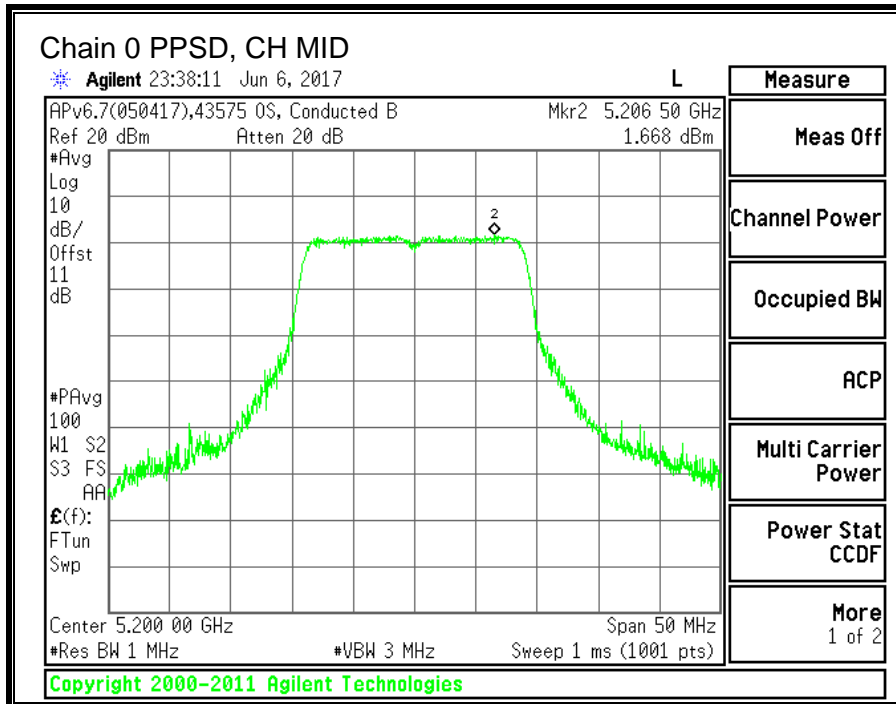

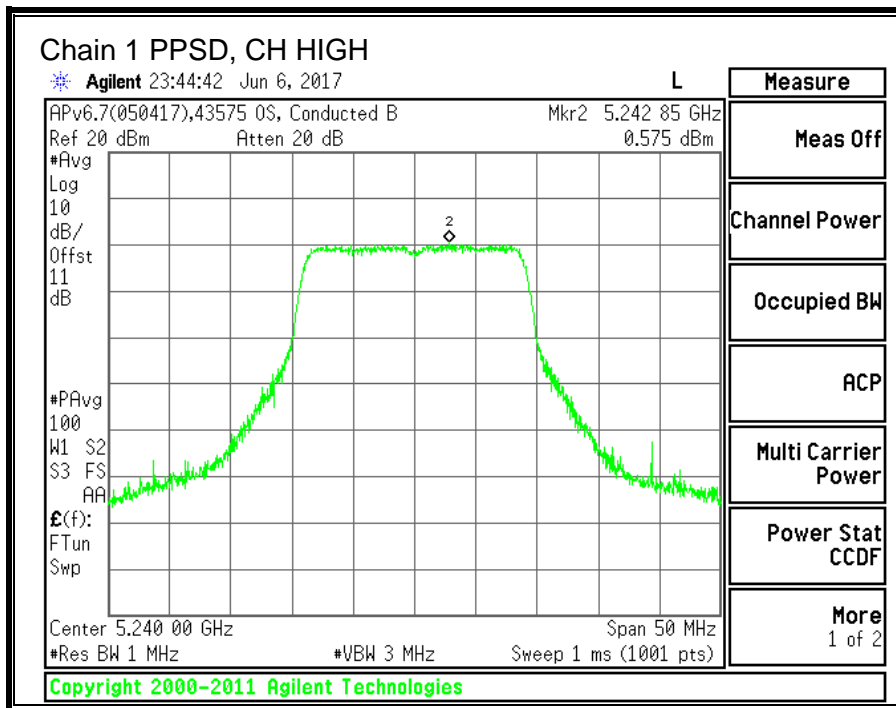
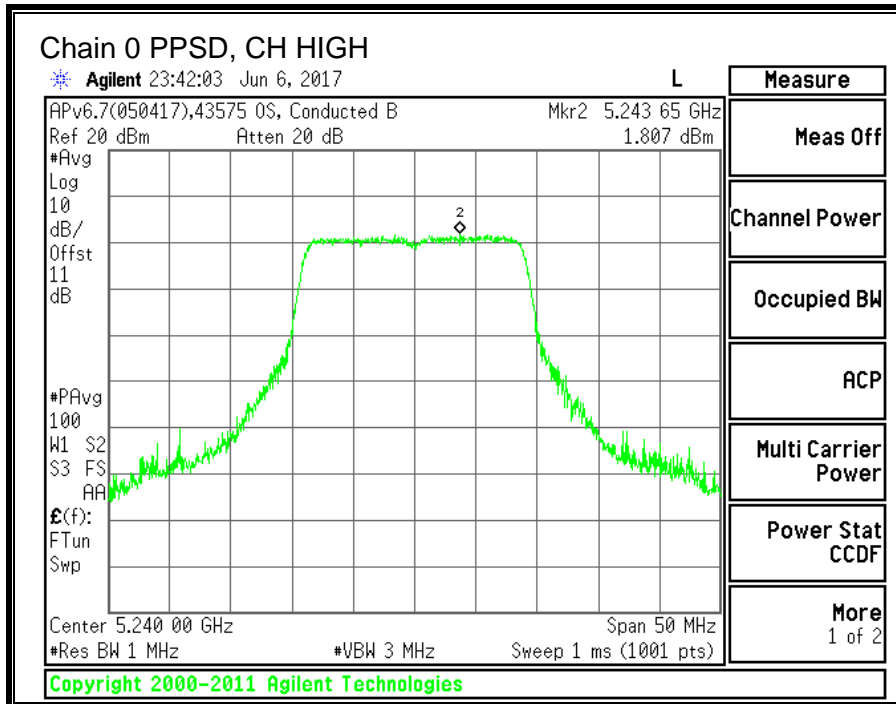



### 10.3. 11n HT40 2TX CDD MIMO MODE IN THE 5.2GHz BAND

#### 10.3.1. 26 dB BANDWIDTH

##### LIMITS

None; for reporting purposes only.

##### RESULTS

Channel	Frequency	26 dB BW Chain 0 (MHz)	26 dB BW Chain 1 (MHz)
Low	5190	43.2	42.6
High	5230	43.0	42.2

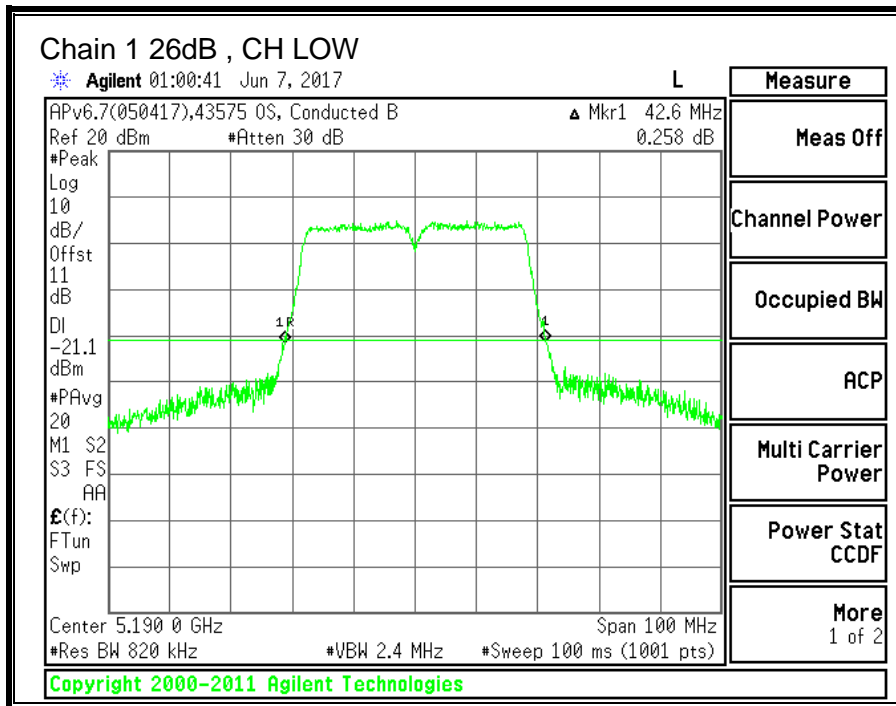
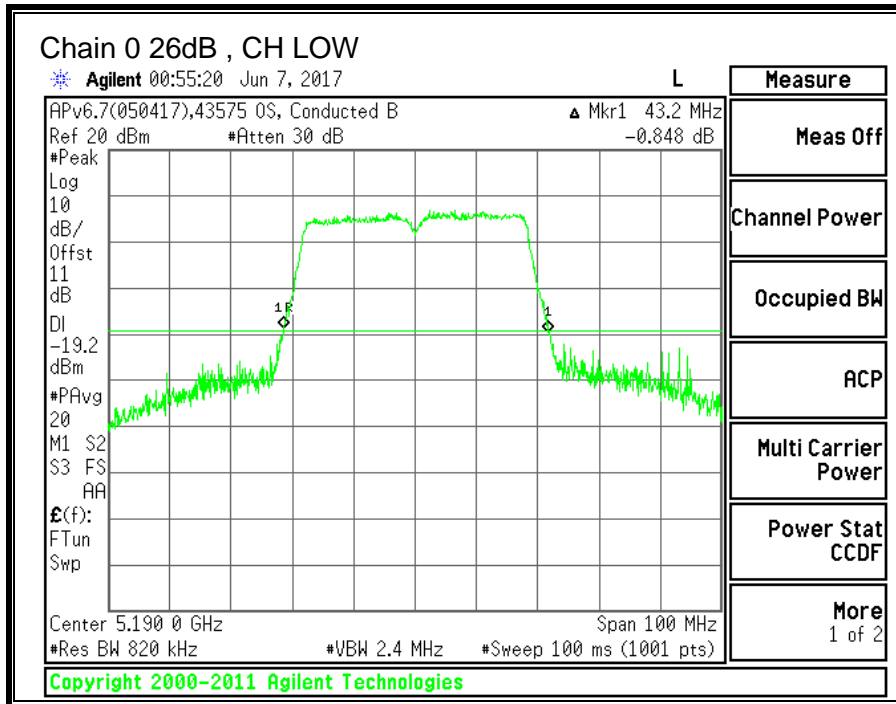

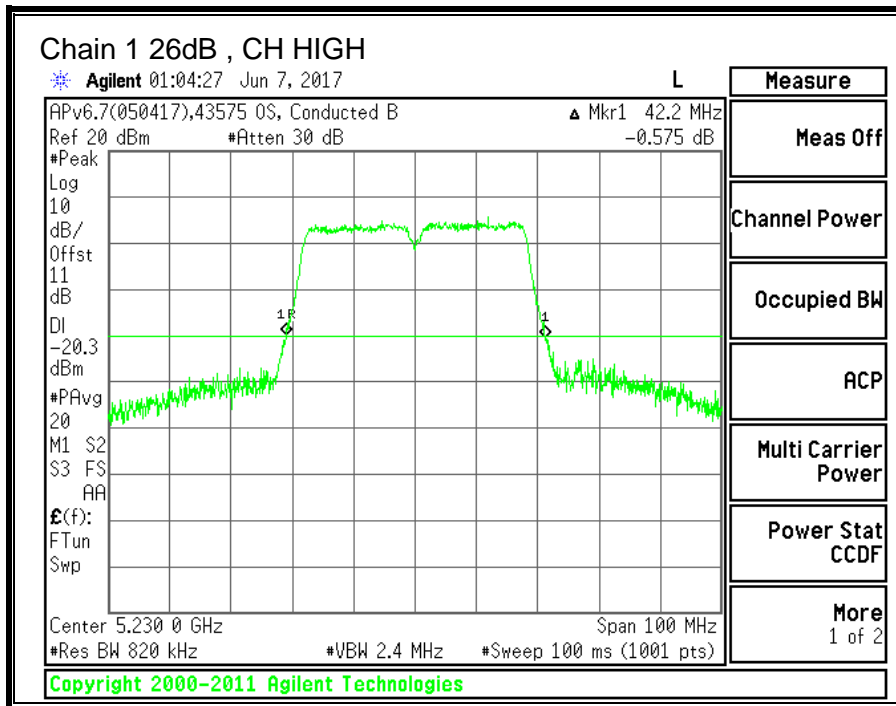
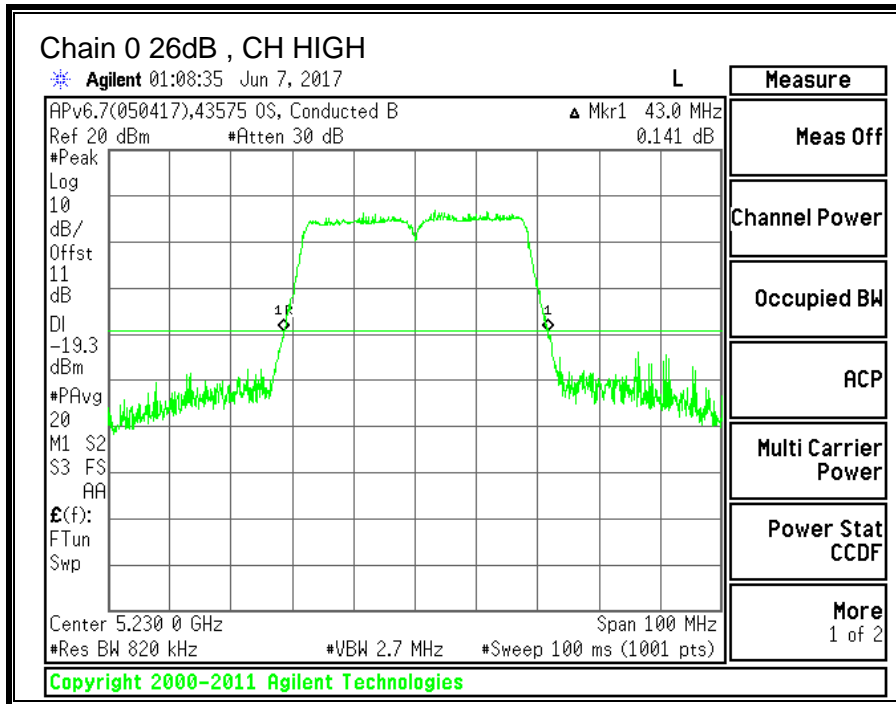

---

**10.3.2. 99% BANDWIDTH**

**LIMITS**

None; for reporting purposes only.

**RESULTS**

<b>Channel</b>	<b>Frequency</b>	<b>99% BW Chain 0 (MHz)</b>	<b>99% BW Chain 1 (MHz)</b>
Low	5190	35.479	35.407
High	5230	35.384	35.975

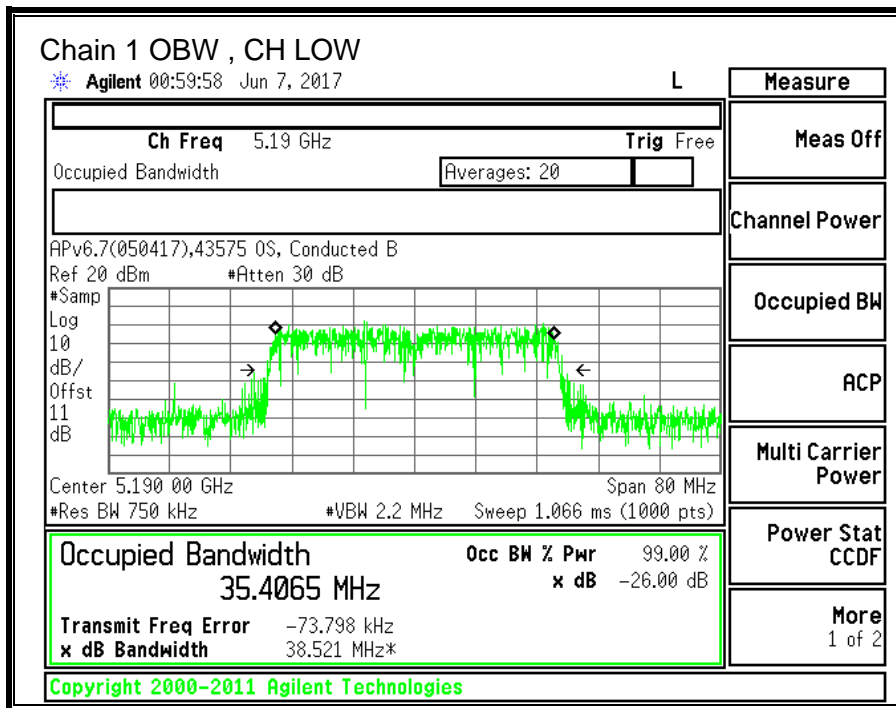
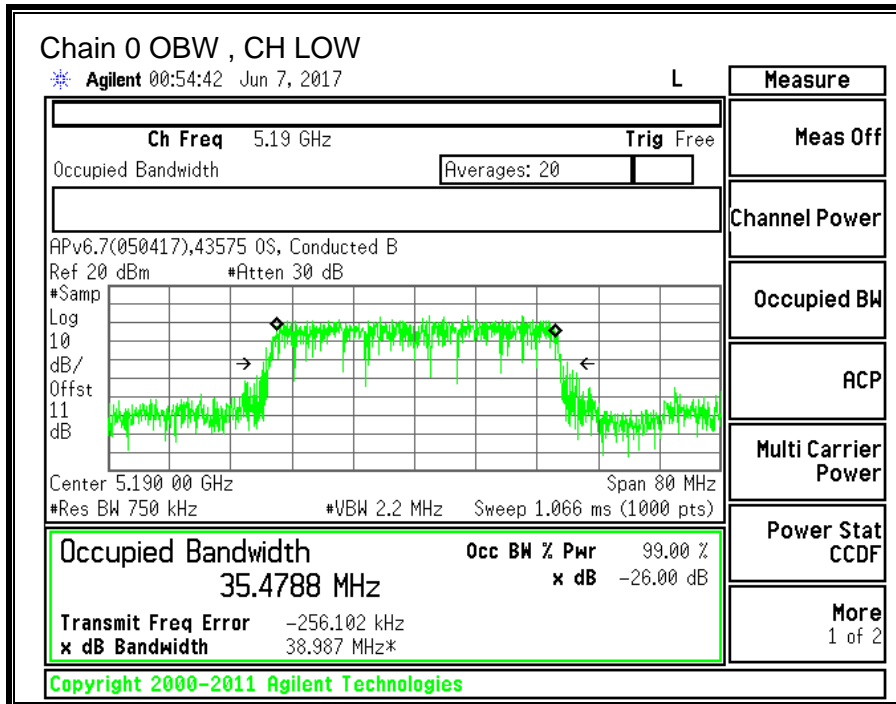

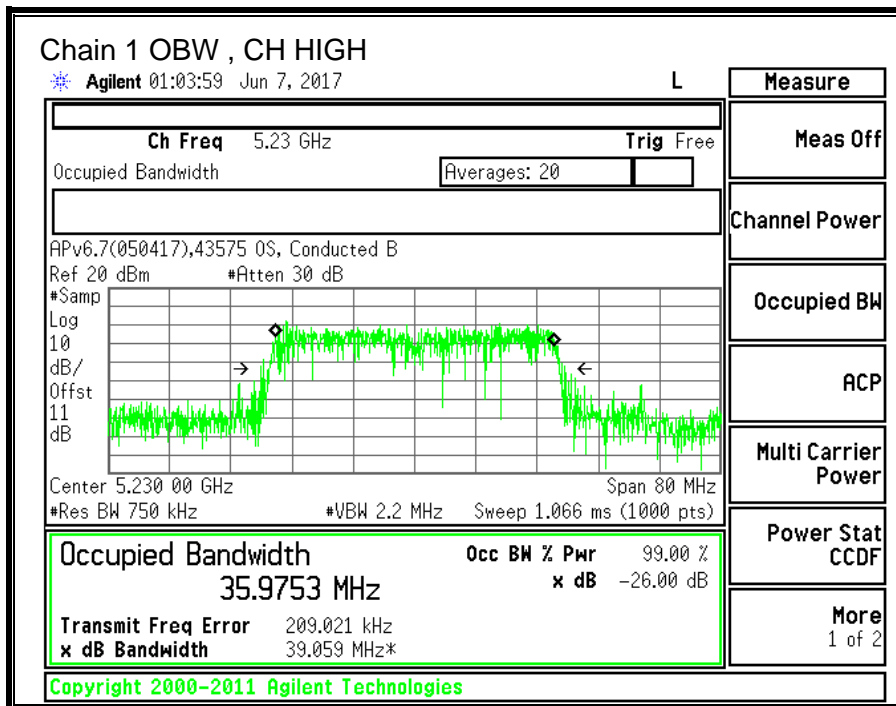
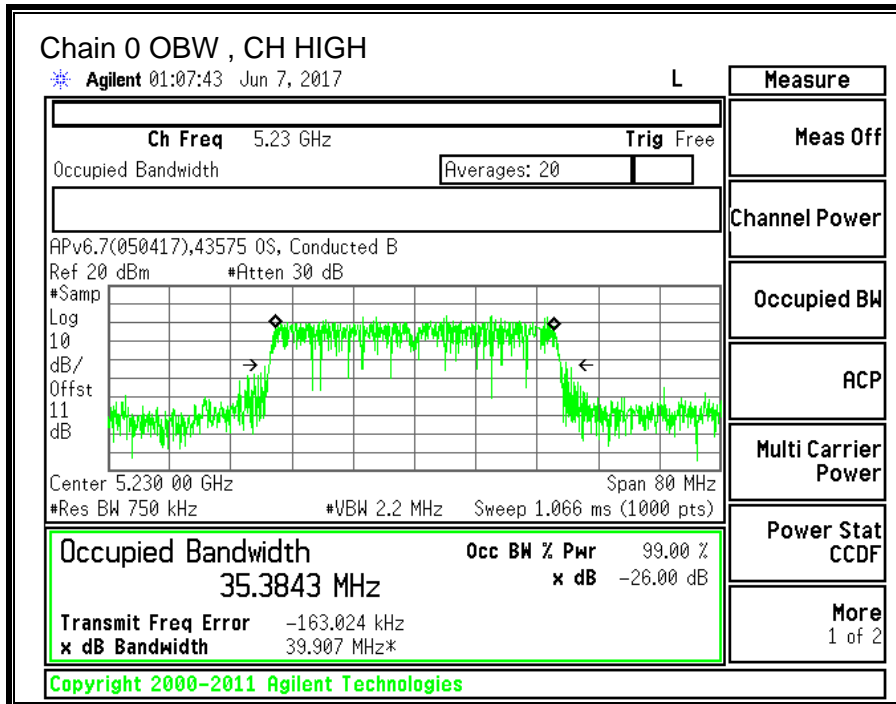

---

### 10.3.3. OUTPUT POWER AND PPSD

#### **LIMITS**

FCC §15.407 (a) (1)

(i) For an outdoor access point operating in the band 5.15-5.25 GHz, the maximum conducted output power over the frequency band of operation shall not exceed 1 W provided the maximum antenna gain does not exceed 6 dBi. In addition, the maximum power spectral density shall not exceed 17 dBm in any 1 megahertz band. If transmitting antennas of directional gain greater than 6 dBi are used, both the maximum conducted output power and the maximum power spectral density shall be reduced by the amount in dB that the directional gain of the antenna exceeds 6 dBi. The maximum e.i.r.p. at any elevation angle above 30 degrees as measured from the horizon must not exceed 125 mW (21 dBm).

(ii) For an indoor access point operating in the band 5.15-5.25 GHz, the maximum conducted output power over the frequency band of operation shall not exceed 1 W provided the maximum antenna gain does not exceed 6 dBi. In addition, the maximum power spectral density shall not exceed 17 dBm in any 1 megahertz band. If transmitting antennas of directional gain greater than 6 dBi are used, both the maximum conducted output power and the maximum power spectral density shall be reduced by the amount in dB that the directional gain of the antenna exceeds 6 dBi.

(iii) For fixed point-to-point access points operating in the band 5.15-5.25 GHz, the maximum conducted output power over the frequency band of operation shall not exceed 1 W. Fixed point-to-point U-NII devices may employ antennas with directional gain up to 23 dBi without any corresponding reduction in the maximum conducted output power or maximum power spectral density. For fixed point-to-point transmitters that employ a directional antenna gain greater than 23 dBi, a 1 dB reduction in maximum conducted output power and maximum power spectral density is required for each 1 dB of antenna gain in excess of 23 dBi. Fixed, point-to-point operations exclude the use of point-to-multipoint systems, omnidirectional applications, and multiple collocated transmitters transmitting the same information. The operator of the U-NII device, or if the equipment is professionally installed, the installer, is responsible for ensuring that systems employing high gain directional antennas are used exclusively for fixed, point-to-point operations.

(iv) For mobile and portable client devices in the 5.15-5.25 GHz band, the maximum conducted output power over the frequency band of operation shall not exceed 250 mW provided the maximum antenna gain does not exceed 6 dBi. In addition, the maximum power spectral density shall not exceed 11 dBm in any 1 megahertz band. If transmitting antennas of directional gain greater than 6 dBi are used, both the maximum conducted output power and the maximum power spectral density shall be reduced by the amount in dB that the directional gain of the antenna exceeds 6 dBi.

#### **TEST PROCEDURE**

Measurements perform using a wideband gated RF power meter provided that the gate parameters are adjusted such that the power is measured only when the EUT is transmitting at its maximum power control level. Since the measurement is made only during the ON time of the transmitter, no duty cycle correction factor is required.

**DIRECTIONAL ANTENNA GAIN**

For power, the TX chains are uncorrelated and the antenna gain is unequal among the chains. The directional gain is:

**5150-5250 MHz**

<b>Chain 0 Antenna Gain (dBi)</b>	<b>Chain 1 Antenna Gain (dBi)</b>	<b>Uncorrelated Chains Directional Gain (dBi)</b>
-4.40	-6.70	-5.40

For PSD the TX chains are correlated and the antenna gain is unequal among the chains. The directional gain is:

**5150-5250 MHz**

<b>Chain 0 Antenna Gain (dBi)</b>	<b>Chain 1 Antenna Gain (dBi)</b>	<b>Correlated Chains Directional Gain (dBi)</b>
-4.40	-6.70	-2.46



**RESULTS**

<b>ID:</b>	43574	<b>Date:</b>	06/06/17
------------	-------	--------------	----------

**Bandwidth and Antenna Gain**

Channel	Frequency (MHz)	Min 26 dB BW (MHz)	Min 99% BW (MHz)	Directional Gain for Power (dBi)	Directional Gain for PPSD (dBi)
Low	5190	42.60	35.407	-5.40	-2.46
High	5230	42.20	35.384	-5.40	-2.46

**Limits**

Channel	Frequency (MHz)	FCC Power Limit (dBm)	IC EIRP Limit (dBm)	Max IC Power (dBm)	Power Limit (dBm)	FCC PPSD Limit (dBm)	IC eirp PSD Limit (dBm)	PPSD Limit (dBm)
Low	5190	24.00	23.00	28.40	24.00	11.00	10.00	11.00
High	5230	24.00	23.00	28.40	24.00	11.00	10.00	11.00

<b>Duty Cycle CF (dB)</b>	0.40	<b>Included in Calculations of Corr'd PPSD</b>
---------------------------	------	--

**Output Power Results**

Channel	Frequency (MHz)	Chain 0 Meas Power (dBm)	Chain 1 Meas Power (dBm)	Total Corr'd Power (dBm)	Power Limit (dBm)	Power Margin (dB)
Low	5190	13.17	11.91	15.60	24.00	-8.40
High	5230	13.26	12.10	15.73	24.00	-8.27

**PPSD Results**

Channel	Frequency (MHz)	Chain 0 Meas PPSD (dBm)	Chain 1 Meas PPSD (dBm)	Total Corr'd PPSD (dBm)	PPSD Limit (dBm)	PPSD Margin (dB)
Low	5190	-0.691	-3.614	1.50	11.00	-9.50
High	5230	-1.043	-3.687	1.24	11.00	-9.76

**Note:** the power readings above were measured with gated method, and the measurement was taken only during the ON time. No duty cycle correction was necessary.

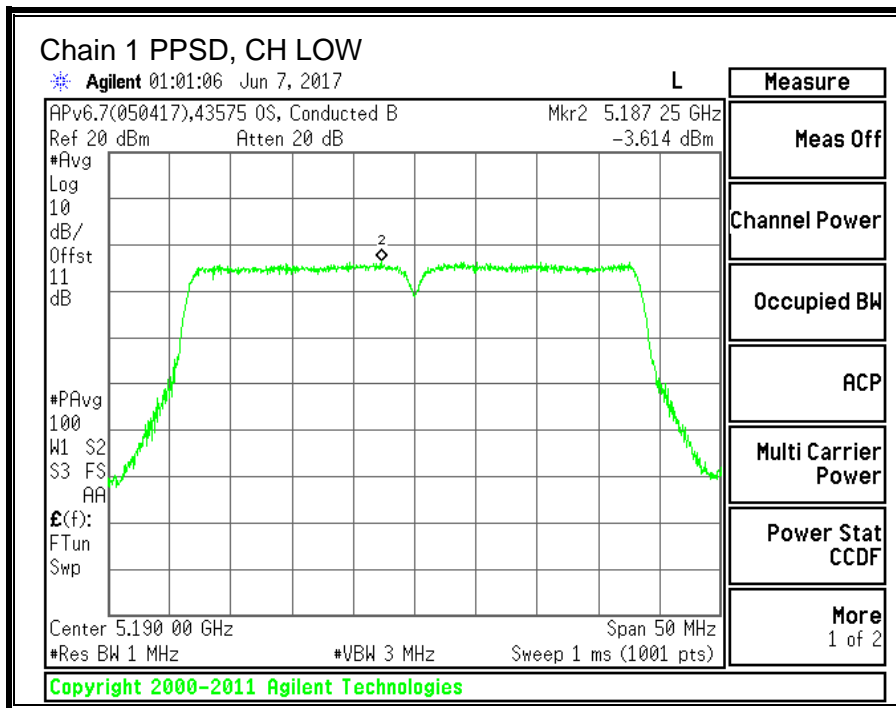
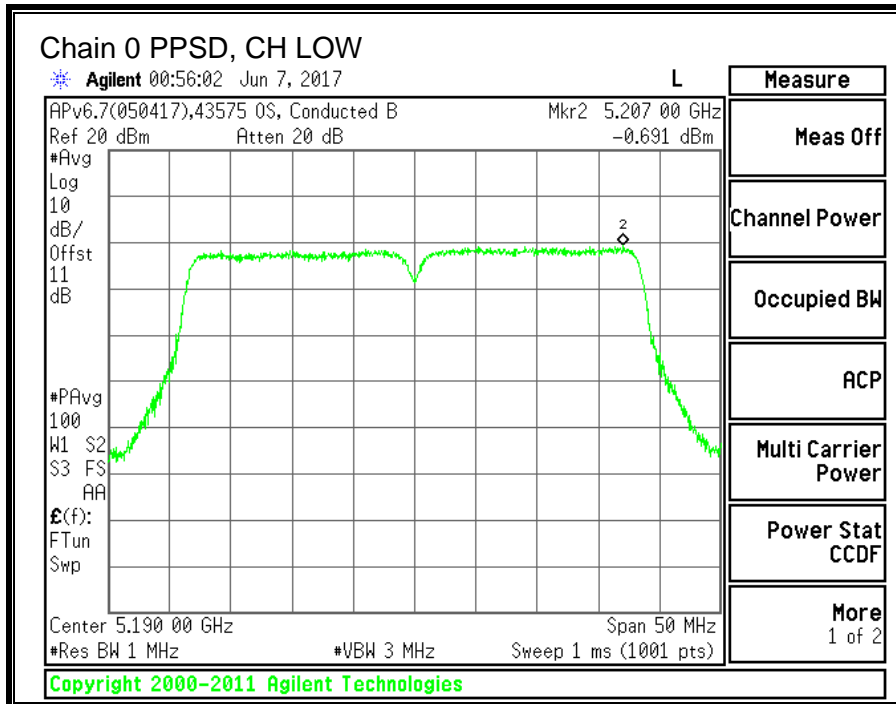

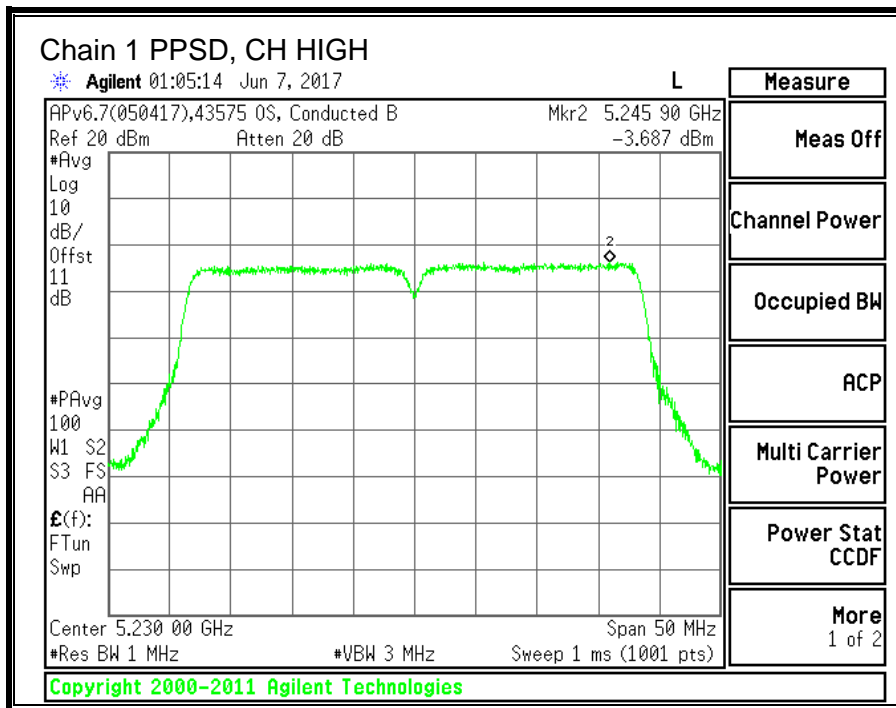
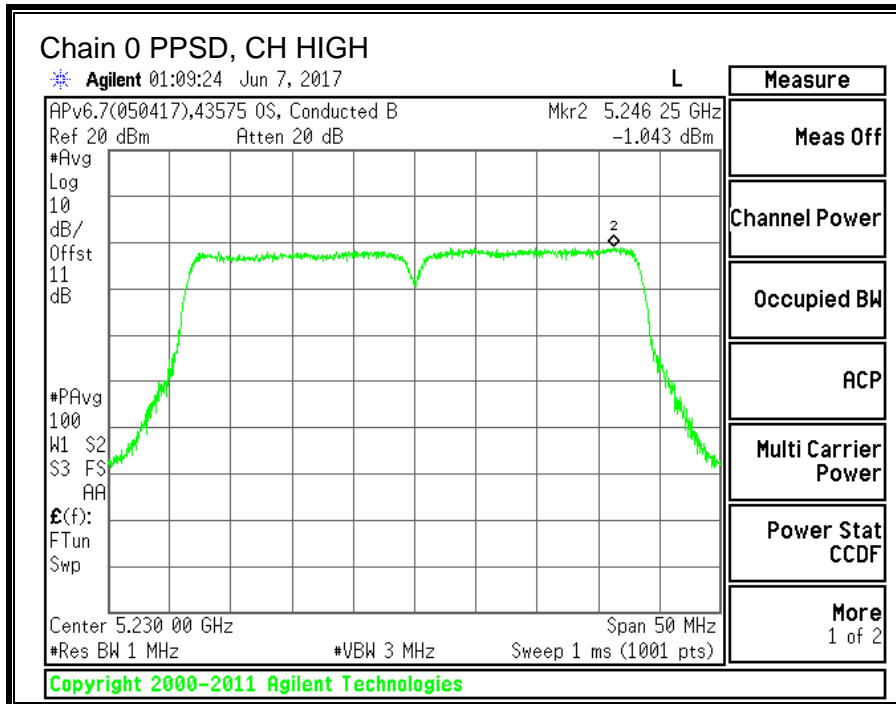

---

**10.4. 11ac HT80 2TX CDD MIMO MODE IN THE 5.2GHz BAND**

**10.4.1. 26 dB BANDWIDTH**

**LIMITS**

None; for reporting purposes only.

**RESULTS**

Channel	Frequency	26 dB BW Chain 0 (MHz)	26 dB BW Chain 1 (MHz)
Mid	5210	87.6	85.2

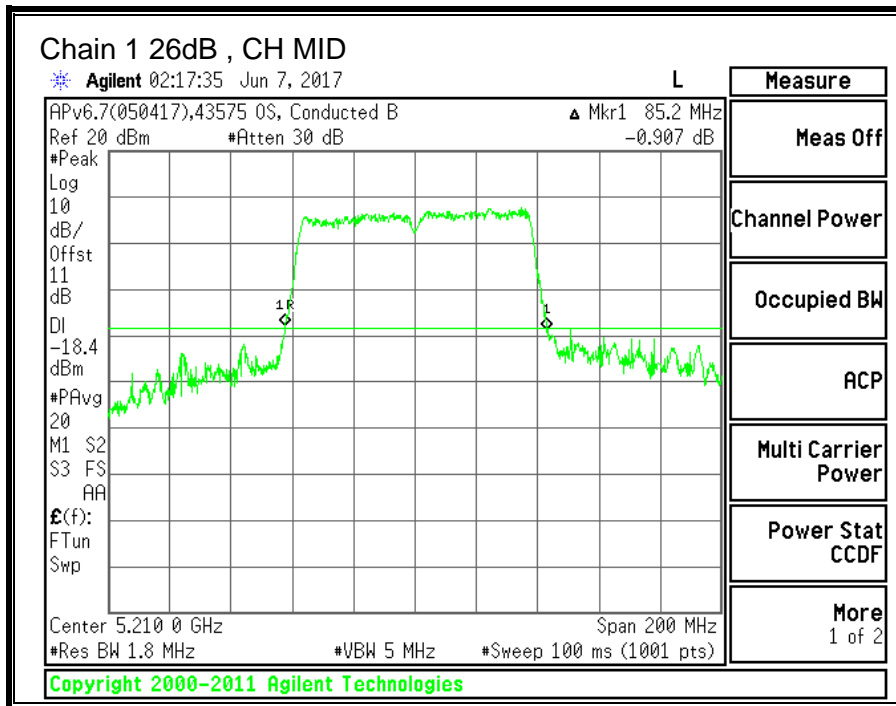
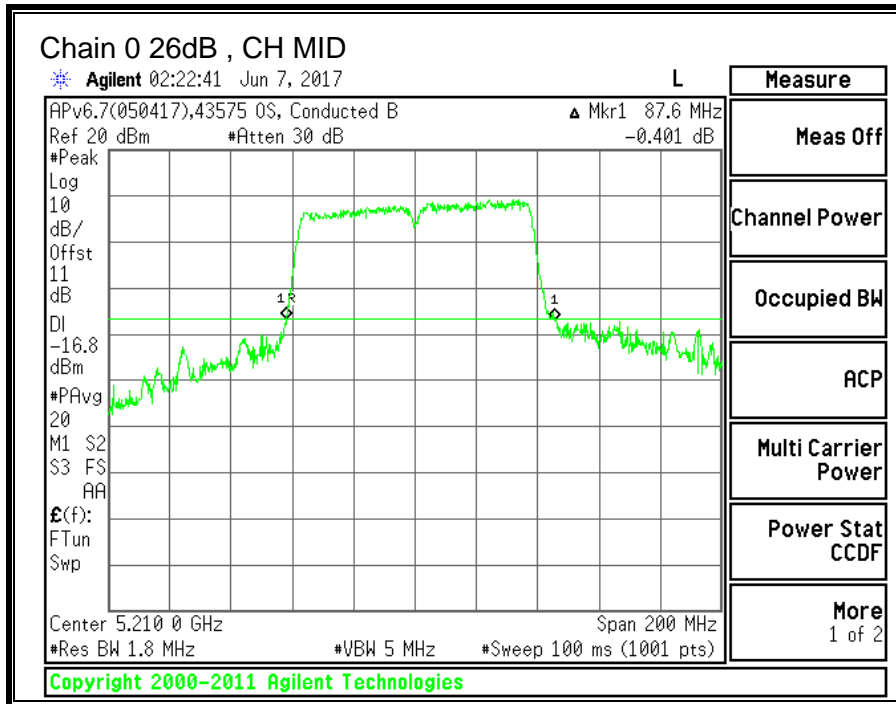

---

**10.4.2. 99% BANDWIDTH**

**LIMITS**

None; for reporting purposes only.

**RESULTS**

<b>Channel</b>	<b>Frequency</b>	<b>99% BW Chain 0 (MHz)</b>	<b>99% BW Chain 1 (MHz)</b>
Mid	5210	72.644	72.576

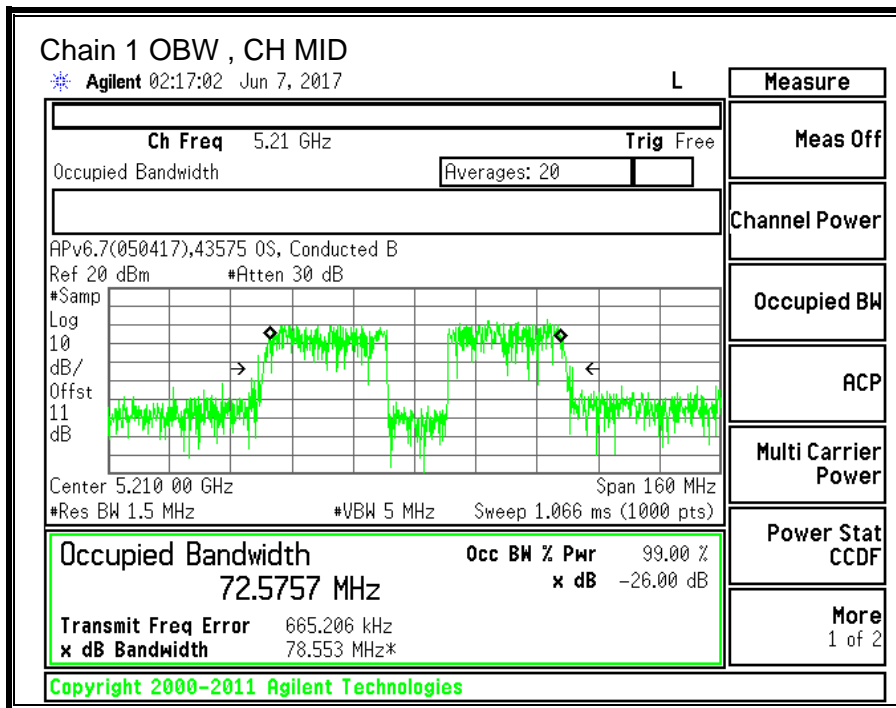
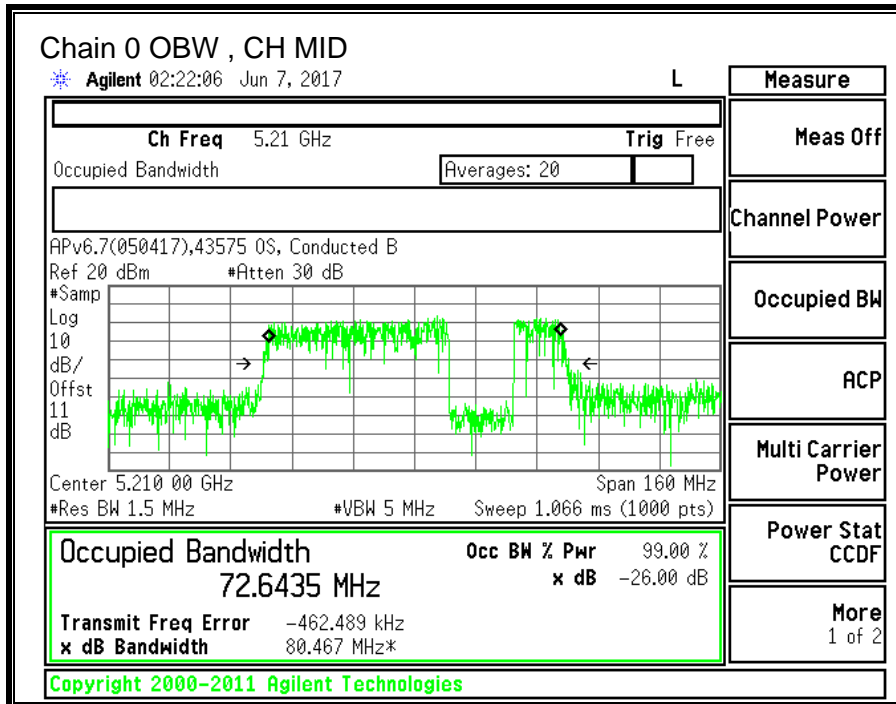

---

### 10.4.3. OUTPUT POWER AND PPSD

#### **LIMITS**

FCC §15.407 (a) (1)

(i) For an outdoor access point operating in the band 5.15-5.25 GHz, the maximum conducted output power over the frequency band of operation shall not exceed 1 W provided the maximum antenna gain does not exceed 6 dBi. In addition, the maximum power spectral density shall not exceed 17 dBm in any 1 megahertz band. If transmitting antennas of directional gain greater than 6 dBi are used, both the maximum conducted output power and the maximum power spectral density shall be reduced by the amount in dB that the directional gain of the antenna exceeds 6 dBi. The maximum e.i.r.p. at any elevation angle above 30 degrees as measured from the horizon must not exceed 125 mW (21 dBm).

(ii) For an indoor access point operating in the band 5.15-5.25 GHz, the maximum conducted output power over the frequency band of operation shall not exceed 1 W provided the maximum antenna gain does not exceed 6 dBi. In addition, the maximum power spectral density shall not exceed 17 dBm in any 1 megahertz band. If transmitting antennas of directional gain greater than 6 dBi are used, both the maximum conducted output power and the maximum power spectral density shall be reduced by the amount in dB that the directional gain of the antenna exceeds 6 dBi.

(iii) For fixed point-to-point access points operating in the band 5.15-5.25 GHz, the maximum conducted output power over the frequency band of operation shall not exceed 1 W. Fixed point-to-point U-NII devices may employ antennas with directional gain up to 23 dBi without any corresponding reduction in the maximum conducted output power or maximum power spectral density. For fixed point-to-point transmitters that employ a directional antenna gain greater than 23 dBi, a 1 dB reduction in maximum conducted output power and maximum power spectral density is required for each 1 dB of antenna gain in excess of 23 dBi. Fixed, point-to-point operations exclude the use of point-to-multipoint systems, omnidirectional applications, and multiple collocated transmitters transmitting the same information. The operator of the U-NII device, or if the equipment is professionally installed, the installer, is responsible for ensuring that systems employing high gain directional antennas are used exclusively for fixed, point-to-point operations.

(iv) For mobile and portable client devices in the 5.15-5.25 GHz band, the maximum conducted output power over the frequency band of operation shall not exceed 250 mW provided the maximum antenna gain does not exceed 6 dBi. In addition, the maximum power spectral density shall not exceed 11 dBm in any 1 megahertz band. If transmitting antennas of directional gain greater than 6 dBi are used, both the maximum conducted output power and the maximum power spectral density shall be reduced by the amount in dB that the directional gain of the antenna exceeds 6 dBi.

#### **TEST PROCEDURE**

Measurements perform using a wideband gated RF power meter provided that the gate parameters are adjusted such that the power is measured only when the EUT is transmitting at its maximum power control level. Since the measurement is made only during the ON time of the transmitter, no duty cycle correction factor is required.



**DIRECTIONAL ANTENNA GAIN**

For power, the TX chains are uncorrelated and the antenna gain is unequal among the chains. The directional gain is:

**5150-5250 MHz**

<b>Chain 0 Antenna Gain (dBi)</b>	<b>Chain 1 Antenna Gain (dBi)</b>	<b>Uncorrelated Chains Directional Gain (dBi)</b>
-4.40	-6.70	-5.40

For PSD the TX chains are correlated and the antenna gain is unequal among the chains. The directional gain is:

**5150-5250 MHz**

<b>Chain 0 Antenna Gain (dBi)</b>	<b>Chain 1 Antenna Gain (dBi)</b>	<b>Correlated Chains Directional Gain (dBi)</b>
-4.40	-6.70	-2.46

**RESULTS**

<b>ID:</b>	43574	<b>Date:</b>	06/06/17
------------	-------	--------------	----------

**Bandwidth and Antenna Gain**

Channel	Frequency (MHz)	Min 26 dB BW (MHz)	Min 99% BW (MHz)	Directional Gain for Power (dBi)	Directional Gain for PPSD (dBi)
Low	5210	85.20	72.576	-5.40	-2.46

**Limits**

Channel	Frequency (MHz)	FCC Power Limit (dBm)	IC EIRP Limit (dBm)	Max IC Power (dBm)	Power Limit (dBm)	FCC PPSD Limit (dBm)	IC eirp PSD Limit (dBm)	PPSD Limit (dBm)
Low	5210	24.00	23.00	28.40	24.00	11.00	10.00	11.00

<b>Duty Cycle CF (dB)</b>	0.75	<b>Included in Calculations of Corr'd PPSD</b>
---------------------------	------	--

**Output Power Results**

Channel	Frequency (MHz)	Chain 0 Meas Power (dBm)	Chain 1 Meas Power (dBm)	Total Corr'd Power (dBm)	Power Limit (dBm)	Power Margin (dB)
Low	5210	13.35	11.89	15.69	24.00	-8.31

**PPSD Results**

Channel	Frequency (MHz)	Chain 0 Meas PPSD (dBm)	Chain 1 Meas PPSD (dBm)	Total Corr'd PPSD (dBm)	PPSD Limit (dBm)	PPSD Margin (dB)
Low	5210	-3.627	-5.460	-0.69	11.00	-11.69

**Note:** the power readings above were measured with gated method, and the measurement was taken only during the ON time. No duty cycle correction was necessary.

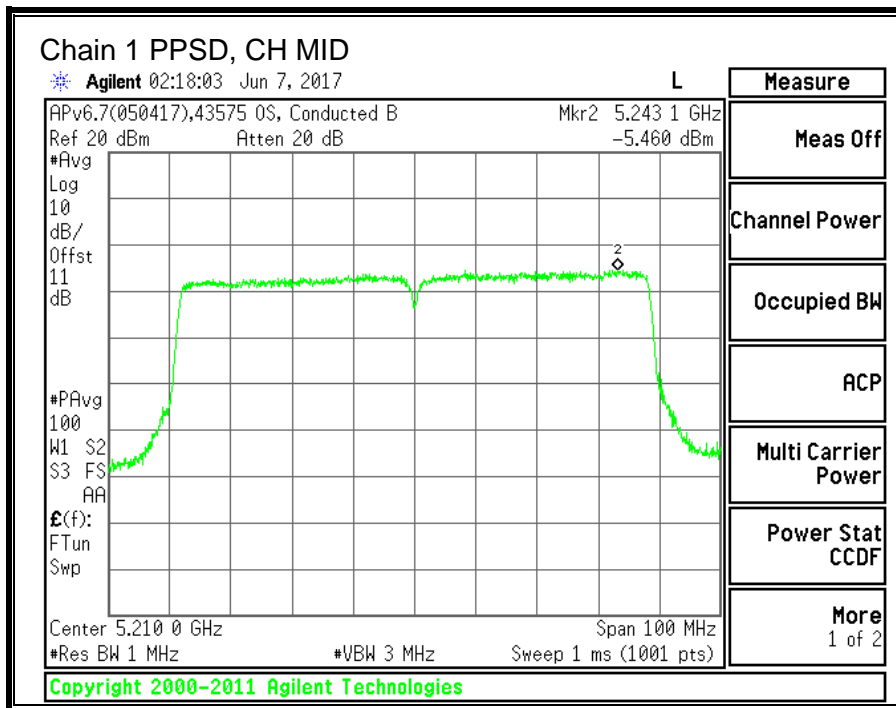
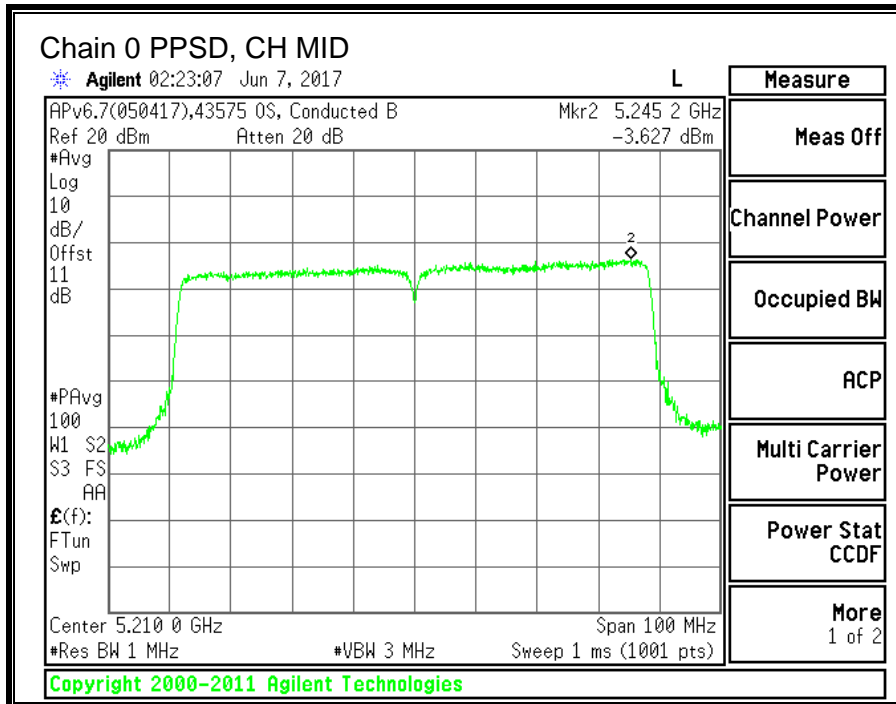

---

**10.5. 11a 2TX CDD MIMO MODE IN THE 5.3GHz BAND**

**10.5.1. 26 dB BANDWIDTH**

**LIMITS**

None; for reporting purposes only.

**RESULTS**

<b>Channel</b>	<b>Frequency</b>	<b>26 dB BW Chain 0 (MHz)</b>	<b>26 dB BW Chain 1 (MHz)</b>
Low	5260	23.15	21.95
Mid	5300	23.60	22.40
High	5320	23.20	21.90

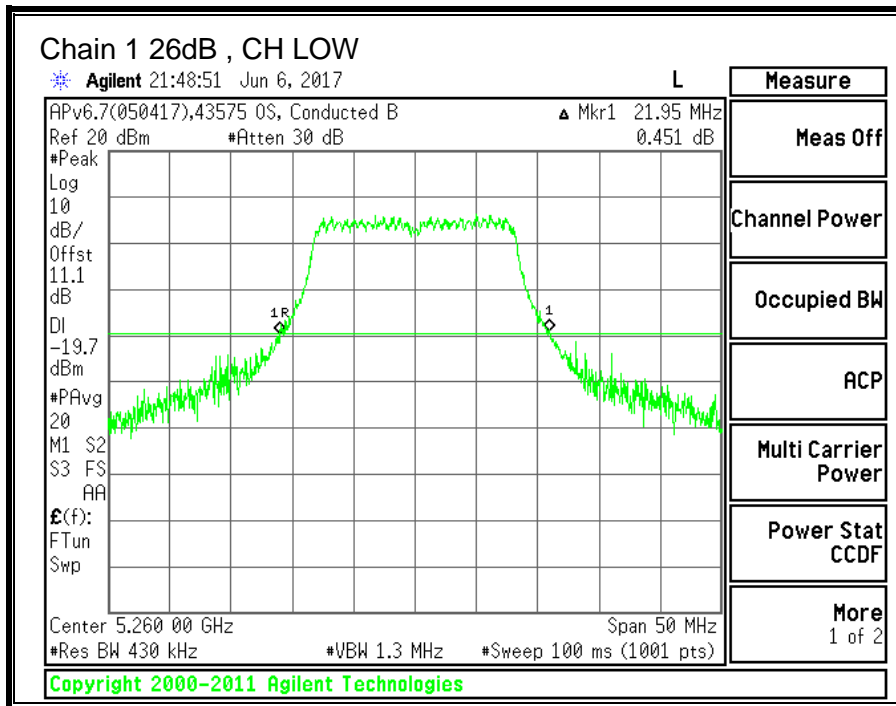
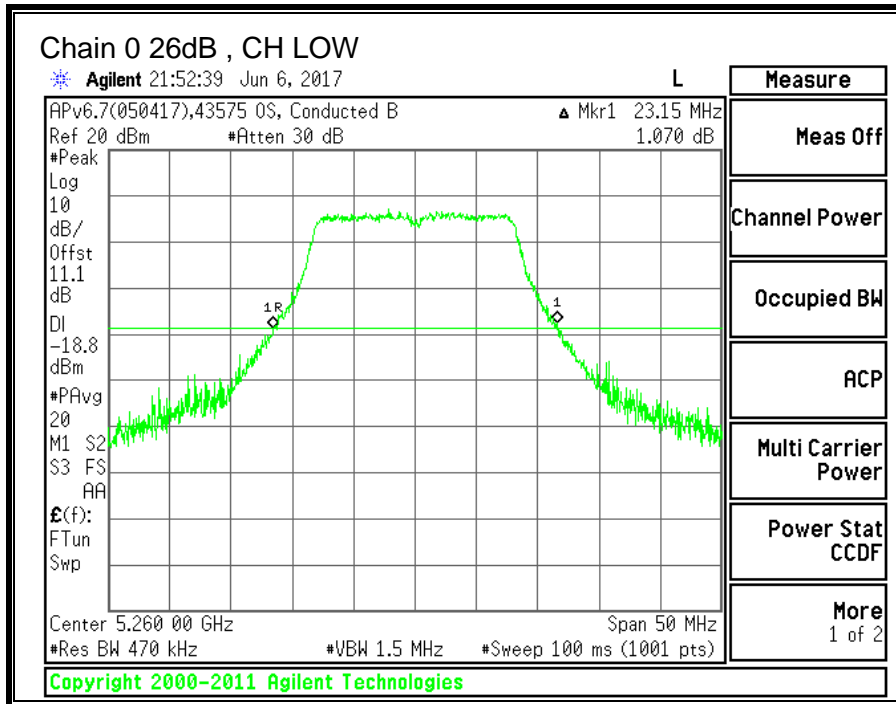

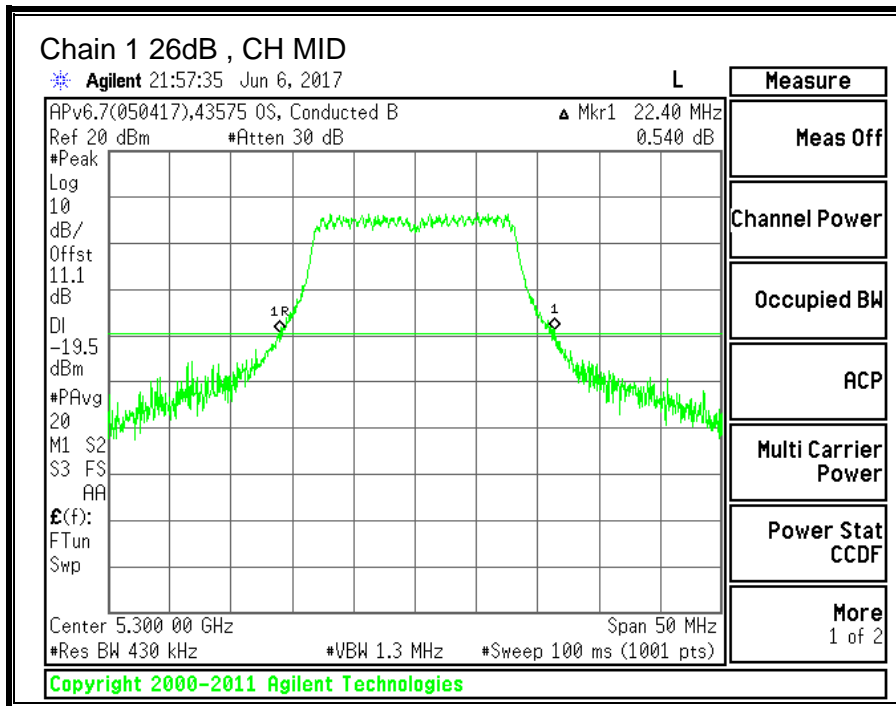
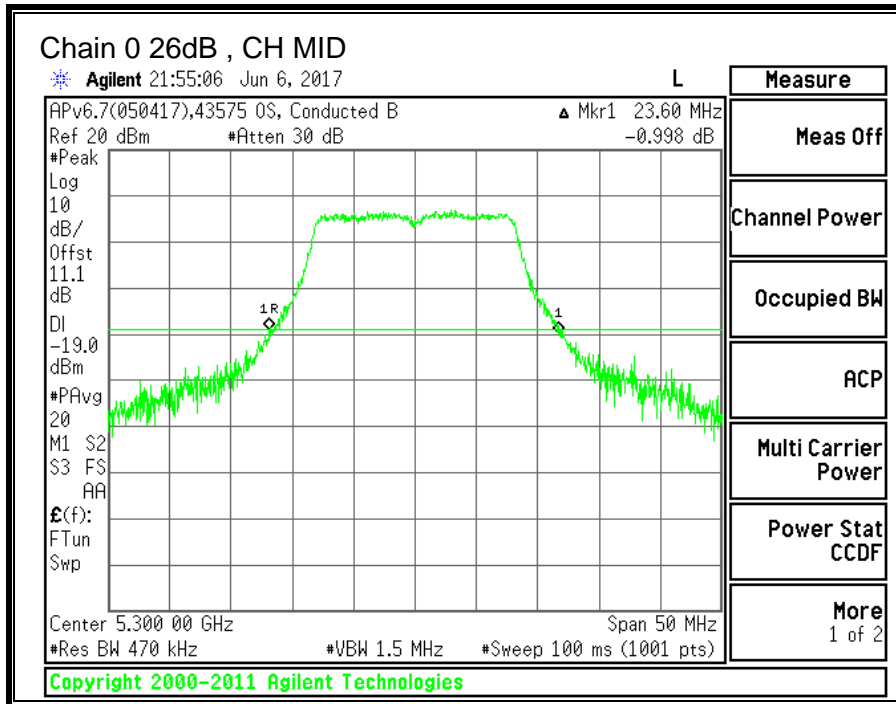

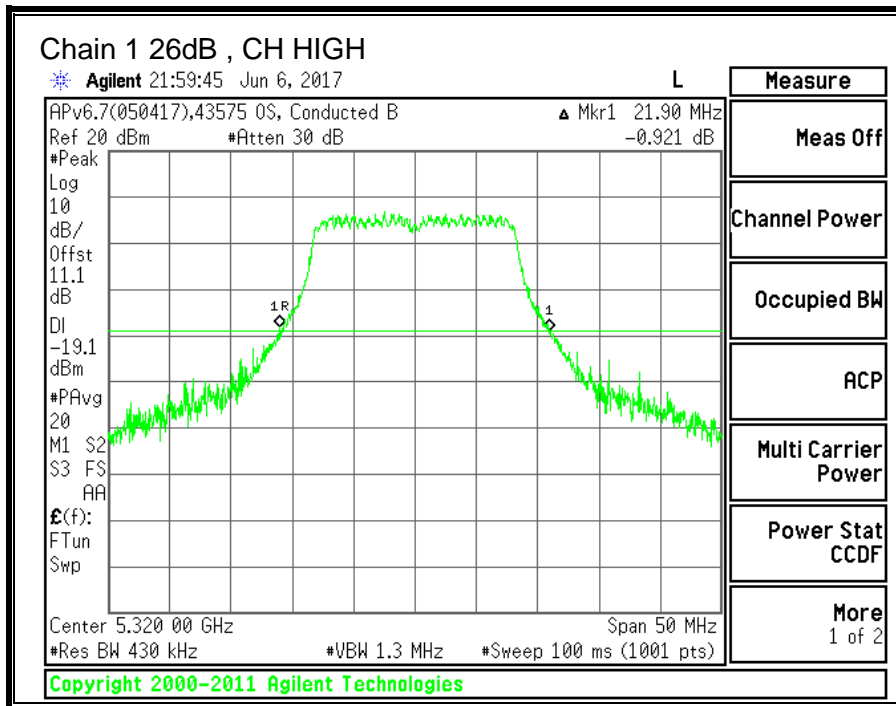
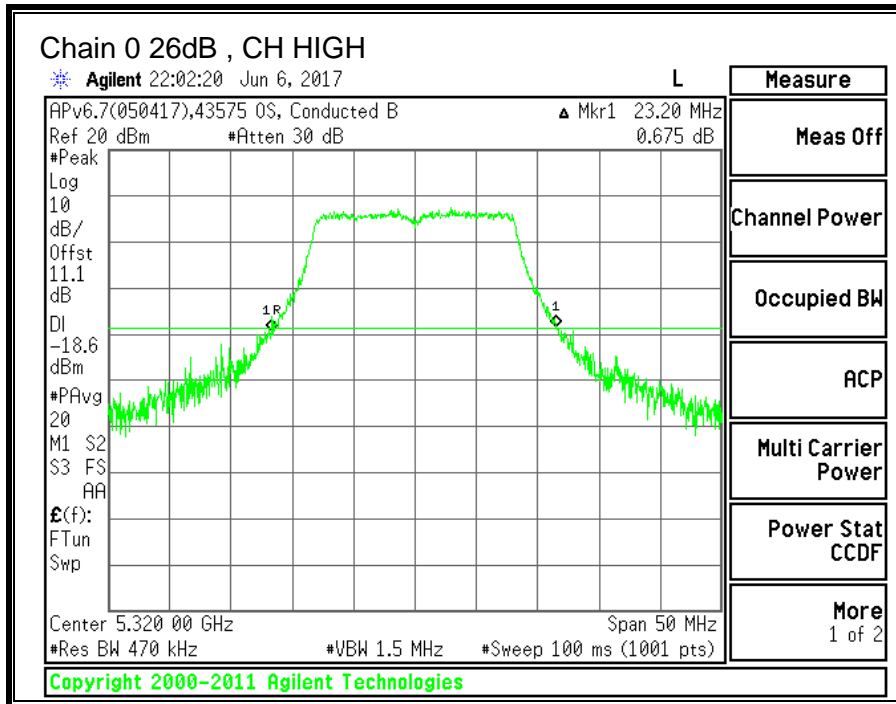

---

**10.5.2. 99% BANDWIDTH**

**LIMITS**

None; for reporting purposes only.

**RESULTS**

<b>Channel</b>	<b>Frequency</b>	<b>99% BW Chain 0 (MHz)</b>	<b>99% BW Chain 1 (MHz)</b>
Low	5260	16.225	16.341
Mid	5300	15.936	16.336
High	5320	16.368	16.009



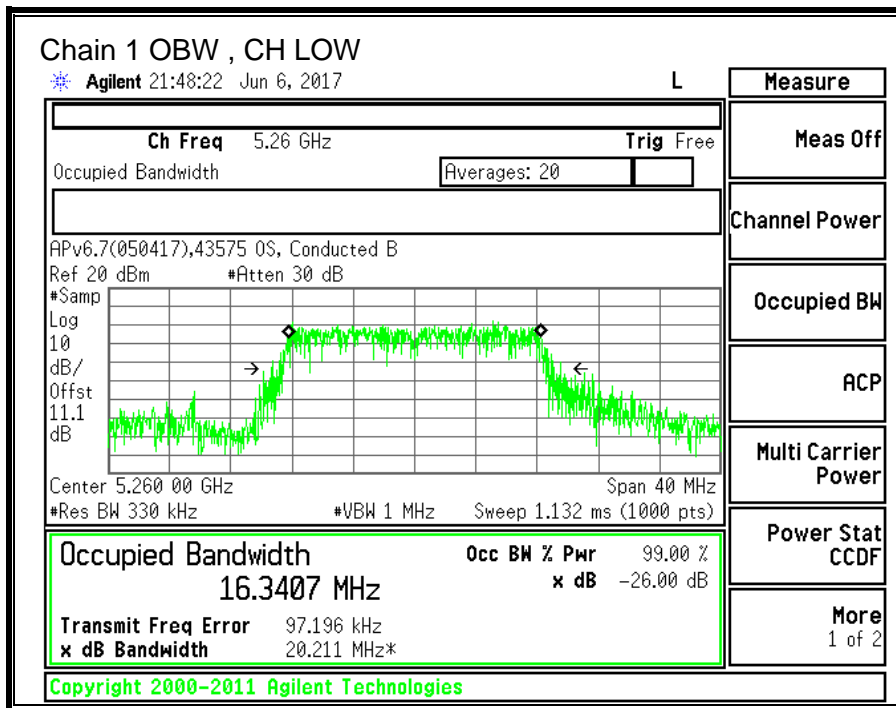
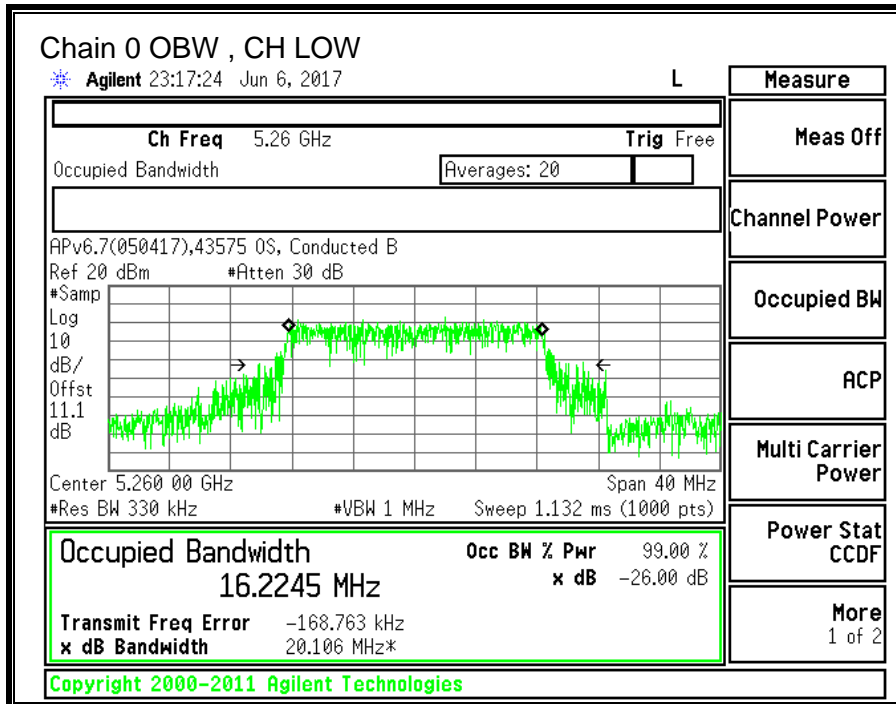

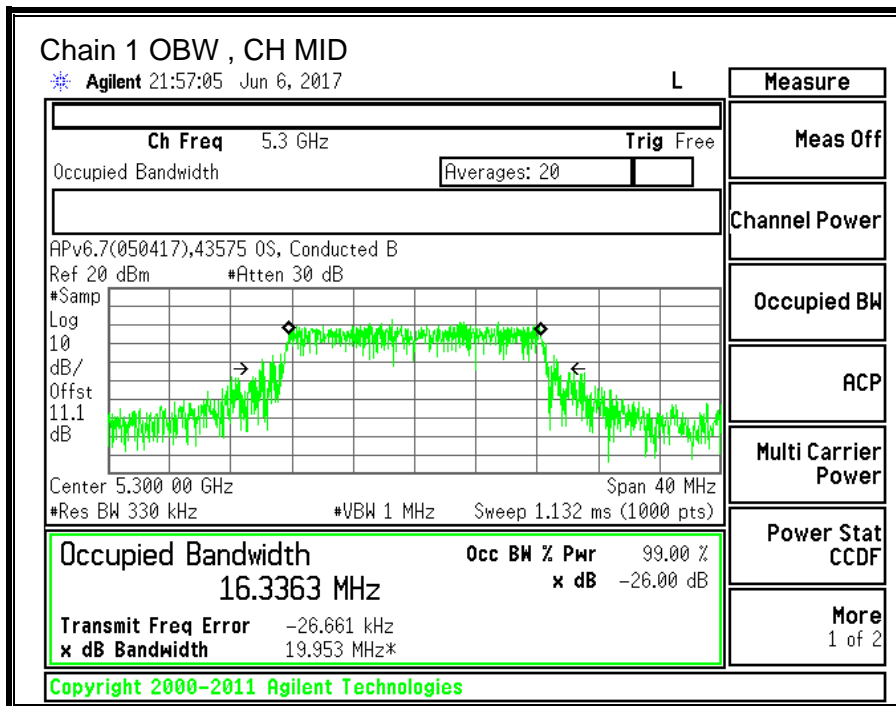
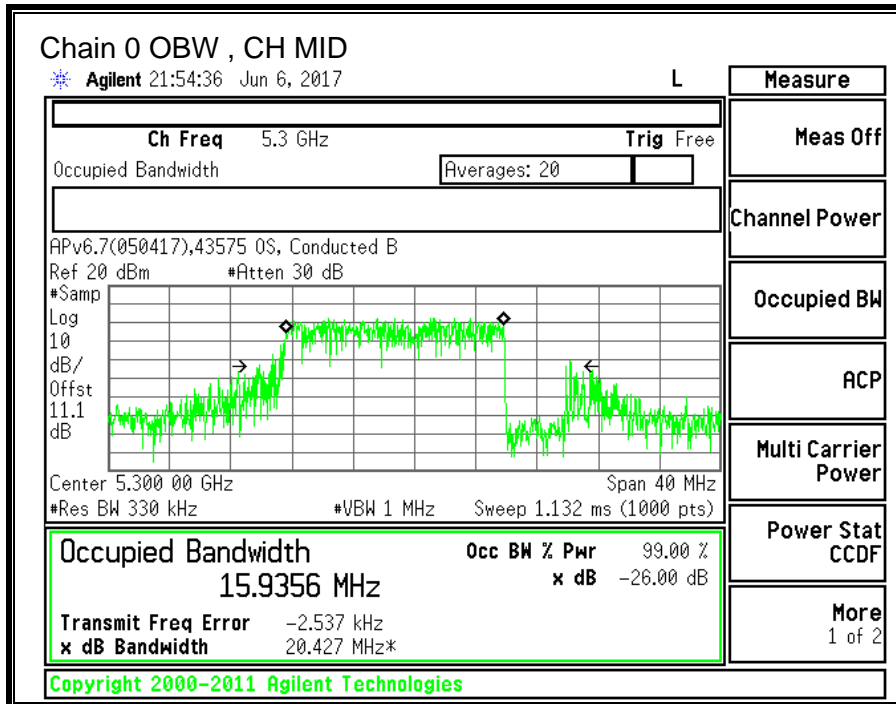

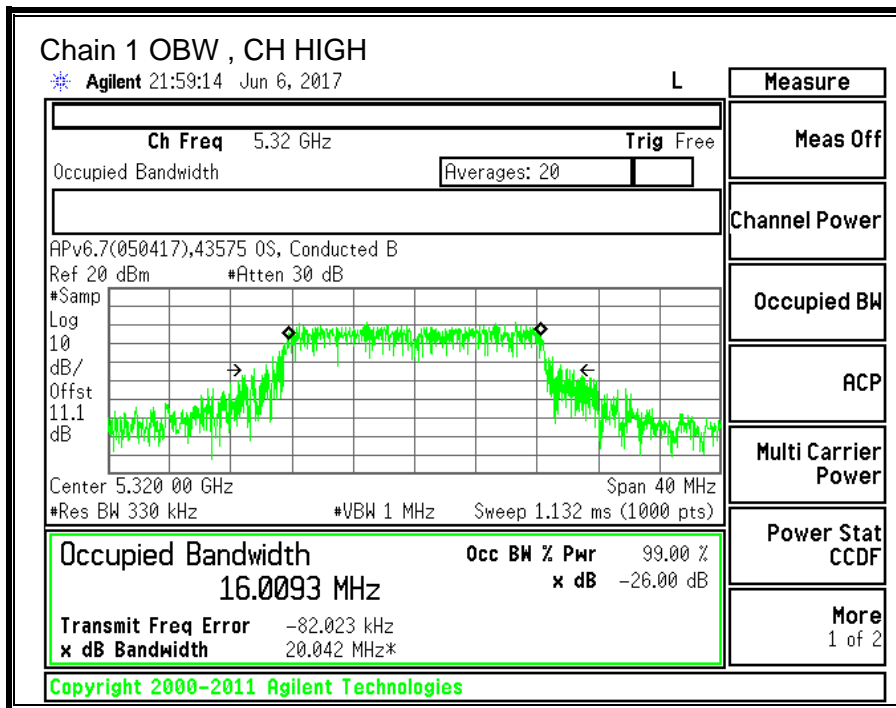
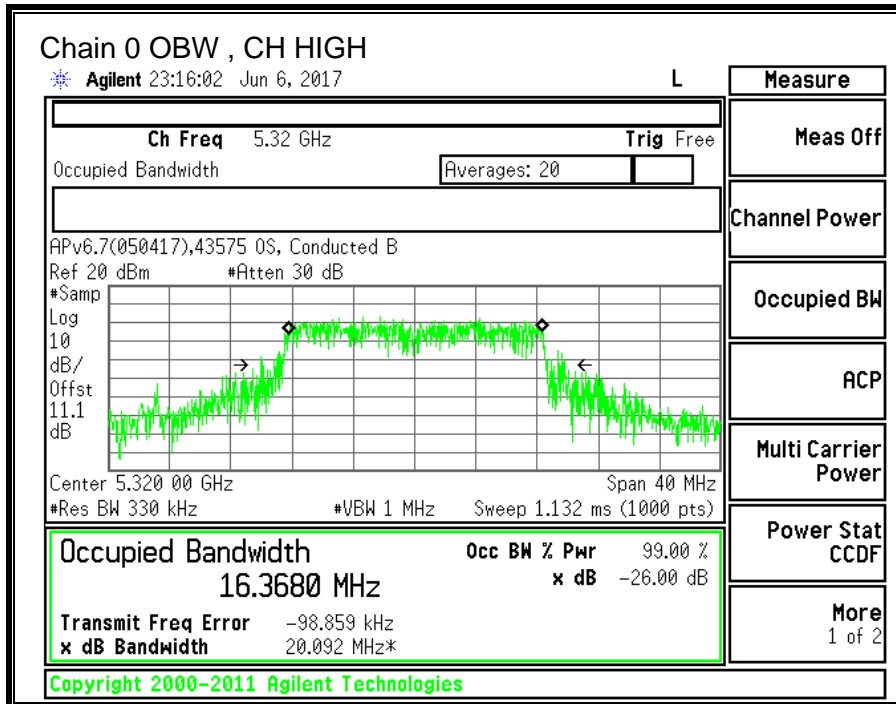

---

### 10.5.3. OUTPUT POWER AND PPSD

#### **LIMITS**

FCC §15.407 (a) (2)

For the band 5.25–5.35 GHz, the maximum conducted output power over the frequency band of operation shall not exceed the lesser of 250 mW or  $11 \text{ dBm} + 10 \log B$ , where B is the 26–dB emission bandwidth in MHz. In addition, the maximum power spectral density shall not exceed 11 dBm in any 1–MHz band. If transmitting antennas of directional gain greater than 6 dBi are used, both the maximum conducted output power and the peak power spectral density shall be reduced by the amount in dB that the directional gain of the antenna exceeds 6 dBi.

#### **TEST PROCEDURE**

Measurements perform using a wideband gated RF power meter provided that the gate parameters are adjusted such that the power is measured only when the EUT is transmitting at its maximum power control level. Since the measurement is made only during the ON time of the transmitter, no duty cycle correction factor is required.

**DIRECTIONAL ANTENNA GAIN**

For power, the TX chains are uncorrelated and the antenna gain is unequal among the chains. The directional gain is:

**5250-5350 MHz**

<b>Chain 0 Antenna Gain (dBi)</b>	<b>Chain 1 Antenna Gain (dBi)</b>	<b>Uncorrelated Chains Directional Gain (dBi)</b>
-4.40	-6.70	-5.40

For PSD the TX chains are correlated and the antenna gain is unequal among the chains. The directional gain is:

**5250-5230 MHz**

<b>Chain 0 Antenna Gain (dBi)</b>	<b>Chain 1 Antenna Gain (dBi)</b>	<b>Correlated Chains Directional Gain (dBi)</b>
-4.40	-6.70	-2.46

**RESULTS**

<b>ID:</b>	43574	<b>Date:</b>	06/06/17
------------	-------	--------------	----------

**Bandwidth and Antenna Gain**

Channel	Frequency (MHz)	Min 26 dB BW (MHz)	Min 99% BW (MHz)	Directional Gain for Power (dBi)	Directional Gain for PPSD (dBi)
Low	5260	21.95	16.225	-5.40	-2.46
Mid	5300	22.40	15.936	-5.40	-2.46
High	5320	21.90	16.009	-5.40	-2.46

**Limits**

Channel	Frequency (MHz)	FCC Power Limit (dBm)	IC Power Limit (dBm)	IC EIRP Limit (dBm)	Power Limit (dBm)	FCC PPSD Limit (dBm)	IC PSD Limit (dBm)	PPSD Limit (dBm)
Low	5260	24.00	23.10	29.10	23.10	11.00	11.00	11.00
Mid	5300	24.00	23.02	29.02	23.02	11.00	11.00	11.00
High	5320	24.00	23.04	29.04	23.04	11.00	11.00	11.00

<b>Duty Cycle CF (dB)</b>	0.24	<b>Included in Calculations of Corr'd PPSD</b>
---------------------------	------	--

**Output Power Results**

Channel	Frequency (MHz)	Chain 0 Meas Power (dBm)	Chain 1 Meas Power (dBm)	Total Corr'd Power (dBm)	Power Limit (dBm)	Power Margin (dB)
Low	5260	13.18	11.90	15.60	23.10	-7.50
Mid	5300	13.21	12.18	15.74	23.02	-7.29
High	5320	13.31	12.06	15.74	23.04	-7.30

**PPSD Results**

Channel	Frequency (MHz)	Chain 0 Meas PPSD (dBm)	Chain 1 Meas PPSD (dBm)	Total Corr'd PPSD (dBm)	PPSD Limit (dBm)	PPSD Margin (dB)
Low	5260	2.160	0.814	4.79	11.00	-6.21
Mid	5300	2.249	1.468	5.13	11.00	-5.87
High	5320	2.609	1.399	5.30	11.00	-5.70

**Note:** the power readings above were measured with gated method, and the measurement was taken only during the ON time. No duty cycle correction was necessary.

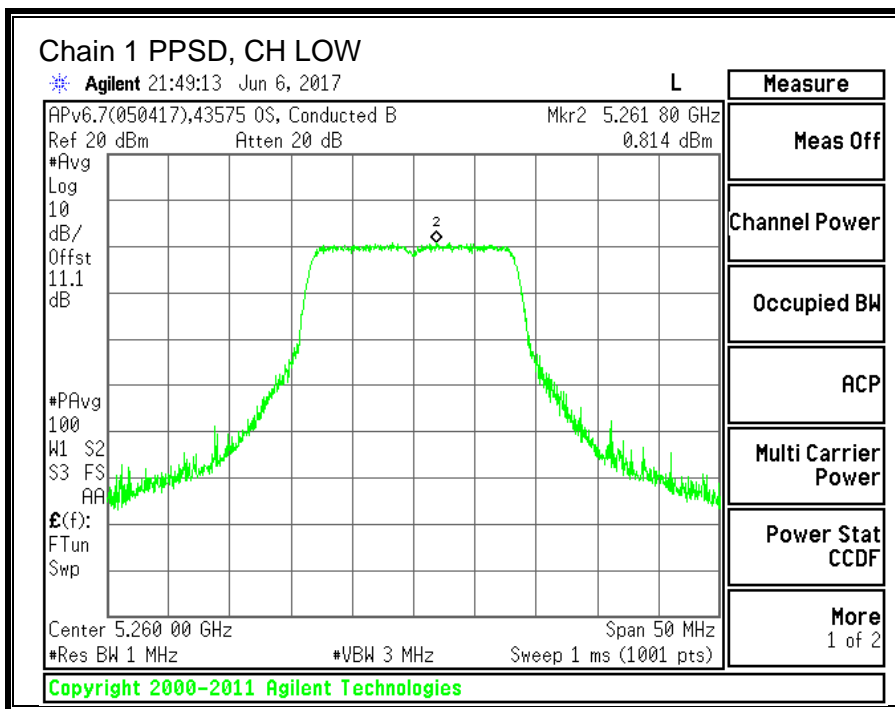
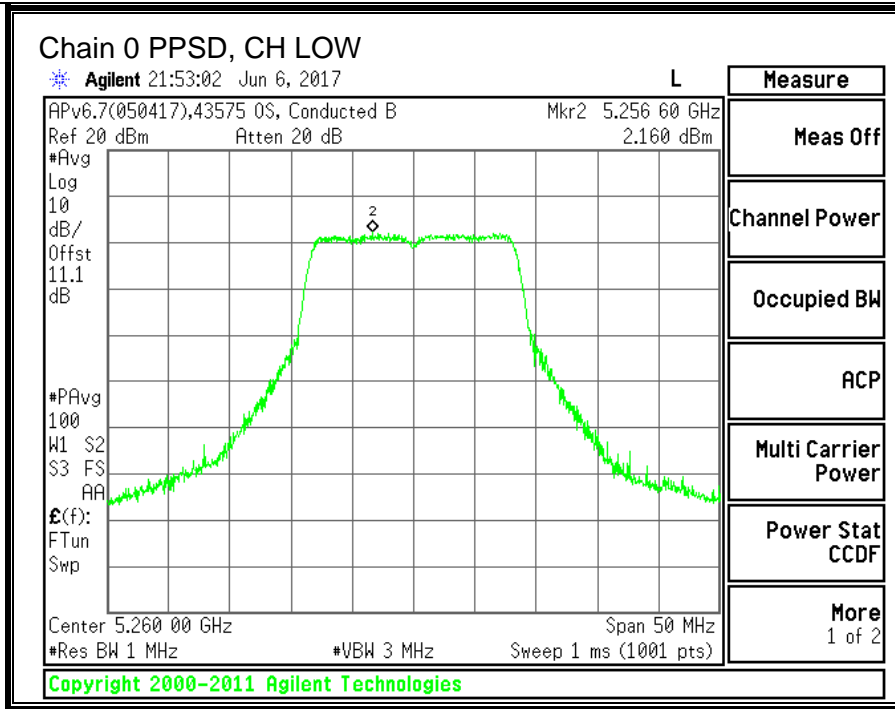

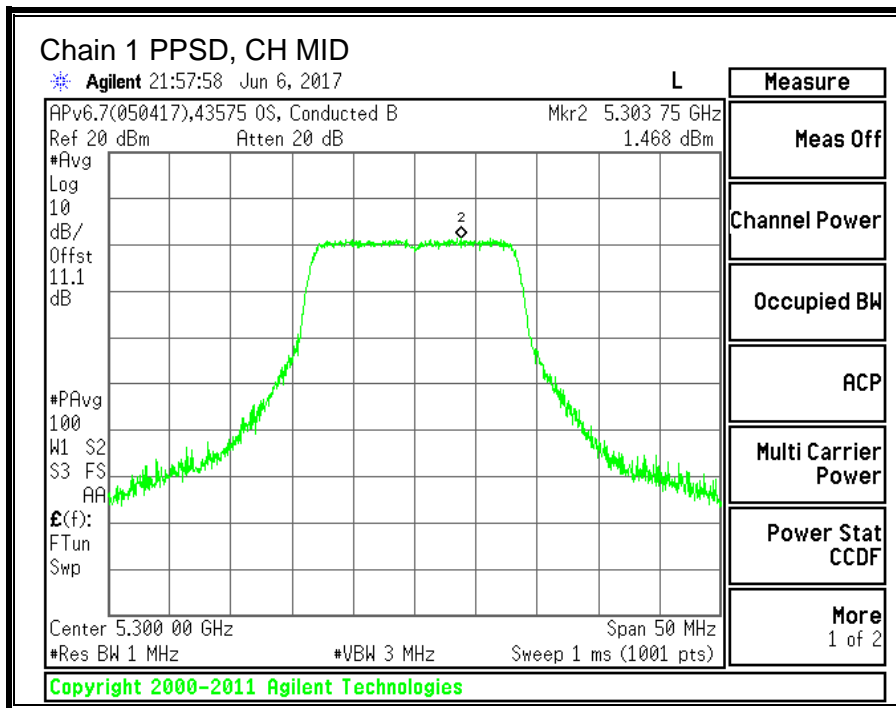
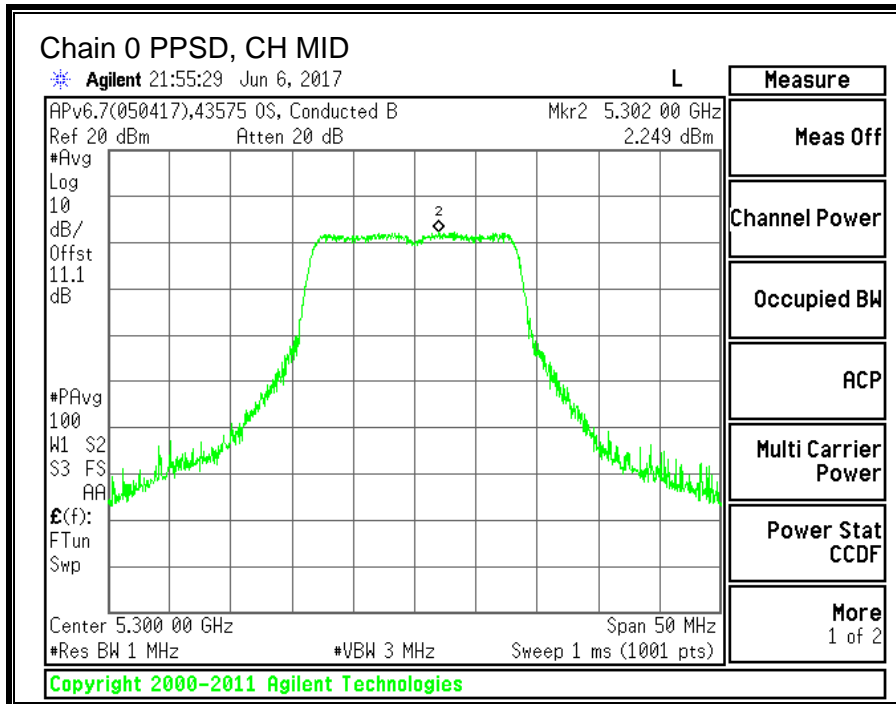



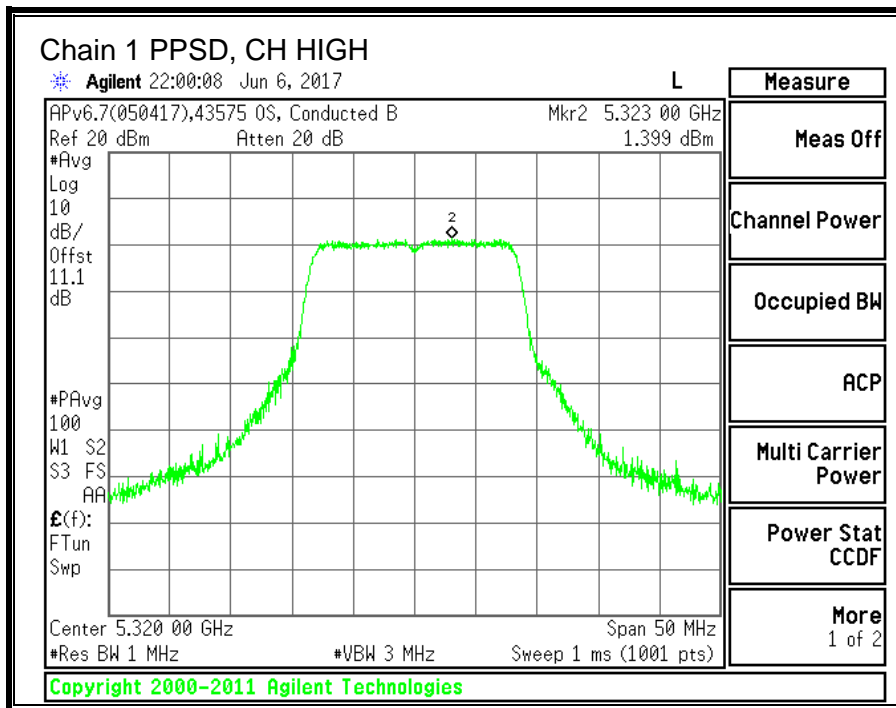
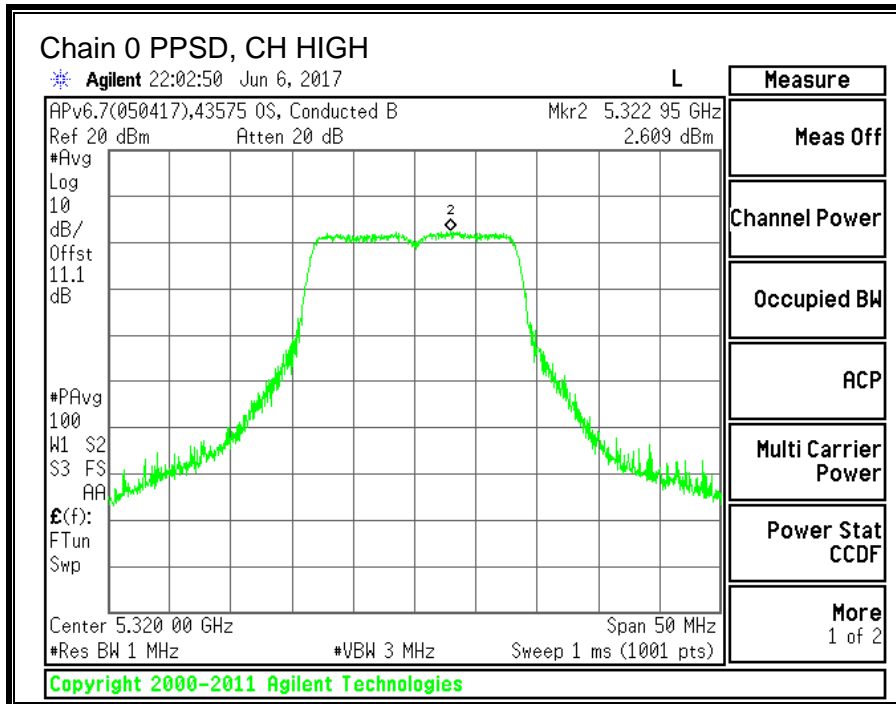

---

**10.6. 11n HT20 2TX CDD MIMO MODE IN THE 5.3GHz BAND**

**10.6.1. 26 dB BANDWIDTH**

**LIMITS**

None; for reporting purposes only.

**RESULTS**

<b>Channel</b>	<b>Frequency</b>	<b>26 dB BW Chain 0 (MHz)</b>	<b>26 dB BW Chain 1 (MHz)</b>
Low	5260	24.35	23.90
Mid	5300	24.70	23.25
High	5320	24.95	23.05

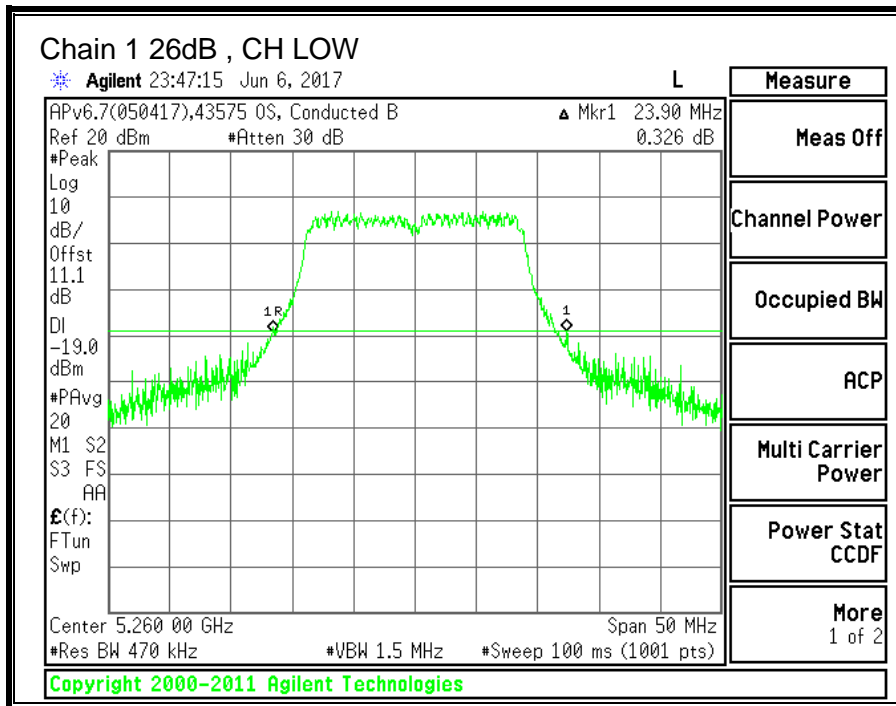
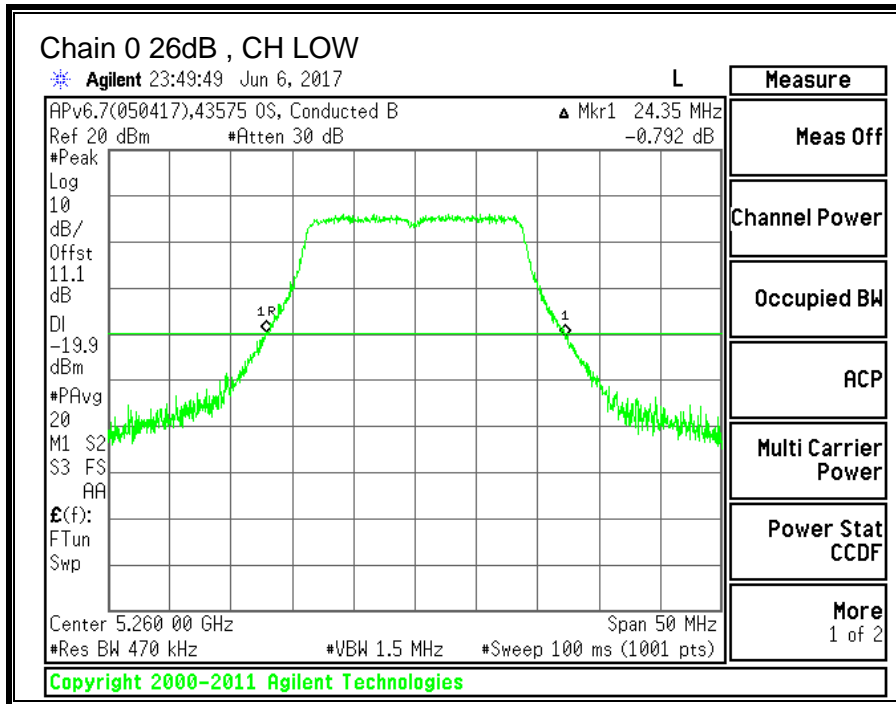

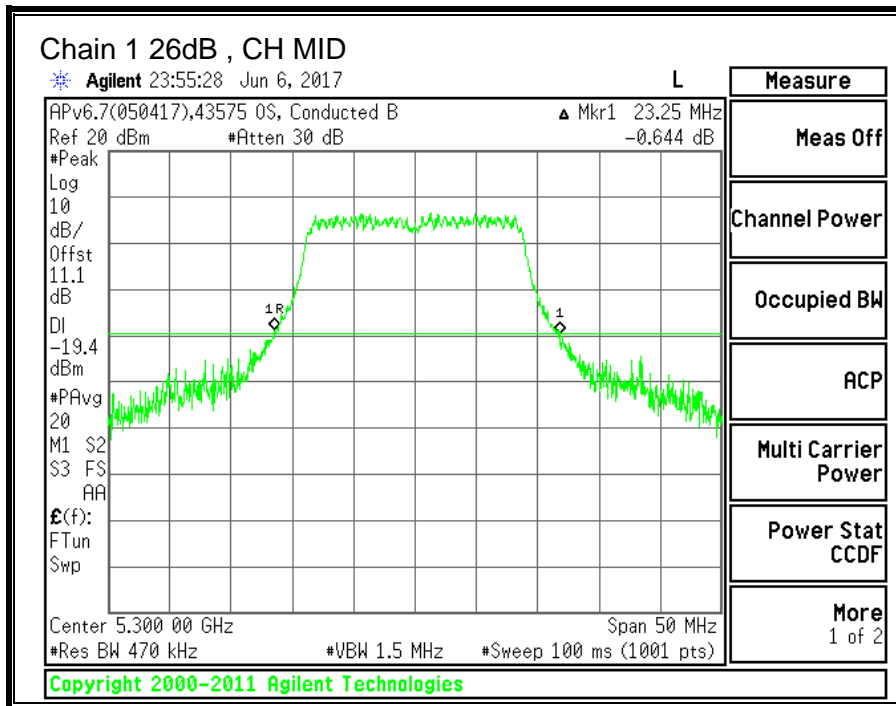
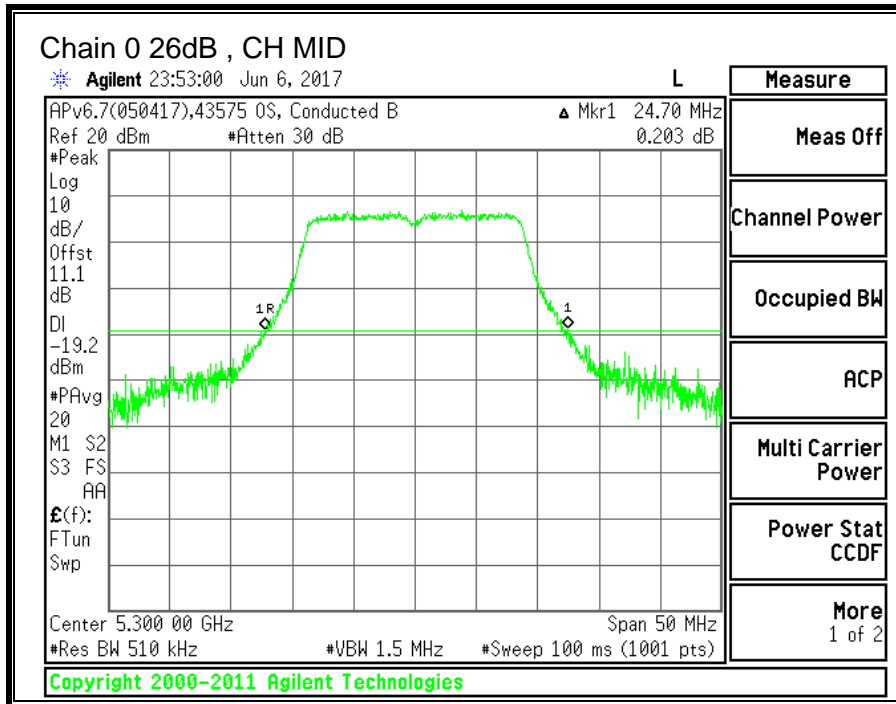

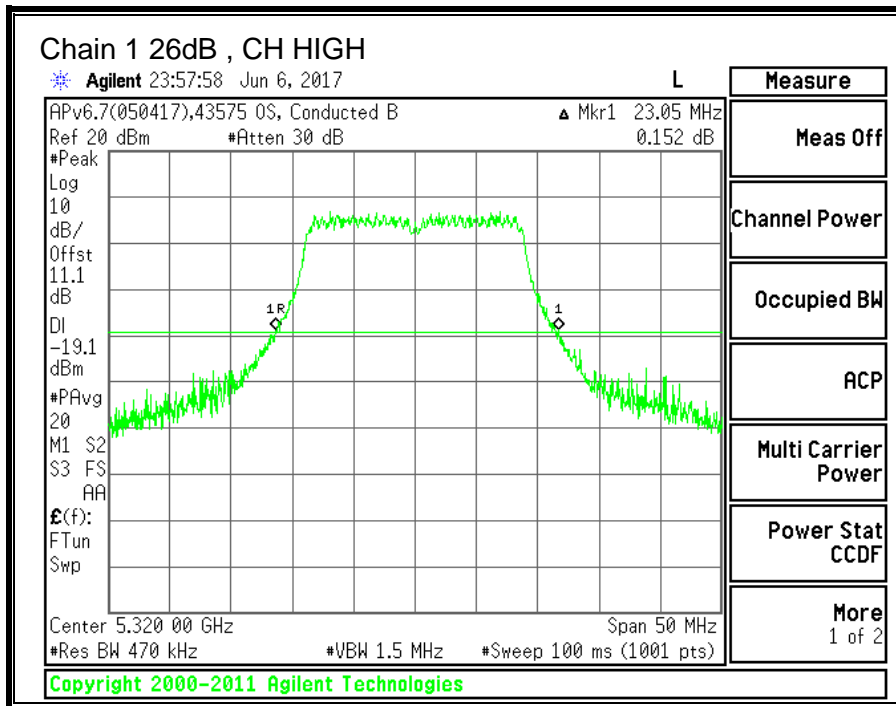
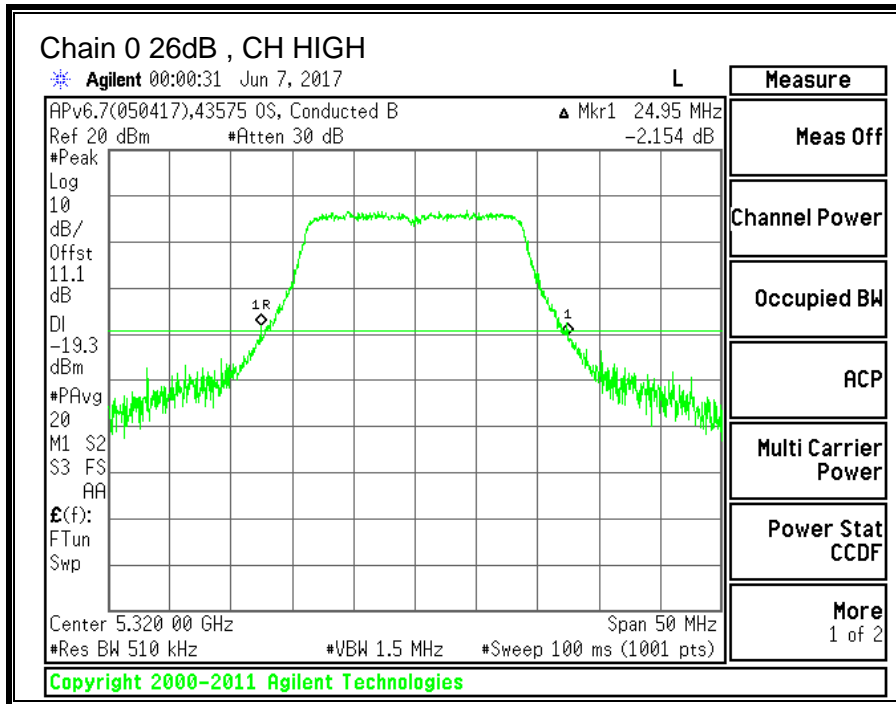

---

**10.6.2. 99% BANDWIDTH**

**LIMITS**

None; for reporting purposes only.

**RESULTS**

<b>Channel</b>	<b>Frequency</b>	<b>99% BW Chain 0 (MHz)</b>	<b>99% BW Chain 1 (MHz)</b>
Low	5260	17.598	17.583
Mid	5300	17.725	17.704
High	5320	16.832	17.322

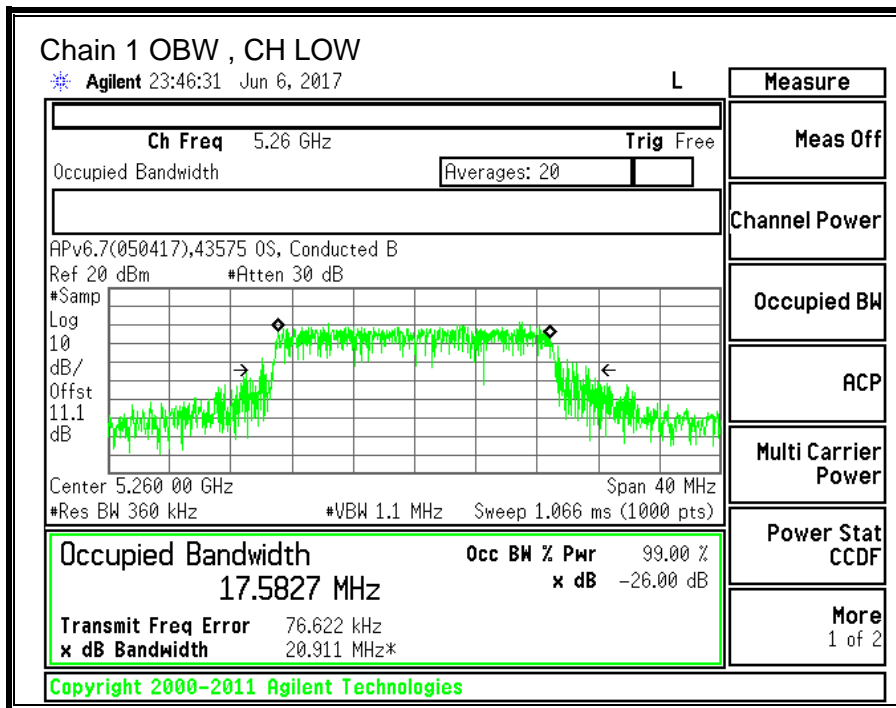
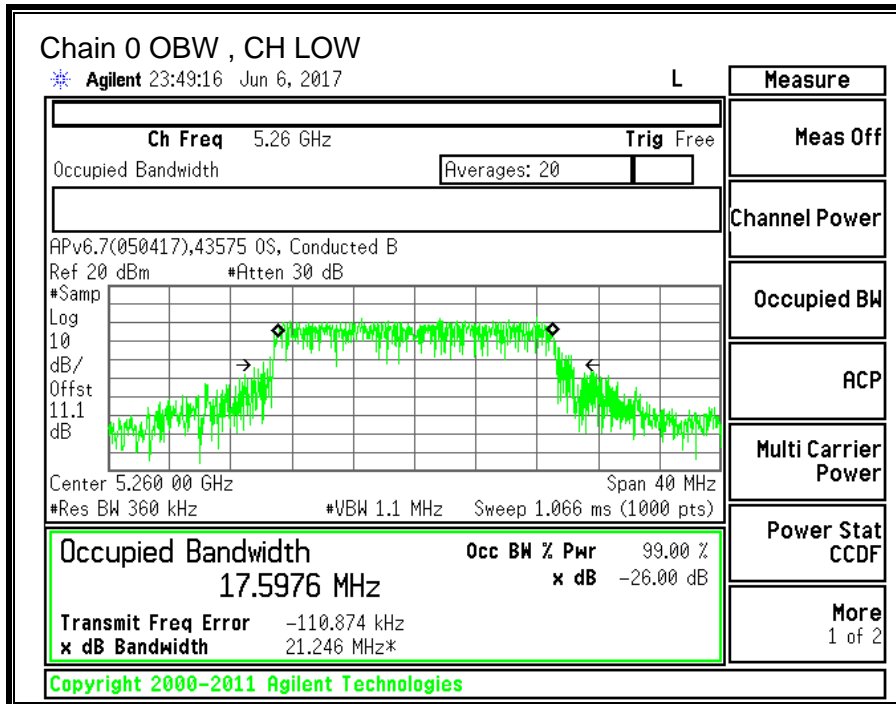

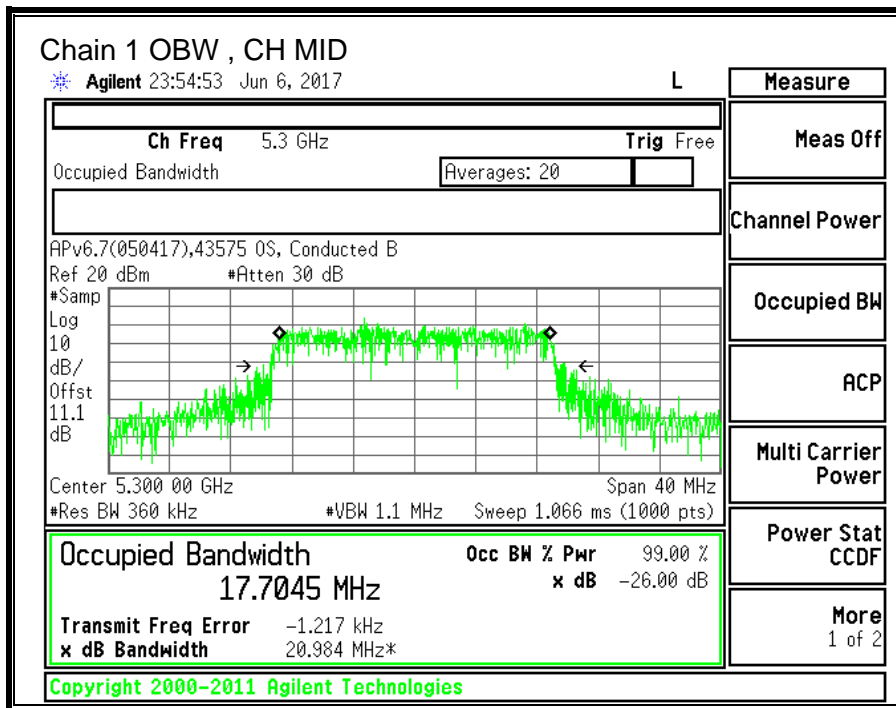
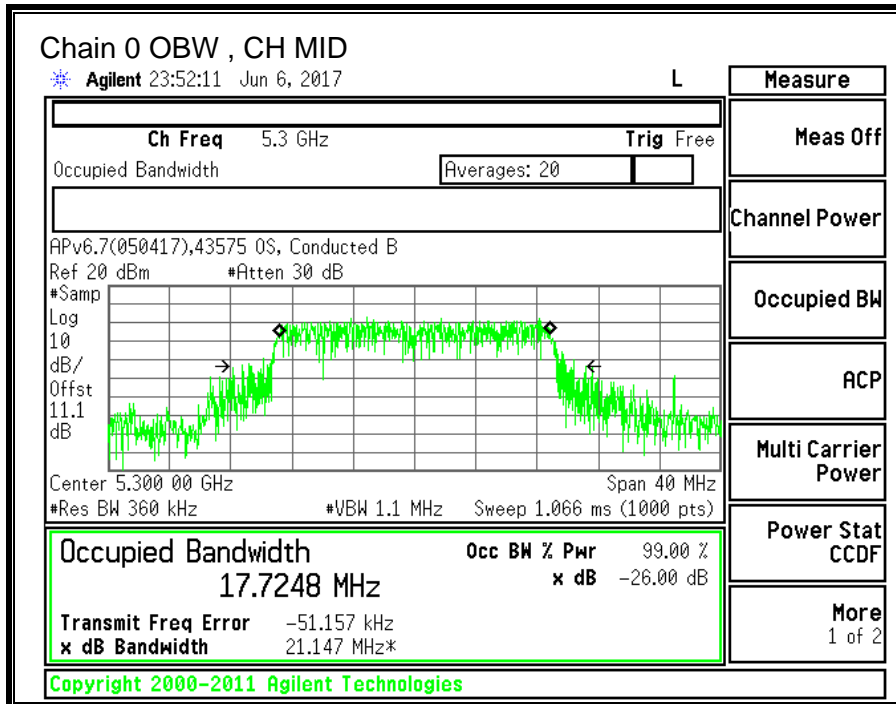



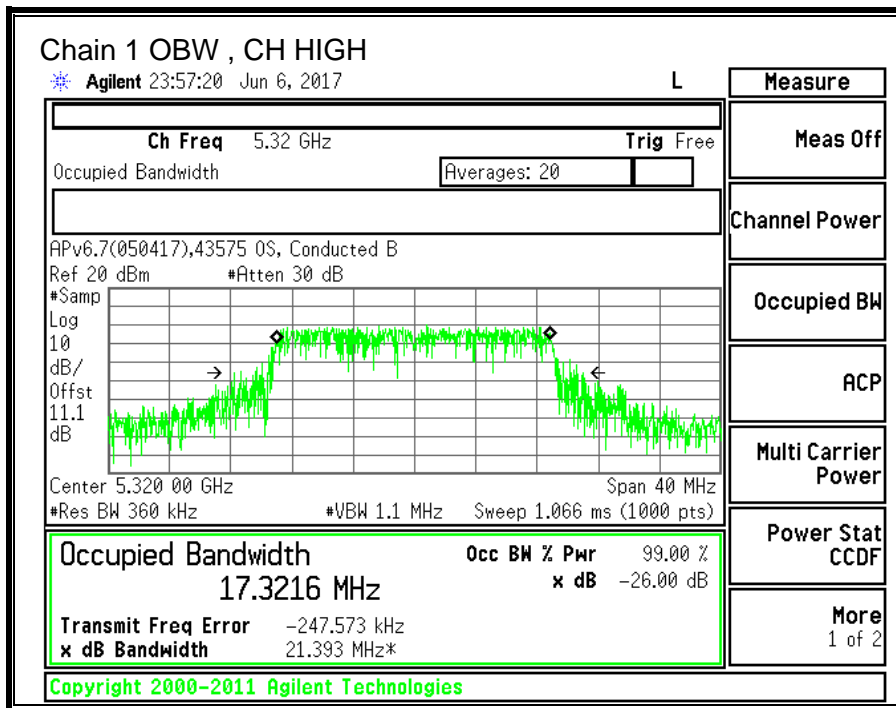
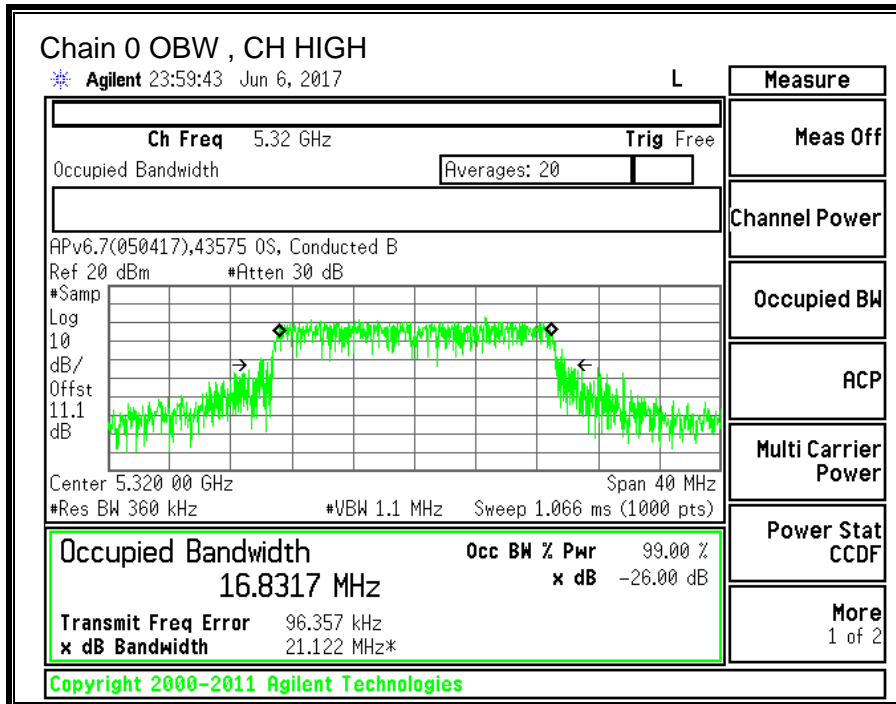

---

### 10.6.3. OUTPUT POWER AND PPSD

#### LIMITS

FCC §15.407 (a) (2)

For the band 5.25–5.35 GHz, the maximum conducted output power over the frequency band of operation shall not exceed the lesser of 250 mW or  $11 \text{ dBm} + 10 \log B$ , where B is the 26–dB emission bandwidth in MHz. In addition, the maximum power spectral density shall not exceed 11 dBm in any 1–MHz band. If transmitting antennas of directional gain greater than 6 dBi are used, both the maximum conducted output power and the peak power spectral density shall be reduced by the amount in dB that the directional gain of the antenna exceeds 6 dBi.

#### TEST PROCEDURE

Measurements perform using a wideband gated RF power meter provided that the gate parameters are adjusted such that the power is measured only when the EUT is transmitting at its maximum power control level. Since the measurement is made only during the ON time of the transmitter, no duty cycle correction factor is required.

**DIRECTIONAL ANTENNA GAIN**

For power, the TX chains are uncorrelated and the antenna gain is unequal among the chains. The directional gain is:

**5250-5350 MHz**

<b>Chain 0 Antenna Gain (dBi)</b>	<b>Chain 1 Antenna Gain (dBi)</b>	<b>Uncorrelated Chains Directional Gain (dBi)</b>
-4.40	-6.70	-5.40

For PSD the TX chains are correlated and the antenna gain is unequal among the chains. The directional gain is:

**5250-5230 MHz**

<b>Chain 0 Antenna Gain (dBi)</b>	<b>Chain 1 Antenna Gain (dBi)</b>	<b>Correlated Chains Directional Gain (dBi)</b>
-4.40	-6.70	-2.46

**RESULTS**

<b>ID:</b>	43574	<b>Date:</b>	06/06/17
------------	-------	--------------	----------

**Bandwidth and Antenna Gain**

Channel	Frequency (MHz)	Min 26 dB BW (MHz)	Min 99% BW (MHz)	Directional Gain for Power (dBi)	Directional Gain for PPSD (dBi)
Low	5260	23.90	17.583	-5.40	-2.46
Mid	5300	23.25	17.704	-5.40	-2.46
High	5320	23.05	16.832	-5.40	-2.46

**Limits**

Channel	Frequency (MHz)	FCC Power Limit (dBm)	IC Power Limit (dBm)	IC EIRP Limit (dBm)	Power Limit (dBm)	FCC PPSD Limit (dBm)	IC PSD Limit (dBm)	PPSD Limit (dBm)
Low	5260	24.00	23.45	29.45	23.45	11.00	11.00	11.00
Mid	5300	24.00	23.48	29.48	23.48	11.00	11.00	11.00
High	5320	24.00	23.26	29.26	23.26	11.00	11.00	11.00

<b>Duty Cycle CF (dB)</b>	0.20	<b>Included in Calculations of Corr'd PPSD</b>
---------------------------	------	--

**Output Power Results**

Channel	Frequency (MHz)	Chain 0 Meas Power (dBm)	Chain 1 Meas Power (dBm)	Total Corr'd Power (dBm)	Power Limit (dBm)	Power Margin (dB)
Low	5260	13.24	11.96	15.66	23.45	-7.79
Mid	5300	13.26	12.32	15.83	23.48	-7.66
High	5320	13.46	12.25	15.91	23.26	-7.35

**PPSD Results**

Channel	Frequency (MHz)	Chain 0 Meas PPSD (dBm)	Chain 1 Meas PPSD (dBm)	Total Corr'd PPSD (dBm)	PPSD Limit (dBm)	PPSD Margin (dB)
Low	5260	1.736	0.485	4.37	11.00	-6.63
Mid	5300	2.004	0.591	4.57	11.00	-6.43
High	5320	2.213	0.551	4.67	11.00	-6.33

**Note:** the power readings above were measured with gated method, and the measurement was taken only during the ON time. No duty cycle correction was necessary.

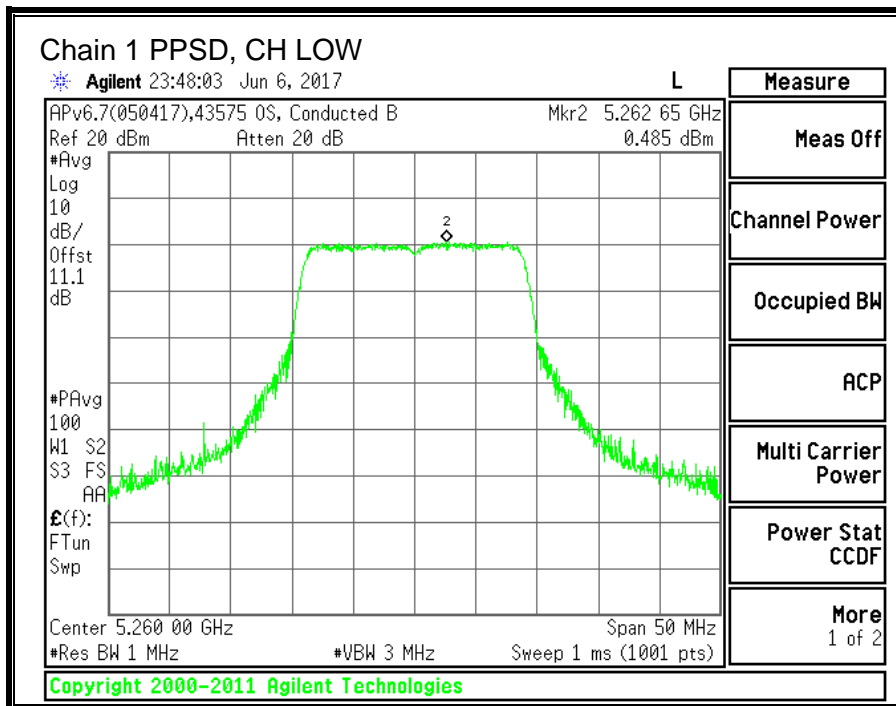
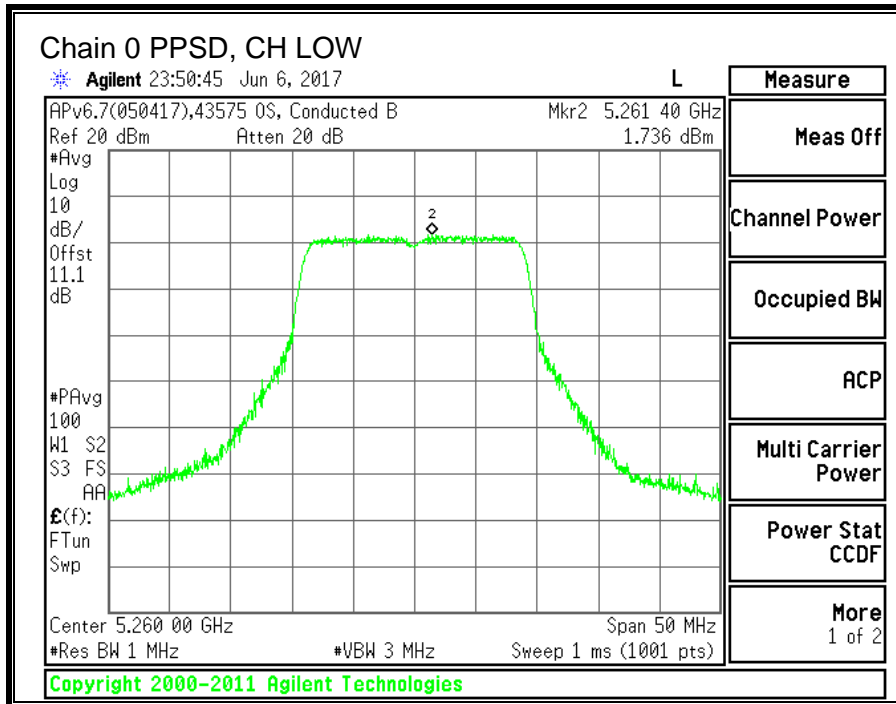

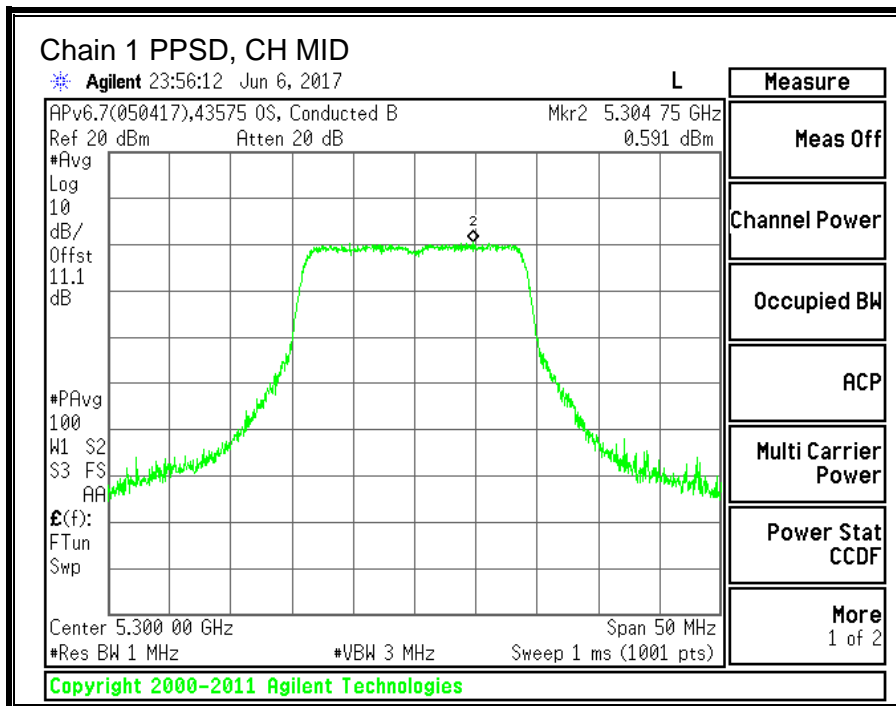
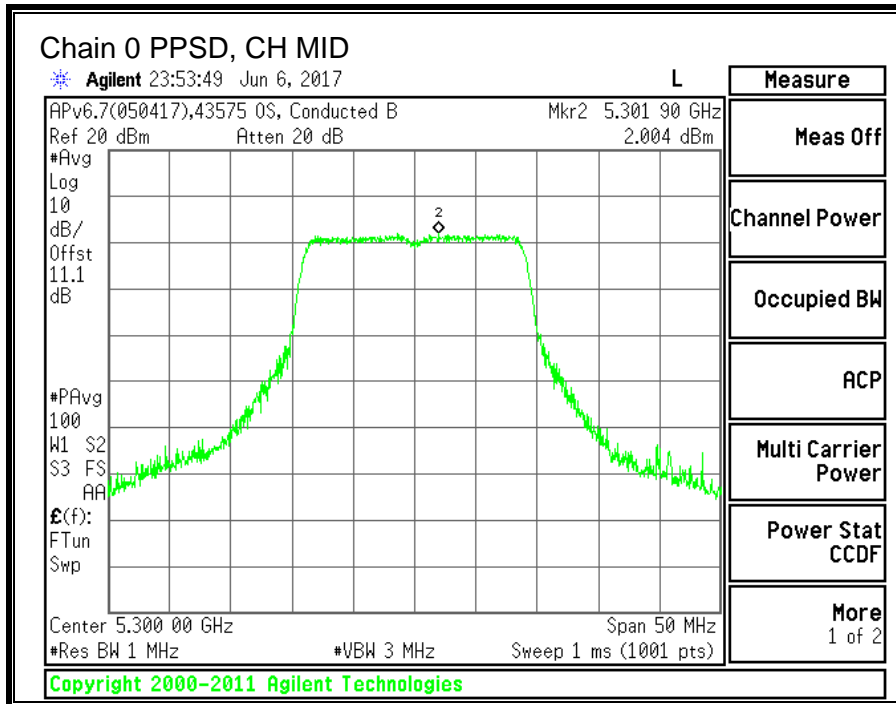

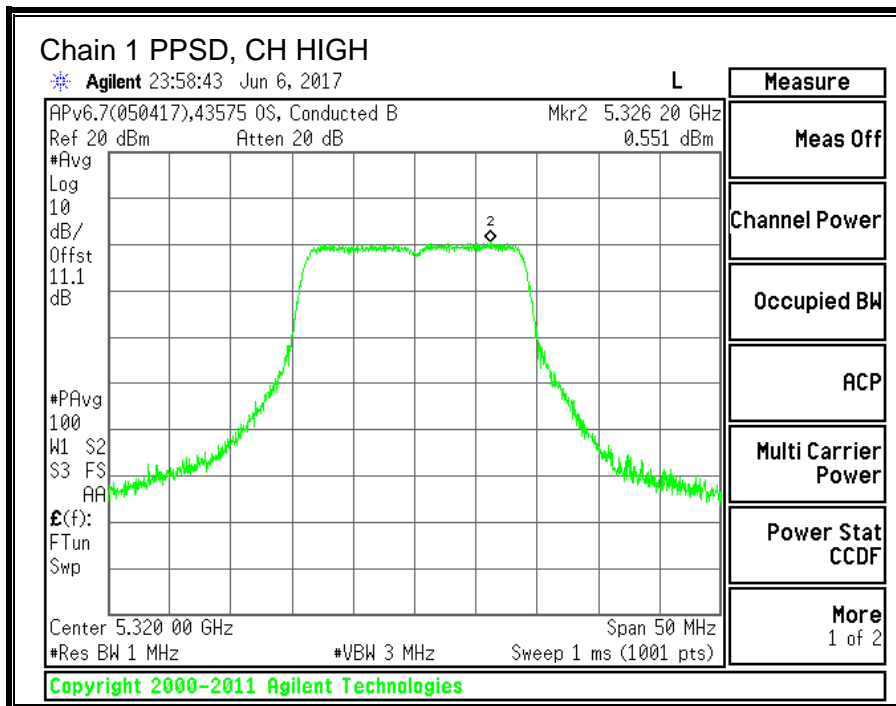
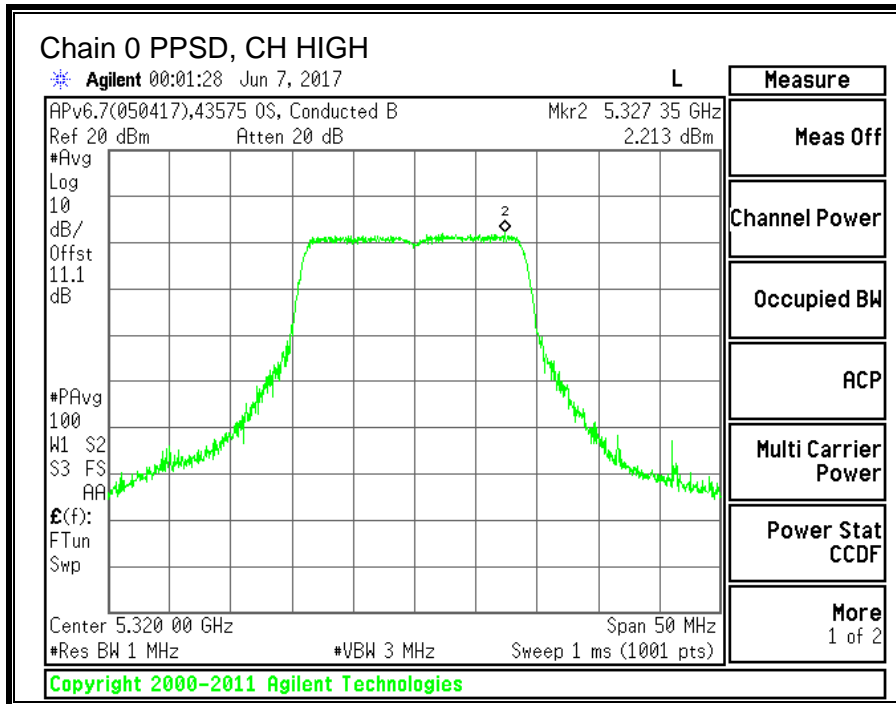

---

**10.7. 11n HT40 2TX CDD MIMO MODE IN THE 5.3GHz BAND**

**10.7.1. 26 dB BANDWIDTH**

**LIMITS**

None; for reporting purposes only.

**RESULTS**

<b>Channel</b>	<b>Frequency</b>	<b>26 dB BW Chain 0 (MHz)</b>	<b>26 dB BW Chain 1 (MHz)</b>
Low	5270	43.2	42.3
High	5310	43.2	42.5



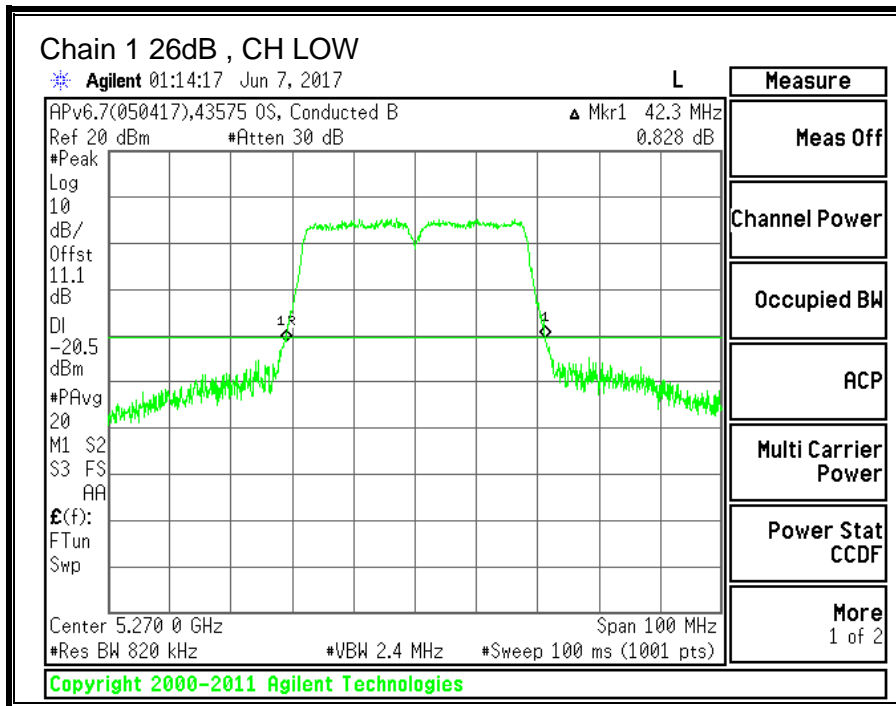
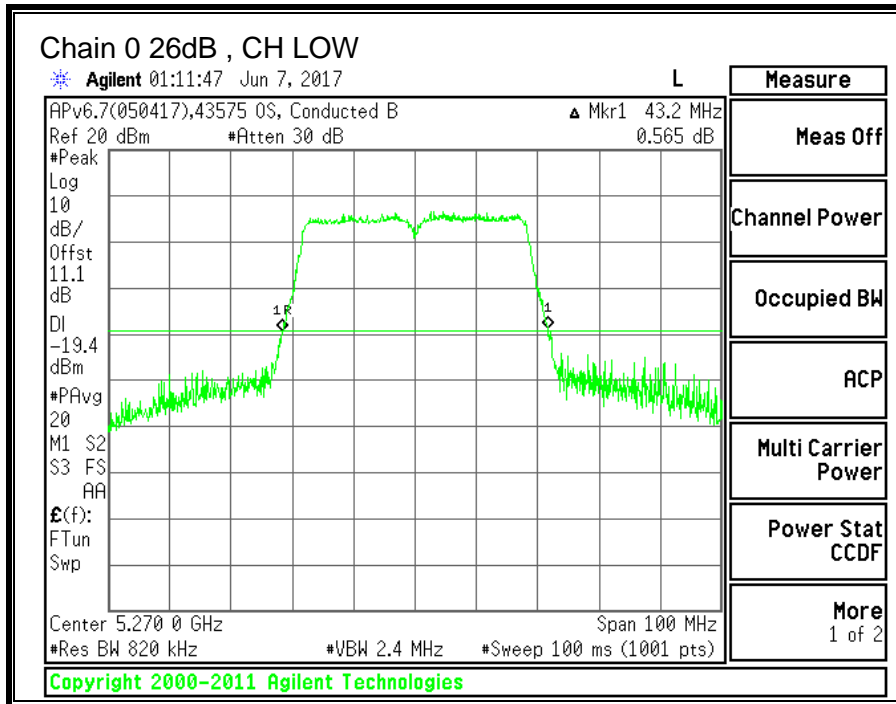

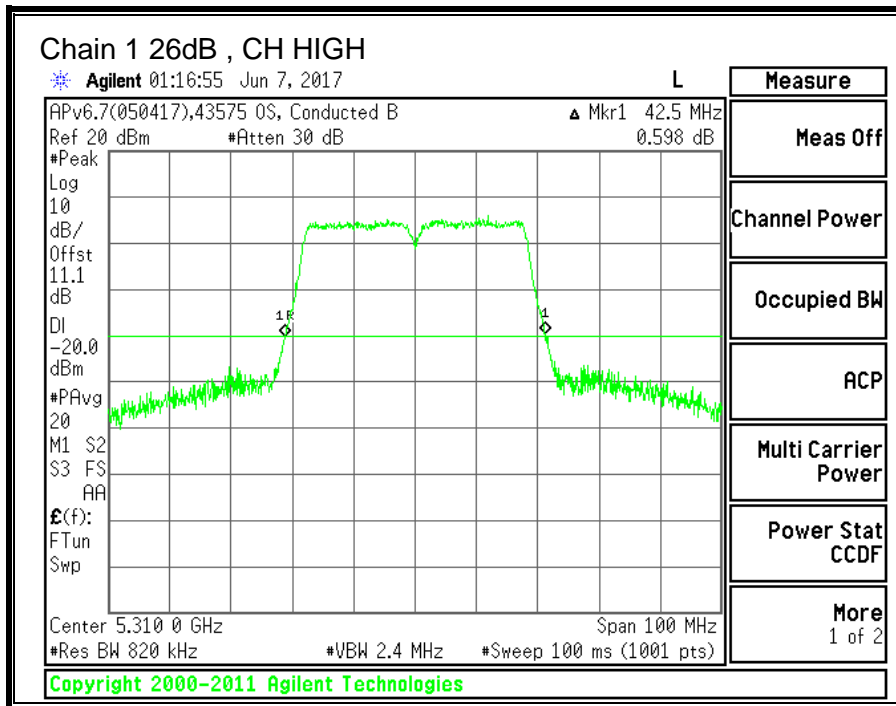
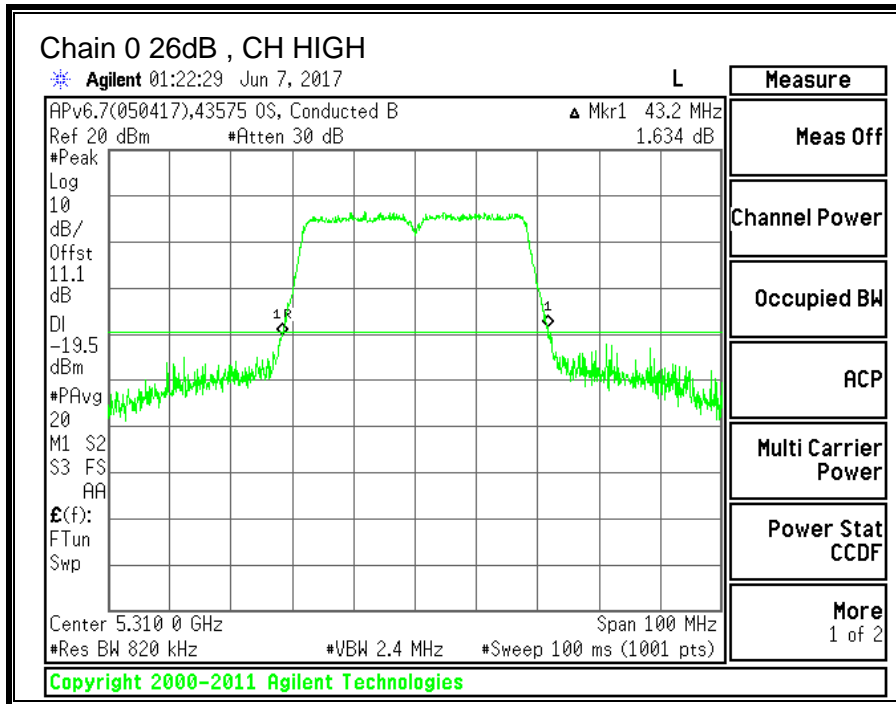

### 10.7.2. 99% BANDWIDTH

#### LIMITS

None; for reporting purposes only.

#### RESULTS

Channel	Frequency	99% BW Chain 0 (MHz)	99% BW Chain 1 (MHz)
Low	5270	36.479	35.169
High	5310	36.318	35.961

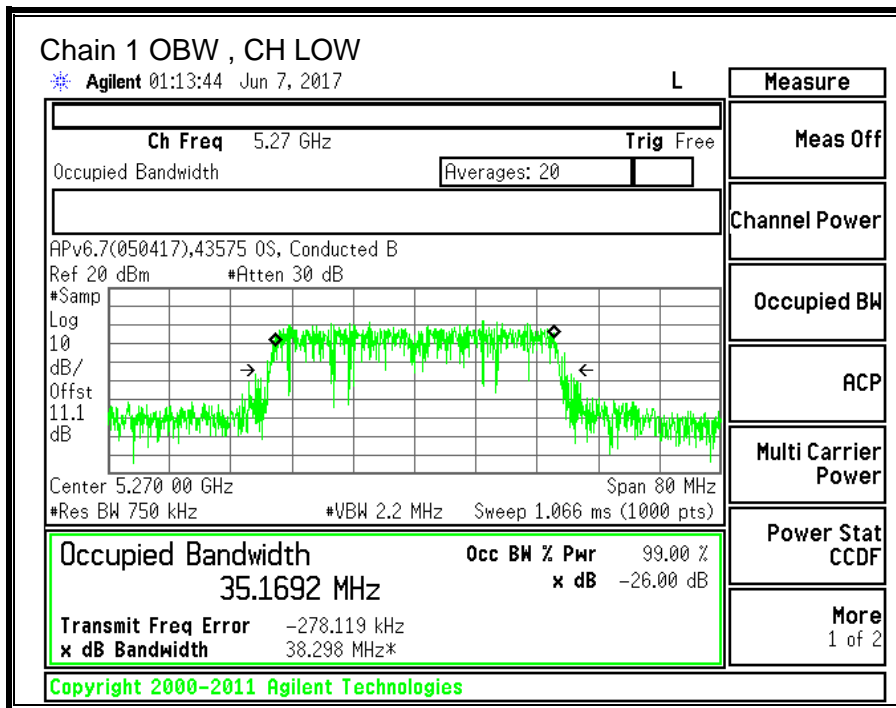
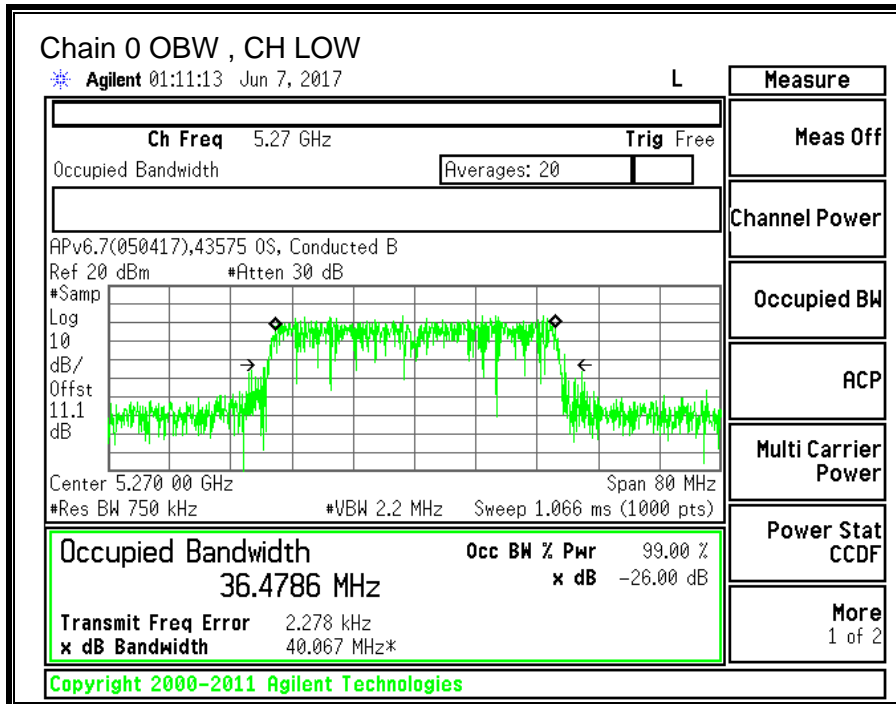

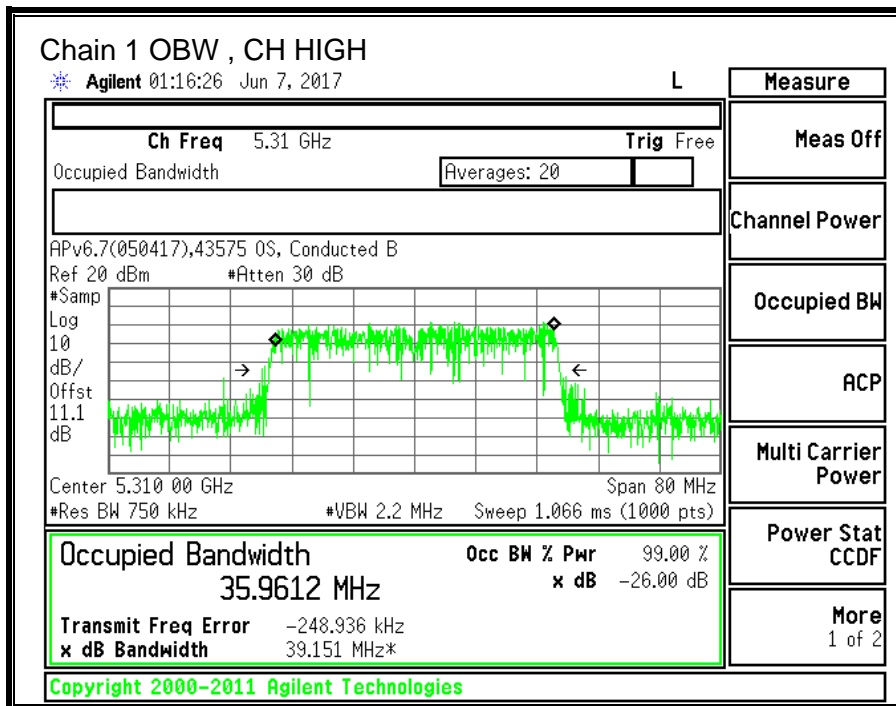
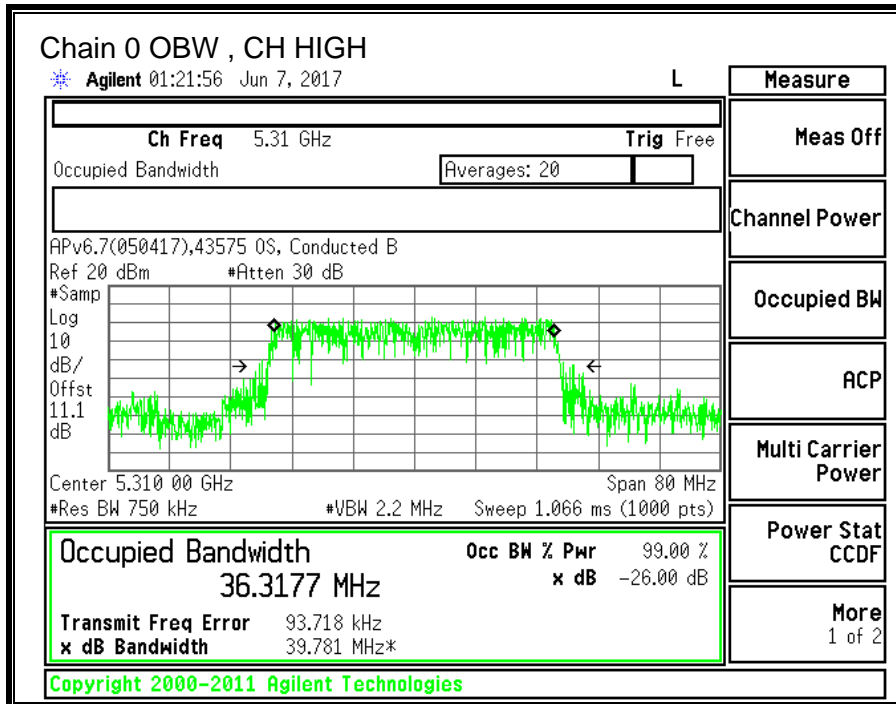

---

### 10.7.3. OUTPUT POWER AND PPSD

#### **LIMITS**

FCC §15.407 (a) (2)

For the band 5.25–5.35 GHz, the maximum conducted output power over the frequency band of operation shall not exceed the lesser of 250 mW or  $11 \text{ dBm} + 10 \log B$ , where B is the 26–dB emission bandwidth in MHz. In addition, the maximum power spectral density shall not exceed 11 dBm in any 1–MHz band. If transmitting antennas of directional gain greater than 6 dBi are used, both the maximum conducted output power and the peak power spectral density shall be reduced by the amount in dB that the directional gain of the antenna exceeds 6 dBi.

#### **TEST PROCEDURE**

Measurements perform using a wideband gated RF power meter provided that the gate parameters are adjusted such that the power is measured only when the EUT is transmitting at its maximum power control level. Since the measurement is made only during the ON time of the transmitter, no duty cycle correction factor is required.

**DIRECTIONAL ANTENNA GAIN**

For power, the TX chains are uncorrelated and the antenna gain is unequal among the chains. The directional gain is:

**5250-5350 MHz**

<b>Chain 0 Antenna Gain (dBi)</b>	<b>Chain 1 Antenna Gain (dBi)</b>	<b>Uncorrelated Chains Directional Gain (dBi)</b>
-4.40	-6.70	-5.40

For PSD the TX chains are correlated and the antenna gain is unequal among the chains. The directional gain is:

**5250-5230 MHz**

<b>Chain 0 Antenna Gain (dBi)</b>	<b>Chain 1 Antenna Gain (dBi)</b>	<b>Correlated Chains Directional Gain (dBi)</b>
-4.40	-6.70	-2.46

**RESULTS**

<b>ID:</b>	43574	<b>Date:</b>	06/06/17
------------	-------	--------------	----------

**Bandwidth and Antenna Gain**

Channel	Frequency (MHz)	Min 26 dB BW (MHz)	Min 99% BW (MHz)	Directional Gain for Power (dBi)	Directional Gain for PPSD (dBi)
Low	5270	42.30	35.169	-5.40	-2.46
High	5310	42.50	35.961	-5.40	-2.46

**Limits**

Channel	Frequency (MHz)	FCC Power Limit (dBm)	IC Power Limit (dBm)	IC EIRP Limit (dBm)	Power Limit (dBm)	FCC PPSD Limit (dBm)	IC PSD Limit (dBm)	PPSD Limit (dBm)
Low	5270	24.00	24.00	30.00	24.00	11.00	11.00	11.00
High	5310	24.00	24.00	30.00	24.00	11.00	11.00	11.00

<b>Duty Cycle CF (dB)</b>	0.40	<b>Included in Calculations of Corr'd PPSD</b>
---------------------------	------	--

**Output Power Results**

Channel	Frequency (MHz)	Chain 0 Meas Power (dBm)	Chain 1 Meas Power (dBm)	Total Corr'd Power (dBm)	Power Limit (dBm)	Power Margin (dB)
Low	5270	13.05	11.81	15.48	24.00	-8.52
High	5310	13.28	12.17	15.77	24.00	-8.23

**PPSD Results**

Channel	Frequency (MHz)	Chain 0 Meas PPSD (dBm)	Chain 1 Meas PPSD (dBm)	Total Corr'd PPSD (dBm)	PPSD Limit (dBm)	PPSD Margin (dB)
Low	5270	-1.348	-3.334	1.18	11.00	-9.82
High	5310	-0.828	-2.980	1.64	11.00	-9.36

**Note:** the power readings above were measured with gated method, and the measurement was taken only during the ON time. No duty cycle correction was necessary.



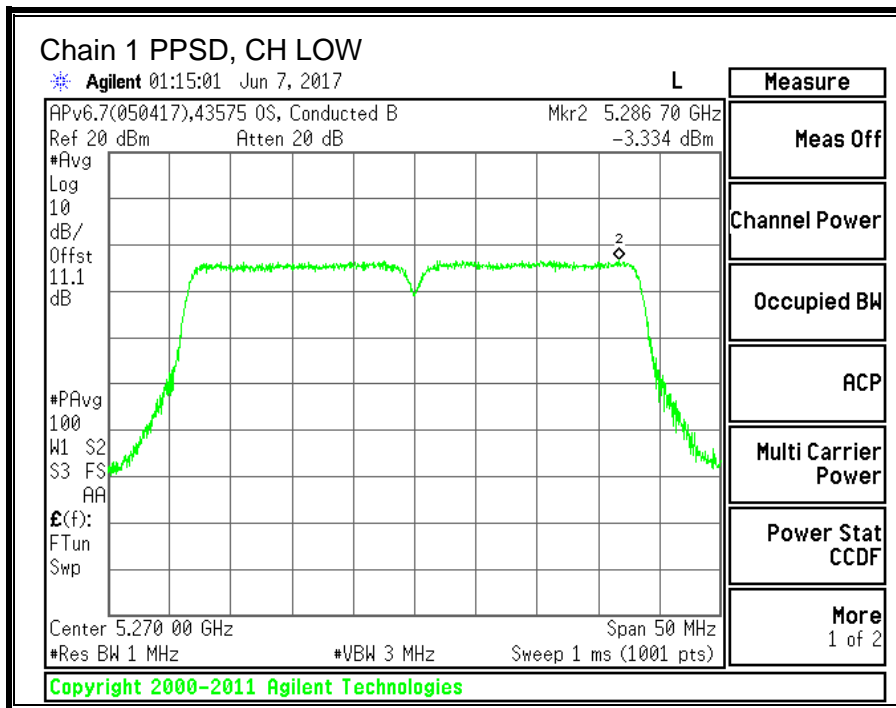
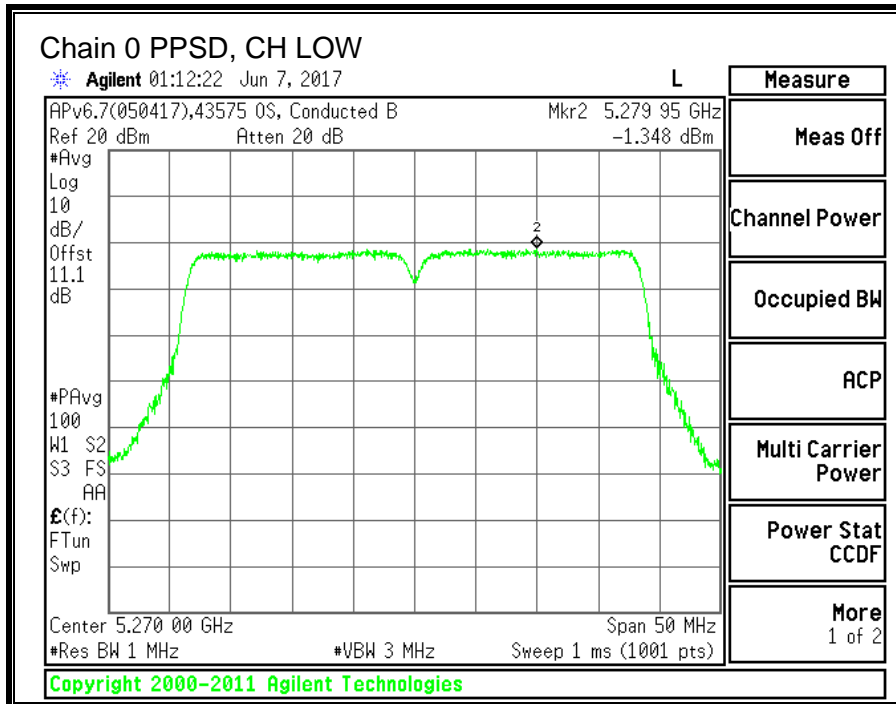

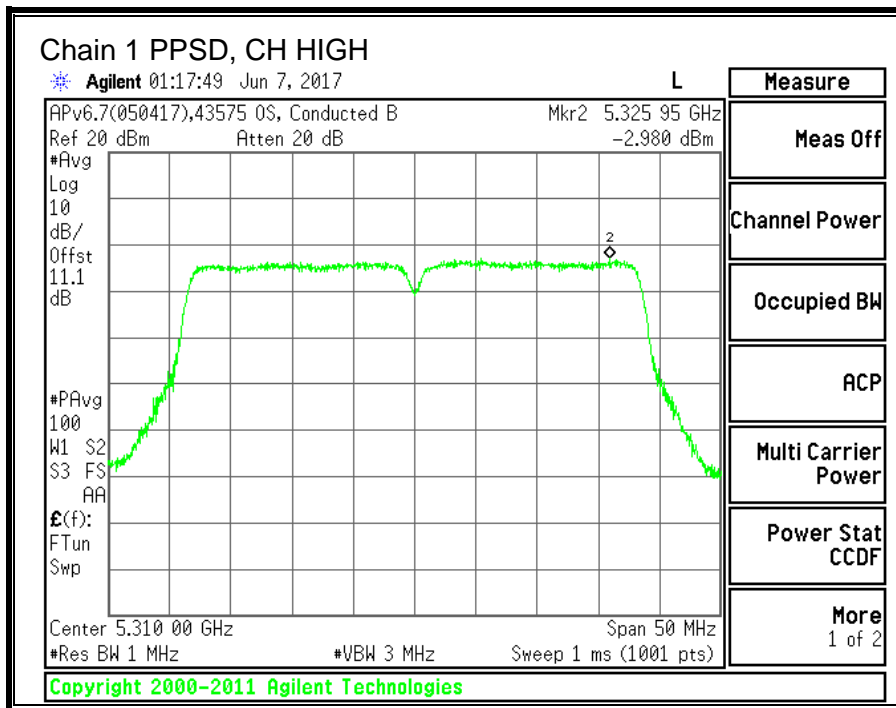
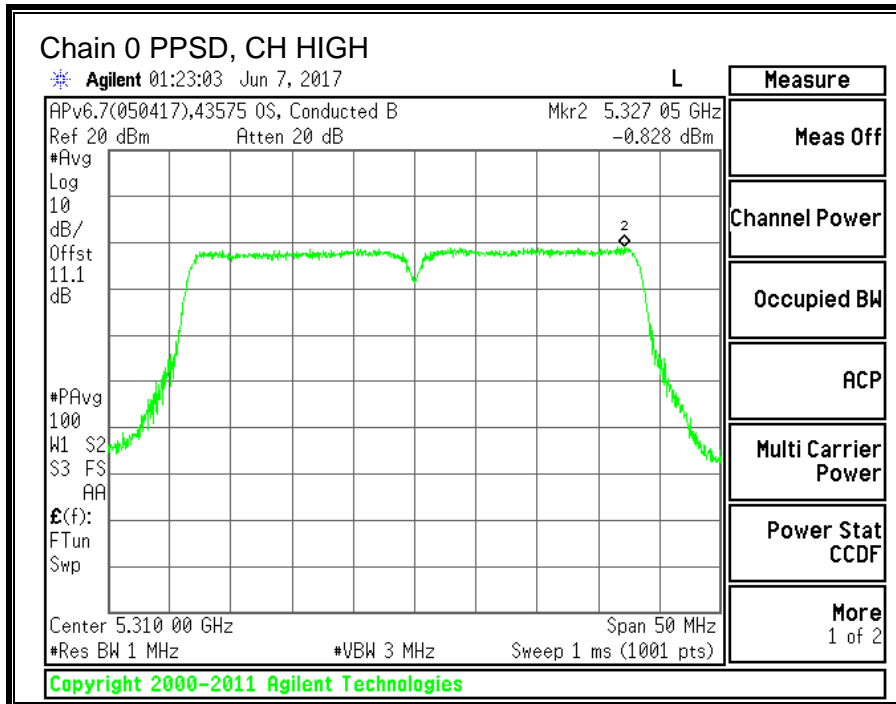

---

**10.8. 11ac HT80 2TX CDD MIMO MODE IN THE 5.3GHz BAND**

**10.8.1. 26 dB BANDWIDTH**

**LIMITS**

None; for reporting purposes only.

**RESULTS**

<b>Channel</b>	<b>Frequency</b>	<b>26 dB BW Chain 0 (MHz)</b>	<b>26 dB BW Chain 1 (MHz)</b>
Mid	5290	86.4	85.6

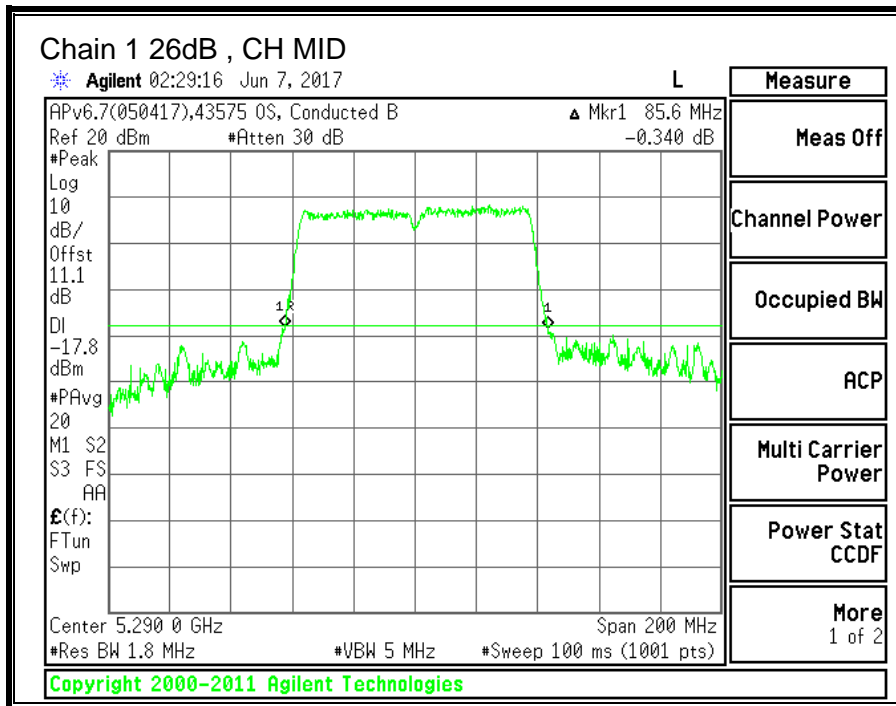
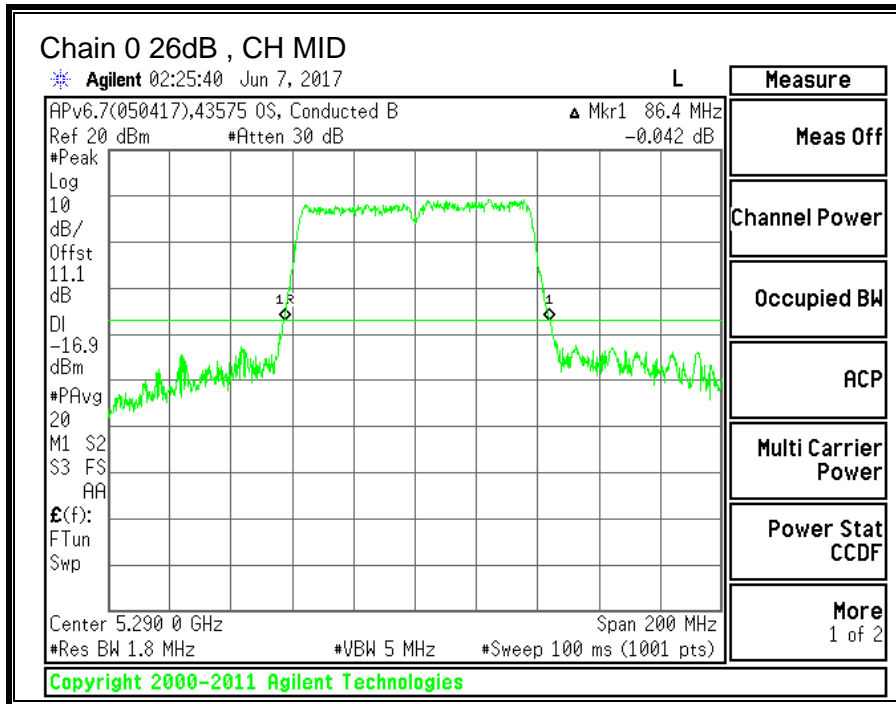

---

**10.8.2. 99% BANDWIDTH**

**LIMITS**

None; for reporting purposes only.

**RESULTS**

<b>Channel</b>	<b>Frequency</b>	<b>99% BW Chain 0 (MHz)</b>	<b>99% BW Chain 1 (MHz)</b>
Mid	5290	75.037	73.090

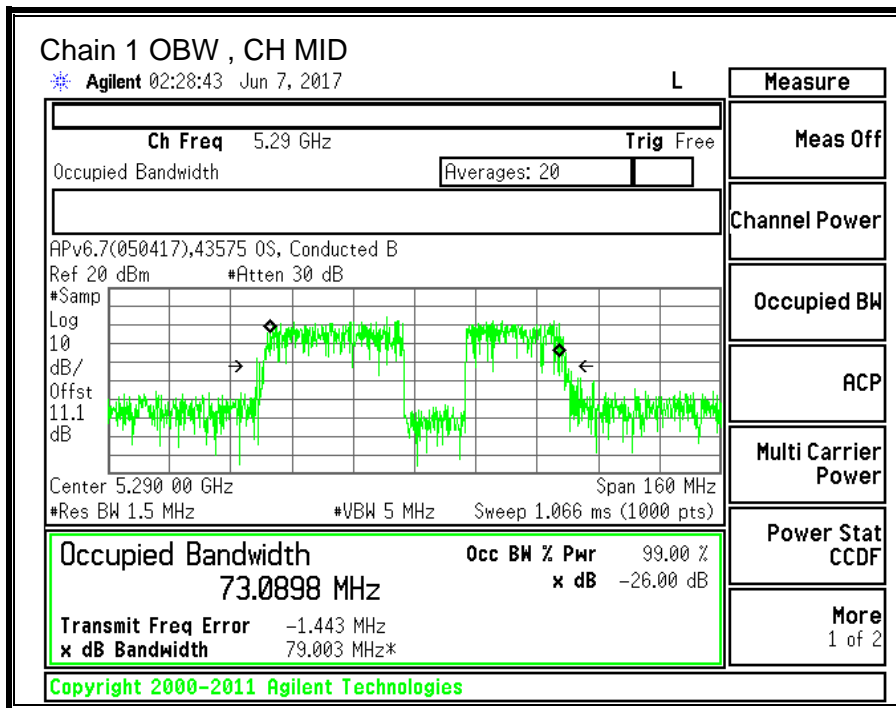
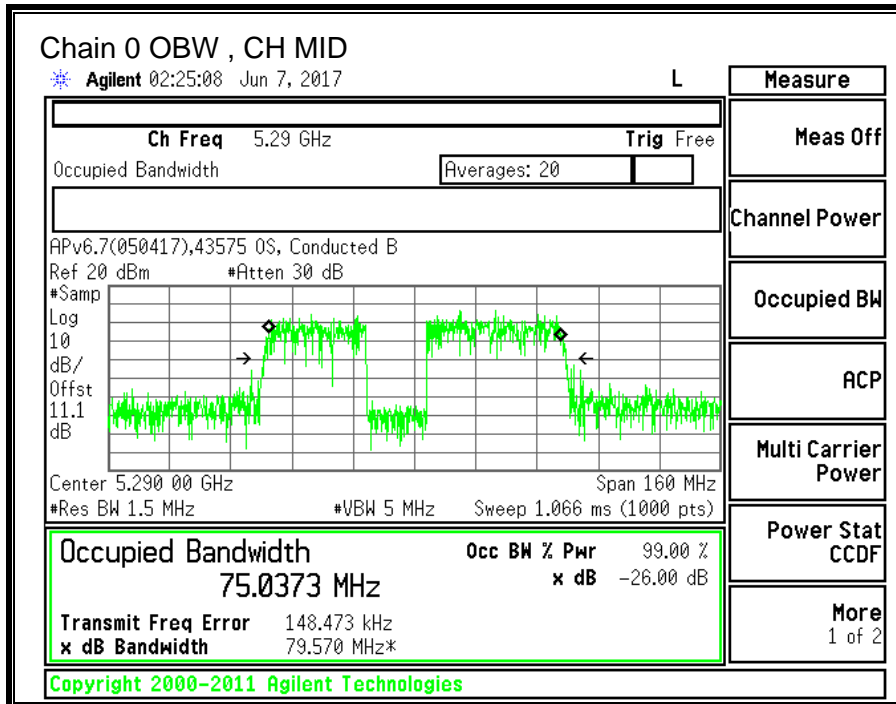

**10.8.3. OUTPUT POWER AND PPSD**

**LIMITS**

FCC §15.407 (a) (2)

For the band 5.25–5.35 GHz, the maximum conducted output power over the frequency band of operation shall not exceed the lesser of 250 mW or 11 dBm + 10 log B, where B is the 26–dB emission bandwidth in MHz. In addition, the maximum power spectral density shall not exceed 11 dBm in any 1–MHz band. If transmitting antennas of directional gain greater than 6 dBi are used, both the maximum conducted output power and the peak power spectral density shall be reduced by the amount in dB that the directional gain of the antenna exceeds 6 dBi.

**TEST PROCEDURE**

Measurements perform using a wideband gated RF power meter provided that the gate parameters are adjusted such that the power is measured only when the EUT is transmitting at its maximum power control level. Since the measurement is made only during the ON time of the transmitter, no duty cycle correction factor is required.

**DIRECTIONAL ANTENNA GAIN**

For power, the TX chains are uncorrelated and the antenna gain is unequal among the chains. The directional gain is:

**5250-5350 MHz**

Chain 0 Antenna Gain (dBi)	Chain 1 Antenna Gain (dBi)	Uncorrelated Chains Directional Gain (dBi)
-4.40	-6.70	-5.40

For PSD the TX chains are correlated and the antenna gain is unequal among the chains. The directional gain is:

**5250-5230 MHz**

Chain 0 Antenna Gain (dBi)	Chain 1 Antenna Gain (dBi)	Correlated Chains Directional Gain (dBi)
-4.40	-6.70	-2.46

**RESULTS**

<b>ID:</b>	43574	<b>Date:</b>	06/06/17
------------	-------	--------------	----------

**Bandwidth and Antenna Gain**

Channel	Frequency (MHz)	Min 26 dB BW (MHz)	Min 99% BW (MHz)	Directional Gain for Power (dBi)	Directional Gain for PPSD (dBi)
Low	5290	85.60	73.090	-5.40	-2.46

**Limits**

Channel	Frequency (MHz)	FCC Power Limit (dBm)	IC Power Limit (dBm)	IC EIRP Limit (dBm)	Power Limit (dBm)	FCC PPSD Limit (dBm)	IC PSD Limit (dBm)	PPSD Limit (dBm)
Low	5290	24.00	24.00	30.00	24.00	11.00	11.00	11.00

<b>Duty Cycle CF (dB)</b>	0.75	<b>Included in Calculations of Corr'd PPSD</b>
---------------------------	------	--

**Output Power Results**

Channel	Frequency (MHz)	Chain 0 Meas Power (dBm)	Chain 1 Meas Power (dBm)	Total Corr'd Power (dBm)	Power Limit (dBm)	Power Margin (dB)
Low	5290	13.35	12.57	15.99	24.00	-8.01

**PPSD Results**

Channel	Frequency (MHz)	Chain 0 Meas PPSD (dBm)	Chain 1 Meas PPSD (dBm)	Total Corr'd PPSD (dBm)	PPSD Limit (dBm)	PPSD Margin (dB)
Low	5290	-3.578	-4.768	-0.37	11.00	-11.37

**Note:** the power readings above were measured with gated method, and the measurement was taken only during the ON time. No duty cycle correction was necessary.



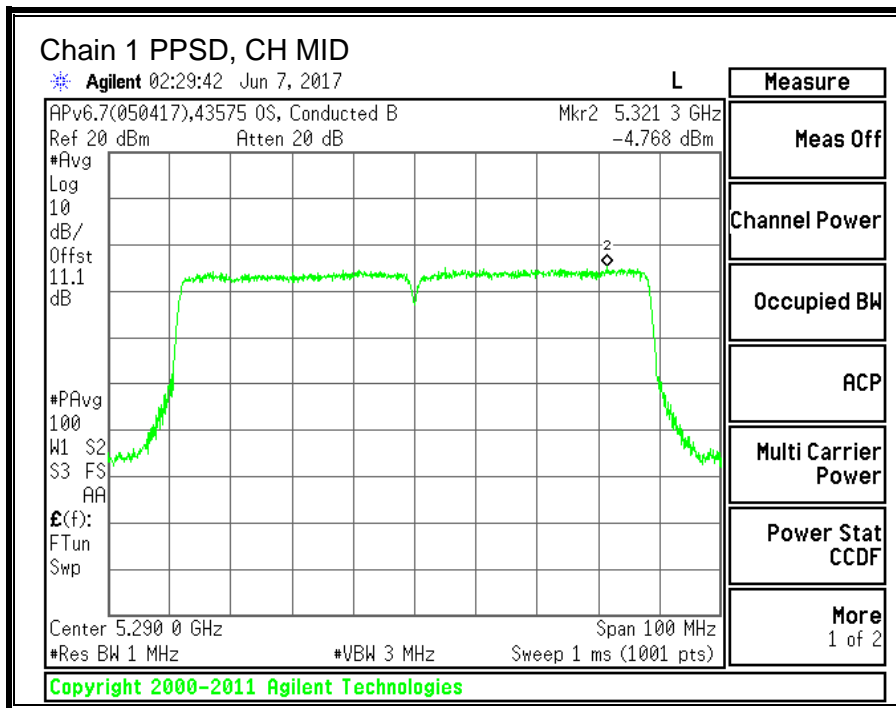
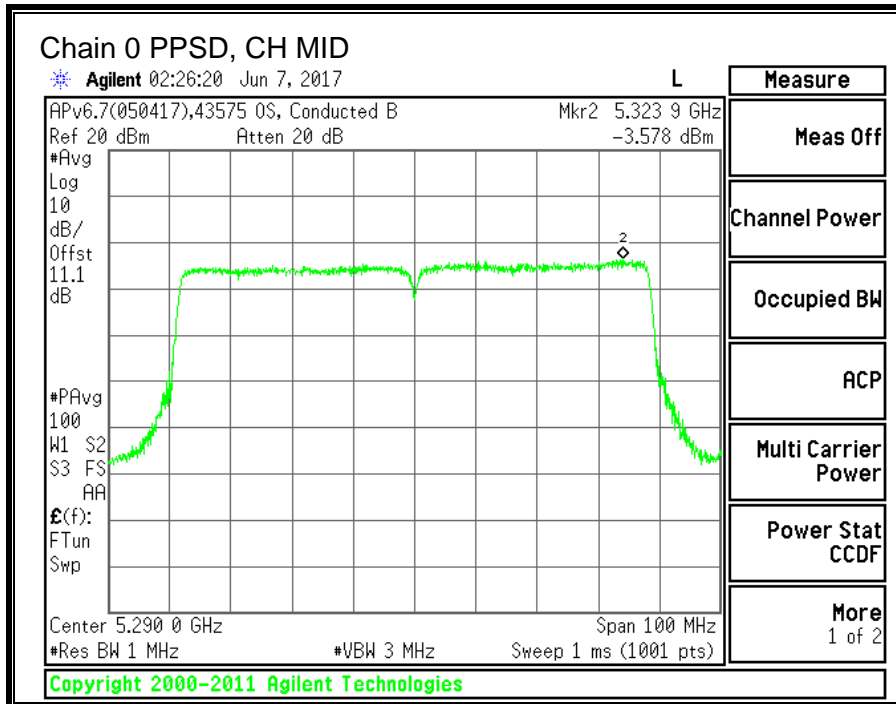

## 10.9. 11a 2TX CDD MIMO MODE IN THE 5.6GHz BAND

### 10.9.1. 26 dB BANDWIDTH

#### LIMITS

None; for reporting purposes only.

#### RESULTS

Channel	Frequency	26 dB BW Chain 0 (MHz)	26 dB BW Chain 1 (MHz)
Low	5500	23.40	22.20
Mid	5580	23.25	21.95
Mid (FCC)	5640	23.40	22.05
High	5700	23.60	22.15
144	5720	23.45	22.30

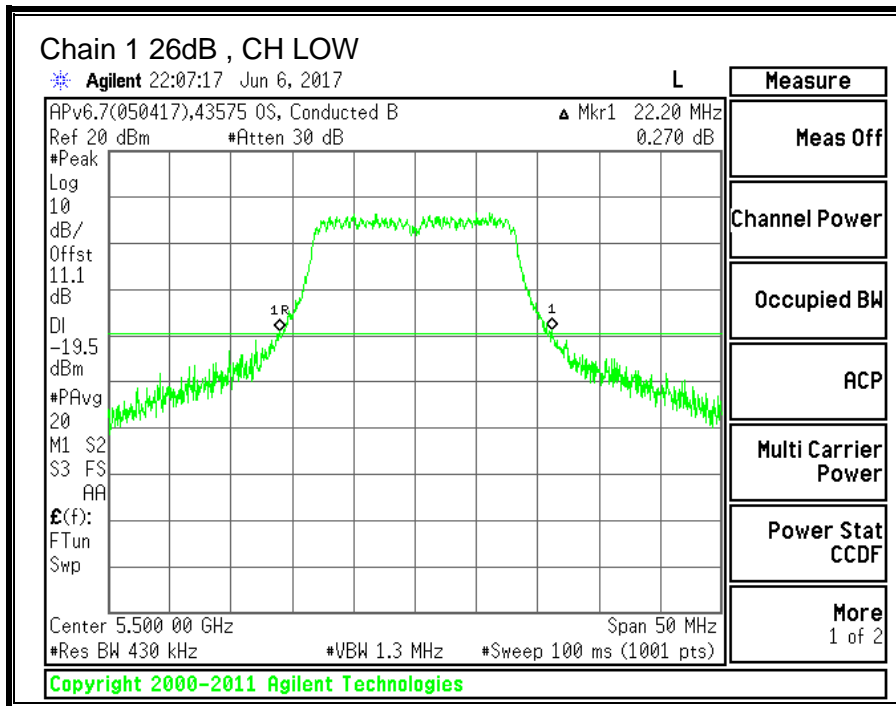
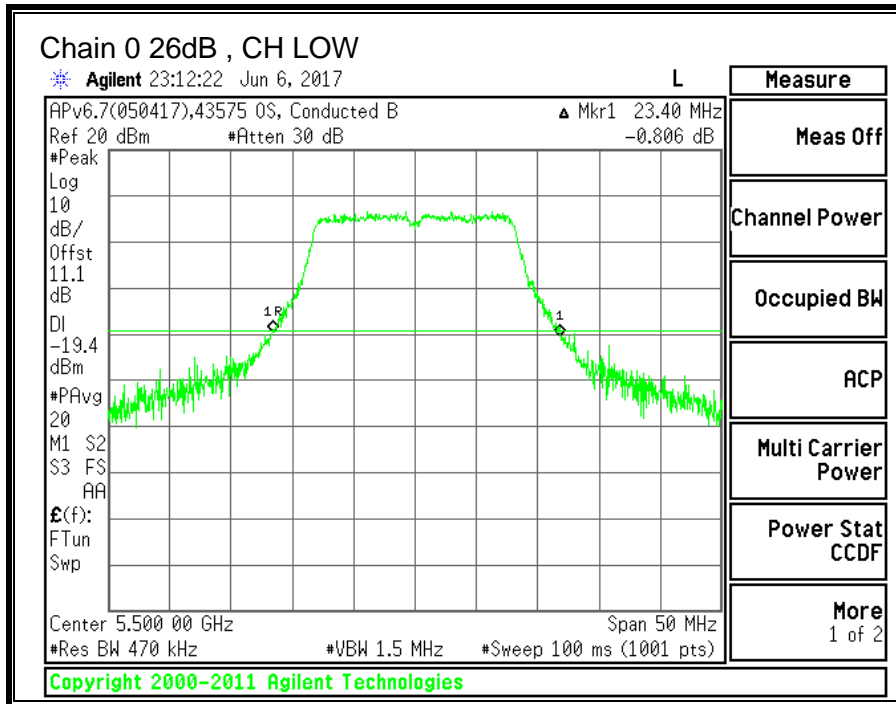

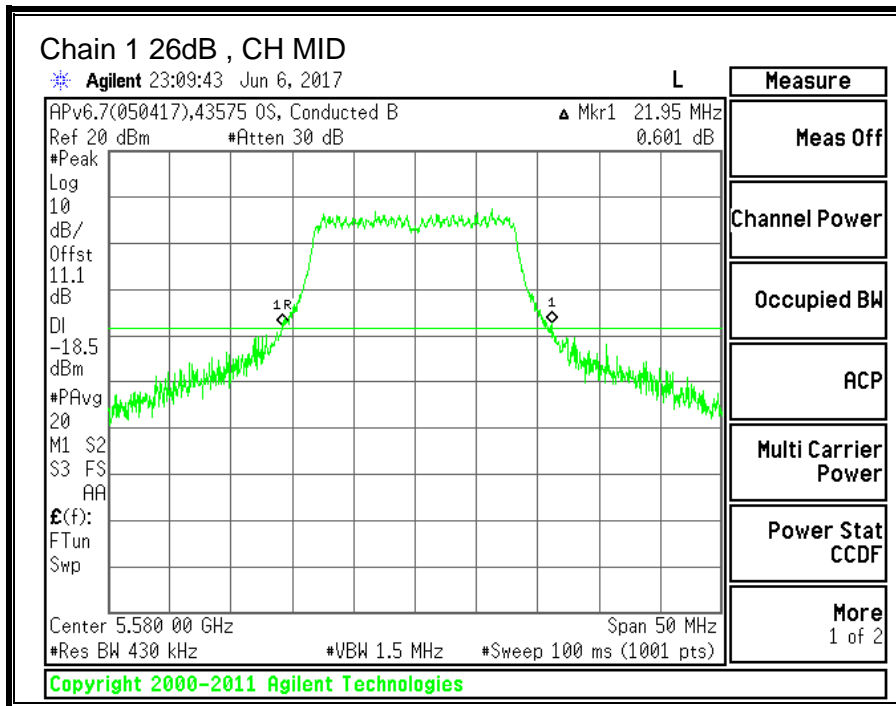
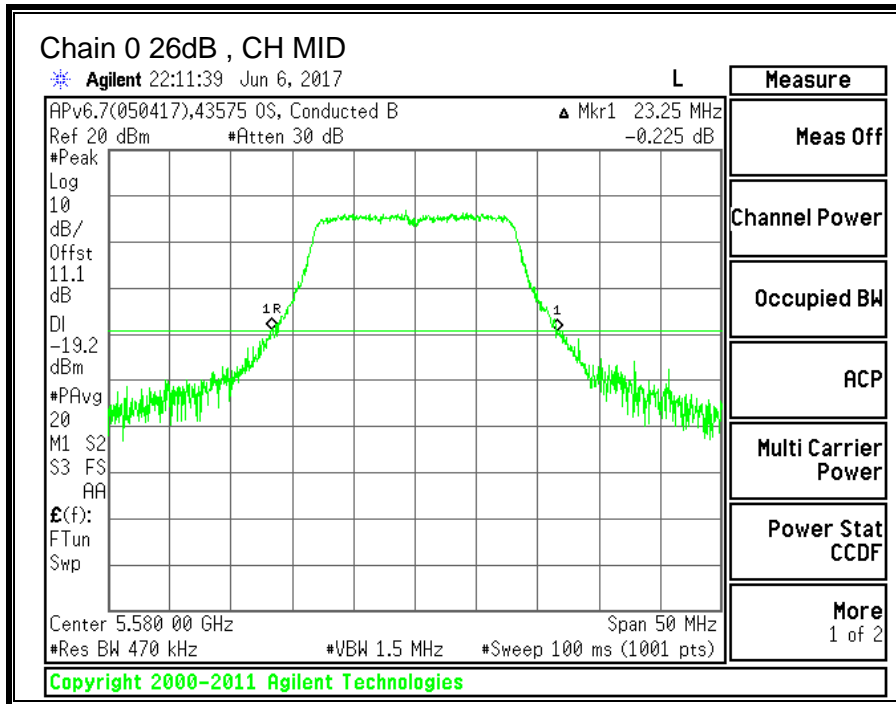

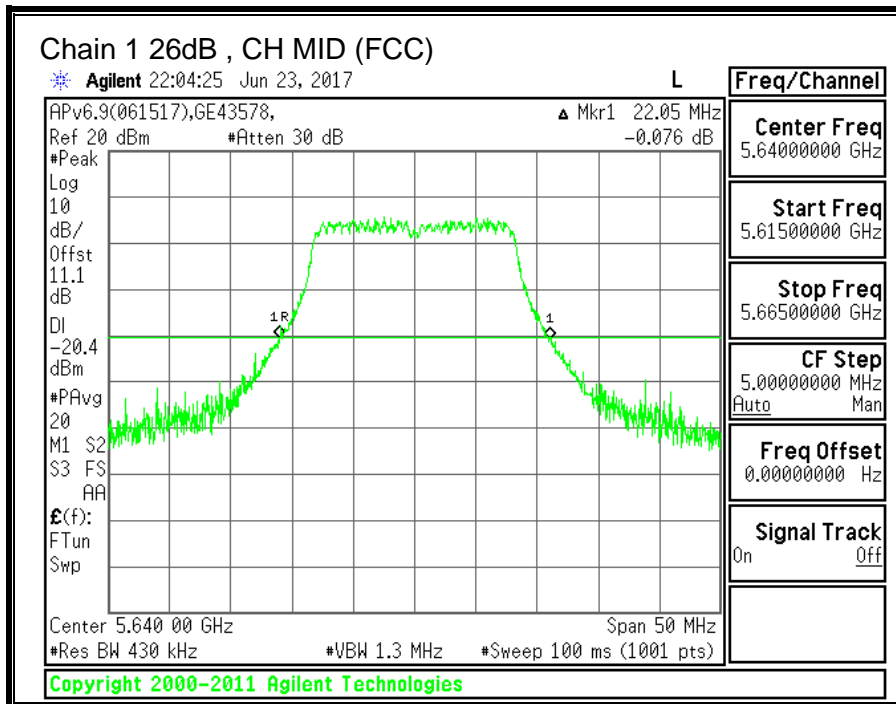
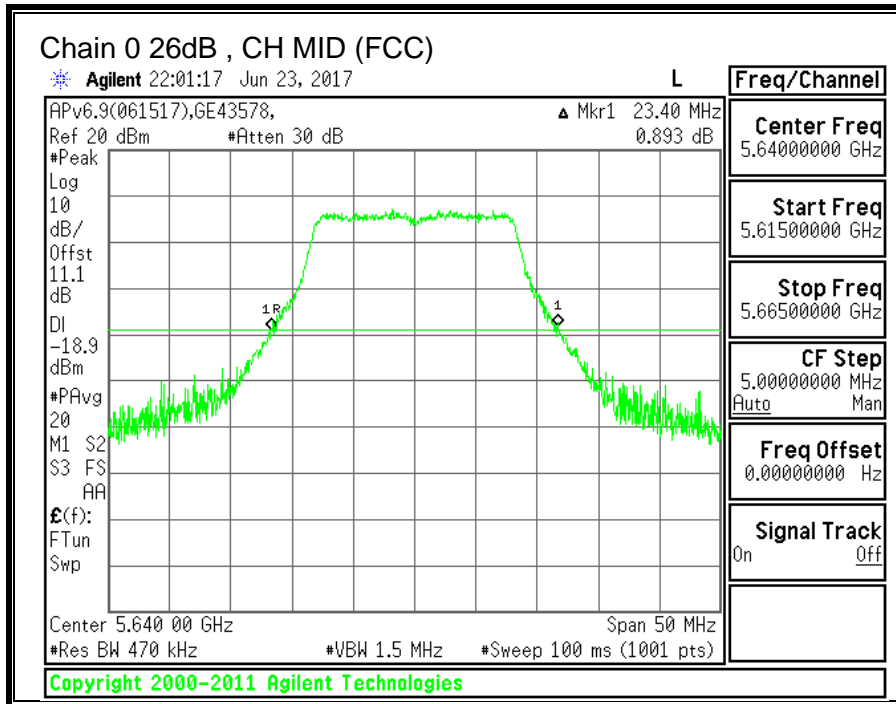

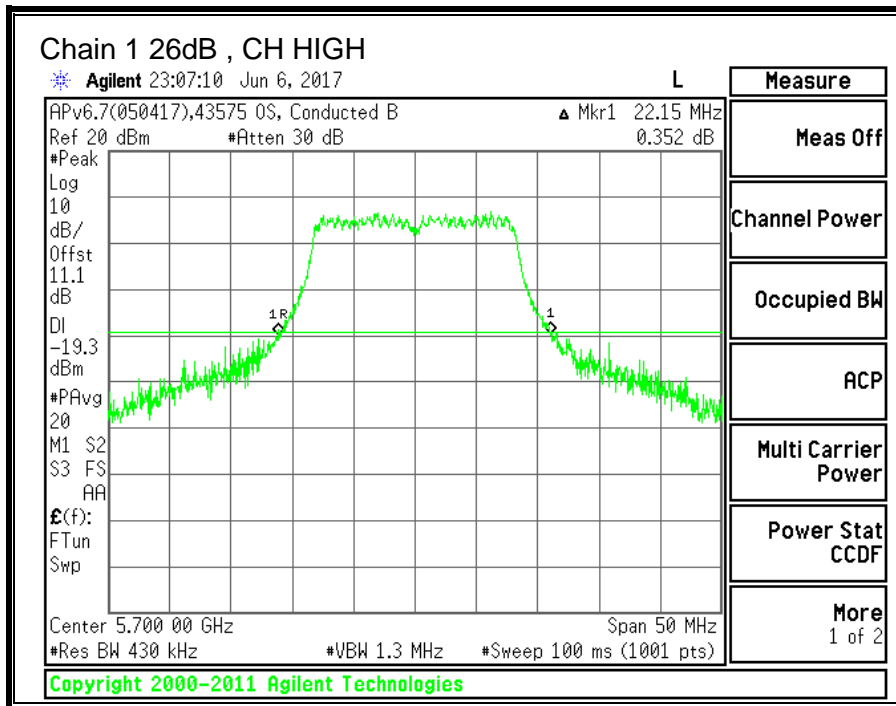
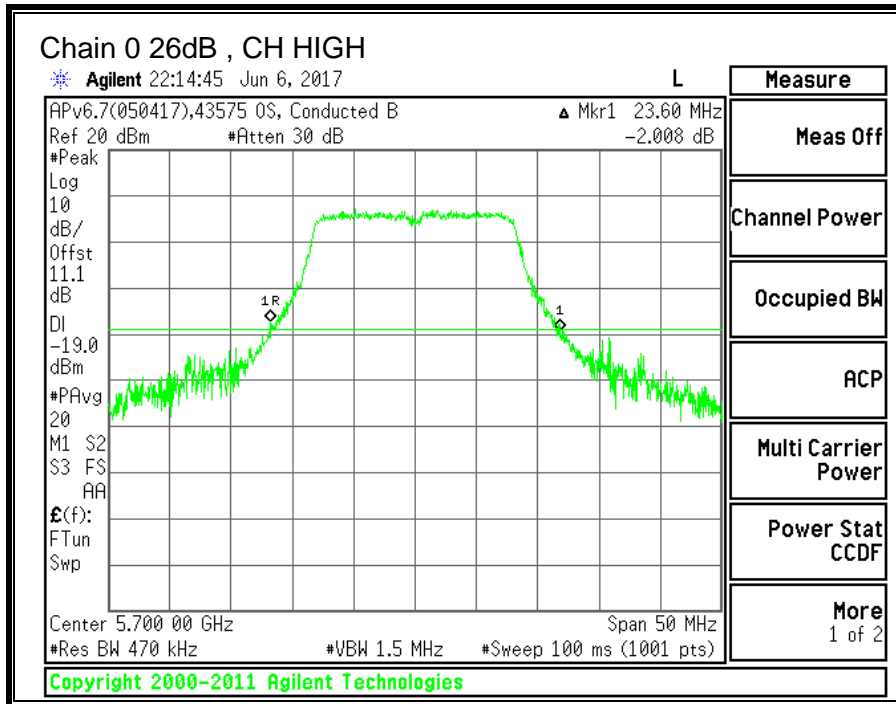

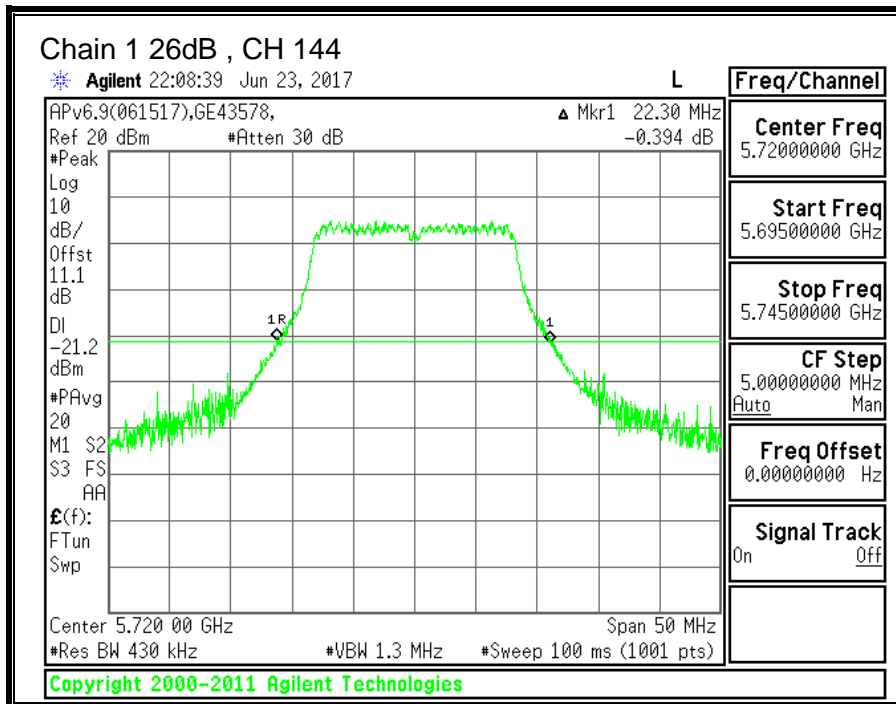
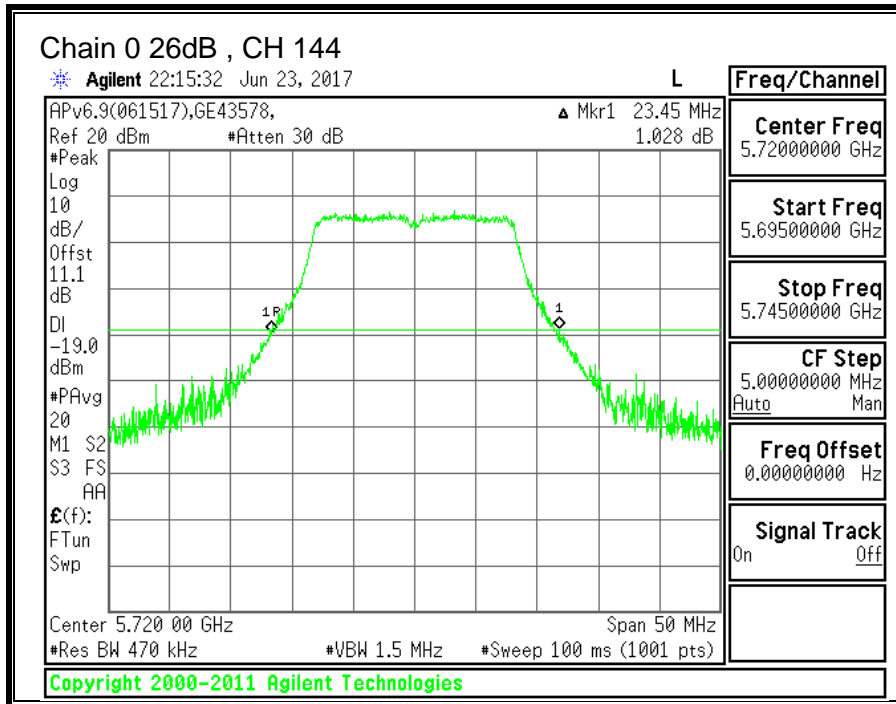

---

**10.9.2. 99% BANDWIDTH**

**LIMITS**

None; for reporting purposes only.

**RESULTS**

<b>Channel</b>	<b>Frequency</b>	<b>99% BW Chain 0 (MHz)</b>	<b>99% BW Chain 1 (MHz)</b>
Low	5500	16.4246	16.2062
Mid	5580	16.5311	16.1327
Mid (FCC)	5640	16.2726	16.0113
High	5700	16.1776	16.4790
144	5720	16.5491	16.3893



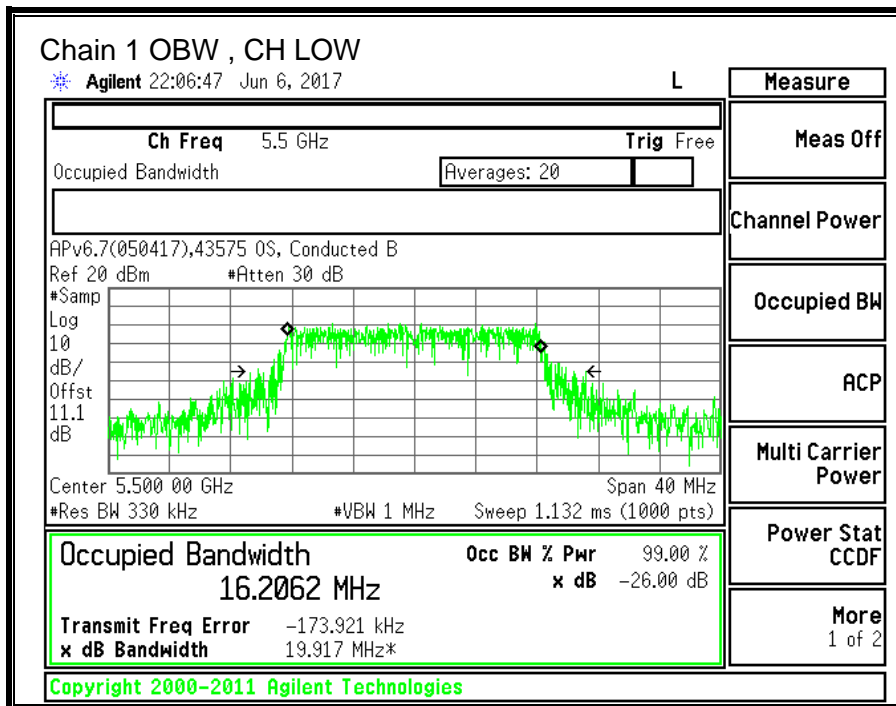
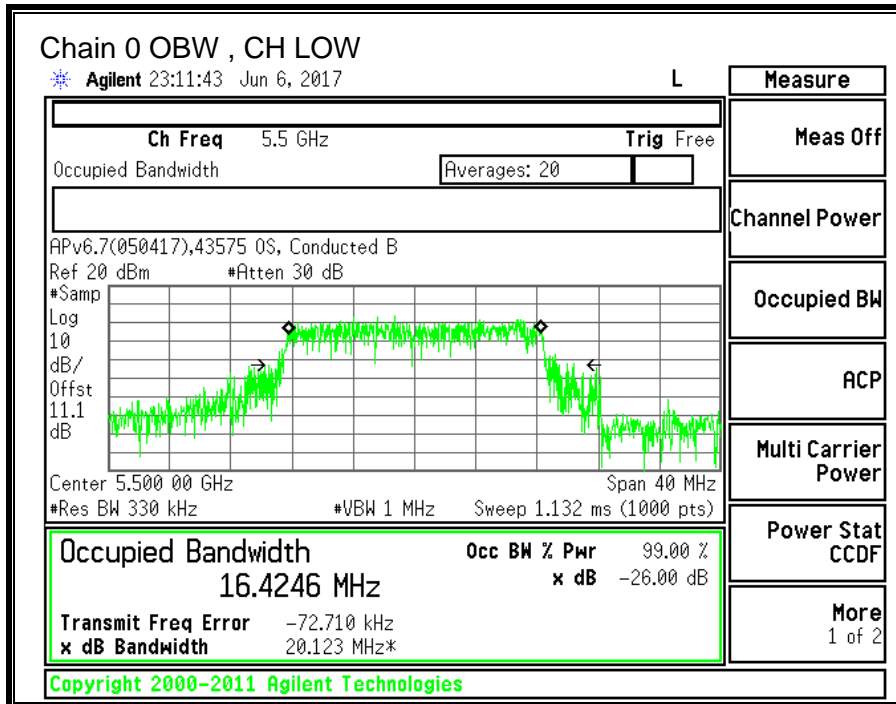

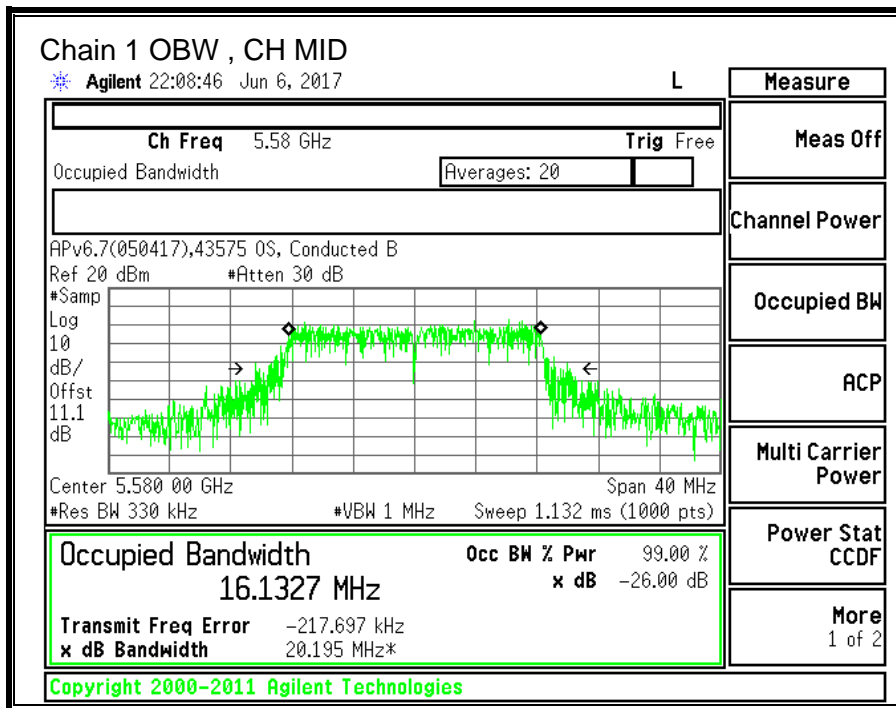
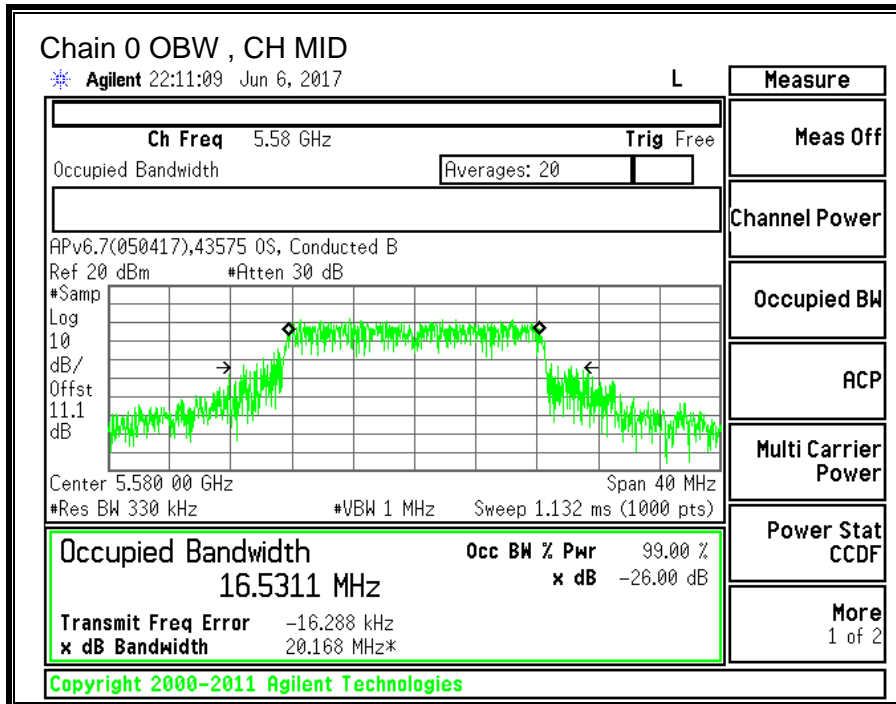

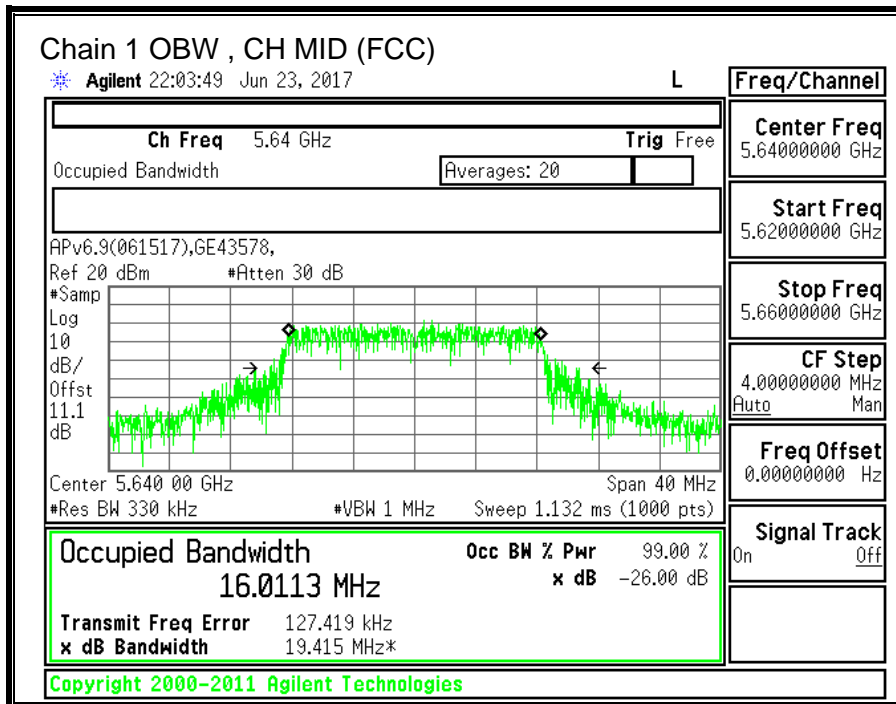
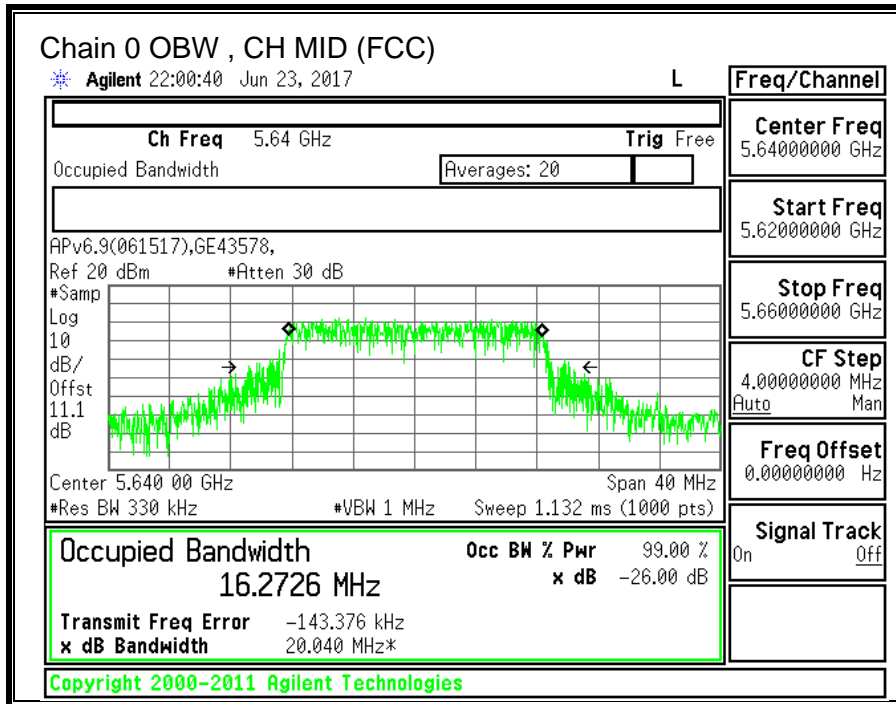

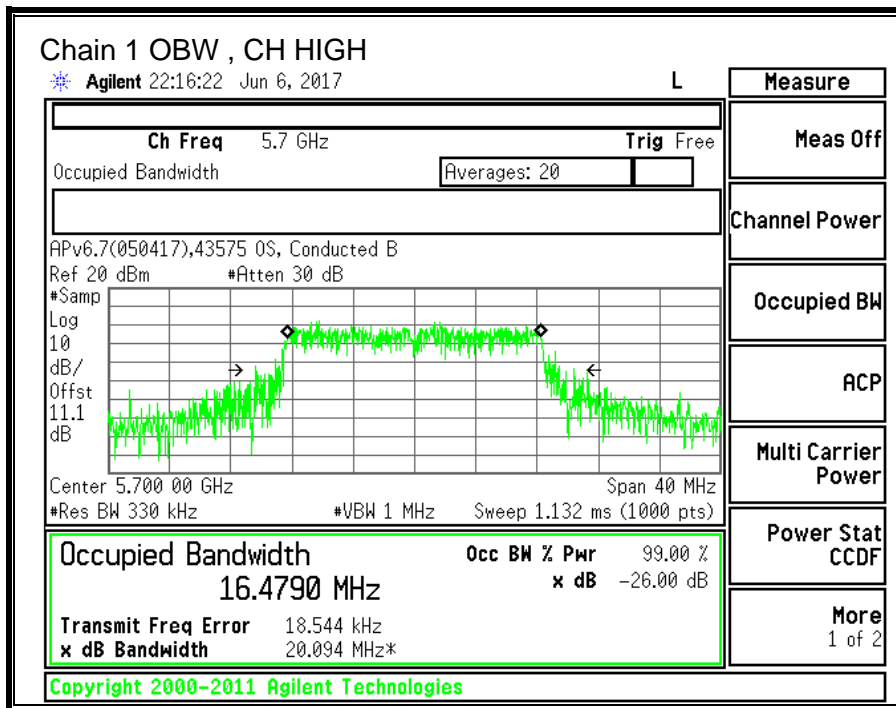
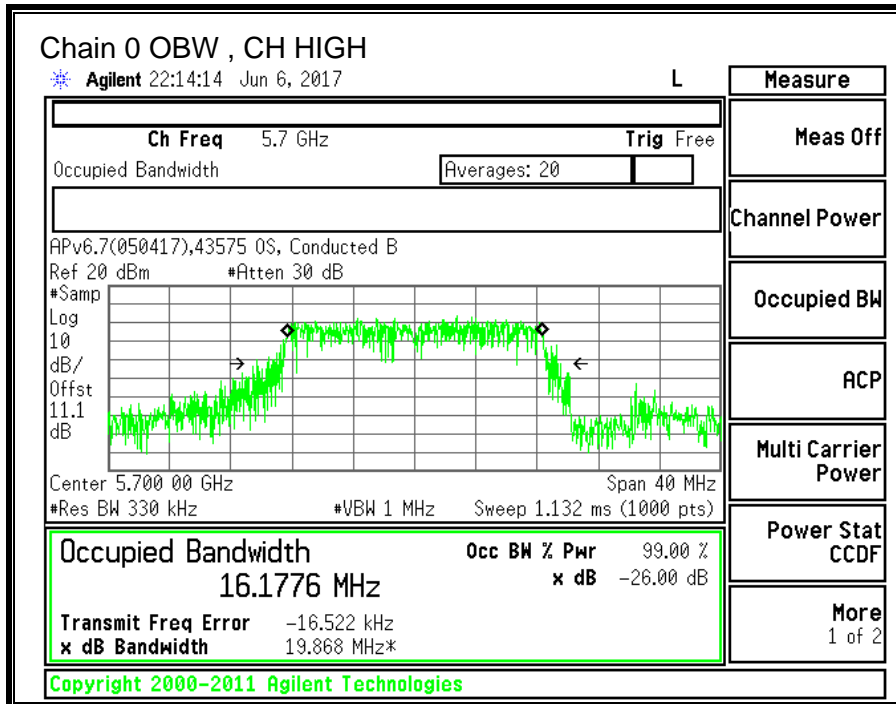

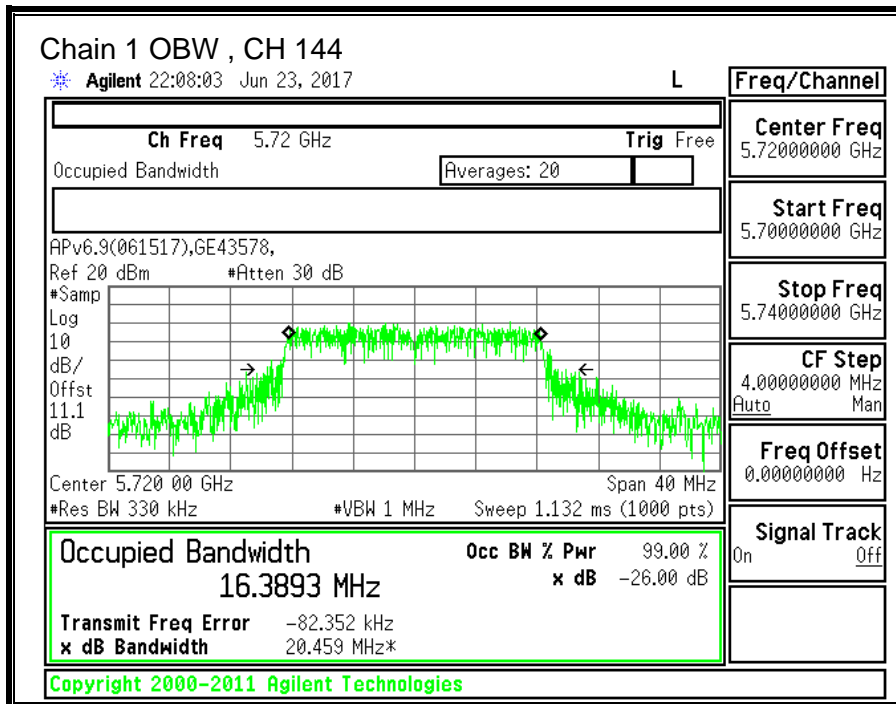
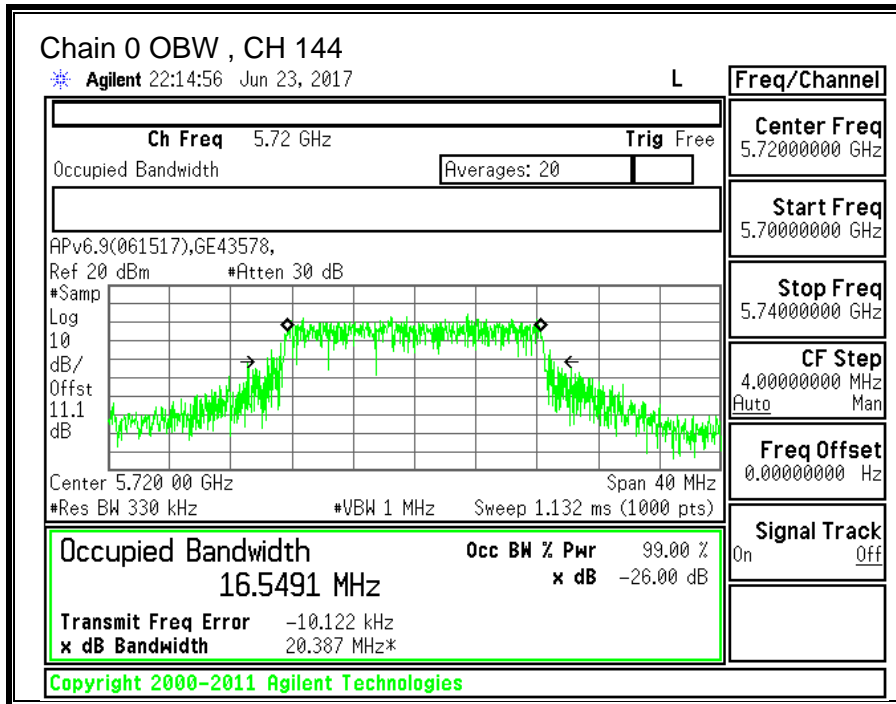

**10.9.3. OUTPUT POWER AND PPSD**

**LIMITS**

FCC §15.407 (a) (2)

For the band 5.47–5.725 GHz, the maximum conducted output power over the frequency band of operation shall not exceed the lesser of 250 mW or 11 dBm + 10 log B, where B is the 26–dB emission bandwidth in MHz. In addition, the maximum power spectral density shall not exceed 11 dBm in any 1–MHz band. If transmitting antennas of directional gain greater than 6 dBi are used, both the maximum conducted output power and the peak power spectral density shall be reduced by the amount in dB that the directional gain of the antenna exceeds 6 dBi.

**TEST PROCEDURE**

Measurements perform using a wideband gated RF power meter provided that the gate parameters are adjusted such that the power is measured only when the EUT is transmitting at its maximum power control level. Since the measurement is made only during the ON time of the transmitter, no duty cycle correction factor is required.

Straddle channel power is measured using PXA spectrum analyzer, duty cycle correction factor is required.

**DIRECTIONAL ANTENNA GAIN**

For power, the TX chains are uncorrelated and the antenna gain is unequal among the chains. The directional gain is:

**5470-5725 MHz**

Chain 0 Antenna Gain (dBi)	Chain 1 Antenna Gain (dBi)	Uncorrelated Chains Directional Gain (dBi)
-3.10	-8.40	-4.99

For PSD the TX chains are correlated and the antenna gain is unequal among the chains. The directional gain is:

**5470-5725 MHz**

Chain 0 Antenna Gain (dBi)	Chain 1 Antenna Gain (dBi)	Correlated Chains Directional Gain (dBi)
-3.10	-8.40	-2.34

**RESULTS**

<b>ID:</b>	43574	<b>Date:</b>	06/06/17
------------	-------	--------------	----------

**Bandwidth and Antenna Gain**

Channel	Frequency (MHz)	Min 26 dB BW (MHz)	Min 99% BW (MHz)	Directional Gain for Power (dBi)	Directional Gain for PPSD (dBi)
Low	5500	22.20	16.2062	-4.99	-2.34
Mid	5580	21.95	16.1327	-4.99	-2.34
Mid (FCC)	5640	22.05	16.0113	-4.99	-2.34
High	5700	22.15	16.1776	-4.99	-2.34
144	5720	22.30	16.3893	-4.99	-2.34

**Limits**

Channel	Frequency (MHz)	FCC Power Limit (dBm)	IC Power Limit (dBm)	IC EIRP Limit (dBm)	Power Limit (dBm)	FCC PPSD Limit (dBm)	IC PSD Limit (dBm)	PPSD Limit (dBm)
Low	5500	24.00	23.10	29.10	23.10	11.00	11.00	11.00
Mid	5580	24.00	23.08	29.08	23.08	11.00	11.00	11.00
Mid (FCC)	5640	24.00	23.04	29.04	23.04	11.00	11.00	11.00
High	5700	24.00	23.09	29.09	23.09	11.00	11.00	11.00
144	5720	24.00	23.15	29.15	23.15	11.00	11.00	11.00

<b>Duty Cycle CF (dB)</b>	0.24	<b>Included in Calculations of Corr'd PPSD</b>
---------------------------	------	--

**Output Power Results**

Channel	Frequency (MHz)	Chain 0 Meas Power (dBm)	Chain 1 Meas Power (dBm)	Total Corr'd Power (dBm)	Power Limit (dBm)	Power Margin (dB)
Low	5500	13.07	12.34	15.73	23.10	-7.37
Mid	5580	13.09	12.40	15.77	23.08	-7.31
Mid (FCC)	5640	13.27	12.23	15.79	23.04	-7.25
High	5700	13.51	12.19	15.91	23.09	-7.18
144	5720	13.44	12.16	15.86	23.15	-7.29

**PPSD Results**

Channel	Frequency (MHz)	Chain 0 Meas PPSD (dBm)	Chain 1 Meas PPSD (dBm)	Total Corr'd PPSD (dBm)	PPSD Limit (dBm)	PPSD Margin (dB)
Low	5500	2.252	1.030	4.93	11.00	-6.07
Mid	5580	2.064	1.024	4.83	11.00	-6.17
Mid (FCC)	5640	2.252	0.070	4.55	11.00	-6.45
High	5700	2.561	0.636	4.95	11.00	-6.05
144	5720	1.873	-0.001	4.29	11.00	-6.71

**Note:** the power readings above were measured with gated method, and the measurement was taken only during the ON time. No duty cycle correction was necessary.

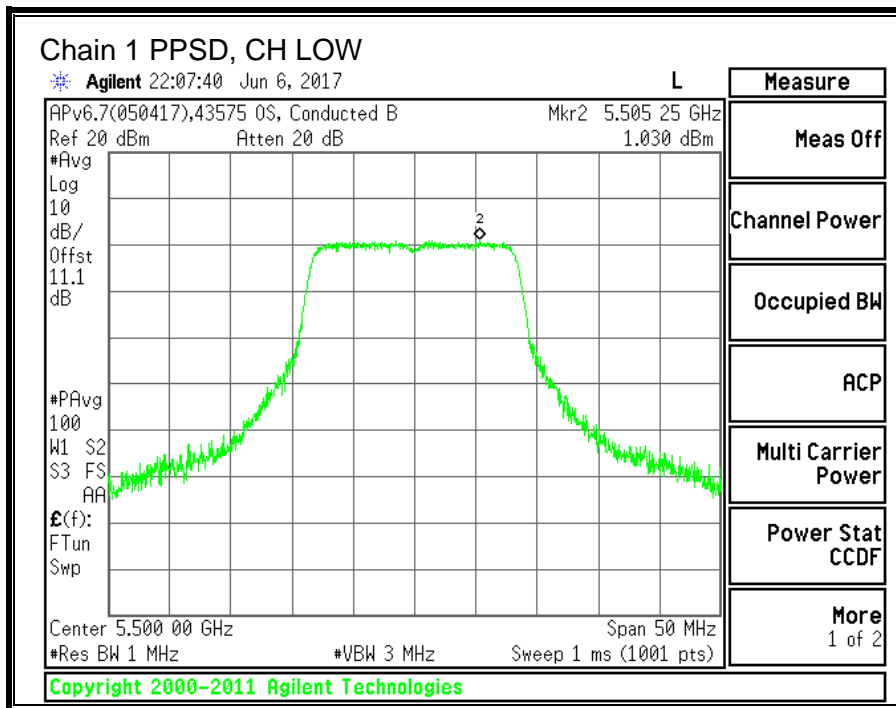
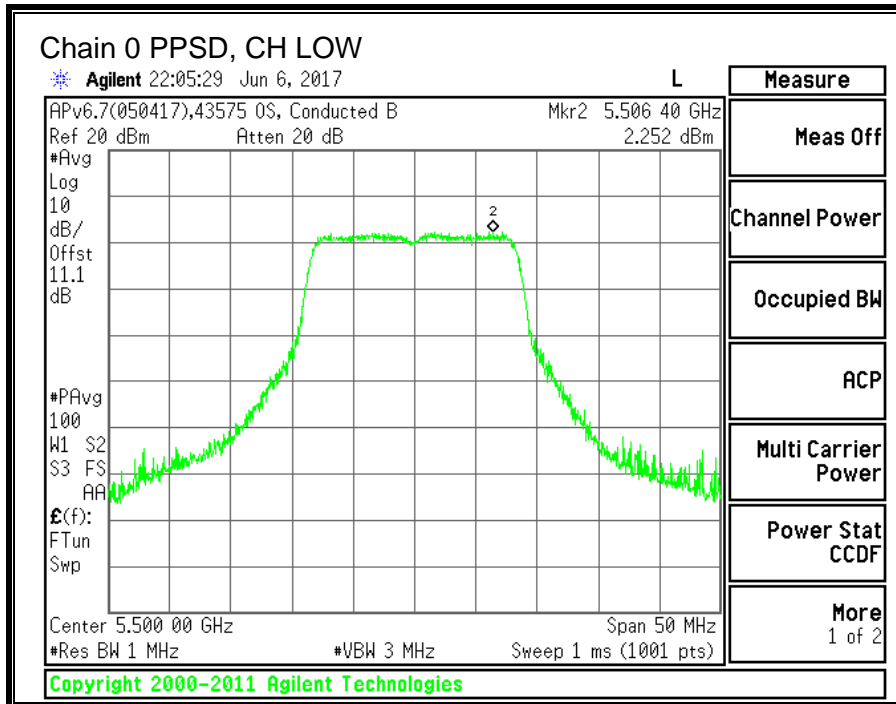



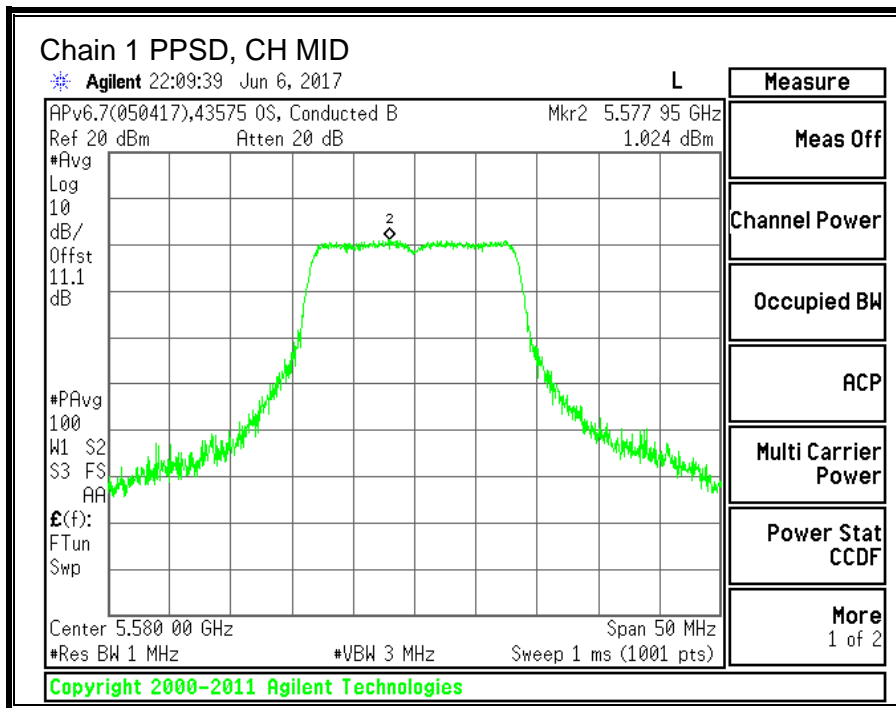
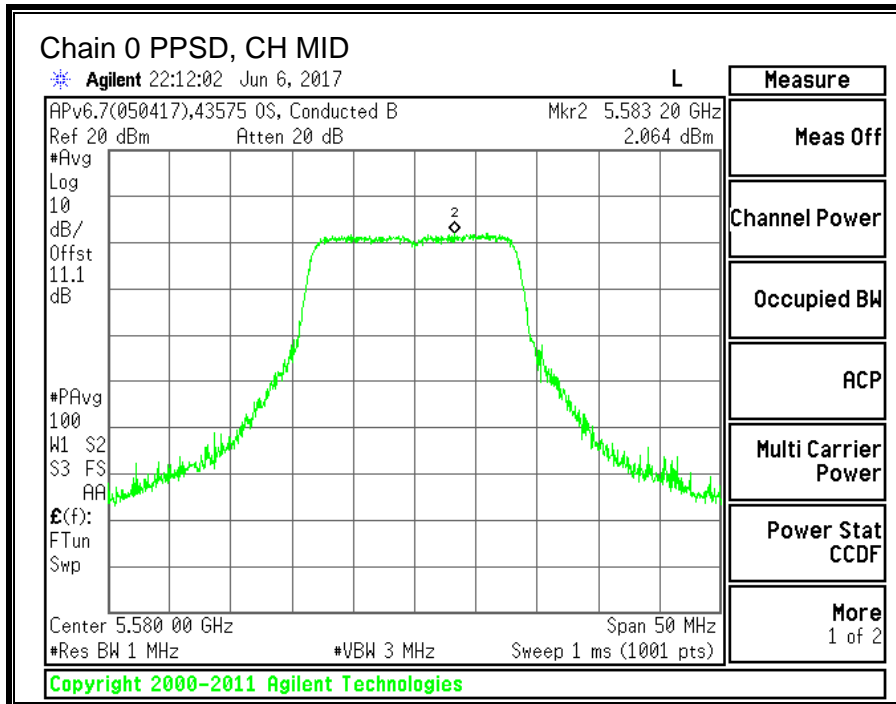

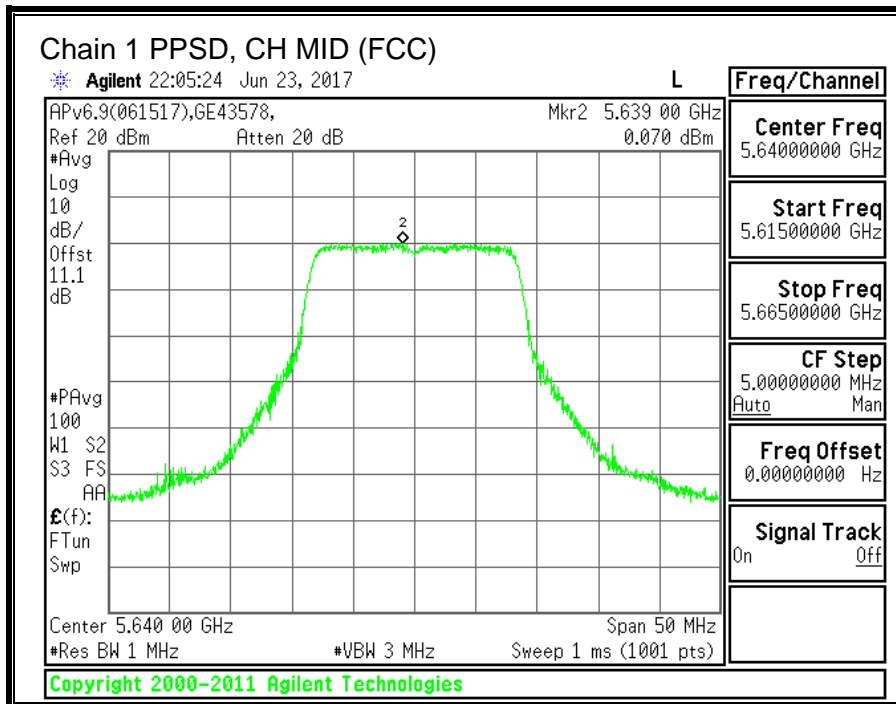
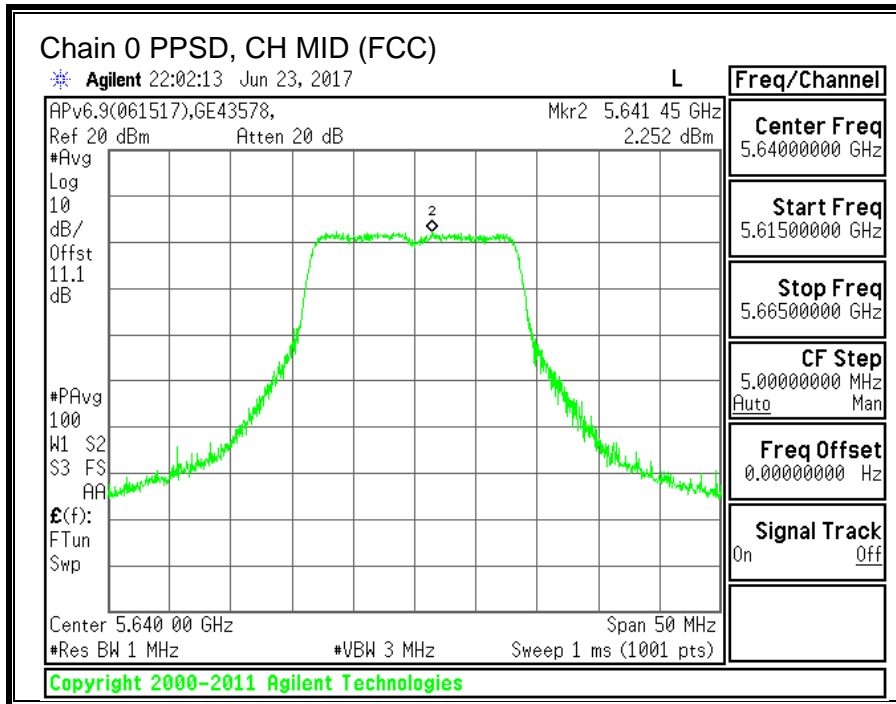

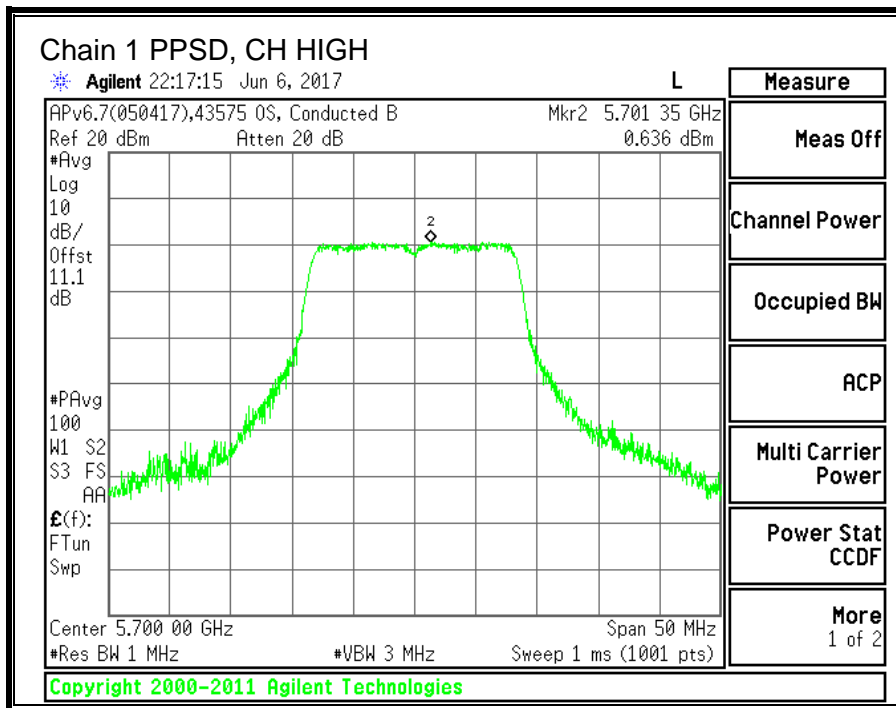
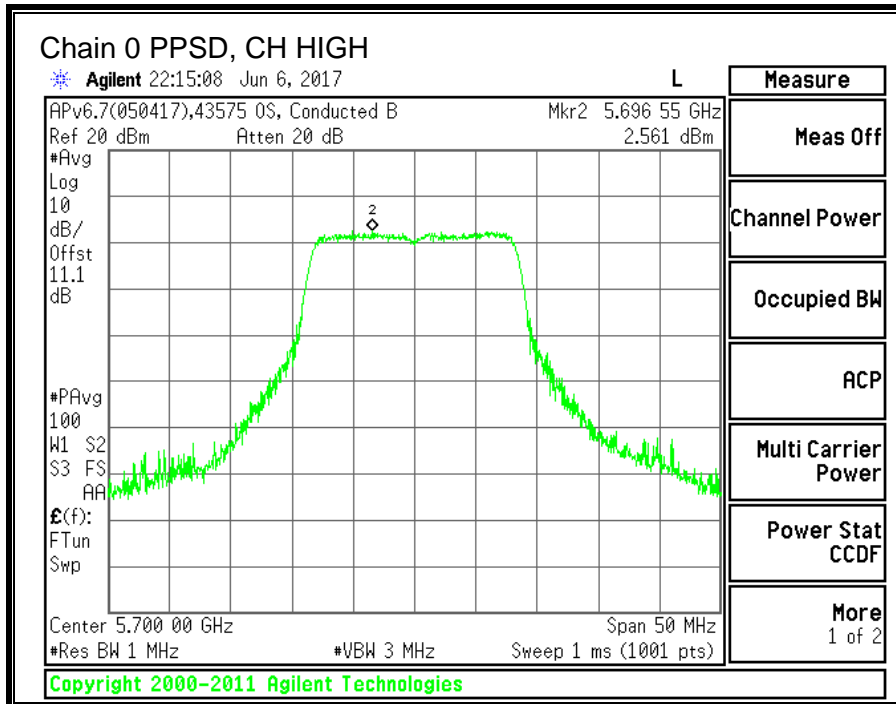

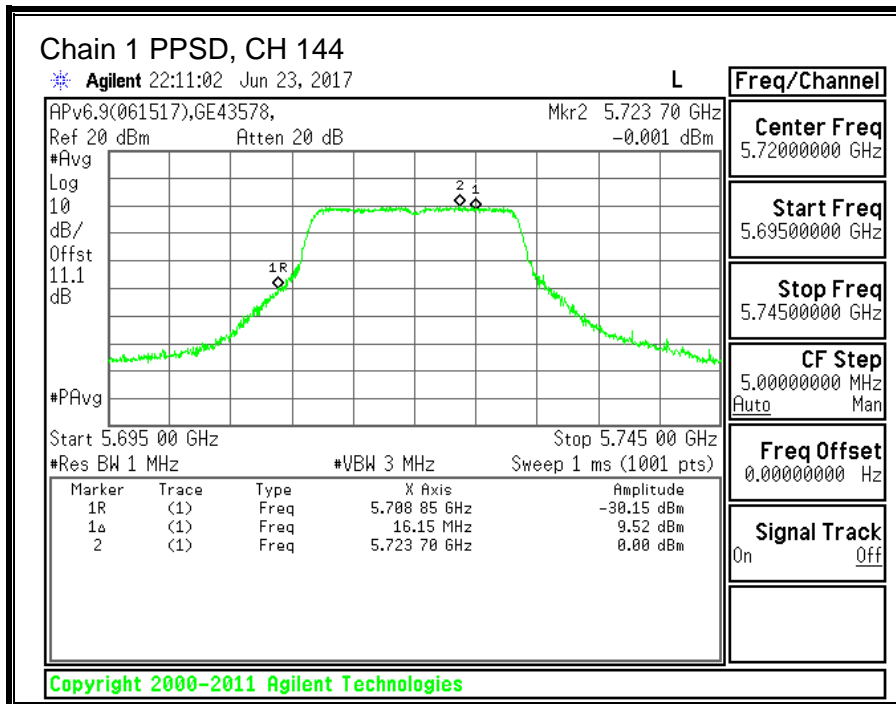
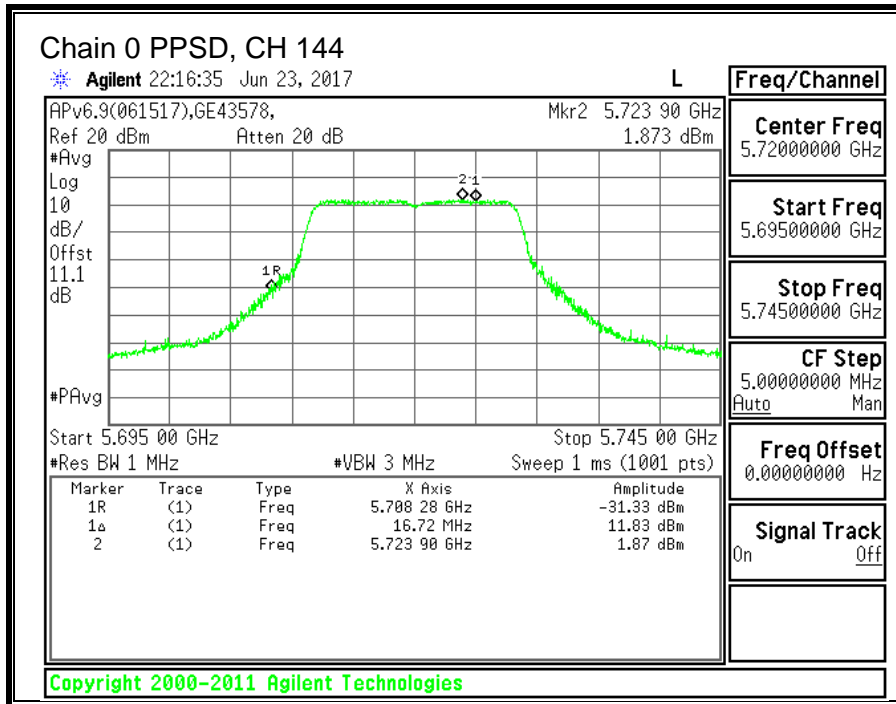

---

**10.10. 11n HT20 2TX CDD MIMO MODE IN THE 5.6GHz BAND**

**10.10.1. 26 dB BANDWIDTH**

**LIMITS**

None; for reporting purposes only.

**RESULTS**

<b>Channel</b>	<b>Frequency</b>	<b>26 dB BW Chain 0 (MHz)</b>	<b>26 dB BW Chain 1 (MHz)</b>
Low	5500	24.65	24.70
Mid	5580	25.30	23.00
Mid (FCC)	5640	24.90	23.15
High	5700	25.10	23.15
144	5720	25.00	23.10

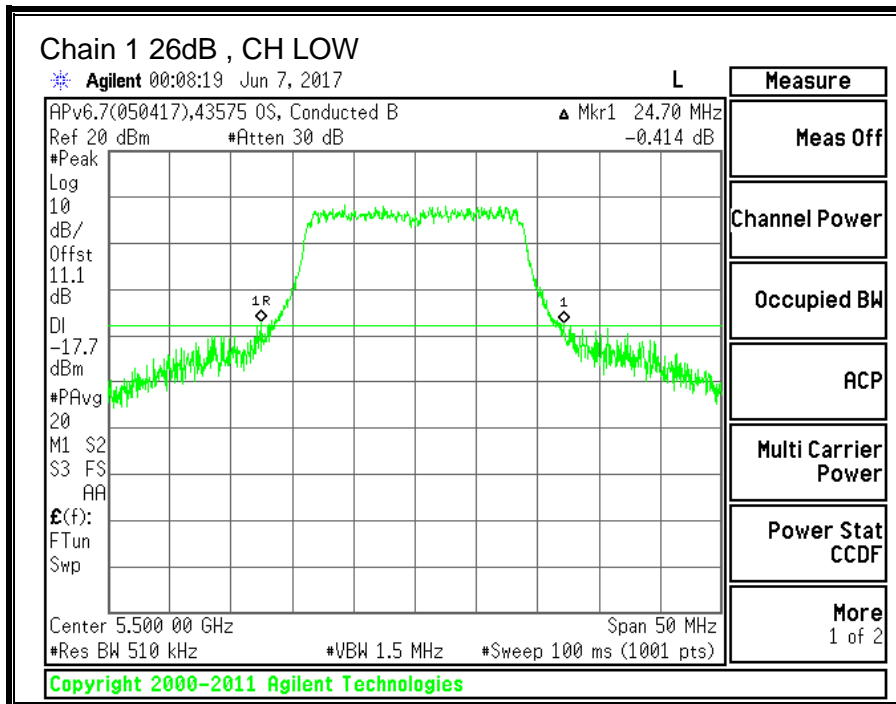
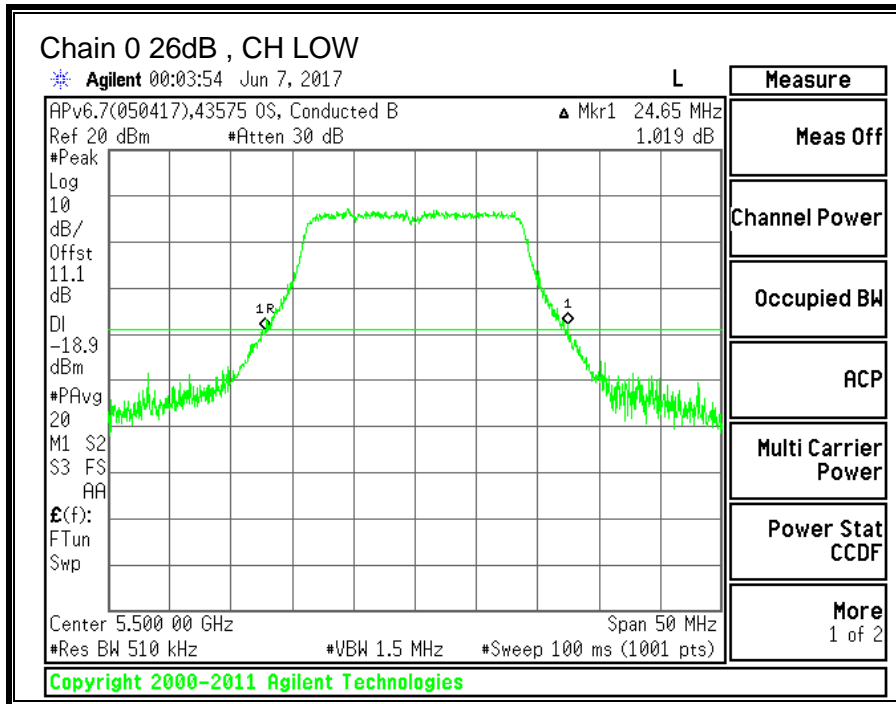

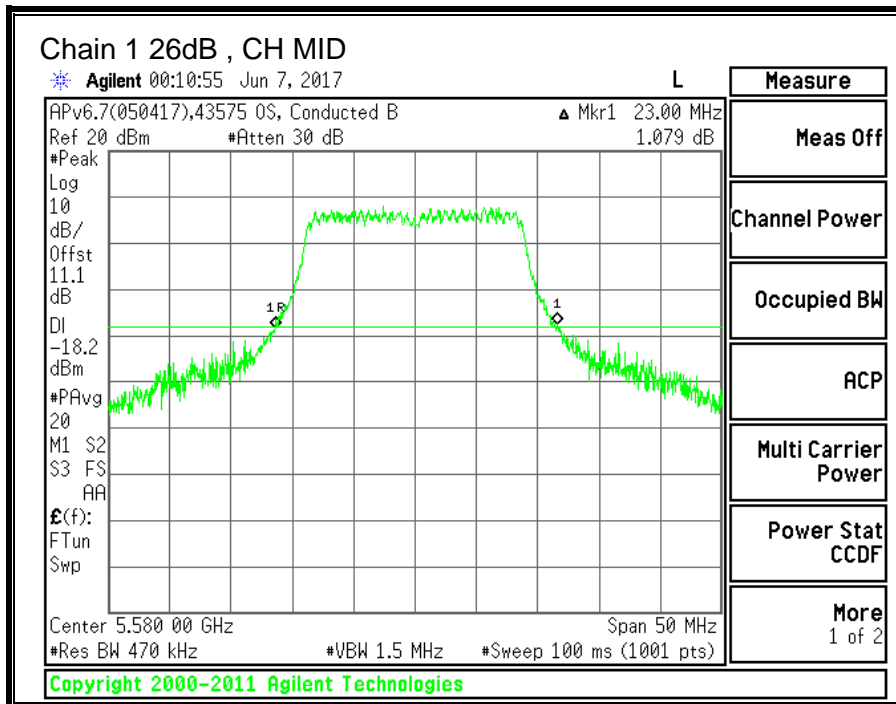
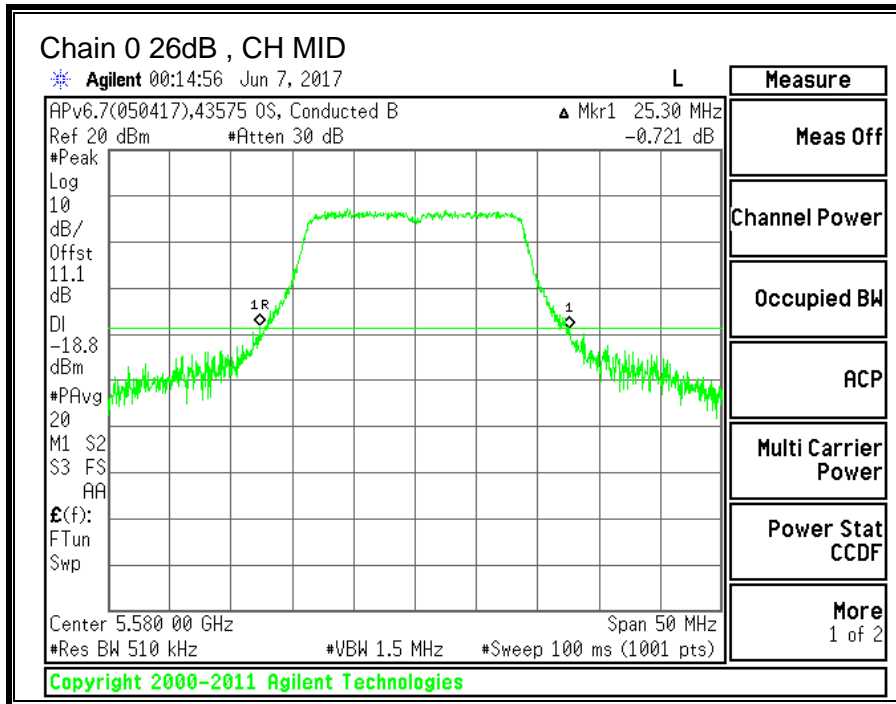

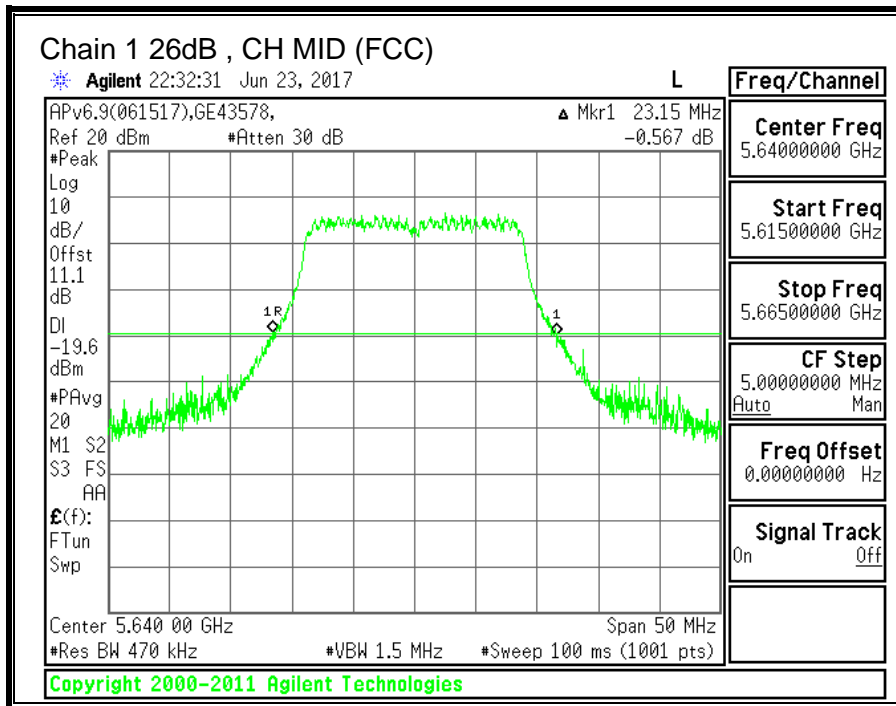
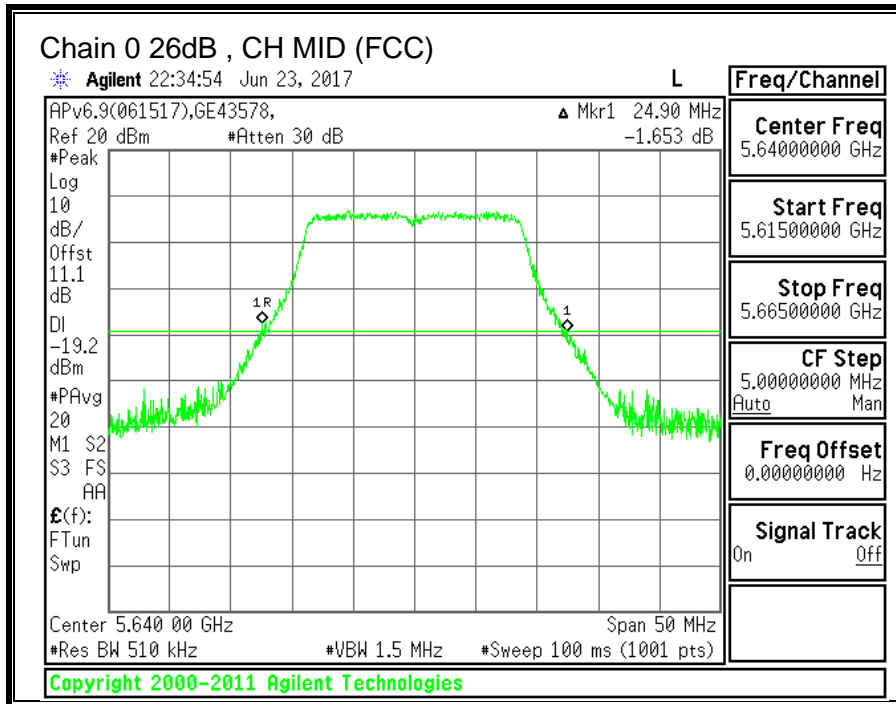



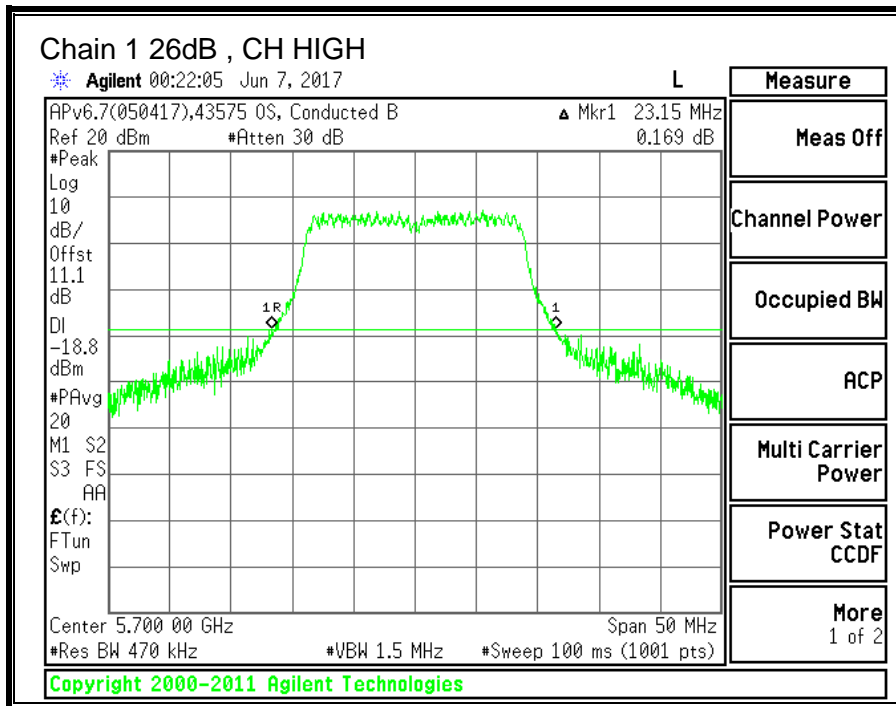
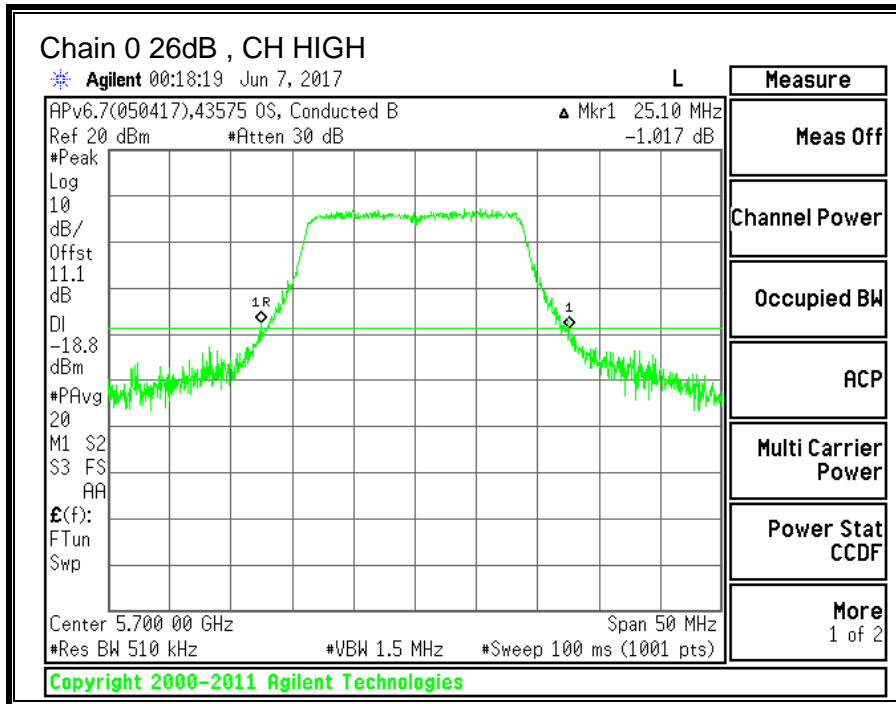

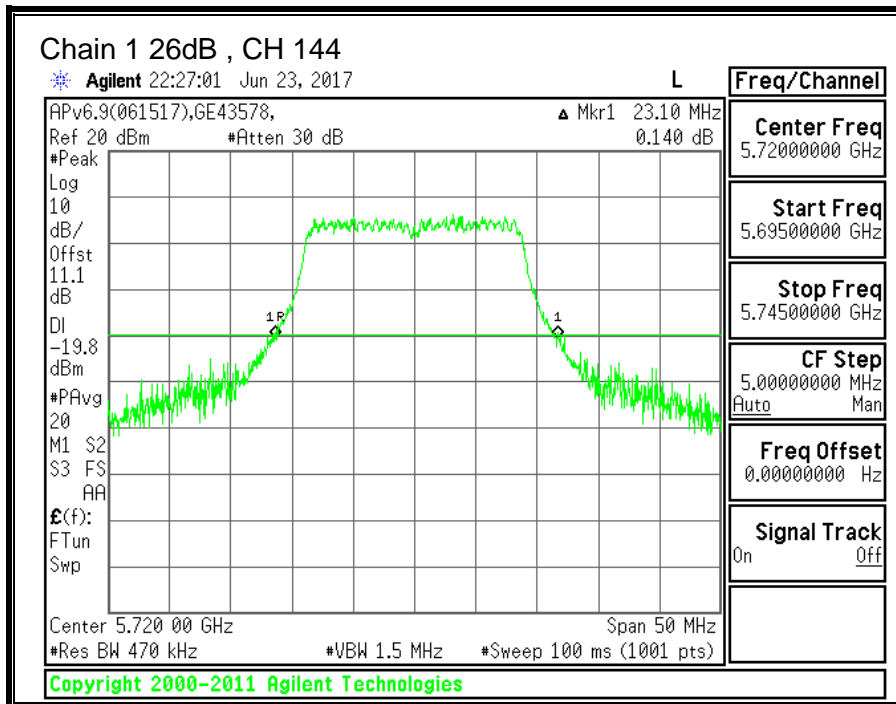
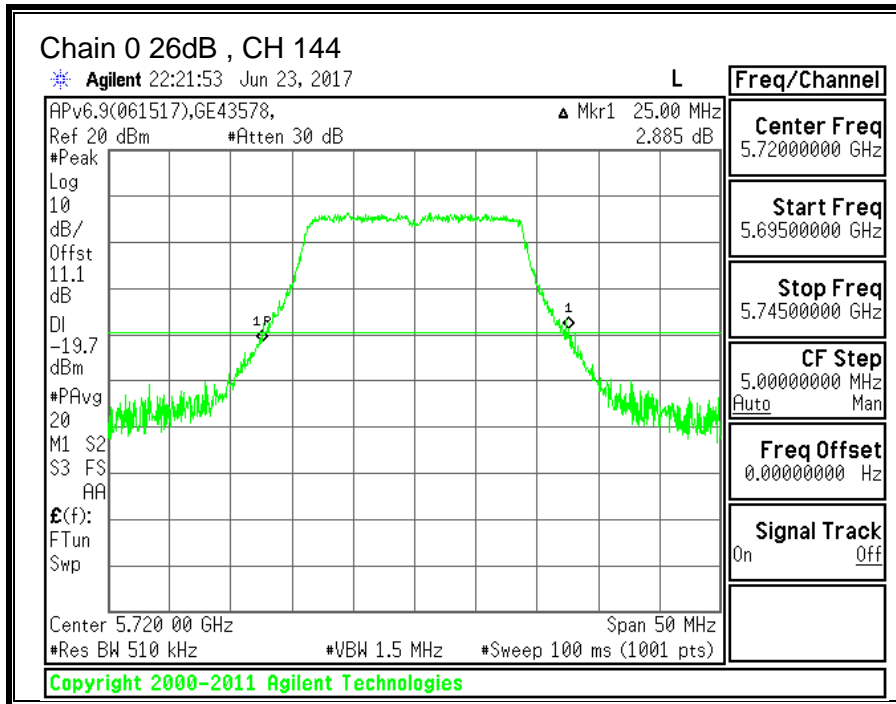

### 10.10.2. 99% BANDWIDTH

#### LIMITS

None; for reporting purposes only.

#### RESULTS

Channel	Frequency	99% BW Chain 0 (MHz)	99% BW Chain 1 (MHz)
Low	5500	17.6356	17.4664
Mid	5580	17.8028	17.3476
Mid (FCC)	5640	17.5687	17.4269
High	5700	17.5538	17.7604
144	5720	17.7302	17.5361

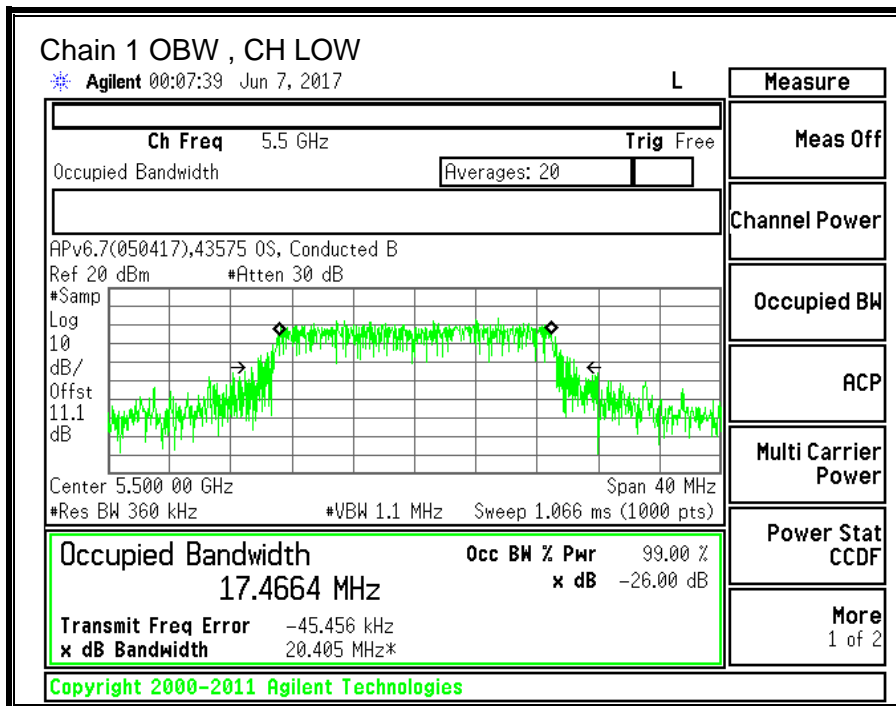
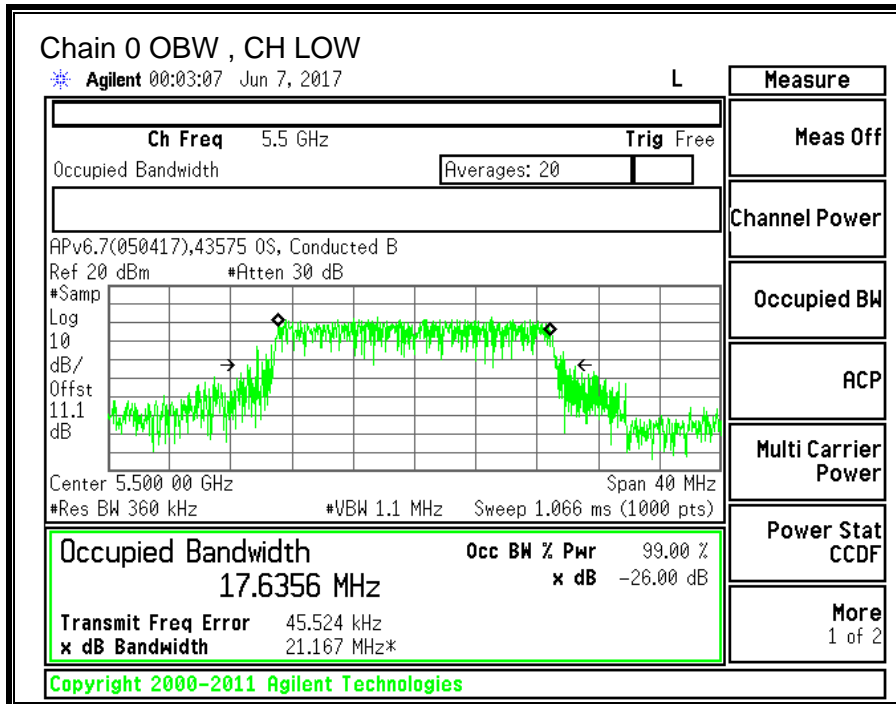

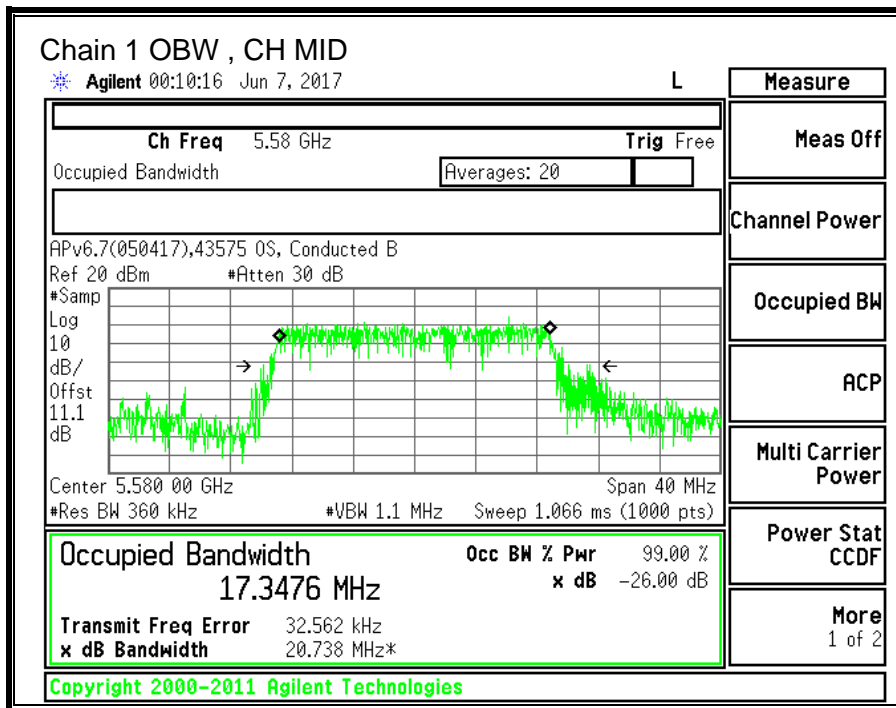
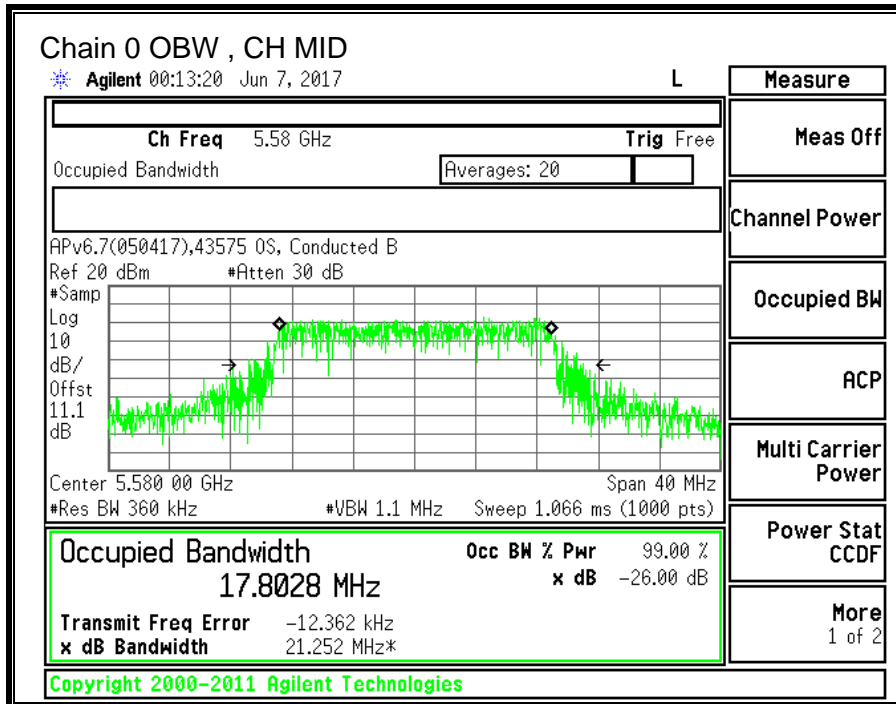

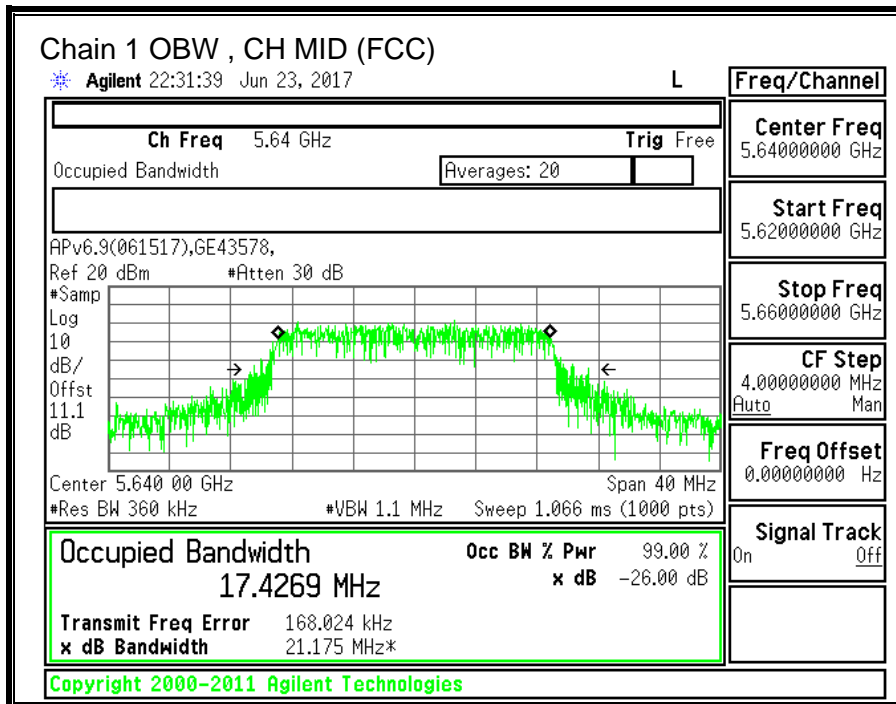
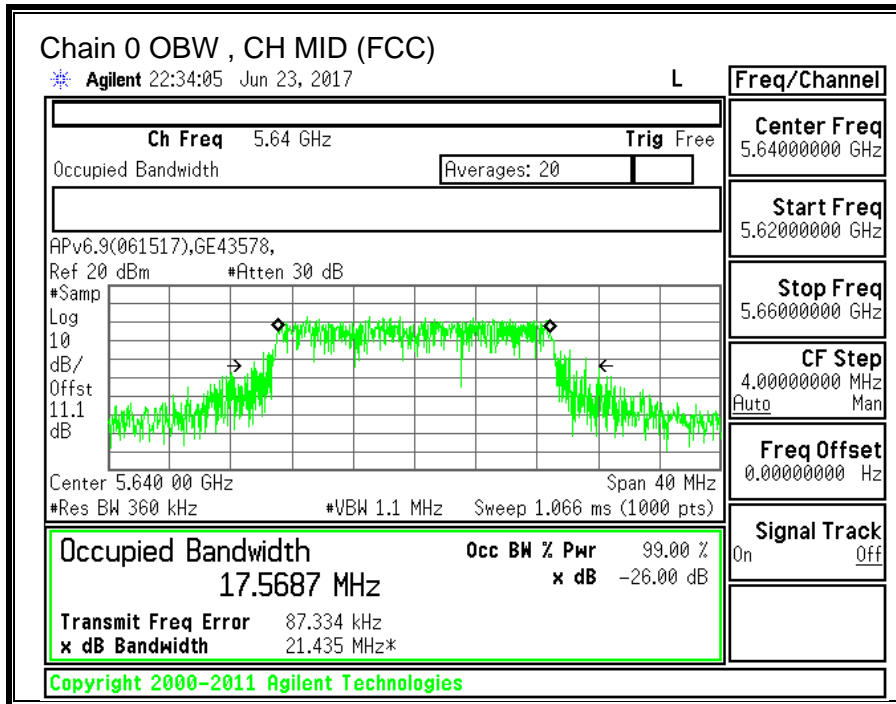

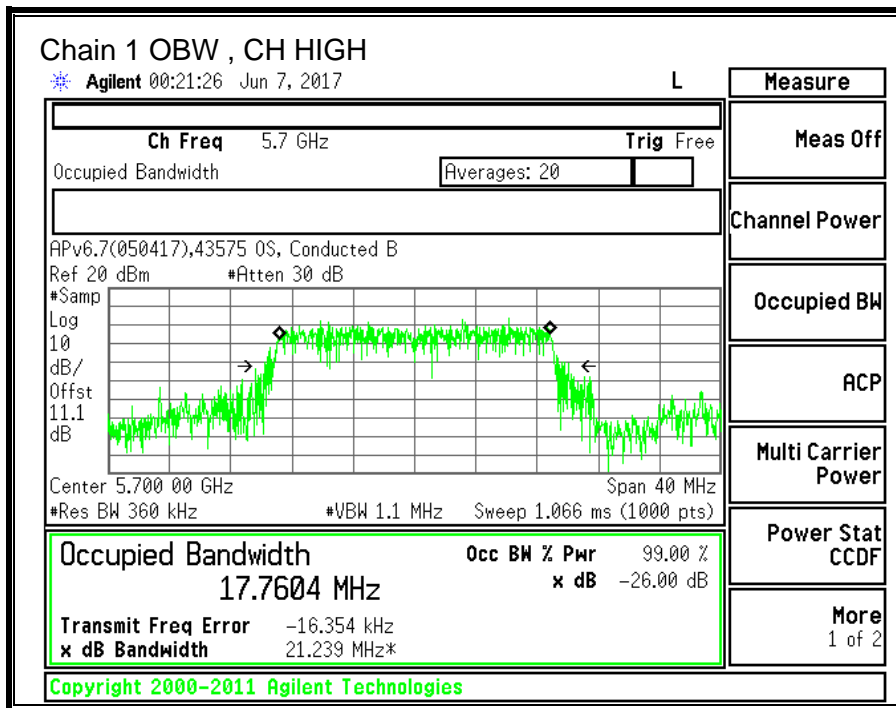
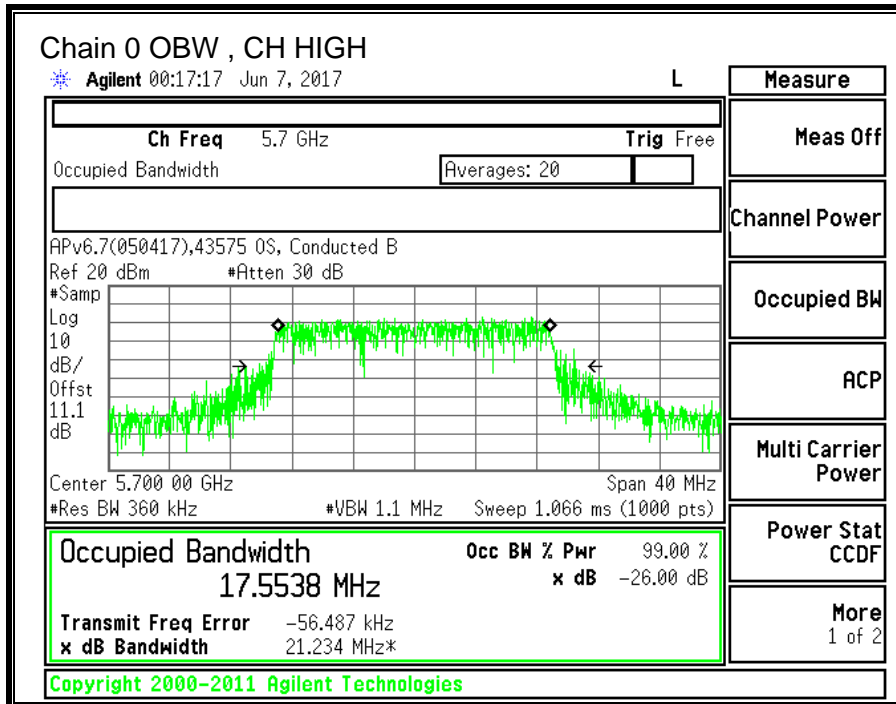

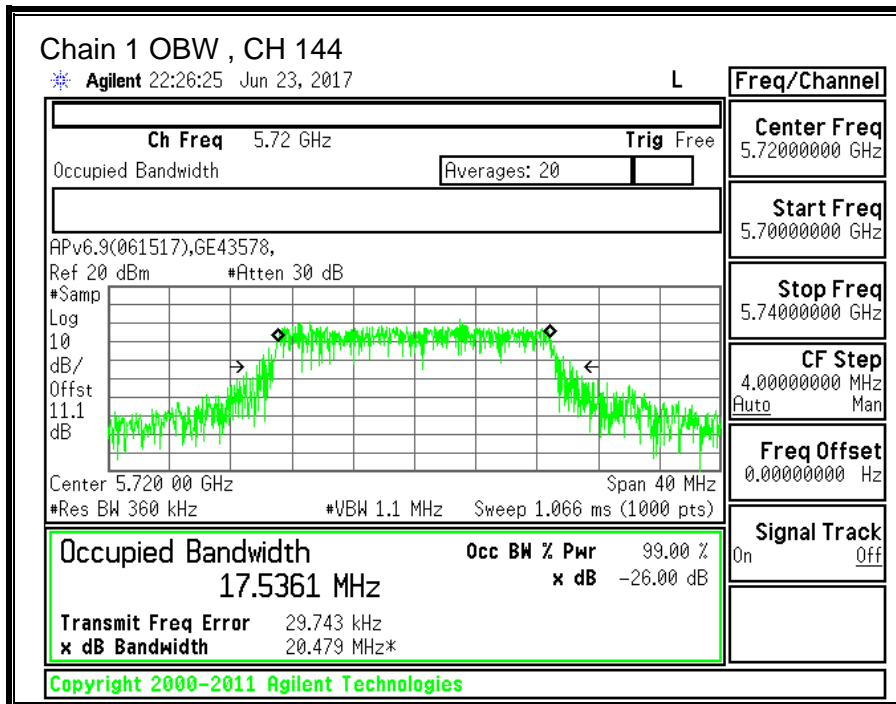
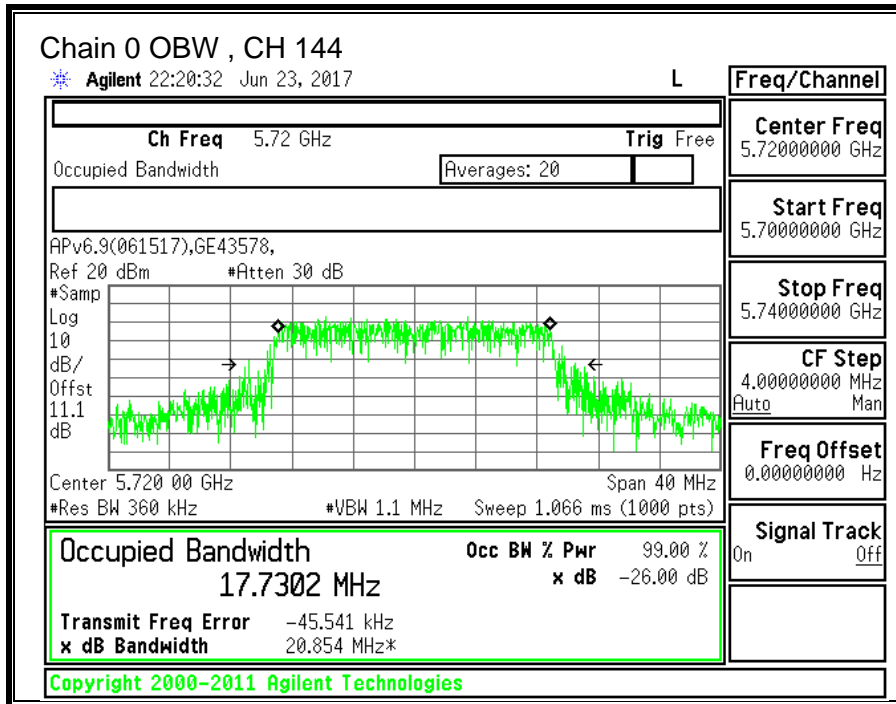



**10.10.3. OUTPUT POWER AND PPSD**

**LIMITS**

FCC §15.407 (a) (2)

For the band 5.47–5.725 GHz, the maximum conducted output power over the frequency band of operation shall not exceed the lesser of 250 mW or 11 dBm + 10 log B, where B is the 26–dB emission bandwidth in MHz. In addition, the maximum power spectral density shall not exceed 11 dBm in any 1–MHz band. If transmitting antennas of directional gain greater than 6 dBi are used, both the maximum conducted output power and the peak power spectral density shall be reduced by the amount in dB that the directional gain of the antenna exceeds 6 dBi.

**TEST PROCEDURE**

Measurements perform using a wideband gated RF power meter provided that the gate parameters are adjusted such that the power is measured only when the EUT is transmitting at its maximum power control level. Since the measurement is made only during the ON time of the transmitter, no duty cycle correction factor is required.

Straddle channel power is measured using PXA spectrum analyzer, duty cycle correction factor is required.

**DIRECTIONAL ANTENNA GAIN**

For power, the TX chains are uncorrelated and the antenna gain is unequal among the chains. The directional gain is:

**5470-5725 MHz**

Chain 0 Antenna Gain (dBi)	Chain 1 Antenna Gain (dBi)	Uncorrelated Chains Directional Gain (dBi)
-3.10	-8.40	-4.99

For PSD the TX chains are correlated and the antenna gain is unequal among the chains. The directional gain is:

**5470-5725 MHz**

Chain 0 Antenna Gain (dBi)	Chain 1 Antenna Gain (dBi)	Correlated Chains Directional Gain (dBi)
-3.10	-8.40	-2.34

**RESULTS**

<b>ID:</b>	43574	<b>Date:</b>	06/06/17
------------	-------	--------------	----------

**Bandwidth and Antenna Gain**

Channel	Frequency (MHz)	Min 26 dB BW (MHz)	Min 99% BW (MHz)	Directional Gain for Power (dBi)	Directional Gain for PPSD (dBi)
Low	5500	24.65	17.466	-4.99	-2.34
Mid	5580	23.00	17.348	-4.99	-2.34
Mid (FCC)	5640	23.15	17.427	-4.99	-2.34
High	5700	23.15	17.554	-4.99	-2.34
144	5720	23.10	17.536	-4.99	-2.34

**Limits**

Channel	Frequency (MHz)	FCC Power Limit (dBm)	IC Power Limit (dBm)	IC EIRP Limit (dBm)	Power Limit (dBm)	FCC PPSD Limit (dBm)	IC PSD Limit (dBm)	PPSD Limit (dBm)
Low	5500	24.00	23.42	29.42	23.42	11.00	11.00	11.00
Mid	5580	24.00	23.39	29.39	23.39	11.00	11.00	11.00
Mid (FCC)	5640	24.00	23.41	29.41	23.41	11.00	11.00	11.00
High	5700	24.00	23.44	29.44	23.44	11.00	11.00	11.00
144	5720	24.00	23.44	29.44	23.44	11.00	11.00	11.00

<b>Duty Cycle CF (dB)</b>	0.20	<b>Included in Calculations of Corr'd PPSD</b>
---------------------------	------	--

**Output Power Results**

Channel	Frequency (MHz)	Chain 0 Meas Power (dBm)	Chain 1 Meas Power (dBm)	Total Corr'd Power (dBm)	Power Limit (dBm)	Power Margin (dB)
Low	5500	13.56	12.95	16.28	23.42	-7.15
Mid	5580	13.45	12.83	16.16	23.39	-7.23
Mid (FCC)	5640	13.21	12.31	15.79	23.41	-7.62
High	5700	13.33	12.06	15.75	23.44	-7.69
144	5720	13.40	12.12	15.82	23.44	-7.62

**PPSD Results**

Channel	Frequency (MHz)	Chain 0 Meas PPSD (dBm)	Chain 1 Meas PPSD (dBm)	Total Corr'd PPSD (dBm)	PPSD Limit (dBm)	PPSD Margin (dB)
Low	5500	2.051	1.996	5.23	11.00	-5.77
Mid	5580	2.372	1.514	5.17	11.00	-5.83
Mid (FCC)	5640	1.830	-0.027	4.21	11.00	-6.79
High	5700	2.338	0.866	4.87	11.00	-6.13
144	5720	1.677	-0.203	4.05	11.00	-6.95

**Note:** the power readings above were measured with gated method, and the measurement was taken only during the ON time. No duty cycle correction was necessary.

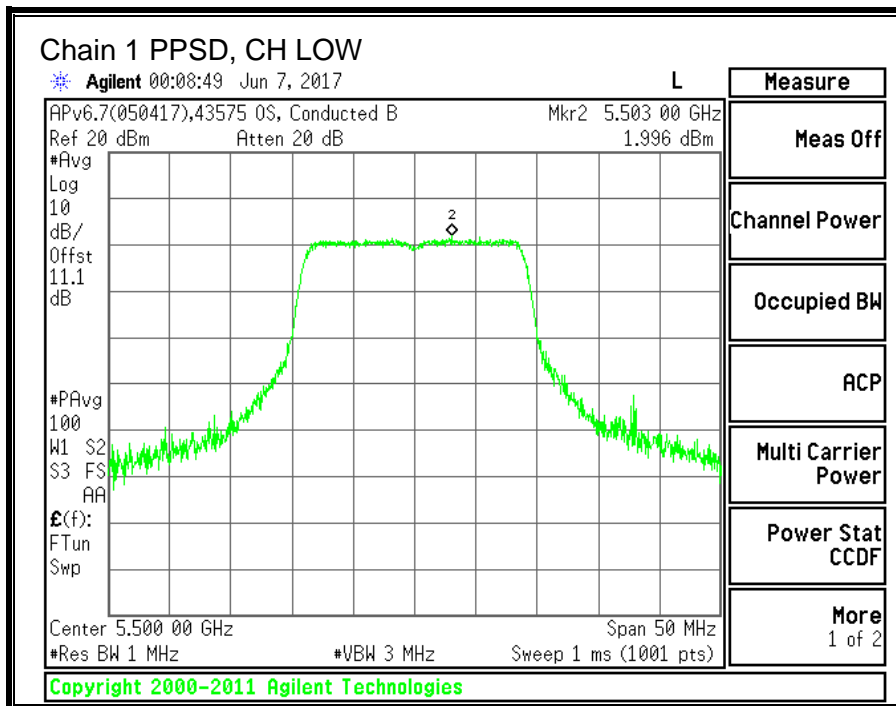
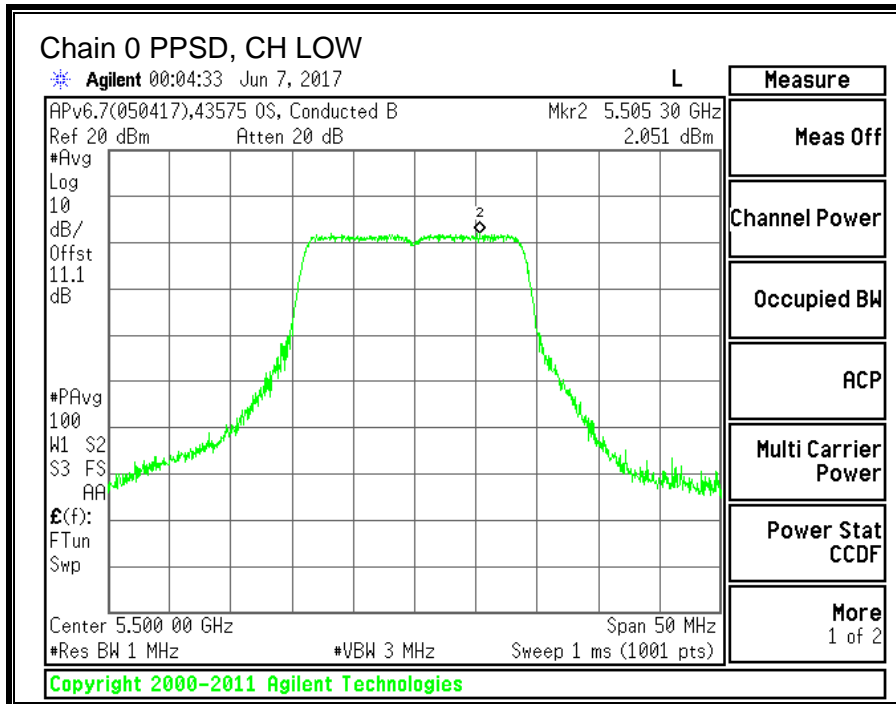

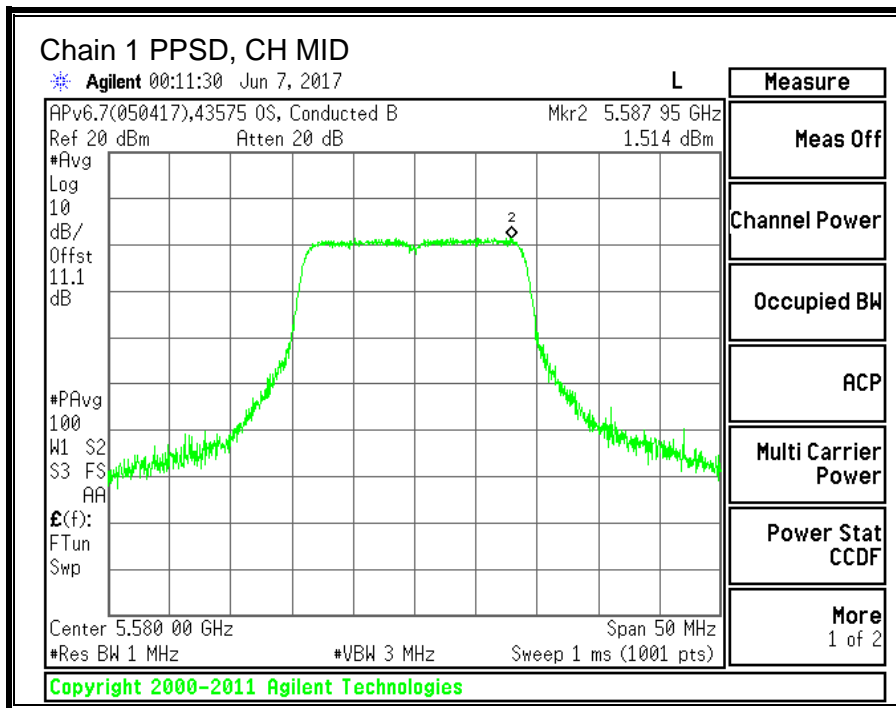
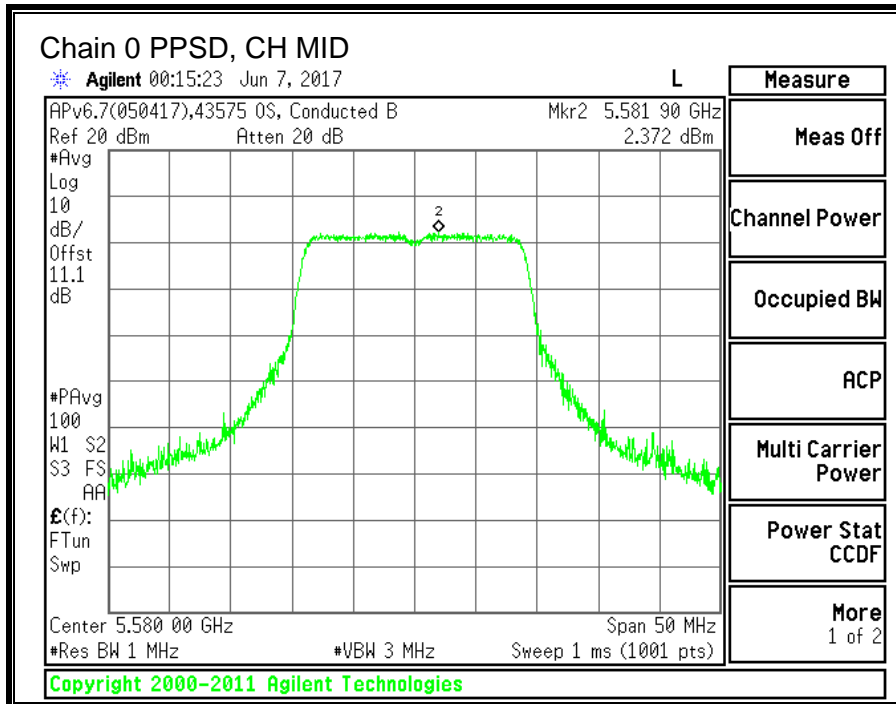

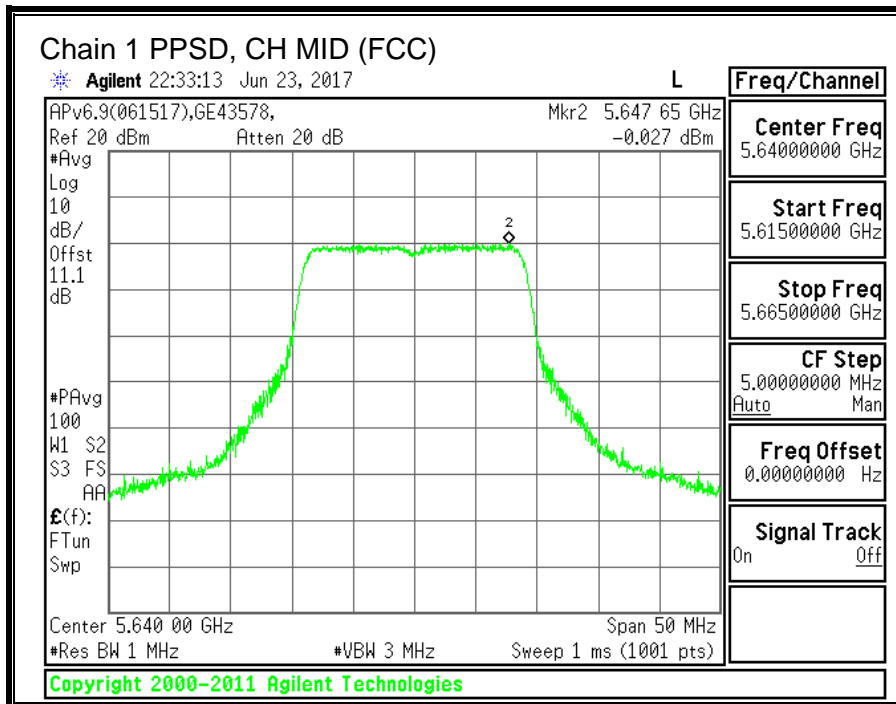
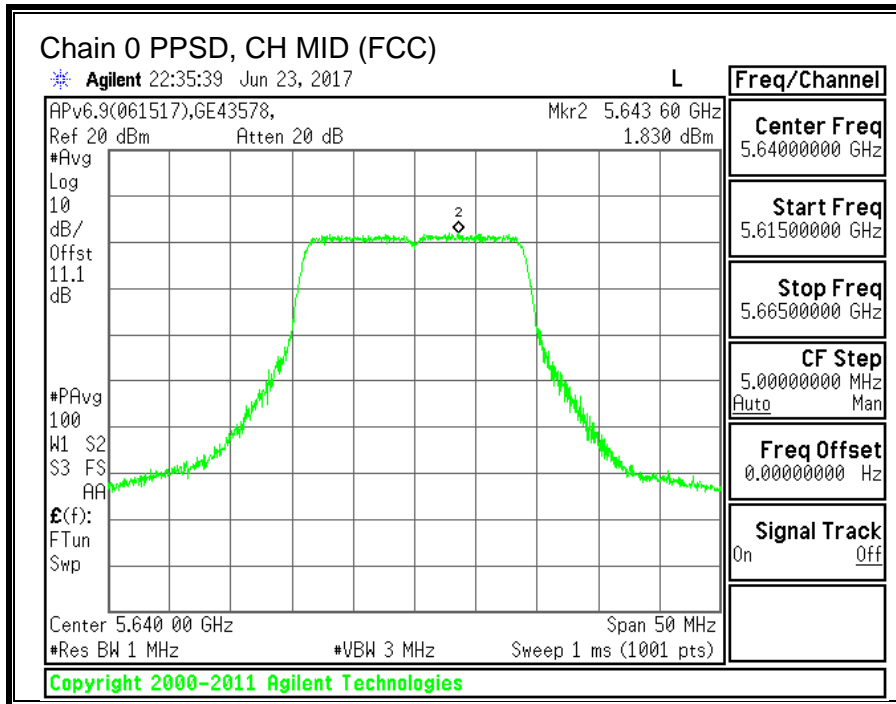

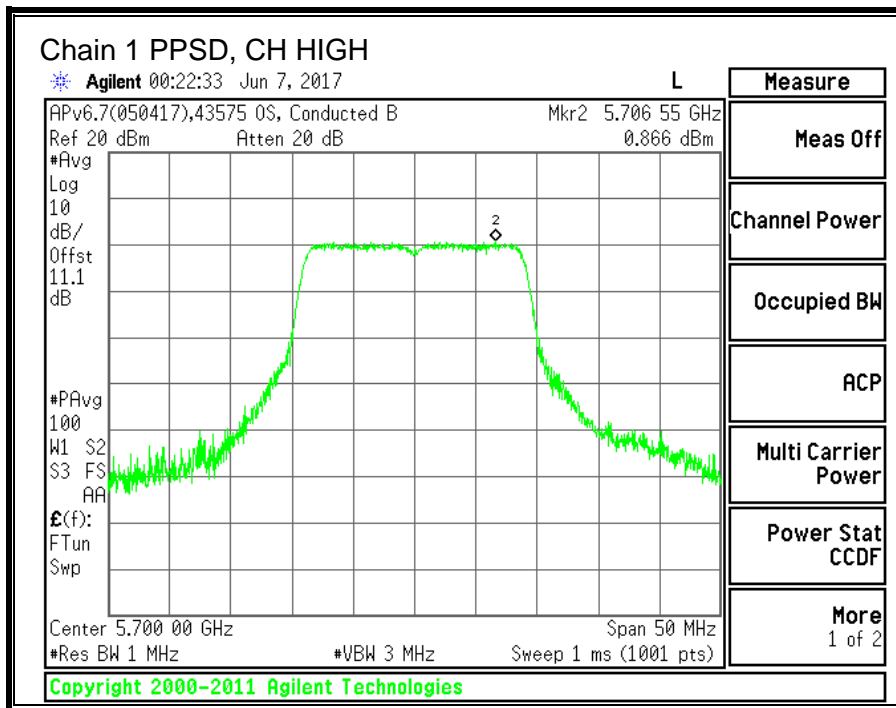
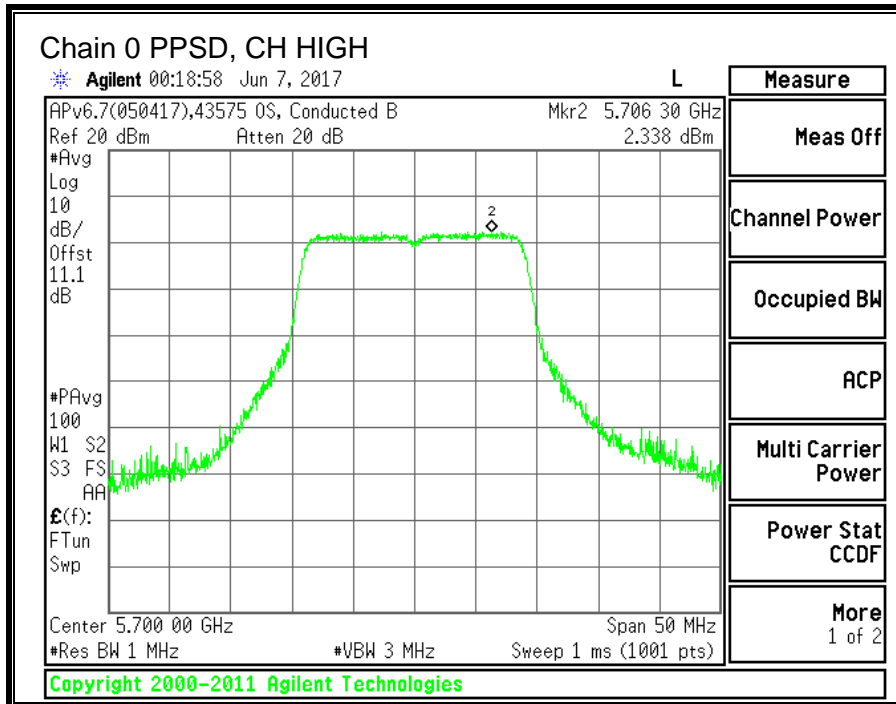

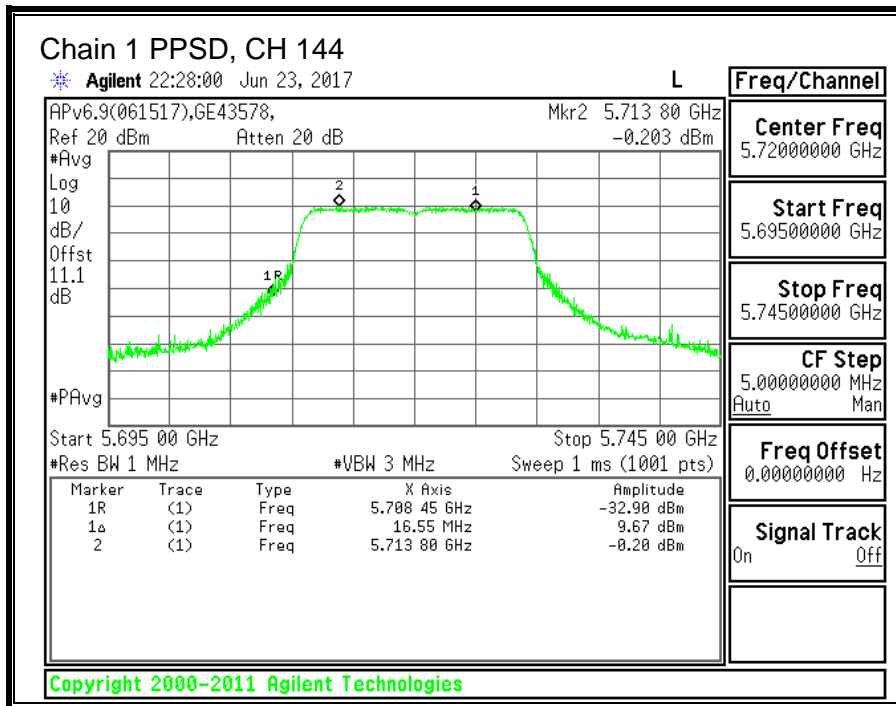
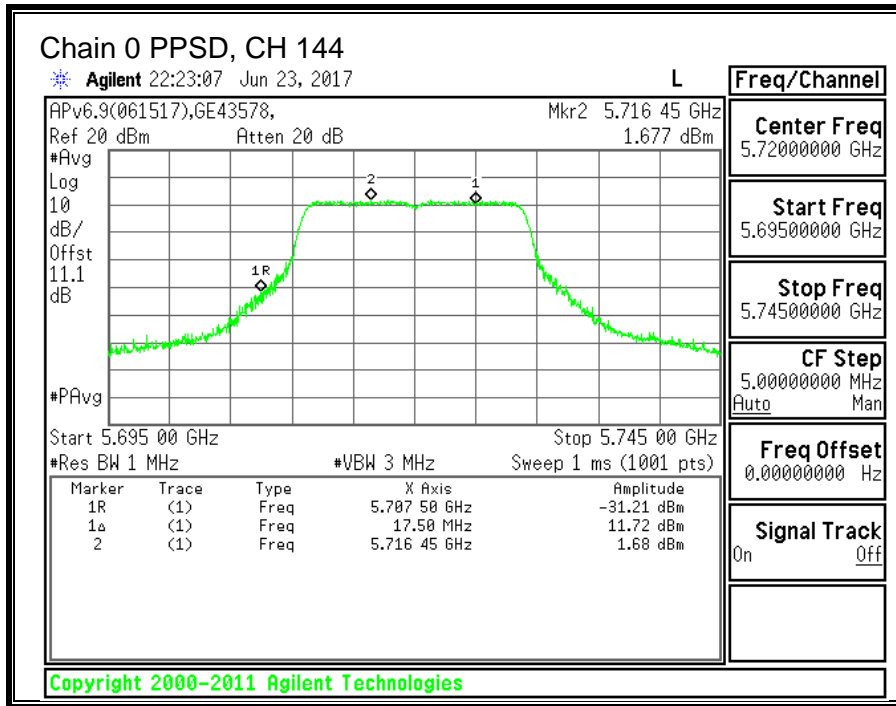

## 10.11. 11n HT40 2TX CDD MIMO MODE IN THE 5.6GHz BAND

### 10.11.1.26 dB BANDWIDTH

#### LIMITS

None; for reporting purposes only.

#### RESULTS

Channel	Frequency	26 dB BW Chain 0 (MHz)	26 dB BW Chain 1 (MHz)
Low	5510	43.2	43.2
Mid	5550	43.2	42.5
Mid (FCC)	5630	43.4	42.5
High	5670	43.1	42.7
142	5710	43.2	42.6



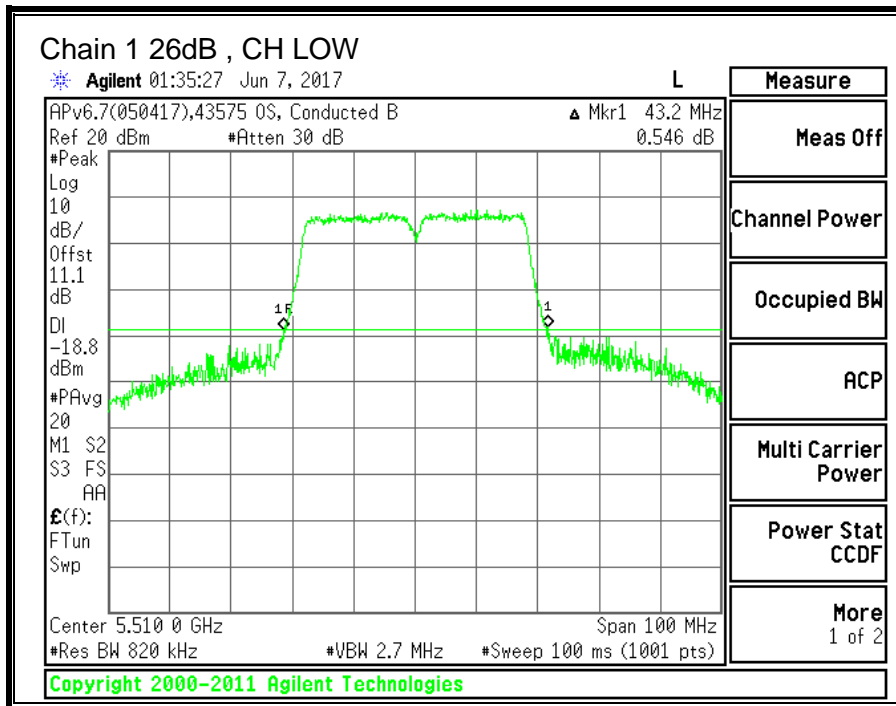
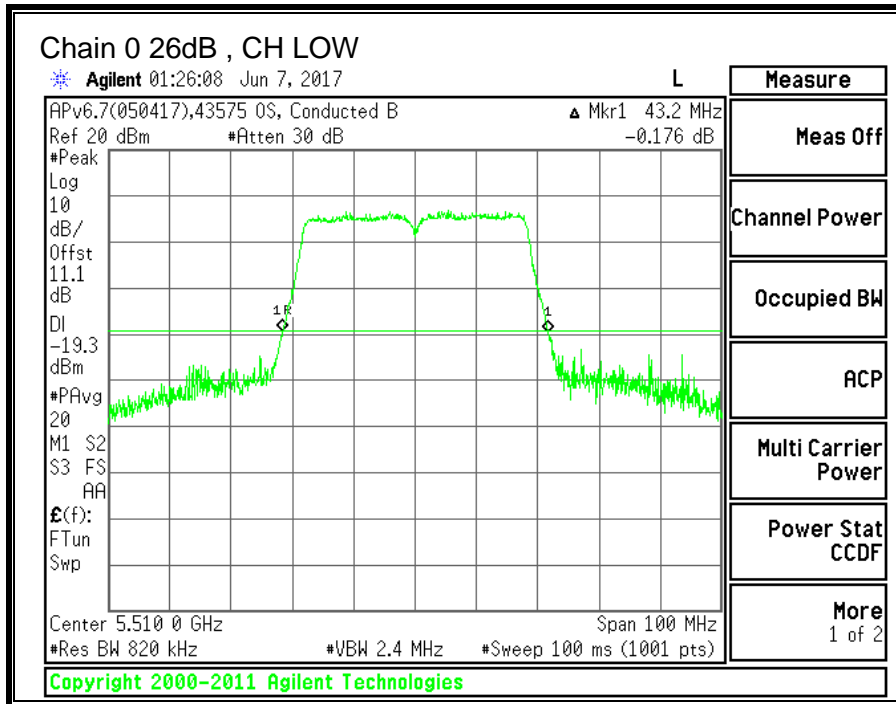

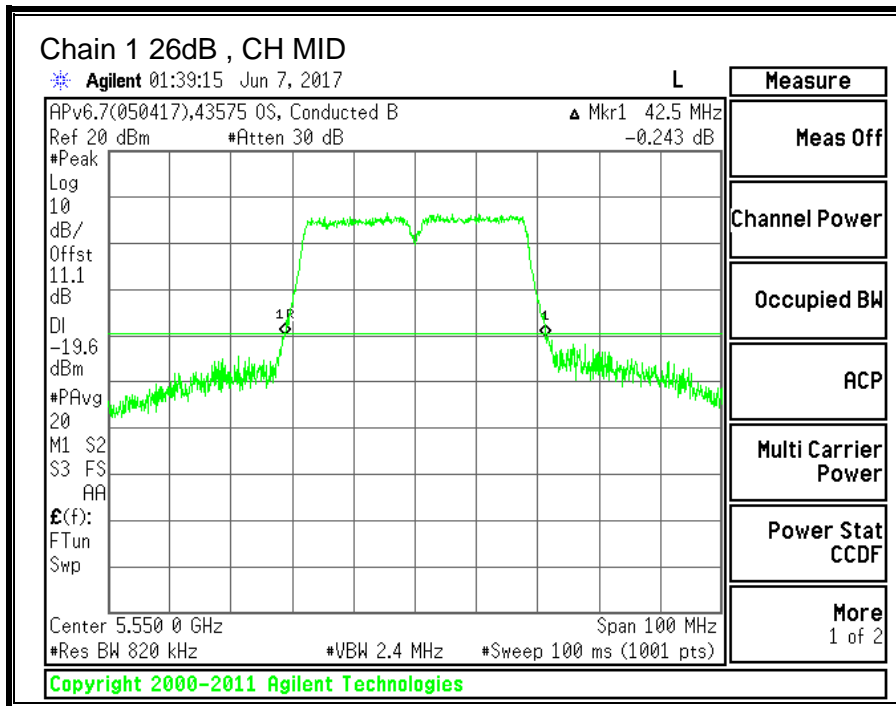
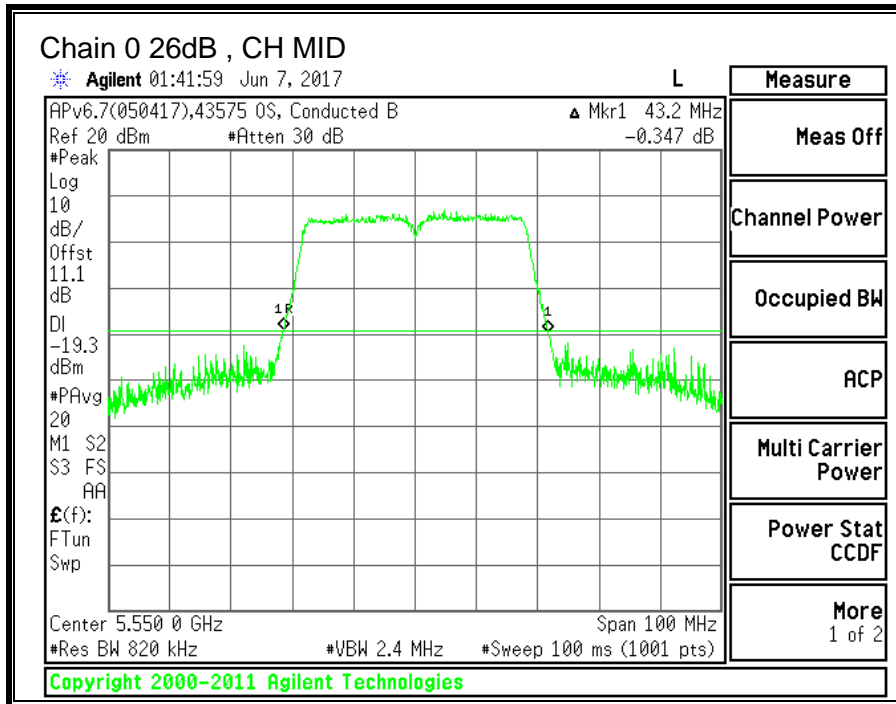

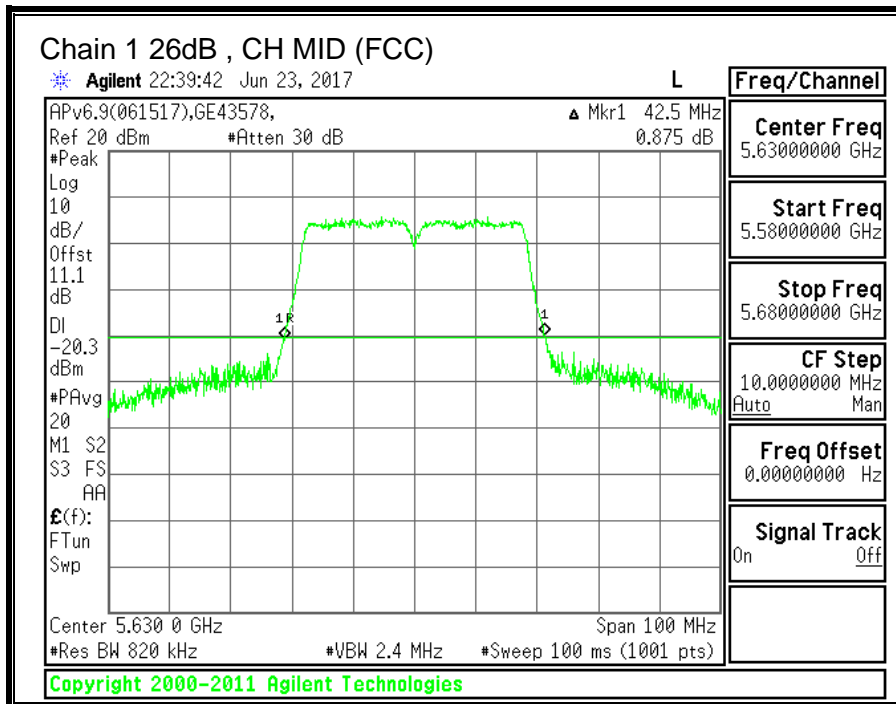
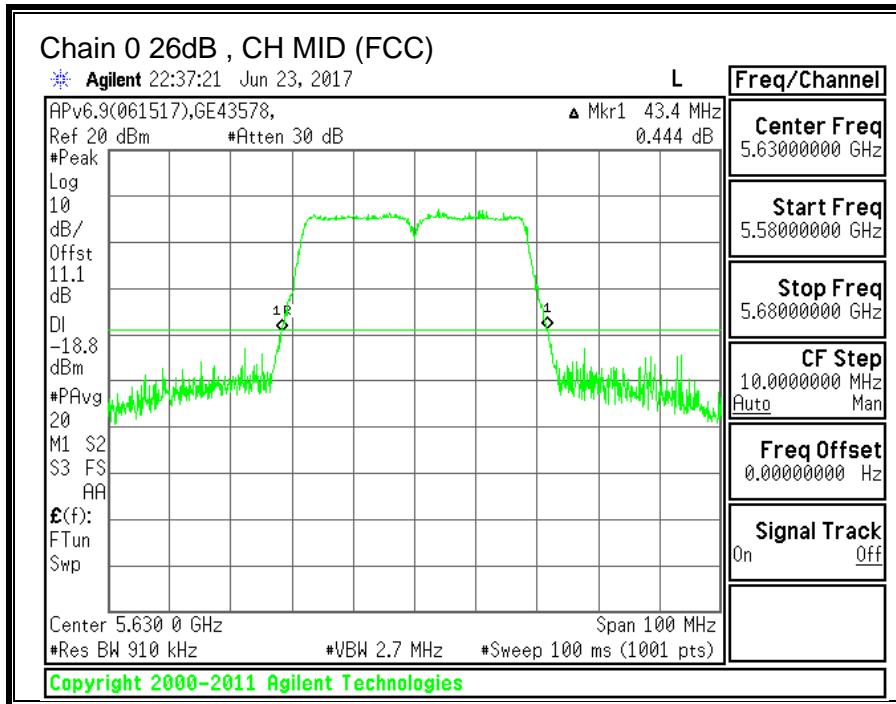

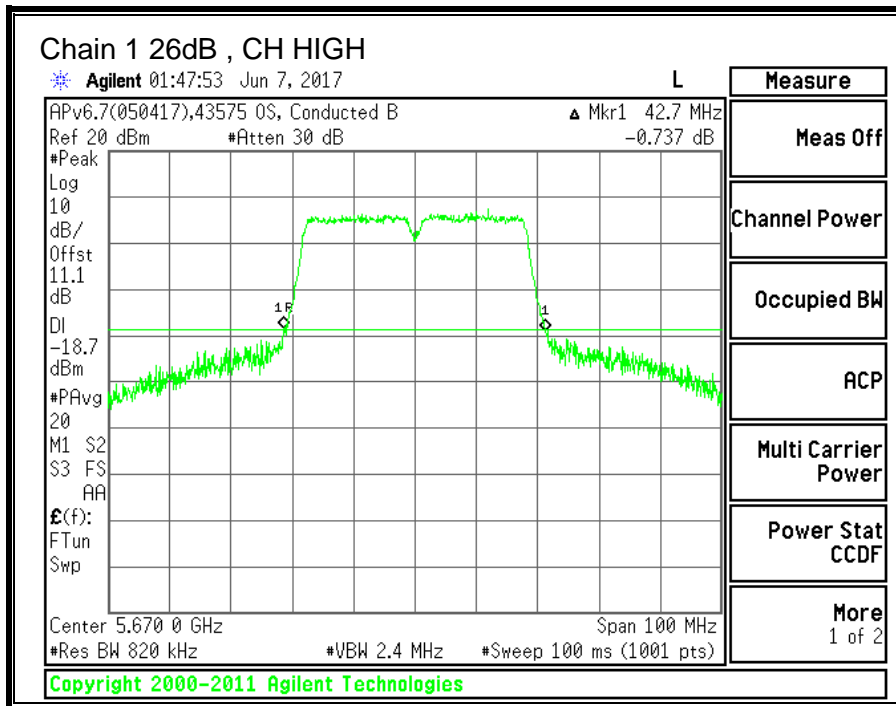
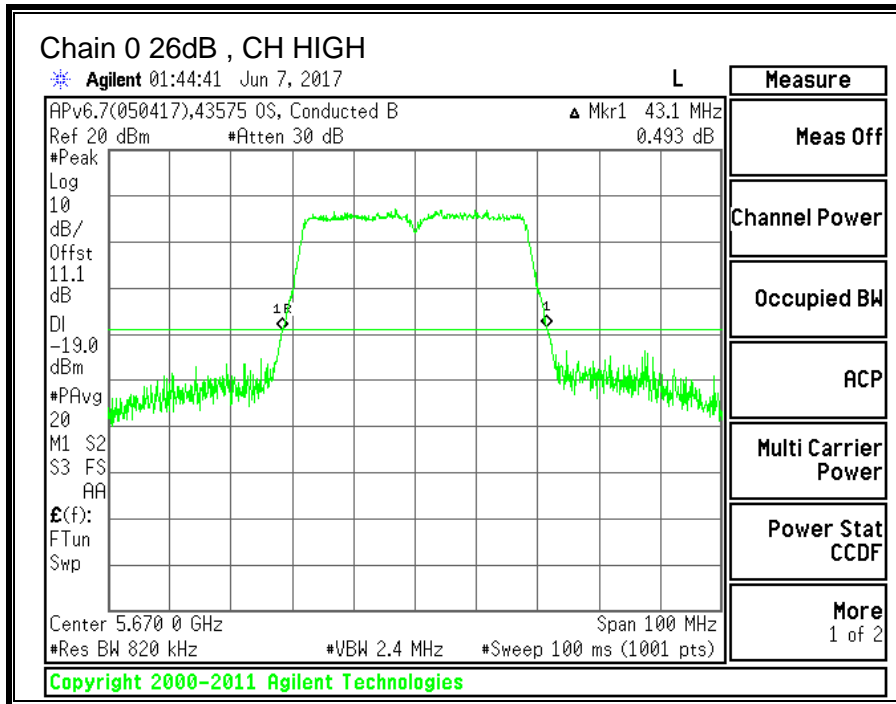

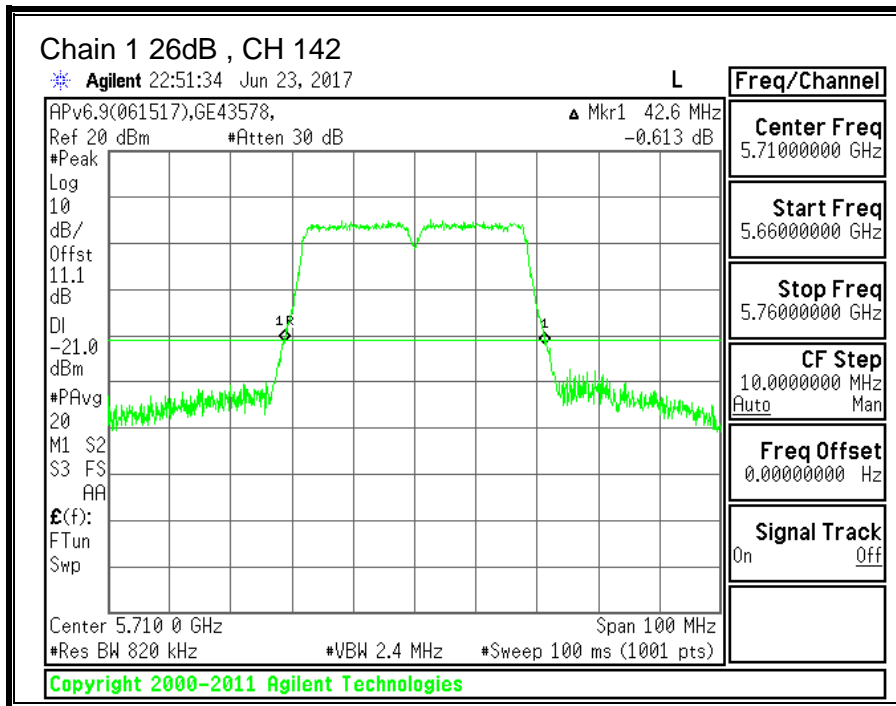
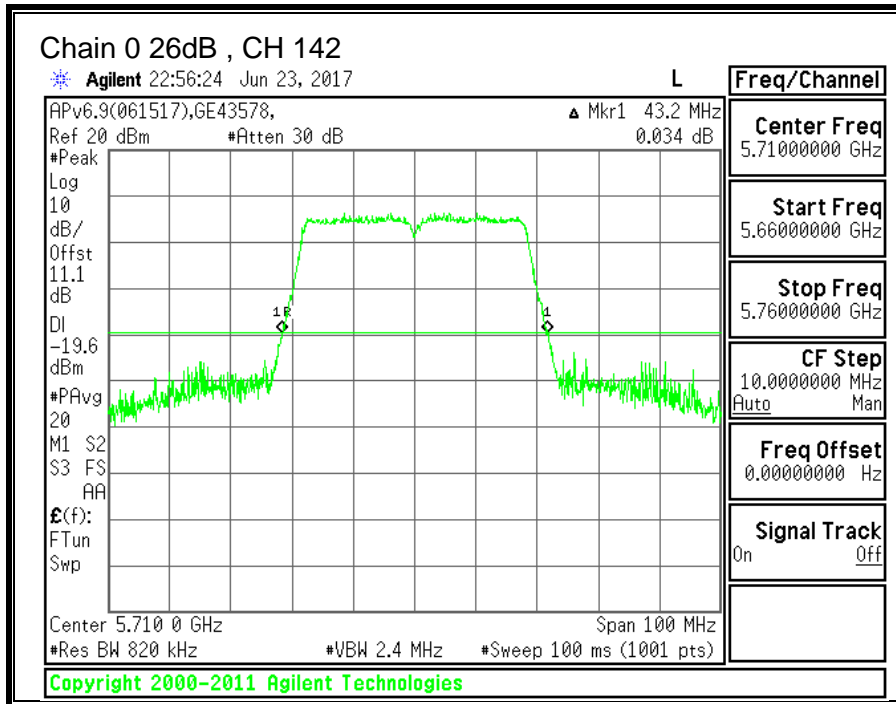

### 10.11.2. 99% BANDWIDTH

#### LIMITS

None; for reporting purposes only.

#### RESULTS

Channel	Frequency	99% BW Chain 0 (MHz)	99% BW Chain 1 (MHz)
Low	5510	35.5407	36.4162
Mid	5550	35.1539	35.2396
Mid (FCC)	5630	35.7711	35.5192
High	5670	35.4584	35.8954
142	5710	35.6354	35.7691

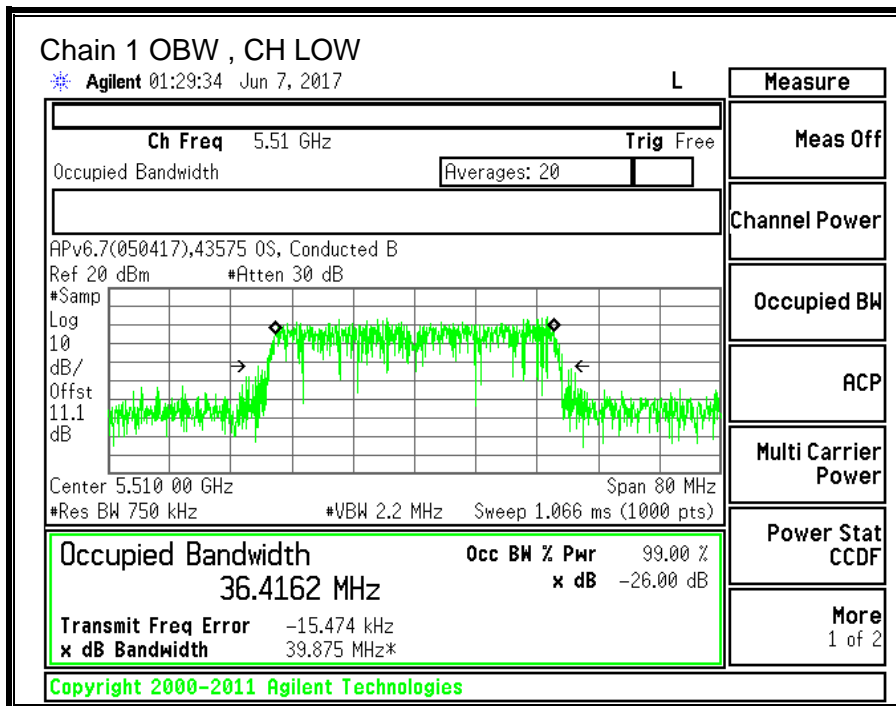
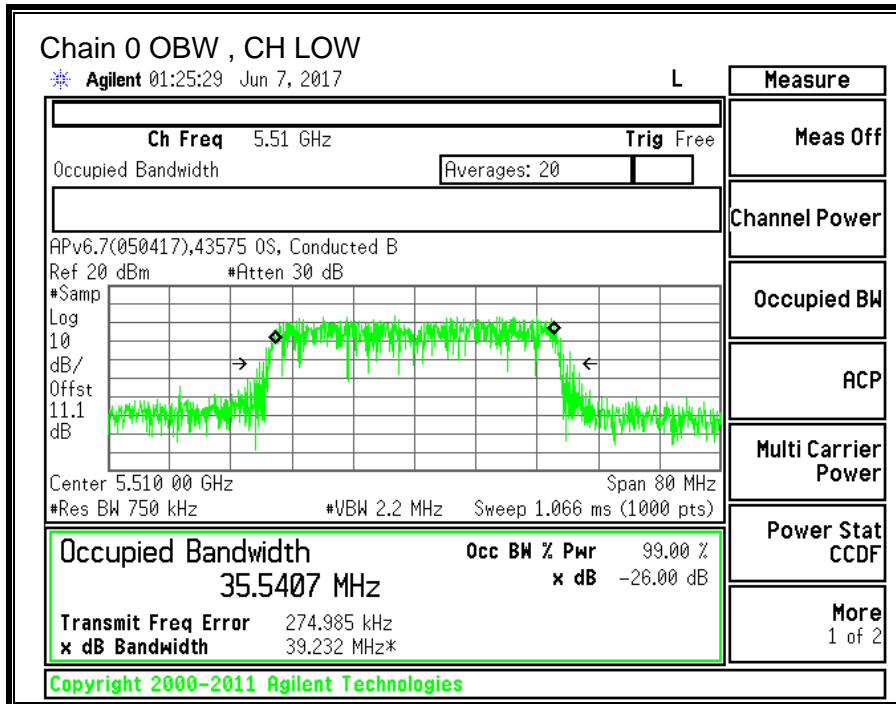

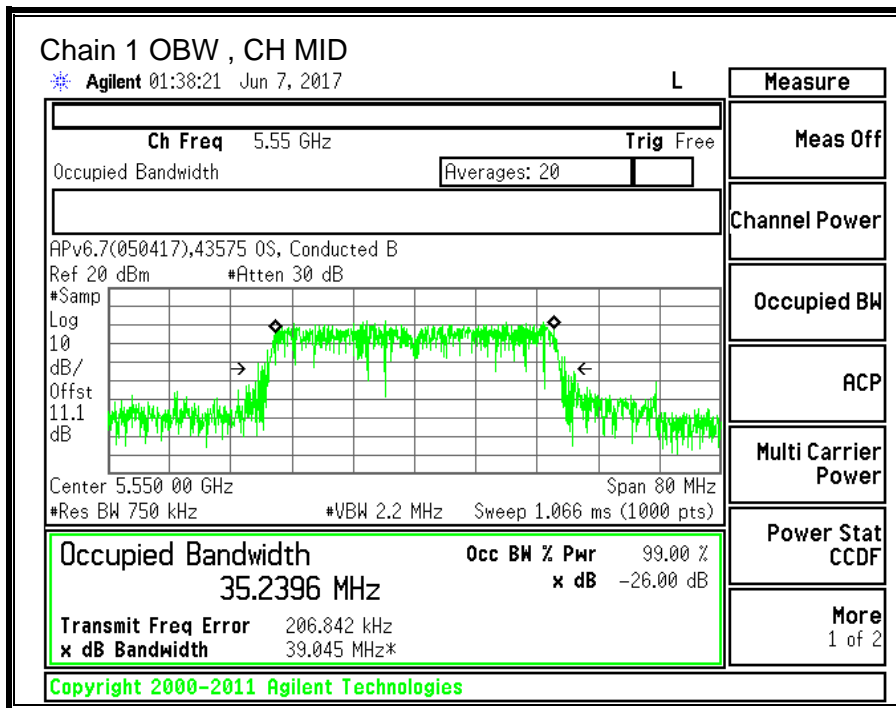
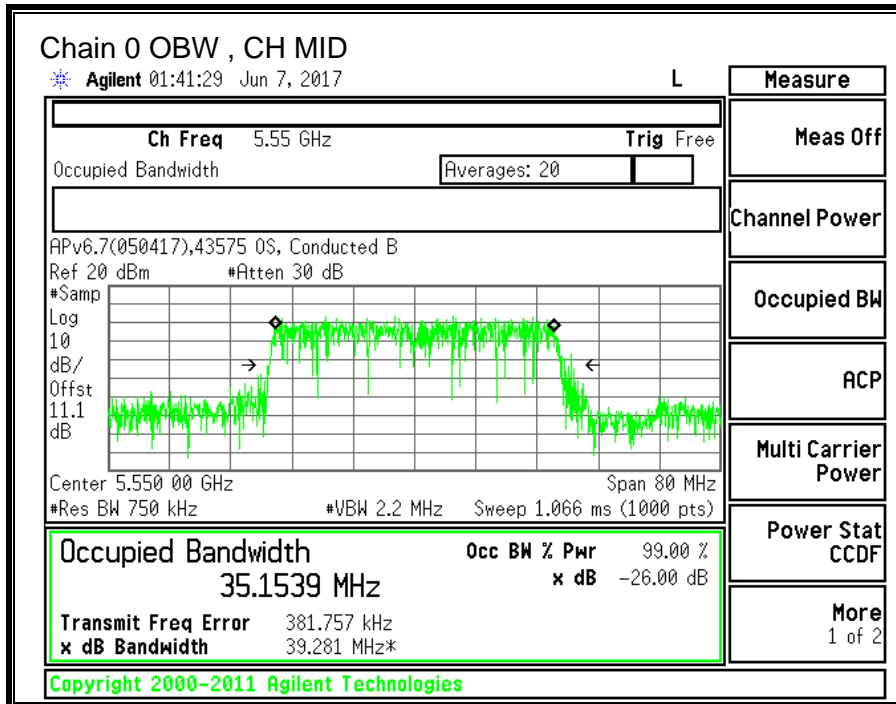



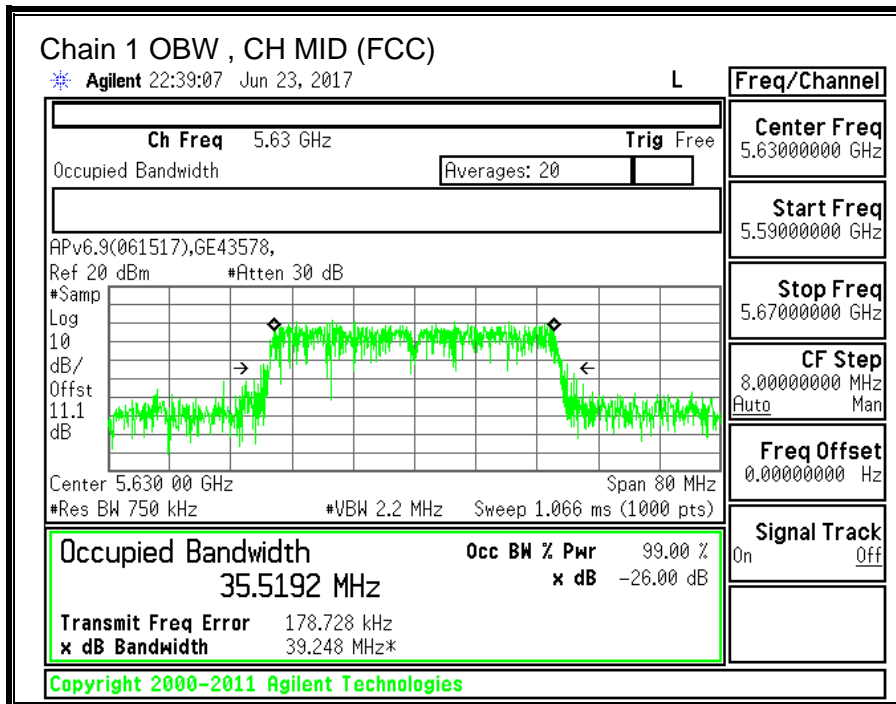
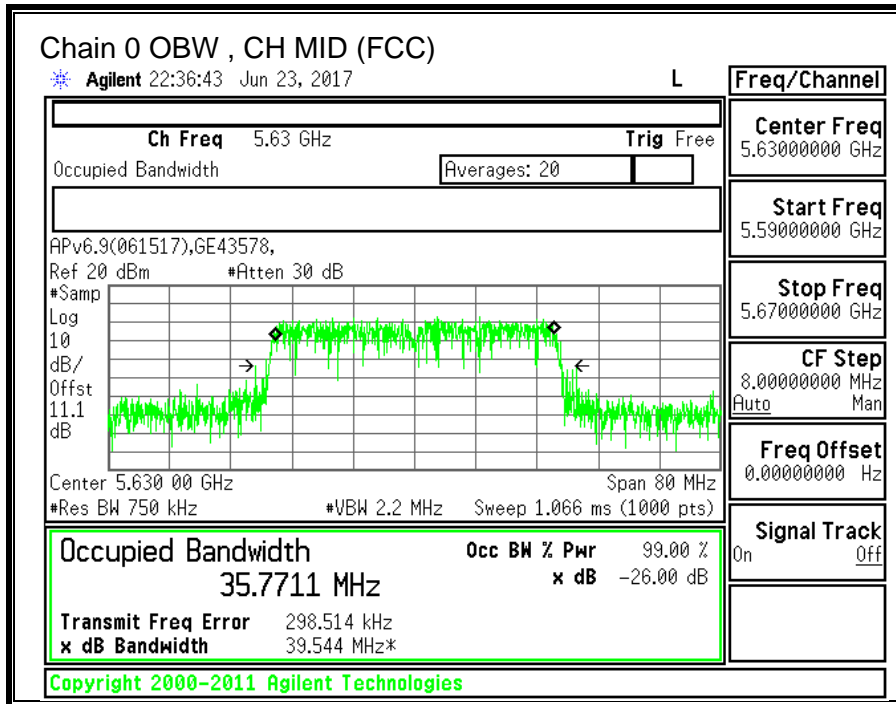

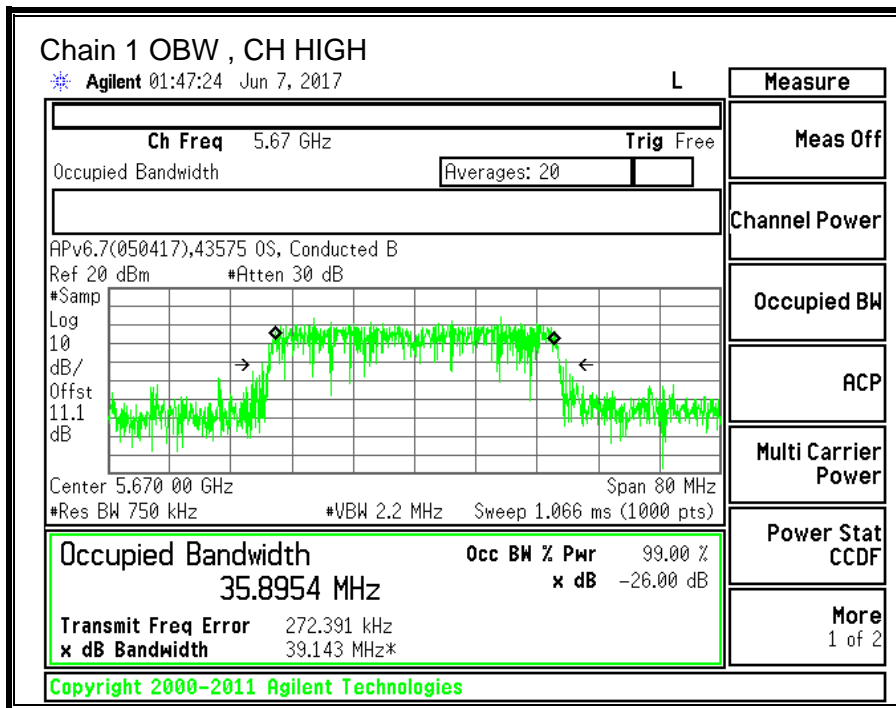
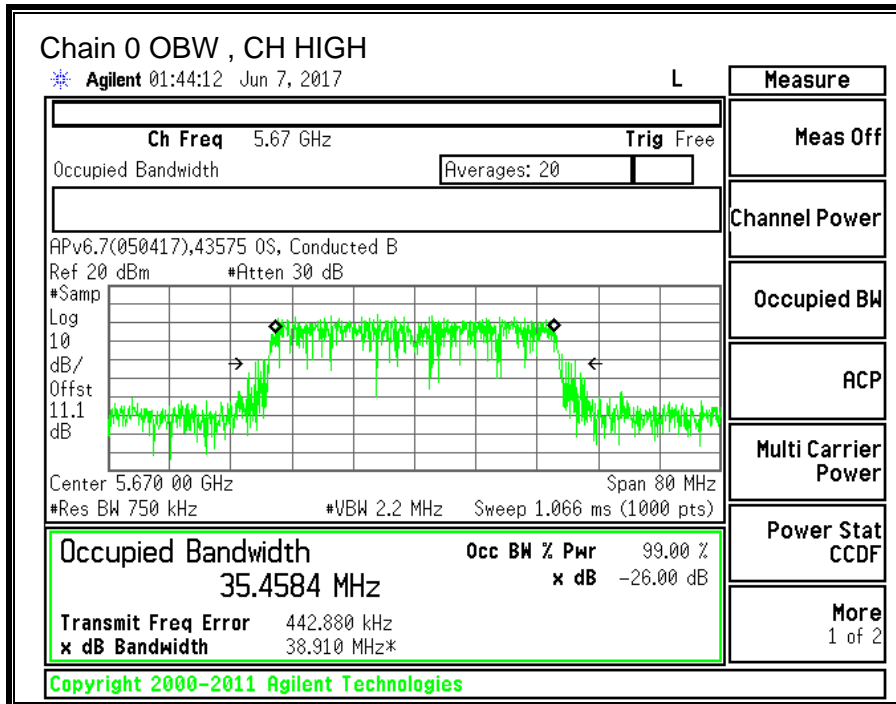

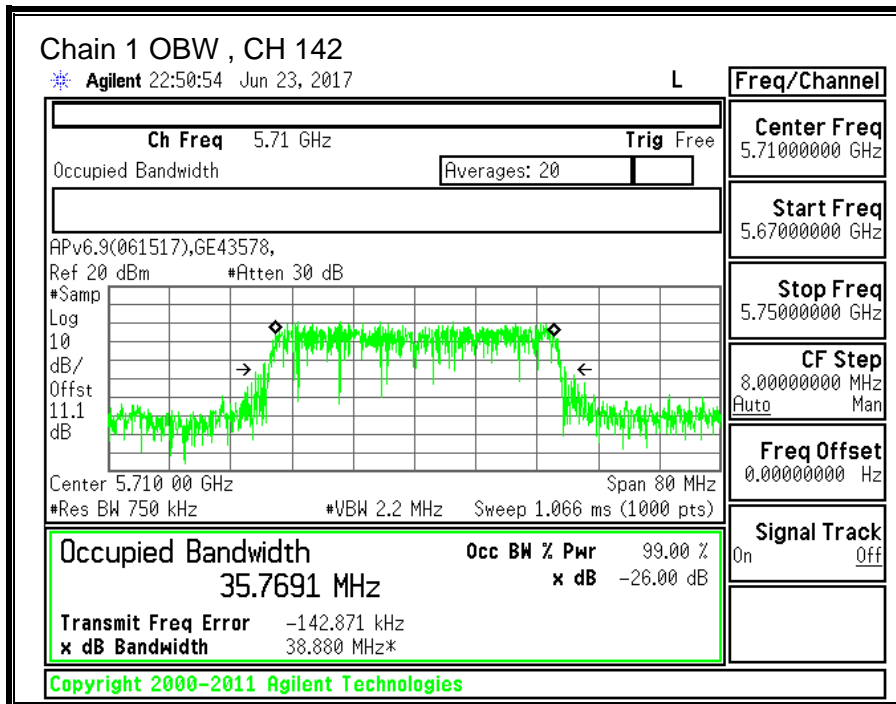
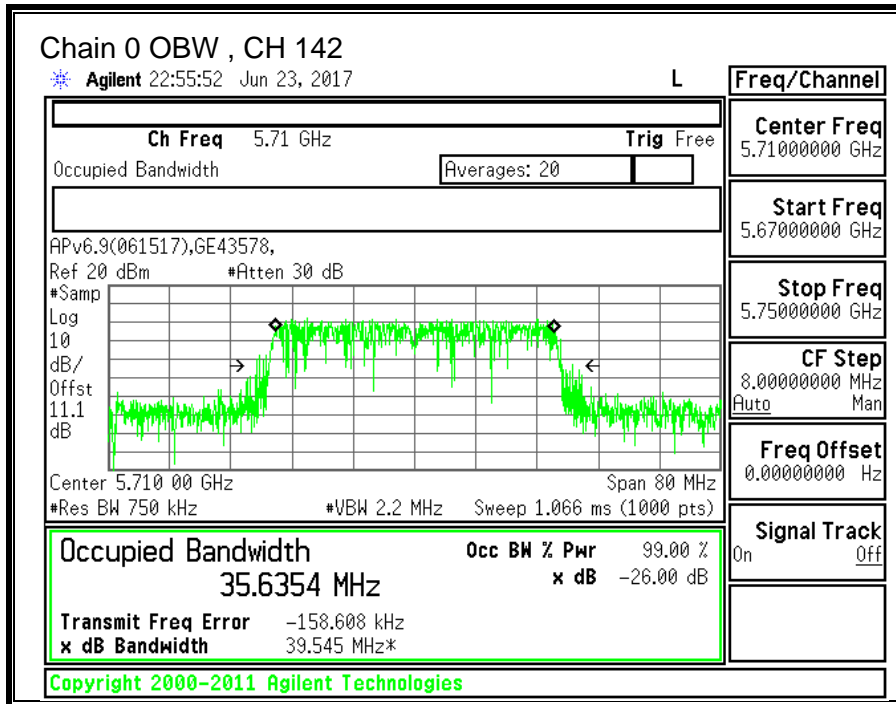

### 10.11.3. OUTPUT POWER AND PPSD

#### LIMITS

FCC §15.407 (a) (2)

For the band 5.47–5.725 GHz, the maximum conducted output power over the frequency band of operation shall not exceed the lesser of 250 mW or 11 dBm + 10 log B, where B is the 26–dB emission bandwidth in MHz. In addition, the maximum power spectral density shall not exceed 11 dBm in any 1–MHz band. If transmitting antennas of directional gain greater than 6 dBi are used, both the maximum conducted output power and the peak power spectral density shall be reduced by the amount in dB that the directional gain of the antenna exceeds 6 dBi.

#### TEST PROCEDURE

Measurements perform using a wideband gated RF power meter provided that the gate parameters are adjusted such that the power is measured only when the EUT is transmitting at its maximum power control level. Since the measurement is made only during the ON time of the transmitter, no duty cycle correction factor is required.

Straddle channel power is measured using PXA spectrum analyzer, duty cycle correction factor is required.

#### DIRECTIONAL ANTENNA GAIN

For power, the TX chains are uncorrelated and the antenna gain is unequal among the chains. The directional gain is:

##### 5470-5725 MHz

Chain 0 Antenna Gain (dBi)	Chain 1 Antenna Gain (dBi)	Uncorrelated Chains Directional Gain (dBi)
-3.10	-8.40	-4.99

For PSD the TX chains are correlated and the antenna gain is unequal among the chains. The directional gain is:

##### 5470-5725 MHz

Chain 0 Antenna Gain (dBi)	Chain 1 Antenna Gain (dBi)	Correlated Chains Directional Gain (dBi)
-3.10	-8.40	-2.34

#### RESULTS

<b>ID:</b>	43574	<b>Date:</b>	06/06/17
------------	-------	--------------	----------

**Bandwidth and Antenna Gain**

Channel	Frequency (MHz)	Min 26 dB BW (MHz)	Min 99% BW (MHz)	Directional Gain for Power (dBi)	Directional Gain for PPSD (dBi)
Low	5510	43.20	35.541	-4.99	-2.34
Mid	5550	42.50	35.154	-4.99	-2.34
Mid (FCC)	5630	42.50	35.519	-4.99	-2.34
High	5670	42.70	35.458	-4.99	-2.34
142	5710	42.60	35.635	-4.99	-2.34

**Limits**

Channel	Frequency (MHz)	FCC Power Limit (dBm)	IC Power Limit (dBm)	IC EIRP Limit (dBm)	Power Limit (dBm)	FCC PPSD Limit (dBm)	IC PSD Limit (dBm)	PPSD Limit (dBm)
Low	5510	24.00	24.00	30.00	24.00	11.00	11.00	11.00
Mid	5550	24.00	24.00	30.00	24.00	11.00	11.00	11.00
Mid (FCC)	5630	24.00	24.00	30.00	24.00	11.00	11.00	11.00
High	5670	24.00	24.00	30.00	24.00	11.00	11.00	11.00
142	5710	24.00	24.00	30.00	24.00	11.00	11.00	11.00

<b>Duty Cycle CF (dB)</b>	0.40	<b>Included in Calculations of Corr'd PPSD</b>
---------------------------	------	--

**Output Power Results**

Channel	Frequency (MHz)	Chain 0 Meas Power (dBm)	Chain 1 Meas Power (dBm)	Total Corr'd Power (dBm)	Power Limit (dBm)	Power Margin (dB)
Low	5510	13.49	12.74	16.14	24.00	-7.86
Mid	5550	13.05	12.14	15.63	24.00	-8.37
Mid (FCC)	5630	13.00	12.01	15.54	24.00	-8.46
High	5670	13.54	12.22	15.94	24.00	-8.06
142	5710	13.23	12.24	15.77	24.00	-8.23

**PPSD Results**

Channel	Frequency (MHz)	Chain 0 Meas PPSD (dBm)	Chain 1 Meas PPSD (dBm)	Total Corr'd PPSD (dBm)	PPSD Limit (dBm)	PPSD Margin (dB)
Low	5510	-0.882	-0.885	2.53	11.00	-8.47
Mid	5550	-1.242	-2.045	1.79	11.00	-9.21
Mid (FCC)	5630	-1.329	-2.768	1.42	11.00	-9.58
High	5670	-0.714	-2.125	2.05	11.00	-8.95
142	5710	-1.483	-3.780	0.93	11.00	-10.07

**Note:** the power readings above were measured with gated method, and the measurement was taken only during the ON time. No duty cycle correction was necessary.

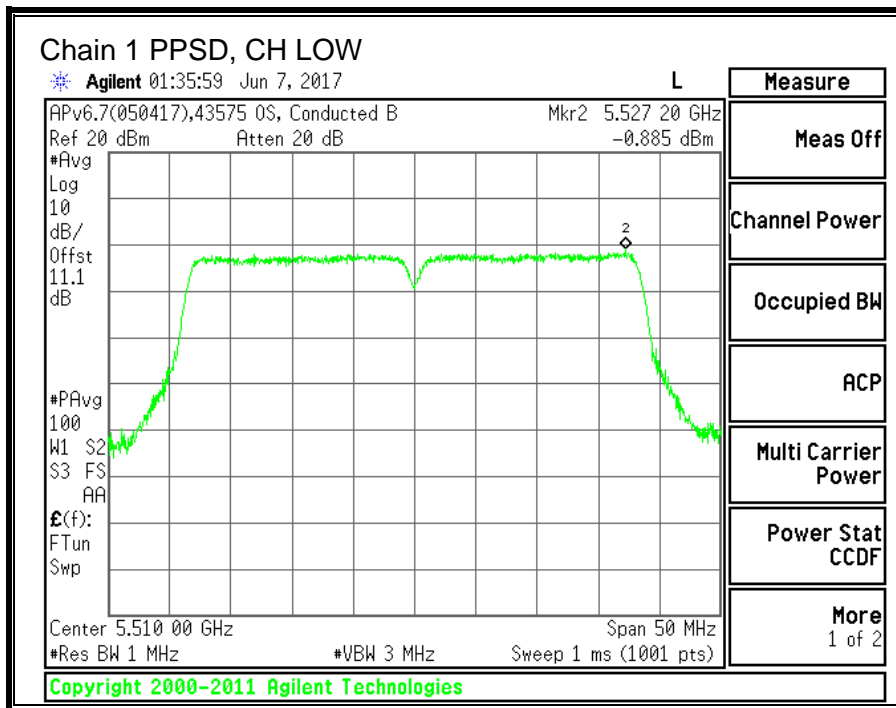
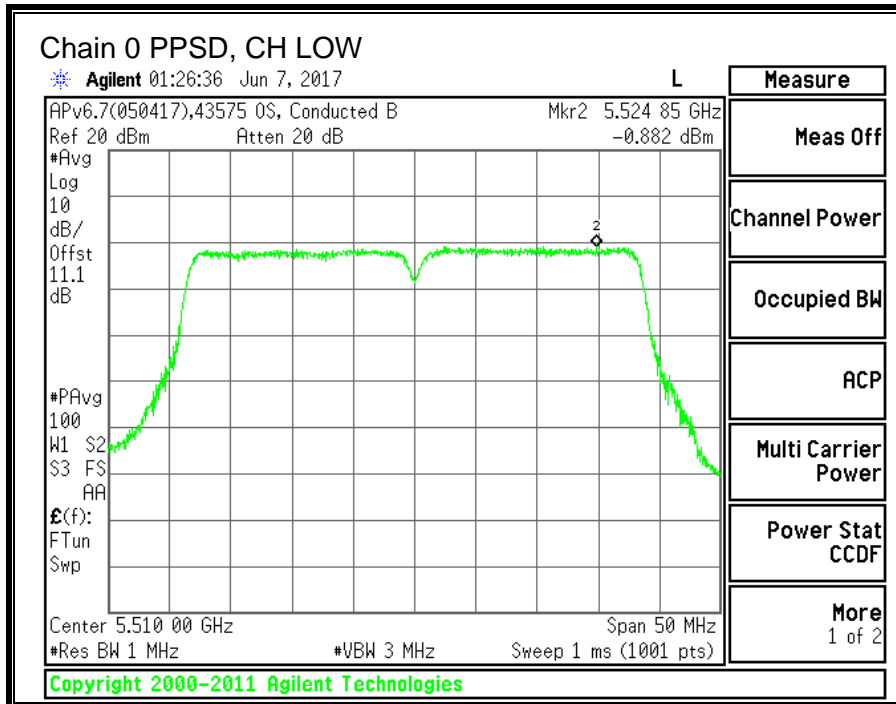

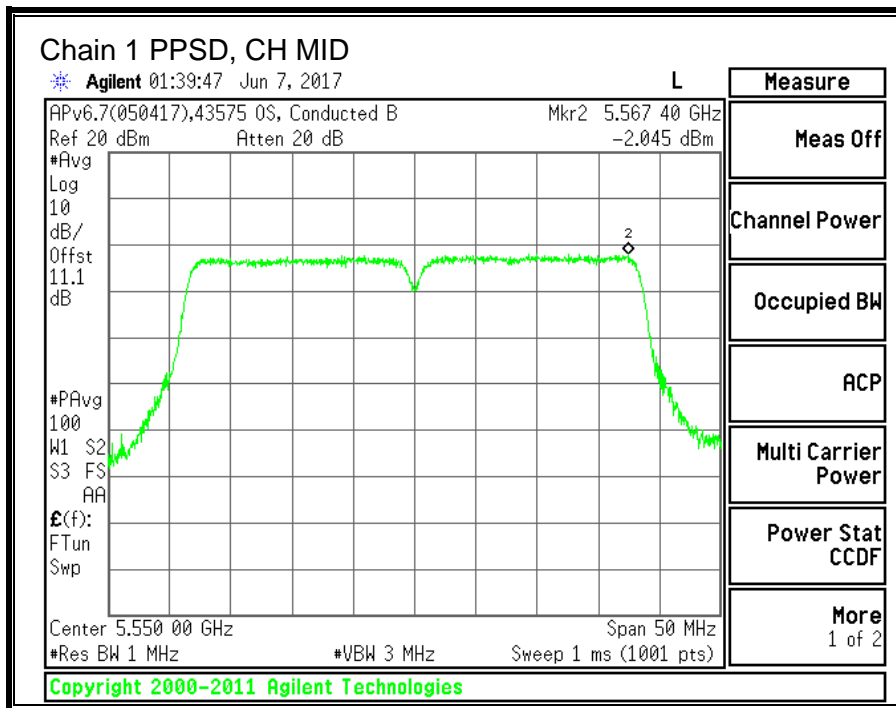
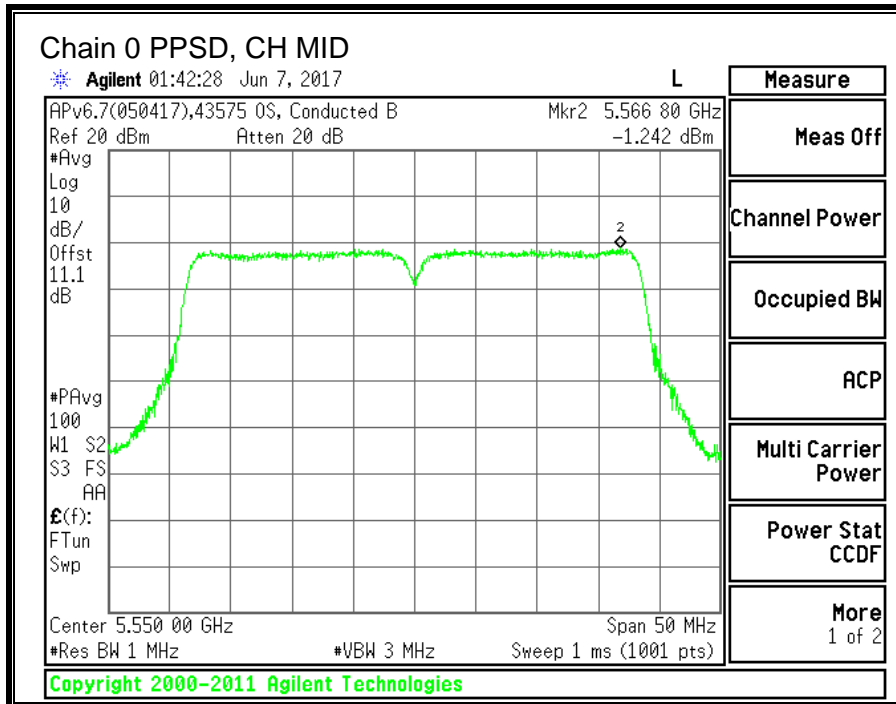

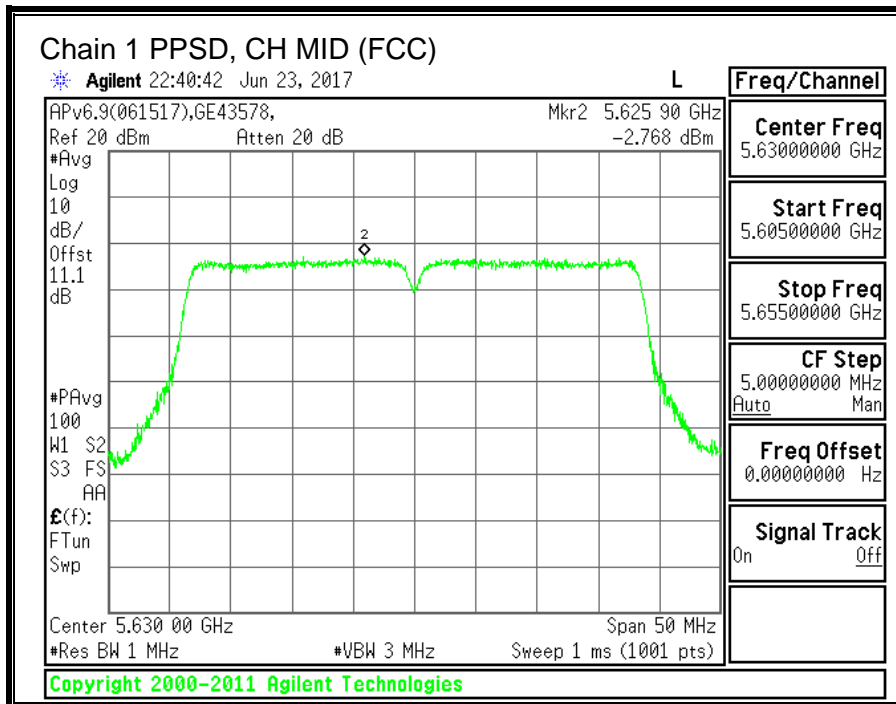
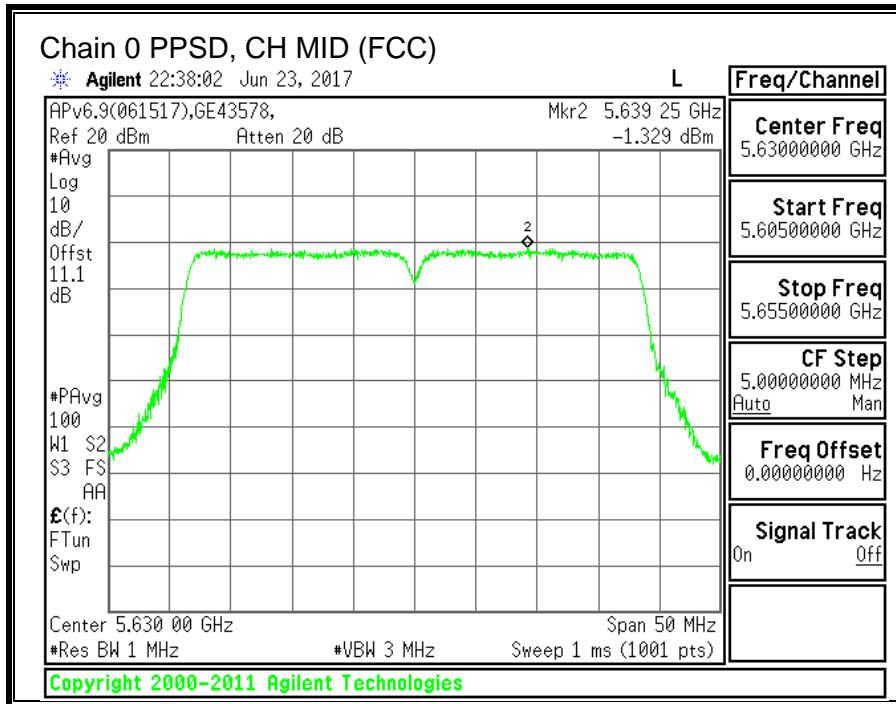



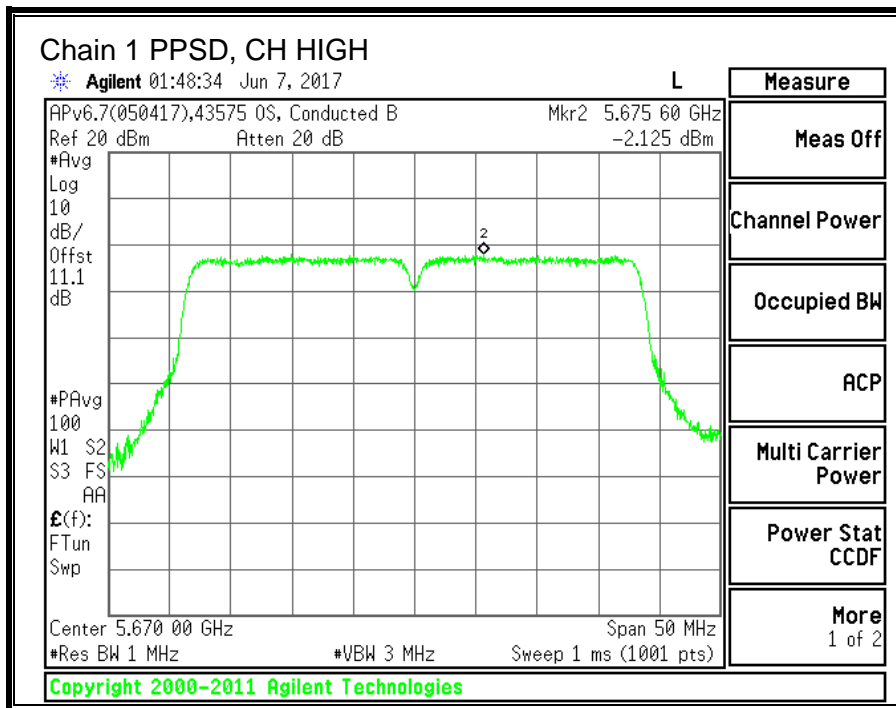
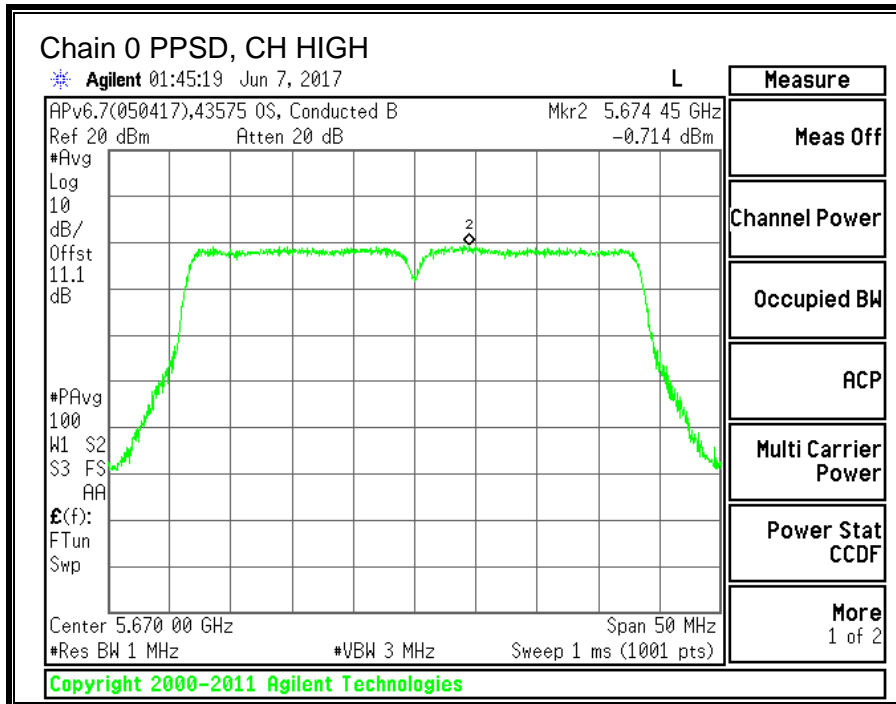

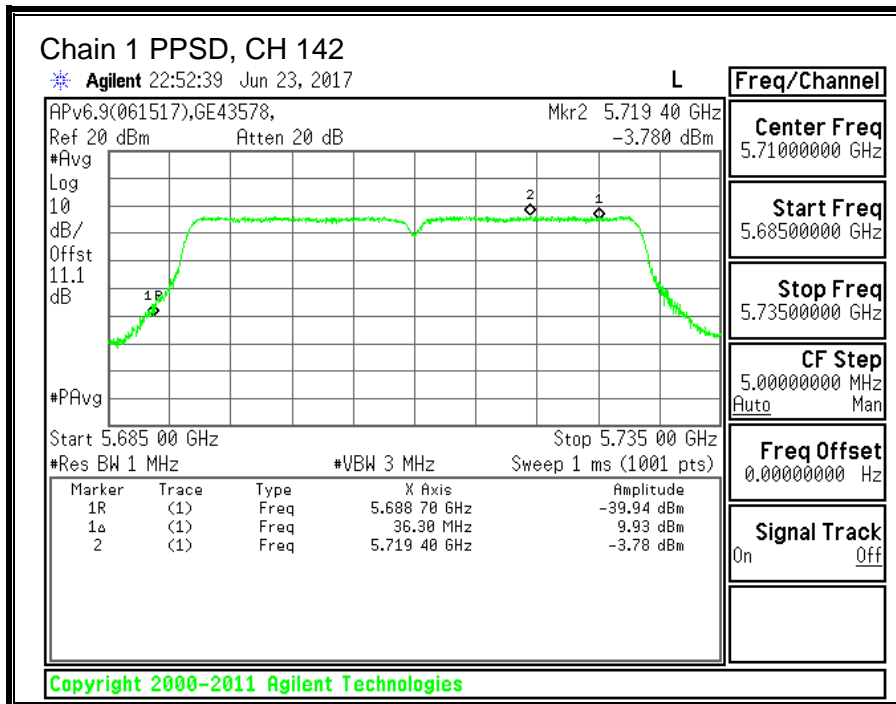
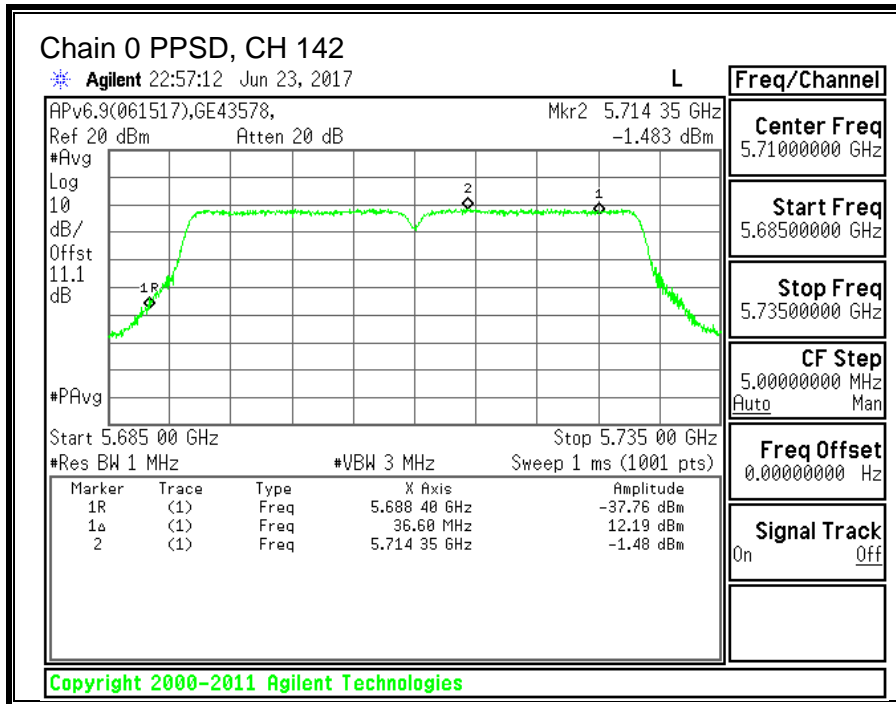

## 10.12. 11ac HT80 2TX CDD MIMO MODE IN THE 5.6GHz BAND

### 10.12.1.26 dB BANDWIDTH

#### LIMITS

None; for reporting purposes only.

#### RESULTS

Channel	Frequency	26 dB BW Chain 0 (MHz)	26 dB BW Chain 1 (MHz)
Low	5530	86.2	87.6
Mid	5610	86.2	88.4
138	5690	87.0	86.0

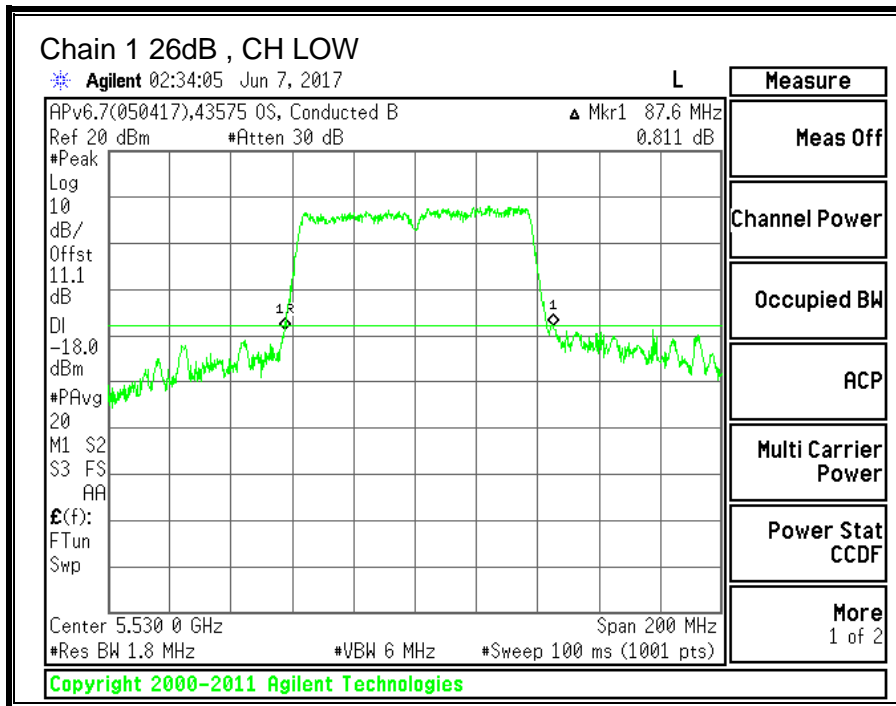
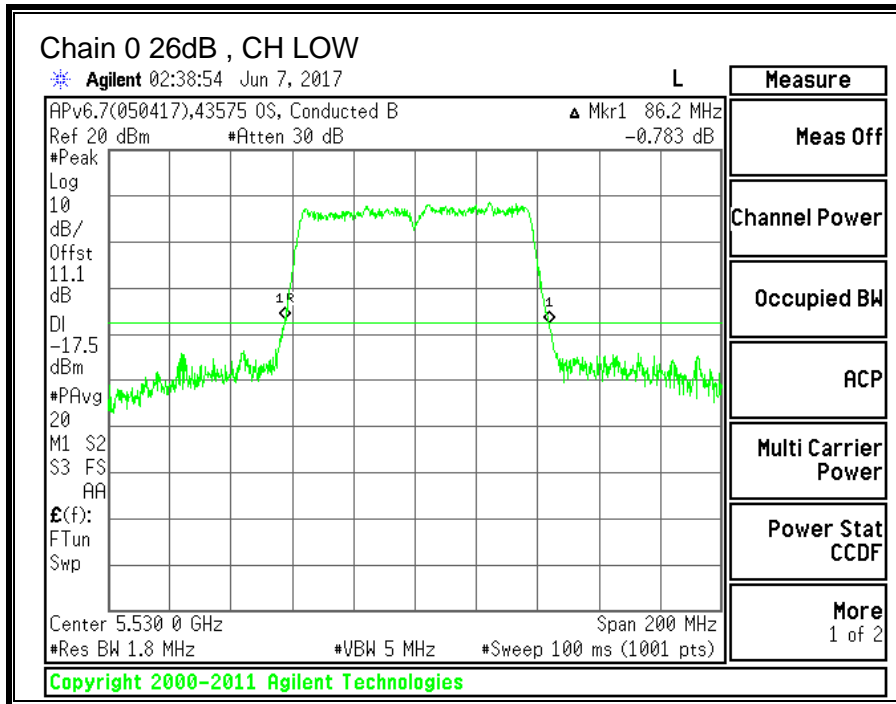

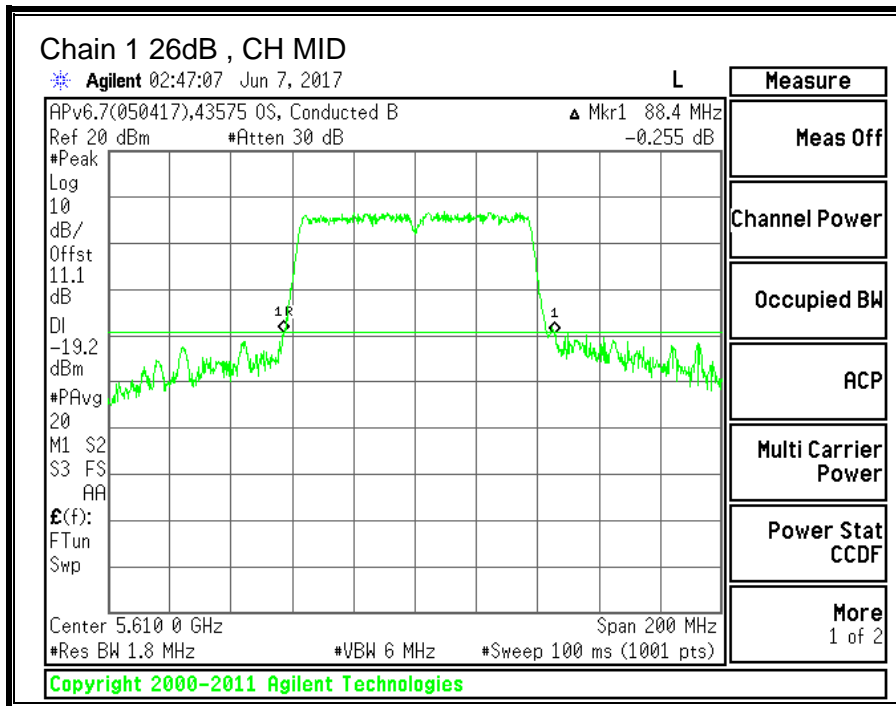
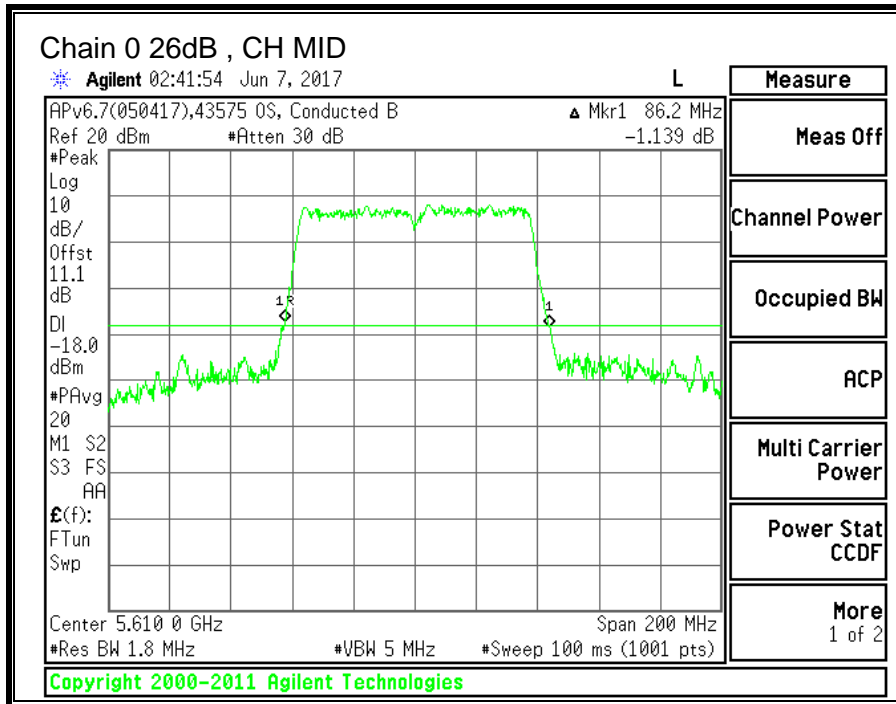

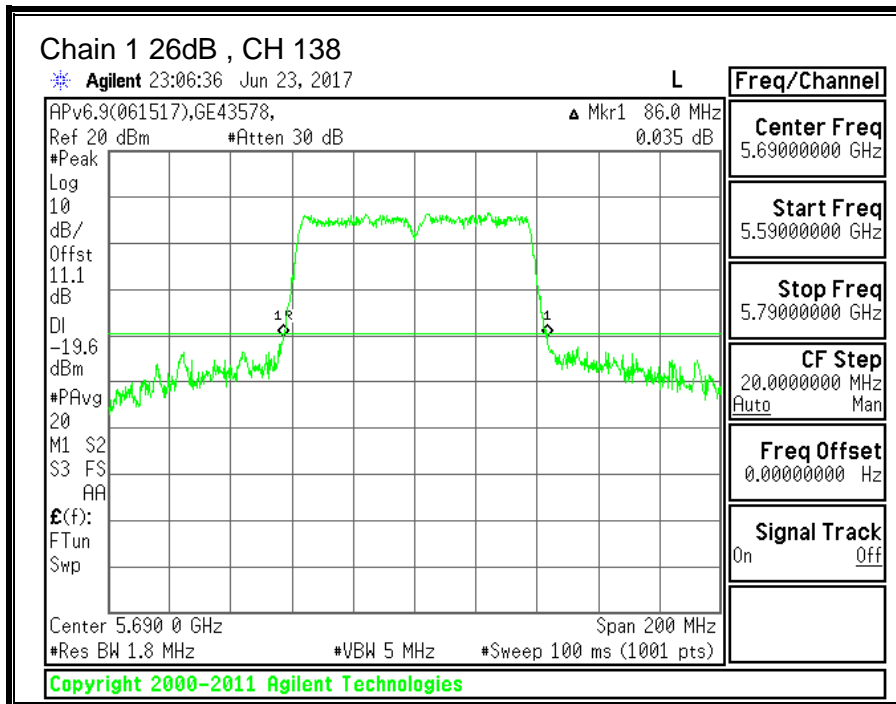
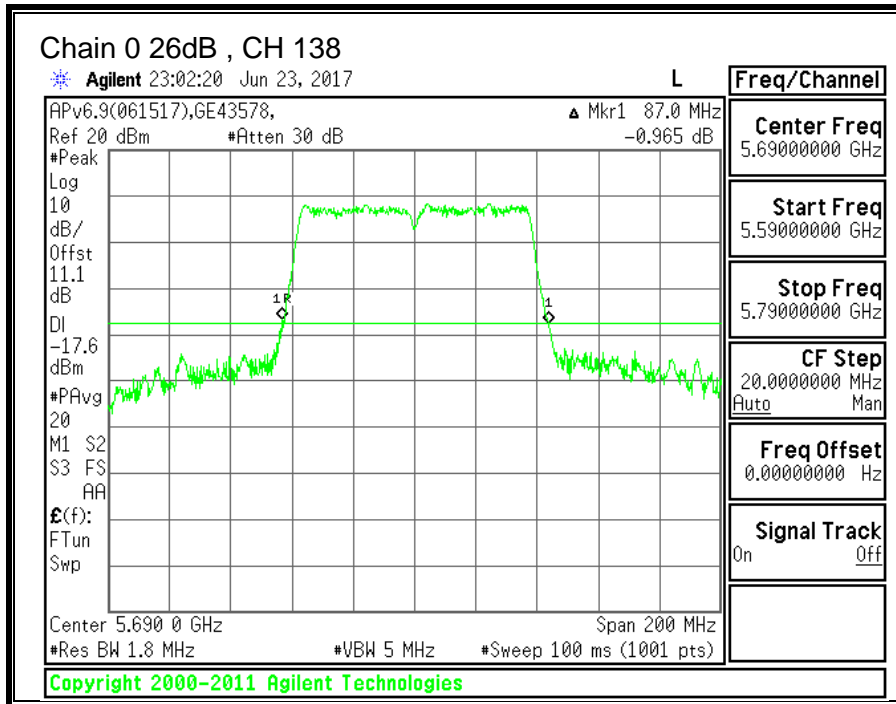

### 10.12.2. 99% BANDWIDTH

#### LIMITS

None; for reporting purposes only.

#### RESULTS

Channel	Frequency	99% BW Chain 0 (MHz)	99% BW Chain 1 (MHz)
Low	5530	73.4695	74.0256
Mid	5610	73.1755	73.6186
138	5690	73.3096	74.5509

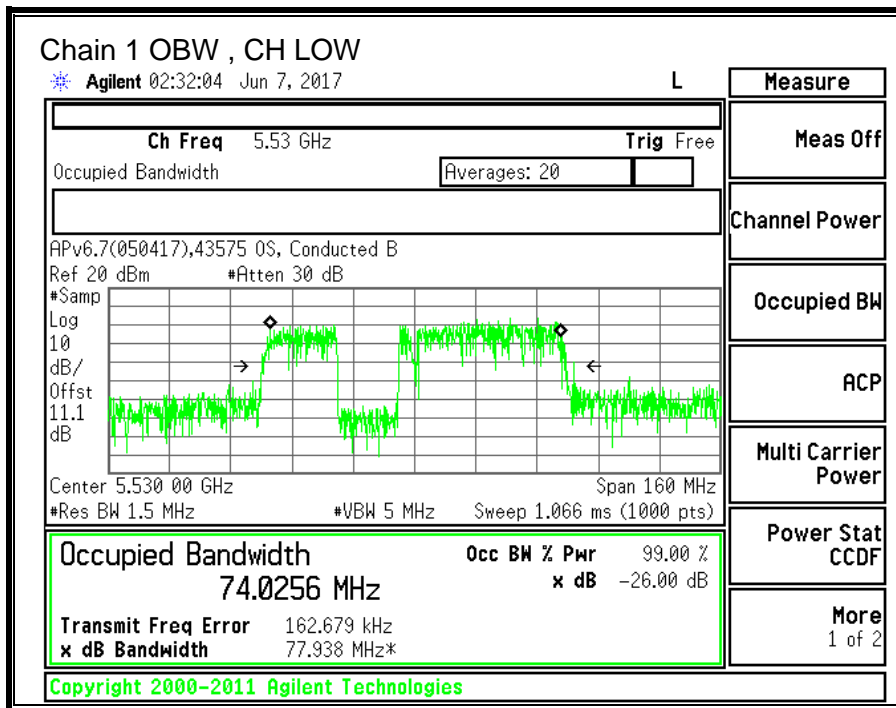
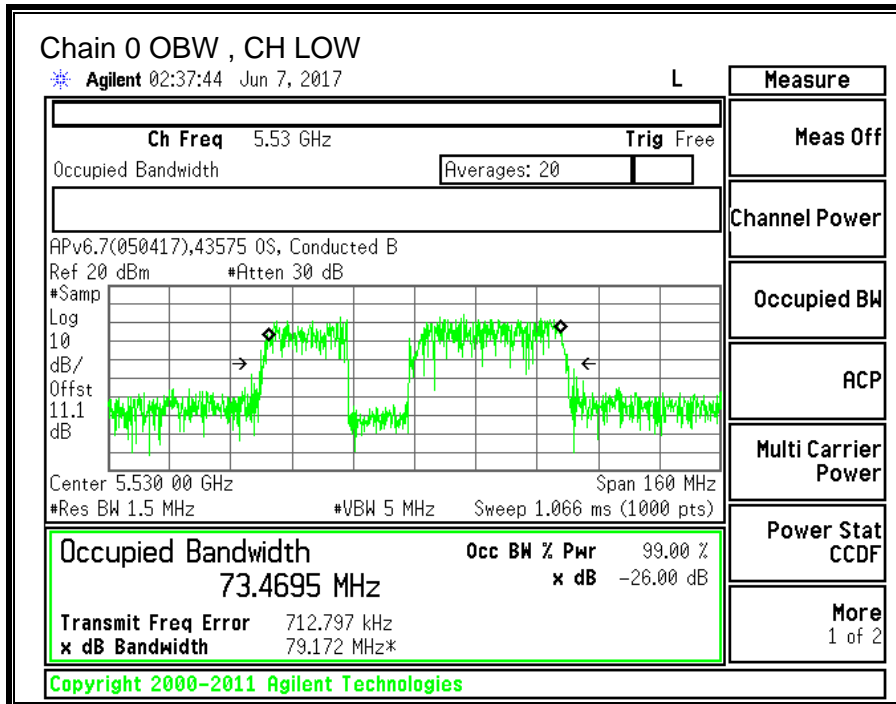



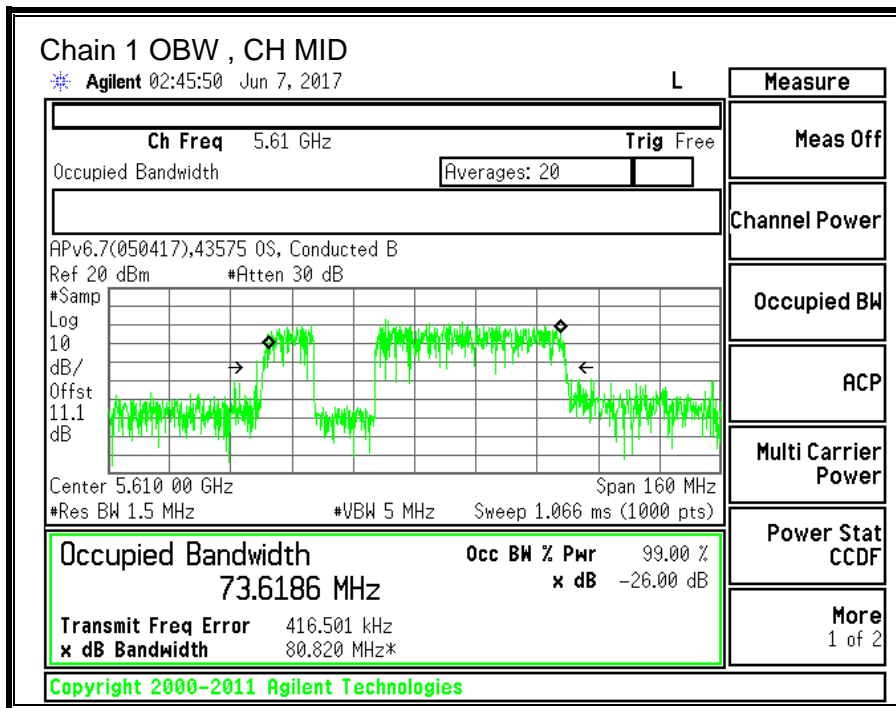
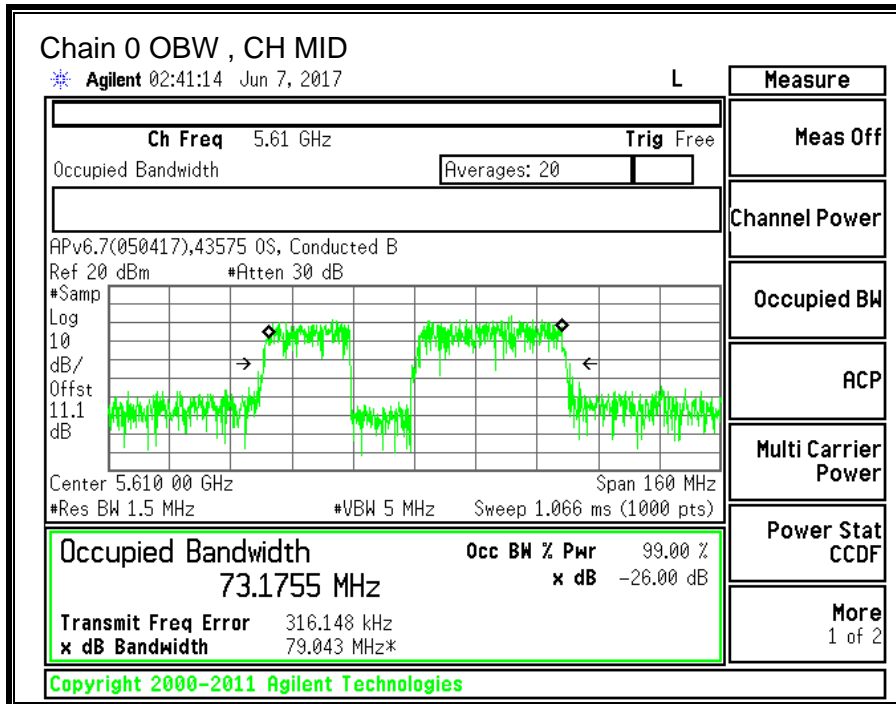

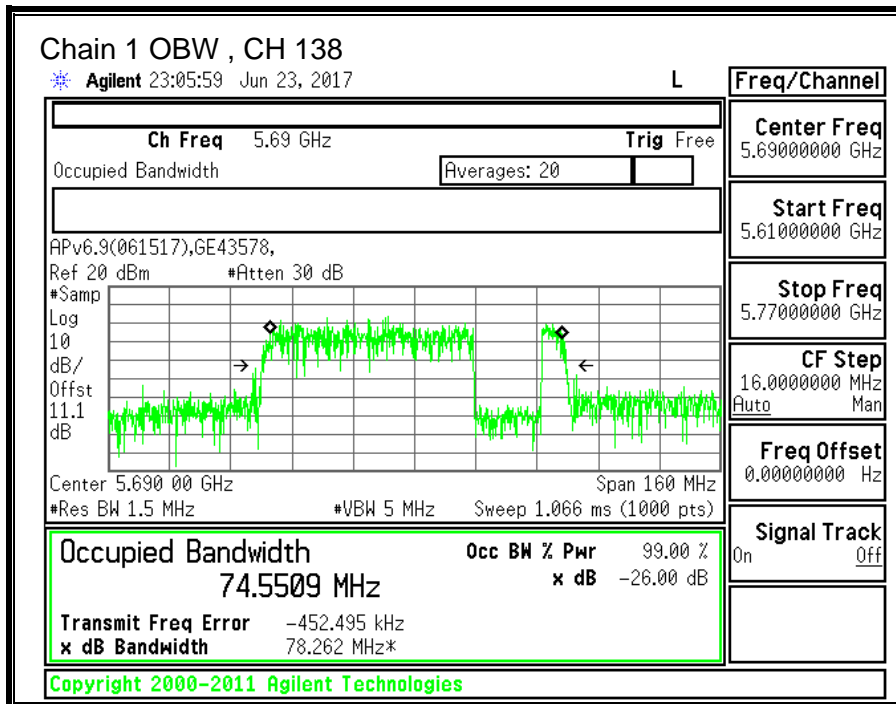
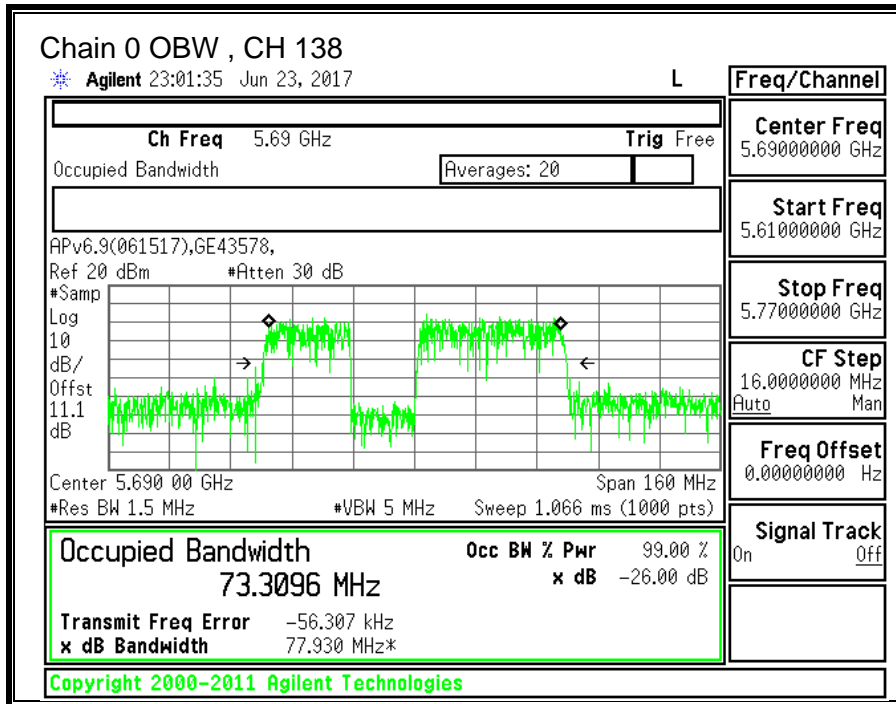

### 10.12.3. OUTPUT POWER AND PPSD

#### LIMITS

FCC §15.407 (a) (2)

For the band 5.47–5.725 GHz, the maximum conducted output power over the frequency band of operation shall not exceed the lesser of 250 mW or 11 dBm + 10 log B, where B is the 26–dB emission bandwidth in MHz. In addition, the maximum power spectral density shall not exceed 11 dBm in any 1–MHz band. If transmitting antennas of directional gain greater than 6 dBi are used, both the maximum conducted output power and the peak power spectral density shall be reduced by the amount in dB that the directional gain of the antenna exceeds 6 dBi.

#### TEST PROCEDURE

Measurements perform using a wideband gated RF power meter provided that the gate parameters are adjusted such that the power is measured only when the EUT is transmitting at its maximum power control level. Since the measurement is made only during the ON time of the transmitter, no duty cycle correction factor is required.

Straddle channel power is measured using PXA spectrum analyzer, duty cycle correction factor is required.

#### DIRECTIONAL ANTENNA GAIN

For power, the TX chains are uncorrelated and the antenna gain is unequal among the chains. The directional gain is:

##### 5470-5725 MHz

Chain 0 Antenna Gain (dBi)	Chain 1 Antenna Gain (dBi)	Uncorrelated Chains Directional Gain (dBi)
-3.10	-8.40	-4.99

For PSD the TX chains are correlated and the antenna gain is unequal among the chains. The directional gain is:

##### 5470-5725 MHz

Chain 0 Antenna Gain (dBi)	Chain 1 Antenna Gain (dBi)	Correlated Chains Directional Gain (dBi)
-3.10	-8.40	-2.34

#### RESULTS

<b>ID:</b>	43574	<b>Date:</b>	06/06/17
------------	-------	--------------	----------

**Bandwidth and Antenna Gain**

Channel	Frequency (MHz)	Min 26 dB BW (MHz)	Min 99% BW (MHz)	Directional Gain for Power (dBi)	Directional Gain for PPSD (dBi)
Low	5530	86.20	73.470	-4.99	-2.34
Mid	5610	86.20	73.176	-4.99	-2.34
138	5690	86.00	17.310	-4.99	-2.34

**Limits**

Channel	Frequency (MHz)	FCC Power Limit (dBm)	IC Power Limit (dBm)	IC EIRP Limit (dBm)	Power Limit (dBm)	FCC PPSD Limit (dBm)	IC PSD Limit (dBm)	PPSD Limit (dBm)
Low	5530	24.00	24.00	30.00	24.00	11.00	11.00	11.00
Mid	5610	24.00	24.00	30.00	24.00	11.00	11.00	11.00
138	5690	24.00	23.38	29.38	23.38	11.00	11.00	11.00

<b>Duty Cycle CF (dB)</b>	0.75	<b>Included in Calculations of Corr'd PPSD</b>
---------------------------	------	--

**Output Power Results**

Channel	Frequency (MHz)	Chain 0 Meas Power (dBm)	Chain 1 Meas Power (dBm)	Total Corr'd Power (dBm)	Power Limit (dBm)	Power Margin (dB)
Low	5530	13.04	12.16	15.63	24.00	-8.37
Mid	5610	12.85	12.05	15.48	24.00	-8.52
138	5690	13.16	12.20	15.72	23.38	-7.67

**PPSD Results**

Channel	Frequency (MHz)	Chain 0 Meas PPSD (dBm)	Chain 1 Meas PPSD (dBm)	Total Corr'd PPSD (dBm)	PPSD Limit (dBm)	PPSD Margin (dB)
Low	5530	-4.838	-5.199	-1.25	11.00	-12.25
Mid	5610	-5.273	-6.408	-2.04	11.00	-13.04
138	5690	-4.645	-6.807	-1.83	11.00	-12.83

**Note:** the power readings above were measured with gated method, and the measurement was taken only during the ON time. No duty cycle correction was necessary.

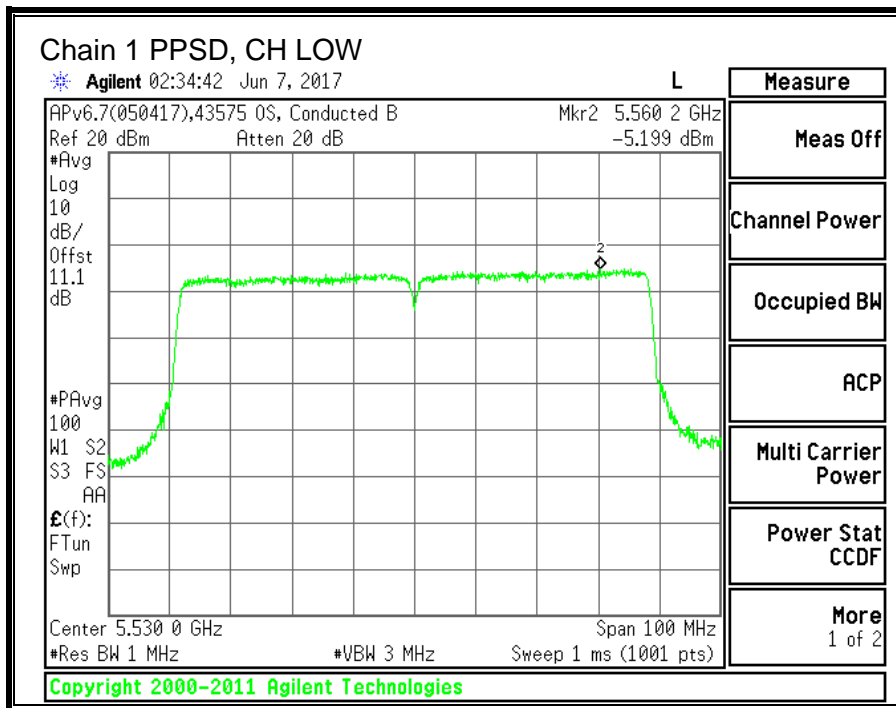
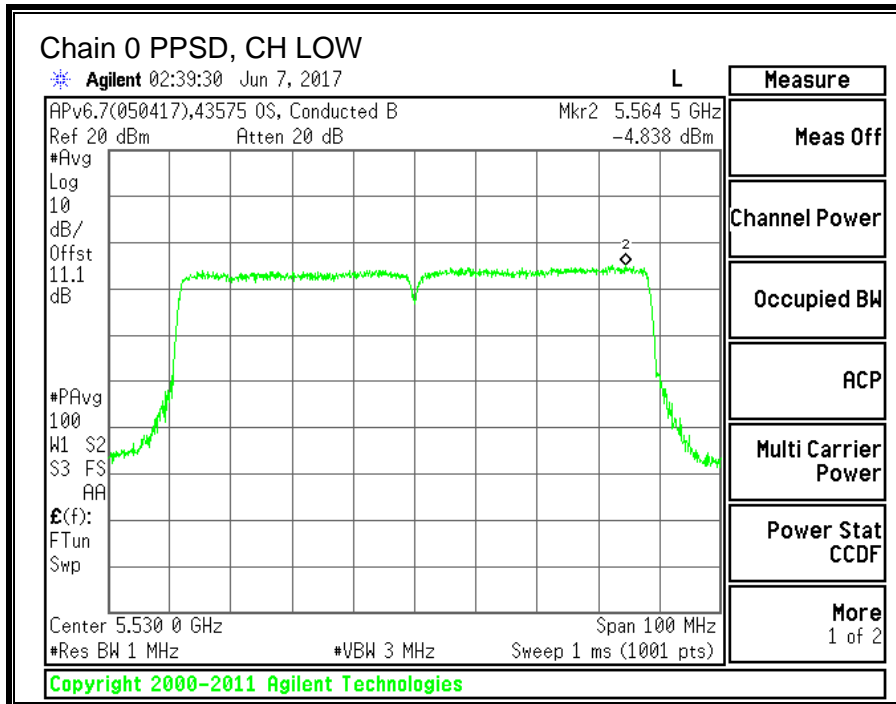

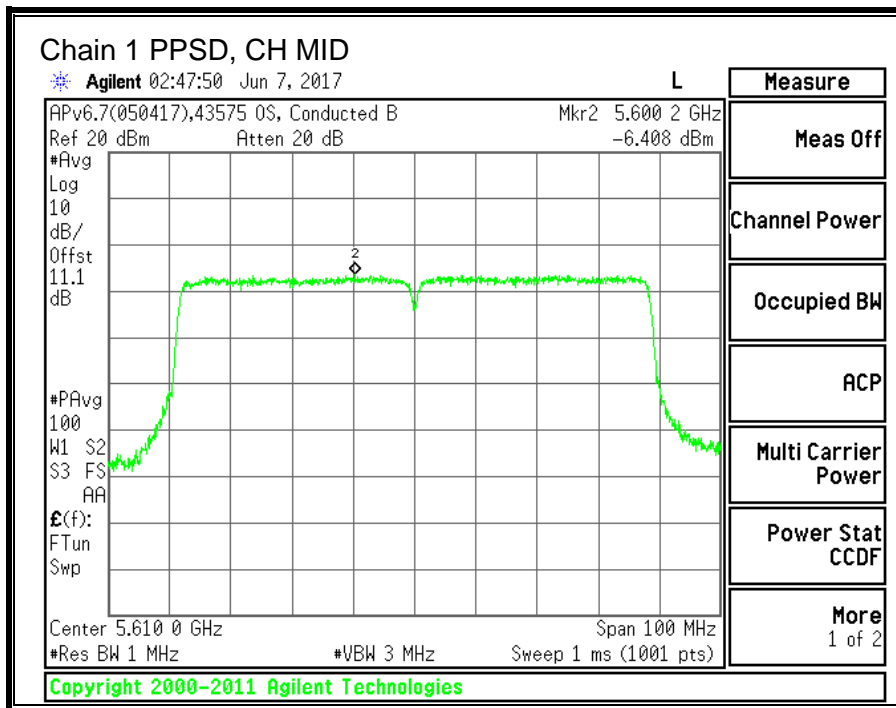
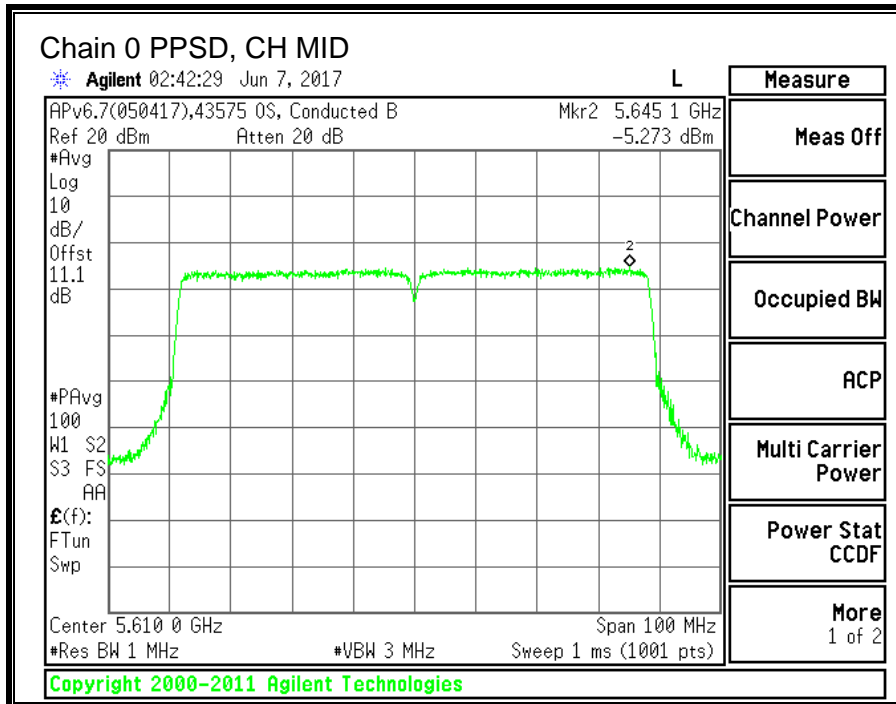

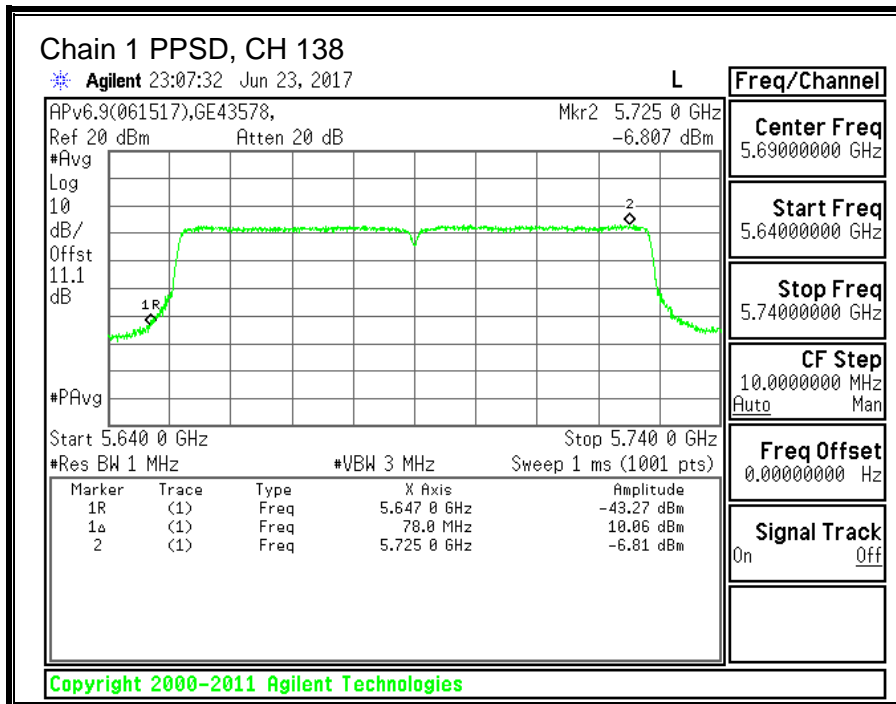
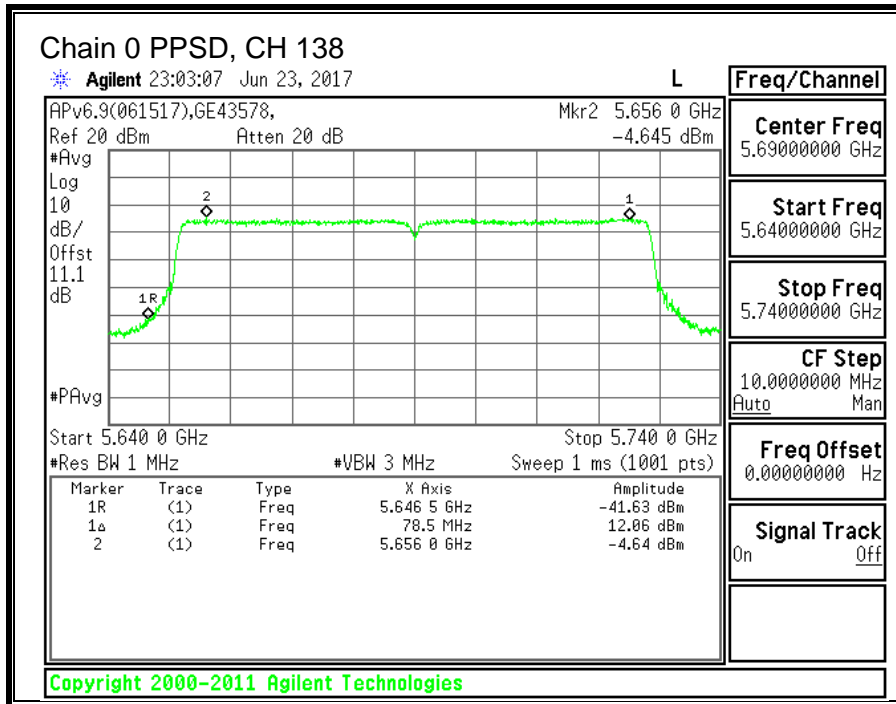

### 10.13. 11a 2TX CDD MIMO MODE IN THE 5.8GHz BAND

#### 10.13.1. 6 dB BANDWIDTH

##### LIMITS

FCC §15.407 (e)

The minimum 6 dB bandwidth shall be at least 500 kHz.

##### RESULTS

Channel	Frequency	6 dB BW Chain 0 (MHz)	6 dB BW Chain 1 (MHz)	Minimum Limit (MHz)
Low	5745	16.45	16.45	0.5
Mid	5785	16.45	16.40	0.5
High	5825	16.55	16.45	0.5



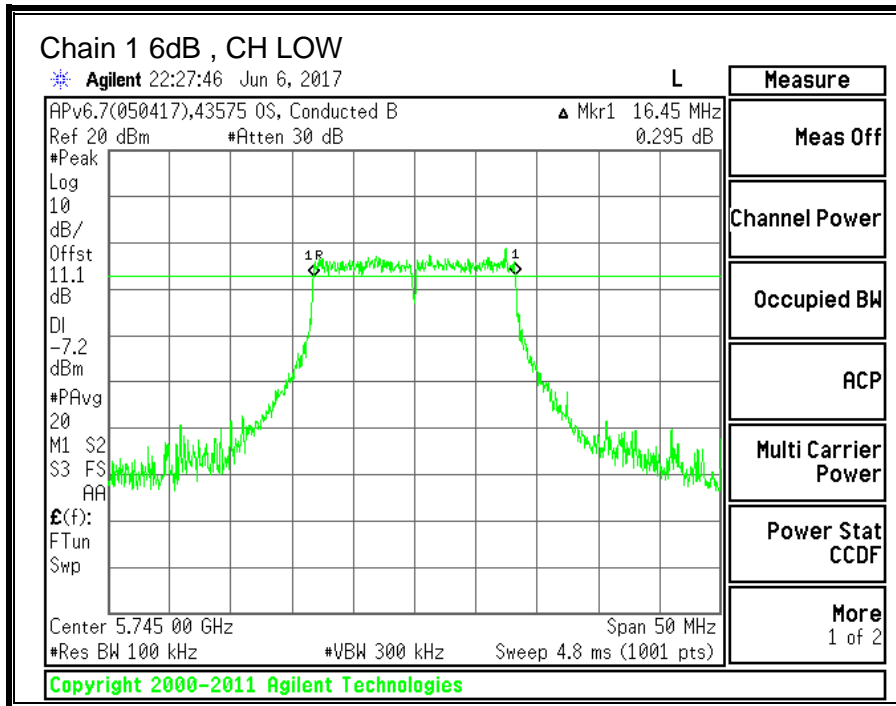
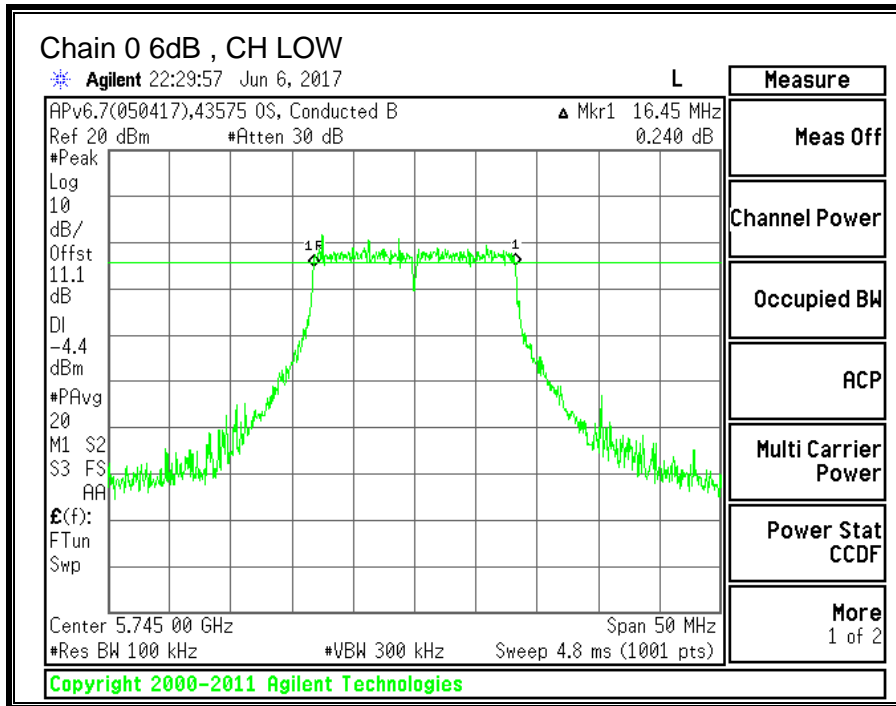

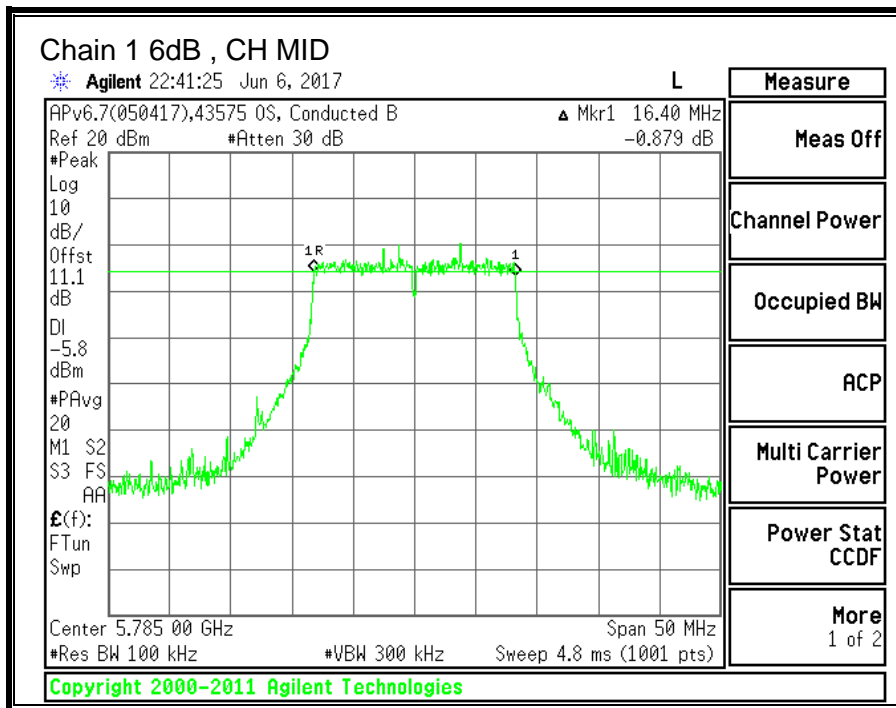
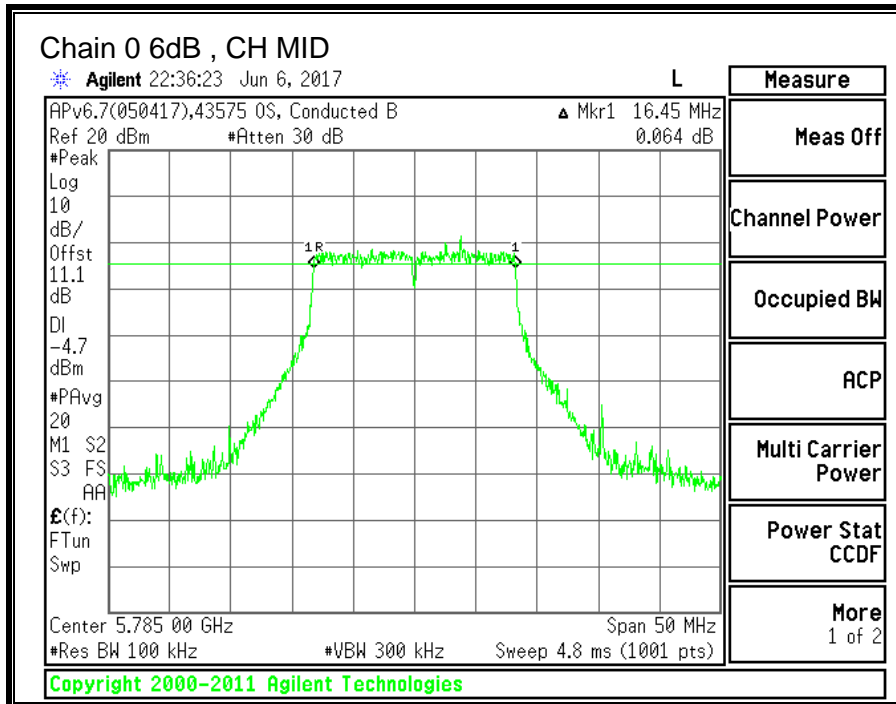

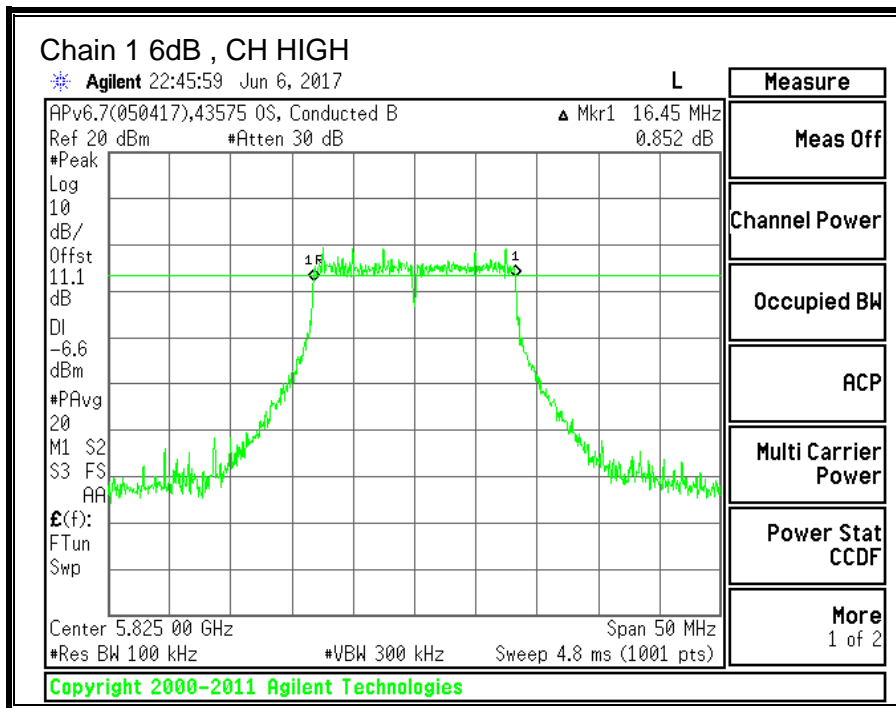
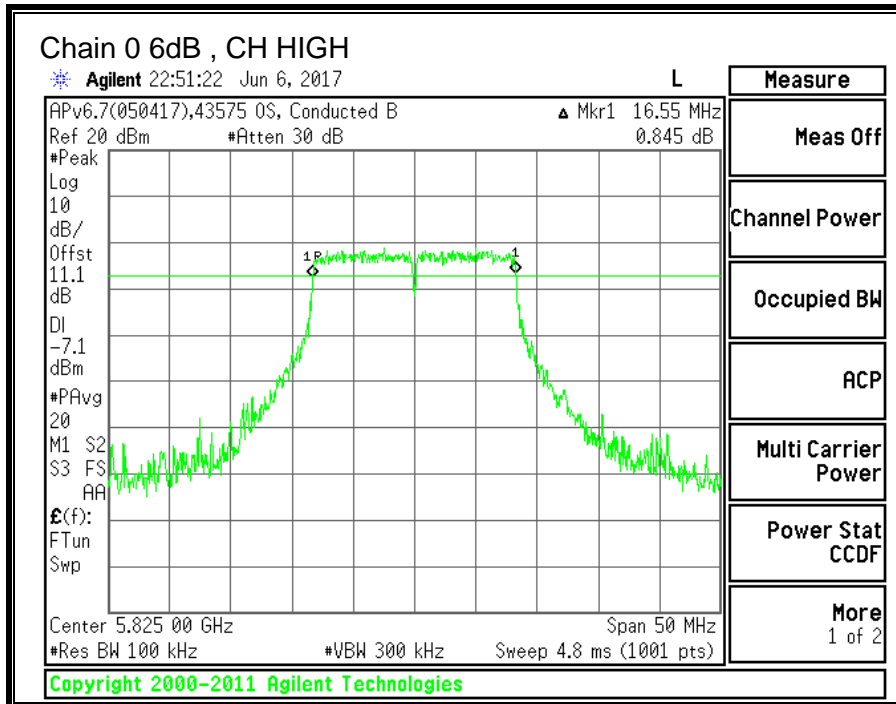

---

**10.13.2. 99% BANDWIDTH**

**LIMITS**

None; for reporting purposes only.

**RESULTS**

<b>Channel</b>	<b>Frequency</b>	<b>99% BW Chain 0 (MHz)</b>	<b>99% BW Chain 1 (MHz)</b>
Low	5745	16.499	16.389
Mid	5785	16.407	16.246
High	5825	16.327	16.328

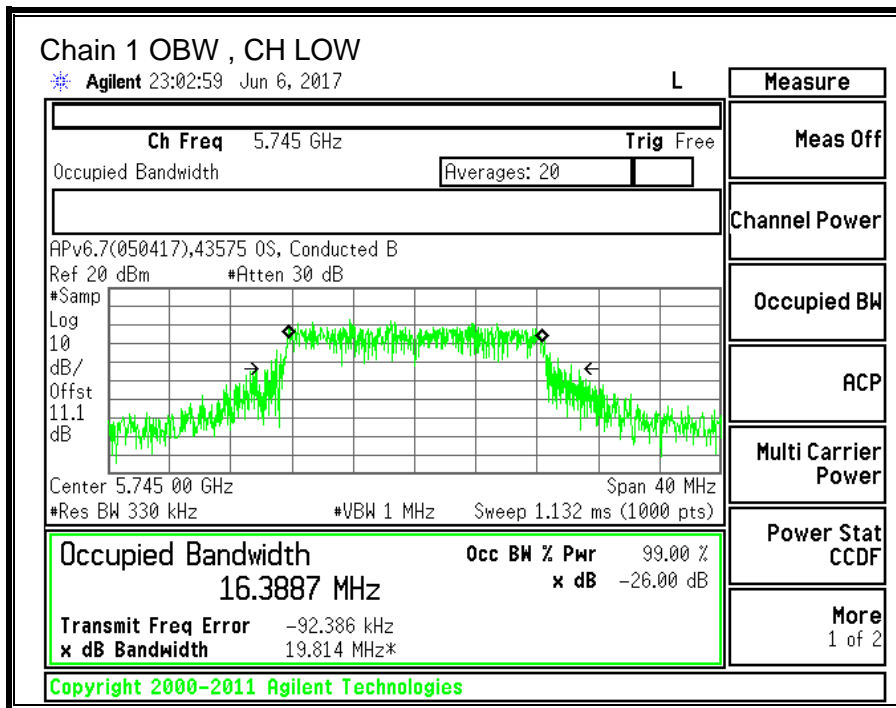
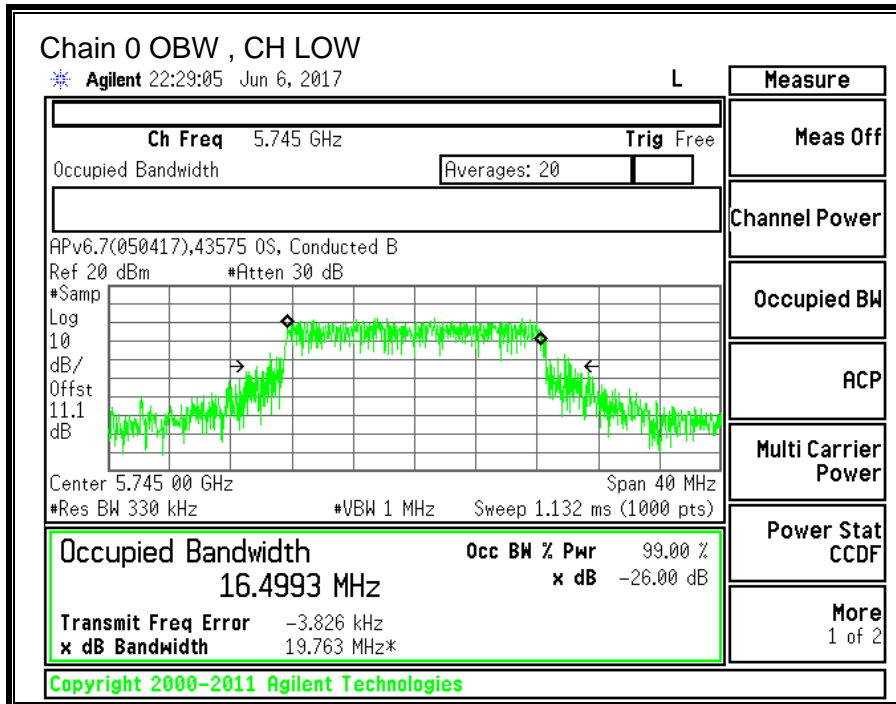

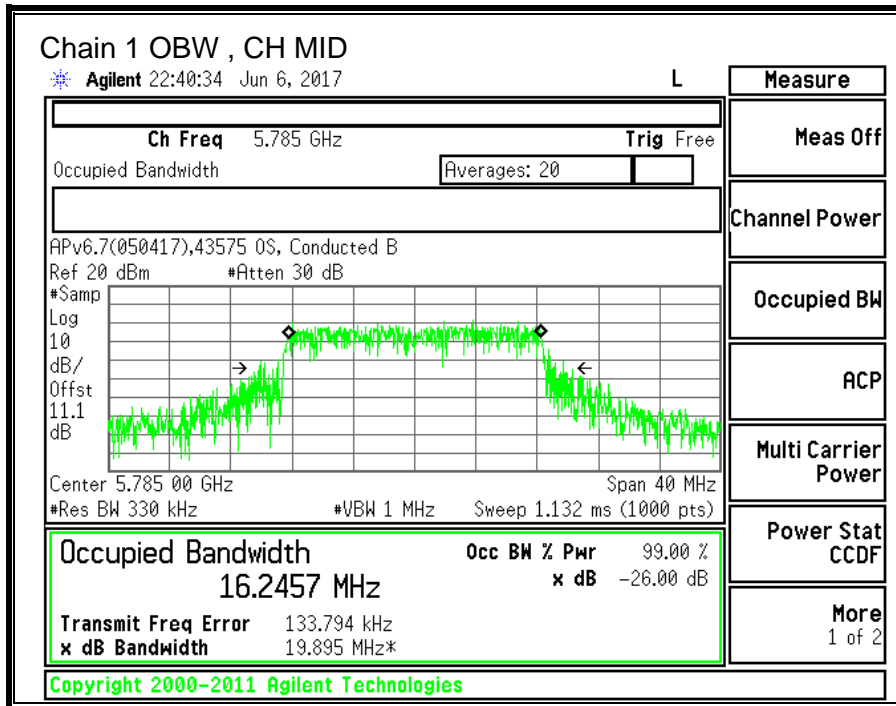
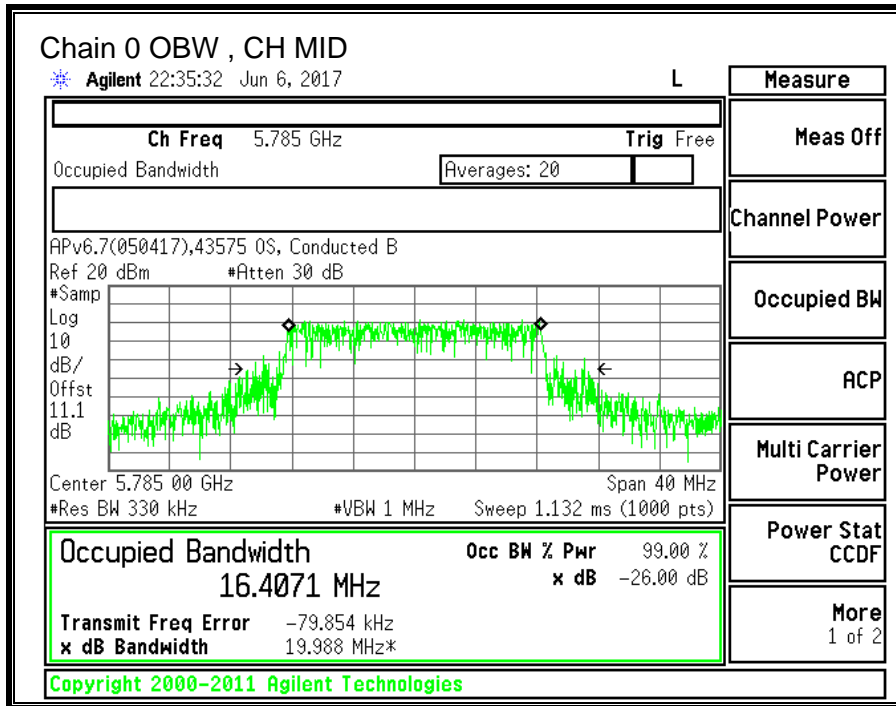

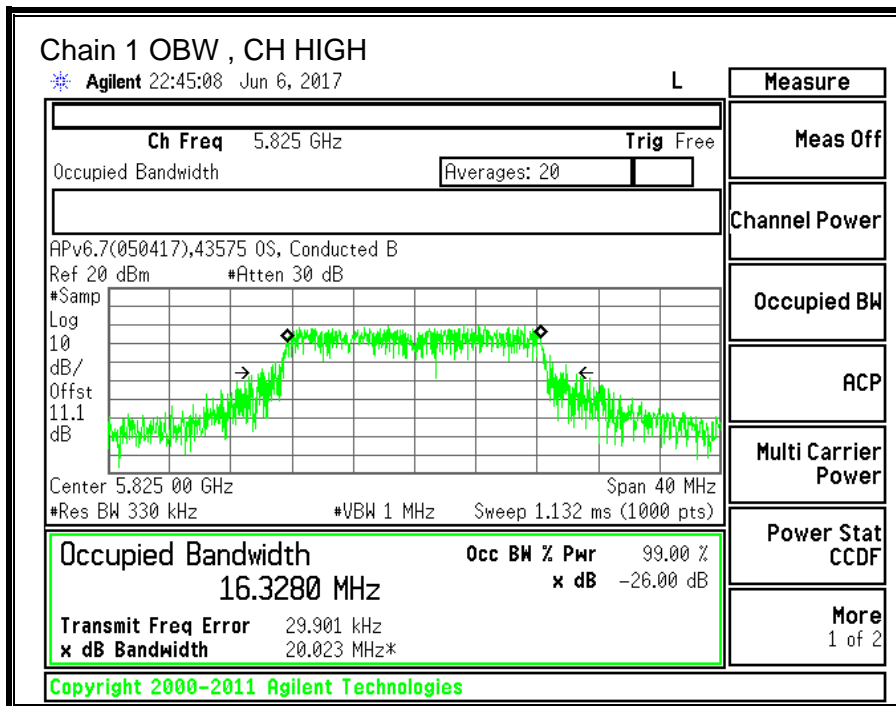
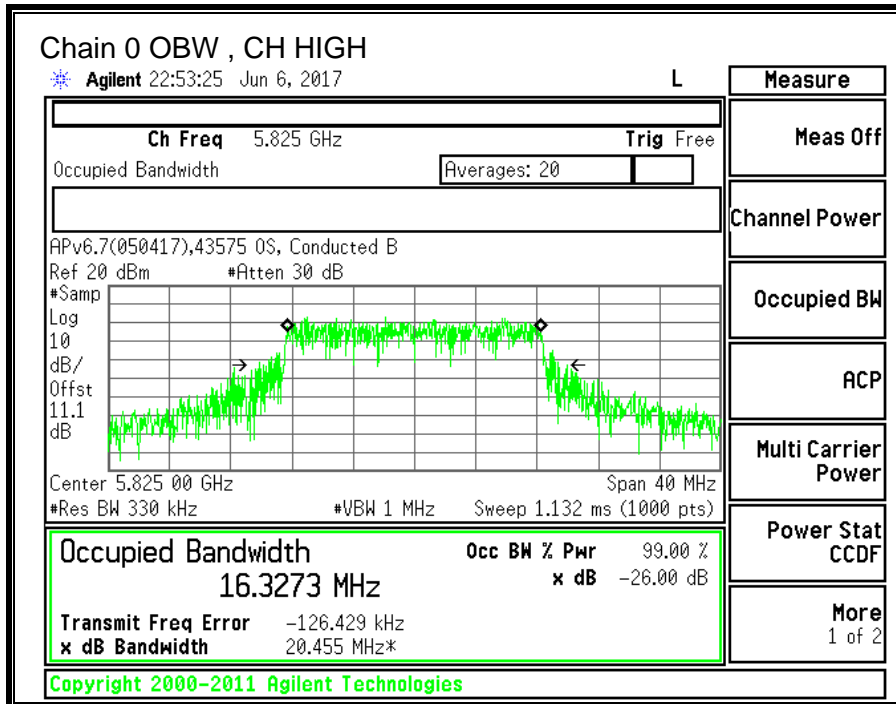

### 10.13.3. OUTPUT POWER AND PSD

#### LIMITS

FCC §15.407 (a) (3)

For the band 5.725-5.85 GHz, the maximum conducted output power over the frequency band of operation shall not exceed 1 W. In addition, the maximum power spectral density shall not exceed 30 dBm in any 500-kHz band. If transmitting antennas of directional gain greater than 6 dBi are used, both the maximum conducted output power and the maximum power spectral density shall be reduced by the amount in dB that the directional gain of the antenna exceeds 6 dBi.

#### TEST PROCEDURE

Measurements perform using a wideband gated RF power meter provided that the gate parameters are adjusted such that the power is measured only when the EUT is transmitting at its maximum power control level. Since the measurement is made only during the ON time of the transmitter, no duty cycle correction factor is required.

#### DIRECTIONAL ANTENNA GAIN

For power, the TX chains are uncorrelated and the antenna gain is unequal among the chains. The directional gain is:

##### 5725-5850 MHz

Chain 0 Antenna Gain (dBi)	Chain 1 Antenna Gain (dBi)	Uncorrelated Chains Directional Gain (dBi)
-3.50	-8.40	-5.29

For PSD the TX chains are correlated and the antenna gain is unequal among the chains. The directional gain is:

##### 5725-5850 MHz

Chain 0 Antenna Gain (dBi)	Chain 1 Antenna Gain (dBi)	Correlated Chains Directional Gain (dBi)
-3.50	-8.40	-2.60



**RESULTS**

<b>ID:</b>	43574	<b>Date:</b>	06/06/17
------------	-------	--------------	----------

**Antenna Gain and Limit**

Channel	Frequency (MHz)	Directional Gain for Power (dBi)	Directional Gain for PSD (dBi)	Power Limit (dBm)	Power Limit (dBm)
Low	5745	-5.29	-2.60	30.00	30.00
Mid	5785	-5.29	-2.60	30.00	30.00
High	5825	-5.29	-2.60	30.00	30.00

<b>Duty Cycle CF (dB)</b>	0.24	<b>Included in Calculations of Corr'd PSD</b>
---------------------------	------	---

**Output Power Results**

Channel	Frequency (MHz)	Chain 0 Meas Power (dBm)	Chain 1 Meas Power (dBm)	Total Corr'd Power (dBm)	Power Limit (dBm)	Power Margin (dB)
Low	5745	13.33	11.53	15.53	30.00	-14.47
Mid	5785	13.43	11.62	15.63	30.00	-14.37
High	5825	13.13	11.05	15.22	30.00	-14.78

**PSD Results**

Channel	Frequency (MHz)	Chain 0 Meas PSD (dBm)	Chain 1 Meas PSD (dBm)	Total Corr'd PSD (dBm)	PSD Limit (dBm)	PSD Margin (dB)
Low	5745	-0.615	-1.952	2.02	30.00	-27.98
Mid	5785	-1.040	-2.695	1.46	30.00	-28.54
High	5825	-0.682	-2.980	1.57	30.00	-28.43

**Note:** the power readings above were measured with gated method, and the measurement was taken only during the ON time. No duty cycle correction was necessary.

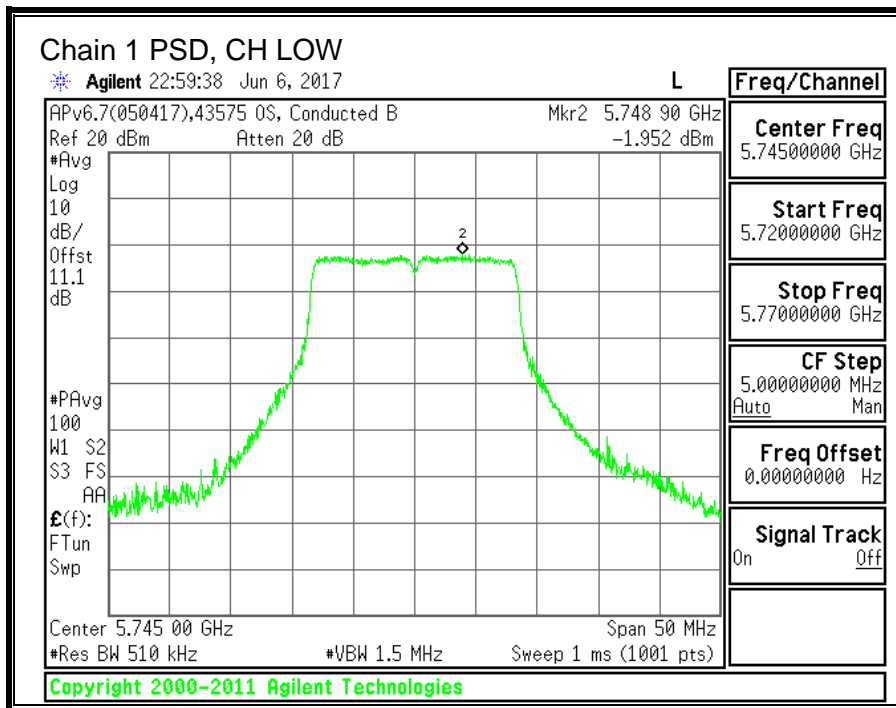
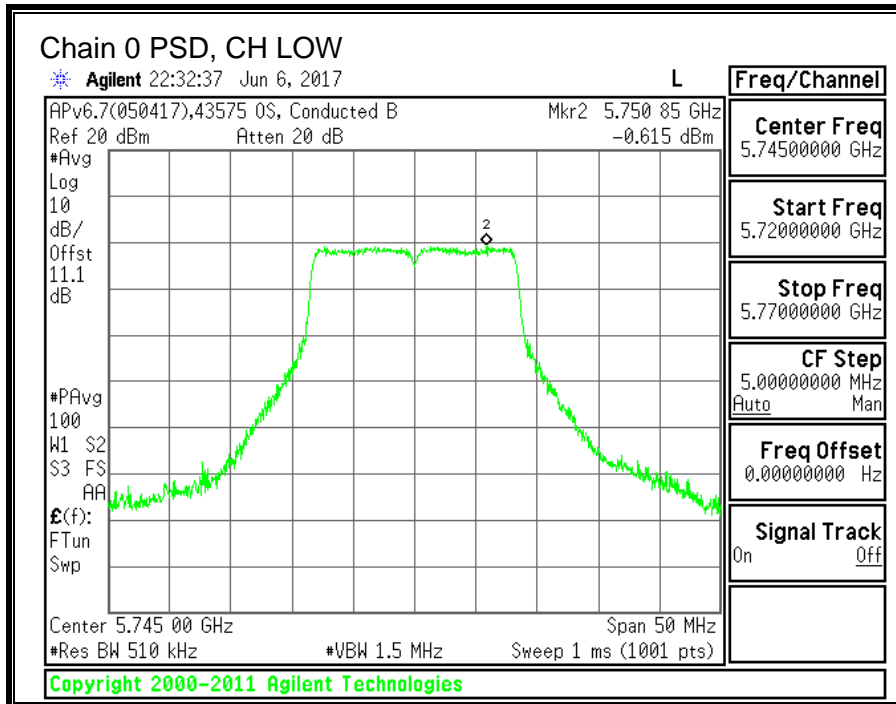

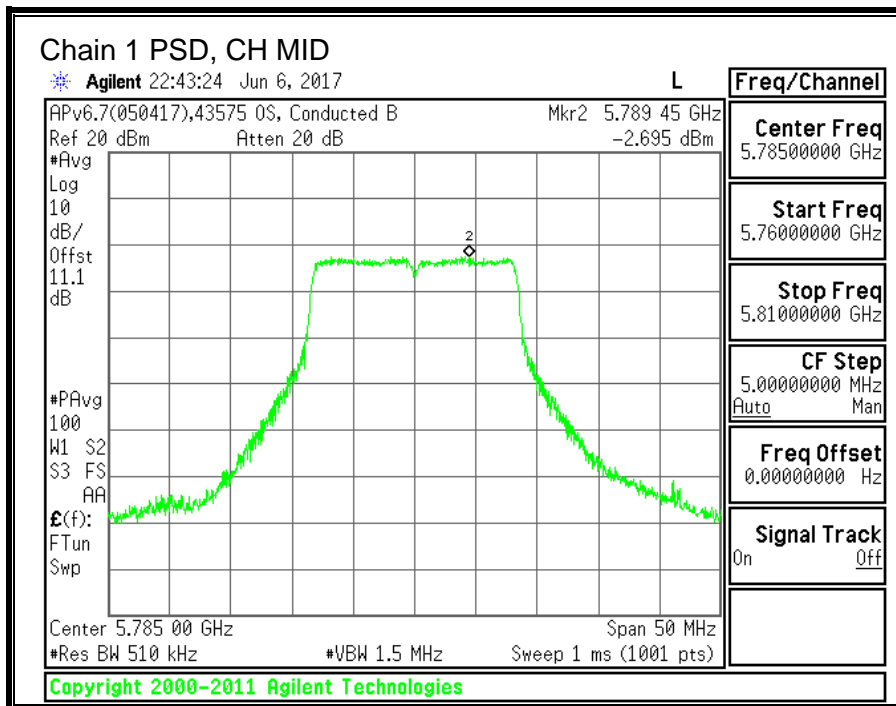
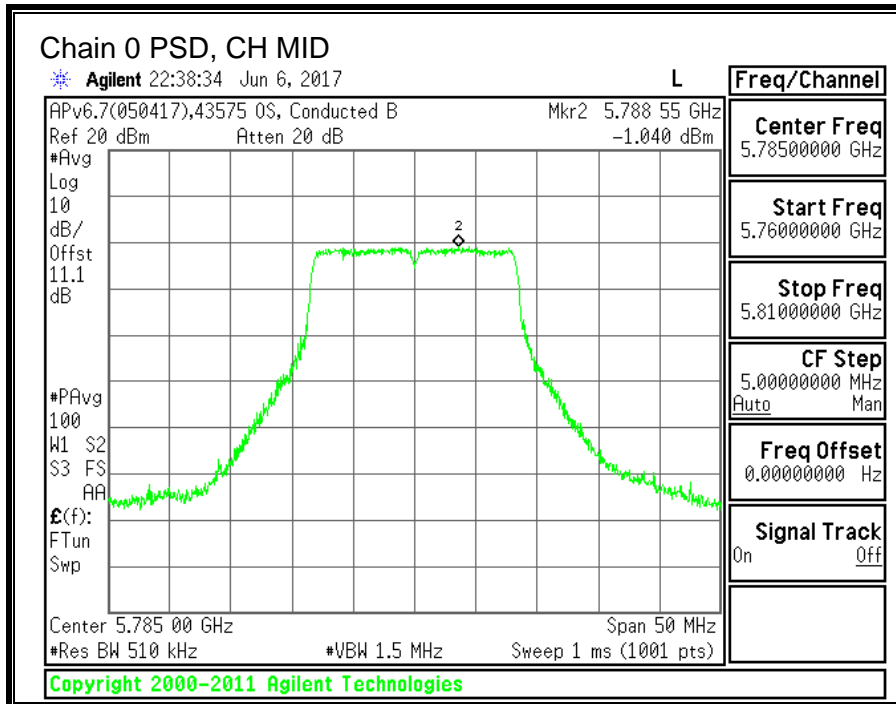

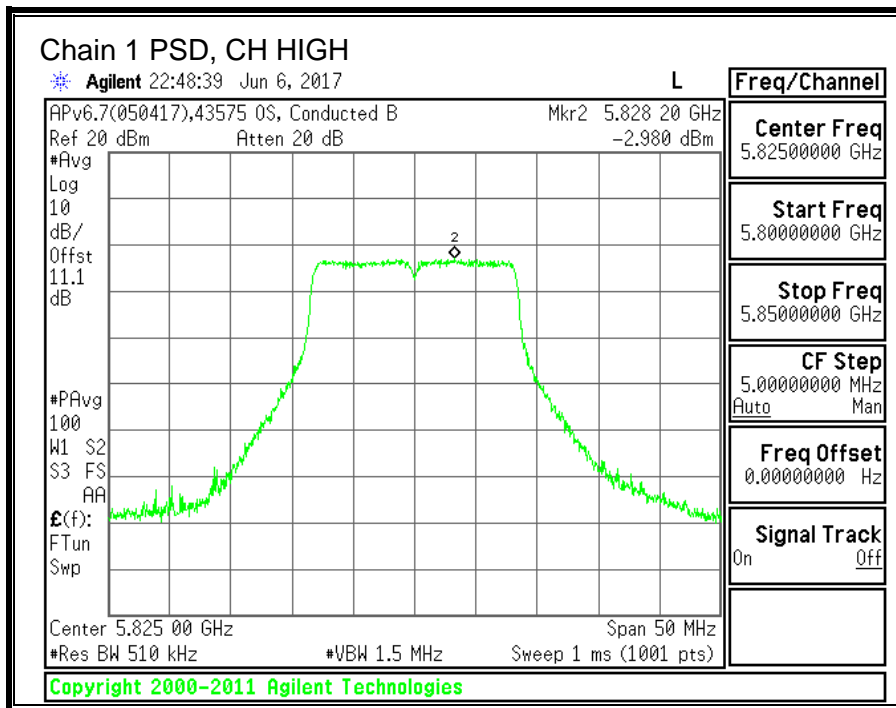
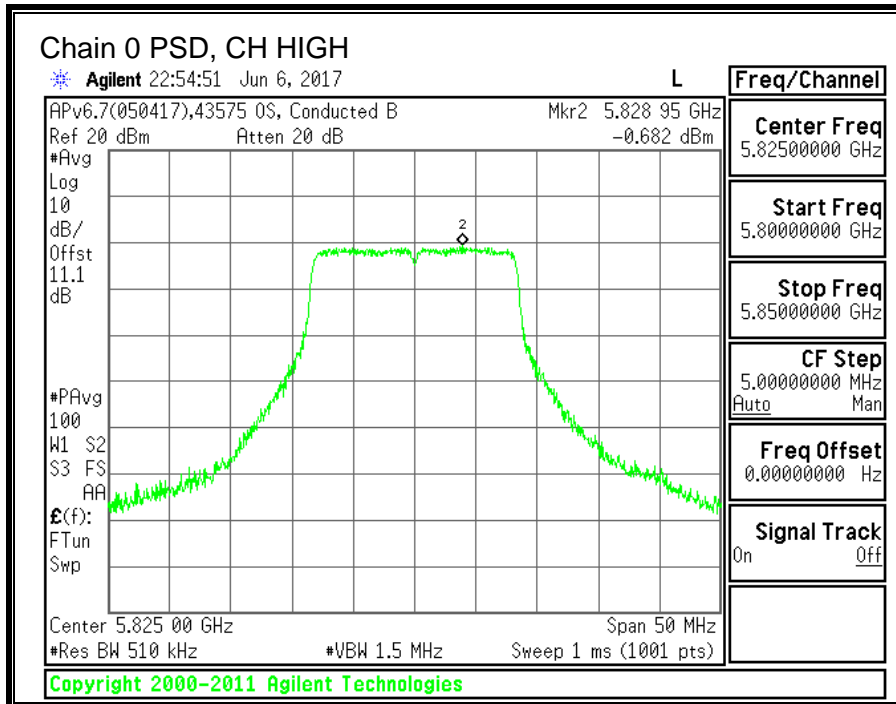

---

**10.14. 11n HT20 2TX CDD MIMO MODE IN THE 5.8GHz BAND**

**10.14.1. 6 dB BANDWIDTH**

**LIMITS**

FCC §15.407 (e)

The minimum 6 dB bandwidth shall be at least 500 kHz.

**RESULTS**

Channel	Frequency	6 dB BW Chain 0 (MHz)	6 dB BW Chain 1 (MHz)	Minimum Limit (MHz)
Low	5745	17.80	17.70	0.5
Mid	5785	17.65	17.65	0.5
High	5825	17.65	17.65	0.5

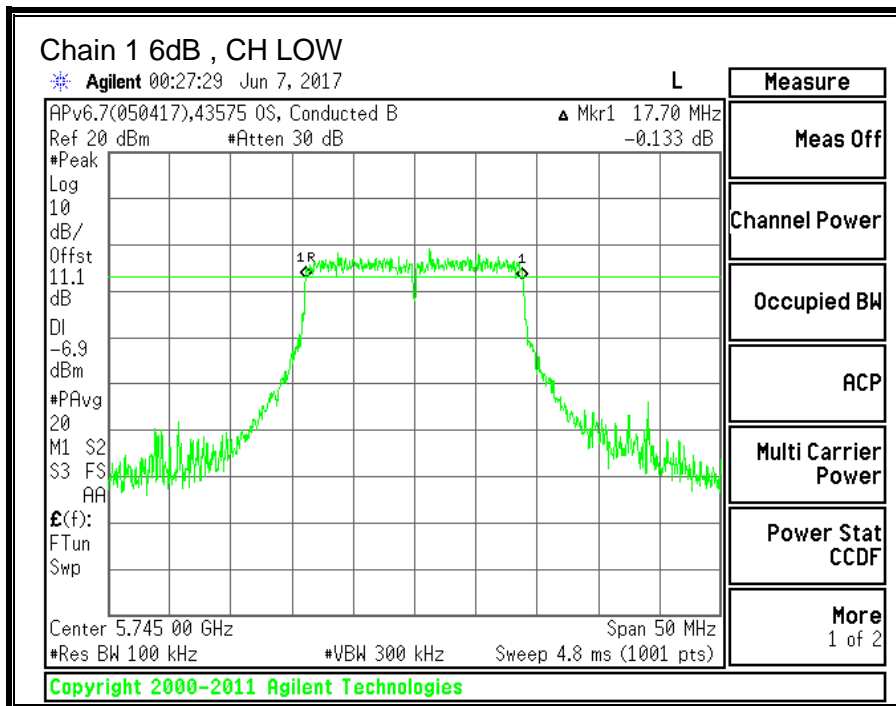
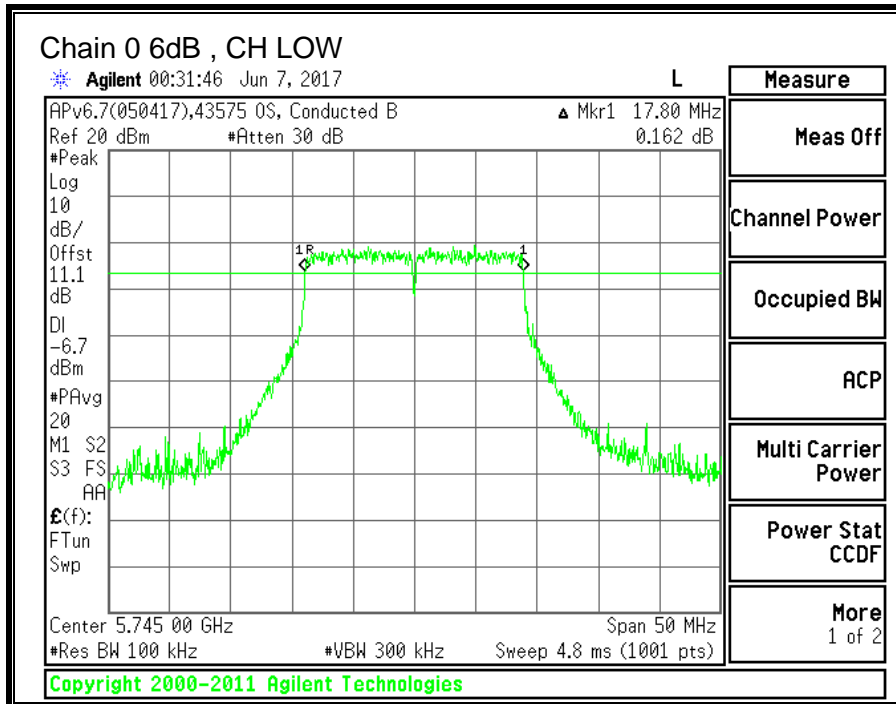

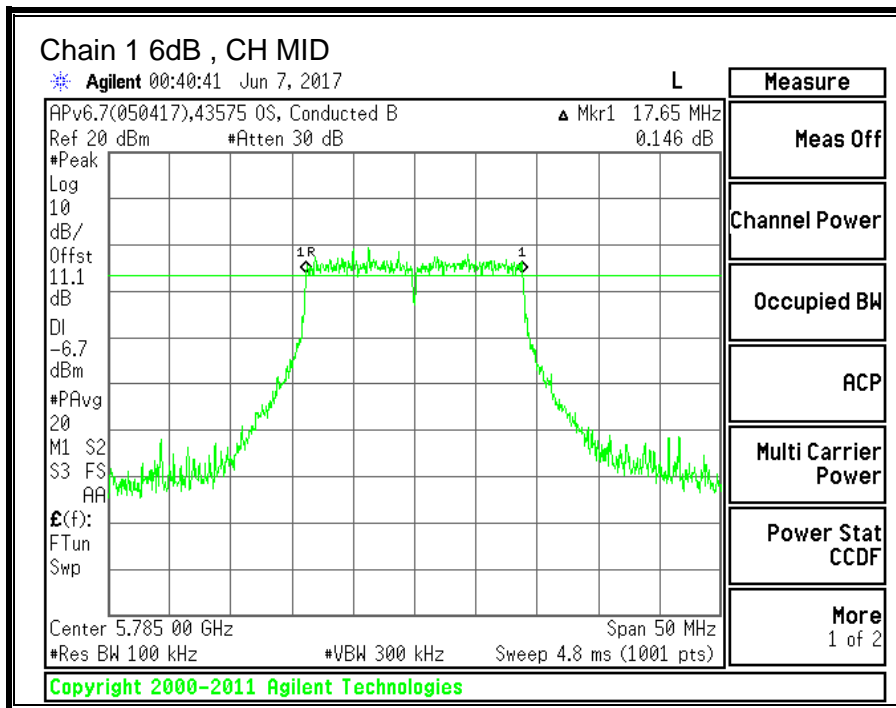
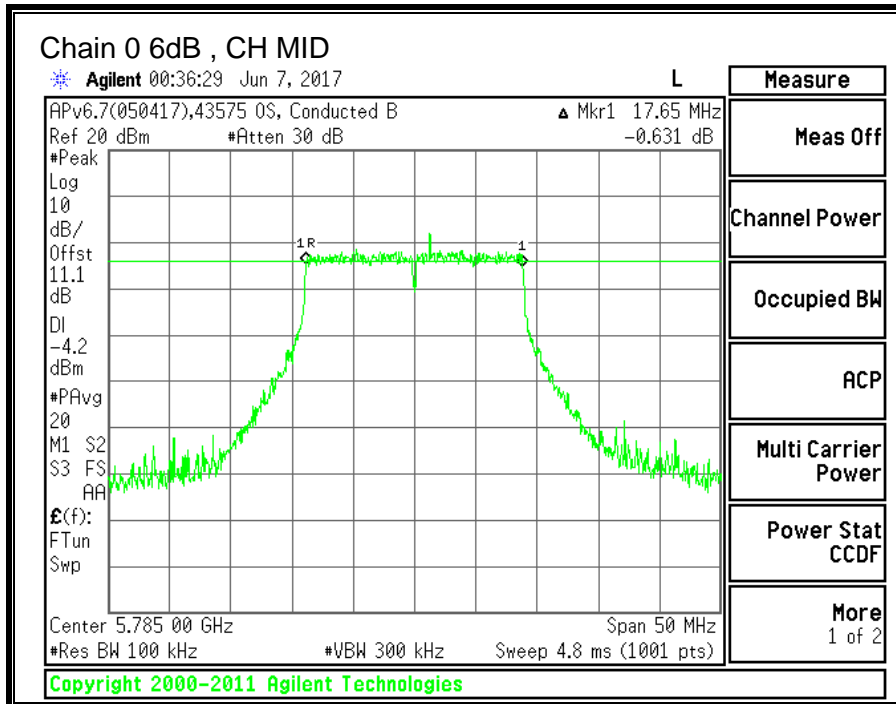

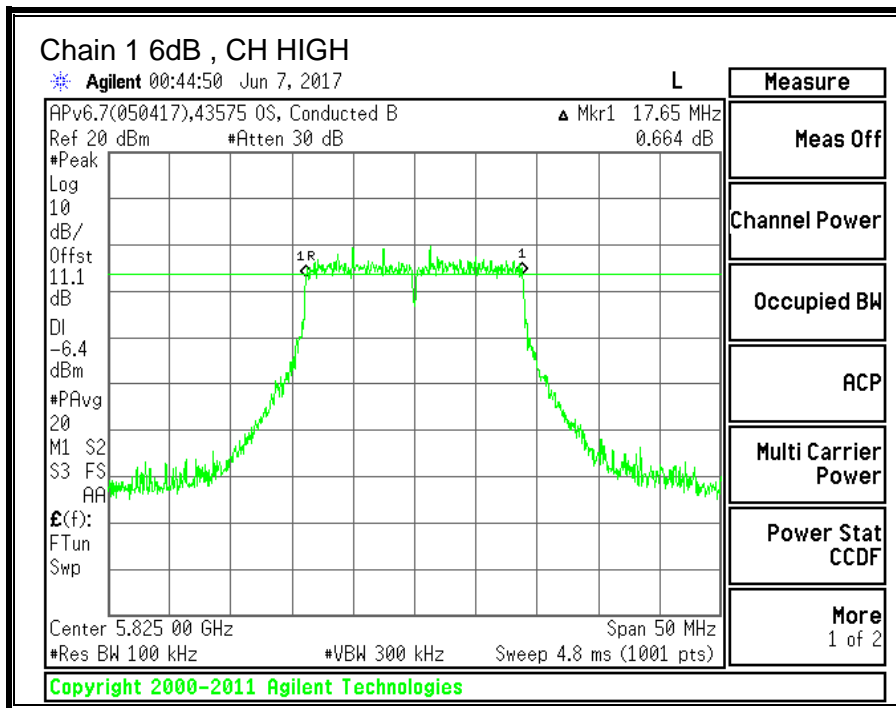
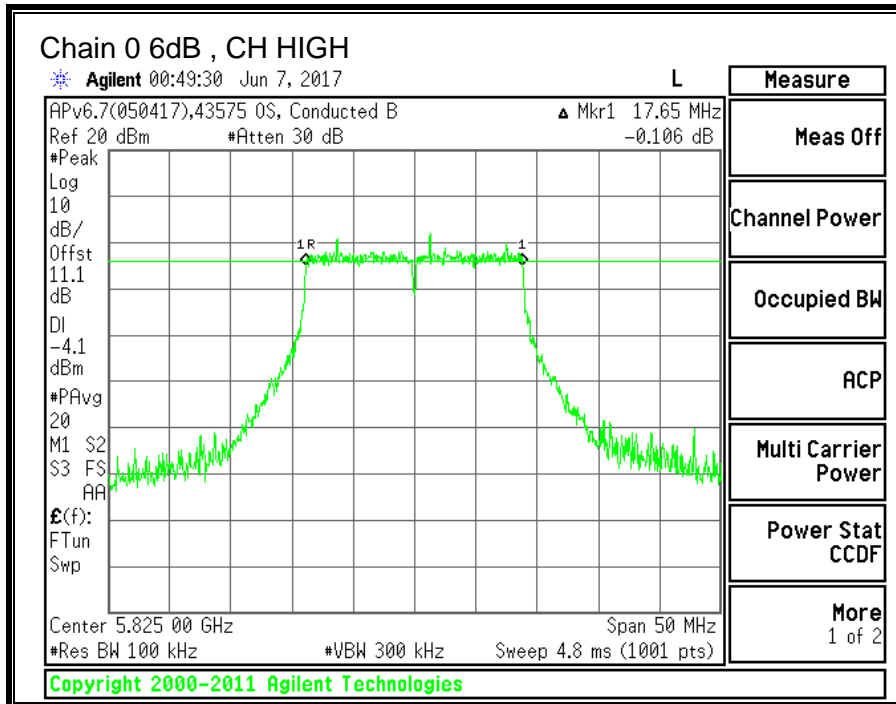



---

**10.14.2. 99% BANDWIDTH**

**LIMITS**

None; for reporting purposes only.

**RESULTS**

<b>Channel</b>	<b>Frequency</b>	<b>99% BW Chain 0 (MHz)</b>	<b>99% BW Chain 1 (MHz)</b>
Low	5745	17.769	17.729
Mid	5785	17.759	17.733
High	5825	17.408	17.234

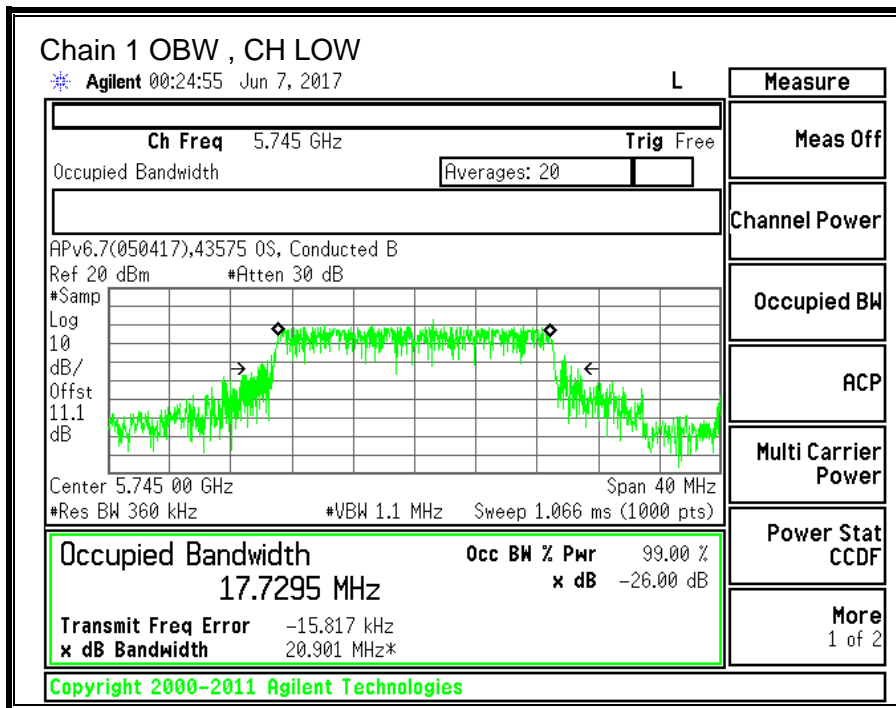
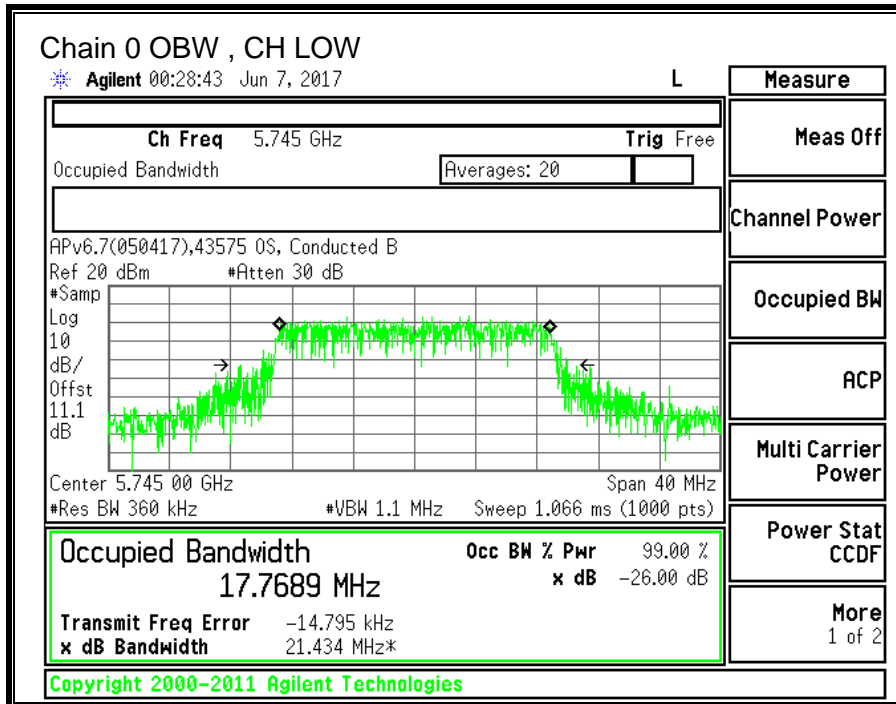

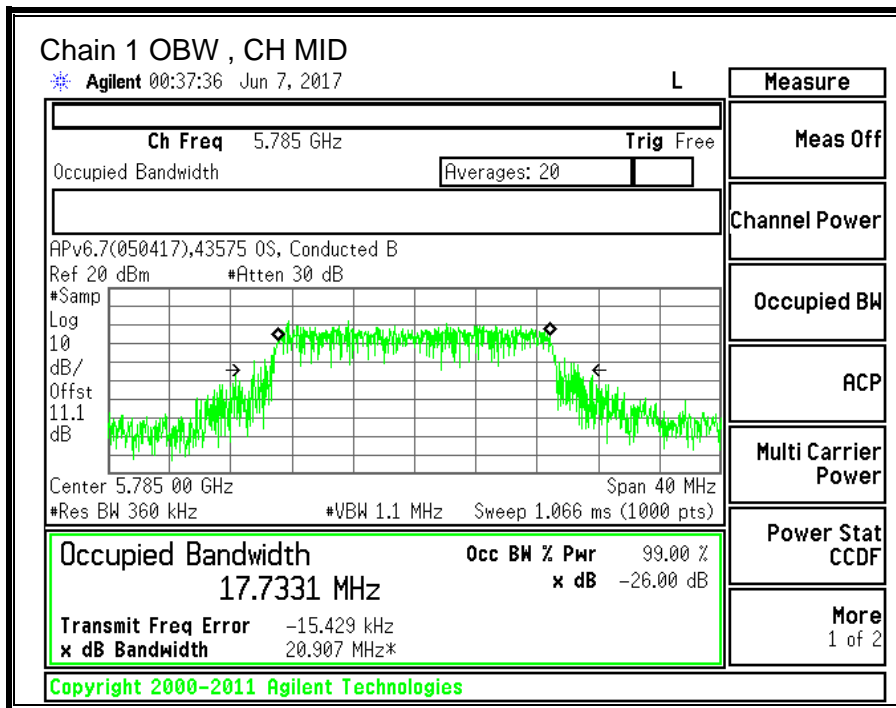
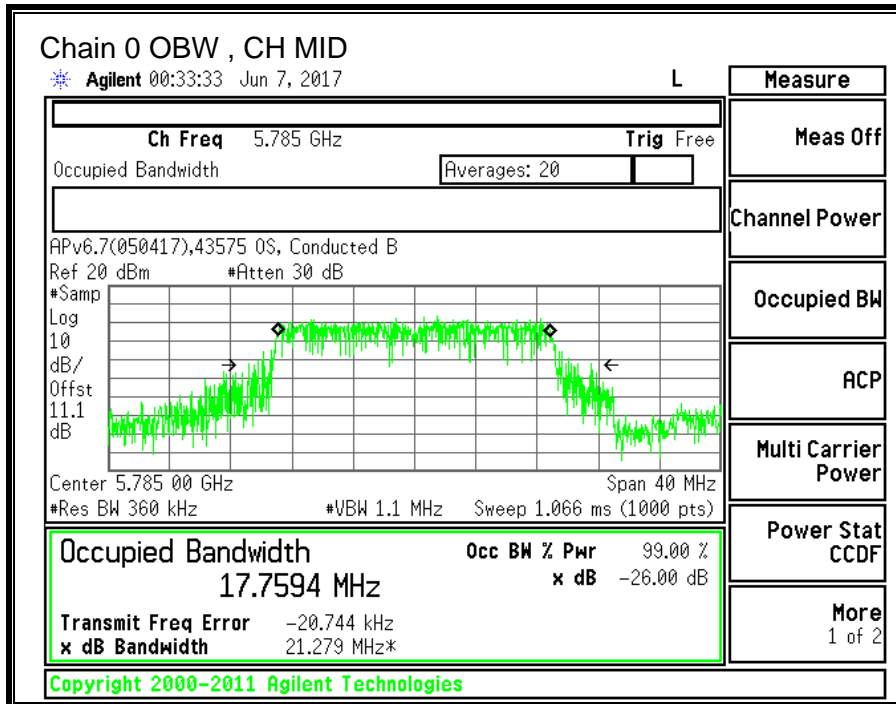

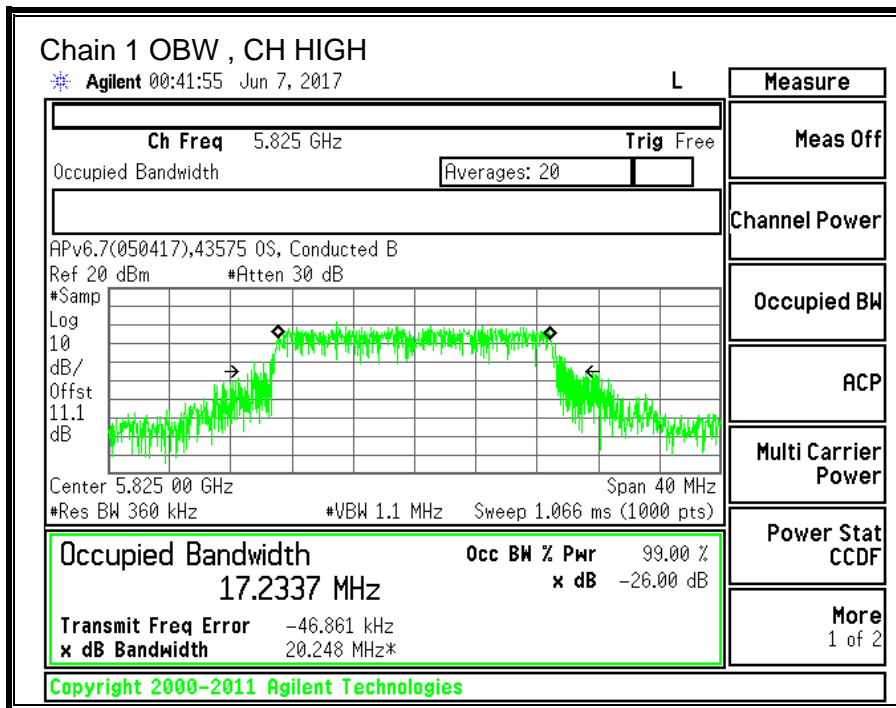
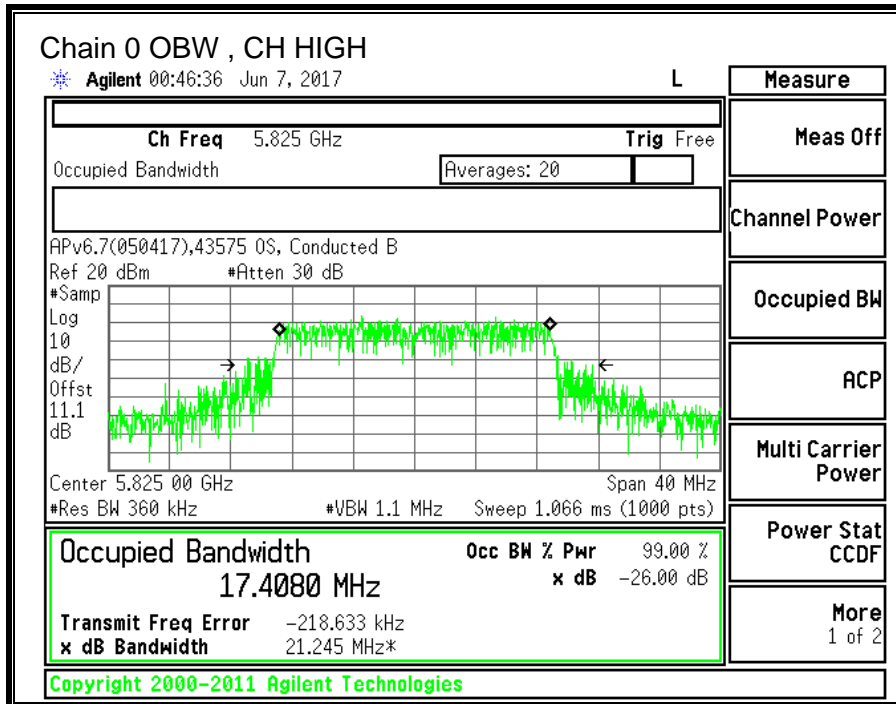

### 10.14.3. OUTPUT POWER AND PSD

#### LIMITS

FCC §15.407 (a) (3)

For the band 5.725-5.85 GHz, the maximum conducted output power over the frequency band of operation shall not exceed 1 W. In addition, the maximum power spectral density shall not exceed 30 dBm in any 500-kHz band. If transmitting antennas of directional gain greater than 6 dBi are used, both the maximum conducted output power and the maximum power spectral density shall be reduced by the amount in dB that the directional gain of the antenna exceeds 6 dBi.

#### TEST PROCEDURE

Measurements perform using a wideband gated RF power meter provided that the gate parameters are adjusted such that the power is measured only when the EUT is transmitting at its maximum power control level. Since the measurement is made only during the ON time of the transmitter, no duty cycle correction factor is required.

#### DIRECTIONAL ANTENNA GAIN

For power, the TX chains are uncorrelated and the antenna gain is unequal among the chains. The directional gain is:

##### 5725-5850 MHz

Chain 0 Antenna Gain (dBi)	Chain 1 Antenna Gain (dBi)	Uncorrelated Chains Directional Gain (dBi)
-3.50	-8.40	-5.29

For PSD the TX chains are correlated and the antenna gain is unequal among the chains. The directional gain is:

##### 5725-5850 MHz

Chain 0 Antenna Gain (dBi)	Chain 1 Antenna Gain (dBi)	Correlated Chains Directional Gain (dBi)
-3.50	-8.40	-2.60

**RESULTS**

<b>ID:</b>	43574	<b>Date:</b>	06/06/17
------------	-------	--------------	----------

**Antenna Gain and Limit**

Channel	Frequency (MHz)	Directional Gain for Power (dBi)	Directional Gain for PSD (dBi)	Power Limit (dBm)	Power Limit (dBm)
Low	5745	-5.29	-2.60	30.00	30.00
Mid	5785	-5.29	-2.60	30.00	30.00
High	5825	-5.29	-2.60	30.00	30.00

<b>Duty Cycle CF (dB)</b>	0.20	<b>Included in Calculations of Corr'd PSD</b>
---------------------------	------	---

**Output Power Results**

Channel	Frequency (MHz)	Chain 0 Meas Power (dBm)	Chain 1 Meas Power (dBm)	Total Corr'd Power (dBm)	Power Limit (dBm)	Power Margin (dB)
Low	5745	13.18	11.62	15.48	30.00	-14.52
Mid	5785	13.33	11.53	15.53	30.00	-14.47
High	5825	13.12	11.07	15.23	30.00	-14.77

**PSD Results**

Channel	Frequency (MHz)	Chain 0 Meas PSD (dBm)	Chain 1 Meas PSD (dBm)	Total Corr'd PSD (dBm)	PSD Limit (dBm)	PSD Margin (dB)
Low	5745	-0.797	-2.352	1.71	30.00	-28.29
Mid	5785	-1.039	-2.760	1.40	30.00	-28.60
High	5825	-0.868	-3.130	1.36	30.00	-28.64

**Note:** the power readings above were measured with gated method, and the measurement was taken only during the ON time. No duty cycle correction was necessary.

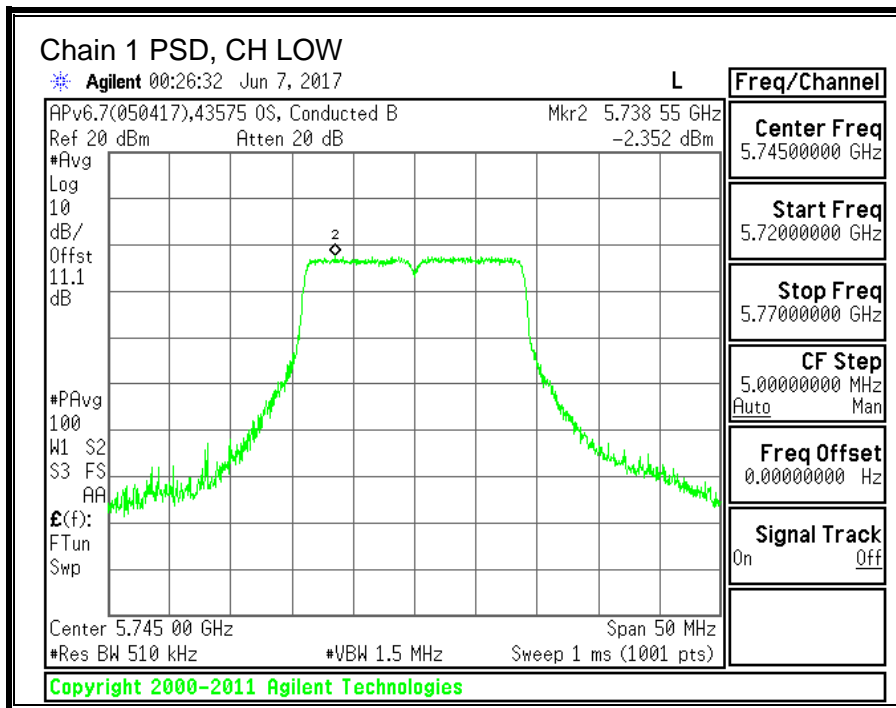
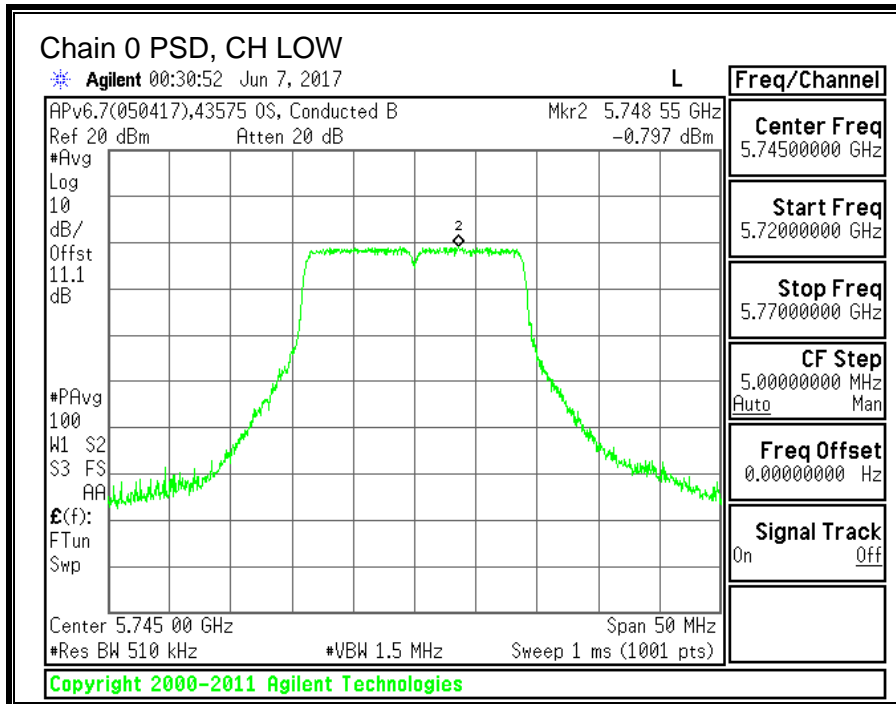

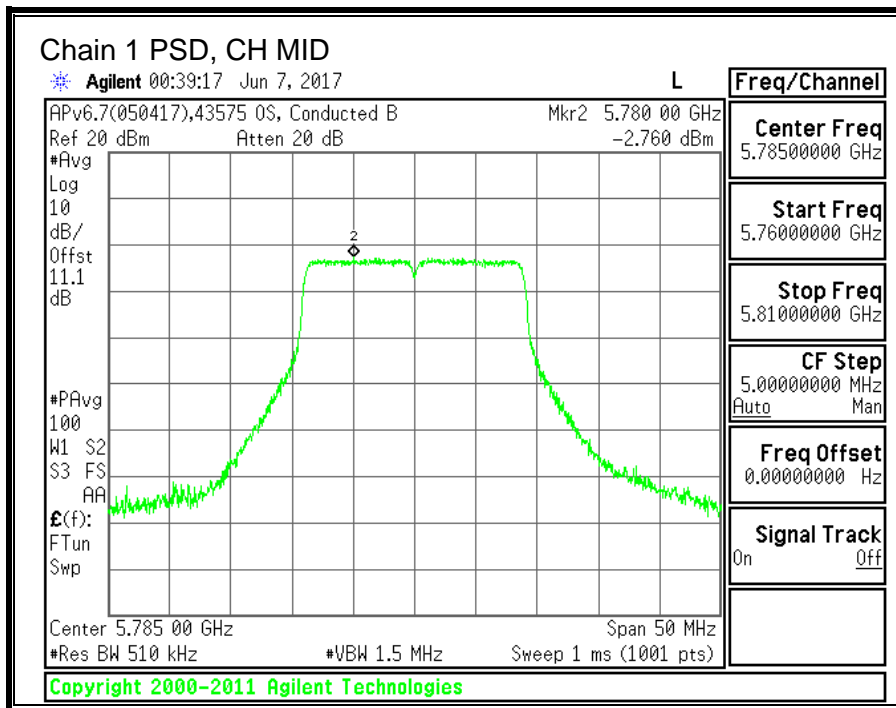
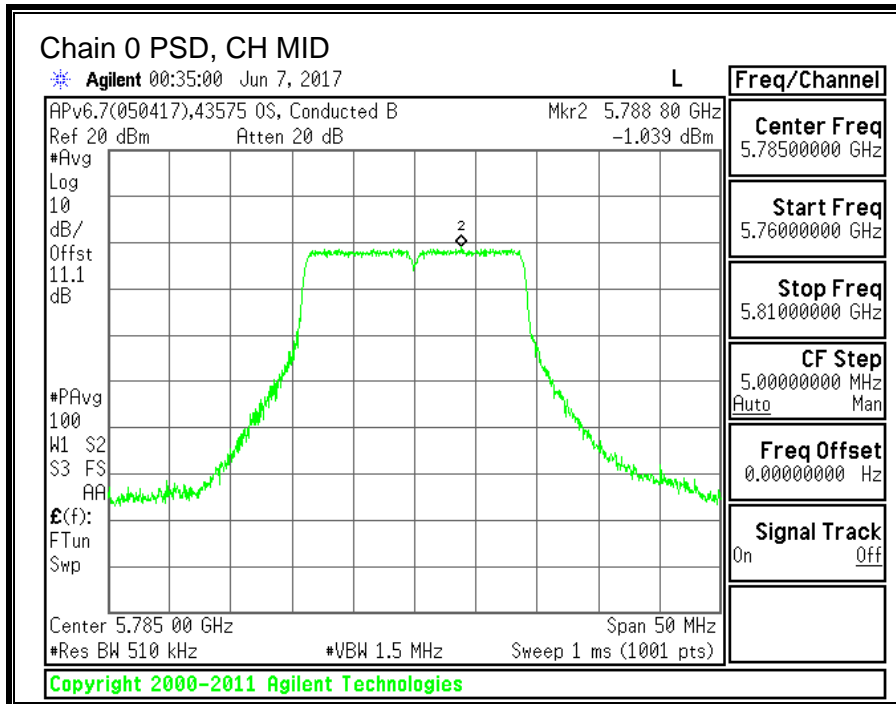



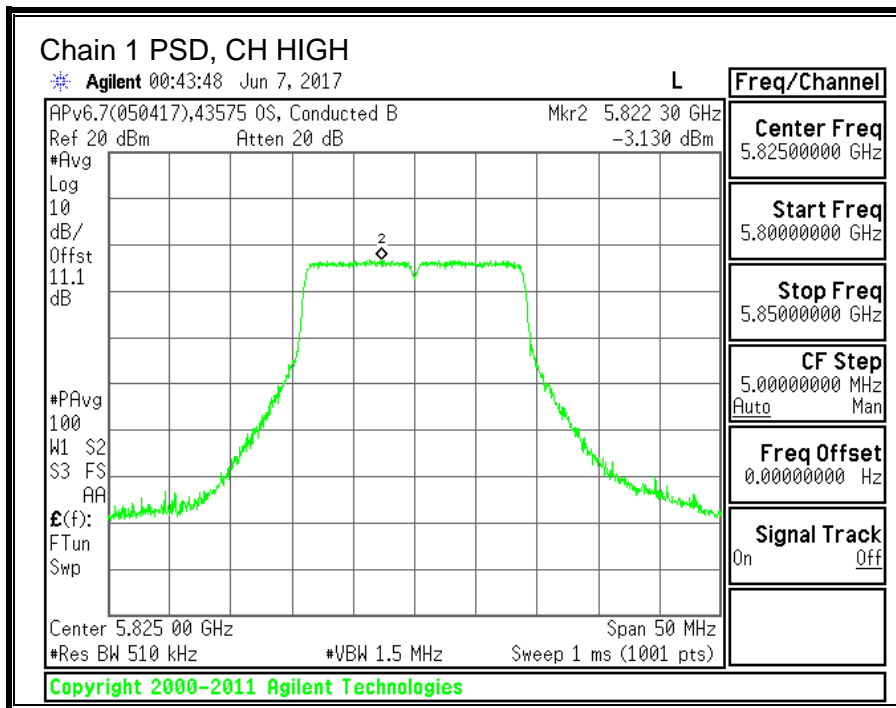
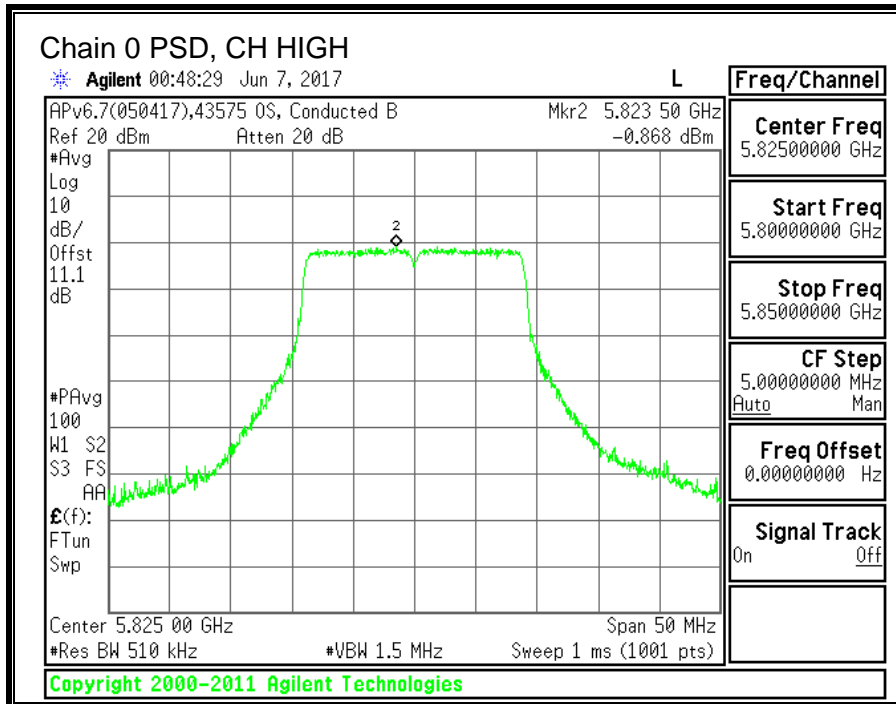

---

**10.15. 11n HT40 2TX CDD MIMO MODE IN THE 5.8GHz BAND**

**10.15.1.6 dB BANDWIDTH**

**LIMITS**

FCC §15.407 (e)

The minimum 6 dB bandwidth shall be at least 500 kHz.

**RESULTS**

Channel	Frequency	6 dB BW Chain 0 (MHz)	6 dB BW Chain 1 (MHz)	Minimum Limit (MHz)
Low	5755	36.3	36.4	0.5
High	5795	36.3	36.4	0.5

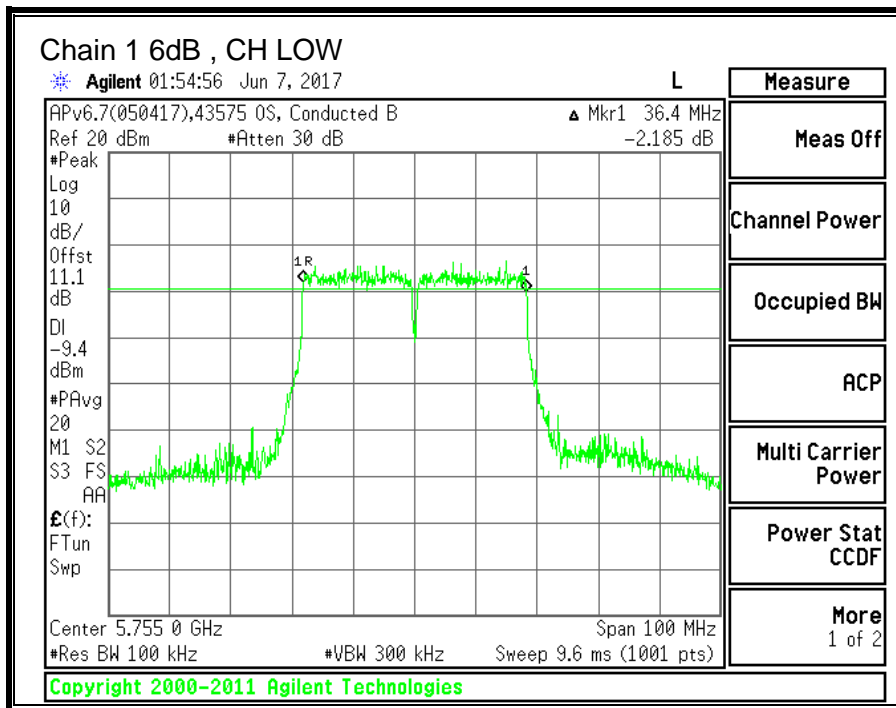
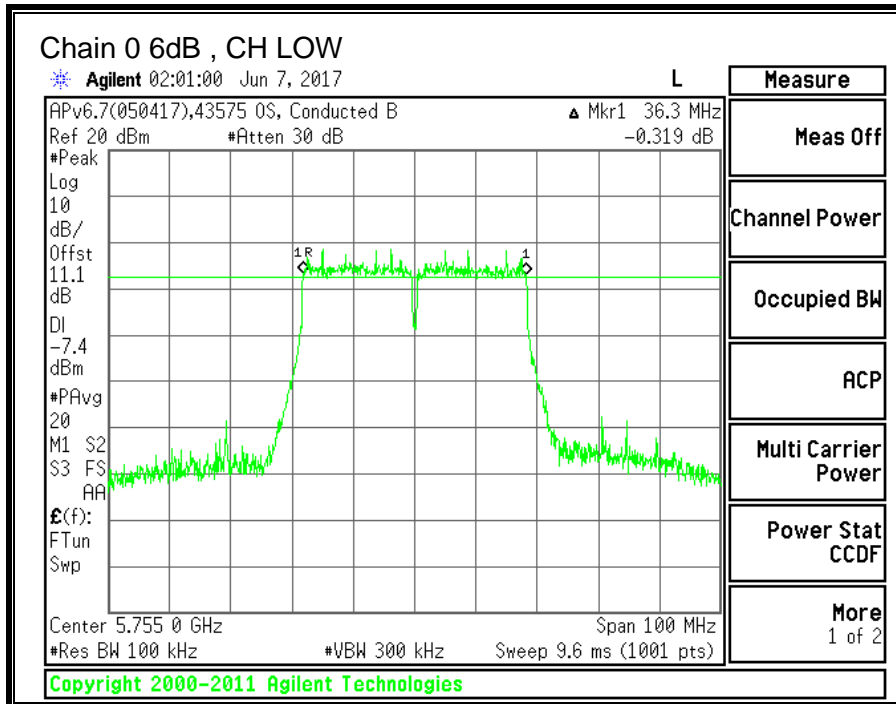

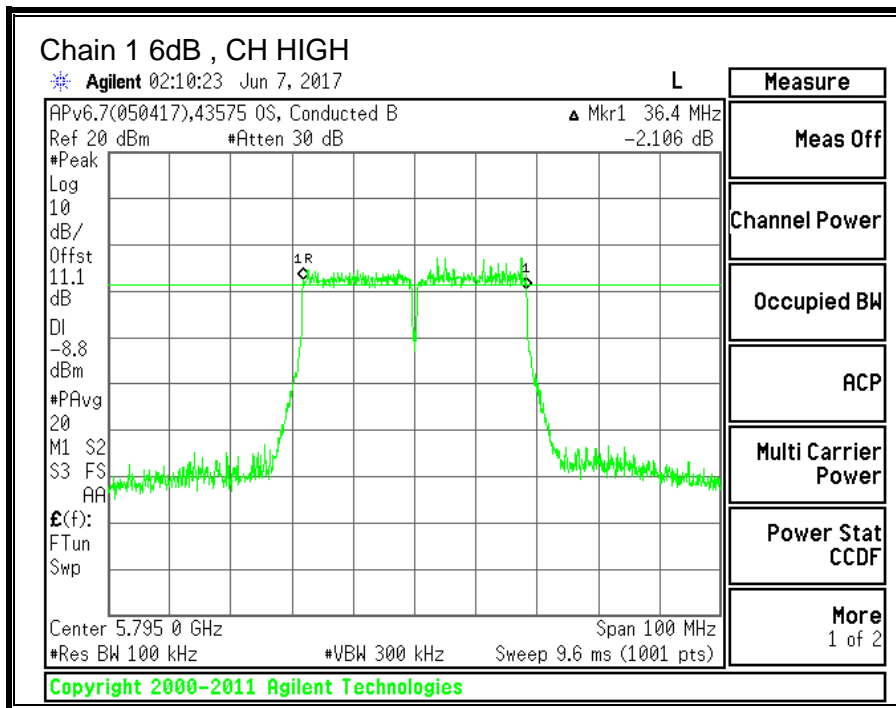
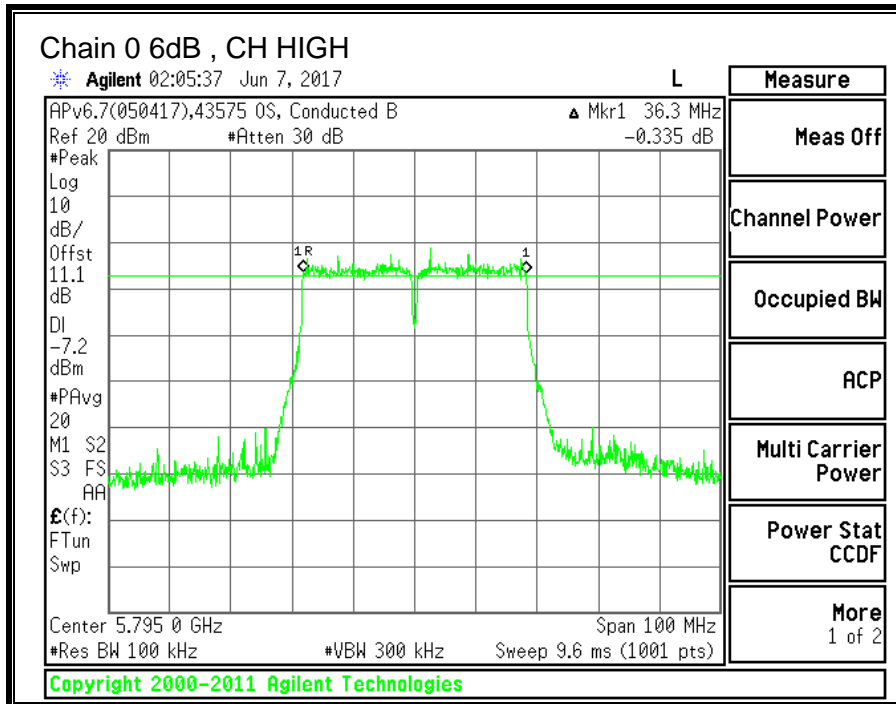

---

**10.15.2. 99% BANDWIDTH**

**LIMITS**

None; for reporting purposes only.

**RESULTS**

<b>Channel</b>	<b>Frequency</b>	<b>99% BW Chain 0 (MHz)</b>	<b>99% BW Chain 1 (MHz)</b>
Low	5755	34.685	35.656
High	5795	36.154	35.409

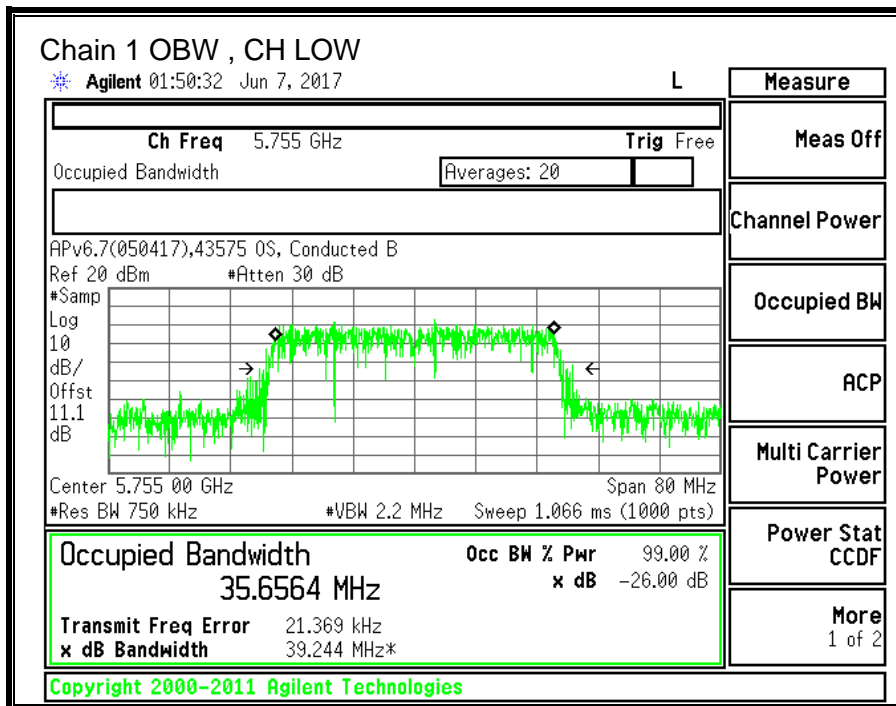
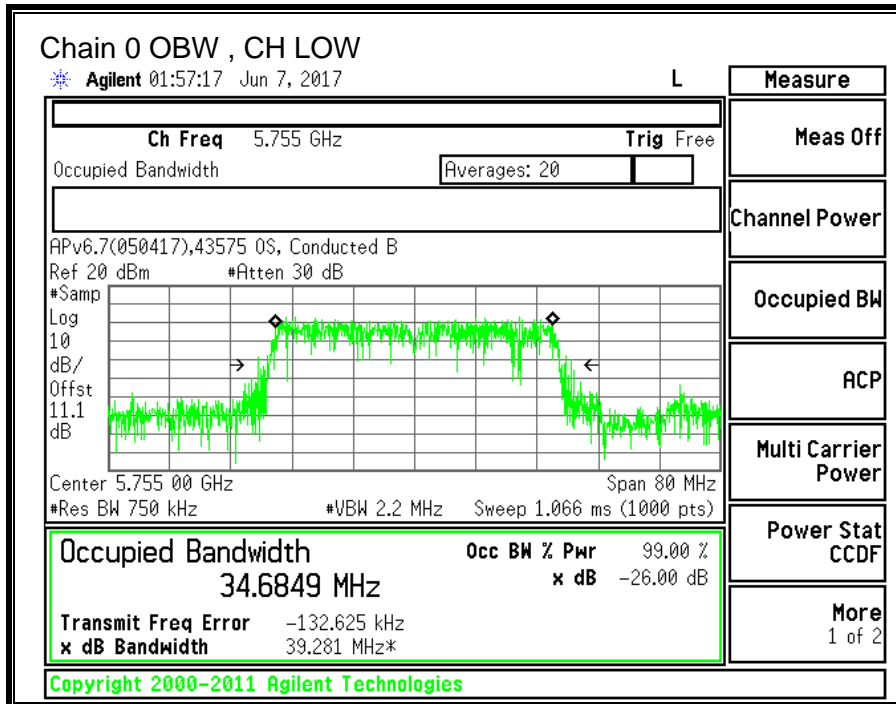

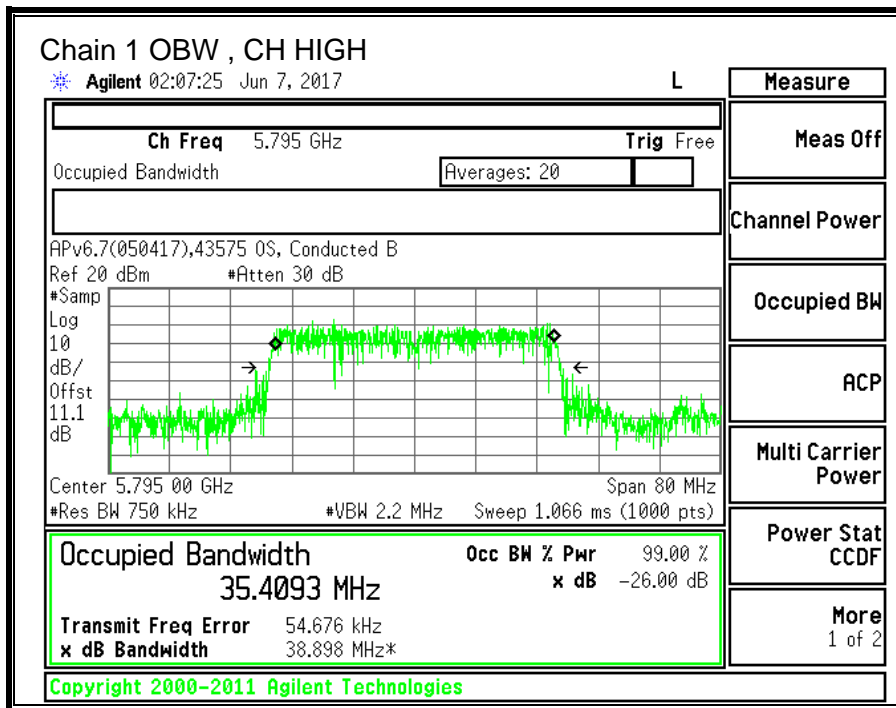
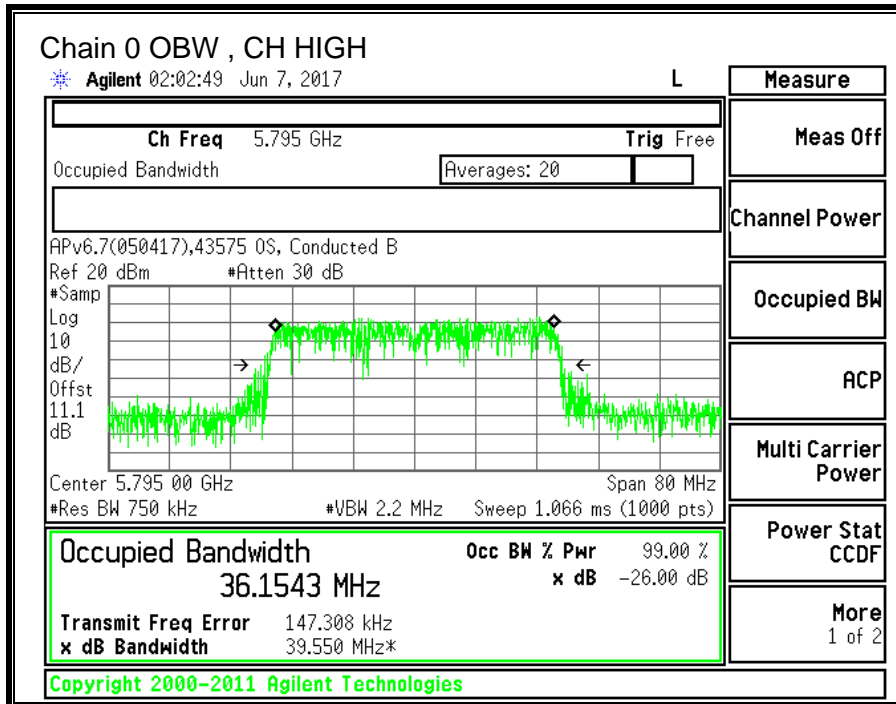

### 10.15.3. OUTPUT POWER AND PSD

#### LIMITS

FCC §15.407 (a) (3)

For the band 5.725-5.85 GHz, the maximum conducted output power over the frequency band of operation shall not exceed 1 W. In addition, the maximum power spectral density shall not exceed 30 dBm in any 500-kHz band. If transmitting antennas of directional gain greater than 6 dBi are used, both the maximum conducted output power and the maximum power spectral density shall be reduced by the amount in dB that the directional gain of the antenna exceeds 6 dBi.

#### TEST PROCEDURE

Measurements perform using a wideband gated RF power meter provided that the gate parameters are adjusted such that the power is measured only when the EUT is transmitting at its maximum power control level. Since the measurement is made only during the ON time of the transmitter, no duty cycle correction factor is required.

#### DIRECTIONAL ANTENNA GAIN

For power, the TX chains are uncorrelated and the antenna gain is unequal among the chains. The directional gain is:

##### 5725-5850 MHz

Chain 0 Antenna Gain (dBi)	Chain 1 Antenna Gain (dBi)	Uncorrelated Chains Directional Gain (dBi)
-3.50	-8.40	-5.29

For PSD the TX chains are correlated and the antenna gain is unequal among the chains. The directional gain is:

##### 5725-5850 MHz

Chain 0 Antenna Gain (dBi)	Chain 1 Antenna Gain (dBi)	Correlated Chains Directional Gain (dBi)
-3.50	-8.40	-2.60



**RESULTS**

<b>ID:</b>	43574	<b>Date:</b>	06/06/17
------------	-------	--------------	----------

**Antenna Gain and Limit**

Channel	Frequency (MHz)	Directional Gain For Power (dBi)	Directional Gain For PSD (dBi)	Power Limit (dBm)	Power Limit (dBm)
Low	5755	-5.29	-2.60	30.00	30.00
High	5795	-5.29	-2.60	30.00	30.00

<b>Duty Cycle CF (dB)</b>	0.40	<b>Included in Calculations of Corr'd PSD</b>
---------------------------	------	---

**Output Power Results**

Channel	Frequency (MHz)	Chain 0 Meas Power (dBm)	Chain 1 Meas Power (dBm)	Total Corr'd Power (dBm)	Power Limit (dBm)	Power Margin (dB)
Low	5755	13.17	11.59	15.46	30.00	-14.54
High	5795	13.26	11.51	15.48	30.00	-14.52

**Output Power Results**

Channel	Frequency (MHz)	Chain 0 Meas PSD (dBm)	Chain 1 Meas PSD (dBm)	Total Corr'd PSD (dBm)	PSD Limit (dBm)	PSD Margin (dB)
Low	5755	-4.184	-5.541	-1.40	30.00	-31.40
High	5795	-3.986	-5.856	-1.41	30.00	-31.41

**Note:** the power readings above were measured with gated method, and the measurement was taken only during the ON time. No duty cycle correction was necessary.

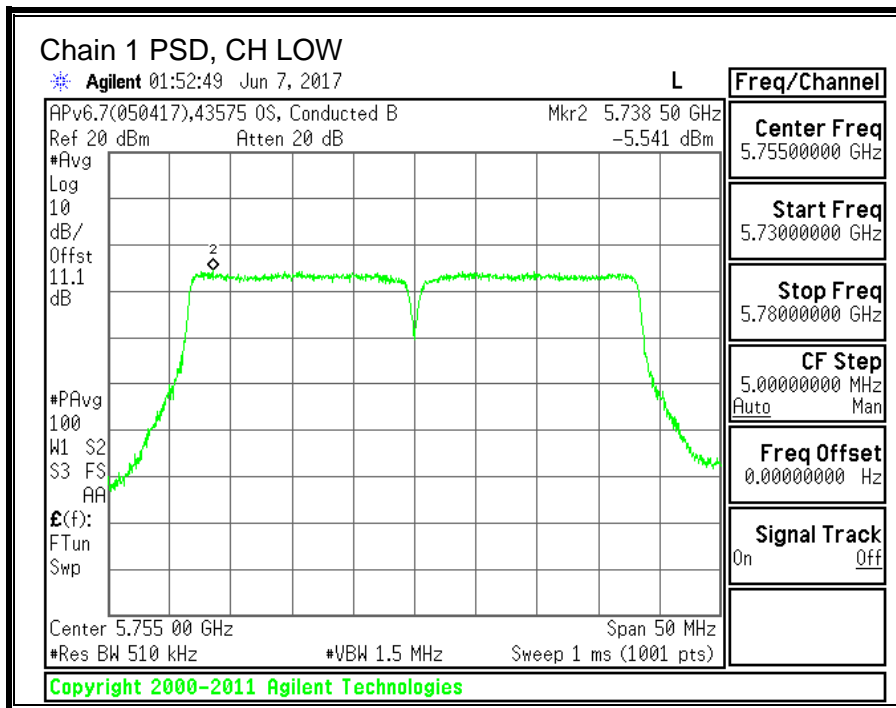
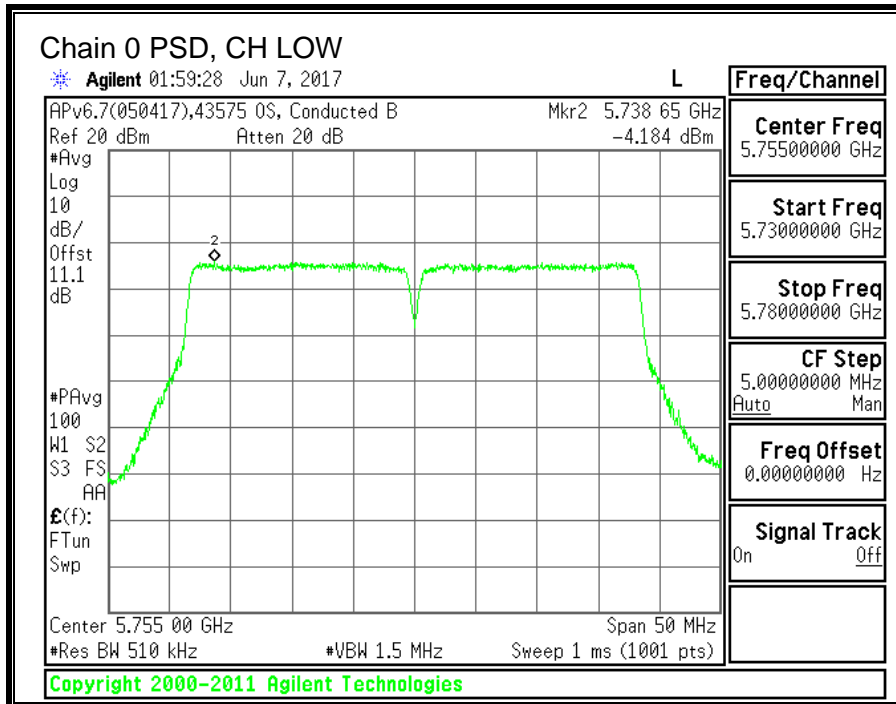

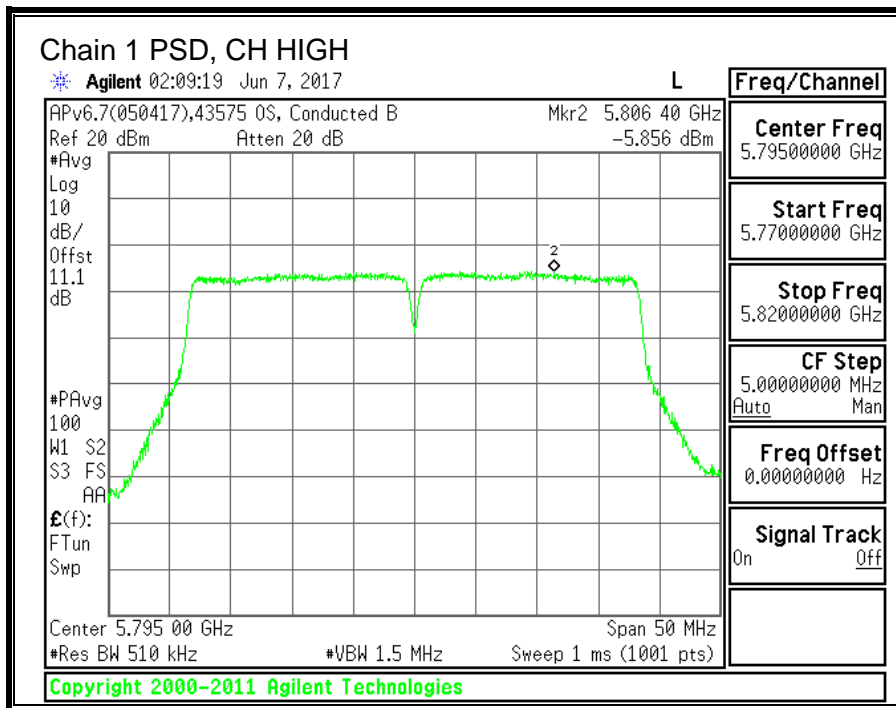
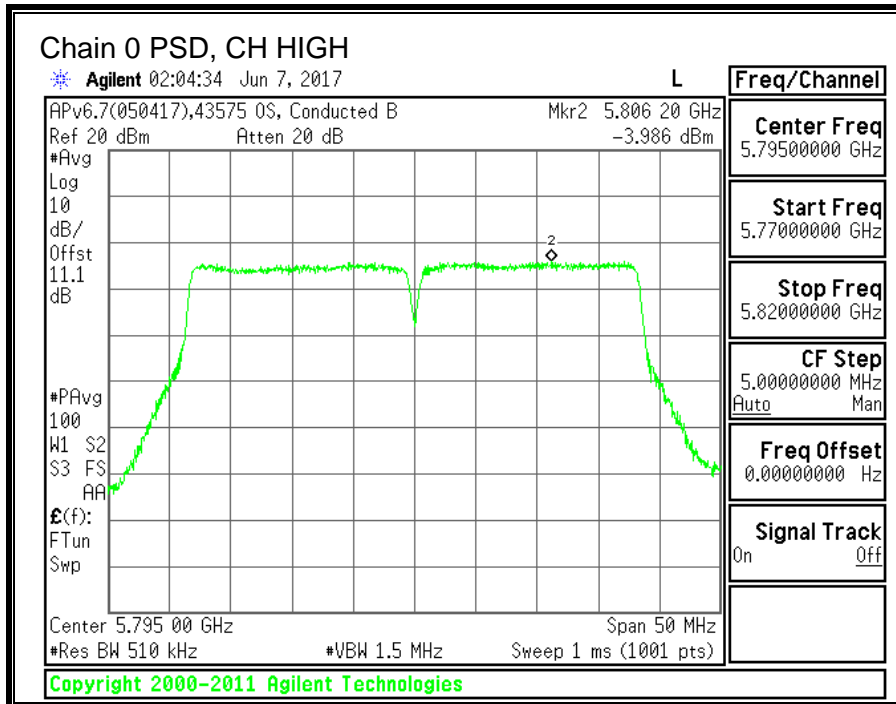

---

**10.16. 11ac HT80 2TX CDD MIMO MODE IN THE 5.8GHz BAND**

**10.16.1.6 dB BANDWIDTH**

**LIMITS**

FCC §15.407 (e)

The minimum 6 dB bandwidth shall be at least 500 kHz.

**RESULTS**

<b>Channel</b>	<b>Frequency</b>	<b>6 dB BW Chain 0 (MHz)</b>	<b>6 dB BW Chain 1 (MHz)</b>	<b>Minimum Limit (MHz)</b>
Mid	5775	76.4	76.4	0.5

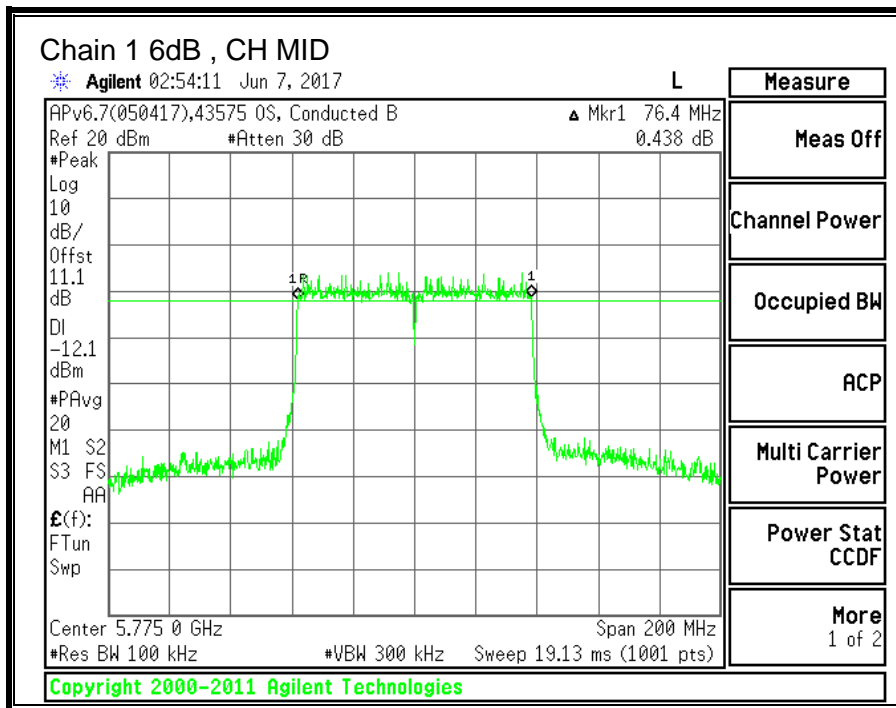
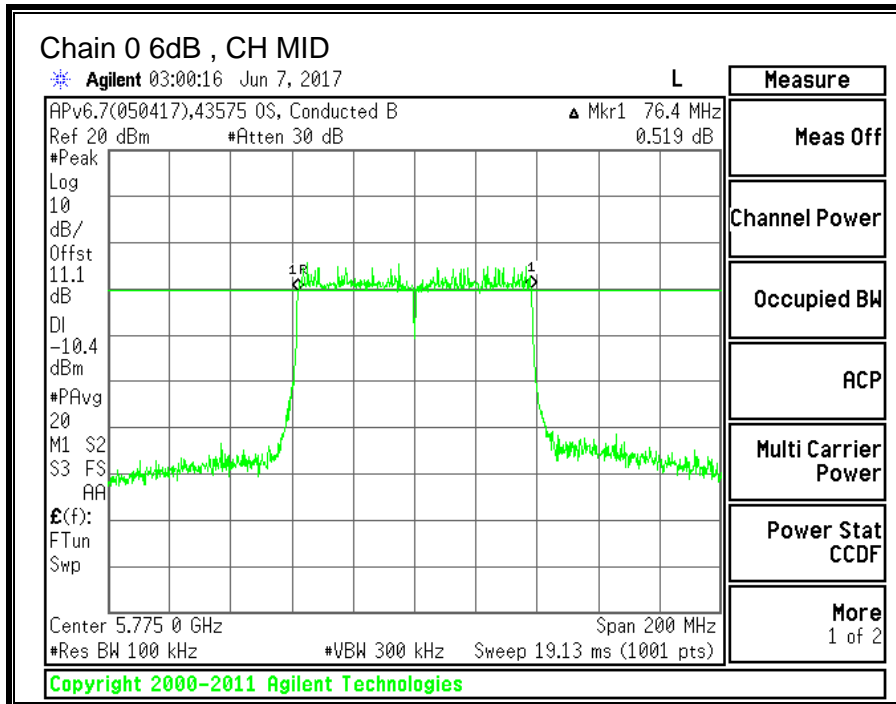

---

**10.16.2. 99% BANDWIDTH**

**LIMITS**

None; for reporting purposes only.

**RESULTS**

<b>Channel</b>	<b>Frequency</b>	<b>99% BW Chain 0 (MHz)</b>	<b>99% BW Chain 1 (MHz)</b>
Mid	5775	74.476	73.183

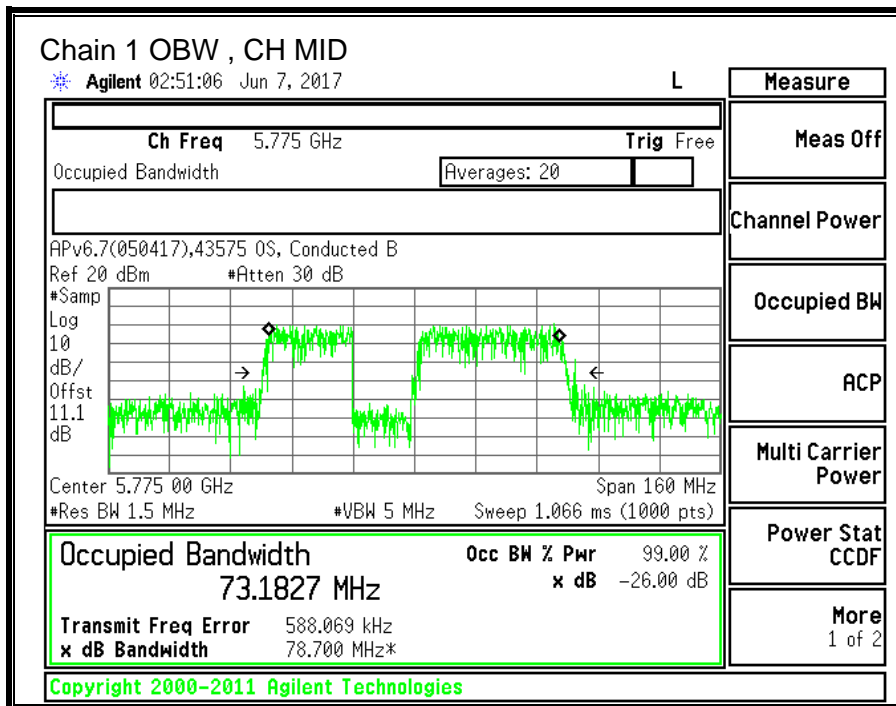
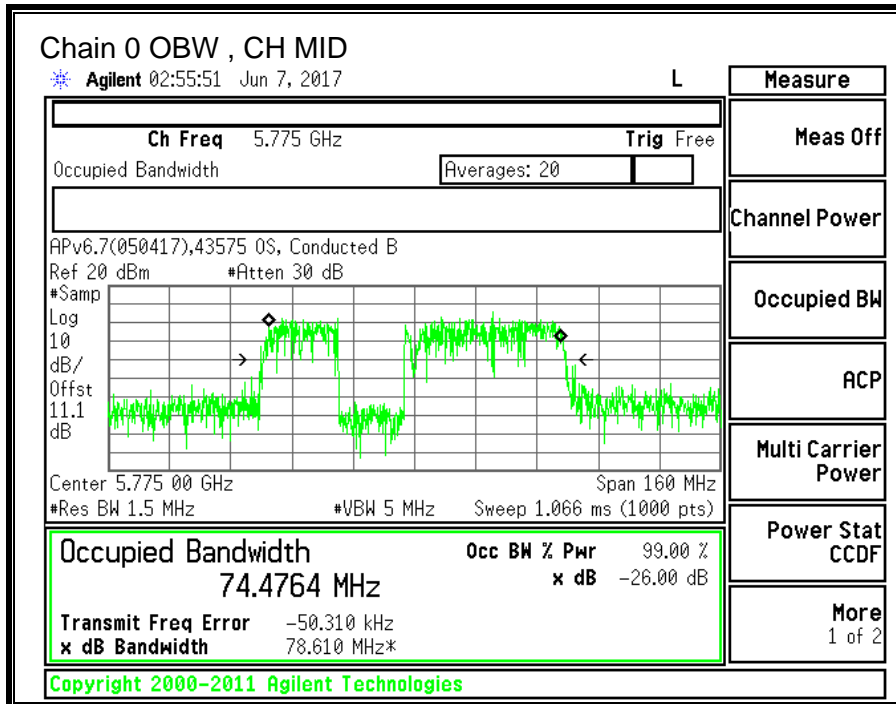

### 10.16.3. OUTPUT POWER AND PSD

#### LIMITS

FCC §15.407 (a) (3)

For the band 5.725-5.85 GHz, the maximum conducted output power over the frequency band of operation shall not exceed 1 W. In addition, the maximum power spectral density shall not exceed 30 dBm in any 500-kHz band. If transmitting antennas of directional gain greater than 6 dBi are used, both the maximum conducted output power and the maximum power spectral density shall be reduced by the amount in dB that the directional gain of the antenna exceeds 6 dBi.

#### TEST PROCEDURE

Measurements perform using a wideband gated RF power meter provided that the gate parameters are adjusted such that the power is measured only when the EUT is transmitting at its maximum power control level. Since the measurement is made only during the ON time of the transmitter, no duty cycle correction factor is required.

#### DIRECTIONAL ANTENNA GAIN

For power, the TX chains are uncorrelated and the antenna gain is unequal among the chains. The directional gain is:

##### 5725-5850 MHz

Chain 0 Antenna Gain (dBi)	Chain 1 Antenna Gain (dBi)	Uncorrelated Chains Directional Gain (dBi)
-3.50	-8.40	-5.29

For PSD the TX chains are correlated and the antenna gain is unequal among the chains. The directional gain is:

##### 5725-5850 MHz

Chain 0 Antenna Gain (dBi)	Chain 1 Antenna Gain (dBi)	Correlated Chains Directional Gain (dBi)
-3.50	-8.40	-2.60



**RESULTS**

<b>ID:</b>	43574	<b>Date:</b>	06/06/17
------------	-------	--------------	----------

**Antenna Gain and Limit**

Channel	Frequency (MHz)	Directional Gain for Power (dBi)	Power Limit for PSD (dBi)	Power Limit (dBm)	PSD Limit (dBm)
Mid	5775	-5.29	-2.60	30.00	30.00

<b>Duty Cycle CF (dB)</b>	0.75	<b>Included in Calculations of Corr'd PSD</b>
---------------------------	------	---

**Output Power Results**

Channel	Frequency (MHz)	Chain 0 Meas Power (dBm)	Chain 1 Meas Power (dBm)	Total Corr'd Power (dBm)	Power Limit (dBm)	Power Margin (dB)
Mid	5775	12.93	11.47	15.27	30.00	-14.73

**PSD Results**

Channel	Frequency (MHz)	Chain 0 Meas Power (dBm)	Chain 1 Meas Power (dBm)	Total Corr'd Power (dBm)	Power Limit (dBm)	Power Margin (dB)
Mid	5775	-7.516	-9.761	-4.73	30.00	-34.73

**Note:** the power readings above were measured with gated method, and the measurement was taken only during the ON time. No duty cycle correction was necessary.

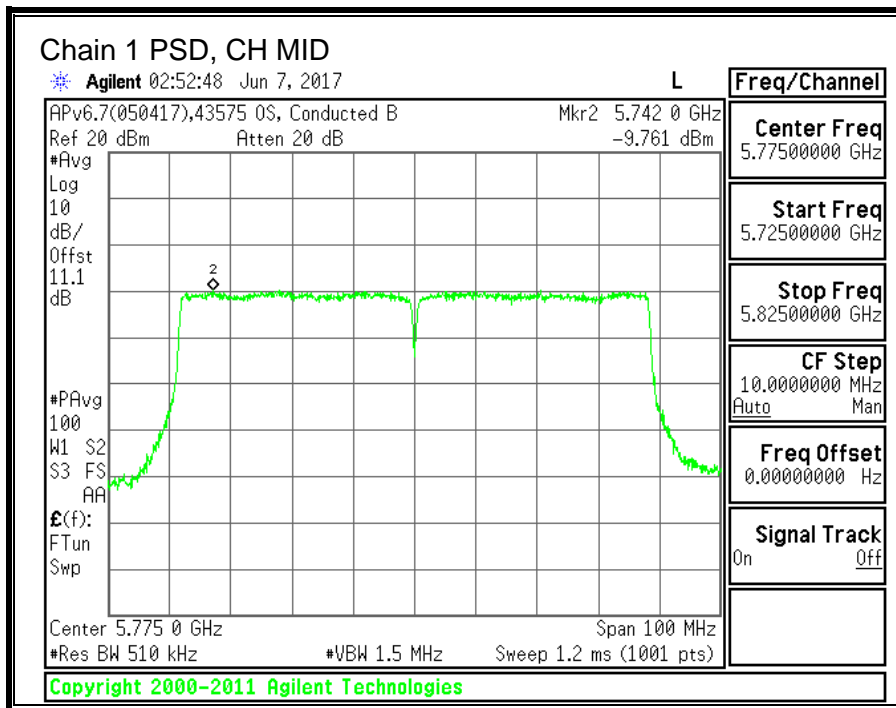
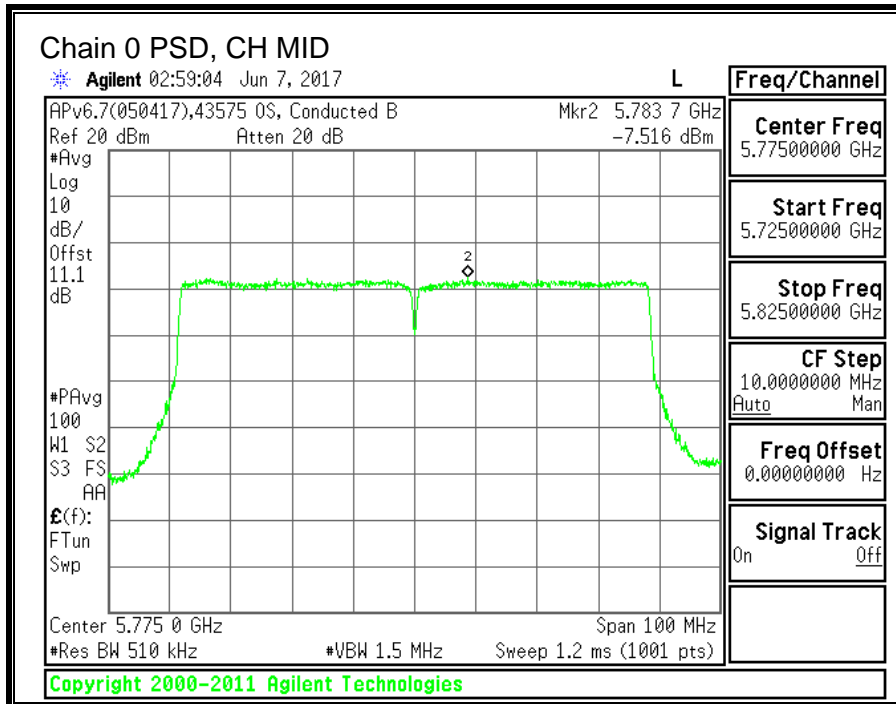

## 11. RADIATED TEST RESULTS

### 11.1. LIMITS AND PROCEDURE

#### LIMITS

FCC §15.205 and §15.209

Frequency Range (MHz)	Field Strength Limit (uV/m) at 3 m	Field Strength Limit (dBuV/m) at 3 m
30 - 88	100	40
88 - 216	150	43.5
216 - 960	200	46
Above 960	500	54

#### TEST PROCEDURE

The EUT is placed on a non-conducting table 80 cm above the ground plane for measurement below 1GHz; 1.5 m above the ground plane for measurement above 1GHz. The antenna to EUT distance is 3 meters. The EUT is configured in accordance with ANSI C63.10. The EUT is set to transmit in a continuous mode.

For measurements below 1 GHz the resolution bandwidth is set to 100 kHz for peak detection measurements or 120 kHz for quasi-peak detection measurements. Peak detection is used unless otherwise noted as quasi-peak.

For pre-scans above 1 GHz the resolution bandwidth is set to 1 MHz; the video bandwidth is set to 30 KHz for peak measurements.

For measurements above 1 GHz the resolution bandwidth is set to 1 MHz; the video bandwidth is set to 3 MHz for peak measurements and add duty cycle factor for average measurements.

The spectrum from 1 GHz to 18 GHz is investigated with the transmitter set to the lowest, middle, and highest channels in each applicable band. Below 1GHz and above 18GHz emissions, the channel with the highest output power was tested.

The frequency range of interest is monitored at a fixed antenna height and EUT azimuth. The EUT is rotated through 360 degrees to maximize emissions received. The antenna is scanned from 1 to 4 meters above the ground plane to further maximize the emission. Measurements are made with the antenna polarized in both the vertical and the horizontal positions.

Radiated emission were performed with the EUT set to transmit at the channel with highest output power as worst-case scenario.

### 11.1.1. 11a 2TX CDD MIMO MODE IN THE 5.2GHZ BAND

#### RESTRICTED BANDEDGE (LOW CHANNEL)

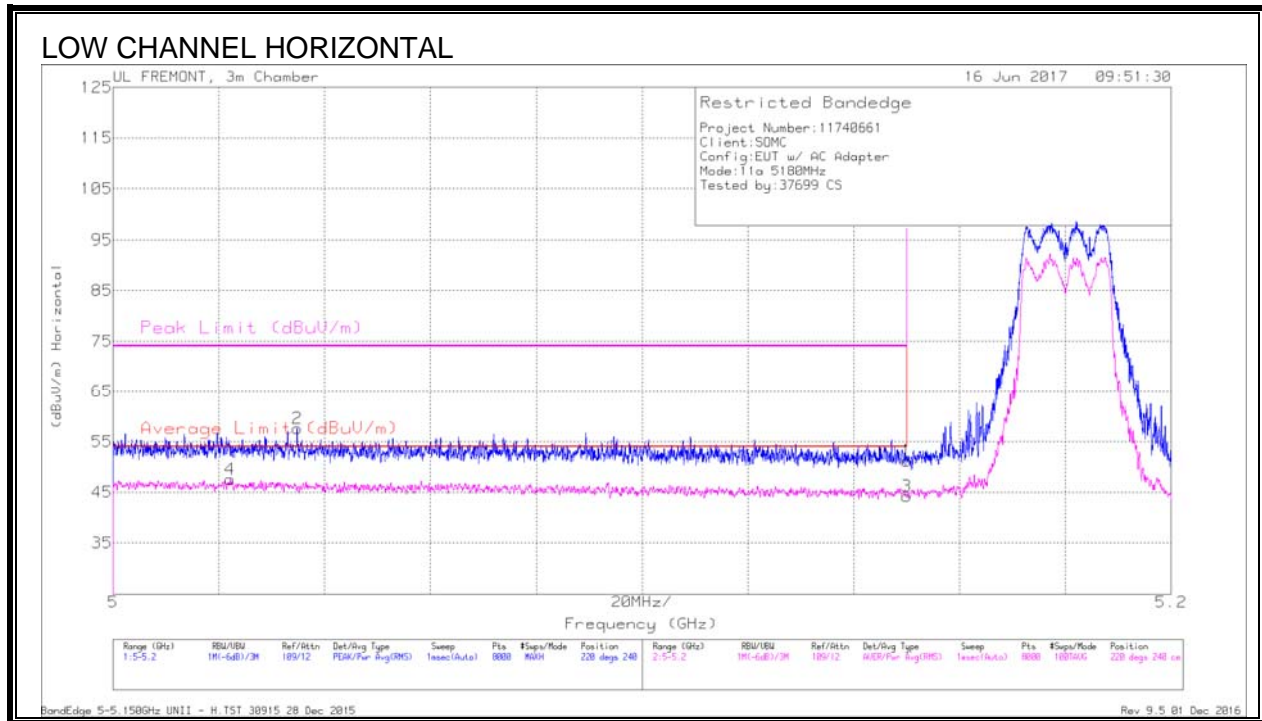

#### Trace Markers

Marker	Frequency (GHz)	Meter Reading (dBuV)	Det	AF T712 (dB/m)	Amp/Cb/Ftr/Pad (dB)	DC Corr (dB)	Corrected Reading (dBuV/m)	Average Limit (dBuV/m)	Margin (dB)	Peak Limit (dBuV/m)	PK Margin (dB)	Azimuth (Degs)	Height (cm)	Polarity
4	5.022	32.52	RMS	34.1	-19.3	.24	47.57	54	-6.43	-	-	220	240	H
2	5.035	42.66	Pk	34.1	-19.2	0	57.56	-	-	74	-16.44	220	240	H
1	5.15	36.62	Pk	34.2	-19.6	0	51.22	-	-	74	-22.78	220	240	H
3	5.15	29.31	RMS	34.2	-19.6	.24	44.16	54	-9.84	-	-	220	240	H

\* - indicates frequency in CFR15.205/IC8.10 RSS-Restricted Band

Pk - Peak detector

RMS - RMS detection

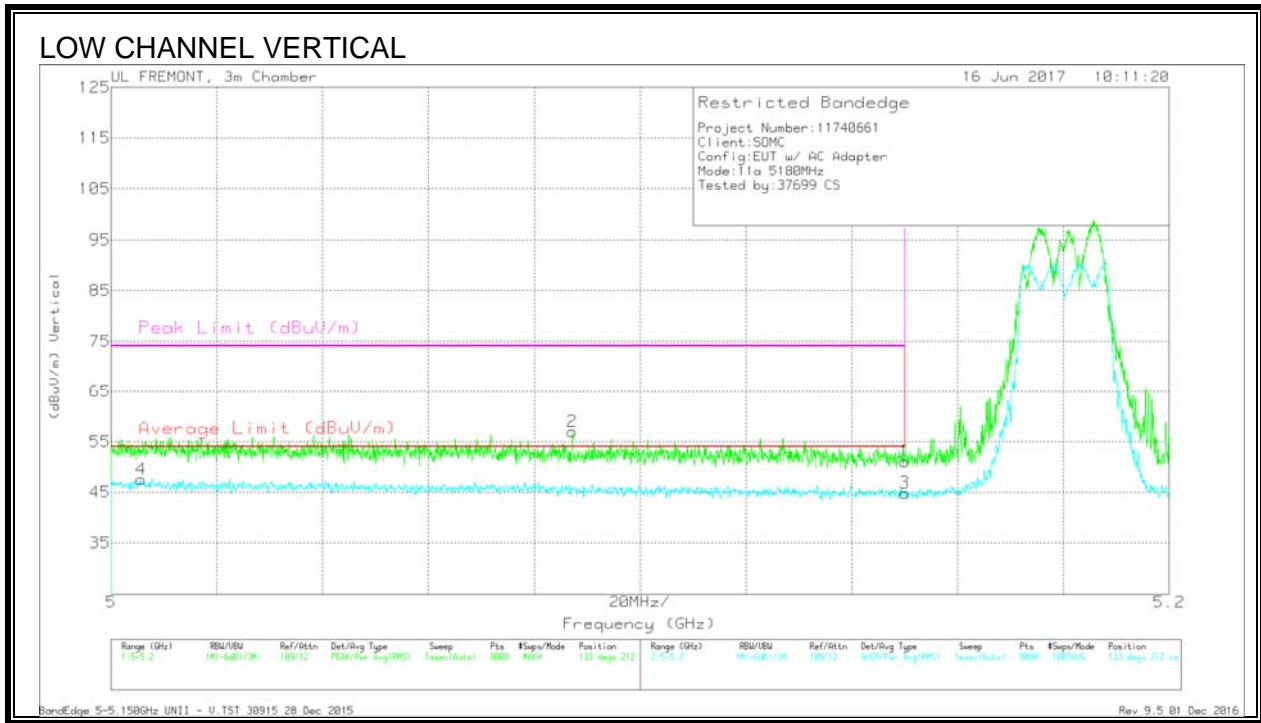

Trace Markers

Marker	Frequency (GHz)	Meter Reading (dBuV)	Det	AFT712 (dB/m)	Amp/Cb/Filt/Pad (dB)	DC Corr (dB)	Corrected Reading (dBuV/m)	Average Limit (dBuV/m)	Margin (dB)	Peak Limit (dBuV/m)	PK Margin (dB)	Azimuth (Degs)	Height (cm)	Polarity
4	5.006	32.36	RMS	34.1	-19.1	.24	47.61	54	-6.39	-	-	133	212	V
2	5.087	42.16	Pk	34.1	-19.3	0	56.96	-	-	74	-17.04	133	212	V
1	5.15	36.5	Pk	34.2	-19.6	0	51.1	-	-	74	-22.9	133	212	V
3	5.15	30.04	RMS	34.2	-19.6	.24	44.89	54	-9.11	-	-	133	212	V

\* - indicates frequency in CFR15.205/IC8.10 RSS-Restricted Band  
 Pk - Peak detector  
 RMS - RMS detection

**HARMONICS AND SPURIOUS EMISSIONS**

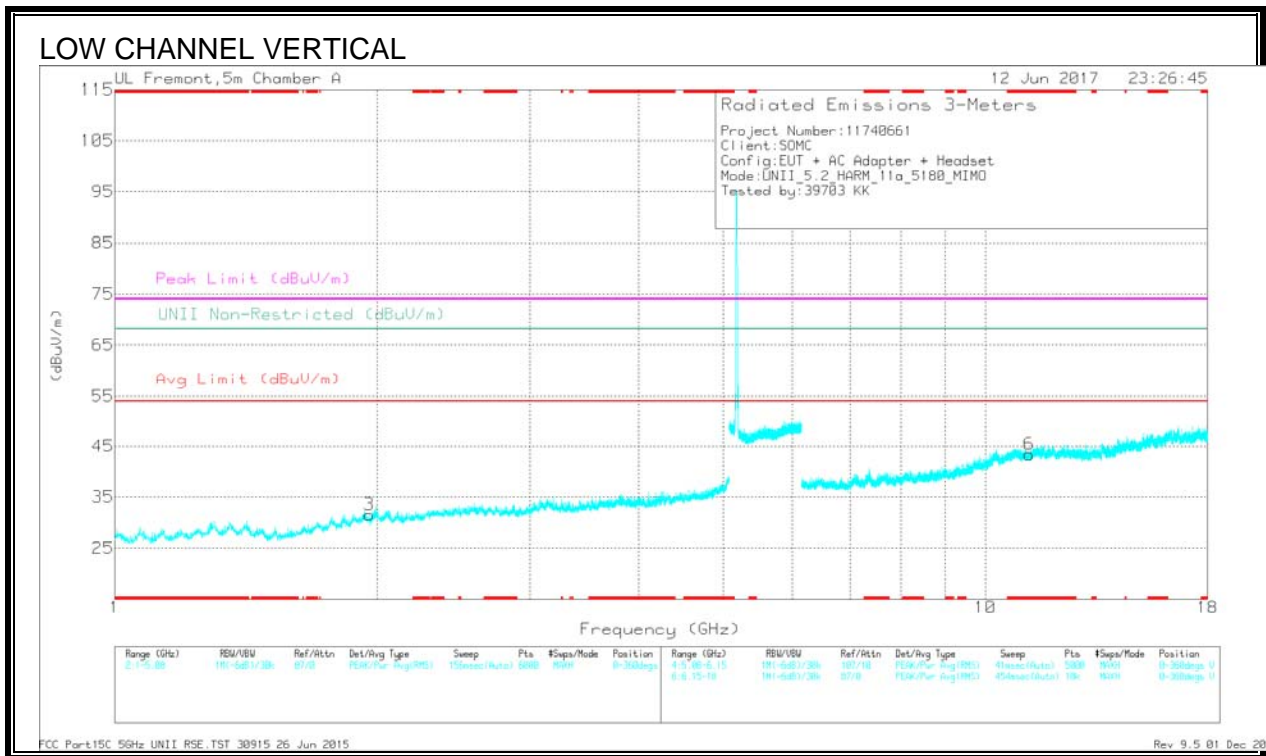
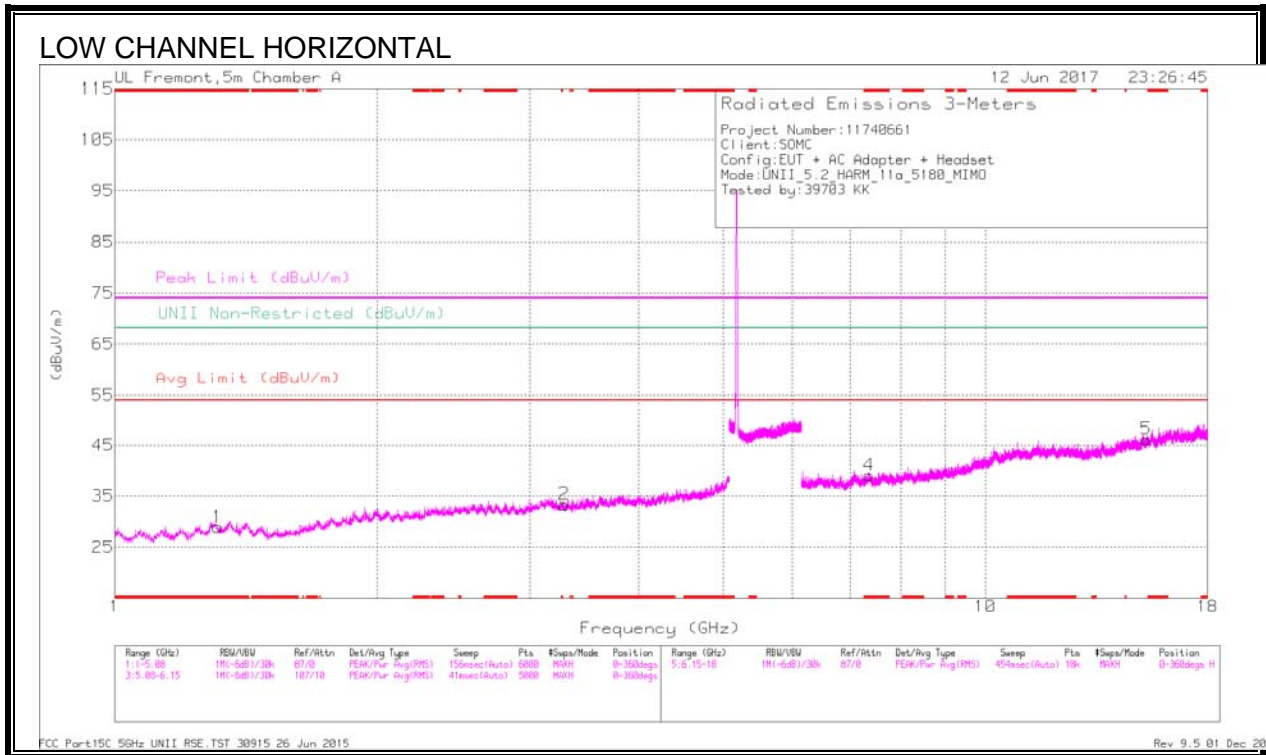

Trace Markers

Marker	Frequency (GHz)	Meter Reading (dBuV)	Det	AF T711 (dB/m)	Amp/CM/Ftr/Pad (dB)	DC Corr (dB)	Corrected Reading (dBuV/m)	Avg Limit (dBuV/m)	Margin (dB)	Peak Limit (dBuV/m)	PK Margin (dB)	U/NII Non-Restricted (dBuV/m)	PK Margin (dB)	Altitude (Daps)	Height (cm)	Polarity
1	* 1.313	33.25	Pk	29.5	-33.8	0	28.95	-	-	74	-45.05	-	-	0-360	199	H
4	* 7.351	26.77	Pk	35.5	-23.2	0	39.07	-	-	74	-34.93	-	-	0-360	199	H
6	* 11.231	25.67	Pk	37.8	-20.1	0	43.37	-	-	74	-30.63	-	-	0-360	200	V
3	1.962	32.91	Pk	31.4	-32.8	0	31.51	-	-	-	-	68.2	-36.69	0-360	200	V
2	3.283	31.86	Pk	32.8	-31.3	0	33.36	-	-	-	-	68.2	-34.84	0-360	100	H
5	15.309	26.97	Pk	40	-20.8	0	46.17	-	-	-	-	68.2	-22.03	0-360	199	H

\* - indicates frequency in CFR47 Pt 15 / IC RSS-Restricted Band

Pk - Peak detector

Radiated Emissions

Frequency (GHz)	Meter Reading (dBuV)	Det	AF T711 (dB/m)	Amp/CM/Ftr/Pad (dB)	DC Corr (dB)	Corrected Reading (dBuV/m)	Avg Limit (dBuV/m)	Margin (dB)	Peak Limit (dBuV/m)	PK Margin (dB)	U/NII Non-Restricted (dBuV/m)	PK Margin (dB)	Altitude (Daps)	Height (cm)	Polarity
* 1.313	40.16	PK-U	29.5	-33.8	0	35.86	-	-	74	-38.14	-	-	360	200	H
* 1.312	29.15	ADR	29.5	-33.8	.24	25.1	54	-28.9	-	-	-	-	360	200	H
* 7.352	33.4	PK-U	35.5	-23.2	0	45.7	-	-	74	-28.3	-	-	63	200	H
* 7.351	22.44	ADR	35.5	-23.2	.24	34.99	54	-19.01	-	-	-	-	63	200	H
* 11.23	32	PK-U	37.8	-20	0	49.8	-	-	74	-24.2	-	-	63	200	V
* 11.23	21.2	ADR	37.8	-20	.24	39.25	54	-14.75	-	-	-	-	63	200	V
1.96	28.02	ADR	31.4	-32.8	.24	26.87	-	-	-	-	-	-	63	200	V
1.962	39.44	PK-U	31.4	-32.8	0	38.04	-	-	-	-	68.2	-30.16	63	200	V
3.282	38.31	PK-U	32.8	-31.3	0	39.81	-	-	-	-	68.2	-28.39	63	180	H
3.284	26.71	ADR	32.8	-31.3	.24	28.46	-	-	-	-	-	-	63	180	H
15.307	22.15	ADR	40	-20.8	.24	41.6	-	-	-	-	-	-	63	200	H
15.311	33.07	PK-U	40	-20.8	0	52.27	-	-	-	-	68.2	-15.93	63	200	H

\* - indicates frequency in CFR47 Pt 15 / IC RSS-Restricted Band

PK-U - U-NII: Maximum Peak

ADR - U-NII AD primary method, RMS average

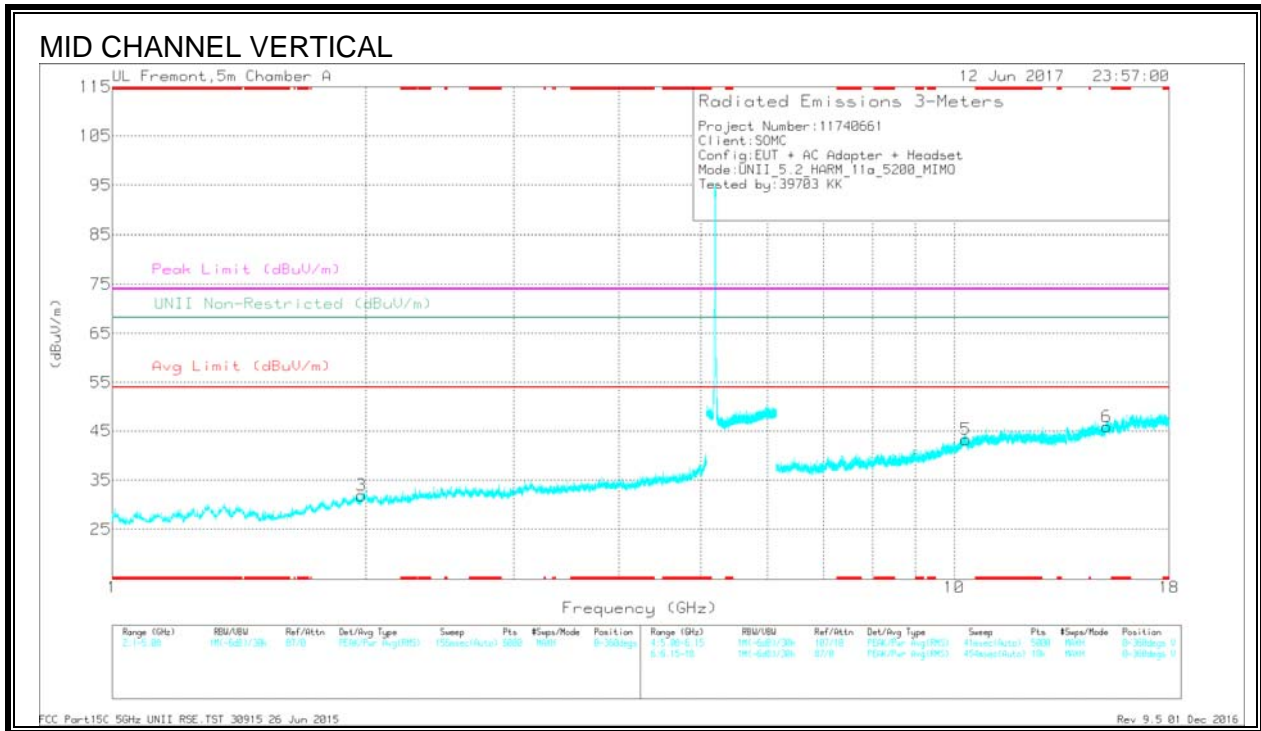
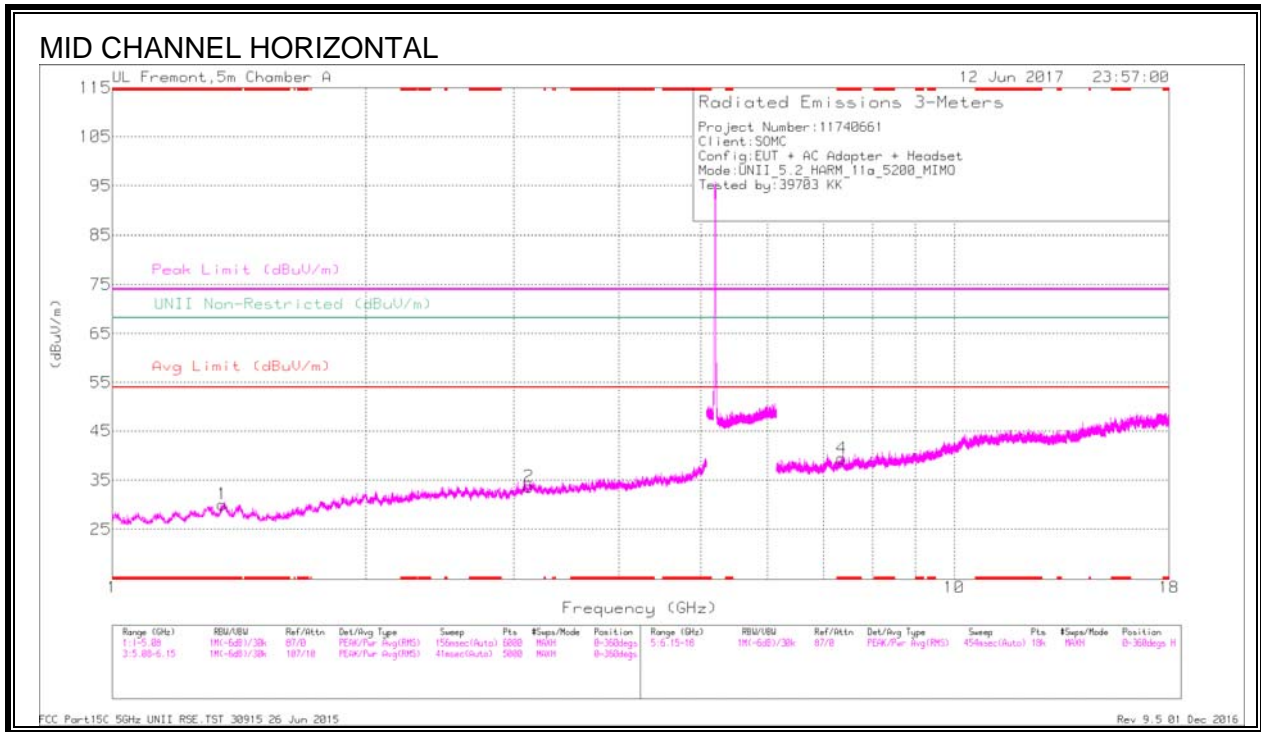



Trace Markers

Marker	Frequency (GHz)	Meter Reading (dBuV)	Det	AF T711 (dB/m)	Amp/Cbl/Ftr/Pad (dB)	DC Corr (dB)	Corrected Reading (dBuV/m)	Avg Limit (dBuV/m)	Margin (dB)	Peak Limit (dBuV/m)	PK Margin (dB)	UNII Non-Restricted (dBuV/m)	PK Margin (dB)	Altitude (Degs)	Height (cm)	Polarity
1	* 1.352	34.28	Pk	29.4	-33.6	0	30.08	-	-	74	-43.92	-	-	0-360	101	H
4	* 7.35	27.12	Pk	35.5	-23.2	0	39.42	-	-	74	-34.58	-	-	0-360	199	H
3	1.977	33.28	Pk	31.4	-32.8	0	31.88	-	-	-	-	68.2	-36.32	0-360	200	V
2	3.126	31.07	Pk	33	-30.4	0	33.67	-	-	-	-	68.2	-34.53	0-360	199	H
5	10.319	25.85	Pk	37.3	-19.9	0	43.25	-	-	-	-	68.2	-24.95	0-360	101	V
6	15.178	25.63	Pk	39.9	-19.7	0	45.83	-	-	-	-	68.2	-22.37	0-360	200	V

\* - indicates frequency in CFR47 Pt 15 / IC RSS-Restricted Band

Pk - Peak detector

Radiated Emissions

Frequency (GHz)	Meter Reading (dBuV)	Det	AF T711 (dB/m)	Amp/Cbl/Ftr/Pad (dB)	DC Corr (dB)	Corrected Reading (dBuV/m)	Avg Limit (dBuV/m)	Margin (dB)	Peak Limit (dBuV/m)	PK Margin (dB)	UNII Non-Restricted (dBuV/m)	PK Margin (dB)	Altitude (Degs)	Height (cm)	Polarity
* 1.352	41.14	PK-U	29.4	-33.6	0	36.94	-	-	74	-37.06	-	-	0	100	H
* 1.353	29.31	ADR	29.4	-33.5	-24	25.46	54	-28.54	-	-	-	-	0	100	H
* 7.35	33.7	PK-U	35.5	-23.2	0	46	-	-	74	-28	-	-	0	199	H
* 7.348	22.51	ADR	35.5	-23.2	-24	35.06	54	-18.94	-	-	-	-	0	199	H
1.977	39.76	PK-U	31.4	-32.8	0	38.36	-	-	-	-	68.2	-29.84	0	199	V
1.978	28.23	ADR	31.4	-32.8	-24	27.08	-	-	-	-	-	-	0	199	V
3.127	26.7	ADR	33	-30.4	-24	29.55	-	-	-	-	-	-	0	199	H
3.128	38.09	PK-U	33	-30.4	0	40.69	-	-	-	-	68.2	-27.51	0	199	H
10.319	21.36	ADR	37.3	-19.9	-24	39.01	-	-	-	-	-	-	0	102	V
10.321	31.86	PK-U	37.3	-20	0	49.16	-	-	-	-	68.2	-19.04	0	102	V
15.176	32.46	PK-U	39.9	-19.8	0	52.56	-	-	-	-	68.2	-15.64	0	200	V
15.179	21.82	ADR	39.9	-19.6	-24	42.37	-	-	-	-	-	-	0	200	V

\* - indicates frequency in CFR15.205/IC8.10 RSS-Restricted Band

PK-U - U-NII: Maximum Peak

ADR - U-NII AD primary method, RMS average

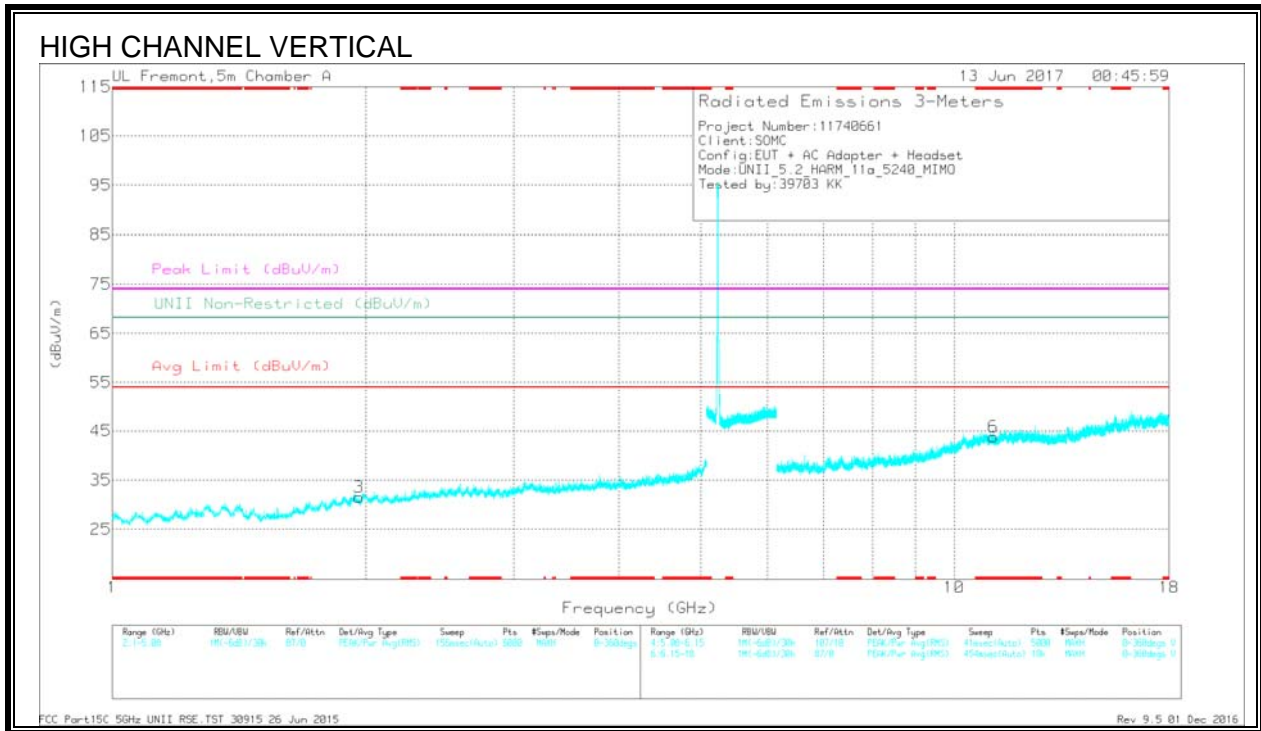
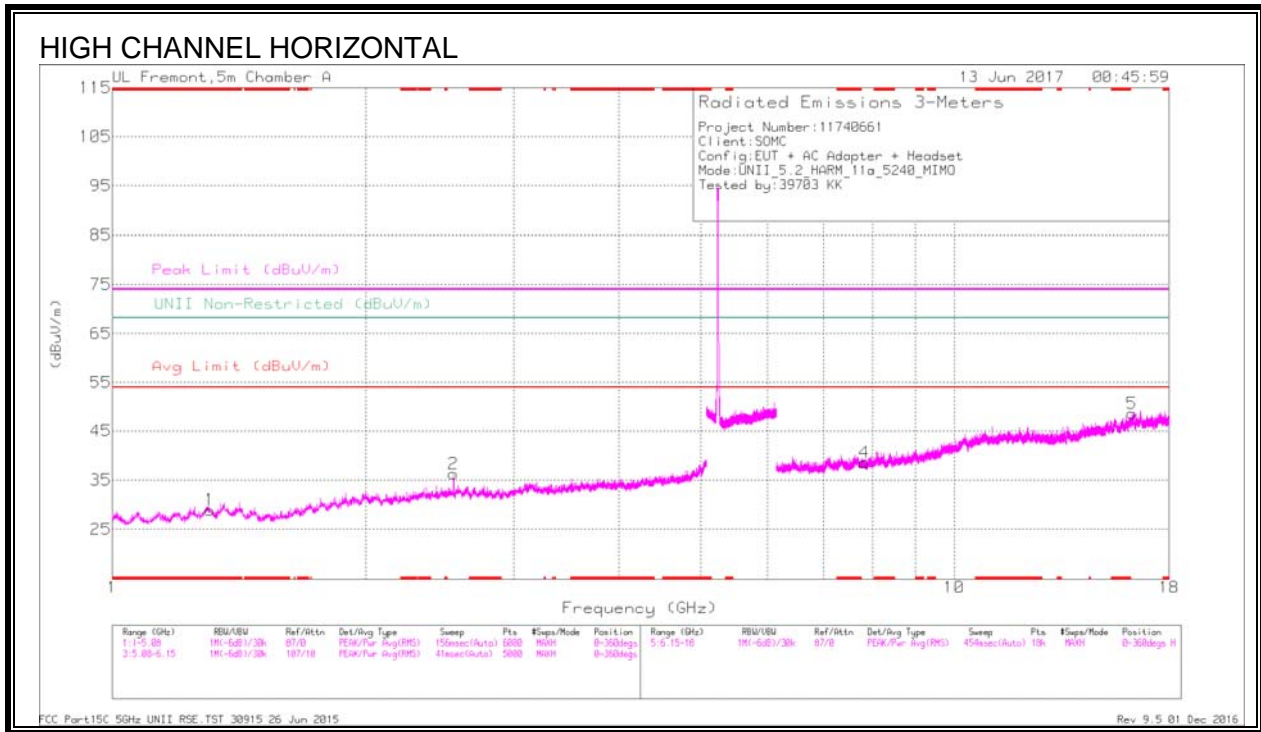

Trace Markers

Marker	Frequency (GHz)	Meter Reading (dBuV)	Det	AF T711 (dBm)	Amp/Cbl/Ftr/Pad (dB)	DC Corr (dB)	Corrected Reading (dBuV/m)	Avg Limit (dBuV/m)	Margin (dB)	Peak Limit (dBuV/m)	PK Margin (dB)	UNII Non-Restricted (dBuV/m)	PK Margin (dB)	Azimuth (Degs)	Height (cm)	Polarity
1	* 1.306	33.29	Pk	29.5	-33.9	0	28.89	-	-	74	-45.11	-	-	0-360	199	H
6	* 11.133	25.92	Pk	37.8	-19.9	0	43.82	-	-	74	-30.18	-	-	0-360	200	V
3	1.965	33.05	Pk	31.4	-32.9	0	31.55	-	-	-	-	68.2	-36.65	0-360	199	V
2	2.541	35.98	Pk	32.6	-32.3	0	36.28	-	-	-	-	68.2	-31.92	0-360	101	H
4	7.822	27.06	Pk	35.6	-24.1	0	38.56	-	-	-	-	68.2	-29.64	0-360	101	H
5	16.257	27.32	Pk	41.3	-20.1	0	48.52	-	-	-	-	68.2	-18.68	0-360	199	H

\* - indicates frequency in CFR47 Pt 15 / IC RSS-Restricted Band

Pk - Peak detector

Radiated Emissions

Frequency (GHz)	Meter Reading (dBuV)	Det	AF T711 (dBm)	Amp/Cbl/Ftr/Pad (dB)	DC Corr (dB)	Corrected Reading (dBuV/m)	Avg Limit (dBuV/m)	Margin (dB)	Peak Limit (dBuV/m)	PK Margin (dB)	UNII Non-Restricted (dBuV/m)	PK Margin (dB)	Azimuth (Degs)	Height (cm)	Polarity
* 1.305	40.73	PK-U	29.5	-33.9	0	36.33	-	-	74	-37.67	-	-	0	200	H
* 1.304	29.57	ADR	29.6	-33.9	24	25.52	54	-28.48	-	-	-	-	0	200	H
* 11.134	32.18	PK-U	37.8	-19.9	0	50.06	-	-	74	-23.92	-	-	0	199	V
* 11.133	21.36	ADR	37.8	-19.9	24	39.51	54	-14.49	-	-	-	-	0	199	V
1.963	28.05	ADR	31.4	-32.9	24	26.8	-	-	-	-	-	-	0	199	V
1.964	39.75	PK-U	31.4	-32.9	0	38.25	-	-	-	-	68.2	-29.95	0	199	V
2.541	27.46	ADR	32.6	-32.3	24	28.01	-	-	-	-	-	-	0	102	H
2.542	39.15	PK-U	32.6	-32.3	0	39.45	-	-	-	-	68.2	-28.75	0	102	H
7.821	33.46	PK-U	35.6	-24.2	0	44.86	-	-	-	-	68.2	-23.34	0	102	H
7.821	22.29	ADR	35.6	-24.2	24	33.94	-	-	-	-	-	-	0	102	H
16.255	32.81	PK-U	41.3	-20.1	0	54.01	-	-	-	-	68.2	-14.19	0	199	H
16.258	22.17	ADR	41.3	-20.1	24	43.62	-	-	-	-	-	-	0	199	H

\* - indicates frequency in CFR15.205/IC8.10 RSS-Restricted Band

PK-U - U-NII: Maximum Peak

ADR - U-NII AD primary method, RMS average

### 11.1.2. 11n HT20 2TX CDD MIMO MODE IN THE 5.2GHZ BAND

#### RESTRICTED BANDEDGE (LOW CHANNEL)

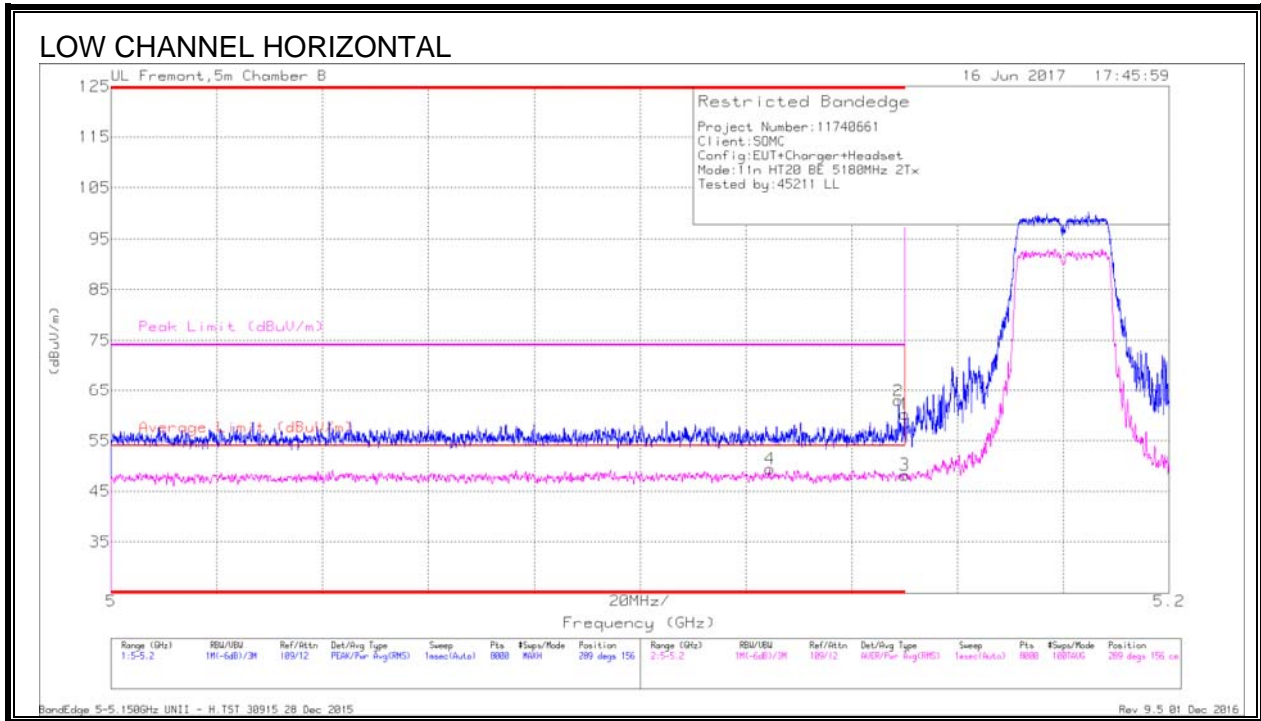

#### Trace Markers

Marker	Frequency (GHz)	Meter Reading (dBuV)	Det	AFT346 (dB/m)	Amp/Cb/Ftr/Pad (dB)	DC Corr (dB)	Corrected Reading (dBuV/m)	Average Limit (dBuV/m)	Margin (dB)	Peak Limit (dBuV/m)	PK Margin (dB)	Azimuth (Degs)	Height (cm)	Polarity
1	* 5.15	43.57	Pk	34.8	-18.1	0	60.27	-	-	74	-13.73	289	156	H
2	* 5.149	46.23	Pk	34.8	-18.1	0	62.93	-	-	74	-11.07	289	156	H
3	* 5.15	31.34	RMS	34.8	-18.1	.2	48.24	54	-5.76	-	-	289	156	H
4	* 5.125	32.22	RMS	34.7	-17.7	.2	49.42	54	-4.58	-	-	289	156	H

\* - indicates frequency in CFR15.205/IC8.10 RSS-Restricted Band

Pk - Peak detector

RMS - RMS detection

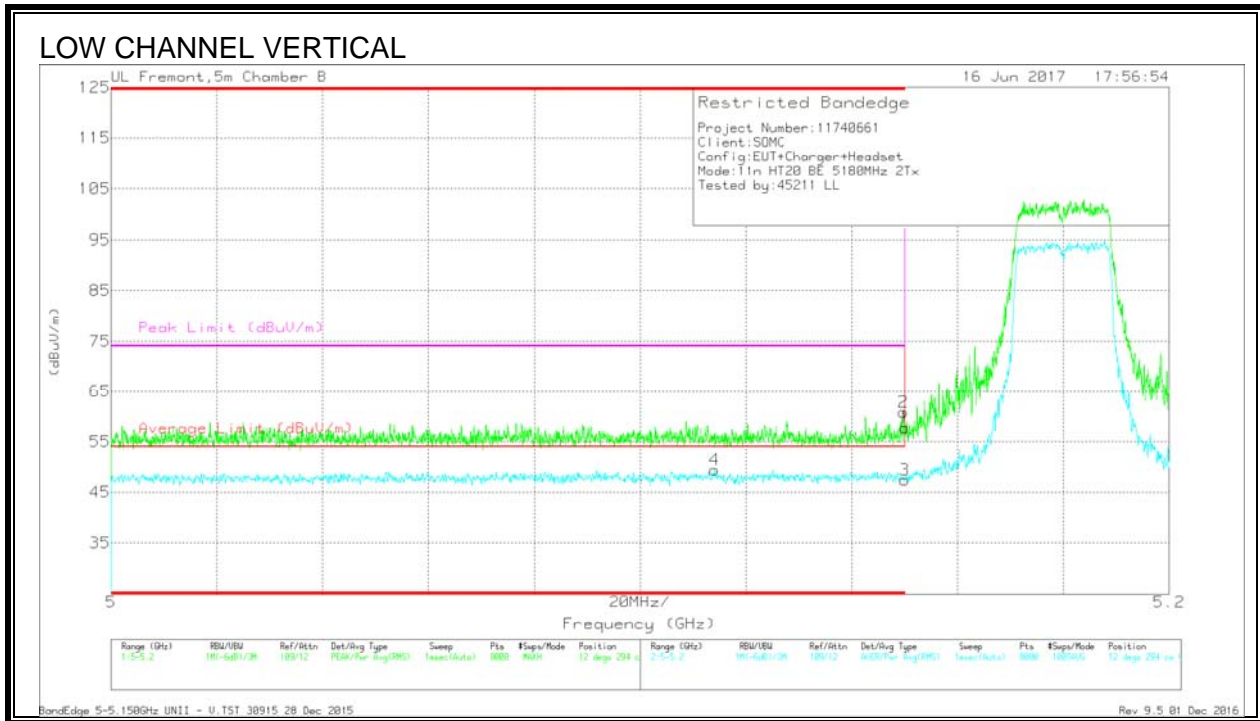

Trace Markers

Marker	Frequency (GHz)	Meter Reading (dBuV)	Det	AFT346 (dB/m)	Amp/Cb/Ftr/Pad (dB)	DC Corr (dB)	Corrected Reading (dBuV/m)	Average Limit (dBuV/m)	Margin (dB)	Peak Limit (dBuV/m)	PK Margin (dB)	Altitude (Degs)	Height (cm)	Polarity
1	* 5.15	41.06	Pk	34.8	-18.1	0	57.76	-	-	74	-16.24	12	294	V
2	* 5.15	44.09	Pk	34.8	-18.1	0	60.79	-	-	74	-13.21	12	294	V
3	* 5.15	30.48	RMS	34.8	-18.1	.2	47.38	54	-6.62	-	-	12	294	V
4	* 5.114	32.4	RMS	34.7	-17.9	.2	49.4	54	-4.6	-	-	12	294	V

\* - indicates frequency in CFR15.205/IC8.10 RSS-Restricted Band

Pk - Peak detector

RMS - RMS detection

**HARMONICS AND SPURIOUS EMISSIONS**

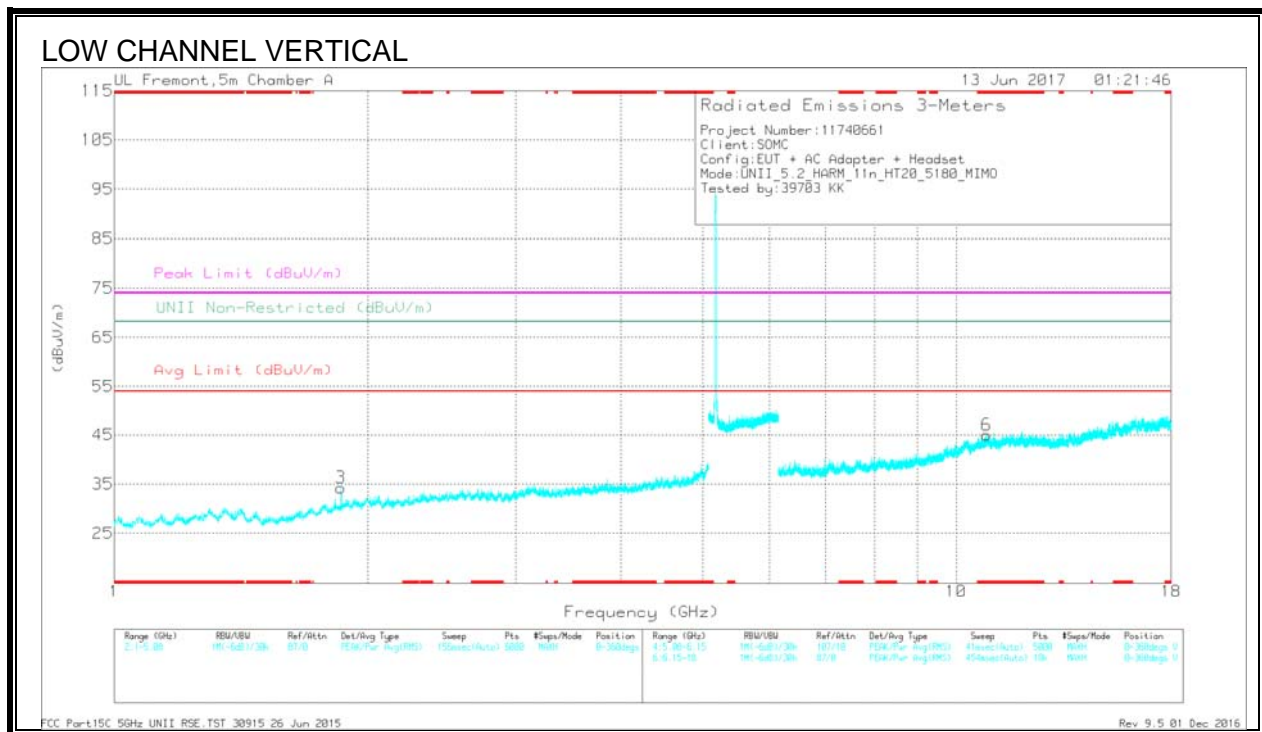
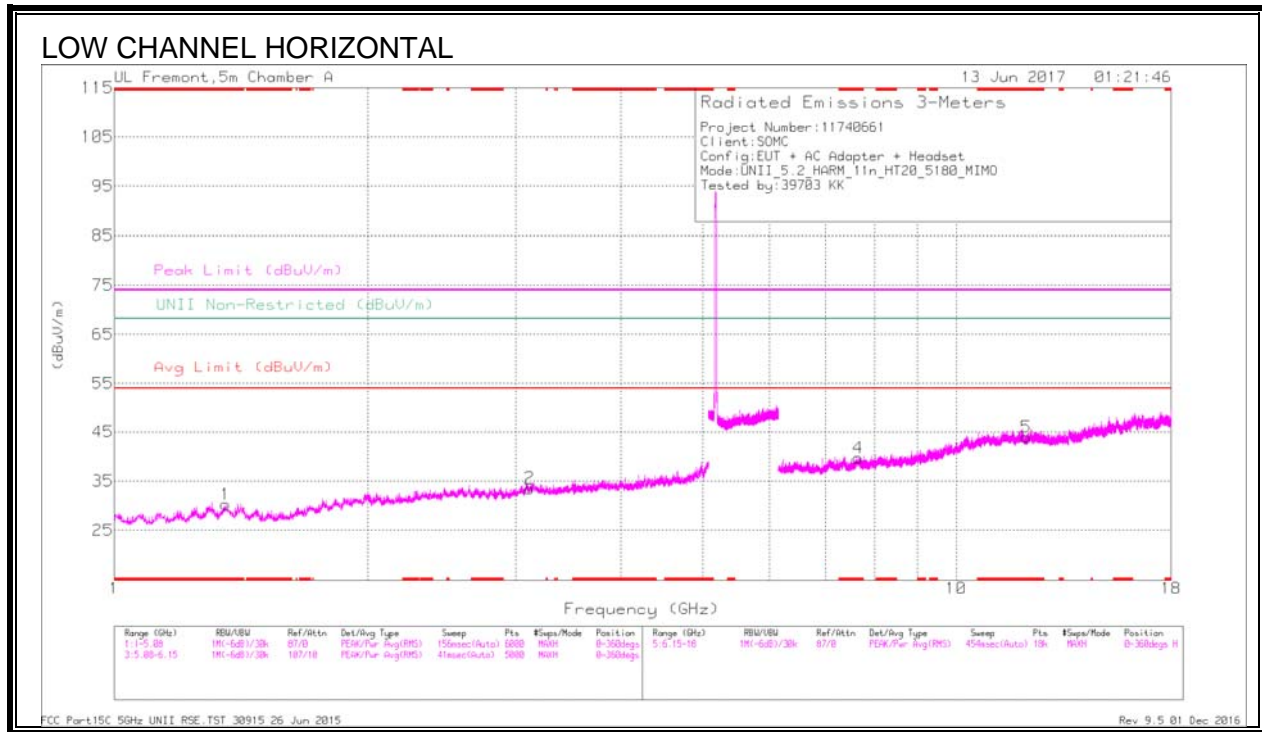

Trace Markers

Marker	Frequency (GHz)	Meter Reading (dBuV)	Det	AF 1711 (dB/m)	Amp/CS/Flt/Pad (dB)	DC Corr (dB)	Corrected Reading (dBuV/m)	Avg Limit (dBuV/m)	Margin (dB)	Peak Limit (dBuV/m)	PK Margin (dB)	UNII Non-Restricted (dBuV/m)	PK Margin (dB)	Azimuth (Degs)	Height (cm)	Polarity
1	* 1.357	34.35	Pk	29.4	-33.5	0	30.25	-	-	74	-43.75	-	-	0-360	199	H
4	* 7.648	27.4	Pk	35.6	-23.3	0	39.7	-	-	74	-34.3	-	-	0-360	199	H
5	* 12.114	25.81	Pk	38.7	-20.6	0	43.91	-	-	74	-30.09	-	-	0-360	101	H
6	* 10.869	26.58	Pk	37.9	-19.5	0	44.58	-	-	74	-29.02	-	-	0-360	200	V
3	1.86	36.96	Pk	30.9	-33.6	0	34.26	-	-	-	-	68.2	-33.94	0-360	200	V
2	3.113	31.01	Pk	33	-30.5	0	33.51	-	-	-	-	68.2	-34.69	0-360	199	H

\* - indicates frequency in CFR47 Pt 15 / IC RSS-Restricted Band

Pk - Peak detector

Radiated Emissions

Frequency (GHz)	Meter Reading (dBuV)	Det	AF 1711 (dB/m)	Amp/CS/Flt/Pad (dB)	DC Corr (dB)	Corrected Reading (dBuV/m)	Avg Limit (dBuV/m)	Margin (dB)	Peak Limit (dBuV/m)	PK Margin (dB)	UNII Non-Restricted (dBuV/m)	PK Margin (dB)	Azimuth (Degs)	Height (cm)	Polarity
* 1.359	41.61	PK-U	29.4	-33.6	0	37.41	-	-	74	-36.59	-	-	0	199	H
* 1.356	29.55	ADR	29.4	-33.4	.2	25.77	54	-28.23	-	-	-	-	0	199	H
* 7.648	33.66	PK-U	35.6	-23.3	0	45.96	-	-	74	-28.04	-	-	0	199	H
* 7.647	22.85	ADR	35.6	-23.3	.2	35.37	54	-18.63	-	-	-	-	0	199	H
* 12.112	32.28	PK-U	38.7	-20.6	0	50.38	-	-	74	-23.62	-	-	0	102	H
* 12.114	21.16	ADR	38.7	-20.5	.2	39.58	54	-14.42	-	-	-	-	0	102	H
* 10.869	31.6	PK-U	37.9	-19.5	0	50	-	-	74	-24	-	-	0	200	V
* 10.867	21.18	ADR	37.9	-19.5	.2	39.8	54	-14.2	-	-	-	-	0	200	V
1.859	52.57	PK-U	30.9	-33.6	0	49.87	-	-	-	-	68.2	-18.33	0	199	V
1.86	28.53	ADR	30.9	-33.6	.2	26.05	-	-	-	-	-	-	0	199	V
3.111	38.23	PK-U	33	-30.6	0	40.63	-	-	-	-	68.2	-27.57	0	199	H
3.113	26.61	ADR	33	-30.5	.2	29.33	-	-	-	-	-	-	0	199	H

\* - indicates frequency in CFR15.205/IC8.10 RSS-Restricted Band

PK-U - U-NII: Maximum Peak

ADR - U-NII AD primary method, RMS average



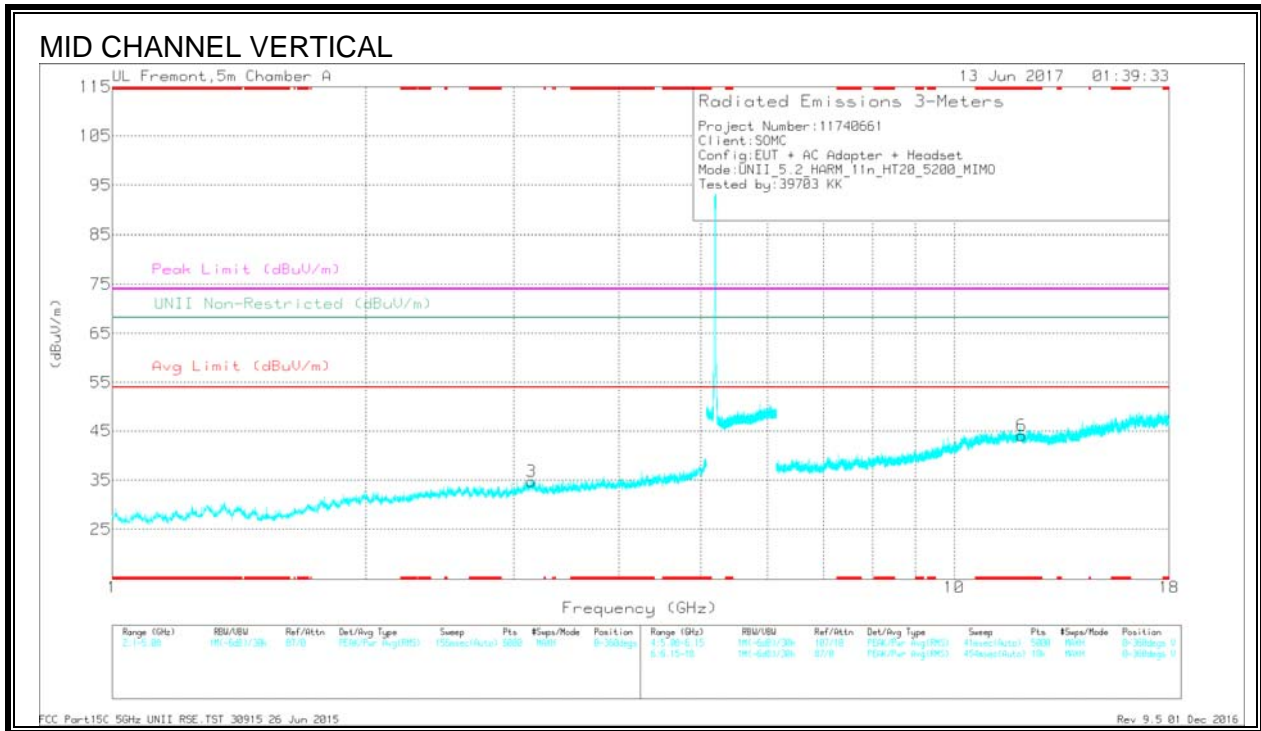
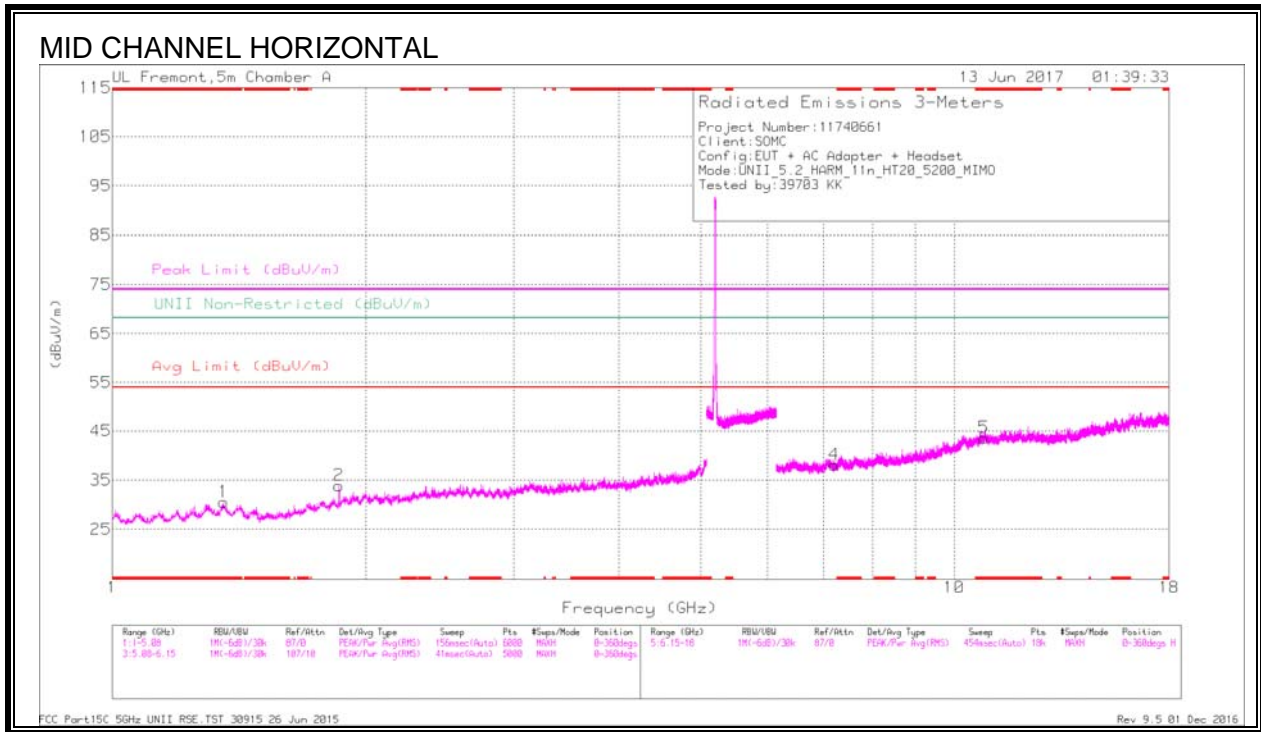



Trace Markers

Marker	Frequency (GHz)	Meter Reading (dBuV)	Det	AF 1711 (dB/m)	Amp/CS/Flt/Pad (dB)	DC Corr (dB)	Corrected Reading (dBuV/m)	Avg Limit (dBuV/m)	Margin (dB)	Peak Limit (dBuV/m)	PK Margin (dB)	UNII Non-Restricted (dBuV/m)	PK Margin (dB)	Azimuth (Degs)	Height (cm)	Polarity
1	* 1.357	34.66	Pk	29.4	-33.5	0	30.56	-	-	74	-43.44	-	-	0-360	101	H
5	* 10.846	25.32	Pk	37.9	-19.6	0	43.62	-	-	74	-30.38	-	-	0-360	101	H
6	* 12.023	25.43	Pk	38.7	-20.1	0	44.03	-	-	74	-29.97	-	-	0-360	200	V
2	1.86	36.61	Pk	30.9	-33.6	0	33.91	-	-	-	-	68.2	-34.29	0-360	199	H
3	3.149	32.11	Pk	33	-30.4	0	34.71	-	-	-	-	68.2	-33.49	0-360	200	V
4	7.207	27.92	Pk	35.5	-25.3	0	38.12	-	-	-	-	68.2	-30.08	0-360	101	H

\* - indicates frequency in CFR47 Pt 15 / IC RSS-Restricted Band

Pk - Peak detector

Radiated Emissions

Frequency (GHz)	Meter Reading (dBuV)	Det	AF 1711 (dB/m)	Amp/CS/Flt/Pad (dB)	DC Corr (dB)	Corrected Reading (dBuV/m)	Avg Limit (dBuV/m)	Margin (dB)	Peak Limit (dBuV/m)	PK Margin (dB)	UNII Non-Restricted (dBuV/m)	PK Margin (dB)	Azimuth (Degs)	Height (cm)	Polarity
* 1.356	40.89	PK-U	29.4	-33.4	0	36.89	-	-	74	-37.11	-	-	0	100	H
* 1.355	29.51	ADR	29.4	-33.4	.2	25.73	54	-28.27	-	-	-	-	0	100	H
* 10.847	32.02	PK-U	37.9	-19.7	0	50.22	-	-	74	-23.78	-	-	0	102	H
* 10.845	21.01	ADR	37.9	-19.6	.2	39.53	54	-14.47	-	-	-	-	0	102	H
* 12.021	32.15	PK-U	38.7	-20.1	0	50.75	-	-	74	-23.25	-	-	0	200	V
* 12.024	21.14	ADR	38.7	-20.1	.2	39.96	54	-14.04	-	-	-	-	0	200	V
1.859	60.22	PK-U	30.9	-33.6	0	57.52	-	-	-	-	68.2	-10.68	0	199	H
1.862	28.46	ADR	30.9	-33.6	.2	25.98	-	-	-	-	-	-	0	199	H
3.149	27.29	ADR	33	-30.4	.2	30.11	-	-	-	-	-	-	0	199	V
3.15	38.95	PK-U	33	-30.4	0	41.55	-	-	-	-	68.2	-26.65	0	199	V
7.206	23.39	ADR	35.5	-25.3	.2	33.81	-	-	-	-	-	-	0	102	H
7.207	33.95	PK-U	35.5	-25.3	0	44.15	-	-	-	-	68.2	-24.05	0	102	H

\* - indicates frequency in CFR15.205/IC8.10 RSS-Restricted Band

PK-U - U-NII: Maximum Peak

ADR - U-NII AD primary method, RMS average

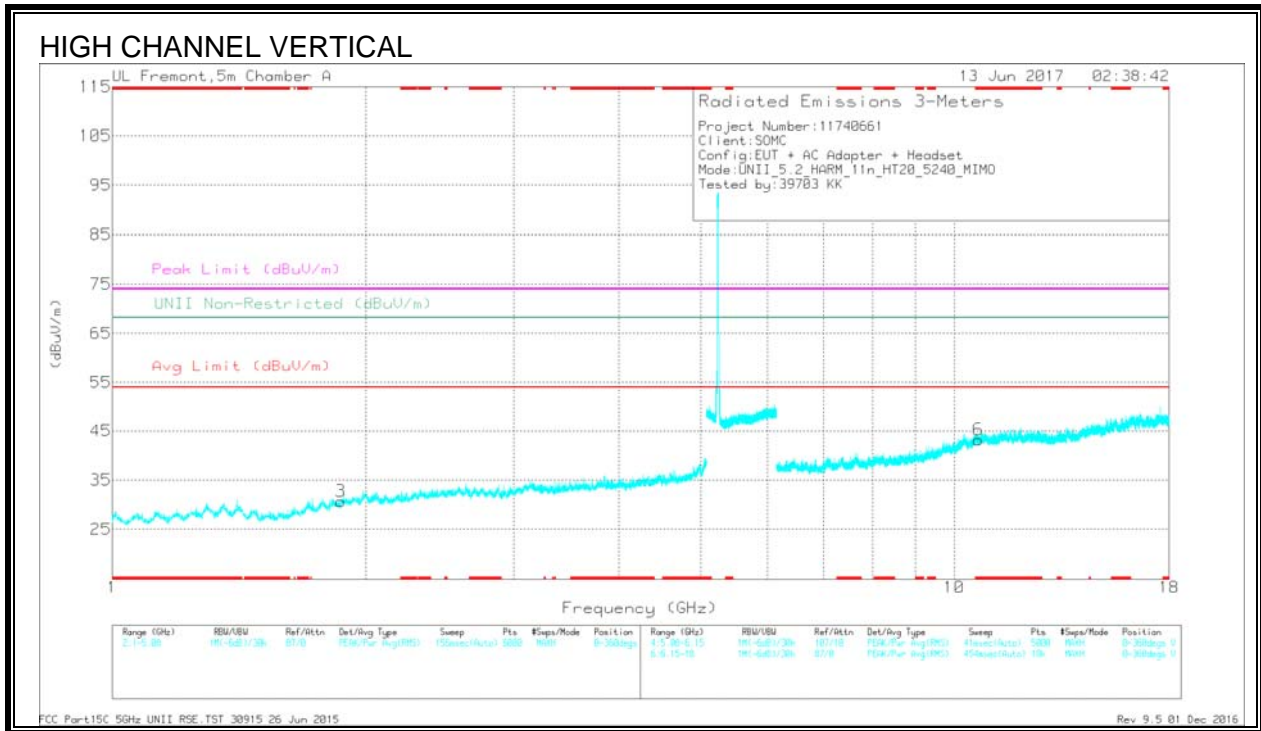
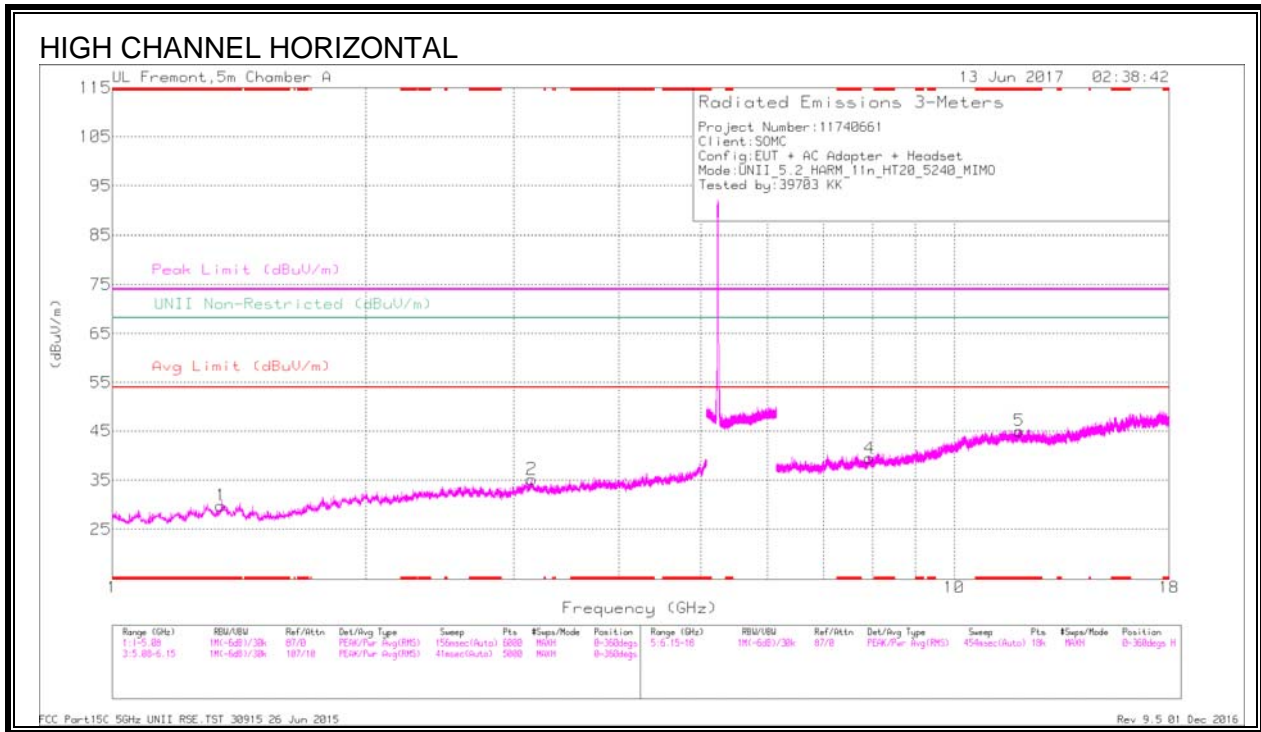

Trace Markers

Marker	Frequency (GHz)	Meter Reading (dBuV)	Det	AF 1711 (dB/m)	Amp/CS/Flt/Pad (dB)	DC Corr (dB)	Corrected Reading (dBuV/m)	Avg Limit (dBuV/m)	Margin (dB)	Peak Limit (dBuV/m)	PK Margin (dB)	UNII Non-Restricted (dBuV/m)	PK Margin (dB)	Azimuth (Degs)	Height (cm)	Polarity
1	* 1.346	33.92	Pk	29.4	-33.5	0	29.82	-	-	74	-44.18	-	-	0-360	199	H
5	* 11.95	26.22	Pk	38.6	-19.8	0	45.02	-	-	74	-28.98	-	-	0-360	101	H
6	* 10.684	26.1	Pk	37.8	-20.7	0	43.2	-	-	74	-30.8	-	-	0-360	200	V
3	1.868	33.29	Pk	31	-33.6	0	30.69	-	-	-	-	68.2	-37.51	0-360	200	V
2	3.15	32.57	Pk	33	-30.4	0	35.17	-	-	-	-	68.2	-33.03	0-360	101	H
4	7.932	27.23	Pk	35.6	-23.4	0	39.43	-	-	-	-	68.2	-28.77	0-360	199	H

\* - indicates frequency in CFR47 Pt 15 / IC RSS-Restricted Band

Pk - Peak detector

Radiated Emissions

Frequency (GHz)	Meter Reading (dBuV)	Det	AF 1711 (dB/m)	Amp/CS/Flt/Pad (dB)	DC Corr (dB)	Corrected Reading (dBuV/m)	Avg Limit (dBuV/m)	Margin (dB)	Peak Limit (dBuV/m)	PK Margin (dB)	UNII Non-Restricted (dBuV/m)	PK Margin (dB)	Azimuth (Degs)	Height (cm)	Polarity
* 1.347	40.57	PK-U	29.4	-33.5	0	36.47	-	-	74	-37.53	-	-	0	199	H
* 1.348	28.98	ADR	29.4	-33.5	.2	25.1	54	-28.9	-	-	-	-	0	199	H
* 11.95	31.52	PK-U	38.6	-19.8	0	50.32	-	-	74	-23.68	-	-	0	102	H
* 11.95	21	ADR	38.6	-19.8	.2	40.02	54	-13.98	-	-	-	-	0	102	H
* 10.685	32.86	PK-U	37.8	-20.8	0	49.86	-	-	74	-24.14	-	-	0	200	V
* 10.684	21.55	ADR	37.8	-20.7	.2	38.87	54	-15.13	-	-	-	-	0	200	V
1.866	28.74	ADR	31	-33.6	.2	26.36	-	-	-	-	-	-	0	200	V
1.87	41.28	PK-U	31	-33.6	0	38.68	-	-	-	-	68.2	-29.52	0	200	V
3.15	38.72	PK-U	33	-30.4	0	41.32	-	-	-	-	68.2	-26.88	0	102	H
3.152	27.01	ADR	33	-30.5	.2	29.73	-	-	-	-	-	-	0	102	H
7.93	33.81	PK-U	35.6	-23.4	0	46.01	-	-	-	-	68.2	-22.19	0	200	H
7.931	22.76	ADR	35.6	-23.4	.2	35.18	-	-	-	-	-	-	0	200	H

\* - indicates frequency in CFR15.205/IC8.10 RSS-Restricted Band

PK-U - U-NII: Maximum Peak

ADR - U-NII AD primary method, RMS average

### 11.1.3. 11n HT40 2TX CDD MIMO MODE IN THE 5.2GHz BAND

#### RESTRICTED BANDEDGE (LOW CHANNEL)

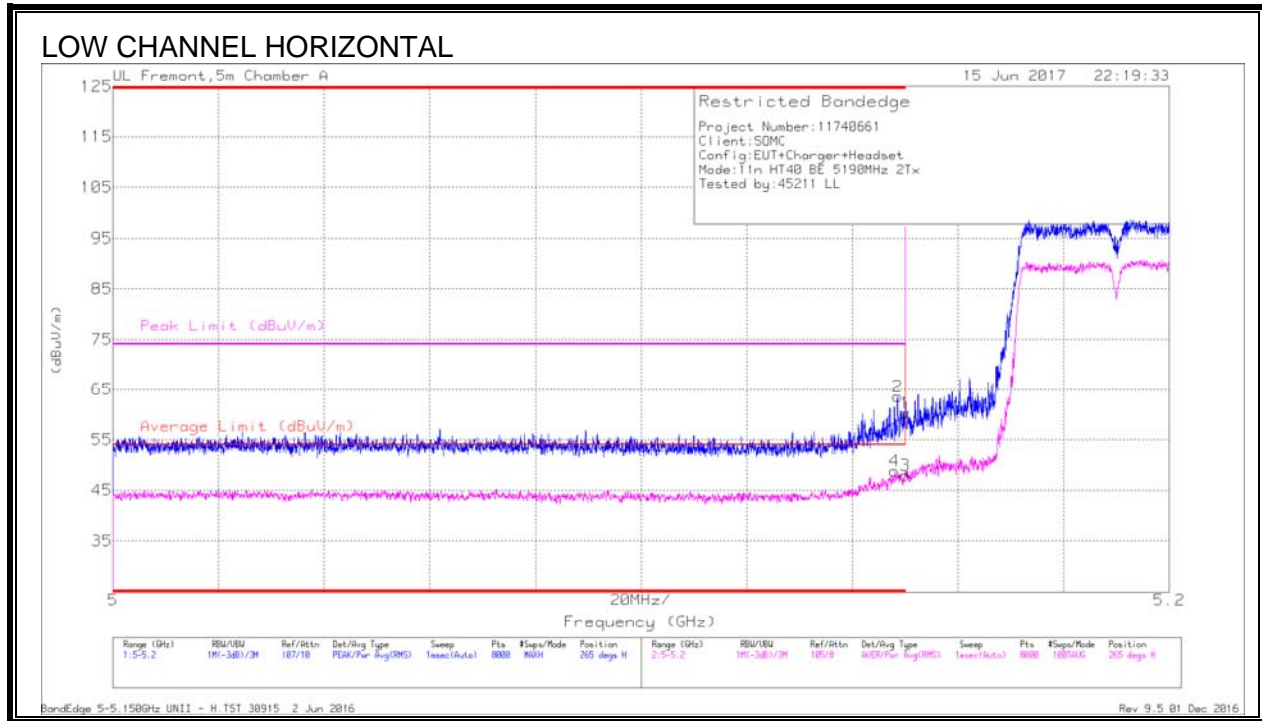

#### Trace Markers

Marker	Frequency (GHz)	Meter Reading (dBuV)	Det	AFT711 (dB/m)	Amp/Cb/Ftr/Pad (dB)	DC Corr (dB)	Corrected Reading (dBuV/m)	Average Limit (dBuV/m)	Margin (dB)	Peak Limit (dBuV/m)	PK Margin (dB)	Azimuth (Degs)	Height (cm)	Polarity
4	* 5.148	32.91	RMS	34.1	-18.6	.4	48.81	54	-5.19	-	-	265	124	H
2	* 5.149	48.05	Pk	34.1	-18.6	0	63.55	-	-	74	-10.45	265	124	H
1	* 5.15	44.81	Pk	34.1	-18.7	0	60.21	-	-	74	-13.79	265	124	H
3	* 5.15	32.08	RMS	34.1	-18.7	.4	47.88	54	-6.12	-	-	265	124	H

\* - indicates frequency in CFR15.205/IC8.10 RSS-Restricted Band  
 Pk - Peak detector  
 RMS - RMS detection

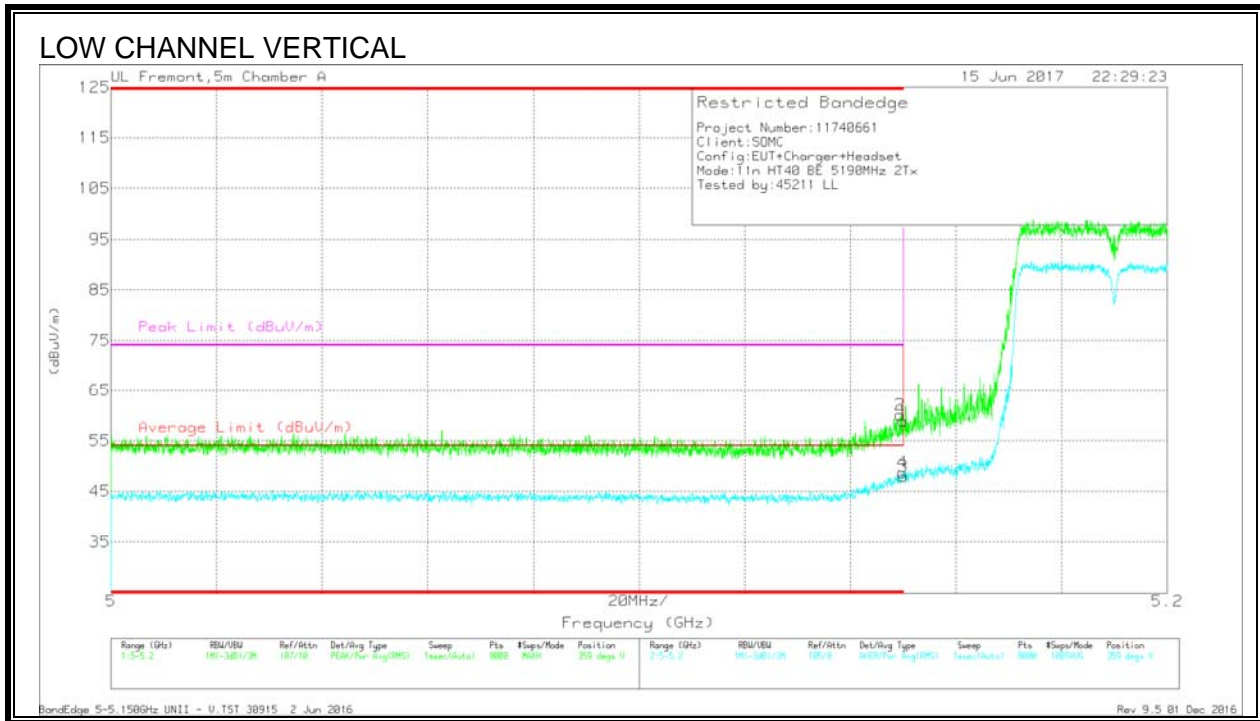

Trace Markers

Marker	Frequency (GHz)	Meter Reading (dBuV)	Det	AFT711 (dB/m)	Amp/Cb/Ftr/Pad (dB)	DC Corr (dB)	Corrected Reading (dBuV/m)	Average Limit (dBuV/m)	Margin (dB)	Peak Limit (dBuV/m)	PK Margin (dB)	Altitude (Degs)	Height (cm)	Polarity
2	* 5.149	44.61	Pk	34.1	-18.6	0	60.11	-	-	74	-13.89	359	294	V
1	* 5.15	43.42	Pk	34.1	-18.7	0	58.82	-	-	74	-15.18	359	294	V
3	* 5.15	32.1	RMS	34.1	-18.7	.4	47.9	54	-6.1	-	-	359	294	V
4	* 5.15	32.89	RMS	34.1	-18.7	.4	48.69	54	-5.31	-	-	359	294	V

\* - indicates frequency in CFR15.205/IC8.10 RSS-Restricted Band

Pk - Peak detector

RMS - RMS detection

**HARMONICS AND SPURIOUS EMISSIONS**

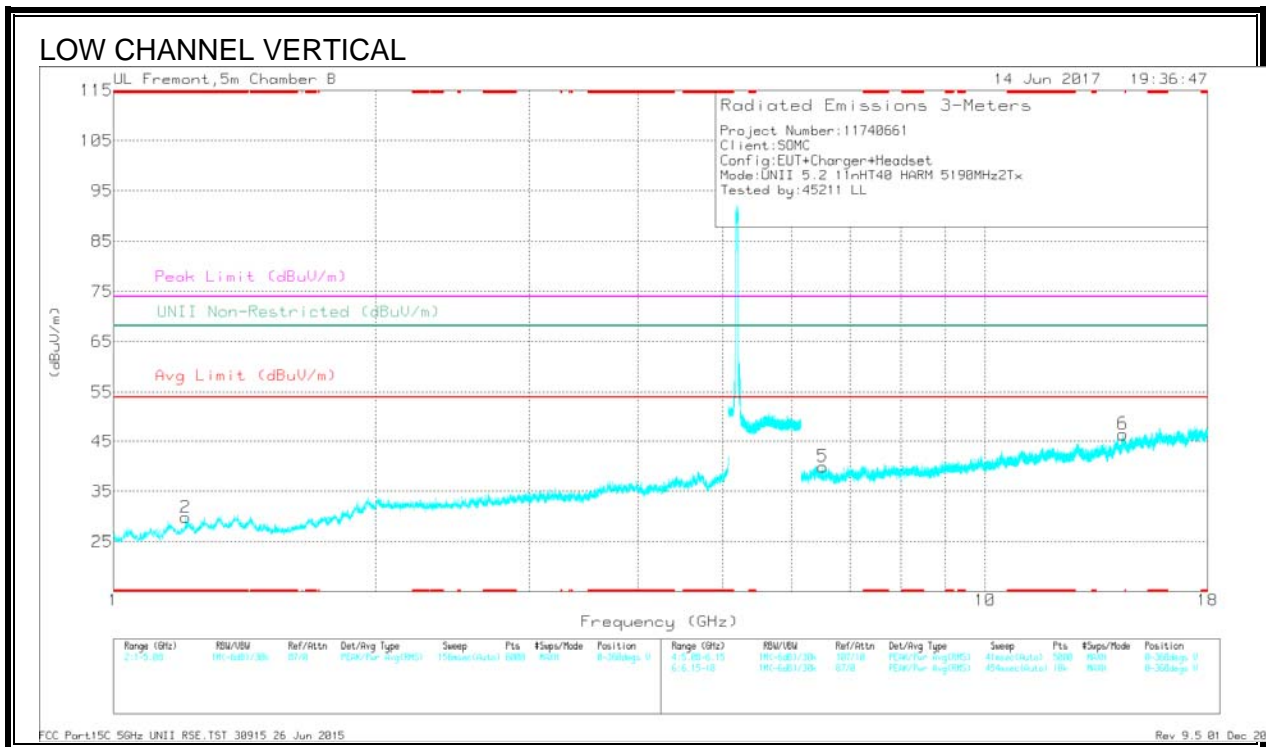
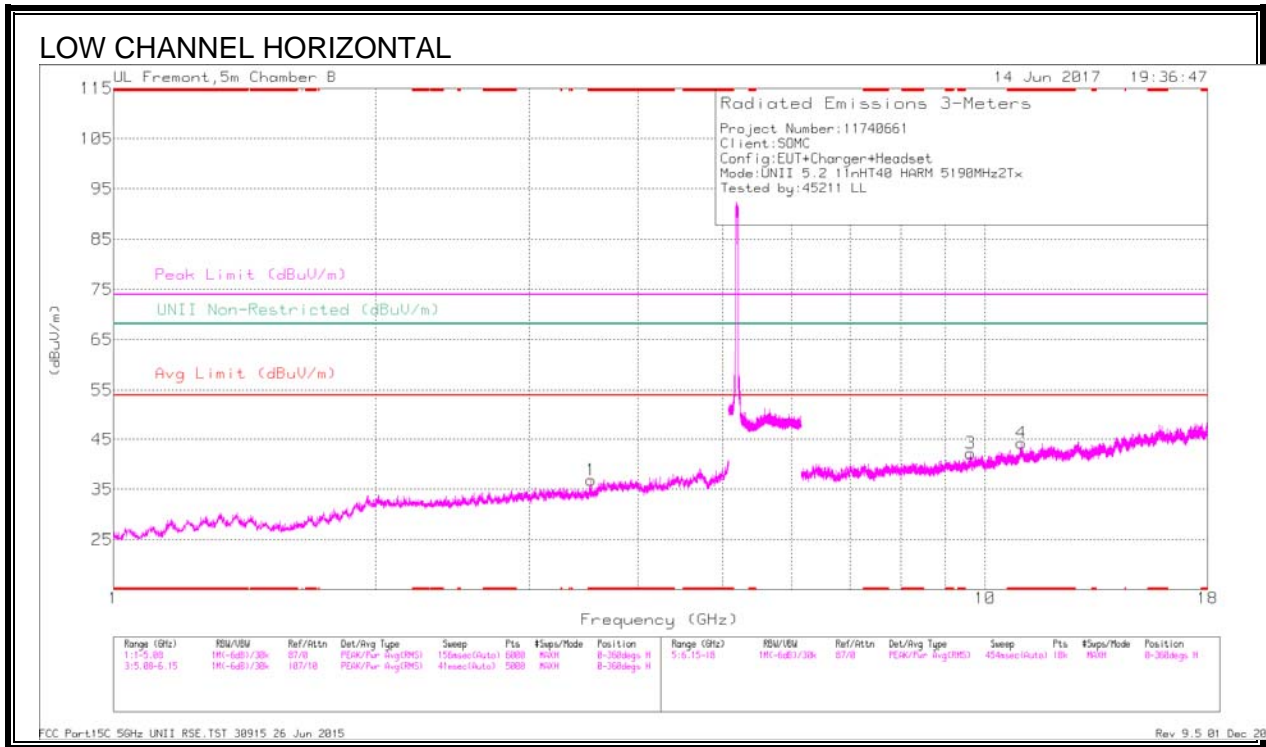

Trace Markers

Marker	Frequency (GHz)	Meter Reading (dBuV)	Det	AF T346 (dB/m)	Amp/Ch/Filt/Pad (dB)	DC Corr (dB)	Corrected Reading (dBuV/m)	Avg Limit (dBuV/m)	Margin (dB)	Peak Limit (dBuV/m)	PK Margin (dB)	UNII Non-Restricted (dBuV/m)	PK Margin (dB)	Azimuth (Degs)	Height (cm)	Polarity
1	* 3.535	34.38	Pk	33.2	-30.7	0	36.88	-	-	74	-37.12	-	-	0-360	199	H
2	* 1.211	36.05	Pk	28.1	-34.3	0	29.85	-	-	74	-44.15	-	-	0-360	102	V
4	* 11.008	28.12	Pk	38.5	-22.4	0	44.22	-	-	74	-29.78	-	-	0-360	102	H
5	6.509	32.8	Pk	36.1	-28.9	0	40	-	-	-	-	68.2	-28.2	0-360	199	V
3	9.619	29.08	Pk	37.3	-24.2	0	42.18	-	-	-	-	68.2	-26.02	0-360	199	H
6	14.401	27.82	Pk	40.9	-22.3	0	46.42	-	-	-	-	68.2	-21.78	0-360	199	V

\* - indicates frequency in CFR47 Pt 15 / IC RSS-Restricted Band

Pk - Peak detector

Radiated Emissions

Frequency (GHz)	Meter Reading (dBuV)	Det	AF T346 (dB/m)	Amp/Ch/Filt/Pad (dB)	DC Corr (dB)	Corrected Reading (dBuV/m)	Avg Limit (dBuV/m)	Margin (dB)	Peak Limit (dBuV/m)	PK Margin (dB)	UNII Non-Restricted (dBuV/m)	PK Margin (dB)	Azimuth (Degs)	Height (cm)	Polarity
* 3.536	39.17	PK-U	33.2	-30.6	0	41.77	-	-	74	-32.23	-	-	277	199	H
* 3.533	27.59	ADR	33.2	-30.7	.4	30.51	54	-23.49	-	-	-	-	277	199	H
* 1.213	41.16	PK-U	28.1	-34.3	0	34.96	-	-	74	-39.04	-	-	307	104	V
* 1.213	30.19	ADR	28.1	-34.3	.4	24.41	54	-29.59	-	-	-	-	307	104	V
* 11.006	32.93	PK-U	38.5	-22.4	0	49.03	-	-	74	-24.97	-	-	203	104	H
* 11.008	22.2	ADR	38.5	-22.4	.4	38.72	54	-15.28	-	-	-	-	203	104	H
6.508	39.09	PK-U	36.1	-28.8	0	46.39	-	-	-	-	68.2	-21.81	165	199	V
9.619	34.25	PK-U	37.3	-24.2	0	47.35	-	-	-	-	68.2	-20.85	246	198	H
14.4	32.49	PK-U	40.9	-22.3	0	51.09	-	-	-	-	68.2	-17.11	200	199	V

\* - indicates frequency in CFR15.205/IC8.10 RSS-Restricted Band

PK-U - U-NII: Maximum Peak

ADR - U-NII AD primary method, RMS average



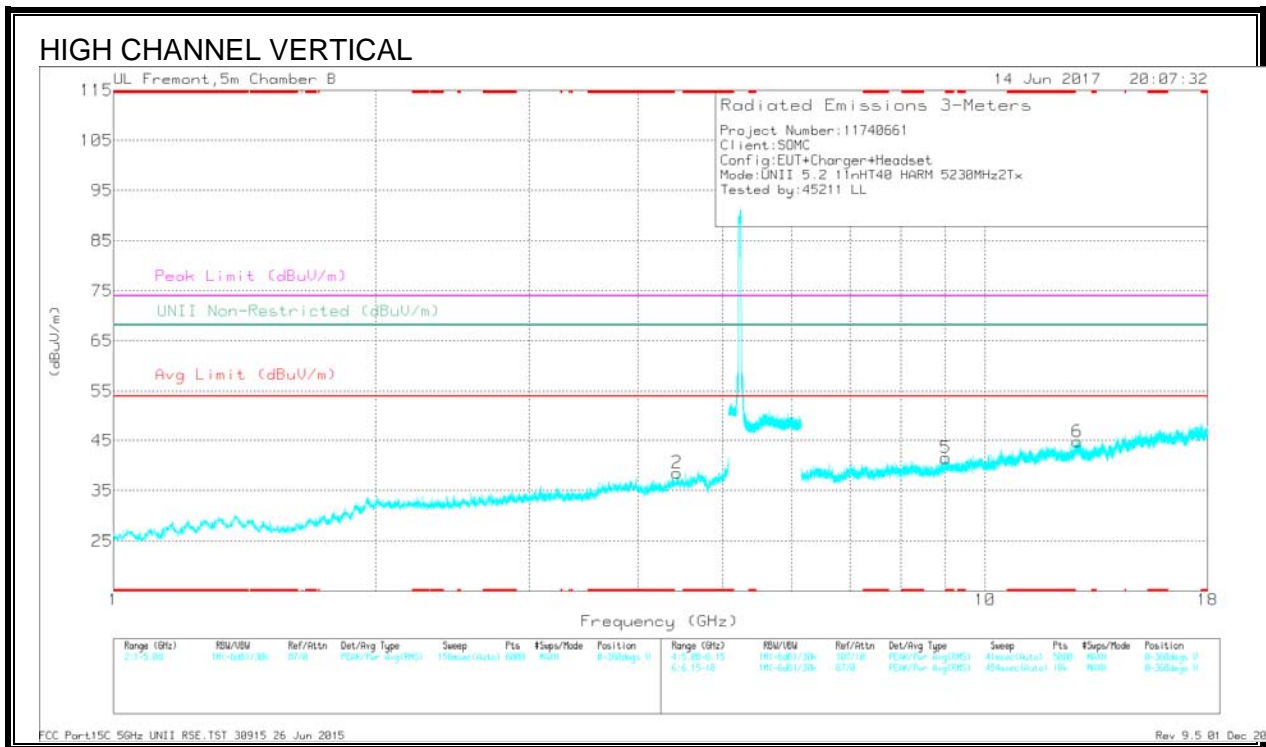
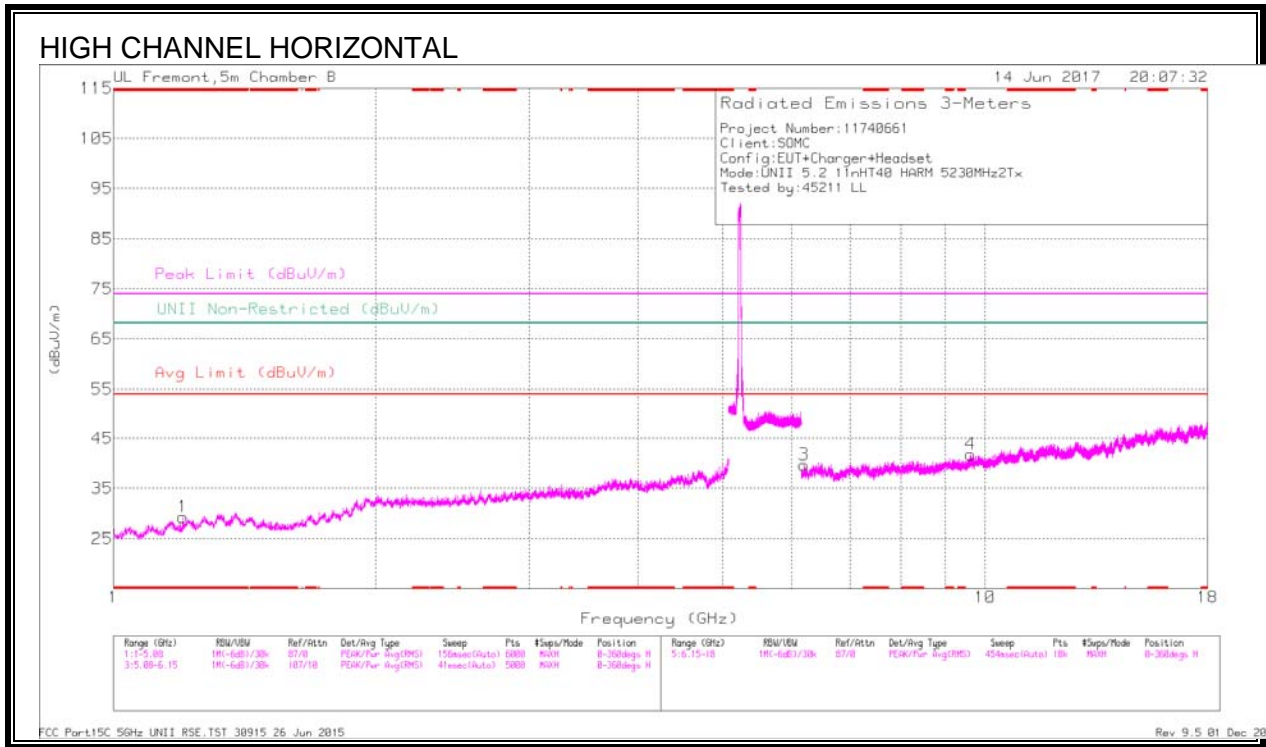



Trace Markers

Marker	Frequency (GHz)	Meter Reading (dBuV)	Det	AF T346 (dB/m)	Amp/Chl/Fbr/Psd (dB)	DC Corr (dB)	Corrected Reading (dBuV/m)	Avg Limit (dBuV/m)	Margin (dB)	Peak Limit (dBuV/m)	PK Margin (dB)	UNII Non-Restricted (dBuV/m)	PK Margin (dB)	Azimuth (Degs)	Height (cm)	Polarity
1	* 1.201	35.48	Pk	28	-34.2	0	29.28	-	-	74	-44.72	-	-	0-360	102	H
5	* 9.02	29.91	Pk	36.9	-25.3	0	41.51	-	-	74	-32.49	-	-	0-360	102	V
2	4.433	33.28	Pk	34.2	-28.9	0	38.58	-	-	-	-	68.2	-29.62	0-360	102	V
3	6.201	32.4	Pk	35.9	-28.6	0	39.7	-	-	-	-	68.2	-28.5	0-360	102	H
4	9.63	28.83	Pk	37.3	-24.3	0	41.83	-	-	-	-	68.2	-26.37	0-360	199	H
6	12.755	27.39	Pk	39.7	-22.3	0	44.79	-	-	-	-	68.2	-23.41	0-360	102	V

\* - indicates frequency in CFR47 Pt 15 / IC RSS-Restricted Band

Pk - Peak detector

Radiated Emissions

Frequency (GHz)	Meter Reading (dBuV)	Det	AF T346 (dB/m)	Amp/Chl/Fbr/Psd (dB)	DC Corr (dB)	Corrected Reading (dBuV/m)	Avg Limit (dBuV/m)	Margin (dB)	Peak Limit (dBuV/m)	PK Margin (dB)	UNII Non-Restricted (dBuV/m)	PK Margin (dB)	Azimuth (Degs)	Height (cm)	Polarity
* 1.203	40.74	PK-U	28	-34.2	0	34.54	-	-	74	-39.46	-	-	304	101	H
* 1.203	29.23	ADR	28	-34.2	.4	23.45	54	-30.55	-	-	-	-	304	101	H
* 9.022	35.32	PK-U	36.9	-25.3	0	46.92	-	-	74	-27.08	-	-	188	104	V
* 9.022	24.38	ADR	36.9	-25.3	.4	36.4	54	-17.6	-	-	-	-	188	104	V
4.433	39.18	PK-U	34.2	-28.9	0	44.48	-	-	-	-	68.2	-23.72	286	101	V
6.201	38.67	PK-U	35.9	-28.6	0	45.97	-	-	-	-	68.2	-22.23	216	101	H
9.628	35.43	PK-U	37.3	-24.3	0	48.43	-	-	-	-	68.2	-19.77	265	199	H
12.754	33.03	PK-U	39.7	-22.3	0	50.43	-	-	-	-	68.2	-17.77	218	104	V

\* - indicates frequency in CFR15.205/IC8.10 RSS-Restricted Band

PK-U - U-NII: Maximum Peak

ADR - U-NII AD primary method, RMS average

### 11.1.4. 11ac HT80 2TX CDD MIMO MODE IN THE 5.2GHz BAND

#### RESTRICTED BANDEDGE (LOW CHANNEL)

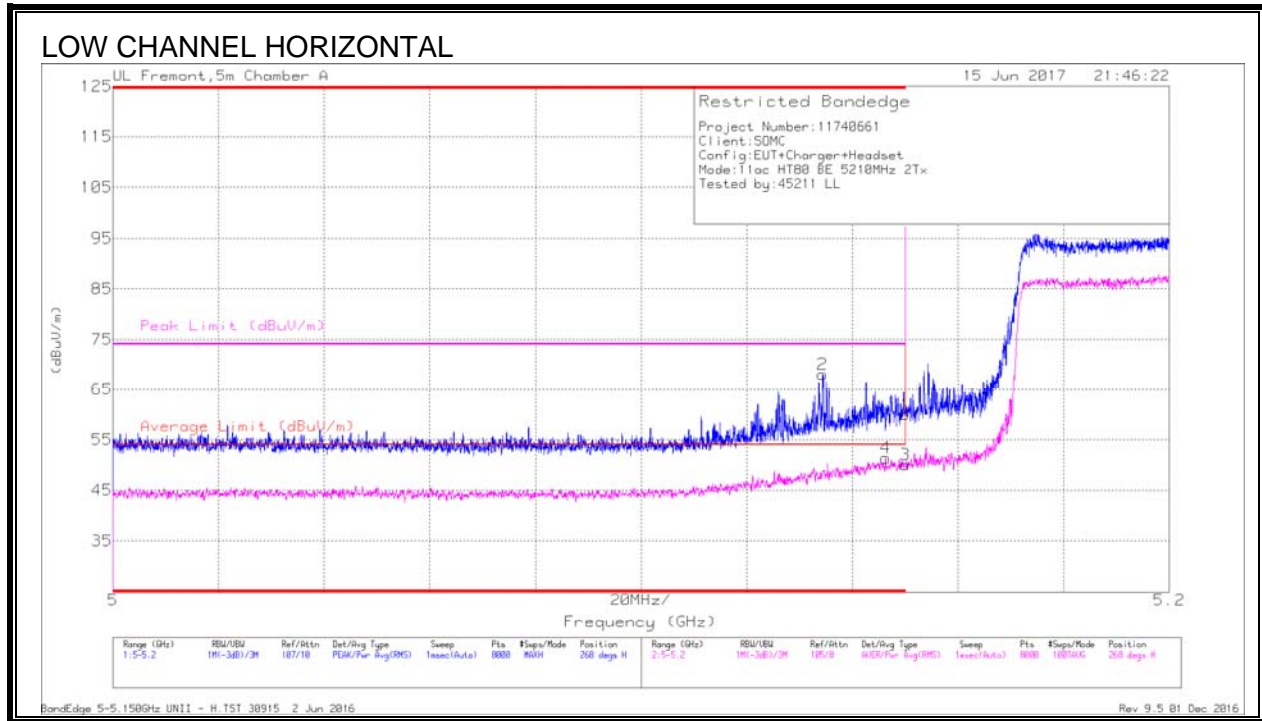

#### Trace Markers

Marker	Frequency (GHz)	Meter Reading (dBuV)	Det	AFT711 (dB/m)	Amp/Cb/Ftr/Pad (dB)	DC Corr (dB)	Corrected Reading (dBuV/m)	Average Limit (dBuV/m)	Margin (dB)	Peak Limit (dBuV/m)	PK Margin (dB)	Azimuth (Degs)	Height (cm)	Polarity
2	* 5.134	52.51	Pk	34.1	-18.6	0	68.01	-	-	74	-5.99	268	266	H
4	* 5.146	35.1	RMS	34.1	-18.6	.75	51.35	54	-2.65	-	-	268	266	H
1	* 5.15	44.57	Pk	34.1	-18.7	0	59.97	-	-	74	-14.03	268	266	H
3	* 5.15	33.95	RMS	34.1	-18.7	.75	50.1	54	-3.9	-	-	268	266	H

\* - indicates frequency in CFR15.205/IC8.10 RSS-Restricted Band  
 Pk - Peak detector  
 RMS - RMS detection