



CERTIFICATION TEST REPORT

Report Number. : 11740661-E2V3

Applicant : SONY MOBILE COMMUNICATIONS, INC.
4-12-3 HIGASHI-SHINAGAWA,
SHINAGAWA -KU, TOKYO, 140-0002, JAPAN

FCC ID : PY7-81775I

EUT Description : GSM/WCDMA/LTE Phone with BT, DTS/UNII a/b/g/n/ac, GPS & NFC

Test Standard(s) : FCC 47 CFR PART 15 SUBPART C

Date Of Issue:

July 11, 2017

Prepared by:

UL Verification Services Inc.
47173 Benicia Street
Fremont, CA 94538, U.S.A.
TEL: (510) 771-1000
FAX: (510) 661-0888



NVLAP LAB CODE 200065-0

Revision History

<u>Rev.</u>	<u>Issue Date</u>	<u>Revisions</u>	<u>Revised By</u>
V1	06/23/17	Initial Review	D. Corona
V2	07/08/17	Updated Section 5.5 & 6	D. Corona
V3	07/11/17	Updated Section 5.3, 7.1.5, 7.2.5, 8.1, 8.2.1, & 8.2.2	D. Corona

TABLE OF CONTENTS

1. ATTESTATION OF TEST RESULTS	5
2. TEST METHODOLOGY	6
3. FACILITIES AND ACCREDITATION	6
4. CALIBRATION AND UNCERTAINTY	7
4.1. MEASURING INSTRUMENT CALIBRATION	7
4.2. SAMPLE CALCULATION	7
4.3. MEASUREMENT UNCERTAINTY.....	7
5. EQUIPMENT UNDER TEST.....	8
5.1. DESCRIPTION OF EUT.....	8
5.2. MAXIMUM OUTPUT POWER.....	8
5.3. DESCRIPTION OF AVAILABLE ANTENNAS.....	8
5.4. SOFTWARE AND FIRMWARE.....	8
5.5. WORST-CASE CONFIGURATION AND MODE.....	9
5.6. DESCRIPTION OF TEST SETUP.....	10
6. TEST AND MEASUREMENT EQUIPMENT	13
7. ANTENNA PORT TEST RESULTS.....	14
7.1. BASIC DATA RATE GFSK MODULATION.....	15
7.1.1. 20 dB AND 99% BANDWIDTH	15
7.1.2. HOPPING FREQUENCY SEPARATION	18
7.1.3. NUMBER OF HOPPING CHANNELS.....	19
7.1.4. AVERAGE TIME OF OCCUPANCY	22
7.1.5. OUTPUT POWER	26
7.1.6. AVERAGE POWER.....	28
7.1.7. CONDUCTED BANDEDGE AND SPURIOUS EMISSIONS.....	29
7.2. ENHANCED DATA RATE 8PSK MODULATION	33
7.2.1. 20 dB AND 99% BANDWIDTH	33
7.2.2. HOPPING FREQUENCY SEPARATION	36
7.2.3. NUMBER OF HOPPING CHANNELS.....	37
7.2.4. AVERAGE TIME OF OCCUPANCY	40
7.2.5. OUTPUT POWER	44
7.2.6. AVERAGE POWER.....	46
7.2.7. CONDUCTED BANDEDGE AND SPURIOUS EMISSIONS.....	47
8. RADIATED TEST RESULTS.....	51
8.1. LIMITS AND PROCEDURE.....	51

8.2.	<i>BASIC DATA RATE GFSK MODULATION</i>	52
8.2.1.	RESTRICTED BANDEDGE (LOW CHANNEL).....	52
8.2.2.	AUTHORIZED BANDEDGE (HIGH CHANNEL).....	54
8.2.3.	HARMONICS AND SPURIOUS EMISSIONS	56
8.3.	<i>ENHANCED DATA RATE 8PSK MODULATION</i>	62
8.3.1.	RESTRICTED BANDEDGE (LOW CHANNEL).....	62
8.3.2.	AUTHORIZED BANDEDGE (HIGH CHANNEL).....	64
8.3.3.	HARMONICS AND SPURIOUS EMISSIONS	66
8.4.	<i>WORST-CASE BELOW 30 MHz</i>	72
8.5.	<i>WORST-CASE BELOW 1 GHz</i>	73
8.6.	<i>WORST-CASE ABOVE 18 GHz</i>	75
9.	AC POWER LINE CONDUCTED EMISSIONS	77
10.	SETUP PHOTOS	80

1. ATTESTATION OF TEST RESULTS

COMPANY NAME: SONY MOBILE COMMUNICATIONS, INC.
4-12-3 HIGASHI-SHINAGAWA,
SHINAGAWA -KU, TOKYO, 140-0002, JAPAN

EUT DESCRIPTION: GSM/WCDMA/LTE Phone with BT, DTS/UNII a/b/g/n/ac, GPS & NFC

SERIAL NUMBER: RADIATED: QV7001PT0N, QV7001Q50N
CONDUCTED: QV7000LN0P, QV7000HV0P

DATE TESTED: JUNE 8 – JULY 11, 2017

APPLICABLE STANDARDS	
STANDARD	TEST RESULTS
CFR 47 Part 15 Subpart C	Pass

UL Verification Services Inc. tested the above equipment in accordance with the requirements set forth in the above standards. All indications of Pass/Fail in this report are opinions expressed by UL Verification Services Inc. based on interpretations and/or observations of test results. Measurement Uncertainties were not taken into account and are published for informational purposes only. The test results show that the equipment tested is capable of demonstrating compliance with the requirements as documented in this report.

Note: The results documented in this report apply only to the tested sample, under the conditions and modes of operation as described herein. This document may not be altered or revised in any way unless done so by UL Verification Services Inc. and all revisions are duly noted in the revisions section. Any alteration of this document not carried out by UL Verification Services Inc. will constitute fraud and shall nullify the document. This report must not be used by the client to claim product certification, approval, or endorsement by NVLAP, NIST, any agency of the Federal Government, or any agency of any government.

Approved & Released For
UL Verification Services Inc. By:



DAN CORONIA
WiSE PROJECT LEAD
UL VERIFICATION SERVICES INC.

Prepared By:



JASON QIAN
WiSE LAB ENGINEER
UL VERIFICATION SERVICES INC.

2. TEST METHODOLOGY

The tests documented in this report were performed in accordance with FCC CFR 47 Part 2, FCC CFR 47 Part 15, ANSI C63.10-2013.

3. FACILITIES AND ACCREDITATION

The test sites and measurement facilities used to collect data are located at 47173 and 47266 Benicia Street, Fremont, California, USA. Line conducted emissions are measured only at the 47173 address. The following table identifies which facilities were utilized for radiated emission measurements documented in this report. Specific facilities are also identified in the test results sections.

47173 Benicia Street	47266 Benicia Street
<input checked="" type="checkbox"/> Chamber A(IC: 2324B-1)	<input type="checkbox"/> Chamber D(IC: 22541-1)
<input checked="" type="checkbox"/> Chamber B(IC: 2324B-2)	<input type="checkbox"/> Chamber E(IC: 22541-2)
<input type="checkbox"/> Chamber C(IC: 2324B-3)	<input type="checkbox"/> Chamber F(IC: 22541-3)
	<input type="checkbox"/> Chamber G(IC: 22541-4)
	<input type="checkbox"/> Chamber H(IC: 22541-5)

The above test sites and facilities are covered under FCC Test Firm Registration # 208313. UL Verification Services Inc. is accredited by NVLAP, Laboratory Code 200065-0. Chambers A through C are covered under Industry Canada company address code 2324B with site numbers 2324B -1 through 2324B-3, respectively. Chambers D through H are covered under Industry Canada company address code 22541 with site numbers 22541 -1 through 22541-5, respectively.

4. CALIBRATION AND UNCERTAINTY

4.1. MEASURING INSTRUMENT CALIBRATION

The measuring equipment utilized to perform the tests documented in this report has been calibrated in accordance with the manufacturer's recommendations, and is traceable to recognized national standards.

4.2. SAMPLE CALCULATION

Where relevant, the following sample calculation is provided:

$$\begin{aligned} \text{Field Strength (dBuV/m)} &= \text{Measured Voltage (dBuV)} + \text{Antenna Factor (dB/m)} + \\ &\text{Cable Loss (dB)} - \text{Preamp Gain (dB)} \\ 36.5 \text{ dBuV} + 18.7 \text{ dB/m} + 0.6 \text{ dB} - 26.9 \text{ dB} &= 28.9 \text{ dBuV/m} \end{aligned}$$

4.3. MEASUREMENT UNCERTAINTY

Where relevant, the following measurement uncertainty levels have been estimated for tests performed on the apparatus:

Parameter	Uncertainty
Worst Case Conducted Disturbance, 9KHz to 0.15 MHz	3.84 dB
Worst Case Conducted Disturbance, 0.15 to 30 MHz	3.65 dB
Worst Case Radiated Disturbance, 9KHz to 30 MHz	3.15 dB
Worst Case Radiated Disturbance, 30 to 1000 MHz	5.36 dB
Worst Case Radiated Disturbance, 1000 to 18000 MHz	4.32 dB
Worst Case Radiated Disturbance, 18000 to 26000 MHz	4.45 dB
Worst Case Radiated Disturbance, 26000 to 40000 MHz	5.24 dB

Uncertainty figures are valid to a confidence level of 95%.

5. EQUIPMENT UNDER TEST

5.1. DESCRIPTION OF EUT

The EUT is a GSM/WCDMA/LTE Phone with BT, DTS/UNII a/b/g/n/ac, GPS & NFC.

5.2. MAXIMUM OUTPUT POWER

The transmitter has a maximum peak conducted output power as follows:

Frequency Range (MHz)	Mode	Output Power (dBm)	Output Power (mW)
2402 - 2480	Basic GFSK	11.88	15.42
2402 - 2480	Enhanced 8PSK	11.59	14.42

5.3. DESCRIPTION OF AVAILABLE ANTENNAS

The radio utilizes integrated antenna, with the maximum gains:

Frequency Band (GHz)	Antenna Gain (dBi)
2402-2480	-2.80

5.4. SOFTWARE AND FIRMWARE

The firmware installed in the EUT during testing was SONY, s_atp_1_00139_B_10_5.
The test utility software used during testing was Tera Term Ver 4.79.

5.5. WORST-CASE CONFIGURATION AND MODE

Radiated band edge, harmonics, and spurious emissions from 1 GHz to 18GHz were performed with the EUT was set to transmit at the Low/Middle/High channels.

Radiated emission below 30MHz, below 1GHz, above 18GHz, and power line conducted emission were performed with the EUT was set to transmit at the channel with highest output power as worst-case scenario.

The fundamental of the EUT was investigated in three orthogonal orientations X, Y, & Z, and it was determined that Y-Axis orientation was worst-case orientation; therefore, all final radiated testing was performed with the EUT in Y-Axis orientation.

Worst-case data rates were:

GFSK mode: DH5
8PSK mode: 3-DH5

DQPSK mode has been verified to have the lowest power.

5.6. DESCRIPTION OF TEST SETUP

SUPPORT EQUIPMENT

Support Equipment List				
Description	Manufacturer	Model	Serial Number	FCC ID
Laptop	Lenovo	20B7S0A200	PC015REW	NA
AC Adapter	SONY	1300-7137.1	4016W40310044	NA
Headphones	SONY	N/A	N/A	N/A

I/O CABLES (CONDUCTED TEST)

I/O Cable List						
Cable No	Port	# of identical ports	Connector Type	Cable Type	Cable Length (m)	Remarks
1	Antenna	1	RF	Shielded	0.2	To spectrum Analyzer
2	USB	1	USB	Shielded	1	N/A
3	DC	1	DC	Shielded	0.3	N/A

I/O CABLES (RADIATED AND CONDUCTED EMISSIONS)

I/O Cable List						
Cable No	Port	# of identical ports	Connector Type	Cable Type	Cable Length (m)	Remarks
1	USB	1	USB	Shielded	3	N/A
2	Audio	1	3.5mm	Shielded	1	N/A

TEST SETUP- CONDUCTED PORT

The EUT was tested connected to a host Laptop via USB cable adapter and spectrum analyzer to antenna port. Test software exercised the EUT.

SETUP DIAGRAM

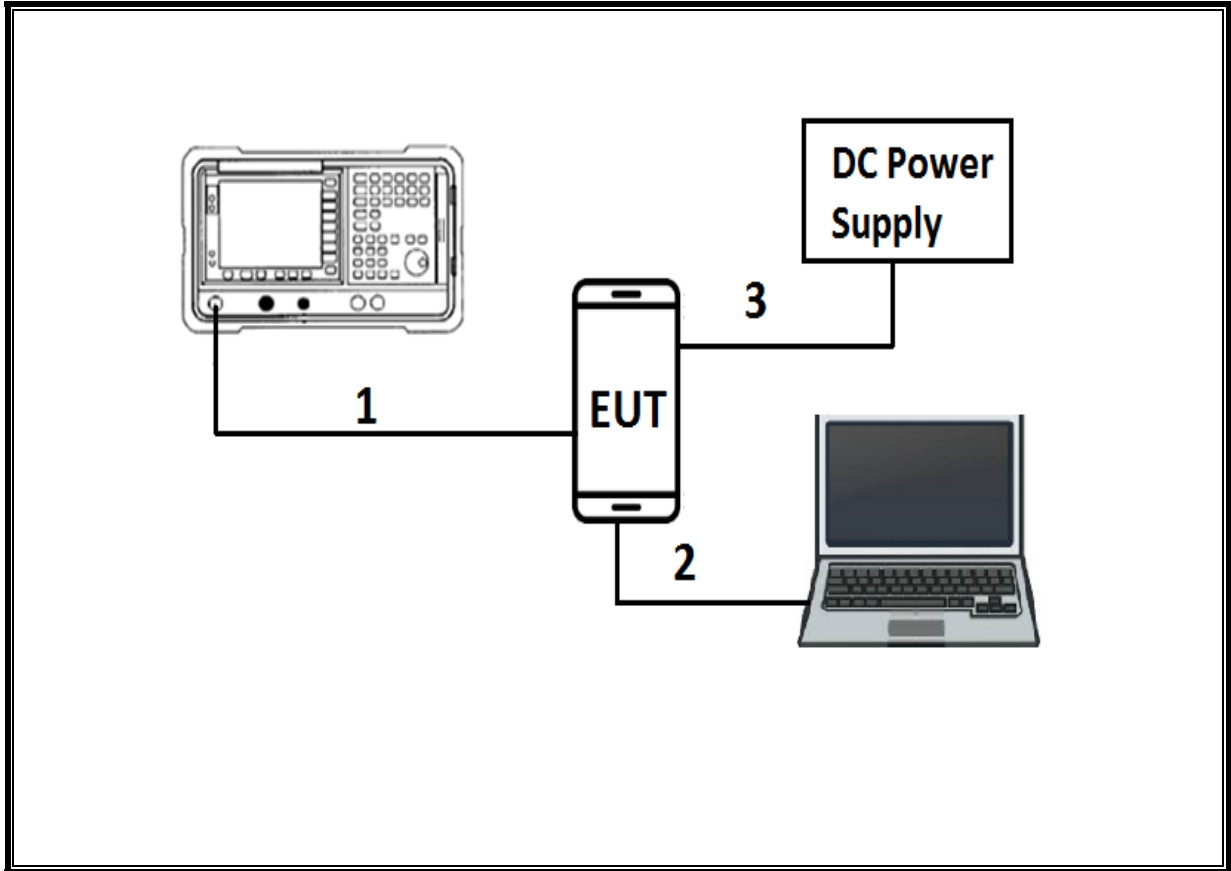

TEST SETUP- RADIATED-ABOVE 1 GHZ and AC LINE CONDUCTED TESTS

The EUT was powered by AC Adapter. Test software exercised the EUT.

SETUP DIAGRAM

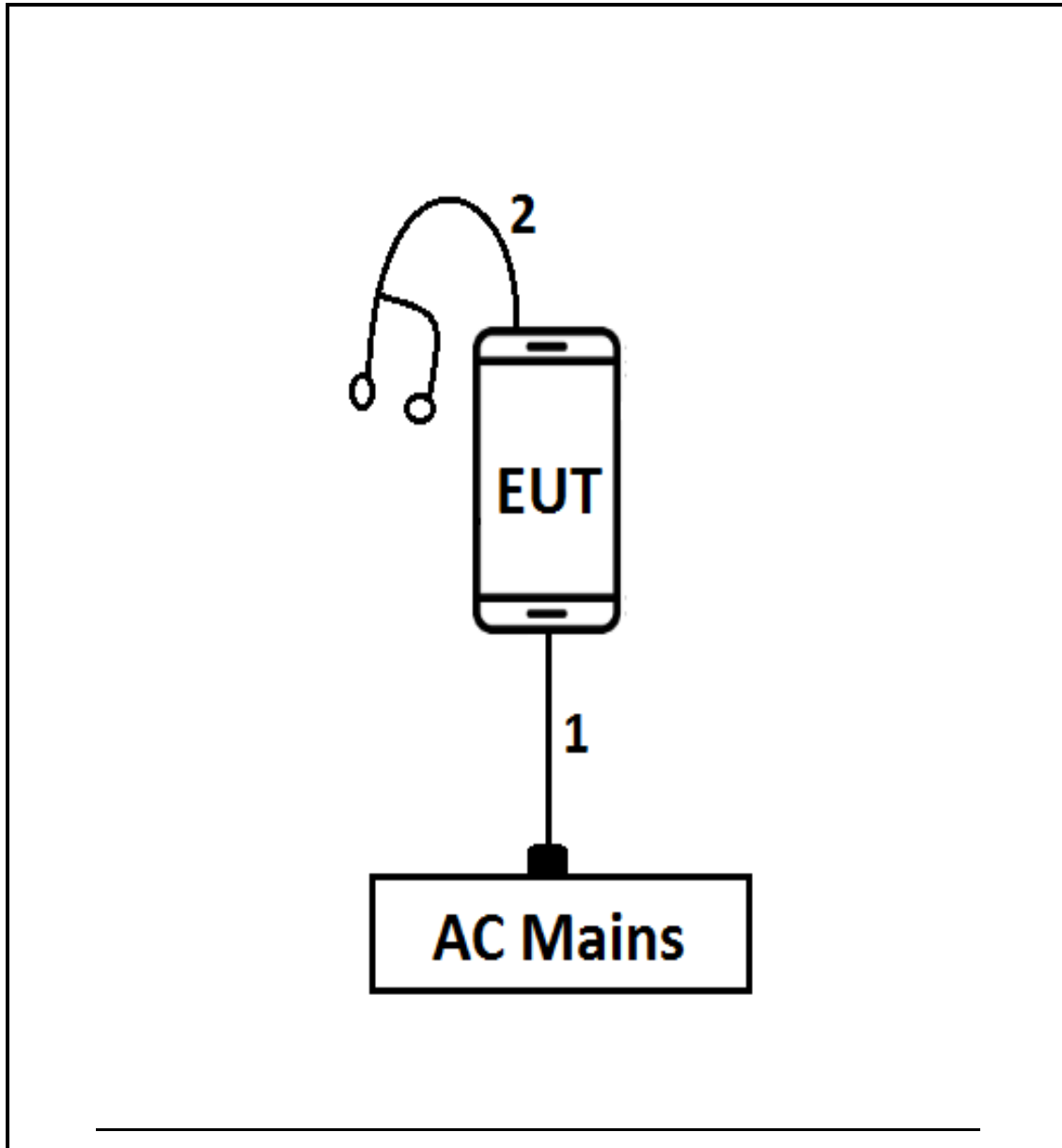

6. TEST AND MEASUREMENT EQUIPMENT

TEST EQUIPMENT LIST				
Description	Manufacturer	Model	Asset	Cal Due
Antenna, Broadband Hybrid, 30MHz to 2000MHz w/4dB Pad	Sunol Sciences Corp.	JB3	T477	06/22/2017
Antenna, Active Loop 9kHz-30MHz	ETS-Lindgren	6502	T1683	02/17/2018
Antenna, Horn 1-18GHz	ETS-Lindgren	3117	T345	03/07/2018
Antenna, Horn 18-26.5GHz	ARA	MWH-1826/B	T449	06/12/2018
Power Meter, P-series single channel	Agilent (Keysight) Technologies	N1911A	T1264	07/08/2017
Power Sensor, P – series, 50MHz to 18GHz, Wideband	Agilent (Keysight) Technologies	N1921A	T308	01/05/2018
Amplifier, 1-26.5GHz	Agilent (Keysight) Technologies	8449B	T404	07/05/2017
Amplifier, 10kHz-1GHz	Agilent (Keysight) Technologies	8447D	T15	08/26/2017
RF Amplifier	MITEQ	AFS42-00101800-25-S-42	T493	02/15/2018
Spectrum Analyzer, PSA, 3Hz to 26.5GHz	Agilent (Keysight) Technologies	E4440A	T199	07/22/2017
Spectrum Analyzer, PXA, 3Hz to 44GHz	Agilent (Keysight) Technologies	N9030A	T907	01/23/2018
Spectrum Analyzer, PSA, 3Hz to 26.5GHz	Agilent (Keysight) Technologies	E9030A	T905	01/11/2018
LISN	FISCHER	FCC-LISN-50/250-25-2-01	T1310	01/17/2018

Test Software List			
Description	Manufacturer	Model	Version
Radiated Software	UL	UL EMC	Ver 9.5, Apr 26, 2016
Conducted Software	UL	UL EMC	Ver 9.5, May 26, 2015
Antenna Port Software	UL	UL RF	Ver 5.1.1, July 15, 2016

7. ANTENNA PORT TEST RESULTS

ON TIME AND DUTY CYCLE

LIMITS

None; for reporting purposes only.

PROCEDURE

KDB 558074 Zero-Span Spectrum Analyzer Method.

ON TIME AND DUTY CYCLE RESULTS

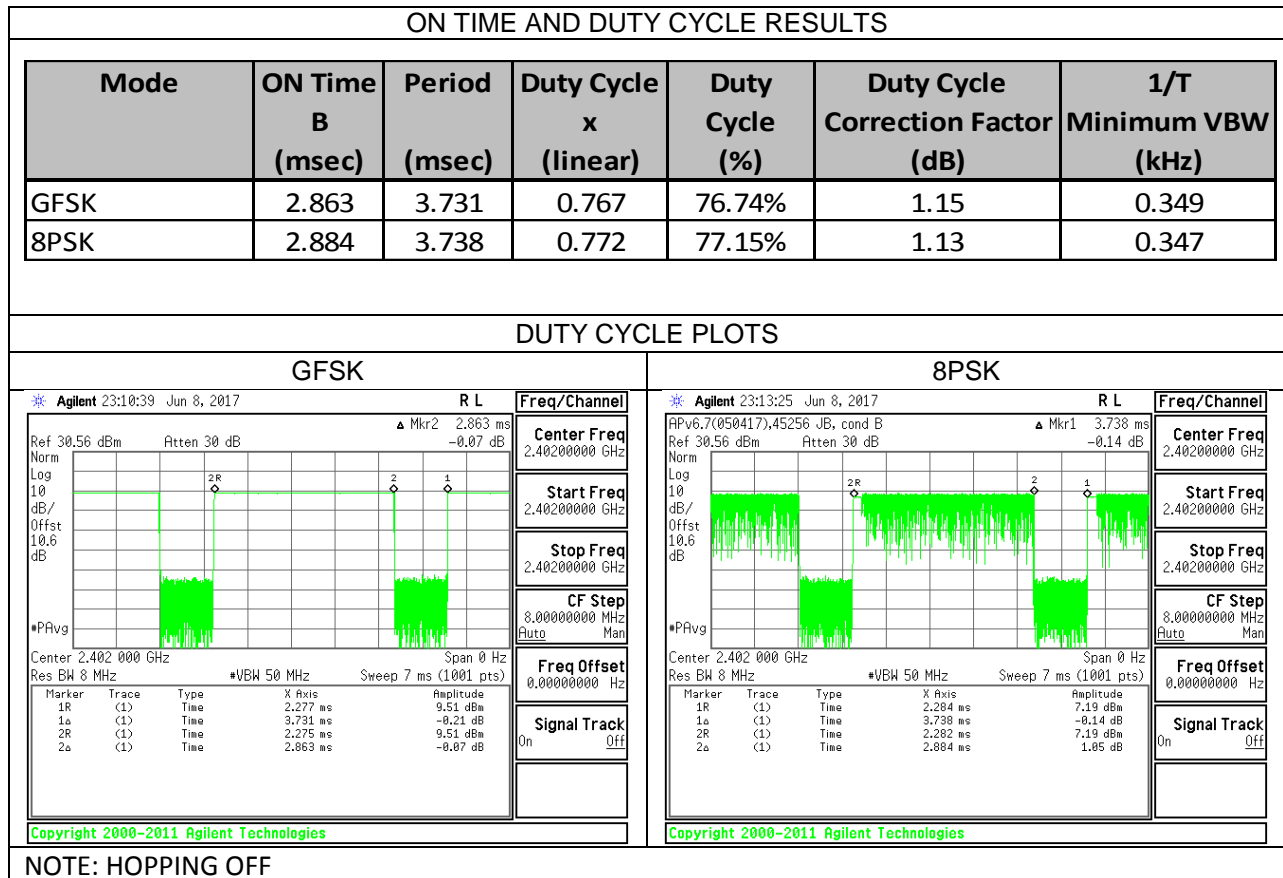

7.1. BASIC DATA RATE GFSK MODULATION

7.1.1. 20 dB AND 99% BANDWIDTH

LIMITS

None; for reporting purposes only.

TEST PROCEDURE

The transmitter output is connected to a spectrum analyzer. The RBW is set to $\geq 1\%$ of the 20 dB bandwidth. The VBW is set to \geq RBW. The sweep time is coupled.

RESULTS

Channel	Frequency (MHz)	20 dB Bandwidth (KHz)	99% Bandwidth (KHz)
Low	2402	864.23	865.02
Middle	2441	855.77	857.40
High	2480	869.55	856.83

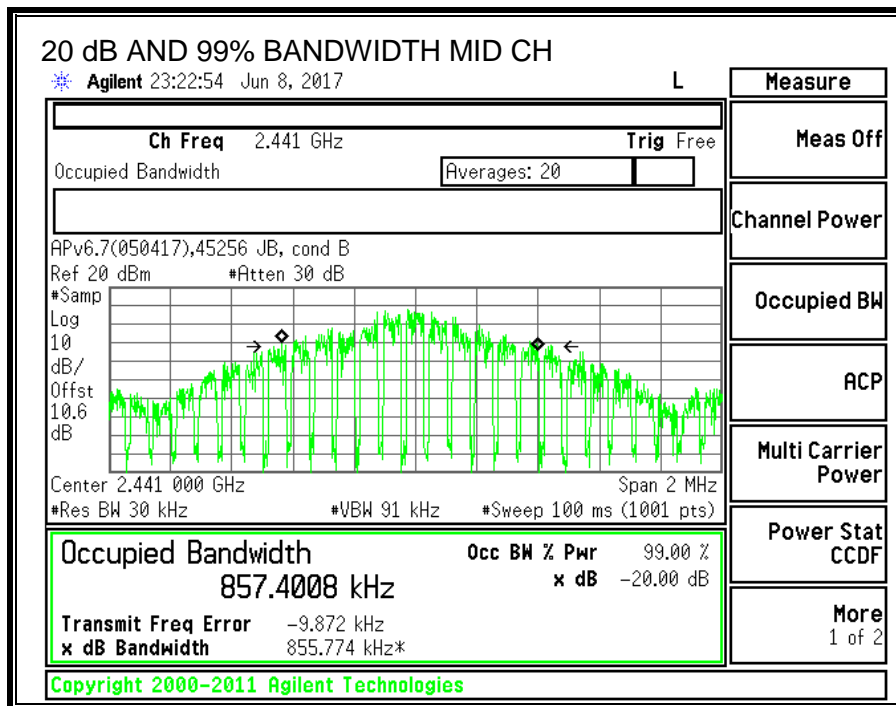
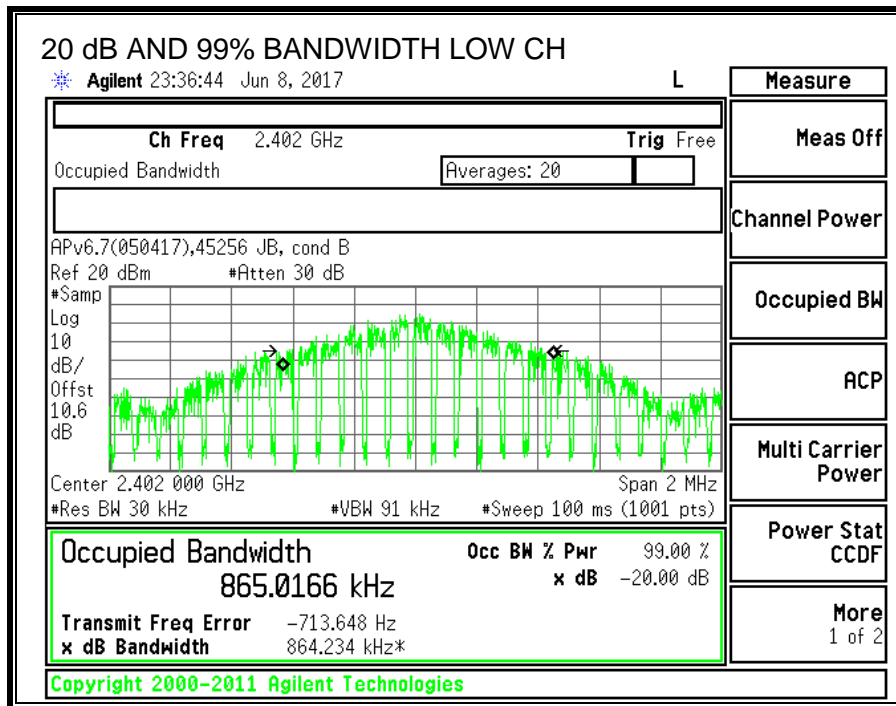

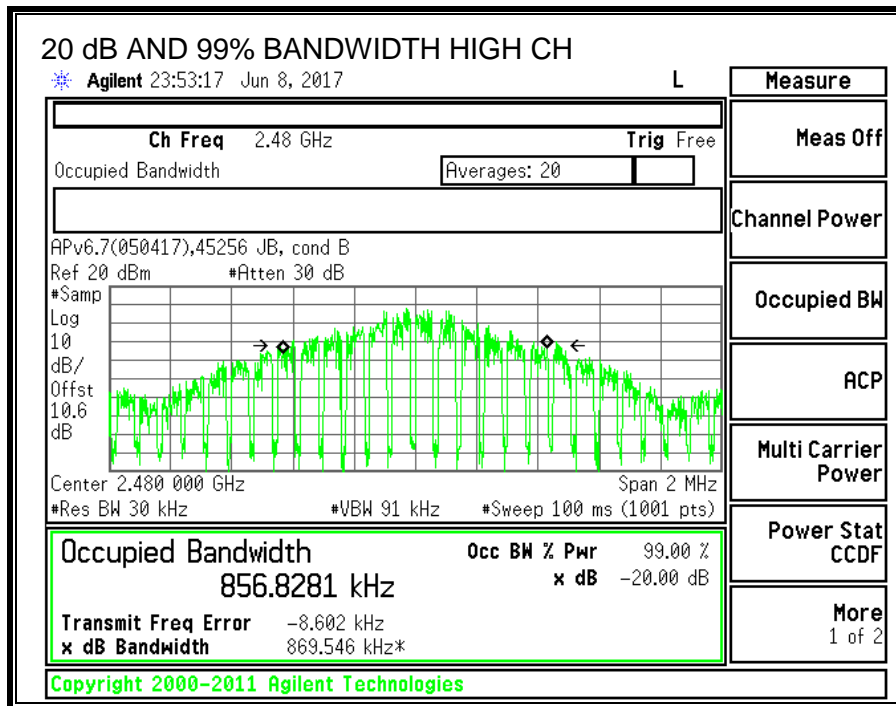

7.1.2. HOPPING FREQUENCY SEPARATION

LIMITS

FCC §15.247 (a) (1)

Frequency hopping systems shall have hopping channel carrier frequencies separated by a minimum of 25 kHz or the 20 dB bandwidth of the hopping channel, whichever is greater.

Alternatively, frequency hopping systems operating in the 2400-2483.5 MHz band may have hopping channel carrier frequencies that are separated by 25 kHz or two-thirds of the 20 dB bandwidth of the hopping channel, whichever is greater, provided the systems operate with an output power no greater than 125 mW.

TEST PROCEDURE

The transmitter output is connected to a spectrum analyzer. The RBW is set to 300 kHz and the VBW is set to 910 kHz. The sweep time is coupled.

RESULTS

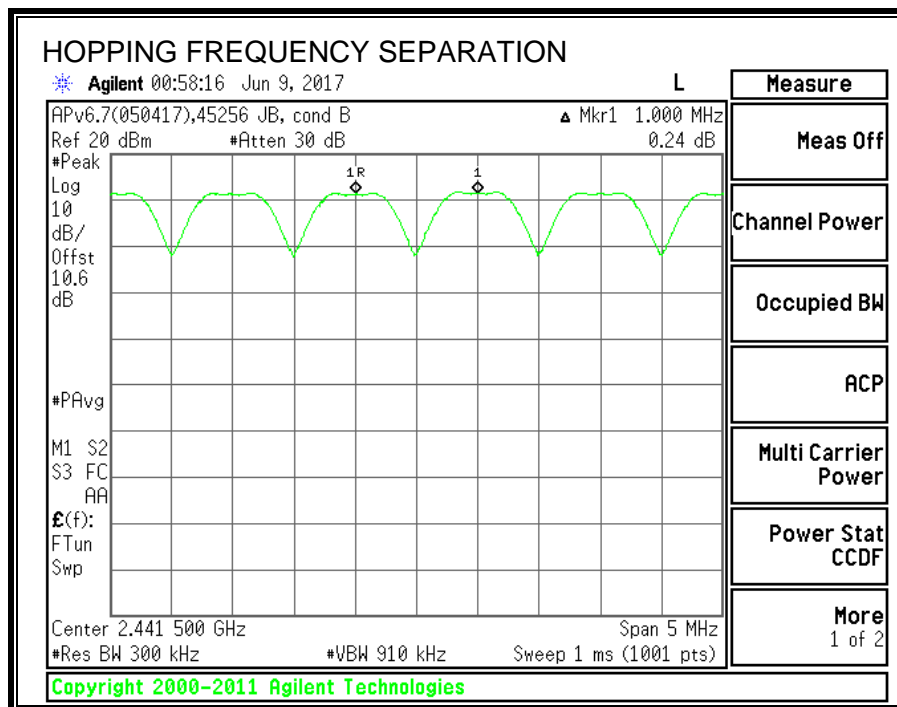

7.1.3. NUMBER OF HOPPING CHANNELS

LIMITS

FCC §15.247 (a) (1) (iii)

Frequency hopping systems in the 2400 – 2483.5 MHz band shall use at least 15 non-overlapping channels.

TEST PROCEDURE

The transmitter output is connected to a spectrum analyzer. The span is set to cover the entire authorized band, in either a single sweep or in multiple contiguous sweeps. The RBW is set to a maximum of 1 % of the span. The analyzer is set to Max Hold.

RESULTS

Normal Mode: 79 Channels observed.

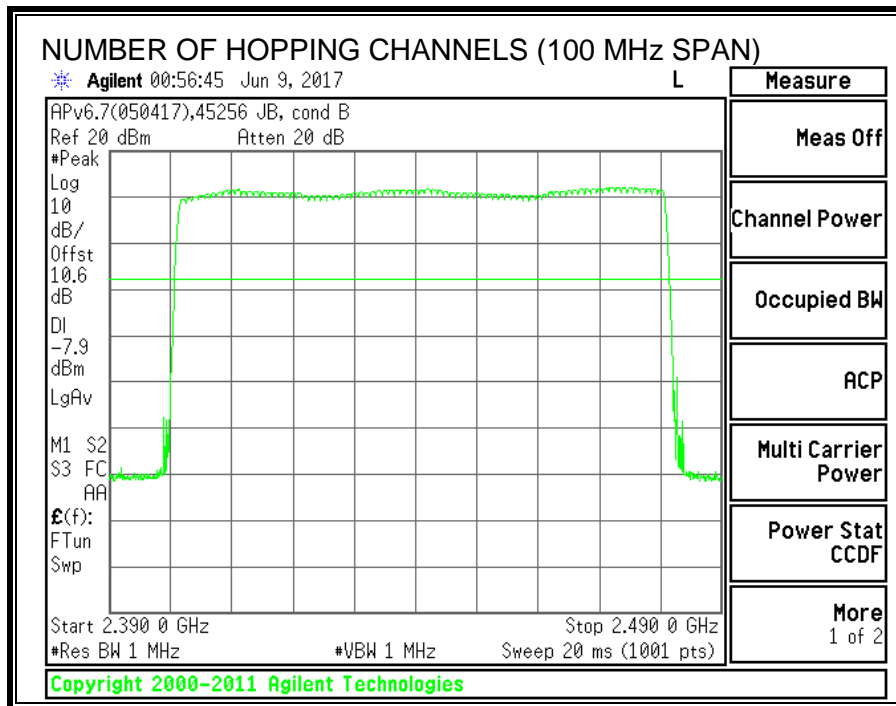

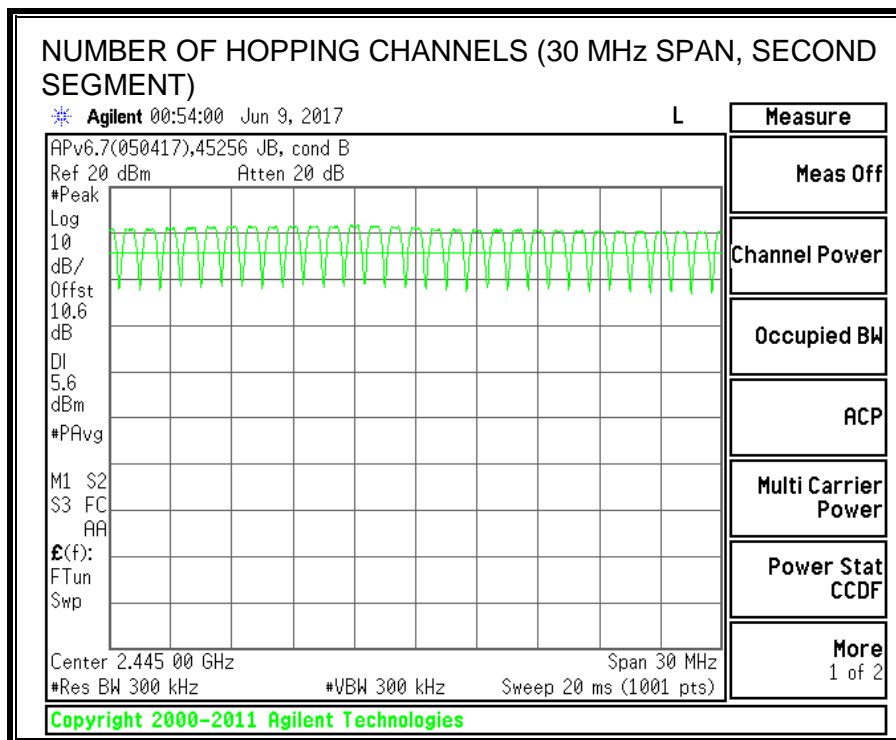
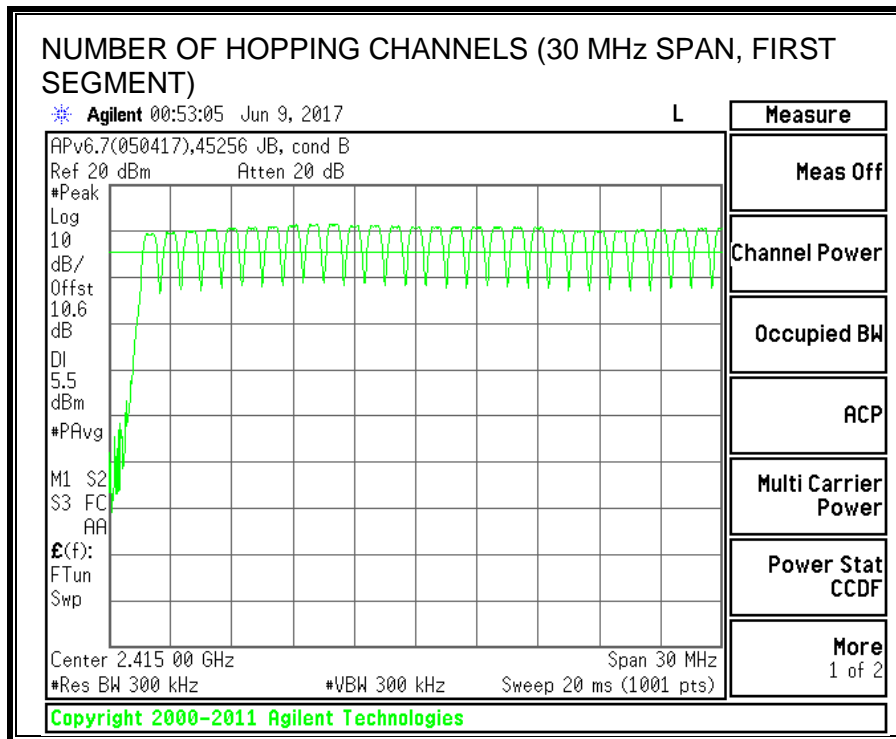

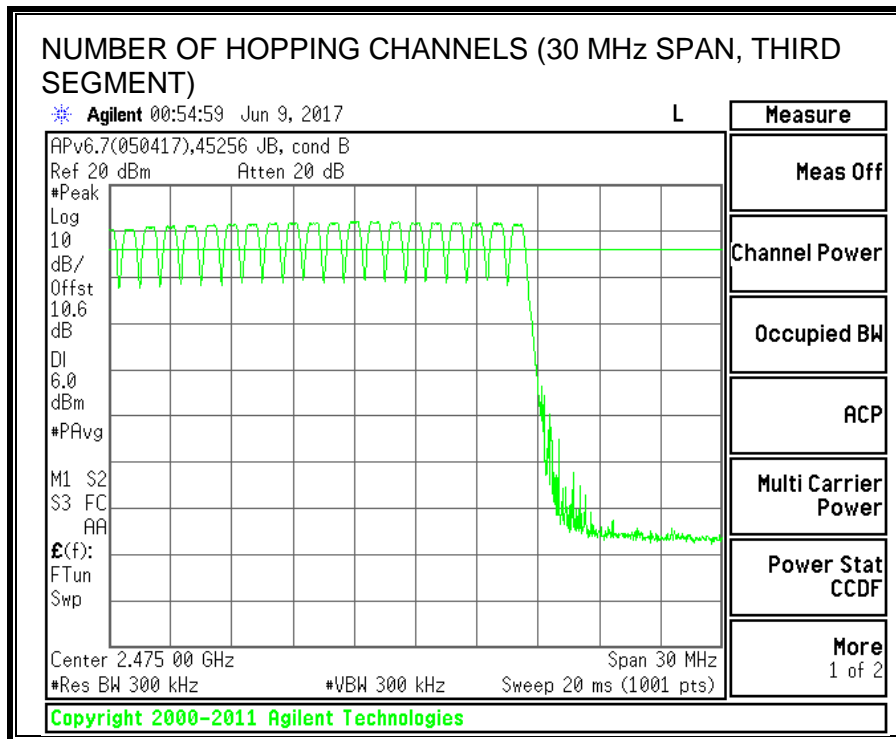

7.1.4. AVERAGE TIME OF OCCUPANCY

LIMITS

FCC §15.247 (a) (1) (iii)

The average time of occupancy on any channel shall not be greater than 0.4 seconds within a period of 0.4 seconds multiplied by the number of hopping channels employed.

TEST PROCEDURE

The transmitter output is connected to a spectrum analyzer. The span is set to 0 Hz, centered on a single, selected hopping channel. The width of a single pulse is measured in a fast scan. The number of pulses is measured in a 3.16 second scan, to enable resolution of each occurrence.

The average time of occupancy in the specified 31.6 second period (79 channels * 0.4 s) is equal to $10 * (\# \text{ of pulses in } 3.16 \text{ s}) * \text{ pulse width}$.

For AFH mode, the average time of occupancy in the specified 8 second period (20 channels * 0.4 seconds) is equal to $10 * (\# \text{ of pulses in } 0.8 \text{ s}) * \text{ pulse width}$.

RESULTS

AVERAGE TIME OF OCCUPANCY					
DH Packet	Pulse Width (msec)	Number of Pulses in 3.16 seconds	Average Time of Occupancy (sec)	Limit (sec)	Margin (sec)
GFSK Normal Mode					
DH1	0.383	29	0.1110	0.4	-0.2890
DH3	1.638	15	0.2457	0.4	-0.1543
DH5	2.886	5	0.1443	0.4	-0.2557
DH Packet	Pulse Width (sec)	Number of Pulses in 0.8 seconds	Average Time of Occupancy (sec)	Limit (sec)	Margin (sec)
GFSK AFH Mode					
DH1	0.383	7.25	0.02776	0.4	-0.3722
DH3	1.638	3.75	0.06143	0.4	-0.3386
DH5	2.886	1.25	0.03608	0.4	-0.3639
NOTE: --					

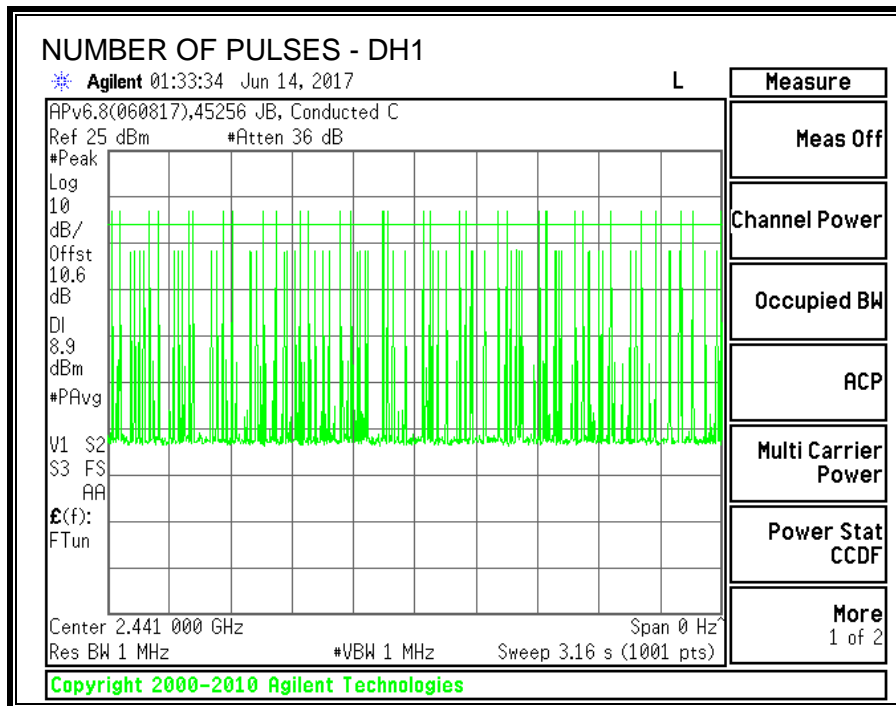
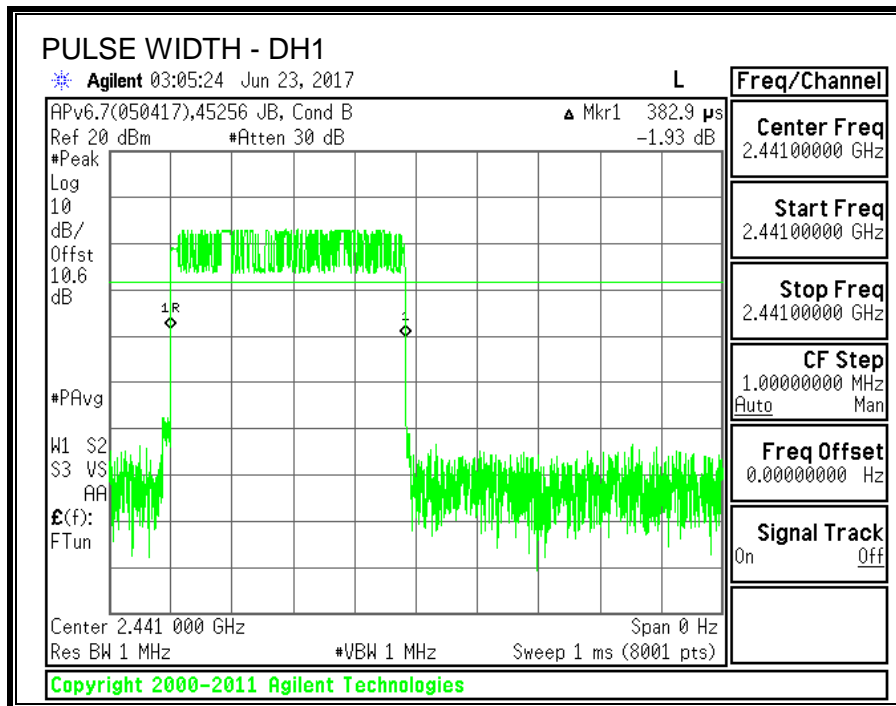

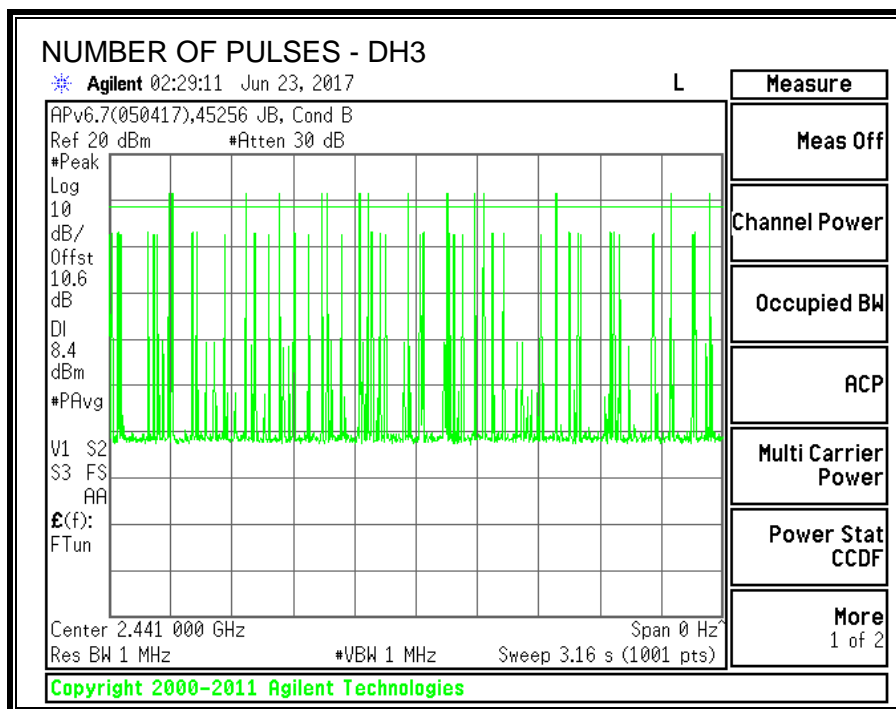
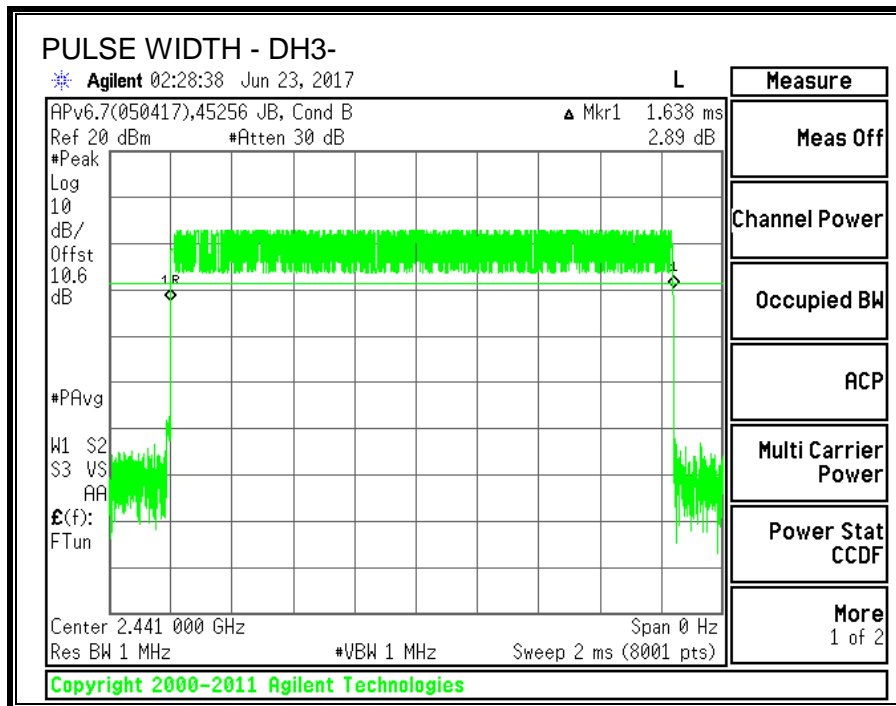

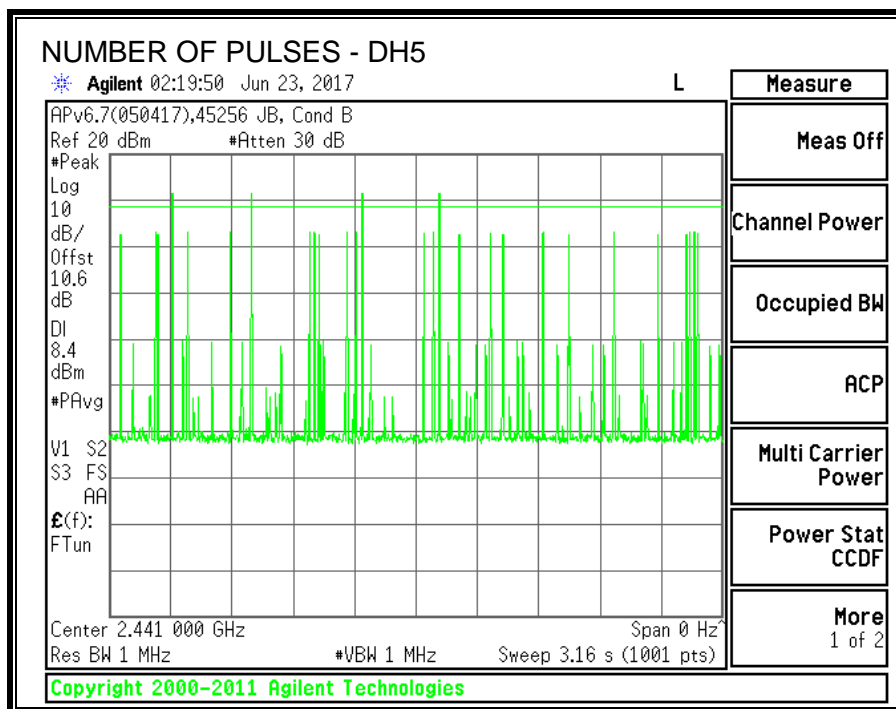
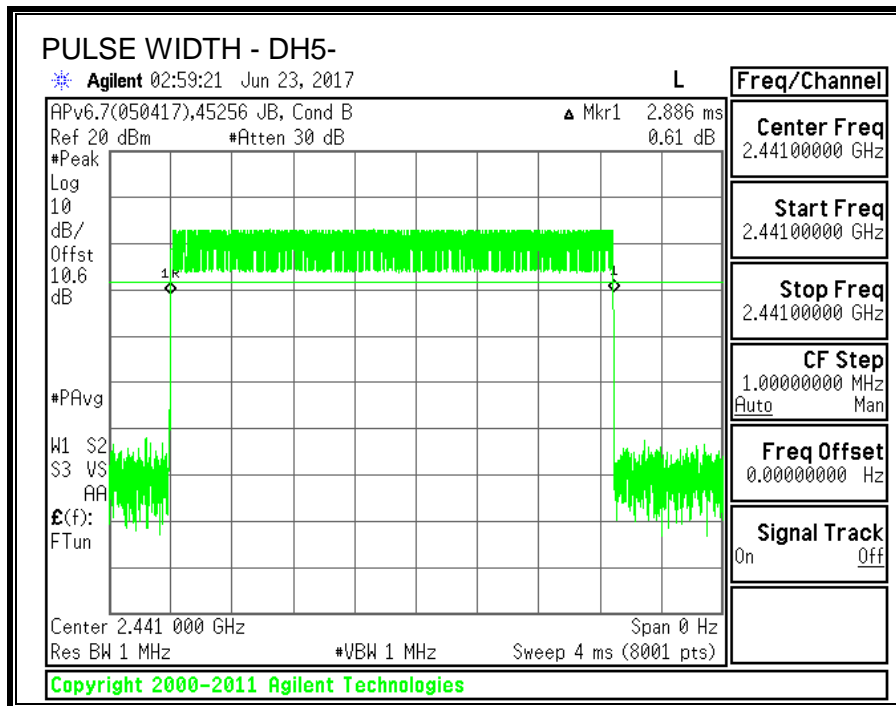

7.1.5. OUTPUT POWER

LIMITS

§15.247 (b) (1)

The maximum antenna gain is less than 6 dBi, therefore the limit is 30 dBm.

TEST PROCEDURE

The transmitter output is connected to a spectrum analyzer.

RESULTS

TEST ENGINEER:	45256	Date:	6/14/2017
-----------------------	-------	--------------	-----------

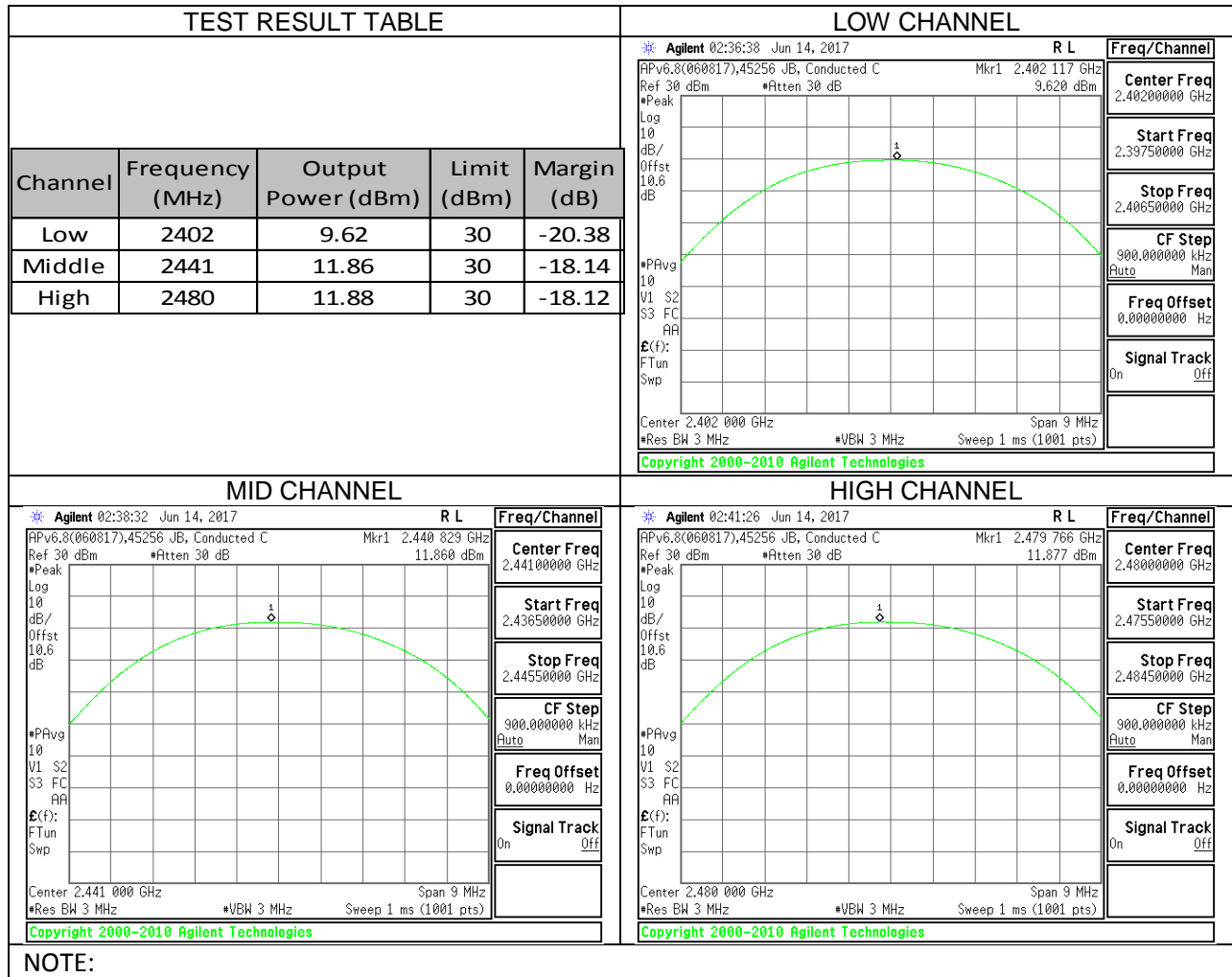

7.1.6. AVERAGE POWER

LIMITS

None; for reporting purposes only.

TEST PROCEDURE

The transmitter output is connected to a power meter.

RESULTS

The cable assembly insertion loss of 11 dB (including 10 dB pad and 1 dB cable) was entered as an offset in the power meter to allow for direct reading of power.

TEST ENGINEER:	39703	Date:	6/8/2017
-----------------------	-------	--------------	----------

Channel	Frequency (MHz)	Average Power (dBm)
Low	2402	9.21
Middle	2441	11.37
High	2480	11.44

7.1.7. CONDUCTED BANDEDGE AND SPURIOUS EMISSIONS

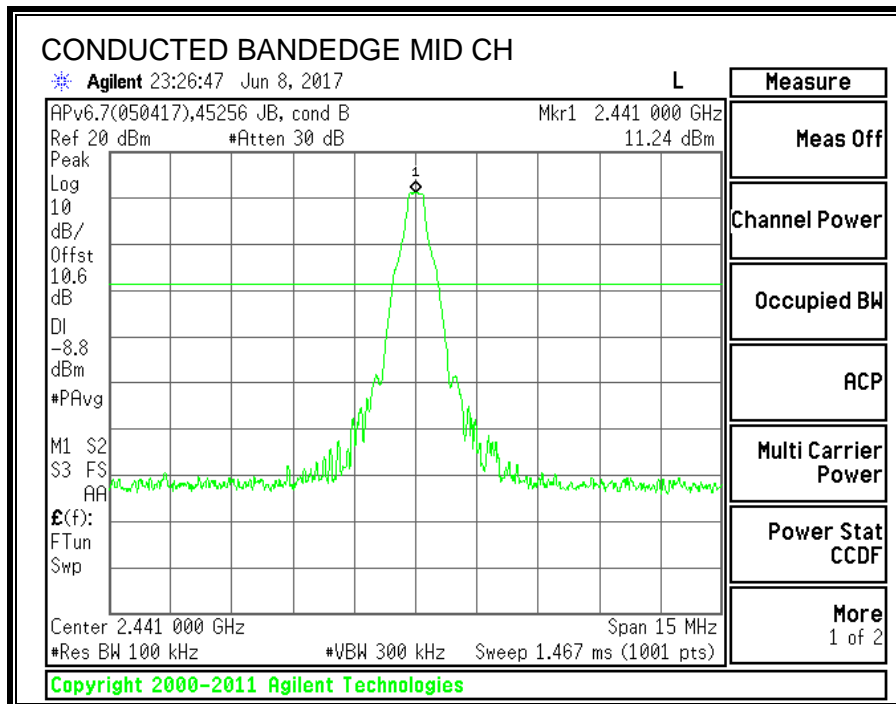
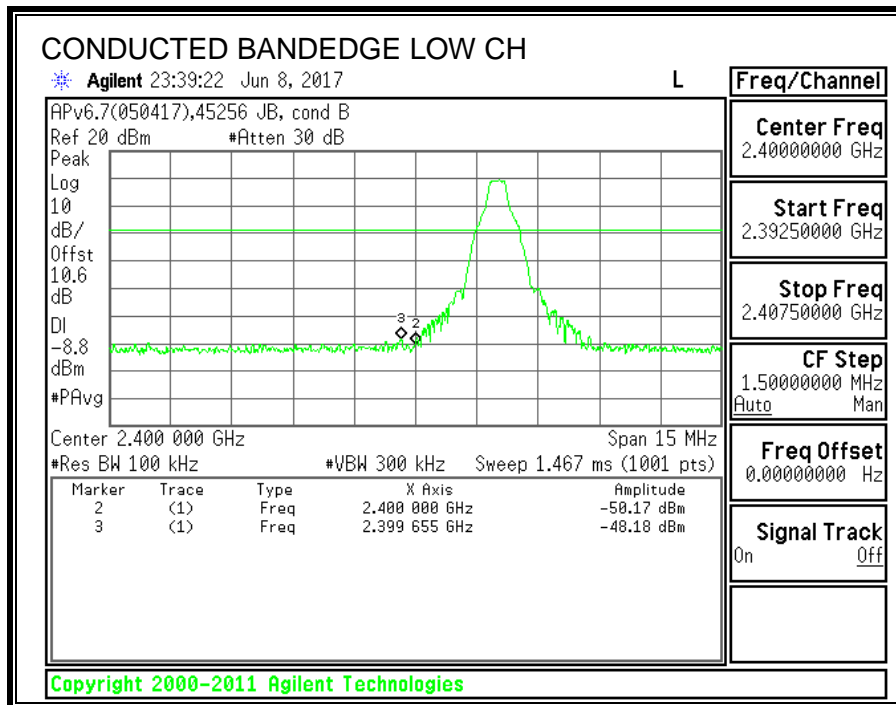

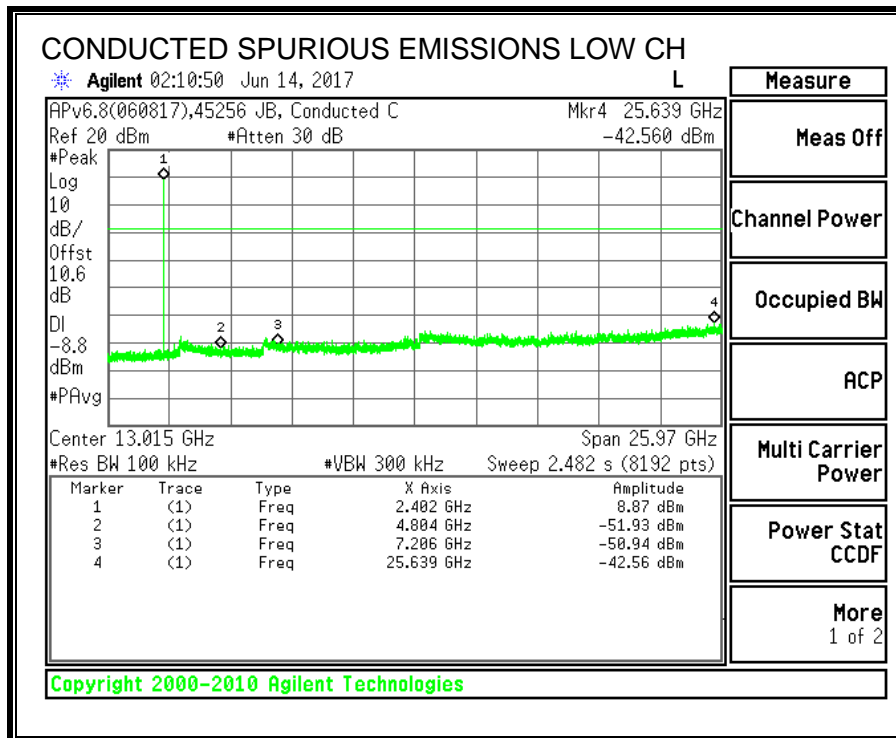
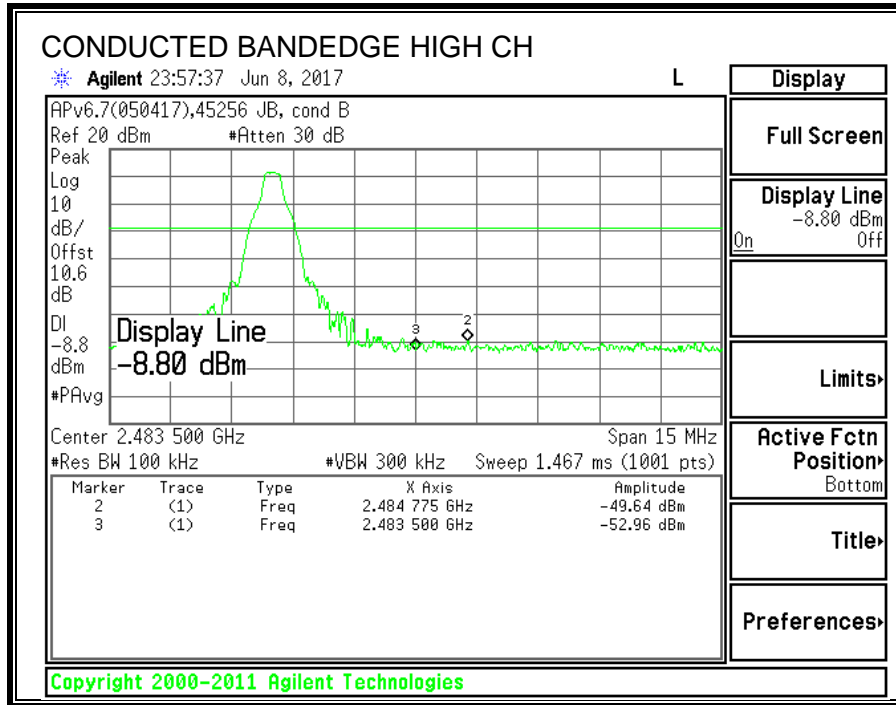

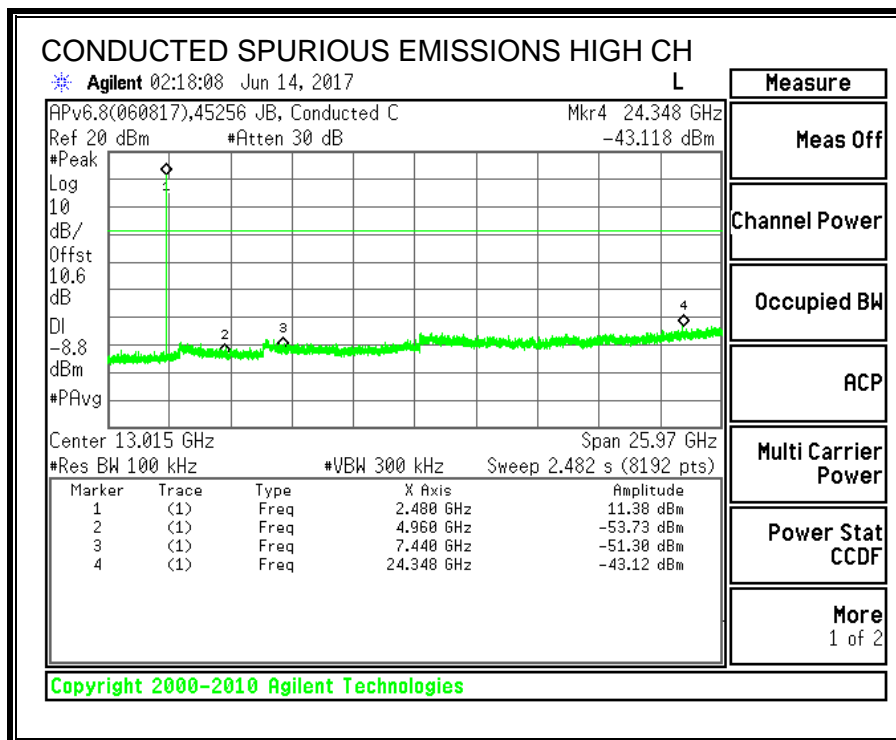
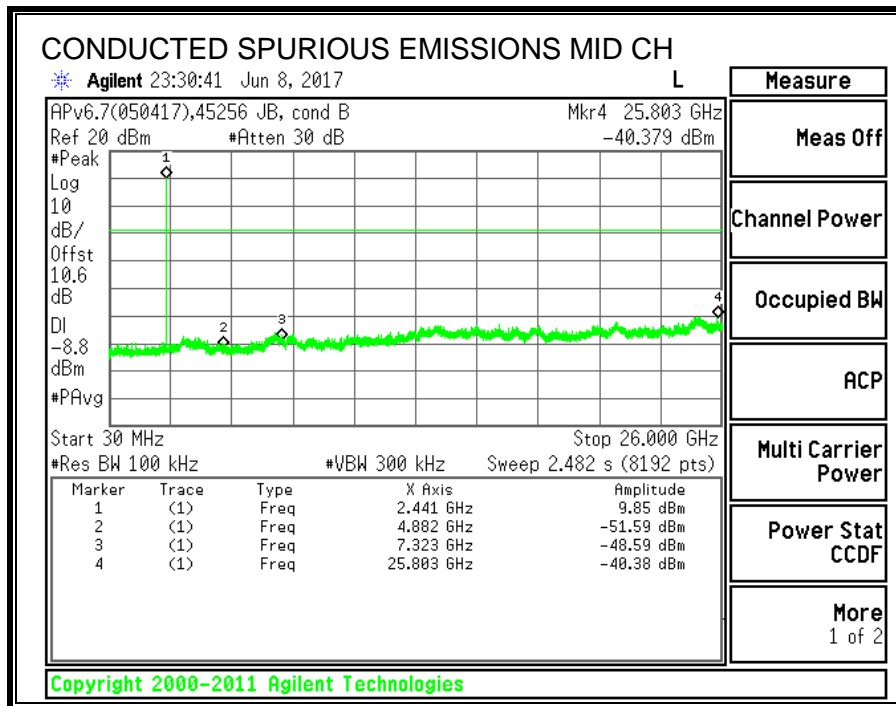

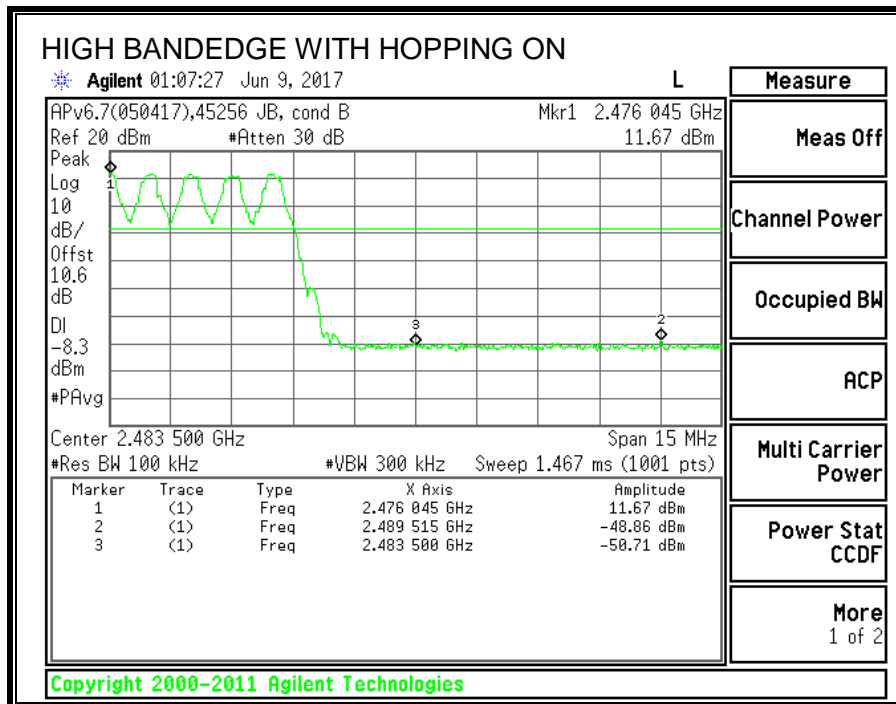
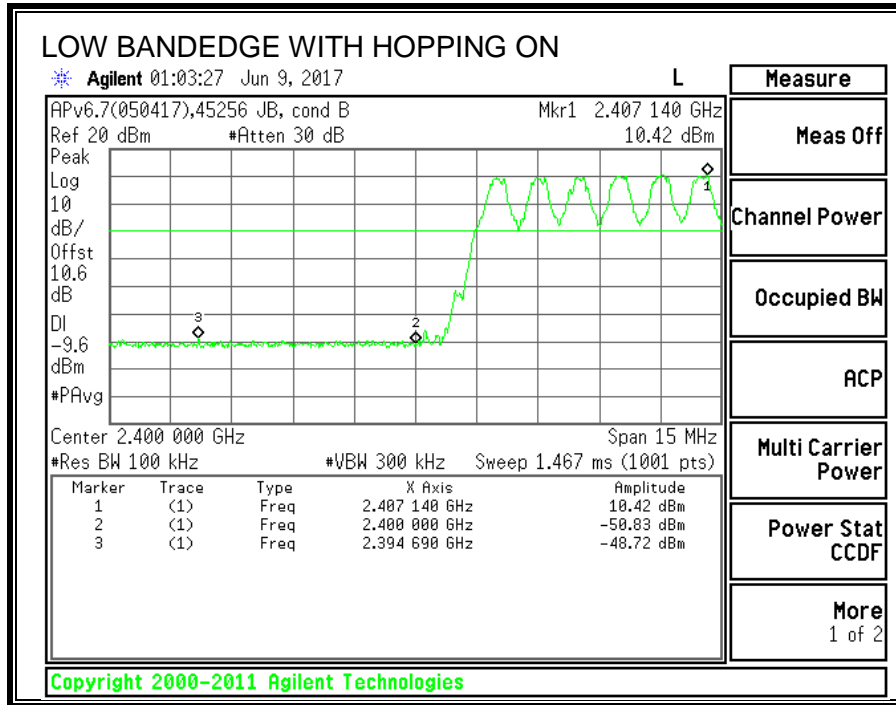

7.2. ENHANCED DATA RATE 8PSK MODULATION

7.2.1. 20 dB AND 99% BANDWIDTH

LIMITS

None; for reporting purposes only.

TEST PROCEDURE

The transmitter output is connected to a spectrum analyzer. The RBW is set to $\geq 1\%$ of the 20 dB bandwidth. The VBW is set to \geq RBW. The sweep time is coupled.

RESULTS

Channel	Frequency (MHz)	20 dB Bandwidth (MHz)	99% Bandwidth (MHz)
Low	2402	1.282	1.191
Middle	2441	1.293	1.185
High	2480	1.292	1.197

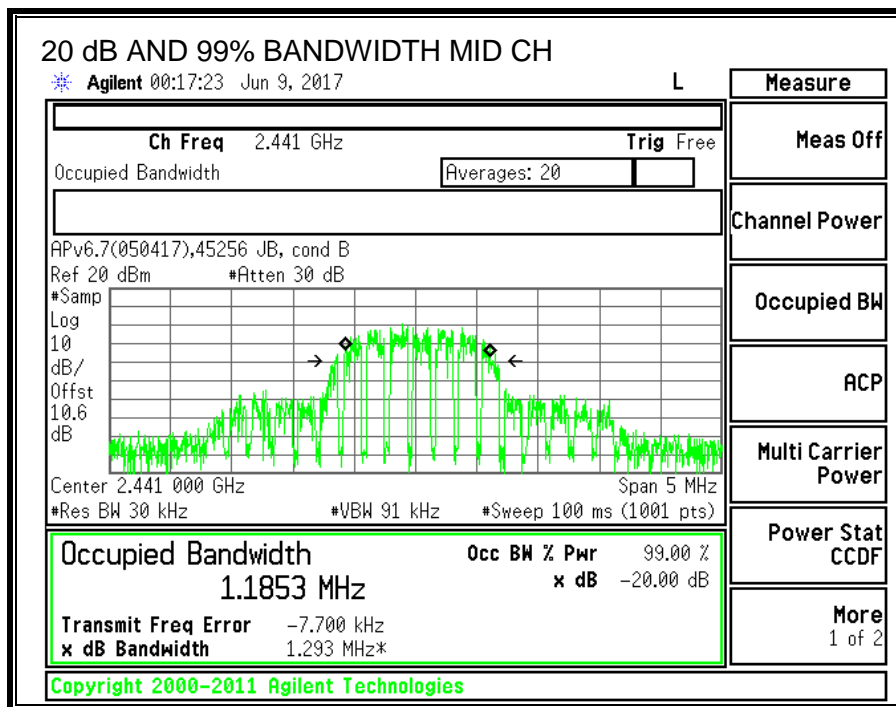
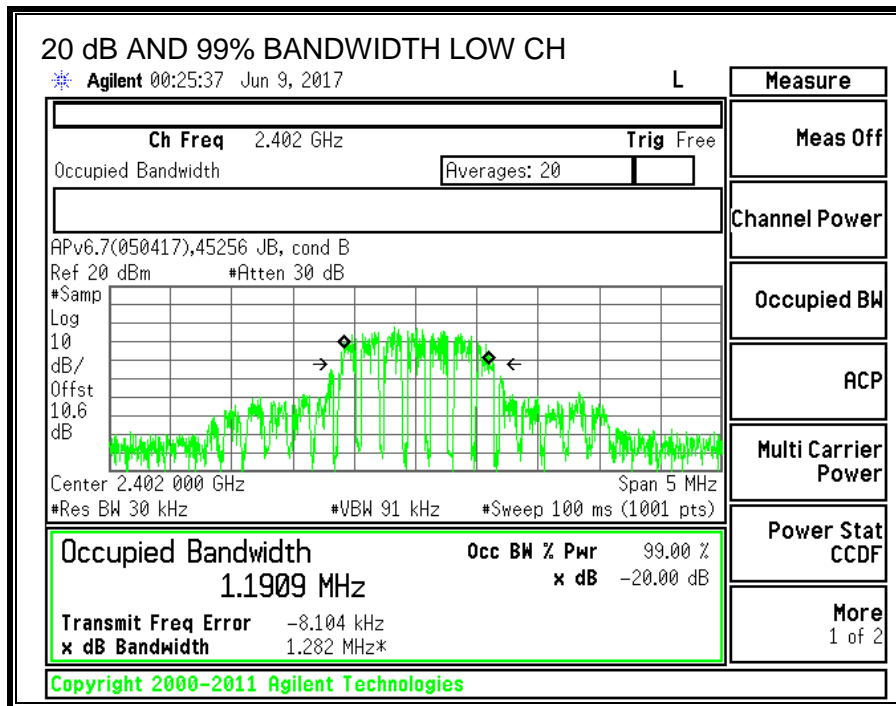

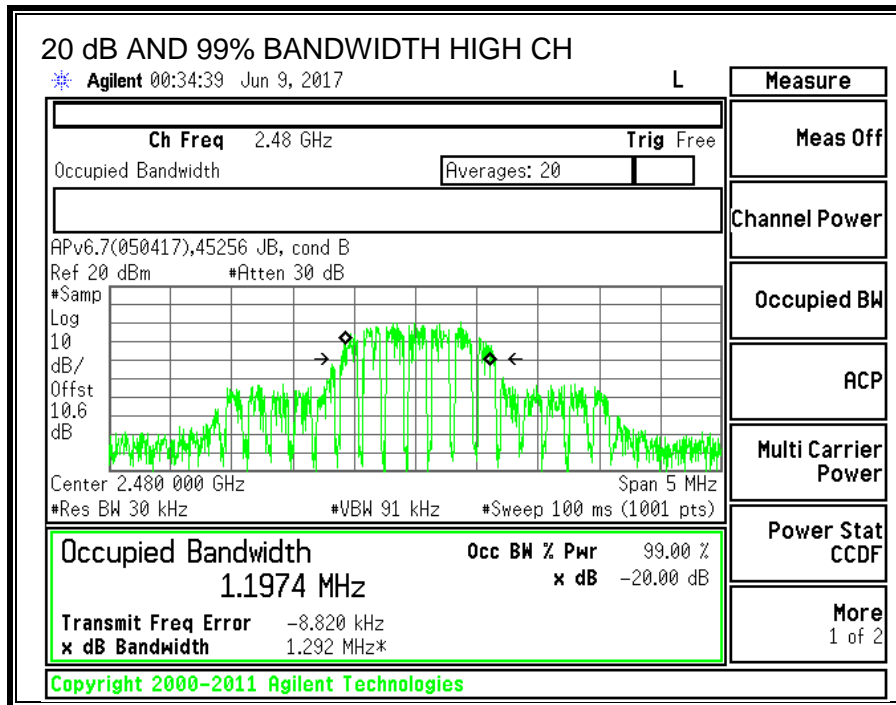

7.2.2. HOPPING FREQUENCY SEPARATION

LIMITS

FCC §15.247 (a) (1)

Frequency hopping systems shall have hopping channel carrier frequencies separated by a minimum of 25 kHz or the 20 dB bandwidth of the hopping channel, whichever is greater.

Alternatively, frequency hopping systems operating in the 2400-2483.5 MHz band may have hopping channel carrier frequencies that are separated by 25 kHz or two-thirds of the 20 dB bandwidth of the hopping channel, whichever is greater, provided the systems operate with an output power no greater than 125 mW.

TEST PROCEDURE

The transmitter output is connected to a spectrum analyzer. The RBW is set to 300 kHz and the VBW is set to 910 kHz. The sweep time is coupled.

RESULTS

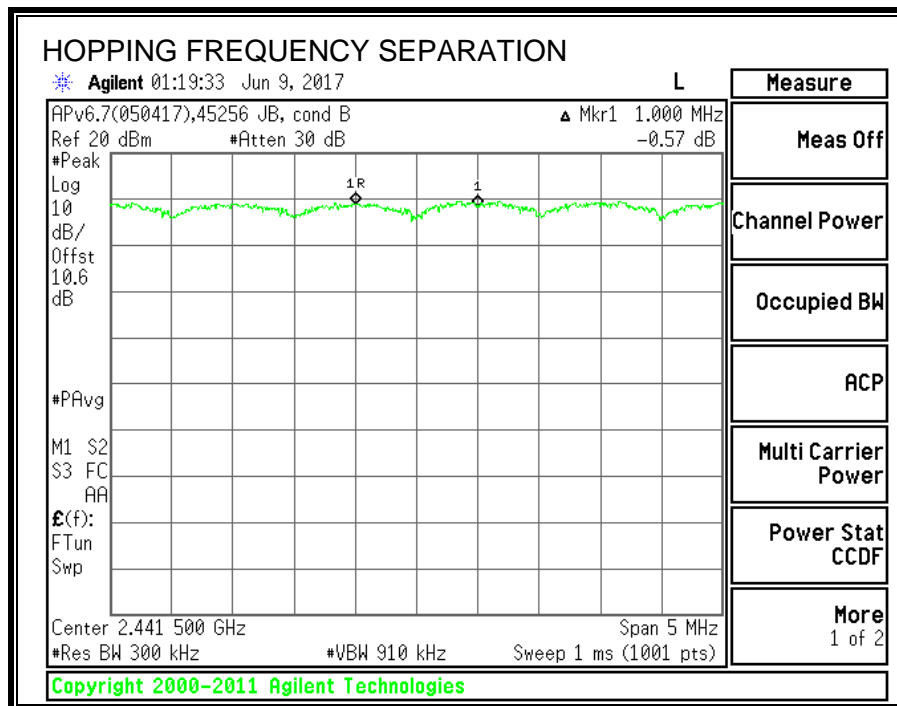

7.2.3. NUMBER OF HOPPING CHANNELS

LIMITS

FCC §15.247 (a) (1) (iii)

Frequency hopping systems in the 2400 – 2483.5 MHz band shall use at least 15 non-overlapping channels.

TEST PROCEDURE

The transmitter output is connected to a spectrum analyzer. The span is set to cover the entire authorized band, in either a single sweep or in multiple contiguous sweeps. The RBW is set to a maximum of 1 % of the span. The analyzer is set to Max Hold.

RESULTS

Normal Mode: 79 Channels observed.

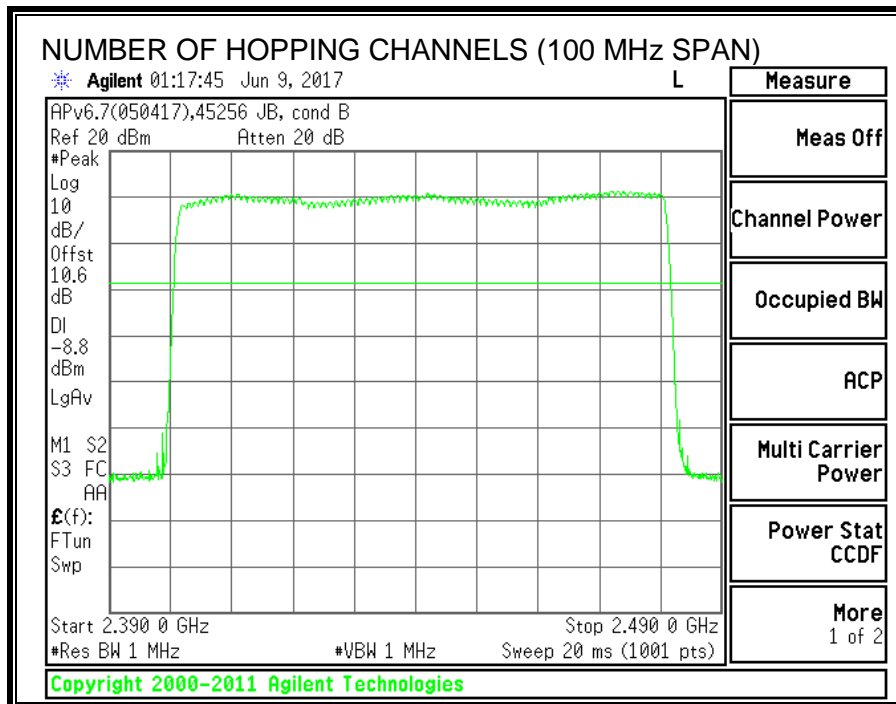

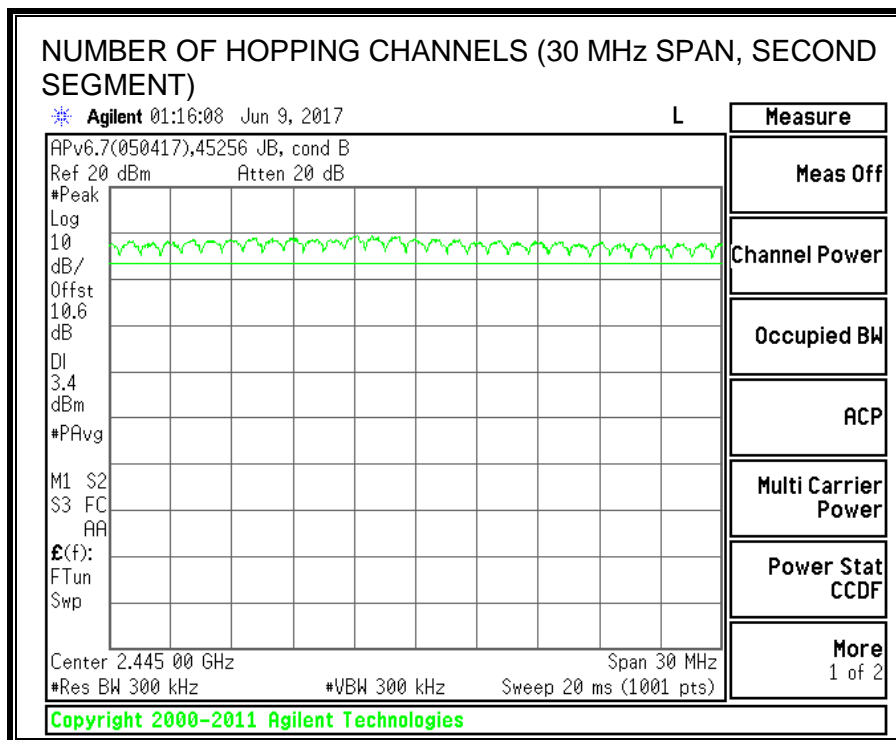
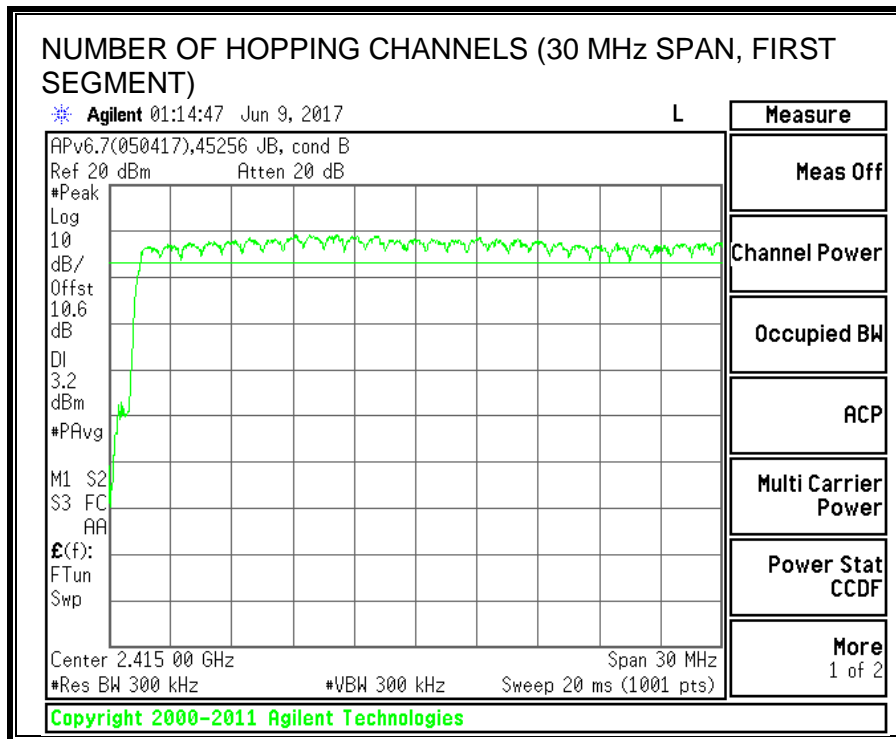

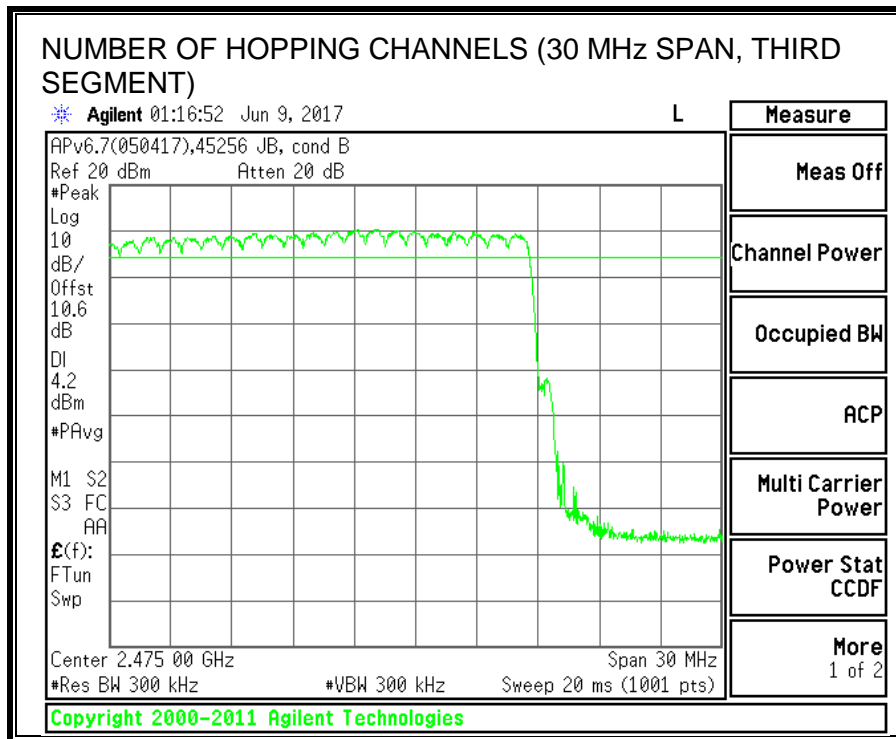

7.2.4. AVERAGE TIME OF OCCUPANCY

LIMITS

FCC §15.247 (a) (1) (iii)

The average time of occupancy on any channel shall not be greater than 0.4 seconds within a period of 0.4 seconds multiplied by the number of hopping channels employed.

TEST PROCEDURE

The transmitter output is connected to a spectrum analyzer. The span is set to 0 Hz, centered on a single, selected hopping channel. The width of a single pulse is measured in a fast scan. The number of pulses is measured in a 3.16 second scan, to enable resolution of each occurrence.

The average time of occupancy in the specified 31.6 second period (79 channels * 0.4 s) is equal to $10 * (\# \text{ of pulses in } 3.16 \text{ s}) * \text{ pulse width}$.

For AFH mode, the average time of occupancy in the specified 8 second period (20 channels * 0.4 seconds) is equal to $10 * (\# \text{ of pulses in } 0.8 \text{ s}) * \text{ pulse width}$.

RESULTS

AVERAGE TIME OF OCCUPANCY					
DH Packet	Pulse Width (msec)	Number of Pulses in 3.16 seconds	Average Time of Occupancy (sec)	Limit (sec)	Margin (sec)
GFSK Normal Mode					
DH1	0.389	31	0.1206	0.4	-0.2794
DH3	1.640	16	0.2624	0.4	-0.1376
DH5	2.889	13	0.3756	0.4	-0.0244
DH Packet	Pulse Width (sec)	Number of Pulses in 0.8 seconds	Average Time of Occupancy (sec)	Limit (sec)	Margin (sec)
GFSK AFH Mode					
DH1	0.389	7.75	0.03014	0.4	-0.3699
DH3	1.640	4	0.06560	0.4	-0.3344
DH5	2.889	3.25	0.09389	0.4	-0.3061
NOTE: --					

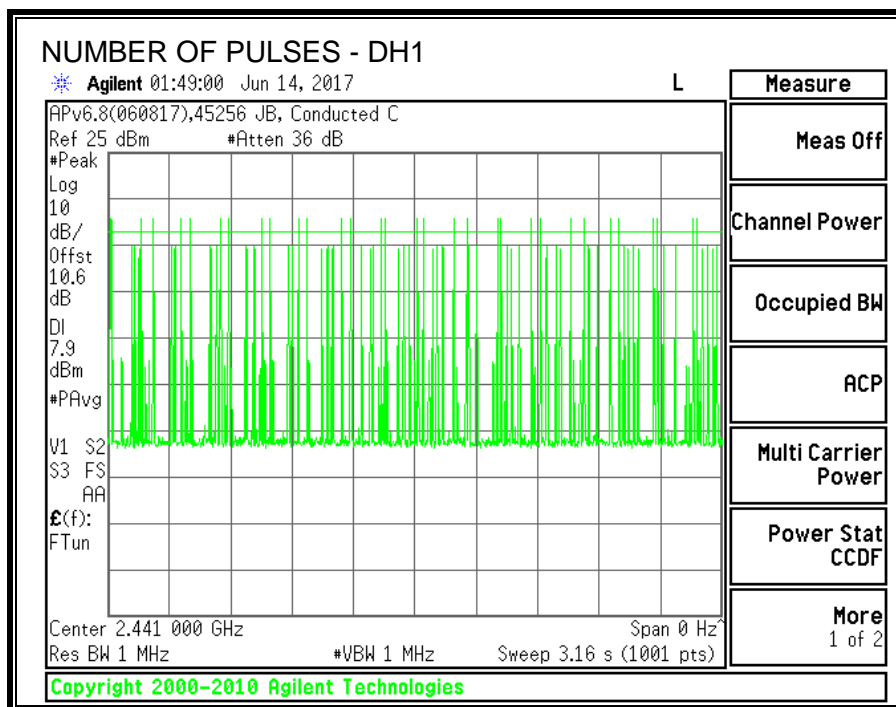
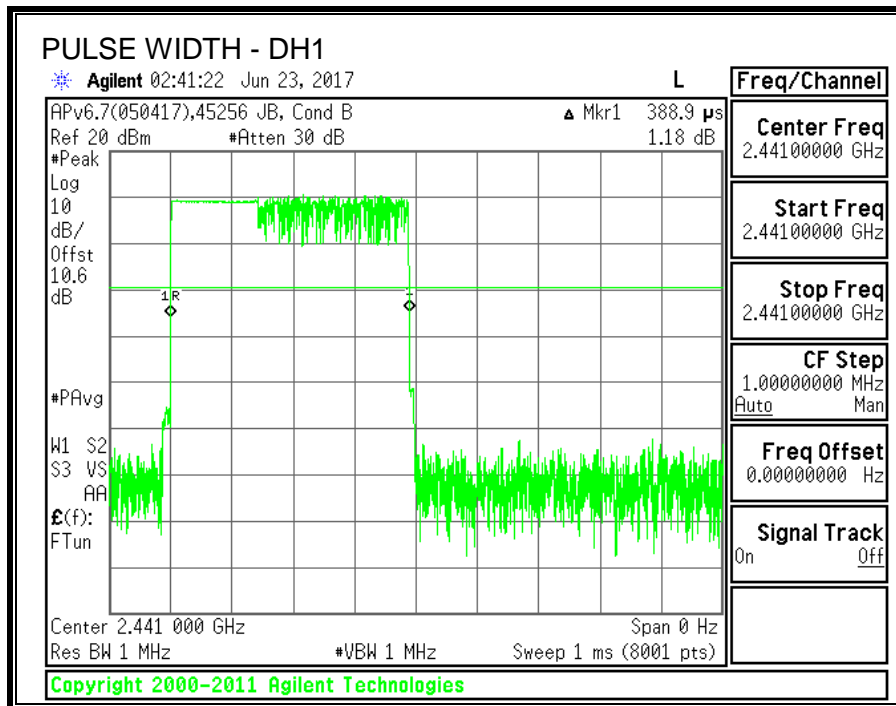

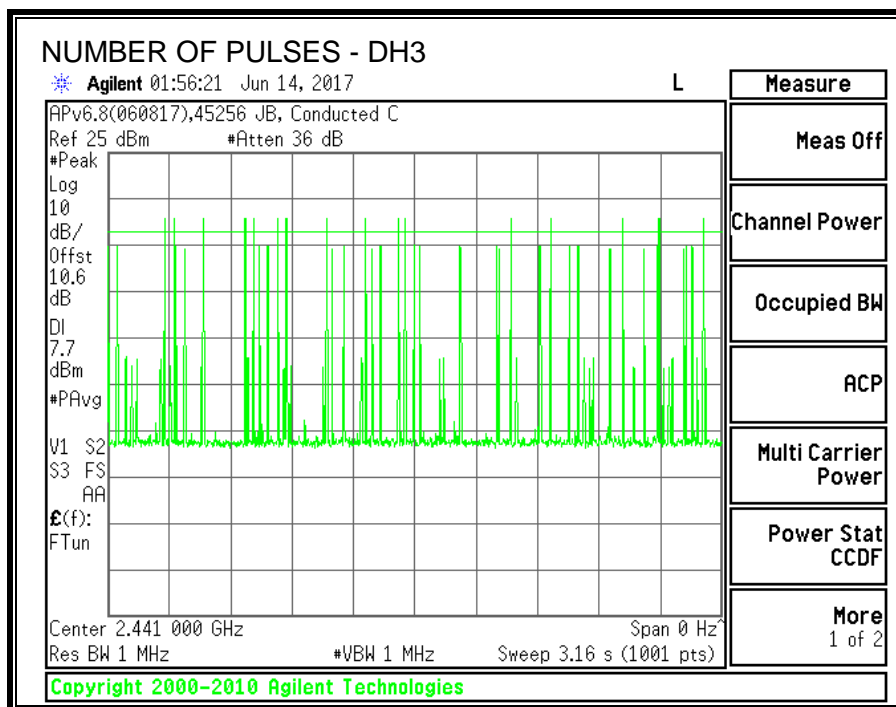
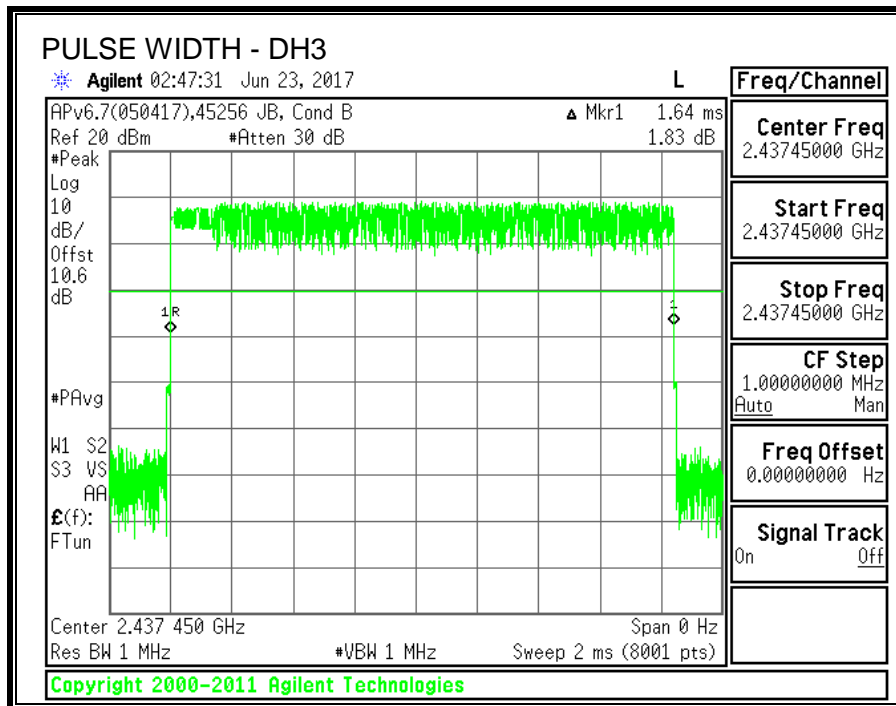

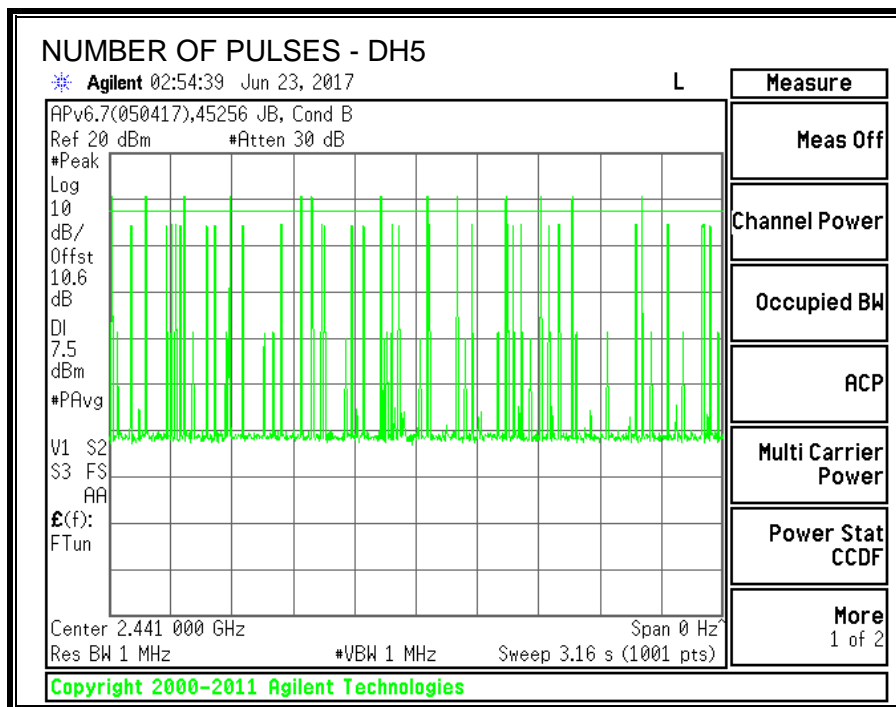
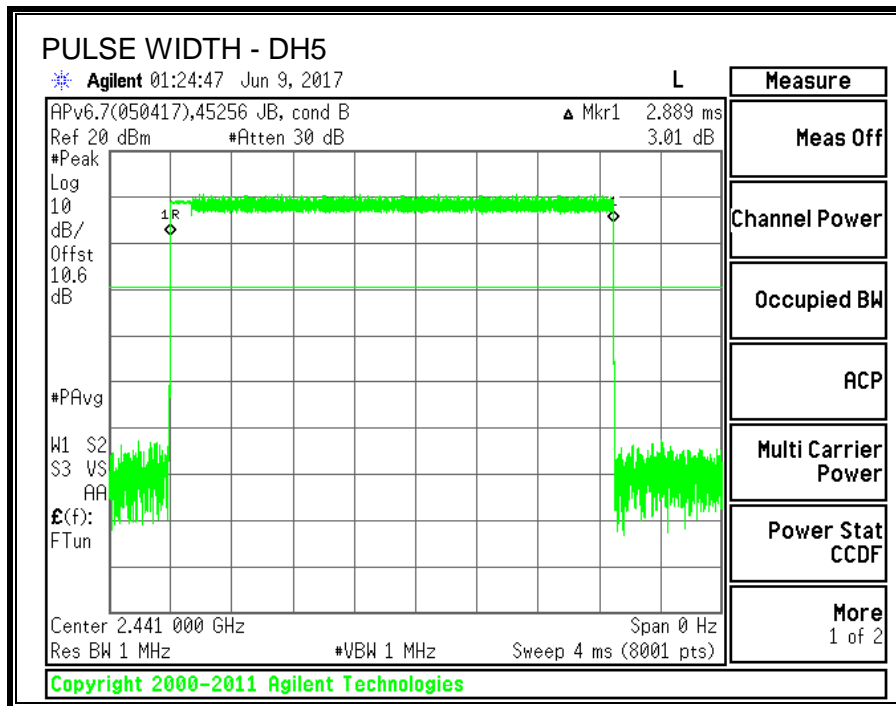

7.2.5. OUTPUT POWER

LIMITS

§15.247 (b) (1)

The maximum antenna gain is less than 6 dBi, therefore the limit is 30 dBm.

TEST PROCEDURE

The transmitter output is connected to a spectrum analyzer.

RESULTS

TEST ENGINEER:	45256	Date:	6/14/2017
-----------------------	-------	--------------	-----------

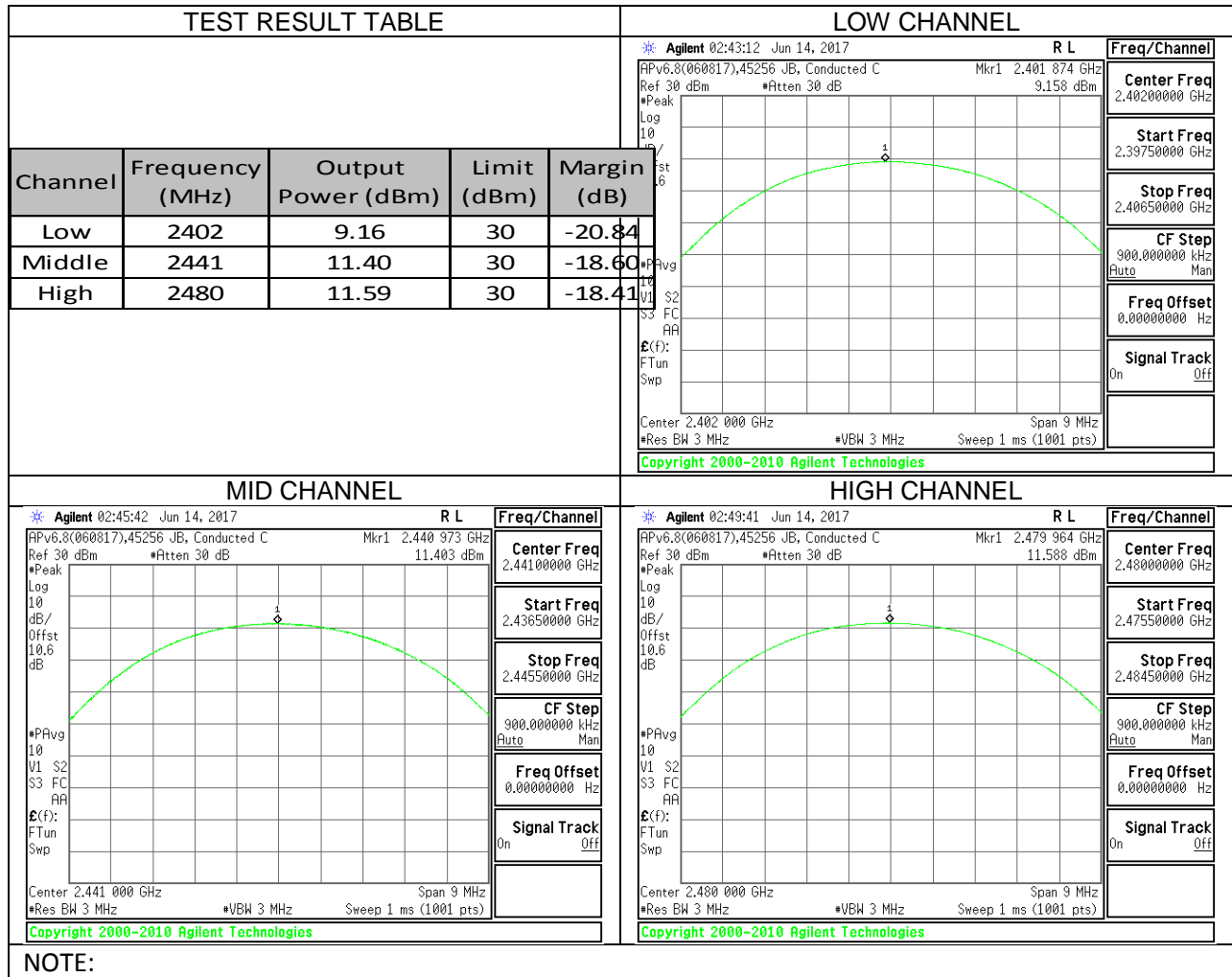

7.2.6. AVERAGE POWER

LIMITS

None; for reporting purposes only.

TEST PROCEDURE

The transmitter output is connected to a power meter.

RESULTS

The cable assembly insertion loss of 11 dB (including 10 dB pad and 1 dB cable) was entered as an offset in the power meter to allow for direct reading of power.

TEST ENGINEER:	39703	Date:	6/8/2017
-----------------------	-------	--------------	----------

Channel	Frequency (MHz)	Average Power (dBm)
Low	2402	6.01
Middle	2441	8.32
High	2480	8.81

7.2.7. CONDUCTED BANDEDGE AND SPURIOUS EMISSIONS

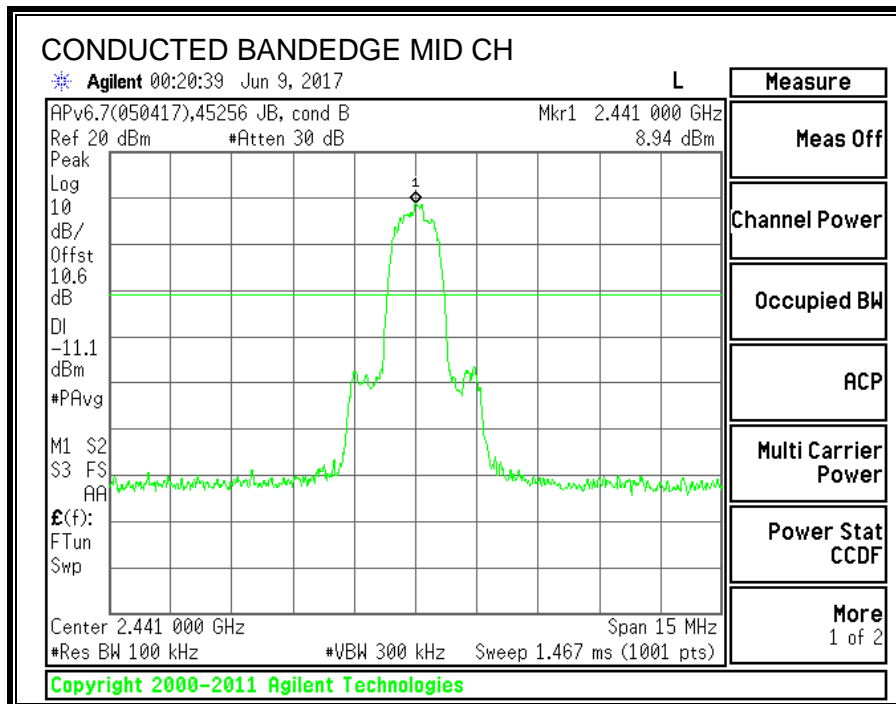
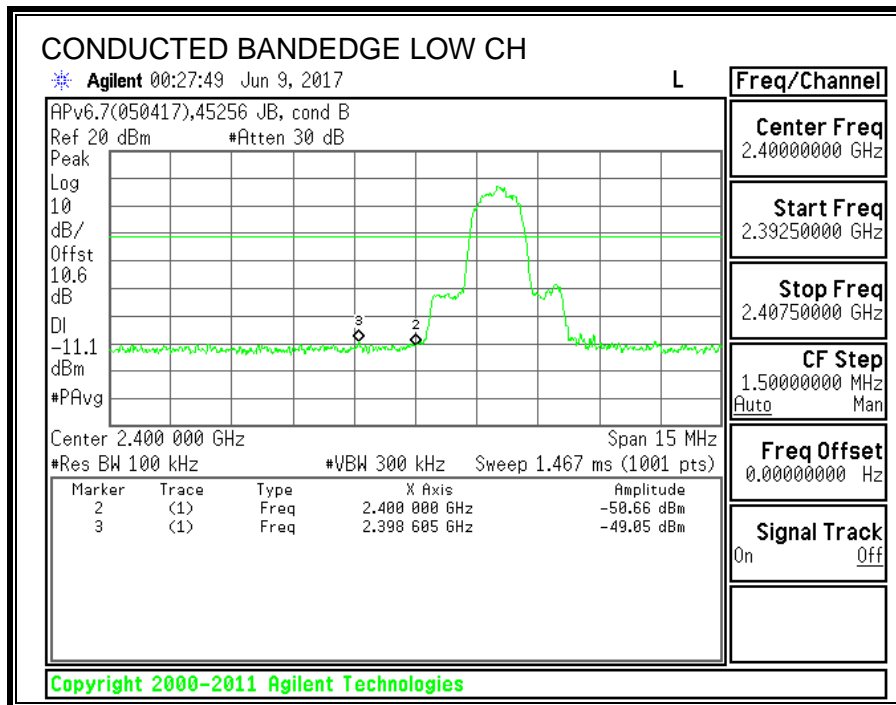

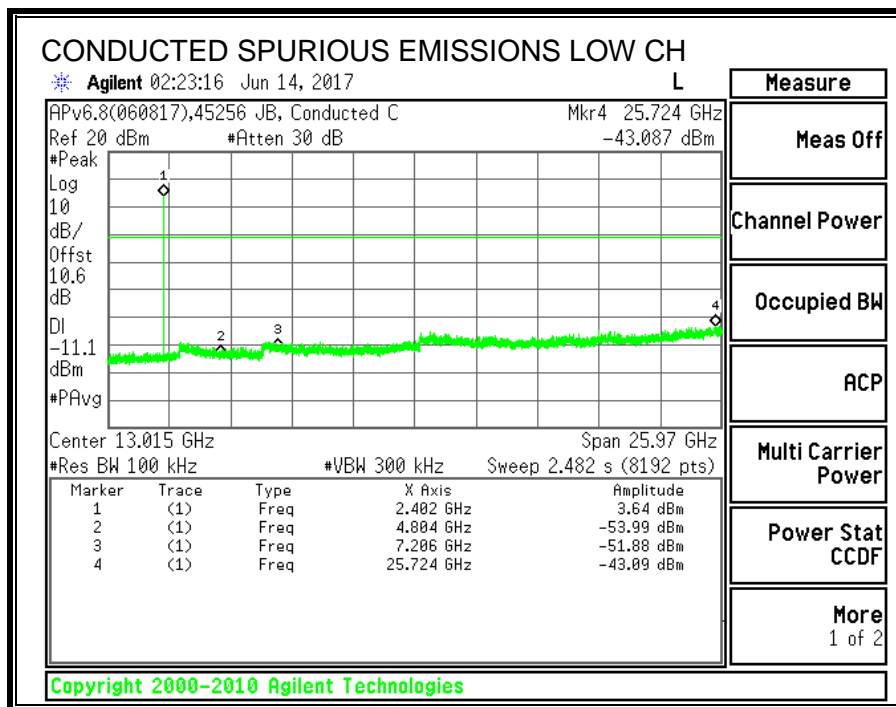
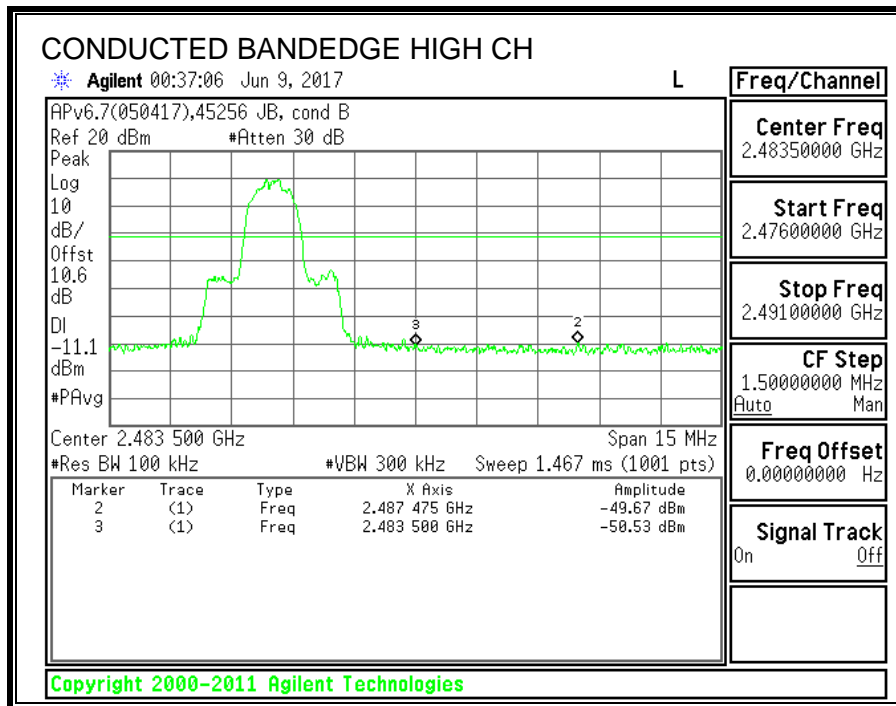

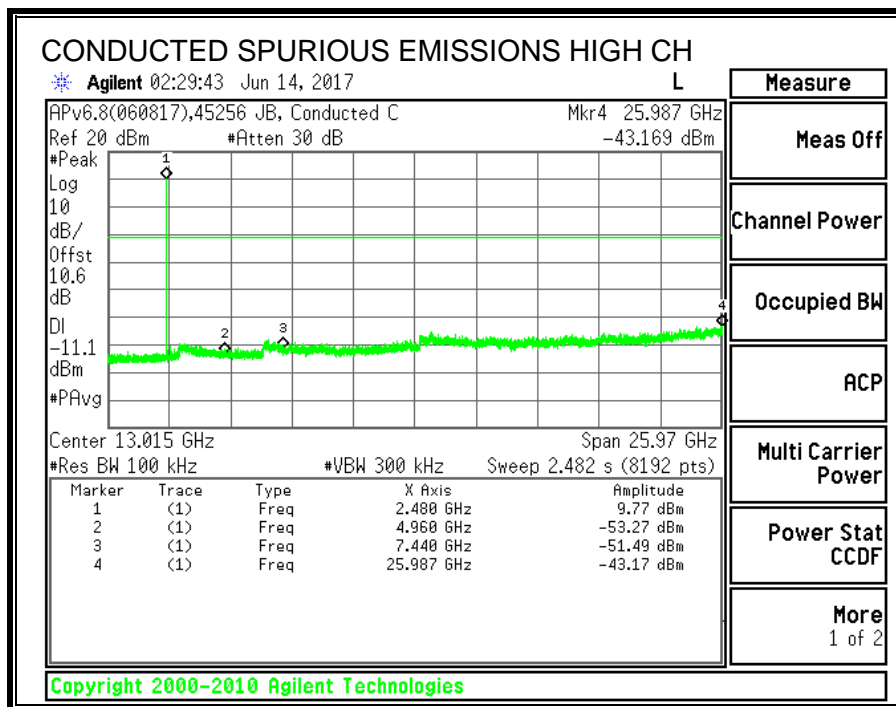
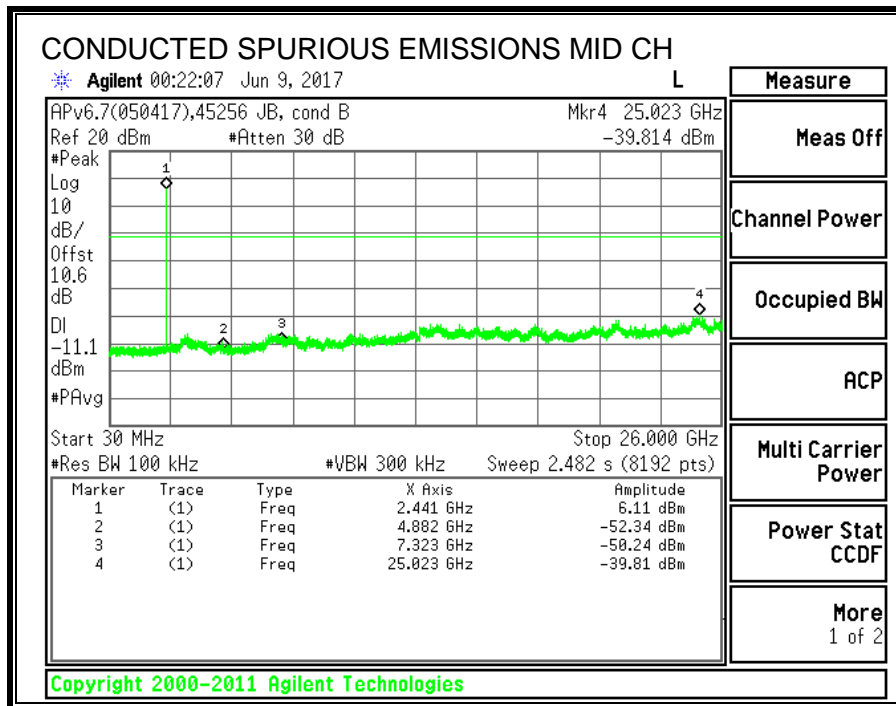

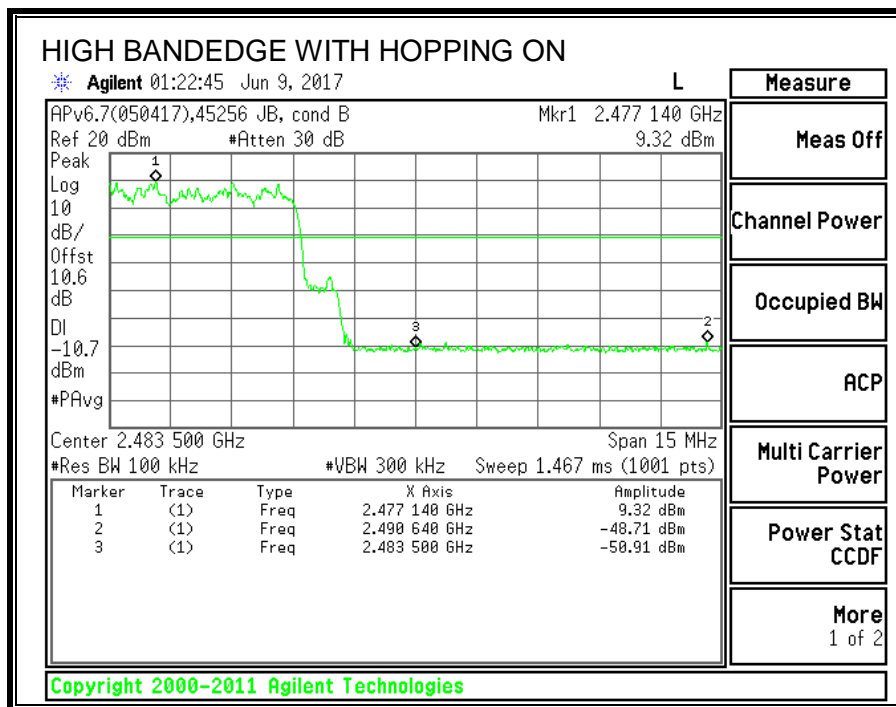
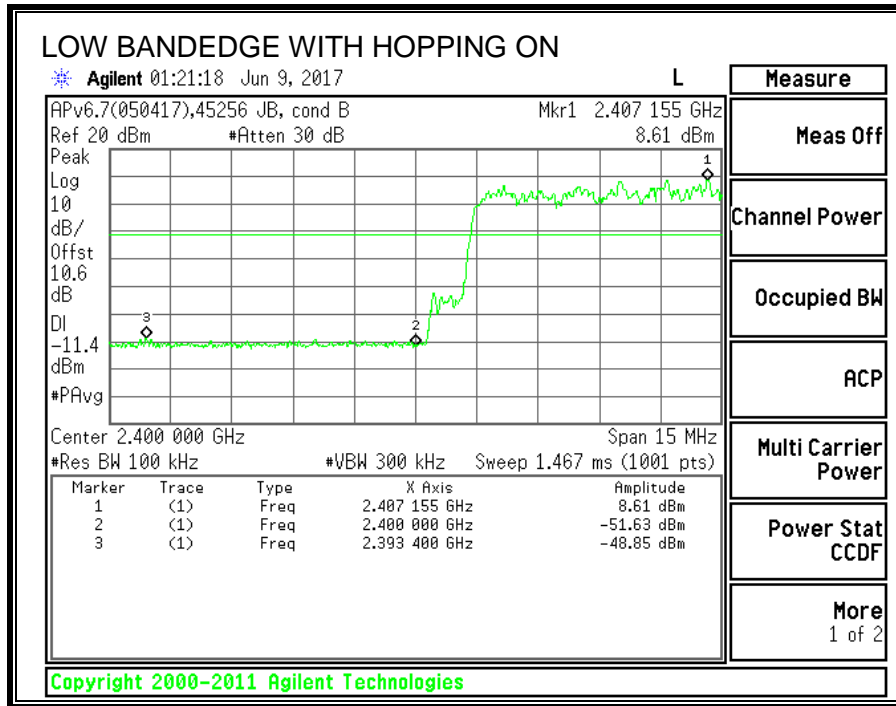

8. RADIATED TEST RESULTS

8.1. LIMITS AND PROCEDURE

LIMITS

FCC §15.205 and §15.209

Frequency Range (MHz)	Field Strength Limit (uV/m) at 3 m	Field Strength Limit (dBuV/m) at 3 m
0.009-0.490	2400/F(kHz) @ 300 m	-
0.490-1.705	24000/F(kHz) @ 30 m	-
1.705 - 30	30 @ 30m	-
30 - 88	100	40
88 - 216	150	43.5
216 - 960	200	46
Above 960	500	54

TEST PROCEDURE

The EUT is placed on a non-conducting table 80 cm above the ground plane for measurement below 1GHz; 1.5 m above the ground plane for measurement above 1GHz. The antenna to EUT distance is 3 meters. The EUT is configured in accordance with ANSI C63.10. The EUT is set to transmit in a continuous mode.

For measurements below 1 GHz the resolution bandwidth is set to 100 kHz for peak detection measurements or 120 kHz for quasi-peak detection measurements. Peak detection is used unless otherwise noted as quasi-peak.

For measurements above 1 GHz the resolution bandwidth is set to 1 MHz, then the video bandwidth is set to 3 MHz for peak measurements and 1 MHz resolution bandwidth with 1/T (10 Hz) video bandwidth with peak detector for average measurements.

The spectrum from 1 GHz to 18 GHz is investigated with the transmitter set to the lowest, middle, and highest channels in each applicable band. Below 1GHz and above 18GHz emissions, the channel with the highest output power was tested.

The frequency range of interest is monitored at a fixed antenna height and EUT azimuth. The EUT is rotated through 360 degrees to maximize emissions received. The antenna is scanned from 1 to 4 meters above the ground plane to further maximize the emission. Measurements are made with the antenna polarized in both the vertical and the horizontal positions.

RESULTS

8.2. BASIC DATA RATE GFSK MODULATION

8.2.1. RESTRICTED BANDEGE (LOW CHANNEL)

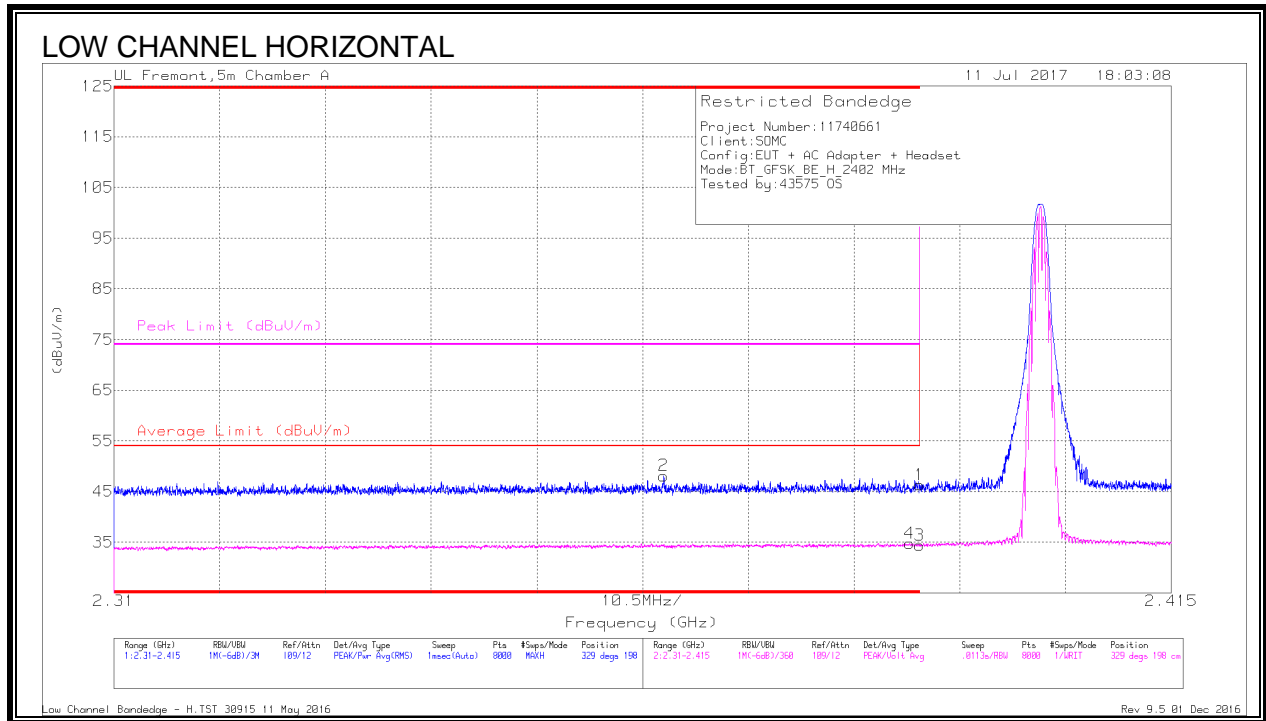

Marker	Frequency (GHz)	Meter Reading (dBuV)	Det	AF T862 (dB/m)	Amp/Cb/Fitr/P ad (dB)	Corrected Reading (dBuV/m)	Average Limit (dBuV/m)	Margin (dB)	Peak Limit (dBuV/m)	PK Margin (dB)	Azimuth (Degs)	Height (cm)	Polarity
1	* 2.39	37.69	Pk	31.8	-23.2	46.29	-	-	74	-27.71	329	198	H
2	* 2.365	39.72	Pk	31.6	-23.2	48.12	-	-	74	-25.88	329	198	H
3	* 2.39	25.77	VA1T	31.8	-23.2	34.37	54	-19.63	-	-	329	198	H
4	* 2.389	26.2	VA1T	31.8	-23.2	34.8	54	-19.2	-	-	329	198	H

* - indicates frequency in CFR15.205/RSS-GEN 8.10 -Restricted Band

Pk - Peak detector

VA1T - FHSS: Linear Voltage Average $V_B=1/T_{on}$ where: T_{on} is transmit duration

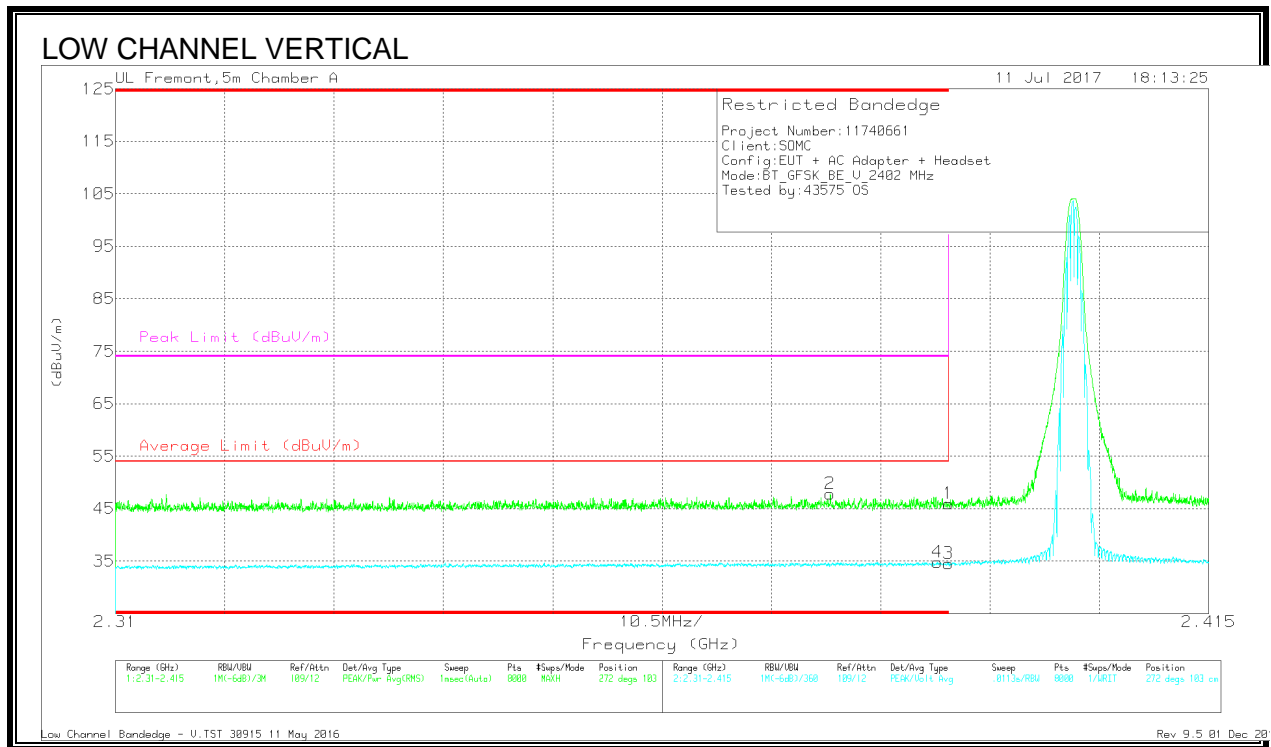

Marker	Frequency (GHz)	Meter Reading (dBuV)	Det	AF T862 (dB/m)	Amp/Cbl/Filtr/Pad (dB)	Corrected Reading (dBuV/m)	Average Limit (dBuV/m)	Margin (dB)	Peak Limit (dBuV/m)	PK Margin (dB)	Azimuth (Degs)	Height (cm)	Polarity
2	* 2.379	39.29	Pk	31.7	-23.2	47.79	-	-	74	-26.21	272	103	V
4	* 2.389	26.15	VA1T	31.8	-23.2	34.75	54	-19.25	-	-	272	103	V
1	* 2.39	37.3	Pk	31.8	-23.2	45.9	-	-	74	-28.1	272	103	V
3	* 2.39	25.92	VA1T	31.8	-23.2	34.52	54	-19.48	-	-	272	103	V

* - indicates frequency in CFR15.205/RSS-GEN 8.10 -Restricted Band
 Pk - Peak detector
 VA1T - FHSS: Linear Voltage Average VB=1/Ton where: Ton is transmit duration

8.2.2. AUTHORIZED BANDEDGE (HIGH CHANNEL)

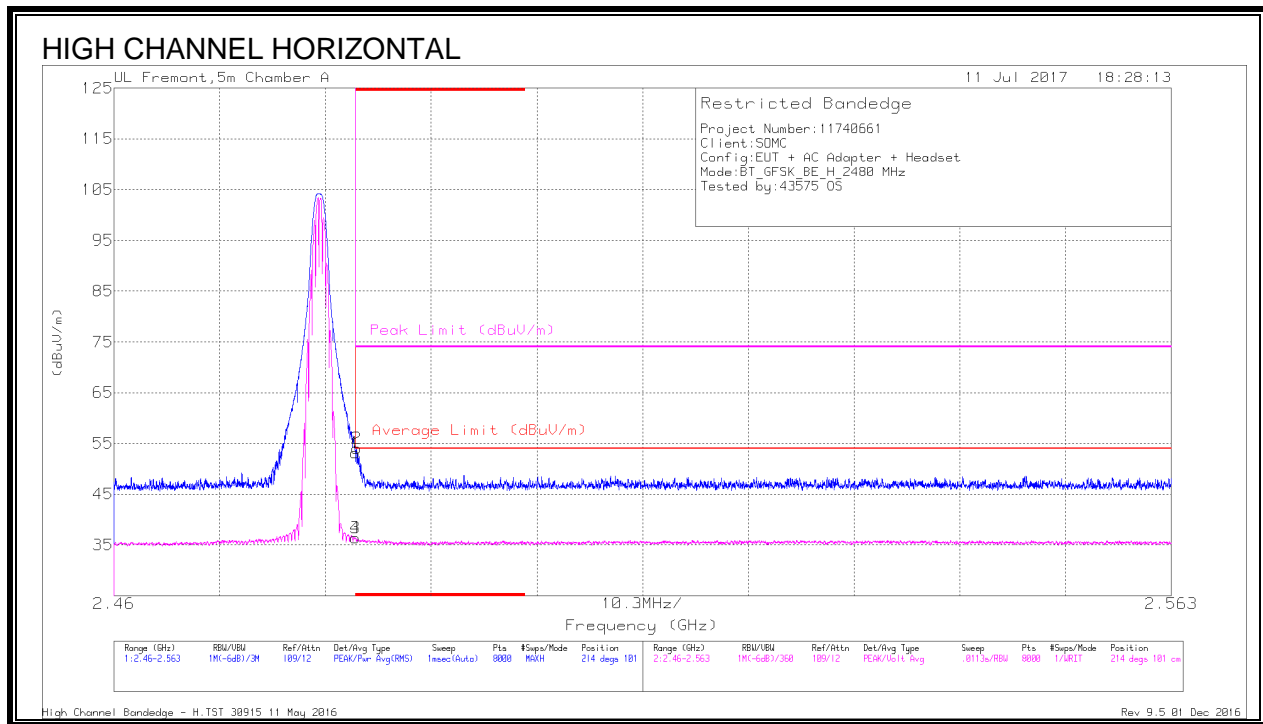

Marker	Frequency (GHz)	Meter Reading (dBuV)	Det	AF T862 (dB/m)	Amp/Cbl/Filtr/P ad (dB)	Corrected Reading (dBuV/m)	Average Limit (dBuV/m)	Margin (dB)	Peak Limit (dBuV/m)	PK Margin (dB)	Azimuth (Degs)	Height (cm)	Polarity
1	* 2.484	43.91	Pk	32.3	-23.1	53.11	-	-	74	-20.89	214	101	H
2	* 2.484	44.82	Pk	32.3	-23.1	54.02	-	-	74	-19.98	214	101	H
3	* 2.484	27.18	VA1T	32.3	-23.1	36.38	54	-17.62	-	-	214	101	H
4	* 2.484	27.2	VA1T	32.3	-23.1	36.4	54	-17.6	-	-	214	101	H

* - indicates frequency in CFR15.205/RSS-GEN 8.10 -Restricted Band

Pk - Peak detector

VA1T - FHSS: Linear Voltage Average VB=1/Ton where: Ton is transmit duration

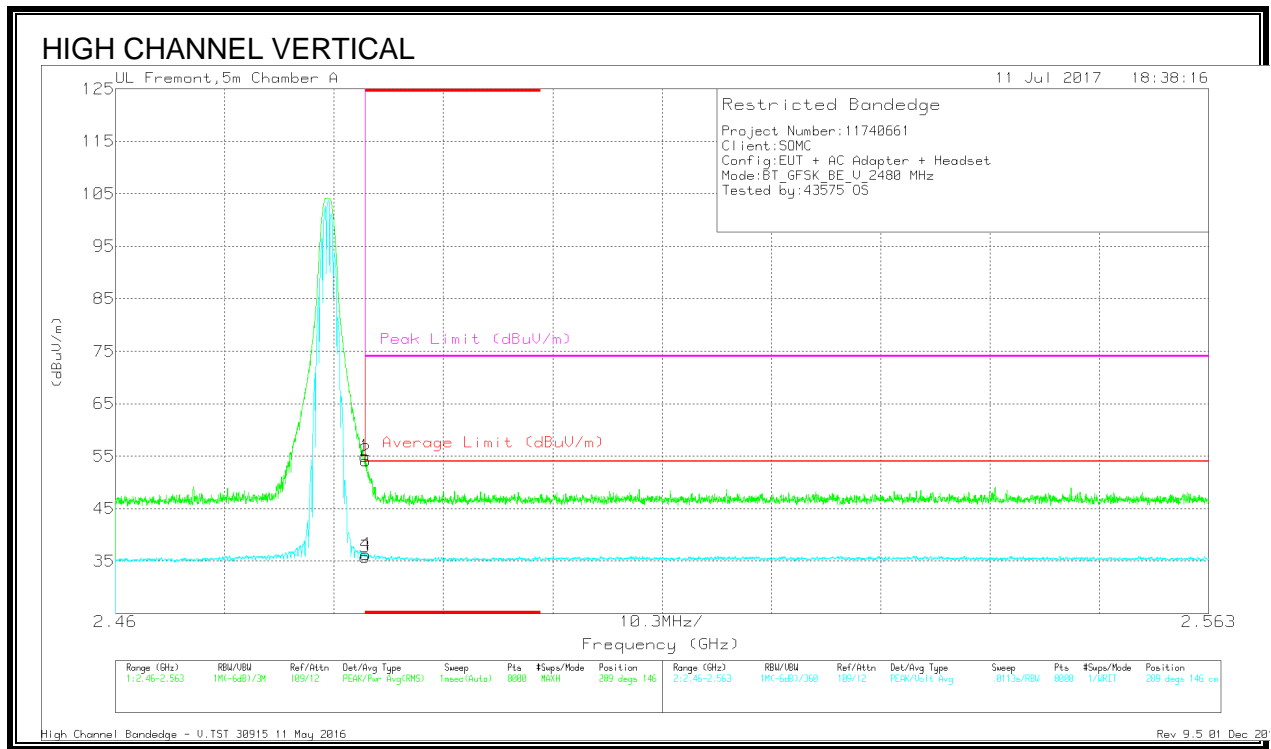

Marker	Frequency (GHz)	Meter Reading (dBuV)	Det	AF T862 (dB/m)	Amp/Cbl/Fitr/Pad (dB)	Corrected Reading (dBuV/m)	Average Limit (dBuV/m)	Margin (dB)	Peak Limit (dBuV/m)	PK Margin (dB)	Azimuth (Degs)	Height (cm)	Polarity
1	* 2.484	45.8	Pk	32.3	-23.1	55	-	-	74	-19	289	146	V
2	* 2.484	44.97	Pk	32.3	-23.1	54.17	-	-	74	-19.83	289	146	V
3	* 2.484	26.61	VA1T	32.3	-23.1	35.81	54	-18.19	-	-	289	146	V
4	* 2.484	27.1	VA1T	32.3	-23.1	36.3	54	-17.7	-	-	289	146	V

* - indicates frequency in CFR15.205/RSS-GEN 8.10 -Restricted Band
 Pk - Peak detector
 VA1T - FHSS: Linear Voltage Average $V_B=1/T_{on}$ where: T_{on} is transmit duration

8.2.3. HARMONICS AND SPURIOUS EMISSIONS

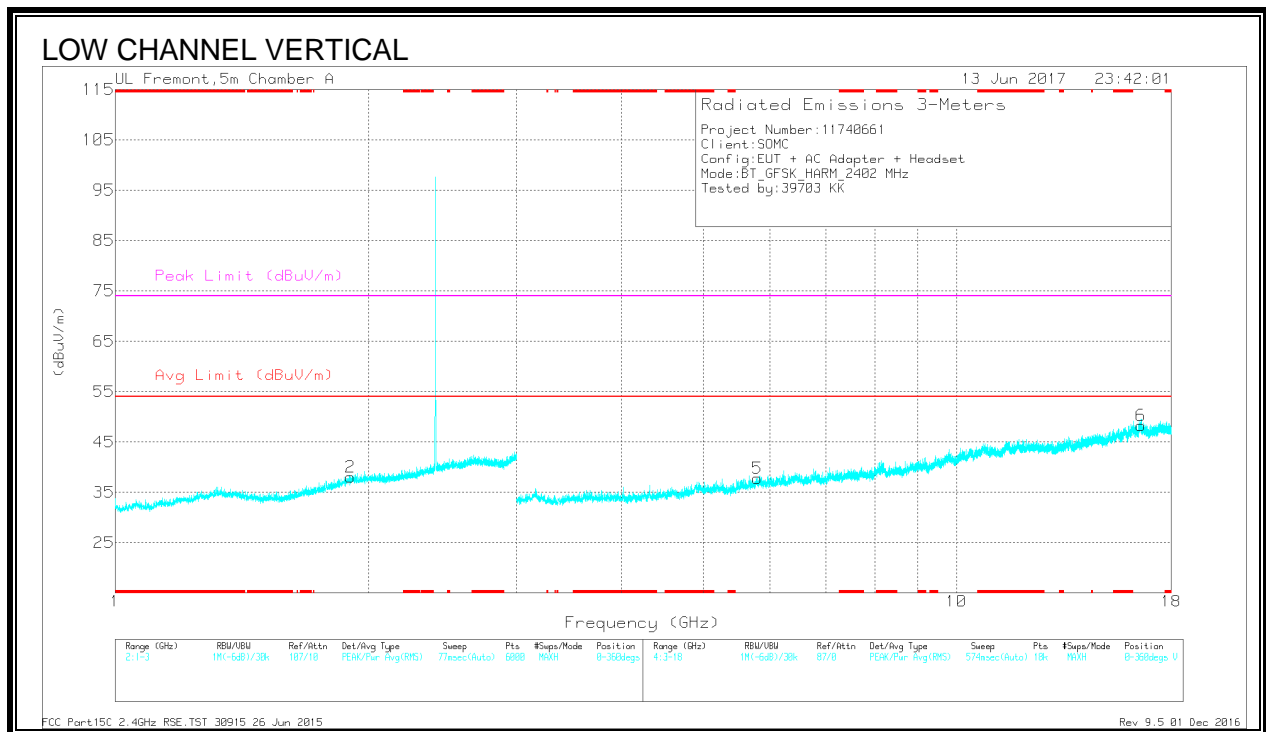
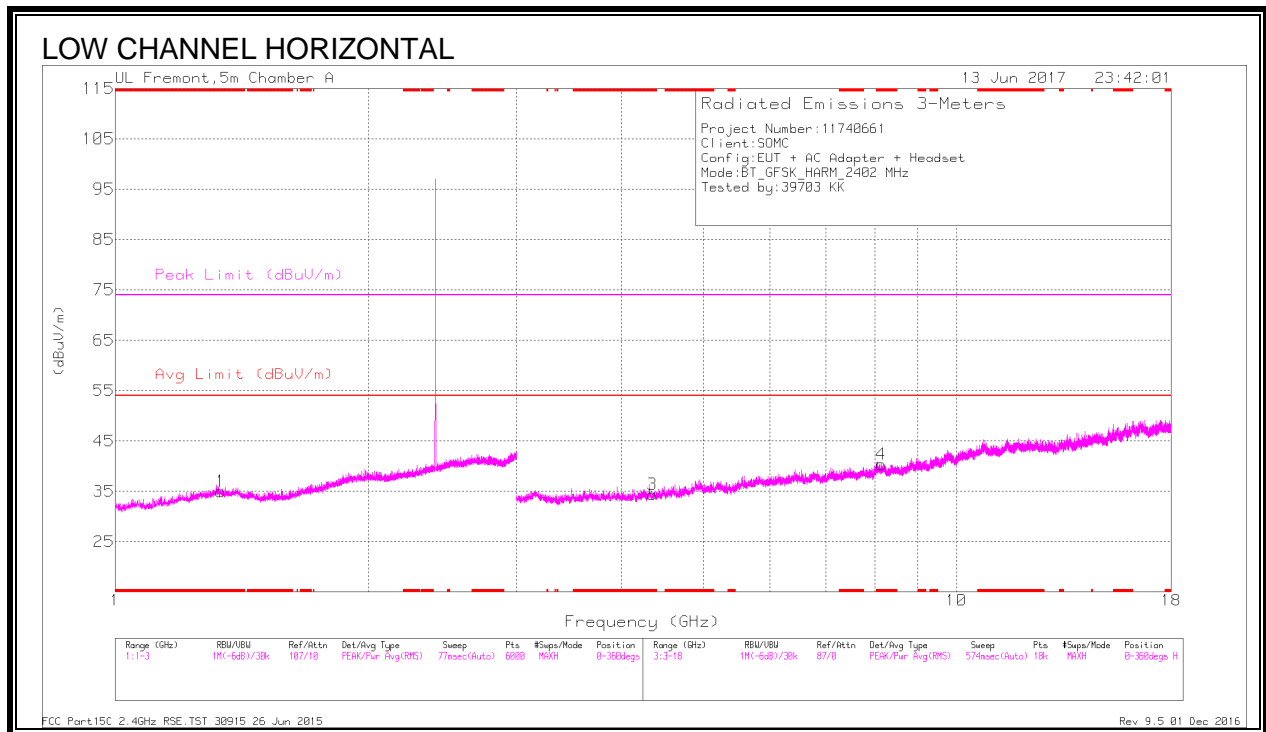

Frequency (GHz)	Meter Reading (dBuV)	Det	AF T711 (dB/m)	Amp/Cb/Fitr/Pad (dB)	Corrected Reading (dBuV/m)	Avg Limit (dBuV/m)	Margin (dB)	Peak Limit (dBuV/m)	PK Margin (dB)	Azimuth (Degs)	Height (cm)	Polarity
* 1.335	35.13	PKFH	29.4	-23.9	40.63	-	-	74	-33.37	360	199	H
* 1.335	22.91	VA1T	29.4	-23.9	28.41	54	-25.59	-	-	360	199	H
* 4.352	36.95	PKFH	33.5	-30	40.45	-	-	74	-33.55	360	199	H
* 4.353	24.92	VA1T	33.5	-30	28.42	54	-25.58	-	-	360	199	H
* 8.136	32.18	PKFH	35.7	-22.5	45.38	-	-	74	-28.62	360	199	H
* 8.134	20.62	VA1T	35.7	-22.6	33.72	54	-20.28	-	-	360	199	H
1.905	34.44	PKFH	31.3	-23.5	42.24	-	-	-	-	360	102	V
1.905	23.02	VA1T	31.3	-23.5	30.82	-	-	-	-	360	102	V
5.796	23.03	VA1T	34.7	-26.4	31.33	-	-	-	-	360	199	V
5.797	35.25	PKFH	34.7	-26.3	43.65	-	-	-	-	360	199	V
16.568	31.61	PKFH	41.7	-19.5	53.81	-	-	-	-	360	199	V
16.57	19.75	VA1T	41.7	-19.6	41.85	-	-	-	-	360	199	V

* - indicates frequency in CFR15.205/RSS-GEN 8.10 -Restricted Band
 PKFH - FHSS: RB=100k/1MHz VB=3 x RB, Peak
 VA1T - FHSS: Linear Voltage Average VB=1/Ton where: Ton is transmit duration

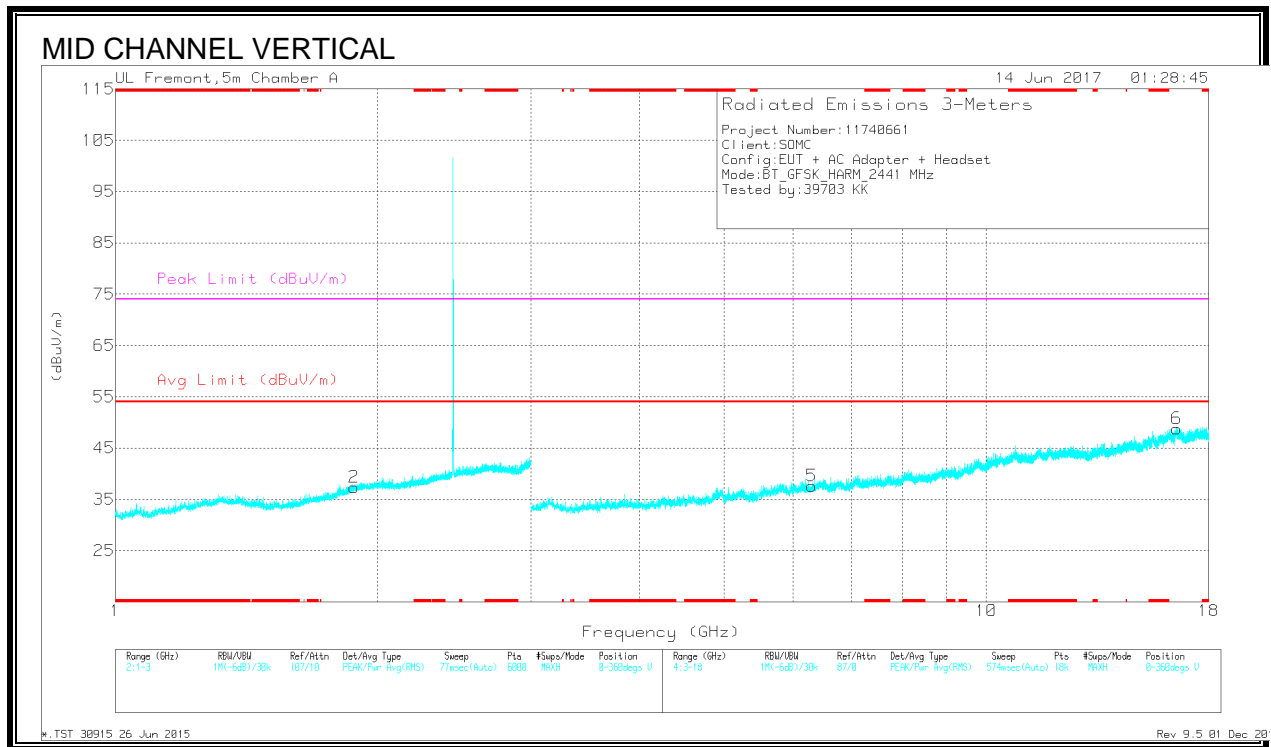
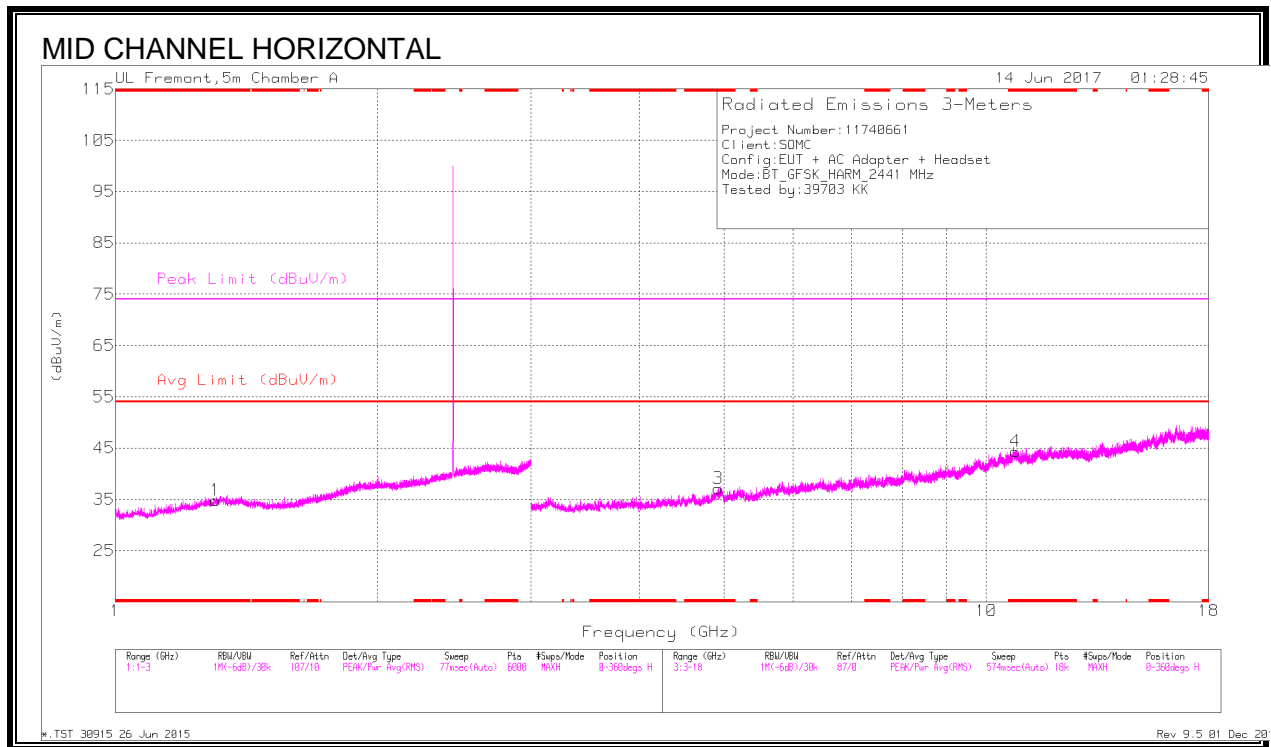

Frequency (GHz)	Meter Reading (dBuV)	Det	AF T711 (dB/m)	Amp/Cbl/Filtr/Pad (dB)	Corrected Reading (dBuV/m)	Avg Limit (dBuV/m)	Margin (dB)	Peak Limit (dBuV/m)	PK Margin (dB)	Azimuth (Degs)	Height (cm)	Polarity
* 1.304	34.38	PKFH	29.6	-24	39.98	-	-	74	-34.02	0	199	H
* 1.304	22.67	VA1T	29.6	-24	28.27	54	-25.73	-	-	0	199	H
* 4.92	35.78	PKFH	34.1	-27.6	42.28	-	-	74	-31.72	0	199	H
* 4.922	23.92	VA1T	34.1	-27.7	30.32	54	-23.68	-	-	0	199	H
* 10.804	31.48	PKFH	37.9	-19.5	49.88	-	-	74	-24.12	0	199	H
* 10.8	19.46	VA1T	37.9	-19.5	37.86	54	-16.14	-	-	0	199	H
1.876	34.81	PKFH	31.1	-23.6	42.31	-	-	-	-	0	102	V
1.876	23.24	VA1T	31.1	-23.6	30.74	-	-	-	-	0	102	V
6.305	34.59	PKFH	35.4	-26.5	43.49	-	-	-	-	0	199	V
6.306	22.7	VA1T	35.4	-26.5	31.6	-	-	-	-	0	199	V
16.54	19.73	VA1T	41.7	-19	42.43	-	-	-	-	0	102	V
16.543	31.39	PKFH	41.7	-18.9	54.19	-	-	-	-	0	102	V

* - indicates frequency in CFR15.205/RSS-GEN 8.10 -Restricted Band
 PKFH - FHSS: RB=100k/1MHz VB=3 x RB, Peak
 VA1T - FHSS: Linear Voltage Average VB=1/Ton where: Ton is transmit duration

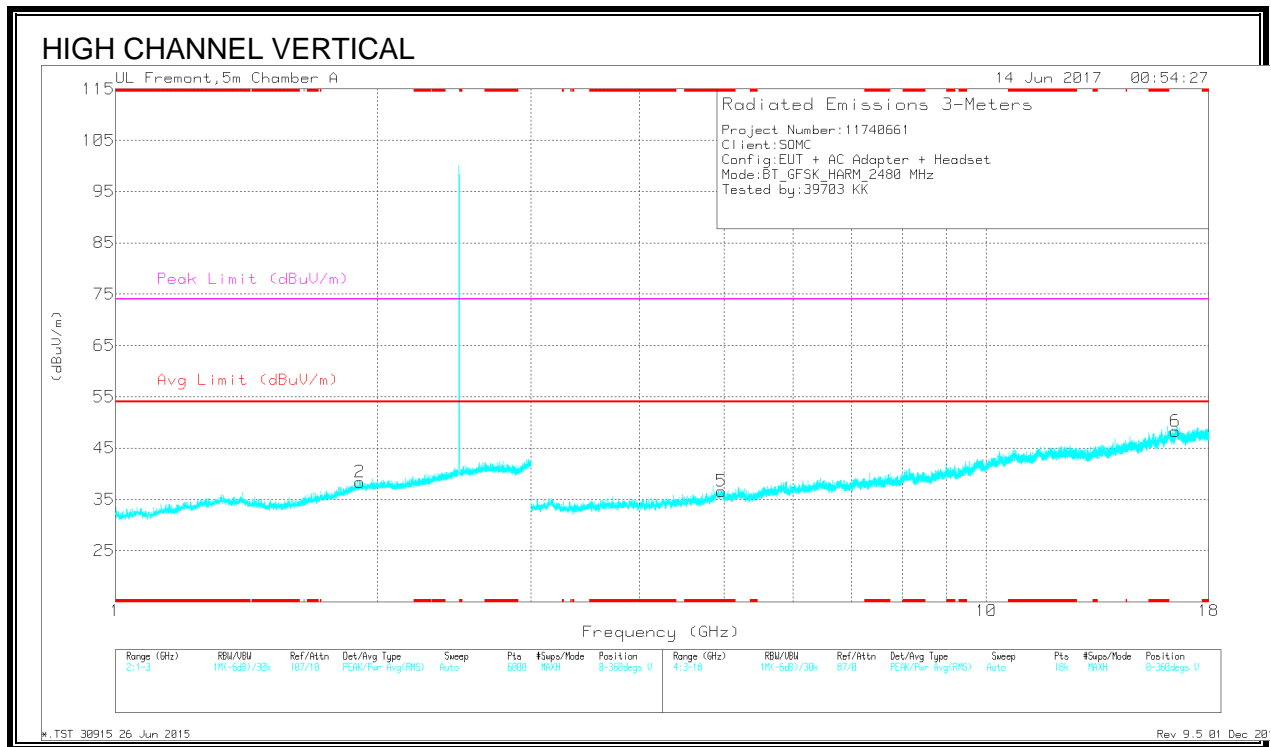
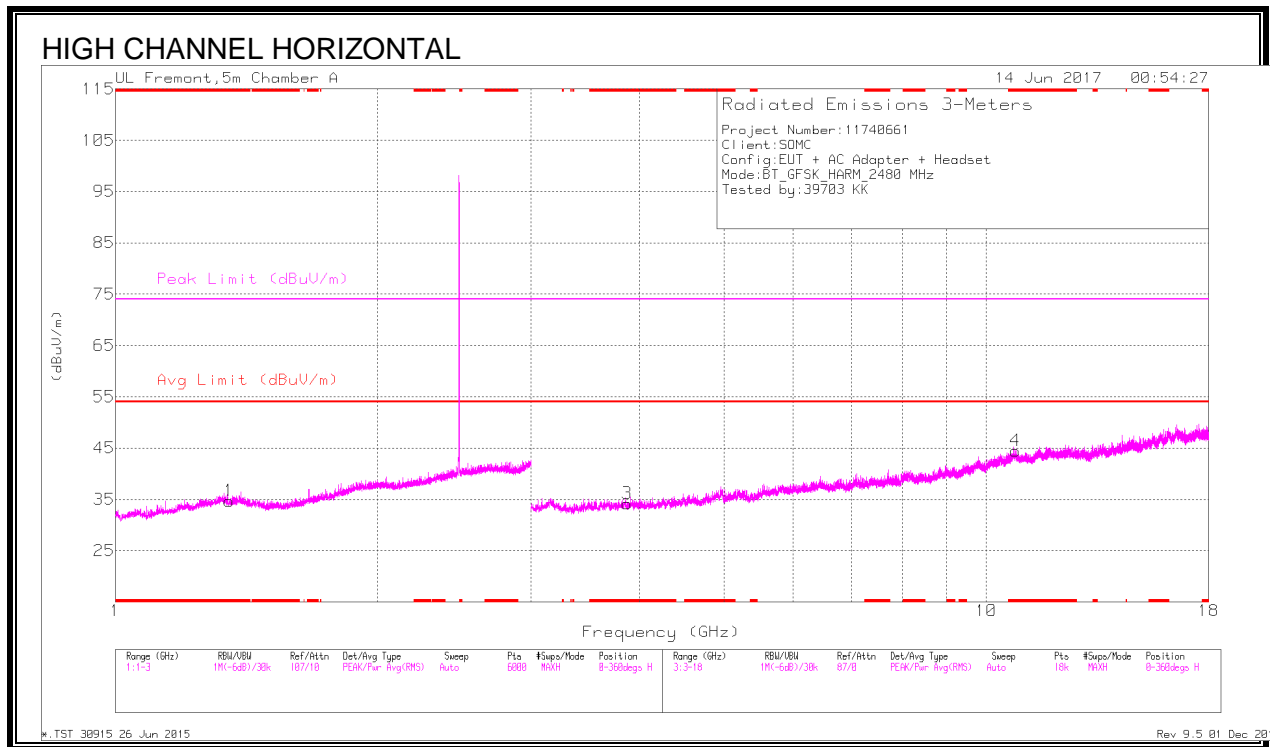

Frequency (GHz)	Meter Reading (dBuV)	Det	AF T711 (dB/m)	Amp/Cbl/Fitr/Pad (dB)	Corrected Reading (dBuV/m)	Avg Limit (dBuV/m)	Margin (dB)	Peak Limit (dBuV/m)	PK Margin (dB)	Azimuth (Degs)	Height (cm)	Polarity
* 1.352	34.9	PKFH	29.4	-23.8	40.5	-	-	74	-33.5	0	100	H
* 1.351	22.65	VA1T	29.4	-23.8	28.25	54	-25.75	-	-	0	100	H
* 3.865	36.97	PKFH	33.3	-30.1	40.17	-	-	74	-33.83	0	200	H
* 3.867	25.41	VA1T	33.3	-30.1	28.61	54	-25.39	-	-	0	200	H
* 10.793	30.73	PKFH	37.9	-19.7	48.93	-	-	74	-25.07	0	102	H
* 10.793	19.3	VA1T	37.9	-19.7	37.5	54	-16.5	-	-	0	102	H
* 4.968	36.22	PKFH	34.1	-28.5	41.82	-	-	74	-32.18	0	200	V
* 4.968	24.81	VA1T	34.1	-28.5	30.41	54	-23.59	-	-	0	200	V
1.907	35.35	PKFH	31.3	-23.5	43.15	-	-	-	-	0	200	V
1.907	23.32	VA1T	31.3	-23.6	31.02	-	-	-	-	0	200	V
16.483	31.38	PKFH	41.6	-19.4	53.58	-	-	-	-	0	200	V
16.483	19.87	VA1T	41.6	-19.4	42.07	-	-	-	-	0	200	V

* - indicates frequency in CFR15.205/RSS-GEN 8.10 -Restricted Band
 PKFH - FHSS: RB=100k/1MHz VB=3 x RB, Peak
 VA1T - FHSS: Linear Voltage Average VB=1/Ton where: Ton is transmit duration

8.3. ENHANCED DATA RATE 8PSK MODULATION

8.3.1. RESTRICTED BANDEDGE (LOW CHANNEL)

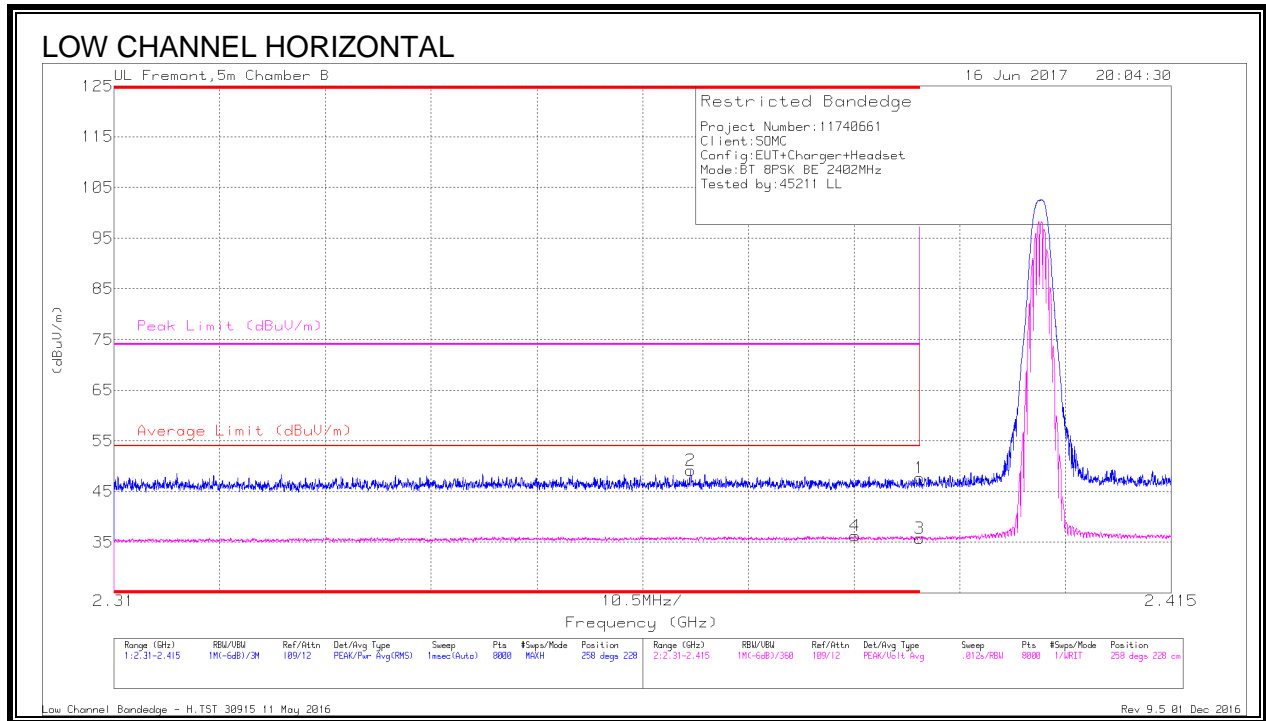

Marker	Frequency (GHz)	Meter Reading (dBuV)	Det	AF T346 (dB/m)	Amp/Cb/Fltr/Pa d (dB)	Corrected Reading (dBuV/m)	Average Limit (dBuV/m)	Margin (dB)	Peak Limit (dBuV/m)	PK Margin (dB)	Azimuth (Degs)	Height (cm)	Polarity
1	* 2.39	36.96	Pk	32	-21.3	47.66	-	-	74	-26.34	258	228	H
2	* 2.367	38.53	Pk	31.9	-21.2	49.23	-	-	74	-24.77	258	228	H
3	* 2.39	25.09	VA1T	32	-21.3	35.79	54	-18.21	-	-	258	228	H
4	* 2.384	25.64	VA1T	31.9	-21.3	36.24	54	-17.76	-	-	258	228	H

* - indicates frequency in CFR15.205/RSS-GEN 8.10 -Restricted Band

Pk - Peak detector

VA1T - FHSS: Linear Voltage Average VB=1/Ton where: Ton is transmit duration

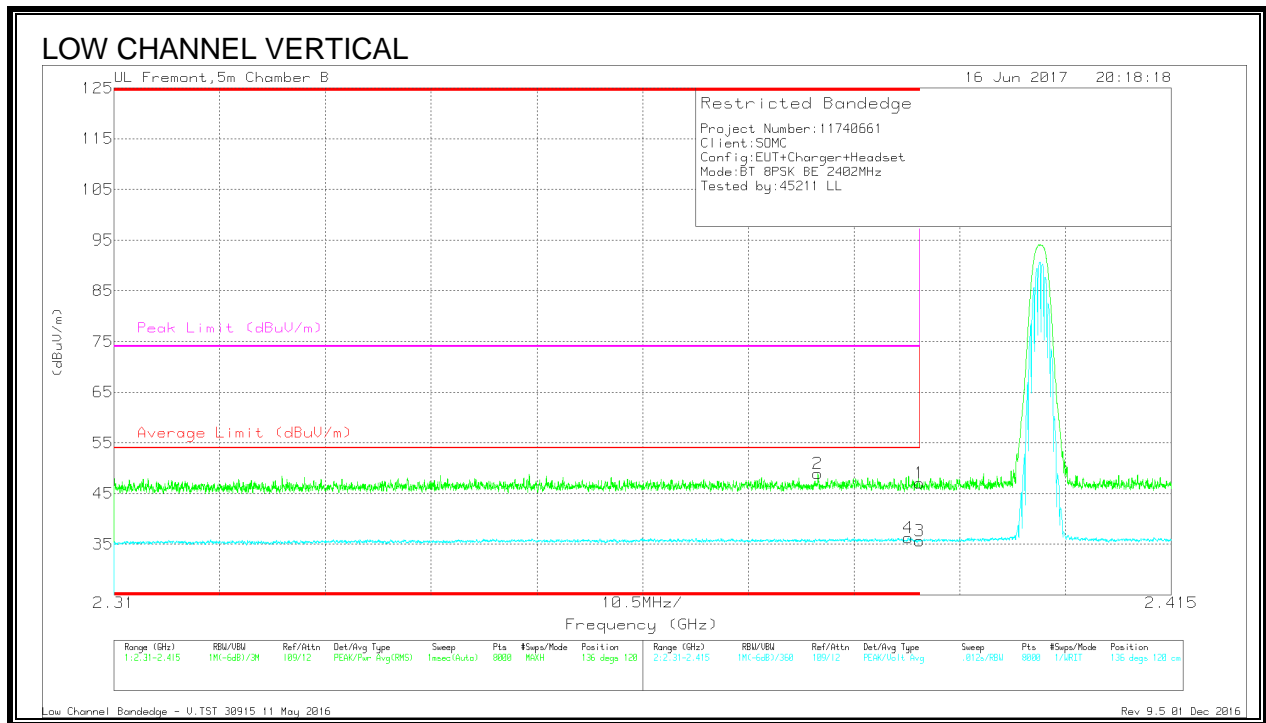

Marker	Frequency (GHz)	Meter Reading (dBuV)	Det	AF T346 (dB/m)	Amp/Cb/Fltr/Pad (dB)	Corrected Reading (dBuV/m)	Average Limit (dBuV/m)	Margin (dB)	Peak Limit (dBuV/m)	PK Margin (dB)	Azimuth (Degs)	Height (cm)	Polarity
1	* 2.39	36.33	Pk	32	-21.3	47.03	-	-	74	-26.97	136	120	V
2	* 2.38	38.27	Pk	31.9	-21.3	48.87	-	-	74	-25.13	136	120	V
3	* 2.39	24.97	VA1T	32	-21.3	35.67	54	-18.33	-	-	136	120	V
4	* 2.389	25.62	VA1T	31.9	-21.3	36.22	54	-17.78	-	-	136	120	V

* - indicates frequency in CFR15.205/RSS-GEN 8.10 -Restricted Band
 Pk - Peak detector
 VA1T - FHSS: Linear Voltage Average VB=1/Ton where: Ton is transmit duration

8.3.2. AUTHORIZED BANDEDGE (HIGH CHANNEL)

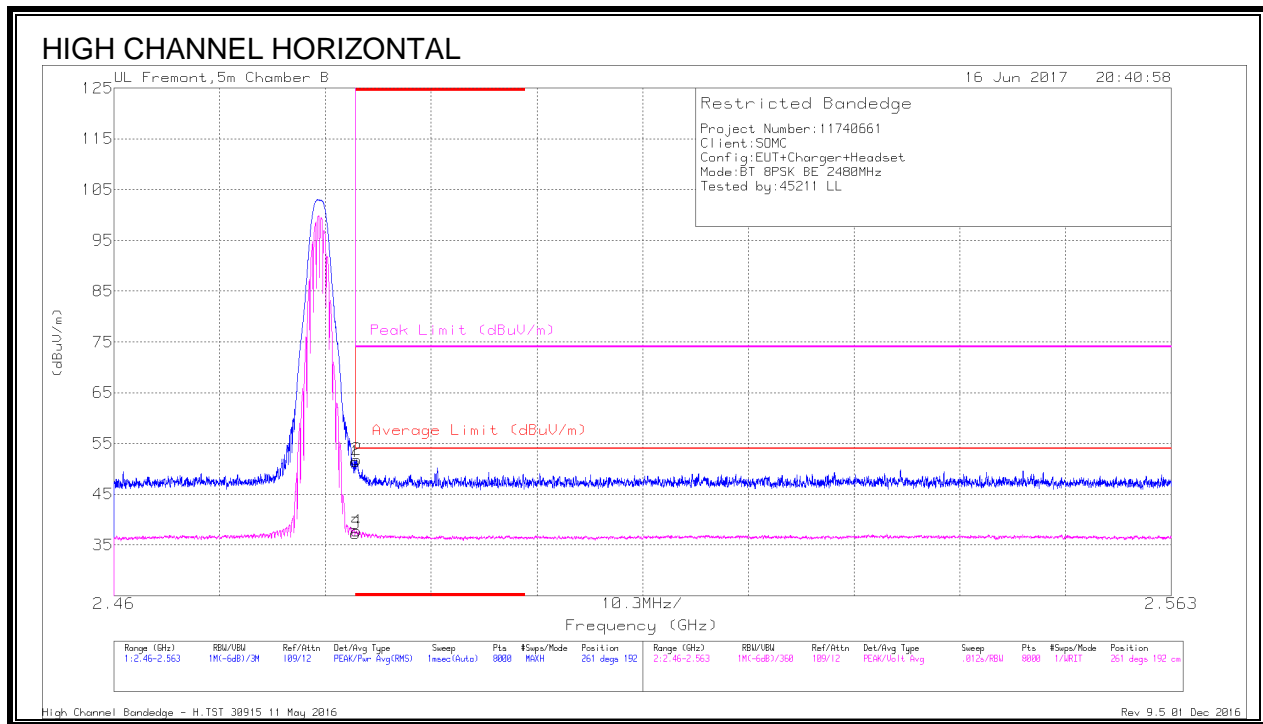

Marker	Frequency (GHz)	Meter Reading (dBuV)	Det	AF T346 (dB/m)	Amp/Cbl/Fitr/Pad (dB)	Corrected Reading (dBuV/m)	Average Limit (dBuV/m)	Margin (dB)	Peak Limit (dBuV/m)	PK Margin (dB)	Azimuth (Degs)	Height (cm)	Polarity
1	* 2.484	40.54	Pk	32.1	-21.2	51.44	-	-	74	-22.56	261	192	H
2	* 2.484	40.94	Pk	32.1	-21.2	51.84	-	-	74	-22.16	261	192	H
3	* 2.484	26.38	VA1T	32.1	-21.2	37.28	54	-16.72	-	-	261	192	H
4	* 2.484	26.84	VA1T	32.1	-21.2	37.74	54	-16.26	-	-	261	192	H

* - indicates frequency in CFR15.205/RSS-GEN 8.10 -Restricted Band

Pk - Peak detector

VA1T - FHSS: Linear Voltage Average VB=1/Ton where: Ton is transmit duration

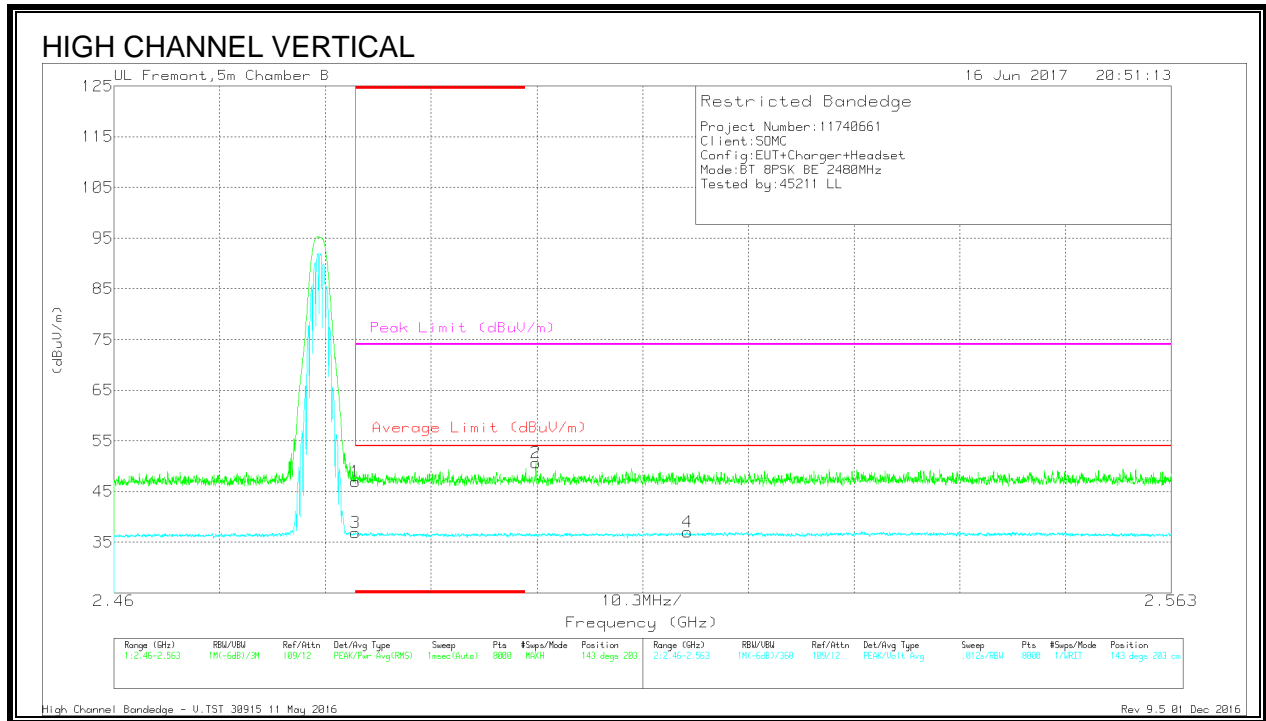

Marker	Frequency (GHz)	Meter Reading (dBuV)	Det	AF T346 (dB/m)	Amp/Cbl/Fitr/Pad (dB)	Corrected Reading (dBuV/m)	Average Limit (dBuV/m)	Margin (dB)	Peak Limit (dBuV/m)	PK Margin (dB)	Azimuth (Degs)	Height (cm)	Polarity
1	* 2.484	36	Pk	32.1	-21.2	46.9	-	-	74	-27.1	143	203	V
3	* 2.484	26.01	VA1T	32.1	-21.2	36.91	54	-17.09	-	-	143	203	V
2	2.501	39.76	Pk	32.1	-21.2	50.66	-	-	74	-23.34	143	203	V
4	2.516	26.01	VA1T	32.1	-21.1	37.01	54	-16.99	-	-	143	203	V

* - indicates frequency in CFR15.205/RSS-GEN 8.10 -Restricted Band

Pk - Peak detector

VA1T - FHSS: Linear Voltage Average $V_B=1/T_{on}$ where: T_{on} is transmit duration

8.3.3. HARMONICS AND SPURIOUS EMISSIONS

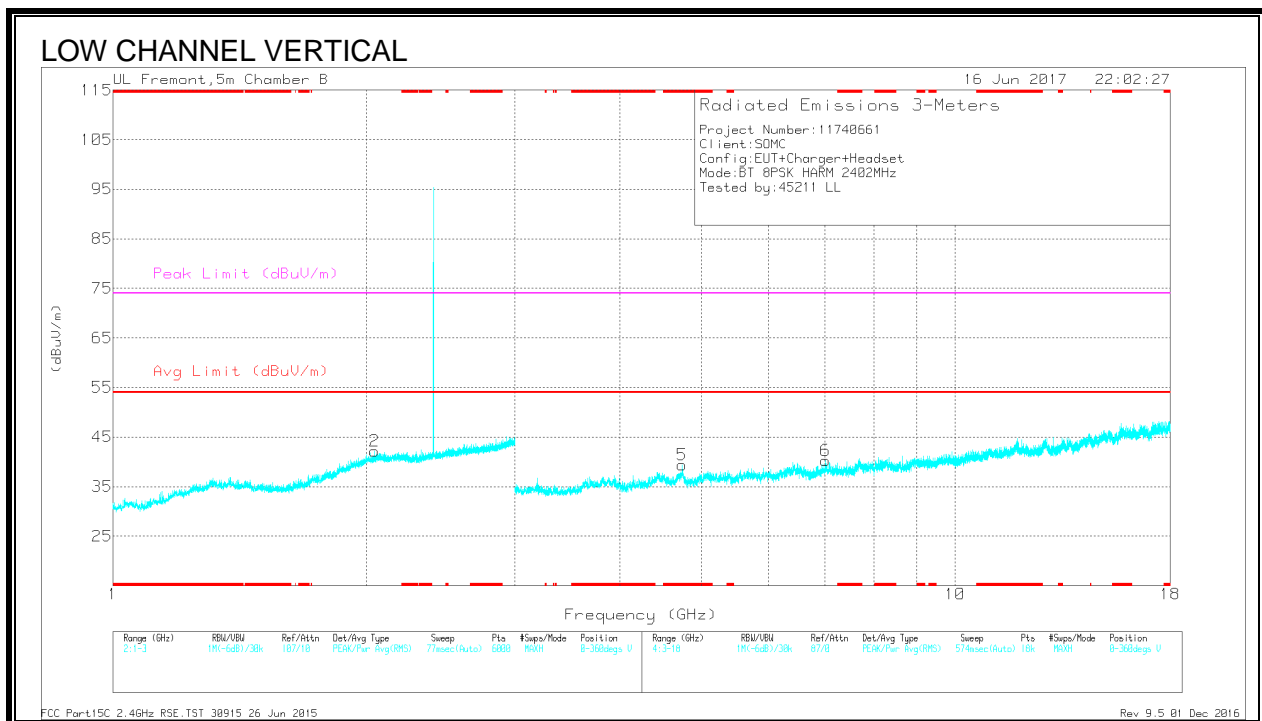
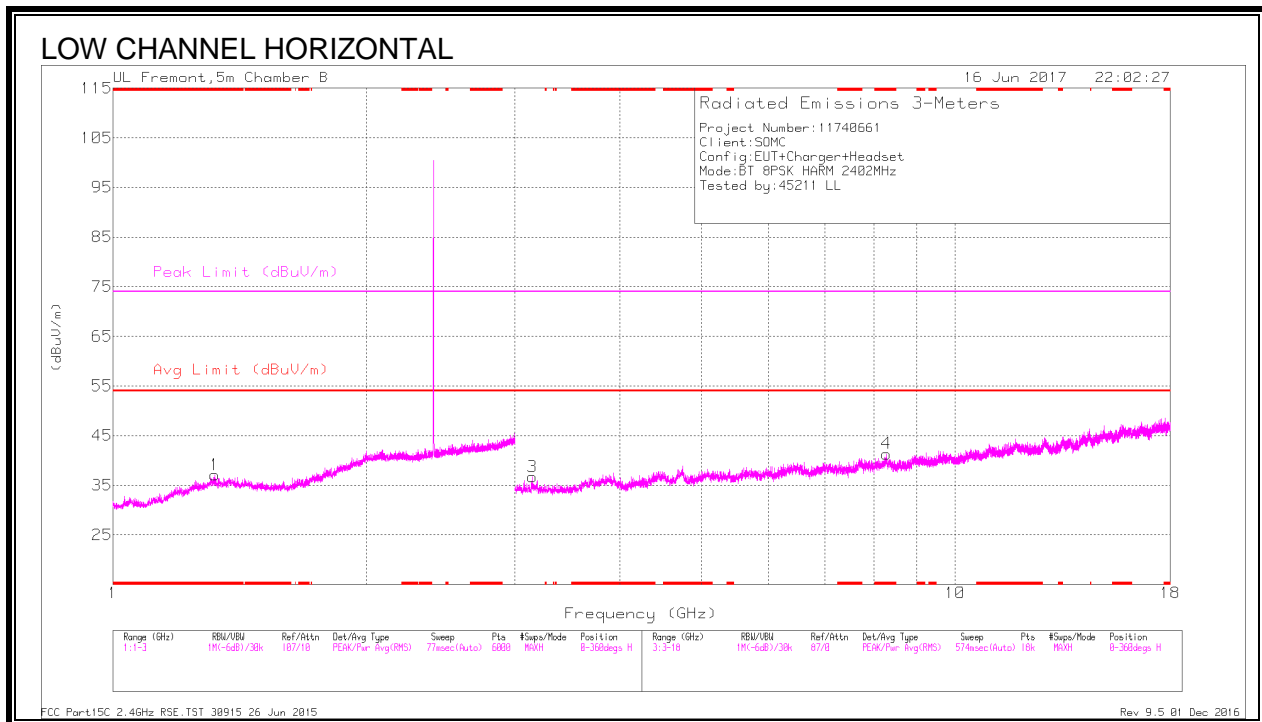

Frequency (GHz)	Meter Reading (dBuV)	Det	AF T346 (dB/m)	Amp/Cbl/Fitr/Pad (dB)	Corrected Reading (dBuV/m)	Avg Limit (dBuV/m)	Margin (dB)	Peak Limit (dBuV/m)	PK Margin (dB)	Azimuth (Degs)	Height (cm)	Polarity
* 1.322	33.47	PKFH	28.9	-21.8	40.57	-	-	74	-33.43	62	199	H
* 1.32	22.54	VA1T	28.9	-21.8	29.64	54	-24.36	-	-	62	199	H
* 8.28	34.89	PKFH	36.5	-25.3	46.09	-	-	74	-27.91	253	199	H
* 8.283	23.37	VA1T	36.5	-25.3	34.57	54	-19.43	-	-	253	199	H
* 4.743	39.04	PKFH	34.4	-28.6	44.84	-	-	74	-29.16	293	199	V
* 4.742	27.1	VA1T	34.4	-28.6	32.9	54	-21.1	-	-	293	199	V
2.043	35.36	PKFH	32.1	-21.1	46.36	-	-	-	-	122	103	V
2.045	23.47	VA1T	32.1	-21.1	34.47	-	-	-	-	122	103	V
3.143	37.82	PKFH	33.1	-30.2	40.72	-	-	-	-	185	103	H
3.145	26.38	VA1T	33	-30.2	29.18	-	-	-	-	185	103	H
7.009	36.01	PKFH	36.2	-28.2	44.01	-	-	-	-	321	104	V
7.011	24.98	VA1T	36.2	-28.1	33.08	-	-	-	-	321	104	V

* - indicates frequency in CFR15.205/RSS-GEN 8.10 -Restricted Band
 PKFH - FHSS: RB=100k/1MHz VB=3 x RB, Peak
 VA1T - FHSS: Linear Voltage Average VB=1/Ton where: Ton is transmit duration

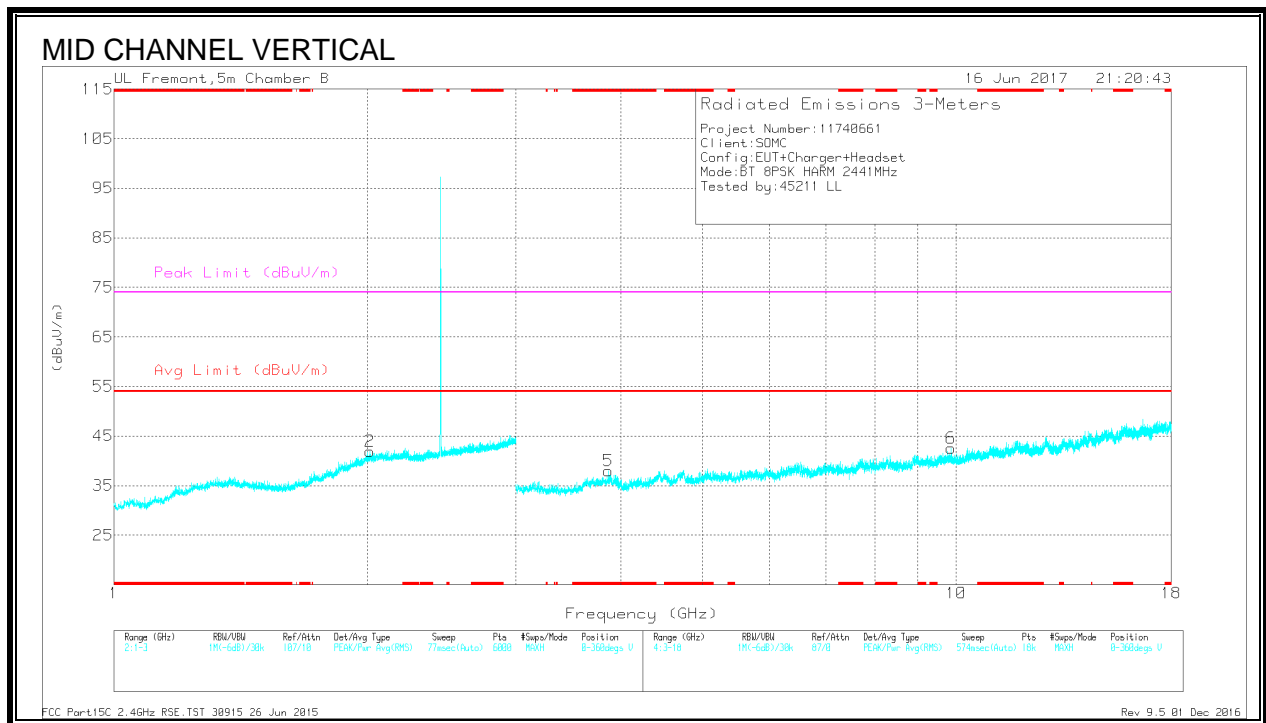
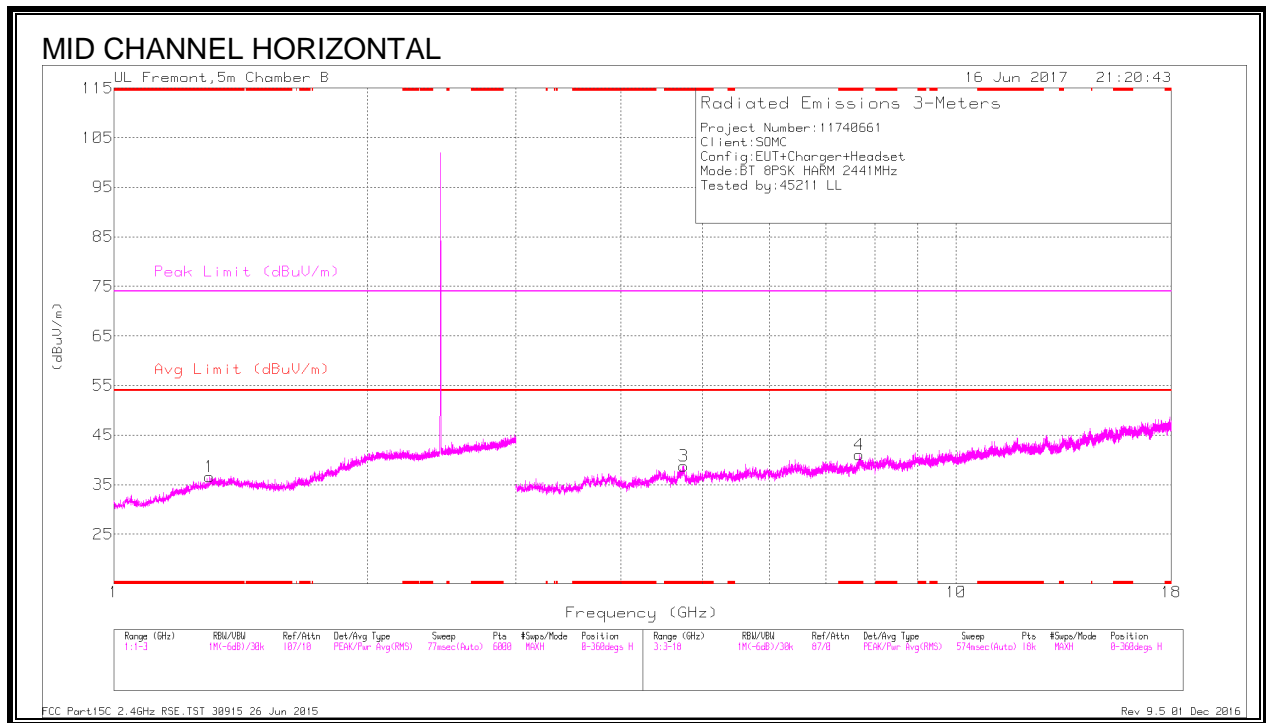

Frequency (GHz)	Meter Reading (dBuV)	Det	AF T346 (dB/m)	Amp/Cbl/Filtr/Pad (dB)	Corrected Reading (dBuV/m)	Avg Limit (dBuV/m)	Margin (dB)	Peak Limit (dBuV/m)	PK Margin (dB)	Azimuth (Degs)	Height (cm)	Polarity
* 1.298	34.25	PKFH	28.9	-22.1	41.05	-	-	74	-32.95	300	199	H
* 1.301	22.33	VA1T	28.9	-21.9	29.33	54	-24.67	-	-	300	199	H
* 4.746	38.64	PKFH	34.4	-28.6	44.44	-	-	74	-29.56	274	104	H
* 4.744	26.92	VA1T	34.4	-28.6	32.72	54	-21.28	-	-	274	104	H
* 7.676	35.59	PKFH	36.5	-26.3	45.79	-	-	74	-28.21	231	104	H
* 7.676	23.43	VA1T	36.5	-26.2	33.73	54	-20.27	-	-	231	104	H
* 3.867	37.92	PKFH	33.7	-29.6	42.02	-	-	74	-31.98	132	199	V
* 3.867	27.11	VA1T	33.7	-29.6	31.21	54	-22.79	-	-	132	199	V
2.011	35.44	PKFH	32.1	-20.8	46.74	-	-	-	-	240	104	V
2.014	23.02	VA1T	32.1	-20.9	34.22	-	-	-	-	240	104	V
9.862	21.61	VA1T	37.6	-24.3	34.91	-	-	-	-	164	104	V
9.863	33.38	PKFH	37.6	-24.3	46.68	-	-	-	-	164	104	V

* - indicates frequency in CFR15.205/RSS-GEN 8.10 -Restricted Band
 PKFH - FHSS: RB=100k/1MHz VB=3 x RB, Peak
 VA1T - FHSS: Linear Voltage Average VB=1/Ton where: Ton is transmit duration

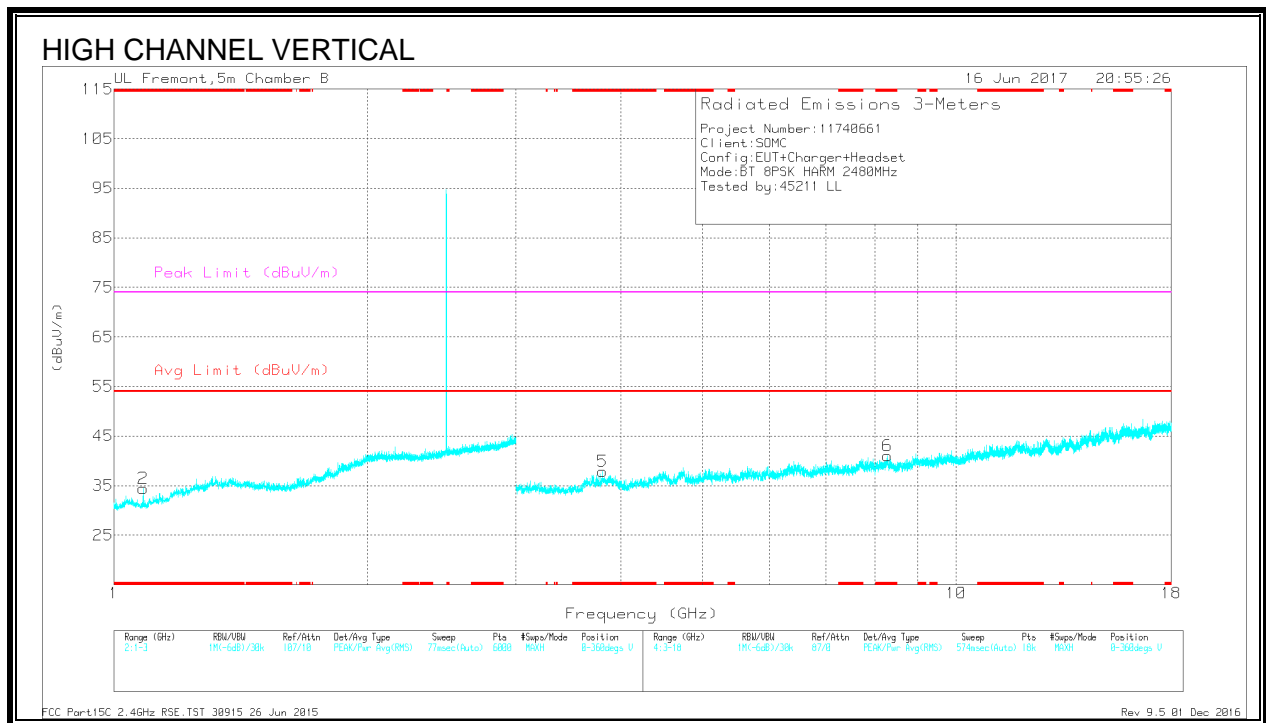
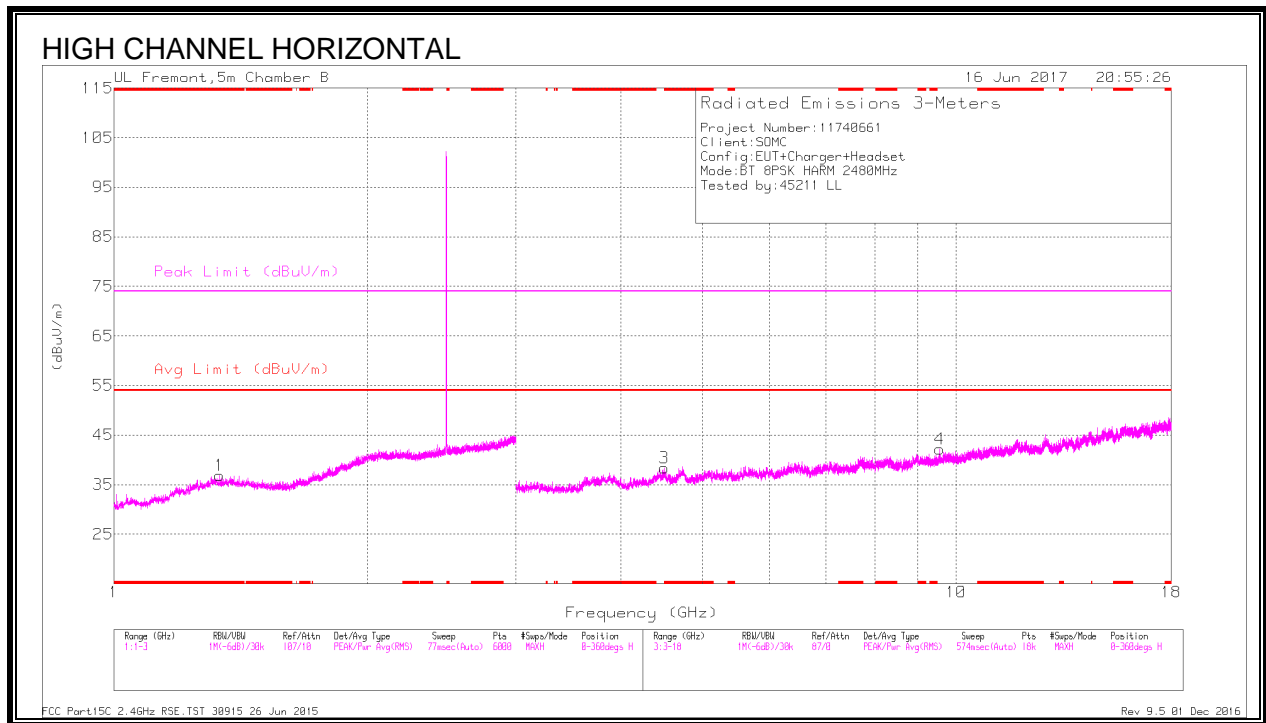

Frequency (GHz)	Meter Reading (dBuV)	Det	AF T346 (dB/m)	Amp/Cbl/Fitr/Pad (dB)	Corrected Reading (dBuV/m)	Avg Limit (dBuV/m)	Margin (dB)	Peak Limit (dBuV/m)	PK Margin (dB)	Azimuth (Degs)	Height (cm)	Polarity
* 1.334	33.52	PKFH	28.9	-21.7	40.72	-	-	74	-33.28	141	199	H
* 1.333	22.26	VA1T	28.9	-21.9	29.26	54	-24.74	-	-	141	199	H
* 1.085	33.1	PKFH	26.4	-23	36.5	-	-	74	-37.5	184	199	V
* 1.084	22.11	VA1T	26.4	-22.9	25.61	54	-28.39	-	-	184	199	V
* 3.806	38.66	PKFH	33.7	-30.3	42.06	-	-	74	-31.94	195	104	V
* 3.806	27.51	VA1T	33.7	-30.3	30.91	54	-23.09	-	-	195	104	V
* 8.281	35.27	PKFH	36.5	-25.3	46.47	-	-	74	-27.53	225	104	V
* 8.282	23.2	VA1T	36.5	-25.3	34.4	54	-19.6	-	-	225	104	V
4.497	37.12	PKFH	34.5	-28.9	42.72	-	-	-	-	232	199	H
4.499	26.28	VA1T	34.5	-29	31.78	-	-	-	-	232	199	H
9.557	32.85	PKFH	37.3	-24	46.15	-	-	-	-	274	104	H
9.559	21.68	VA1T	37.3	-24.1	34.88	-	-	-	-	274	104	H

* - indicates frequency in CFR15.205/RSS-GEN 8.10 -Restricted Band
 PKFH - FHSS: RB=100k/1MHz VB=3 x RB, Peak
 VA1T - FHSS: Linear Voltage Average VB=1/Ton where: Ton is transmit duration

8.4. WORST-CASE BELOW 30 MHz

SPURIOUS EMISSIONS BELOW 30 MHz (WORST-CASE CONFIGURATION)

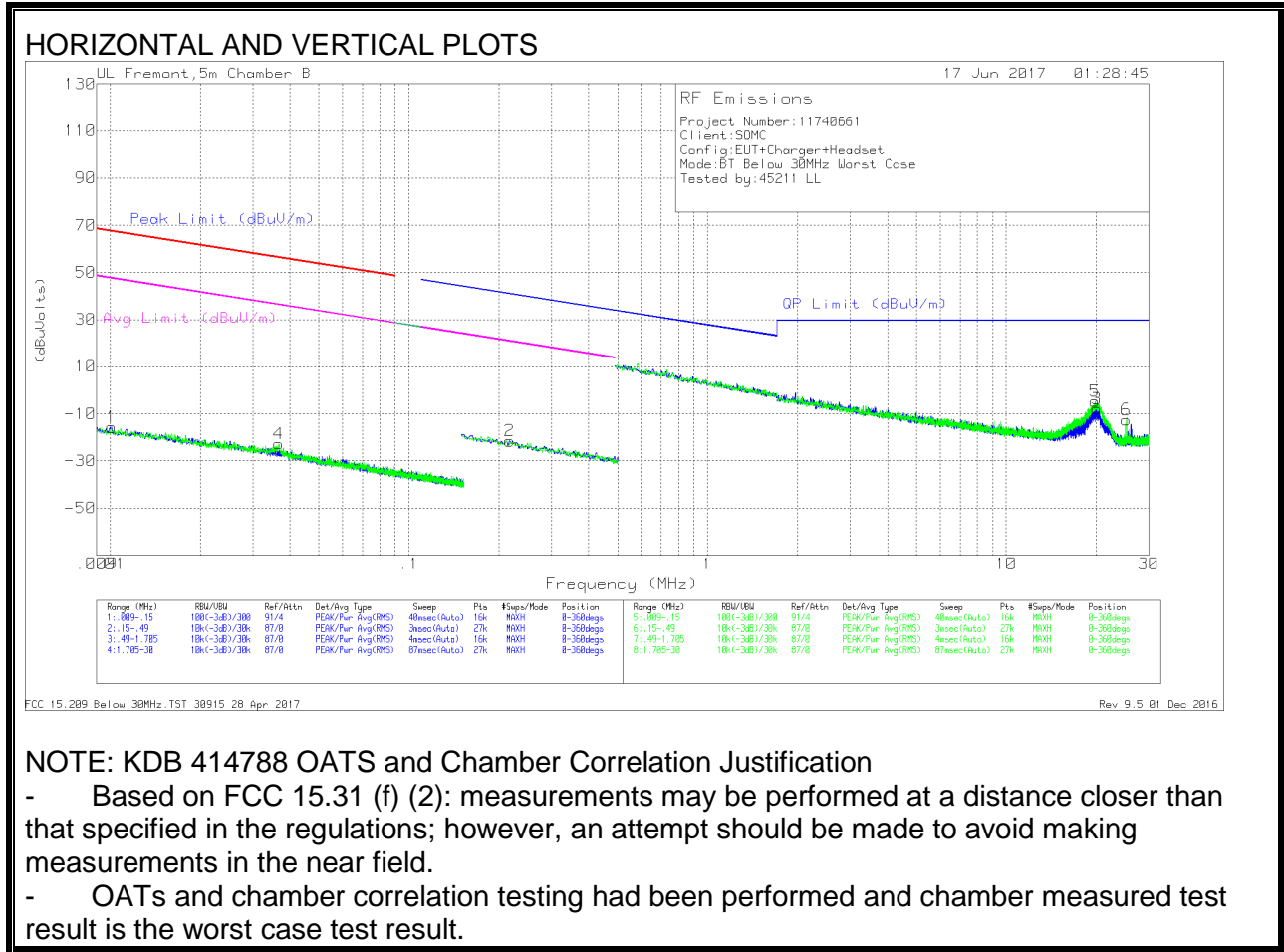

Trace Markers

Marker	Frequency	Meter	Det	Loop Antenna (dB/m)	Cbl (dB)	Dist Corr 300m	Corrected	Peak Limit (dBuV/)	Margin	Avg Limit (dBuV/)	Margin	QP Limit (dBuV/ m)	Margin	QP Limit (dBuV/ m)	Margin	Peak Limit (dBuV/)	Margin	Avg Limit (dBuV/)	Margin	Azimuth	
1	0.0101	43.41	Pk	19.5	1.4	-80	-15.69	67.5	-83.19	47.5	-63.19	-	-	-	-	-	-	-	-	-	0-360
4	0.03666	42.09	Pk	13.7	1.4	-80	-22.81	56.3	-79.11	36.3	-59.11	-	-	-	-	-	-	-	-	-	0-360
2	0.21749	45.46	Pk	11.5	1.5	-80	-21.54	-	-	-	-	-	-	-	-	40.87	-62.41	20.87	-42.41	-	0-360

Pk - Peak detector

Marker	Frequency	Meter	Det	Loop Antenna (dB/m)	Cbl (dB)	Dist Corr (dB) 40Log	Corrected	Peak Limit (dBuV/)	Margin	Avg Limit (dBuV/)	Margin	QP Limit (dBuV/ m)	Margin	QP Limit (dBuV/ m)	Margin	Peak Limit (dBuV/)	Margin	Avg Limit (dBuV/)	Margin	Azimuth	
5	19.82387	23.97	Pk	9.7	1.6	-40	-4.73	-	-	-	-	-	-	-	-	29.5	-34.23	-	-	-	0-360
3	20.06491	20.65	Pk	9.7	1.7	-40	-7.95	-	-	-	-	-	-	-	-	29.5	-37.45	-	-	-	0-360
6	25.23365	16.88	Pk	8.9	1.7	-40	-12.52	-	-	-	-	-	-	-	-	29.5	-42.02	-	-	-	0-360

Pk - Peak detector

8.5. WORST-CASE BELOW 1 GHz

SPURIOUS EMISSIONS 30 TO 1000 MHz (WORST-CASE CONFIGURATION)

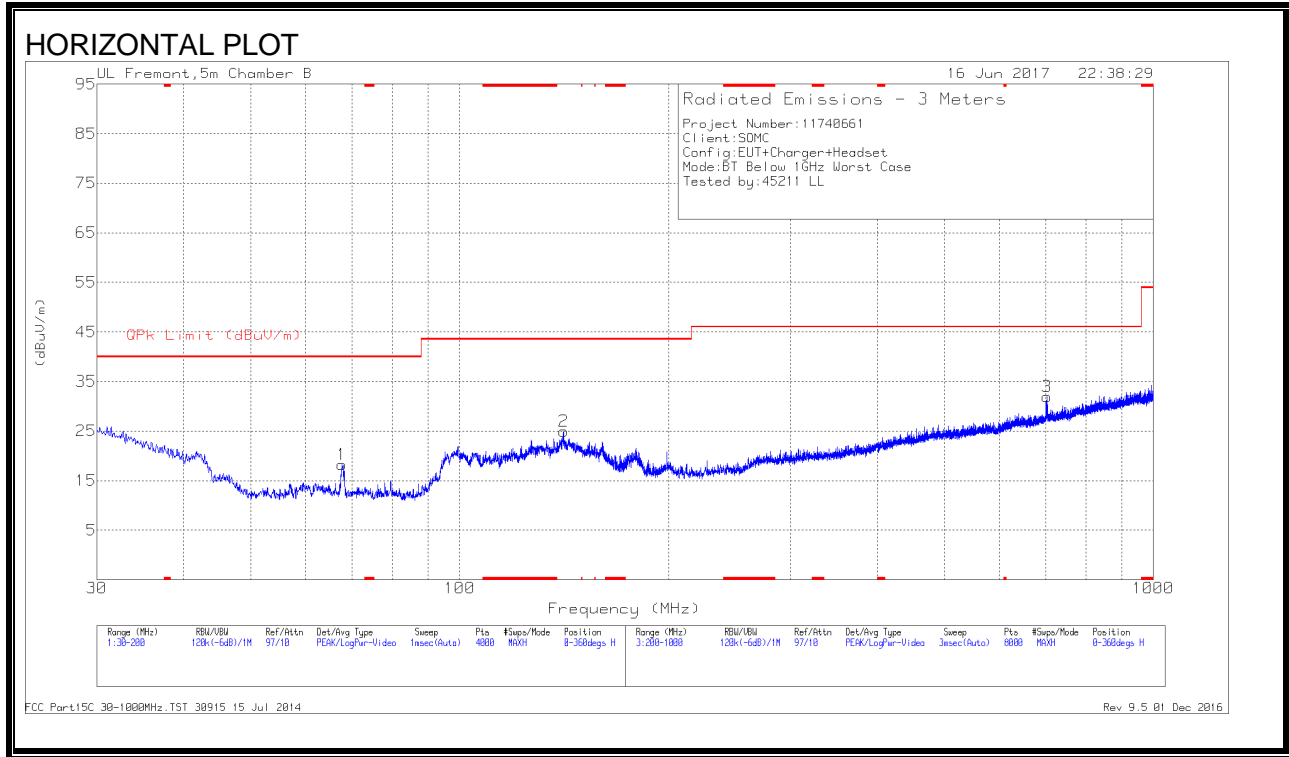

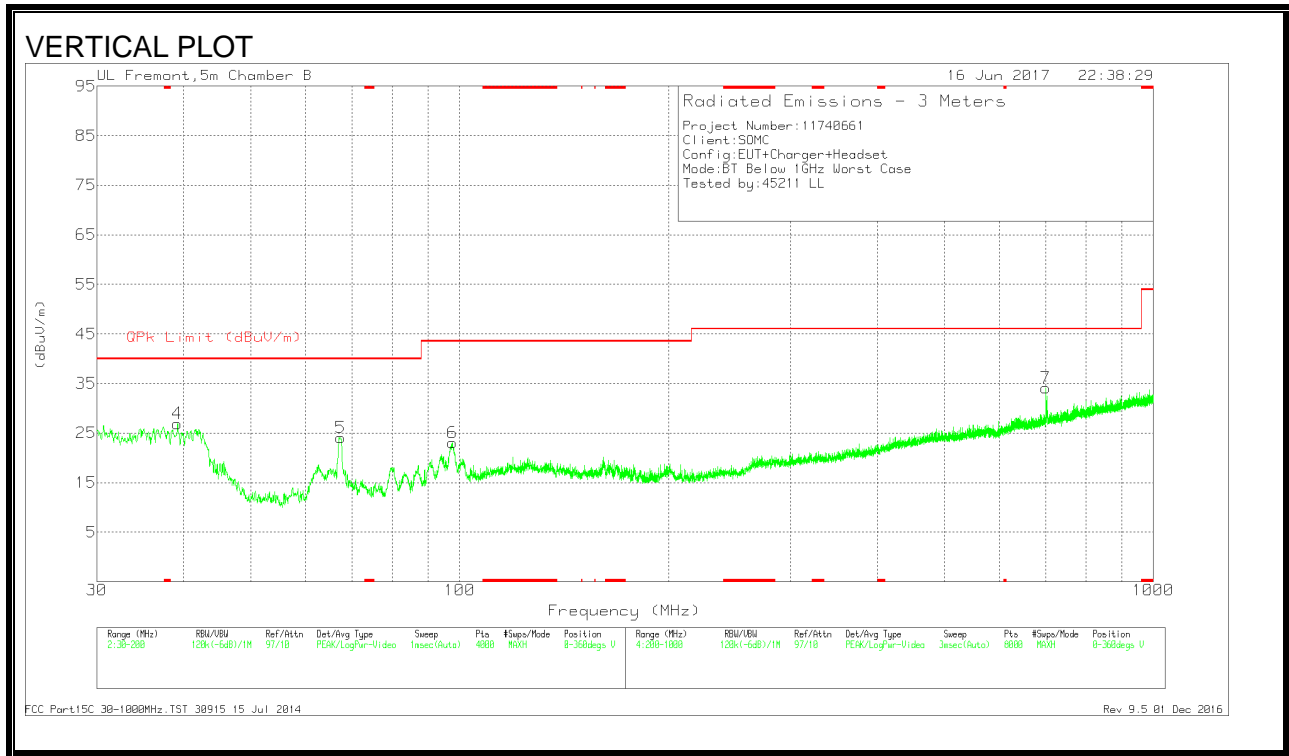

DATA

Marker	Frequency (MHz)	Meter Reading (dBuV)	Det	AF T477 (dB/m)	Amp/Cbl (dB)	Corrected Reading (dBuV/m)	QPk Limit (dBuV/m)	Margin (dB)	Azimuth (Degs)	Height (cm)	Polarity
4	39.1824	36.93	Pk	18.7	-28.7	26.93	40	-13.07	0-360	100	V
5	67.3672	40.46	Pk	11.9	-28.3	24.06	40	-15.94	0-360	100	V
1	67.6647	34.69	Pk	11.9	-28.3	18.29	40	-21.71	0-360	400	H
6	97.5925	37.38	Pk	13.6	-27.9	23.08	43.52	-20.44	0-360	100	V
2	141.1875	35.51	Pk	16.9	-27.4	25.01	43.52	-18.51	0-360	200	H
7	700.165	34.95	Pk	24.1	-25	34.05	46.02	-11.97	0-360	100	V
3	703.3654	32.78	Pk	24.2	-25	31.98	46.02	-14.04	0-360	200	H

Pk - Peak detector

8.6. WORST-CASE ABOVE 18 GHz

SPURIOUS EMISSIONS 18 TO 26 GHz (WORST-CASE CONFIGURATION)

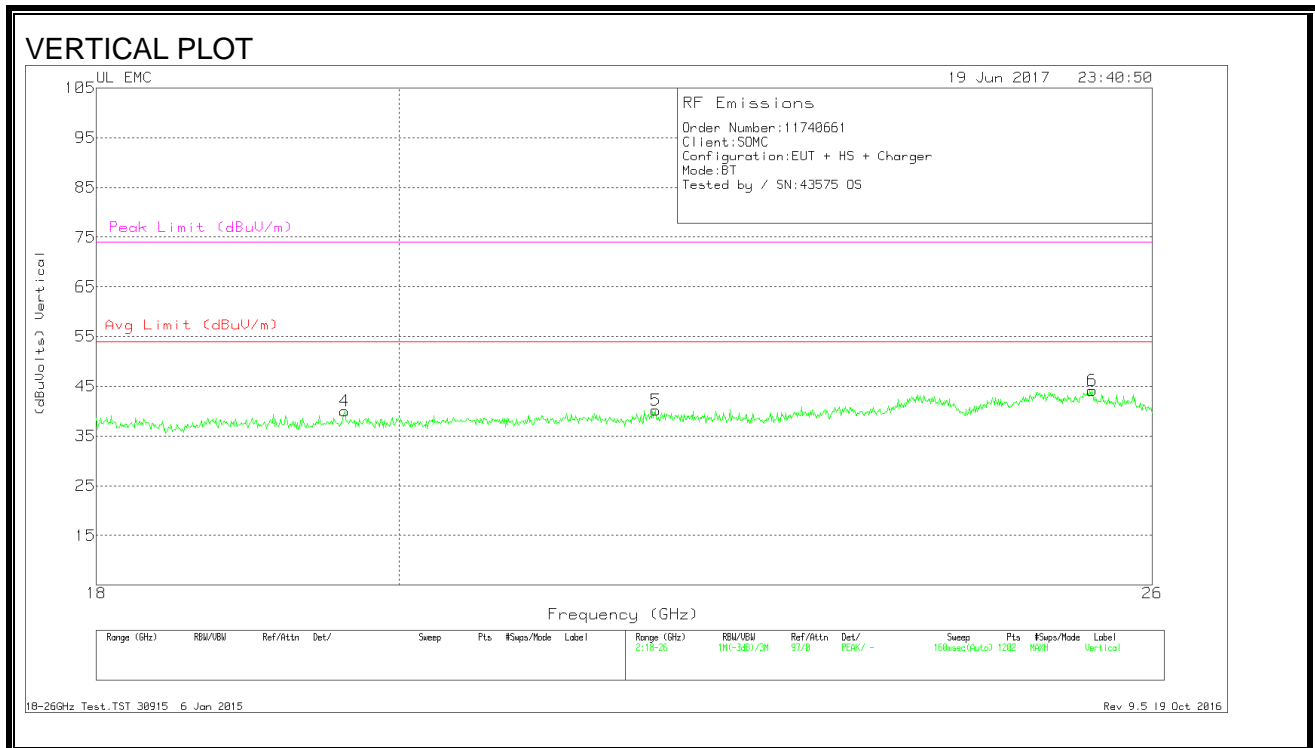
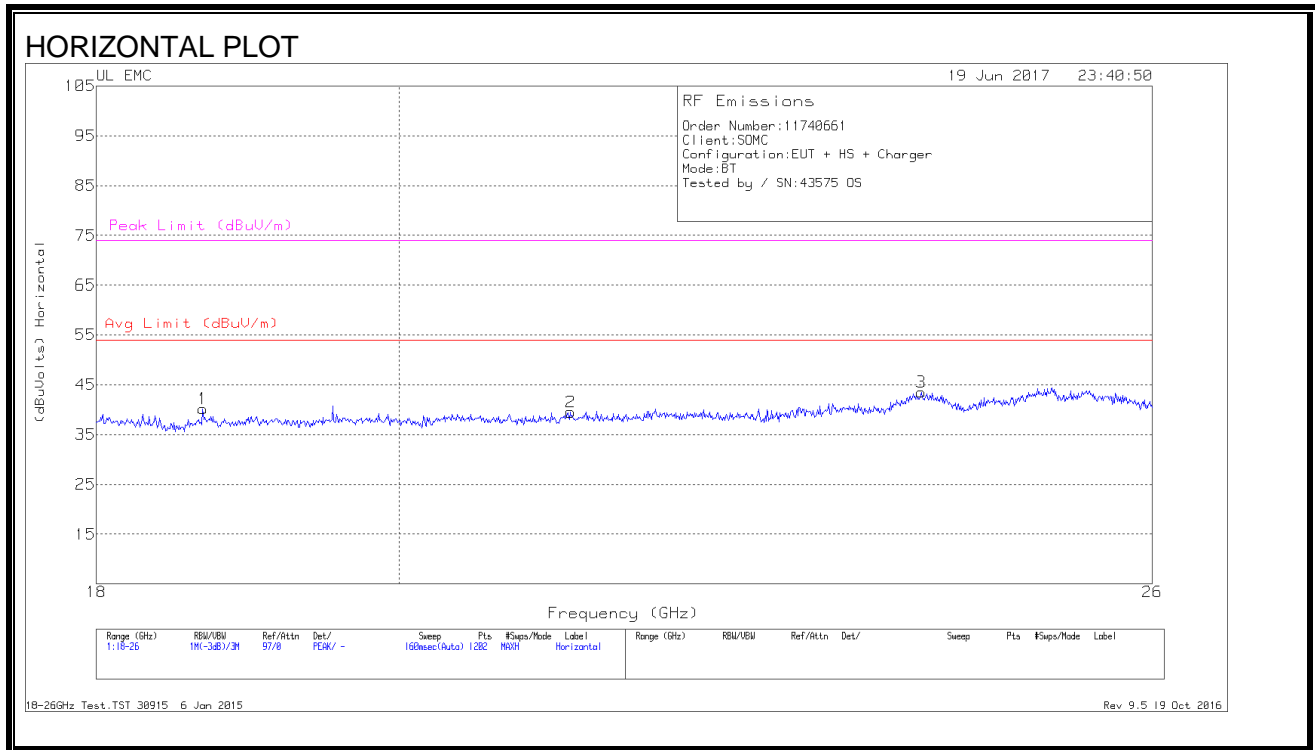

Data

Trace Markers

Marker	Frequency (GHz)	Meter Reading (dBuV)	Det	AF T449 (dB/m)	Amp/Cbl (dB)	Dist Corr (dB)	Corrected Reading (dBuVolts)	Avg Limit (dBuV/m)	Margin (dB)	Peak Limit (dBuV/m)	PK Margin (dB)
1	18.679	41.97	Pk	32.3	-24.6	-9.5	40.17	54	-13.83	74	-33.83
2	21.231	41.1	Pk	33	-25.1	-9.5	39.5	54	-14.5	74	-34.5
3	23.988	43.4	Pk	33.9	-24.3	-9.5	43.5	54	-10.5	74	-30.5
4	19.625	41.7	Pk	32.7	-24.9	-9.5	40	54	-14	74	-34
5	21.87	41.07	Pk	33.3	-24.7	-9.5	40.17	54	-13.83	74	-33.83
6	25.46	43.77	Pk	34.4	-24.5	-9.5	44.17	54	-9.83	74	-29.83

Pk - Peak detector

9. AC POWER LINE CONDUCTED EMISSIONS

LIMITS

FCC §15.207 (a)

RSS-Gen 8.8

Frequency of Emission (MHz)	Conducted Limit (dB μ V)	
	Quasi-peak	Average
0.15-0.5	66 to 56 *	56 to 46 *
0.5-5	56	46
5-30	60	50

*Decreases with the logarithm of the frequency.

TEST PROCEDURE

The EUT is placed on a non-conducting table 40 cm from the vertical ground plane and 80 cm above the horizontal ground plane. The EUT is configured in accordance with ANSI C63.10.

The receiver is set to a resolution bandwidth of 9 kHz. Peak detection is used unless otherwise noted as quasi-peak or average.

Line conducted data is recorded for both NEUTRAL and HOT lines.

RESULTS

LINE 1 RESULTS

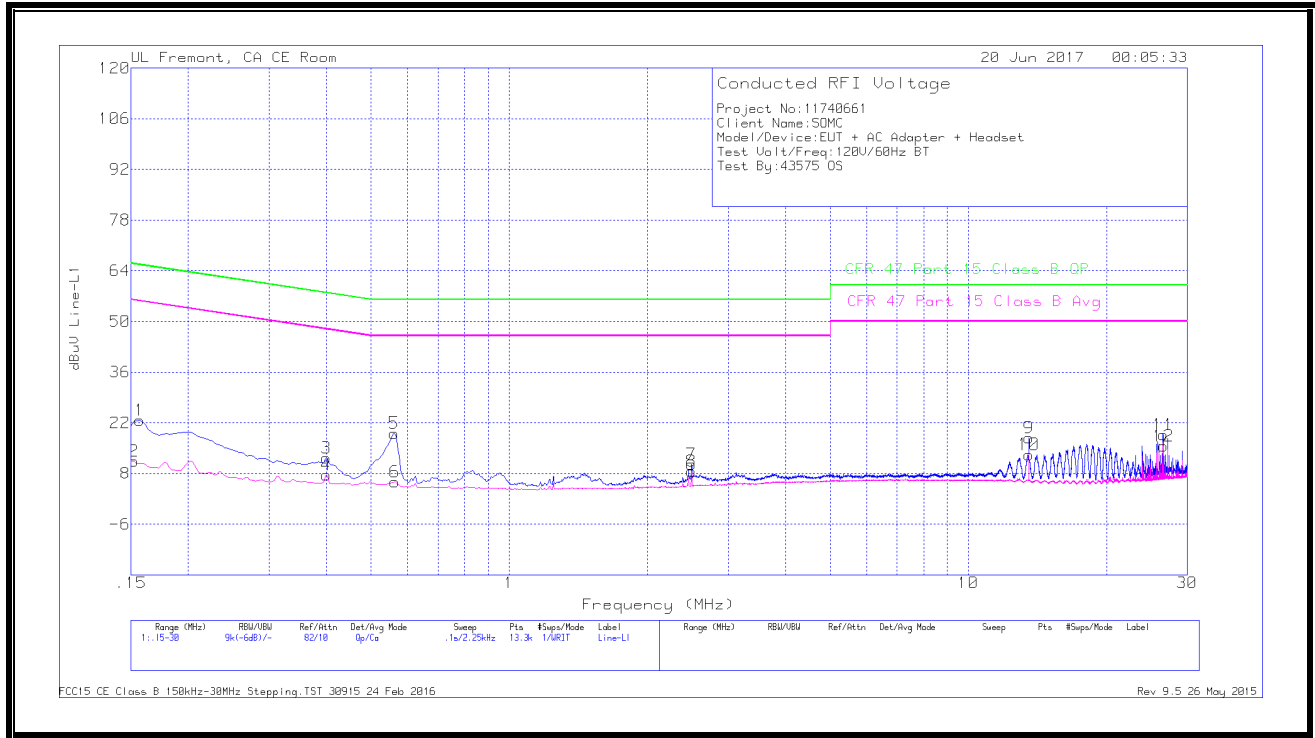

WORST EMISSIONS

Trace Markers

Range 1: Line-L1 .15 - 30MHz											
Marker	Frequency (MHz)	Meter Reading (dBuV)	Det	T24 IL L1	LC Cables C1&C3	Limiter (dB)	Corrected Reading dBuV	CFR 47 Part 15 Class B QP	QP Margin (dB)	CFR 47 Part 15 Class B Avg	Av(CISPR) Margin (dB)
1	.15675	11.26	Qp	1.2	.1	10.1	22.66	65.63	-42.97	-	-
2	.15225	-.06	Ca	1.3	.1	10.1	11.44	-	-	55.88	-44.44
3	.39975	1.75	Qp	.4	.1	10.1	12.35	57.86	-45.51	-	-
4	.39975	-3.03	Ca	.4	.1	10.1	7.57	-	-	47.86	-40.29
5	.56175	8.64	Qp	.3	.1	10.1	19.14	56	-36.86	-	-
6	.564	-4.89	Ca	.3	.1	10.1	5.61	-	-	46	-40.39
7	2.49675	.12	Qp	.2	.1	10.1	10.52	56	-45.48	-	-
8	2.49675	-1.84	Ca	.2	.1	10.1	8.56	-	-	46	-37.44
9	13.56	7.2	Qp	.2	.2	10.2	17.8	60	-42.2	-	-
10	13.56	2.63	Ca	.2	.2	10.2	13.23	-	-	50	-36.77
11	26.61225	7.6	Qp	.3	.3	10.5	18.7	60	-41.3	-	-
12	26.61225	4.41	Ca	.3	.3	10.5	15.51	-	-	50	-34.49

Qp - Quasi-Peak detector

Ca - CISPR average detection

LINE 2 RESULTS

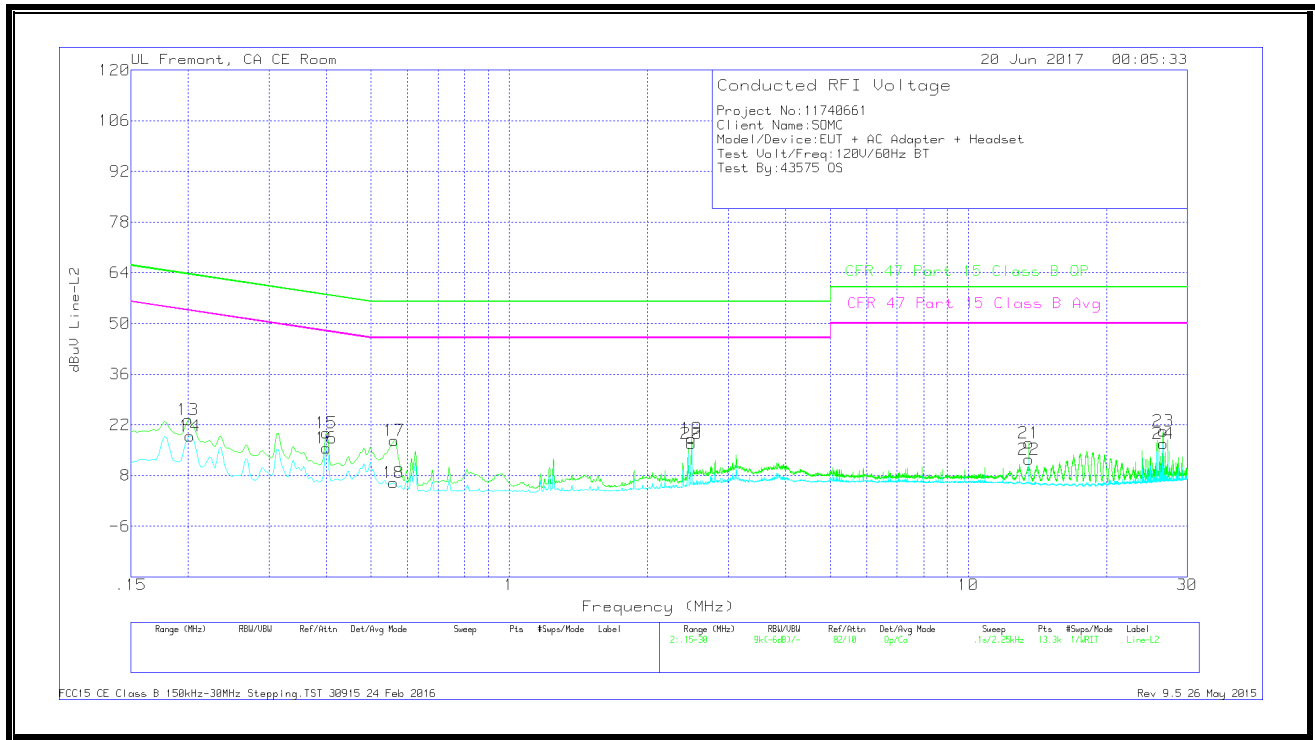

WORST EMISSIONS

Trace Markers

Range 2: Line-L2 .15 - 30MHz											
Marker	Frequency (MHz)	Meter Reading (dBuV)	Det	T24 IL L2	LC Cables C2&C3	Limiter (dB)	Corrected Reading dBuV	CFR 47 Part 15 Class B QP	QP Margin (dB)	CFR 47 Part 15 Class B Avg	Av(CISPR) Margin (dB)
13	.1995	12.28	Qp	1	.1	10.1	23.48	63.63	-40.15	-	-
14	.20175	7.74	Ca	1	.1	10.1	18.94	-	-	53.54	-34.6
15	.39975	9.23	Qp	.4	.1	10.1	19.83	57.86	-38.03	-	-
16	.39975	5.05	Ca	.4	.1	10.1	15.65	-	-	47.86	-32.21
17	.56175	7.12	Qp	.3	.1	10.1	17.62	56	-38.38	-	-
18	.5595	-4.48	Ca	.3	.1	10.1	6.02	-	-	46	-39.98
19	2.49675	7.84	Qp	.2	.1	10.1	18.24	56	-37.76	-	-
20	2.49675	6.45	Ca	.2	.1	10.1	16.85	-	-	46	-29.15
21	13.56	6.23	Qp	.3	.2	10.2	16.93	60	-43.07	-	-
22	13.56	1.79	Ca	.3	.2	10.2	12.49	-	-	50	-37.51
23	26.61225	9.17	Qp	.3	.3	10.5	20.27	60	-39.73	-	-
24	26.61225	5.76	Ca	.3	.3	10.5	16.86	-	-	50	-33.14

Qp - Quasi-Peak detector

Ca - CISPR average detection