



# **CERTIFICATION TEST REPORT**

**Report Number. :** 11740661-E3V2

**Applicant :** SONY MOBILE COMMUNICATIONS, INC.  
4-12-3 HIGASHI-SHINAGAWA,  
SHINAGAWA -KU, TOKYO, 140-0002, JAPAN

**FCC ID :** PY7-81775I

**EUT Description :** GSM/WCDMA/LTE Phone with BT, DTS/UNII a/b/g/n/ac, GPS & NFC

**Test Standard(s) :** FCC 47 CFR PART 15 SUBPART C

**Date Of Issue:**

July 11, 2017

**Prepared by:**

UL Verification Services Inc.  
47173 Benicia Street  
Fremont, CA 94538, U.S.A.  
TEL: (510) 771-1000  
FAX: (510) 661-0888



NVLAP LAB CODE 200065-0

Revision History

<u>Rev.</u>	<u>Issue Date</u>	<u>Revisions</u>	<u>Revised By</u>
V1	06/23/17	Initial Issue	D. Coronia
V2	07/08/17	Updated Section 2, 5.2, 5.5, 7, 8.1 & 8.6	D. Coronia
V3	07/11/17	Updated Section 5.3 & 9.1	D. Coronia

## TABLE OF CONTENTS

<b>1. ATTESTATION OF TEST RESULTS</b> .....	<b>5</b>
<b>2. TEST METHODOLOGY</b> .....	<b>6</b>
<b>3. FACILITIES AND ACCREDITATION</b> .....	<b>6</b>
<b>4. CALIBRATION AND UNCERTAINTY</b> .....	<b>7</b>
4.1. <i>MEASURING INSTRUMENT CALIBRATION</i> .....	7
4.2. <i>SAMPLE CALCULATION</i> .....	7
4.3. <i>MEASUREMENT UNCERTAINTY</i> .....	7
<b>5. EQUIPMENT UNDER TEST</b> .....	<b>8</b>
5.1. <i>DESCRIPTION OF EUT</i> .....	8
5.2. <i>MAXIMUM OUTPUT POWER</i> .....	8
5.3. <i>DESCRIPTION OF AVAILABLE ANTENNAS</i> .....	8
5.4. <i>SOFTWARE AND FIRMWARE</i> .....	8
5.5. <i>WORST-CASE CONFIGURATION AND MODE</i> .....	8
5.6. <i>DESCRIPTION OF TEST SETUP</i> .....	9
<b>6. TEST AND MEASUREMENT EQUIPMENT</b> .....	<b>12</b>
<b>7. SUMMARY TABLE</b> .....	<b>13</b>
<b>8. ANTENNA PORT TEST RESULTS</b> .....	<b>14</b>
8.1. <i>MEASUREMENT METHODS</i> .....	14
8.2. <i>ON TIME, DUTY CYCLE</i> .....	15
8.3. <i>6 dB BANDWIDTH</i> .....	17
8.4. <i>99% BANDWIDTH</i> .....	21
8.5. <i>AVERAGE POWER</i> .....	25
8.6. <i>OUTPUT POWER</i> .....	26
8.7. <i>POWER SPECTRAL DENSITY</i> .....	30
8.8. <i>CONDUCTED BANDEDGE AND SPURIOUS EMISSIONS</i> .....	34
<b>9. RADIATED TEST RESULTS</b> .....	<b>42</b>
9.1. <i>LIMITS AND PROCEDURE</i> .....	42
9.2. <i>TRANSMITTER ABOVE 1 GHz</i> .....	43
9.2.1. <i>RESTRICTED BANDEDGE (LOW CHANNEL)</i> .....	43

---

9.2.2.	AUTHORIZED BANDEDGE (HIGH CHANNEL) .....	45
9.3.	SPURIOUS EMISSIONS BELOW 30 MHz (WORST-CASE CONFIGURATION).....	53
9.4.	SPURIOUS EMISSIONS 30 TO 1000 MHz (WORST-CASE CONFIGURATION).....	55
9.5.	WORST-CASE 18 to 26 GHz .....	57
<b>10.</b>	<b>AC POWER LINE CONDUCTED EMISSIONS .....</b>	<b>59</b>
<b>11.</b>	<b>SETUP PHOTOS .....</b>	<b>62</b>

# 1. ATTESTATION OF TEST RESULTS

**COMPANY NAME:** SONY MOBILE COMMUNICATIONS, INC.  
4-12-3 HIGASHI-SHINAGAWA,  
SHINAGAWA -KU, TOKYO, 140-0002, JAPAN

**EUT DESCRIPTION:** GSM/WCDMA/LTE Phone with BT, DTS/UNII a/b/g/n/ac, GPS & NFC

**SERIAL NUMBER:** RADIATED: CB512DQZV2, CB512DQZU5  
CONDUCTED: CB512DHRTV, CB512DHRVC

**DATE TESTED:** JUNE 08 - 20, 2017

APPLICABLE STANDARDS	
STANDARD	TEST RESULTS
CFR 47 Part 15 Subpart C	Pass

UL Verification Services Inc. tested the above equipment in accordance with the requirements set forth in the above standards. All indications of Pass/Fail in this report are opinions expressed by UL Verification Services Inc. based on interpretations and/or observations of test results. Measurement Uncertainties were not taken into account and are published for informational purposes only. The test results show that the equipment tested is capable of demonstrating compliance with the requirements as documented in this report.

**Note:** The results documented in this report apply only to the tested sample, under the conditions and modes of operation as described herein. This document may not be altered or revised in any way unless done so by UL Verification Services Inc. and all revisions are duly noted in the revisions section. Any alteration of this document not carried out by UL Verification Services Inc. will constitute fraud and shall nullify the document. This report must not be used by the client to claim product certification, approval, or endorsement by NVLAP, NIST, any agency of the Federal Government, or any agency of any government.

Approved & Released For  
UL Verification Services Inc. By:



DAN CORONIA  
WISE PROJECT LEAD  
UL VERIFICATION SERVICES INC.

Prepared By:



JASON QIAN  
WISE LAB ENGINEER  
UL VERIFICATION SERVICES INC.

## 2. TEST METHODOLOGY

The tests documented in this report were performed in accordance with FCC CFR 47 Part 2, FCC CFR 47 Part 15, KDB 558074 D01 v04 and ANSI C63.10-2013.

## 3. FACILITIES AND ACCREDITATION

The test sites and measurement facilities used to collect data are located at 47173 and 47266 Benicia Street, Fremont, California, USA. Line conducted emissions are measured only at the 47173 address. The following table identifies which facilities were utilized for radiated emission measurements documented in this report. Specific facilities are also identified in the test results sections.

47173 Benicia Street	47266 Benicia Street
<input type="checkbox"/> Chamber A(IC: 2324B-1)	<input type="checkbox"/> Chamber D(IC: 22541-1)
<input checked="" type="checkbox"/> Chamber B(IC: 2324B-2)	<input type="checkbox"/> Chamber E(IC: 22541-2)
<input checked="" type="checkbox"/> Chamber C(IC: 2324B-3)	<input type="checkbox"/> Chamber F(IC: 22541-3)
	<input type="checkbox"/> Chamber G(IC: 22541-4)
	<input type="checkbox"/> Chamber H(IC: 22541-5)

The above test sites and facilities are covered under FCC Test Firm Registration # 208313. UL Verification Services Inc. is accredited by NVLAP, Laboratory Code 200065-0. Chambers A through C are covered under Industry Canada company address code 2324B with site numbers 2324B -1 through 2324B-3, respectively. Chambers D through H are covered under Industry Canada company address code 22541 with site numbers 22541 -1 through 22541-5, respectively.

## 4. CALIBRATION AND UNCERTAINTY

### 4.1. MEASURING INSTRUMENT CALIBRATION

The measuring equipment utilized to perform the tests documented in this report has been calibrated in accordance with the manufacturer's recommendations, and is traceable to recognized national standards.

### 4.2. SAMPLE CALCULATION

Where relevant, the following sample calculation is provided:

$$\begin{aligned} \text{Field Strength (dBuV/m)} &= \text{Measured Voltage (dBuV)} + \text{Antenna Factor (dB/m)} + \\ &\text{Cable Loss (dB)} - \text{Preamp Gain (dB)} \\ 36.5 \text{ dBuV} + 18.7 \text{ dB/m} + 0.6 \text{ dB} - 26.9 \text{ dB} &= 28.9 \text{ dBuV/m} \end{aligned}$$

### 4.3. MEASUREMENT UNCERTAINTY

Where relevant, the following measurement uncertainty levels have been estimated for tests performed on the apparatus:

Parameter	Uncertainty
Worst Case Conducted Disturbance, 9KHz to 0.15 MHz	3.84 dB
Worst Case Conducted Disturbance, 0.15 to 30 MHz	3.65 dB
Worst Case Radiated Disturbance, 9KHz to 30 MHz	3.15 dB
Worst Case Radiated Disturbance, 30 to 1000 MHz	5.36 dB
Worst Case Radiated Disturbance, 1000 to 18000 MHz	4.32 dB
Worst Case Radiated Disturbance, 18000 to 26000 MHz	4.45 dB
Worst Case Radiated Disturbance, 26000 to 40000 MHz	5.24 dB

Uncertainty figures are valid to a confidence level of 95%.

## 5. EQUIPMENT UNDER TEST

### 5.1. DESCRIPTION OF EUT

The EUT is a GSM/WCDMA/LTE Phone with BT, DTS/UNII a/b/g/n/ac, GPS & NFC.

### 5.2. MAXIMUM OUTPUT POWER

The transmitter has a maximum peak conducted output power as follows:

Frequency Range (MHz)	Mode	Output Power (dBm)	Output Power (mW)
2402 - 2480	BLE (1Mbps)	7.09	5.12

### 5.3. DESCRIPTION OF AVAILABLE ANTENNAS

The radio utilizes integrated antenna, with the maximum gains:

Frequency Band (GHz)	Antenna Gain (dBi)
2402-2480	-2.80

### 5.4. SOFTWARE AND FIRMWARE

The firmware installed in the EUT during testing was SONY, s\_atp\_1\_00139\_B\_10\_5.  
The test utility software used during testing was Tera Term Ver 4.79.

### 5.5. WORST-CASE CONFIGURATION AND MODE

Radiated band edge, harmonics, and spurious emissions from 1 GHz to 18GHz were performed with the EUT was set to transmit at the Low/Middle/High channels.

Radiated emission below 30MHz, below 1GHz, above 18GHz, and power line conducted emission were performed with the EUT was set to transmit at the channel with highest output power as worst-case scenario.

The fundamental of the EUT was investigated in three orthogonal orientations X, Y, & Z, and it was determined that Y-Axis orientation was worst-case orientation; therefore, all final radiated testing was performed with the EUT in Y-Axis orientation.

Worst-case data rates as provided by the client were:

1Mbps  
2Mbps



## 5.6. DESCRIPTION OF TEST SETUP

### SUPPORT EQUIPMENT

Support Equipment List				
Description	Manufacturer	Model	Serial Number	FCC ID
Laptop	Lenovo	20B7S0A200	PC015REW	NA
AC Adapter	SONY	1300-7137.1	4016W40310044	NA
Headphones	SONY	N/A	N/A	N/A

### I/O CABLES (CONDUCTED TEST)

I/O Cable List						
Cable No	Port	# of identical ports	Connector Type	Cable Type	Cable Length (m)	Remarks
1	Antenna	1	RF	Shielded	0.2	To spectrum Analyzer
2	USB	1	USB	Shielded	1	N/A
3	DC	1	DC	Shielded	0.3	N/A

### I/O CABLES (RADIATED AND CONDUCTED EMISSIONS)

I/O Cable List						
Cable No	Port	# of identical ports	Connector Type	Cable Type	Cable Length (m)	Remarks
1	USB	1	USB	Shielded	3	N/A
2	Audio	1	3.5mm	Shielded	1	N/A

**TEST SETUP**

**CONDUCTED TEST SETUP DIAGRAM**

The EUT was tested connected to a host Laptop via USB cable adapter and spectrum analyzer to antenna port. Test software exercised the EUT.

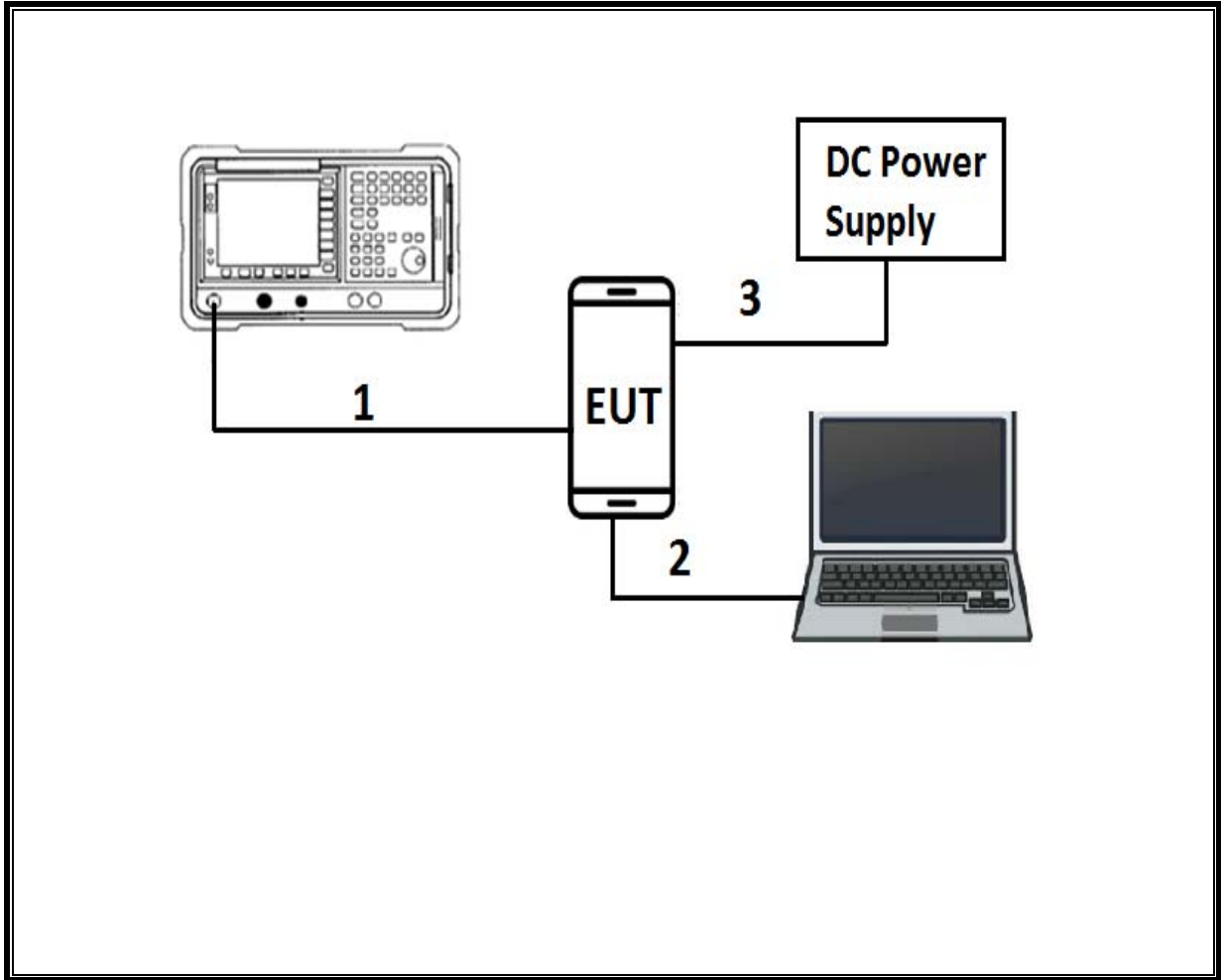

**TEST SETUP**

**RADIATED AND AC LINE CONDUCTED EMISSIONS SETUP DIAGRAM**

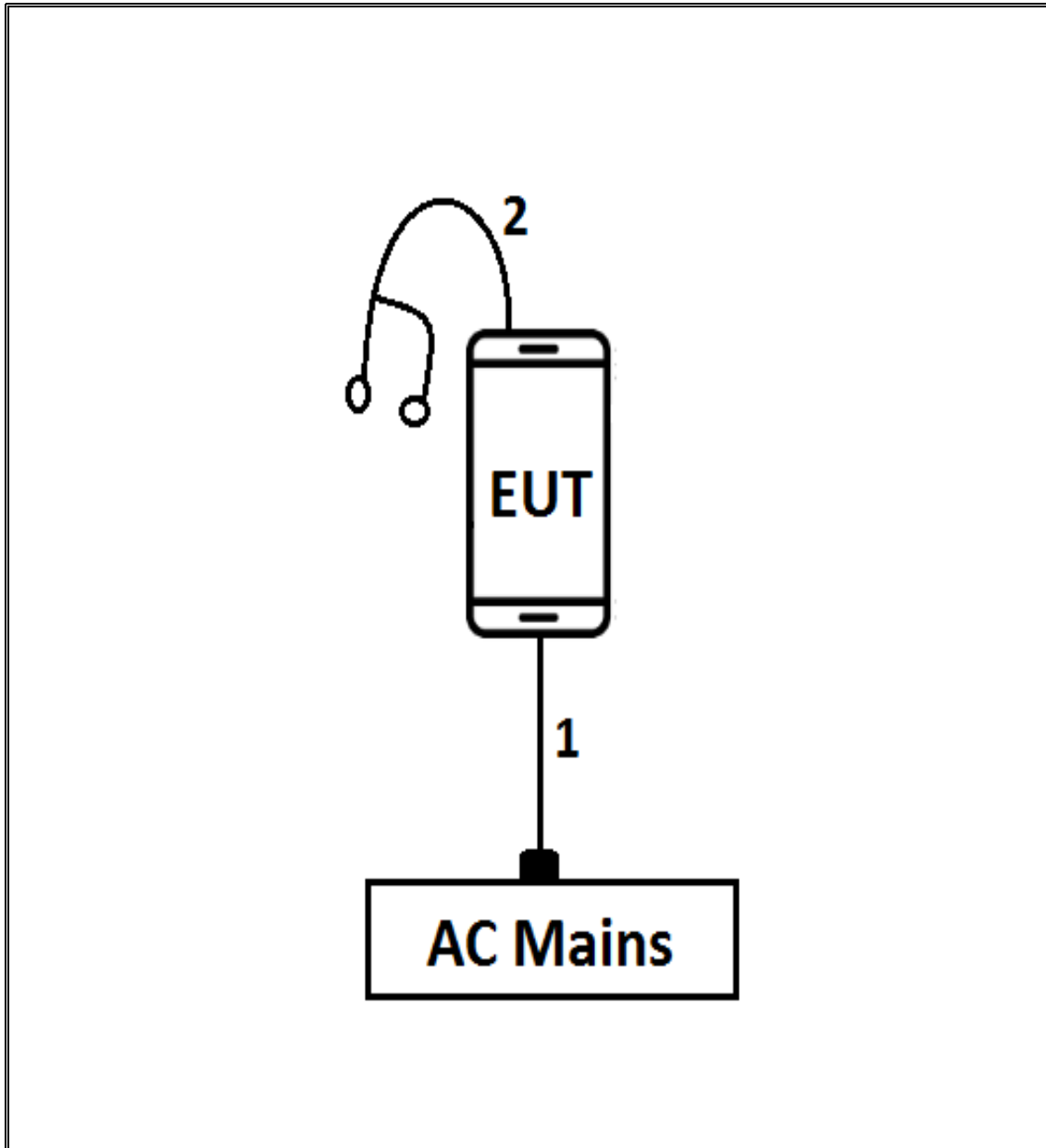

## 6. TEST AND MEASUREMENT EQUIPMENT

The following test and measurement equipment was utilized for the tests documented in this report:

TEST EQUIPMENT LIST				
Description	Manufacturer	Model	Asset	Cal Due
Antenna, Broadband Hybrid, 30MHz to 2000MHz w/4dB Pad	Sunol Sciences Corp.	JB3	T477	06/22/2017
Antenna, Active Loop 9kHz-30MHz	ETS-Lindgren	6502	T1683	02/17/2018
Antenna, Horn 1-18GHz	ETS-Lindgren	3117	T345	03/07/2018
Antenna, Horn 18-26.5GHz	ARA	MWH-1826/B	T449	05/26/2018
Power Meter, P-series single channel	Agilent (Keysight) Technologies	N1911A	T1264	07/08/2017
Power Sensor, P – series, 50MHz to 18GHz, Wideband	Agilent (Keysight) Technologies	N1921A	T413	06/20/2017
Amplifier, 1-26.5GHz	Agilent (Keysight) Technologies	8449B	T404	07/05/2017
Amplifier, 10kHz-1GHz	Agilent (Keysight) Technologies	8447D	T15	08/26/2017
RF Amplifier	MITEQ	AFS42-00101800-25-S-42	T493	02/15/2018
Spectrum Analyzer, PSA, 3Hz to 26.5GHz	Agilent (Keysight) Technologies	E4440A	T199	07/22/2017
Spectrum Analyzer, PXA, 3Hz to 44GHz	Agilent (Keysight) Technologies	N9030A	T907	01/23/2018
Spectrum Analyzer, PSA, 3Hz to 26.5GHz	Agilent (Keysight) Technologies	E9030A	T905	01/11/2018
LISN	FISCHER	FCC-LISN-50/250-25-2-01	T1310	01/17/2018

Test Software List			
Description	Manufacturer	Model	Version
Radiated Software	UL	UL EMC	Ver 9.5, Apr 26, 2016
Conducted Software	UL	UL EMC	Ver 9.5, May 26, 2015
Antenna Port Software	UL	UL RF	Ver 5.1.1, July 15, 2016

## 7. SUMMARY TABLE

FCC Part Section	Test Description	Test Limit	Test Condition	Test Result
15.247 (a)(2)	Occupied Band width (6dB)	>500KHz	Conducted	Pass
2.1051, 15.247 (d)	Band Edge / Conducted Spurious Emission	-20dBc		Pass
15.247	TX conducted output power	<30dBm		Pass
15.247	PSD	<8dBm		Pass
15.207 (a)	AC Power Line conducted emissions	Section 10	Radiated	Pass
15.205, 15.209, 15.247(d)	Radiated Spurious Emission	< 54dBuV/m		Pass

## 8. ANTENNA PORT TEST RESULTS

### 8.1. MEASUREMENT METHODS

6 dB BW: KDB 558074 D01 v04, Section 8.1.

Output Power: KDB 558074 D01 v04, Section 9.1.1.

Power Spectral Density: KDB 558074 D01 v04, Section 10.2.

Out-of-band emissions in non-restricted bands: KDB 558074 D01 v04, Section 11.0.

Out-of-band emissions in restricted bands: KDB 558074 D01 v04, Section 12.1.

Band-edge: KDB 558074 D01 v04, Section 12.1.

AC Power Line Conducted Emissions: ANSI C63.10-2013, Section 6.2.

## 8.2. ON TIME, DUTY CYCLE

### LIMITS

None; for reporting purposes only.

### PROCEDURE

KDB 558074 Zero-Span Spectrum Analyzer Method.

### ON TIME AND DUTY CYCLE RESULTS

Mode	ON Time B (msec)	Period (msec)	Duty Cycle x (linear)	Duty Cycle (%)	Duty Cycle Correction Factor (dB)	1/T Minimum VBW (kHz)
BLE (1Mbps)	2.125	2.497	0.851	85.10	0.70	0.471

**DUTY CYCLE PLOT**

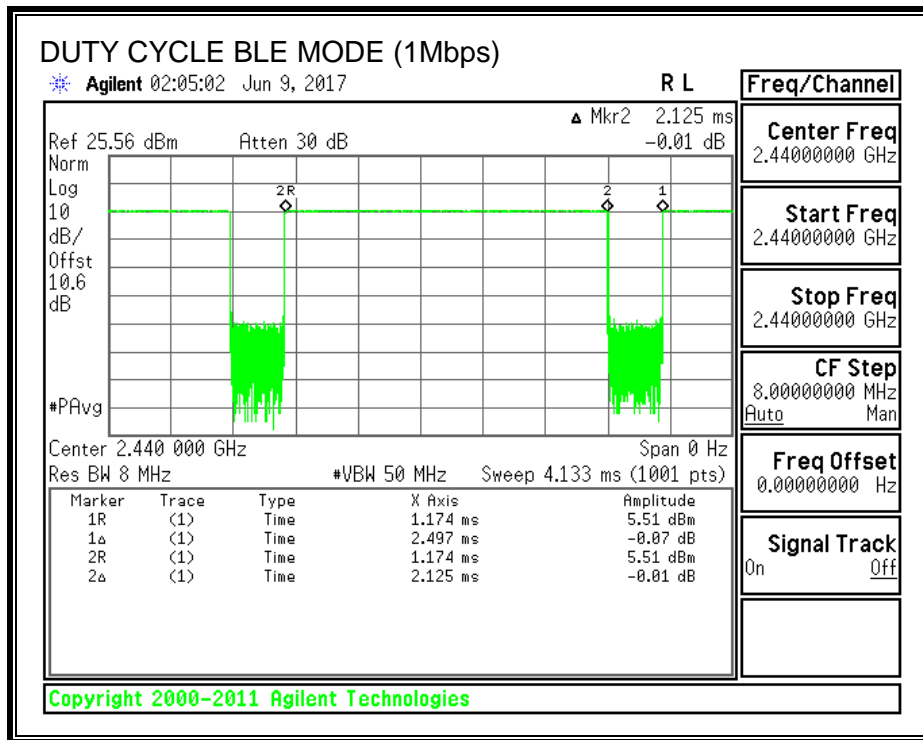



### 8.3. 6 dB BANDWIDTH

#### LIMITS

FCC §15.247 (a) (2)

The minimum 6 dB bandwidth shall be at least 500 kHz.

#### RESULTS

##### 6 dB BANDWIDTH (1Mbps)

Channel	Frequency	6 dB Bandwidth (MHz)	Minimum Limit (MHz)
Low	2402	0.654	0.5
Middle	2440	0.716	0.5
High	2480	0.644	0.5

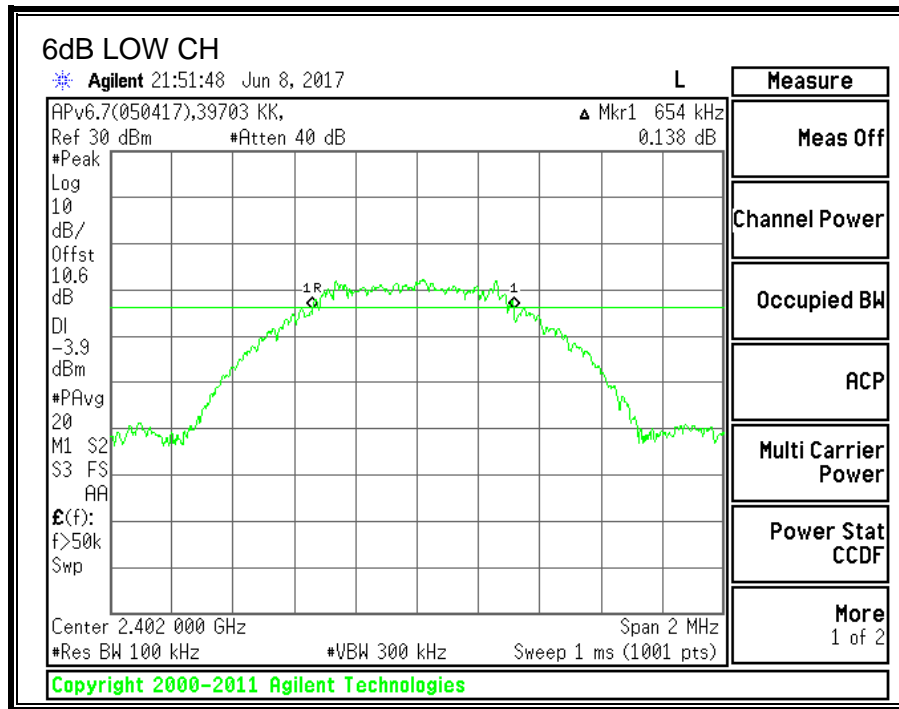

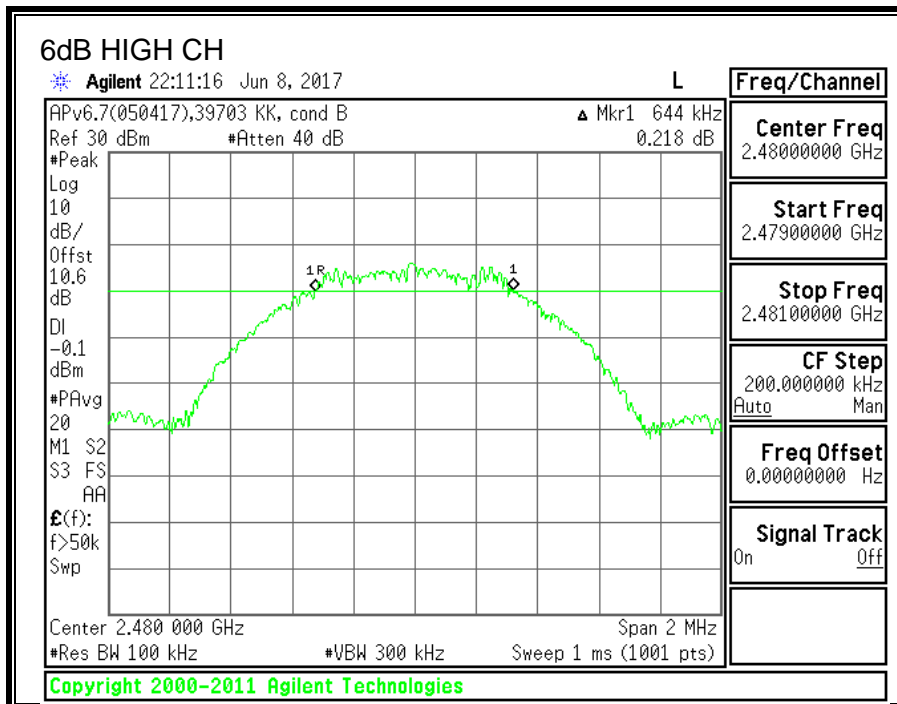
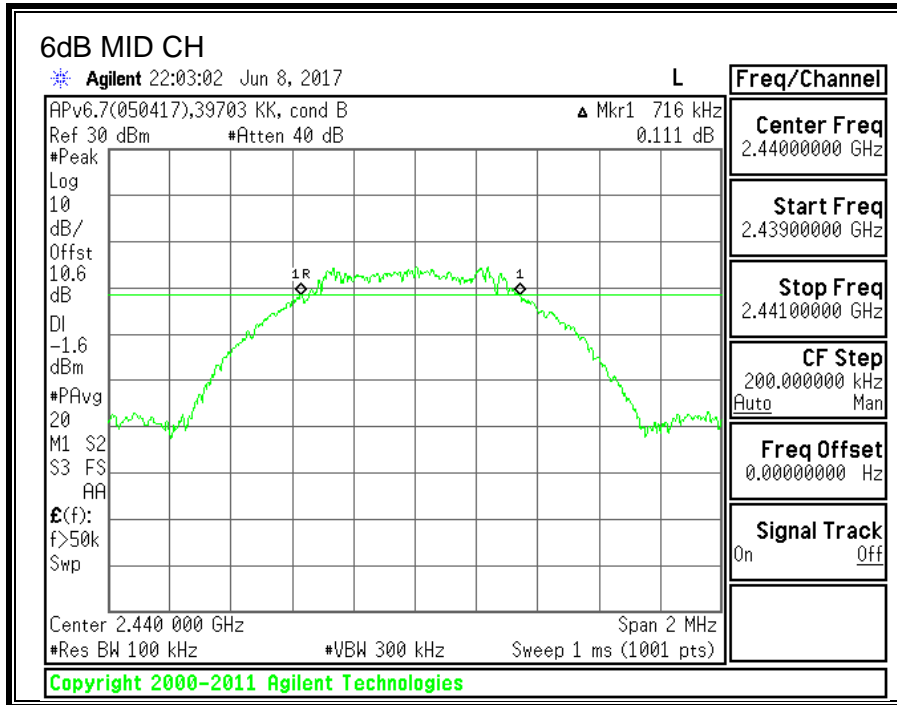

**6 dB BANDWIDTH (2Mbps)**

Channel	Frequency	6 dB Bandwidth (MHz)	Minimum Limit (MHz)
Low	2402	1.146	0.5
Middle	2440	1.132	0.5
High	2480	1.110	0.5

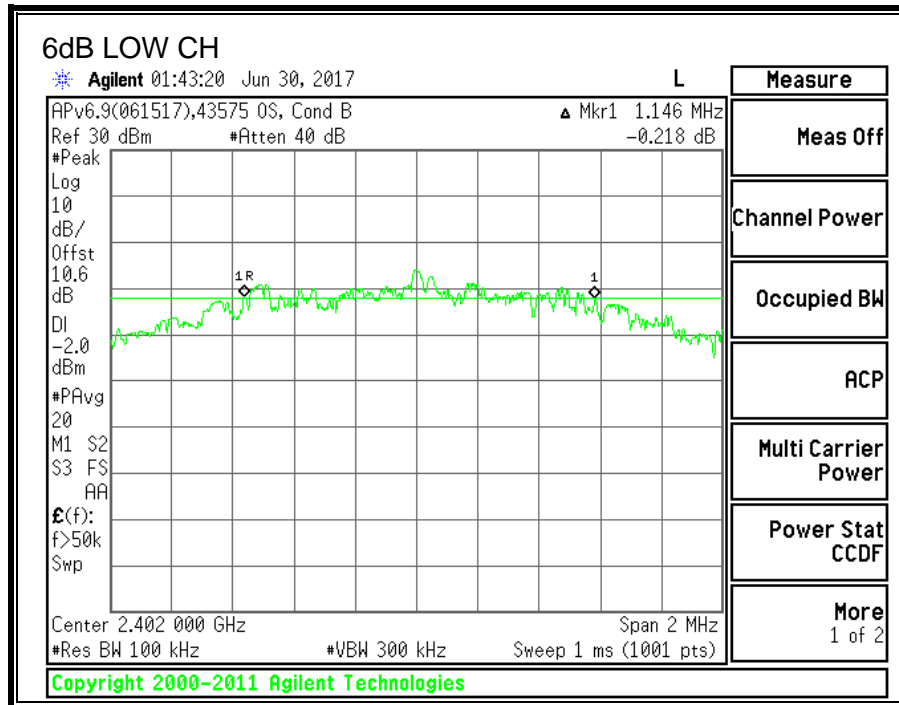

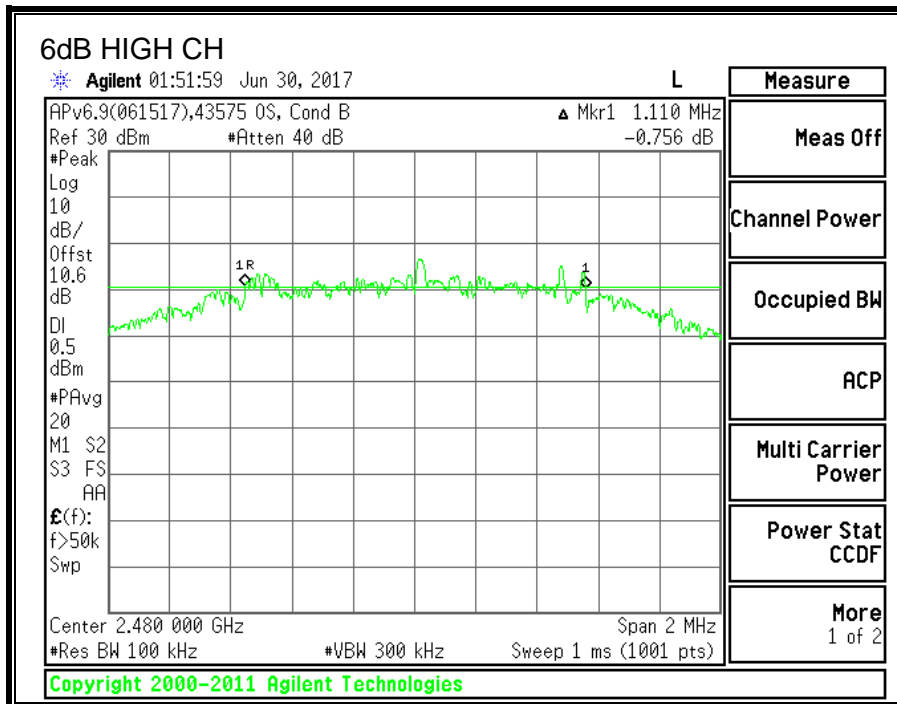
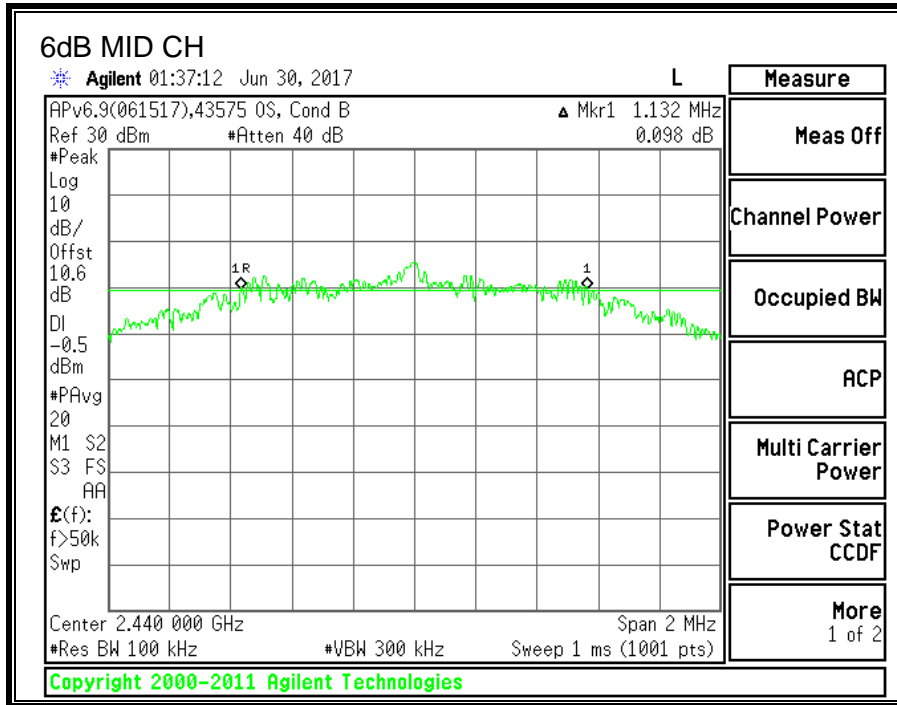

## 8.4. 99% BANDWIDTH

### LIMITS

None; for reporting purposes only.

### Test Procedure

The transmitter output is connected to the spectrum analyzer. The RBW is set to 1% to 3% of the 99 % bandwidth and to 1% of the span. The VBW is set to 3 times the RBW. The sweep time is coupled. The spectrum analyzer internal 99% bandwidth function is utilized.

### RESULTS

#### 99% BANDWIDTH (1Mbps)

Channel	Frequency (MHz)	99% Bandwidth (MHz)
Low	2402	1.0345
Middle	2440	1.0380
High	2480	1.0350

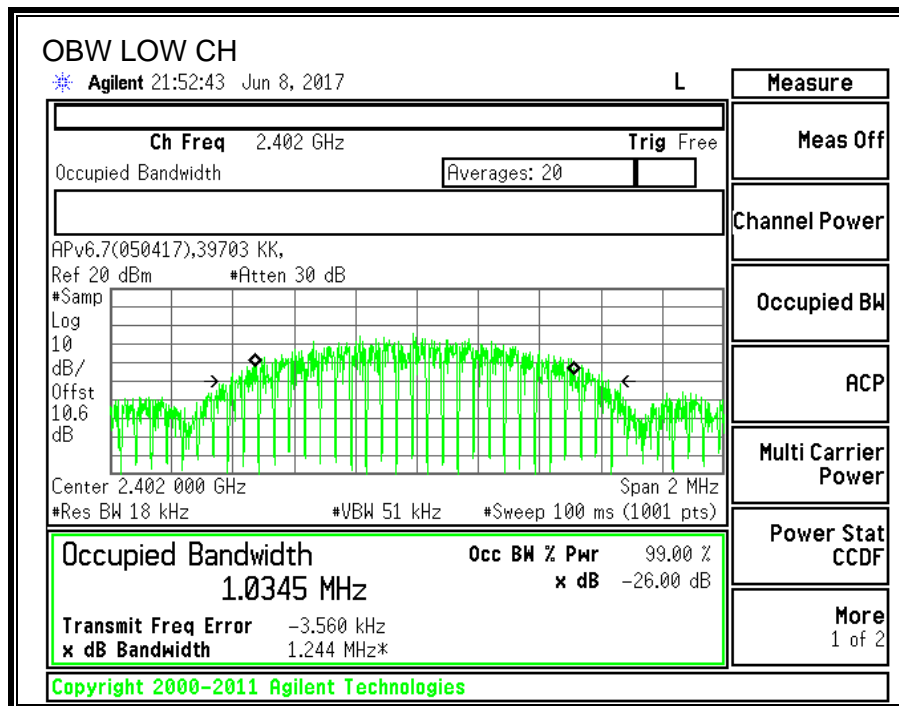

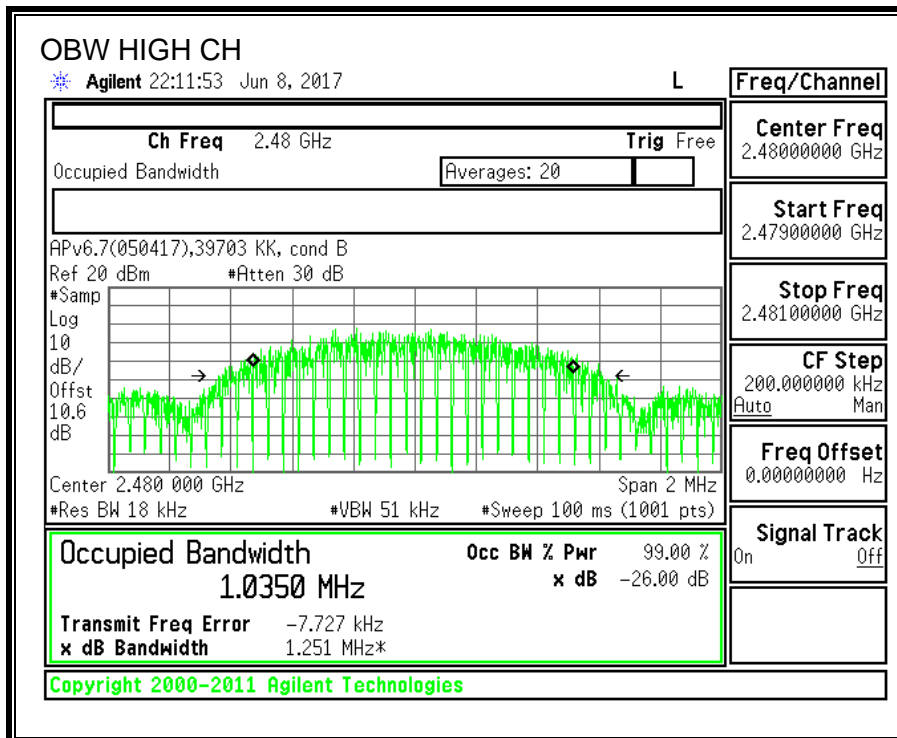
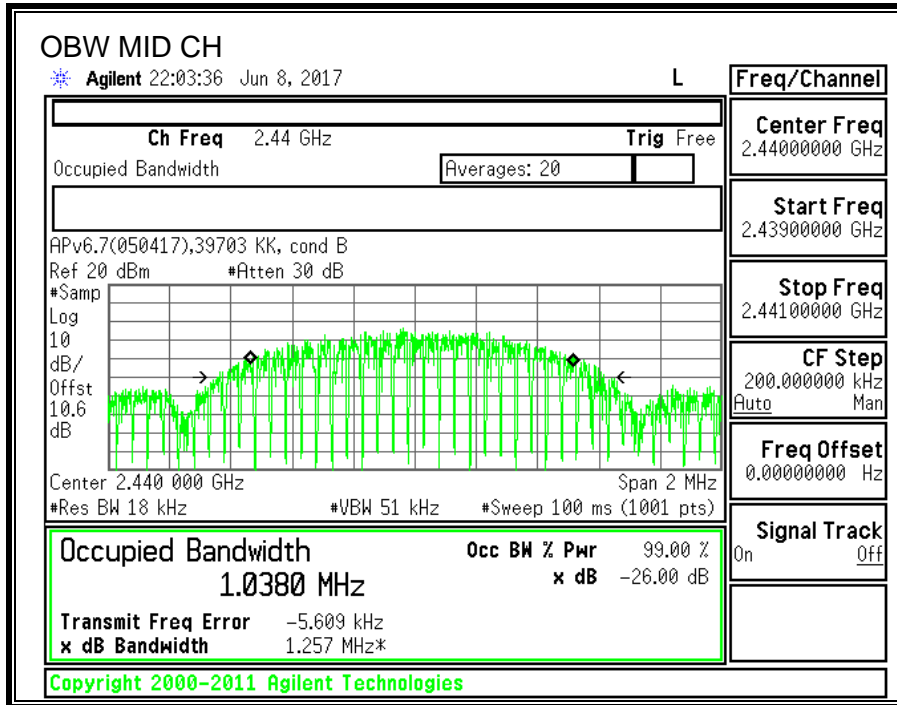

**99% BANDWIDTH (2Mbps)**

Channel	Frequency (MHz)	99% Bandwidth (MHz)
Low	2402	2.0576
Middle	2440	2.0532
High	2480	2.0579

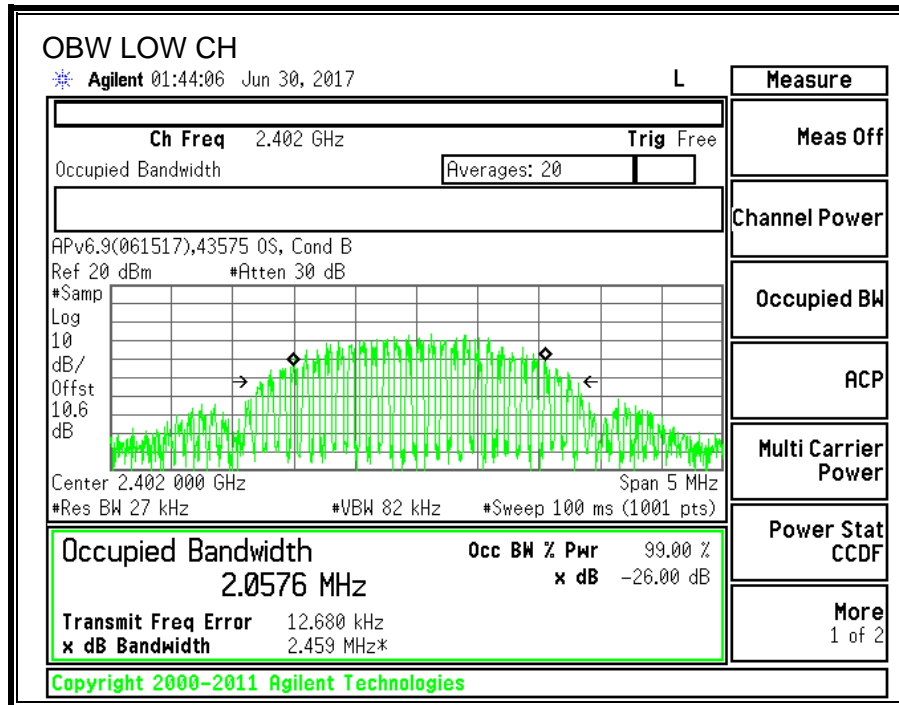

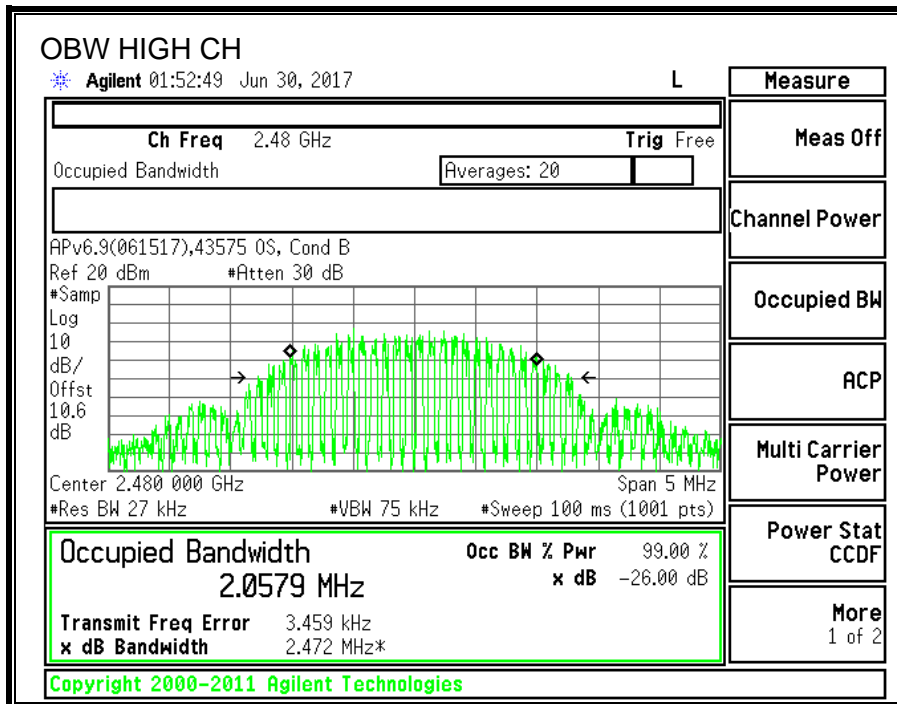
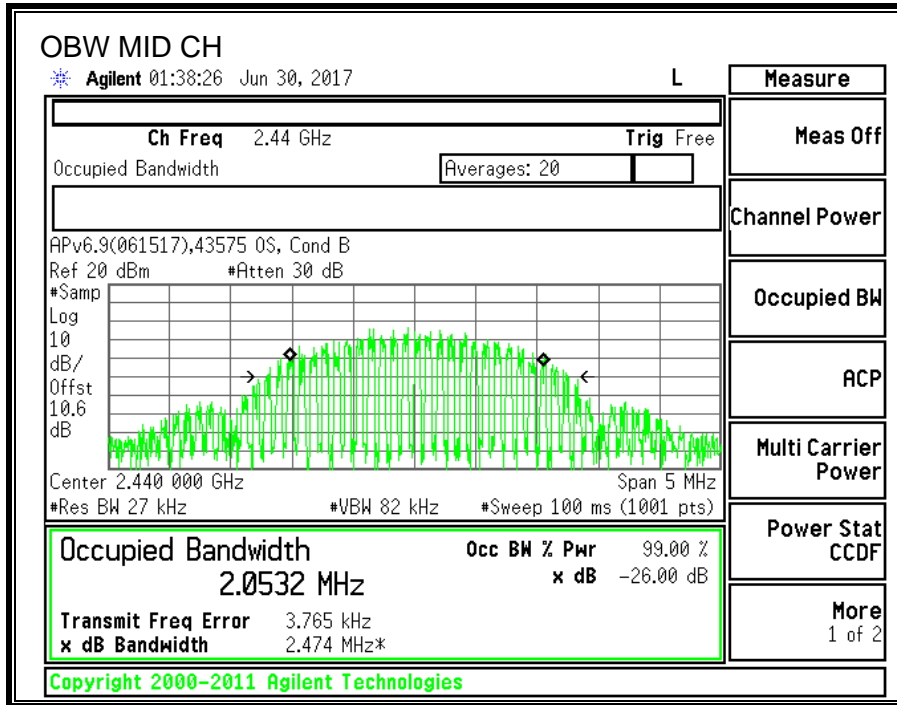



## 8.5. AVERAGE POWER

### LIMITS

None; for reporting purposes only.

The cable assembly insertion loss of 10.6 dB (including 10 dB pad and 0.6 dB cable) was entered as an offset in the power meter to allow for direct reading of power.

### RESULTS

<b>TEST ENGINEER:</b>	39703	<b>Date:</b>	6/8/2017
-----------------------	-------	--------------	----------

#### 1Mbps

Channel	Frequency (MHz)	AV Power (dBm)
Low	2402	2.79
Middle	2440	5.40
High	2480	6.67

#### 2Mbps

Channel	Frequency (MHz)	AV Power (dBm)
Low	2402	3.98
Middle	2440	5.53
High	2480	6.41

## 8.6. OUTPUT POWER

### LIMITS

FCC §15.247 (b)

The maximum antenna gain is less than or equal to 6 dBi, therefore the limit is 30 dBm.

### RESULTS

#### OUTPUT POWER (1Mbps)

Channel	Frequency (MHz)	Peak Power Reading (dBm)	Limit (dBm)	Margin (dB)
Low	2402	3.17	30	-25.63
Middle	2440	5.58	30	-24.01
High	2480	6.57	30	-22.92

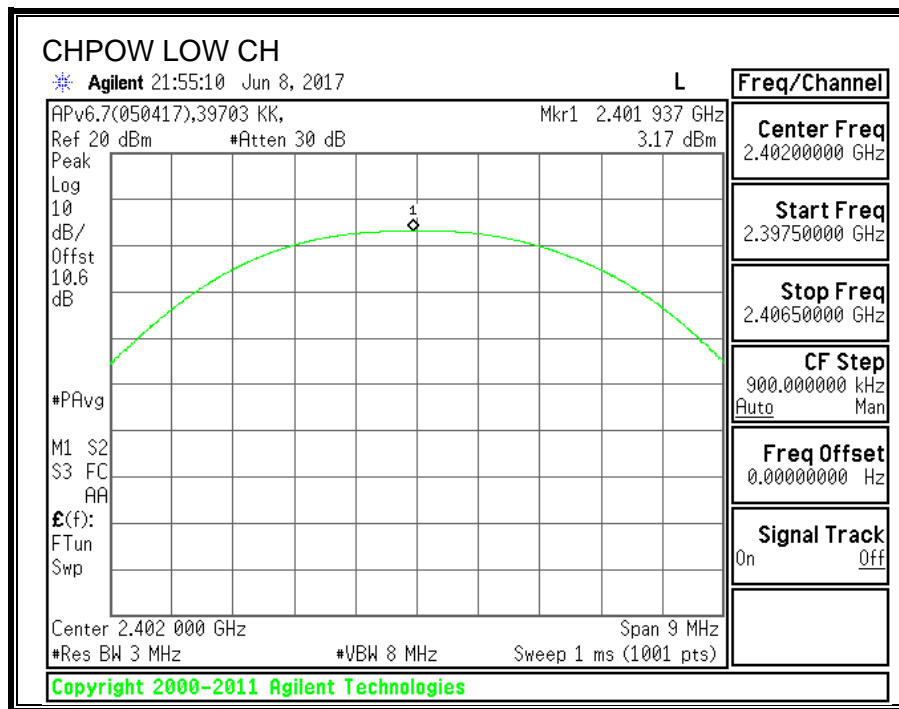

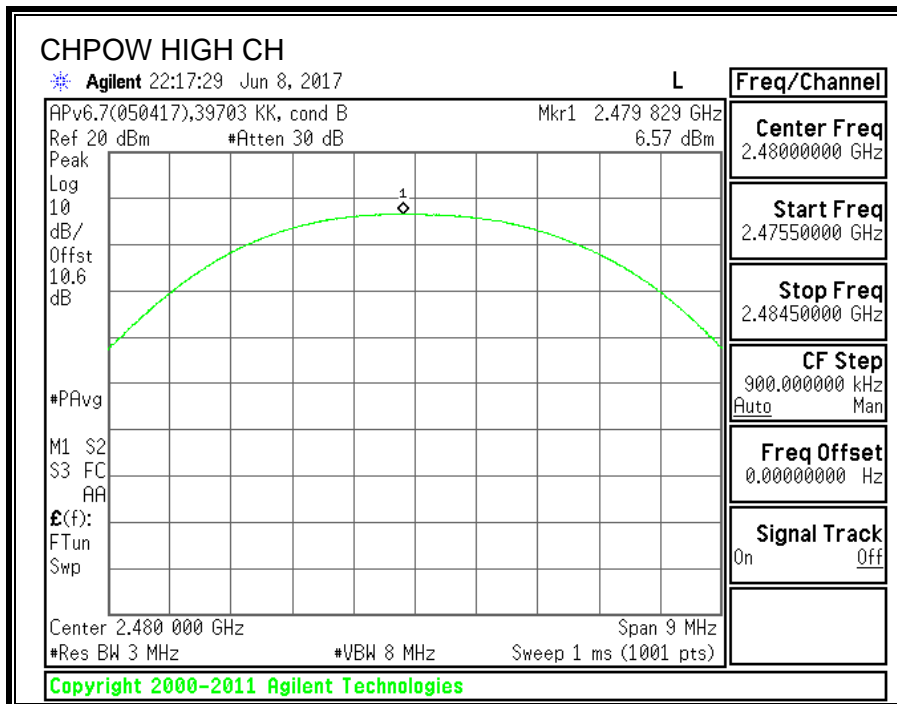
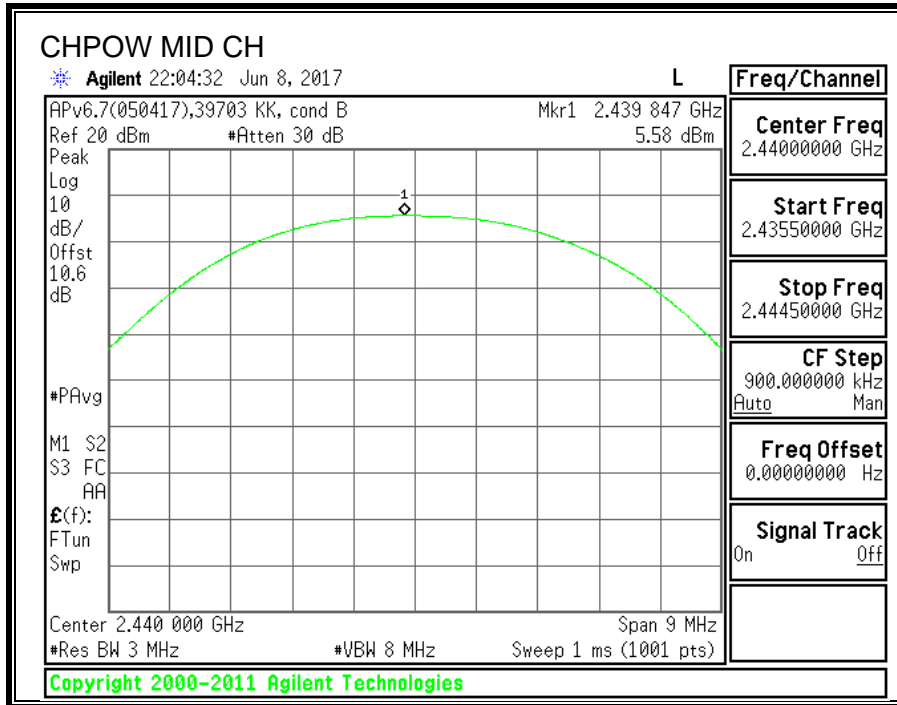

**OUTPUT POWER (2Mbps)**

Channel	Frequency (MHz)	Peak Power Reading (dBm)	Limit (dBm)	Margin (dB)
Low	2402	4.75	30	-25.63
Middle	2440	6.23	30	-24.01
High	2480	7.09	30	-22.92

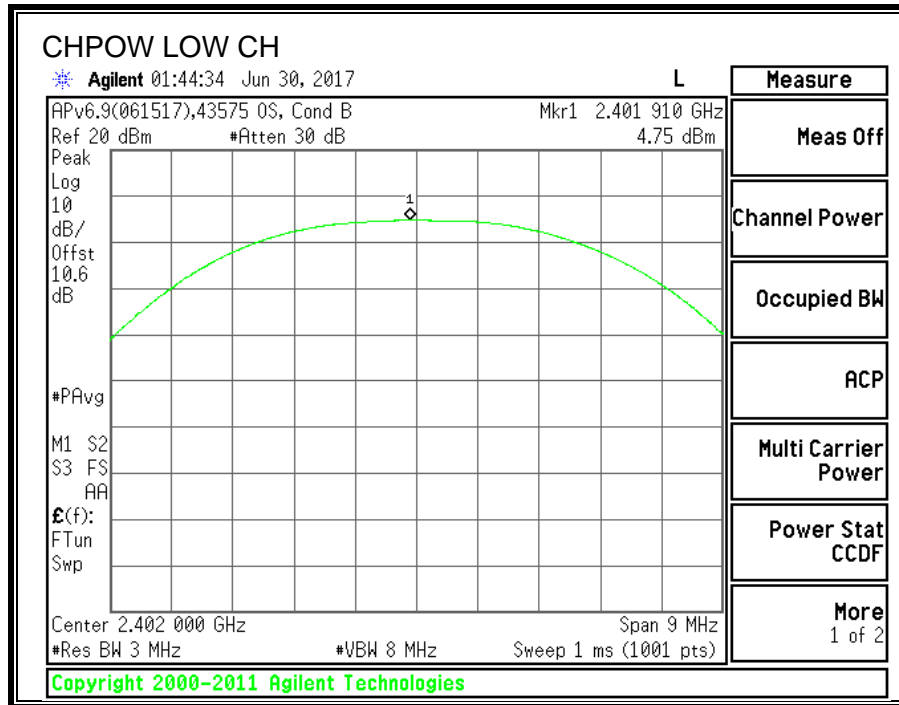

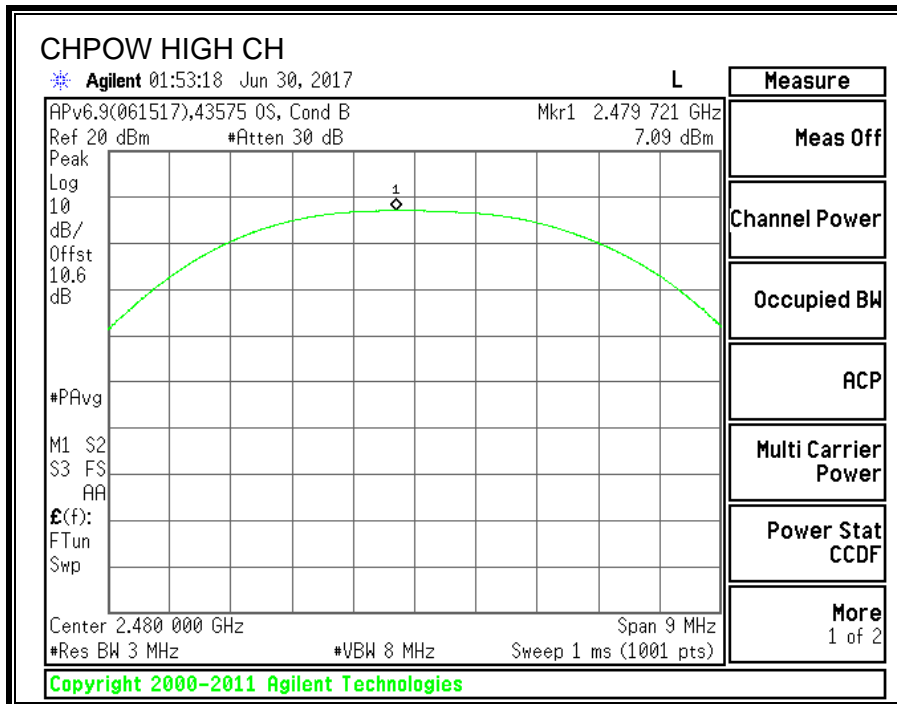
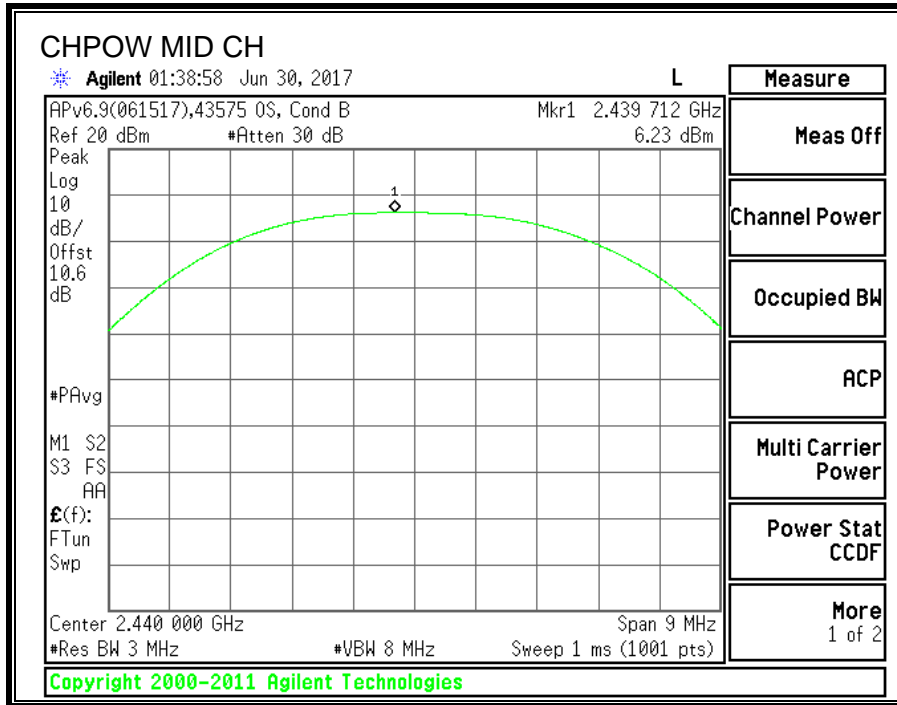

## 8.7. POWER SPECTRAL DENSITY

### LIMITS

FCC §15.247 (e)

The power spectral density conducted from the transmitter to the antenna shall not be greater than 8 dBm in any 3 kHz band during any time interval of continuous transmission.

### RESULTS

#### POWER SPECTRAL DENSITY (1Mbps)

Channel	Frequency (MHz)	PSD (dBm)	Limit (dBm)	Margin (dB)
Low	2402	-15.955	8	-20.264
Middle	2440	-10.660	8	-18.271
High	2480	-12.622	8	-17.044

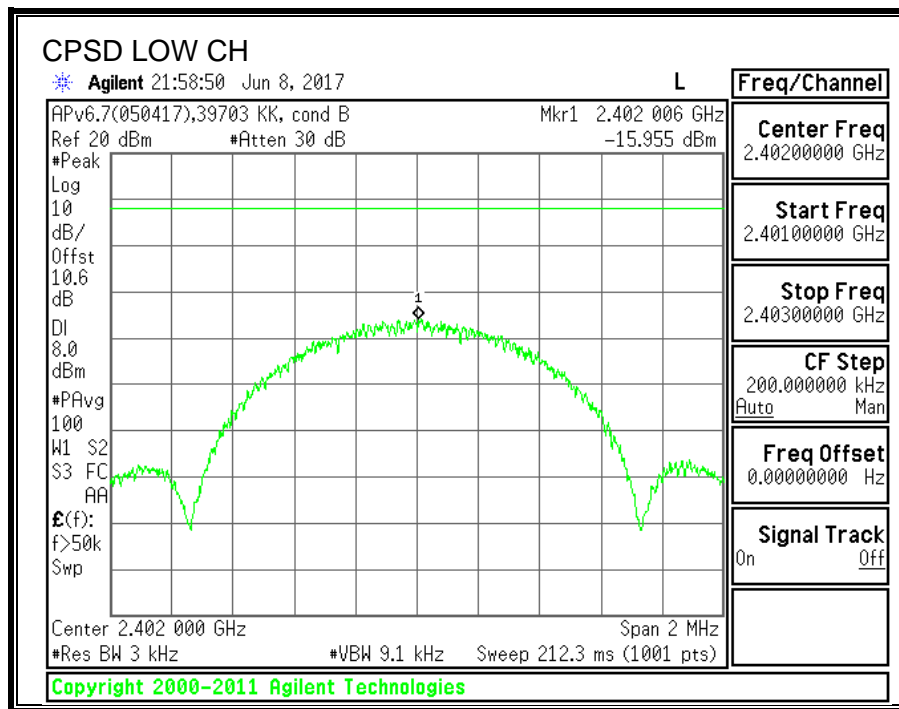

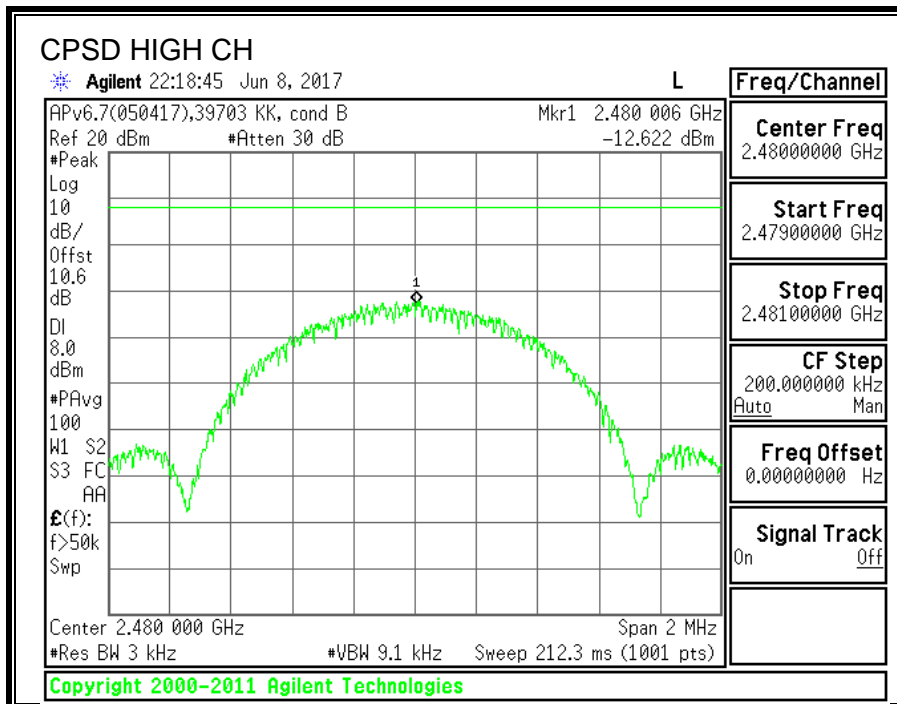
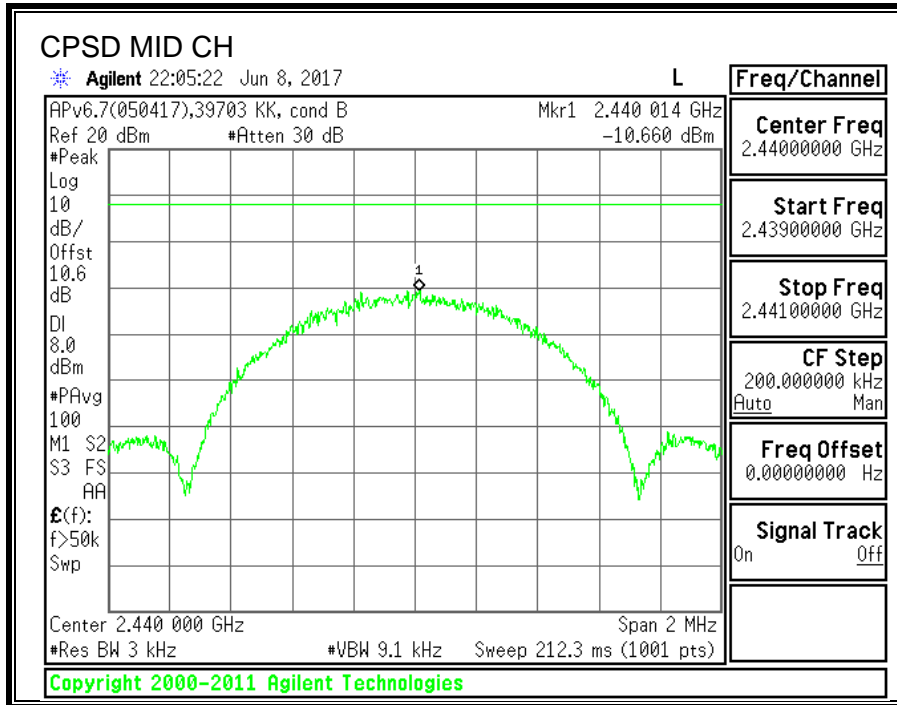

**POWER SPECTRAL DENSITY (2Mbps)**

Channel	Frequency (MHz)	PSD (dBm)	Limit (dBm)	Margin (dB)
Low	2402	-14.021	8	-22.021
Middle	2440	-12.575	8	-20.575
High	2480	-11.691	8	-19.691

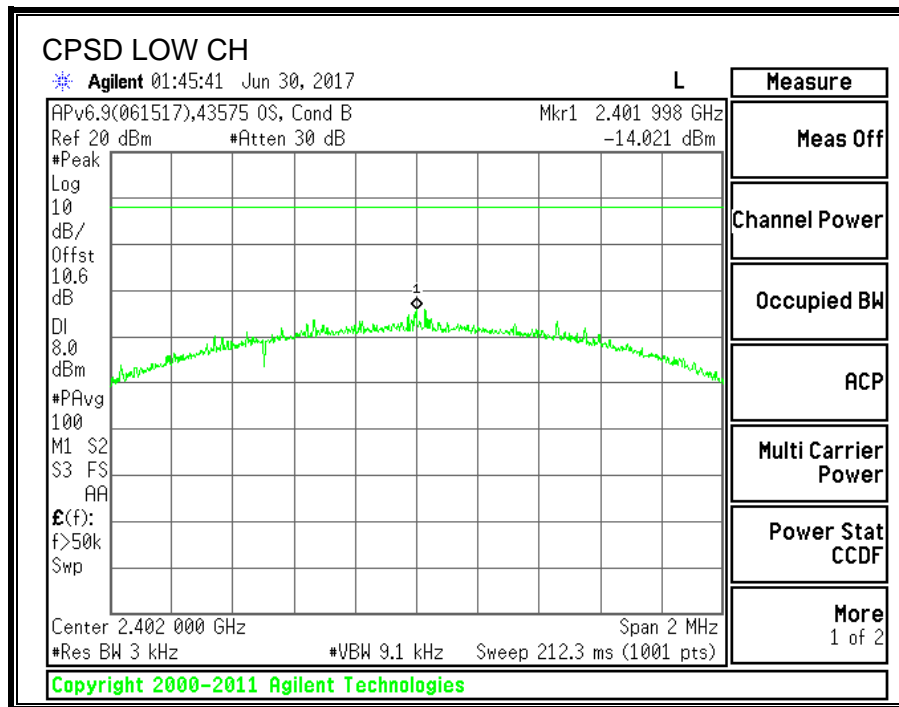



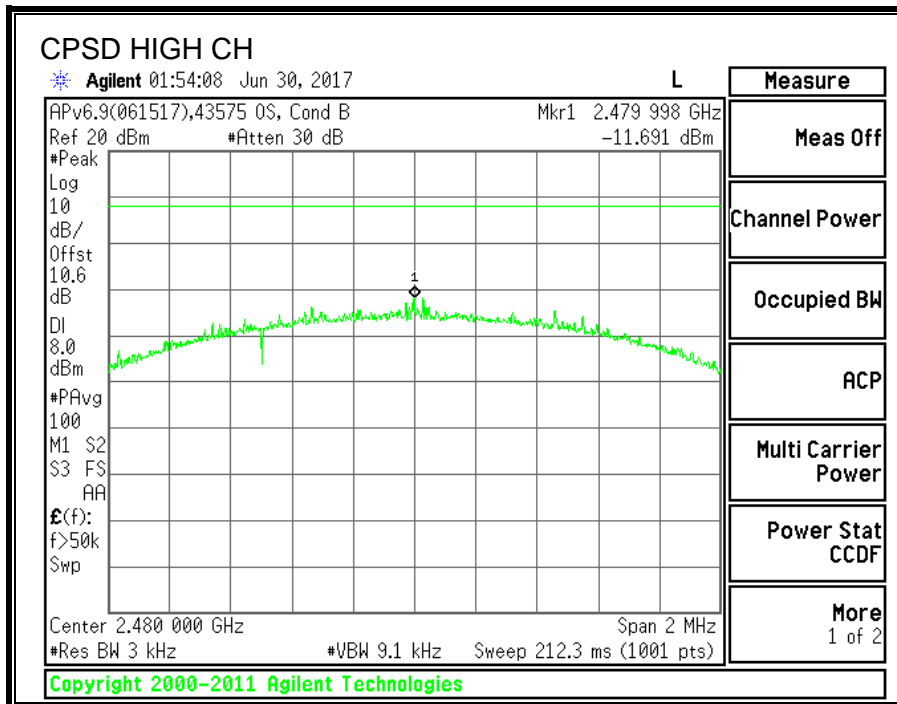
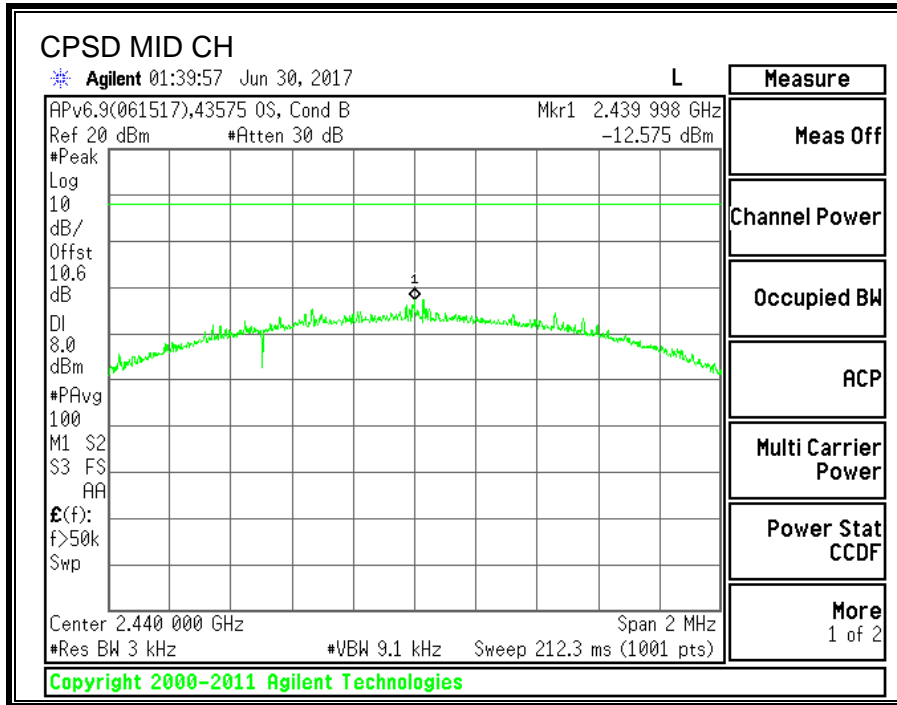

## 8.8. CONDUCTED BANDEGE AND SPURIOUS EMISSIONS

### LIMITS

FCC §15.247 (d)

Output power was measured based on the use of a peak measurement, therefore the required attenuation is 20 dB.

### RESULTS

#### CONDUCTED BANDEGE AND SPURIOUS EMISSIONS (1Mbps)

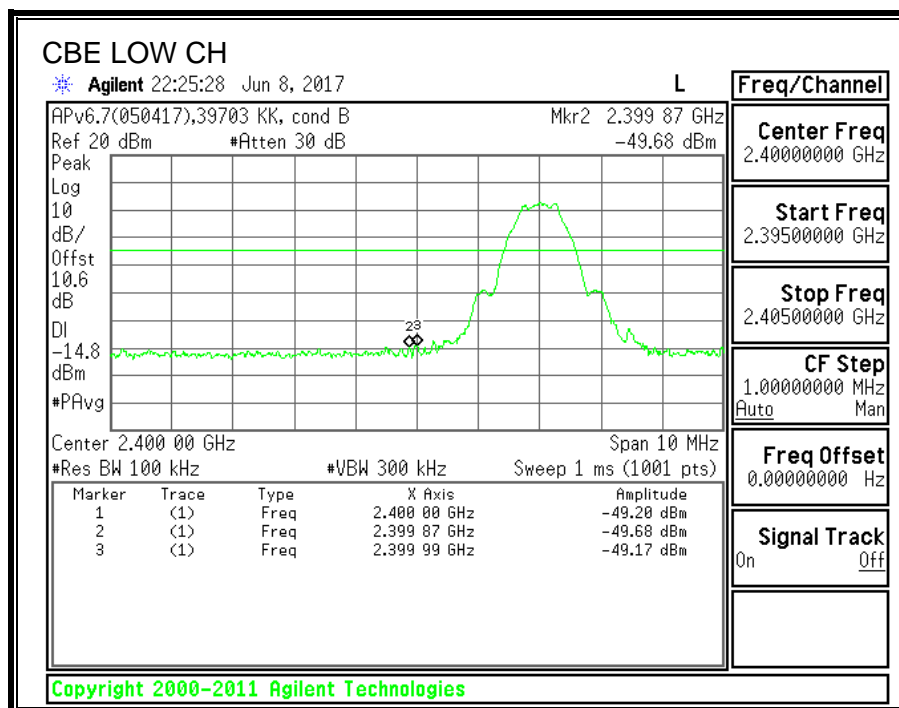

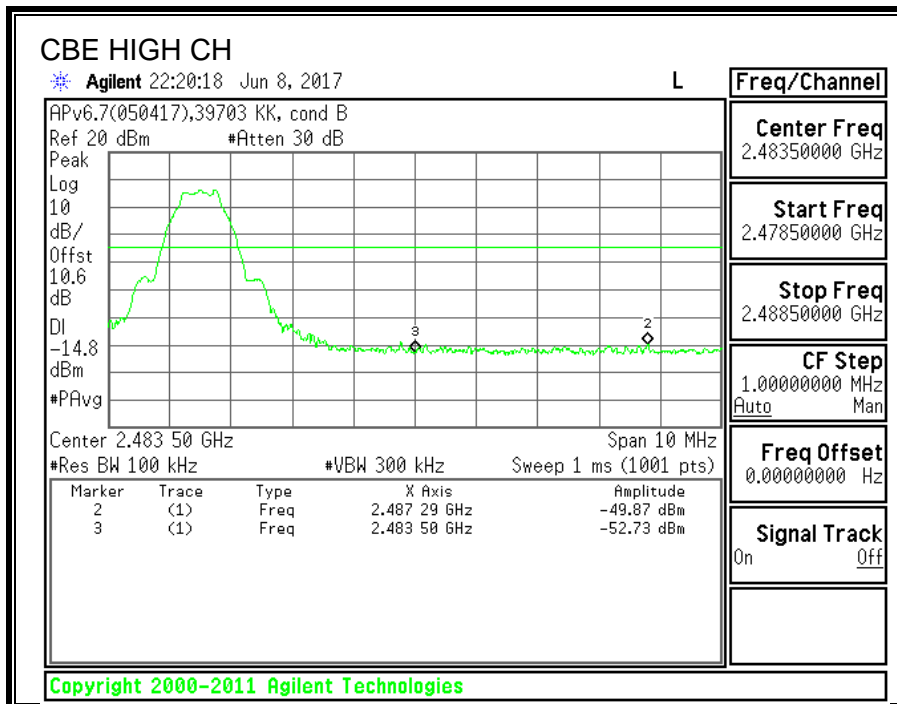
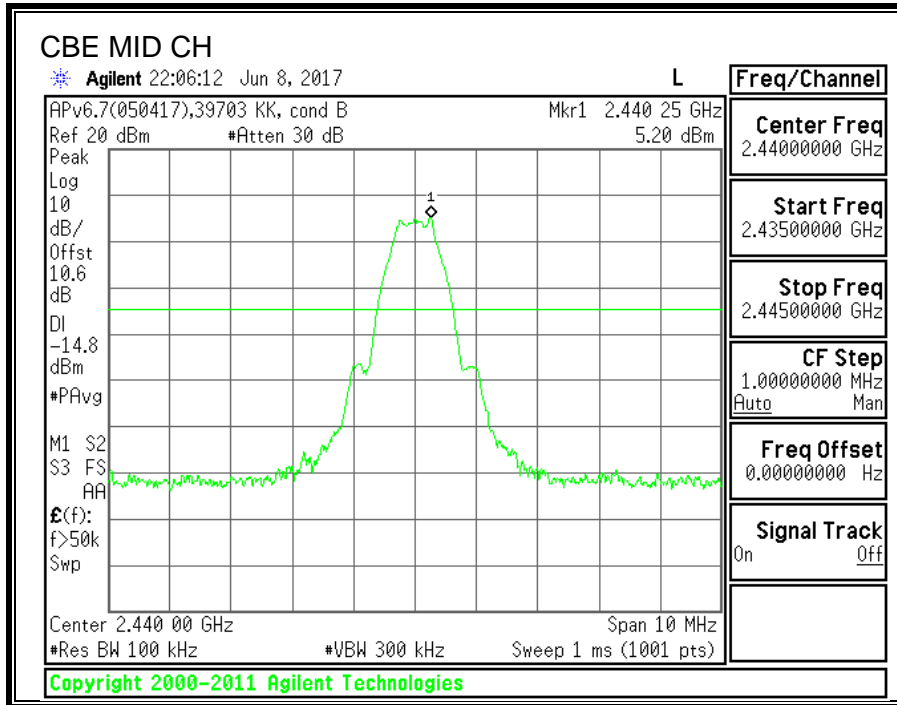

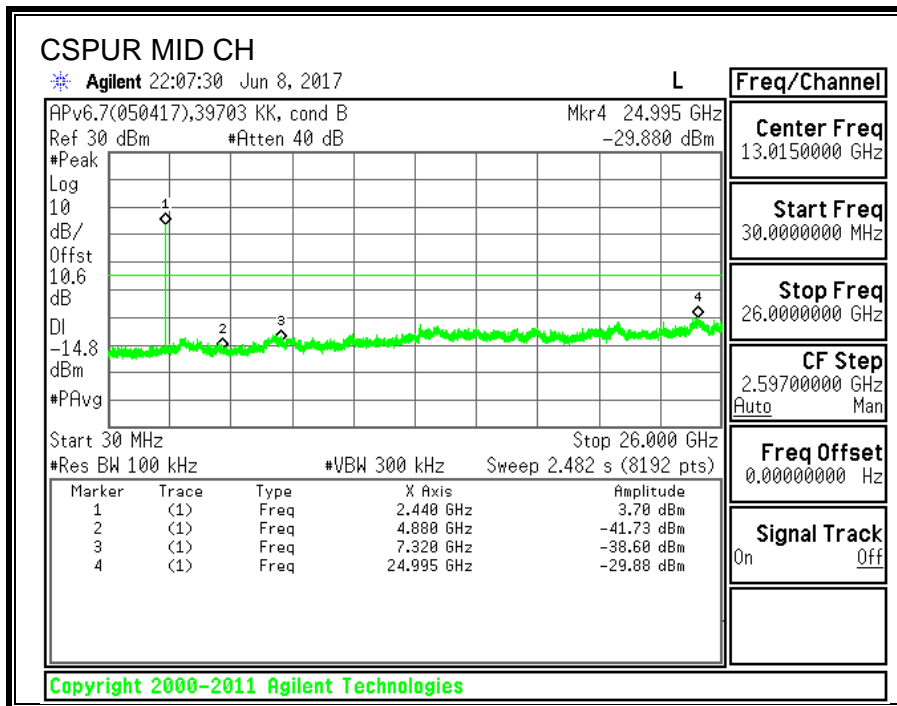
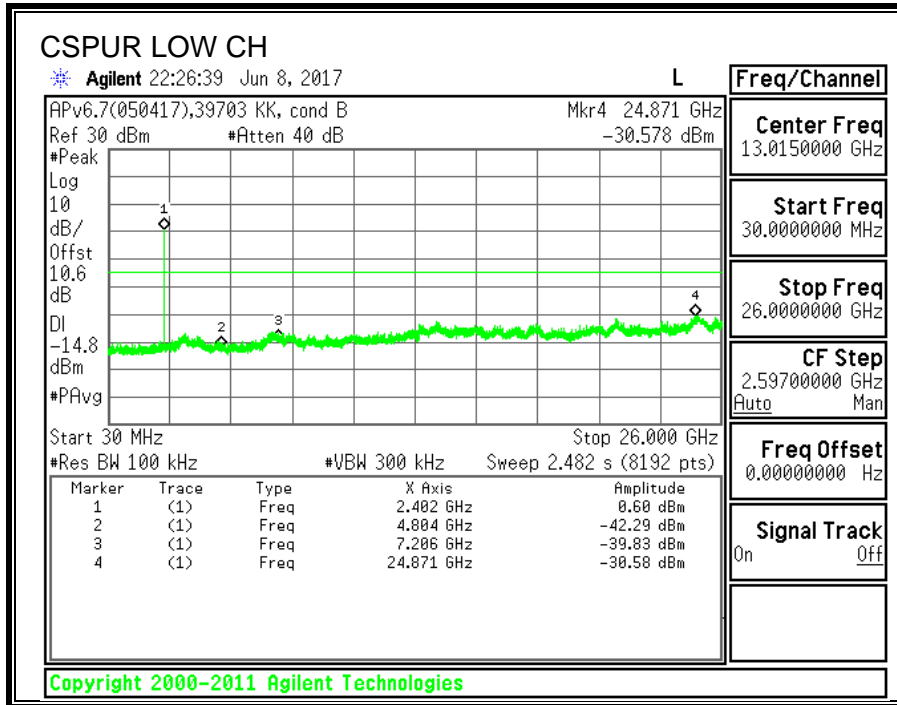

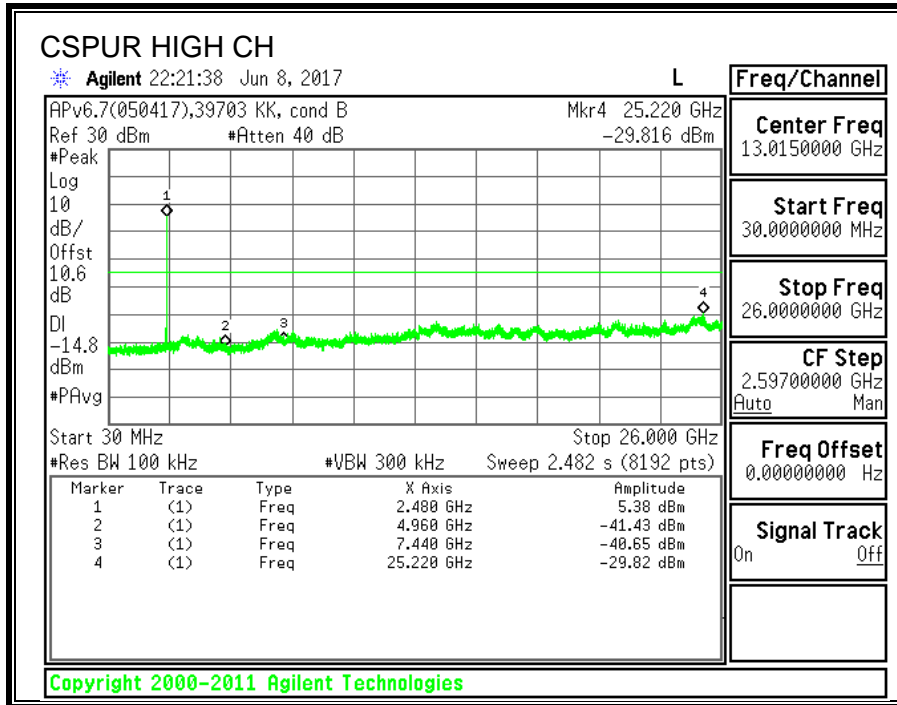

**CONDUCTED BANDEDGE AND SPURIOUS EMISSIONS (2Mbps)**

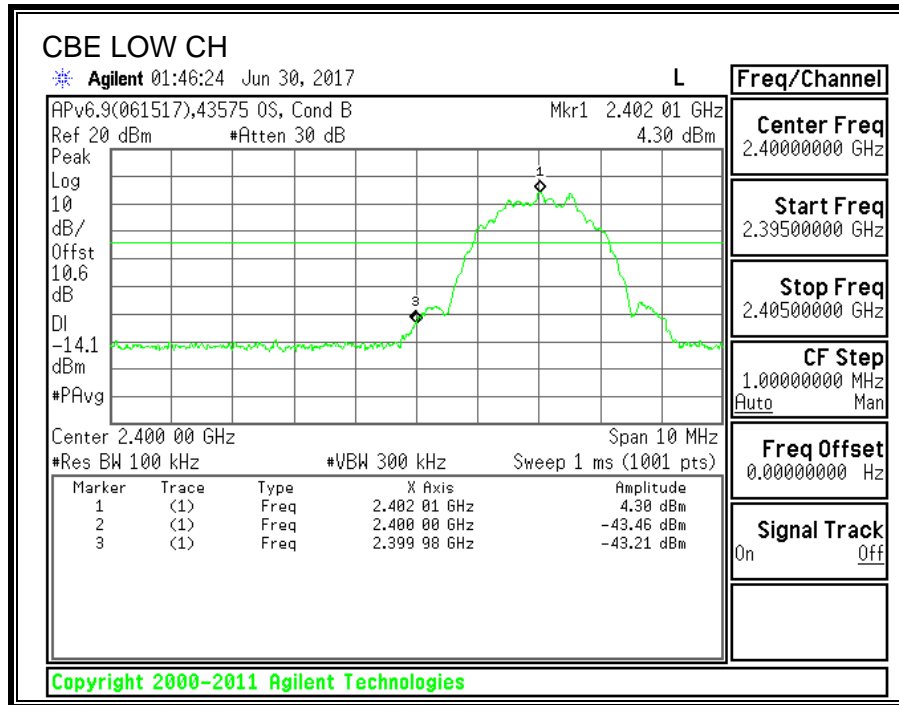

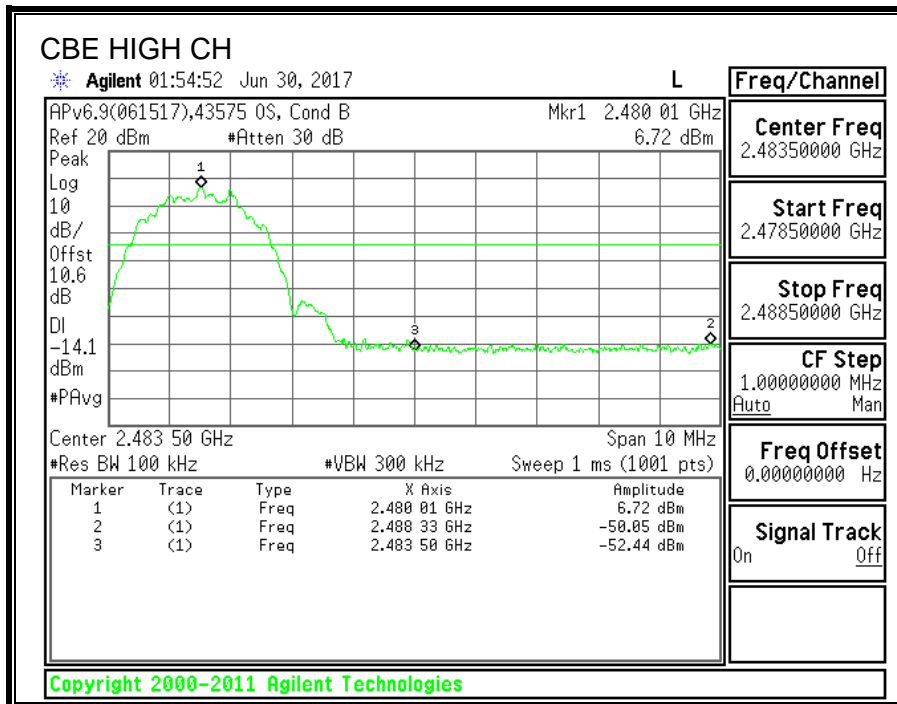
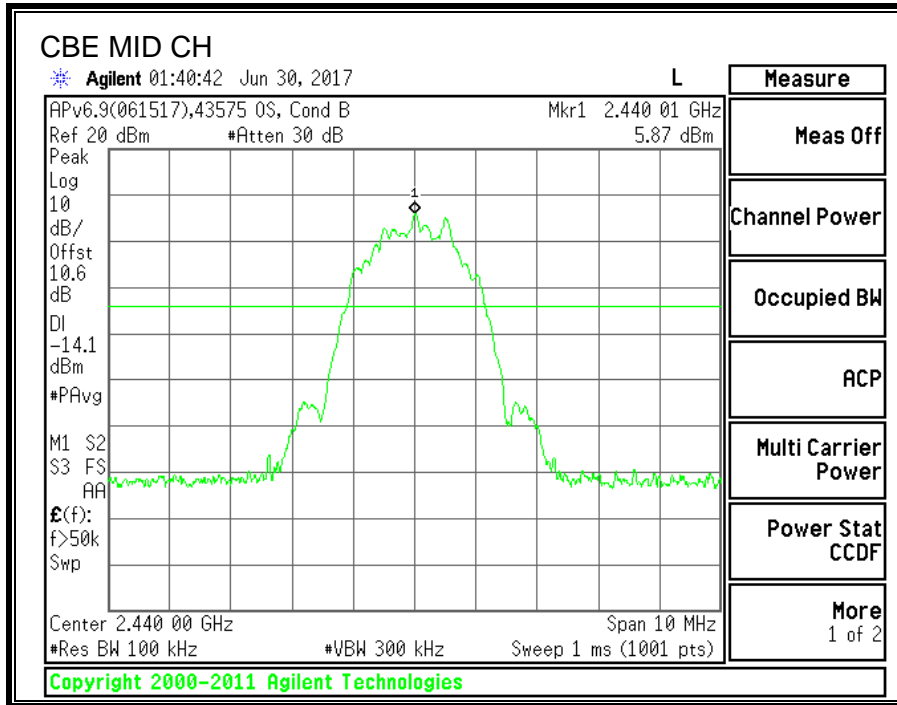

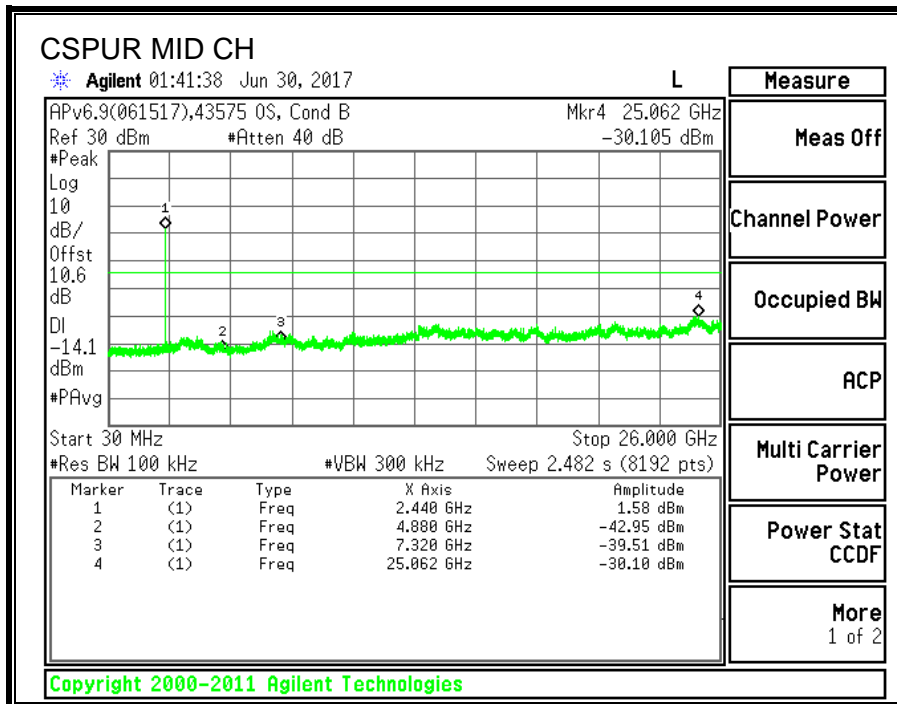
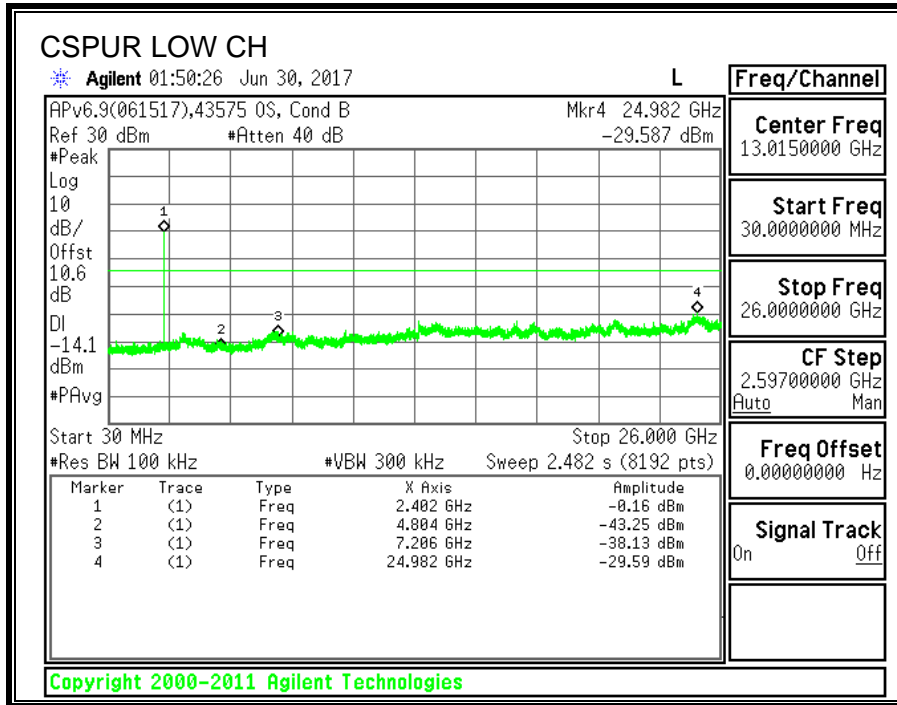



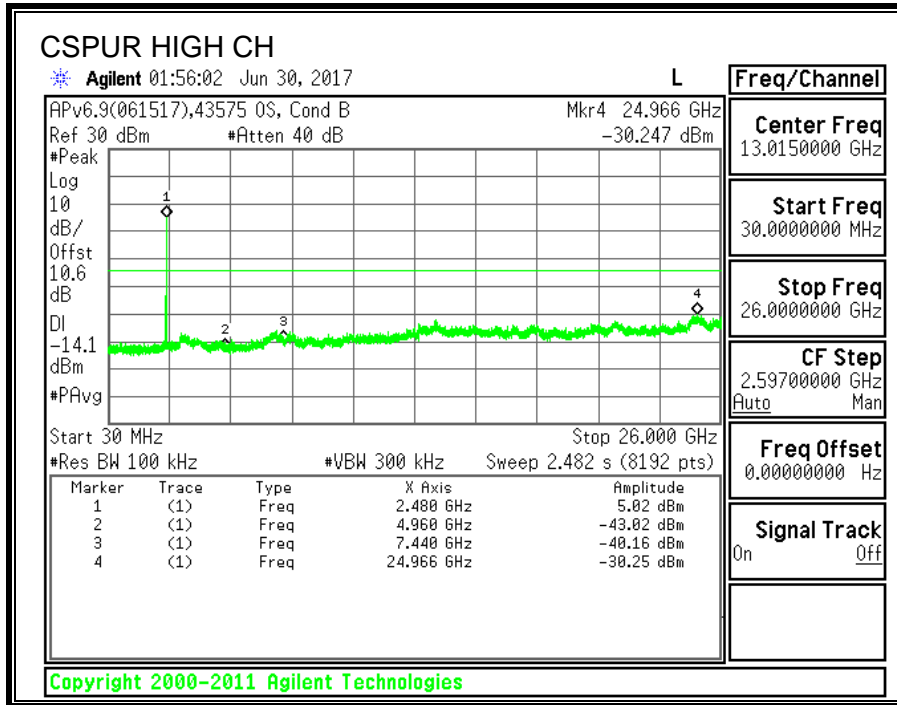

## 9. RADIATED TEST RESULTS

### 9.1. LIMITS AND PROCEDURE

#### LIMITS

FCC §15.205 and §15.209

Frequency Range (MHz)	Field Strength Limit (uV/m) at 3 m	Field Strength Limit (dBuV/m) at 3 m
0.009-0.490	2400/F(kHz) @ 300 m	-
0.490-1.705	24000/F(kHz) @ 30 m	-
1.705 - 30	30 @ 30m	-
30 - 88	100	40
88 - 216	150	43.5
216 - 960	200	46
Above 960	500	54

#### TEST PROCEDURE

The EUT is placed on a non-conducting table 80 cm above the ground plane for measurement below 1GHz; 1.5 m above the ground plane for measurement above 1GHz. The antenna to EUT distance is 3 meters. The EUT is configured in accordance with ANSI C63.10. The EUT is set to transmit in a continuous mode.

For measurements below 1 GHz the resolution bandwidth is set to 100 kHz for peak detection measurements or 120 kHz for quasi-peak detection measurements. Peak detection is used unless otherwise noted as quasi-peak.

For pre-scans above 1 GHz the resolution bandwidth is set to 1 MHz; the video bandwidth is set to 30 KHz for peak measurements.

For final measurements above 1 GHz the resolution bandwidth is set to 1 MHz; the video bandwidth is set to 3 MHz for peak measurements and as applicable for average measurements.

The spectrum from 1 GHz to 18 GHz is investigated with the transmitter set to the lowest, middle, and highest channels in each applicable band. Below 1GHz and above 18GHz emissions, the channel with the highest output power was tested.

The frequency range of interest is monitored at a fixed antenna height and EUT azimuth. The EUT is rotated through 360 degrees to maximize emissions received. The antenna is scanned from 1 to 4 meters above the ground plane to further maximize the emission. Measurements are made with the antenna polarized in both the vertical and the horizontal positions.

#### Results

Radiated Bandedge and Spurious Emissions were tested using 1Mbps as Worst-case data rates.

## 9.2. TRANSMITTER ABOVE 1 GHz

### 9.2.1. RESTRICTED BANDEDGE (LOW CHANNEL)

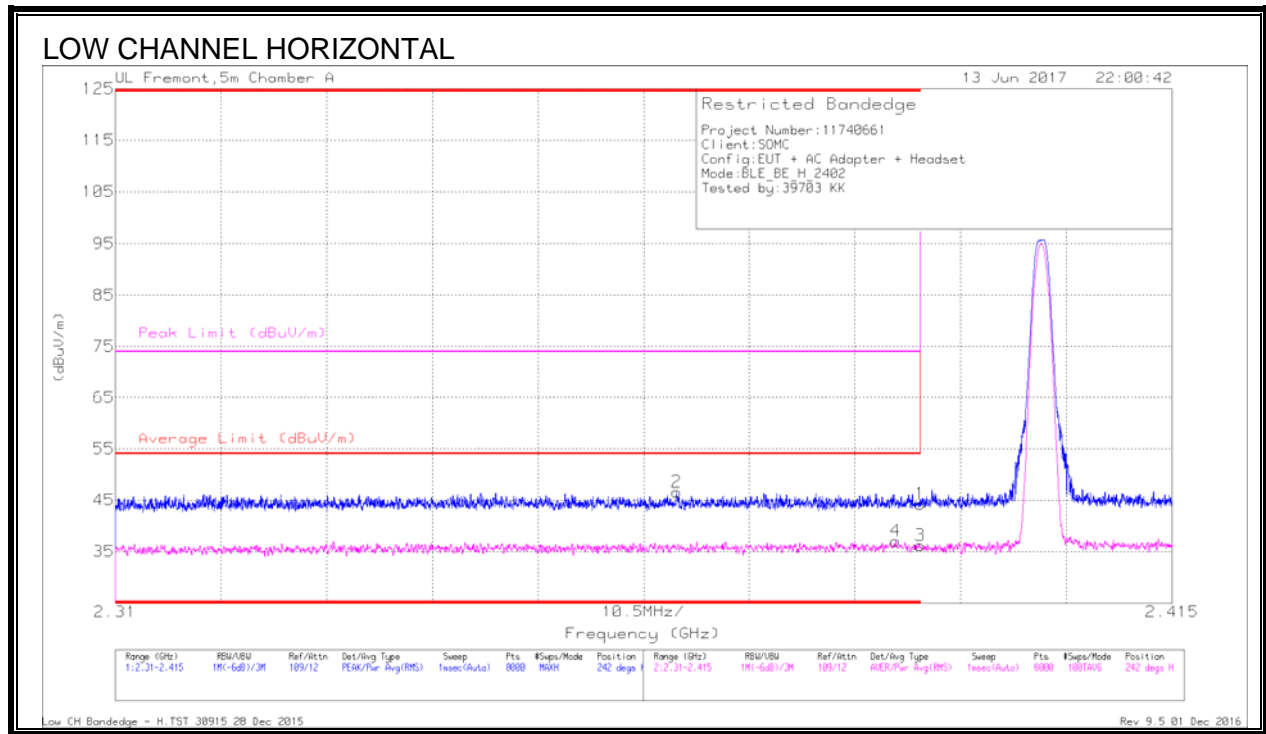

#### Trace Markers

Marker	Frequency (GHz)	Meter Reading (dBuV)	Det	Af T111 (dB/m)	Amp/Cb/Fit/Pad (dB)	DC Corr (dB)	Corrected Reading (dBuV/m)	Average Limit (dBuV/m)	Margin (dB)	Peak Limit (dBuV/m)	PK Margin (dB)	Azimuth (Degs)	Height (cm)	Polarity
1	* 2.39	35.87	Pk	32.1	-23.7	0	44.27	-	-	74	-29.73	242	197	H
2	* 2.366	38.17	Pk	32.1	-23.7	0	46.57	-	-	74	-27.43	242	197	H
3	* 2.39	27.09	RMS	32.1	-23.7	.7	36.19	54	-17.81	-	-	242	197	H
4	* 2.388	27.96	RMS	32.1	-23.7	.7	37.06	54	-16.94	-	-	242	197	H

Pk - Peak detector  
 RMS - RMS detection

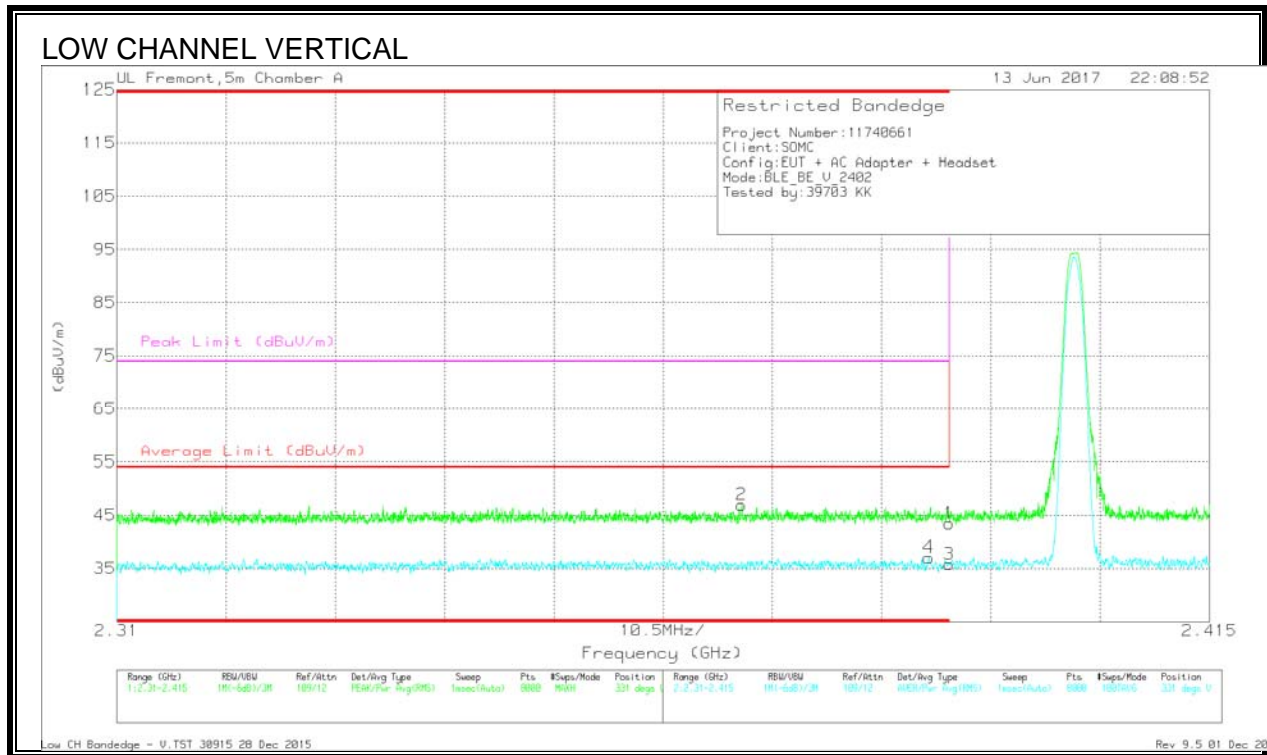

Trace Markers

Marker	Frequency (GHz)	Meter Reading (dBuV)	Det	Az T211 (dB/m)	Amp/Ch/Flr/Pad (dB)	DC Corr (dB)	Corrected Reading (dBuV/m)	Average Limit (dBuV/m)	Margin (dB)	Peak Limit (dBuV/m)	PK Margin (dB)	Azimuth (Degs)	Height (cm)	Polarity
2	* 2.37	38.48	Pk	32.1	-23.7	0	46.88	-	-	74	-27.12	331	323	V
4	* 2.388	27.94	RMS	32.1	-23.7	.7	37.04	54	-16.96	-	-	331	323	V
1	* 2.39	35.05	Pk	32.1	-23.7	0	43.45	-	-	74	-30.55	331	323	V
3	* 2.39	26.67	RMS	32.1	-23.7	.7	35.77	54	-18.23	-	-	331	323	V

Pk - Peak detector  
 RMS - RMS detection

### 9.2.2. AUTHORIZED BANDEDGE (HIGH CHANNEL)

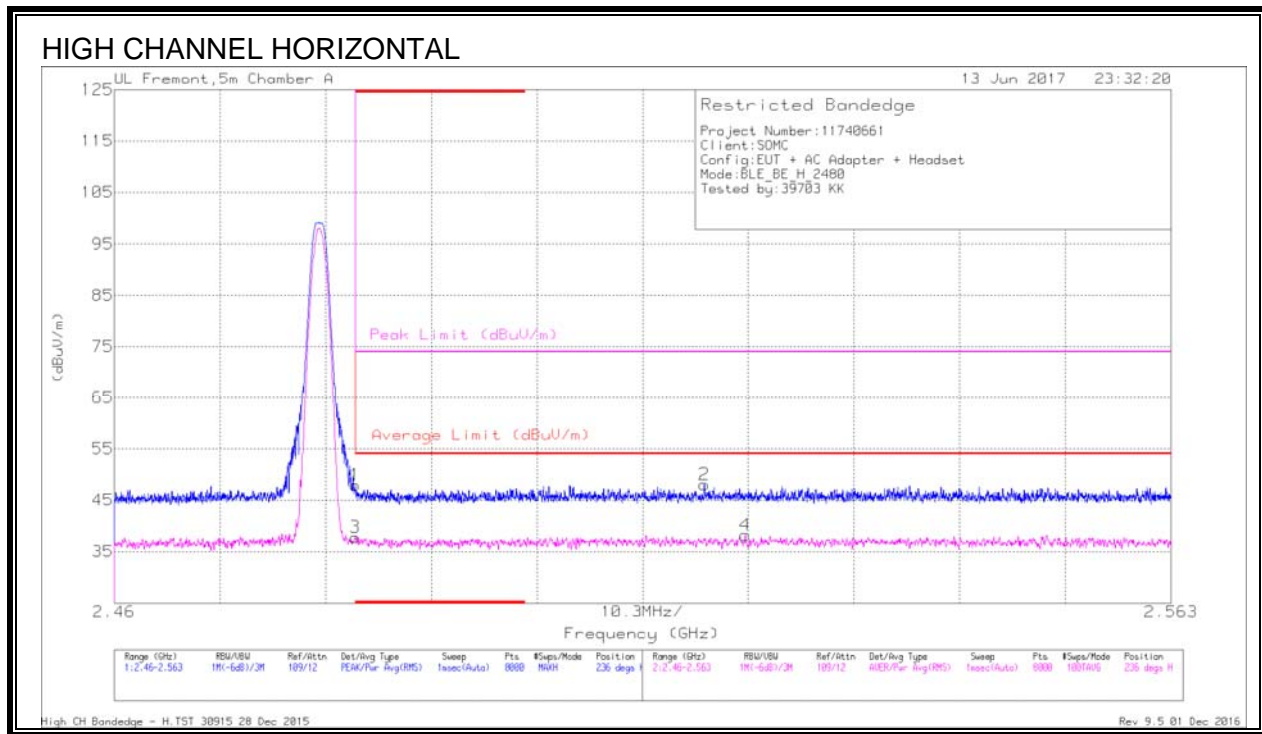

#### Trace Markers

Marker	Frequency (GHz)	Meter Reading (dBuV)	Det	Af T711 (dB/m)	Amp/Ch/Ftr/Pad (dB)	DC Corr (dB)	Corrected Reading (dBuV/m)	Average Limit (dBuV/m)	Margin (dB)	Peak Limit (dBuV/m)	PK Margin (dB)	Azimuth (Degs)	Height (cm)	Polarity
1	* 2.484	39.01	Pk	32.5	-23.6	0	47.91	-	-	74	-26.09	236	205	H
3	* 2.484	28.18	RMS	32.5	-23.6	.7	37.78	54	-16.22	-	-	236	205	H
2	2.518	39.03	Pk	32.6	-23.6	0	48.03	-	-	74	-25.97	236	205	H
4	2.522	28.48	RMS	32.6	-23.6	.7	38.18	54	-15.82	-	-	236	205	H

Pk - Peak detector  
 RMS - RMS detection

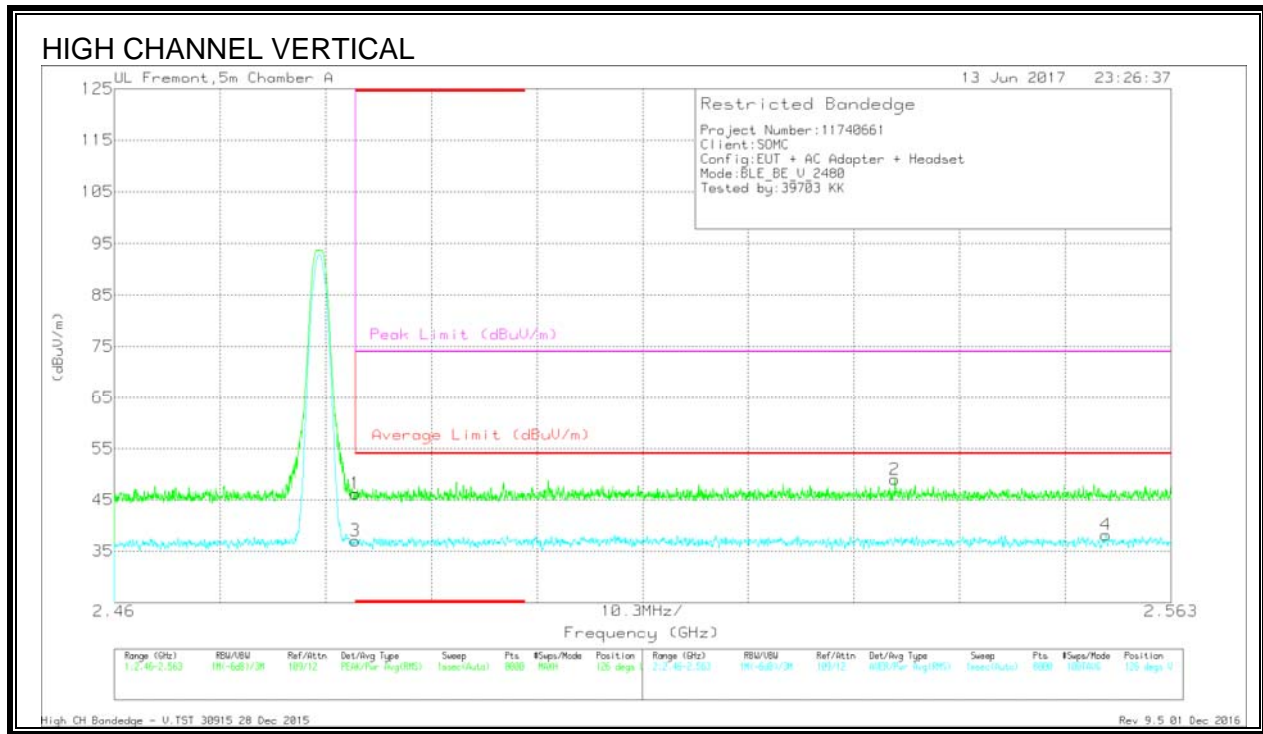

Trace Markers

Marker	Frequency (GHz)	Meter Reading (dBuV)	Det	AF 1711 (dB/m)	Amp/Cbl/Ftr/Pad (dB)	DC Corr (dB)	Corrected Reading (dBuV/m)	Average Limit (dBuV/m)	Margin (dB)	Peak Limit (dBuV/m)	PK Margin (dB)	Azimuth (Degs)	Height (cm)	Polarity
1	* 2.484	37.31	PK	32.5	-23.6	0	46.21	-	-	74	-27.79	126	375	V
3	* 2.484	27.44	RMS	32.5	-23.6	.7	37.04	54	-16.96	-	-	126	375	V
2	2.536	39.86	PK	32.6	-23.5	0	48.96	-	-	74	-25.04	126	375	V
4	2.557	28.37	RMS	32.6	-23.5	.7	38.17	54	-15.83	-	-	126	375	V

Pk - Peak detector  
 RMS - RMS detection

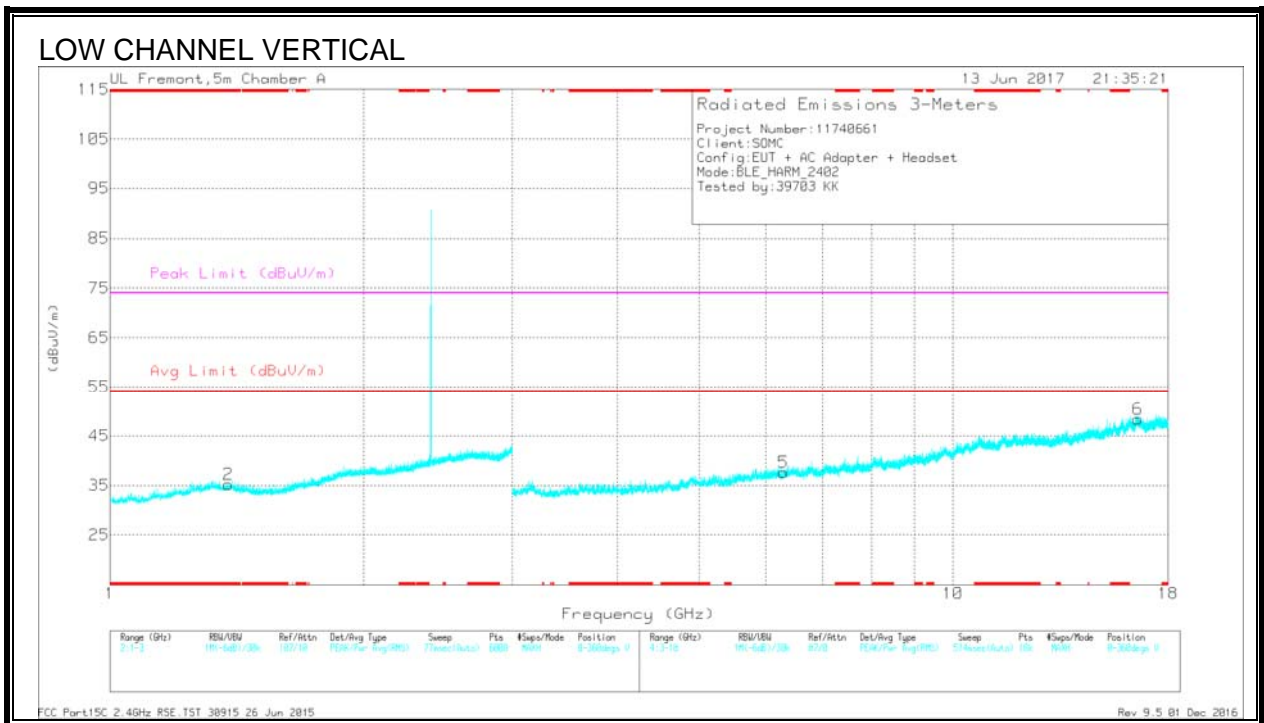
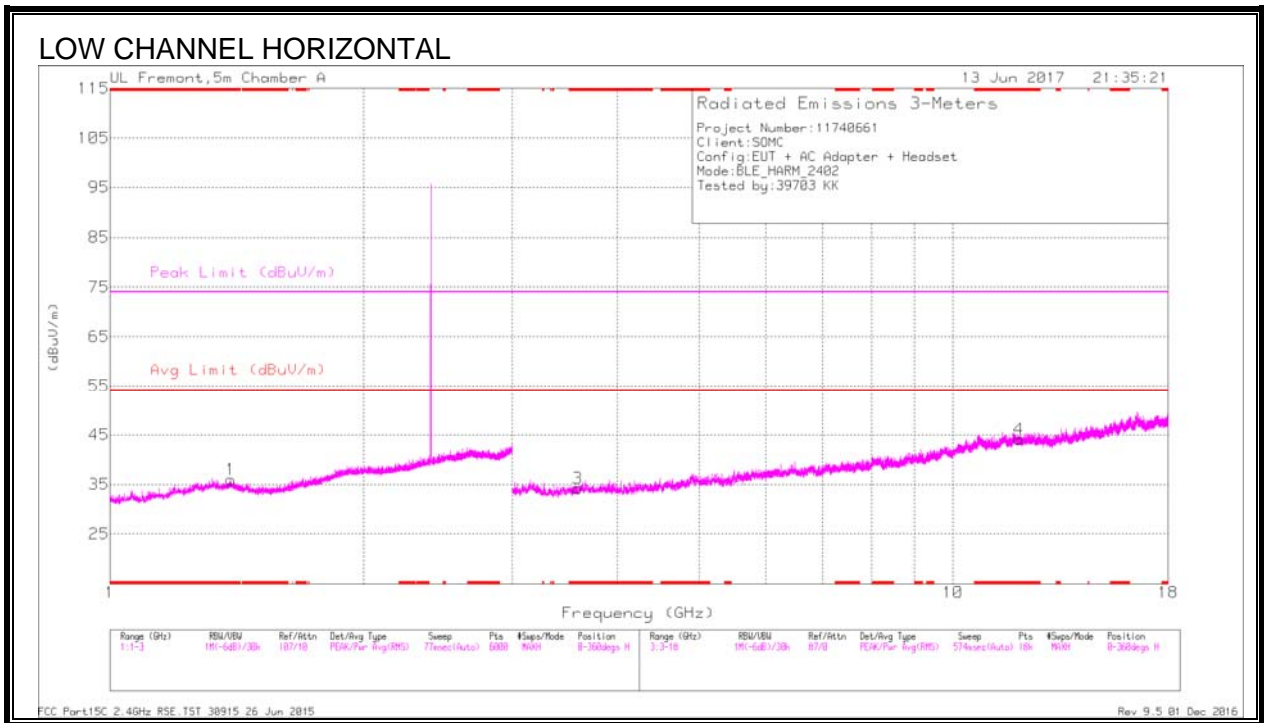

Radiated Emissions

Frequency (GHz)	Meter Reading (dBuV)	Det	AF T711 (dB/m)	Amp/Cbl/Filtr/ Pad (dB)	DC Corr (dB)	Corrected Reading (dBuV/m)	Avg Limit (dBuV/m)	Margin (dB)	Peak Limit (dBuV/m)	PK Margin (dB)	Azimuth (Degs)	Height (cm)	Polarity
* 1.393	35.72	PK2	29.3	-23.7	0	41.32	-	-	74	-32.68	0	101	H
* 1.394	24.56	MAV1	29.3	-23.7	.7	30.86	54	-23.14	-	-	0	101	H
* 1.383	36.03	PK2	29.3	-23.8	0	41.53	-	-	74	-32.47	0	200	V
* 1.383	24.54	MAV1	29.3	-23.8	.7	30.74	54	-23.26	-	-	0	200	V
* 3.585	38.78	PK2	33.1	-30.7	0	41.18	-	-	74	-32.82	0	102	H
* 3.586	27.19	MAV1	33.1	-30.7	.7	30.29	54	-23.71	-	-	0	102	H
* 11.972	32.2	PK2	38.6	-19.9	0	50.9	-	-	74	-23.1	0	102	H
* 11.972	21.1	MAV1	38.6	-19.9	.7	40.5	54	-13.5	-	-	0	102	H
6.289	35.4	PK2	35.4	-26.6	0	44.2	-	-	-	-	0	200	V
6.29	24.45	MAV1	35.4	-26.6	.7	33.95	-	-	-	-	0	200	V
16.566	31.8	PK2	41.7	-19.5	0	54	-	-	-	-	0	200	V
16.567	21.61	MAV1	41.7	-19.5	.7	44.51	-	-	-	-	0	200	V

\* - indicates frequency in CFR15.205/RSS-GEN 8.10 -Restricted Band  
 PK2 - KDB558074 Method: Maximum Peak  
 MAV1 - KDB558074 Option 1 Maximum RMS Average



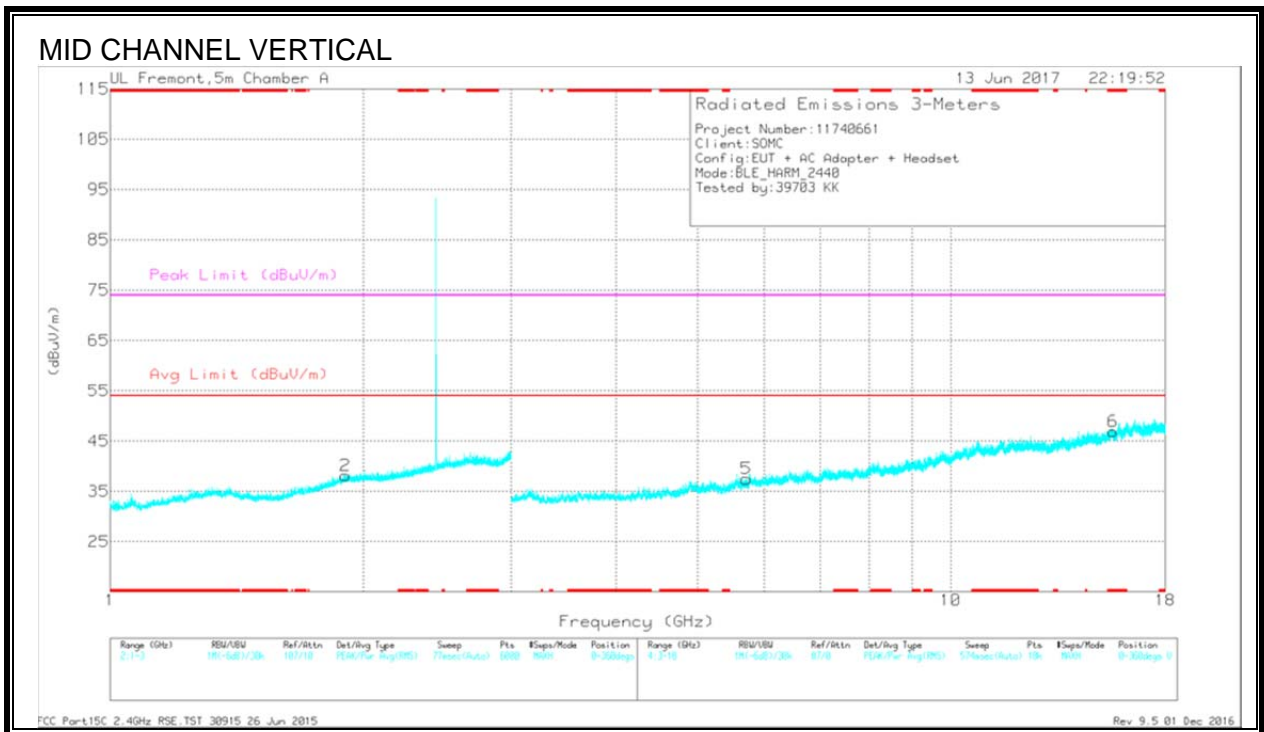
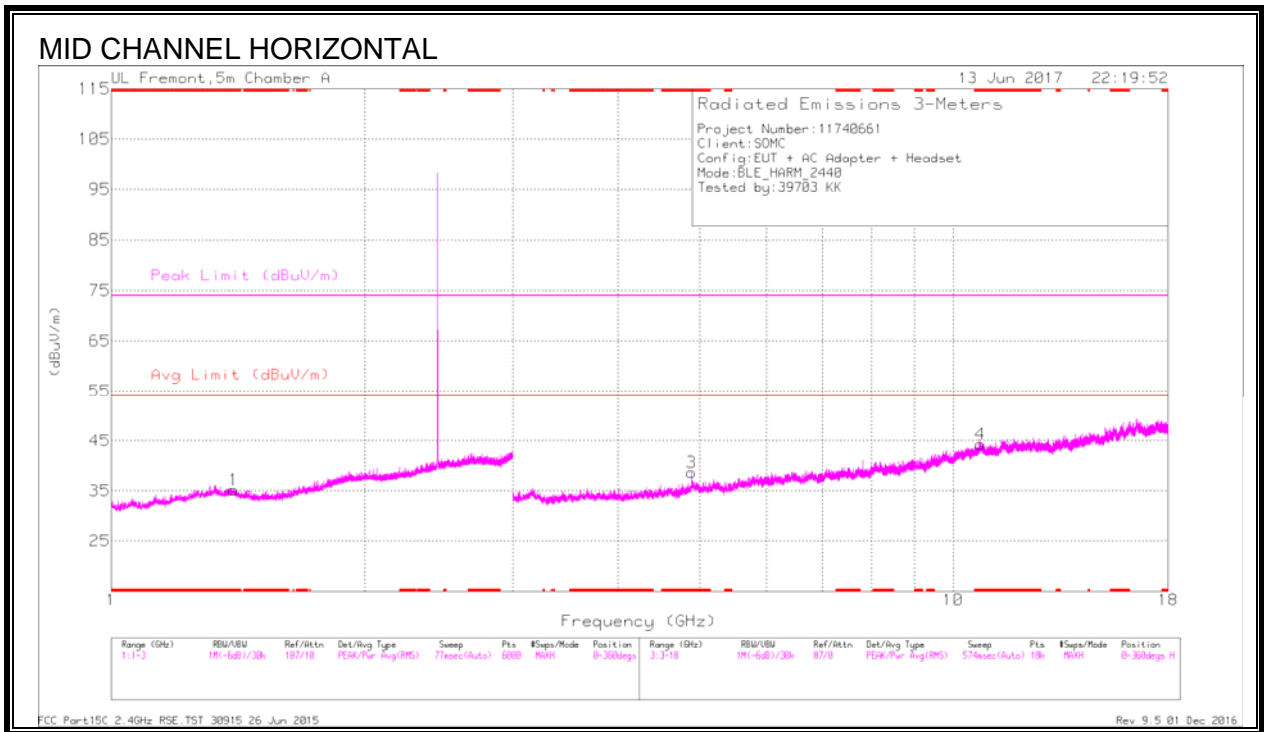

Radiated Emissions

Frequency (GHz)	Meter Reading (dBuV)	Det	AF T711 (dB/m)	Amp/Cbl/Fitr/ Pad (dB)	DC Corr (dB)	Corrected Reading (dBuV/m)	Avg Limit (dBuV/m)	Margin (dB)	Peak Limit (dBuV/m)	PK Margin (dB)	Azimuth (Degs)	Height (cm)	Polarity
* 1.398	36.34	PK2	29.2	-23.8	0	41.74	-	-	74	-32.26	360	199	H
* 1.398	24.55	MAV1	29.2	-23.8	.7	30.65	54	-23.35	-	-	360	199	H
* 4.891	37.62	PK2	34	-27.5	0	44.12	-	-	74	-29.88	360	199	H
* 4.894	25.96	MAV1	34	-27.2	.7	33.46	54	-20.54	-	-	360	199	H
* 10.777	32.11	PK2	37.9	-19.8	0	50.21	-	-	74	-23.79	360	199	H
* 10.775	21.56	MAV1	37.9	-19.8	.7	40.36	54	-13.64	-	-	360	199	H
* 15.602	32.75	PK2	40.4	-19.8	0	53.35	-	-	74	-20.65	360	200	V
* 15.602	21.62	MAV1	40.4	-19.8	.7	42.92	54	-11.08	-	-	360	200	V
1.904	36.29	PK2	31.3	-23.5	0	44.09	-	-	-	-	360	102	V
1.904	24.83	MAV1	31.3	-23.5	.7	33.33	-	-	-	-	360	102	V
5.714	25.16	MAV1	34.8	-27.3	.7	33.36	-	-	-	-	360	102	V
5.715	35.99	PK2	34.8	-27.2	0	43.59	-	-	-	-	360	102	V

\* - indicates frequency in CFR15.205/RSS-GEN 8.10 -Restricted Band  
 PK2 - KDB558074 Method: Maximum Peak  
 MAV1 - KDB558074 Option 1 Maximum RMS Average

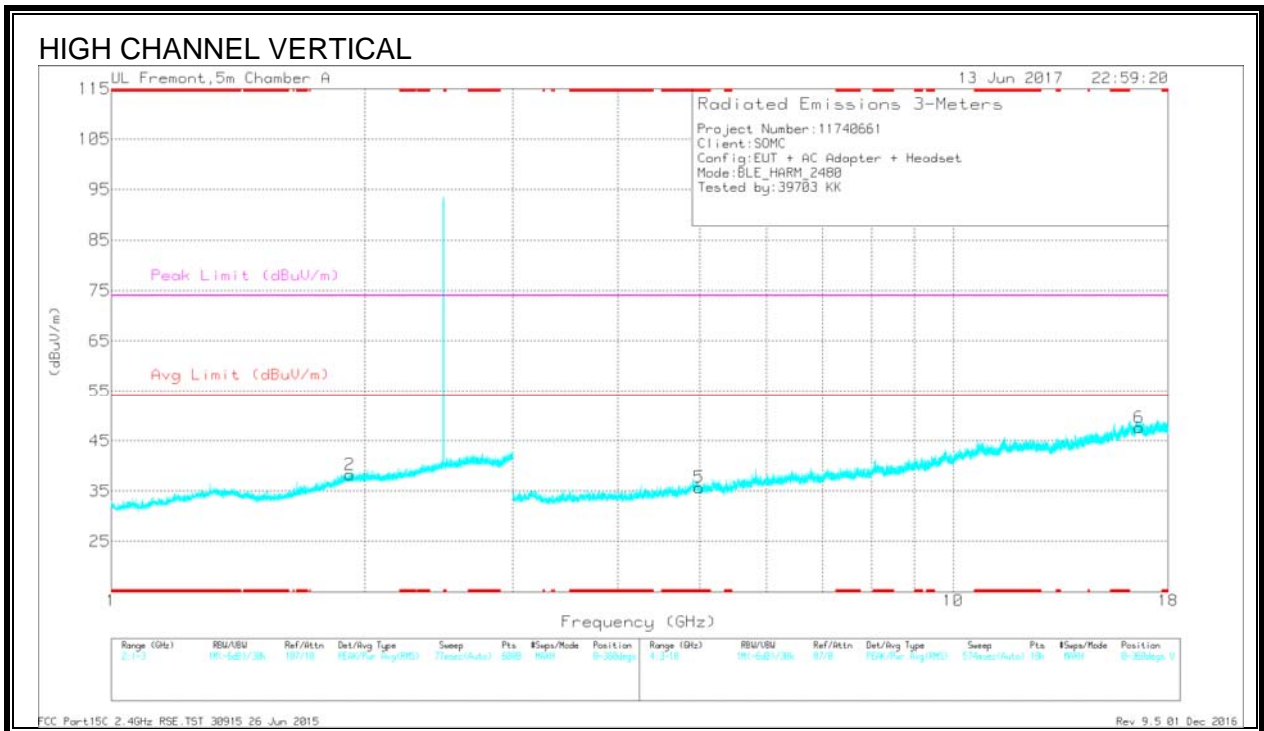
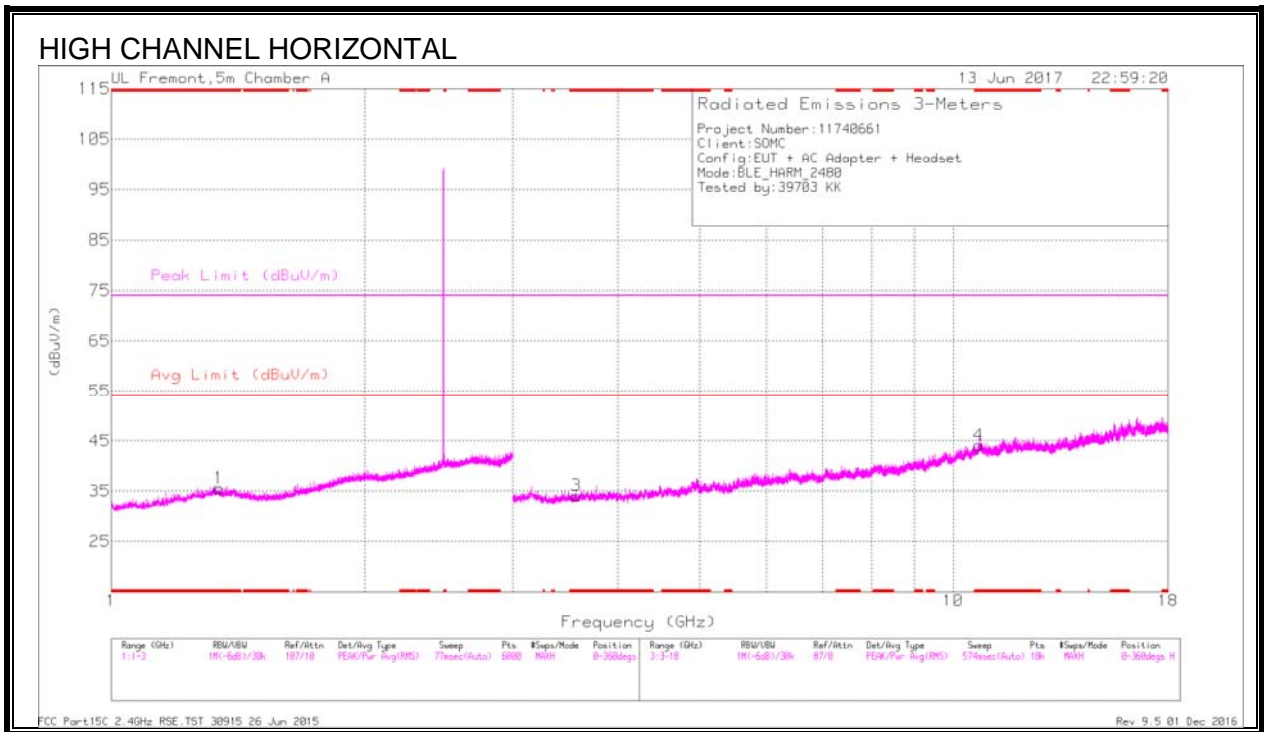

Radiated Emissions

Frequency (GHz)	Meter Reading (dBuV)	Det	AF T711 (dB/m)	Amp/Cbl/Fitr/ Pad (dB)	DC Corr (dB)	Corrected Reading (dBuV/m)	Avg Limit (dBuV/m)	Margin (dB)	Peak Limit (dBuV/m)	PK Margin (dB)	Azimuth (Degs)	Height (cm)	Polarity
* 1.342	36.03	PK2	29.4	-23.9	0	41.53	-	-	74	-32.47	360	100	H
* 1.342	24.49	MAV1	29.4	-23.9	.7	30.69	54	-23.31	-	-	360	100	H
* 3.567	39.2	PK2	33.1	-30.6	0	41.7	-	-	74	-32.3	360	200	H
* 3.567	27.53	MAV1	33.1	-30.6	.7	30.73	54	-23.27	-	-	360	200	H
* 10.716	32.15	PK2	37.9	-20.4	0	49.65	-	-	74	-24.35	360	200	H
* 10.715	21.55	MAV1	37.9	-20.4	.7	39.75	54	-14.25	-	-	360	200	H
* 4.991	37.85	PK2	34.1	-29	0	42.95	-	-	74	-31.05	360	200	V
* 4.991	26.96	MAV1	34.1	-29	.7	32.76	54	-21.24	-	-	360	200	V
1.921	24.8	MAV1	31.3	-23.5	.7	33.3	-	-	-	-	360	200	V
1.922	36.43	PK2	31.3	-23.5	0	44.23	-	-	-	-	360	200	V
16.628	21.37	MAV1	41.7	-19.8	.7	43.97	-	-	-	-	360	102	V
16.631	31.89	PK2	41.7	-19.9	0	53.69	-	-	-	-	360	102	V

\* - indicates frequency in CFR15.205/RSS-GEN 8.10 -Restricted Band  
 PK2 - KDB558074 Method: Maximum Peak  
 MAV1 - KDB558074 Option 1 Maximum RMS Average

### 9.3. SPURIOUS EMISSIONS BELOW 30 MHz (WORST-CASE CONFIGURATION)

#### HORIZONTAL AND VERTICAL PLOTS

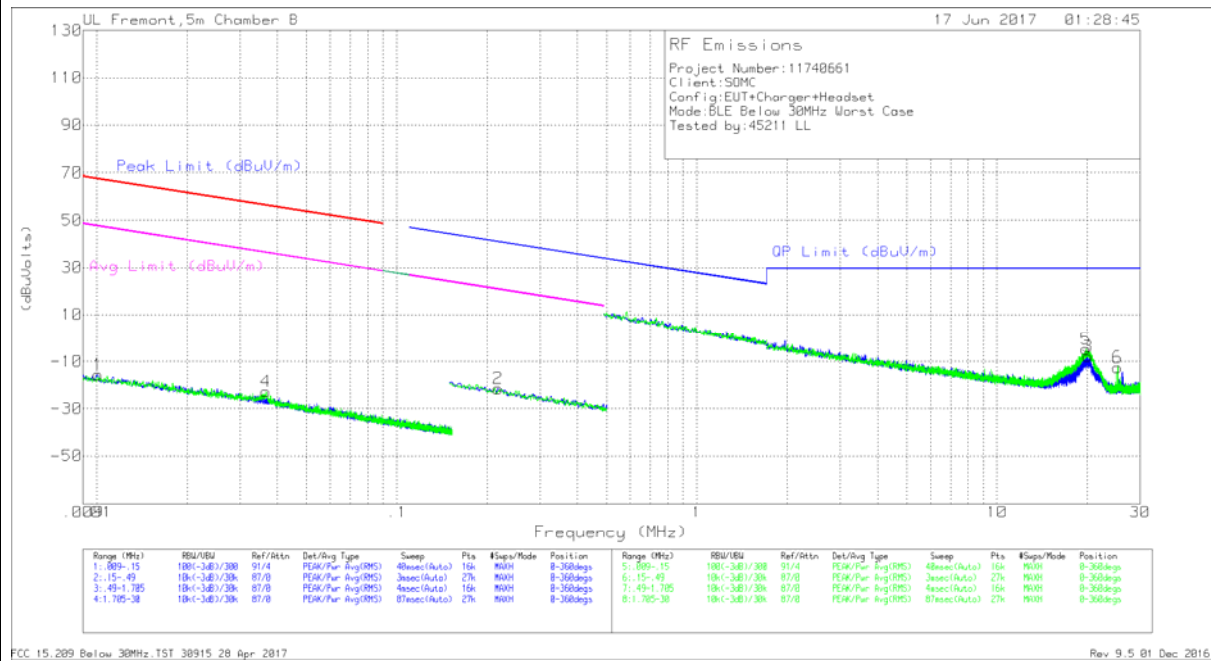
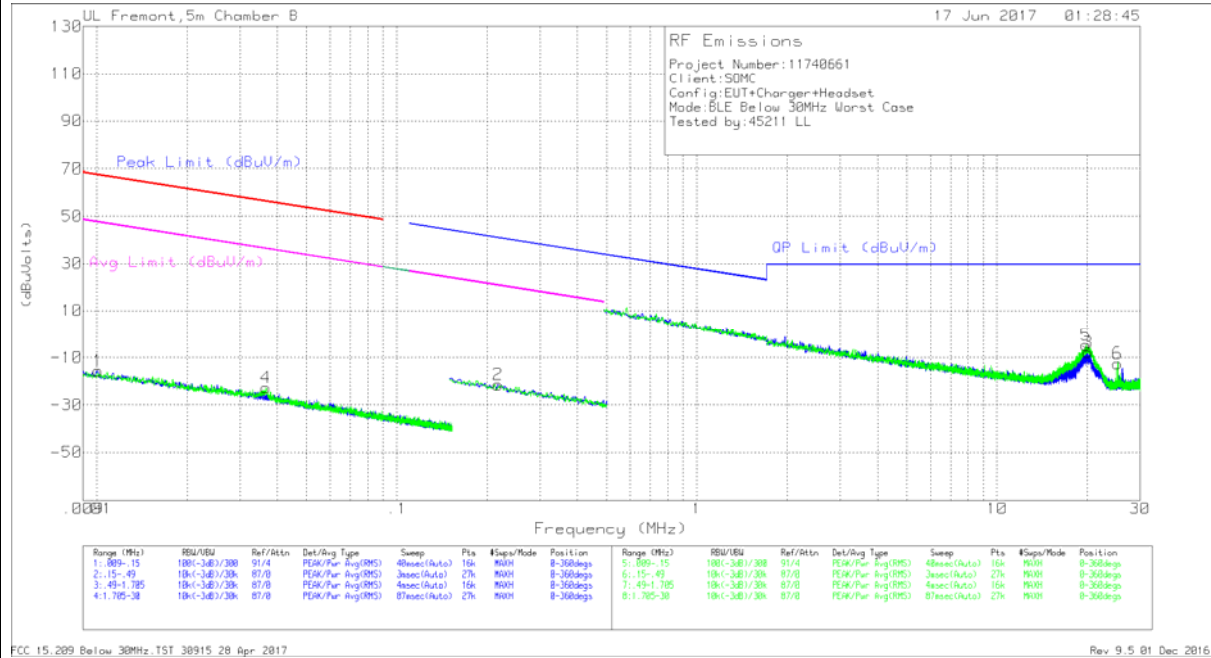

NOTE: KDB 414788 OATS and Chamber Correlation Justification

- Based on FCC 15.31 (f) (2): measurements may be performed at a distance closer than that specified in the regulations; however, an attempt should be made to avoid making measurements in the near field.
- OATs and chamber correlation testing had been performed and chamber measured test result is the worst case test result.

Trace Markers

Marker	Frequency	Meter	Det	Loop Antenna (dB/m)	Cbl (dB)	Dist Corr 300m	Corrected	Peak Limit (dBuV/)	Margin	Avg Limit (dBuV/)	Margin	QP Limit (dBuV/ m)	Margin	QP Limit (dBuV/ m)	Margin	Peak Limit (dBuV/)	Margin	Avg Limit (dBuV/)	Margin	Azimuth
1	0.0101	43.41	Pk	19.5	1.4	-80	-15.69	67.5	-83.19	47.5	-63.19	-	-	-	-	-	-	-	-	0-360
4	0.03666	42.09	Pk	13.7	1.4	-80	-22.81	56.3	-79.11	36.3	-59.11	-	-	-	-	-	-	-	-	0-360
2	0.21749	45.46	Pk	11.5	1.5	-80	-21.54	-	-	-	-	-	-	-	-	40.87	-62.41	20.87	-42.41	0-360

Pk - Peak detector

Marker	Frequency	Meter	Det	Loop Antenna (dB/m)	Cbl (dB)	Dist Corr 40Log	Corrected	Peak Limit (dBuV/)	Margin	Avg Limit (dBuV/)	Margin	QP Limit (dBuV/ m)	Margin	QP Limit (dBuV/ m)	Margin	Peak Limit (dBuV/)	Margin	Avg Limit (dBuV/)	Margin	Azimuth
5	19.82387	23.97	Pk	9.7	1.6	-40	-4.73	-	-	-	-	-	-	29.5	-34.23	-	-	-	-	0-360
3	20.06491	20.65	Pk	9.7	1.7	-40	-7.95	-	-	-	-	-	-	29.5	-37.45	-	-	-	-	0-360
6	25.23365	16.88	Pk	8.9	1.7	-40	-12.52	-	-	-	-	-	-	29.5	-42.02	-	-	-	-	0-360

Pk - Peak detector

### 9.4. SPURIOUS EMISSIONS 30 TO 1000 MHz (WORST-CASE CONFIGURATION)

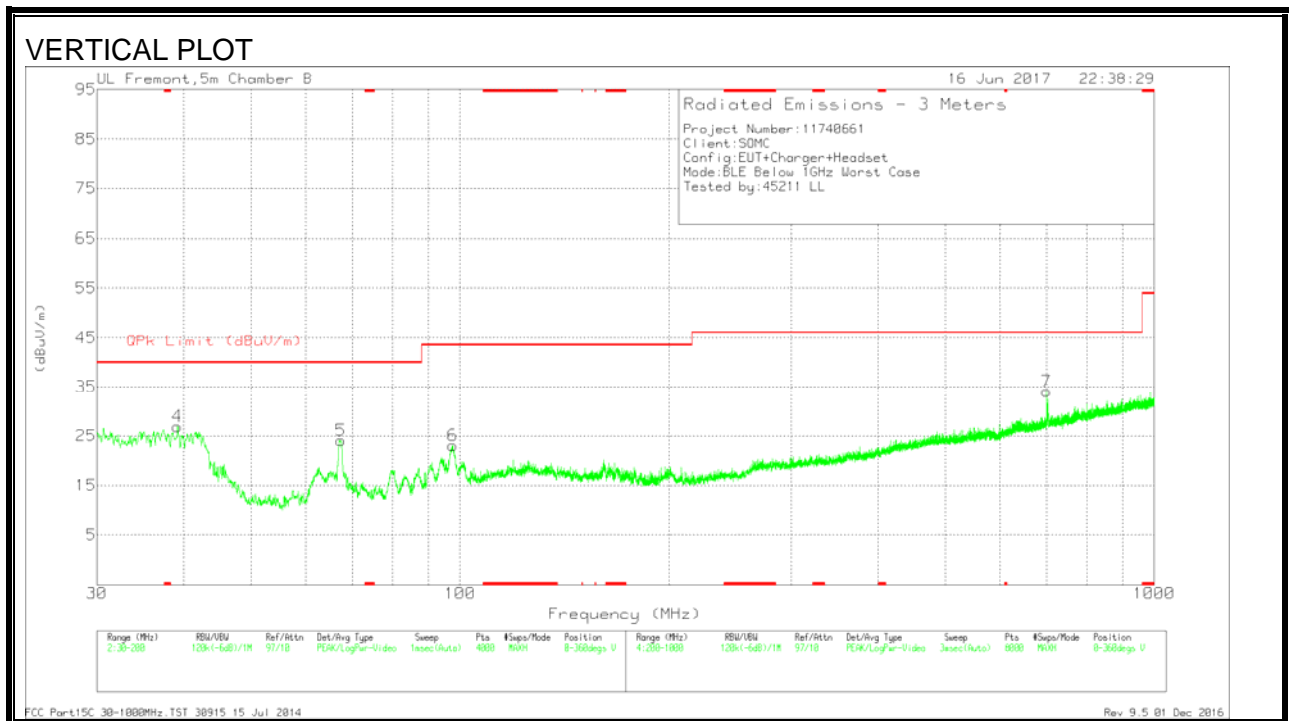
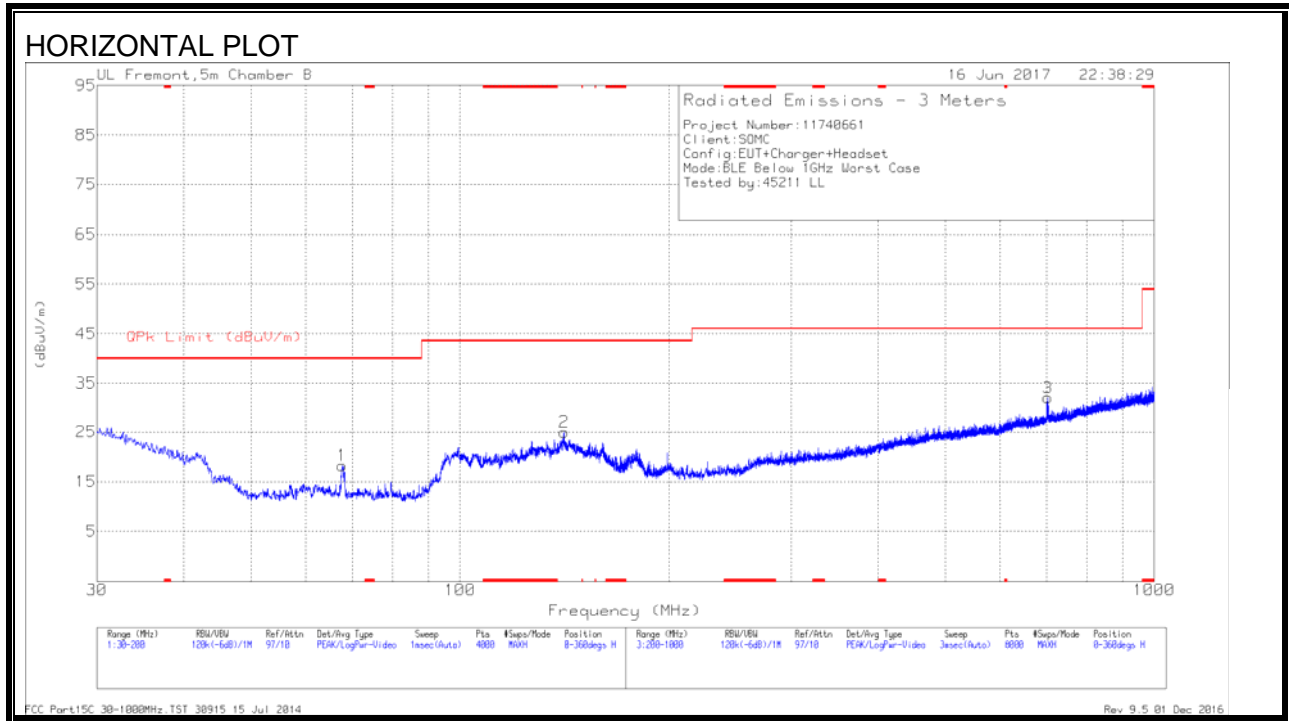

Trace Markers

Marker	Frequency (MHz)	Meter Reading (dBuV)	Det	AF T477 (dB/m)	Amp/Cbl (dB)	Corrected Reading (dBuV/m)	QPk Limit (dBuV/m)	Margin (dB)	Azimuth (Degs)	Height (cm)	Polarity
4	39.1824	36.93	Pk	18.7	-28.7	26.93	40	-13.07	0-360	100	V
5	67.3672	40.46	Pk	11.9	-28.3	24.06	40	-15.94	0-360	100	V
1	67.6647	34.69	Pk	11.9	-28.3	18.29	40	-21.71	0-360	400	H
6	97.5925	37.38	Pk	13.6	-27.9	23.08	43.52	-20.44	0-360	100	V
2	141.1875	35.51	Pk	16.9	-27.4	25.01	43.52	-18.51	0-360	200	H
7	700.165	34.95	Pk	24.1	-25	34.05	46.02	-11.97	0-360	100	V
3	703.3654	32.78	Pk	24.2	-25	31.98	46.02	-14.04	0-360	200	H

Pk - Peak detector



### 9.5. WORST-CASE 18 to 26 GHz

#### SPURIOUS EMISSIONS 18 TO 26 GHz (WORST-CASE CONFIGURATION, HORIZONTAL & VERTICAL)

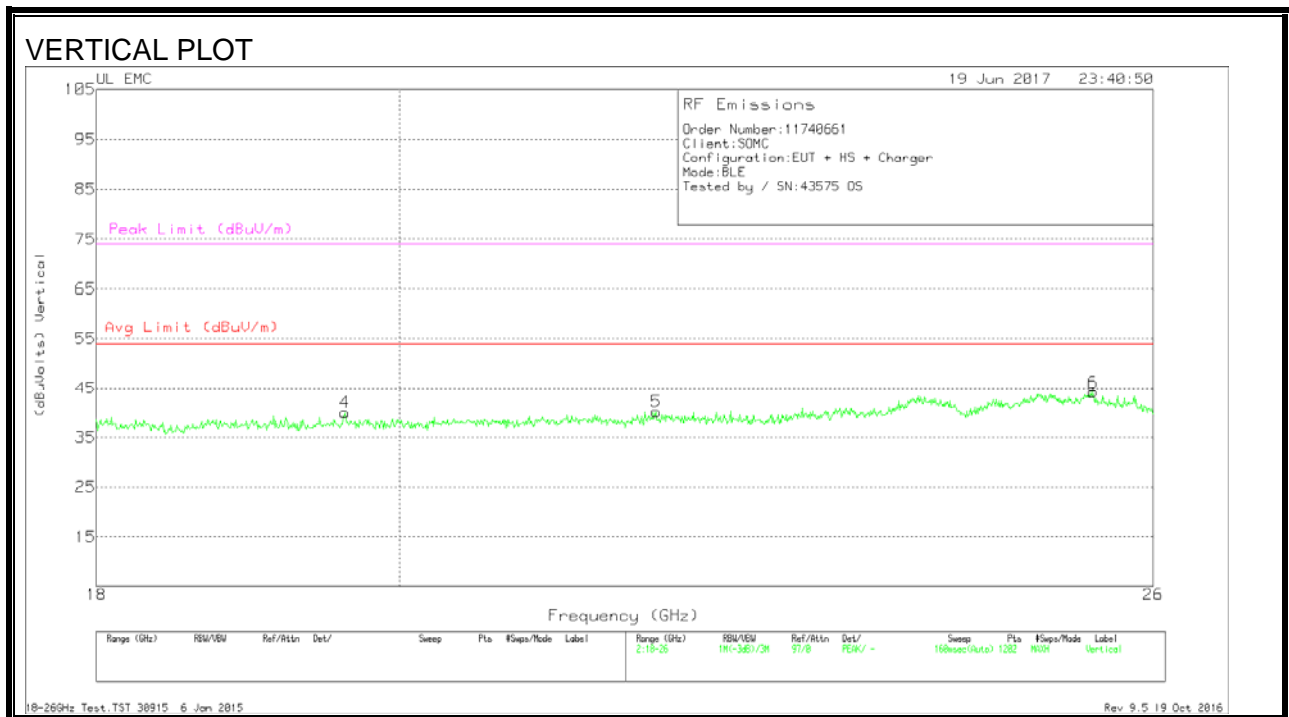
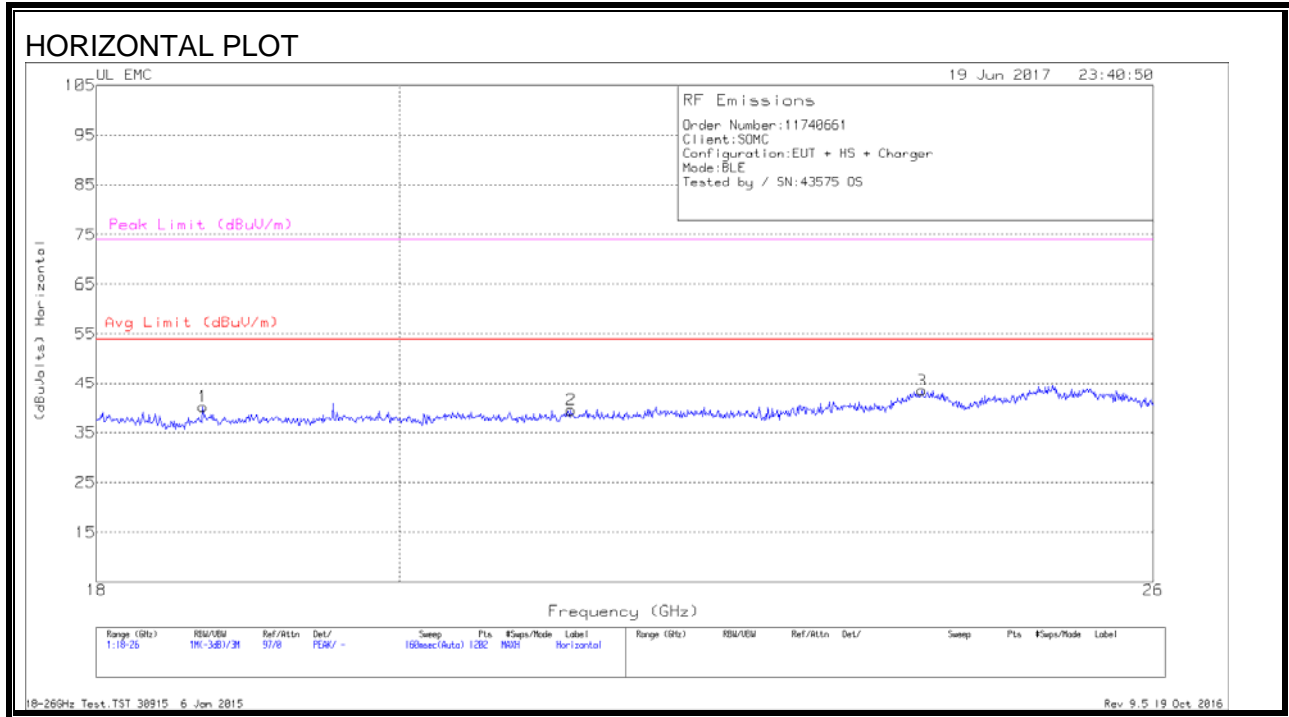

**DATA**

Trace Markers

Marker	Frequency (GHz)	Meter Reading (dBuV)	Det	AF T449 (dB/m)	Amp/Cbl (dB)	Dist Corr (dB)	Corrected Reading (dBuVolts)	Avg Limit (dBuV/m)	Margin (dB)	Peak Limit (dBuV/m)	PK Margin (dB)
1	18.679	41.97	Pk	32.3	-24.6	-9.5	40.17	54	-13.83	74	-33.83
2	21.231	41.1	Pk	33	-25.1	-9.5	39.5	54	-14.5	74	-34.5
3	23.988	43.4	Pk	33.9	-24.3	-9.5	43.5	54	-10.5	74	-30.5
4	19.625	41.7	Pk	32.7	-24.9	-9.5	40	54	-14	74	-34
5	21.87	41.07	Pk	33.3	-24.7	-9.5	40.17	54	-13.83	74	-33.83
6	25.46	43.77	Pk	34.4	-24.5	-9.5	44.17	54	-9.83	74	-29.83

Pk - Peak detector

## 10. AC POWER LINE CONDUCTED EMISSIONS

### LIMITS

FCC §15.207 (a)  
RSS-Gen 8.8

Frequency of Emission (MHz)	Conducted Limit (dB $\mu$ V)	
	Quasi-peak	Average
0.15-0.5	66 to 56 *	56 to 46 *
0.5-5	56	46
5-30	60	50

\*Decreases with the logarithm of the frequency.

### TEST PROCEDURE

The EUT is placed on a non-conducting table 40 cm from the vertical ground plane and 80 cm above the horizontal ground plane. The EUT is configured in accordance with ANSI C63.10.

The receiver is set to a resolution bandwidth of 9 kHz. Peak detection is used unless otherwise noted as quasi-peak or average.

Line conducted data is recorded for both NEUTRAL and HOT lines.

### RESULTS

**LINE 1 RESULTS**

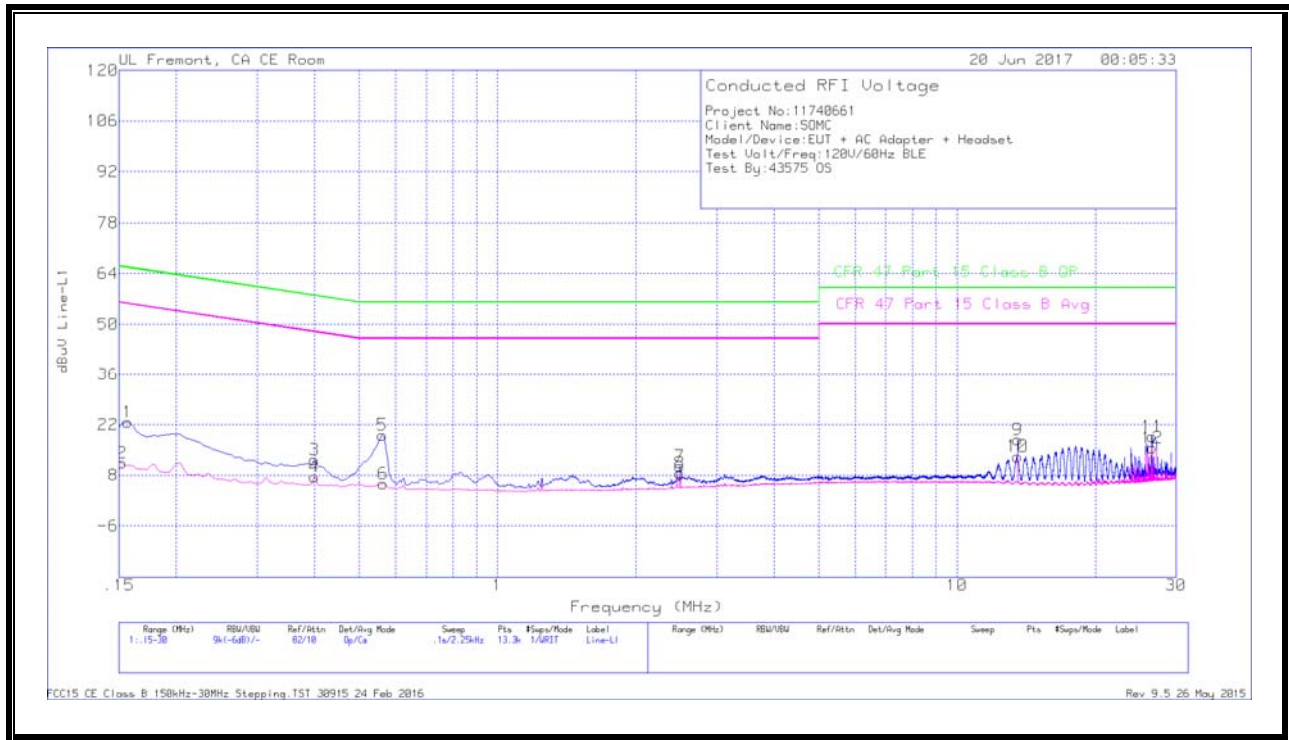

**WORST EMISSIONS**

Trace Markers

Range 1: Line-L1 .15 - 30MHz											
Marker	Frequency (MHz)	Meter Reading (dBuV)	Det	T24 IL L1	LC Cables C1&C3	Limiter (dB)	Corrected Reading dBuV	CFR 47 Part 15 Class B QP	QP Margin (dB)	CFR 47 Part 15 Class B Avg	Av(CISPR) Margin (dB)
1	.15675	11.26	Qp	1.2	.1	10.1	22.66	65.63	-42.97	-	-
2	.15225	-0.06	Ca	1.3	.1	10.1	11.44	-	-	55.88	-44.44
3	.39975	1.75	Qp	.4	.1	10.1	12.35	57.86	-45.51	-	-
4	.39975	-3.03	Ca	.4	.1	10.1	7.57	-	-	47.86	-40.29
5	.56175	8.64	Qp	.3	.1	10.1	19.14	56	-36.86	-	-
6	.564	-4.89	Ca	.3	.1	10.1	5.61	-	-	46	-40.39
7	2.49675	.12	Qp	.2	.1	10.1	10.52	56	-45.48	-	-
8	2.49675	-1.84	Ca	.2	.1	10.1	8.56	-	-	46	-37.44
9	13.56	7.2	Qp	.2	.2	10.2	17.8	60	-42.2	-	-
10	13.56	2.63	Ca	.2	.2	10.2	13.23	-	-	50	-36.77
11	26.61225	7.6	Qp	.3	.3	10.5	18.7	60	-41.3	-	-
12	26.61225	4.41	Ca	.3	.3	10.5	15.51	-	-	50	-34.49

Qp - Quasi-Peak detector  
 Ca - CISPR average detection

**LINE 2 RESULTS**

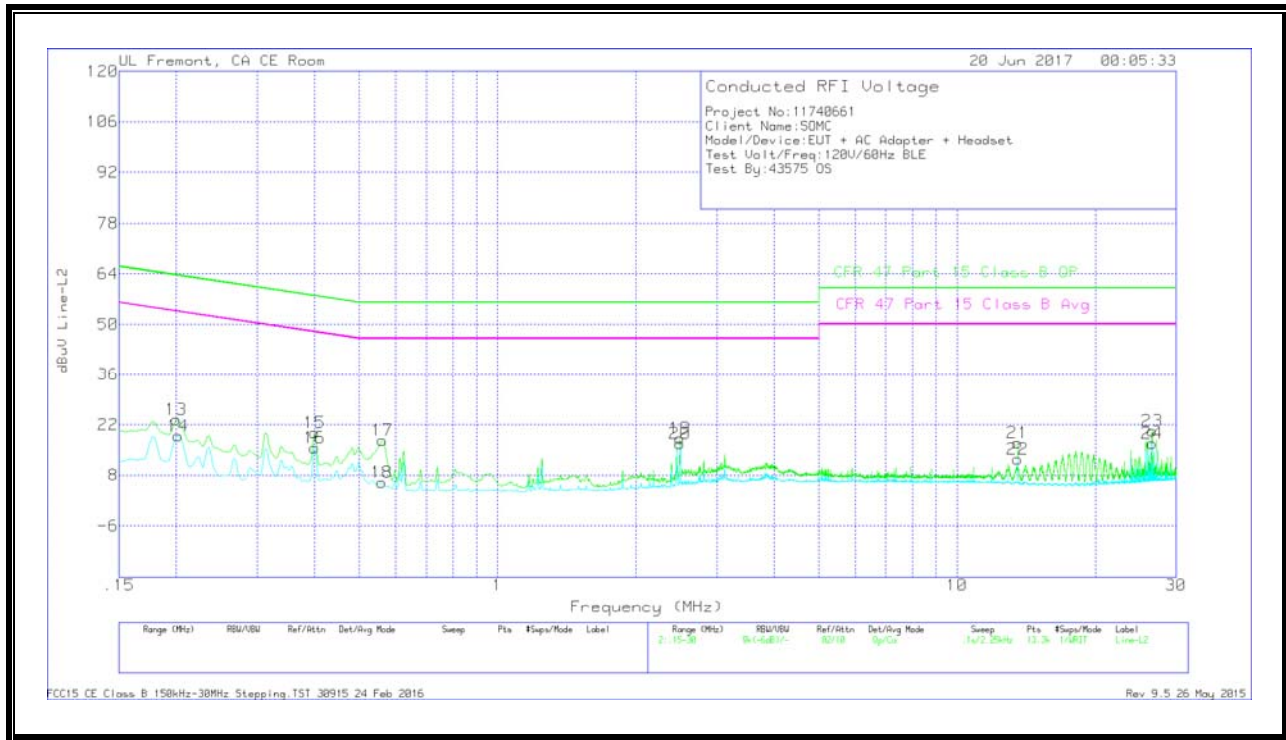

**WORST EMISSIONS**

Trace Markers

Range 2: Line-L2 .15 - 30MHz											
Marker	Frequency (MHz)	Meter Reading (dBuV)	Det	T24 IL L2	LC Cables C2&C3	Limiter (dB)	Corrected Reading dBuV	CFR 47 Part 15 Class B QP	QP Margin (dB)	CFR 47 Part 15 Class B Avg	Av(CISPR) Margin (dB)
13	.1995	12.28	Qp	1	.1	10.1	23.48	63.63	-40.15	-	-
14	.20175	7.74	Ca	1	.1	10.1	18.94	-	-	53.54	-34.6
15	.39975	9.23	Qp	.4	.1	10.1	19.83	57.86	-38.03	-	-
16	.39975	5.05	Ca	.4	.1	10.1	15.65	-	-	47.86	-32.21
17	.56175	7.12	Qp	.3	.1	10.1	17.62	56	-38.38	-	-
18	.5595	-4.48	Ca	.3	.1	10.1	6.02	-	-	46	-39.98
19	2.49675	7.84	Qp	.2	.1	10.1	18.24	56	-37.76	-	-
20	2.49675	6.45	Ca	.2	.1	10.1	16.85	-	-	46	-29.15
21	13.56	6.23	Qp	.3	.2	10.2	16.93	60	-43.07	-	-
22	13.56	1.79	Ca	.3	.2	10.2	12.49	-	-	50	-37.51
23	26.61225	9.17	Qp	.3	.3	10.5	20.27	60	-39.73	-	-
24	26.61225	5.76	Ca	.3	.3	10.5	16.86	-	-	50	-33.14

Qp - Quasi-Peak detector  
 Ca - CISPR average detection