



FCC RADIO TEST REPORT

FCC ID : PY7-80422D
Equipment : GSM/WCDMA/LTE Phone with BT, DTS/UNII
a/b/g/n/ac, GPS and NFC
Brand Name : Sony
Applicant : Sony Mobile Communications Inc.
4-12-3 Higashi-Shinagawa, Shinagawa-ku,
Tokyo, 140-0002, Japan
Manufacturer : Sony Mobile Communications Inc.
4-12-3 Higashi-Shinagawa, Shinagawa-ku,
Tokyo, 140-0002, Japan
Standard : 47 CFR Part 2, 22(H), 24(E), 27(L)

The product was received on Nov. 02, 2018 and testing was started from Mar. 04, 2019 and completed on Mar. 19, 2019. We, SPORTON INTERNATIONAL INC. EMC & Wireless Communications Laboratory, would like to declare that the tested sample has been evaluated in accordance with the test procedures given in ANSI / TIA-603-E and has been in compliance with the applicable technical standards.

The report must not be used by the client to claim product certification, approval, or endorsement by TAF or any agency of government.

The test results in this report apply exclusively to the tested model / sample. Without written approval of SPORTON INTERNATIONAL INC. EMC & Wireless Communications Laboratory, the test report shall not be reproduced except in full.

Approved by: Jones Tsai

SPORTON INTERNATIONAL INC. EMC & Wireless Communications Laboratory

No. 52, Huaya 1st Rd., Guishan Dist., Taoyuan City, Taiwan (R.O.C.)



Table of Contents

History of this test report 3

Summary of Test Result 4

1 General Description..... 5

 1.1 Product Feature of Equipment Under Test..... 5

 1.2 Modification of EUT..... 5

 1.3 Maximum ERP/EIRP Power, Frequency Tolerance, and Emission Designator 6

 1.4 Testing Location..... 7

 1.5 Applicable Standards..... 7

2 Test Configuration of Equipment Under Test..... 8

 2.1 Test Mode 8

 2.2 Connection Diagram of Test System..... 9

 2.3 Support Unit used in test configuration..... 9

 2.4 Measurement Results Explanation Example..... 9

 2.5 Frequency List of Low/Middle/High Channels 10

3 Conducted Test Result..... 11

 3.1 Measuring Instruments 11

 3.2 Conducted Output Power and ERP/EIRP 12

 3.3 Peak-to-Average Ratio..... 13

 3.4 99% Occupied Bandwidth and 26dB Bandwidth Measurement..... 14

 3.5 Conducted Band Edge..... 15

 3.6 Conducted Spurious Emission..... 16

 3.7 Frequency Stability 17

4 Radiated Test Items 18

 4.1 Measuring Instruments 18

 4.2 Test Setup..... 18

 4.3 Test Result of Radiated Test 18

 4.4 Field Strength of Spurious Radiation Measurement..... 19

5 List of Measuring Equipment 20

6 Uncertainty of Evaluation 22

Appendix A. Test Results of Conducted Test

Appendix B. Test Results of ERP/EIRP and Radiated Test



Summary of Test Result

Report Clause	Ref Std. Clause	Test Items	Result (PASS/FAIL)	Remark
3.2	§2.1046	Conducted Output Power	Pass	-
	§22.913 (a)(2)	Effective Radiated Power		
	§24.232 (c)	Equivalent Isotropic Radiated Power		
	§27.50 (d)(4)	Equivalent Isotropic Radiated Power		
3.3	§24.232 (d)	Peak-to-Average Ratio	Pass	-
3.4	§2.1049 §22.917 (b) §24.238 (b) §27.53 (g)	Occupied Bandwidth	Pass	-
3.5	§2.1051 §22.917 (a) §24.238 (a) §27.53 (g)	Band Edge Measurement	Pass	-
3.6	§2.1051 §22.917 (a) §24.238 (a) §27.53 (g)	Conducted Emission	Pass	-
3.7	§2.1055 §22.355	Frequency Stability Temperature & Voltage	Pass	-
	§2.1055 §24.235 §27.54			-
4.4	§2.1053 §22.917 (a) §24.238 (a) §27.53 (h)	Field Strength of Spurious Radiation	Pass	Under limit 34.34 dB at 7520.000 MHz

Declaration of Conformity:

The test results with all measurement uncertainty excluded are presented in accordance with the regulation limits or requirements declared by manufacturers.

Comments and Explanations:

The declared of product specification for EUT presented in the report are provided by the manufacturer, and the manufacturer takes all the responsibilities for the accuracy of product specification.

Reviewed by: Wii Chang

Report Producer: Natasha Hsieh



1 General Description

1.1 Product Feature of Equipment Under Test

GSM/WCDMA/LTE, Bluetooth, DTS/UNII a/b/g/n/ac, NFC, and GNSS.

Standards-related Product Specification	
Antenna Type	Monopole / Loop Antenna

EUT Information List			
HW Version	SW Version	S/N	Performed Test Item
A	0.203	BH9700DSFY	Conducted Measurement
		BH9700B0FY	ERP/EIRP Test
		BH97004FFY	Radiated Spurious Emission

Accessory List	
AC Adapter	Model No. : UCH32
	S/N: 6218W30200140
Earphone	Model No.: MH750
	S/N : N/A
USB Cable	Model No.: UCB24
	S/N : N/A
2 in 1 USB Audio Cable	Model No.: EC270
	S/N : N/A

Note:

1. Above EUT list used are electrically identical per declared by manufacturer.
2. Above the accessories list are used to exercise the EUT during test, and the serial number of each type of accessories is listed in each section of this report. .
3. For other wireless features of this EUT, test report will be issued separately.

1.2 Modification of EUT

No modifications are made to the EUT during all test items.



1.3 Maximum ERP/EIRP Power, Frequency Tolerance, and Emission Designator

FCC Rule	Frequency Range (MHz)	System	Type of Modulation	Maximum ERP/EIRP (W)	Frequency Tolerance (ppm)	Emission Designator
Part 22	824.2 ~848.8	GSM850 GPRS class 8	GMSK	0.4699	0.0120 ppm	247KGXW
Part 22	824.2 ~848.8	GSM850 EDGE class 8	8PSK	0.1652	0.0179 ppm	246KG7W
Part 24	1850.2 ~1909.8	GSM1900 GPRS class 8	GMSK	0.1730	0.0053 ppm	241KGXW
Part 24	1850.2 ~1909.8	GSM1900 EDGE class 8	8PSK	0.1337	0.0080 ppm	242KG7W
Part 24	1852.4 ~ 1907.6	WCDMA Band II RMC 12.2Kbps	BPSK	0.0247	0.0021 ppm	4M16F9W
Part 27	1712.4 ~ 1752.6	WCDMA Band IV RMC 12.2Kbps	BPSK	0.0757	0.0075 ppm	4M16F9W



1.4 Testing Location

Test Site	SPORTON INTERNATIONAL INC.
Test Site Location	No.52, Huaya 1st Rd., Guishan Dist., Taoyuan City, Taiwan (R.O.C.) TEL: +886-3-327-3456 FAX: +886-3-328-4978
Test Site No.	Sporton Site No.
	TH03-HY

Note: The test site complies with ANSI C63.4 2014 requirement.

Test Site	SPORTON INTERNATIONAL INC.
Test Site Location	No.58, Aly. 75, Ln. 564, Wenhua 3rd, Rd., Guishan Dist., Taoyuan City, Taiwan (R.O.C.) TEL: +886-3-327-0868 FAX: +886-3-327-0855
Test Site No.	Sporton Site No.
	03CH10-HY

Note: The test site complies with ANSI C63.4 2014 requirement.

FCC Designation No.: TW1190 and TW0007

1.5 Applicable Standards

According to the specifications of the manufacturer, the EUT must comply with the requirements of the following standards:

- ♦ ANSI C63.26-2015
- ♦ ANSI / TIA-603-E
- ♦ 47 CFR Part 2, 22(H), 24(E), 27(L)
- ♦ FCC KDB 971168 D01 Power Meas. License Digital Systems v03r01
- ♦ FCC KDB 412172 D01 Determining ERP and EIRP v01r01

Remark:

1. All test items were verified and recorded according to the standards and without any deviation during the test.
2. This EUT has also been tested and complied with the requirements of FCC Part 15, Subpart B, recorded in a separate test report.



2 Test Configuration of Equipment Under Test

2.1 Test Mode

Antenna port conducted and radiated test items were performed according to KDB 971168 D01 Power Meas. License Digital Systems v03r01 with maximum output power.

For radiated measurement, pre-scanned in three orthogonal panels, X, Y, Z. The worst cases (X plane) were recorded in this report.

Radiated emissions were investigated as following frequency range:

1. 30 MHz to 9000 MHz for GSM850
2. 30 MHz to 18000 MHz for WCDMA Band IV.
3. 30 MHz to 19100 MHz for GSM1900 and WCDMA Band II.

All modes and data rates and positions were investigated.

Test modes are chosen to be reported as the worst case configuration below:

Test Modes		
Band	Radiated TCs	Conducted TCs
GSM 850	■ GPRS Class 8 Link	■ GPRS Class 8 Link
	■ EDGE Class 8 Link	■ EDGE Class 8 Link
GSM 1900	■ GPRS Class 8 Link	■ GPRS Class 8 Link
	■ EDGE Class 8 Link	■ EDGE Class 8 Link
WCDMA Band II	■ RMC 12.2Kbps Link	■ RMC 12.2Kbps Link
WCDMA Band IV	■ RMC 12.2Kbps Link	■ RMC 12.2Kbps Link

2.2 Connection Diagram of Test System

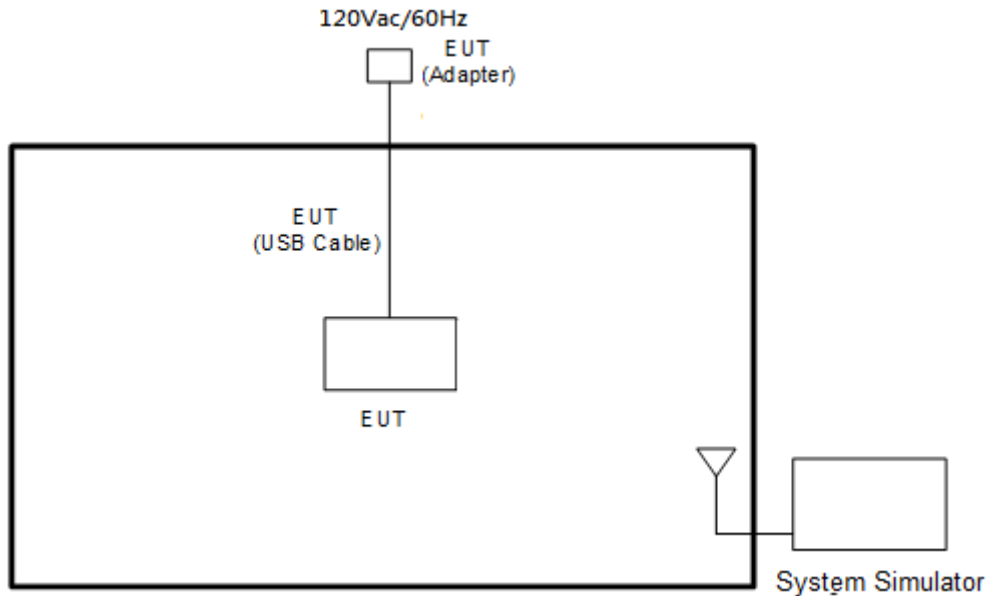

2.3 Support Unit used in test configuration

Item	Equipment	Trade Name	Model No.	FCC ID	Data Cable	Power Cord
1.	System Simulator	Anritsu	8820C	N/A	N/A	Unshielded, 1.8 m

2.4 Measurement Results Explanation Example

For all conducted test items:

The offset level is set in the spectrum analyzer to compensate the RF cable loss and attenuator factor between RF conducted output port and spectrum analyzer. With the offset compensation, the spectrum analyzer reading level will be exactly the RF output level.

The spectrum analyzer offset is derived from RF cable loss and attenuator factor.

Offset = RF cable loss + attenuator factor.

The following shows an offset computation example with RF cable loss 4.2 dB and a 10dB attenuator.

Example:

$$\begin{aligned} \text{Offset(dB)} &= \text{RF cable loss(dB)} + \text{attenuator factor(dB)}. \\ &= 4.2 + 10 = 14.2 \text{ (dB)} \end{aligned}$$



2.5 Frequency List of Low/Middle/High Channels

Frequency List				
Band	Channel/Frequency(MHz)	Lowest	Middle	Highest
GSM850	Channel	128	189	251
	Frequency	824.2	836.4	848.8
GSM1900	Channel	512	661	810
	Frequency	1850.2	1880.0	1909.8
WCDMA Band II	Channel	9262	9400	9538
	Frequency	1852.4	1880.0	1907.6
WCDMA Band IV	Channel	1312	1413	1513
	Frequency	1712.4	1732.6	1752.6

3 Conducted Test Result

3.1 Measuring Instruments

See list of measuring instruments of this test report.

3.1.1 Test Setup

3.1.2 Conducted Output Power

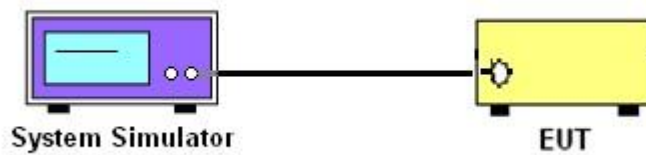

3.1.3 Peak-to-Average Ratio, Occupied Bandwidth, Conducted Band-Edge and Conducted Spurious Emission

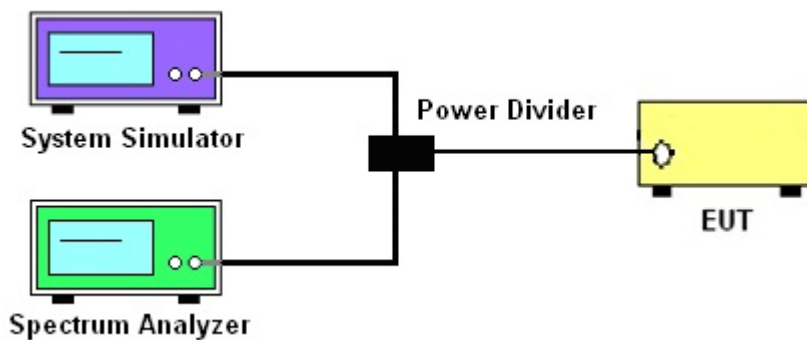

3.1.4 Frequency Stability

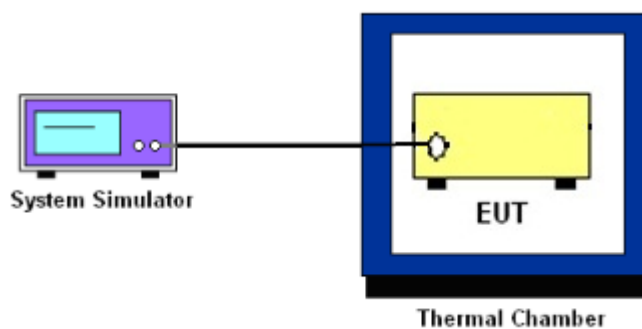

3.1.5 Test Result of Conducted Test

Please refer to Appendix A.



3.2 Conducted Output Power and ERP/EIRP

3.2.1 Description of the Conducted Output Power and ERP/EIRP

A system simulator was used to establish communication with the EUT. Its parameters were set to enforce EUT transmitting at the maximum power. The measured power in the radio frequency on the transmitter output terminals shall be reported.

The ERP of mobile transmitters must not exceed 7 Watts for GSM850.

The EIRP of mobile transmitters must not exceed 2 Watts for GSM1900 and WCDMA Band II.

The EIRP of mobile transmitters must not exceed 1 Watts for WCDMA Band IV.

According to KDB 412172 D01 Power Approach,

$EIRP = P_T + G_T - L_C$, $ERP = EIRP - 2.15$, where

P_T = transmitter output power in dBm

G_T = gain of the transmitting antenna in dBi

L_C = signal attenuation in the connecting cable between the transmitter and antenna in dB

3.2.2 Test Procedures

1. The transmitter output port was connected to the system simulator.
2. Set EUT at maximum power through system simulator.
3. Select lowest, middle, and highest channels for each band and different modulation.
4. Measure the maximum burst average power for GSM and maximum average power for other modulation signal.



3.3 Peak-to-Average Ratio

3.3.1 Description of the PAR Measurement

The peak-to-average ratio (PAR) of the transmission may not exceed 13 dB.

3.3.2 Test Procedures

The testing follows ANSI C63.26-2015 Section 5.2.6

1. The EUT was connected to spectrum analyzer and system simulator via a power divider.
2. Set EUT to transmit at maximum output power.
3. When the duty cycle is less than 98%, then signal gating will be implemented on the spectrum analyzer by triggering from the system simulator.
4. Set the CCDF (Complementary Cumulative Distribution Function) option of the spectrum analyzer.
5. Record the maximum PAPR level associated with a probability of 0.1%.



3.4 99% Occupied Bandwidth and 26dB Bandwidth Measurement

3.4.1 Description of 99% Occupied Bandwidth and 26dB Bandwidth Measurement

The occupied bandwidth is the width of a frequency band such that, below the lower and above the upper frequency limits, the mean powers emitted are each equal to a specified percentage 0.5% of the total mean transmitted power.

The 26 dB emission bandwidth is defined as the frequency range between two points, one above and one below the carrier frequency, at which the spectral density of the emission is attenuated 26 dB below the maximum in-band spectral density of the modulated signal. Spectral density (power per unit bandwidth) is to be measured with a detector of resolution bandwidth equal to approximately 1.0% of the emission bandwidth.

3.4.2 Test Procedures

The testing follows ANSI C63.26-2015 Section 5.4.3 (26dB BW) and Section 5.4.4 (OBW)

1. The EUT was connected to spectrum analyzer and system simulator via a power divider.
2. The spectrum analyzer center frequency is set to the nominal EUT channel center frequency. The span range for the spectrum analyzer shall be between two and five times the anticipated OBW.
3. The nominal resolution bandwidth (RBW) shall be in the range of 1 to 5 % of the anticipated OBW, and the VBW shall be at least 3 times the RBW.
4. Set the detection mode to peak, and the trace mode to max hold.
5. Determine the reference value: Set the EUT to transmit a modulated signal. Allow the trace to stabilize. Set the spectrum analyzer marker to the highest level of the displayed trace.
(this is the reference value)
6. Determine the “-26 dB down amplitude” as equal to (Reference Value – X).
7. Place two markers, one at the lowest and the other at the highest frequency of the envelope of the spectral display such that each marker is at or slightly below the “-X dB down amplitude” determined in step 6. If a marker is below this “-X dB down amplitude” value it shall be placed as close as possible to this value. The OBW is the positive frequency difference between the two markers.
8. Use the 99 % power bandwidth function of the spectrum analyzer and report the measured bandwidth.



3.5 Conducted Band Edge

3.5.1 Description of Conducted Band Edge Measurement

The power of any emission outside of the authorized operating frequency ranges must be lower than the transmitter power (P) by a factor of at least $43 + 10 \log (P)$ dB.

3.5.2 Test Procedures

The testing follows ANSI C63.26-2015 Section 5.7.

1. The EUT was connected to the spectrum analyzer and system simulator via a power divider.
2. The RF output of EUT was connected to the spectrum analyzer by an RF cable and attenuator. The path loss was compensated to the results for each measurement.
3. The band edges of low and high channels for the highest RF powers were measured.
4. The RF fundamental frequency should be excluded against the limit line in the operating frequency band.
5. The limit line is derived from $43 + 10\log(P)$ dB below the transmitter power P(Watts)



3.6 Conducted Spurious Emission

3.6.1 Description of Conducted Spurious Emission Measurement

The power of any emission outside of the authorized operating frequency ranges must be lower than the transmitter power (P) by a factor of at least $43 + 10 \log (P)$ dB.

It is measured by means of a calibrated spectrum analyzer and scanned from 30 MHz up to a frequency including its 10th harmonic.

3.6.2 Test Procedures

The testing follows ANSI C63.26-2015 Section 5.7.

1. The EUT was connected to the spectrum analyzer and system simulator via a power divider.
2. The RF output of EUT was connected to the spectrum analyzer by an RF cable and attenuator. The path loss was compensated to the results for each measurement.
3. The middle channel for the highest RF power within the transmitting frequency was measured.
4. The conducted spurious emission for the whole frequency range was taken.
5. The RF fundamental frequency should be excluded against the limit line in the operating frequency band.
6. The limit line is derived from $43 + 10\log(P)$ dB below the transmitter power P(Watts)



3.7 Frequency Stability

3.7.1 Description of Frequency Stability Measurement

22.355

The frequency stability shall be measured by variation of ambient temperature and variation of primary supply voltage to ensure that the fundamental emission stays within the authorized frequency block. The frequency stability of the transmitter shall be maintained within $\pm 0.00025\%$ ($\pm 2.5\text{ppm}$) of the center frequency.

24.235 & 27.54

The frequency stability shall be sufficient to ensure that the fundamental emission stays within the authorized frequency block.

3.7.2 Test Procedures for Temperature Variation

The testing follows FCC KDB 971168 D01 v03r01 Section 9.0.

1. The EUT was set up in the thermal chamber and connected with the system simulator.
2. With power OFF, the temperature was decreased to -30°C and the EUT was stabilized before testing. Power was applied and the maximum change in frequency was recorded within one minute.
3. With power OFF, the temperature was raised in 10°C steps up to 50°C . The EUT was stabilized at each step for at least half an hour. Power was applied and the maximum frequency change was recorded within one minute.

3.7.3 Test Procedures for Voltage Variation

The testing follows FCC KDB 971168 D01 v03r01 Section 9.0.

1. The EUT was placed in a temperature chamber at $20\pm 5^{\circ}\text{C}$ and connected with the system simulator.
2. The power supply voltage to the EUT was varied from 85% to 115% of the nominal value measured at the input to the EUT.
3. The variation in frequency was measured for the worst case.

4 Radiated Test Items

4.1 Measuring Instruments

See list of measuring instruments of this test report.

4.2 Test Setup

For radiated test from 30MHz to 1GHz

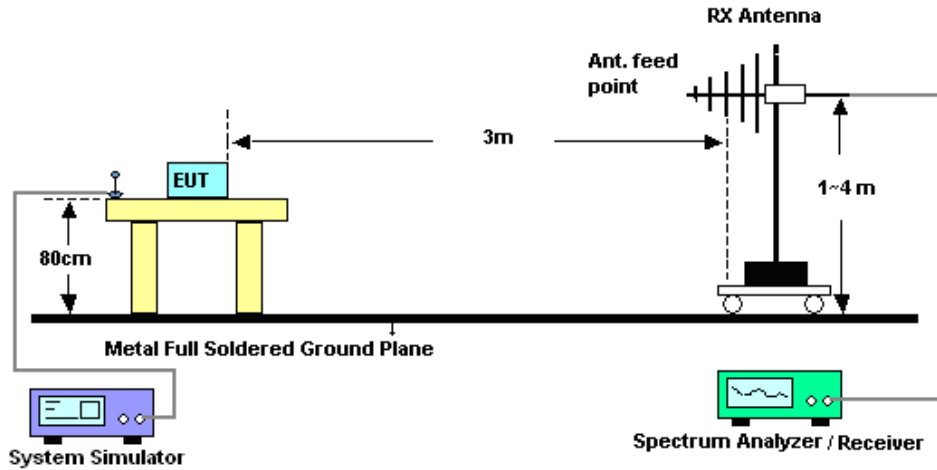

For radiated test above 1GHz

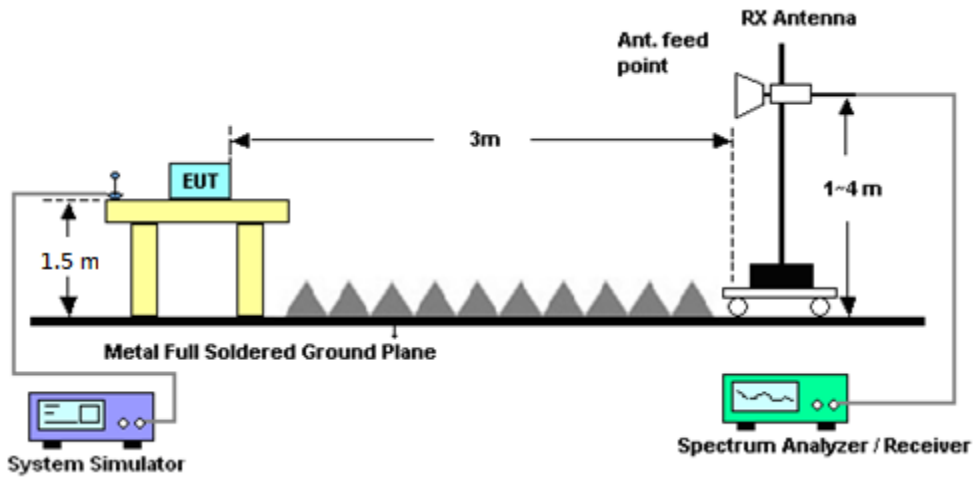

4.3 Test Result of Radiated Test

Please refer to Appendix B.



4.4 Field Strength of Spurious Radiation Measurement

4.4.1 Description of Field Strength of Spurious Radiated Measurement

The power of any emission outside of the authorized operating frequency ranges must be attenuated below the transmitter power (P) by a factor of at least $43 + 10 \log (P)$ dB. The spectrum is scanned from 30 MHz up to a frequency including its 10th harmonic.

4.4.2 Test Procedures

The testing follows FCC KDB 971168 D01 v03r01 Section 5.8 and ANSI / TIA-603-E Section 2.2.12.

1. The EUT was placed on a rotatable wooden table 0.8 meters for frequency below 1GHz and 1.5 meter for frequency above 1GHz above the ground.
2. The EUT was set 3 meters from the receiving antenna, which was mounted on the antenna tower.
3. The table was rotated 360 degrees to determine the position of the highest spurious emission.
4. The height of the receiving antenna is varied between one meter and four meters to search for the maximum spurious emission for both horizontal and vertical polarizations.
5. Make the measurement with the spectrum analyzer's RBW = 1MHz, VBW = 3MHz, taking record of maximum spurious emission.
6. A horn antenna was substituted in place of the EUT and was driven by a signal generator.
7. Tune the output power of signal generator to the same emission level with EUT maximum spurious emission.
8. Taking the record of output power at antenna port.
9. Repeat step 7 to step 8 for another polarization.
10. $EIRP (dBm) = S.G. Power - Tx Cable Loss + Tx Antenna Gain$
11. $ERP (dBm) = EIRP - 2.15$
12. The RF fundamental frequency should be excluded against the limit line in the operating frequency band.
13. The limit line is derived from $43 + 10\log(P)$ dB below the transmitter power P(Watts)



5 List of Measuring Equipment

Instrument	Manufacturer	Model No.	Serial No.	Characteristics	Calibration Date	Test Date	Due Date	Remark
Hygrometer	Testo	608-H1	34893241	N/A	Mar. 04, 2019	Mar. 04, 2019~ Mar. 19, 2019	Mar. 03, 2020	Conducted (TH03-HY)
Spectrum Analyzer	Rohde & Schwarz	FSP30	101329	9kHz~30GHz	Jun. 29, 2018	Mar. 04, 2019~ Mar. 19, 2019	Jun. 28, 2019	Conducted (TH03-HY)
Temperature Chamber	ESPEC	SU-641	92013721	-30°C ~70°C	Dec. 06, 2017	Mar. 04, 2019~ Mar. 19, 2019	Dec. 05, 2019	Conducted (TH03-HY)
Programmable Power Supply	GW Instek	PSS-2005	EL883644	Voltage:0~20V;Current:0~5A	Dec. 06, 2017	Mar. 04, 2019~ Mar. 19, 2019	Dec. 05, 2019	Conducted (TH03-HY)
Base Station (Measure)	Rohde & Schwarz	CMU200	117995	GSM / GPRS / WCDMA / CDMA	Aug. 10, 2018	Mar. 04, 2019~ Mar. 19, 2019	Aug. 09, 2019	Conducted (TH03-HY)
Amplifier	SONOMA	310N	187311	9kHz~1GHz	Oct. 23, 2018	Mar. 06, 2019~ Mar. 09, 2019	Oct. 22, 2019	Radiation (03CH10-HY)
Bilog Antenna	TESEQ	CBL 6111D&0080 0N1D01N-06	35413&02	30MHz~1GHz	Feb. 12, 2019	Mar. 06, 2019~ Mar. 09, 2019	Feb. 11, 2020	Radiation (03CH10-HY)
Horn Antenna	SCHWARZBECK	BBHA 9120 D	9120D-1325	1GHz ~ 18GHz	Oct. 02, 2018	Mar. 06, 2019~ Mar. 09, 2019	Oct. 01, 2019	Radiation (03CH10-HY)
Horn Antenna	ESCO	3117	00211469	1GHz~18GHz	Aug. 06, 2018	Mar. 06, 2019~ Mar. 09, 2019	Aug. 05, 2019	Radiation (03CH10-HY)
Loop Antenna	Rohde & Schwarz	HFH2-Z2	100315	9 kHz~30 MHz	May 15, 2017	Mar. 06, 2019~ Mar. 09, 2019	May 14, 2019	Radiation (03CH10-HY)
Preamplifier	Keysight	83017A	MY5327007 8	1GHz~26.5GHz	Oct. 28, 2018	Mar. 06, 2019~ Mar. 09, 2019	Oct. 27, 2019	Radiation (03CH10-HY)
Spectrum Analyzer	Keysight	N9010A	MY5420048 5	10Hz ~ 44GHz	Nov. 02, 2018	Mar. 06, 2019~ Mar. 09, 2019	Nov. 01, 2019	Radiation (03CH10-HY)
Controller	EMEC	EM 1000	N/A	Control Turn table & Ant Mast	N/A	Mar. 06, 2019~ Mar. 09, 2019	N/A	Radiation (03CH10-HY)
Antenna Mast	EMEC	AM-BS-4500 -B	N/A	1~4m	N/A	Mar. 06, 2019~ Mar. 09, 2019	N/A	Radiation (03CH10-HY)
Turn Table	EMEC	TT 2200	N/A	0~360 Degree	N/A	Mar. 06, 2019~ Mar. 09, 2019	N/A	Radiation (03CH10-HY)
Software	Audix	E3 6.2009-8-24	RK-001042	N/A	N/A	Mar. 06, 2019~ Mar. 09, 2019	N/A	Radiation (03CH10-HY)
Signal Generator	Rohde & Schwarz	SMF100A	101107	100kHz~40GHz	May 22, 2018	Mar. 06, 2019~ Mar. 09, 2019	May 21, 2019	Radiation (03CH10-HY)
SHF-EHF Horn Antenna	SCHWARZBECK	BBHA 9170	BBHA91705 76	18GHz ~ 40GHz	May 08, 2018	Mar. 06, 2019~ Mar. 09, 2019	May 07, 2019	Radiation (03CH10-HY)
SHF-EHF Horn Antenna	SCHWARZBECK	BBHA 9170	BBHA91702 51	18GHz ~ 40GHz	Nov. 20, 2018	Mar. 06, 2019~ Mar. 09, 2019	Nov. 19, 2019	Radiation (03CH10-HY)



Instrument	Manufacturer	Model No.	Serial No.	Characteristics	Calibration Date	Test Date	Due Date	Remark
RF Cable	HUBER + SUHNER	SUCOFLEX 104 / 102	MY11692/4PE, MY11693/4PE, MY2855/2	30M-1G	Nov. 08, 2018	Mar. 06, 2019~ Mar. 09, 2019	Nov. 07, 2019	Radiation (03CH10-HY)
RF Cable	HUBER + SUHNER	SUCOFLEX 104 / 102	MY11692/4PE, MY11693/4PE, MY2855/2	1G-18G	Nov. 08, 2018	Mar. 06, 2019~ Mar. 09, 2019	Nov. 07, 2019	Radiation (03CH10-HY)
RF Cable	HUBER + SUHNER	SUCOFLEX 102	505134/2	30M~40GHz	Oct. 16, 2018	Mar. 06, 2019~ Mar. 09, 2019	Oct. 15, 2019	Radiation (03CH10-HY)
RF Cable	HUBER + SUHNER	SUCOFLEX 102	800740/2	30M~40GHz	Oct. 16, 2018	Mar. 06, 2019~ Mar. 09, 2019	Oct. 15, 2019	Radiation (03CH10-HY)
Notch Filter	Wainwright	WRCT/800/960-0.2/40-8SSK	SN11	N/A	Apr. 23, 2018	Mar. 06, 2019~ Mar. 09, 2019	Apr. 22, 2019	Radiation (03CH10-HY)
Notch Filter	Wainwright	WTRCT5-824-849-20-70-60SSK	SN1	824-849	Mar. 22, 2018	Mar. 06, 2019~ Mar. 09, 2019	Mar. 21, 2019	Radiation (03CH10-HY)
Notch Filter	Wainwright	WRCT10-1920-1980-20-40-40SSK	SN1	1920-1980	May 22, 2018	Mar. 06, 2019~ Mar. 09, 2019	May 21, 2019	Radiation (03CH10-HY)
Notch Filter	Wainwright	WRCG1710/1755-1690/1755-45/7SS	SN2	AWS Band	Nov. 06, 2018	Mar. 06, 2019~ Mar. 09, 2019	Nov. 05, 2019	Radiation (03CH10-HY)
Notch Filter	Wainwright	WRCT2500/2700-10/20-10SSK	SN3	2500-2700	Nov. 01, 2018	Mar. 06, 2019~ Mar. 09, 2019	Oct. 31, 2019	Radiation (03CH10-HY)
Filter	Wainwright	WLJ4-1000-1530-6000-40ST	SN3	1.53 GHz Lowpass	Mar. 21, 2018	Mar. 06, 2019~ Mar. 09, 2019	Mar. 20, 2019	Radiation (03CH10-HY)
Filter	Microwave	H1G013G1	SN477215	1.0G High Pass	Nov. 02, 2018	Mar. 06, 2019~ Mar. 09, 2019	Nov. 01, 2019	Radiation (03CH10-HY)
Filter	Microwave	H3G018G1	SN477220	3.0G High Pass	Nov. 02, 2018	Mar. 06, 2019~ Mar. 09, 2019	Nov. 01, 2019	Radiation (03CH10-HY)



6 Uncertainty of Evaluation

Uncertainty of Radiated Emission Measurement (30 MHz ~ 1000 MHz)

Measuring Uncertainty for a Level of Confidence of 95% ($U = 2Uc(y)$)	3.17
-------------------------------------------------------------------------	------

Uncertainty of Radiated Emission Measurement (1 GHz ~ 18 GHz)

Measuring Uncertainty for a Level of Confidence of 95% ($U = 2Uc(y)$)	3.48
-------------------------------------------------------------------------	------

Uncertainty of Radiated Emission Measurement (18 GHz ~ 40 GHz)

Measuring Uncertainty for a Level of Confidence of 95% ($U = 2Uc(y)$)	4.00
-------------------------------------------------------------------------	------



Appendix A. Test Results of Conducted Test

Conducted Output Power(Average power)

Conducted Power (*Unit: dBm)						
Band	GSM850			GSM1900		
Channel	128	189	251	512	661	810
Frequency	824.2	836.4	848.8	1850.2	1880	1909.8
GSM	31.71	31.56	31.55	26.62	26.96	26.96
GPRS class 8	31.77	31.64	31.61	26.53	26.96	26.98
GPRS class 10	29.58	29.01	29.09	24.64	24.97	24.93
GPRS class 11	27.62	27.27	27.31	22.58	22.97	22.90
GPRS class 12	26.81	26.50	26.48	21.53	21.99	21.88
EGPRS class 8	27.13	27.23	27.05	25.43	25.86	25.79
EGPRS class 10	25.59	25.45	25.54	24.03	24.07	24.11
EGPRS class 11	23.42	23.58	23.33	22.16	22.25	22.11
EGPRS class 12	22.56	22.56	22.22	21.06	21.33	21.25

Conducted Power (*Unit: dBm)						
Band	WCDMA Band IV			WCDMA Band II		
Channel	1312	1413	1513	9262	9400	9538
Frequency	1712.4	1732.6	1752.6	1852.4	1880	1907.6
RMC 12.2K	18.69	18.65	18.60	18.41	18.53	18.42
HSDPA Subtest-1	17.72	17.62	17.60	17.43	17.67	17.53
HSDPA Subtest-2	17.70	17.64	17.59	17.40	17.68	17.52
HSDPA Subtest-3	17.17	17.16	17.13	16.91	17.15	17.01
HSDPA Subtest-4	17.19	17.14	17.12	16.88	17.17	17.02
HSUPA Subtest-1	17.72	17.61	17.56	17.48	17.62	17.41
HSUPA Subtest-2	15.66	15.63	15.52	15.32	15.58	15.42
HSUPA Subtest-3	16.63	16.55	16.54	16.22	16.57	16.42
HSUPA Subtest-4	15.70	15.68	15.57	15.33	15.60	15.46
HSUPA Subtest-5	17.70	17.60	17.48	17.40	17.60	17.40



A2. GSM

Peak-to-Average Ratio

Mode	GSM850		Limit: 13dB
Mod.	GPRS class 8	EDGE class 8	Result
Lowest CH	0.28	3.36	PASS
Middle CH	0.32	3.20	
Highest CH	0.32	3.36	

Mode	GSM1900		Limit: 13dB
Mod.	GPRS class 8	EDGE class 8	Result
Lowest CH	0.52	3.68	PASS
Middle CH	0.56	3.72	
Highest CH	0.52	3.40	

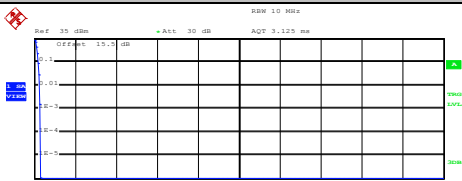
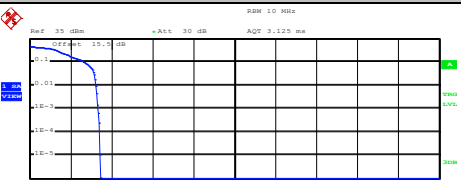
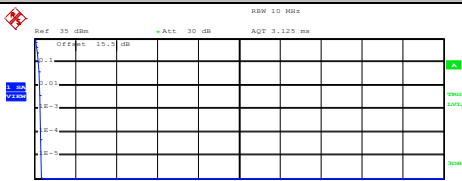
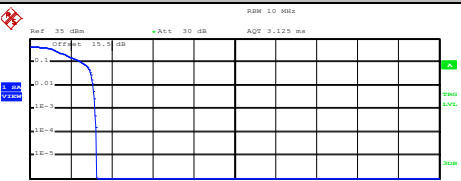
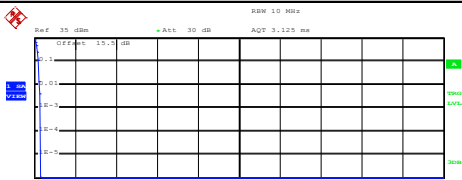
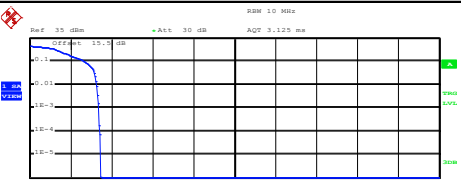

GSM850 (GPRS class 8)	GSM850 (EDGE class 8)																
<p align="center">Lowest Channel</p>  <p>Center 824.2 MHz 2 dB/ Mean Pwr + 20 dB</p> <p>Complementary Cumulative Distribution Function (100000 samples) Trace 1 Mean 30.88 dBm Peak 31.16 dBm Crest 0.28 dB</p> <table border="1"> <tr><td>10 %</td><td>0.20 dB</td></tr> <tr><td>1 %</td><td>0.28 dB</td></tr> <tr><td>.1 %</td><td>0.28 dB</td></tr> <tr><td>.01 %</td><td>0.32 dB</td></tr> </table> <p>Date: 4.MAR.2019 09:51:16</p>	10 %	0.20 dB	1 %	0.28 dB	.1 %	0.28 dB	.01 %	0.32 dB	<p align="center">Lowest Channel</p>  <p>Center 824.2 MHz 2 dB/ Mean Pwr + 20 dB</p> <p>Complementary Cumulative Distribution Function (100000 samples) Trace 1 Mean 26.60 dBm Peak 30.03 dBm Crest 3.43 dB</p> <table border="1"> <tr><td>10 %</td><td>2.68 dB</td></tr> <tr><td>1 %</td><td>3.24 dB</td></tr> <tr><td>.1 %</td><td>3.36 dB</td></tr> <tr><td>.01 %</td><td>3.44 dB</td></tr> </table> <p>Date: 4.MAR.2019 10:04:18</p>	10 %	2.68 dB	1 %	3.24 dB	.1 %	3.36 dB	.01 %	3.44 dB
10 %	0.20 dB																
1 %	0.28 dB																
.1 %	0.28 dB																
.01 %	0.32 dB																
10 %	2.68 dB																
1 %	3.24 dB																
.1 %	3.36 dB																
.01 %	3.44 dB																
<p align="center">Middle Channel</p>  <p>Center 836.4 MHz 2 dB/ Mean Pwr + 20 dB</p> <p>Complementary Cumulative Distribution Function (100000 samples) Trace 1 Mean 30.59 dBm Peak 30.95 dBm Crest 0.35 dB</p> <table border="1"> <tr><td>10 %</td><td>0.20 dB</td></tr> <tr><td>1 %</td><td>0.28 dB</td></tr> <tr><td>.1 %</td><td>0.32 dB</td></tr> <tr><td>.01 %</td><td>0.32 dB</td></tr> </table> <p>Date: 4.MAR.2019 09:51:33</p>	10 %	0.20 dB	1 %	0.28 dB	.1 %	0.32 dB	.01 %	0.32 dB	<p align="center">Middle Channel</p>  <p>Center 836.4 MHz 2 dB/ Mean Pwr + 20 dB</p> <p>Complementary Cumulative Distribution Function (100000 samples) Trace 1 Mean 26.50 dBm Peak 29.75 dBm Crest 3.25 dB</p> <table border="1"> <tr><td>10 %</td><td>2.56 dB</td></tr> <tr><td>1 %</td><td>3.08 dB</td></tr> <tr><td>.1 %</td><td>3.20 dB</td></tr> <tr><td>.01 %</td><td>3.24 dB</td></tr> </table> <p>Date: 4.MAR.2019 10:04:35</p>	10 %	2.56 dB	1 %	3.08 dB	.1 %	3.20 dB	.01 %	3.24 dB
10 %	0.20 dB																
1 %	0.28 dB																
.1 %	0.32 dB																
.01 %	0.32 dB																
10 %	2.56 dB																
1 %	3.08 dB																
.1 %	3.20 dB																
.01 %	3.24 dB																
<p align="center">Highest Channel</p>  <p>Center 848.8 MHz 2 dB/ Mean Pwr + 20 dB</p> <p>Complementary Cumulative Distribution Function (100000 samples) Trace 1 Mean 30.57 dBm Peak 30.88 dBm Crest 0.31 dB</p> <table border="1"> <tr><td>10 %</td><td>0.20 dB</td></tr> <tr><td>1 %</td><td>0.24 dB</td></tr> <tr><td>.1 %</td><td>0.32 dB</td></tr> <tr><td>.01 %</td><td>0.32 dB</td></tr> </table> <p>Date: 4.MAR.2019 09:51:53</p>	10 %	0.20 dB	1 %	0.24 dB	.1 %	0.32 dB	.01 %	0.32 dB	<p align="center">Highest Channel</p>  <p>Center 848.8 MHz 2 dB/ Mean Pwr + 20 dB</p> <p>Complementary Cumulative Distribution Function (100000 samples) Trace 1 Mean 26.29 dBm Peak 29.75 dBm Crest 3.46 dB</p> <table border="1"> <tr><td>10 %</td><td>2.68 dB</td></tr> <tr><td>1 %</td><td>3.28 dB</td></tr> <tr><td>.1 %</td><td>3.36 dB</td></tr> <tr><td>.01 %</td><td>3.44 dB</td></tr> </table> <p>Date: 4.MAR.2019 10:04:51</p>	10 %	2.68 dB	1 %	3.28 dB	.1 %	3.36 dB	.01 %	3.44 dB
10 %	0.20 dB																
1 %	0.24 dB																
.1 %	0.32 dB																
.01 %	0.32 dB																
10 %	2.68 dB																
1 %	3.28 dB																
.1 %	3.36 dB																
.01 %	3.44 dB																

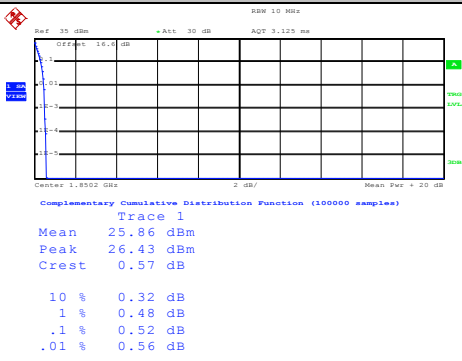
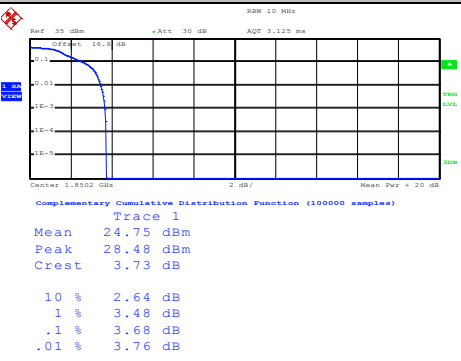
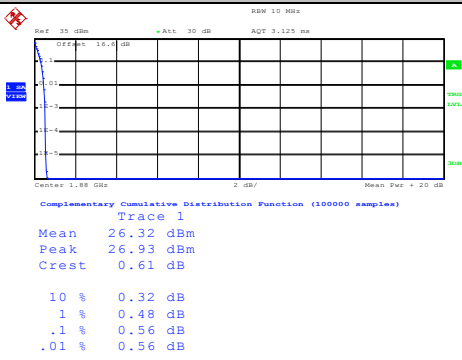
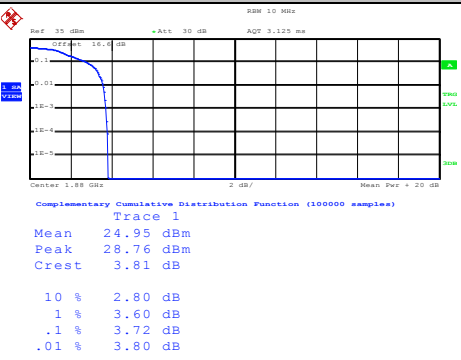
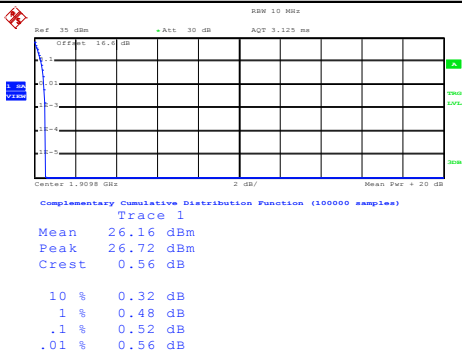
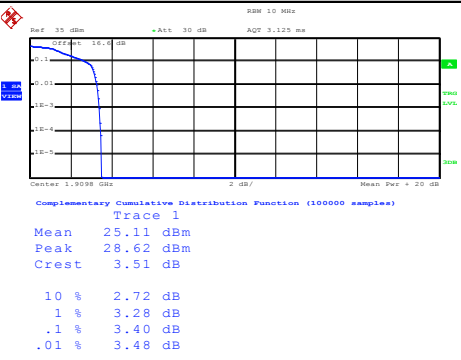

GSM1900 (GPRS class 8)	GSM1900 (EDGE class 8)
<p style="text-align: center;">Lowest Channel</p>  <p style="text-align: center;">Date: 4.MAR.2019 10:18:56</p>	<p style="text-align: center;">Lowest Channel</p>  <p style="text-align: center;">Date: 4.MAR.2019 10:58:28</p>
<p style="text-align: center;">Middle Channel</p>  <p style="text-align: center;">Date: 4.MAR.2019 10:19:15</p>	<p style="text-align: center;">Middle Channel</p>  <p style="text-align: center;">Date: 4.MAR.2019 10:58:46</p>
<p style="text-align: center;">Highest Channel</p>  <p style="text-align: center;">Date: 4.MAR.2019 10:19:32</p>	<p style="text-align: center;">Highest Channel</p>  <p style="text-align: center;">Date: 4.MAR.2019 10:59:04</p>



26dB Bandwidth

Mode	GSM850: 26dB BW(MHz)	
Mod.	GPRS class 8	EDGE class 8
Lowest CH	0.309	0.285
Middle CH	0.296	0.291
Highest CH	0.314	0.286

Mode	GSM1900: 26dB BW(MHz)	
Mod.	GPRS class 8	EDGE class 8
Lowest CH	0.301	0.299
Middle CH	0.308	0.291
Highest CH	0.297	0.304

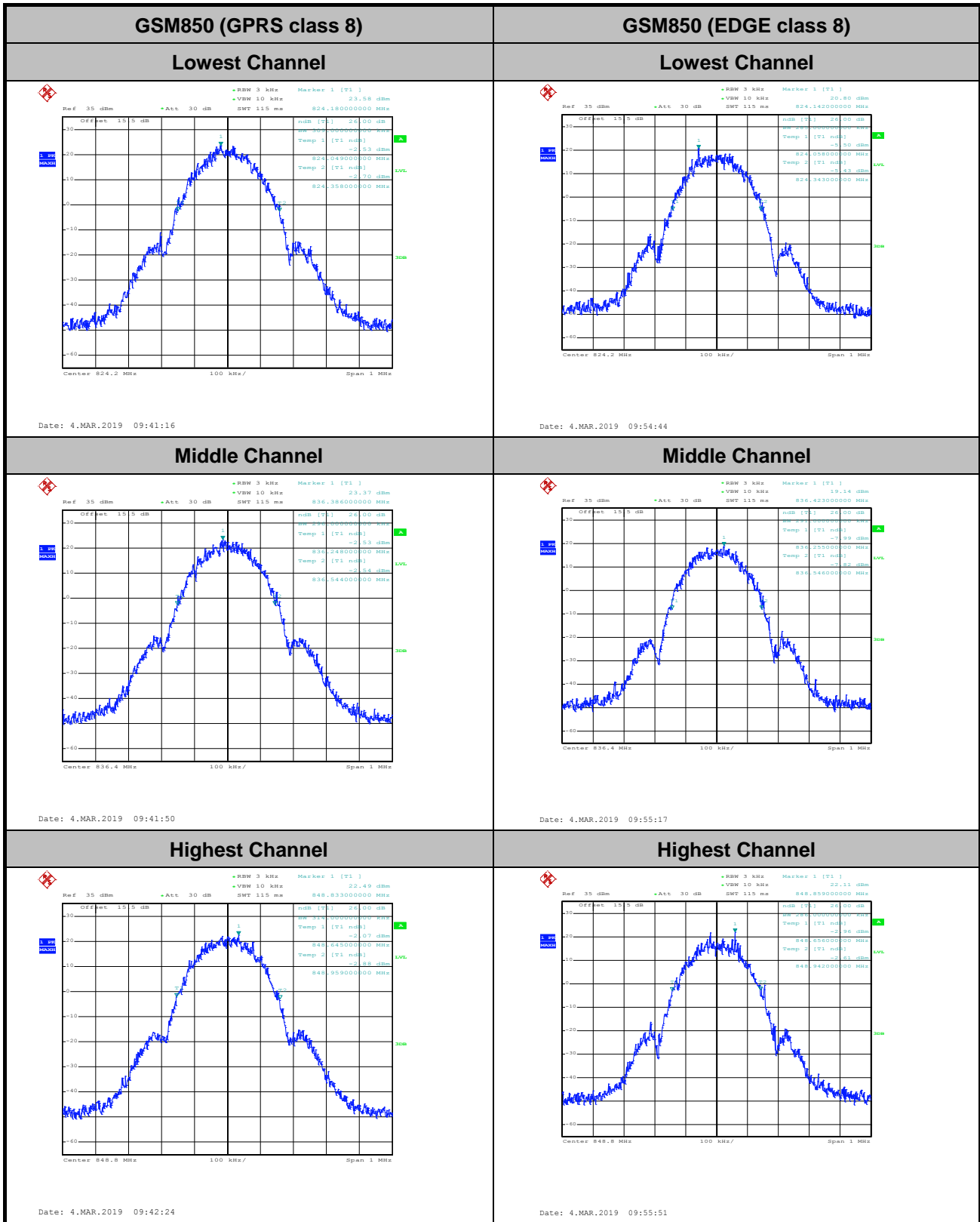

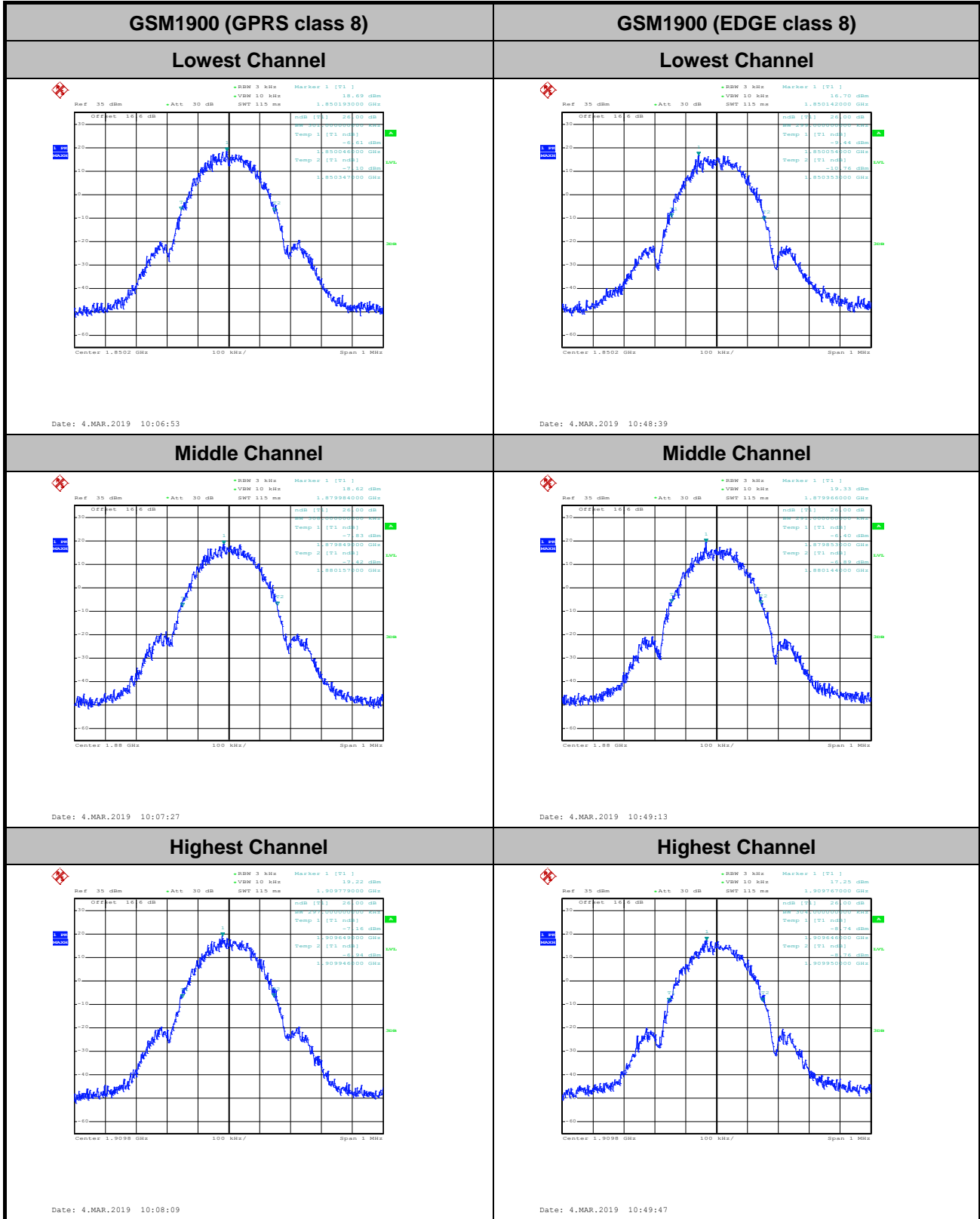



Occupied Bandwidth

Mode	GSM850 : 99% OBW(MHz)	
Mod.	GPRS class 8	EDGE class 8
Lowest CH	0.247	0.243
Middle CH	0.242	0.238
Highest CH	0.241	0.246

Mode	GSM1900: 99% OBW(MHz)	
Mod.	GPRS class 8	EDGE class 8
Lowest CH	0.240	0.239
Middle CH	0.238	0.242
Highest CH	0.241	0.242

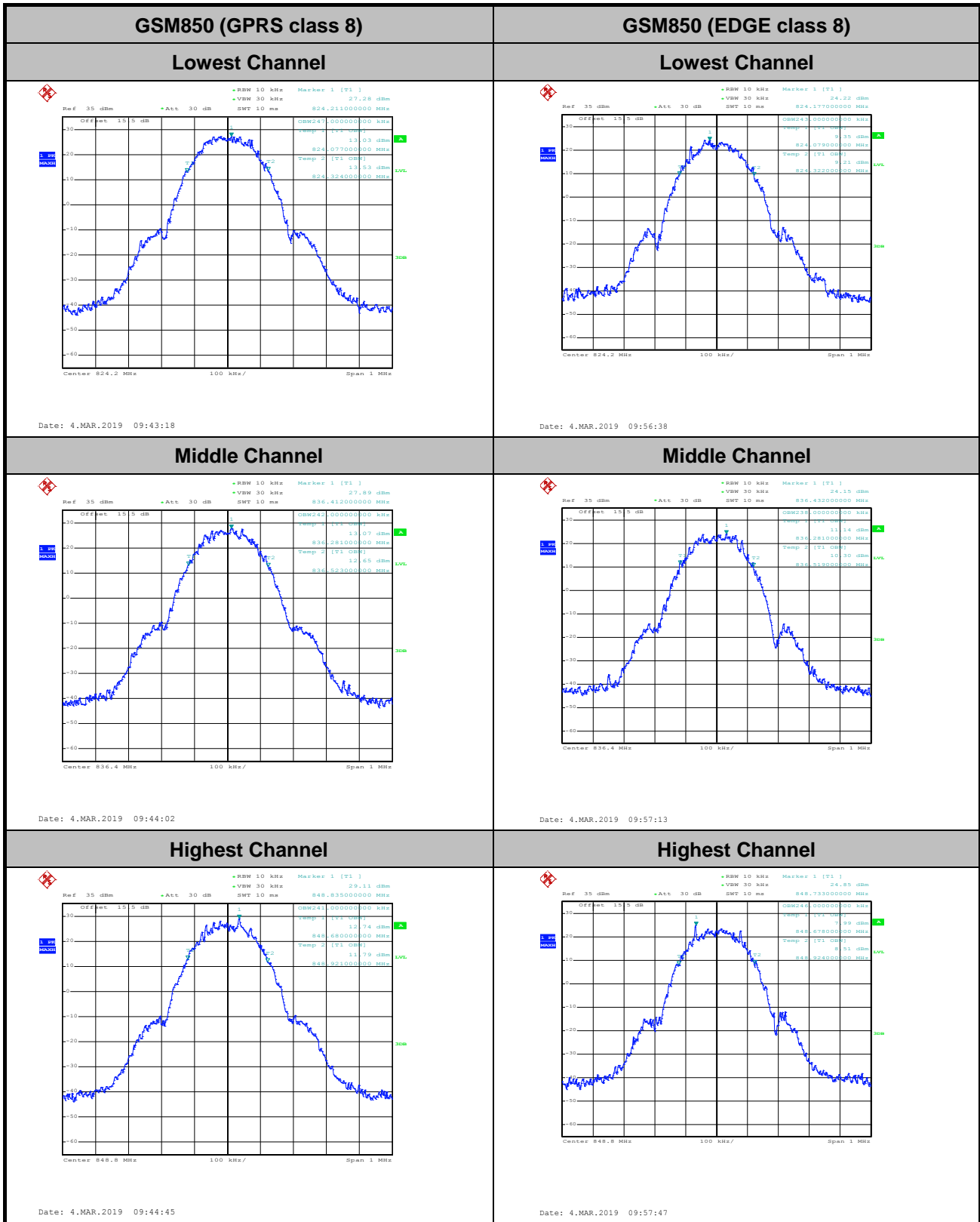

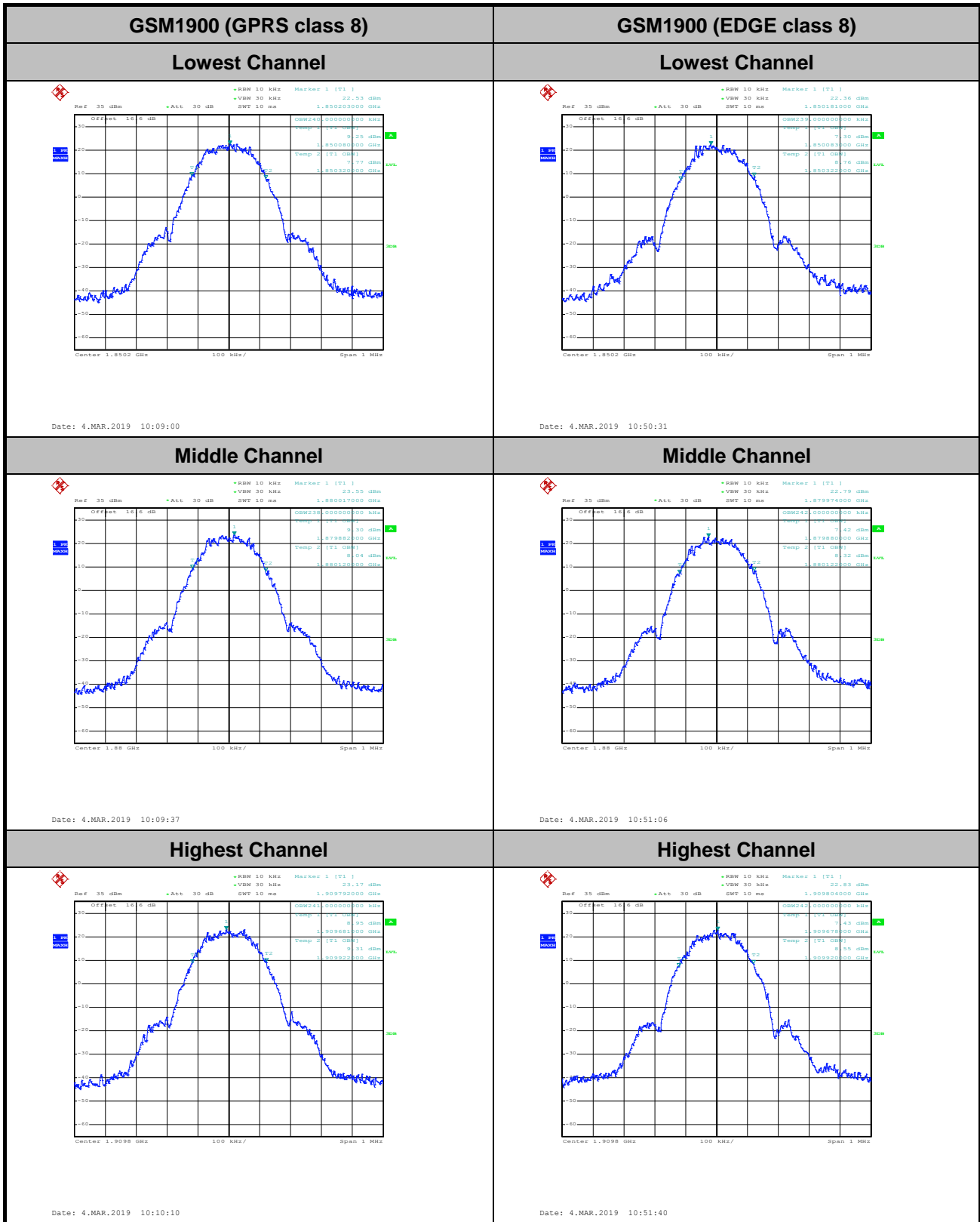



Conducted Band Edge

GSM850 (GPRS class 8)

Lowest Band Edge

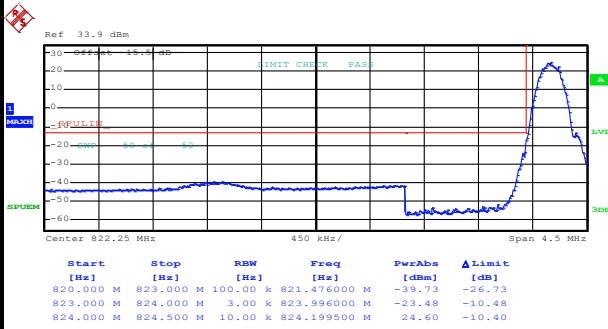

Date: 4.MAR.2019 09:46:37

Highest Band Edge

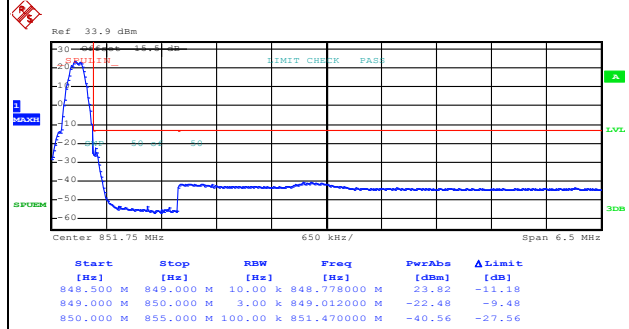

Date: 4.MAR.2019 09:48:10

GSM850 (EDGE class 8)

Lowest Band Edge

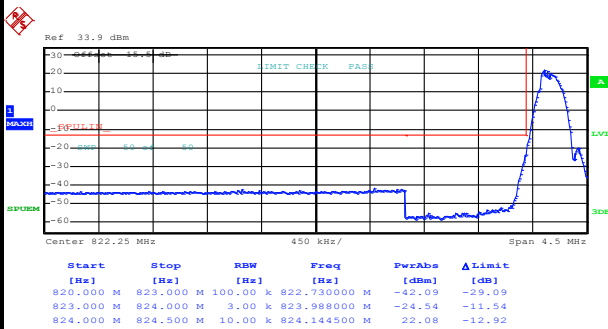

Date: 4.MAR.2019 09:59:29

Highest Band Edge

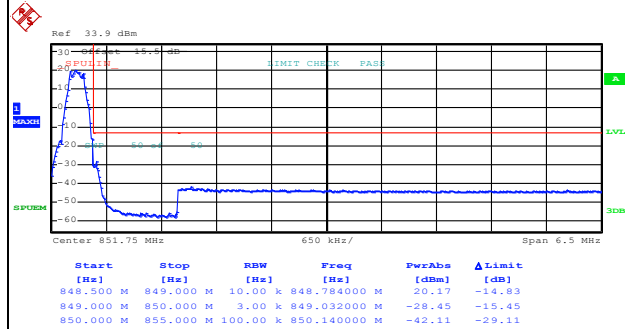

Date: 4.MAR.2019 10:01:03



GSM1900 (GPRS class 8)

Lowest Band Edge

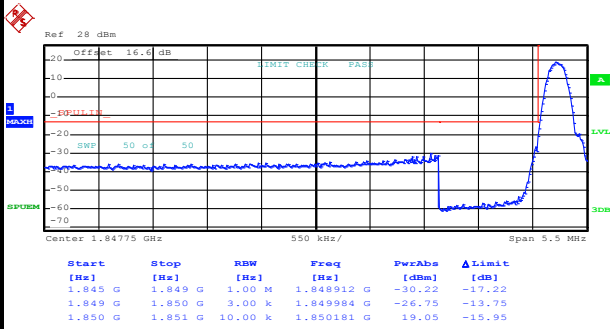

Date: 4.MAR.2019 10:11:46

Highest Band Edge

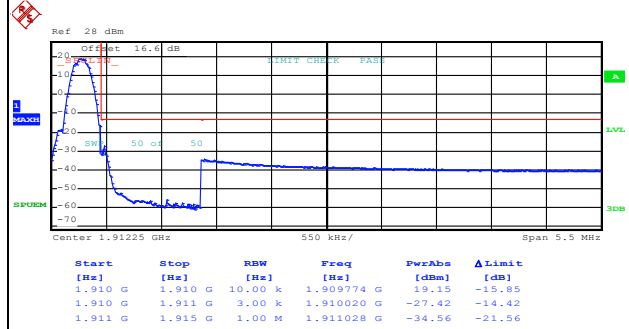

Date: 4.MAR.2019 10:13:29

GSM1900 (EDGE class 8)

Lowest Band Edge

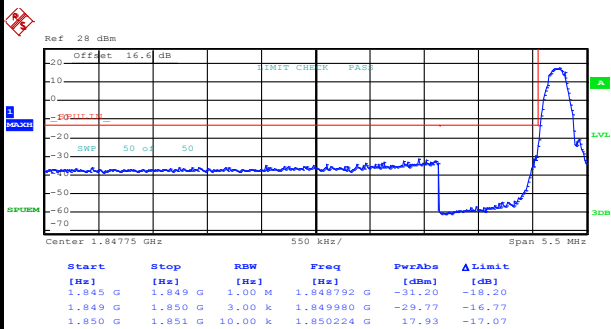

Date: 4.MAR.2019 10:53:18

Highest Band Edge

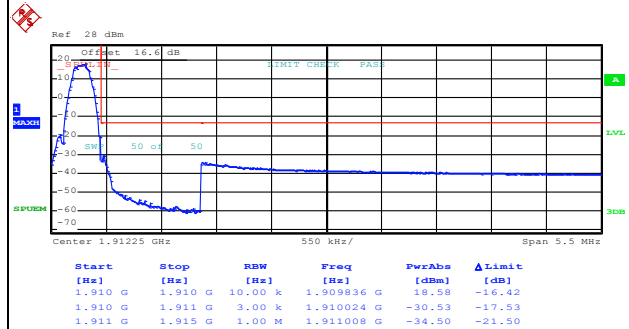

Date: 4.MAR.2019 10:54:55

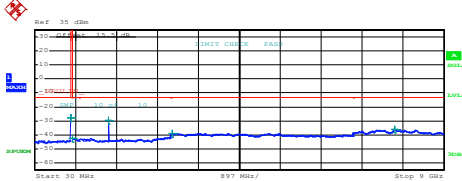
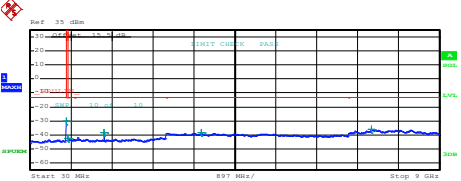
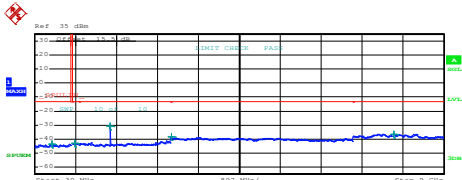
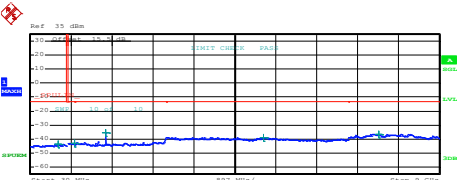
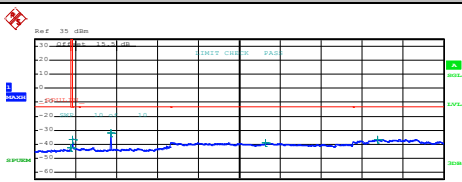
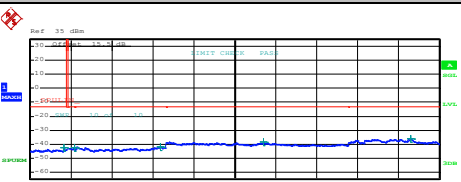

Conducted Spurious Emission

GSM850 (GPRS class 8)	GSM850 (EDGE class 8)																																																																								
<p style="text-align: center;">Lowest Channel</p>  <table border="1" data-bbox="239 660 654 739"> <thead> <tr> <th>Start [Hz]</th> <th>Stop [Hz]</th> <th>RBW [Hz]</th> <th>Freq [Hz]</th> <th>Power [dBm]</th> <th>ΔLimit [dB]</th> </tr> </thead> <tbody> <tr> <td>30,000 M</td> <td>820,000 M</td> <td>1,000 M</td> <td>819,802500 M</td> <td>-17.89</td> <td>-14.89</td> </tr> <tr> <td>855,000 M</td> <td>1,000 G</td> <td>1,000 G</td> <td>860,437500 M</td> <td>-42.42</td> <td>-29.42</td> </tr> <tr> <td>1,000 G</td> <td>3,000 G</td> <td>1,000 M</td> <td>1,648000 G</td> <td>-29.48</td> <td>-26.48</td> </tr> <tr> <td>3,000 G</td> <td>7,000 G</td> <td>1,000 M</td> <td>3,043000 G</td> <td>-38.72</td> <td>-25.72</td> </tr> <tr> <td>7,000 G</td> <td>9,000 G</td> <td>1,000 M</td> <td>7,915500 G</td> <td>-35.98</td> <td>-22.98</td> </tr> </tbody> </table> <p>Date: 4.MAR.2019 09:49:08</p>	Start [Hz]	Stop [Hz]	RBW [Hz]	Freq [Hz]	Power [dBm]	ΔLimit [dB]	30,000 M	820,000 M	1,000 M	819,802500 M	-17.89	-14.89	855,000 M	1,000 G	1,000 G	860,437500 M	-42.42	-29.42	1,000 G	3,000 G	1,000 M	1,648000 G	-29.48	-26.48	3,000 G	7,000 G	1,000 M	3,043000 G	-38.72	-25.72	7,000 G	9,000 G	1,000 M	7,915500 G	-35.98	-22.98	<p style="text-align: center;">Lowest Channel</p>  <table border="1" data-bbox="893 660 1308 739"> <thead> <tr> <th>Start [Hz]</th> <th>Stop [Hz]</th> <th>RBW [Hz]</th> <th>Freq [Hz]</th> <th>Power [dBm]</th> <th>ΔLimit [dB]</th> </tr> </thead> <tbody> <tr> <td>30,000 M</td> <td>820,000 M</td> <td>1,000 M</td> <td>819,802500 M</td> <td>-17.23</td> <td>-14.23</td> </tr> <tr> <td>855,000 M</td> <td>1,000 G</td> <td>1,000 G</td> <td>858,371250 M</td> <td>-42.70</td> <td>-29.70</td> </tr> <tr> <td>1,000 G</td> <td>3,000 G</td> <td>1,000 M</td> <td>1,648000 G</td> <td>-29.42</td> <td>-26.42</td> </tr> <tr> <td>3,000 G</td> <td>7,000 G</td> <td>1,000 M</td> <td>3,777000 G</td> <td>-38.57</td> <td>-25.57</td> </tr> <tr> <td>7,000 G</td> <td>9,000 G</td> <td>1,000 M</td> <td>7,518000 G</td> <td>-36.20</td> <td>-23.20</td> </tr> </tbody> </table> <p>Date: 4.MAR.2019 10:02:00</p>	Start [Hz]	Stop [Hz]	RBW [Hz]	Freq [Hz]	Power [dBm]	ΔLimit [dB]	30,000 M	820,000 M	1,000 M	819,802500 M	-17.23	-14.23	855,000 M	1,000 G	1,000 G	858,371250 M	-42.70	-29.70	1,000 G	3,000 G	1,000 M	1,648000 G	-29.42	-26.42	3,000 G	7,000 G	1,000 M	3,777000 G	-38.57	-25.57	7,000 G	9,000 G	1,000 M	7,518000 G	-36.20	-23.20
Start [Hz]	Stop [Hz]	RBW [Hz]	Freq [Hz]	Power [dBm]	ΔLimit [dB]																																																																				
30,000 M	820,000 M	1,000 M	819,802500 M	-17.89	-14.89																																																																				
855,000 M	1,000 G	1,000 G	860,437500 M	-42.42	-29.42																																																																				
1,000 G	3,000 G	1,000 M	1,648000 G	-29.48	-26.48																																																																				
3,000 G	7,000 G	1,000 M	3,043000 G	-38.72	-25.72																																																																				
7,000 G	9,000 G	1,000 M	7,915500 G	-35.98	-22.98																																																																				
Start [Hz]	Stop [Hz]	RBW [Hz]	Freq [Hz]	Power [dBm]	ΔLimit [dB]																																																																				
30,000 M	820,000 M	1,000 M	819,802500 M	-17.23	-14.23																																																																				
855,000 M	1,000 G	1,000 G	858,371250 M	-42.70	-29.70																																																																				
1,000 G	3,000 G	1,000 M	1,648000 G	-29.42	-26.42																																																																				
3,000 G	7,000 G	1,000 M	3,777000 G	-38.57	-25.57																																																																				
7,000 G	9,000 G	1,000 M	7,518000 G	-36.20	-23.20																																																																				
<p style="text-align: center;">Middle Channel</p>  <table border="1" data-bbox="239 1176 654 1254"> <thead> <tr> <th>Start [Hz]</th> <th>Stop [Hz]</th> <th>RBW [Hz]</th> <th>Freq [Hz]</th> <th>Power [dBm]</th> <th>ΔLimit [dB]</th> </tr> </thead> <tbody> <tr> <td>30,000 M</td> <td>820,000 M</td> <td>1,000 M</td> <td>412,597500 M</td> <td>-43.44</td> <td>-30.44</td> </tr> <tr> <td>855,000 M</td> <td>1,000 G</td> <td>1,000 M</td> <td>308,287504 M</td> <td>-42.94</td> <td>-29.94</td> </tr> <tr> <td>1,000 G</td> <td>3,000 G</td> <td>1,000 M</td> <td>1,673000 G</td> <td>-30.54</td> <td>-17.54</td> </tr> <tr> <td>3,000 G</td> <td>7,000 G</td> <td>1,000 M</td> <td>3,029000 G</td> <td>-38.49</td> <td>-25.49</td> </tr> <tr> <td>7,000 G</td> <td>9,000 G</td> <td>1,000 M</td> <td>7,915500 G</td> <td>-36.51</td> <td>-23.51</td> </tr> </tbody> </table> <p>Date: 4.MAR.2019 09:50:01</p>	Start [Hz]	Stop [Hz]	RBW [Hz]	Freq [Hz]	Power [dBm]	ΔLimit [dB]	30,000 M	820,000 M	1,000 M	412,597500 M	-43.44	-30.44	855,000 M	1,000 G	1,000 M	308,287504 M	-42.94	-29.94	1,000 G	3,000 G	1,000 M	1,673000 G	-30.54	-17.54	3,000 G	7,000 G	1,000 M	3,029000 G	-38.49	-25.49	7,000 G	9,000 G	1,000 M	7,915500 G	-36.51	-23.51	<p style="text-align: center;">Middle Channel</p>  <table border="1" data-bbox="893 1176 1308 1254"> <thead> <tr> <th>Start [Hz]</th> <th>Stop [Hz]</th> <th>RBW [Hz]</th> <th>Freq [Hz]</th> <th>Power [dBm]</th> <th>ΔLimit [dB]</th> </tr> </thead> <tbody> <tr> <td>30,000 M</td> <td>820,000 M</td> <td>1,000 M</td> <td>639,480000 M</td> <td>-43.50</td> <td>-30.50</td> </tr> <tr> <td>855,000 M</td> <td>1,000 G</td> <td>1,000 M</td> <td>993,482510 M</td> <td>-42.90</td> <td>-29.90</td> </tr> <tr> <td>1,000 G</td> <td>3,000 G</td> <td>1,000 M</td> <td>1,673000 G</td> <td>-35.46</td> <td>-22.46</td> </tr> <tr> <td>3,000 G</td> <td>7,000 G</td> <td>1,000 M</td> <td>5,148000 G</td> <td>-38.81</td> <td>-25.81</td> </tr> <tr> <td>7,000 G</td> <td>9,000 G</td> <td>1,000 M</td> <td>7,671500 G</td> <td>-36.41</td> <td>-23.41</td> </tr> </tbody> </table> <p>Date: 4.MAR.2019 10:02:51</p>	Start [Hz]	Stop [Hz]	RBW [Hz]	Freq [Hz]	Power [dBm]	ΔLimit [dB]	30,000 M	820,000 M	1,000 M	639,480000 M	-43.50	-30.50	855,000 M	1,000 G	1,000 M	993,482510 M	-42.90	-29.90	1,000 G	3,000 G	1,000 M	1,673000 G	-35.46	-22.46	3,000 G	7,000 G	1,000 M	5,148000 G	-38.81	-25.81	7,000 G	9,000 G	1,000 M	7,671500 G	-36.41	-23.41
Start [Hz]	Stop [Hz]	RBW [Hz]	Freq [Hz]	Power [dBm]	ΔLimit [dB]																																																																				
30,000 M	820,000 M	1,000 M	412,597500 M	-43.44	-30.44																																																																				
855,000 M	1,000 G	1,000 M	308,287504 M	-42.94	-29.94																																																																				
1,000 G	3,000 G	1,000 M	1,673000 G	-30.54	-17.54																																																																				
3,000 G	7,000 G	1,000 M	3,029000 G	-38.49	-25.49																																																																				
7,000 G	9,000 G	1,000 M	7,915500 G	-36.51	-23.51																																																																				
Start [Hz]	Stop [Hz]	RBW [Hz]	Freq [Hz]	Power [dBm]	ΔLimit [dB]																																																																				
30,000 M	820,000 M	1,000 M	639,480000 M	-43.50	-30.50																																																																				
855,000 M	1,000 G	1,000 M	993,482510 M	-42.90	-29.90																																																																				
1,000 G	3,000 G	1,000 M	1,673000 G	-35.46	-22.46																																																																				
3,000 G	7,000 G	1,000 M	5,148000 G	-38.81	-25.81																																																																				
7,000 G	9,000 G	1,000 M	7,671500 G	-36.41	-23.41																																																																				
<p style="text-align: center;">Highest Channel</p>  <table border="1" data-bbox="239 1691 654 1769"> <thead> <tr> <th>Start [Hz]</th> <th>Stop [Hz]</th> <th>RBW [Hz]</th> <th>Freq [Hz]</th> <th>Power [dBm]</th> <th>ΔLimit [dB]</th> </tr> </thead> <tbody> <tr> <td>30,000 M</td> <td>820,000 M</td> <td>1,000 M</td> <td>812,100000 M</td> <td>-42.53</td> <td>-29.53</td> </tr> <tr> <td>855,000 M</td> <td>1,000 G</td> <td>1,000 M</td> <td>856,036250 M</td> <td>-36.45</td> <td>-23.45</td> </tr> <tr> <td>1,000 G</td> <td>3,000 G</td> <td>1,000 M</td> <td>1,697500 G</td> <td>-32.99</td> <td>-19.99</td> </tr> <tr> <td>3,000 G</td> <td>7,000 G</td> <td>1,000 M</td> <td>5,084000 G</td> <td>-38.78</td> <td>-25.78</td> </tr> <tr> <td>7,000 G</td> <td>9,000 G</td> <td>1,000 M</td> <td>7,942000 G</td> <td>-36.42</td> <td>-23.42</td> </tr> </tbody> </table> <p>Date: 4.MAR.2019 09:50:51</p>	Start [Hz]	Stop [Hz]	RBW [Hz]	Freq [Hz]	Power [dBm]	ΔLimit [dB]	30,000 M	820,000 M	1,000 M	812,100000 M	-42.53	-29.53	855,000 M	1,000 G	1,000 M	856,036250 M	-36.45	-23.45	1,000 G	3,000 G	1,000 M	1,697500 G	-32.99	-19.99	3,000 G	7,000 G	1,000 M	5,084000 G	-38.78	-25.78	7,000 G	9,000 G	1,000 M	7,942000 G	-36.42	-23.42	<p style="text-align: center;">Highest Channel</p>  <table border="1" data-bbox="893 1691 1308 1769"> <thead> <tr> <th>Start [Hz]</th> <th>Stop [Hz]</th> <th>RBW [Hz]</th> <th>Freq [Hz]</th> <th>Power [dBm]</th> <th>ΔLimit [dB]</th> </tr> </thead> <tbody> <tr> <td>30,000 M</td> <td>820,000 M</td> <td>1,000 M</td> <td>771,850000 M</td> <td>-42.53</td> <td>-29.53</td> </tr> <tr> <td>855,000 M</td> <td>1,000 G</td> <td>1,000 M</td> <td>996,556260 M</td> <td>-42.21</td> <td>-29.21</td> </tr> <tr> <td>1,000 G</td> <td>3,000 G</td> <td>1,000 M</td> <td>2,880000 G</td> <td>-41.72</td> <td>-28.72</td> </tr> <tr> <td>3,000 G</td> <td>7,000 G</td> <td>1,000 M</td> <td>5,138000 G</td> <td>-38.41</td> <td>-25.41</td> </tr> <tr> <td>7,000 G</td> <td>9,000 G</td> <td>1,000 M</td> <td>8,363500 G</td> <td>-36.06</td> <td>-23.06</td> </tr> </tbody> </table> <p>Date: 4.MAR.2019 10:03:45</p>	Start [Hz]	Stop [Hz]	RBW [Hz]	Freq [Hz]	Power [dBm]	ΔLimit [dB]	30,000 M	820,000 M	1,000 M	771,850000 M	-42.53	-29.53	855,000 M	1,000 G	1,000 M	996,556260 M	-42.21	-29.21	1,000 G	3,000 G	1,000 M	2,880000 G	-41.72	-28.72	3,000 G	7,000 G	1,000 M	5,138000 G	-38.41	-25.41	7,000 G	9,000 G	1,000 M	8,363500 G	-36.06	-23.06
Start [Hz]	Stop [Hz]	RBW [Hz]	Freq [Hz]	Power [dBm]	ΔLimit [dB]																																																																				
30,000 M	820,000 M	1,000 M	812,100000 M	-42.53	-29.53																																																																				
855,000 M	1,000 G	1,000 M	856,036250 M	-36.45	-23.45																																																																				
1,000 G	3,000 G	1,000 M	1,697500 G	-32.99	-19.99																																																																				
3,000 G	7,000 G	1,000 M	5,084000 G	-38.78	-25.78																																																																				
7,000 G	9,000 G	1,000 M	7,942000 G	-36.42	-23.42																																																																				
Start [Hz]	Stop [Hz]	RBW [Hz]	Freq [Hz]	Power [dBm]	ΔLimit [dB]																																																																				
30,000 M	820,000 M	1,000 M	771,850000 M	-42.53	-29.53																																																																				
855,000 M	1,000 G	1,000 M	996,556260 M	-42.21	-29.21																																																																				
1,000 G	3,000 G	1,000 M	2,880000 G	-41.72	-28.72																																																																				
3,000 G	7,000 G	1,000 M	5,138000 G	-38.41	-25.41																																																																				
7,000 G	9,000 G	1,000 M	8,363500 G	-36.06	-23.06																																																																				



GSM1900 (GPRS class 8)

Lowest Channel

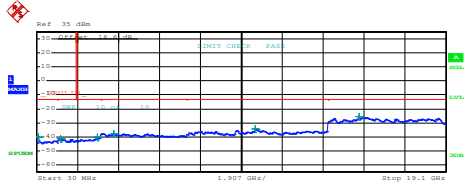

Start [Hz]	Stop [Hz]	RBW [Hz]	Freq [Hz]	Power [dBm]	ΔLimit [dB]
30.000 M	1.000 G	1.00 M	111.963000 M	-40.95	-27.05
1.000 G	1.845 G	1.00 M	1.138157 G	-41.17	-28.17
1.845 G	3.000 G	1.00 M	2.942346 G	-40.39	-27.39
3.000 G	7.000 G	1.00 M	3.603000 G	-37.90	-24.90
7.000 G	13.600 G	1.00 M	10.231325 G	-34.03	-21.03
13.600 G	19.100 G	1.00 M	15.057000 G	-29.73	-12.73

Date: 4.MAR.2019 10:15:56

GSM1900 (EDGE class 8)

Lowest Channel

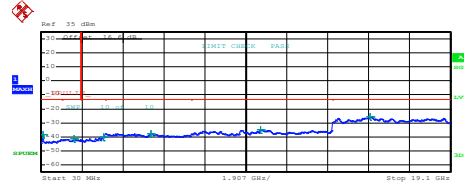

Start [Hz]	Stop [Hz]	RBW [Hz]	Freq [Hz]	Power [dBm]	ΔLimit [dB]
30.000 M	1.000 G	1.00 M	111.963000 M	-39.20	-25.20
1.000 G	1.845 G	1.00 M	1.1570164 G	-41.29	-28.29
1.845 G	3.000 G	1.00 M	2.933641 G	-40.38	-27.38
3.000 G	7.000 G	1.00 M	3.133000 G	-37.61	-24.61
7.000 G	13.600 G	1.00 M	10.239590 G	-34.82	-21.82
13.600 G	19.100 G	1.00 M	15.105653 G	-29.32	-12.32

Date: 4.MAR.2019 10:55:53

Middle Channel

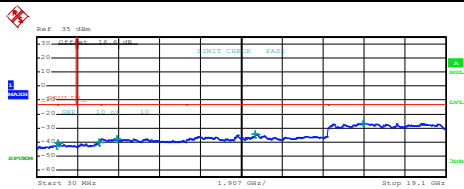

Start [Hz]	Stop [Hz]	RBW [Hz]	Freq [Hz]	Power [dBm]	ΔLimit [dB]
30.000 M	1.000 G	1.00 M	963.625000 M	-42.27	-29.27
1.000 G	1.845 G	1.00 M	1.034856 G	-40.62	-27.62
1.845 G	3.000 G	1.00 M	2.929204 G	-40.00	-27.00
3.000 G	7.000 G	1.00 M	3.770000 G	-37.56	-24.56
7.000 G	13.600 G	1.00 M	10.208425 G	-34.33	-21.33
13.600 G	19.100 G	1.00 M	15.230063 G	-26.50	-13.50

Date: 4.MAR.2019 10:17:36

Middle Channel

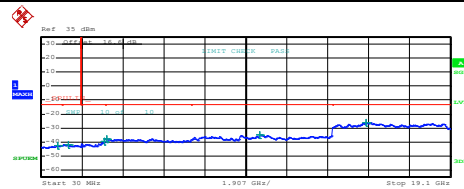

Start [Hz]	Stop [Hz]	RBW [Hz]	Freq [Hz]	Power [dBm]	ΔLimit [dB]
30.000 M	1.000 G	1.00 M	805.272500 M	-42.30	-29.30
1.000 G	1.845 G	1.00 M	1.185679 G	-41.94	-28.94
1.845 G	3.000 G	1.00 M	2.949548 G	-39.66	-26.66
3.000 G	7.000 G	1.00 M	3.099000 G	-37.66	-24.66
7.000 G	13.600 G	1.00 M	10.209250 G	-35.08	-22.08
13.600 G	19.100 G	1.00 M	15.154438 G	-25.97	-12.97

Date: 4.MAR.2019 10:56:47

Highest Channel

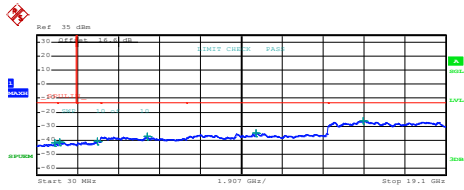

Start [Hz]	Stop [Hz]	RBW [Hz]	Freq [Hz]	Power [dBm]	ΔLimit [dB]
30.000 M	1.000 G	1.00 M	800.862500 M	-42.02	-29.02
1.000 G	1.845 G	1.00 M	1.103301 G	-41.44	-28.44
1.845 G	3.000 G	1.00 M	2.860329 G	-40.82	-27.82
3.000 G	7.000 G	1.00 M	3.161000 G	-37.29	-24.29
7.000 G	13.600 G	1.00 M	10.237300 G	-35.01	-22.01
13.600 G	19.100 G	1.00 M	15.243875 G	-26.23	-13.23

Date: 4.MAR.2019 10:18:29

Highest Channel

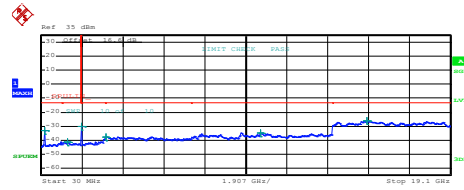

Start [Hz]	Stop [Hz]	RBW [Hz]	Freq [Hz]	Power [dBm]	ΔLimit [dB]
30.000 M	1.000 G	1.00 M	171.625000 M	-33.36	-20.36
1.000 G	1.845 G	1.00 M	1.268921 G	-41.10	-28.10
1.845 G	3.000 G	1.00 M	2.933271 G	-39.61	-26.61
3.000 G	7.000 G	1.00 M	3.030000 G	-37.58	-24.58
7.000 G	13.600 G	1.00 M	10.239775 G	-34.75	-21.75
13.600 G	19.100 G	1.00 M	15.227313 G	-26.29	-13.29

Date: 4.MAR.2019 10:57:57



Frequency Stability

Test Conditions	Middle Channel	GSM850 (GPRS class 8)	GSM850 (EDGE class 8)	Limit 2.5ppm
Temperature (°C)	Voltage (Volt)	Deviation (ppm)		Result
50	Normal Voltage	0.0024	0.0012	PASS
40	Normal Voltage	0.0048	0.0048	
30	Normal Voltage	0.0024	0.0024	
20(Ref.)	Normal Voltage	0.0000	0.0000	
10	Normal Voltage	0.0012	0.0012	
0	Normal Voltage	0.0024	0.0024	
-10	Normal Voltage	0.0072	0.0072	
-20	Normal Voltage	0.0132	0.0108	
-30	Normal Voltage	0.0167	0.0155	
20	Maximum Voltage	0.0000	0.0012	
20	Normal Voltage	0.0000	0.0000	
20	Battery End Point	0.0012	0.0012	



Test Conditions	Middle Channel	GSM1900 (GPRS class 8)	GSM1900 (EDGE class 8)	Limit Note 2.
Temperature (°C)	Voltage (Volt)	Deviation (ppm)		Result
50	Normal Voltage	0.0000	0.0016	PASS
40	Normal Voltage	0.0027	0.0027	
30	Normal Voltage	0.0011	0.0021	
20(Ref.)	Normal Voltage	0.0000	0.0000	
10	Normal Voltage	0.0011	0.0027	
0	Normal Voltage	0.0027	0.0037	
-10	Normal Voltage	0.0043	0.0016	
-20	Normal Voltage	0.0085	0.0085	
-30	Normal Voltage	0.0112	0.0096	
20	Maximum Voltage	0.0000	0.0021	
20	Normal Voltage	0.0000	0.0000	
20	Battery End Point	0.0011	0.0021	

Note:

- 1. Normal Voltage = 3.85V. ; Battery End Point (BEP) = 3.65 V. ; Maximum Voltage =4.25 V
- 2. The frequency fundamental emissions stay within the authorized frequency block.



A3. WCDMA

Peak-to-Average Ratio

Mode	WCDMA Band II	WCDMA Band IV	Limit: 13dB
Mod.	RMC 12.2Kbps	RMC 12.2Kbps	Result
Lowest CH	2.92	3.04	PASS
Middle CH	3.00	2.92	
Highest CH	3.00	3.00	

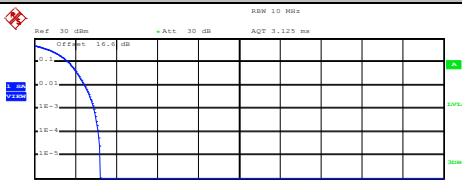
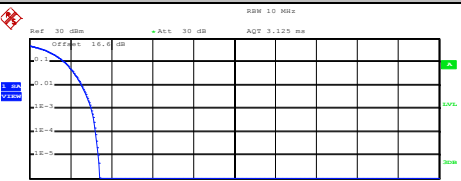
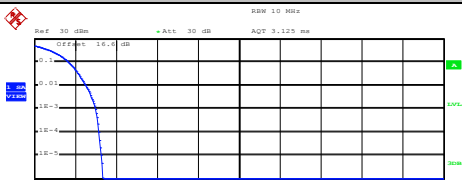
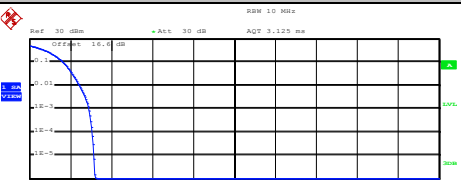
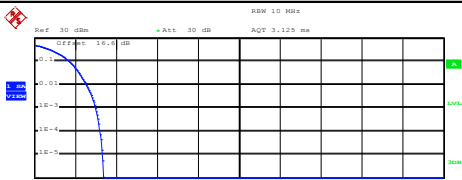
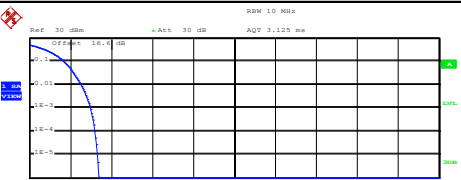

WCDMA Band II (RMC 12.2Kbps)	WCDMA Band IV (RMC 12.2Kbps)																
<p style="text-align: center;">Lowest Channel</p>  <p>Center 1.8524 GHz 2 dB/ Mean Pwr + 20 dB</p> <p>Complementary Cumulative Distribution Function (100000 samples)</p> <p>Trace 1</p> <p>Mean 17.28 dBm Peak 20.52 dBm Crest 3.23 dB</p> <table border="0"> <tr><td>10 %</td><td>1.68 dB</td></tr> <tr><td>1 %</td><td>2.48 dB</td></tr> <tr><td>.1 %</td><td>2.92 dB</td></tr> <tr><td>.01 %</td><td>3.12 dB</td></tr> </table> <p>Date: 4.MAR.2019 11:17:23</p>	10 %	1.68 dB	1 %	2.48 dB	.1 %	2.92 dB	.01 %	3.12 dB	<p style="text-align: center;">Lowest Channel</p>  <p>Center 1.7124 GHz 2 dB/ Mean Pwr + 20 dB</p> <p>Complementary Cumulative Distribution Function (100000 samples)</p> <p>Trace 1</p> <p>Mean 17.44 dBm Peak 20.87 dBm Crest 3.43 dB</p> <table border="0"> <tr><td>10 %</td><td>1.72 dB</td></tr> <tr><td>1 %</td><td>2.56 dB</td></tr> <tr><td>.1 %</td><td>3.04 dB</td></tr> <tr><td>.01 %</td><td>3.24 dB</td></tr> </table> <p>Date: 4.MAR.2019 11:40:54</p>	10 %	1.72 dB	1 %	2.56 dB	.1 %	3.04 dB	.01 %	3.24 dB
10 %	1.68 dB																
1 %	2.48 dB																
.1 %	2.92 dB																
.01 %	3.12 dB																
10 %	1.72 dB																
1 %	2.56 dB																
.1 %	3.04 dB																
.01 %	3.24 dB																
<p style="text-align: center;">Middle Channel</p>  <p>Center 1.88 GHz 2 dB/ Mean Pwr + 20 dB</p> <p>Complementary Cumulative Distribution Function (100000 samples)</p> <p>Trace 1</p> <p>Mean 17.52 dBm Peak 20.87 dBm Crest 3.35 dB</p> <table border="0"> <tr><td>10 %</td><td>1.68 dB</td></tr> <tr><td>1 %</td><td>2.52 dB</td></tr> <tr><td>.1 %</td><td>3.00 dB</td></tr> <tr><td>.01 %</td><td>3.16 dB</td></tr> </table> <p>Date: 4.MAR.2019 11:17:38</p>	10 %	1.68 dB	1 %	2.52 dB	.1 %	3.00 dB	.01 %	3.16 dB	<p style="text-align: center;">Middle Channel</p>  <p>Center 1.7326 GHz 2 dB/ Mean Pwr + 20 dB</p> <p>Complementary Cumulative Distribution Function (100000 samples)</p> <p>Trace 1</p> <p>Mean 17.38 dBm Peak 20.59 dBm Crest 3.20 dB</p> <table border="0"> <tr><td>10 %</td><td>1.64 dB</td></tr> <tr><td>1 %</td><td>2.44 dB</td></tr> <tr><td>.1 %</td><td>2.92 dB</td></tr> <tr><td>.01 %</td><td>3.08 dB</td></tr> </table> <p>Date: 4.MAR.2019 11:41:13</p>	10 %	1.64 dB	1 %	2.44 dB	.1 %	2.92 dB	.01 %	3.08 dB
10 %	1.68 dB																
1 %	2.52 dB																
.1 %	3.00 dB																
.01 %	3.16 dB																
10 %	1.64 dB																
1 %	2.44 dB																
.1 %	2.92 dB																
.01 %	3.08 dB																
<p style="text-align: center;">Highest Channel</p>  <p>Center 1.9076 GHz 2 dB/ Mean Pwr + 20 dB</p> <p>Complementary Cumulative Distribution Function (100000 samples)</p> <p>Trace 1</p> <p>Mean 17.48 dBm Peak 20.87 dBm Crest 3.39 dB</p> <table border="0"> <tr><td>10 %</td><td>1.72 dB</td></tr> <tr><td>1 %</td><td>2.56 dB</td></tr> <tr><td>.1 %</td><td>3.00 dB</td></tr> <tr><td>.01 %</td><td>3.20 dB</td></tr> </table> <p>Date: 4.MAR.2019 11:17:53</p>	10 %	1.72 dB	1 %	2.56 dB	.1 %	3.00 dB	.01 %	3.20 dB	<p style="text-align: center;">Highest Channel</p>  <p>Center 1.7526 GHz 2 dB/ Mean Pwr + 20 dB</p> <p>Complementary Cumulative Distribution Function (100000 samples)</p> <p>Trace 1</p> <p>Mean 17.34 dBm Peak 20.73 dBm Crest 3.39 dB</p> <table border="0"> <tr><td>10 %</td><td>1.68 dB</td></tr> <tr><td>1 %</td><td>2.52 dB</td></tr> <tr><td>.1 %</td><td>3.00 dB</td></tr> <tr><td>.01 %</td><td>3.20 dB</td></tr> </table> <p>Date: 4.MAR.2019 11:41:31</p>	10 %	1.68 dB	1 %	2.52 dB	.1 %	3.00 dB	.01 %	3.20 dB
10 %	1.72 dB																
1 %	2.56 dB																
.1 %	3.00 dB																
.01 %	3.20 dB																
10 %	1.68 dB																
1 %	2.52 dB																
.1 %	3.00 dB																
.01 %	3.20 dB																



26dB Bandwidth

Mode	WCDMA Band II 26dB BW(MHz)	WCDMA Band IV 26dB BW(MHz)
Mod.	RMC 12.2Kbps	RMC 12.2Kbps
Lowest CH	4.73	4.72
Middle CH	4.72	4.73
Highest CH	4.72	4.73



WCDMA Band II (RMC 12.2Kbps)

Lowest Channel

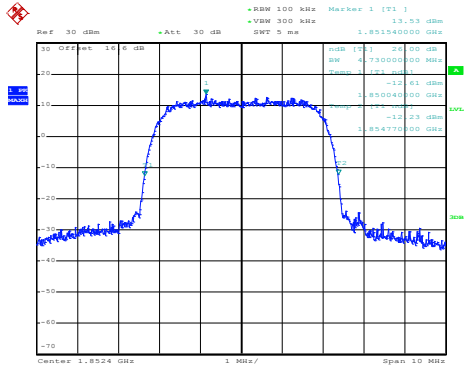

Date: 4.MAR.2019 11:04:38

WCDMA Band IV (RMC 12.2Kbps)

Lowest Channel

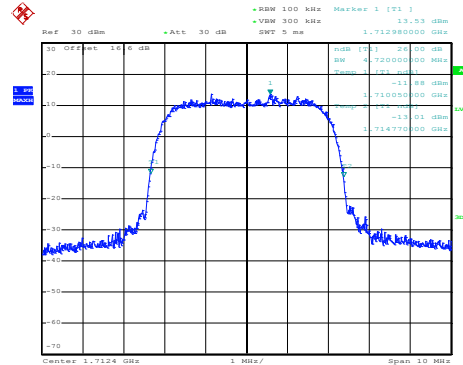

Date: 4.MAR.2019 11:21:21

Middle Channel

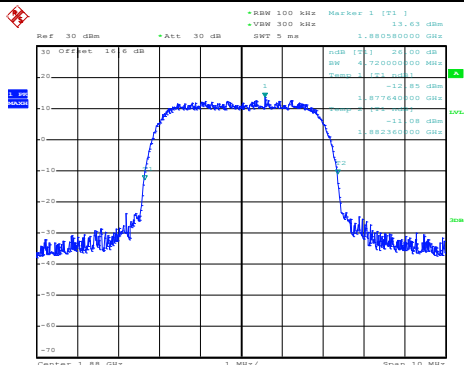

Date: 4.MAR.2019 11:05:13

Middle Channel

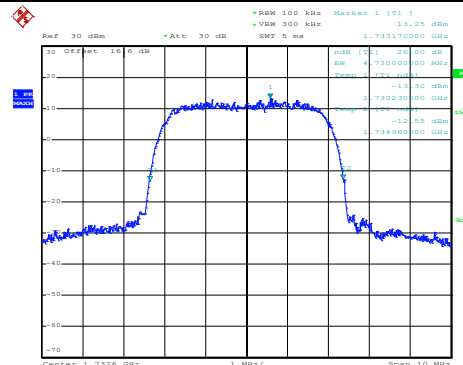

Date: 4.MAR.2019 11:21:55

Highest Channel

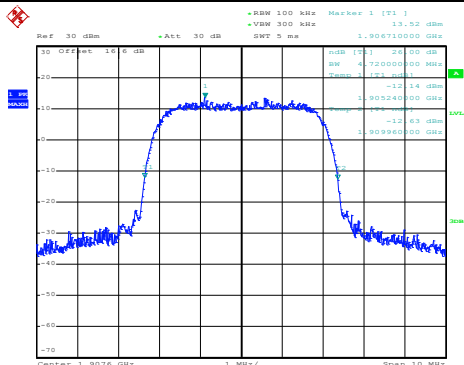

Date: 4.MAR.2019 11:05:50

Highest Channel

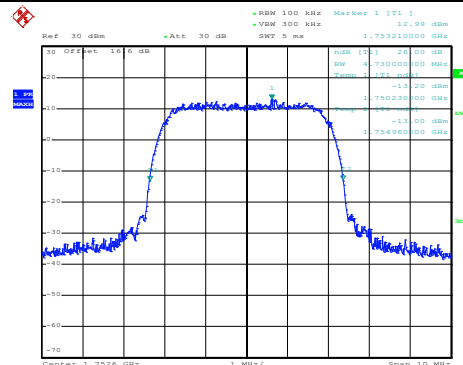

Date: 4.MAR.2019 11:23:14



Occupied Bandwidth

Mode	WCDMA Band II 99% OBW(MHz)	WCDMA Band IV 99% OBW(MHz)
Mod.	RMC 12.2Kbps	RMC 12.2Kbps
Lowest CH	4.16	4.14
Middle CH	4.16	4.16
Highest CH	4.16	4.15



WCDMA Band II (RMC 12.2Kbps)	WCDMA Band IV (RMC 12.2Kbps)
<p style="text-align: center;">Lowest Channel</p> <p>Date: 4.MAR.2019 11:06:29</p>	<p style="text-align: center;">Lowest Channel</p> <p>Date: 4.MAR.2019 11:23:57</p>
<p style="text-align: center;">Middle Channel</p> <p>Date: 4.MAR.2019 11:07:03</p>	<p style="text-align: center;">Middle Channel</p> <p>Date: 4.MAR.2019 11:24:32</p>
<p style="text-align: center;">Highest Channel</p> <p>Date: 4.MAR.2019 11:07:39</p>	<p style="text-align: center;">Highest Channel</p> <p>Date: 4.MAR.2019 11:25:07</p>



Conducted Band Edge

WCDMA Band II (RMC 12.2Kbps)

Lowest Band Edge

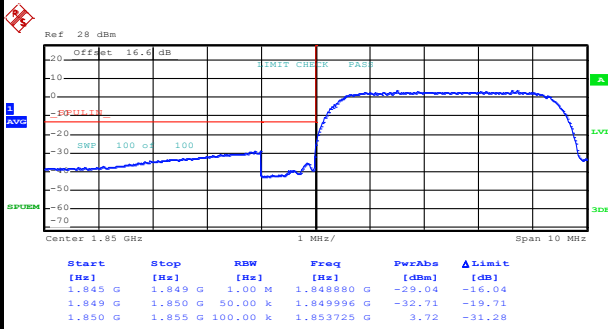

Date: 4.MAR.2019 11:10:46

Highest Band Edge

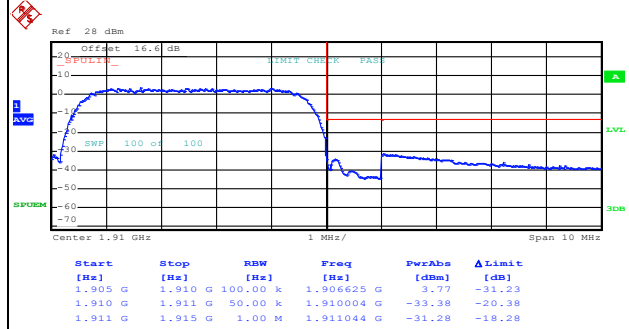

Date: 4.MAR.2019 11:14:08

WCDMA Band IV (RMC 12.2Kbps)

Lowest Band Edge

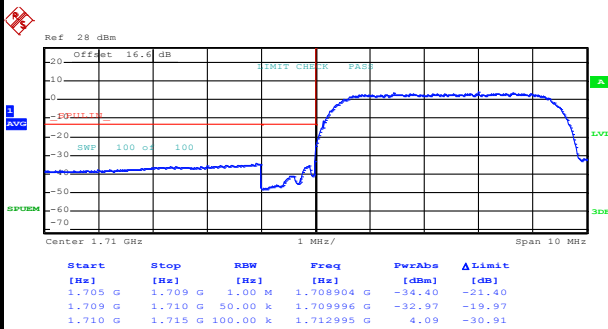

Date: 4.MAR.2019 11:28:22

Highest Band Edge

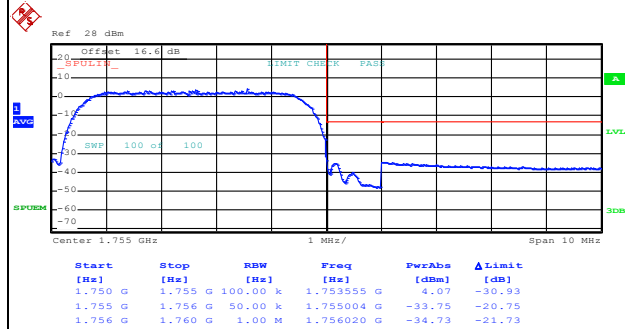

Date: 4.MAR.2019 11:31:20



Conducted Spurious Emission

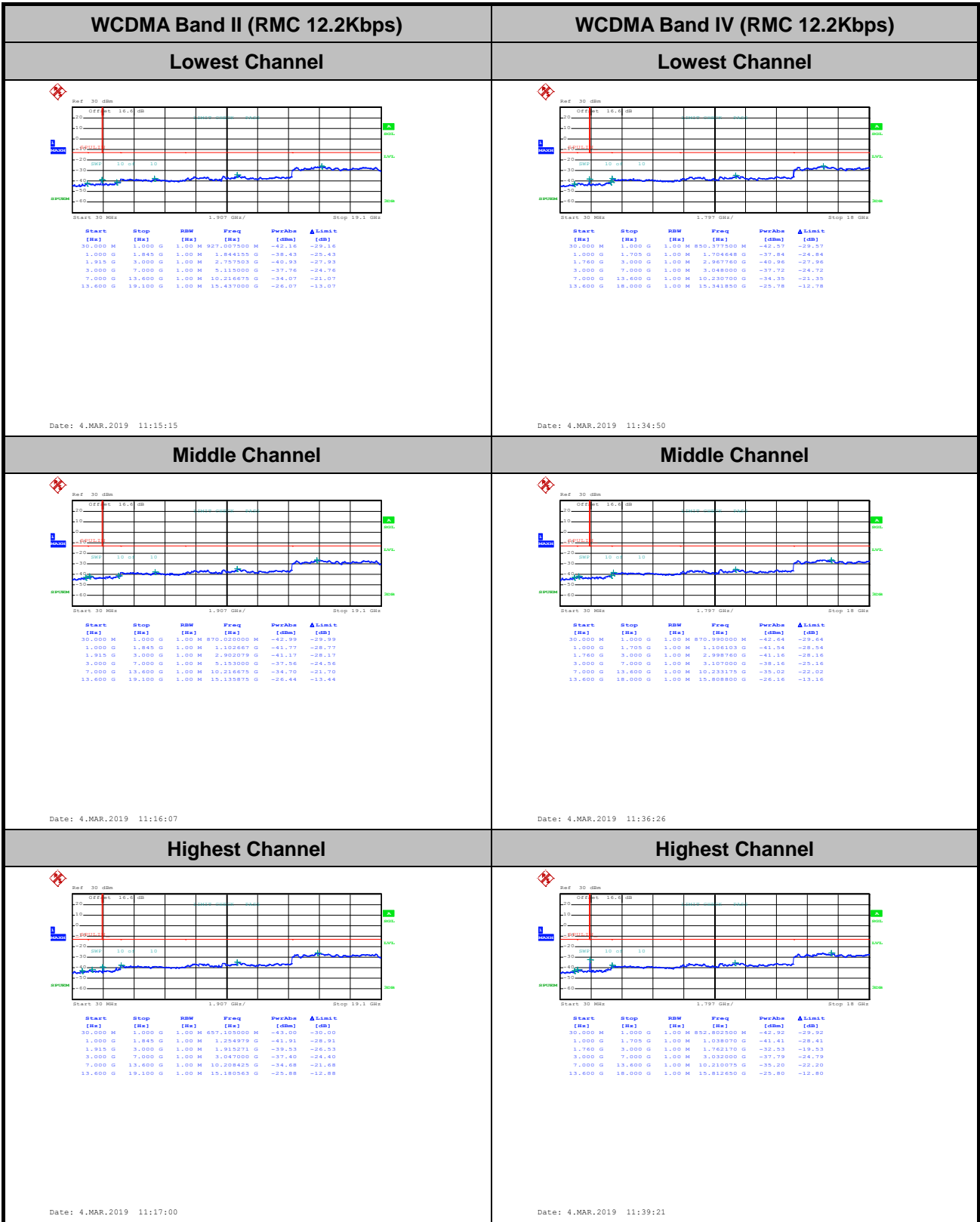



Frequency Stability

Test Conditions	Middle Channel	WCDMA Band II (RMC 12.2Kbps)	Limit Note 2.
Temperature (°C)	Voltage (Volt)	Deviation (ppm)	Result
50	Normal Voltage	0.0021	PASS
40	Normal Voltage	0.0000	
30	Normal Voltage	0.0016	
20(Ref.)	Normal Voltage	0.0000	
10	Normal Voltage	0.0011	
0	Normal Voltage	0.0005	
-10	Normal Voltage	0.0016	
-20	Normal Voltage	0.0032	
-30	Normal Voltage	0.0069	
20	Maximum Voltage	0.0005	
20	Normal Voltage	0.0000	
20	Battery End Point	0.0011	



Test Conditions	Middle Channel	WCDMA Band IV (RMC 12.2Kbps)	Limit Note 2.
Temperature (°C)	Voltage (Volt)	Deviation (ppm)	Result
50	Normal Voltage	0.0040	PASS
40	Normal Voltage	0.0046	
30	Normal Voltage	0.0023	
20(Ref.)	Normal Voltage	0.0000	
10	Normal Voltage	0.0017	
0	Normal Voltage	0.0040	
-10	Normal Voltage	0.0029	
-20	Normal Voltage	0.0012	
-30	Normal Voltage	0.0035	
20	Maximum Voltage	0.0012	
20	Normal Voltage	0.0000	
20	Battery End Point	0.0012	

Note:

1. Normal Voltage = 3.85V. ; Battery End Point (BEP) = 3.65 V. ; Maximum Voltage =4.25 V
2. The frequency fundamental emissions stay within the authorized frequency block.



Appendix B. Test Results of ERP/EIRP and Radiated Test

ERP/EIRP

Channel	Mode	Conducted		ERP	
		Power (dBm)	Power (Watts)	ERP(dBm)	ERP(W)
Lowest	GSM850 GPRS class 8 (GT - LC = -2.9 dB)	31.77	1.5031	26.72	0.4699
Middle		31.64	1.4588	26.59	0.4560
Highest		31.61	1.4488	26.56	0.4529
Lowest	GSM850 EDGE class 8 (GT - LC = -2.9 dB)	27.13	0.5164	22.08	0.1614
Middle		27.23	0.5284	22.18	0.1652
Highest		27.05	0.5070	22.00	0.1585
Limit	ERP < 7W	Result		PASS	

Channel	Mode	Conducted		EIRP	
		Power (dBm)	Power (Watts)	EIRP(dBm)	EIRP(W)
Lowest	GSM1900 GPRS class 8 (GT - LC = -4.6 dB)	26.53	0.4498	21.93	0.1560
Middle		26.96	0.4966	22.36	0.1722
Highest		26.98	0.4989	22.38	0.1730
Lowest	GSM1900 EDGE class 8 (GT - LC = -4.6 dB)	25.43	0.3491	20.83	0.1211
Middle		25.86	0.3855	21.26	0.1337
Highest		25.79	0.3793	21.19	0.1315
Lowest	WCDMA Band II RMC 12.2Kbps (GT - LC = -4.6 dB)	18.41	0.0693	13.81	0.0240
Middle		18.53	0.0713	13.93	0.0247
Highest		18.42	0.0695	13.82	0.0241
Limit	EIRP < 2W	Result		PASS	

Channel	Mode	Conducted		EIRP	
		Power (dBm)	Power (Watts)	EIRP(dBm)	EIRP(W)
Lowest	WCDMA Band IV RMC 12.2Kbps (GT - LC = 0.1 dB)	18.69	0.0740	18.79	0.0757
Middle		18.65	0.0733	18.75	0.0750
Highest		18.60	0.0724	18.70	0.0741
Limit	EIRP < 1W	Result		PASS	



Radiated Spurious Emission

GPRS 850

GPRS 850									
Channel	Frequency (MHz)	ERP (dBm)	Limit (dBm)	Over Limit (dB)	SPA Reading (dBm)	S.G. Power (dBm)	TX Cable loss (dB)	TX Antenna Gain (dBi)	Polarization (H/V)
Lowest	1648	-62.35	-13	-49.35	-71.1	-68.08	0.81	8.69	H
	2472	-59.38	-13	-46.38	-72.97	-66.95	1.04	10.76	H
	3296	-57.88	-13	-44.88	-73.59	-66.48	1.10	11.85	H
									H
									H
	1648	-62.93	-13	-49.93	-70.52	-68.66	0.81	8.69	H
	2472	-59.38	-13	-46.38	-73.09	-66.95	1.04	10.76	V
	3296	-57.51	-13	-44.51	73.49	-66.11	1.10	11.85	V
									V
									V
									V
	Middle	1672	-61.66	-13	-48.66	-70.48	-67.48	0.82	8.79
2504		-60.08	-13	-47.08	-73.7	-67.68	1.05	10.80	H
3344		-58.22	-13	-45.22	-73.6	-66.93	1.10	11.96	H
									H
									H
									H
1672		-62.30	-13	-49.30	-70.98	-68.12	0.82	8.79	V
2504		-60.05	-13	-47.05	-73.75	-67.65	1.05	10.80	V
3344		-57.59	-13	-44.59	-73.47	-66.30	1.10	11.96	V
									V
									V
									V



Highest	1696	-63.11	-13	-50.11	-72.04	-69.01	0.83	8.88	H
	2544	-59.80	-13	-46.80	-73.5	-67.43	1.06	10.84	H
	3392	-58.32	-13	-45.32	-73.44	-67.13	1.10	12.06	H
									H
									H
									H
									H
	1696	-63.75	-13	-50.75	-72.51	-69.65	0.83	8.88	V
	2544	-59.80	-13	-46.80	-73.59	-67.43	1.06	10.84	V
	3392	-57.27	-13	-44.27	-73.04	-66.08	1.10	12.06	V
									V
									V
									V
									V

Remark: Spurious emissions within 30-1000MHz were found more than 20dB below limit line.



EDGE 850

EDGE 850									
Channel	Frequency (MHz)	ERP (dBm)	Limit (dBm)	Over Limit (dB)	SPA Reading (dBm)	S.G. Power (dBm)	TX Cable loss (dB)	TX Antenna Gain (dBi)	Polarization (H/V)
Lowest	1648	-63.67	-13	-50.67	-72.41	-69.40	0.81	8.69	H
	2472	-59.58	-13	-46.58	-73.17	-67.15	1.04	10.76	H
	3296	-57.73	-13	-44.73	-73.34	-66.33	1.10	11.85	H
									H
									H
									H
	1648	-65.17	-13	-52.17	-73.77	-70.90	0.81	8.69	V
	2472	-60.86	-13	-47.86	-74.58	-68.43	1.04	10.76	V
	3296	-58.24	-13	-45.24	-74.22	-66.84	1.10	11.85	V
									V
									V
									V
Middle	1672	-59.84	-13	-46.84	-68.66	-65.66	0.82	8.79	H
	2504	-59.99	-13	-46.99	-73.61	-67.59	1.05	10.80	H
	3344	-57.79	-13	-44.79	-73.17	-66.50	1.10	11.96	H
									H
									H
									H
	1672	-61.75	-13	-48.75	-70.43	-67.57	0.82	8.79	V
	2504	-59.86	-13	-46.86	-73.56	-67.46	1.05	10.80	V
	3344	-57.54	-13	-44.54	-73.42	-66.25	1.10	11.96	V
									V
									V
									V



Highest	1696	-60.33	-13	-47.33	-69.25	-66.23	0.83	8.88	H
	2544	-56.24	-13	-43.24	-69.94	-63.87	1.06	10.84	H
	3392	-58.44	-13	-45.44	-73.56	-67.25	1.10	12.06	H
									H
									H
									H
									H
	1696	-57.77	-13	-44.77	-66.53	-63.67	0.83	8.88	V
	2544	-59.74	-13	-46.74	-73.52	-67.37	1.06	10.84	V
	3392	-57.57	-13	-44.57	-73.33	-66.38	1.10	12.06	V
									V
									V
									V
									V

Remark: Spurious emissions within 30-1000MHz were found more than 20dB below limit line.



GPRS 1900

GPRS 1900									
Channel	Frequency (MHz)	EIRP (dBm)	Limit (dBm)	Over Limit (dB)	SPA Reading (dBm)	S.G. Power (dBm)	TX Cable loss (dB)	TX Antenna Gain (dBi)	Polarization (H/V)
Lowest	3700.4	-56.30	-13	-43.30	-73.86	-67.53	1.23	12.46	H
	5550.6	-53.59	-13	-40.59	-75.2	-65.08	1.80	13.29	H
	7400.8	-49.43	-13	-36.43	-75.45	-58.24	2.43	11.24	H
									H
									H
									H
									H
	3700.4	-56.00	-13	-43.00	-74.08	-67.23	1.23	12.46	V
	5550.6	-52.80	-13	-39.80	-75.2	-64.29	1.80	13.29	V
	7400.8	-49.75	-13	-36.75	-75.51	-58.56	2.43	11.24	V
									V
									V
									V
									V
Middle	3760	-56.09	-13	-43.09	-73.72	-67.33	1.27	12.51	H
	5640	-52.98	-13	-39.98	-74.73	-64.40	1.85	13.27	H
	7520	-48.41	-13	-35.41	-75.07	-57.03	2.50	11.11	H
									H
									H
									H
									H
	3760	-55.66	-13	-42.66	-73.89	-66.90	1.27	12.51	V
	5640	-52.87	-13	-39.87	-75.28	-64.29	1.85	13.27	V
	7520	-48.24	-13	-35.24	-74.7	-56.86	2.50	11.11	V
									V
									V
									V
									V



Highest	3819.6	-56.63	-13	-43.63	-74.35	-67.88	1.31	12.56	H
	5729.4	-53.15	-13	-40.15	-75.09	-64.50	1.90	13.25	H
	7639.2	-49.81	-13	-36.81	-75.87	-58.40	2.59	11.18	H
									H
									H
									H
									H
	3819.6	-55.66	-13	-42.66	-74.06	-66.91	1.31	12.56	V
	5729.4	-53.04	-13	-40.04	-75.62	-64.39	1.90	13.25	V
	7639.2	-49.39	-13	-36.39	-75.53	-57.98	2.59	11.18	V
									V
									V
									V
									V

Remark: Spurious emissions within 30-1000MHz were found more than 20dB below limit line.



EDGE 1900

EDGE 1900									
Channel	Frequency (MHz)	EIRP (dBm)	Limit (dBm)	Over Limit (dB)	SPA Reading (dBm)	S.G. Power (dBm)	TX Cable loss (dB)	TX Antenna Gain (dBi)	Polarization (H/V)
Lowest	3700	-56.43	-13	-43.43	-73.99	-67.66	1.23	12.46	H
	5550	-53.30	-13	-40.30	-74.91	-64.79	1.80	13.29	H
	7400	-49.04	-13	-36.04	-75.05	-57.85	2.43	11.24	H
									H
									H
									H
									H
	3700	-56.17	-13	-43.17	-74.25	-67.40	1.23	12.46	V
	5550	-52.29	-13	-39.29	-74.69	-63.78	1.80	13.29	V
	7400	-49.09	-13	-36.09	-74.83	-57.90	2.43	11.24	V
									V
									V
									V
									V
Middle	3760	-55.76	-13	-42.76	-73.39	-67.00	1.27	12.51	H
	5640	-52.64	-13	-39.64	-74.39	-64.06	1.85	13.27	H
	7520	-47.34	-13	-34.34	-74	-55.96	2.50	11.11	H
									H
									H
									H
									H
	3760	-55.35	-13	-42.35	-73.58	-66.59	1.27	12.51	V
	5640	-52.29	-13	-39.29	-74.7	-63.71	1.85	13.27	V
	7520	-48.33	-13	-35.33	-74.81	-56.95	2.50	11.11	V
									V
									V
									V
									V



Highest	3820	-56.40	-13	-43.40	-74.12	-67.65	1.31	12.56	H
	5730	-53.58	-13	-40.58	-75.5	-64.93	1.90	13.25	H
	7640	-49.34	-13	-36.34	-75.4	-57.93	2.59	11.18	H
									H
									H
									H
									H
	3820	-55.95	-13	-42.95	-74.35	-67.20	1.31	12.56	V
	5730	-52.44	-13	-39.44	-75.02	-63.79	1.90	13.25	V
	7640	-49.13	-13	-36.13	-75.26	-57.72	2.59	11.18	V
									V
									V
									V
									V

Remark: Spurious emissions within 30-1000MHz were found more than 20dB below limit line.



WCDMA Band 2

WCDMA Band 2									
Channel	Frequency (MHz)	EIRP (dBm)	Limit (dBm)	Over Limit (dB)	SPA Reading (dBm)	S.G. Power (dBm)	TX Cable loss (dB)	TX Antenna Gain (dBi)	Polarization (H/V)
Lowest	3705	-55.35	-13	-42.35	-72.92	-66.58	1.24	12.46	H
	5557	-51.99	-13	-38.99	-73.61	-63.48	1.80	13.29	H
	7410	-48.76	-13	-35.76	-74.86	-57.55	2.44	11.23	H
									H
									H
									H
									H
	3705	-55.65	-13	-42.65	-73.74	-66.88	1.24	12.46	V
	5557	-52.28	-13	-39.28	-74.68	-63.77	1.80	13.29	V
	7410	-49.08	-13	-36.08	-74.91	-57.87	2.44	11.23	V
									V
									V
									V
									V
Middle	3760	-56.32	-13	-43.32	-73.95	-67.56	1.27	12.51	H
	5640	-52.84	-13	-39.84	-74.59	-64.26	1.85	13.27	H
	7520	-48.27	-13	-35.27	-74.93	-56.89	2.50	11.11	H
									H
									H
									H
									H
	3760	-55.63	-13	-42.63	-73.86	-66.87	1.27	12.51	V
	5640	-52.32	-13	-39.32	-74.73	-63.74	1.85	13.27	V
	7520	-48.46	-13	-35.46	-74.94	-57.08	2.50	11.11	V
									V
									V
									V
									V



Highest	3815	-56.30	-13	-43.30	-74.01	-67.54	1.31	12.55	H
	5723	-53.33	-13	-40.33	-75.23	-64.69	1.90	13.26	H
	7630	-49.68	-13	-36.68	-75.73	-58.28	2.58	11.18	H
									H
									H
									H
									H
	3815	-55.75	-13	-42.75	-74.14	-66.99	1.31	12.55	V
	5723	-52.56	-13	-39.56	-75.12	-63.92	1.90	13.26	V
	7630	-49.46	-13	-36.46	-75.58	-58.06	2.58	11.18	V
									V
									V
									V
									V

Remark: Spurious emissions within 30-1000MHz were found more than 20dB below limit line.



WCDMA Band 4

WCDMA Band 4									
Channel	Frequency (MHz)	ERP (dBm)	Limit (dBm)	Over Limit (dB)	SPA Reading (dBm)	S.G. Power (dBm)	TX Cable loss (dB)	TX Antenna Gain (dBi)	Polarization (H/V)
Lowest	3427	-57.39	-13	-44.39	-73.5	-68.43	1.10	12.14	H
	5137	-55.11	-13	-42.11	-76.02	-66.45	1.52	12.86	H
	6850	-51.17	-13	-38.17	-75.44	-60.94	2.18	11.95	H
									H
									H
									H
									H
	3427	-56.93	-13	-43.93	-73.55	-67.97	1.10	12.14	V
	5137	-54.26	-13	-41.26	-75.81	-65.60	1.52	12.86	V
	6850	-50.78	-13	-37.78	-75.27	-60.55	2.18	11.95	V
									V
									V
									V
									V
Middle	3465	-56.18	-13	-43.18	-72.86	-67.30	1.10	12.22	H
	5198	-54.45	-13	-41.45	-75.47	-65.82	1.56	12.94	H
	6927	-50.77	-13	-37.77	-75.07	-60.43	2.21	11.87	H
									H
									H
									H
									H
	3465	-56.31	-13	-43.31	-73.38	-67.43	1.10	12.22	V
	5198	-53.97	-13	-40.97	-75.69	-65.34	1.56	12.94	V
	6927	-50.63	-13	-37.63	-75.44	-60.29	2.21	11.87	V
									V
									V
									V
									V



Highest	3504	-56.09	-13	-43.09	-73.39	-67.29	1.10	12.30	H
	5258	-54.26	-13	-41.26	-75.38	-65.66	1.61	13.01	H
	7011	-50.45	-13	-37.45	-74.84	-59.99	2.25	11.78	H
									H
									H
									H
									H
	3504	-56.03	-13	-43.03	-73.51	-67.23	1.10	12.30	V
	5258	-53.55	-13	-40.55	-75.38	-64.95	1.61	13.01	V
	7011	-49.98	-13	-36.98	-75.14	-59.52	2.25	11.78	V
									V
									V
									V
									V

Remark: Spurious emissions within 30-1000MHz were found more than 20dB below limit line.