



FCC RF Test Report

APPLICANT : Sony Mobile Communications Inc.
EQUIPMENT : GSM/WCDMA/LTE Phone+Bluetooth, DTS/UNII
a/b/g/n/ac and NFC
BRAND NAME : Sony
FCC ID : PY7-78553D
STANDARD : FCC Part 15 Subpart E §15.407
CLASSIFICATION : (NII) Unlicensed National Information Infrastructure

This is a variant report which is only valid together with the original test report. The product was received on Jun. 27, 2017 and testing was completed on Oct. 24, 2017. We, SPORTON INTERNATIONAL INC., would like to declare that the tested sample has been evaluated in accordance with the test procedures and has been in compliance with the applicable technical standards.

The test results in this report apply exclusively to the tested model / sample. Without written approval of SPORTON INTERNATIONAL INC., the test report shall not be reproduced except in full.

Reviewed by: Joseph Lin / Supervisor

Approved by: Jones Tsai / Manager



SPORTON INTERNATIONAL INC.

No. 52, Hwa Ya 1st Rd., Hwa Ya Technology Park, Kwei-Shan District, Tao Yuan City, Taiwan, R.O.C.

SPORTON INTERNATIONAL INC.

TEL : 886-3-327-3456

FAX : 886-3-328-4978

FCC ID : PY7-78553D

Page Number : 1 of 21

Report Issued Date : Nov. 13, 2017

Report Version : Rev. 02

Report Template No.: BU5-FR15EWLB4 AC MA Version 2.0



TABLE OF CONTENTS

REVISION HISTORY..... 3

SUMMARY OF TEST RESULT 4

1 GENERAL DESCRIPTION 5

 1.1 Applicant 5

 1.2 Manufacturer..... 5

 1.3 Product Feature of Equipment Under Test..... 5

 1.4 Modification of EUT 5

 1.5 Testing Location 6

 1.6 Applicable Standards..... 6

2 TEST CONFIGURATION OF EQUIPMENT UNDER TEST 7

 2.1 Carrier Frequency and Channel 7

 2.2 Test Mode..... 8

 2.3 Connection Diagram of Test System..... 8

 2.4 EUT Operation Test Setup 9

3 TEST RESULT..... 10

 3.1 Maximum Conducted Output Power Measurement 10

 3.2 Unwanted Emissions Measurement 11

 3.3 Automatically Discontinue Transmission 17

 3.4 Antenna Requirements..... 18

4 LIST OF MEASURING EQUIPMENT 19

5 UNCERTAINTY OF EVALUATION..... 21

APPENDIX A. CONDUCTED TEST RESULTS

APPENDIX B. RADIATED SPURIOUS EMISSION

APPENDIX C. RADIATED SPURIOUS EMISSION PLOTS

APPENDIX D. DUTY CYCLE PLOTS

APPENDIX E. ORIGINAL REPORT



SUMMARY OF TEST RESULT

Report Section	FCC Rule	Description	Limit	Result	Remark
3.1	15.407(a)	Maximum Conducted Output Power	≤ 30 dBm	Pass	-
3.2	15.407(b)	Unwanted Emissions	15.407(b)(4)(i) & 15.209(a)	Pass	Under limit 5.24 dB at 47.010 MHz
3.3	15.407(c)	Automatically Discontinue Transmission	Discontinue Transmission	Pass	-
3.4	15.203 & 15.407(a)	Antenna Requirement	N/A	Pass	-



1 General Description

1.1 Applicant

Sony Mobile Communications Inc.

4-12-3 Higashi-Shinagawa, Shinagawa-ku, Tokyo, 140-0002, Japan

1.2 Manufacturer

Sony Mobile Communications Inc.

4-12-3 Higashi-Shinagawa, Shinagawa-ku, Tokyo, 140-0002, Japan

1.3 Product Feature of Equipment Under Test

GSM/WCDMA/LTE, Bluetooth, DTS/UNII a/b/g/n/ac, FM Receiver, NFC, and GPS.

Standards-related Product Specification	
Antenna Type / Gain	Monopole Antenna with gain -2.2 dBi

Remark: This is a variant report. All the test cases were performed on original report which can be referred to Sporton Report Number FR762713-01F

EUT Information List			
HW Version	SW Version	S/N	Performed Test Item
A	2.27	CQ30000180	RF conducted measurement
		CQ3000016P	Radiated Spurious Emission

Accessory List	
AC Adapter	Model Name: UCH12
	S/N: VB17W34100228
Earphone 1	Model Name: MH410c
	S/N: N/A
USB Cable	Model Name: UCB20
	S/N: N/A

Note:

1. Above EUT list and accessory list used are electrically identical per declared by manufacturer.
2. Above the accessories list are used to exercise the EUT during test.
3. For other wireless features of this EUT, test report will be issued separately.

1.4 Modification of EUT

No modifications are made to the EUT during all test items.



1.5 Testing Location

Sporton Lab is accredited to ISO 17025 by Taiwan Accreditation Foundation (TAF code : 1190) and the FCC designation No. TW1190 and TW0007 under the FCC 2.948(e) by Mutual Recognition Agreement (MRA) in FCC Test.

Test Site	SPORTON INTERNATIONAL INC.
Test Site Location	No. 52, Hwa Ya 1 st Rd., Hwa Ya Technology Park, Kwei-Shan District, Tao Yuan City, Taiwan, R.O.C. TEL: +886-3-327-3456 FAX: +886-3-328-4978
Test Site No.	Sporton Site No.
	TH05-HY

Note: The test site complies with ANSI C63.4 2014 requirement.

Test Site	SPORTON INTERNATIONAL INC.
Test Site Location	No.58, Aly. 75, Ln. 564, Wenhua 3rd Rd. Guishan Dist, Taoyuan City, Taiwan (R.O.C.) TEL: +886-3-327-0868 FAX: +886-3-327-0855
Test Site No.	Sporton Site No.
	03CH11-HY

Note: The test site complies with ANSI C63.4 2014 requirement.

1.6 Applicable Standards

According to the specifications of the manufacturer, the EUT must comply with the requirements of the following standards:

- FCC Part 15 Subpart E
- FCC KDB 789033 D02 General UNII Test Procedures New Rules v01r04
- ANSI C63.10-2013

Remark:

1. All test items were verified and recorded according to the standards and without any deviation during the test.
2. This EUT has also been tested and complied with the requirements of FCC Part 15, Subpart B, recorded in a separate test report.



2 Test Configuration of Equipment Under Test

- a. The EUT has been associated with peripherals and configuration operated in a manner tended to maximize its emission characteristics in a typical application. Frequency range investigated: radiated emission (9 kHz to the 10th harmonic of the highest fundamental frequency or to 40 GHz, whichever is lower). For radiated measurement, pre-scanned in three orthogonal panels, X, Y, Z. The worst cases (X plane) were recorded in this report.

2.1 Carrier Frequency and Channel

Frequency Band	Channel	Freq. (MHz)	Channel	Freq. (MHz)
5725-5850 MHz Band 4 (U-NII-3)	149	5745	157	5785
	151*	5755	159*	5795
	153	5765	161	5805
	155 [#]	5775	165	5825

Note:

- 1. The above Frequency and Channel in "*" were 802.11n HT40 and 802.11ac VHT40.
- 2. The above Frequency and Channel in "[#]" were 802.11ac VHT80.

2.2 Test Mode

Final test mode of conducted test items and radiated spurious emissions are considering the modulation and worse data rates as below table.

Modulation	Data Rate
802.11a	6 Mbps
802.11n HT20	MCS0
802.11n HT40	MCS0
802.11ac VHT20	MCS0
802.11ac VHT40	MCS0
802.11ac VHT80	MCS0

Ch. #		Band IV : 5725-5850 MHz
		802.11ac VHT40
L	Low	151
M	Middle	-
H	High	-

2.3 Connection Diagram of Test System

<WLAN Tx Mode>

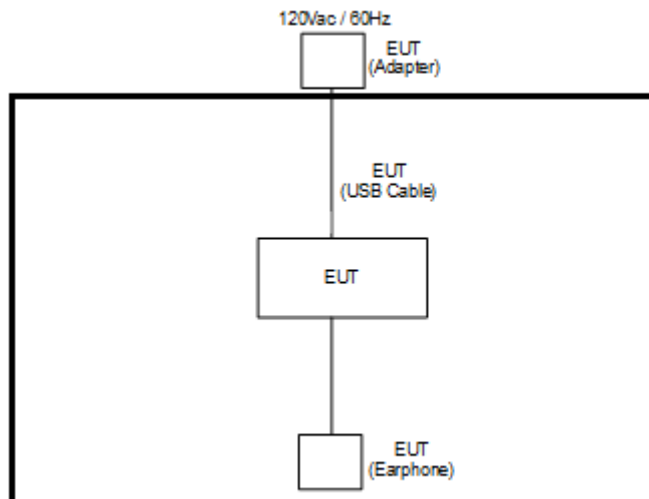



2.4 EUT Operation Test Setup

For RF test items, an engineering test program was provided and enabled to make EUT transmitting signals.

3 Test Result

3.1 Maximum Conducted Output Power Measurement

3.1.1 Limit of Maximum Conducted Output Power

For the band 5.725–5.85 GHz, the maximum conducted output power over the frequency band of operation shall not exceed 1 W.

If transmitting antennas of directional gain greater than 6 dBi are used, the peak output power shall be reduced by the amount in dB that the directional gain of the antenna exceeds 6 dBi.

3.1.2 Measuring Instruments

The measuring equipment is listed in the section 4 of this test report.

3.1.3 Test Procedures

The testing follows Method PM of FCC KDB 789033 D02 General UNII Test Procedures New Rules v01r04.

Method PM (Measurement using an RF average power meter):

1. Measurement is performed using a wideband RF power meter.
2. The EUT is configured to transmit continuously with a consistent duty cycle at its maximum power control level.
3. Measure the average power of the transmitter, and the average power is corrected with duty factor, $10 \log(1/x)$, where x is the duty cycle.

3.1.4 Test Setup

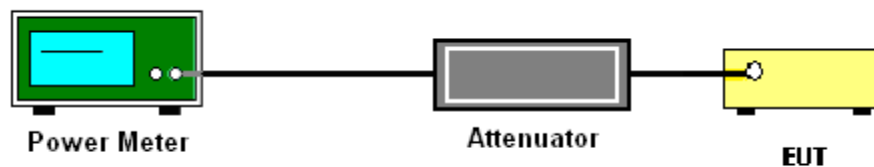

3.1.5 Test Result of Maximum Conducted Output Power

Please refer to Appendix A.



3.2 Unwanted Emissions Measurement

This section is to measure unwanted emissions through radiated measurement for band edge spurious emissions and out of band emissions measurement.

3.2.1 Limit of Unwanted Emissions

(1) For transmitters operating in the 5.725-5.85 GHz band:

15.407(b)(4)(i) All emissions shall be limited to a level of -27 dBm/MHz at 75 MHz or more above or below the band edge increasing linearly to 10 dBm/MHz at 25 MHz above or below the band edge, and from 25 MHz above or below the band edge increasing linearly to a level of 15.6 dBm/MHz at 5 MHz above or below the band edge, and from 5 MHz above or below the band edge increasing linearly to a level of 27 dBm/MHz at the band edge.

(2) Unwanted spurious emissions fallen in restricted bands shall comply with the general field strength limits as below table,

Frequency (MHz)	Field Strength (microvolts/meter)	Measurement Distance (meters)
0.009 – 0.490	2400/F(kHz)	300
0.490 – 1.705	24000/F(kHz)	30
1.705 – 30.0	30	30
30 – 88	100	3
88 – 216	150	3
216 - 960	200	3
Above 960	500	3

Note: The following formula is used to convert the EIRP to field strength.

$$E = \frac{1000000\sqrt{30P}}{3} \text{ } \mu\text{V/m, where P is the eirp (Watts)}$$



EIRP (dBm)	Field Strength at 3m (dBµV/m)
-17	78.3
- 27	68.3

(3) KDB789033 D02 v01r04 G)2)c)

- (i) Sections 15.407(b)(1) to (b)(3) specify the unwanted emission limits for the U-NII-1 and U-NII-2 bands. As specified, emissions above 1000 MHz that are outside of the restricted bands are subject to a peak emission limit of -27 dBm/MHz.³
- (ii) Section 15.407(b)(4) specifies the unwanted emission limit for the U-NII-3 band. A band emissions mask is specified in Section 15.407(b)(4)(i). The emission limits are in terms of a Peak detector. An alternative to the band emissions mask is specified in Section 15.407(b)(4)(ii). The alternative limits are based on the highest antenna gain specified in the filing. There are also marketing and importation restrictions for the devices using the alternative limit.⁴

Note 3: An out-of-band emission that complies with both the average and peak limits of Section 15.209 is not required to satisfy the -27 dBm/MHz peak emission limit.

Note 4: Only devices with antenna gains of 10 dBi or less may be approved using the emission limits specified in Section 15.247(d) till March 2, 2018; all other devices operating in this band must use the mask specified in Section 15.407(b)(4)(i).

3.2.2 Measuring Instruments

The measuring equipment is listed in the section 4 of this test report.



3.2.3 Test Procedures

1. The testing follows FCC KDB 789033 D02 General UNII Test Procedures New Rules v01r04. Section G) Unwanted emissions measurement.

(1) Procedure for Unwanted Emissions Measurements Below 1000MHz

- RBW = 120 kHz
- VBW = 300 kHz
- Detector = Peak
- Trace mode = max hold

(2) Procedure for Peak Unwanted Emissions Measurements Above 1000 MHz

- RBW = 1 MHz
- VBW \geq 3 MHz
- Detector = Peak
- Sweep time = auto
- Trace mode = max hold

(3) Procedures for Average Unwanted Emissions Measurements Above 1000MHz

- RBW = 1 MHz
- VBW = 10 Hz, when duty cycle is no less than 98 percent.
- VBW \geq 1/T, when duty cycle is less than 98 percent where T is the minimum transmission duration over which the transmitter is on and is transmitting at its maximum power control level for the tested mode of operation.

2. The EUT was placed on a turntable with 0.8 meter for frequency below 1GHz and 1.5 meter for frequency above 1GHz respectively above ground.
3. The EUT was set 3 meters from the interference receiving antenna which was mounted on the top of a variable height antenna tower.
4. The antenna is a broadband antenna and its height is adjusted between one meter and four meters above ground to find the maximum value of the field strength for both horizontal polarization and vertical polarization of the antenna.
5. For each suspected emission, the EUT was arranged to its worst case and then adjust the antenna tower (from 1 m to 4 m) and turntable (from 0 degree to 360 degrees) to find the maximum reading.
6. For testing below 1GHz, if the emission level of the EUT in peak mode was 3 dB lower than the limit specified, then peak values of EUT will be reported, otherwise, the emissions will be repeated one by one using the CISPR quasi-peak method and reported.
7. For testing above 1GHz, the emission level of the EUT in peak mode was 20dB lower than average limit (that means the emission level in average mode also complies with the limit in average mode), then peak values of EUT will be reported, otherwise, the emissions will be measured in average mode again and reported.

3.2.4 Test Setup

For radiated emissions below 30MHz

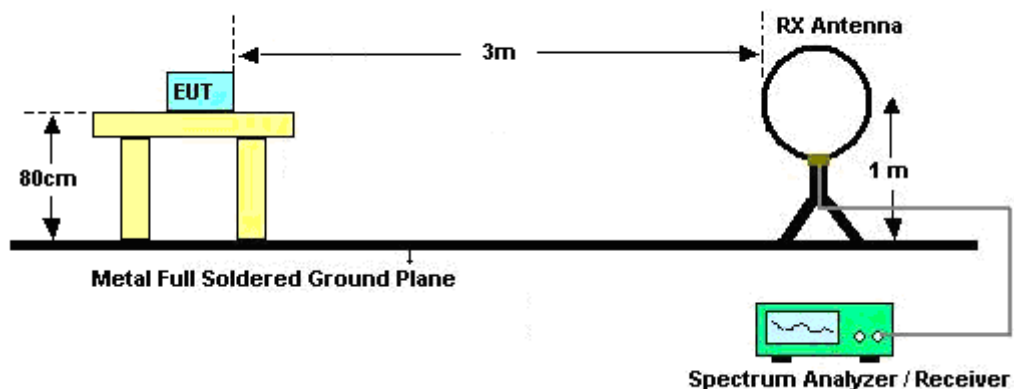

For radiated emissions from 30MHz to 1GHz

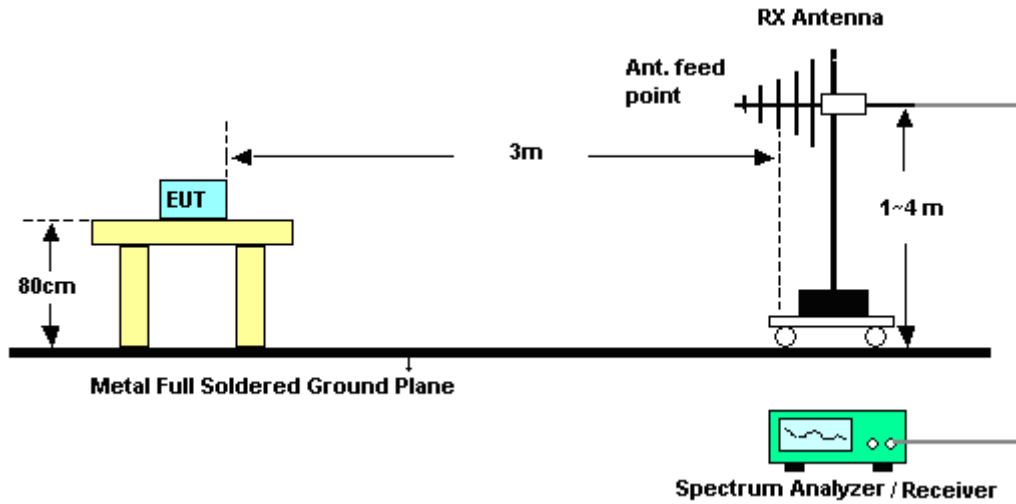

For radiated emissions above 1GHz

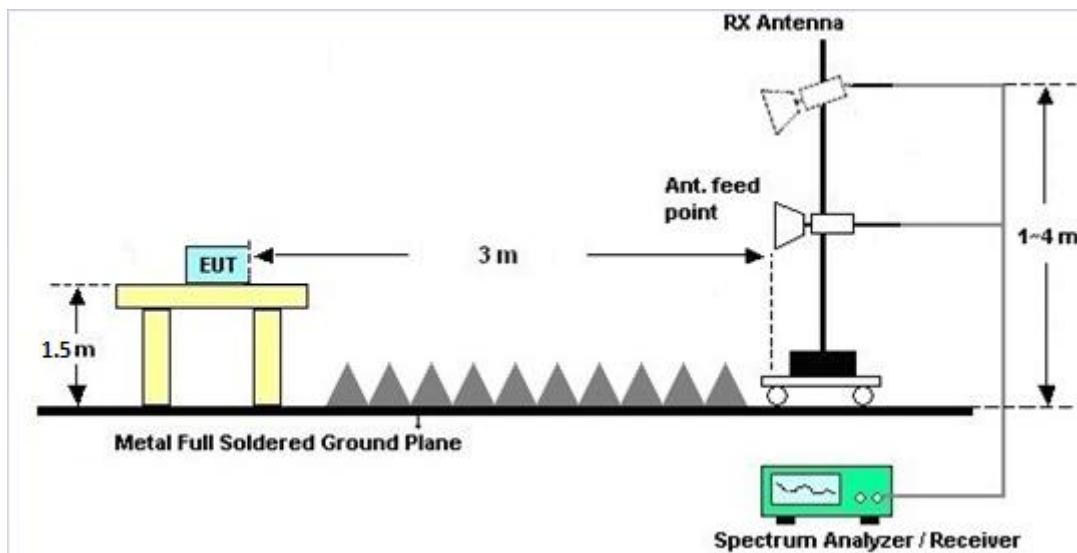



3.2.5 Test Results of Radiated Spurious Emissions (9 kHz ~ 30 MHz)

The low frequency, which started from 9 kHz to 30MHz, was pre-scanned and the result which was 20dB lower than the limit line was not reported.

There is a comparison data of both open-field test site and semi-Anechoic chamber, and the result came out very similar.

3.2.6 Test Result of Radiated Spurious at Band Edges

Please refer to Appendix B and C.

3.2.7 Duty Cycle

Please refer to Appendix D.

3.2.8 Test Result of Radiated Spurious Emissions (30MHz ~ 10th Harmonic)

Please refer to Appendix B and C.



3.3 Automatically Discontinue Transmission

3.3.1 Limit of Automatically Discontinue Transmission

The device shall automatically discontinue transmission in case of either absence of information to transmit or operational failure. These provisions are not intended to preclude the transmission of control or signaling information or the use of repetitive codes used by certain digital technologies to complete frame or burst intervals. Applicants shall include in their application for equipment authorization to describe how this requirement is met.

3.3.2 Measuring Instruments

The measuring equipment is listed in the section 4 of this test report.

3.3.3 Test Result of Automatically Discontinue Transmission

While the EUT is not transmitting any information, the EUT can automatically discontinue transmission and become standby mode for power saving. The EUT can detect the controlling signal of ACK message transmitting from remote device and verify whether it shall resend or discontinue transmission.



3.4 Antenna Requirements

3.4.1 Standard Applicable

If transmitting antenna directional gain is greater than 6 dBi, both the peak transmit power and the peak power spectral density shall be reduced by the amount in dB that the directional gain of the antenna exceeds 6 dBi.

3.4.2 Antenna Anti-Replacement Construction

An embedded-in antenna design is used.

3.4.3 Antenna Gain

The antenna gain is less than 6 dBi. Therefore, it is not necessary to reduce maximum peak output power limit.



4 List of Measuring Equipment

Instrument	Manufacturer	Model No.	Serial No.	Characteristics	Calibration Date	Test Date	Due Date	Remark
Power Meter	Agilent	E4416A	GB41292344	N/A	Dec. 26, 2016	Sep. 27, 2017~ Oct. 24, 2017	Dec. 25, 2017	Conducted (TH05-HY)
Power Sensor	Agilent	E9327A	US40441548	50MHz~18GHz	Dec. 26, 2016	Sep. 27, 2017~ Oct. 24, 2017	Dec. 25, 2017	Conducted (TH05-HY)
Spectrum Analyzer	Rohde & Schwarz	FSP30	101067	9kHz ~ 30GHz	Nov. 17, 2016	Sep. 27, 2017~ Oct. 24, 2017	Nov. 16, 2017	Conducted (TH05-HY)
Hygrometer	TECEPEL	DTM-303B	TP157151	N/A	Mar. 20, 2017	Sep. 27, 2017~ Oct. 24, 2017	Mar. 19, 2018	Conducted (TH05-HY)
RF Cable	HUBER + SUHNER	SUCOFLEX 104	MY84209521	1GHz~26GHz	Dec. 02, 2016	Sep. 27, 2017~ Oct. 24, 2017	Dec. 01, 2017	Conducted (TH05-HY)
Loop Antenna	Rohde & Schwarz	HFH2-Z2	100488	9 kHz~30 MHz	Oct. 20, 2016	Oct. 07, 2017	Oct. 19, 2018	Radiation (03CH11-HY)
Bilog Antenna	TESEQ	CBL 6111D&N-6-06	35414&AT-N0602	30MHz~1GHz	Oct. 15, 2016	Oct. 07, 2017	Oct. 14, 2017	Radiation (03CH11-HY)
Horn Antenna	SCHWARZBECK	BBHA 9120 D	9120D-1241	1GHz ~ 18GHz	May. 02, 2017	Oct. 07, 2017	May. 01, 2018	Radiation (03CH11-HY)
SHF-EHF Horn Antenna	SCHWARZBECK	BBHA 9170	BBHA9170584	18GHz- 40GHz	Nov. 08, 2016	Oct. 07, 2017	Nov. 07, 2017	Radiation (03CH11-HY)
Spectrum Analyzer	Keysight	N9010A	MY54200486	10Hz ~ 44GHz	Oct. 12, 2016	Oct. 07, 2017	Oct. 11, 2017	Radiation (03CH11-HY)
EMI Test Receiver	Agilent	N9038A(MXE)	MY53290053	20Hz to 26.5GHz	Jan. 12, 2017	Oct. 07, 2017	Jan. 11, 2018	Radiation (03CH11-HY)
Amplifier	SONOMA	310N	187312	9kHz~1GHz	Nov. 10, 2016	Oct. 07, 2017	Nov. 09, 2017	Radiation (03CH11-HY)
Preamplifier	MITEQ	AMF-7D-0010 1800-30-10P	1902247	1GHz~18GHz	Jun. 23, 2017	Oct. 07, 2017	Jun. 22, 2018	Radiation (03CH11-HY)
Preamplifier	Keysight	83017A	MY53270080	1GHz~26.5GHz	Nov. 10, 2016	Oct. 07, 2017	Nov. 09, 2017	Radiation (03CH11-HY)
Amplifier	MITEQ	TTA1840-35-HG	1871923	18GHz~40GHz, VSWR : 2.5:1 max	Jul. 18, 2017	Oct. 07, 2017	Jul. 17, 2018	Radiation (03CH11-HY)



Instrument	Manufacturer	Model No.	Serial No.	Characteristics	Calibration Date	Test Date	Due Date	Remark
Hygrometer	TECPEL	DTN-303B	TP140325	N/A	Nov. 14, 2016	Oct. 07, 2017	Nov. 13, 2017	Radiation (03CH11-HY)
RF Cable	HUBER + SUHNER	SUCOFLEX 104	MY9837/4 MY28419/4MY 28654/4	25GHz~40GHz	Sep. 11, 2017	Oct. 07, 2017	Sep. 10, 2018	Radiation (03CH11-HY)
RF Cable	HUBER + SUHNER	SUCOFLEX 104	MY9837/4 MY28419/4MY 28654/4	1GHz~25GHz	Sep. 11, 2017	Oct. 07, 2017	Sep. 10, 2018	Radiation (03CH11-HY)
RF Cable	HUBER + SUHNER	SUCOFLEX 104	MY9837/4 MY28419/4MY 28654/4	30MHz~1GHz	Sep. 11, 2017	Oct. 07, 2017	Sep. 10, 2018	Radiation (03CH11-HY)
RF Cable	HUBER + SUHNER	SUCOFLEX 104	MY9837/4 MY28419/4MY 28654/4	9KHz~30MHz	Sep. 11, 2017	Oct. 07, 2017	Sep. 10, 2018	Radiation (03CH11-HY)
Controller	EMEC	EM 1000	N/A	Control Turn table & Ant Mast	N/A	Oct. 07, 2017	N/A	Radiation (03CH11-HY)
Antenna Mast	EMEC	AM-BS-4500-B	N/A	1~4m	N/A	Oct. 07, 2017	N/A	Radiation (03CH11-HY)
Turn Table	EMEC	TT 2000	N/A	0~360 Degree	N/A	Oct. 07, 2017	N/A	Radiation (03CH11-HY)
Test Software	Audix	E3	6.2009-8-24	N/A	N/A	Oct. 07, 2017	N/A	Radiation (03CH11-HY)
Filter	Wainwright	WLKS1200-1 2SS	SN2	1.2G Low Pass	Mar. 24, 2017	Oct. 07, 2017	Mar. 23, 2018	Radiation (03CH11-HY)
Filter	Wainwright	WHKX12-270 0-3000-18000 -60SS	SN3	2.7G High Pass	Sep. 19, 2017	Oct. 07, 2017	Sep. 18, 2018	Radiation (03CH11-HY)
Filter	Woken	WHKX8-5872. 5-6750-18000 -40ST	SN3	6.75GHz High Pass	Sep. 19, 2017	Oct. 07, 2017	Sep. 18, 2018	Radiation (03CH11-HY)



5 Uncertainty of Evaluation

Uncertainty of Radiated Emission Measurement (30 MHz ~ 1000 MHz)

Measuring Uncertainty for a Level of Confidence of 95% ($U = 2Uc(y)$)	5.20
---	------

Uncertainty of Radiated Emission Measurement (1000 MHz ~ 18000 MHz)

Measuring Uncertainty for a Level of Confidence of 95% ($U = 2Uc(y)$)	5.50
---	------

Uncertainty of Radiated Emission Measurement (18000 MHz ~ 40000 MHz)

Measuring Uncertainty for a Level of Confidence of 95% ($U = 2Uc(y)$)	5.20
---	------

Appendix A. Test Result of Conducted Test Items

Test Engineer:	Reece Lin/Shiming Liu	Temperature:	21~25	°C
Test Date:	2017/9/27~2017/10/24	Relative Humidity:	51~54	%

TEST RESULTS DATA
Average Power Table

Band IV										
Mod.	Data Rate	NTX	CH.	Freq. (MHz)	Duty Factor (dB)	Average Conducted Power (dBm)	FCC Conducted Power Limit (dBm)	DG (dBi)		Pass/Fail
11a	6M bps	1	149	5745	0.23	13.83	30.00	-2.20		Pass
11a	6Mbps	1	157	5785	0.23	13.81	30.00	-2.20		Pass
11a	6Mbps	1	165	5825	0.23	13.68	30.00	-2.20		Pass
HT20	MCS 0	1	149	5745	0.22	13.89	30.00	-2.20		Pass
HT20	MCS 0	1	157	5785	0.22	13.80	30.00	-2.20		Pass
HT20	MCS 0	1	165	5825	0.22	13.79	30.00	-2.20		Pass
HT40	MCS 0	1	151	5755	0.40	12.86	30.00	-2.20		Pass
HT40	MCS 0	1	159	5795	0.40	12.90	30.00	-2.20		Pass
VHT20	MCS 0	1	149	5745	0.24	13.74	30.00	-2.20		Pass
VHT20	MCS 0	1	157	5785	0.24	13.75	30.00	-2.20		Pass
VHT20	MCS 0	1	165	5825	0.24	13.68	30.00	-2.20		Pass
VHT40	MCS 0	1	151	5755	0.42	12.82	30.00	-2.20		Pass
VHT40	MCS 0	1	159	5795	0.42	12.79	30.00	-2.20		Pass
VHT80	MCS 0	1	155	5775	0.46	11.66	30.00	-2.20		Pass



Appendix B. Radiated Spurious Emission

Test Engineer :	Ken Wu	Temperature :	24~26°C
		Relative Humidity :	50~55%

Band 4 - 5725~5850MHz

WIFI 802.11ac VHT40 (Band Edge @ 3m)

WIFI Ant.	Note	Frequency (MHz)	Level (dBμV/m)	Over Limit (dB)	Limit Line (dBμV/m)	Read Level (dBμV)	Antenna Factor (dB/m)	Cable Loss (dB)	Preamp Factor (dB)	Ant Pos (cm)	Table Pos (deg)	Peak Avg. (P/A)	Pol. (H/V)	
802.11ac VHT40 CH 151 5755MHz		5616.2	50.01	-18.19	68.2	40.85	32.69	9.55	33.08	100	121	P	H	
		5699.2	55.01	-49.6	104.61	45.52	32.86	9.75	33.12	100	121	P	H	
		5719.2	64.64	-45.94	110.58	55.02	32.94	9.81	33.13	100	121	P	H	
		5721	63.45	-49.63	113.08	53.83	32.94	9.81	33.13	100	121	P	H	
	*	5755	103.46	-	-	93.71	33.02	9.88	33.15	100	121	P	H	
	*	5755	95.06	-	-	85.31	33.02	9.88	33.15	100	121	A	H	
		5854.2	50.25	-62.37	112.62	40.15	33.27	10.02	33.19	100	121	P	H	
		5870.2	50.55	-55.99	106.54	40.47	33.27	10.02	33.21	100	121	P	H	
		5906.8	50.28	-31.35	81.63	40.09	33.39	10.02	33.22	100	121	P	H	
		5947.6	50.69	-17.51	68.2	40.43	33.48	10.02	33.24	100	121	P	H	
														H
			5623.8	50.04	-18.16	68.2	40.88	32.69	9.55	33.08	252	82	P	V
			5697.4	51.44	-51.84	103.28	41.95	32.86	9.75	33.12	252	82	P	V
			5719.6	61.35	-49.34	110.69	51.73	32.94	9.81	33.13	252	82	P	V
			5724.8	64.32	-57.42	121.74	54.7	32.94	9.81	33.13	252	82	P	V
	*	5755	102.25	-	-	92.5	33.02	9.88	33.15	252	82	P	V	
	*	5755	94.27	-	-	84.52	33.02	9.88	33.15	252	82	A	V	
			5852	50.22	-67.42	117.64	40.16	33.23	10.02	33.19	252	82	P	V
			5856.8	49.17	-61.13	110.3	39.07	33.27	10.02	33.19	252	82	P	V
		5898	51.42	-36.72	88.14	41.27	33.35	10.02	33.22	252	82	P	V	
		5936.2	50.65	-17.55	68.2	40.44	33.43	10.02	33.24	252	82	P	V	
													V	



Band 4 5725~5850MHz
WIFI 802.11ac VHT40 (Harmonic @ 3m)

WIFI Ant. 1	Note	Frequency (MHz)	Level (dBμV/m)	Over Limit (dB)	Limit Line (dBμV/m)	Read Level (dBμV)	Antenna Factor (dB/m)	Cable Loss (dB)	Preamp Factor (dB)	Ant Pos (cm)	Table Pos (deg)	Peak Avg. (P/A)	Pol. (H/V)	
802.11ac VHT40 CH 151 5755MHz		11510	46.25	-27.75	74	55.02	38.5	15.45	63	100	0	P	H	
		17265	48.71	-19.49	68.2	49.18	40.74	19.26	60.83	100	0	P	H	
													H	
													H	
			11510	46.55	-27.45	74	55.32	38.5	15.45	63	100	0	P	V
			17265	48.74	-19.46	68.2	49.21	40.74	19.26	60.83	100	0	P	V
														V
														V
Remark	1. No other spurious found. 2. All results are PASS against Peak and Average limit line.													



Note symbol

*	Fundamental Frequency which can be ignored. However, the level of any unwanted emissions shall not exceed the level of the fundamental frequency.
!	Test result is over limit line.
P/A	Peak or Average
H/V	Horizontal or Vertical



A calculation example for radiated spurious emission is shown as below:

WIFI	Note	Frequency	Level	Over	Limit	Read	Antenna	Cable	Preamp	Ant	Table	Peak	Pol.
Ant.				Limit	Line	Level	Factor	Loss	Factor	Pos	Pos	Avg.	
1		(MHz)	(dBμV/m)	(dB)	(dBμV/m)	(dBμV)	(dB/m)	(dB)	(dB)	(cm)	(deg)	(P/A)	(H/V)
802.11b		2390	55.45	-18.55	74	54.51	32.22	4.58	35.86	103	308	P	H
CH 01													
2412MHz		2390	43.54	-10.46	54	42.6	32.22	4.58	35.86	103	308	A	H

- Level(dBμV/m) =
Antenna Factor(dB/m) + Cable Loss(dB) + Read Level(dBμV) - Preamp Factor(dB)
- Over Limit(dB) = Level(dBμV/m) – Limit Line(dBμV/m)

For Peak Limit @ 2390MHz:

- Level(dBμV/m)
= Antenna Factor(dB/m) + Cable Loss(dB) + Read Level(dBμV) - Preamp Factor(dB)
= 32.22(dB/m) + 4.58(dB) + 54.51(dBμV) – 35.86 (dB)
= 55.45 (dBμV/m)
- Over Limit(dB)
= Level(dBμV/m) – Limit Line(dBμV/m)
= 55.45(dBμV/m) – 74(dBμV/m)
= -18.55(dB)

For Average Limit @ 2390MHz:

- Level(dBμV/m)
= Antenna Factor(dB/m) + Cable Loss(dB) + Read Level(dBμV) - Preamp Factor(dB)
= 32.22(dB/m) + 4.58(dB) + 42.6(dBμV) – 35.86 (dB)
= 43.54 (dBμV/m)
- Over Limit(dB)
= Level(dBμV/m) – Limit Line(dBμV/m)
= 43.54(dBμV/m) – 54(dBμV/m)
= -10.46(dB)

Both peak and average measured complies with the limit line, so test result is “PASS”.



Appendix C. Radiated Spurious Emission Plots

Test Engineer :	Ken Wu	Temperature :	24~26°C
		Relative Humidity :	50~55%

Note symbol

-L	Low channel location
-R	High channel location



Band 4 - 5725~5850MHz
WIFI 802.11ac VHT40 (Band Edge @ 3m)

WIFI	Band 4 5725~5850MHz Band Edge @ 3m	
ANT	802.11ac VHT40 CH151 5755MHz	
1	Horizontal	Fundamental
Peak	<p>Site : 03CH11-HY Condition : PEAK_BE(B4) 16-24 3m HORN 9120D-HF HORIZONTAL</p>	<p>Site : 03CH11-HY Condition : PEAK(LINE) 3m HORN 9120D-HF HORIZONTAL</p>
Peak	<p>Site : 03CH11-HY Condition : PEAK_BE(B4) 16-24 3m HORN 9120D-HF HORIZONTAL</p>	Left blank



WIFI	Band 4 5725~5850MHz Band Edge @ 3m	
ANT	802.11ac VHT40 CH151 5755MHz	
1	Vertical	Fundamental
Peak	<p>Site : 03CH11-HY Condition : PEAK_BE(B4) 16-24 3m HORN 9120D-HF VERTICAL</p>	<p>Site : 03CH11-HY Condition : PEAKUNB1 3m HORN 9120D-HF VERTICAL</p>
Peak	<p>Site : 03CH11-HY Condition : PEAK_BE(B4) 16-24 3m HORN 9120D-HF VERTICAL</p>	Left blank



Band 4 - 5725~5850MHz
WIFI 802.11ac VHT40 (Harmonic @ 3m)

WIFI	Band 4 5725~5850MHz Harmonic @ 3m	
ANT	802.11ac VHT40 CH151 5755MHz	
1	Horizontal	Vertical
<p>Peak Avg.</p>	<p>Site : 03CH11-14Y Condition : PEAK(LINE1) 3m HORN 9120D-1HF HORIZONTAL</p>	<p>Site : 03CH11-14Y Condition : PEAK(LINE1) 3m HORN 9120D-1HF VERTICAL</p>



Emission below 1GHz
5GHz WIFI 802.11ac VHT40 (LF)

WIFI	5GHz 5725-5850MHz	
ANT	802.11ac VHT40 LF	
1	Horizontal	Vertical
QP / Peak	<p>Site : 03CH11-HY Condition : QP 3m BE-LOG 6111D-LF ETC HORIZONTAL</p>	<p>Site : 03CH11-HY Condition : QP 3m BE-LOG 6111D-LF ETC VERTICAL</p>



Appendix D. Duty Cycle Plots

Band	Duty Cycle(%)	T(us)	1/T(kHz)	VBW Setting	Duty Factor(dB)
802.11a	94.87	2035	0.49	1kHz	0.23
5GHz 802.11n HT20	95.00	1900	0.53	1kHz	0.22
5GHz 802.11n HT40	91.19	932	1.07	3kHz	0.40
5GHz 802.11ac VHT20	94.53	1900	0.53	1kHz	0.24
5GHz 802.11ac VHT40	90.70	936	1.07	3kHz	0.42
5GHz 802.11ac VHT80	89.87	852	1.17	3kHz	0.46



802.11a

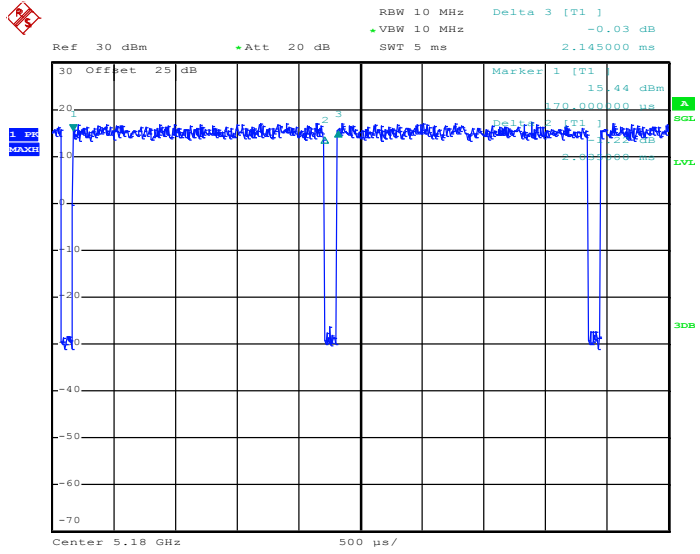

Date: 27.SEP.2017 05:02:58

802.11n HT20

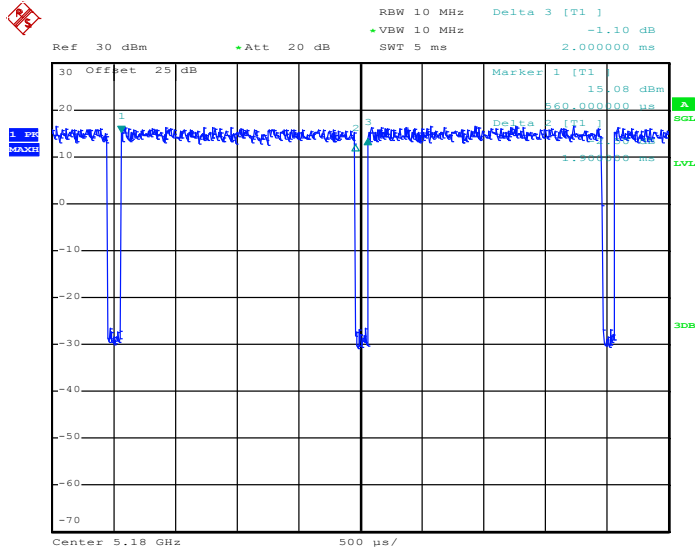

Date: 27.SEP.2017 05:21:59



802.11n HT40

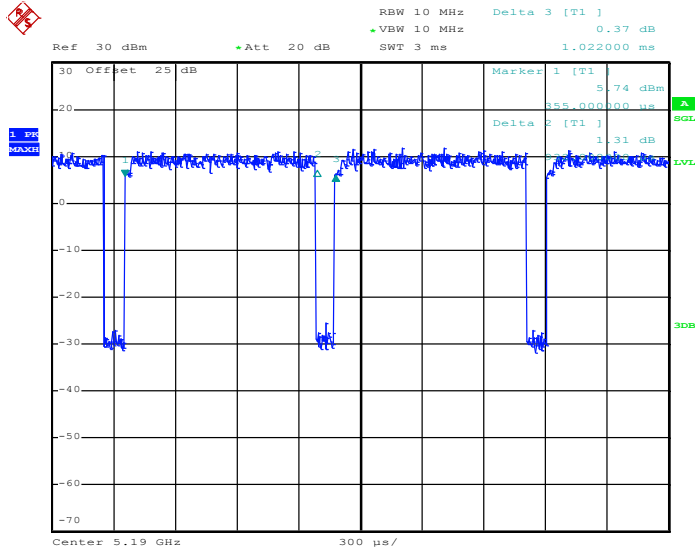

Date: 27.SEP.2017 05:35:39

802.11ac VHT20

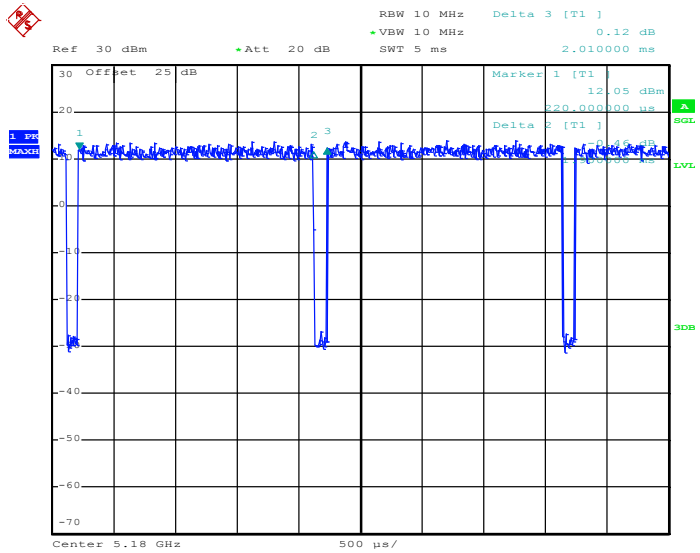

Date: 27.SEP.2017 05:46:57



802.11ac VHT40

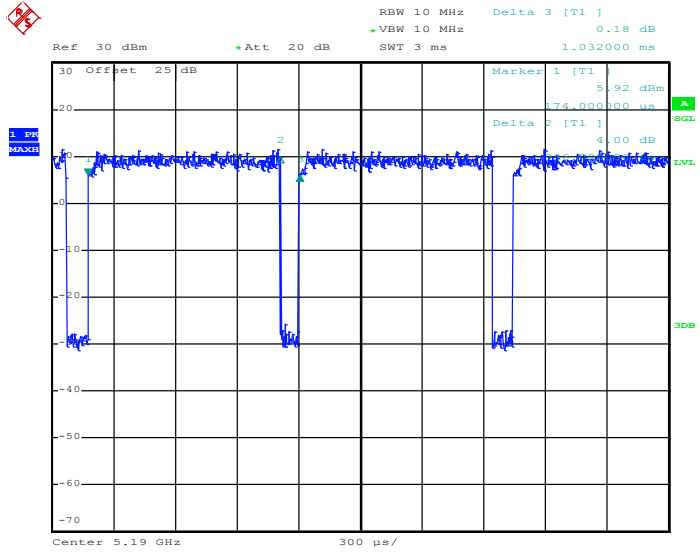

Date: 27.SEP.2017 06:02:02

802.11ac VHT80

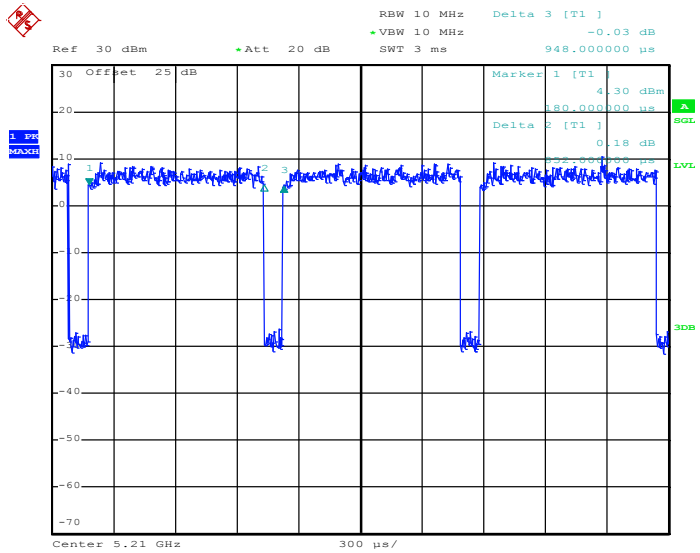

Date: 27.SEP.2017 06:13:51



Appendix E. Original Report

Please refer to Sporton report number FR762713-01F