



FCC RADIO TEST REPORT

FCC ID : PY7-00532F
Equipment : GSM/WCDMA/LTE Phone with BT, DTS/UNII
a/b/g/n/ac, GPS and NFC
Brand Name : Sony
Applicant : Sony Mobile Communications Inc.
4-12-3 Higashi-Shinagawa, Shinagawa-ku,
Tokyo, 140-0002, Japan
Manufacturer : Sony Mobile Communications Inc.
4-12-3 Higashi-Shinagawa, Shinagawa-ku,
Tokyo, 140-0002, Japan
Standard : FCC Part 15 Subpart E §15.407

The product was received on Jun. 04, 2019 and testing was started from Jun. 07, 2019 and completed on Jul. 02, 2019. We, SPORTON INTERNATIONAL INC. EMC & Wireless Communications Laboratory, would like to declare that the tested sample has been evaluated in accordance with the test procedures and has been in compliance with the applicable technical standards.

The report must not be used by the client to claim product certification, approval, or endorsement by TAF or any agency of government.

The test results in this report apply exclusively to the tested model / sample. Without written approval of SPORTON INTERNATIONAL INC. EMC & Wireless Communications Laboratory, the test report shall not be reproduced except in full.

Approved by: Jones Tsai

SPORTON INTERNATIONAL INC. EMC & Wireless Communications Laboratory

No. 52, Huaya 1st Rd., Guishan Dist., Taoyuan City, Taiwan (R.O.C.)



Table of Contents

History of this test report.....3

Summary of Test Result.....4

1 General Description5

 1.1 Product Feature of Equipment Under Test5

 1.2 Modification of EUT5

 1.3 Testing Location6

 1.4 Applicable Standards.....6

2 Test Configuration of Equipment Under Test.....7

 2.1 Carrier Frequency and Channel7

 2.2 Test Mode8

 2.3 Connection Diagram of Test System9

 2.4 Support Unit used in test configuration and system10

 2.5 EUT Operation Test Setup10

 2.6 Measurement Results Explanation Example10

3 Test Result11

 3.1 6dB and 26dB and 99% Occupied Bandwidth Measurement11

 3.2 Maximum Conducted Output Power Measurement14

 3.3 Power Spectral Density Measurement15

 3.4 Unwanted Emissions Measurement.....18

 3.5 AC Conducted Emission Measurement23

 3.6 Automatically Discontinue Transmission.....25

 3.7 Antenna Requirements27

4 List of Measuring Equipment.....28

5 Uncertainty of Evaluation.....30

Appendix A. Conducted Test Results

Appendix B. AC Conducted Emission Test Result

Appendix C. Radiated Spurious Emission

Appendix D. Radiated Spurious Emission Plots

Appendix E. Duty Cycle Plots



History of this test report

Report No.	Version	Description	Issued Date
FR940901-03F	01	Initial issue of report	Jul. 12, 2019



Summary of Test Result

Report Clause	Ref Std. Clause	Test Items	Result (PASS/FAIL)	Remark
3.1	15.403 (i)	6dB & 26dB Bandwidth	Pass	-
3.1	2.1049	99% Occupied Bandwidth	Reporting only	-
3.2	15.407 (a)	Maximum Conducted Output Power	Pass	-
3.3	15.407 (a)	Power Spectral Density	Pass	-
3.4	15.407(b)	Unwanted Emissions	Pass	Under limit 12.43 dB at 5949.200 MHz
3.5	15.207	AC Conducted Emission	Pass	Under limit 17.20 dB at 0.596 MHz
3.6	15.407 (c)	Automatically Discontinue Transmission	Pass	-
3.7	15.203 & 15.407 (a)	Antenna Requirement	Pass	-

Declaration of Conformity:

The test results with all measurement uncertainty excluded are presented in accordance with the regulation limits or requirements declared by manufacturers.

Comments and Explanations:

The declared of product specification for EUT presented in the report are provided by the manufacturer, and the manufacturer takes all the responsibilities for the accuracy of product specification.

Reviewed by: Wii Chang

Report Producer: Yimin Ho



1 General Description

1.1 Product Feature of Equipment Under Test

GSM/WCDMA/LTE, Bluetooth, DTS/UNII a/b/g/n/ac, NFC, and GNSS.

Standards-related Product Specification	
Antenna Type / Gain	<Ant. 1>: Loop Antenna with gain -1.5 dBi <Ant. 2>: Loop Antenna with gain -4.8 dBi

EUT Information List			
HW Version	SW Version	S/N	Performed Test Item
A	0_77003_A_28_2	BH93001BH0	RF conducted measurement
	3.122	BH9300F0GX	Radiated Spurious Emission
		BH93011VGX	AC Conducted Emission

Accessory List	
AC Adapter	Model Name : UCH32
	S/N: 6218W30200106 (for radiation emission) 6218W30200197 (for conducted emission)
Earphone	Model Name.: MH750
	S/N : N/A
USB Cable	Model Name.: UCB24
	S/N : N/A
2 in 1 USB Audio Cable	Model Name.: EC270
	S/N : N/A

Note:

1. Above EUT list used are electrically identical per declared by manufacturer.
2. Above the accessories list are used to exercise the EUT during test, and the serial number of each type of accessories is listed in each section of this report. .
3. For other wireless features of this EUT, test report will be issued separately.
4. The antenna 1 and antenna 2 in this test report are equivalent to WLAN chain 0 and chain 1 in Antenna Specification by manufacturer.
5. The firmware installed in the EUT during testing was 0_77003_A_28_2.

1.2 Modification of EUT

No modifications are made to the EUT during all test items.



1.3 Testing Location

Test Site	SPORTON INTERNATIONAL INC. EMC & Wireless Communications Laboratory	
Test Site Location	No.52, Huaya 1st Rd., Guishan Dist., Taoyuan City, Taiwan (R.O.C.) TEL: +886-3-327-3456 FAX: +886-3-328-4978	
Test Site No.	Sporton Site No.	
	TH05-HY	CO05-HY

Note: The test site complies with ANSI C63.4 2014 requirement.

Test Site	SPORTON INTERNATIONAL INC. EMC & Wireless Communications Laboratory	
Test Site Location	No.58, Aly. 75, Ln. 564, Wenhua 3rd, Rd., Guishan Dist., Taoyuan City, Taiwan (R.O.C.) TEL: +886-3-327-0868 FAX: +886-3-327-0855	
Test Site No.	Sporton Site No.	
	03CH16-HY	

Note: The test site complies with ANSI C63.4 2014 requirement.

FCC Designation No.: TW1190 and TW0007

1.4 Applicable Standards

According to the specifications of the manufacturer, the EUT must comply with the requirements of the following standards:

- ♦ FCC Part 15 Subpart E
- ♦ FCC KDB 789033 D02 General UNII Test Procedures New Rules v02r01.
- ♦ FCC KDB 414788 D01 Radiated Test Site v01r01.
- ♦ FCC KDB 662911 D01 Multiple Transmitter Output v02r01.
- ♦ ANSI C63.10-2013

Remark:

1. All test items were verified and recorded according to the standards and without any deviation during the test.
2. This EUT has also been tested and complied with the requirements of FCC Part 15, Subpart B, recorded in a separate test report.



2 Test Configuration of Equipment Under Test

- a. The EUT has been associated with peripherals and configuration operated in a manner tended to maximize its emission characteristics in a typical application. Frequency range investigated: conduction emission (150 kHz to 30 MHz), radiation emission (9 kHz to the 10th harmonic of the highest fundamental frequency or to 40 GHz, whichever is lower). For radiated measurement, pre-scanned in three orthogonal panels X, Y, Z and Accessory. The worst cases (X plane with Adapter) were recorded in this report.

- b. AC power line Conducted Emission was tested under maximum output power.

2.1 Carrier Frequency and Channel

Frequency Band	Channel	Freq. (MHz)	Channel	Freq. (MHz)
5725-5850 MHz Band 4 (U-NII-3)	149	5745	157	5785
	151*	5755	159*	5795
	153	5765	161	5805
	155 [#]	5775	165	5825

Note:

- 1. The above Frequency and Channel in "*" were 802.11n HT40 and 802.11ac VHT40.
- 2. The above Frequency and Channel in "[#]" were 802.11ac VHT80.



2.2 Test Mode

Final test modes are considering the modulation and worse data rates as below table.

Modulation	Data Rate
802.11a	6 Mbps
802.11n HT20	MCS0
802.11n HT40	MCS0
802.11ac VHT20 (Covered by HT20)	MCS0
802.11ac VHT40 (Covered by HT40)	MCS0
802.11ac VHT80	MCS0

Test Cases	
AC Conducted Emission	Mode 1 : GSM850 (Low Channel) Idle + Bluetooth Link + WLAN (5GHz) Link + Camera (Rear) + Battery + USB Cable (Charging from Adapter)
Remark: The single mode covered by MIMO mode base on the MIMO mode power higher than the single mode.	

Ch. #	Band IV : 5725-5850 MHz			
	802.11a	802.11n HT20	802.11n HT40	802.11ac VHT80
L Low	149	149	151	-
M Middle	157	157	-	155
H High	165	165	159	-

2.3 Connection Diagram of Test System

<WLAN Tx Mode>

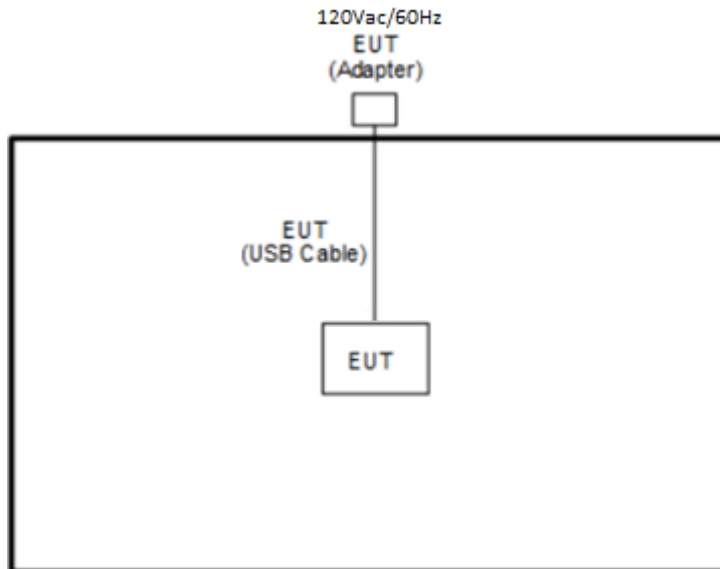

<AC Conducted Emission Mode>

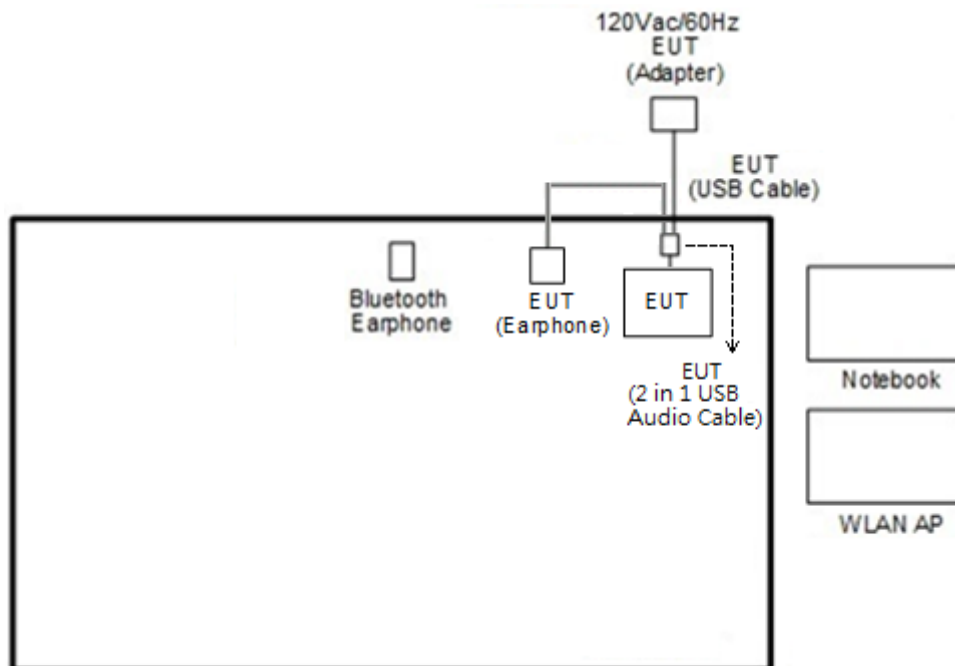

2.4 Support Unit used in test configuration and system

Item	Equipment	Trade Name	Model Name	FCC ID	Data Cable	Power Cord
1.	System Simulator	Anritsu	MT8820C	N/A	N/A	Unshielded, 1.8 m
2.	Bluetooth Earphone	Sony	SBH82D	PY7-RD0010	N/A	N/A
3.	WLAN AP	ASUS	RT-AC1750	MSQ-RTAC66U	N/A	Unshielded, 1.8 m
4.	Notebook	DELL	Latitude E3340	FCC DoC	N/A	AC I/P: Unshielded, 1.2 m DC O/P: Shielded, 1.8 m
5.	SD Card	SanDisk	MicroSD HC	FCC DoC	N/A	N/A

2.5 EUT Operation Test Setup

The RF test items, utility “Tera Term” was installed in Notebook which was programmed in order to make the EUT get into the engineering modes to provide channel selection, power level, data rate and the application type and for continuous transmitting signals.

2.6 Measurement Results Explanation Example

For all conducted test items:

The offset level is set in the spectrum analyzer to compensate the RF cable loss and attenuator factor between EUT conducted output port and spectrum analyzer. With the offset compensation, the spectrum analyzer reading level is exactly the EUT RF output level.

Example :

The spectrum analyzer offset is derived from RF cable loss and attenuator factor.

Offset = RF cable loss + attenuator factor.

Following shows an offset computation example with cable loss 4.2 dB and 10dB attenuator.

$$\begin{aligned}
 \text{Offset(dB)} &= \text{RF cable loss(dB)} + \text{attenuator factor(dB)}. \\
 &= 4.2 + 10 = 14.2 \text{ (dB)}
 \end{aligned}$$

3 Test Result

3.1 6dB and 26dB and 99% Occupied Bandwidth Measurement

3.1.1 Description of 6dB and 26dB and 99% Occupied Bandwidth

The minimum 6 dB bandwidth shall be at least 500 kHz.

26dB and 99% Occupied bandwidth are reporting only.

3.1.2 Measuring Instruments

See list of measuring equipment of this test report.

3.1.3 Test Procedures

1. The testing follows FCC KDB 789033 D02 General UNII Test Procedures New Rules v02r01. Section C) Emission bandwidth for the band 5.725-5.85GHz
2. Set RBW = 100kHz.
3. Set the VBW $\geq 3 \times$ RBW.
4. Detector = Peak.
5. Trace mode = max hold
6. Measure the maximum width of the emission that is 6 dB down from the peak of the emission.
7. Measure and record the results in the test report.

3.1.4 Test Setup

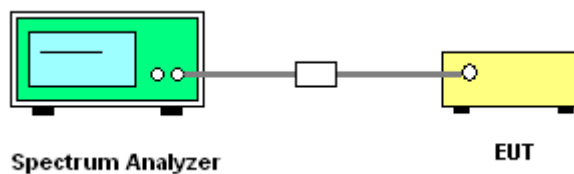

3.1.5 Test Result of 6dB Bandwidth

Please refer to Appendix A.

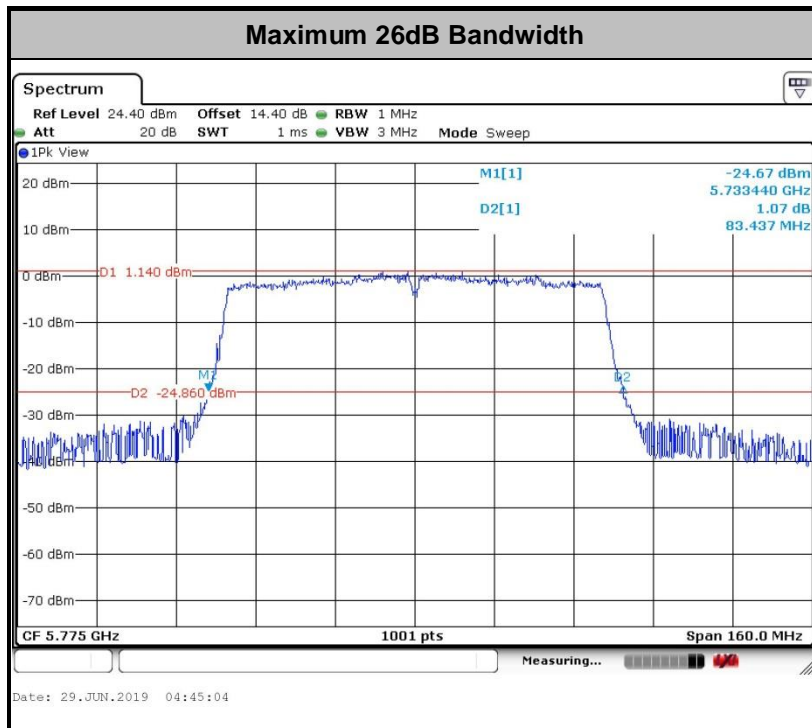
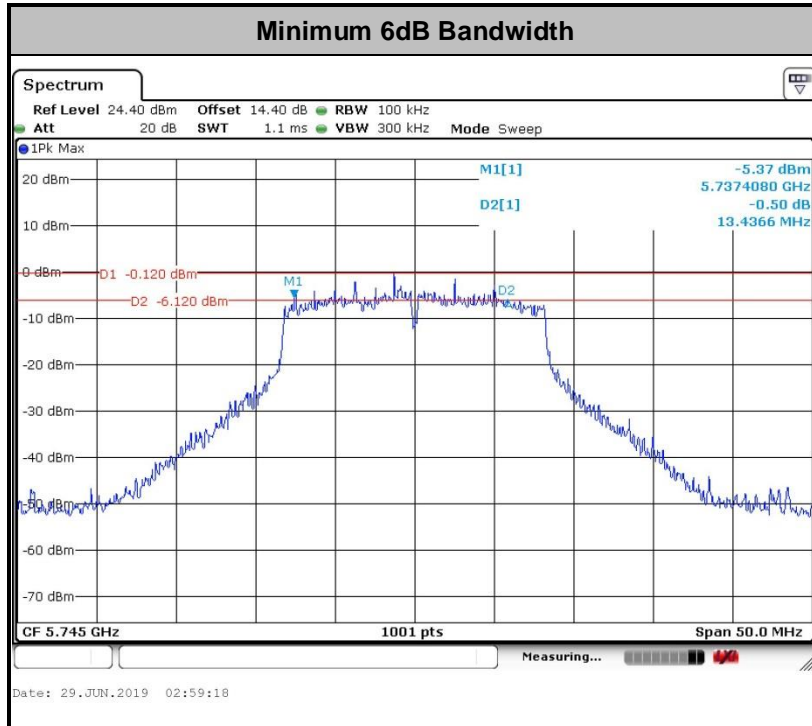

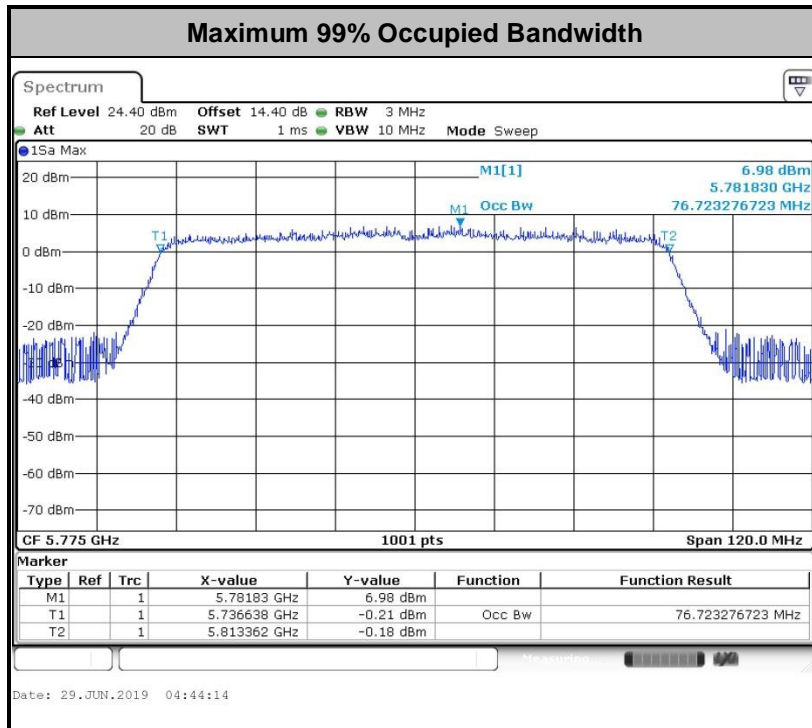

Note: The occupied channel bandwidth is maintained within the band of operation for all of the modulations.

3.2 Maximum Conducted Output Power Measurement

3.2.1 Limit of Maximum Conducted Output Power

For the band 5.725–5.85 GHz, the maximum conducted output power over the frequency band of operation shall not exceed 1 W.

If transmitting antennas of directional gain greater than 6 dBi are used, the peak output power shall be reduced by the amount in dB that the directional gain of the antenna exceeds 6 dBi.

3.2.2 Measuring Instruments

See list of measuring equipment of this test report.

3.2.3 Test Procedures

The testing follows Method PM-G of FCC KDB 789033 D02 General UNII Test Procedures New Rules v02r01.

Method PM-G (Measurement using a gated RF average power meter):

1. Measurement is performed using a wideband RF power meter.
2. The EUT is configured to transmit continuously at its maximum power control level.
3. Measure the average power of the transmitter.

3.2.4 Test Setup

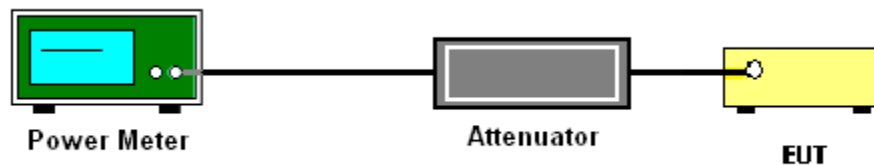

3.2.5 Test Result of Maximum Conducted Output Power

Please refer to Appendix A.



3.3 Power Spectral Density Measurement

3.3.1 Limit of Power Spectral Density

For the band 5.725–5.85 GHz, the maximum power spectral density shall not exceed 30 dBm in any 500-kHz band.

If transmitting antennas of directional gain greater than 6 dBi are used, the peak output power shall be reduced by the amount in dB that the directional gain of the antenna exceeds 6 dBi.

3.3.2 Measuring Instruments

See list of measuring equipment of this test report.

3.3.3 Test Procedures

The testing follows FCC KDB 789033 D02 General UNII Test Procedures New Rules v02r01.
Section F) Maximum power spectral density.

Method SA-2

(trace averaging across on and off times of the EUT transmissions, followed by duty cycle correction).

- Measure the duty cycle.
- Set span to encompass the entire emission bandwidth (EBW) of the signal.
- Set RBW = 300 kHz.
- Set VBW \geq 1 MHz.
- Number of points in sweep \geq 2 Span / RBW.
- Sweep time = auto.
- Detector = RMS
- Trace average at least 100 traces in power averaging mode.
- Add $10 \log(500\text{kHz}/\text{RBW})$ to the test result.
- Add $10 \log(1/x)$, where x is the duty cycle, to the measured power in order to compute the average power during the actual transmission times. For example, add $10 \log(1/0.25) = 6$ dB if the duty cycle is 25 percent.

1. The RF output of EUT was connected to the spectrum analyzer by a low loss cable.
2. Each plot has already offset with cable loss, and attenuator loss. Measure the PPSD and record it.
3. For MIMO mode, calculation method follows FCC KDB 662911 D01 Multiple Transmitter Output v02r01.

Method (c): Measure and add $10 \log(N_{ANT})$ dB.

With this technique, spectrum measurements are performed at each output of the device, but rather than summing the spectra or the spectral peaks across the outputs, the quantity $10 \log(N_{ANT})$ dB is added to each spectrum value before comparing to the emission limit. The addition of $10 \log(N_{ANT})$ dB serves to apportion the emission limit among the N_{ANT} outputs so that each output is permitted to contribute no more than $1/N_{ANT}^{\text{th}}$ of the PSD limit.

3.3.4 Test Setup

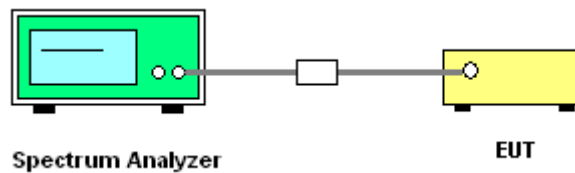

3.3.5 Test Result of Power Spectral Density

Please refer to Appendix A.



<CDD Modes>

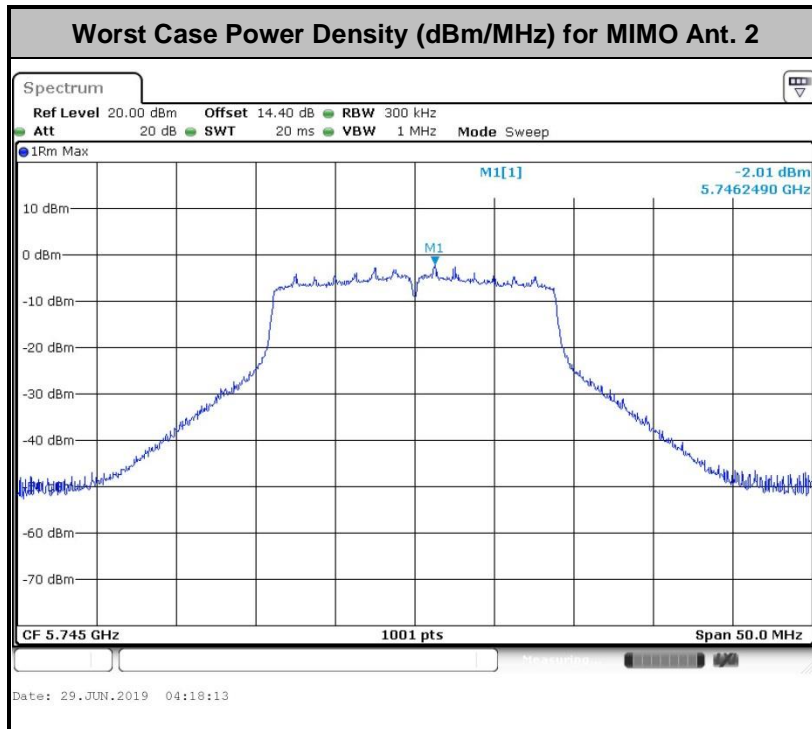
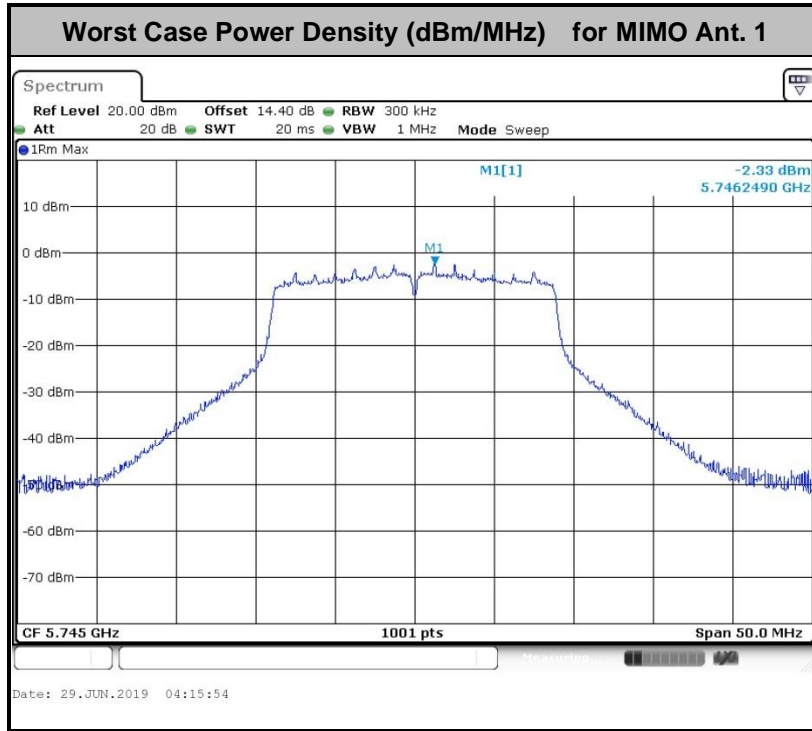



3.4 Unwanted Emissions Measurement

This section is to measure unwanted emissions through radiated measurement for band edge spurious emissions and out of band emissions measurement.

3.4.1 Limit of Unwanted Emissions

(1) For transmitters operating in the 5.725-5.85 GHz band:

15.407(b)(4)(i) All emissions shall be limited to a level of -27 dBm/MHz at 75 MHz or more above or below the band edge increasing linearly to 10 dBm/MHz at 25 MHz above or below the band edge, and from 25 MHz above or below the band edge increasing linearly to a level of 15.6 dBm/MHz at 5 MHz above or below the band edge, and from 5 MHz above or below the band edge increasing linearly to a level of 27 dBm/MHz at the band edge.

(2) Unwanted spurious emissions fallen in restricted bands shall comply with the general field strength limits as below table,

Frequency (MHz)	Field Strength (microvolts/meter)	Measurement Distance (meters)
0.009 – 0.490	2400/F(kHz)	300
0.490 – 1.705	24000/F(kHz)	30
1.705 – 30.0	30	30
30 – 88	100	3
88 – 216	150	3
216 - 960	200	3
Above 960	500	3

Note: The following formula is used to convert the EIRP to field strength.

$$E = \frac{1000000\sqrt{30P}}{3} \mu\text{V/m, where P is the eirp (Watts)}$$



EIRP (dBm)	Field Strength at 3m (dBµV/m)
- 27	68.3

(3) KDB789033 D02 v02r01 G)2)c)

- (i) Section 15.407(b)(1) to (b)(3) specify the unwanted emission limits for the U-NII-1 and U-NII-2 bands. As specified, emissions above 1000 MHz that are outside of the restricted bands are subject to a peak emission limit of -27 dBm/MHz.³
- (ii) Section 15.407(b)(4) specifies the unwanted emission limit for the U-NII-3 band. A band emissions mask is specified in Section 15.407(b)(4)(i). The emission limits are in terms of a Peak detector. An alternative to the band emissions mask is specified in Section 15.407(b)(4)(ii). The alternative limits are based on the highest antenna gain specified in the filing. There are also marketing and importation restrictions for the devices using the alternative limit.⁴

Note 3: An out-of-band emission that complies with both the average and peak limits of Section 15.209 is not required to satisfy the -27 dBm/MHz peak emission limit.

Note 4: Only devices with antenna gains of 10 dBi or less may be approved using the emission limits specified in Section 15.247(d) till March 2, 2018; all other devices operating in this band must use the mask specified in Section 15.407(b)(4)(i).

3.4.2 Measuring Instruments

See list of measuring equipment of this test report.

3.4.3 Test Procedures

1. The testing follows FCC KDB 789033 D02 General UNII Test Procedures New Rules v02r01. Section G) Unwanted emissions measurement.
 - (1) Procedure for Unwanted Emissions Measurements Below 1000MHz
 - RBW = 120 kHz
 - VBW = 300 kHz
 - Detector = Peak
 - Trace mode = max hold
 - (2) Procedure for Peak Unwanted Emissions Measurements Above 1000 MHz
 - RBW = 1 MHz
 - VBW ≥ 3 MHz
 - Detector = Peak
 - Sweep time = auto
 - Trace mode = max hold



(3) Procedures for Average Unwanted Emissions Measurements Above 1000MHz

- RBW = 1 MHz
 - VBW = 10 Hz, when duty cycle is no less than 98 percent.
 - $VBW \geq 1/T$, when duty cycle is less than 98 percent where T is the minimum transmission duration over which the transmitter is on and is transmitting at its maximum power control level for the tested mode of operation.
2. The EUT was placed on a turntable with 0.8 meter for frequency below 1GHz and 1.5 meter for frequency above 1GHz respectively above ground.
 3. The EUT was set 3 meters from the interference receiving antenna which was mounted on the top of a variable height antenna tower.
 4. The antenna is a broadband antenna and its height is adjusted between one meter and four meters above ground to find the maximum value of the field strength for both horizontal polarization and vertical polarization of the antenna.
 5. For each suspected emission, the EUT was arranged to its worst case and then adjust the antenna tower (from 1 m to 4 m) and turntable (from 0 degree to 360 degrees) to find the maximum reading.
 6. For testing below 1GHz, if the emission level of the EUT in peak mode was 3 dB lower than the limit specified, then peak values of EUT will be reported, otherwise, the emissions will be repeated one by one using the CISPR quasi-peak method and reported.
 7. For testing above 1GHz, the emission level of the EUT in peak mode was 20dB lower than average limit (that means the emission level in average mode also complies with the limit in average mode), then peak values of EUT will be reported, otherwise, the emissions will be measured in average mode again and reported.

3.4.4 Test Setup

For radiated emissions below 30MHz

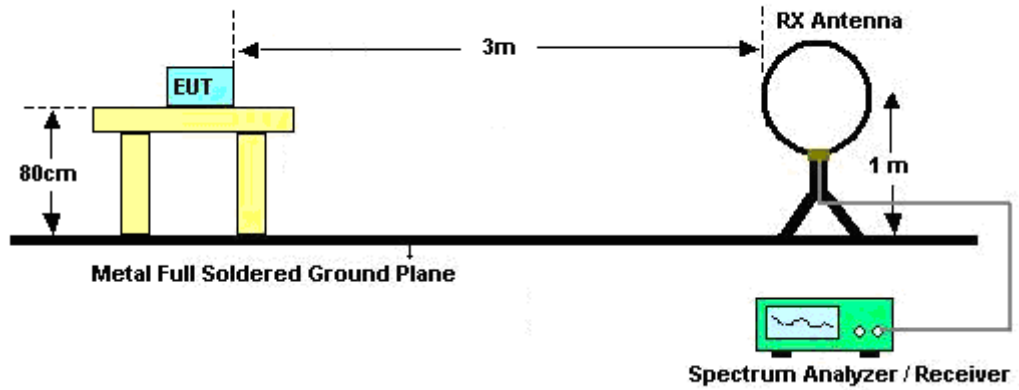

For radiated emissions from 30MHz to 1GHz

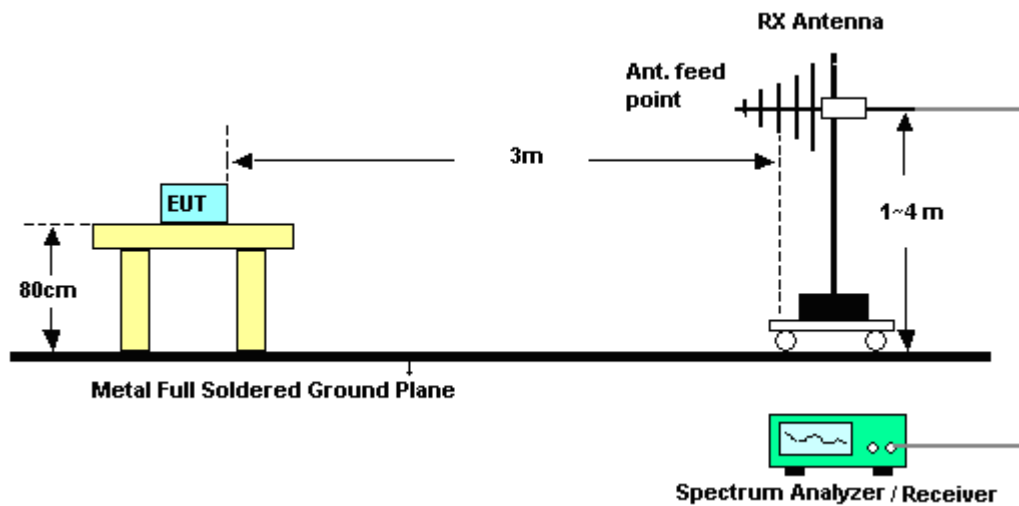

For radiated emissions above 1GHz

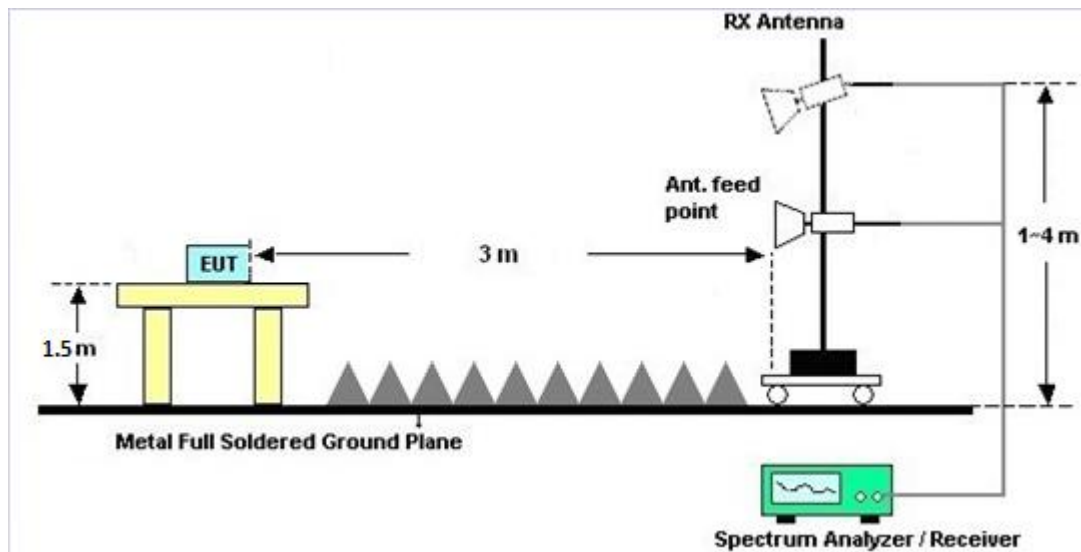

3.4.5 Test Results of Radiated Emissions (9 kHz ~ 30 MHz)

The low frequency, which started from 9 kHz to 30MHz, was pre-scanned and the result which was 20dB lower than the limit line was not reported.

There is a comparison data of both open-field test site and alternative test site - semi-Anechoic chamber according to 414788 D01 Radiated Test Site v01r01, and the result came out very similar.

3.4.6 Test Result of Radiated Band Edges

Please refer to Appendix C and D.

3.4.7 Duty Cycle

Please refer to Appendix E.

3.4.8 Test Result of Unwanted Radiated Emission (30MHz ~ 10th Harmonic)

Please refer to Appendix C and D.



3.5 AC Conducted Emission Measurement

3.5.1 Limit of AC Conducted Emission

For equipment that is designed to be connected to the public utility (AC) power line, the radio frequency voltage that is conducted back onto the AC power line on any frequency or frequencies within the band 150 kHz to 30 MHz shall not exceed the limits in the following table.

Frequency of emission (MHz)	Conducted limit (dB μ V)	
	Quasi-peak	Average
0.15-0.5	66 to 56*	56 to 46*
0.5-5	56	46
5-30	60	50

*Decreases with the logarithm of the frequency.

3.5.2 Measuring Instruments

See list of measuring equipment of this test report.

3.5.3 Test Procedures

1. The EUT was placed 0.4 meter from the conducting wall of the shielding room was kept at least 80 centimeters from any other grounded conducting surface.
2. Connect EUT to the power mains through a line impedance stabilization network (LISN).
3. All the support units are connecting to the other LISN.
4. The LISN provides 50 ohm coupling impedance for the measuring instrument.
5. The FCC states that a 50 ohm, 50 microhenry LISN should be used.
6. Both sides of AC line were checked for maximum conducted interference.
7. The frequency range from 150 kHz to 30 MHz was searched.
8. Set the test-receiver system to Peak Detect Function and specified bandwidth with Maximum Hold Mode.

3.5.4 Test Setup

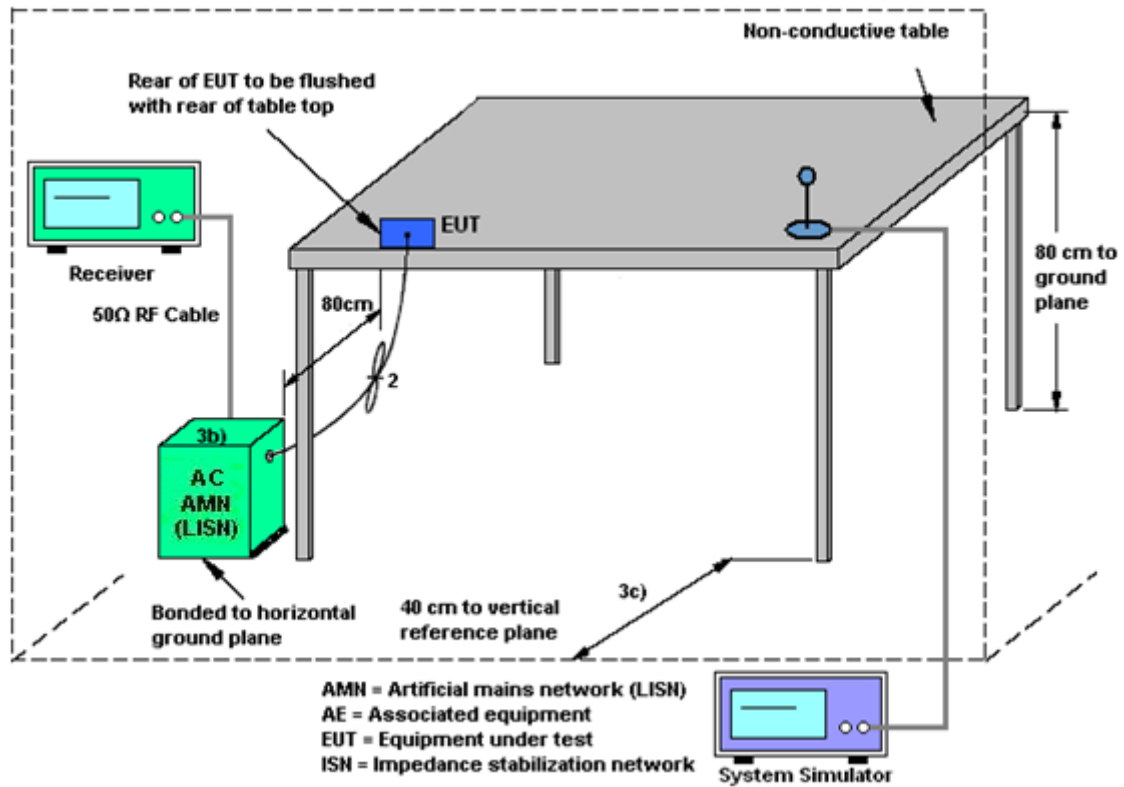

3.5.5 Test Result of AC Conducted Emission

Please refer to Appendix B.



3.6 Automatically Discontinue Transmission

3.6.1 Limit of Automatically Discontinue Transmission

The device shall automatically discontinue transmission in case of either absence of information to transmit or operational failure. These provisions are not intended to preclude the transmission of control or signaling information or the use of repetitive codes used by certain digital technologies to complete frame or burst intervals. Applicants shall include in their application for equipment authorization to describe how this requirement is met.

3.6.2 Measuring Instruments

See list of measuring equipment of this test report.

3.6.3 Test Result of Automatically Discontinue Transmission

EUT is verified this characteristic during the function check of normal sample associated with an access point:

- A. Information start: make EUT supply information to the access point.
- B. Information stop: stop supplying information to the access point.

While the EUT is not transmitting any information, the EUT can automatically discontinue transmission and become standby mode for power saving.

- C. Information start: make EUT supply information to the access point again.

The EUT can detect the controlling signal of ACK message transmitting from remote device and verify whether it shall resend or discontinue transmission.

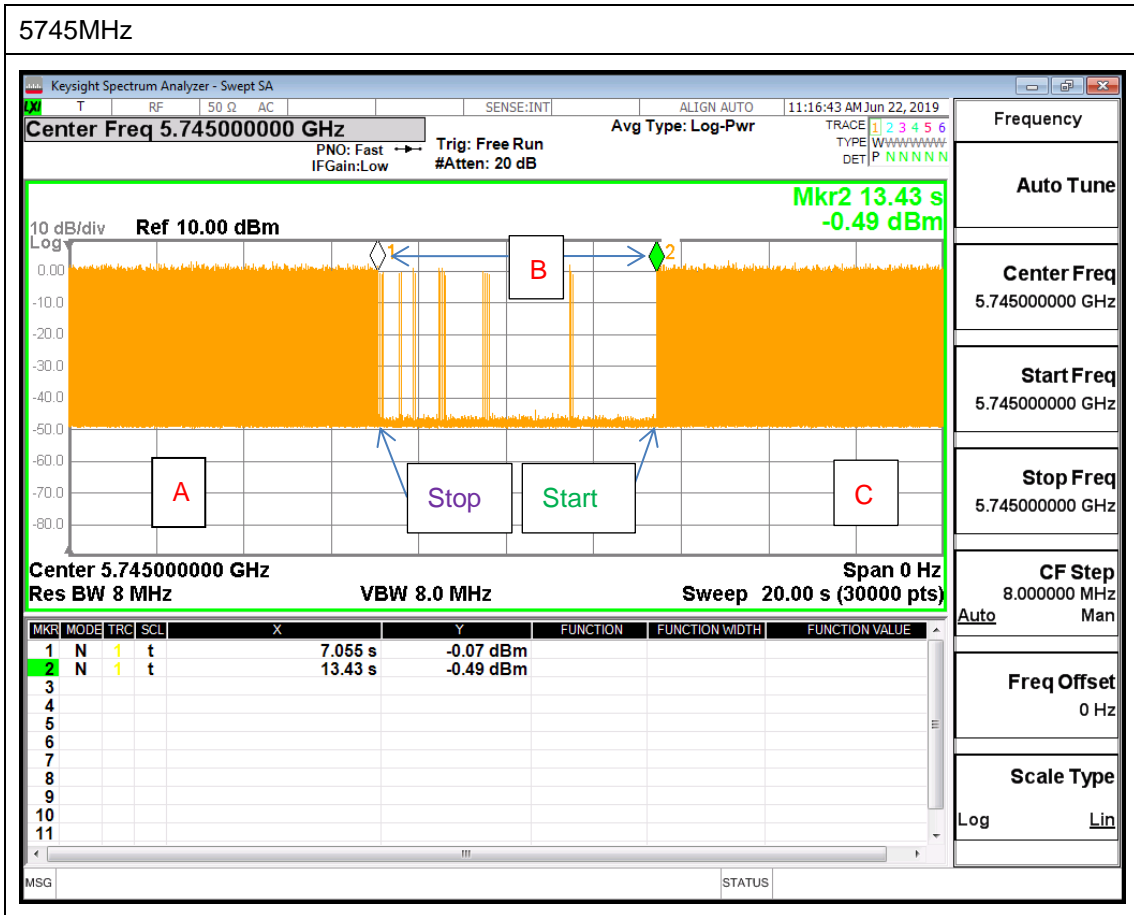

Note: The control / signalling information during the period B is precluded.



3.7 Antenna Requirements

3.7.1 Standard Applicable

If transmitting antenna directional gain is greater than 6 dBi, both the peak transmit power and the peak power spectral density shall be reduced by the amount in dB that the directional gain of the antenna exceeds 6 dBi.

3.7.2 Antenna Anti-Replacement Construction

An embedded-in antenna design is used.

3.7.3 Antenna Gain

<CDD Modes >

FCC KDB 662911 D01 Multiple Transmitter Output v02r01

For CDD transmissions, directional gain is calculated as

Directional gain = GANT + Array Gain, where Array Gain is as follows.

For power spectral density (PSD) measurements on all devices,

Array Gain = 10 log(NANT/NSS=1) dB.

For power measurements on IEEE 802.11 devices,

Array Gain = 0 dB (i.e., no array gain) for NANT ≤ 4.

Directional gain may be calculated by using the formulas applicable to equal gain antennas with GANT set equal to the gain of the antenna having the highest gain;

The EUT supports CDD mode.

For power, the directional gain GANT is set equal to the antenna having the highest gain, i.e., F)2)f)i).

For PSD, the directional gain calculation is following F)2)f)ii) of KDB 662911 D01 v02r01.

The power and PSD limit should be modified if the directional gain of EUT is over 6 dBi,

The directional gain "DG" is calculated as following table.

<CDD Modes>						
			DG	DG	Power	PSD
	Ant. 1	Ant. 2	for	for	Limit	Limit
	(dBi)	(dBi)	Power	PSD	Reduction	Reduction
			(dBi)	(dBi)	(dB)	(dB)
Band IV	-1.50	-4.80	-1.50	0.02	0.00	0.00

Power Limit Reduction = DG(Power) – 6dBi, (min = 0)

PSD Limit Reduction = DG(PSD) – 6dBi, (min = 0)



4 List of Measuring Equipment

Instrument	Manufacturer	Model No.	Serial No.	Characteristics	Calibration Date	Test Date	Due Date	Remark
Hygrometer	Testo	DTM-303A	TP157075	N/A	Nov. 05, 2018	Jun. 07, 2019~ Jun. 29, 2019	Nov. 04, 2019	Conducted (TH05-HY)
Power Sensor	DARE	RPR3006W	16I00054SN O10	10MHz~6GHz	Dec. 19, 2018	Jun. 07, 2019~ Jun. 29, 2019	Dec. 18 2019	Conducted (TH05-HY)
Spectrum Analyzer	Rohde & Schwarz	FSP40	100057	9kHz-40GHz	Nov. 21, 2018	Jun. 07, 2019~ Jun. 29, 2019	Nov. 20, 2019	Conducted (TH05-HY)
Signal Analyzer	Rohde & Schwarz	FSV40	101397	10Hz~40GHz	Nov. 13, 2018	Jun. 07, 2019~ Jun. 29, 2019	Nov. 12, 2019	Conducted (TH05-HY)
Switch Box & RF Cable	Burgeon	ETF-058	EC1208382	N/A	Mar. 27, 2019	Jun. 07, 2019~ Jun. 29, 2019	Mar. 26, 2020	Conducted (TH05-HY)
AC Power Source	ChainTek	APC-1000W	N/A	N/A	N/A	Jun. 21, 2019	N/A	Conduction (CO05-HY)
EMI Test Receiver	Rohde & Schwarz	ESR3	102388	9kHz~3.6GHz	Nov. 12, 2018	Jun. 21, 2019	Nov. 11, 2019	Conduction (CO05-HY)
Hygrometer	Testo	608-H1	34913912	N/A	Mar. 19, 2019	Jun. 21, 2019	Mar. 18, 2020	Conduction (CO05-HY)
LISN	Rohde & Schwarz	ENV216	100080	9kHz~30MHz	Nov. 14, 2018	Jun. 21, 2019	Nov. 13, 2019	Conduction (CO05-HY)
LISN	Rohde & Schwarz	ENV216	100081	9kHz~30MHz	Nov. 09, 2018	Jun. 21, 2019	Nov. 08, 2019	Conduction (CO05-HY)
Software	Rohde & Schwarz	EMC32 V10.30	N/A	N/A	N/A	Jun. 21, 2019	N/A	Conduction (CO05-HY)
LF Cable	HUBER + SUHNER	RG-214/U	LF01	N/A	Dec. 31, 2018	Jun. 21, 2019	Dec. 30, 2019	Conduction (CO05-HY)
Pulse Limiter	Rohde & Schwarz	ESH3-Z2	100851	N/A	Dec. 31, 2018	Jun. 21, 2019	Dec. 30, 2019	Conduction (CO05-HY)
Loop Antenna	Rohde & Schwarz	HFH2-Z2	100315	9 kHz~30 MHz	Jan. 11, 2019	Jun. 25, 2019~ Jul. 02, 2019	Jan. 10, 2020	Radiation (03CH16-HY)
Bilog Antenna	TESEQ	CBL6111D& 00802N1D0 1N-06	47020&06	30MHz to 1GHz	Oct. 13, 2018	Jun. 25, 2019~ Jul. 02, 2019	Oct. 12, 2019	Radiation (03CH16-HY)
Horn Antenna	SCHWARZBE CK	BBHA 9120 D	9120D-1522	1G~18GHz	Sep. 07, 2018	Jun. 25, 2019~ Jul. 02, 2019	Sep. 06, 2019	Radiation (03CH16-HY)
SHF-EHF Horn Antenna	SCHWARZBE CK	BBHA 9170	BBHA91702 51	18GHz ~ 40GHz	Nov. 20, 2018	Jun. 25, 2019~ Jul. 02, 2019	Nov. 19, 2019	Radiation (03CH16-HY)
Amplifier	SONOMA	310N	371607	9kHz~1000MHz	Oct. 02. 2018	Jun. 25, 2019~ Jul. 02, 2019	Oct. 01. 2019	Radiation (03CH16-HY)
Preamplifier	Jet-Power	JPA0118-55- 303	1710001800 055007	1GHz~18GHz	Apr. 01, 2019	Jun. 25, 2019~ Jul. 02, 2019	Mar. 31, 2020	Radiation (03CH16-HY)
Preamplifier	Keysight	83017A	MY5327026 4	1GHz~26.5GHz	Dec. 12, 2018	Jun. 25, 2019~ Jul. 02, 2019	Dec. 11, 2019	Radiation (03CH16-HY)
Amplifier	MITEQ	TTA1840-35- HG	1871923	18GHz~40GHz, VSWR : 2.5:1 max	Jul. 16, 2018	Jun. 25, 2019~ Jul. 02, 2019	Jul. 15, 2019	Radiation (03CH16-HY)
EMI Test Receiver	Keysight	N9038A (MXE)	MY57290111	3Hz~26.5GHz	Nov. 29, 2018	Jun. 25, 2019~ Jul. 02, 2019	Nov. 28, 2019	Radiation (03CH16-HY)
Spectrum Analyzer	Agilent	N9010A	MY5420048 6	10Hz~44GHz	Oct. 19, 2018	Jun. 25, 2019~ Jul. 02, 2019	Oct. 18, 2019	Radiation (03CH16-HY)



Instrument	Manufacturer	Model No.	Serial No.	Characteristics	Calibration Date	Test Date	Due Date	Remark
Hygrometer	TECPEL	DTM-303B	TP162965	N/A	Oct. 22, 2018	Jun. 25, 2019~ Jul. 02, 2019	Oct. 21, 2019	Radiation (03CH16-HY)
Filter	Wainwright	WLK4-1000- 1530-8000-4 0SS	SN11	1G Low Pass	Sep. 16, 2018	Jun. 25, 2019~ Jul. 02, 2019	Sep. 15, 2019	Radiation (03CH16-HY)
Filter	Wainwright	WHKX8-587 2.5-6750-18 000-40ST	SN3	6.75 GHz Highpass	Sep. 16, 2018	Jun. 25, 2019~ Jul. 02, 2019	Sep. 15, 2019	Radiation (03CH16-HY)
RF Cable	HUBER + SUHNER	SUCOFLEX 126E	MY1082/26 EA	30M-18G	Oct. 15, 2018	Jun. 25, 2019~ Jul. 02, 2019	Oct. 14, 2019	Radiation (03CH16-HY)
RF Cable	HUBER + SUHNER	SUCOFLEX 104	MY15539/4	30M-18G	Feb. 26, 2019	Jun. 25, 2019~ Jul. 02, 2019	Feb. 25, 2020	Radiation (03CH16-HY)
RF Cable	HUBER + SUHNER	SUCOFLEX 104	MY36980/4	30M~18GHz	Apr. 15, 2019	Jun. 25, 2019~ Jul. 02, 2019	Apr. 14, 2020	Radiation (03CH16-HY)
Controller	ChainTek	3000-1	N/A	Control Turn table & Ant Mast	N/A	Jun. 25, 2019~ Jul. 02, 2019	N/A	Radiation (03CH16-HY)
Antenna Mast	ChainTek	MBS-520-1	N/A	1m~4m	N/A	Jun. 25, 2019~ Jul. 02, 2019	N/A	Radiation (03CH16-HY)
Turn Table	ChainTek	T-200-S-1	N/A	0~360 Degree	N/A	Jun. 25, 2019~ Jul. 02, 2019	N/A	Radiation (03CH16-HY)
Software	Audix	E3 6.2009-8-24	RK-001136	N/A	N/A	Jun. 25, 2019~ Jul. 02, 2019	N/A	Radiation (03CH16-HY)



5 Uncertainty of Evaluation

Uncertainty of Conducted Emission Measurement (150kHz ~ 30MHz)

Measuring Uncertainty for a Level of Confidence of 95% ($U = 2Uc(y)$)	2.20
-------------------------------------------------------------------------	------

Uncertainty of Radiated Emission Measurement (30 MHz ~ 1000 MHz)

Measuring Uncertainty for a Level of Confidence of 95% ($U = 2Uc(y)$)	4.90
-------------------------------------------------------------------------	------

Uncertainty of Radiated Emission Measurement (1000 MHz ~ 18000 MHz)

Measuring Uncertainty for a Level of Confidence of 95% ($U = 2Uc(y)$)	5.80
-------------------------------------------------------------------------	------

Uncertainty of Radiated Emission Measurement (18000 MHz ~ 40000 MHz)

Measuring Uncertainty for a Level of Confidence of 95% ($U = 2Uc(y)$)	3.90
-------------------------------------------------------------------------	------

Appendix A. Test Result of Conducted Test Items

Test Engineer:	Leo Li	Temperature:	21~25	°C
Test Date:	2019/6/7~2019/6/29	Relative Humidity:	51~54	%

TEST RESULTS DATA
6dB and 26dB EBW and 99% OBW

Band IV												
Mod.	Data Rate	NTX	CH.	Freq. (MHz)	99% Bandwidth (MHz)		26dB Bandwidth (MHz)		6 dB Bandwidth (MHz)		6 dB Bandwidth Min. Limit (MHz)	Pass/Fail
					Ant 1	Ant 2	Ant 1	Ant 2	Ant 1	Ant 2		
11a	6Mbps	2	149	5745	16.83	16.73	24.48	23.73	13.44	15.39	0.5	Pass
11a	6Mbps	2	157	5785	16.83	16.73	25.67	24.63	15.68	15.04	0.5	Pass
11a	6Mbps	2	165	5825	16.88	16.73	25.08	25.08	15.68	16.23	0.5	Pass
HT20	MCS0	2	149	5745	17.93	17.93	25.92	25.72	16.63	16.23	0.5	Pass
HT20	MCS0	2	157	5785	18.03	17.93	25.92	26.07	15.98	16.53	0.5	Pass
HT20	MCS0	2	165	5825	17.93	17.83	25.67	25.18	15.29	16.28	0.5	Pass
HT40	MCS0	2	151	5755	36.56	36.46	42.35	42.17	35.47	35.07	0.5	Pass
HT40	MCS0	2	159	5795	36.56	36.46	42.08	41.72	35.07	35.87	0.5	Pass
VHT80	MCS0	2	155	5775	76.72	76.60	83.44	83.12	75.13	75.13	0.5	Pass

TEST RESULTS DATA
Average Power Table

Band IV												
Mod.	Data Rate	NTX	CH.	Freq. (MHz)	Average Conducted Power (dBm)			FCC Conducted Power Limit (dBm)		DG (dBi)		Pass/Fail
					Ant 1	Ant 2	SUM	Ant 1	Ant 2	Ant 1	Ant 2	
11a	6Mbps	1	149	5745	10.30	9.00		30.00	30.00	-1.50	-4.80	Pass
11a	6Mbps	1	157	5785	10.40	8.90		30.00	30.00	-1.50	-4.80	Pass
11a	6Mbps	1	165	5825	10.00	9.00		30.00	30.00	-1.50	-4.80	Pass
HT20	MCS0	1	149	5745	10.00	8.90		30.00	30.00	-1.50	-4.80	Pass
HT20	MCS0	1	157	5785	10.10	8.70		30.00	30.00	-1.50	-4.80	Pass
HT20	MCS0	1	165	5825	10.20	8.80		30.00	30.00	-1.50	-4.80	Pass
HT40	MCS0	1	151	5755	10.20	9.10		30.00	30.00	-1.50	-4.80	Pass
HT40	MCS0	1	159	5795	10.40	8.80		30.00	30.00	-1.50	-4.80	Pass
VHT20	MCS0	1	149	5745	9.90	8.80		30.00	30.00	-1.50	-4.80	Pass
VHT20	MCS0	1	157	5785	10.00	8.60		30.00	30.00	-1.50	-4.80	Pass
VHT20	MCS0	1	165	5825	10.10	8.70		30.00	30.00	-1.50	-4.80	Pass
VHT40	MCS0	1	151	5755	10.10	9.00		30.00	30.00	-1.50	-4.80	Pass
VHT40	MCS0	1	159	5795	10.30	8.70		30.00	30.00	-1.50	-4.80	Pass
VHT80	MCS0	1	155	5775	10.00	9.00		30.00	30.00	-1.50	-4.80	Pass
11a	6Mbps	2	149	5745	10.40	9.10	12.81	30.00		-1.50		Pass
11a	6Mbps	2	157	5785	10.50	9.00	12.82	30.00		-1.50		Pass
11a	6Mbps	2	165	5825	10.50	9.10	12.87	30.00		-1.50		Pass
HT20	MCS0	2	149	5745	10.10	9.00	12.60	30.00		-1.50		Pass
HT20	MCS0	2	157	5785	10.40	8.80	12.68	30.00		-1.50		Pass
HT20	MCS0	2	165	5825	10.30	8.90	12.67	30.00		-1.50		Pass
HT40	MCS0	2	151	5755	10.30	9.20	12.80	30.00		-1.50		Pass
HT40	MCS0	2	159	5795	10.50	9.20	12.91	30.00		-1.50		Pass
VHT20	MCS0	2	149	5745	10.00	8.90	12.50	30.00		-1.50		Pass
VHT20	MCS0	2	157	5785	10.30	8.70	12.58	30.00		-1.50		Pass
VHT20	MCS0	2	165	5825	10.20	8.80	12.57	30.00		-1.50		Pass
VHT40	MCS0	2	151	5755	10.20	9.10	12.70	30.00		-1.50		Pass
VHT40	MCS0	2	159	5795	10.40	9.10	12.81	30.00		-1.50		Pass
VHT80	MCS0	2	155	5775	10.20	9.10	12.70	30.00		-1.50		Pass

TEST RESULTS DATA
Power Spectral Density

Band IV																
Mod.	Data Rate	NTX	CH.	Freq. (MHz)	Duty Factor (dB)		10log (500kHz /RBW) Factor (dB)		Average Power Density (dBm/500kHz)			Average PSD Limit (dBm/500kHz)		DG (dBi)		Pass /Fail
					Ant 1	Ant 2	Ant 1	Ant 2	Ant 1	Ant 2	SUM	Ant 1	Ant 2	Ant 1	Ant 2	
11a	6Mbps	2	149	5745	0.00	0.00	2.22		0.05	-0.38	3.06	30.00		0.02		Pass
11a	6Mbps	2	157	5785	0.00	0.00	2.22		-0.90	-0.17	2.84	30.00		0.02		Pass
11a	6Mbps	2	165	5825	0.00	0.00	2.22		-0.30	0.09	3.10	30.00		0.02		Pass
HT20	MCS0	2	149	5745	0.00	0.00	2.22		-0.11	0.21	3.22	30.00		0.02		Pass
HT20	MCS0	2	157	5785	0.00	0.00	2.22		-0.58	-0.94	2.43	30.00		0.02		Pass
HT20	MCS0	2	165	5825	0.00	0.00	2.22		-0.15	-0.37	2.86	30.00		0.02		Pass
HT40	MCS0	2	151	5755	0.00	0.00	2.22		-3.28	-3.42	-0.27	30.00		0.02		Pass
HT40	MCS0	2	159	5795	0.00	0.00	2.22		-3.85	-4.03	-0.84	30.00		0.02		Pass
VHT80	MCS0	2	155	5775	0.00	0.00	2.22		-6.08	-5.61	-2.60	30.00		0.02		Pass

Note: PSD Sum = Max PSD(Ant. 1, Ant. 2) + 10 log (n)



Appendix B. AC Conducted Emission Test Results

Test Engineer :	Jimmy Chang	Temperature :	24~26°C
		Relative Humidity :	51~53%

EUT Information

Report NO : 940901-03
 Test Mode : Mode 1
 Test Voltage : 120Vac/60Hz
 Phase : Line

Full Spectrum

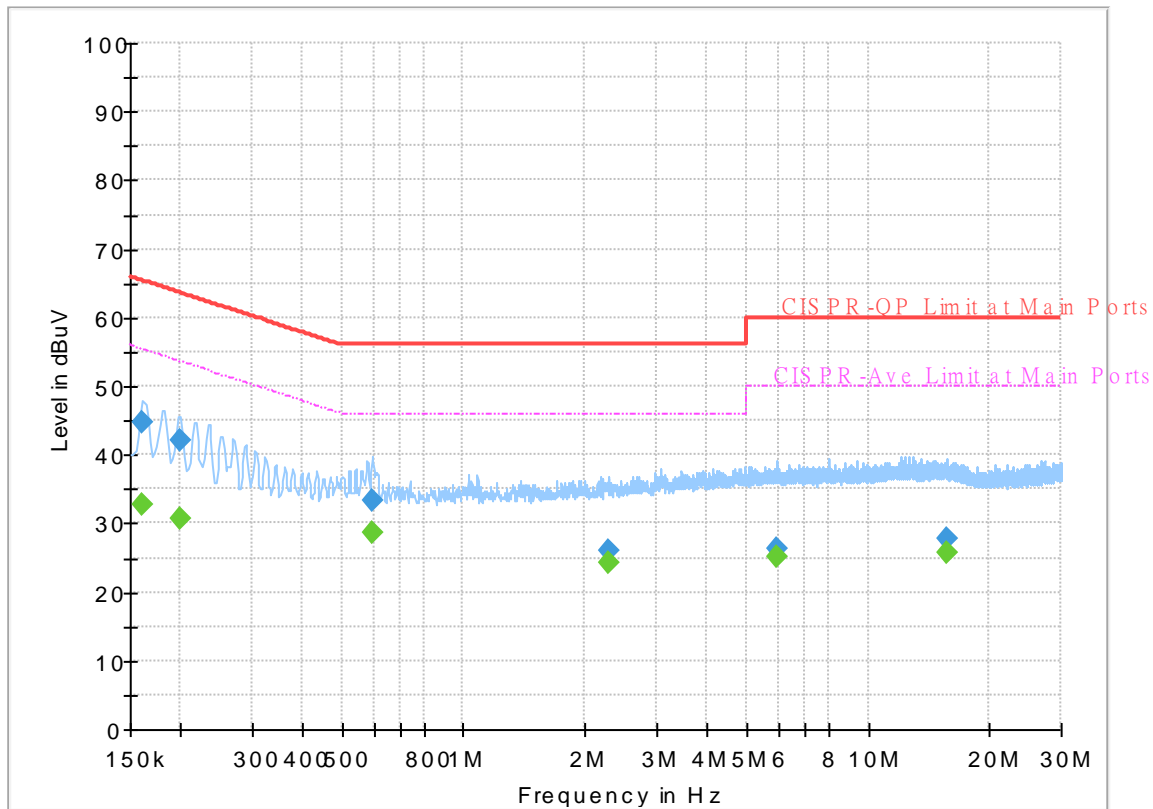

Final Result

Frequency (MHz)	QuasiPeak (dBuV)	CAverage (dBuV)	Limit (dBuV)	Margin (dB)	Line	Filter	Corr. (dB)
0.161250	---	32.78	55.40	22.62	L1	OFF	19.5
0.161250	44.87	---	65.40	20.53	L1	OFF	19.5
0.199500	---	30.59	53.63	23.04	L1	OFF	19.5
0.199500	41.96	---	63.63	21.67	L1	OFF	19.5
0.595500	---	28.80	46.00	17.20	L1	OFF	19.5
0.595500	33.20	---	56.00	22.80	L1	OFF	19.5
2.289750	---	24.13	46.00	21.87	L1	OFF	19.5
2.289750	25.96	---	56.00	30.04	L1	OFF	19.5
5.934750	---	25.28	50.00	24.72	L1	OFF	19.8
5.934750	26.28	---	60.00	33.72	L1	OFF	19.8
15.747000	---	25.78	50.00	24.22	L1	OFF	20.1
15.747000	27.83	---	60.00	32.17	L1	OFF	20.1

EUT Information

Report NO : 940901-03
 Test Mode : Mode 1
 Test Voltage : 120Vac/60Hz
 Phase : Neutral

Full Spectrum

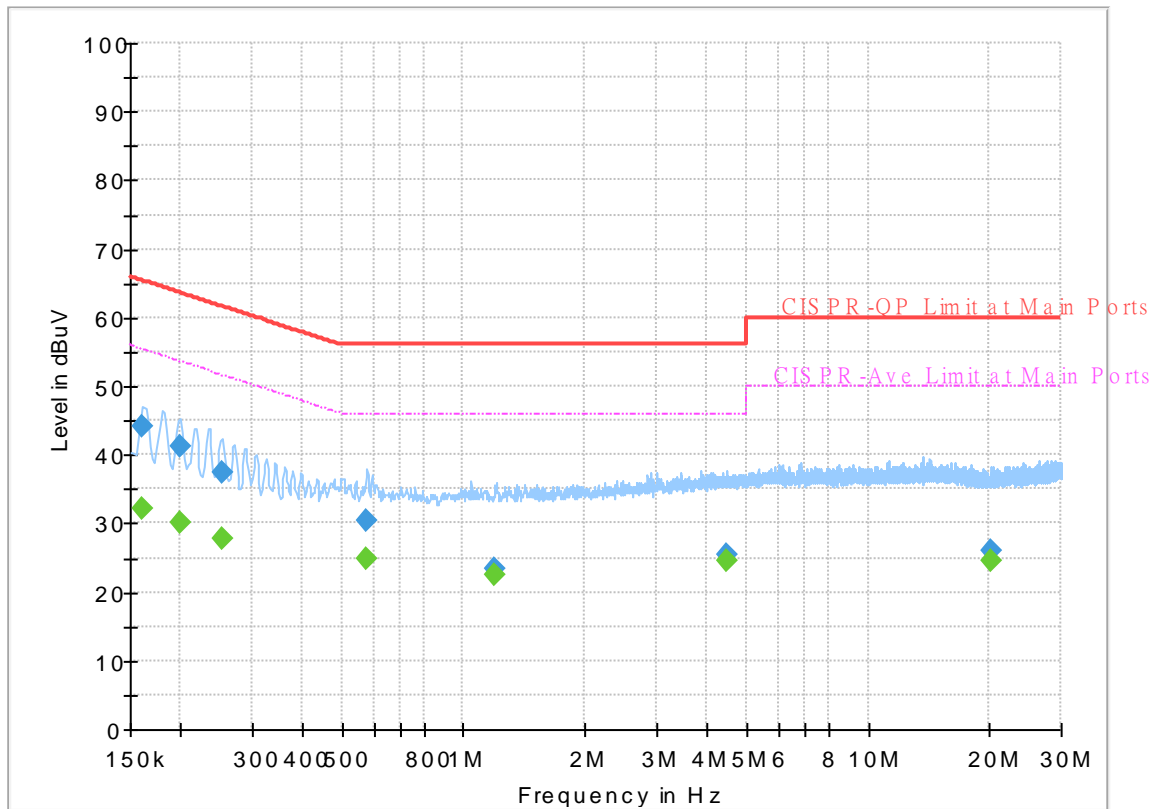

Final_Result

Frequency (MHz)	QuasiPeak (dBuV)	CAverage (dBuV)	Limit (dBuV)	Margin (dB)	Line	Filter	Corr. (dB)
0.161250	---	32.17	55.40	23.23	N	OFF	19.5
0.161250	44.09	---	65.40	21.31	N	OFF	19.5
0.199500	---	29.97	53.63	23.66	N	OFF	19.5
0.199500	41.22	---	63.63	22.41	N	OFF	19.5
0.253500	---	27.86	51.64	23.78	N	OFF	19.5
0.253500	37.50	---	61.64	24.14	N	OFF	19.5
0.577500	---	24.90	46.00	21.10	N	OFF	19.5
0.577500	30.28	---	56.00	25.72	N	OFF	19.5
1.198500	---	22.41	46.00	23.59	N	OFF	19.6
1.198500	23.53	---	56.00	32.47	N	OFF	19.6
4.479000	---	24.51	46.00	21.49	N	OFF	19.7
4.479000	25.40	---	56.00	30.60	N	OFF	19.7
20.109750	---	24.70	50.00	25.30	N	OFF	20.3
20.109750	26.00	---	60.00	34.00	N	OFF	20.3



Appendix C. Radiated Spurious Emission

Test Engineer :	Jacky Hung, Austin LI, and CR Liro	Temperature :	20~25°C
		Relative Humidity :	55~60%

Band 4 - 5725~5850MHz

WIFI 802.11a (Band Edge @ 3m)

WIFI	Note	Frequency	Level	Over	Limit	Read	Antenna	Path	Preamp	Ant	Table	Peak	Pol.	
Ant.		(MHz)	(dBμV/m)	Limit	Line	Level	Factor	Loss	Factor	Pos	Pos	Avg.		
1+2				(dB)	(dBμV/m)	(dBμV)	(dB/m)	(dB)	(dB)	(cm)	(deg)	(P/A)	(H/V)	
802.11a CH 149 5745MHz		5617.4	54.4	-13.8	68.2	38.03	32.46	13.71	29.8	100	57	P	H	
		5697.6	54.2	-49.23	103.43	37.48	32.63	13.92	29.83	100	57	P	H	
		5720	53.52	-57.28	110.8	36.71	32.68	13.98	29.85	100	57	P	H	
		5724.2	57.08	-63.3	120.38	40.24	32.69	14	29.85	100	57	P	H	
	*	5745	100.91	-	-	83.98	32.74	14.05	29.86	100	57	P	H	
	*	5745	92.93	-	-	76	32.74	14.05	29.86	100	57	A	H	
														H
														H
			5629.6	54.09	-14.11	68.2	37.66	32.49	13.74	29.8	100	120	P	V
			5689.4	55.49	-41.89	97.38	38.8	32.62	13.9	29.83	100	120	P	V
			5718.2	55.78	-54.52	110.3	38.96	32.68	13.98	29.84	100	120	P	V
			5723.2	55.54	-62.56	118.1	38.71	32.69	13.99	29.85	100	120	P	V
	*		5745	107.75	-	-	90.82	32.74	14.05	29.86	100	120	P	V
	*		5745	99.34	-	-	82.41	32.74	14.05	29.86	100	120	A	V
														V
													V	



WIFI Ant.	Note	Frequency	Level	Over Limit	Limit Line	Read Level	Antenna Factor	Path Loss	Preamp Factor	Ant Pos	Table Pos	Peak Avg.	Pol.
1+2		(MHz)	(dBμV/m)	(dB)	(dBμV/m)	(dBμV)	(dB/m)	(dB)	(dB)	(cm)	(deg)	(P/A)	(H/V)
		5645.2	53.99	-14.21	68.2	37.5	32.52	13.78	29.81	100	55	P	H
		5695.4	54.1	-47.71	101.81	37.38	32.63	13.92	29.83	100	55	P	H
		5700.6	54.53	-50.84	105.37	37.8	32.64	13.93	29.84	100	55	P	H
		5721.8	52.79	-62.11	114.9	35.96	32.69	13.99	29.85	100	55	P	H
	*	5785	101.05	-	-	83.94	32.83	14.16	29.88	100	55	P	H
	*	5785	93.03	-	-	75.92	32.83	14.16	29.88	100	55	A	H
		5853.8	53.44	-60.1	113.54	36.35	32.98	14.02	29.91	100	55	P	H
		5867.2	55.48	-51.9	107.38	38.42	33.01	13.97	29.92	100	55	P	H
		5875	54.76	-50.44	105.2	37.7	33.03	13.95	29.92	100	55	P	H
		5931.8	53.92	-14.28	68.2	36.96	33.15	13.76	29.95	100	55	P	H
													H
													H
802.11a													
CH 157													
5785MHz		5605	54.15	-14.05	68.2	37.84	32.43	13.67	29.79	101	123	P	V
		5671.2	54.14	-29.79	83.93	37.53	32.58	13.85	29.82	101	123	P	V
		5704.4	55.16	-51.27	106.43	38.41	32.65	13.94	29.84	101	123	P	V
		5720.4	54.23	-57.48	111.71	37.41	32.68	13.99	29.85	101	123	P	V
	*	5785	107.68	-	-	90.57	32.83	14.16	29.88	101	123	P	V
	*	5785	99.34	-	-	82.23	32.83	14.16	29.88	101	123	A	V
		5850.4	53.89	-67.4	121.29	36.8	32.97	14.03	29.91	101	123	P	V
		5874.8	54.62	-50.64	105.26	37.57	33.02	13.95	29.92	101	123	P	V
		5878.6	55.35	-47.18	102.53	38.3	33.03	13.94	29.92	101	123	P	V
		5938	55.54	-12.66	68.2	38.59	33.16	13.74	29.95	101	123	P	V
													V
													V



WIFI Ant.	Note	Frequency	Level	Over Limit	Limit Line	Read Level	Antenna Factor	Path Loss	Preamp Factor	Ant Pos	Table Pos	Peak Avg.	Pol.	
1+2		(MHz)	(dBµV/m)	(dB)	(dBµV/m)	(dBµV)	(dB/m)	(dB)	(dB)	(cm)	(deg)	(P/A)	(H/V)	
802.11a CH 165 5825MHz	*	5825	102.33	-	-	85.19	32.92	14.12	29.9	100	57	P	H	
	*	5825	94.23	-	-	77.09	32.92	14.12	29.9	100	57	A	H	
		5850.4	54.19	-67.1	121.29	37.1	32.97	14.03	29.91	100	57	P	H	
		5868	55.02	-52.14	107.16	37.96	33.01	13.97	29.92	100	57	P	H	
		5919.8	54.64	-17.39	72.03	37.66	33.12	13.8	29.94	100	57	P	H	
		5934.6	54.44	-13.76	68.2	37.48	33.16	13.75	29.95	100	57	P	H	
														H
														H
	*	5825	108.05	-	-	90.91	32.92	14.12	29.9	100	120	120	P	V
	*	5825	99.92	-	-	82.78	32.92	14.12	29.9	100	120	120	A	V
		5854.6	55.32	-56.39	111.71	38.23	32.98	14.02	29.91	100	120	120	P	V
		5870.4	55.77	-50.72	106.49	38.72	33.01	13.96	29.92	100	120	120	P	V
		5875.2	54.61	-50.44	105.05	37.55	33.03	13.95	29.92	100	120	120	P	V
		5939.6	55.48	-12.72	68.2	38.53	33.17	13.73	29.95	100	120	120	P	V
													V	
													V	
													V	
Remark	1. No other spurious found. 2. All results are PASS against Peak and Average limit line.													



Band 4 5725~5850MHz

WIFI 802.11a (Harmonic @ 3m)

WIFI Ant.	Note	Frequency	Level	Over Limit	Limit Line	Read Level	Antenna Factor	Path Loss	Preamp Factor	Ant Pos	Table Pos	Peak Avg.	Pol.
1+2		(MHz)	(dBμV/m)	(dB)	(dBμV/m)	(dBμV)	(dB/m)	(dB)	(dB)	(cm)	(deg)	(P/A)	(H/V)
802.11a CH 149 5745MHz		11490	44.13	-29.87	74	46.8	39.71	18.37	60.75	100	0	P	H
		17235	49.44	-18.76	68.2	39.97	43.12	23.27	56.92	100	0	P	H
													H
													H
		11490	44.23	-29.77	74	46.9	39.71	18.37	60.75	100	0	P	V
		17235	49.07	-19.13	68.2	39.6	43.12	23.27	56.92	100	0	P	V
													V
													V
802.11a CH 157 5785MHz		11570	44.7	-29.3	74	47.42	39.6	18.44	60.76	100	0	P	H
		17355	49.41	-18.79	68.2	38.71	43.75	23.43	56.48	100	0	P	H
													H
													H
		11570	45.67	-28.33	74	48.39	39.6	18.44	60.76	100	0	P	V
		17355	50.29	-17.91	68.2	39.59	43.75	23.43	56.48	100	0	P	V
													V
													V
802.11a CH 165 5825MHz		11650	44.39	-29.61	74	47.15	39.49	18.5	60.75	100	0	P	H
		17475	50.92	-17.28	68.2	39.01	44.37	23.59	56.05	100	0	P	H
													H
													H
		11650	44.82	-29.18	74	47.58	39.49	18.5	60.75	100	0	P	V
		17475	50.9	-17.3	68.2	38.99	44.37	23.59	56.05	100	0	P	V
													V
													V
Remark	1. No other spurious found. 2. All results are PASS against Peak and Average limit line.												



Band 4 5725~5850MHz

WIFI 802.11n HT20 (Band Edge @ 3m)

WIFI	Note	Frequency	Level	Over	Limit	Read	Antenna	Path	Preamp	Ant	Table	Peak	Pol.	
Ant. 1+2		(MHz)	(dBµV/m)	(dB)	Line (dBµV/m)	Level (dBµV)	Factor (dB/m)	Loss (dB)	Factor (dB)	Pos (cm)	Pos (deg)	Avg. (P/A)	(H/V)	
802.11n HT20 CH 149 5745MHz		5648.2	53.8	-14.4	68.2	37.29	32.53	13.79	29.81	101	59	P	H	
		5685	54.31	-39.82	94.13	37.64	32.61	13.89	29.83	101	59	P	H	
		5717.4	53.87	-56.2	110.07	37.05	32.68	13.98	29.84	101	59	P	H	
		5725	54.04	-68.16	122.2	37.2	32.69	14	29.85	101	59	P	H	
	*	5745	100.8	-	-	83.87	32.74	14.05	29.86	101	59	P	H	
	*	5745	91.46	-	-	74.53	32.74	14.05	29.86	101	59	A	H	
														H
														H
			5637.6	54.08	-14.12	68.2	37.63	32.5	13.76	29.81	100	125	P	V
			5687.4	54.05	-41.86	95.91	37.37	32.61	13.9	29.83	100	125	P	V
			5711.2	55.33	-53.01	108.34	38.55	32.66	13.96	29.84	100	125	P	V
			5723.4	57.03	-61.52	118.55	40.2	32.69	13.99	29.85	100	125	P	V
	*		5745	106.14	-	-	89.21	32.74	14.05	29.86	100	125	P	V
	*		5745	96.83	-	-	79.9	32.74	14.05	29.86	100	125	A	V
													V	
													V	



WIFI Ant.	Note	Frequency	Level	Over Limit	Limit Line	Read Level	Antenna Factor	Path Loss	Preamp Factor	Ant Pos	Table Pos	Peak Avg.	Pol.
1+2		(MHz)	(dBμV/m)	(dB)	(dBμV/m)	(dBμV)	(dB/m)	(dB)	(dB)	(cm)	(deg)	(P/A)	(H/V)
		5627	54.15	-14.05	68.2	37.74	32.48	13.73	29.8	100	57	P	H
		5672.4	54.62	-30.2	84.82	38	32.58	13.86	29.82	100	57	P	H
		5715.8	54.67	-54.96	109.63	37.87	32.67	13.97	29.84	100	57	P	H
		5724.2	53.93	-66.45	120.38	37.09	32.69	14	29.85	100	57	P	H
	*	5785	101.01	-	-	83.9	32.83	14.16	29.88	100	57	P	H
	*	5785	91.67	-	-	74.56	32.83	14.16	29.88	100	57	A	H
		5854.6	54.7	-57.01	111.71	37.61	32.98	14.02	29.91	100	57	P	H
		5864.8	54.82	-53.23	108.05	37.76	33	13.98	29.92	100	57	P	H
		5919.4	54.86	-17.47	72.33	37.88	33.12	13.8	29.94	100	57	P	H
		5942.6	54.68	-13.52	68.2	37.74	33.17	13.72	29.95	100	57	P	H
802.11n													H
HT20													H
CH 157		5644	54.41	-13.79	68.2	37.92	32.52	13.78	29.81	100	123	P	V
5785MHz		5663.2	54.7	-23.3	78	38.13	32.56	13.83	29.82	100	123	P	V
		5705.2	54.17	-52.49	106.66	37.42	32.65	13.94	29.84	100	123	P	V
		5721	53.75	-59.33	113.08	36.92	32.69	13.99	29.85	100	123	P	V
	*	5785	106.71	-	-	89.6	32.83	14.16	29.88	100	123	P	V
	*	5785	97.35	-	-	80.24	32.83	14.16	29.88	100	123	A	V
		5855	53.59	-57.21	110.8	36.5	32.98	14.02	29.91	100	123	P	V
		5865.6	55.29	-52.54	107.83	38.23	33	13.98	29.92	100	123	P	V
		5921.8	54.86	-15.7	70.56	37.88	33.13	13.79	29.94	100	123	P	V
		5948.6	54.54	-13.66	68.2	37.61	33.19	13.7	29.96	100	123	P	V
													V
													V



WIFI Ant.	Note	Frequency	Level	Over Limit	Limit Line	Read Level	Antenna Factor	Path Loss	Preamp Factor	Ant Pos	Table Pos	Peak Avg.	Pol.	
1+2		(MHz)	(dBμV/m)	(dB)	(dBμV/m)	(dBμV)	(dB/m)	(dB)	(dB)	(cm)	(deg)	(P/A)	(H/V)	
802.11n HT20 CH 165 5825MHz	*	5825	101.37	-	-	84.23	32.92	14.12	29.9	100	57	P	H	
	*	5825	91.97	-	-	74.83	32.92	14.12	29.9	100	57	A	H	
		5850.8	53.06	-67.32	120.38	35.97	32.97	14.03	29.91	100	57	P	H	
		5868	54.59	-52.57	107.16	37.53	33.01	13.97	29.92	100	57	P	H	
		5881.6	54.77	-45.53	100.3	37.72	33.04	13.93	29.92	100	57	P	H	
		5947	55.13	-13.07	68.2	38.19	33.18	13.71	29.95	100	57	P	H	
														H
														H
	*	5825	107.04	-	-	89.9	32.92	14.12	29.9	100	123	P	V	
	*	5825	97.75	-	-	80.61	32.92	14.12	29.9	100	123	A	V	
		5852.2	58.12	-59.06	117.18	41.03	32.97	14.03	29.91	100	123	P	V	
		5856.6	57.57	-52.78	110.35	40.49	32.98	14.01	29.91	100	123	P	V	
		5890	54.89	-39.18	94.07	37.86	33.06	13.9	29.93	100	123	P	V	
		5949.2	55.77	-12.43	68.2	38.84	33.19	13.7	29.96	100	123	P	V	
													V	
													V	
Remark	<ol style="list-style-type: none"> No other spurious found. All results are PASS against Peak and Average limit line. 													



Band 4 5725~5850MHz

WIFI 802.11n HT20 (Harmonic @ 3m)

WIFI Ant.	Note	Frequency	Level	Over Limit	Limit Line	Read Level	Antenna Factor	Path Loss	Preamp Factor	Ant Pos	Table Pos	Peak Avg.	Pol.
1+2		(MHz)	(dBμV/m)	(dB)	(dBμV/m)	(dBμV)	(dB/m)	(dB)	(dB)	(cm)	(deg)	(P/A)	(H/V)
802.11n HT20 CH 149 5745MHz		11490	46.05	-27.95	74	48.72	39.71	18.37	60.75	100	0	P	H
		17235	49.29	-18.91	68.2	39.82	43.12	23.27	56.92	100	0	P	H
													H
													H
		11490	44.69	-29.31	74	47.36	39.71	18.37	60.75	100	0	P	V
		17235	49.18	-19.02	68.2	39.71	43.12	23.27	56.92	100	0	P	V
													V
802.11n HT20 CH 157 5785MHz		11570	44.28	-29.72	74	47	39.6	18.44	60.76	100	0	P	H
		17355	50.47	-17.73	68.2	39.77	43.75	23.43	56.48	100	0	P	H
													H
													H
		11570	44.66	-29.34	74	47.38	39.6	18.44	60.76	100	0	P	V
		17355	50.5	-17.7	68.2	39.8	43.75	23.43	56.48	100	0	P	V
													V
802.11n HT20 CH 165 5825MHz		11650	45.38	-28.62	74	48.14	39.49	18.5	60.75	100	0	P	H
		17475	51.18	-17.02	68.2	39.27	44.37	23.59	56.05	100	0	P	H
													H
													H
		11650	45.04	-28.96	74	47.8	39.49	18.5	60.75	100	0	P	V
		17475	51.08	-17.12	68.2	39.17	44.37	23.59	56.05	100	0	P	V
													V
Remark	1. No other spurious found.												
	2. All results are PASS against Peak and Average limit line.												



Band 4 5725~5850MHz

WIFI 802.11n HT40 (Band Edge @ 3m)

WIFI	Note	Frequency	Level	Over	Limit	Read	Antenna	Path	Preamp	Ant	Table	Peak	Pol.
Ant. 1+2		(MHz)	(dBµV/m)	(dB)	Line (dBµV/m)	Level (dBµV)	Factor (dB/m)	Loss (dB)	Factor (dB)	Pos (cm)	Pos (deg)	Avg. (P/A)	(H/V)
		5634.6	54.53	-13.67	68.2	38.08	32.5	13.75	29.8	100	57	P	H
		5663.8	55.84	-22.6	78.44	39.27	32.56	13.83	29.82	100	57	P	H
		5714.8	56.5	-52.85	109.35	39.7	32.67	13.97	29.84	100	57	P	H
		5724.2	55.67	-64.71	120.38	38.83	32.69	14	29.85	100	57	P	H
	*	5755	97.78	-	-	80.8	32.76	14.08	29.86	100	57	P	H
	*	5755	88.84	-	-	71.86	32.76	14.08	29.86	100	57	A	H
		5853.2	53.69	-61.21	114.9	36.6	32.98	14.02	29.91	100	57	P	H
		5864.8	53.96	-54.09	108.05	36.9	33	13.98	29.92	100	57	P	H
		5893.4	54.94	-36.61	91.55	37.91	33.07	13.89	29.93	100	57	P	H
		5933.2	54.92	-13.28	68.2	37.97	33.15	13.75	29.95	100	57	P	H
													H
													H
802.11n													
HT40													
CH 151		5630.4	53.75	-14.45	68.2	37.32	32.49	13.74	29.8	100	123	P	V
5755MHz		5688.4	55.06	-41.58	96.64	38.38	32.61	13.9	29.83	100	123	P	V
		5718.8	57.67	-52.79	110.46	40.86	32.68	13.98	29.85	100	123	P	V
		5722.8	57.63	-59.55	117.18	40.8	32.69	13.99	29.85	100	123	P	V
	*	5755	103.09	-	-	86.11	32.76	14.08	29.86	100	123	P	V
	*	5755	94.91	-	-	77.93	32.76	14.08	29.86	100	123	A	V
		5851	54.23	-65.69	119.92	37.14	32.97	14.03	29.91	100	123	P	V
		5870.8	54.62	-51.75	106.37	37.56	33.02	13.96	29.92	100	123	P	V
		5890.8	54.79	-38.68	93.47	37.76	33.06	13.9	29.93	100	123	P	V
		5948.4	54.35	-13.85	68.2	37.42	33.19	13.7	29.96	100	123	P	V
													V
													V



WIFI Ant.	Note	Frequency (MHz)	Level (dBμV/m)	Over Limit (dB)	Limit Line (dBμV/m)	Read Level (dBμV)	Antenna Factor (dB/m)	Path Loss (dB)	Preamp Factor (dB)	Ant Pos (cm)	Table Pos (deg)	Peak Avg. (P/A)	Pol. (H/V)	
802.11n HT40 CH 159 5795MHz		5633.4	53.97	-14.23	68.2	37.53	32.49	13.75	29.8	100	59	P	H	
		5674.8	54.26	-32.33	86.59	37.64	32.58	13.86	29.82	100	59	P	H	
		5713	54.02	-54.82	108.84	37.22	32.67	13.97	29.84	100	59	P	H	
		5721.4	53.39	-60.6	113.99	36.56	32.69	13.99	29.85	100	59	P	H	
	*	5795	97.5	-	-	80.34	32.85	14.19	29.88	100	59	P	H	
	*	5795	88.07	-	-	70.91	32.85	14.19	29.88	100	59	A	H	
		5853.2	56.1	-58.8	114.9	39.01	32.98	14.02	29.91	100	59	P	H	
		5858.2	55.11	-54.79	109.9	38.02	32.99	14.01	29.91	100	59	P	H	
		5889.8	54.97	-39.25	94.22	37.94	33.06	13.9	29.93	100	59	P	H	
		5949	54.35	-13.85	68.2	37.42	33.19	13.7	29.96	100	59	P	H	
														H
														H
			5620.6	54.19	-14.01	68.2	37.8	32.47	13.72	29.8	100	123	P	V
			5654.8	54.24	-17.53	71.77	37.7	32.54	13.81	29.81	100	123	P	V
			5705.8	54.97	-51.86	106.83	38.21	32.65	13.95	29.84	100	123	P	V
			5720.6	53.32	-58.85	112.17	36.49	32.69	13.99	29.85	100	123	P	V
	*		5795	103.58	-	-	86.42	32.85	14.19	29.88	100	123	P	V
	*		5795	94.58	-	-	77.42	32.85	14.19	29.88	100	123	A	V
			5852.2	55.43	-61.75	117.18	38.34	32.97	14.03	29.91	100	123	P	V
			5868.2	55.54	-51.56	107.1	38.48	33.01	13.97	29.92	100	123	P	V
		5893.4	55.32	-36.23	91.55	38.29	33.07	13.89	29.93	100	123	P	V	
		5928.2	54.64	-13.56	68.2	37.68	33.14	13.77	29.95	100	123	P	V	
													V	
													V	
Remark	1. No other spurious found. 2. All results are PASS against Peak and Average limit line.													



Band 4 5725~5850MHz

WIFI 802.11n HT40 (Harmonic @ 3m)

WIFI Ant. 1+2	Note	Frequency (MHz)	Level (dBμV/m)	Over Limit (dB)	Limit Line (dBμV/m)	Read Level (dBμV)	Antenna Factor (dB/m)	Path Loss (dB)	Preamp Factor (dB)	Ant Pos (cm)	Table Pos (deg)	Peak Avg. (P/A)	Pol. (H/V)	
802.11n HT40 CH 151 5755MHz		11510	44.63	-29.37	74	47.31	39.69	18.39	60.76	100	0	P	H	
		17265	49.2	-19	68.2	39.43	43.28	23.3	56.81	100	0	P	H	
													H	
													H	
			11510	44.36	-29.64	74	47.04	39.69	18.39	60.76	100	0	P	V
			17265	49.2	-19	68.2	39.43	43.28	23.3	56.81	100	0	P	V
														V
802.11n HT40 CH 159 5795MHz		11590	44.12	-29.88	74	46.85	39.57	18.46	60.76	100	0	P	H	
		17385	50.14	-18.06	68.2	39.15	43.9	23.47	56.38	100	0	P	H	
													H	
													H	
			11590	44.38	-29.62	74	47.11	39.57	18.46	60.76	100	0	P	V
			17385	50.5	-17.7	68.2	39.51	43.9	23.47	56.38	100	0	P	V
														V
Remark	1. No other spurious found.													
	2. All results are PASS against Peak and Average limit line.													



Band 4 5725~5850MHz

WIFI 802.11ac VHT80 (Band Edge @ 3m)

WIFI	Note	Frequency	Level	Over	Limit	Read	Antenna	Path	Preamp	Ant	Table	Peak	Pol.	
Ant. 1+2		(MHz)	(dBµV/m)	(dB)	Line (dBµV/m)	Level (dBµV)	Factor (dB/m)	Loss (dB)	Factor (dB)	Pos (cm)	Pos (deg)	Avg. (P/A)	(H/V)	
802.11ac VHT80 CH 155 5775MHz		5604.8	53.74	-14.46	68.2	37.43	32.43	13.67	29.79	100	57	P	H	
		5697.8	55	-48.58	103.58	38.27	32.64	13.92	29.83	100	57	P	H	
		5706.4	55.94	-51.05	106.99	39.18	32.65	13.95	29.84	100	57	P	H	
		5722.6	55.59	-61.14	116.73	38.76	32.69	13.99	29.85	100	57	P	H	
	*	5775	94.8	-	-	77.73	32.81	14.13	29.87	100	57	P	H	
	*	5775	85.87	-	-	68.8	32.81	14.13	29.87	100	57	A	H	
		5852.2	54.58	-62.6	117.18	37.49	32.97	14.03	29.91	100	57	P	H	
		5868.6	55.2	-51.79	106.99	38.14	33.01	13.97	29.92	100	57	P	H	
		5878.8	54.74	-47.64	102.38	37.69	33.03	13.94	29.92	100	57	P	H	
		5934.2	55.19	-13.01	68.2	38.23	33.16	13.75	29.95	100	57	P	H	
														H
														H
			5618	55.35	-12.85	68.2	38.98	32.46	13.71	29.8	100	120	P	V
			5687.8	56.38	-39.82	96.2	39.7	32.61	13.9	29.83	100	120	P	V
			5719.8	60.08	-50.66	110.74	43.27	32.68	13.98	29.85	100	120	P	V
			5720.2	61.36	-49.9	111.26	44.55	32.68	13.98	29.85	100	120	P	V
	*		5775	100.63	-	-	83.56	32.81	14.13	29.87	100	120	P	V
	*		5775	92.98	-	-	75.91	32.81	14.13	29.87	100	120	A	V
			5855	58.62	-52.18	110.8	41.53	32.98	14.02	29.91	100	120	P	V
			5867.6	55.86	-51.41	107.27	38.8	33.01	13.97	29.92	100	120	P	V
		5908.8	55.62	-24.53	80.15	38.62	33.1	13.84	29.94	100	120	P	V	
		5936	54.53	-13.67	68.2	37.58	33.16	13.74	29.95	100	120	P	V	
													V	
													V	
Remark	1. No other spurious found. 2. All results are PASS against Peak and Average limit line.													



Band 4 5725~5850MHz

WIFI 802.11ac VHT80 (Harmonic @ 3m)

WIFI Ant. 1+2	Note	Frequency (MHz)	Level (dBμV/m)	Over Limit (dB)	Limit Line (dBμV/m)	Read Level (dBμV)	Antenna Factor (dB/m)	Path Loss (dB)	Preamp Factor (dB)	Ant Pos (cm)	Table Pos (deg)	Peak Avg. (P/A)	Pol. (H/V)	
802.11ac VHT80 CH 155 5775MHz		11550	44.56	-29.44	74	47.27	39.63	18.42	60.76	100	0	P	H	
		17325	49.65	-18.55	68.2	39.26	43.59	23.39	56.59	100	0	P	H	
													H	
													H	
			11550	44.6	-29.4	74	47.31	39.63	18.42	60.76	100	0	P	V
			17325	48.98	-19.22	68.2	38.59	43.59	23.39	56.59	100	0	P	V
														V
Remark	1. No other spurious found.													
	2. All results are PASS against Peak and Average limit line.													



**Emission below 1GHz
5GHz WIFI 802.11n HT20 (LF @ 3m)**

WIFI	Note	Frequency	Level	Over	Limit	Read	Antenna	Path	Preamp	Ant	Table	Peak	Pol.	
Ant. 1+2		(MHz)	(dBμV/m)	(dB)	Line (dBμV/m)	Level (dBμV)	Factor (dB/m)	Loss (dB)	Factor (dB)	Pos (cm)	Pos (deg)	Avg. (P/A)	(H/V)	
5GHz 802.11n HT20 LF		105.66	22.89	-20.61	43.5	37.45	16.71	1.1	32.37	-	-	P	H	
		182.29	27.7	-15.8	43.5	43.45	14.95	1.65	32.35	-	-	P	H	
		453.89	28.84	-17.16	46	35	23.2	3.18	32.54	-	-	P	H	
		645.95	31.7	-14.3	46	33.99	26.26	4.06	32.61	-	-	P	H	
		894.27	32.2	-13.8	46	30.36	29.01	4.65	31.82	100	0	P	H	
		976.72	34.13	-19.87	54	29.22	30.88	5.14	31.11	-	-	P	H	
														H
														H
														H
														H
														H
														H
														H
														H
														H
														H
														H
			38.73	26.44	-13.56	40	38.61	19.84	0.43	32.44	-	-	P	V
			182.29	29.19	-14.31	43.5	44.94	14.95	1.65	32.35	-	-	P	V
		444.19	24.43	-21.57	46	30.77	23.03	3.17	32.54	-	-	P	V	
		643.04	28.34	-17.66	46	30.67	26.24	4.05	32.62	-	-	P	V	
		800.18	30.13	-15.87	46	29.97	28.18	4.34	32.36	-	-	P	V	
		934.04	33.37	-12.63	46	30.02	30.21	4.63	31.49	100	0	P	V	
													V	
													V	
													V	
													V	
													V	
													V	
													V	
Remark	1. No other spurious found. 2. All results are PASS against limit line.													



Note symbol

*	Fundamental Frequency which can be ignored. However, the level of any unwanted emissions shall not exceed the level of the fundamental frequency.
!	Test result is over limit line.
P/A	Peak or Average
H/V	Horizontal or Vertical



A calculation example for radiated spurious emission is shown as below:

WIFI Ant. 1+2	Note	Frequency (MHz)	Level (dBµV/m)	Over Limit (dB)	Limit Line (dBµV/m)	Read Level (dBµV)	Antenna Factor (dB/m)	Path Loss (dB)	Preamp Factor (dB)	Ant Pos (cm)	Table Pos (deg)	Peak Avg. (P/A)	Pol. (H/V)
802.11b CH 01 2412MHz		2390	55.45	-18.55	74	54.51	32.22	4.58	35.86	103	308	P	H
		2390	43.54	-10.46	54	42.6	32.22	4.58	35.86	103	308	A	H

1. Path Loss(dB) = Cable loss(dB) + Filter loss(dB) + Attenuator loss(dB)
2. Level(dBµV/m) = Antenna Factor(dB/m) + Path Loss(dB) + Read Level(dBµV) - Preamp Factor(dB)
3. Over Limit(dB) = Level(dBµV/m) – Limit Line(dBµV/m)

For Peak Limit @ 2390MHz:

1. Level(dBµV/m)
= Antenna Factor(dB/m) + Path Loss(dB) + Read Level(dBµV) - Preamp Factor(dB)
= 32.22(dB/m) + 4.58(dB) + 54.51(dBµV) – 35.86 (dB)
= 55.45 (dBµV/m)
2. Over Limit(dB)
= Level(dBµV/m) – Limit Line(dBµV/m)
= 55.45(dBµV/m) – 74(dBµV/m)
= -18.55(dB)

For Average Limit @ 2390MHz:

1. Level(dBµV/m)
= Antenna Factor(dB/m) + Path Loss(dB) + Read Level(dBµV) - Preamp Factor(dB)
= 32.22(dB/m) + 4.58(dB) + 42.6(dBµV) – 35.86 (dB)
= 43.54 (dBµV/m)
2. Over Limit(dB) = Level(dBµV/m) – Limit Line(dBµV/m)
= 43.54(dBµV/m) – 54(dBµV/m)
= -10.46(dB)

Both peak and average measured complies with the limit line, so test result is “PASS”.



Appendix D. Radiated Spurious Emission Plots

Test Engineer :	Jacky Hung, Austin LI, and CR Liro	Temperature :	20~25°C
		Relative Humidity :	55~60%

Note symbol

-L	Low channel location
-R	High channel location



Band 4 - 5725~5850MHz
WIFI 802.11a (Band Edge @ 3m)

WIFI	Band 4 5725~5850MHz Band Edge @ 3m	
ANT	802.11a CH149 5745MHz	
1+2	Horizontal	Fundamental
Peak	<p> Site : 03CH16-HY Condition : PEAK_BE(84)_16-24 3m 91200_1522 HORIZONTAL RBW : 1000.000KHz VBW:3000.000KHz SWT:Auto Detector : Peak Project : 940901-03 </p>	<p> Site : 03CH16-HY Condition : PEAK(UNIT) 3m 91200_1522 HORIZONTAL RBW:3000.000KHz VBW:3000.000KHz SWT:Auto Detector : Peak Project : 940901-03 </p>

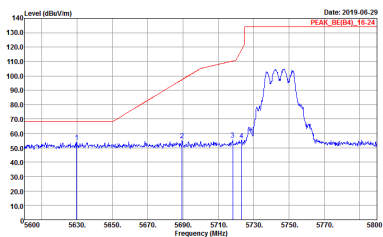
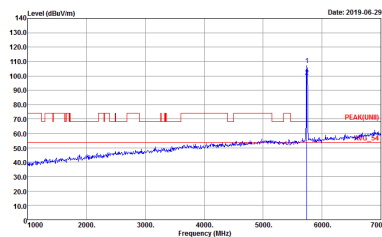

WIFI	Band 4 5725~5850MHz Band Edge @ 3m	
ANT	802.11a CH149 5745MHz	
1+2	Vertical	Fundamental
Peak	 <p>Date: 2019-06-29 PEAK_BE(84)_16-22</p> <p>Site : 03CH16-HY Condition : PEAK_BE(84)_16-24 3m 91200_1522 VERTICAL RBW:1000.000KHz VBW:3000.000KHz SWT:Auto Detector : Peak Project : 940901-03</p>	 <p>Date: 2019-06-29 PEAK(84)_16-22</p> <p>Site : 03CH16-HY Condition : PEAK(UNIT) 3m 91200_1522 VERTICAL RBW:1000.000KHz VBW:3000.000KHz SWT:Auto Detector : Peak Project : 940901-03</p>



WIFI	Band 4 5725~5850MHz Band Edge @ 3m	
ANT	802.11a CH157 5785MHz	
1+2	Horizontal	Fundamental
Peak	<p>Site : 03CH16-HY Condition : PEAK_BE(84)_16-24 3m 91200_1522 HORIZONTAL Detector : Peak Project : 940901-03</p>	<p>Site : 03CH16-HY Condition : PEAK(UNIT) 3m 91200_1522 HORIZONTAL Detector : Peak Project : 940901-03</p>
Peak	<p>Site : 03CH16-HY Condition : PEAK_BE(84)_16-24 3m 91200_1522 HORIZONTAL Detector : Peak Project : 940901-03</p>	Left blank



WIFI	Band 4 5725~5850MHz Band Edge @ 3m	
ANT	802.11a CH157 5785MHz	
1+2	Vertical	Fundamental
<p>Peak</p>	<p>Date: 2019-06-29 PEAK_BE(84)_16-24</p> <p>Site : 03CH16-HY Condition : PEAK_BE(84)_16-24 3m 91200_1522 VERTICAL RBW:1000.000kHz VBW:3000.000kHz SWT:Auto Detector : Peak Project : 940901-03</p>	<p>Date: 2019-06-29 PEAK(UB)</p> <p>Site : 03CH16-HY Condition : PEAK(UNIT) 3m 91200_1522 VERTICAL RBW:1000.000kHz VBW:3000.000kHz SWT:Auto Detector : Peak Project : 940901-03</p>
<p>Peak</p>	<p>Date: 2019-06-29 PEAK_BE(84)_16-24</p> <p>Site : 03CH16-HY Condition : PEAK_BE(84)_16-24 3m 91200_1522 VERTICAL RBW:1000.000kHz VBW:3000.000kHz SWT:Auto Detector : Peak Project : 940901-03</p>	<p>Left blank</p>

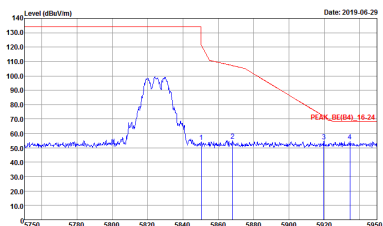
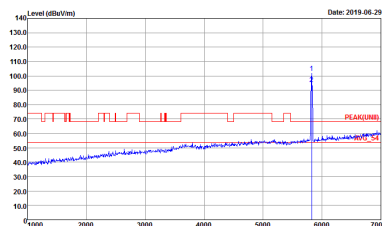

WIFI	Band 4 5725~5850MHz Band Edge @ 3m	
ANT	802.11a CH165 5825MHz	
1+2	Horizontal	Fundamental
Peak	 <p>Site : 03CH16-HY Condition : PEAK_BE(84)_16-24 3m 91200_1522 HORIZONTAL RBW:1000.000KHz VBW:3000.000KHz SWT:Auto Detector : Peak Project : 940901-03</p>	 <p>Site : 03CH16-HY Condition : PEAK(UNIT) 3m 91200_1522 HORIZONTAL RBW:1000.000KHz VBW:3000.000KHz SWT:Auto Detector : Peak Project : 940901-03</p>

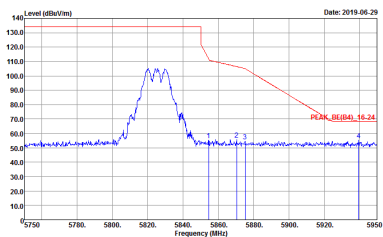
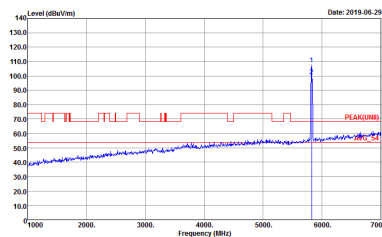

WIFI	Band 4 5725~5850MHz Band Edge @ 3m	
ANT	802.11a CH165 5825MHz	
1+2	Vertical	Fundamental
Peak	 <p>Site : 03CH16-HY Condition : PEAK_BE(B4)_16-24 3m 91200_1522 VERTICAL RBW:1000.000KHz VBW:3000.000KHz SWT:Auto Detector : Peak Project : 940901-03</p>	 <p>Site : 03CH16-HY Condition : PEAK(UNIT) 3m 91200_1522 VERTICAL RBW:1000.000KHz VBW:3000.000KHz SWT:Auto Detector : Peak Project : 940901-03</p>



Band 4 5725~5850MHz
WIFI 802.11n HT20 (Band Edge @ 3m)

WIFI	Band 4 5725~5850MHz Band Edge @ 3m	
ANT	802.11n HT20 CH149 5745MHz	
1+2	Horizontal	Fundamental
Peak	<p>Site : 03CH16-HY Condition : PEAK_BE(B4)_16-24 3m 91200_1522 HORIZONTAL RBW:1000.000KHz VBW:3000.000KHz SWT:Auto Detector : Peak Project : 940901-03</p>	<p>Site : 03CH16-HY Condition : PEAK(UNIT) 3m 91200_1522 HORIZONTAL RBW:1000.000KHz VBW:3000.000KHz SWT:Auto Detector : Peak Project : 940901-03</p>

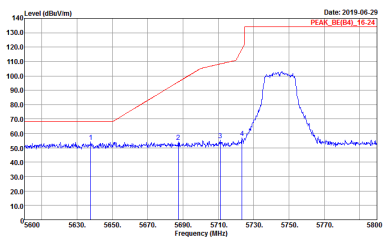
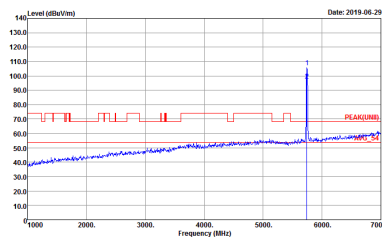

WIFI	Band 4 5725~5850MHz Band Edge @ 3m	
ANT	802.11n HT20 CH149 5745MHz	
1+2	Vertical	Fundamental
Peak	 <p>Site : 03CH16-HY Condition : PEAK_BE(84)_16-24 3m 91200_1522 VERTICAL Detector : RBW:1000.000KHz VBW:3000.000KHz SWT:Auto Project : 940901-03</p>	 <p>Site : 03CH16-HY Condition : PEAK(UNIT) 3m 91200_1522 VERTICAL Detector : RBW:1000.000KHz VBW:3000.000KHz SWT:Auto Project : 940901-03</p>



WIFI	Band 4 5725~5850MHz Band Edge @ 3m	
ANT	802.11n HT20 CH157 5785MHz	
1+2	Horizontal	Fundamental
Peak	<p>Date: 2019-06-29 PEAK_BE(B4)_16-24</p> <p>Site : 03CH16-HY Condition : PEAK_BE(B4)_16-24 3m 91200_1522 HORIZONTAL Detector : Peak Project : 940901-03</p>	<p>Date: 2019-06-29 PEAK(UB)</p> <p>Site : 03CH16-HY Condition : PEAK(UNIT) 3m 91200_1522 HORIZONTAL Detector : Peak Project : 940901-03</p>
Peak	<p>Date: 2019-06-29 PEAK_BE(B4)_16-24</p> <p>Site : 03CH16-HY Condition : PEAK_BE(B4)_16-24 3m 91200_1522 HORIZONTAL Detector : Peak Project : 940901-03</p>	Left blank



WIFI	Band 4 5725~5850MHz Band Edge @ 3m	
ANT	802.11n HT20 CH157 5785MHz	
1+2	Vertical	Fundamental
Peak	<p>Date: 2019-06-29 PEAK_BE(B4)_16-24</p> <p>Site : 03CH16-HY Condition : PEAK_BE(B4)_16-24 3m 91200_1522 VERTICAL RBW:1000.000KHz VBW:3000.000KHz SWT:Auto Detector : Peak Project : 940901-03</p>	<p>Date: 2019-06-29 PEAK(UNIT)</p> <p>Site : 03CH16-HY Condition : PEAK(UNIT) 3m 91200_1522 VERTICAL RBW:1000.000KHz VBW:3000.000KHz SWT:Auto Detector : Peak Project : 940901-03</p>
Peak	<p>Date: 2019-06-29 PEAK_BE(B4)_16-24</p> <p>Site : 03CH16-HY Condition : PEAK_BE(B4)_16-24 3m 91200_1522 VERTICAL RBW:1000.000KHz VBW:3000.000KHz SWT:Auto Detector : Peak Project : 940901-03</p>	Left blank

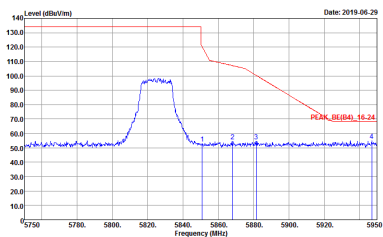
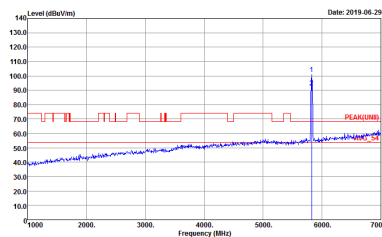

WIFI	Band 4 5725~5850MHz Band Edge @ 3m	
ANT	802.11n HT20 CH165 5825MHz	
1+2	Horizontal	Fundamental
Peak	 <p>Site : 03CH16-HY Condition : PEAK_BE(B4)_16-24 3m 91200_1522 HORIZONTAL Detector : RBW:1000.000KHz VBW:3000.000KHz SWT:Auto Project : 940901-03</p>	 <p>Site : 03CH16-HY Condition : PEAK(UNIT) 3m 91200_1522 HORIZONTAL Detector : RBW:1000.000KHz VBW:3000.000KHz SWT:Auto Project : 940901-03</p>

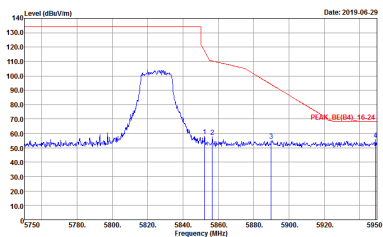
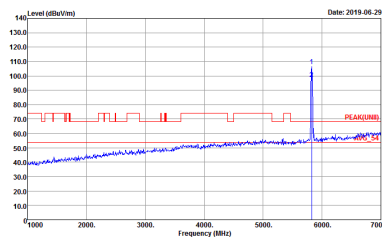

WIFI	Band 4 5725~5850MHz Band Edge @ 3m	
ANT	802.11n HT20 CH165 5825MHz	
1+2	Vertical	Fundamental
Peak	 <p>Date: 2019-06-29</p> <p>Site : 03CH16-HY Condition : PEAK_BE(84)_16-24 3m 91200_1522 VERTICAL RBW:1000.000KHz VBW:3000.000KHz SWT:Auto Detector : Peak Project : 940901-03</p>	 <p>Date: 2019-06-29</p> <p>Site : 03CH16-HY Condition : PEAK(UNIT) 3m 91200_1522 VERTICAL RBW:1000.000KHz VBW:3000.000KHz SWT:Auto Detector : Peak Project : 940901-03</p>



Band 4 5725~5850MHz

WIFI 802.11n HT40 (Band Edge @ 3m)

WIFI	Band 4 5725~5850MHz Band Edge @ 3m	
ANT	802.11n HT40 CH151 5755MHz	
1+2	Horizontal	Fundamental
Peak	<p> Site : 03CH16-HY Condition : PEAK_BE(B4)_16-24 3m 91200_1522 HORIZONTAL Detector : RBW:1000.000kHz VBW:3000.000kHz SWT:Auto Project : 940901-03 </p>	<p> Site : 03CH16-HY Condition : PEAK(UNIT) 3m 91200_1522 HORIZONTAL Detector : RBW:1000.000kHz VBW:3000.000kHz SWT:Auto Project : 940901-03 </p>
Peak	<p> Site : 03CH16-HY Condition : PEAK_BE(B4)_16-24 3m 91200_1522 HORIZONTAL Detector : RBW:1000.000kHz VBW:3000.000kHz SWT:Auto Project : 940901-03 </p>	Left blank



WIFI	Band 4 5725~5850MHz Band Edge @ 3m	
ANT	802.11n HT40 CH151 5755MHz	
1+2	Vertical	Fundamental
Peak	<p> Site : 03CH16-HY Condition : PEAK_BE(84)_16-24 3m 91200_1522 VERTICAL Detector : Peak Project : 940901-03 </p>	<p> Site : 03CH16-HY Condition : PEAK(UNIT) 3m 91200_1522 VERTICAL Detector : Peak Project : 940901-03 </p>
Peak	<p> Site : 03CH16-HY Condition : PEAK_BE(84)_16-24 3m 91200_1522 VERTICAL Detector : Peak Project : 940901-03 </p>	Left blank

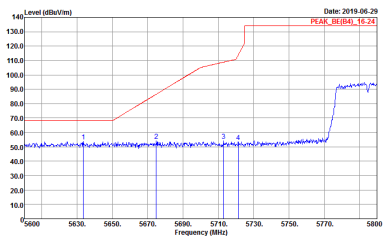
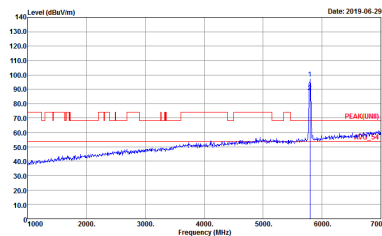
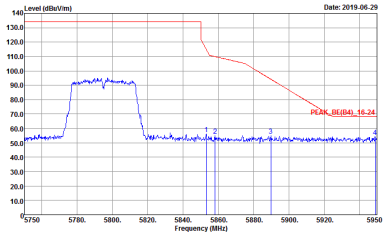

WIFI	Band 4 5725~5850MHz Band Edge @ 3m	
ANT	802.11n HT40 CH159 5795MHz	
1+2	Horizontal	Fundamental
Peak	 <p>Site : 03CH16-HY Condition : PEAK_BE(84)_16-24 3m 91200_1522 HORIZONTAL Detector : Peak Project : 940901-03</p>	 <p>Site : 03CH16-HY Condition : PEAK(UNIT) 3m 91200_1522 HORIZONTAL Detector : Peak Project : 940901-03</p>
Peak	 <p>Site : 03CH16-HY Condition : PEAK_BE(84)_16-24 3m 91200_1522 HORIZONTAL Detector : Peak Project : 940901-03</p>	Left blank

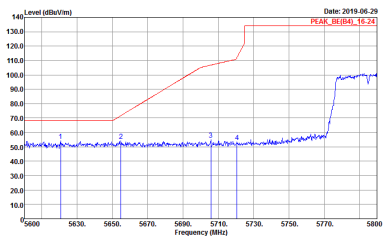
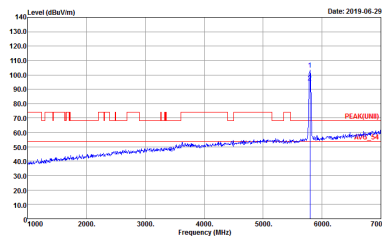
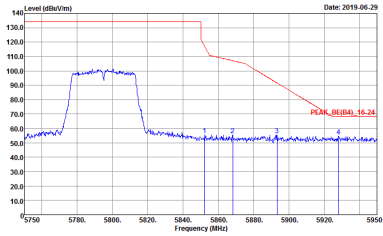

WIFI	Band 4 5725~5850MHz Band Edge @ 3m	
ANT	802.11n HT40 CH159 5795MHz	
1+2	Vertical	Fundamental
Peak	 <p>Site : 03CH16-HY Condition : PEAK_BE(84)_16-24 3m 91200_1522 VERTICAL RBW:1000.000kHz VBW:3000.000kHz SWT:Auto Detector : Peak Project : 940901-03</p>	 <p>Site : 03CH16-HY Condition : PEAK(UNIT) 3m 91200_1522 VERTICAL RBW:1000.000kHz VBW:3000.000kHz SWT:Auto Detector : Peak Project : 940901-03</p>
Peak	 <p>Site : 03CH16-HY Condition : PEAK_BE(84)_16-24 3m 91200_1522 VERTICAL RBW:1000.000kHz VBW:3000.000kHz SWT:Auto Detector : Peak Project : 940901-03</p>	Left blank



Band 4 5725~5850MHz
WIFI 802.11ac VHT80 (Band Edge @ 3m)

WIFI	Band 4 5725~5850MHz Band Edge @ 3m	
ANT	802.11ac VHT80 CH155 5775MHz	
1+2	Horizontal	Fundamental
Peak	<p>Site : 03CH16-HY Condition : PEAK_BE(B4)_16-24 3m 91200_1522 HORIZONTAL Detector : Peak Project : 940901-03</p>	<p>Site : 03CH16-HY Condition : PEAK(UNIT) 3m 91200_1522 HORIZONTAL Detector : Peak Project : 940901-03</p>
Peak	<p>Site : 03CH16-HY Condition : PEAK_BE(B4)_16-24 3m 91200_1522 HORIZONTAL Detector : Peak Project : 940901-03</p>	<p>Left blank</p>

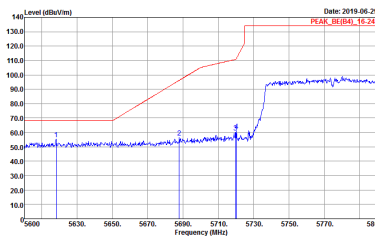
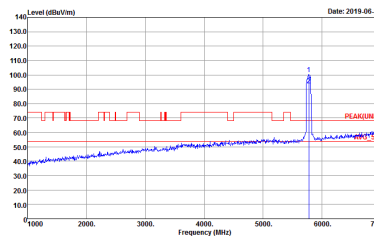
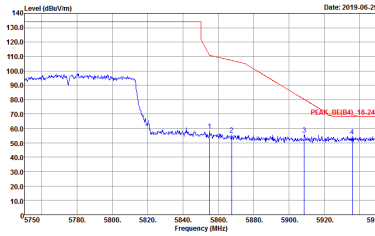

WIFI	Band 4 5725~5850MHz Band Edge @ 3m	
ANT	802.11ac VHT80 CH155 5775MHz	
1+2	Vertical	Fundamental
Peak	 <p>Site : 03CH16-HY Condition : PEAK_BE(84)_16-24 3m 91200_1522 VERTICAL RBW:1000.000KHz VBW:3000.000KHz SWT:Auto Detector : Peak Project : 940901-03</p>	 <p>Site : 03CH16-HY Condition : PEAK(UNIT) 3m 91200_1522 VERTICAL RBW:1000.000KHz VBW:3000.000KHz SWT:Auto Detector : Peak Project : 940901-03</p>
Peak	 <p>Site : 03CH16-HY Condition : PEAK_BE(84)_16-24 3m 91200_1522 VERTICAL RBW:1000.000KHz VBW:3000.000KHz SWT:Auto Detector : Peak Project : 940901-03</p>	Left blank



Band 4 - 5725~5850MHz
WIFI 802.11a (Harmonic @ 3m)

WIFI	Band 4 5725~5850MHz Harmonic @ 3m	
ANT	802.11a CH149 5745MHz	
1+2	Horizontal	Vertical
Peak Avg.	<p>Site : 03CH16-HY Condition : PEAK(LINII) 3m 91200_1522 HORIZONTAL Detector : Peak Project : 940901-03</p>	<p>Site : 03CH16-HY Condition : PEAK(LINII) 3m 91200_1522 VERTICAL Detector : Peak Project : 940901-03</p>

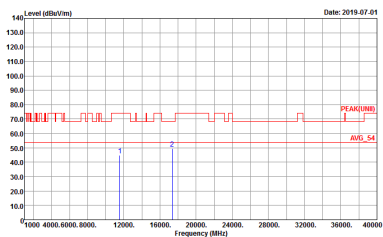
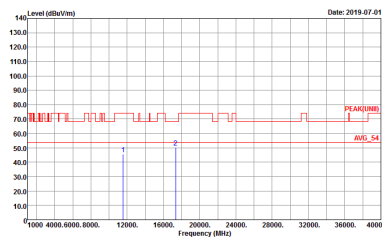

WIFI	Band 4 5725~5850MHz Harmonic @ 3m	
ANT	802.11a CH157 5785MHz	
1+2	Horizontal	Vertical
<p>Peak</p> <p>Avg.</p>	 <p>Site : 03CH16-HY Condition : PEAK(LINII) 3m 91200_1522 HORIZONTAL Detector : Peak Project : 940901-03</p>	 <p>Site : 03CH16-HY Condition : PEAK(LINII) 3m 91200_1522 VERTICAL Detector : Peak Project : 940901-03</p>

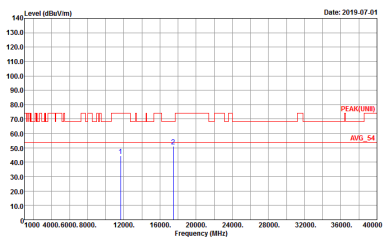
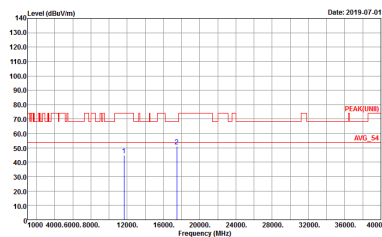

WIFI	Band 4 5725~5850MHz Harmonic @ 3m	
ANT	802.11a CH165 5825MHz	
1+2	Horizontal	Vertical
Peak Avg.	 <p>Site : 03CH16-HY Condition : PEAK(LINII) 3m 91200_1522 HORIZONTAL Detector : Peak Project : 940901-03</p>	 <p>Site : 03CH16-HY Condition : PEAK(LINII) 3m 91200_1522 VERTICAL Detector : Peak Project : 940901-03</p>



Band 4 5725~5850MHz
WIFI 802.11n HT20 (Harmonic @ 3m)

WIFI	Band 4 5725~5850MHz Harmonic @ 3m	
ANT	802.11n HT20 CH149 5745MHz	
1+2	Horizontal	Vertical
Peak Avg.	<p>Site : 03CH16-HY Condition : PEAK(LINII) 3m 91200_1522 HORIZONTAL Detector : Peak Project : 940901-03</p>	<p>Site : 03CH16-HY Condition : PEAK(LINII) 3m 91200_1522 VERTICAL Detector : Peak Project : 940901-03</p>

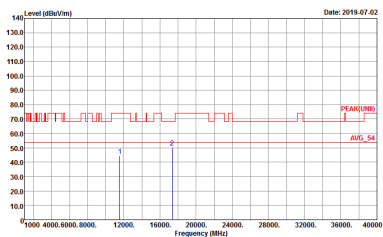
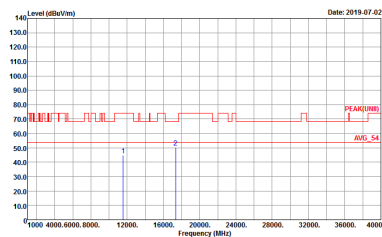

WIFI	Band 4 5725~5850MHz Harmonic @ 3m	
ANT	802.11n HT20 CH157 5785MHz	
1+2	Horizontal	Vertical
Peak Avg.	 <p>Site : 03CH16-HY Condition : PEAK(LINII) 3m 91200_1522 HORIZONTAL Detector : Peak Project : 940901-03</p>	 <p>Site : 03CH16-HY Condition : PEAK(LINII) 3m 91200_1522 VERTICAL Detector : Peak Project : 940901-03</p>

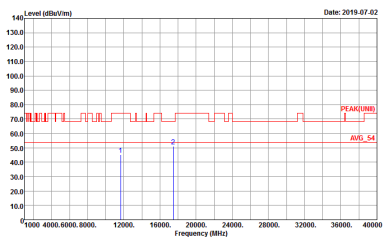
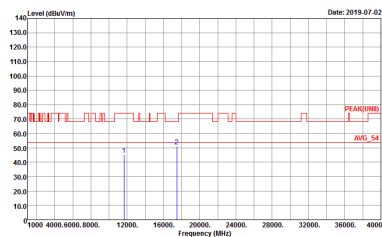

WIFI	Band 4 5725~5850MHz Harmonic @ 3m	
ANT	802.11n HT20 CH165 5825MHz	
1+2	Horizontal	Vertical
Peak Avg.	 <p>Site : 03CH16-HY Condition : PEAK(LINII) 3m 91200_1522 HORIZONTAL Detector : Peak Project : 940901-03</p>	 <p>Site : 03CH16-HY Condition : PEAK(LINII) 3m 91200_1522 VERTICAL Detector : Peak Project : 940901-03</p>



Band 4 5725~5850MHz
WIFI 802.11n HT40 (Harmonic @ 3m)

WIFI	Band 4 5725~5850MHz Harmonic @ 3m	
ANT	802.11n HT40 CH151 5755MHz	
1+2	Horizontal	Vertical
Peak Avg.	<p>Site : 03CH16-HY Condition : PEAK(LINII) 3m 91200_1522 HORIZONTAL Detector : Peak Project : 940901-03</p>	<p>Site : 03CH16-HY Condition : PEAK(LINII) 3m 91200_1522 VERTICAL Detector : Peak Project : 940901-03</p>

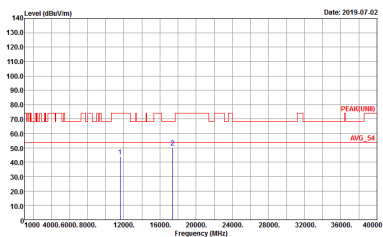
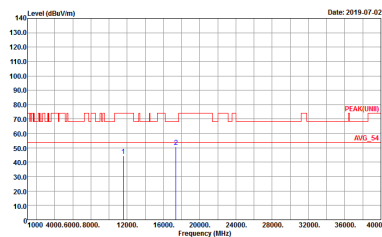

WIFI	Band 4 5725~5850MHz Harmonic @ 3m	
ANT	802.11n HT40 CH159 5795MHz	
1+2	Horizontal	Vertical
<p>Peak</p> <p>Avg.</p>	 <p>Site : 03CH16-HY Condition : PEAK(LINII) 3m 91200_1522 HORIZONTAL Detector : Peak Project : 940901-03</p>	 <p>Site : 03CH16-HY Condition : PEAK(LINII) 3m 91200_1522 VERTICAL Detector : Peak Project : 940901-03</p>



**Band 4 5725~5850MHz
WIFI 802.11ac VHT80 (Harmonic @ 3m)**

WIFI	Band 4 5725~5850MHz Harmonic @ 3m	
ANT	802.11ac VHT80 CH155 5775MHz	
1+2	Horizontal	Vertical
Peak Avg.	<p>Site : 03CH16-HY Condition : PEAK(LINEI) 3m 91200_1522 HORIZONTAL Detector : Peak Project : 940901-03</p>	<p>Site : 03CH16-HY Condition : PEAK(LINEI) 3m 91200_1522 VERTICAL Detector : Peak Project : 940901-03</p>



**Emission below 1GHz
5GHz WIFI 802.11n HT20 (LF)**

WIFI	5GHz 5725~5850MHz	
ANT	802.11n HT20 LF	
1+2	Horizontal	Vertical
QP / Peak	<p>Site : 03CH16-HY Condition : QP 3m B1LOG_47020406 HORIZONTAL Detector : Peak Project : 940901-03</p>	<p>Site : 03CH16-HY Condition : QP 3m B1LOG_47020406 VERTICAL Detector : Peak Project : 940901-03</p>



Appendix E. Duty Cycle Plots

Antenna	Band	Duty Cycle(%)	T(us)	1/T(kHz)	VBW Setting	Duty Factor(dB)
1	802.11a	98.54	-	-	10Hz	0.06
2	802.11a	98.54	-	-	10Hz	0.06
1+2	802.11a for Ant. 1	98.07	-	-	10Hz	0.08
1+2	802.11a for Ant. 2	98.54	-	-	10Hz	0.06
1	5GHz 802.11n HT20	99.50	-	-	10Hz	0.02
2	5GHz 802.11n HT20	98.90	-	-	10Hz	0.05
1+2	5GHz 802.11n HT20 for Ant. 1	98.82	-	-	10Hz	0.05
1+2	5GHz 802.11n HT20 for Ant. 2	98.43	-	-	10Hz	0.07
1	5GHz 802.11n HT40	98.37	-	-	10Hz	0.07
2	5GHz 802.11n HT40	98.77	-	-	10Hz	0.05
1+2	5GHz 802.11n HT40 for Ant. 1	96.84	1225	0.82	1kHz	0.14
1+2	5GHz 802.11n HT40 for Ant. 2	97.23	1230	0.81	1kHz	0.12
1	5GHz 802.11ac VHT20	99.20	-	-	10Hz	0.03
2	5GHz 802.11ac VHT20	99.10	-	-	10Hz	0.04
1+2	5GHz 802.11ac VHT20 for Ant. 1	98.43	-	-	10Hz	0.07
1+2	5GHz 802.11ac VHT20 for Ant. 2	98.05	-	-	10Hz	0.09
1	5GHz 802.11ac VHT40	98.37	-	-	10Hz	0.07
2	5GHz 802.11ac VHT40	98.78	-	-	10Hz	0.05
1+2	5GHz 802.11ac VHT40 for Ant. 1	97.23	1230	0.81	1kHz	0.12
1+2	5GHz 802.11ac VHT40 for Ant. 2	97.24	1235	0.81	1kHz	0.12
1	5GHz 802.11ac VHT80	96.60	1135	0.88	1kHz	0.15
2	5GHz 802.11ac VHT80	96.60	1135	0.88	1kHz	0.15
1+2	5GHz 802.11ac VHT80 for Ant. 1	94.44	595	1.68	3kHz	0.25
1+2	5GHz 802.11ac VHT80 for Ant. 2	93.65	590	1.69	3kHz	0.28



<Ant. 1>

802.11a

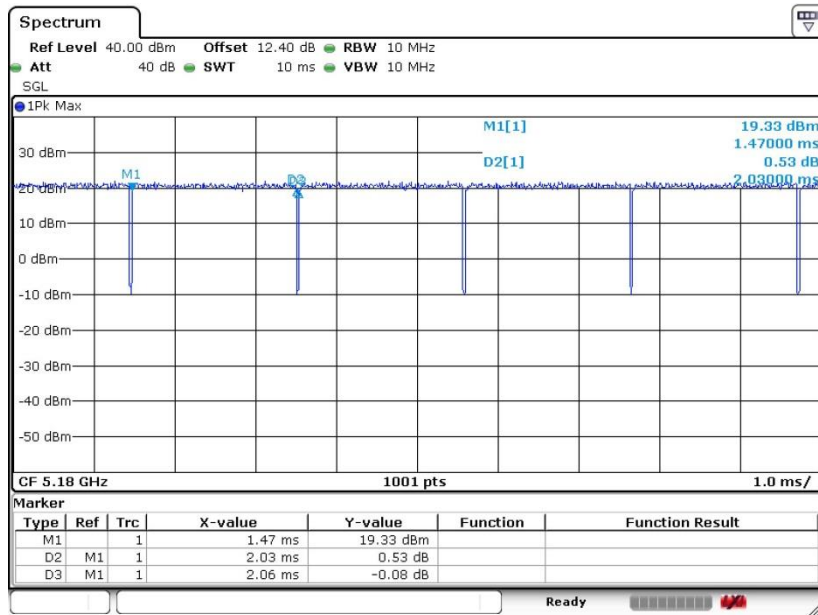

Date: 8.JUN.2019 09:45:11

802.11n HT20

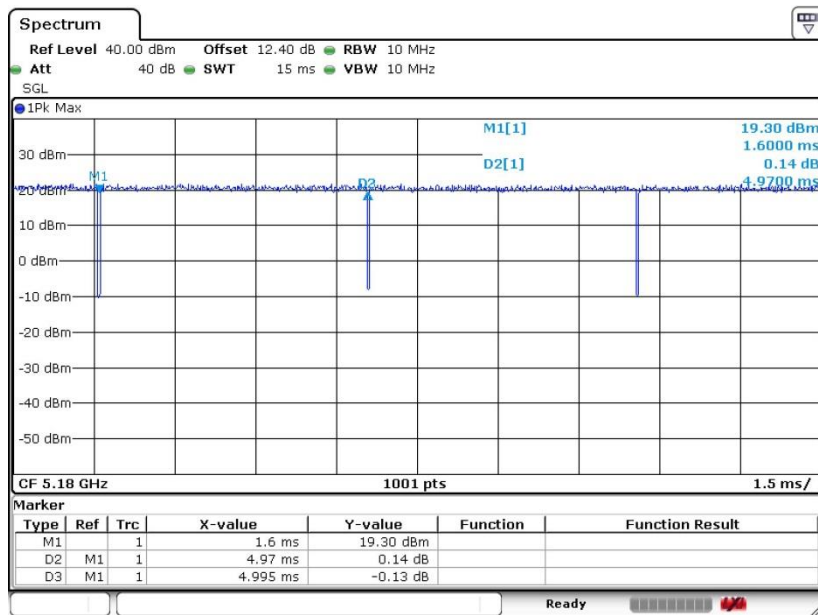

Date: 8.JUN.2019 09:46:04



802.11n HT40

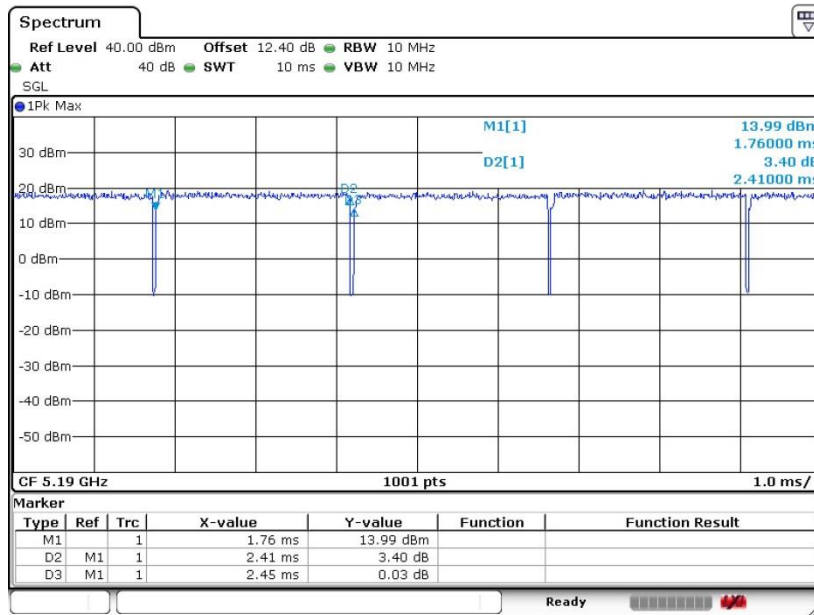

Date: 8.JUN.2019 09:50:02

802.11ac VHT20

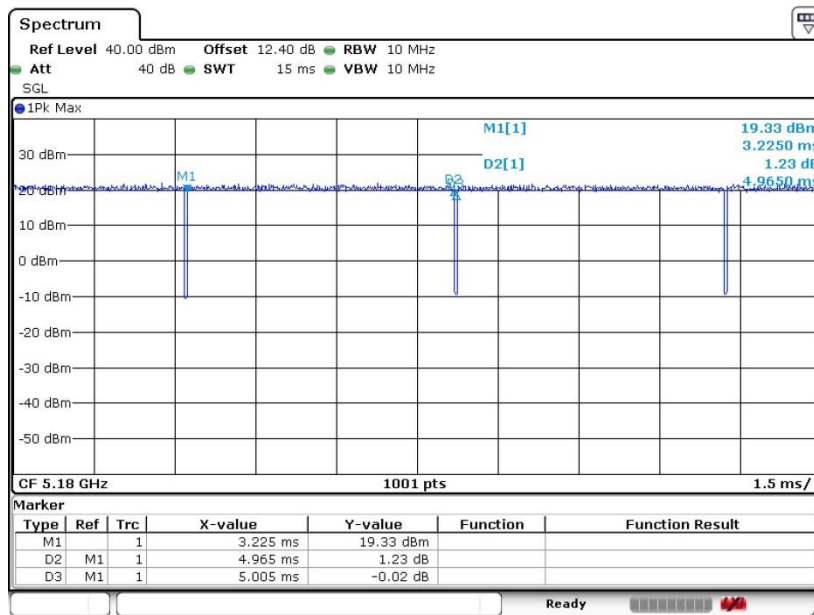

Date: 8.JUN.2019 09:53:54



802.11ac VHT40

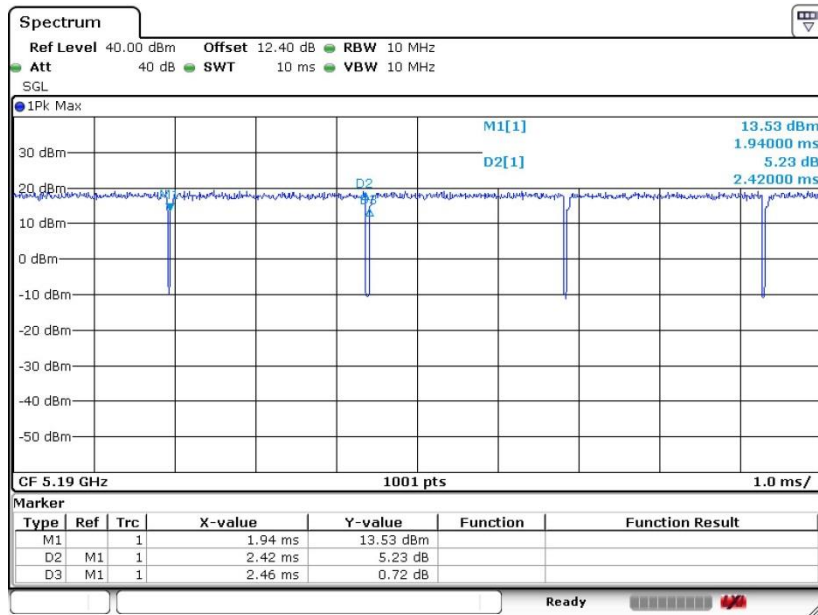

Date: 8.JUN.2019 09:55:33

802.11ac VHT80

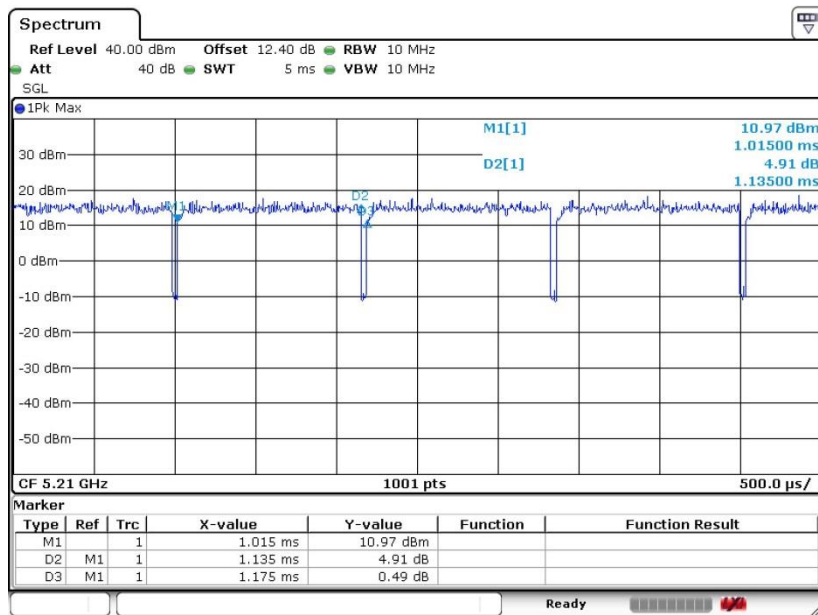

Date: 8.JUN.2019 09:58:08



<Ant. 2>

802.11a

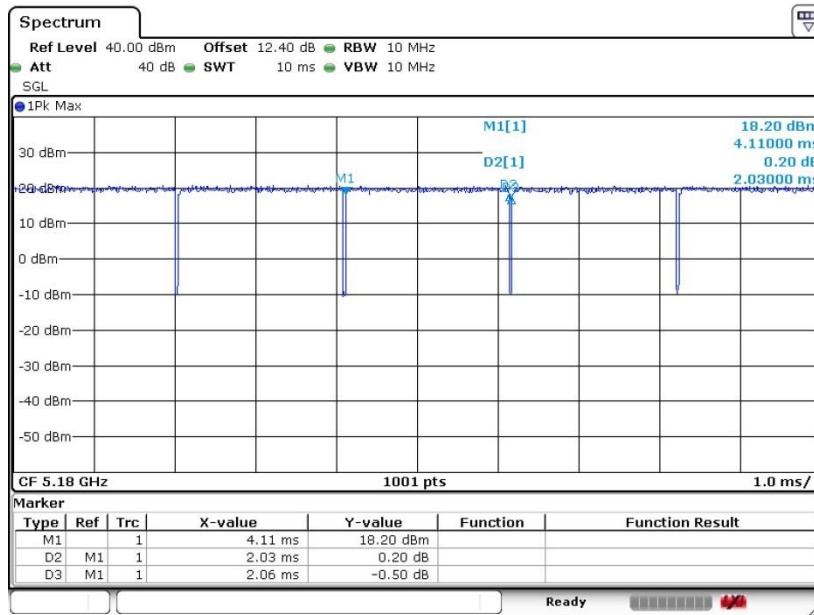

Date: 8.JUN.2019 09:59:48

802.11n HT20

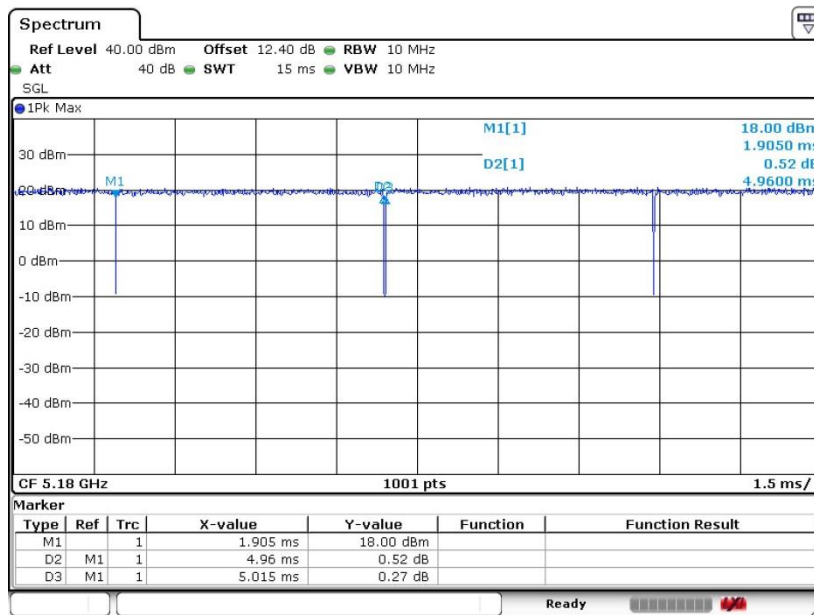

Date: 8.JUN.2019 10:01:14



802.11n HT40

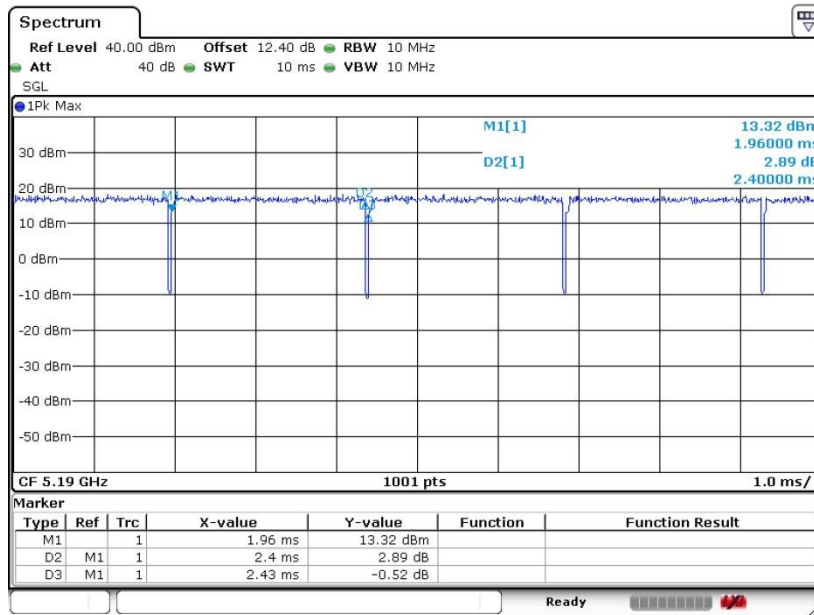

Date: 8.JUN.2019 10:02:59

802.11ac VHT20

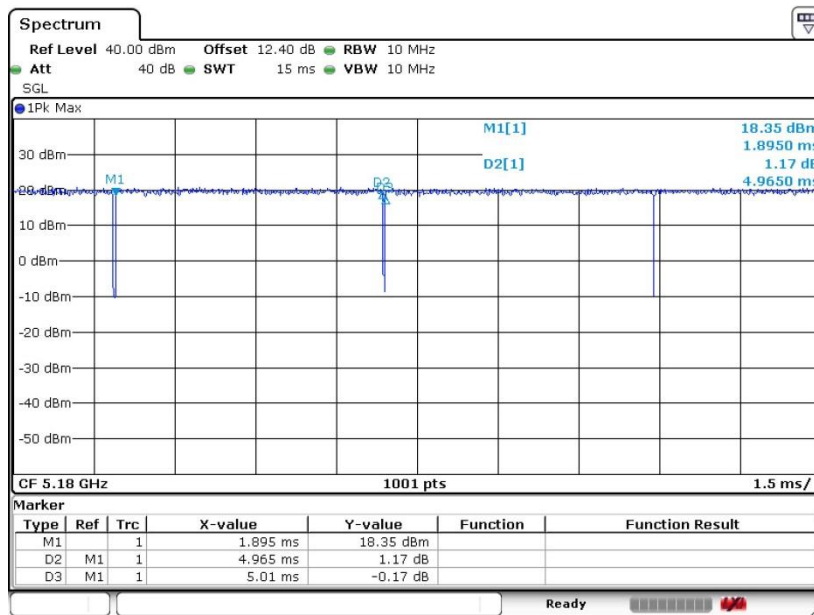

Date: 8.JUN.2019 10:04:34



802.11ac VHT40

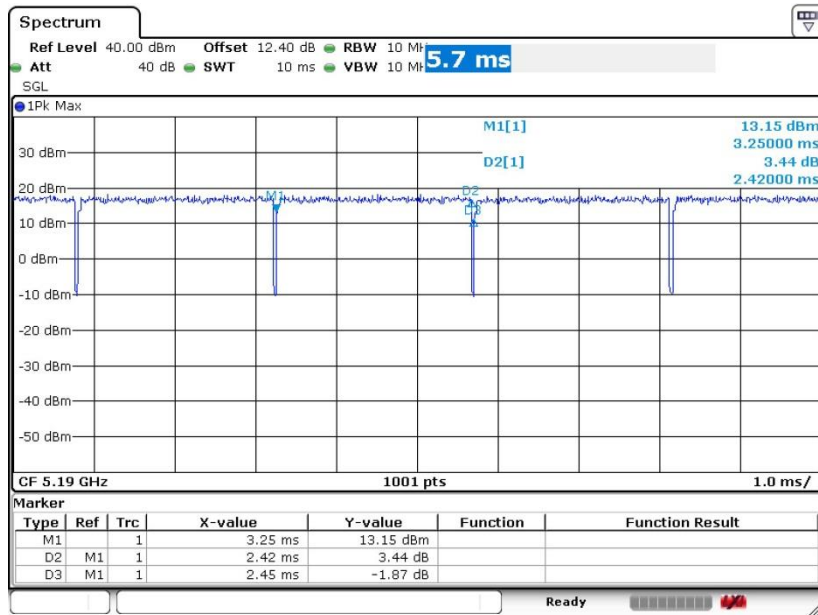

Date: 8.JUN.2019 10:05:54

802.11ac VHT80

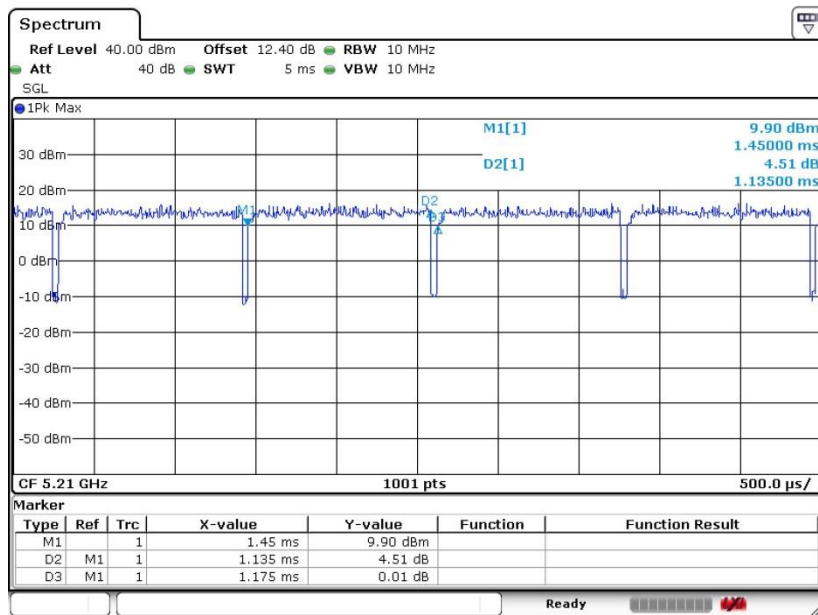

Date: 8.JUN.2019 10:07:51



MIMO <Ant. 1>

802.11a

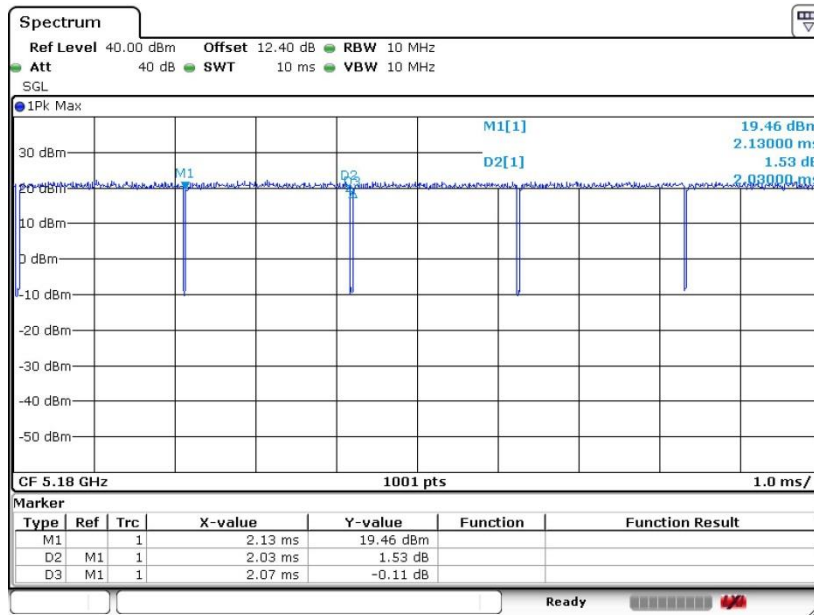

Date: 8.JUN.2019 10:10:17

802.11n HT20

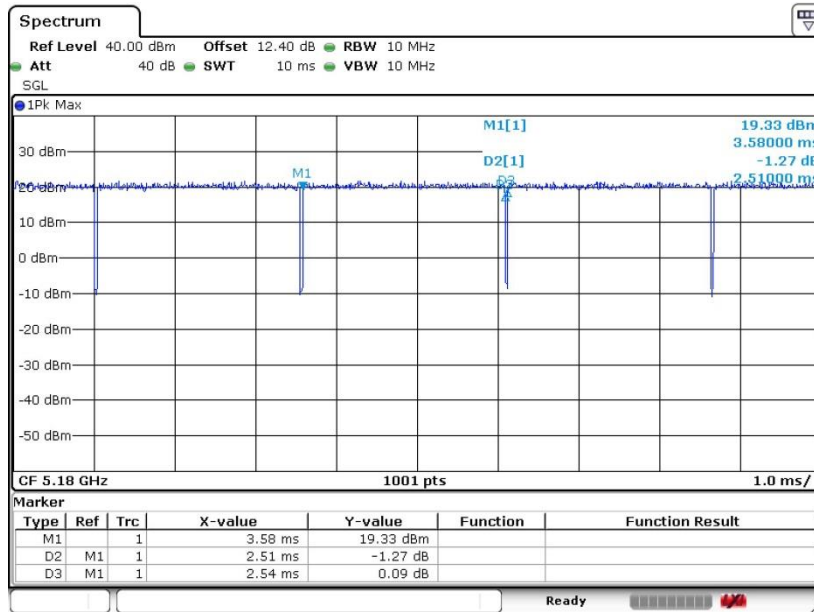

Date: 8.JUN.2019 10:13:02



802.11n HT40

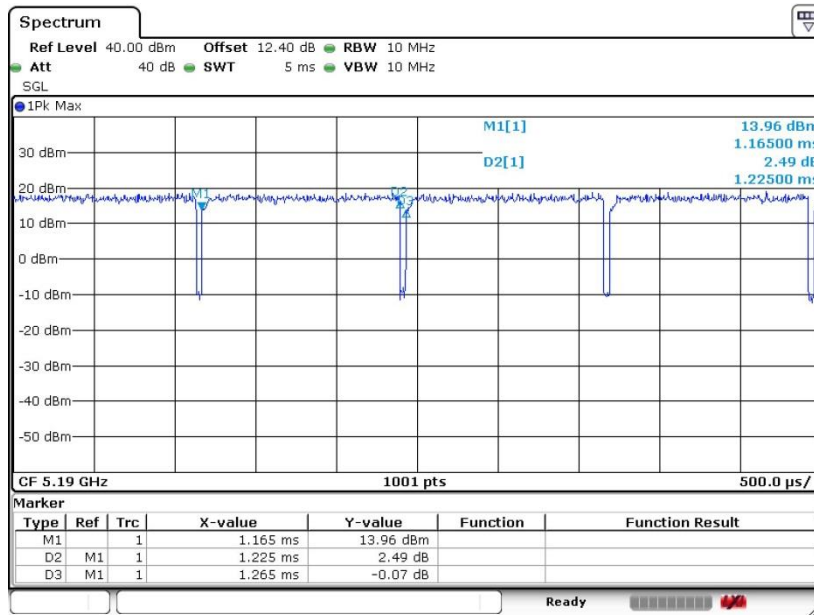

Date: 8.JUN.2019 10:16:11

802.11ac VHT20

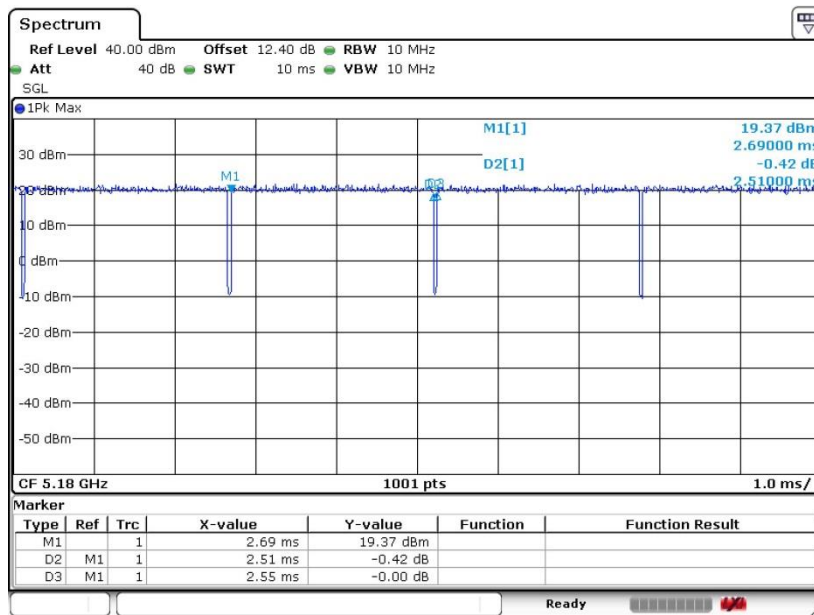

Date: 8.JUN.2019 10:20:18



802.11ac VHT40

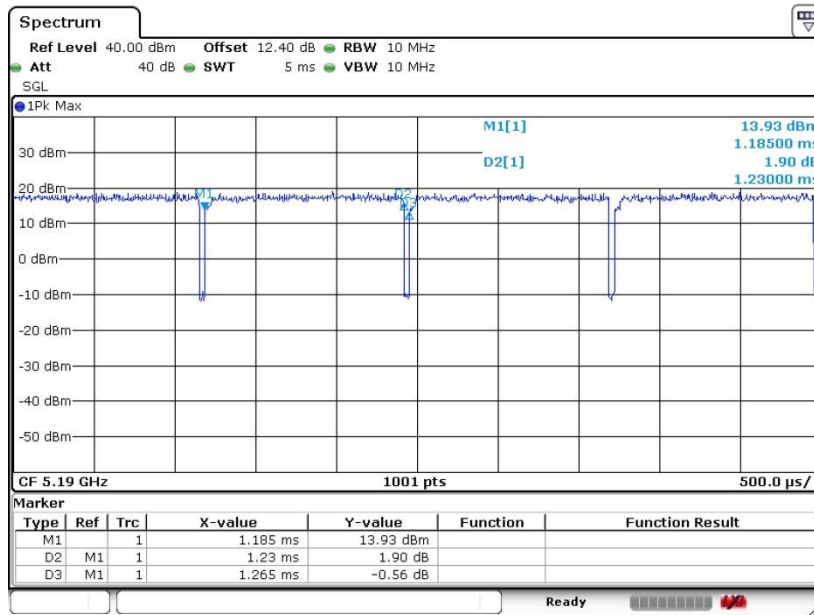

Date: 8.JUN.2019 10:24:58

802.11ac VHT80

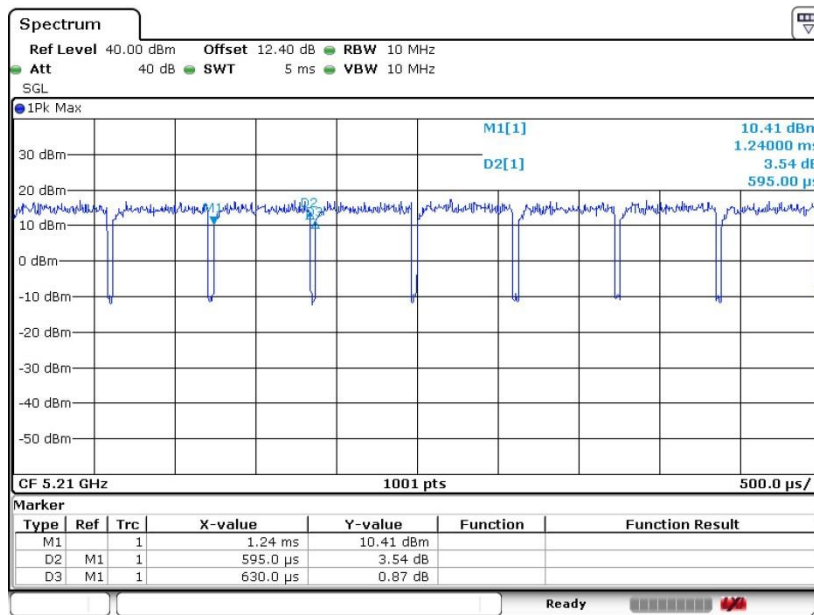

Date: 8.JUN.2019 10:31:27



MIMO <Ant. 2>

802.11a

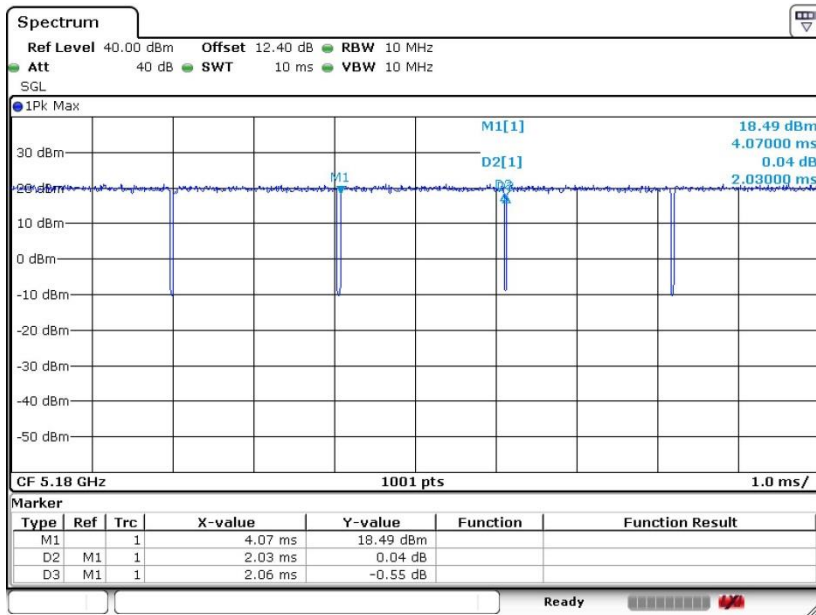

Date: 8.JUN.2019 10:11:35

802.11n HT20

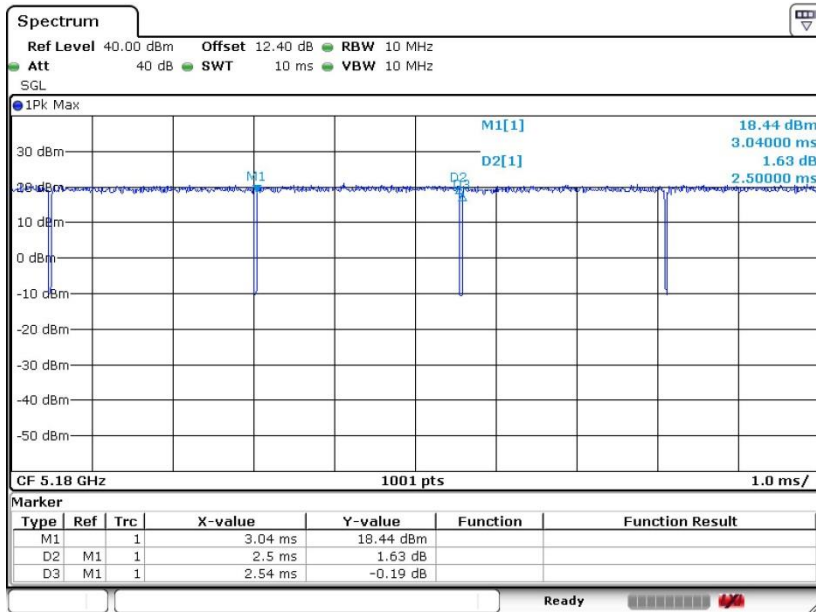

Date: 8.JUN.2019 10:14:23



802.11n HT40

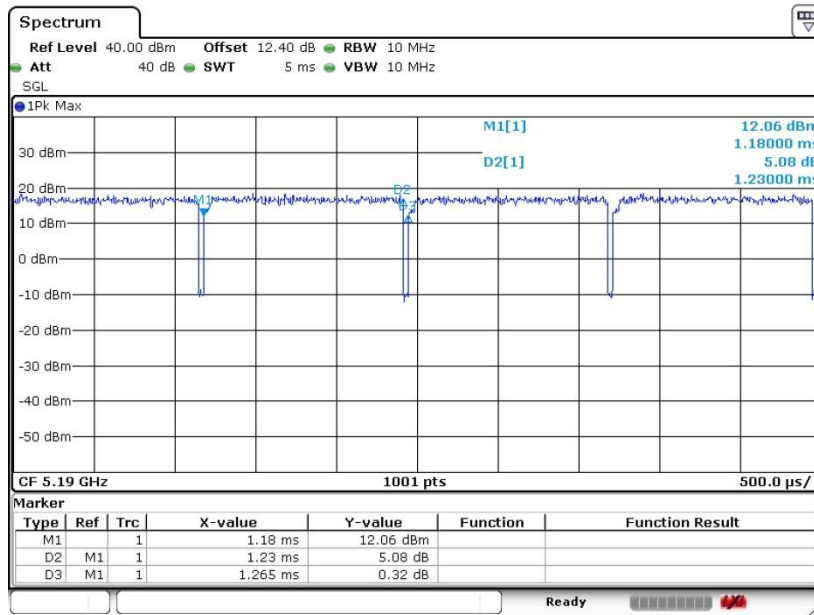

Date: 8.JUN.2019 10:17:57

802.11ac VHT20

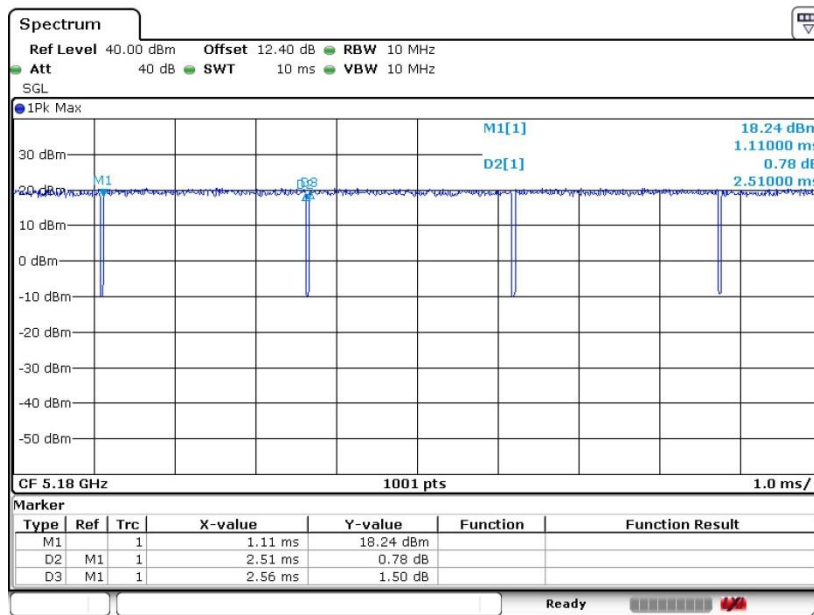

Date: 8.JUN.2019 10:21:44



802.11ac VHT40

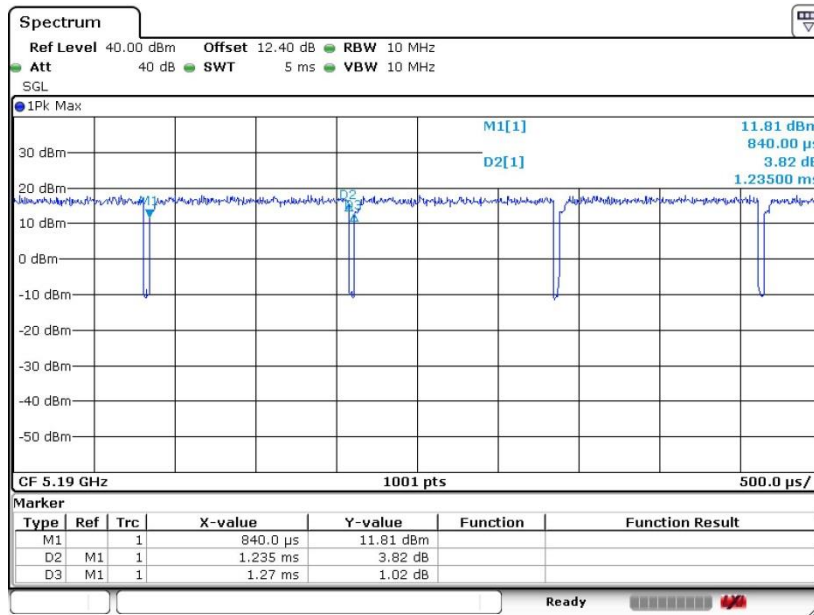

Date: 8.JUN.2019 10:28:59

802.11ac VHT80

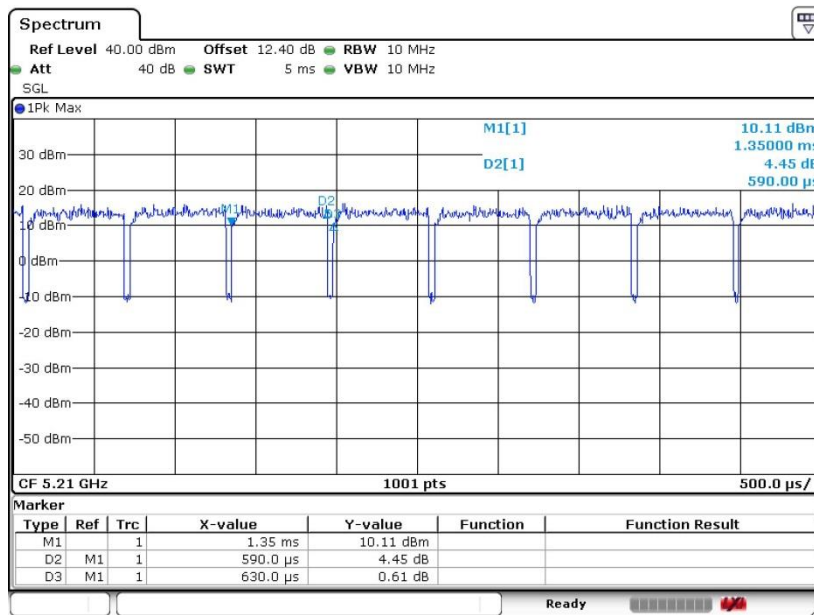

Date: 8.JUN.2019 10:32:51

—————THE END—————