



# FCC RADIO TEST REPORT

**FCC ID** : PY7-77089S  
**Equipment** : GSM/WCDMA/LTE/5G Phone with BT, DTS/UNII  
a/b/g/n/ac/ax, GPS and NFC  
**Brand Name** : Sony  
**Applicant** : Sony Corporation  
1-7-1 Konan Minato-ku Tokyo, 108-0075 Japan  
**Manufacturer** : Sony Corporation  
1-7-1 Konan Minato-ku Tokyo, 108-0075 Japan  
**Standard** : FCC 47 CFR Part 2, 22(H), 27

The product was received on Jun. 11, 2021 and testing was started from Jun. 20, 2021 and completed on Jun. 27, 2021. We, Sporton International Inc. EMC & Wireless Communications Laboratory, would like to declare that the tested sample has been evaluated in accordance with the test procedures given in ANSI / TIA-603-E and has been in compliance with the applicable technical standards.

The test results in this report apply exclusively to the tested model / sample. Without written approval of Sporton International Inc. EMC & Wireless Communications Laboratory, the test report shall not be reproduced except in full.

*Louis Wu*

Approved by: Louis Wu

**Sporton International Inc. EMC & Wireless Communications Laboratory**

No. 52, Huaya 1st Rd., Guishan Dist., Taoyuan City 333, Taiwan (R.O.C.)



## Table of Contents

**History of this test report..... 3**

**Summary of Test Result..... 4**

**1 General Description ..... 6**

    1.1 Product Feature of Equipment Under Test..... 6

    1.2 Modification of EUT ..... 6

    1.3 Emission Designator ..... 7

    1.4 Testing Location ..... 9

    1.5 Applicable Standards ..... 10

**2 Test Configuration of Equipment Under Test ..... 11**

    2.1 Test Mode ..... 11

    2.2 Connection Diagram of Test System ..... 14

    2.3 Support Unit used in test configuration and system ..... 14

    2.4 Measurement Results Explanation Example ..... 14

    2.5 Frequency List of Low/Middle/High Channels ..... 15

**3 Conducted Test Items ..... 17**

    3.1 Measuring Instruments ..... 17

    3.2 Conducted Output Power and ERP/EIRP ..... 18

    3.3 Peak-to-Average Ratio ..... 19

    3.4 Occupied Bandwidth ..... 20

    3.5 Conducted Band Edge ..... 21

    3.6 Conducted Spurious Emission ..... 22

    3.7 Frequency Stability ..... 23

**4 Radiated Test Items ..... 24**

    4.1 Measuring Instruments ..... 24

    4.2 Radiated Spurious Emission Measurement ..... 26

**5 List of Measuring Equipment..... 27**

**6 Uncertainty of Evaluation ..... 29**

**Appendix A. Test Results of Conducted Test**

**Appendix B. Test Results of Radiated Test**





Summary of Test Result

Report Clause	Ref Std. Clause	Test Items	Result (PASS/FAIL)	Remark
3.2	§2.1046	Conducted Output Power	Reporting only	-
	§22.913 (a)(2)	Effective Radiated Power (Band 5)	Pass	
	§27.50 (b)(10) §27.50 (c)(10)	Effective Radiated Power (Band 13) (Band 17)		
	§27.50 (h)(2)	Equivalent Isotropic Radiated Power (Band 7) (Band 41)		
	§27.50 (d)(4)	Equivalent Isotropic Radiated Power (Band 4)		
3.3	§27.50 (d)(5)	Peak-to-Average Ratio	Pass	-
3.4	§2.1049	Occupied Bandwidth	Reporting only	-
3.5	§2.1051 §22.917 (a) §27.53 (c)(2)(4) §27.53 (g) §27.53 (h)	Conducted Band Edge Measurement (Band 4) (Band 5) (Band 13) (Band 17)	Pass	-
	§2.1051 §27.53 (m)(4)	Conducted Band Edge Measurement (Band 7) (Band 41)		
3.6	§2.1051 §22.917 (a) §27.53 (c)(2) §27.53 (g) §27.53 (h)	Conducted Spurious Emission (Band 4) (Band 5) (Band 13) (Band 17)	Pass	-
	§2.1051 §27.53 (m)(4)	Conducted Spurious Emission (Band 7) (Band 41)		
3.7	§2.1055 §22.355 §27.54	Frequency Stability Temperature & Voltage	Pass	-



Report Clause	Ref Std. Clause	Test Items	Result (PASS/FAIL)	Remark
4.2	§2.1053 §22.917 (a) §27.53 (c)(2) §27.53 (f) §27.53 (g) §27.53 (h)	Radiated Spurious Emission (Band 4) (Band 5) (Band 13) (Band 17)	Pass	Under limit 15.85 dB at 1565.000 MHz
	§2.1051 §27.53 (m)(4)	Radiated Spurious Emission (Band 7) (Band 41)		

**Declaration of Conformity:**

The test results with all measurement uncertainty excluded are presented in accordance with the regulation limits or requirements declared by manufacturers.

**Comments and Explanations:**

The declared of product specification for EUT presented in the report are provided by the manufacturer, and the manufacturer takes all the responsibilities for the accuracy of product specification.

**Reviewed by: Keven Cheng**

**Report Producer: Vivian Hsu**



# 1 General Description

## 1.1 Product Feature of Equipment Under Test

GSM/WCDMA/LTE, Bluetooth, DTS/UNII a/b/g/n/ac/ax, NFC, FM Receiver and GNSS.

Product Specification subjective to this standard	
Antenna Type	Loop Antenna
Antenna Gain	LTE Band 4: -0.7dBi LTE Band 5: -4.5dBi LTE Band 7: -0.9dBi LTE Band 13: -7.7dBi LTE Band 17: -5.3dBi LTE Band 41: -0.2dBi

**Remark:** The above EUT's information was declared by manufacturer. Please refer to Comments and Explanations in report summary.

EUT Information List			
HW Version	SW Version	S/N	Performed Test Item
A	3.69	QV72002Y9B	Conducted Measurement
	3.69	QV72002J9B	Radiated Spurious Emission
	3.69	QV72002Y9B	ERP/EIRP Test

Accessory List	
AC Adapter	Model Name : AC-0540-JP S/N: 0020W51300039
Earphone	Model Name : STH40D S/N : N/A
USB Cable	Model Name : XQZ-UB1 S/N : N/A

**Note:**

- Above EUT list used are electrically identical per declared by manufacturer.
- Above the accessories list are used to exercise the EUT during test, and the serial number of each type of accessories is listed in each section of this report. .
- For other wireless features of this EUT, test report will be issued separately.

## 1.2 Modification of EUT

No modifications are made to the EUT during all test items.



### 1.3 Emission Designator

LTE Band 4		QPSK			16QAM			64QAM		
BW (MHz)	Frequency Range (MHz)	Emission Designator (99%OBW)	Frequency Tolerance (ppm)	Maximum EIRP(W)	Emission Designator (99%OBW)	Frequency Tolerance (ppm)	Maximum EIRP(W)	Emission Designator (99%OBW)	Frequency Tolerance (ppm)	Maximum EIRP(W)
1.4	1710.7~1754.3	1M09G7D	-	0.0735	1M09W7D	-	0.0708	1M09W7D	-	0.0697
3	1711.5~1753.5	2M73G7D	-	0.0759	2M72W7D	-	0.0708	2M73W7D	-	0.0718
5	1712.5~1752.5	4M48G7D	-	0.0755	4M46W7D	-	0.0703	4M48W7D	-	0.0713
10	1715.0~1750.0	8M97G7D	0.0109	0.0760	8M99W7D	-	0.0719	9M03W7D	-	0.0713
15	1717.5~1747.5	13M5G7D	-	0.0759	13M5W7D	-	0.0723	13M4W7D	-	0.0701
20	1720.0~1745.0	17M8G7D	-	0.0762	17M8W7D	-	0.0721	17M9W7D	-	0.0698
LTE Band 5		QPSK			16QAM			64QAM		
BW (MHz)	Frequency Range (MHz)	Emission Designator (99%OBW)	Frequency Tolerance (ppm)	Maximum ERP(W)	Emission Designator (99%OBW)	Frequency Tolerance (ppm)	Maximum ERP(W)	Emission Designator (99%OBW)	Frequency Tolerance (ppm)	Maximum ERP(W)
1.4	824.7 ~ 848.3	1M09G7D	-	0.0587	1M09W7D	-	0.0501	1M09W7D	-	0.0463
3	825.5 ~ 847.5	2M71G7D	-	0.0583	2M72W7D	-	0.0502	2M70W7D	-	0.0397
5	826.5 ~ 846.5	4M49G7D	-	0.0579	4M50W7D	-	0.0501	4M49W7D	-	0.0399
10	829.0 ~ 844.0	9M01G7D	0.0142	0.0589	8M99W7D	-	0.0498	9M07W7D	-	0.0382
LTE Band 7		QPSK			16QAM			64QAM		
BW (MHz)	Frequency Range (MHz)	Emission Designator (99%OBW)	Frequency Tolerance (ppm)	Maximum EIRP(W)	Emission Designator (99%OBW)	Frequency Tolerance (ppm)	Maximum EIRP(W)	Emission Designator (99%OBW)	Frequency Tolerance (ppm)	Maximum EIRP(W)
5	2502.5 ~ 2567.5	4M47G7D	-	0.0705	4M47W7D	-	0.0653	4M49W7D	-	0.0652
10	2505.0 ~ 2565.0	9M03G7D	0.0080	0.0708	9M05W7D	-	0.0665	9M05W7D	-	0.0646
15	2507.5 ~ 2562.5	13M5G7D	-	0.0710	13M4W7D	-	0.0670	13M4W7D	-	0.0652
20	2510.0 ~ 2560.0	17M9G7D	-	0.0713	17M9W7D	-	0.0658	17M9W7D	-	0.0653



LTE Band 13		QPSK			16QAM			64QAM		
BW (MHz)	Frequency Range (MHz)	Emission Designator (99%OBW)	Frequency Tolerance (ppm)	Maximum ERP(W)	Emission Designator (99%OBW)	Frequency Tolerance (ppm)	Maximum ERP(W)	Emission Designator (99%OBW)	Frequency Tolerance (ppm)	Maximum ERP(W)
5	779.5 ~ 784.5	4M47G7D	-	0.0277	4M50W7D	-	0.0238	4M50W7D	-	0.0184
10	782.0	9M01G7D	0.0166	0.0280	8M97W7D	-	0.0237	9M05W7D	-	0.0182
LTE Band 17		QPSK			16QAM			64QAM		
BW (MHz)	Frequency Range (MHz)	Emission Designator (99%OBW)	Frequency Tolerance (ppm)	Maximum ERP(W)	Emission Designator (99%OBW)	Frequency Tolerance (ppm)	Maximum ERP(W)	Emission Designator (99%OBW)	Frequency Tolerance (ppm)	Maximum ERP(W)
5	706.5~713.5	4M46G7D	-	0.0489	4M49W7D	-	0.0424	4M51W7D	-	0.0321
10	709.0~711.0	8M97G7D	0.0189	0.0490	9M03W7D	-	0.0426	8M97W7D	-	0.0330
LTE Band 41		QPSK			16QAM			64QAM		
BW (MHz)	Frequency Range (MHz)	Emission Designator (99%OBW)	Frequency Tolerance (ppm)	Maximum EIRP(W)	Emission Designator (99%OBW)	Frequency Tolerance (ppm)	Maximum EIRP(W)	Emission Designator (99%OBW)	Frequency Tolerance (ppm)	Maximum EIRP(W)
5	2498.5 ~ 2687.5	4M49G7D	-	0.0908	4M52W7D	-	0.0809	4M49W7D	-	0.0811
10	2501.0 ~ 2685.0	9M05G7D	0.0077	0.0908	8M95W7D	-	0.0817	9M03W7D	-	0.0834
15	2503.5 ~ 2682.5	13M5G7D	-	0.0906	13M4W7D	-	0.0817	13M5W7D	-	0.0815
20	2506.0 ~ 2680.0	17M9G7D	-	0.0910	17M9W7D	-	0.0813	17M8W7D	-	0.0817





### 1.4 Testing Location

<b>Test Site</b>	Sporton International Inc. EMC & Wireless Communications Laboratory
<b>Test Site Location</b>	No.52, Huaya 1st Rd., Guishan & Dist., Taoyuan City 333, Taiwan (R.O.C.) TEL: +886-3-327-3456 FAX: +886-3-328-4978
<b>Test Site No.</b>	<b>Sporton Site No.</b> TH03-HY
<b>Test Engineer</b>	Benjamin Lin
<b>Temperature</b>	23.2~25.1°C
<b>Relative Humidity</b>	49.9~52.4%

<b>Test Site</b>	Sporton International Inc. Wensan Laboratory
<b>Test Site Location</b>	No.58, Aly. 75, Ln. 564, Wenhua 3rd, Rd., Guishan Dist., Taoyuan City 333010, Taiwan (R.O.C.) TEL: +886-3-327-0868 FAX: +886-3-327-0855
<b>Test Site No.</b>	<b>Sporton Site No.</b> 03CH15-HY (TAF Code: 3786)
<b>Test Engineer</b>	Leo Lee, Mancy Chou and Bigshow Wang
<b>Temperature</b>	22.8~23.2°C
<b>Relative Humidity</b>	46~49%
<b>Remark</b>	The Radiated Spurious Emission Test item subcontracted to Sporton International Inc. Wensan Laboratory

**Note:** The test site complies with ANSI C63.4 2014 requirement.

FCC Designation No.: TW1190 and TW3786



## 1.5 Applicable Standards

According to the specifications of the manufacturer, the EUT must comply with the requirements of the following standards:

- ♦ ANSI C63.26-2015
- ♦ ANSI / TIA-603-E
- ♦ FCC 47 CFR Part 2, 22(H), 27
- ♦ FCC KDB 971168 D01 Power Meas. License Digital Systems v03r01
- ♦ FCC KDB 412172 D01 Determining ERP and EIRP v01r01
- ♦ FCC KDB 414788 D01 Radiated Test Site v01r01.

**Remark:**

1. All test items were verified and recorded according to the standards and without any deviation during the test.
2. This EUT has also been tested and complied with the requirements of FCC Part 15, Subpart B, recorded in a separate test report.
3. The TAF code is not including all the FCC KDB listed without accreditation.



## 2 Test Configuration of Equipment Under Test

### 2.1 Test Mode

Antenna port conducted and radiated test items listed below are performed according to KDB 971168 D01 Power Meas. License Digital Systems v03r01 with maximum output power.

The measured emission level of the EUT was maximized by rotating the EUT on a turntable, adjusting the orientation of the EUT and EUT antenna in three orthogonal axis (X: flat, Y: portrait, Z: landscape), and adjusting the measurement antenna orientation, following C63.26 exploratory test procedures and find X Plane for LTE Band 4, 5, 7, 17, 41; Z Plane for LTE Band 13 as worst plane.

Test Items	Band	Bandwidth (MHz)						Modulation			RB #			Test Channel		
		1.4	3	5	10	15	20	QPSK	16QAM	64QAM	1	Half	Full	L	M	H
Max. Output Power	4	v	v	v	v	v	v	v	v	v	v	v	v	v	v	v
	5	v	v	v	v	-	-	v	v	v	v	v	v	v	v	v
	7	-	-	v	v	v	v	v	v	v	v	v	v	v	v	v
	13	-	-	v	v	-	-	v	v	v	v	v	v	v	v	v
	17	-	-	v	v	-	-	v	v	v	v	v	v	v	v	v
	41	-	-	v	v	v	v	v	v	v	v	v	v	v	v	v
Peak-to-Average Ratio	4						v	v	v	v	v		v		v	
	5				v	-	-	v	v	v	v		v		v	
	7	-	-				v	v	v	v	v		v		v	
	13	-	-		v	-	-	v	v	v	v		v		v	
	17	-	-		v	-	-	v	v	v	v		v		v	
	41	-	-				v	v	v	v	v		v		v	
26dB and 99% Bandwidth	4	v	v	v	v	v	v	v	v	v			v		v	
	5	v	v	v	v	-	-	v	v	v			v		v	
	7	-	-	v	v	v	v	v	v	v			v		v	
	13	-	-	v	v	-	-	v	v	v			v		v	
	17	-	-	v	v	-	-	v	v	v			v		v	
	41	-	-	v	v	v	v	v	v	v			v		v	



Test Items	Band	Bandwidth (MHz)						Modulation			RB #			Test Channel		
		1.4	3	5	10	15	20	QPSK	16QAM	64QAM	1	Half	Full	L	M	H
Conducted Band Edge	4	v	v	v	v	v	v	v	v	v	v		v	v		v
	5	v	v	v	v	-	-	v	v	v	v		v	v		v
	7	-	-	v	v	v	v	v	v	v	v		v	v		v
	13	-	-	v	v	-	-	v	v	v	v		v	v		v
	17	-	-	v	v	-	-	v	v	v	v		v	v		v
	41	-	-	v	v	v	v	v	v	v	v		v	v		v
Conducted Spurious Emission	4	v	v	v	v	v	v	v			v			v	v	v
	5	v	v	v	v	-	-	v			v			v	v	v
	7	-	-	v	v	v	v	v			v			v	v	v
	13	-	-	v	v	-	-	v			v			v	v	v
	17			v	v	-	-	v			v			v	v	v
	41	-	-	v	v	v	v	v			v			v	v	v
Frequency Stability	4				v			v					v		v	
	5				v	-	-	v					v		v	
	7	-	-		v			v					v		v	
	13	-	-		v	-	-	v					v		v	
	17	-	-		v	-	-	v					v		v	
	41	-	-		v			v					v		v	



Test Items	Band	Bandwidth (MHz)						Modulation			RB #			Test Channel		
		1.4	3	5	10	15	20	QPSK	16QAM	64QAM	1	Half	Full	L	M	H
E.R.P / E.I.R.P	4	v	v	v	v	v	v	v	v	v	Max. Power					
	5	v	v	v	v	-	-	v	v	v						
	7	-	-	v	v	v	v	v	v	v						
	13	-	-	v	v	-	-	v	v	v						
	17	-	-	v	v	-	-	v	v	v						
	41	-	-	v	v	v	v	v	v	v						
Radiated Spurious Emission	4	Worst Case										v	v	v		
	5	Worst Case										v	v	v		
	7	Worst Case										v	v	v		
	13	Worst Case										v	v	v		
	17	Worst Case										v	v	v		
	41	Worst Case										v	v	v		
Remark	<ol style="list-style-type: none"> <li>The mark "v" means that this configuration is chosen for testing</li> <li>The mark "-" means that this bandwidth is not supported.</li> <li>The device is investigated from 30MHz to 10 times of fundamental signal for radiated spurious emission test under different RB size/offset and modulations in exploratory test. Subsequently, only the worst case emissions are reported.</li> </ol>															

## 2.2 Connection Diagram of Test System

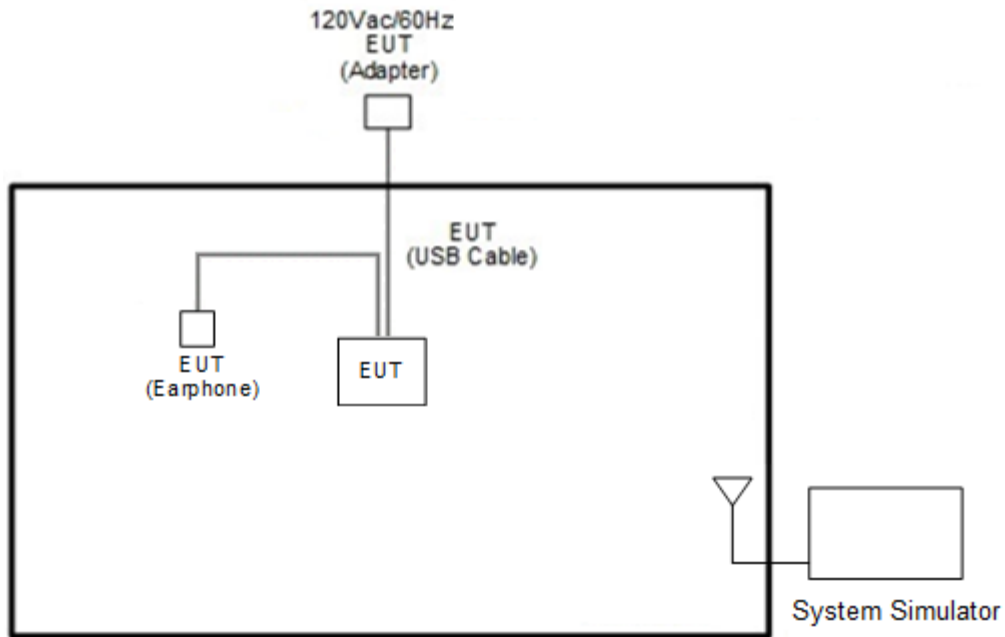

## 2.3 Support Unit used in test configuration and system

Item	Equipment	Brand Name	Model No.	FCC ID	Data Cable	Power Cord
1.	System Simulator	Anritsu	MT8820C	N/A	N/A	Unshielded, 1.8 m

## 2.4 Measurement Results Explanation Example

### For all conducted test items:

The offset level is set in the spectrum analyzer to compensate the RF cable loss and attenuator factor between EUT conducted output port and spectrum analyzer. With the offset compensation, the spectrum analyzer reading level is exactly the EUT RF output level.

The spectrum analyzer offset is derived from RF cable loss and attenuator factor.

*Offset = RF cable loss + attenuator factor.*

Following shows an offset computation example with cable loss 4.2 dB and 10dB attenuator.

Example :

$$\begin{aligned} \text{Offset(dB)} &= \text{RF cable loss(dB)} + \text{attenuator factor(dB)} \\ &= 4.2 + 10 = 14.2 \text{ (dB)} \end{aligned}$$



## 2.5 Frequency List of Low/Middle/High Channels

LTE Band 4 Channel and Frequency List				
BW [MHz]	Channel/Frequency(MHz)	Lowest	Middle	Highest
20	Channel	20050	20175	20300
	Frequency	1720	1732.5	1745
15	Channel	20025	20175	20325
	Frequency	1717.5	1732.5	1747.5
10	Channel	20000	20175	20350
	Frequency	1715	1732.5	1750
5	Channel	19975	20175	20375
	Frequency	1712.5	1732.5	1752.5
3	Channel	19965	20175	20385
	Frequency	1711.5	1732.5	1753.5
1.4	Channel	19957	20175	20393
	Frequency	1710.7	1732.5	1754.3

LTE Band 5 Channel and Frequency List				
BW [MHz]	Channel/Frequency(MHz)	Lowest	Middle	Highest
10	Channel	20450	20525	20600
	Frequency	829	836.5	844
5	Channel	20425	20525	20625
	Frequency	826.5	836.5	846.5
3	Channel	20415	20525	20635
	Frequency	825.5	836.5	847.5
1.4	Channel	20407	20525	20643
	Frequency	824.7	836.5	848.3

LTE Band 7 Channel and Frequency List				
BW [MHz]	Channel/Frequency(MHz)	Lowest	Middle	Highest
20	Channel	20850	21100	21350
	Frequency	2510	2535	2560
15	Channel	20825	21100	21375
	Frequency	2507.5	2535	2562.5
10	Channel	20800	21100	21400
	Frequency	2505	2535	2565
5	Channel	20775	21100	21425
	Frequency	2502.5	2535	2567.5



LTE Band 13 Channel and Frequency List				
BW [MHz]	Channel/Frequency(MHz)	Lowest	Middle	Highest
10	Channel	-	23230	-
	Frequency	-	782	-
5	Channel	23205	23230	23255
	Frequency	779.5	782	784.5

LTE Band 17 Channel and Frequency List				
BW [MHz]	Channel/Frequency(MHz)	Lowest	Middle	Highest
10	Channel	23780	23790	23800
	Frequency	709	710	711
5	Channel	23755	23790	23825
	Frequency	706.5	710	713.5

LTE Band 41 Channel and Frequency List				
BW [MHz]	Channel/Frequency(MHz)	Lowest	Middle	Highest
20	Channel	39750	40620	41490
	Frequency	2506.0	2593.0	2680.0
15	Channel	39725	40620	41515
	Frequency	2503.5	2593.0	2682.5
10	Channel	39700	40620	41540
	Frequency	2501.0	2593.0	2685.0
5	Channel	39675	40620	41565
	Frequency	2498.5	2593.0	2687.5



### 3 Conducted Test Items

#### 3.1 Measuring Instruments

See list of measuring instruments of this test report.

##### 3.1.1 Test Setup

##### 3.1.2 Conducted Output Power

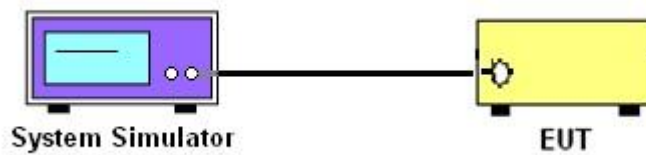

##### 3.1.3 Peak-to-Average Ratio, Occupied Bandwidth ,Conducted Band-Edge and Conducted Spurious Emission

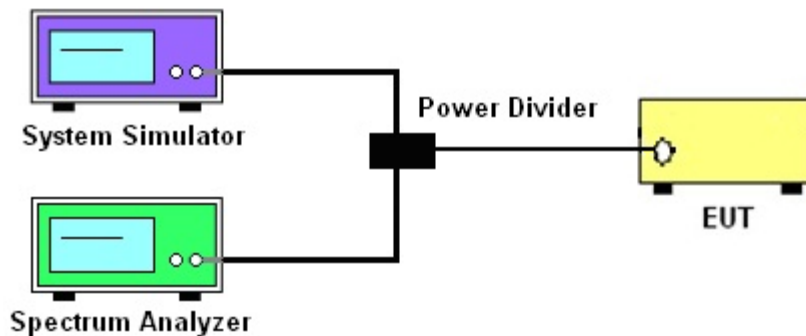

##### 3.1.4 Frequency Stability

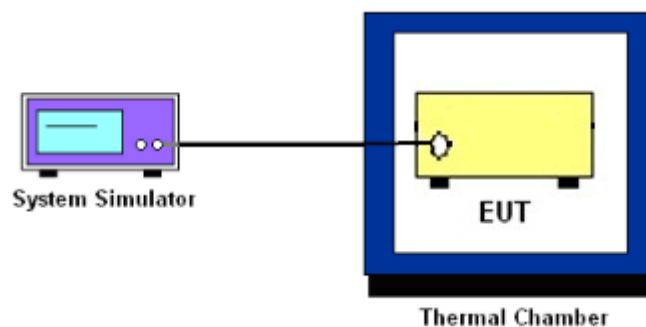

##### 3.1.5 Test Result of Conducted Test

Please refer to Appendix A.



## **3.2 Conducted Output Power and ERP/EIRP**

### **3.2.1 Description of the Conducted Output Power Measurement and ERP/EIRP/EIRP Measurement**

A system simulator was used to establish communication with the EUT. Its parameters were set to force the EUT transmitting at maximum output power. The measured power in the radio frequency on the transmitter output terminals shall be reported.

The ERP of mobile transmitters must not exceed 7 Watts for LTE Band 5

The ERP of mobile transmitters must not exceed 3 Watts for LTE Band 13 and Band 17

The EIRP of mobile transmitters must not exceed 2 Watts for LTE Band 7 and Band 41

The EIRP of mobile transmitters must not exceed 1 Watts for LTE Band 4

According to KDB 412172 D01 Power Approach,

$EIRP = PT + GT - LC$ ,  $ERP = EIRP - 2.15$ , where

PT = transmitter output power in dBm

GT = gain of the transmitting antenna in dBi

LC = signal attenuation in the connecting cable between the transmitter and antenna in Db

### **3.2.2 Test Procedures**

1. The transmitter output port was connected to the system simulator.
2. Set EUT at maximum power through the system simulator.
3. Select lowest, middle, and highest channels for each band and different modulation.
4. Measure and record the power level from the system simulator.



### **3.3 Peak-to-Average Ratio**

#### **3.3.1 Description of the PAR Measurement**

Power Complementary Cumulative Distribution Function (CCDF) curves provide a means for characterizing the power peaks of a digitally modulated signal on a statistical basis. A CCDF curve depicts the probability of the peak signal amplitude exceeding the average power level. Most contemporary measurement instrumentation include the capability to produce CCDF curves for an input signal provided that the instrument's resolution bandwidth can be set wide enough to accommodate the entire input signal bandwidth. In measuring transmissions in this band using an average power technique, the peak-to-average ratio (PAR) of the transmission may not exceed 13 dB.

#### **3.3.2 Test Procedures**

The testing follows ANSI C63.26-2015 Section 5.2.6

1. The EUT was connected to spectrum and system simulator via a power divider.
2. Set the CCDF (Complementary Cumulative Distribution Function) option in spectrum analyzer.
3. The highest RF powers were measured and recorded the maximum PAPR level associated with a probability of 0.1 %.
4. Record the deviation as Peak to Average Ratio.



## 3.4 Occupied Bandwidth

### 3.4.1 Description of Occupied Bandwidth Measurement

The occupied bandwidth is the width of a frequency band such that, below the lower and above the upper frequency limits, the mean powers emitted are each equal to a specified percentage 0.5% of the total mean transmitted power.

The 26 dB emission bandwidth is defined as the frequency range between two points, one above and one below the carrier frequency, at which the spectral density of the emission is attenuated 26 dB below the maximum in-band spectral density of the modulated signal. Spectral density (power per unit bandwidth) is to be measured with a detector of resolution bandwidth equal to approximately 1.0% of the emission bandwidth.

### 3.4.2 Test Procedures

The testing follows ANSI C63.26-2015 Section 5.4.3 (26dB) and Section 5.4.4 (99OB)

1. The EUT was connected to spectrum analyzer and system simulator via a power divider.
2. The spectrum analyzer center frequency is set to the nominal EUT channel center frequency. The span range for the spectrum analyzer shall be between two and five times the anticipated OBW.
3. The nominal resolution bandwidth (RBW) shall be in the range of 1 to 5 % of the anticipated OBW, and the VBW shall be at least 3 times the RBW.
4. Set the detection mode to peak, and the trace mode to max hold.
5. Determine the reference value: Set the EUT to transmit a modulated signal. Allow the trace to stabilize. Set the spectrum analyzer marker to the highest level of the displayed trace.  
(this is the reference value)
6. Determine the “-26 dB down amplitude” as equal to (Reference Value – X).
7. Place two markers, one at the lowest and the other at the highest frequency of the envelope of the spectral display such that each marker is at or slightly below the “-X dB down amplitude” determined in step 6. If a marker is below this “-X dB down amplitude” value it shall be placed as close as possible to this value. The OBW is the positive frequency difference between the two markers.
8. Use the 99 % power bandwidth function of the spectrum analyzer and report the measured bandwidth.



## 3.5 Conducted Band Edge

### 3.5.1 Description of Conducted Band Edge Measurement

27.53 (g)

For operations in the 600MHz band and 698-746 MHz band, the FCC limit is  $43 + 10\log_{10}(P[\text{Watts}])$  dB below the transmitter power P(Watts) in a 100 kHz bandwidth. However, in the 100 kilohertz bands immediately outside and adjacent to a licensee's frequency block, a resolution bandwidth of at least 30 kHz may be employed.

### 3.5.2 Test Procedures

The testing follows FCC KDB 971168 D01 v03r01 Section 6.1.

1. The EUT was connected to spectrum analyzer and system simulator via a power divider.
2. The band edges of low and high channels for the highest RF powers were measured.
3. Set RBW  $\geq$  1% EBW in the 1MHz band immediately outside and adjacent to the band edge.
4. Beyond the 1 MHz band from the band edge, RBW=1MHz was used.
5. Set spectrum analyzer with RMS detector.
6. The RF fundamental frequency should be excluded against the limit line in the operating frequency band.
7. Checked that all the results comply with the emission limit line.

The limit line is derived from  $43 + 10\log(P)$ dB below the transmitter power P(Watts)



## 3.6 Conducted Spurious Emission

### 3.6.1 Description of Conducted Spurious Emission Measurement

The power of any emission outside of the authorized operating frequency ranges must be lower than the transmitter power (P) by a factor of at least  $43 + 10 \log (P)$  dB.

### 3.6.2 Test Procedures

The testing follows FCC KDB 971168 D01 v03r01 Section 6.1.

1. The EUT was connected to spectrum analyzer and system simulator via a power divider.
2. The RF output of EUT was connected to the spectrum analyzer by RF cable and attenuator. The path loss was compensated to the results for each measurement.
3. The middle channel for the highest RF power within the transmitting frequency was measured.
4. The conducted spurious emission for the whole frequency range was taken.
5. Make the measurement with the spectrum analyzer's RBW = 1MHz, VBW = 3MHz.
6. Set spectrum analyzer with RMS detector.
7. Taking the record of maximum spurious emission.
8. The RF fundamental frequency should be excluded against the limit line in the operating frequency band.
9. The limit line is derived from  $43 + 10\log(P)$ dB below the transmitter power P(Watts)



## 3.7 Frequency Stability

### 3.7.1 Description of Frequency Stability Measurement

27.54

The frequency stability shall be sufficient to ensure that the fundamental emission stays within the authorized frequency block.

### 3.7.2 Test Procedures for Temperature Variation

The testing follows FCC KDB 971168 D01 v03r01 Section 9.0.

1. The EUT was set up in the thermal chamber and connected with the system simulator.
2. With power OFF, the temperature was decreased to  $-30^{\circ}\text{C}$  and the EUT was stabilized before testing. Power was applied and the maximum change in frequency was recorded within one minute.
3. With power OFF, the temperature was raised in  $10^{\circ}\text{C}$  step up to  $50^{\circ}\text{C}$ . The EUT was stabilized at each step for at least half an hour. Power was applied and the maximum frequency change was recorded within one minute.

### 3.7.3 Test Procedures for Voltage Variation

The testing follows FCC KDB 971168 D01 v03r01 Section 9.0.

1. The EUT was placed in a temperature chamber at  $20\pm 5^{\circ}\text{C}$  and connected with the system simulator.
2. The power supply voltage to the EUT was varied from 85% to 115% of the nominal value measured at the input to the EUT.
3. The variation in frequency was measured for the worst case.

## 4 Radiated Test Items

### 4.1 Measuring Instruments

See list of measuring instruments of this test report.

#### 4.1.1 Test Setup

For radiated test below 30MHz

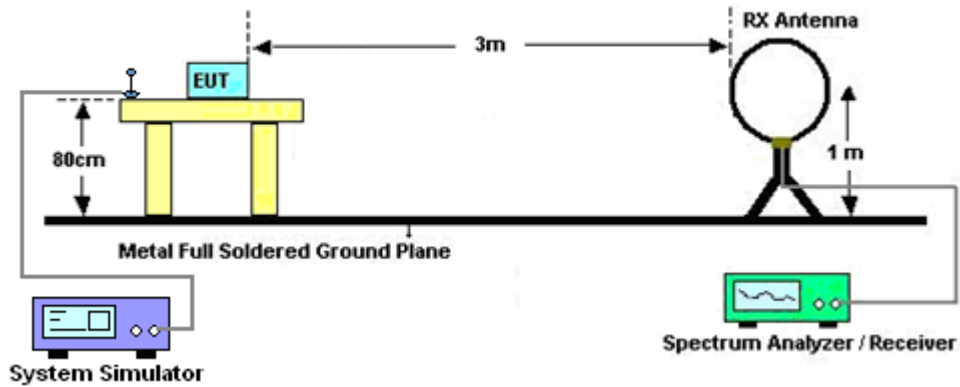

For radiated test from 30MHz to 1GHz

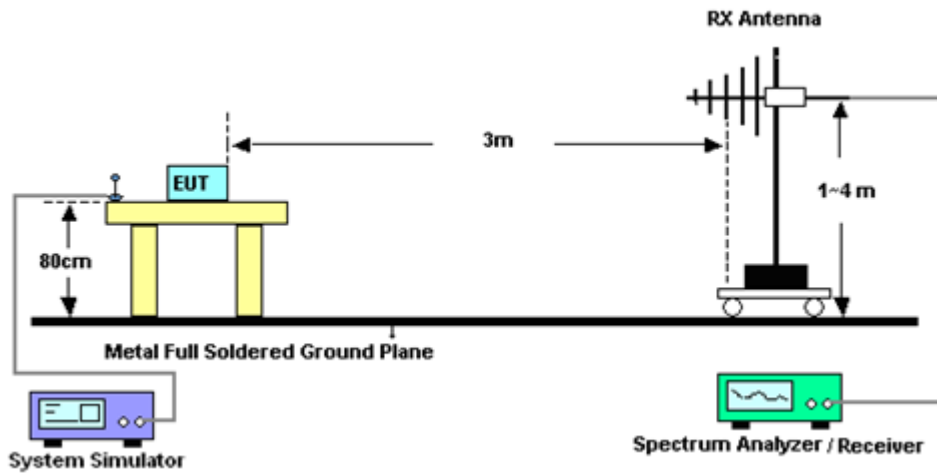



For radiated test from 1GHz to 18GHz

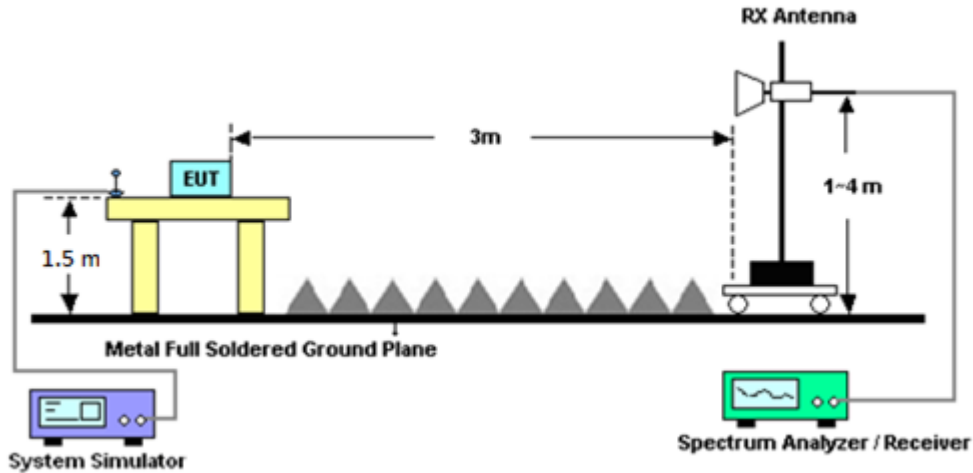

For radiated test above 18GHz

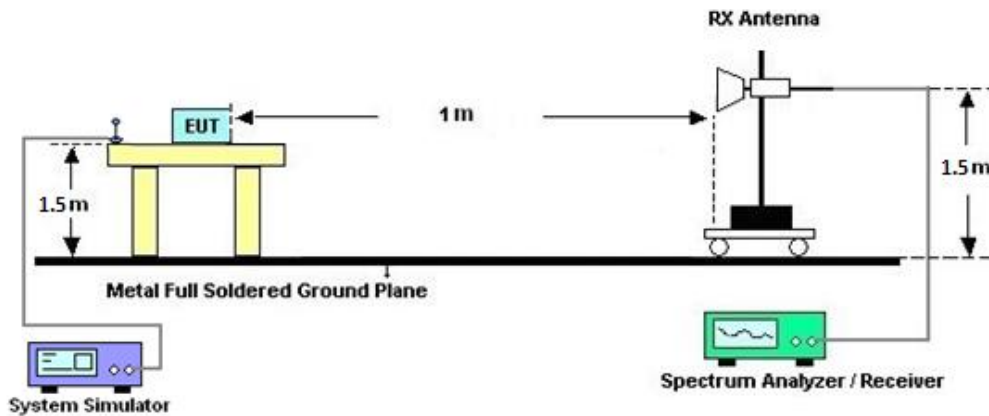

#### 4.1.2 Test Result of Radiated Test

Please refer to Appendix B.

**Note:**

The low frequency, which started from 9 kHz to 30MHz, was pre-scanned and the result which was 20dB lower than the limit line was not reported.

There is adequate comparison measurement of both open-field test site and alternative test site - semi-Anechoic chamber according to 414788 D01 Radiated Test Site v01r01, and the result came out very similar.



## 4.2 Radiated Spurious Emission Measurement

### 4.2.1 Description of Radiated Spurious Emission Measurement

The power of any emission outside of the authorized operating frequency ranges must be attenuated below the transmitter power (P) by a factor of at least  $43 + 10 \log (P)$  dB.

For LTE Band 7, 41

The power of any emission outside of the authorized operating frequency ranges must be attenuated below the transmitter power (P) by a factor of at least  $55 + 10 \log (P)$  dB.

For LTE Band 13

For operations in the 746-758 MHz, 775-788 MHz, and 805-806 MHz bands, emissions in the band 1559-1610 MHz shall be limited to  $-70$  dBW/MHz equivalent isotropically radiated power (EIRP) for wideband signals, and  $-80$  dBW EIRP for discrete emissions of less than 700 Hz bandwidth.

The spectrum is scanned from 30 MHz up to a frequency including its 10th harmonic.

### 4.2.2 Test Procedures

The testing follows FCC KDB 971168 D01 v03r01 Section 7 and ANSI / TIA-603-E Section 2.2.12.

1. The EUT was placed on a turntable with 0.8 meter for frequency below 1GHz and 1.5 meter for frequency above 1GHz respectively above ground.
2. The EUT was set 3 meters from the receiving antenna, which was mounted on the antenna tower.
3. The table was rotated 360 degrees to determine the position of the highest spurious emission.
4. The height of the receiving antenna is varied between one meter and four meters to search the maximum spurious emission for both horizontal and vertical polarizations.
5. Make the measurement with the spectrum analyzer's RBW = 1MHz, VBW = 3MHz, taking the record of maximum spurious emission.
6. A horn antenna was substituted in place of the EUT and was driven by a signal generator.
7. Tune the output power of signal generator to the same emission level with EUT maximum spurious emission.
8. Taking the record of output power at antenna port.
9. Repeat step 7 to step 8 for another polarization.
10. The RF fundamental frequency should be excluded against the limit line in the operating frequency band.

The limit line is derived from  $43 + 10\log(P)$ dB below the transmitter power P(Watts)

For LTE Band 7, 41

The limit line is derived from  $55 + 10\log(P)$ dB below the transmitter power P(Watts)

EIRP (dBm) = S.G. Power – Tx Cable Loss + Tx Antenna Gain

ERP (dBm) = EIRP - 2.15



## 5 List of Measuring Equipment

Instrument	Brand Name	Model No.	Serial No.	Characteristics	Calibration Date	Test Date	Due Date	Remark
Bilog Antenna	TESEQ	CBL 6111D & 00800N1D01N-06	37059 & 01	30MHz~1GHz	Oct. 11, 2020	Jun. 20, 2021~Jun. 27, 2021	Oct. 10, 2021	Radiation (03CH15-HY)
Bilog Antenna	TESEQ	CBL6111D&00800N1D01N-06	41912&05	30MHz to 1GHz	Feb. 08, 2021	Jun. 20, 2021~Jun. 27, 2021	Feb. 07, 2022	Radiation (03CH15-HY)
Amplifier	SONOMA	310N	363440	9kHz~1GHz	Dec. 28, 2020	Jun. 20, 2021~Jun. 27, 2021	Dec. 27, 2021	Radiation (03CH15-HY)
Horn Antenna	SCHWARZBECK	BBHA 9120 D	9120D-02114	1-18GHz	Aug. 04, 2020	Jun. 20, 2021~Jun. 27, 2021	Aug. 03, 2021	Radiation (03CH15-HY)
Horn Antenna	SCHWARZBECK	BBHA 9120 D	9120D-1326	1GHz~18GHz	Nov. 03, 2020	Jun. 20, 2021~Jun. 27, 2021	Nov. 02, 2021	Radiation (03CH15-HY)
SHF-EHF Horn Antenna	SCHWARZBECK	BBHA 9170	BBHA9170251	18GHz- 40GHz	Dec. 02, 2020	Jun. 20, 2021~Jun. 27, 2021	Dec. 01, 2021	Radiation (03CH15-HY)
SHF-EHF Horn Antenna	SCHWARZBECK	BBHA 9170	BBHA9170576	18GHz~40GHz	May 21, 2021	Jun. 20, 2021~Jun. 27, 2021	May 20, 2022	Radiation (03CH15-HY)
Preamplifier	Jet-Power	JPA0118-55-303	1710001800055006	1GHz~18GHz	May 06, 2021	Jun. 20, 2021~Jun. 27, 2021	May 05, 2022	Radiation (03CH15-HY)
Preamplifier	Keysight	83017A	MY53270195	1GHz~26.5GHz	Aug. 21, 2020	Jun. 20, 2021~Jun. 27, 2021	Aug. 20, 2021	Radiation (03CH15-HY)
Preamplifier	EMEC	EM18G40G	060715	18GHz ~ 40GHz	Dec. 11, 2020	Jun. 20, 2021~Jun. 27, 2021	Dec. 10, 2021	Radiation (03CH15-HY)
Spectrum Analyzer	Keysight	N9038A	MY54130085	20MHz~8.4GHz	Nov. 02, 2020	Jun. 20, 2021~Jun. 27, 2021	Nov. 01, 2021	Radiation (03CH15-HY)
Spectrum Analyzer	Keysight	N9010A	MY54200485	10Hz~44GHz	Mar. 05, 2021	Jun. 20, 2021~Jun. 27, 2021	Mar. 04, 2022	Radiation (03CH15-HY)
Antenna Mast	ChainTek	MBS-520-1	N/A	1m~4m	N/A	Jun. 20, 2021~Jun. 27, 2021	N/A	Radiation (03CH15-HY)
Turn Table	ChainTek	T-200-S-1	N/A	0~360 Degree	N/A	Jun. 20, 2021~Jun. 27, 2021	N/A	Radiation (03CH15-HY)
Software	Audix	E3 6.2009-8-24(k5)	RK-000451	N/A	N/A	Jun. 20, 2021~Jun. 27, 2021	N/A	Radiation (03CH15-HY)
RF Cable	HUBER + SUHNER	SUCOFLEX 104, 102E	MY36980/4, MY9838/4PE,508405/2E	30MHz~18G	Nov. 16, 2020	Jun. 20, 2021~Jun. 27, 2021	Nov. 15, 2021	Radiation (03CH15-HY)
RF Cable	HUBER + SUHNER	SUCOFLEX 102	505134/2	30MHz-40GHz	Feb. 22, 2021	Jun. 20, 2021~Jun. 27, 2021	Feb. 21, 2022	Radiation (03CH15-HY)
RF Cable	HUBER + SUHNER	SUCOFLEX 102	800740/2	30MHz-40GHz	Feb. 22, 2021	Jun. 20, 2021~Jun. 27, 2021	Feb. 21, 2022	Radiation (03CH15-HY)
RF Cable	HUBER + SUHNER	SUCOFLEX 104	MY9837/4PE	9kHz~30MHz	Mar. 11, 2021	Jun. 20, 2021~Jun. 27, 2021	Mar. 10, 2022	Radiation (03CH15-HY)



Instrument	Brand Name	Model No.	Serial No.	Characteristics	Calibration Date	Test Date	Due Date	Remark
Filter	Wainwright	WLK4-1000-1530-8000-40SS	SN4	1.53G Low Pass	Jul. 03, 2020	Jun. 20, 2021~ Jun. 27, 2021	Jul. 02, 2021	Radiation (03CH15-HY)
Filter	Wainwright	WHKX12-1080-1200-15000-60ST	SN5	1.2GHz High Pass Filter	Jul. 01, 2020	Jun. 20, 2021~ Jun. 27, 2021	Jun. 30, 2021	Radiation (03CH15-HY)
Filter	Wainwright	WHKX12-2700-3000-18000-60ST	SN4	3GHz High Pass Filter	Sep. 16, 2020	Jun. 20, 2021~ Jun. 27, 2021	Sep. 15, 2021	Radiation (03CH15-HY)
Signal Generator	Anritsu	MG3694C	163401	0.1Hz~40GHz	Jan. 31, 2021	Jun. 20, 2021~ Jun. 27, 2021	Jan. 30, 2022	Radiation (03CH15-HY)
Base Station (Measure)	Anritsu	MT8821C	62620025341	N/A	Oct. 05, 2020	Jun. 27, 2021	Oct. 04, 2021	Conducted (TH03-HY)
Spectrum Analyzer	Rohde & Schwarz	FSV40	101397	10Hz~40GHz	Nov. 27, 2020	Jun. 27, 2021	Nov. 26, 2021	Conducted (TH03-HY)
Thermal Chamber	Ten Billion	TTH-D3SP	TBN-930701	N/A	Aug. 05, 2020	Jun. 27, 2021	Aug. 04, 2021	Conducted (TH03-HY)
Programmable Power Supply	GW Instek	PSS-2005	EL890094	1V~20V 0.5A~5A	Oct. 05, 2020	Jun. 27, 2021	Oct. 04, 2021	Conducted (TH03-HY)
Coupler	Warison	20dB 25W SMA Directional Coupler	#B	1-18GHz	Jan. 09, 2021	Jun. 27, 2021	Jan. 08, 2022	Conducted (TH03-HY)



## 6 Uncertainty of Evaluation

### Uncertainty of Radiated Emission Measurement (30 MHz ~ 1000 MHz)

Measuring Uncertainty for a Level of Confidence of 95% ( $U = 2Uc(y)$ )	2.98
---	------

### Uncertainty of Radiated Emission Measurement (1 GHz ~ 18 GHz)

Measuring Uncertainty for a Level of Confidence of 95% ( $U = 2Uc(y)$ )	3.31
---	------

### Uncertainty of Radiated Emission Measurement (18 GHz ~ 40 GHz)

Measuring Uncertainty for a Level of Confidence of 95% ( $U = 2Uc(y)$ )	3.92
---	------



## Appendix A. Test Results of Conducted Test

### Conducted Output Power(Average power & ERP/EIRP)

LTE Band 4 Maximum Average Power [dBm] (GT - LC = -0.7 dB)								
BW [MHz]	RB Size	RB Offset	Mod	Lowest	Middle	Highest	EIRP (dBm)	EIRP (W)
20	1	0	QPSK	19.45	19.52	19.43	18.82	0.0762
20	1	49		19.18	19.33	19.33		
20	1	99		19.27	19.28	19.28		
20	50	0		19.39	19.48	19.45		
20	50	24		19.44	19.43	19.45		
20	50	50		19.35	19.41	19.37		
20	100	0		19.39	19.43	19.44		
20	1	0	16-QAM	19.18	19.21	19.28	18.58	0.0721
20	1	49		19.06	19.12	19.13		
20	1	99		19.13	19.17	19.13		
20	50	0		18.91	19.02	18.98		
20	50	24		18.94	18.95	18.98		
20	50	50		18.88	18.94	18.89		
20	100	0		18.91	18.92	18.95		
20	1	0	64-QAM	19.04	19.08	19.14	18.44	0.0698
20	1	49		18.87	19.03	19.03		
20	1	99		19.06	19.01	19.00		
20	50	0		18.93	19.05	18.99		
20	50	24		18.98	18.99	19.01		
20	50	50		18.88	18.97	18.92		
20	100	0		18.97	18.96	18.98		
Limit	EIRP < 1W			Result			Pass	



LTE Band 4 Maximum Average Power [dBm] (GT - LC = -0.7 dB)								
BW [MHz]	RB Size	RB Offset	Mod	Lowest	Middle	Highest	EIRP (dBm)	EIRP (W)
15	1	0	QPSK	19.32	19.43	19.43	18.80	0.0759
15	1	37		19.24	19.34	19.28		
15	1	74		19.20	19.29	19.27		
15	36	0		19.39	19.50	19.44		
15	36	20		19.36	19.44	19.47		
15	36	39		19.34	19.44	19.40		
15	75	0		19.39	19.43	19.38		
15	1	0	16-QAM	19.17	19.28	19.29	18.59	0.0723
15	1	37		19.05	19.17	19.12		
15	1	74		19.08	19.21	19.15		
15	36	0		18.89	19.01	18.98		
15	36	20		18.90	18.96	18.98		
15	36	39		18.88	18.95	18.91		
15	75	0		18.92	18.95	18.91		
15	1	0	64-QAM	19.08	19.16	19.16	18.46	0.0701
15	1	37		18.95	19.09	19.05		
15	1	74		18.98	19.04	19.01		
15	36	0		18.91	19.07	19.04		
15	36	20		18.92	19.01	18.99		
15	36	39		18.89	19.02	18.95		
15	75	0		18.93	19.00	18.93		
Limit	EIRP < 1W			Result			Pass	



LTE Band 4 Maximum Average Power [dBm] (GT - LC = -0.7 dB)								
BW [MHz]	RB Size	RB Offset	Mod	Lowest	Middle	Highest	EIRP (dBm)	EIRP (W)
10	1	0	QPSK	19.29	19.40	19.33	18.81	0.0760
10	1	25		19.23	19.37	19.34		
10	1	49		19.22	19.38	19.34		
10	25	0		19.37	19.43	19.37		
10	25	12		19.39	19.47	19.38		
10	25	25		19.40	19.51	19.47		
10	50	0		19.41	19.46	19.42		
10	1	0	16-QAM	19.14	19.27	19.24	18.57	0.0719
10	1	25		19.13	19.24	19.20		
10	1	49		19.15	19.25	19.24		
10	25	0		18.90	18.95	18.91		
10	25	12		18.92	18.97	18.93		
10	25	25		18.93	19.04	18.98		
10	50	0		18.92	18.97	18.92		
10	1	0	64-QAM	19.05	19.08	19.01	18.53	0.0713
10	1	25		19.07	19.23	19.16		
10	1	49		19.05	19.15	19.09		
10	25	0		18.93	19.00	18.93		
10	25	12		18.96	19.03	18.98		
10	25	25		18.94	19.07	19.03		
10	50	0		18.94	19.02	18.94		
Limit	EIRP < 1W			Result			Pass	





LTE Band 4 Maximum Average Power [dBm] (GT - LC = -0.7 dB)								
BW [MHz]	RB Size	RB Offset	Mod	Lowest	Middle	Highest	EIRP (dBm)	EIRP (W)
5	1	0	QPSK	19.23	19.33	19.29	18.78	0.0755
5	1	12		19.23	19.38	19.30		
5	1	24		19.27	19.43	19.38		
5	12	0		19.34	19.38	19.38		
5	12	7		19.40	19.45	19.42		
5	12	13		19.35	19.48	19.40		
5	25	0		19.33	19.35	19.37		
5	1	0	16-QAM	19.03	19.09	19.10	18.47	0.0703
5	1	12		18.99	19.06	19.03		
5	1	24		19.12	19.17	19.05		
5	12	0		18.88	18.89	18.90		
5	12	7		18.93	18.95	18.96		
5	12	13		18.89	19.00	18.90		
5	25	0		18.90	18.91	18.93		
5	1	0	64-QAM	19.08	19.10	19.07	18.53	0.0713
5	1	12		19.05	19.16	19.13		
5	1	24		19.06	19.23	19.19		
5	12	0		18.93	18.96	18.98		
5	12	7		18.99	19.03	19.04		
5	12	13		18.95	19.07	18.99		
5	25	0		18.92	18.95	18.91		
Limit	EIRP < 1W			Result			Pass	



LTE Band 4 Maximum Average Power [dBm] (GT - LC = -0.7 dB)								
BW [MHz]	RB Size	RB Offset	Mod	Lowest	Middle	Highest	EIRP (dBm)	EIRP (W)
3	1	0	QPSK	19.29	19.36	19.35	18.80	0.0759
3	1	8		19.34	19.47	19.40		
3	1	14		19.28	19.41	19.40		
3	8	0		19.36	19.39	19.42		
3	8	4		19.39	19.41	19.44		
3	8	7		19.37	19.50	19.43		
3	15	0		19.38	19.41	19.41		
3	1	0	16-QAM	19.06	19.18	19.12	18.50	0.0708
3	1	8		19.09	19.20	19.13		
3	1	14		19.12	19.17	19.12		
3	8	0		18.89	18.93	18.94		
3	8	4		18.96	19.00	19.00		
3	8	7		18.89	19.01	18.94		
3	15	0		18.91	18.93	18.96		
3	1	0	64-QAM	19.12	19.12	19.12	18.56	0.0718
3	1	8		19.09	19.26	19.24		
3	1	14		19.11	19.23	19.22		
3	8	0		18.95	18.97	19.03		
3	8	4		18.98	19.02	19.03		
3	8	7		18.97	19.04	19.04		
3	15	0		18.94	18.98	19.00		
Limit	EIRP < 1W			Result			Pass	



LTE Band 4 Maximum Average Power [dBm] (GT - LC = -0.7 dB)								
BW [MHz]	RB Size	RB Offset	Mod	Lowest	Middle	Highest	EIRP (dBm)	EIRP (W)
1.4	1	0	QPSK	19.22	19.31	19.25	18.66	0.0735
1.4	1	3		19.26	19.36	19.28		
1.4	1	5		19.22	19.35	19.26		
1.4	3	0		19.11	19.20	19.13		
1.4	3	1		19.32	19.35	19.34		
1.4	3	3		19.20	19.24	19.21		
1.4	6	0		19.33	19.35	19.31		
1.4	1	0	16-QAM	19.05	19.11	19.06	18.50	0.0708
1.4	1	3		19.14	19.20	19.15		
1.4	1	5		19.14	19.16	19.15		
1.4	3	0		18.83	18.94	18.88		
1.4	3	1		18.90	18.99	18.90		
1.4	3	3		18.85	18.97	18.88		
1.4	6	0		18.88	18.92	18.93		
1.4	1	0	64-QAM	19.00	19.03	19.01	18.43	0.0697
1.4	1	3		19.04	19.10	19.00		
1.4	1	5		19.00	19.11	19.00		
1.4	3	0		19.02	19.05	19.03		
1.4	3	1		19.06	19.13	19.04		
1.4	3	3		19.04	19.13	19.03		
1.4	6	0		18.86	18.88	18.87		
Limit	EIRP < 1W			Result			Pass	



LTE Band 5 Maximum Average Power [dBm] (GT - LC = -4.5 dB)								
BW [MHz]	RB Size	RB Offset	Mod	Lowest	Middle	Highest	ERP (dBm)	ERP (W)
10	1	0	QPSK	24.25	24.35	24.07	17.70	0.0589
10	1	25		24.16	24.03	23.97		
10	1	49		24.09	23.95	23.88		
10	25	0		23.30	23.16	23.10		
10	25	12		23.36	23.23	23.19		
10	25	25		23.29	23.17	23.12		
10	50	0		23.33	23.22	23.18		
10	1	0	16-QAM	23.62	23.50	23.42	16.97	0.0498
10	1	25		23.52	23.42	23.31		
10	1	49		23.48	23.39	23.29		
10	25	0		22.28	22.19	22.12		
10	25	12		22.36	22.23	22.15		
10	25	25		22.29	22.16	22.12		
10	50	0		22.33	22.24	22.18		
10	1	0	64-QAM	22.47	22.36	22.29	15.82	0.0382
10	1	25		22.46	22.30	22.30		
10	1	49		22.29	22.13	21.88		
10	25	0		21.31	21.21	21.13		
10	25	12		21.40	21.27	21.22		
10	25	25		21.31	21.20	21.13		
10	50	0		21.37	21.26	21.21		
Limit	ERP < 7W			Result			Pass	



LTE Band 5 Maximum Average Power [dBm] (GT - LC = -4.5 dB)								
BW [MHz]	RB Size	RB Offset	Mod	Lowest	Middle	Highest	ERP (dBm)	ERP (W)
5	1	0	QPSK	24.28	24.15	24.06	17.63	0.0579
5	1	12		24.21	24.03	23.98		
5	1	24		24.13	23.95	23.91		
5	12	0		23.39	23.13	23.06		
5	12	7		23.39	23.20	23.03		
5	12	13		23.29	23.13	23.01		
5	25	0		23.31	23.17	23.00		
5	1	0	16-QAM	23.65	23.43	23.34	17.00	0.0501
5	1	12		23.44	23.25	23.25		
5	1	24		23.51	23.29	23.19		
5	12	0		22.39	22.16	22.06		
5	12	7		22.38	22.22	22.02		
5	12	13		22.27	22.09	22.03		
5	25	0		22.35	22.21	22.03		
5	1	0	64-QAM	22.66	22.41	22.33	16.01	0.0399
5	1	12		22.51	22.29	22.15		
5	1	24		22.44	22.31	21.73		
5	12	0		21.44	21.22	21.13		
5	12	7		21.42	21.23	21.08		
5	12	13		21.32	21.15	20.95		
5	25	0		21.35	21.19	21.03		
Limit	ERP < 7W			Result			Pass	



LTE Band 5 Maximum Average Power [dBm] (GT - LC = -4.5 dB)								
BW [MHz]	RB Size	RB Offset	Mod	Lowest	Middle	Highest	ERP (dBm)	ERP (W)
3	1	0	QPSK	24.31	24.13	24.07	17.66	0.0583
3	1	8		24.29	24.09	24.00		
3	1	14		24.15	24.01	23.91		
3	8	0		23.37	23.15	22.65		
3	8	4		23.34	23.19	22.97		
3	8	7		23.32	23.14	23.03		
3	15	0		23.34	23.17	23.06		
3	1	0	16-QAM	23.60	23.46	23.31	17.01	0.0502
3	1	8		23.66	23.42	23.28		
3	1	14		23.46	23.27	23.21		
3	8	0		22.40	22.12	22.09		
3	8	4		22.43	22.30	22.16		
3	8	7		22.33	22.17	22.06		
3	15	0		22.37	22.22	22.10		
3	1	0	64-QAM	22.64	22.39	22.17	15.99	0.0397
3	1	8		22.60	22.43	22.10		
3	1	14		22.49	22.29	21.82		
3	8	0		21.44	21.19	21.02		
3	8	4		21.43	21.23	20.97		
3	8	7		21.36	21.21	20.89		
3	15	0		21.38	21.24	21.01		
Limit	ERP < 7W			Result			Pass	



LTE Band 5 Maximum Average Power [dBm] (GT - LC = -4.5 dB)								
BW [MHz]	RB Size	RB Offset	Mod	Lowest	Middle	Highest	ERP (dBm)	ERP (W)
1.4	1	0	QPSK	24.20	24.02	23.95	17.69	0.0587
1.4	1	3		24.23	24.03	23.89		
1.4	1	5		24.17	23.98	23.85		
1.4	3	0		24.11	23.96	23.72		
1.4	3	1		24.34	24.04	23.99		
1.4	3	3		24.14	23.97	23.82		
1.4	6	0		23.29	23.11	23.01		
1.4	1	0	16-QAM	23.56	23.34	23.26	17.00	0.0501
1.4	1	3		23.65	23.41	23.27		
1.4	1	5		23.46	23.29	23.24		
1.4	3	0		23.34	23.14	23.05		
1.4	3	1		23.37	23.18	23.06		
1.4	3	3		23.31	23.12	22.99		
1.4	6	0		22.34	22.16	22.05		
1.4	1	0	64-QAM	23.31	22.31	21.89	16.66	0.0463
1.4	1	3		22.45	22.28	21.99		
1.4	1	5		22.37	22.27	21.87		
1.4	3	0		22.45	22.29	21.95		
1.4	3	1		22.51	22.33	21.92		
1.4	3	3		22.48	22.26	21.85		
1.4	6	0		21.32	21.11	20.81		
Limit	ERP < 7W			Result			Pass	



LTE Band 7 Maximum Average Power [dBm] (GT - LC = -0.9 dB)								
BW [MHz]	RB Size	RB Offset	Mod	Lowest	Middle	Highest	EIRP (dBm)	EIRP (W)
20	1	0	QPSK	19.23	19.13	19.07	18.53	0.0713
20	1	49		19.24	19.15	19.14		
20	1	99		19.28	19.17	19.13		
20	50	0		19.38	19.22	19.18		
20	50	24		19.43	19.32	19.29		
20	50	50		19.40	19.30	19.28		
20	100	0		19.38	19.32	19.31		
20	1	0	16-QAM	19.02	19.01	18.93	18.18	0.0658
20	1	49		19.06	18.97	19.01		
20	1	99		19.08	19.06	19.01		
20	50	0		18.86	18.73	18.69		
20	50	24		18.91	18.83	18.82		
20	50	50		18.91	18.82	18.82		
20	100	0		18.90	18.81	18.78		
20	1	0	64-QAM	18.91	18.87	18.79	18.15	0.0653
20	1	49		18.99	18.91	18.87		
20	1	99		19.05	18.96	18.89		
20	50	0		18.91	18.77	18.71		
20	50	24		18.94	18.87	18.83		
20	50	50		18.93	18.83	18.84		
20	100	0		18.93	18.82	18.78		
Limit	EIRP < 2W			Result			Pass	





LTE Band 7 Maximum Average Power [dBm] (GT - LC = -0.9 dB)								
BW [MHz]	RB Size	RB Offset	Mod	Lowest	Middle	Highest	EIRP (dBm)	EIRP (W)
15	1	0	QPSK	19.27	19.17	19.14	18.51	0.0710
15	1	37		19.29	19.23	19.16		
15	1	74		19.31	19.19	19.18		
15	36	0		19.37	19.23	19.20		
15	36	20		19.41	19.33	19.34		
15	36	39		19.39	19.32	19.27		
15	75	0		19.40	19.34	19.20		
15	1	0	16-QAM	19.06	18.99	18.94	18.26	0.0670
15	1	37		19.04	19.06	18.98		
15	1	74		19.16	19.07	19.00		
15	36	0		18.90	18.74	18.69		
15	36	20		18.92	18.82	18.80		
15	36	39		18.90	18.83	18.79		
15	75	0		18.92	18.82	18.72		
15	1	0	64-QAM	18.96	18.90	18.84	18.14	0.0652
15	1	37		19.02	18.92	18.89		
15	1	74		19.04	18.99	18.92		
15	36	0		18.92	18.79	18.76		
15	36	20		18.94	18.88	18.88		
15	36	39		18.94	18.87	18.85		
15	75	0		18.90	18.87	18.74		
Limit	EIRP < 2W			Result			Pass	



LTE Band 7 Maximum Average Power [dBm] (GT - LC = -0.9 dB)								
BW [MHz]	RB Size	RB Offset	Mod	Lowest	Middle	Highest	EIRP (dBm)	EIRP (W)
10	1	0	QPSK	19.22	19.09	19.05	18.50	0.0708
10	1	25		19.17	19.10	19.09		
10	1	49		19.20	19.14	19.09		
10	25	0		19.36	19.23	19.20		
10	25	12		19.39	19.33	19.24		
10	25	25		19.40	19.30	19.29		
10	50	0		19.38	19.31	19.20		
10	1	0	16-QAM	19.13	19.01	18.97	18.23	0.0665
10	1	25		19.08	19.00	18.99		
10	1	49		19.10	19.00	19.00		
10	25	0		18.87	18.69	18.71		
10	25	12		18.92	18.85	18.76		
10	25	25		18.90	18.80	18.79		
10	50	0		18.89	18.80	18.70		
10	1	0	64-QAM	19.00	18.81	18.78	18.10	0.0646
10	1	25		18.97	18.89	18.88		
10	1	49		18.96	18.92	18.88		
10	25	0		18.91	18.77	18.70		
10	25	12		18.94	18.88	18.78		
10	25	25		18.91	18.85	18.80		
10	50	0		18.95	18.84	18.69		
Limit	EIRP < 2W			Result			Pass	



LTE Band 7 Maximum Average Power [dBm] (GT - LC = -0.9 dB)								
BW [MHz]	RB Size	RB Offset	Mod	Lowest	Middle	Highest	EIRP (dBm)	EIRP (W)
5	1	0	QPSK	19.19	19.14	19.08	18.48	0.0705
5	1	12		19.22	19.10	19.01		
5	1	24		19.21	19.15	19.08		
5	12	0		19.35	19.19	19.20		
5	12	7		19.38	19.28	19.24		
5	12	13		19.35	19.25	19.21		
5	25	0		19.32	19.24	19.22		
5	1	0	16-QAM	18.97	18.92	18.93	18.15	0.0653
5	1	12		19.03	18.89	18.74		
5	1	24		19.05	18.90	18.84		
5	12	0		18.87	18.71	18.74		
5	12	7		18.88	18.77	18.73		
5	12	13		18.87	18.76	18.72		
5	25	0		18.90	18.78	18.74		
5	1	0	64-QAM	19.01	18.85	18.89	18.14	0.0652
5	1	12		18.98	18.90	18.78		
5	1	24		19.04	18.93	18.86		
5	12	0		18.91	18.74	18.76		
5	12	7		18.94	18.84	18.76		
5	12	13		18.92	18.81	18.78		
5	25	0		18.83	18.77	18.72		
Limit	EIRP < 2W			Result			Pass	



LTE Band 13 Maximum Average Power [dBm] (GT - LC = -7.7 dB)								
BW [MHz]	RB Size	RB Offset	Mod	Lowest	Middle	Highest	ERP (dBm)	ERP (W)
10	1	0	QPSK		24.32		14.47	0.0280
10	1	25			24.20			
10	1	49			24.16			
10	25	0			23.32			
10	25	12			23.27			
10	25	25			23.36			
10	50	0			23.33			
10	1	0	16-QAM	-	23.60	-	13.75	0.0237
10	1	25			23.56			
10	1	49			23.51			
10	25	0			22.34			
10	25	12			22.32			
10	25	25			22.34			
10	50	0			22.30			
10	1	0	64-QAM		22.08		12.60	0.0182
10	1	25			22.45			
10	1	49			22.44			
10	25	0			20.91			
10	25	12			21.34			
10	25	25			21.40			
10	50	0			21.36			
Limit	ERP < 3W			Result			Pass	



LTE Band 13 Maximum Average Power [dBm] (GT - LC = -7.7 dB)								
BW [MHz]	RB Size	RB Offset	Mod	Lowest	Middle	Highest	ERP (dBm)	ERP (W)
5	1	0	QPSK	24.27	24.23	24.23	14.42	0.0277
5	1	12		24.21	24.16	24.16		
5	1	24		24.18	24.22	24.18		
5	12	0		23.30	23.28	23.28		
5	12	7		23.39	23.38	23.34		
5	12	13		23.34	23.32	23.29		
5	25	0		23.34	23.22	23.34		
5	1	0	16-QAM	23.61	23.48	23.53	13.76	0.0238
5	1	12		23.53	23.53	23.40		
5	1	24		23.50	23.52	23.48		
5	12	0		22.32	22.32	22.30		
5	12	7		22.39	22.39	22.35		
5	12	13		22.36	22.34	22.32		
5	25	0		22.40	22.30	22.33		
5	1	0	64-QAM	21.64	21.91	22.46	12.65	0.0184
5	1	12		22.12	22.45	22.46		
5	1	24		22.50	22.44	22.47		
5	12	0		20.84	21.17	21.32		
5	12	7		20.85	21.40	21.37		
5	12	13		21.10	21.37	21.34		
5	25	0		20.80	21.27	21.36		
Limit	ERP < 3W			Result			Pass	



LTE Band 17 Maximum Average Power [dBm] (GT - LC = -5.3 dB)								
BW [MHz]	RB Size	RB Offset	Mod	Lowest	Middle	Highest	ERP (dBm)	ERP (W)
10	1	0	QPSK	24.35	24.34	24.31	16.90	0.0490
10	1	25		24.33	24.31	24.31		
10	1	49		24.31	24.34	24.32		
10	25	0		23.32	23.38	23.36		
10	25	12		23.43	23.43	23.44		
10	25	25		23.50	23.51	23.50		
10	50	0		23.41	23.38	23.40		
10	1	0	16-QAM	23.64	23.66	23.64	16.29	0.0426
10	1	25		23.69	23.68	23.70		
10	1	49		23.73	23.74	23.74		
10	25	0		22.36	22.38	22.36		
10	25	12		22.39	22.40	22.41		
10	25	25		22.46	22.48	22.47		
10	50	0		22.40	22.39	22.40		
10	1	0	64-QAM	22.34	22.49	22.48	15.18	0.0330
10	1	25		22.62	22.59	22.63		
10	1	49		22.61	22.60	22.58		
10	25	0		21.33	21.37	21.36		
10	25	12		21.26	21.32	21.26		
10	25	25		21.04	21.11	21.09		
10	50	0		21.18	21.26	21.27		
Limit	ERP < 3W			Result			Pass	



LTE Band 17 Maximum Average Power [dBm] (GT - LC = -5.3 dB)								
BW [MHz]	RB Size	RB Offset	Mod	Lowest	Middle	Highest	ERP (dBm)	ERP (W)
5	1	0	QPSK	24.31	24.33	24.32	16.89	0.0489
5	1	12		24.28	24.31	24.26		
5	1	24		24.33	24.34	24.33		
5	12	0		23.37	23.36	23.32		
5	12	7		23.46	23.45	23.47		
5	12	13		23.45	23.44	23.37		
5	25	0		23.40	23.36	23.32		
5	1	0	16-QAM	23.68	23.71	23.59	16.27	0.0424
5	1	12		23.72	23.53	23.57		
5	1	24		23.69	23.72	23.72		
5	12	0		22.41	22.38	22.36		
5	12	7		22.47	22.47	22.45		
5	12	13		22.44	22.46	22.42		
5	25	0		22.47	22.37	22.35		
5	1	0	64-QAM	22.25	22.29	22.38	15.07	0.0321
5	1	12		22.52	22.28	22.42		
5	1	24		22.38	22.03	22.29		
5	12	0		21.13	21.22	21.31		
5	12	7		21.46	21.49	21.22		
5	12	13		21.41	21.36	21.09		
5	25	0		21.20	20.83	21.09		
Limit	ERP < 3W			Result			Pass	



LTE Band 41 Maximum Average Power [dBm] (GT - LC = -0.2 dB)								
BW [MHz]	RB Size	RB Offset	Mod	Lowest	Middle	Highest	EIRP (dBm)	EIRP (W)
20	1	0	QPSK	19.26	19.64	19.51	19.59	0.0910
20	1	49		19.29	19.59	19.36		
20	1	99		19.30	19.70	19.31		
20	50	0		19.42	19.68	19.57		
20	50	24		19.48	19.79	19.56		
20	50	50		19.46	19.76	19.51		
20	100	0		19.50	19.76	19.55		
20	1	0	16-QAM	18.89	19.20	19.11	19.10	0.0813
20	1	49		18.82	19.20	18.94		
20	1	99		18.87	19.26	18.96		
20	50	0		18.95	19.20	19.11		
20	50	24		19.01	19.30	19.08		
20	50	50		19.00	19.29	19.03		
20	100	0		19.01	19.28	19.06		
20	1	0	64-QAM	18.63	18.97	18.83	19.12	0.0817
20	1	49		18.57	18.95	18.73		
20	1	99		18.54	19.02	18.59		
20	50	0		18.93	19.23	19.11		
20	50	24		19.02	19.32	19.09		
20	50	50		18.98	19.32	19.03		
20	100	0		19.00	19.29	19.06		
Limit	EIRP < 2W			Result			Pass	





LTE Band 41 Maximum Average Power [dBm] (GT - LC = -0.2 dB)								
BW [MHz]	RB Size	RB Offset	Mod	Lowest	Middle	Highest	EIRP (dBm)	EIRP (W)
15	1	0	QPSK	19.30	19.62	19.43	19.57	0.0906
15	1	37		19.25	19.56	19.31		
15	1	74		19.28	19.70	19.36		
15	36	0		19.40	19.69	19.54		
15	36	20		19.46	19.77	19.49		
15	36	39		19.44	19.76	19.47		
15	75	0		19.48	19.77	19.51		
15	1	0	16-QAM	18.88	19.18	19.03	19.12	0.0817
15	1	37		18.83	19.15	18.84		
15	1	74		18.85	19.32	19.02		
15	36	0		18.87	19.14	19.03		
15	36	20		18.93	19.21	18.97		
15	36	39		18.91	19.21	18.94		
15	75	0		18.98	19.28	19.03		
15	1	0	64-QAM	18.59	18.89	18.76	19.11	0.0815
15	1	37		18.62	18.97	18.69		
15	1	74		18.56	19.05	18.68		
15	36	0		18.92	19.22	19.07		
15	36	20		18.97	19.30	19.04		
15	36	39		18.95	19.31	19.00		
15	75	0		18.99	19.30	19.03		
Limit	EIRP < 2W			Result			Pass	



LTE Band 41 Maximum Average Power [dBm] (GT - LC = -0.2 dB)								
BW [MHz]	RB Size	RB Offset	Mod	Lowest	Middle	Highest	EIRP (dBm)	EIRP (W)
10	1	0	QPSK	19.40	19.64	19.42	19.58	0.0908
10	1	25		19.32	19.68	19.34		
10	1	49		19.35	19.66	19.34		
10	25	0		19.49	19.69	19.53		
10	25	12		19.51	19.78	19.56		
10	25	25		19.48	19.77	19.52		
10	50	0		19.49	19.78	19.53		
10	1	0	16-QAM	18.97	19.25	19.09	19.12	0.0817
10	1	25		18.91	19.24	19.04		
10	1	49		18.95	19.28	18.98		
10	25	0		19.01	19.22	19.07		
10	25	12		19.04	19.32	19.07		
10	25	25		18.97	19.31	19.00		
10	50	0		18.99	19.31	19.04		
10	1	0	64-QAM	18.82	18.99	18.83	19.21	0.0834
10	1	25		18.82	19.13	18.84		
10	1	49		18.75	19.08	18.73		
10	25	0		19.04	19.27	19.10		
10	25	12		19.07	19.41	19.10		
10	25	25		19.04	19.37	19.06		
10	50	0		18.99	19.33	19.05		
Limit	EIRP < 2W			Result			Pass	



LTE Band 41 Maximum Average Power [dBm] (GT - LC = -0.2 dB)								
BW [MHz]	RB Size	RB Offset	Mod	Lowest	Middle	Highest	EIRP (dBm)	EIRP (W)
5	1	0	QPSK	19.39	19.56	19.33	19.58	0.0908
5	1	12		19.36	19.65	19.40		
5	1	24		19.31	19.58	19.25		
5	12	0		19.45	19.64	19.46		
5	12	7		19.52	19.78	19.52		
5	12	13		19.42	19.72	19.43		
5	25	0		19.42	19.72	19.42		
5	1	0	16-QAM	18.92	19.11	18.89	19.08	0.0809
5	1	12		18.89	19.17	18.92		
5	1	24		18.92	19.19	18.89		
5	12	0		18.91	19.11	18.93		
5	12	7		18.98	19.28	19.00		
5	12	13		18.92	19.24	18.93		
5	25	0		18.98	19.27	18.99		
5	1	0	64-QAM	18.77	18.92	18.70	19.09	0.0811
5	1	12		18.61	18.90	18.71		
5	1	24		18.76	19.04	18.70		
5	12	0		18.95	19.16	18.95		
5	12	7		18.99	19.29	19.01		
5	12	13		18.94	19.24	18.94		
5	25	0		18.97	19.29	19.01		
Limit	EIRP < 2W			Result			Pass	



## LTE Band 4

### Peak-to-Average Ratio

Mode	LTE Band 4 / 20MHz				
Mod.	QPSK	16QAM	64QAM	256QAM	Limit: 13dB
RB Size	Full RB	Full RB	Full RB	Full RB	Result
Middle CH	4.64	5.59	6.35	-	PASS

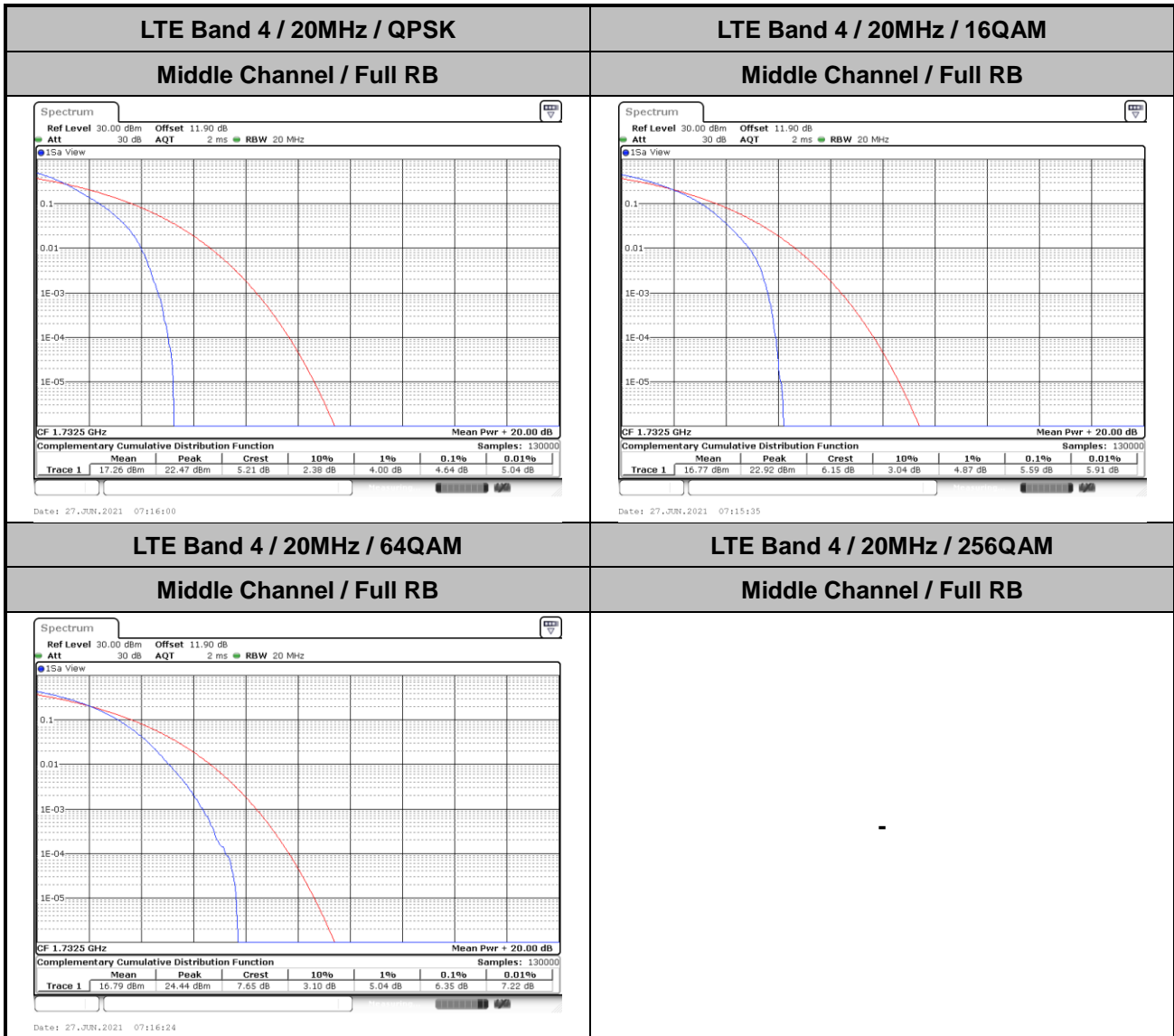



**26dB Bandwidth**

Mode	LTE Band 4 : 26dB BW(MHz)											
BW	1.4MHz		3MHz		5MHz		10MHz		15MHz		20MHz	
Mod.	QPSK	16QAM	QPSK	16QAM	QPSK	16QAM	QPSK	16QAM	QPSK	16QAM	QPSK	16QAM
Middle CH	1.22	1.21	3.00	3.04	4.85	4.84	9.63	9.67	14.30	14.27	18.90	19.10
Mode	LTE Band 4 : 26dB BW(MHz)											
BW	1.4MHz		3MHz		5MHz		10MHz		15MHz		20MHz	
Mod.	64QAM	256 QAM	64QAM	256 QAM	64QAM	256 QAM	64QAM	256 QAM	64QAM	256 QAM	64QAM	256 QAM
Middle CH	1.23	-	3.00	-	4.81	-	9.87	-	14.30	-	19.42	-



LTE Band 4

Middle Channel / 1.4MHz / QPSK

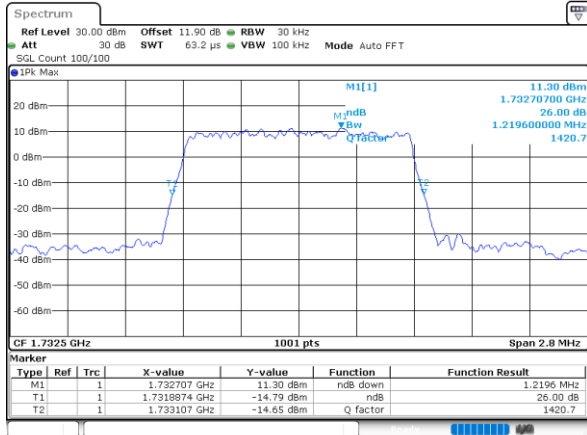

Date: 27\_JUN.2021 06:17:52

Middle Channel / 1.4MHz / 16QAM

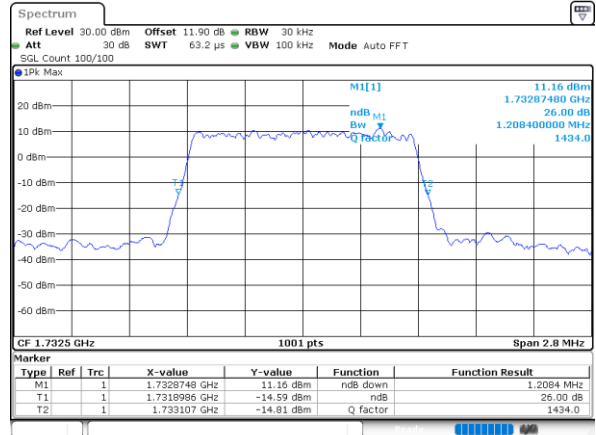

Date: 27\_JUN.2021 06:18:13

Middle Channel / 3MHz / QPSK

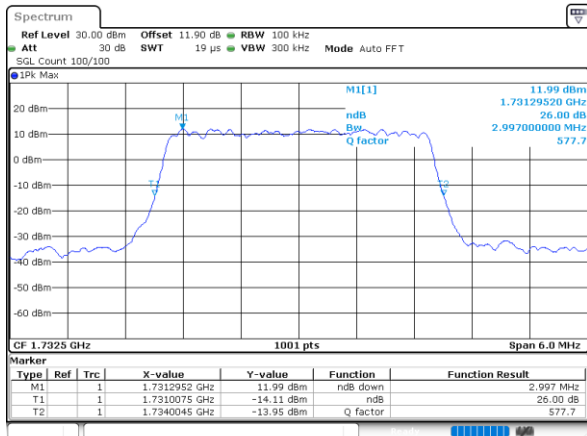

Date: 27\_JUN.2021 06:28:05

Middle Channel / 3MHz / 16QAM

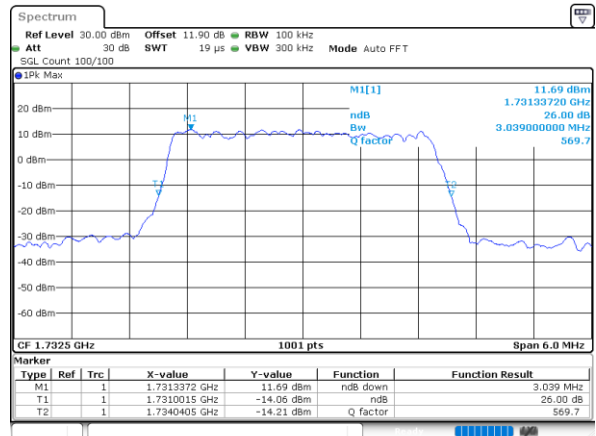

Date: 27\_JUN.2021 06:28:26

Middle Channel / 5MHz / QPSK

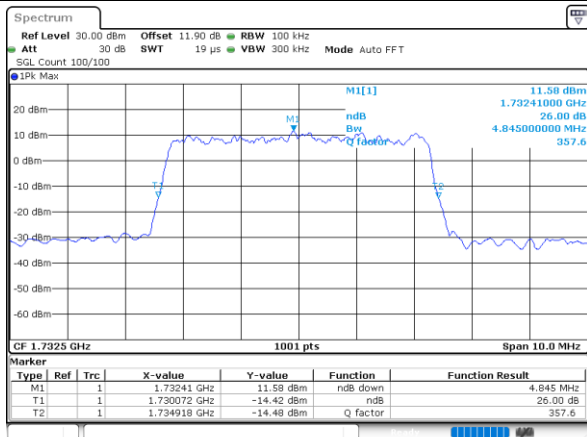

Date: 27\_JUN.2021 06:40:42

Middle Channel / 5MHz / 16QAM

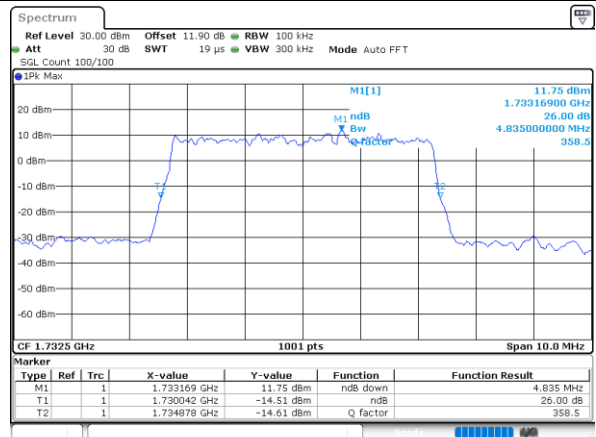

Date: 27\_JUN.2021 06:41:03



LTE Band 4

Middle Channel / 10MHz / QPSK

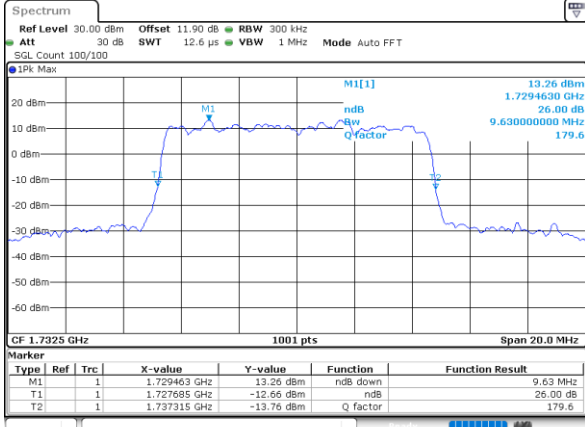

Date: 27\_JUN\_2021 06:48:26

Middle Channel / 10MHz / 16QAM

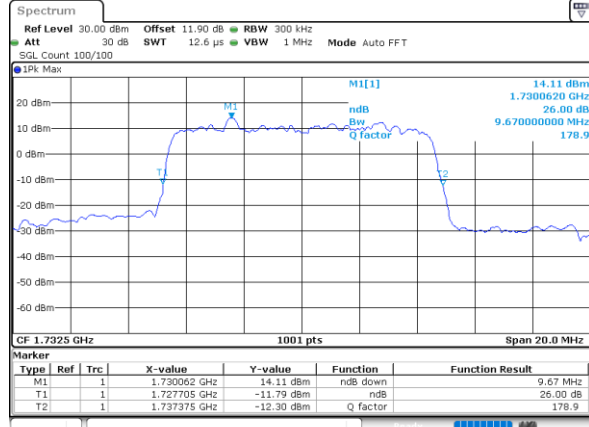

Date: 27\_JUN\_2021 06:48:47

Middle Channel / 15MHz / QPSK

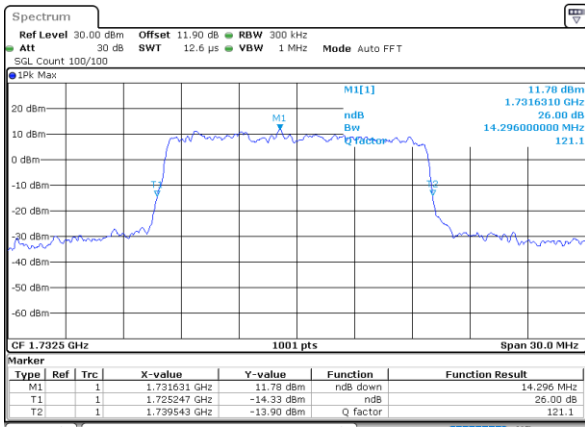

Date: 27\_JUN\_2021 06:58:37

Middle Channel / 15MHz / 16QAM

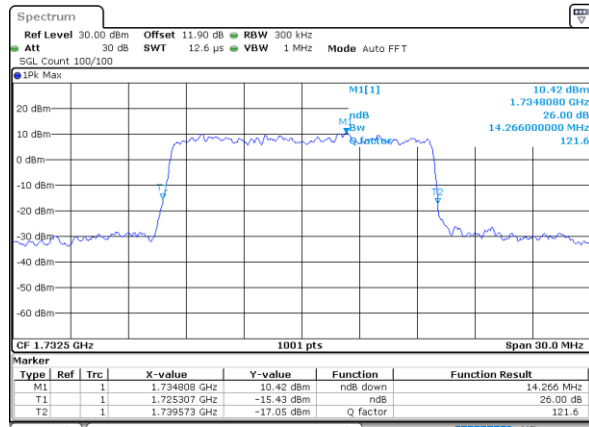

Date: 27\_JUN\_2021 06:58:58

Middle Channel / 20MHz / QPSK

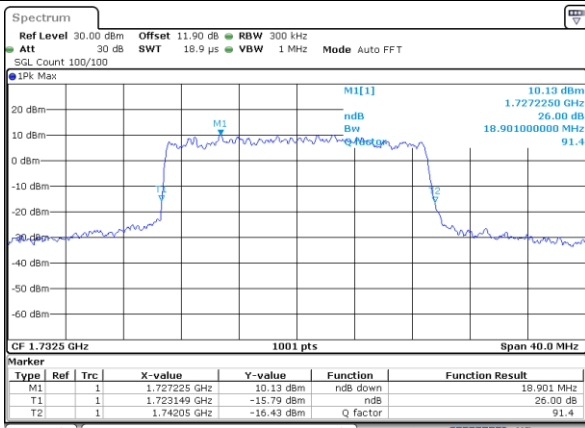

Date: 27\_JUN\_2021 07:08:49

Middle Channel / 20MHz / 16QAM

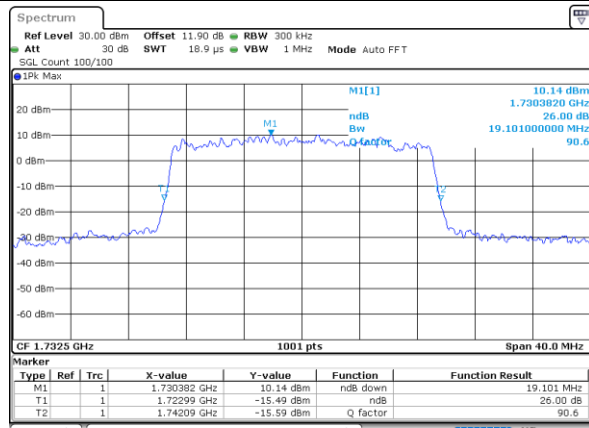

Date: 27\_JUN\_2021 07:09:10





LTE Band 4

Middle Channel / 1.4MHz / 64QAM

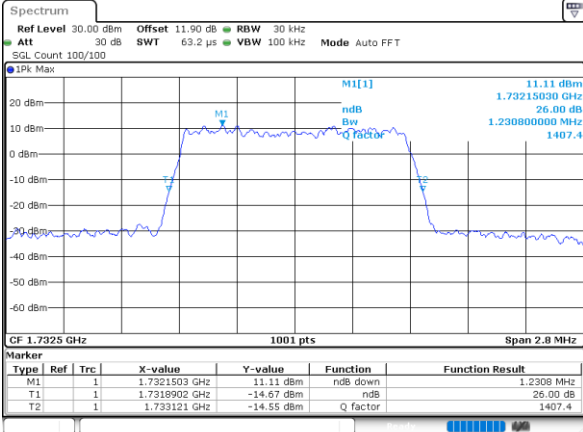

Date: 27\_JUN,2021 06:23:25

Middle Channel / 3MHz / 64QAM

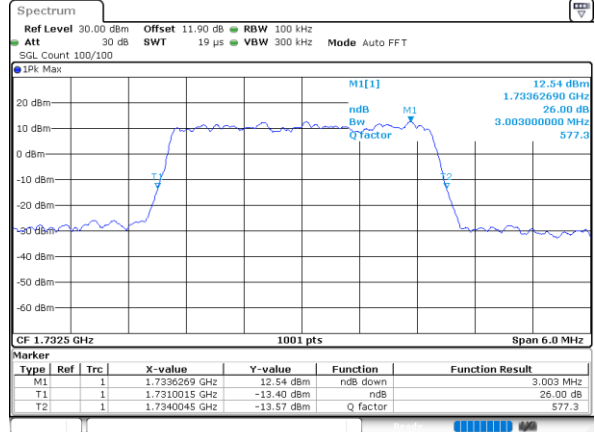

Date: 27\_JUN,2021 06:13:136

Middle Channel / 5MHz / 64QAM

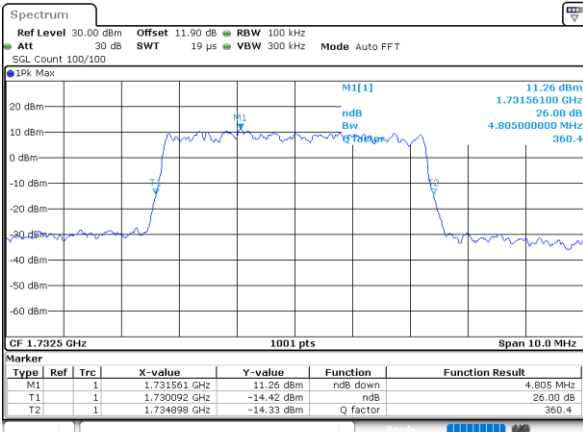

Date: 27\_JUN,2021 06:16:05

Middle Channel / 10MHz / 64QAM

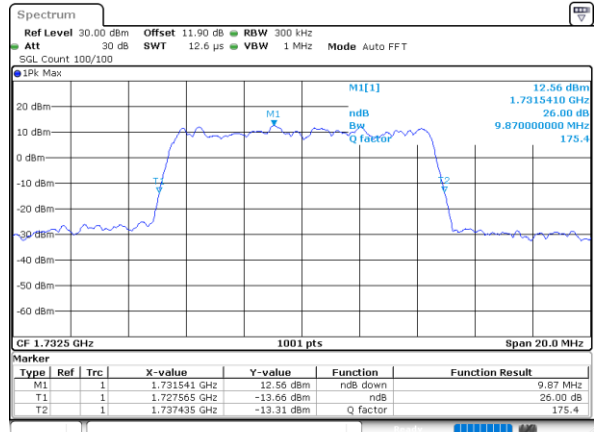

Date: 27\_JUN,2021 06:15:158

Middle Channel / 15MHz / 64QAM

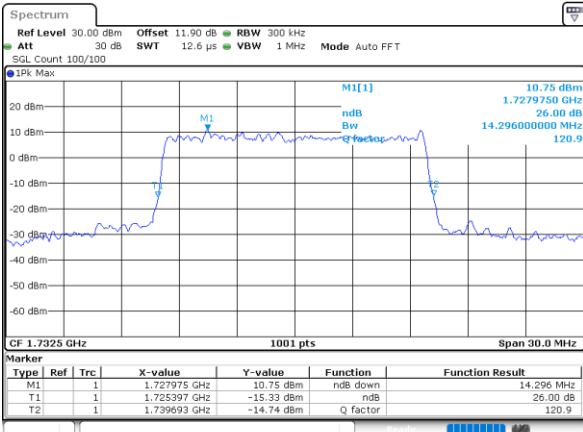

Date: 27\_JUN,2021 07:04:09

Middle Channel / 20MHz / 64QAM

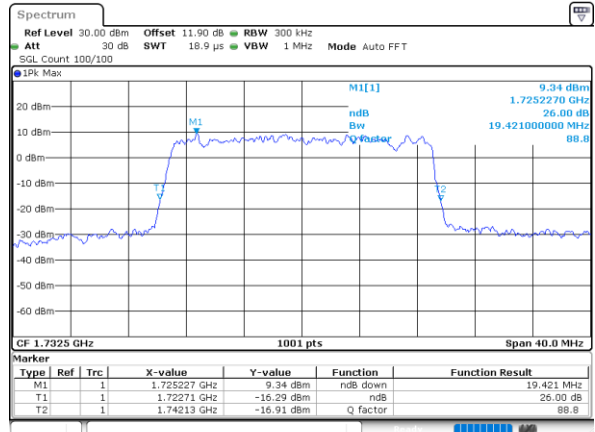

Date: 27\_JUN,2021 07:11:4122



**Occupied Bandwidth**

Mode	LTE Band 4 : 99%OBW(MHz)											
BW	1.4MHz		3MHz		5MHz		10MHz		15MHz		20MHz	
Mod.	QPSK	16QAM	QPSK	16QAM	QPSK	16QAM	QPSK	16QAM	QPSK	16QAM	QPSK	16QAM
Middle CH	1.09	1.09	2.73	2.72	4.48	4.46	8.97	8.99	13.46	13.46	17.82	17.78
Mode	LTE Band 4 : 99%OBW(MHz)											
BW	1.4MHz		3MHz		5MHz		10MHz		15MHz		20MHz	
Mod.	64QAM	256 QAM	64QAM	256 QAM	64QAM	256 QAM	64QAM	256 QAM	64QAM	256 QAM	64QAM	256 QAM
Middle CH	1.09	-	2.73	-	4.48	-	9.03	-	13.40	-	17.86	-



LTE Band 4

Middle Channel / 1.4MHz / QPSK

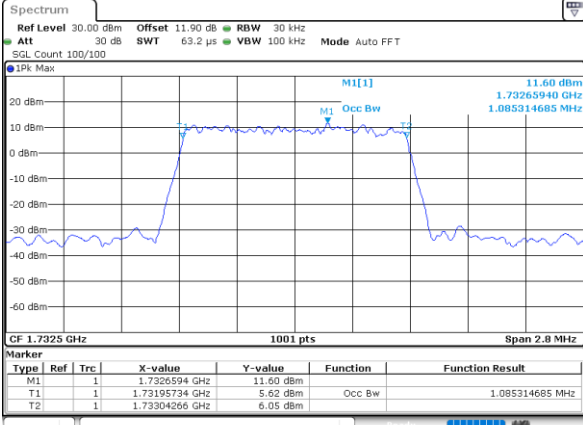

Date: 27 JUN 2021 06:17:07

Middle Channel / 1.4MHz / 16QAM

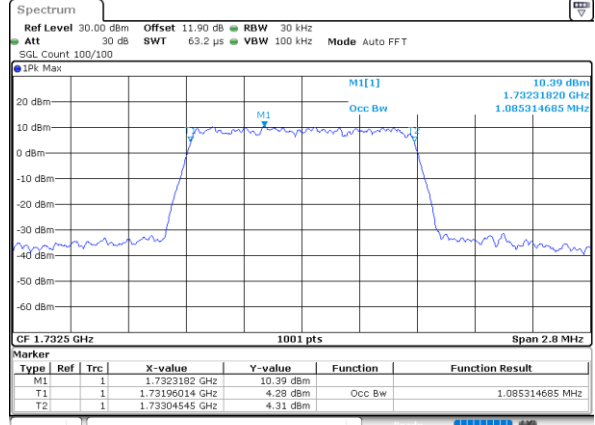

Date: 27 JUN 2021 06:17:30

Middle Channel / 3MHz / QPSK

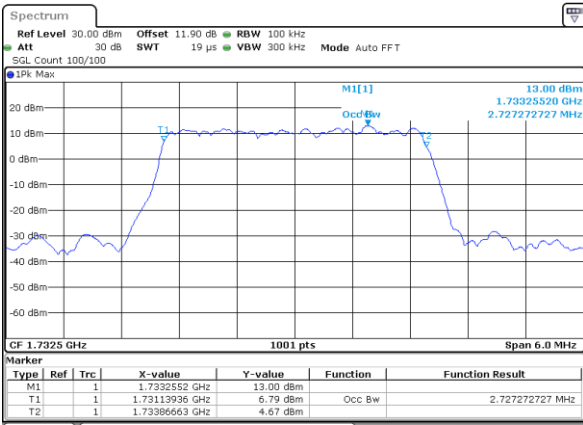

Date: 27 JUN 2021 06:27:20

Middle Channel / 3MHz / 16QAM

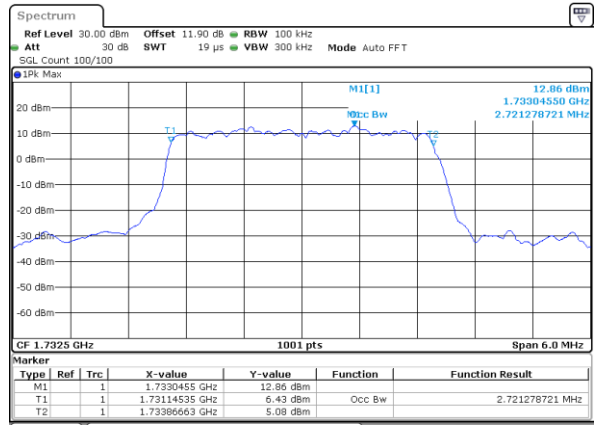

Date: 27 JUN 2021 06:27:42

Middle Channel / 5MHz / QPSK

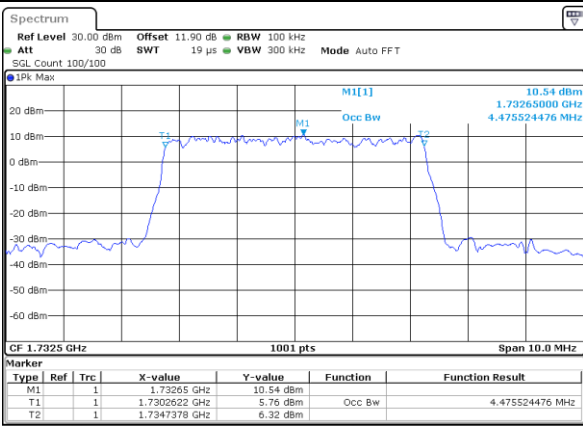

Date: 27 JUN 2021 06:39:57

Middle Channel / 5MHz / 16QAM

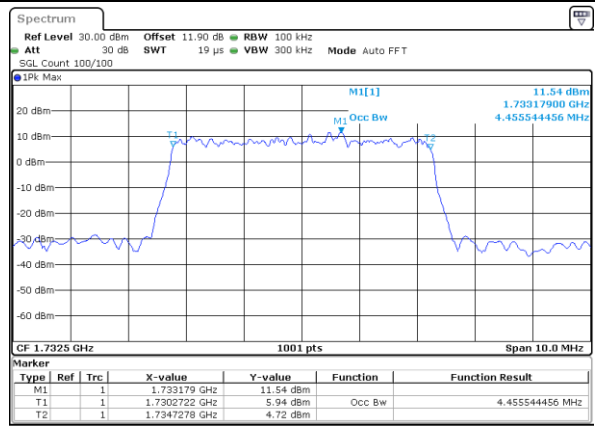

Date: 27 JUN 2021 06:40:20



LTE Band 4

Middle Channel / 10MHz / QPSK

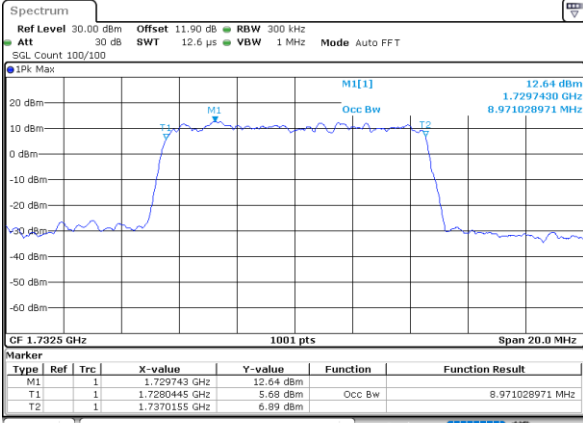

Date: 27\_JUN.2021 06:47:41

Middle Channel / 10MHz / 16QAM

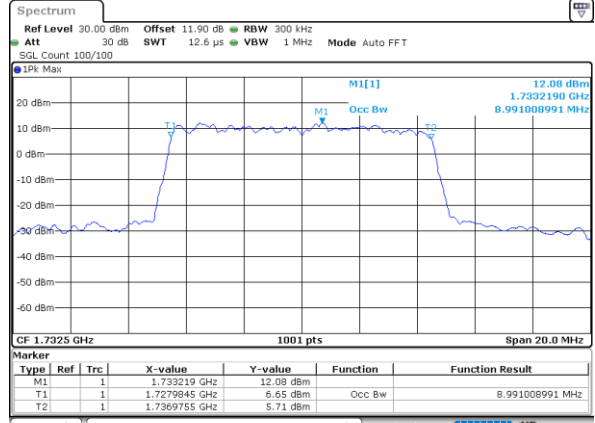

Date: 27\_JUN.2021 06:48:04

Middle Channel / 15MHz / QPSK

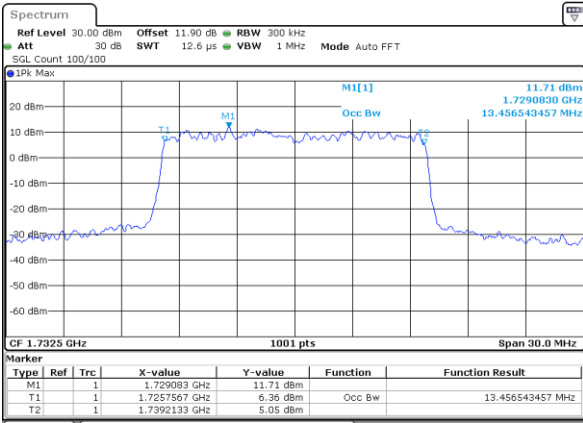

Date: 27\_JUN.2021 06:57:52

Middle Channel / 15MHz / 16QAM

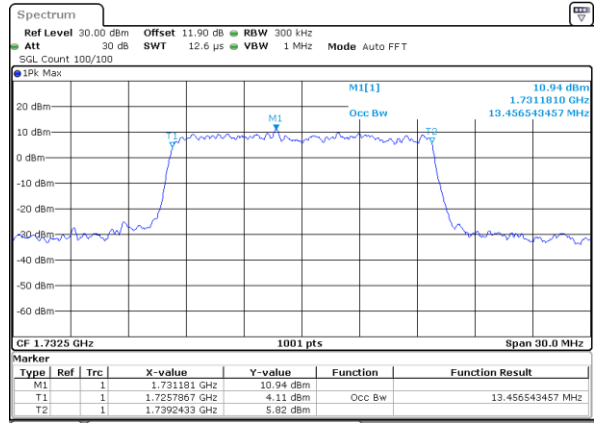

Date: 27\_JUN.2021 06:58:15

Middle Channel / 20MHz / QPSK

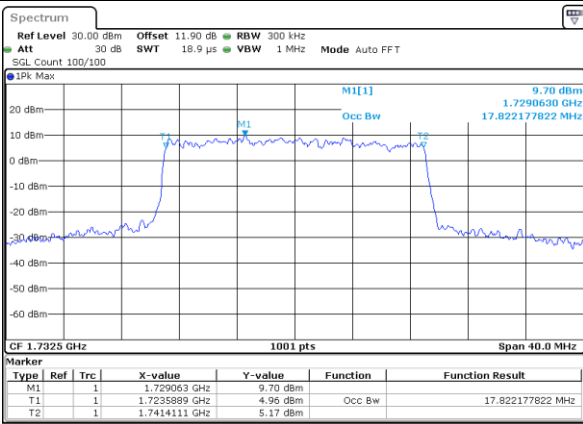

Date: 27\_JUN.2021 07:08:04

Middle Channel / 20MHz / 16QAM

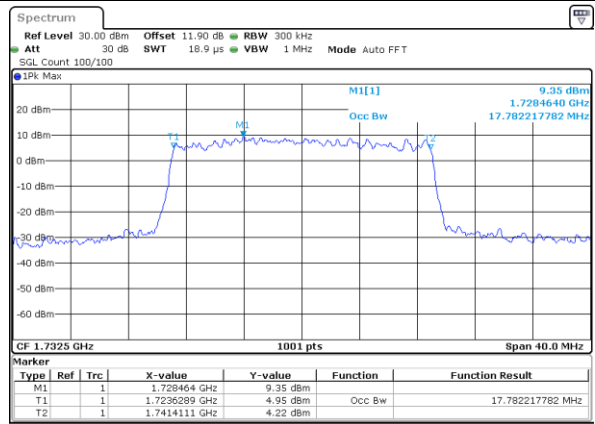

Date: 27\_JUN.2021 07:08:26



LTE Band 4

Middle Channel / 1.4MHz / 64QAM

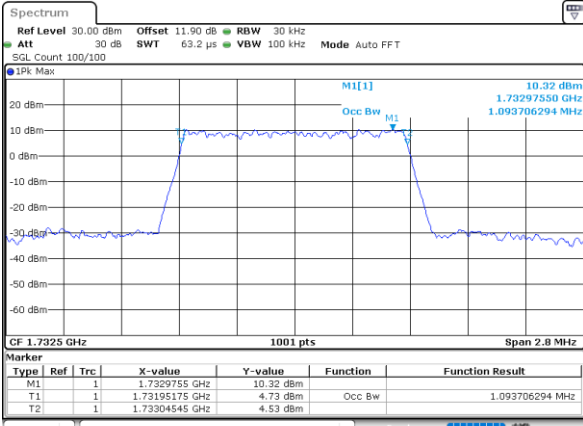

Middle Channel / 3MHz / 64QAM

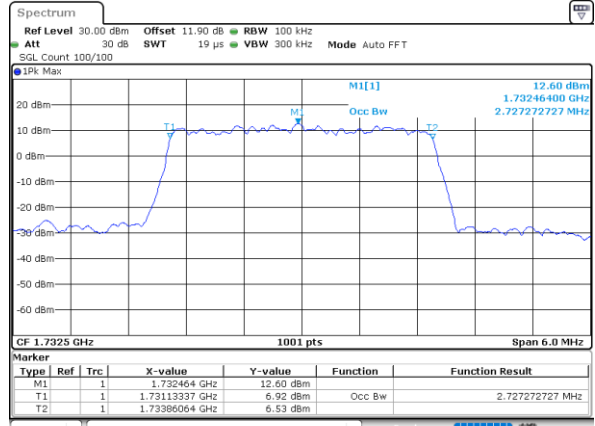

Middle Channel / 5MHz / 64QAM

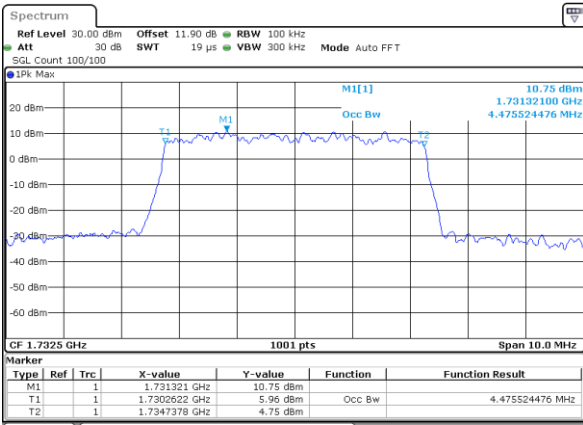

Middle Channel / 10MHz / 64QAM

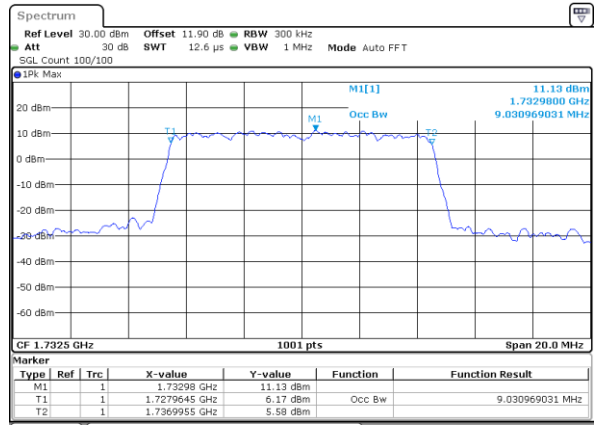

Middle Channel / 15MHz / 64QAM

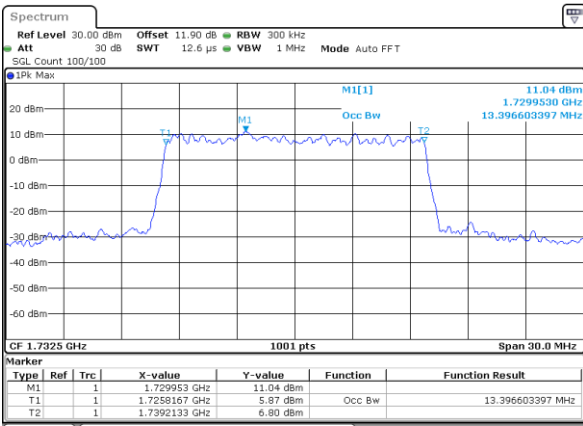

Middle Channel / 20MHz / 64QAM

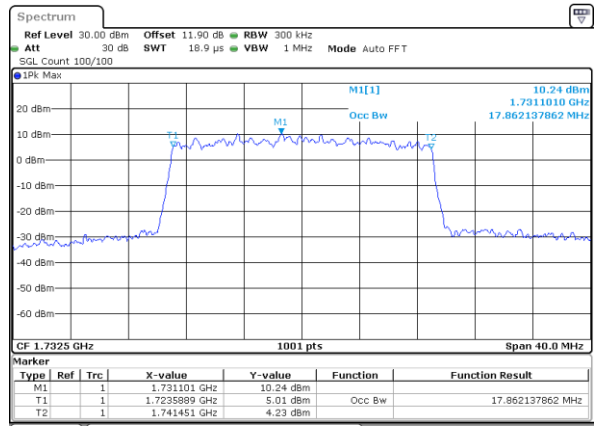



# Conducted Band Edge

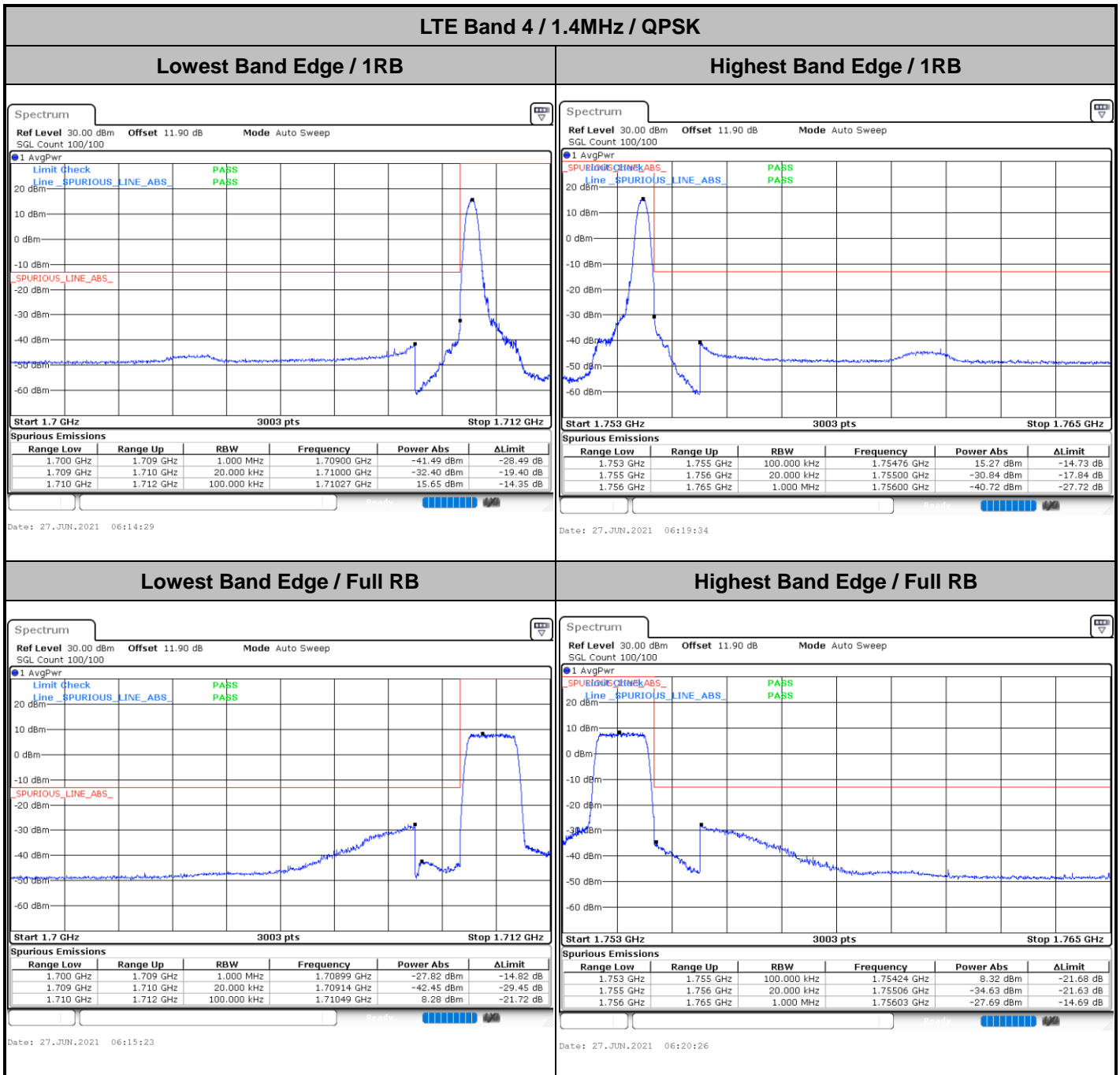



LTE Band 4 / 1.4MHz / 16QAM

Lowest Band Edge / 1 RB

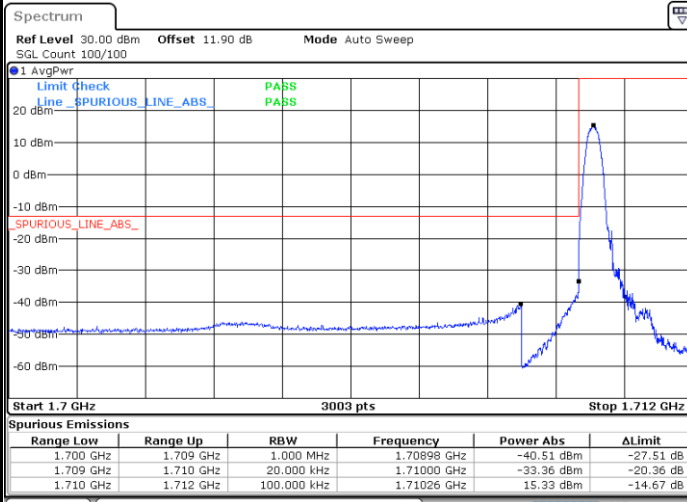

Date: 27.JUN.2021 06:14:57

Highest Band Edge / 1 RB

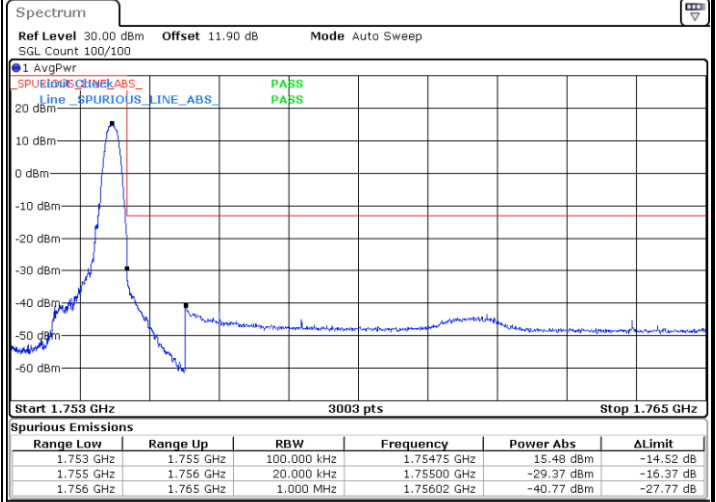

Date: 27.JUN.2021 06:20:00

Lowest Band Edge / Full RB

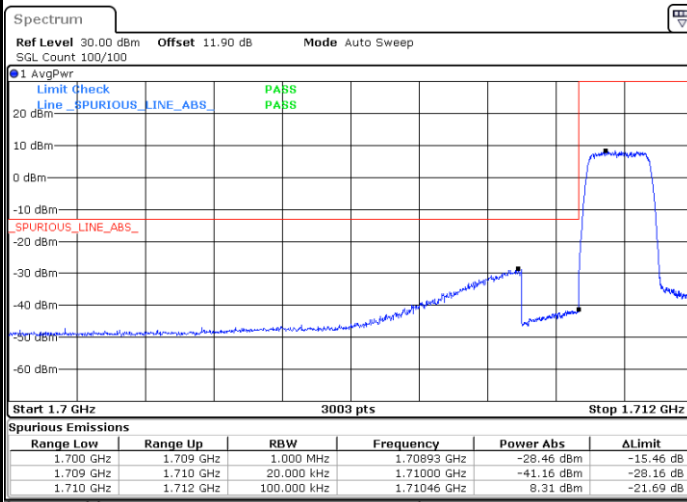

Date: 27.JUN.2021 06:15:49

Highest Band Edge / Full RB

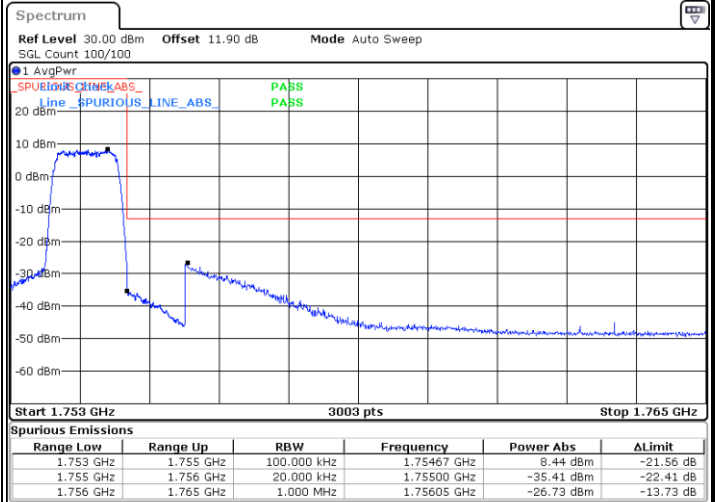

Date: 27.JUN.2021 06:20:52



LTE Band 4 / 1.4MHz / 64QAM

Lowest Band Edge / 1 RB

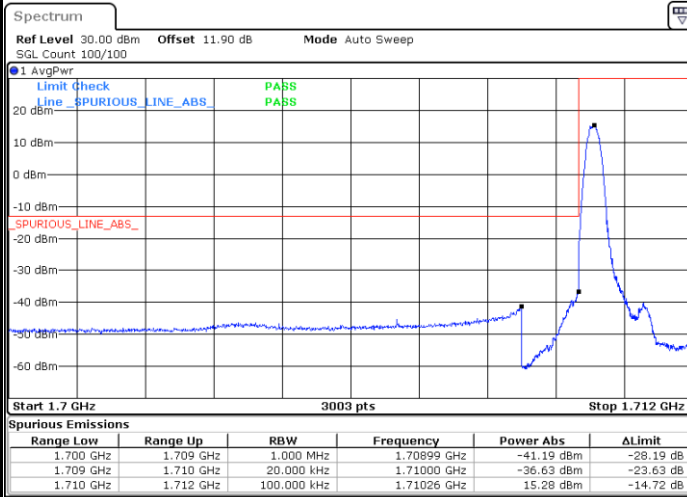

Date: 27 JUN 2021 06:22:14

Highest Band Edge / 1 RB

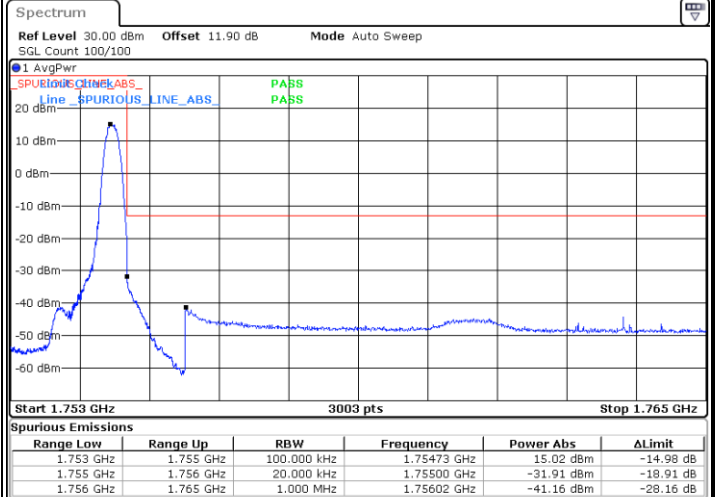

Date: 27 JUN 2021 06:23:50

Lowest Band Edge / Full RB

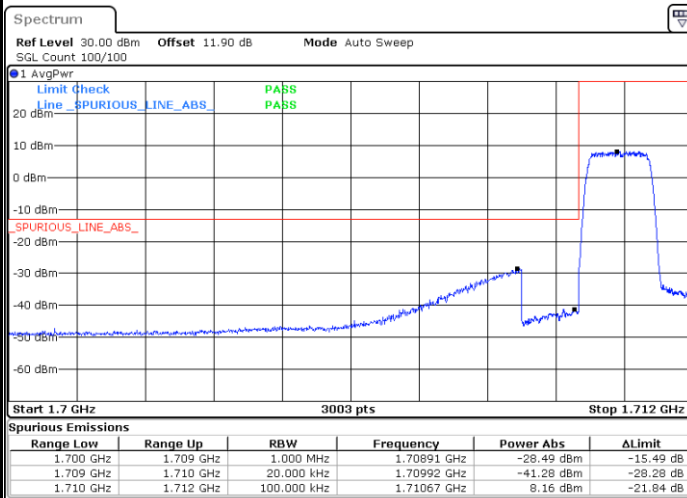

Date: 27 JUN 2021 06:22:41

Highest Band Edge / Full RB

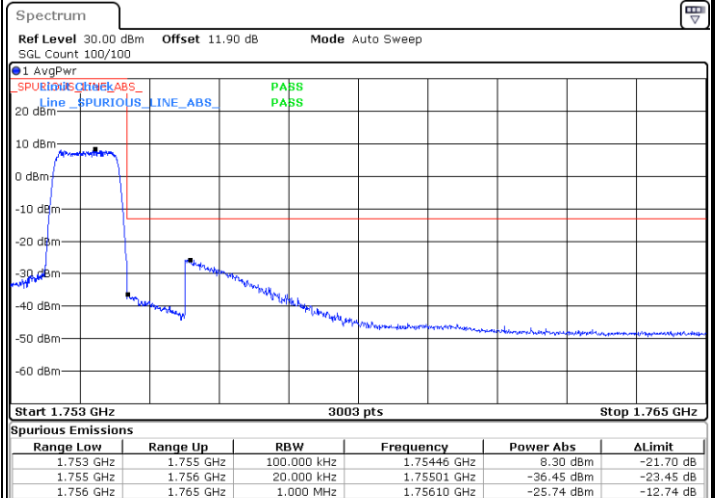

Date: 27 JUN 2021 06:24:16





LTE Band 4 / 3MHz / QPSK

Lowest Band Edge / 1RB

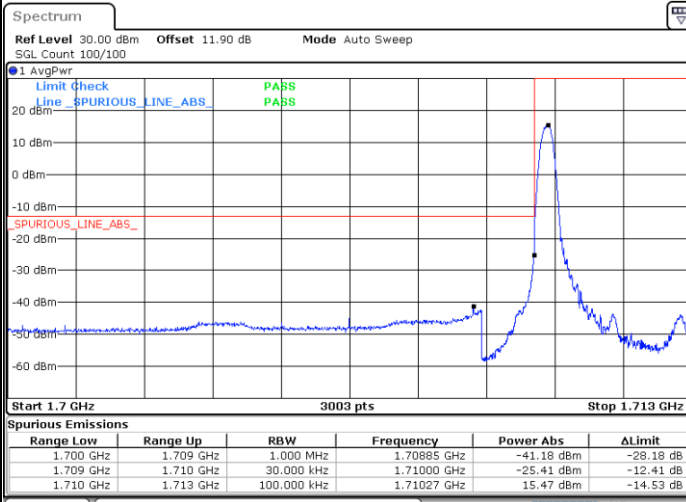

Date: 27 JUN 2021 06:24:43

Highest Band Edge / 1 RB

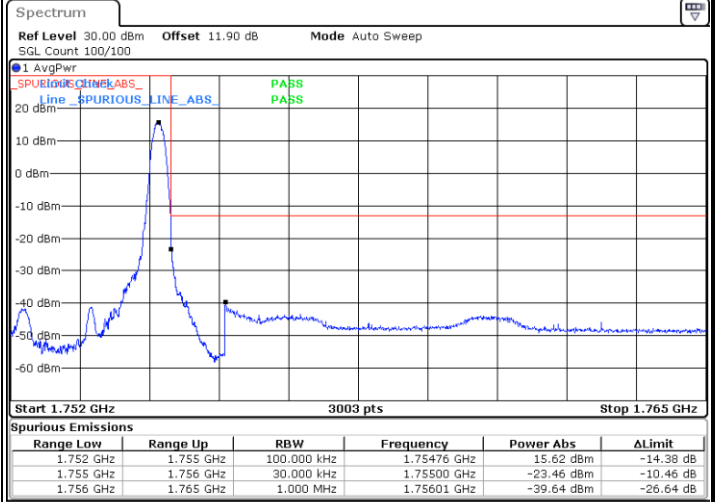

Date: 27 JUN 2021 06:29:47

Lowest Band Edge / Full RB

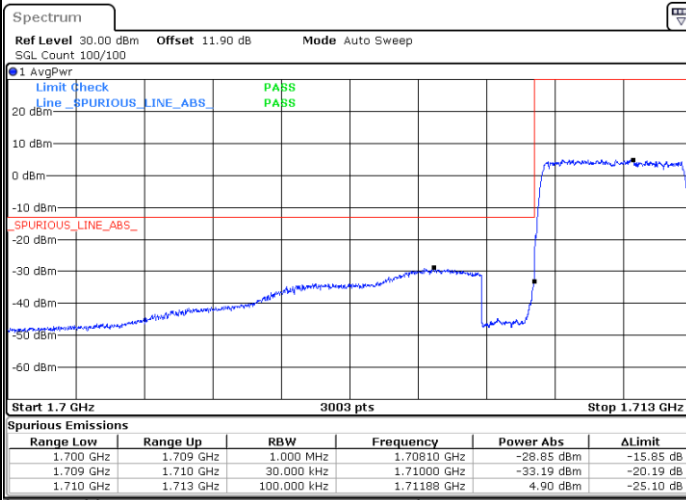

Date: 27 JUN 2021 06:25:36

Highest Band Edge / Full RB

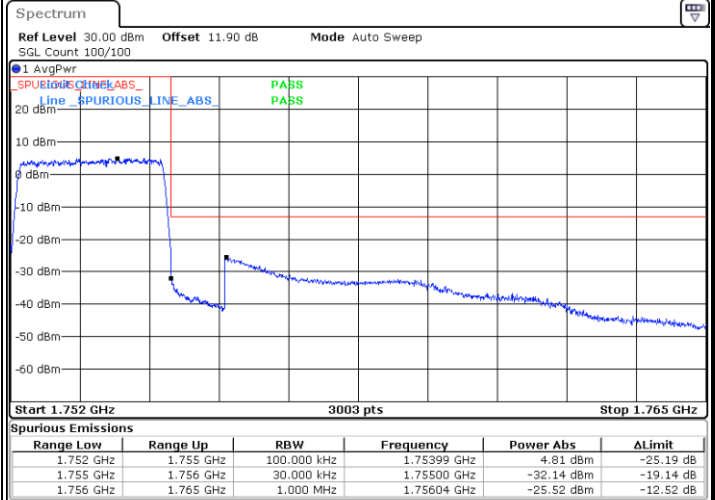

Date: 27 JUN 2021 06:30:38



LTE Band 4 / 3MHz / 16QAM

Lowest Band Edge / 1 RB

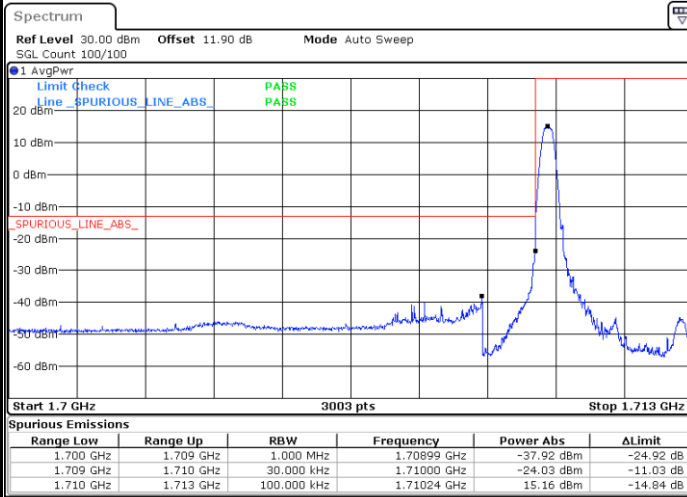

Date: 27 JUN 2021 06:25:10

Highest Band Edge / 1 RB

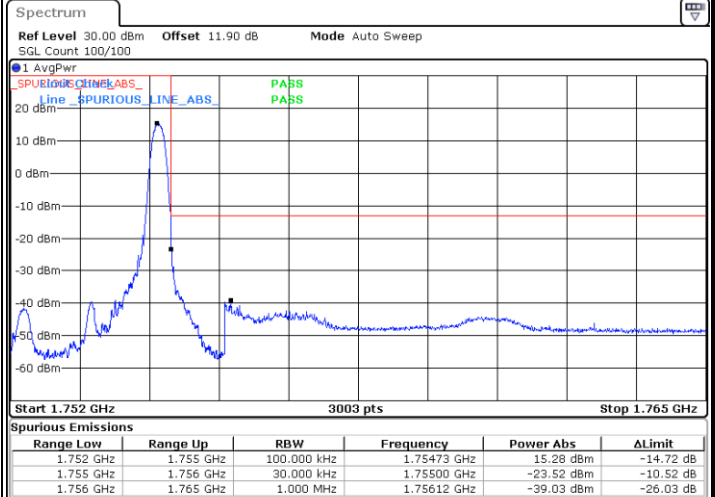

Date: 27 JUN 2021 06:30:12

Lowest Band Edge / Full RB

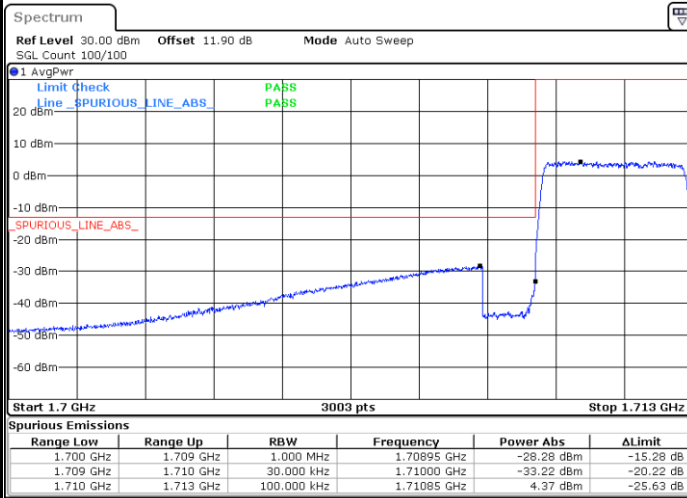

Date: 27 JUN 2021 06:26:02

Highest Band Edge / Full RB

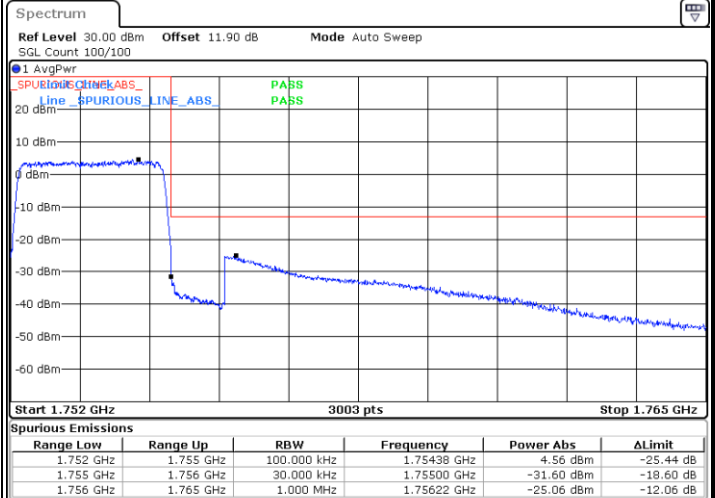

Date: 27 JUN 2021 06:31:04



LTE Band 4 / 3MHz / 64QAM

Lowest Band Edge / 1 RB

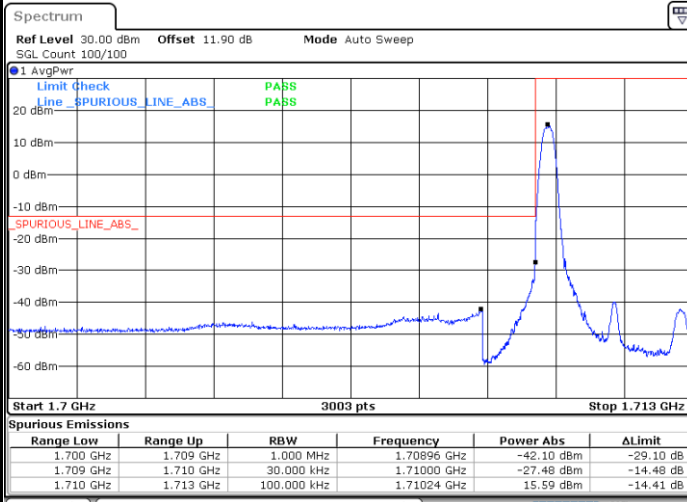

Date: 27 JUN 2021 06:32:26

Highest Band Edge / 1 RB

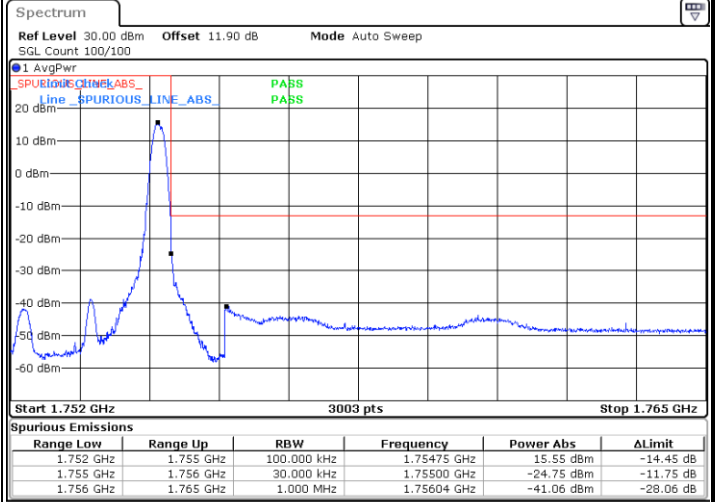

Date: 27 JUN 2021 06:34:01

Lowest Band Edge / Full RB

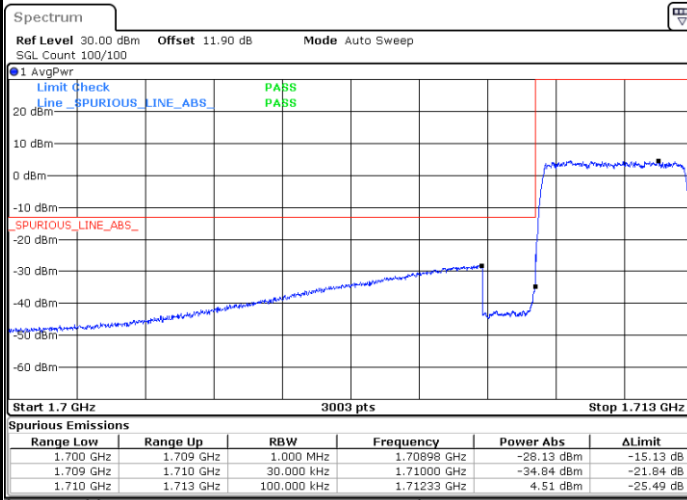

Date: 27 JUN 2021 06:32:52

Highest Band Edge / Full RB

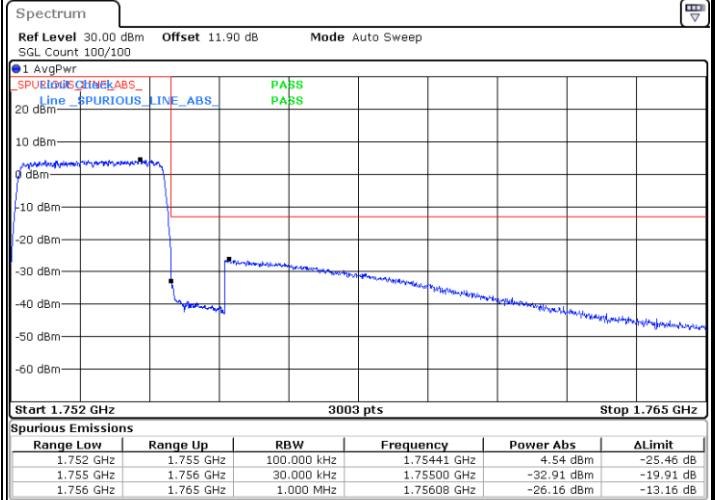

Date: 27 JUN 2021 06:34:27



LTE Band 4 / 5MHz / QPSK

Lowest Band Edge / 1 RB

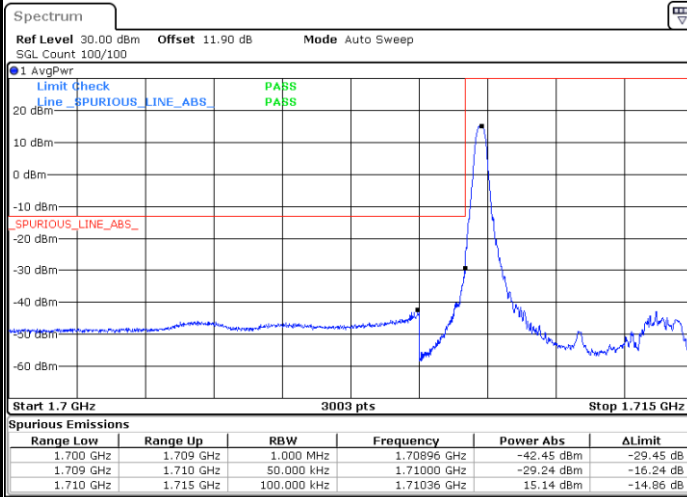

Date: 27.JUN.2021 06:37:21

Highest Band Edge / 1 RB

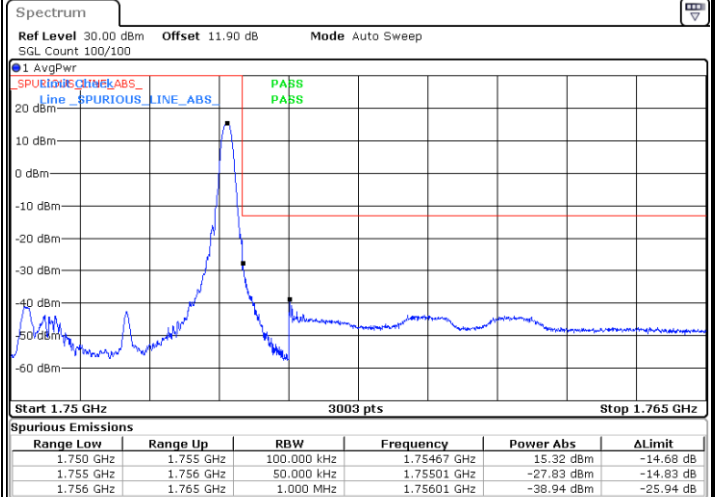

Date: 27.JUN.2021 06:42:23

Lowest Band Edge / Full RB

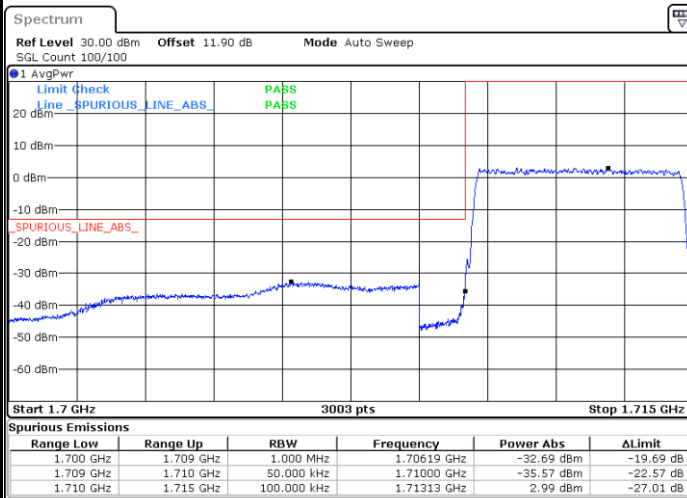

Date: 27.JUN.2021 06:38:13

Highest Band Edge / Full RB

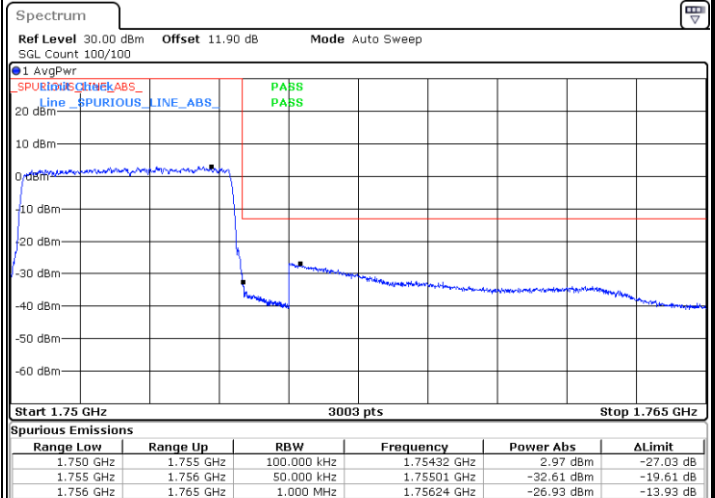

Date: 27.JUN.2021 06:43:16



LTE Band 4 / 5MHz / 16QAM

Lowest Band Edge / 1RB

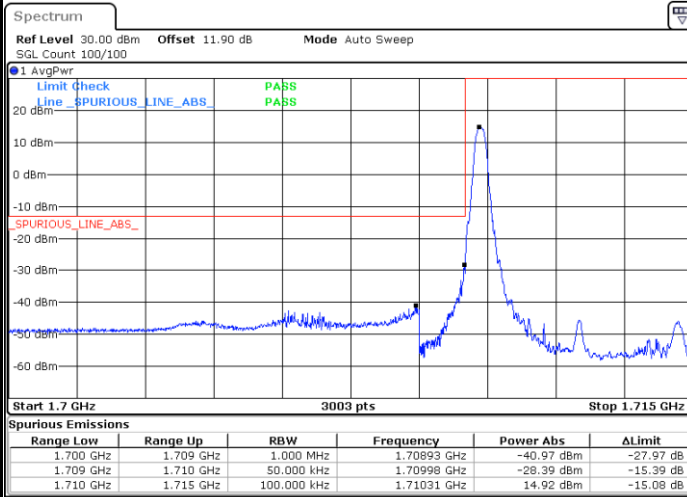

Date: 27 JUN 2021 06:37:47

Highest Band Edge / 1 RB

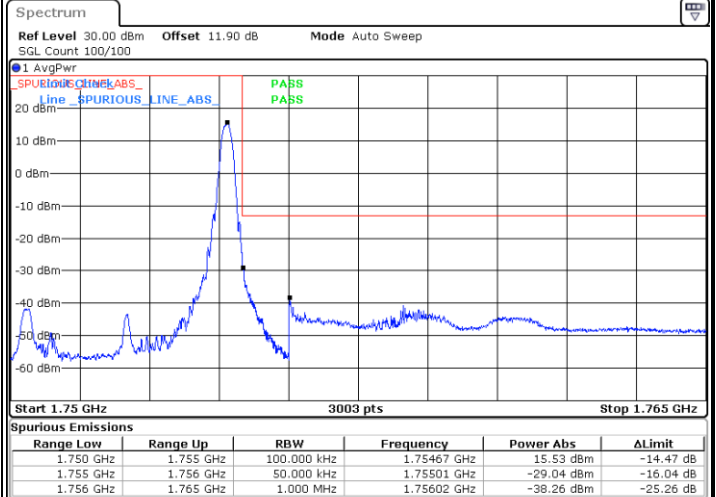

Date: 27 JUN 2021 06:42:49

Lowest Band Edge / Full RB

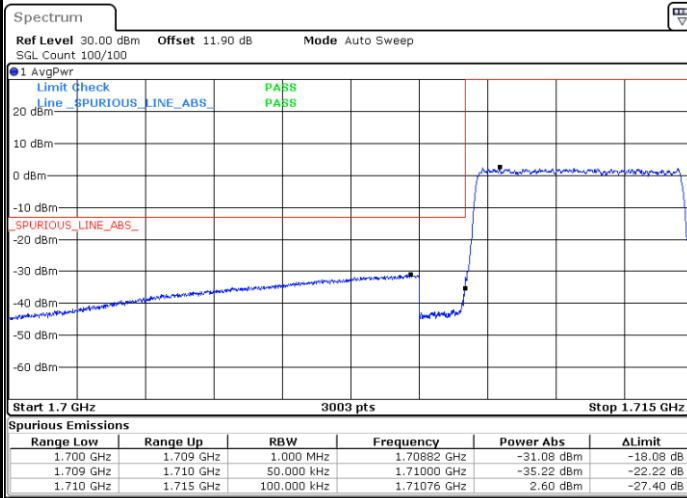

Date: 27 JUN 2021 06:38:39

Highest Band Edge / Full RB

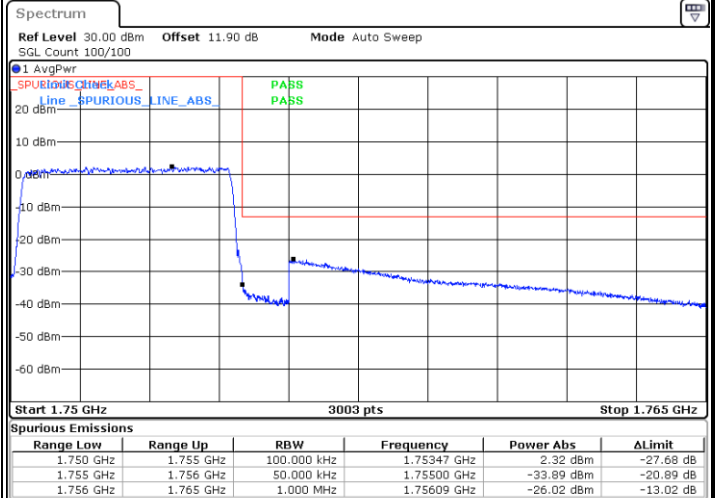

Date: 27 JUN 2021 06:43:41



LTE Band 4 / 5MHz / 64QAM

Lowest Band Edge / 1RB

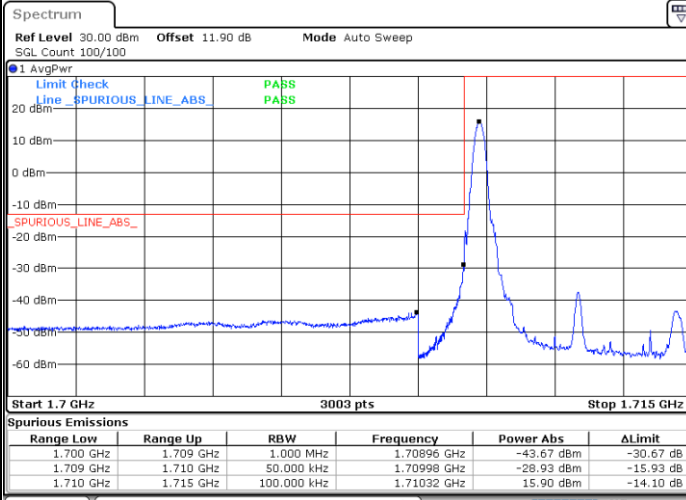

Date: 27 JUN 2021 06:34:55

Highest Band Edge / 1 RB

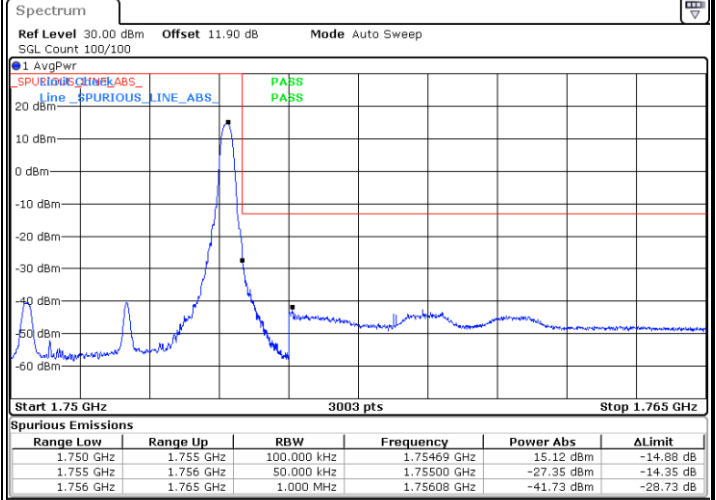

Date: 27 JUN 2021 06:36:30

Lowest Band Edge / Full RB

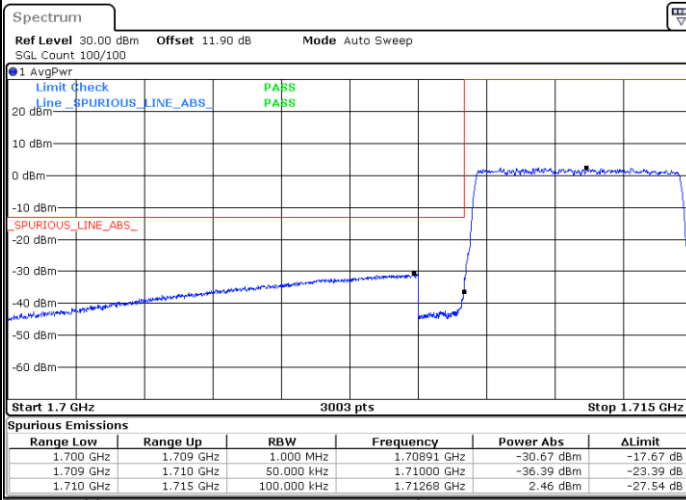

Date: 27 JUN 2021 06:35:21

Highest Band Edge / Full RB

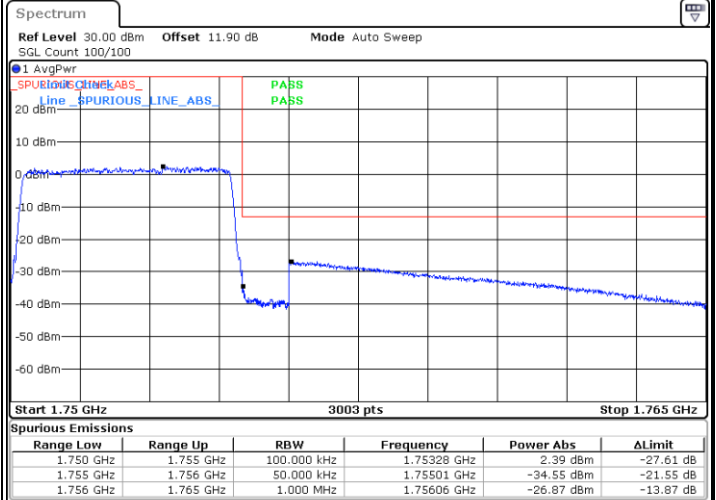

Date: 27 JUN 2021 06:36:56



LTE Band 4 / 10MHz / QPSK

Lowest Band Edge / 1 RB

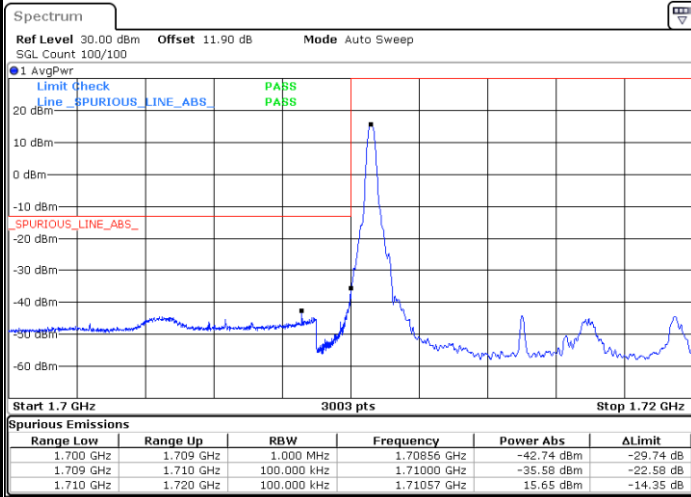

Date: 27. JUN. 2021 06:45:05

Highest Band Edge / 1 RB

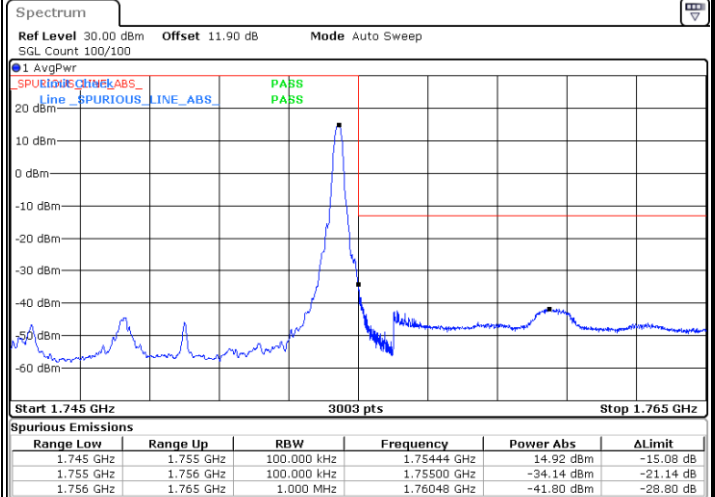

Date: 27. JUN. 2021 06:50:08

Lowest Band Edge / Full RB

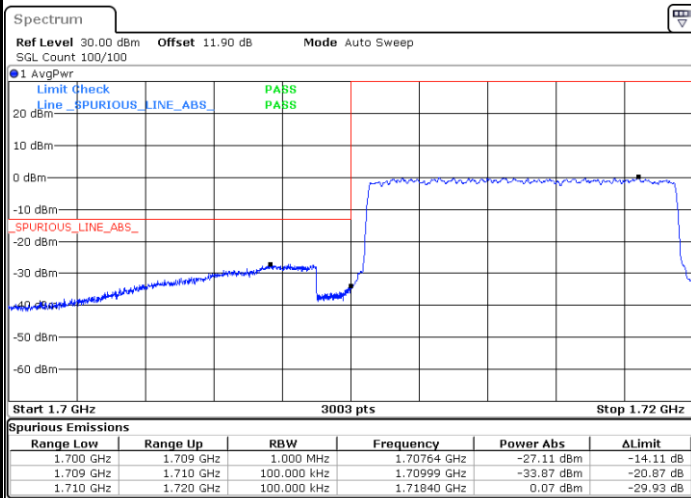

Date: 27. JUN. 2021 06:45:57

Highest Band Edge / Full RB

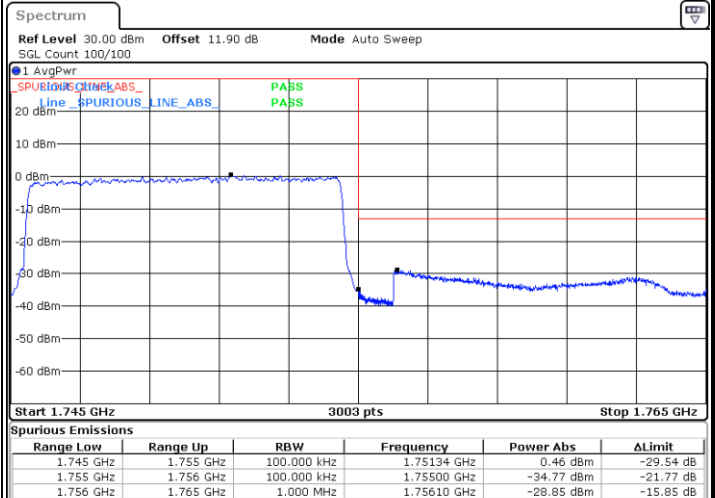

Date: 27. JUN. 2021 06:51:00



LTE Band 4 / 10MHz / 16QAM

Lowest Band Edge / 1 RB

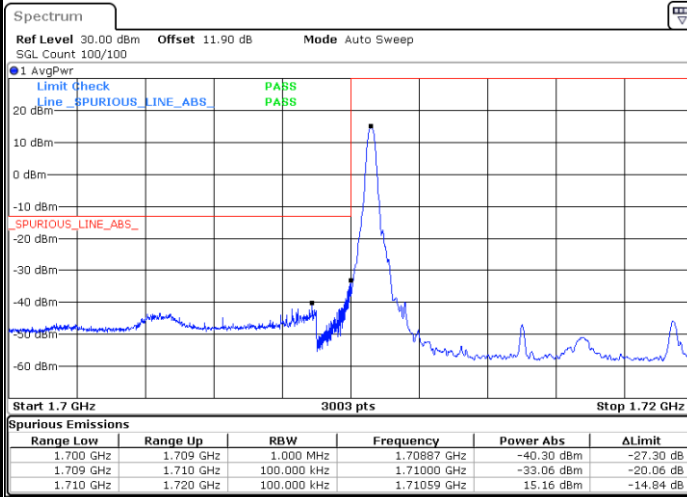

Highest Band Edge / 1 RB

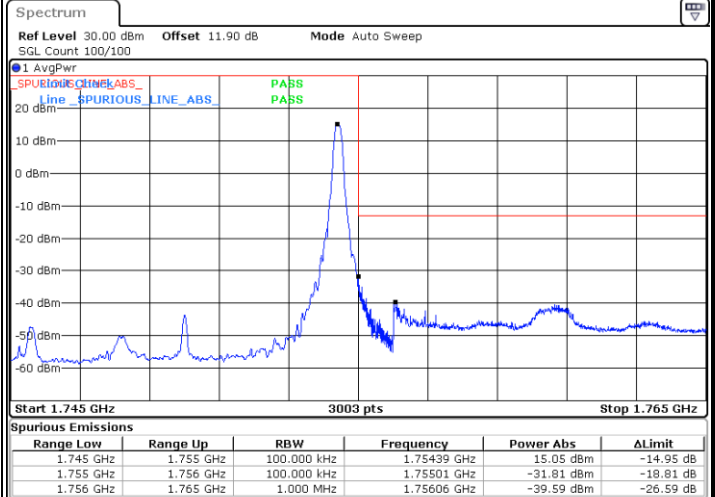

Lowest Band Edge / Full RB

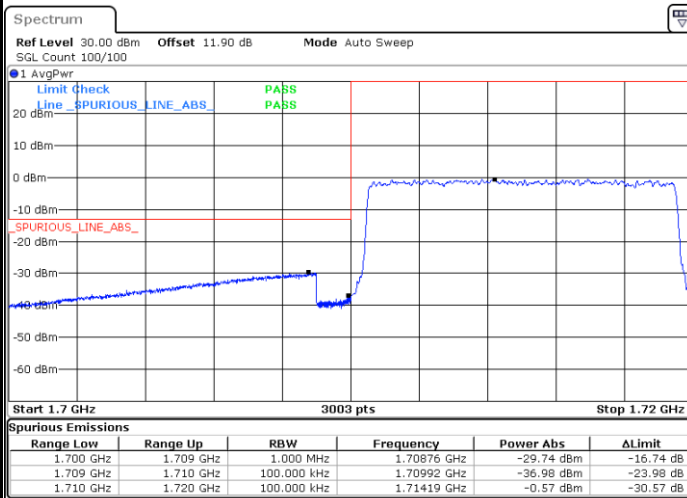

Highest Band Edge / Full RB

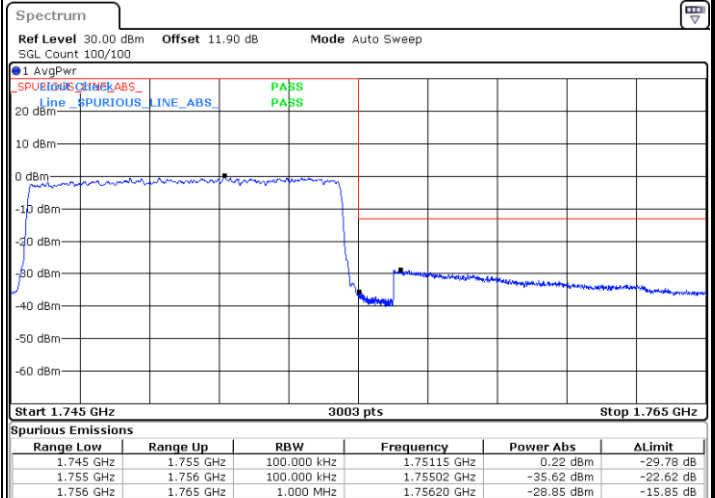





LTE Band 4 / 10MHz / 64QAM

Lowest Band Edge / 1 RB

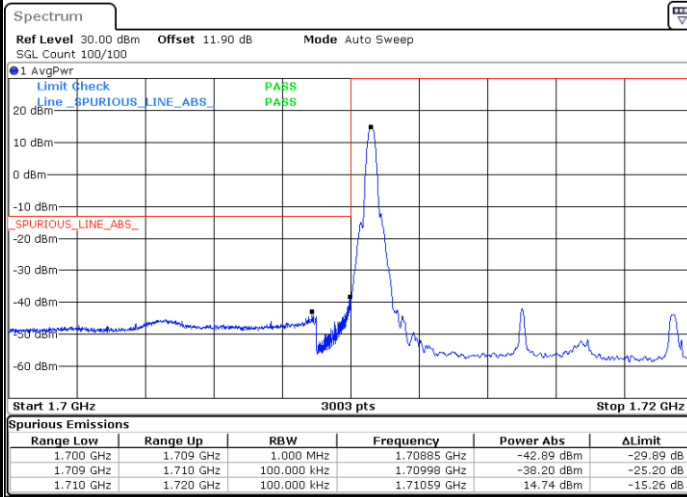

Highest Band Edge / 1 RB

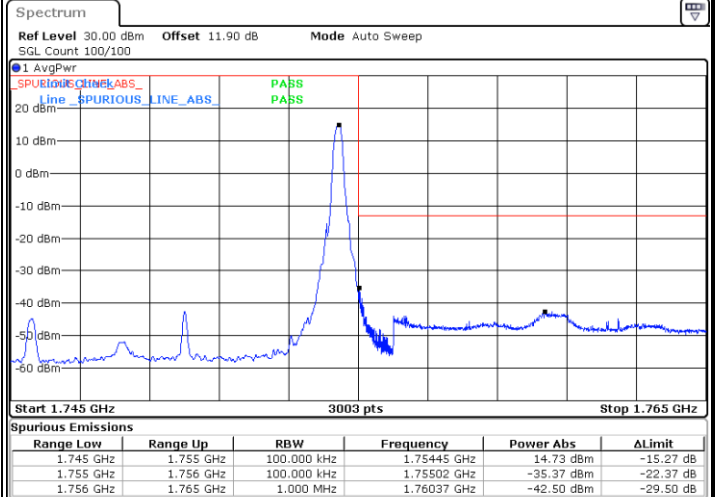

Lowest Band Edge / Full RB

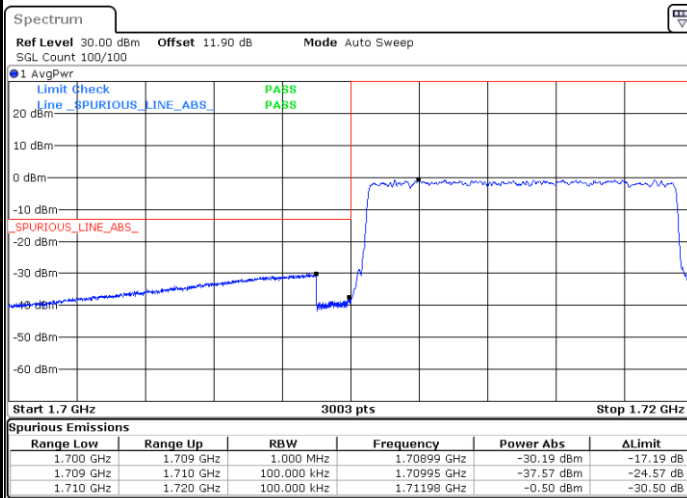

Highest Band Edge / Full RB

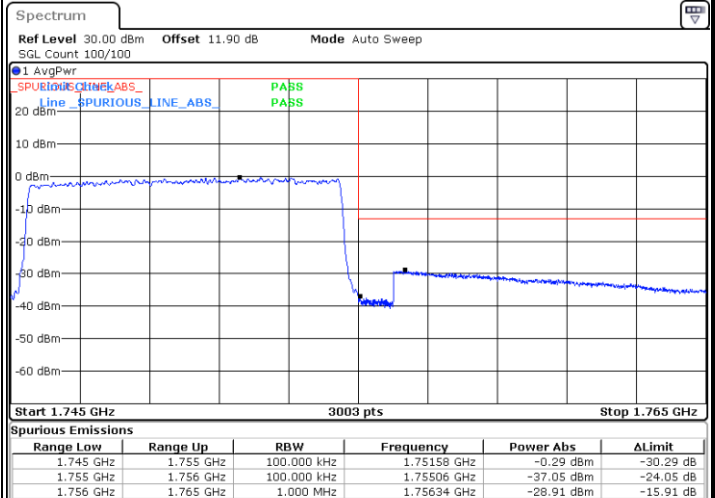



LTE Band 4 / 15MHz / QPSK

Lowest Band Edge / 1 RB

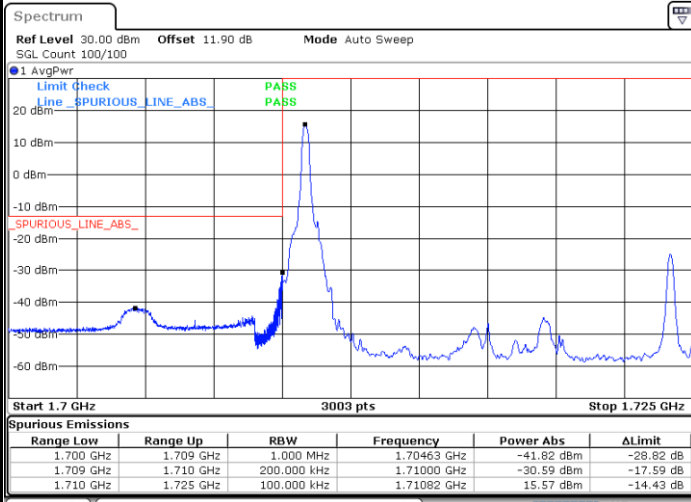

Date: 27.JUN.2021 06:55:17

Highest Band Edge / 1 RB

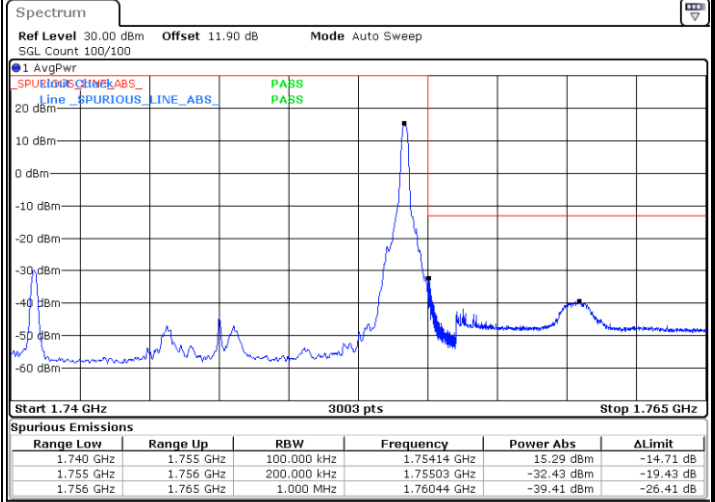

Date: 27.JUN.2021 07:00:20

Lowest Band Edge / Full RB

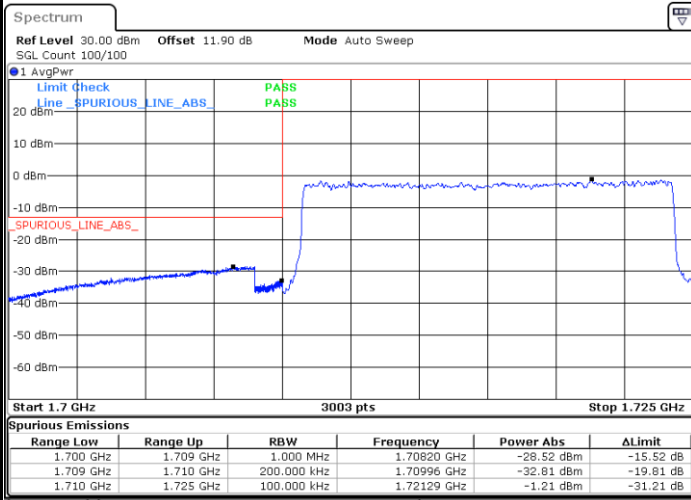

Date: 27.JUN.2021 06:56:09

Highest Band Edge / Full RB

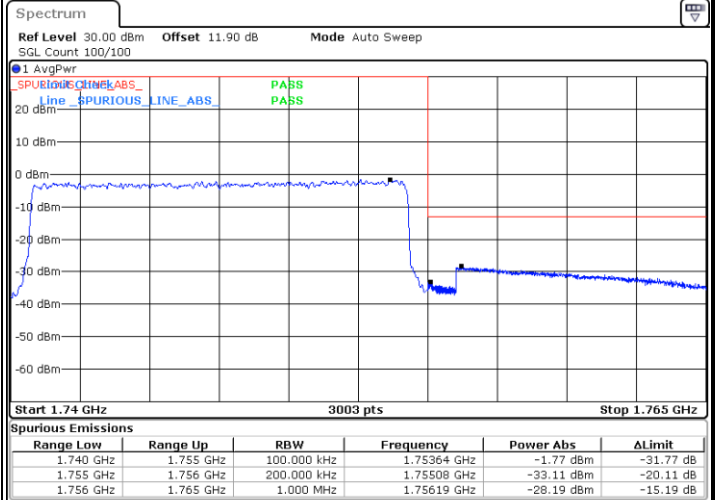

Date: 27.JUN.2021 07:01:11



LTE Band 4 / 15MHz / 16QAM

Lowest Band Edge / 1 RB

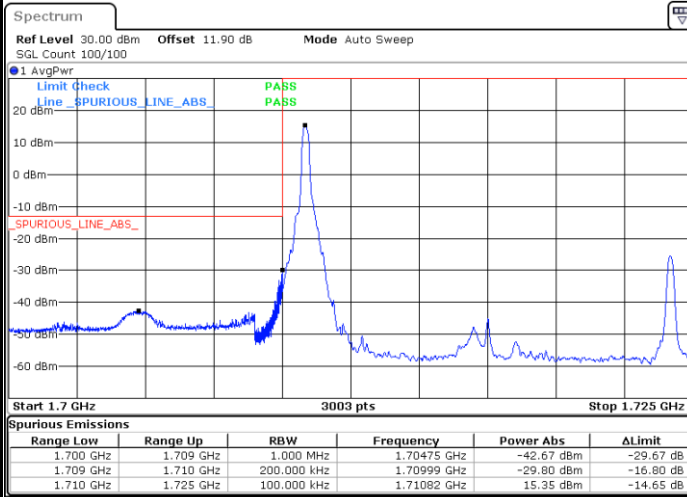

Date: 27.JUN.2021 06:55:42

Highest Band Edge / 1 RB



Date: 27.JUN.2021 07:00:45

Lowest Band Edge / Full RB

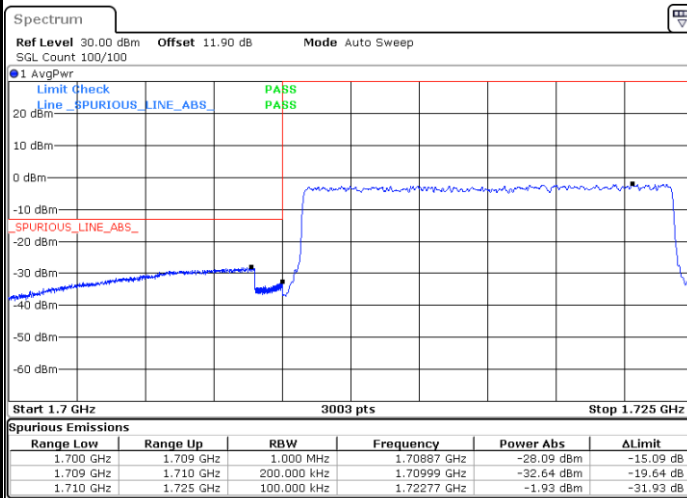

Date: 27.JUN.2021 06:56:34

Highest Band Edge / Full RB

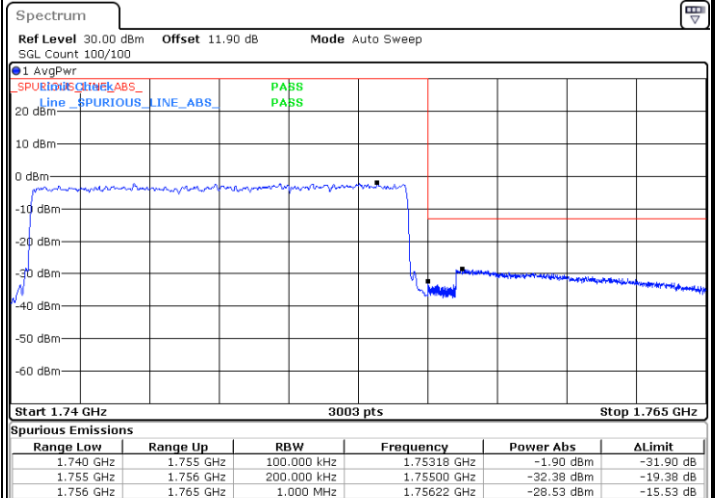

Date: 27.JUN.2021 07:01:37



LTE Band 4 / 15MHz / 64QAM

Lowest Band Edge / 1 RB

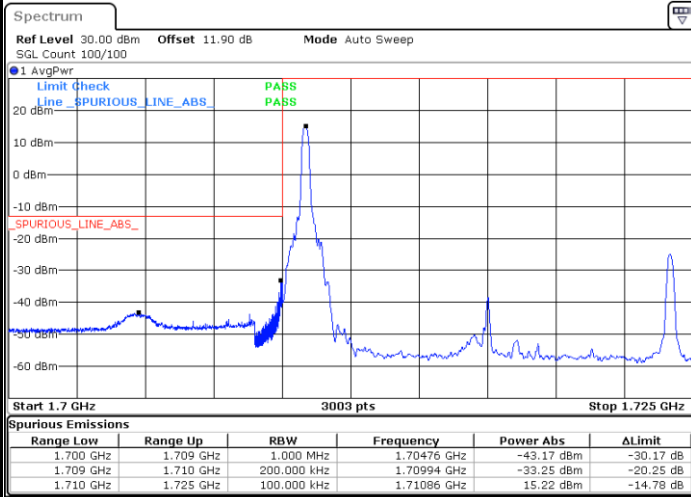

Date: 27.JUN.2021 07:02:59

Highest Band Edge / 1 RB

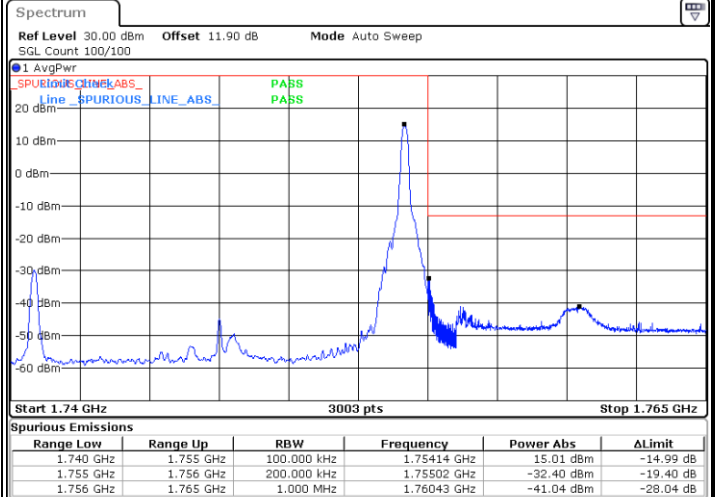

Date: 27.JUN.2021 07:04:34

Lowest Band Edge / Full RB

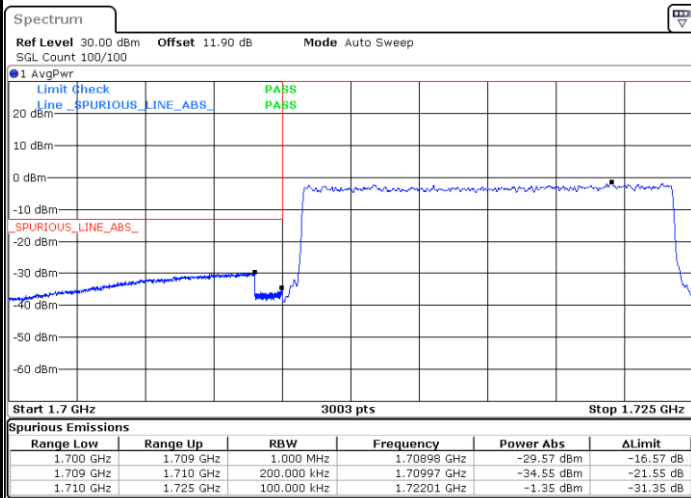

Date: 27.JUN.2021 07:03:25

Highest Band Edge / Full RB

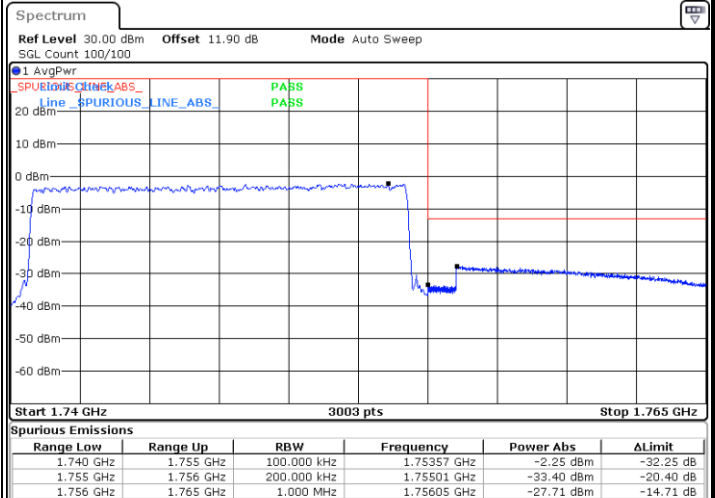

Date: 27.JUN.2021 07:05:00



LTE Band 4 / 20MHz / QPSK

Lowest Band Edge / 1 RB

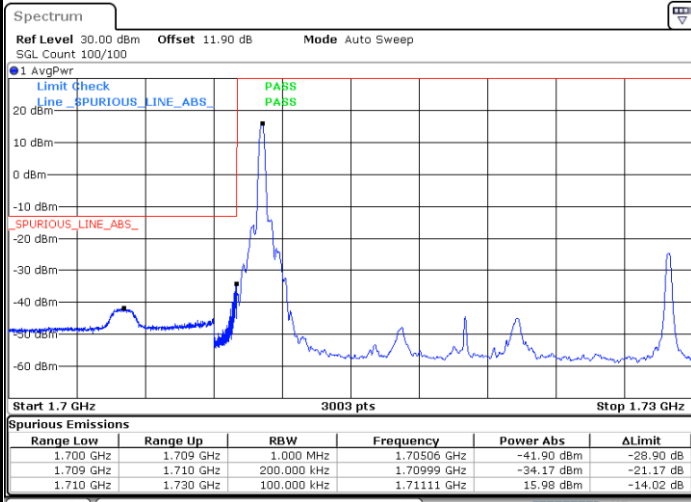

Date: 27.JUN.2021 07:05:27

Highest Band Edge / 1 RB

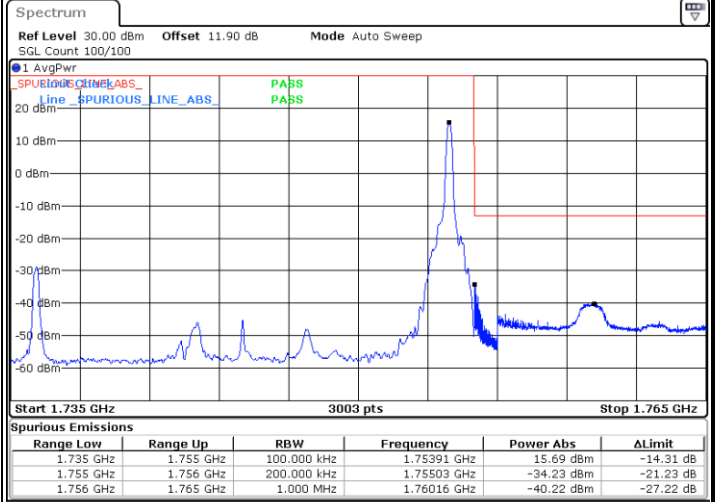

Date: 27.JUN.2021 07:10:31

Lowest Band Edge / Full RB

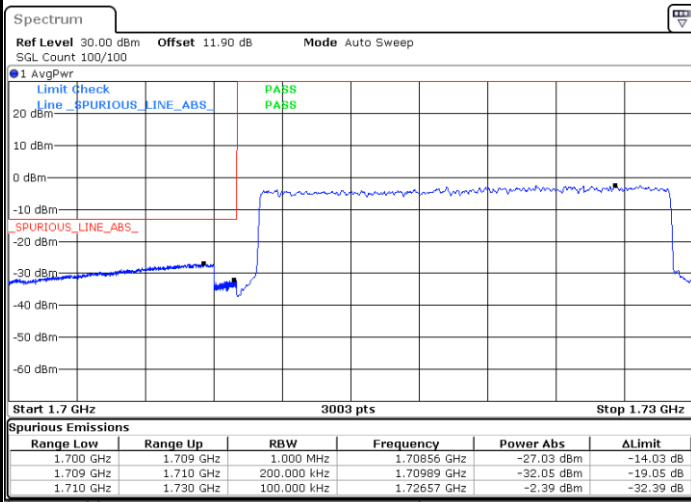

Date: 27.JUN.2021 07:06:20

Highest Band Edge / Full RB

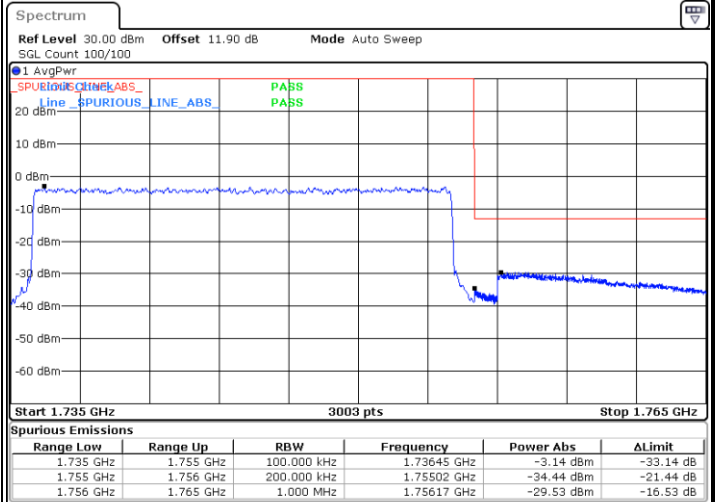

Date: 27.JUN.2021 07:11:24