



FCC RADIO TEST REPORT

FCC ID : PY7-77089S
Equipment : GSM/WCDMA/LTE/5G Phone with BT, DTS/UNII a/b/g/n/ac/ax, GPS and NFC
Brand Name : Sony
Applicant : Sony Corporation
1-7-1 Konan Minato-ku Tokyo, 108-0075 Japan
Manufacturer : Sony Corporation
1-7-1 Konan Minato-ku Tokyo, 108-0075 Japan
Standard : FCC Part 15 Subpart E §15.407

The product was received on Jun. 08, 2021 and testing was started from Jun. 21, 2021 and completed on Jul. 07, 2021. We, Sporton International Inc. EMC & Wireless Communications Laboratory, would like to declare that the tested sample has been evaluated in accordance with the test procedures and has been in compliance with the applicable technical standards.

The test results in this spot check data report apply exclusively to the tested model / sample. Without written approval of Sporton International Inc. EMC & Wireless Communications Laboratory, the test report shall not be reproduced except in full.

Louis Wu

Approved by: Louis Wu

Sporton International Inc. EMC & Wireless Communications Laboratory

No. 52, Huaya 1st Rd., Guishan Dist., Taoyuan City 333, Taiwan (R.O.C.)



Table of Contents

History of this test report.....	3
Summary of Test Result.....	4
1 General Description	5
1.1 Product Feature of Equipment Under Test.....	5
1.2 Modification of EUT	5
1.3 Testing Location	6
1.4 Applicable Standards.....	6
2 Test Configuration of Equipment Under Test	7
2.1 Carrier Frequency and Channel	7
2.2 Test Mode.....	8
2.3 Connection Diagram of Test System.....	9
2.4 EUT Operation Test Setup	9
3 Test Result	10
3.1 Maximum Conducted Output Power Measurement	10
3.2 Unwanted Emissions Measurement	12
3.3 Antenna Requirements.....	17
4 List of Measuring Equipment.....	18
5 Uncertainty of Evaluation	20
Appendix A. Conducted Test Results	
Appendix B. Radiated Spurious Emission	
Appendix C. Radiated Spurious Emission Plots	
Appendix D. Duty Cycle Plots	



Summary of Test Result

Report Clause	Ref Std. Clause	Test Items	Result (PASS/FAIL)	Remark
-	15.403(i)	26dB Bandwidth	-	See Note
-	2.1049	99% Occupied Bandwidth	-	See Note
3.1	15.407(a)	Maximum Conducted Output Power	Pass	-
-	15.407(a)	Power Spectral Density	-	See Note
3.2	15.407(b)	Unwanted Emissions	Pass	Under limit 4.16 dB at 10480.000 MHz
-	15.207	AC Conducted Emission	-	See Note
3.3	15.203 15.407(a)	Antenna Requirement	Pass	-

Note: The RF circuit, output power level and antenna performance is the same in WLAN function across all two FCC ID PY7-38061M and PY7-77089S, since the change, only verify RF output power and radiated spurious emission test data, the worst mode was reported in this report.

Declaration of Conformity: The test results with all measurement uncertainty excluded are presented in accordance with the regulation limits or requirements declared by manufacturers.
Comments and Explanations: The declared of product specification for EUT presented in the report are provided by the manufacturer, and the manufacturer takes all the responsibilities for the accuracy of product specification.

Reviewed by: Keven Cheng

Report Producer: Lucy Wu



1 General Description

1.1 Product Feature of Equipment Under Test

GSM/WCDMA/LTE, Bluetooth, DTS/UNII a/b/g/n/ac/ax, NFC, FM Receiver and GNSS.

Product Specification subjective to this standard	
Antenna Type / Gain	<5150 MHz ~ 5250 MHz>
	<Chain 0>: Loop Antenna with gain -0.90 dBi
	<Chain 1>: Monopole Antenna with gain -5.00 dBi
	<5250 MHz ~ 5350 MHz>
	<Chain 0>: Loop Antenna with gain -2.60 dBi
	<Chain 1>: Monopole Antenna with gain -4.90 dBi
	<5470 MHz ~ 5725 MHz>
	<Chain 0>: Loop Antenna with gain -3.10 dBi
	<Chain 1>: Monopole Antenna with gain -6.00 dBi

Remark: The above EUT's information was declared by manufacturer. Please refer to Comments and Explanations in report summary.

EUT Information List			
HW Version	SW Version	S/N	Performed Test Item
A	3.46	QV72002H9B	RF conducted measurement
	3.46	QV72000H9B	Radiated Spurious Emission

Accessory List	
AC Adapter	Model Name : XQZ-UC1
	S/N : 0020W51300095
Earphone	Model Name : STH40D
	S/N : N/A
USB Cable	Model Name : XQZ-UB1
	S/N : N/A

Note:

1. Above EUT list used are electrically identical per declared by manufacturer.
2. Above the accessories list are used to exercise the EUT during test, and the serial number of each type of accessories is listed in each section of this report. .
3. For other wireless features of this EUT, test report will be issued separately.

1.2 Modification of EUT

No modifications are made to the EUT during all test items.



1.3 Testing Location

Test Site	Sporton International Inc. EMC & Wireless Communications Laboratory
Test Site Location	No.52, Huaya 1st Rd., Guishan Dist., Taoyuan City 333, Taiwan (R.O.C.) TEL: +886-3-327-3456 FAX: +886-3-328-4978
Test Site No.	Sporton Site No. TH02-HY
Test Site	Sporton International Inc. Wensan Laboratory
Test Site Location	No.58, Aly. 75, Ln. 564, Wenhua 3rd, Rd., Guishan Dist., Taoyuan City 333010, Taiwan (R.O.C.) TEL: +886-3-327-0868 FAX: +886-3-327-0855
Test Site No.	Sporton Site No. 03CH11-HY (TAF Code: 3786)
Remark	The Radiated Spurious Emission test item subcontracted to Sporton International Inc. Wensan Laboratory

Note: The test site complies with ANSI C63.4 2014 requirement.

FCC designation No.: TW1190 and TW3786

1.4 Applicable Standards

According to the specifications of the manufacturer, the EUT must comply with the requirements of the following standards:

- ♦ FCC Part 15 Subpart E
- ♦ FCC KDB 789033 D02 General UNII Test Procedures New Rules v02r01.
- ♦ FCC KDB 414788 D01 Radiated Test Site v01r01.
- ♦ FCC KDB 662911 D01 Multiple Transmitter Output v02r01.
- ♦ ANSI C63.10-2013

Remark:

1. All test items were verified and recorded according to the standards and without any deviation during the test.
2. The TAF code is not including all the FCC KDB listed without accreditation.
3. This EUT has also been tested and complied with the requirements of FCC Part 15, Subpart B, recorded in a separate test report.



2 Test Configuration of Equipment Under Test

The EUT has been associated with peripherals and configuration operated in a manner tended to maximize its emission characteristics in a typical application. Frequency range investigated: radiation emission (9 kHz to the 10th harmonic of the highest fundamental frequency or to 40 GHz, whichever is lower). For radiated measurement, the measured emission level of the EUT was maximized by rotating the EUT on a turntable, adjusting the orientation of the EUT and EUT antenna in three orthogonal axis (X: flat, Y: portrait, Z: landscape), and adjusting the measurement antenna orientation, following C63.10 exploratory test procedures and find X plane as worst plane.

2.1 Carrier Frequency and Channel

Frequency Band	Channel	Freq. (MHz)	Channel	Freq. (MHz)
5150-5250 MHz Band 1 (U-NII-1)	36	5180	44	5220
	38*	5190	46*	5230
	40	5200	48	5240
	42 [#]	5210		

Frequency Band	Channel	Freq. (MHz)	Channel	Freq. (MHz)
5250-5350 MHz Band 2 (U-NII-2A)	52	5260	60	5300
	54*	5270	62*	5310
	56	5280	64	5320
	58 [#]	5290		

Frequency Band	Channel	Freq. (MHz)	Channel	Freq. (MHz)
5470-5725 MHz Band 3 (U-NII-2C)	100	5500	112	5560
	102*	5510	116	5580
	104	5520	132	5660
	106 [#]	5530	134*	5670
	108	5540	136	5680
	110*	5550	140	5700

Frequency Band	Channel	Freq. (MHz)
5150-5350 MHz	50 [@]	5250
5470-5725 MHz	114 [@]	5570



Frequency Band	Channel	Freq. (MHz)	Channel	Freq. (MHz)
TDWR Channel	118*	5590	124	5620
	120	5600	126*	5630
	122 [#]	5610	128	5640

Frequency Band	Channel	Freq. (MHz)	Channel	Freq. (MHz)
Straddle Channel	138 [#]	5690	144	5720
	142*	5710		

Note:

1. The above Frequency and Channel in "*" were 802.11n HT40 and 802.11ac VHT40 and 802.11ax HE40.
2. The above Frequency and Channel in "[#]" were 802.11ac VHT80 and 802.11ax HE80.
3. The above Frequency and Channel in "@[#]" were 802.11ac VHT160 and 802.11ax HE160.

2.2 Test Mode

Final test modes are considering the modulation and worse data rates as below table.

Modulation	Data Rate
802.11a	6 Mbps
802.11n HT20	MCS0
802.11n HT40	MCS0
802.11ac VHT20	MCS0
802.11ac VHT40	MCS0
802.11ac VHT80	MCS0
802.11ac VHT160	MCS0
802.11ax HE20	MCS0
802.11ax HE40	MCS0
802.11ax HE80	MCS0
802.11ax HE160	MCS0

Ch. #		Band I : 5150-5250 MHz
		802.11ax HE20
L	Low	-
M	Middle	-
H	High	48
BW160		5150-5350 MHz
		802.11ax HE160
Ch. #		50

Remark: For radiation spurious emission, the final modulation and the worst data rate was reference the original report worse case.

2.3 Connection Diagram of Test System

<WLAN TX Mode>

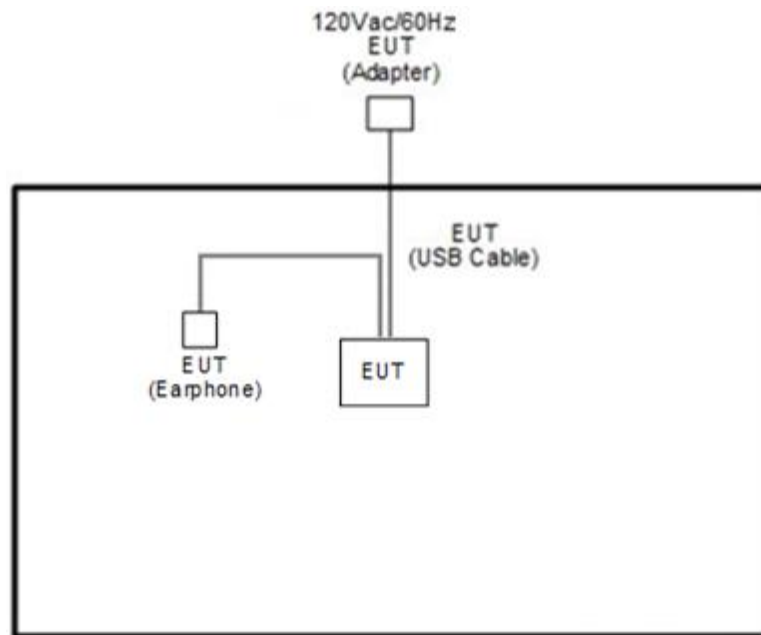

2.4 EUT Operation Test Setup

The RF test items, utility "FTMC_bridge_v0.39" was installed in Notebook which was programmed in order to make the EUT get into the engineering modes to provide channel selection, power level, data rate and the application type and for continuous transmitting signals.



3 Test Result

3.1 Maximum Conducted Output Power Measurement

3.1.1 Limit of Maximum Conducted Output Power

<FCC 14-30 CFR 15.407>

For the 5.15–5.25 GHz bands:

■ For mobile and portable client devices in the 5.15–5.25 GHz band, the maximum conducted output power over the frequency band of operation shall not exceed 250 mW. For an indoor access point operating in the band 5.15-5.25 GHz, the maximum conducted output power over the frequency band of operation shall not exceed 1 W.

For the 5.25–5.725 GHz bands:

■ The maximum conducted output power over the frequency bands of operation shall not exceed the lesser of 250 mW or 11 dBm $10 \log B$, where B is the 26 dB emission bandwidth in megahertz.

For Straddle Channel, according to KDB 789033 D02 General UNII Test Procedures New Rules v02r01, if the power and PSD of the devices are uniform and comply with the lower limits specified for the U-NII-2 bands, a single measurement over the entire emission bandwidth can be performed to show compliance.

If transmitting antennas of directional gain greater than 6 dBi are used, the peak output power shall be reduced by the amount in dB that the directional gain of the antenna exceeds 6 dBi.

Note that U-NII-2 band, devices with a maximum e.i.r.p. greater than 500 mW shall implement TPC in order to have the capability to operate at least 6 dB below the maximum permitted e.i.r.p. of 1 W.

3.1.2 Measuring Instruments

See list of measuring equipment of this test report.

3.1.3 Test Procedures

The testing follows Method PM-G of FCC KDB 789033 D02 General UNII Test Procedures New Rules v02r01.

Method PM-G (Measurement using a gated RF average power meter):

1. Measurement is performed using a wideband RF power meter.
2. The EUT is configured to transmit at its maximum power control level.
3. Measure the average power of the transmitter.
4. Since the measurement is made only during the ON time of the transmitter, no duty cycle correction factor is required.

For Straddle Channel, according to KDB 789033 D02 General UNII Test Procedures New Rules v02r01, if the power and PSD of the devices are uniform and comply with the lower limits specified for the U-NII-2 bands, a single measurement over the entire emission bandwidth can be performed to show compliance.

3.1.4 Test Setup

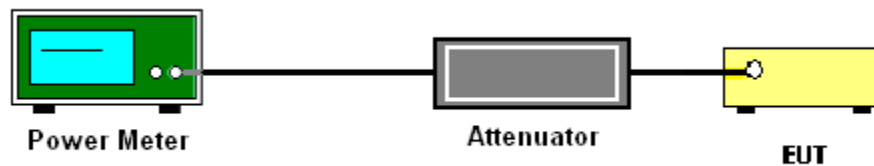

3.1.5 Test Result of Maximum Conducted Output Power

Please refer to Appendix A.



3.2 Unwanted Emissions Measurement

This section is to measure unwanted emissions through radiated measurement for band edge spurious emissions and out of band emissions measurement.

3.2.1 Limit of Unwanted Emissions

(1) For transmitters operating in the 5150-5250 MHz band: all emissions outside of the 5150-5350 MHz band shall not exceed an EIRP of -27dBm/MHz.

For transmitters operating in the 5250-5350 MHz band: all emissions outside of the 5150-5350 MHz band shall not exceed an EIRP of -27 dBm/MHz. Devices operating in the 5250-5350 MHz band that generate emissions in the 5150-5250 MHz band must meet all applicable technical requirements for operation in the 5150-5250 MHz band (including indoor use) or alternatively meet an out-of-band emission EIRP limit of -27 dBm/MHz in the 5150-5250 MHz band.

For transmitters operating in the 5470-5600 MHz and 5650-5725MHz band: all emissions outside of the 5470-5600 MHz and 5650-5725MHz band shall not exceed an EIRP of -27 dBm/MHz.

(2) Unwanted spurious emissions fallen in restricted bands shall comply with the general field strength limits as below table:

Frequency (MHz)	Field Strength (microvolts/meter)	Measurement Distance (meters)
0.009 – 0.490	2400/F(kHz)	300
0.490 – 1.705	24000/F(kHz)	30
1.705 – 30.0	30	30
30 – 88	100	3
88 – 216	150	3
216 - 960	200	3
Above 960	500	3

Note: The following formula is used to convert the EIRP to field strength.

$$E = \frac{1000000\sqrt{30P}}{3} \mu\text{V/m, where P is the eirp (Watts)}$$



EIRP (dBm)	Field Strength at 3m (dBμV/m)
- 27	68.3

(3) KDB789033 D02 v02r01 G)2)c)

(i) Sections 15.407(b)(1-3) specifies the unwanted emissions limit for the U-NII-1 and U-NII-2 bands. As specified, emissions above 1000 MHz that are outside of the restricted bands are subject to a peak emission limit of -27 dBm/MHz.

(ii) Section 15.407(b)(4) specifies the unwanted emissions limit for the U-NII-3 band. A band emissions mask is specified in Section 15.407(b)(4)(i). The emission limits are based on the use of a peak detector.

3.2.2 Measuring Instruments

See list of measuring equipment of this test report.

3.2.3 Test Procedures

1. The testing follows FCC KDB 789033 D02 General UNII Test Procedures New Rules v02r01. Section G) Unwanted emissions measurement.

(1) Procedure for Unwanted Emissions Measurements Below 1000 MHz

- RBW = 120 kHz
- VBW = 300 kHz
- Detector = Peak
- Trace mode = max hold

(2) Procedure for Peak Unwanted Emissions Measurements Above 1000 MHz

- RBW = 1 MHz
- VBW ≥ 3 MHz
- Detector = Peak
- Sweep time = auto
- Trace mode = max hold

(3) Procedures for Average Unwanted Emissions Measurements Above 1000 MHz

- RBW = 1 MHz
- VBW = 10 Hz, when duty cycle is no less than 98 percent.
- $VBW \geq 1/T$, when duty cycle is less than 98 percent where T is the minimum transmission duration over which the transmitter is on and is transmitting at its maximum power control level for the tested mode of operation.

2. The EUT was placed on a turntable with 0.8 meter for frequency below 1 GHz and 1.5 meter for frequency above 1 GHz respectively above ground.
3. The EUT was set 3 meters from the interference receiving antenna which was mounted on the top of a variable height antenna tower.
4. The antenna is a broadband antenna and its height is adjusted between one meter and four meters above ground to find the maximum value of the field strength for both horizontal polarization and vertical polarization of the antenna.
5. For each suspected emission, the EUT was arranged to its worst case and then adjust the antenna tower (from 1 m to 4 m) and turntable (from 0 degree to 360 degrees) to find the maximum reading.
6. For testing below 1 GHz, if the emission level of the EUT in peak mode was 3 dB lower than the limit specified, then peak values of EUT will be reported, otherwise, the emissions will be repeated one by one using the CISPR quasi-peak method and reported.
7. For testing above 1 GHz, the emission level of the EUT in peak mode was 20 dB lower than average limit (that means the emission level in average mode also complies with the limit in average mode), then peak values of EUT will be reported, otherwise, the emissions will be measured in average mode again and reported.

3.2.4 Test Setup

For radiated emissions below 30MHz

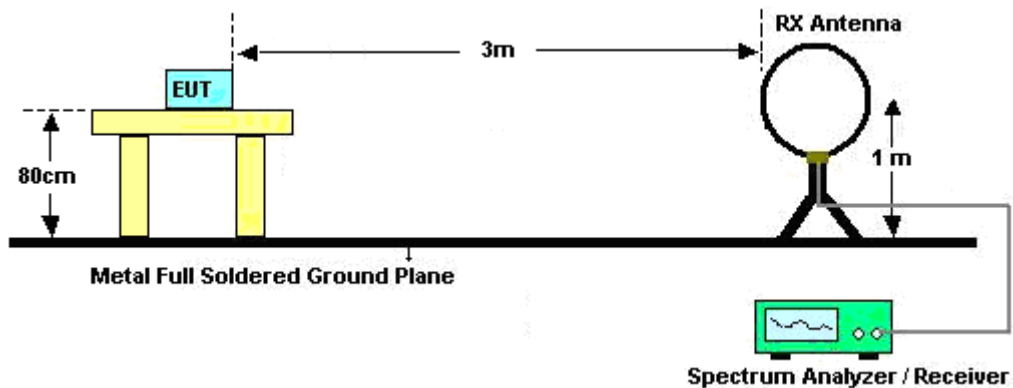

For radiated emissions from 30MHz to 1GHz

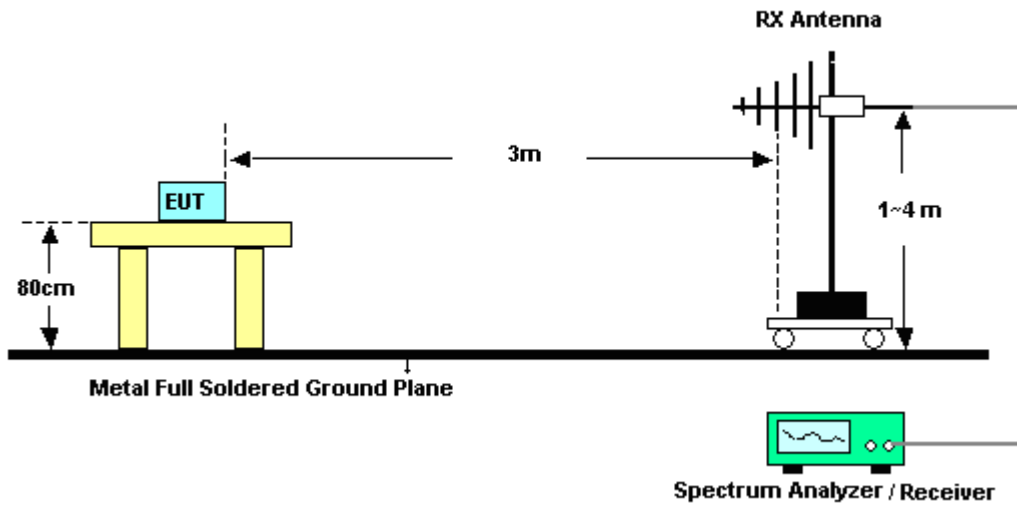

For radiated test from 1GHz to 18GHz

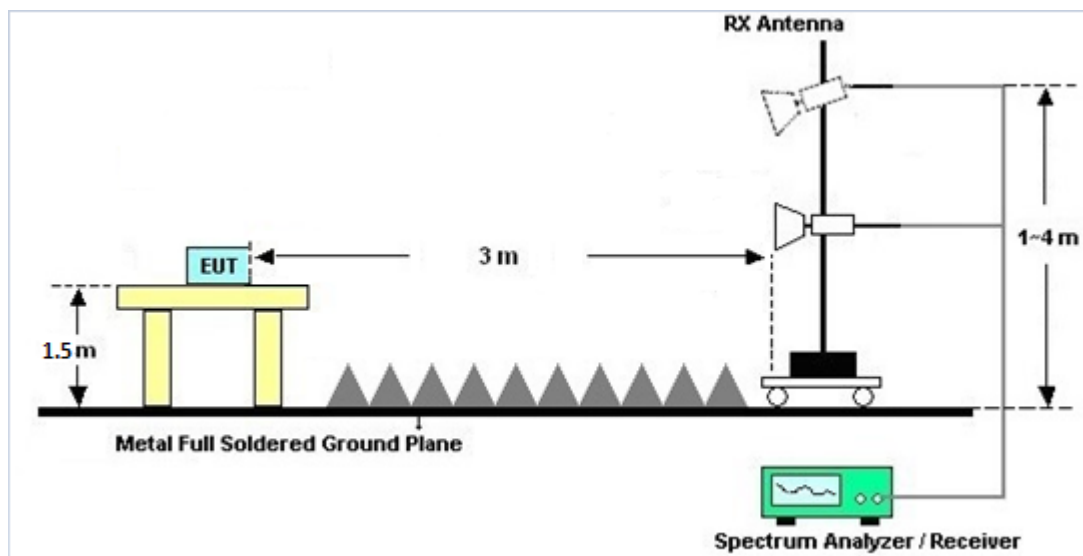

For radiated test above 18GHz

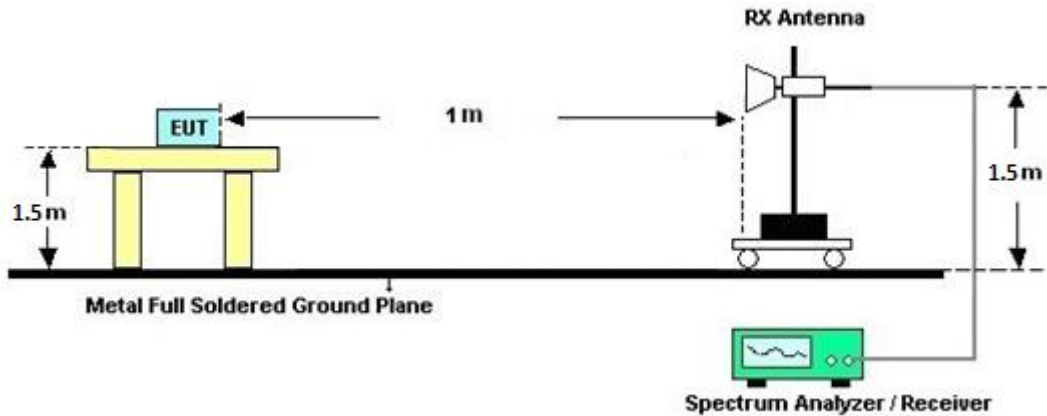

3.2.5 Test Results of Radiated Spurious Emissions (9 kHz ~ 30 MHz)

The low frequency, which started from 9 kHz to 30MHz, was pre-scanned and the result which was 20dB lower than the limit line was not reported.

There is adequate comparison measurement of both open-field test site and alternative test site - semi-Anechoic chamber according to 414788 D01 Radiated Test Site v01r01, and the result came out very similar.

3.2.6 Test Result of Radiated Spurious at Band Edges

Please refer to Appendix B and C.

3.2.7 Duty Cycle

Please refer to Appendix D.

3.2.8 Test Result of Radiated Spurious Emissions (30MHz ~ 10th Harmonic)

Please refer to Appendix B and C.



3.3 Antenna Requirements

3.3.1 Standard Applicable

If transmitting antenna directional gain is greater than 6 dBi, both the peak transmit power and the peak power spectral density shall be reduced by the amount in dB that the directional gain of the antenna exceeds 6 dBi.

3.3.2 Antenna Anti-Replacement Construction

An embedded-in antenna design is used.

3.3.3 Antenna Gain

The antenna peak gain of EUT is less than 6 dBi. Therefore, it is not necessary to reduce maximum peak output power limit.



4 List of Measuring Equipment

Instrument	Brand Name	Model No.	Serial No.	Characteristics	Calibration Date	Test Date	Due Date	Remark
Horn Antenna	SCHWARZBECK	BBHA 9120 D	9120D-1326	1GHz ~ 18GHz	Nov. 03, 2020	Jul. 06, 2021~ Jul. 07, 2021	Nov. 02, 2021	Radiation (03CH11-HY)
SHF-EHF Horn Antenna	SCHWARZBECK	BBHA9170	00991	18GHz~40GHz	May 12, 2021	Jul. 06, 2021~ Jul. 07, 2021	May 11, 2022	Radiation (03CH11-HY)
Bilog Antenna	TESEQ	CBL 6111D & N-6-06	35414 & AT-N0602	30MHz~1GHz	Oct. 11, 2020	Jul. 06, 2021~ Jul. 07, 2021	Oct. 10, 2021	Radiation (03CH11-HY)
Loop Antenna	Rohde & Schwarz	HFH2-Z2	100315	9 kHz~30 MHz	Jan. 04, 2021	Jul. 06, 2021~ Jul. 07, 2021	Jan. 03, 2022	Radiation (03CH11-HY)
Preamplifier	EMEC	EM1G18G	060812	1GHz~18GHz	Oct. 27, 2020	Jul. 06, 2021~ Jul. 07, 2021	Oct. 26, 2021	Radiation (03CH11-HY)
Preamplifier	Keysight	83017A	MY53270080	1GHz~26.5GHz	Nov. 12, 2020	Jul. 06, 2021~ Jul. 07, 2021	Nov. 11, 2021	Radiation (03CH11-HY)
Preamplifier	EMEC	EM18G40G	060801	18GHz~40GHz	Jun. 22, 2021	Jul. 06, 2021~ Jul. 07, 2021	Jun. 21, 2022	Radiation (03CH11-HY)
Amplifier	SONOMA	310N	187312	9kHz~1GHz	Dec. 02, 2020	Jul. 06, 2021~ Jul. 07, 2021	Dec. 01, 2021	Radiation (03CH11-HY)
Spectrum Analyzer	Keysight	N9010A	MY54200486	10Hz~44GHz	Oct. 23, 2020	Jul. 06, 2021~ Jul. 07, 2021	Oct. 22, 2021	Radiation (03CH11-HY)
EMI Test Receiver	Keysight	N9038A (MXE)	MY54130085	20MHz~8.4GHz	Nov. 02, 2020	Jul. 06, 2021~ Jul. 07, 2021	Nov. 01, 2021	Radiation (03CH11-HY)
Antenna Mast	EMEC	AM-BS-4500-B	N/A	1~4m	N/A	Jul. 06, 2021~ Jul. 07, 2021	N/A	Radiation (03CH11-HY)
Turn Table	EMEC	TT 2000	N/A	0~360 Degree	N/A	Jul. 06, 2021~ Jul. 07, 2021	N/A	Radiation (03CH11-HY)
Software	Audix	E3 6.2009-8-24	RK-001053	N/A	N/A	Jul. 06, 2021~ Jul. 07, 2021	N/A	Radiation (03CH11-HY)
RF Cable	HUBER + SUHNER	SUCOFLEX 104	MY9837/4 PE	9kHz-30MHz	Mar. 11, 2021	Jul. 06, 2021~ Jul. 07, 2021	Mar. 10, 2022	Radiation (03CH11-HY)
RF Cable	HUBER + SUHNER	SUCOFLEX 102	MY2859/2	30MHz-40GHz	Mar. 11, 2021	Jul. 06, 2021~ Jul. 07, 2021	Mar. 10, 2022	Radiation (03CH11-HY)
RF Cable	HUBER + SUHNER	SUCOFLEX 104	MY9837/4 PE	30M-18G	Mar. 11, 2021	Jul. 06, 2021~ Jul. 07, 2021	Mar. 10, 2022	Radiation (03CH11-HY)
RF Cable	HUBER + SUHNER	SUCOFLEX 102	MY4274/2	30MHz-40GHz	Mar. 11, 2021	Jul. 06, 2021~ Jul. 07, 2021	Mar. 10, 2022	Radiation (03CH11-HY)
Filter	Wainwright	WHKX8-5872. 5-6750-18000-40SS	SN3	6.75GHz High Pass Filter	Sep. 15, 2020	Jul. 06, 2021~ Jul. 07, 2021	Sep. 14, 2021	Radiation (03CH11-HY)
Filter	Wainwright	WLK4-1000-1 530-8000-40S S	SN1	1.53GHz Low Pass Filter	Sep. 14, 2020	Jul. 06, 2021~ Jul. 07, 2021	Sep. 13, 2021	Radiation (03CH11-HY)
Hygrometer	TECPEL	DTM-303B	TP140325	N/A	Nov. 18, 2020	Jul. 06, 2021~ Jul. 07, 2021	Nov. 17, 2021	Radiation (03CH11-HY)
Hygrometer	TECPEL	DTM-303B	TP200880	QA-3-031	Oct. 22, 2020	Jul. 06, 2021~ Jul. 07, 2021	Oct. 21, 2021	Radiation (03CH11-HY)



Instrument	Brand Name	Model No.	Serial No.	Characteristics	Calibration Date	Test Date	Due Date	Remark
Hygrometer	Testo	608-H1	34893241	N/A	Mar. 03, 2021	Jun. 21, 2021	Mar. 02, 2022	Conducted (TH02-HY)
Power Sensor	DARE	RPR3006W	16I00054S NO10	10MHz~6GHz	Dec. 16, 2020	Jun. 21, 2021	Dec. 15, 2021	Conducted (TH02-HY)
Signal Analyzer	Rohde & Schwarz	FSV40	101566	10Hz ~ 40GHz	Jul. 22, 2020	Jun. 21, 2021	Jul. 21, 2021	Conducted (TH02-HY)
Switch Box & RF Cable	EM Electronics	EMSW18SE	SW200302	N/A	Mar. 17, 2021	Jun. 21, 2021	Mar. 16, 2022	Conducted (TH02-HY)



5 Uncertainty of Evaluation

Uncertainty of Radiated Emission Measurement (30 MHz ~ 1000 MHz)

Measuring Uncertainty for a Level of Confidence of 95% ($U = 2Uc(y)$)	4.7 dB
---	--------

Uncertainty of Radiated Emission Measurement (1000 MHz ~ 18000 MHz)

Measuring Uncertainty for a Level of Confidence of 95% ($U = 2Uc(y)$)	4.9 dB
---	--------

Uncertainty of Radiated Emission Measurement (18000 MHz ~ 40000 MHz)

Measuring Uncertainty for a Level of Confidence of 95% ($U = 2Uc(y)$)	4.2 dB
---	--------

Appendix A. Test Result of Conducted Test Items

Test Engineer:	Eason huang	Temperature:	21~25	°C
Test Date:	2021/6/21	Relative Humidity:	51~54	%

TEST RESULTS DATA
Average Power Table

FCC Band I MIMO												
Mod.	Data Rate	NTX	CH.	Freq. (MHz)	Average Conducted Power (dBm)			FCC Conducted Power Limit (dBm)		DG (dBi)		Pass/Fail
					Chain 0	Chain 1	SUM	Chain 0	Chain 1	Chain 0	Chain 1	
11a	6Mbps	2	36	5180	10.40	10.30	13.36	24.00		-0.90		Pass
11a	6Mbps	2	44	5220	10.40	10.30	13.36	24.00		-0.90		Pass
11a	6Mbps	2	48	5240	10.40	10.30	13.36	24.00		-0.90		Pass
HT20	MCS0	2	36	5180	10.20	10.30	13.26	24.00		-0.90		Pass
HT20	MCS0	2	44	5220	10.20	10.30	13.26	24.00		-0.90		Pass
HT20	MCS0	2	48	5240	10.30	10.30	13.31	24.00		-0.90		Pass
HT40	MCS0	2	38	5190	10.20	10.30	13.26	24.00		-0.90		Pass
HT40	MCS0	2	46	5230	10.30	10.30	13.31	24.00		-0.90		Pass
VHT20	MCS0	2	36	5180	10.20	10.30	13.26	24.00		-0.90		Pass
VHT20	MCS0	2	44	5220	10.20	10.20	13.21	24.00		-0.90		Pass
VHT20	MCS0	2	48	5240	10.30	10.30	13.31	24.00		-0.90		Pass
VHT40	MCS0	2	38	5190	10.20	10.20	13.21	24.00		-0.90		Pass
VHT40	MCS0	2	46	5230	10.30	10.20	13.26	24.00		-0.90		Pass
VHT80	MCS0	2	42	5210	10.30	10.30	13.31	24.00		-0.90		Pass
VHT160	MCS0	2	50	5250	10.30	10.30	13.31	24.00		-0.90		Pass

TEST RESULTS DATA
Average Power Table

FCC Band II MIMO													
Mod.	Data Rate	NTX	CH.	Freq. (MHz)	Average Conducted Power (dBm)			FCC Conducted Power Limit (dBm)		DG (dBi)		EIRP Power Limit (dBm)	Pass/Fail
					Chain 0	Chain 1	SUM	Chain 0	Chain 1	Chain 0	Chain 1		
11a	6Mbps	2	52	5260	10.40	10.30	13.36	23.98		-2.60		26.99	Pass
11a	6Mbps	2	60	5300	8.40	8.40	11.41	23.98		-2.60		26.99	Pass
11a	6Mbps	2	64	5320	8.30	8.50	11.41	23.98		-2.60		26.99	Pass
HT20	MCS0	2	52	5260	10.30	10.30	13.31	23.98		-2.60		26.99	Pass
HT20	MCS0	2	60	5300	8.30	8.30	11.31	23.98		-2.60		26.99	Pass
HT20	MCS0	2	64	5320	8.30	8.30	11.31	23.98		-2.60		26.99	Pass
HT40	MCS0	2	54	5270	10.30	10.20	13.26	23.98		-2.60		26.99	Pass
HT40	MCS0	2	62	5310	10.30	10.30	13.31	23.98		-2.60		26.99	Pass
VHT20	MCS0	2	52	5260	10.20	10.30	13.26	23.98		-2.60		26.99	Pass
VHT20	MCS0	2	60	5300	8.30	8.20	11.26	23.98		-2.60		26.99	Pass
VHT20	MCS0	2	64	5320	8.30	8.30	11.31	23.98		-2.60		26.99	Pass
VHT40	MCS0	2	54	5270	10.30	10.20	13.26	23.98		-2.60		26.99	Pass
VHT40	MCS0	2	62	5310	10.30	10.30	13.31	23.98		-2.60		26.99	Pass
VHT80	MCS0	2	58	5290	10.30	10.40	13.36	23.98		-2.60		26.99	Pass

TEST RESULTS DATA
Average Power Table

FCC Band III MIMO													
Mod.	Data Rate	NTX	CH.	Freq. (MHz)	Average Conducted Power (dBm)			FCC Conducted Power Limit (dBm)		DG (dBi)		EIRP Power Limit (dBm)	Pass/Fail
					Chain 0	Chain 1	SUM	Chain 0	Chain 1	Chain 0	Chain 1		
11a	6Mbps	2	100	5500	10.30	10.30	13.31	23.98		-3.10	26.99	Pass	
11a	6Mbps	2	116	5580	10.40	10.30	13.36	23.98		-3.10	26.99	Pass	
11a	6Mbps	2	140	5700	10.30	10.30	13.31	23.98		-3.10	26.99	Pass	
HT20	MCS0	2	100	5500	10.30	10.30	13.31	23.98		-3.10	26.99	Pass	
HT20	MCS0	2	116	5580	10.30	10.30	13.31	23.98		-3.10	26.99	Pass	
HT20	MCS0	2	140	5700	10.30	10.30	13.31	23.98		-3.10	26.99	Pass	
HT40	MCS0	2	102	5510	10.30	10.30	13.31	23.98		-3.10	26.99	Pass	
HT40	MCS0	2	110	5550	10.30	10.30	13.31	23.98		-3.10	26.99	Pass	
HT40	MCS0	2	134	5670	10.30	10.20	13.26	23.98		-3.10	26.99	Pass	
VHT20	MCS0	2	100	5500	10.20	10.30	13.26	23.98		-3.10	26.99	Pass	
VHT20	MCS0	2	116	5580	10.30	10.20	13.26	23.98		-3.10	26.99	Pass	
VHT20	MCS0	2	140	5700	10.30	10.30	13.31	23.98		-3.10	26.99	Pass	
VHT40	MCS0	2	102	5510	10.30	10.20	13.26	23.98		-3.10	26.99	Pass	
VHT40	MCS0	2	110	5550	10.20	10.30	13.26	23.98		-3.10	26.99	Pass	
VHT40	MCS0	2	134	5670	10.20	10.20	13.21	23.98		-3.10	26.99	Pass	
VHT80	MCS0	2	106	5530	10.40	10.30	13.36	23.98		-3.10	26.99	Pass	
VHT80	MCS0	2	122	5610	10.30	10.30	13.31	23.98		-3.10	26.99	Pass	
VHT160	MCS0	2	114	5570	10.30	10.40	13.36	23.98		-3.10	26.99	Pass	

FCC Band III straddle channel MIMO													
Mod.	Data Rate	NTX	CH.	Freq. (MHz)	Average Conducted Power (dBm)			FCC Conducted Power Limit (dBm)		DG (dBi)		EIRP Power Limit (dBm)	Pass/Fail
					Chain 0	Chain 1	SUM	Chain 0	Chain 1	Chain 0	Chain 1		
11a	6Mbps	2	144	5720	10.30	10.30	13.31	22.82		-3.10	26.99	Pass	
HT20	MCS0	2	144	5720	10.30	10.30	13.31	23.98		-3.10	26.99	Pass	
HT40	MCS0	2	142	5710	10.30	10.30	13.31	23.98		-3.10	26.99	Pass	
VHT20	MCS0	2	144	5720	10.30	10.30	13.31	23.98		-3.10	26.99	Pass	
VHT40	MCS0	2	142	5710	10.30	10.30	13.31	23.98		-3.10	26.99	Pass	
VHT80	MCS0	2	138	5690	10.40	10.30	13.36	23.98		-3.10	26.99	Pass	

TEST RESULTS DATA
Average Power Table

FCC Band I MIMO													
Mod.	Data Rate	NTX	CH.	Freq. (MHz)	RU Config.	Average Conducted Power (dBm)			FCC Conducted Power Limit (dBm)		DG (dBi)		Pass/Fail
						Chain 0	Chain 1	SUM	Chain 0	Chain 1	Chain 0	Chain 1	
HE20	MCS0	2	36	5180	Full	10.50	10.40	13.46	24.00		-0.90		Pass
HE20	MCS0	2	36	5180	26/0	7.80	7.80	10.81	24.00		-0.90		Pass
HE20	MCS0	2	36	5180	52/37	9.70	9.80	12.76	24.00		-0.90		Pass
HE20	MCS0	2	36	5180	106/53	10.40	10.30	13.36	24.00		-0.90		Pass
HE20	MCS0	2	44	5220	Full	10.40	10.40	13.41	24.00		-0.90		Pass
HE20	MCS0	2	48	5240	Full	10.40	10.40	13.41	24.00		-0.90		Pass
HE20	MCS0	2	48	5240	26/8	8.80	8.90	11.86	24.00		-0.90		Pass
HE20	MCS0	2	48	5240	52/40	10.30	10.40	13.36	24.00		-0.90		Pass
HE20	MCS0	2	48	5240	106/54	10.40	10.40	13.41	24.00		-0.90		Pass
HE40	MCS0	2	38	5190	Full	10.30	10.40	13.36	24.00		-0.90		Pass
HE40	MCS0	2	38	5190	242/61	10.30	10.40	13.36	24.00		-0.90		Pass
HE40	MCS0	2	46	5230	Full	10.40	10.40	13.41	24.00		-0.90		Pass
HE40	MCS0	2	46	5230	242/62	10.30	10.30	13.31	24.00		-0.90		Pass
HE80	MCS0	2	42	5210	Full	10.40	10.40	13.41	24.00		-0.90		Pass
HE80	MCS0	2	42	5210	484/65	9.20	9.20	12.21	24.00		-0.90		Pass
HE160	MCS0	2	50	5250	Full	10.40	10.40	13.41	24.00		-0.90		Pass
HE160	MCS0	2	50	5250	996/67	3.70	3.80	6.76	24.00		-0.90		Pass

TEST RESULTS DATA
Average Power Table

FCC Band II MIMO														
Mod.	Data Rate	NTX	CH.	Freq. (MHz)	RU Config.	Average Conducted Power (dBm)			FCC Conducted Power Limit (dBm)		DG (dBi)		EIRP Power Limit (dBm)	Pass/Fail
						Chain 0	Chain 1	SUM	Chain 0	Chain 1	Chain 0	Chain 1		
HE20	MCS0	2	52	5260	Full	10.50	10.40	13.46	23.98		-2.60	26.99	Pass	
HE20	MCS0	2	52	5260	26/0	8.80	8.80	11.81	23.98		-2.60	26.99	Pass	
HE20	MCS0	2	52	5260	52/37	10.30	10.40	13.36	23.98		-2.60	26.99	Pass	
HE20	MCS0	2	52	5260	106/53	10.30	10.30	13.31	23.98		-2.60	26.99	Pass	
HE20	MCS0	2	60	5300	Full	8.40	8.50	11.46	23.98		-2.60	26.99	Pass	
HE20	MCS0	2	64	5320	Full	8.40	8.40	11.41	23.98		-2.60	26.99	Pass	
HE20	MCS0	2	64	5320	26/8	3.80	3.90	6.86	23.98		-2.60	26.99	Pass	
HE20	MCS0	2	64	5320	52/40	5.30	5.30	8.31	23.98		-2.60	26.99	Pass	
HE20	MCS0	2	64	5320	106/54	6.80	6.80	9.81	23.98		-2.60	26.99	Pass	
HE40	MCS0	2	54	5270	Full	10.40	10.30	13.36	23.98		-2.60	26.99	Pass	
HE40	MCS0	2	54	5270	242/61	10.40	10.30	13.36	23.98		-2.60	26.99	Pass	
HE40	MCS0	2	62	5310	Full	10.50	10.40	13.46	23.98		-2.60	26.99	Pass	
HE40	MCS0	2	62	5310	242/62	9.90	9.80	12.86	23.98		-2.60	26.99	Pass	
HE80	MCS0	2	58	5290	Full	10.40	10.50	13.46	23.98		-2.60	26.99	Pass	
HE80	MCS0	2	58	5290	484/66	9.80	9.70	12.76	23.98		-2.60	26.99	Pass	
HE160	MCS0	2	50	5250	996/S67	3.80	3.80	6.81	23.98		-2.60	26.99	Pass	

TEST RESULTS DATA
Average Power Table

FCC Band III MIMO														
Mod.	Data Rate	NTX	CH.	Freq. (MHz)	RU Config.	Average Conducted Power (dBm)			FCC Conducted Power Limit (dBm)		DG (dBi)		EIRP Power Limit (dBm)	Pass/Fail
						Chain 0	Chain 1	SUM	Chain 0	Chain 1	Chain 0	Chain 1		
HE20	MCS0	2	100	5500	Full	10.40	10.40	13.41	23.98		-3.10	26.99	Pass	
HE20	MCS0	2	100	5500	26/0	8.80	8.80	11.81	23.98		-3.10	26.99	Pass	
HE20	MCS0	2	100	5500	52/37	10.30	10.40	13.36	23.98		-3.10	26.99	Pass	
HE20	MCS0	2	100	5500	106/53	10.40	10.40	13.41	23.98		-3.10	26.99	Pass	
HE20	MCS0	2	116	5580	Full	10.40	10.40	13.41	23.98		-3.10	26.99	Pass	
HE20	MCS0	2	140	5700	Full	10.50	10.40	13.46	23.98		-3.10	26.99	Pass	
HE20	MCS0	2	140	5700	26/8	8.80	8.70	11.76	23.98		-3.10	26.99	Pass	
HE20	MCS0	2	140	5700	52/40	10.40	10.40	13.41	23.98		-3.10	26.99	Pass	
HE20	MCS0	2	140	5700	106/54	10.40	10.40	13.41	23.98		-3.10	26.99	Pass	
HE40	MCS0	2	102	5510	Full	10.40	10.40	13.41	23.98		-3.10	26.99	Pass	
HE40	MCS0	2	102	5510	242/61	10.30	10.40	13.36	23.98		-3.10	26.99	Pass	
HE40	MCS0	2	110	5550	Full	10.40	10.40	13.41	23.98		-3.10	26.99	Pass	
HE40	MCS0	2	134	5670	Full	10.40	10.30	13.36	23.98		-3.10	26.99	Pass	
HE40	MCS0	2	134	5670	242/62	10.30	10.40	13.36	23.98		-3.10	26.99	Pass	
HE80	MCS0	2	106	5530	Full	10.50	10.40	13.46	23.98		-3.10	26.99	Pass	
HE80	MCS0	2	106	5530	484/65	10.30	10.20	13.26	23.98		-3.10	26.99	Pass	
HE80	MCS0	2	122	5610	Full	10.40	10.40	13.41	23.98		-3.10	26.99	Pass	
HE80	MCS0	2	122	5610	484/66	10.30	10.20	13.26	23.98		-3.10	26.99	Pass	
HE160	MCS0	2	114	5570	Full	10.40	10.50	13.46	23.98		-3.10	26.99	Pass	
HE160	MCS0	2	114	5570	996/67	9.80	9.70	12.76	23.98		-3.10	26.99	Pass	
HE160	MCS0	2	114	5570	996/S67	9.80	9.80	12.81	23.98		-3.10	26.99	Pass	

FCC Band III straddle channel MIMO														
Mod.	Data Rate	NTX	CH.	Freq. (MHz)	RU Config.	Average Conducted Power (dBm)			FCC Conducted Power Limit (dBm)		DG (dBi)		EIRP Power Limit (dBm)	Pass/Fail
						Chain 0	Chain 1	SUM	Chain 0	Chain 1	Chain 0	Chain 1		
HE20	MCS0	2	144	5720	Full	10.40	10.40	13.41	23.08		-3.10	26.99	Pass	
HE40	MCS0	2	142	5710	Full	10.40	10.40	13.41	23.98		-3.10	26.99	Pass	
HE80	MCS0	2	138	5690	Full	10.50	10.40	13.46	23.98		-3.10	26.99	Pass	



Appendix B. Radiated Spurious Emission

Test Engineer :	Fu Chen and Harvey Guo	Temperature :	20.1~22.2°C
		Relative Humidity :	61.1~67.3%

Band 1 - 5150~5250MHz

WIFI 802.11ax HE20 Full (Harmonic @ 3m)

WIFI	Note	Frequency	Level	Over	Limit	Read	Antenna	Path	Preamp	Ant	Table	Peak	Pol.
Chain				Limit	Line	Level	Factor	Loss	Factor	Pos	Pos	Avg.	
0+1		(MHz)	(dBμV/m)	(dB)	(dBμV/m)	(dBμV)	(dB/m)	(dB)	(dB)	(cm)	(deg)	(P/A)	(H/V)
802.11ax		10480	52.82	-15.38	68.2	62.83	39.96	16.78	66.75	100	0	P	H
		15720	46.18	-27.82	74	53.13	37.7	21.71	66.36	100	0	P	H
		17956	57.96	-16.04	74	53.16	46.52	23.45	65.17	100	0	P	H
HE20 Full		17956	46.59	-7.41	54	41.79	46.52	23.45	65.17	100	0	A	H
CH 48		10480	64.04	-4.16	68.2	74.05	39.96	16.78	66.75	103	243	P	V
5240MHz		15720	46.35	-27.65	74	53.3	37.7	21.71	66.36	100	0	P	V
		17945	57.83	-16.17	74	53.27	46.3	23.44	65.18	100	0	P	V
		17945	46.42	-7.58	54	41.86	46.3	23.44	65.18	100	0	A	V
Remark	1. No other spurious found. 2. All results are PASS against Peak and Average limitline.												



**Band 1 5150~5250MHz
WIFI 802.11ax HE160 Partial 996 (Band Edge @ 3m)**

WIFI	Note	Frequency	Level	Over	Limit	Read	Antenna	Path	Preamp	Ant	Table	Peak	Pol.
Chain				Limit	Line	Level	Factor	Loss	Factor	Pos	Pos	Avg.	
0+1		(MHz)	(dBμV/m)	(dB)	(dBμV/m)	(dBμV)	(dB/m)	(dB)	(dB)	(cm)	(deg)	(P/A)	(H/V)
802.11ax HE160 Partial 996/67S CH 50 5250MHz		5141.7	59.64	-14.36	74	50.25	31.82	10.36	32.79	100	58	P	H
		5131.82	47.8	-6.2	54	38.4	31.84	10.35	32.79	100	58	A	H
	*	5250	93.29	-	-	84.45	31.2	10.49	32.85	100	58	P	H
	*	5250	84.64	-	-	75.8	31.2	10.49	32.85	100	58	A	H
		5396.16	55.79	-18.21	74	46.69	31.38	10.65	32.93	100	58	P	H
		5396.16	44.29	-9.71	54	35.19	31.38	10.65	32.93	100	58	A	H
		5143	55.93	-18.07	74	46.55	31.81	10.36	32.79	327	104	P	V
		5121.42	44.37	-9.63	54	34.96	31.86	10.33	32.78	327	104	A	V
	*	5250	88.74	-	-	79.9	31.2	10.49	32.85	327	104	P	V
	*	5250	80.81	-	-	71.97	31.2	10.49	32.85	327	104	A	V
	5377.4	52.35	-21.65	74	43.33	31.31	10.63	32.92	327	104	P	V	
	5396.16	42.76	-11.24	54	33.66	31.38	10.65	32.93	327	104	A	V	
Remark	1. No other spurious found. 2. All results are PASS against Peak and Average limitline.												



Emission above 18GHz

WIFI 802.11ax HE20 Full (SHF @ 3m)

WIFI	Note	Frequency	Level	Over	Limit	Read	Antenna	Path	Preamp	Ant	Table	Peak	Pol.	
Chain				Limit	Line	Level	Factor	Loss	Factor	Pos	Pos	Avg.		
0+1		(MHz)	(dBμV/m)	(dB)	(dBμV/m)	(dBμV)	(dB/m)	(dB)	(dB)	(cm)	(deg)	(P/A)	(H/V)	
802.11ax HE20 Full SHF		21479	36.31	-37.69	74	56.37	37.98	-3.24	54.8	150	0	P	H	
													H	
													H	
													H	
													H	
													H	
													H	
													H	
													H	
			22893	36.63	-37.37	74	55.57	38.61	-3.19	54.36	150	0	P	V
														V
														V
														V
														V
Remark	1. No other spurious found. 2. All results are PASS against limit line.													



Emission below 1GHz
WIFI 802.11ax HE20 Full (LF @ 3m)

WIFI	Note	Frequency	Level	Over	Limit	Read	Antenna	Path	Preamp	Ant	Table	Peak	Pol.	
Chain				Limit	Line	Level	Factor	Loss	Factor	Pos	Pos	Avg.		
0+1		(MHz)	(dBμV/m)	(dB)	(dBμV/m)	(dBμV)	(dB/m)	(dB)	(dB)	(cm)	(deg)	(P/A)	(H/V)	
802.11ax HE20 Full LF		62.01	22.98	-17.02	40	42.59	11.72	1.21	32.54	-	-	P	H	
		105.66	27.23	-16.27	43.5	41.75	16.41	1.57	32.5	-	-	P	H	
		176.47	27.19	-16.31	43.5	42.68	14.96	2.08	32.53	-	-	P	H	
		782.72	29.17	-16.83	46	28.55	28.15	4.21	31.74	-	-	P	H	
		895.24	30.67	-15.33	46	28.22	29.11	4.56	31.22	-	-	P	H	
		956.35	31.95	-14.05	46	27.09	30.98	4.71	30.83	100	0	P	H	
													H	
													H	
													H	
													H	
													H	
													H	
													H	
													H	
													H	
			43.58	33.82	-6.18	40	48.01	17.3	1.03	32.52	100	0	P	V
			64.92	23.13	-16.87	40	42.67	11.75	1.25	32.54	-	-	P	V
			156.1	27.82	-15.68	43.5	41.83	16.58	1.93	32.52	-	-	P	V
			717.73	30.32	-15.68	46	31.58	26.97	4.02	32.25	-	-	P	V
			851.59	31.1	-14.9	46	28.95	29.15	4.39	31.39	-	-	P	V
		959.26	31.25	-14.75	46	26.23	31.11	4.72	30.81	-	-	P	V	
													V	
													V	
													V	
													V	
													V	
													V	
Remark	1. No other spurious found. 2. All results are PASS against limit line.													



Note symbol

*	Fundamental Frequency which can be ignored. However, the level of any unwanted emissions shall not exceed the level of the fundamental frequency.
!	Test result is over limit line.
P/A	Peak or Average
H/V	Horizontal or Vertical



A calculation example for radiated spurious emission is shown as below:

WIFI	Note	Frequency	Level	Over	Limit	Read	Antenna	Path	Preamp	Ant	Table	Peak	Pol.
Ant.				Limit	Line	Level	Factor	Loss	Factor	Pos	Pos	Avg.	
1+2		(MHz)	(dBμV/m)	(dB)	(dBμV/m)	(dBμV)	(dB/m)	(dB)	(dB)	(cm)	(deg)	(P/A)	(H/V)
802.11b		2390	55.45	-18.55	74	54.51	32.22	4.58	35.86	103	308	P	H
CH 01													
2412MHz		2390	43.54	-10.46	54	42.6	32.22	4.58	35.86	103	308	A	H

1. Path Loss(dB) = Cable loss(dB) + Filter loss(dB) + Attenuator loss(dB)
2. Level(dBμV/m) = Antenna Factor(dB/m) + Path Loss(dB) + Read Level(dBμV) - Preamp Factor(dB)
3. Over Limit(dB) = Level(dBμV/m) - Limit Line(dBμV/m)

For Peak Limit @ 2390MHz:

1. Level(dBμV/m)
 - = Antenna Factor(dB/m) + Path Loss(dB) + Read Level(dBμV) - Preamp Factor(dB)
 - = 32.22(dB/m) + 4.58(dB) + 54.51(dBμV) - 35.86 (dB)
 - = 55.45 (dBμV/m)
2. Over Limit(dB)
 - = Level(dBμV/m) - Limit Line(dBμV/m)
 - = 55.45(dBμV/m) - 74(dBμV/m)
 - = -18.55(dB)

For Average Limit @ 2390MHz:

1. Level(dBμV/m)
 - = Antenna Factor(dB/m) + Path Loss(dB) + Read Level(dBμV) - Preamp Factor(dB)
 - = 32.22(dB/m) + 4.58(dB) + 42.6(dBμV) - 35.86 (dB)
 - = 43.54 (dBμV/m)
2. Over Limit(dB) = Level(dBμV/m) - Limit Line(dBμV/m)
 - = 43.54(dBμV/m) - 54(dBμV/m)
 - = -10.46(dB)

Both peak and average measured complies with the limit line, so test result is "PASS".



Appendix C. Radiated Spurious Emission Plots

Test Engineer :	Fu Chen and Harvey Guo	Temperature :	20.1~22.2°C
		Relative Humidity :	61.1~67.3%

Note symbol

-L	Low channel location
-R	High channel location



Band 1 - 5150~5250MHz

WIFI 802.11ax HE160 Partial 996 (Band Edge @ 3m)

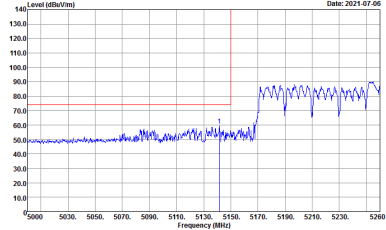
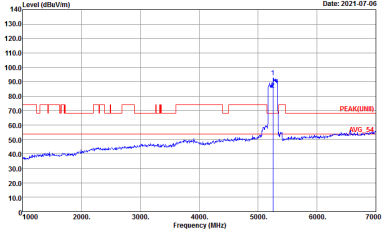
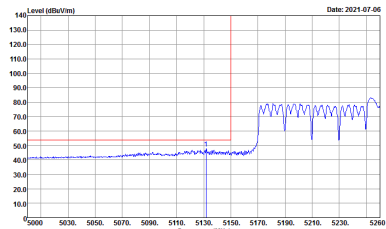
WIFI	Band 1 5150~5250MHz Band Edge @ 3m	
Chain	802.11ax HE160 Partial 996/67S CH50 5250MHz - L	
0+1	Horizontal	Fundamental
Peak	 <p>Site : 03CH11-HY Condition : PEAK_BE_74 3m HORN 91200-HF_1326 HORIZONTAL : RBW:1000.000kHz VBW:3000.000kHz SWT:Auto</p>	 <p>Site : 03CH11-HY Condition : PEAK(UNIT) 3m HORN 91200-HF_1326 HORIZONTAL : RBW:1000.000kHz VBW:3000.000kHz SWT:Auto</p>
Avg.	 <p>Site : 03CH11-HY Condition : AVG_BE_54 3m HORN 91200-HF_1326 HORIZONTAL : RBW:1000.000kHz VBW:3.000kHz SWT:Auto</p>	Left blank



WIFI	Band 1 5150~5250MHz Band Edge @ 3m	
Chain	HE160 Partial 996/67S CH50 5250MHz - R	
0+1	Horizontal	Fundamental
Peak	<p>Site : 03CH11-HY Condition : PEAK_BE_74 3m HORN 91200-HF_1326 HORIZONTAL : RBW:1000.000kHz VBW:3000.000kHz SWT:Auto</p>	Left blank
Avg.	<p>Site : 03CH11-HY Condition : AVG_BE_54 3m HORN 91200-HF_1326 HORIZONTAL : RBW:1000.000kHz VBW:3000.000kHz SWT:Auto</p>	Left blank



WIFI	Band 1 5150~5250MHz Band Edge @ 3m	
Chain	802.11ax HE160 Partial 996/67S CH50 5250MHz - L	
0+1	Vertical	Fundamental
Peak	<p>Date: 2021-07-06</p> <p>Site : 03CH11-HY Condition : PEAK_BE_74 3m HORN 91200-HF_1326 VERTICAL : RBW:1000.000KHz VBW:3000.000KHz SWT:Auto</p>	<p>Date: 2021-07-06</p> <p>Site : 03CH11-HY Condition : PEAK(LINE) 3m HORN 91200-HF_1326 VERTICAL : RBW:1000.000KHz VBW:3000.000KHz SWT:Auto</p>
Avg.	<p>Date: 2021-07-06</p> <p>Site : 03CH11-HY Condition : AV6_BE_54 3m HORN 91200-HF_1326 VERTICAL : RBW:1000.000KHz VBW:3000.000KHz SWT:Auto</p>	Left blank



WIFI	Band 1 5150~5250MHz Band Edge @ 3m	
Chain	802.11ax HE160 Partial 996/67S CH50 5250MHz - R	
0+1	Vertical	Fundamental
Peak	<p>Site : 03CH11-HY Condition : PEAK_BE_74 3m HORN 91200-HF_1326 VERTICAL : RBW:1000.000KHz VBW:3000.000KHz SWT:Auto</p>	Left blank
Avg.	<p>Site : 03CH11-HY Condition : AVG_BE_54 3m HORN 91200-HF_1326 VERTICAL : RBW:1000.000KHz VBW:3000.000KHz SWT:Auto</p>	Left blank



Band 1 - 5150~5250MHz
WIFI 802.11ax HE20 Full (Harmonic @ 3m)

WIFI	Band 1 5150~5250MHz Harmonic @ 3m	
Chain	802.11ax HE20 Full CH48 5240MHz	
0+1	Horizontal	Vertical
Peak Avg.	<p>Site : 03CHI1-HY Condition : PEAK(UNII) 3m HORN 9120D-HF_1326 HORIZONTAL</p>	<p>Site : 03CHI1-HY Condition : PEAK(UNII) 3m HORN 9120D-HF_1326 VERTICAL</p>



Emission above 18GHz
5GHz WIFI 802.11ax HE20 Full (SHF)

WIFI	5GHz WIFI	
Chain	802.11ax HE20 Full SHF	
0+1	Horizontal	Vertical
QP / Peak	<p>Site : 03CH11-HY Condition : PEAK_74 In SHF_00991_210512 HORIZONTAL</p>	<p>Site : 03CH11-HY Condition : PEAK_74 In SHF_00991_210512 VERTICAL</p>



Emission below 1GHz
5GHz WIFI 802.11ax HE20 Full (LF)

WIFI	5GHz WIFI	
Chain	802.11ax HE20 Full LF	
0+1	Horizontal	Vertical
QP / Peak	<p>Site : 03CHI1-HY Condition : QP 3m BE-LO6 6111D-LF_ETC HORIZONTAL</p>	<p>Site : 03CHI1-HY Condition : QP 3m BE-LO6 6111D-LF_ETC VERTICAL</p>



Appendix D. Duty Cycle Plots

Chain	Band	Duty Cycle(%)	T(us)	1/T(kHz)	VBW Setting	Duty Factor(dB)
0+1	5GHz 802.11ax HE20 Full RU	100.00	-	-	10Hz	0.00
0+1	5GHz 802.11ax HE160 996 RU	97.80	710	1.41	3kHz	0.10

MIMO <Chain 0+1>

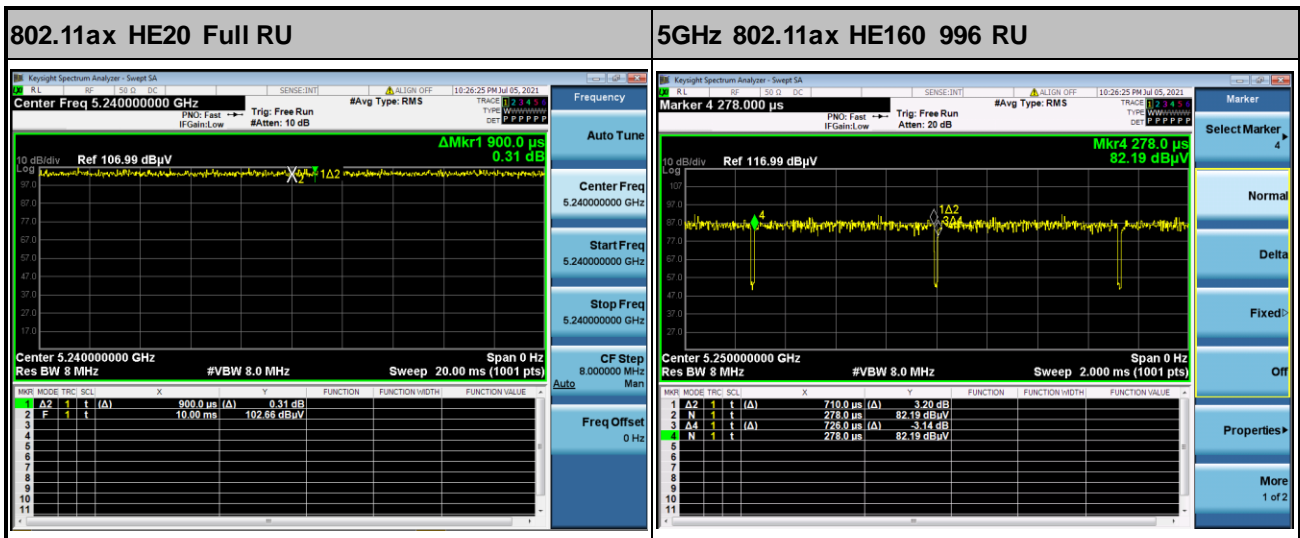

—THE END—