



# FCC CO-LOCATION RADIO TEST REPORT

**FCC ID** : PY7-77089S  
**Equipment** : GSM/WCDMA/LTE/5G Phone with BT,  
DTS/UNII a/b/g/n/ac/ax, GPS and NFC  
**Brand Name** : Sony  
**Applicant** : Sony Corporation  
1-7-1 Konan Minato-ku Tokyo, 108-0075 Japan  
**Manufacturer** : Sony Corporation  
1-7-1 Konan Minato-ku Tokyo, 108-0075 Japan  
**Standard** : FCC Part 15 Subpart E §15.407

The product was received on Jun. 16, 2021 and testing was started from Jul. 02, 2021 and completed on Jul. 06, 2021. We, Sporton International Inc. Wensan Laboratory, would like to declare that the tested sample has been evaluated in accordance with the test procedures and has been in compliance with the applicable technical standards.

The test results in this report apply exclusively to the tested model / sample. Without written approval of Sporton International Inc. Wensan Laboratory, the test report shall not be reproduced except in full.

Approved by: Louis Wu

**Sporton International Inc. Wensan Laboratory**

No.58, Aly. 75, Ln. 564, Wenhua 3rd, Rd., Guishan Dist., Taoyuan City 333010, Taiwan (R.O.C.)



## Table of Contents

**History of this test report..... 3**

**Summary of Test Result..... 4**

**1 General Description ..... 5**

    1.1 Product Feature of Equipment Under Test..... 5

    1.2 Modification of EUT ..... 5

    1.3 Testing Location ..... 6

    1.4 Applicable Standards..... 6

**2 Test Configuration of Equipment Under Test ..... 7**

    2.1 Carrier Frequency and Channel ..... 7

    2.2 Connection Diagram of Test System..... 8

    2.3 Support Unit used in test configuration and system ..... 8

    2.4 EUT Operation Test Setup ..... 9

**3 Test Result ..... 10**

    3.1 Unwanted Emissions Measurement..... 10

    3.2 Antenna Requirements..... 15

**4 List of Measuring Equipment..... 16**

**5 Uncertainty of Evaluation ..... 17**

**Appendix A. Radiated Spurious Emission**

**Appendix B. Radiated Spurious Emission Plots**

**Appendix C. Duty Cycle Plots**



### History of this test report

Report No.	Version	Description	Issued Date
FR133143G	01	Initial issue of report	Jul. 12, 2021



### Summary of Test Result

Report Clause	Ref Std. Clause	Test Items	Result (PASS/FAIL)	Remark
3.1	15.407(b)	Unwanted Emissions	Pass	Under limit 3.22 dB at 18000.000 MHz
3.2	15.203 15.407(a)	Antenna Requirement	Pass	-

**Declaration of Conformity:**  
The test results with all measurement uncertainty excluded are presented in accordance with the regulation limits or requirements declared by manufacturers.

**Comments and Explanations:**  
The declared of product specification for EUT presented in the report are provided by the manufacturer, and the manufacturer takes all the responsibilities for the accuracy of product specification.

**Reviewed by: Keven Cheng**  
**Report Producer: Celery Wei**



# 1 General Description

## 1.1 Product Feature of Equipment Under Test

GSM/WCDMA/LTE, Bluetooth, DTS/UNII a/b/g/n/ac/ax, NFC, FM Receiver, and GNSS.

Product Specification subjective to this standard	
<b>Antenna Type</b>	<b>Bluetooth:</b> <Ant. 0>: Loop Antenna <b>WLAN (2.4GHz)</b> <Chain 0>: Loop Antenna <Chain 1>: Loop Antenna <b>WLAN (5GHz)</b> <Chain 0>: Loop Antenna <Chain 1>: Monopole Antenna

**Remark:** The above EUT's information was declared by manufacturer. Please refer to Comments and Explanations in report summary.

EUT Information List			
HW Version	SW Version	S/N	Performed Test Item
A	3.69	QV72002J9B	Radiated Spurious Emission

Accessory List	
<b>AC Adapter</b>	Model Name : XQZ-UC1
	S/N : 0020W51300039
<b>Earphone</b>	Model Name : STH40D
	S/N : N/A
<b>USB Cable</b>	Model Name : XQZ-UB1
	S/N : N/A

**Note:**

- Above EUT list used are electrically identical per declared by manufacturer.
- Above the accessories list are used to exercise the EUT during test, and the serial number of each type of accessories is listed in each section of this report.
- For other wireless features of this EUT, test report will be issued separately.

## 1.2 Modification of EUT

No modifications are made to the EUT during all test items.



### 1.3 Testing Location

<b>Test Site</b>	Sporton International Inc. Wensan Laboratory
<b>Test Site Location</b>	No.58, Aly. 75, Ln. 564, Wenhua 3rd, Rd., Guishan Dist., Taoyuan City 333010, Taiwan (R.O.C.) TEL: +886-3-327-0868 FAX: +886-3-327-0855
<b>Test Site No.</b>	<b>Sporton Site No.</b> 03CH15-HY

**Note:** The test site complies with ANSI C63.4 2014 requirement.

FCC designation No.: TW3786

### 1.4 Applicable Standards

According to the specifications of the manufacturer, the EUT must comply with the requirements of the following standards:

- ♦ FCC Part 15 Subpart C §15.247
- ♦ FCC Part 15 Subpart E
- ♦ FCC KDB Publication No. 558074 D01 DTS Meas. Guidance v05r02
- ♦ FCC KDB 789033 D02 General UNII Test Procedures New Rules v02r01.
- ♦ FCC KDB 414788 D01 Radiated Test Site v01r01.
- ♦ FCC KDB 662911 D01 Multiple Transmitter Output v02r01.
- ♦ FCC KDB 971168 D01 Power Meas. License Digital Systems v03r01
- ♦ ANSI C63.10-2013

**Remark:**

1. All test items were verified and recorded according to the standards and without any deviation during the test.
2. The TAF code is not including all the FCC KDB listed without accreditation.
3. This EUT has also been tested and complied with the requirements of FCC Part 15, Subpart B, recorded in a separate test report.



## 2 Test Configuration of Equipment Under Test

The EUT has been associated with peripherals and configuration operated in a manner tended to maximize its emission characteristics in a typical application. Frequency range investigated: radiation emission (9 kHz to the 10th harmonic of the highest fundamental frequency or to 40 GHz, whichever is lower). For radiated measurement, the measured emission level of the EUT was maximized by rotating the EUT on a turntable, adjusting the orientation of the EUT and EUT antenna in three orthogonal axis (X: flat, Y: portrait, Z: landscape), and adjusting the measurement antenna orientation, following C63.10 exploratory test procedures.

### 2.1 Carrier Frequency and Channel

<Ant. 0>

2400-2483.5 MHz	
Bluetooth	
Channel	Freq. (MHz)
39	2441

MIMO <Chain 0+1>

2400-2483.5 MHz			
802.11b		802.11g	
Channel	Freq. (MHz)	Channel	Freq. (MHz)
01	2412	01	2412

5150-5350 MHz	
802.11a	
Channel	Freq. (MHz)
36	5180

**Remark:** During the Radiated Spurious Emission test, the EUT turn on the WWAN functions simultaneously.

**<Co-Location>**

Modulation	Plane	Data Rate
2.4GHz 802.11g for MIMO Chain 0+1 + GSM850	X	6 Mbps + GMSK
2.4GHz 802.11b for MIMO Chain 0+1 + LTE Band 41	Z	6 Mbps + QPSK
5GHz 802.11a for MIMO Chain 0+1 + Bluetooth for Ant. 0 + GSM850	X	6 Mbps + GFSK + GMSK
5GHz 802.11a for MIMO Chain 0+1 + Bluetooth for Ant. 0 + LTE Band 41	X	6 Mbps + GFSK + QPSK
2.4GHz 802.11g for MIMO Chain 0+1 + 5GHz 802.11a for MIMO Chain 0+1 + GSM850	X	6 Mbps + 6 Mbps + GMSK
2.4GHz 802.11b for MIMO Chain 0+1 + 5GHz 802.11a for MIMO Chain 0+1 + LTE Band 41	X	6 Mbps + 6 Mbps + QPSK

**2.2 Connection Diagram of Test System**

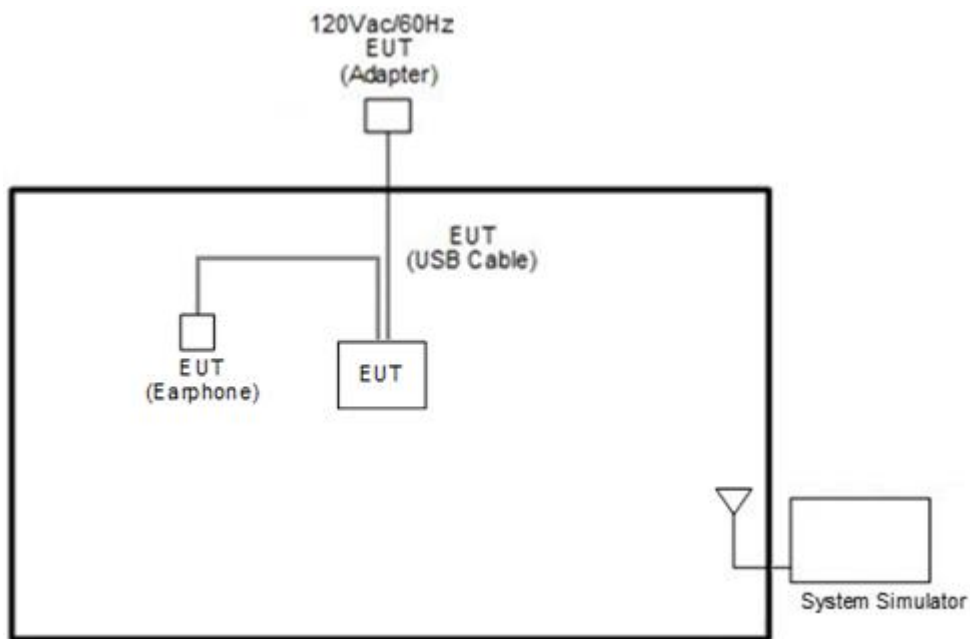

**2.3 Support Unit used in test configuration and system**

Item	Equipment	Brand Name	Model Name	FCC ID	Data Cable	Power Cord
1.	System Simulator	Anritsu	MT8820C	N/A	N/A	Unshielded,1.8m





## **2.4 EUT Operation Test Setup**

The RF test items, utility “FTMC\_bridge 0.39” was installed in Notebook which was programmed in order to make the EUT get into the engineering modes to provide channel selection, power level, data rate and the application type and for continuous transmitting signals.



### 3 Test Result

#### 3.1 Unwanted Emissions Measurement

This section is to measure unwanted emissions through radiated measurement for band edge spurious emissions and out of band emissions measurement.

##### 3.1.1 Limit of Unwanted Emissions

(1) Unwanted spurious emissions fallen in restricted bands shall comply with the general field strength limits as below table:

Frequency (MHz)	Field Strength (microvolts/meter)	Measurement Distance (meters)
0.009 – 0.490	2400/F(kHz)	300
0.490 – 1.705	24000/F(kHz)	30
1.705 – 30.0	30	30
30 – 88	100	3
88 – 216	150	3
216 - 960	200	3
Above 960	500	3

**Note:** The following formula is used to convert the EIRP to field strength.

$$E = \frac{1000000\sqrt{30P}}{3} \mu\text{V/m, where P is the eirp (Watts)}$$

EIRP (dBm)	Field Strength at 3m (dBμV/m)
- 27	68.3

(2) KDB789033 D02 v02r01 G)2)c)

(i) Sections 15.407(b)(1-3) specifies the unwanted emissions limit for the U-NII-1 and U-NII-2 bands. As specified, emissions above 1000 MHz that are outside of the restricted bands are subject to a peak emission limit of -27 dBm/MHz.

(ii) Section 15.407(b)(4) specifies the unwanted emissions limit for the U-NII-3 band. A band emissions mask is specified in Section 15.407(b)(4)(i). The emission limits are based on the use of a peak detector.

##### 3.1.2 Measuring Instruments

See list of measuring equipment of this test report.



### 3.1.3 Test Procedures

1. The testing follows FCC KDB 789033 D02 General UNII Test Procedures New Rules v02r01. Section G) Unwanted emissions measurement.
  - (1) Procedure for Unwanted Emissions Measurements Below 1000 MHz
    - RBW = 120 kHz
    - VBW = 300 kHz
    - Detector = Peak
    - Trace mode = max hold
  - (2) Procedure for Peak Unwanted Emissions Measurements Above 1000 MHz
    - RBW = 1 MHz
    - VBW  $\geq$  3 MHz
    - Detector = Peak
    - Sweep time = auto
    - Trace mode = max hold
  - (3) Procedures for Average Unwanted Emissions Measurements Above 1000 MHz
    - RBW = 1 MHz
    - VBW = 10 Hz, when duty cycle is no less than 98 percent.
    - VBW  $\geq$  1/T, when duty cycle is less than 98 percent where T is the minimum transmission duration over which the transmitter is on and is transmitting at its maximum power control level for the tested mode of operation.
2. The EUT was placed on a turntable with 0.8 meter for frequency below 1 GHz and 1.5 meter for frequency above 1 GHz respectively above ground.
3. The EUT was set 3 meters from the interference receiving antenna which was mounted on the top of a variable height antenna tower.
4. The antenna is a broadband antenna and its height is adjusted between one meter and four meters above ground to find the maximum value of the field strength for both horizontal polarization and vertical polarization of the antenna.
5. For each suspected emission, the EUT was arranged to its worst case and then adjust the antenna tower (from 1 m to 4 m) and turntable (from 0 degree to 360 degrees) to find the maximum reading.
6. For testing below 1 GHz, if the emission level of the EUT in peak mode was 3 dB lower than the limit specified, then peak values of EUT will be reported, otherwise, the emissions will be repeated one by one using the CISPR quasi-peak method and reported.
7. For testing above 1 GHz, the emission level of the EUT in peak mode was 20 dB lower than average limit (that means the emission level in average mode also complies with the limit in average mode), then peak values of EUT will be reported, otherwise, the emissions will be measured in average mode again and reported.

### 3.1.4 Test Setup

For radiated emissions below 30MHz

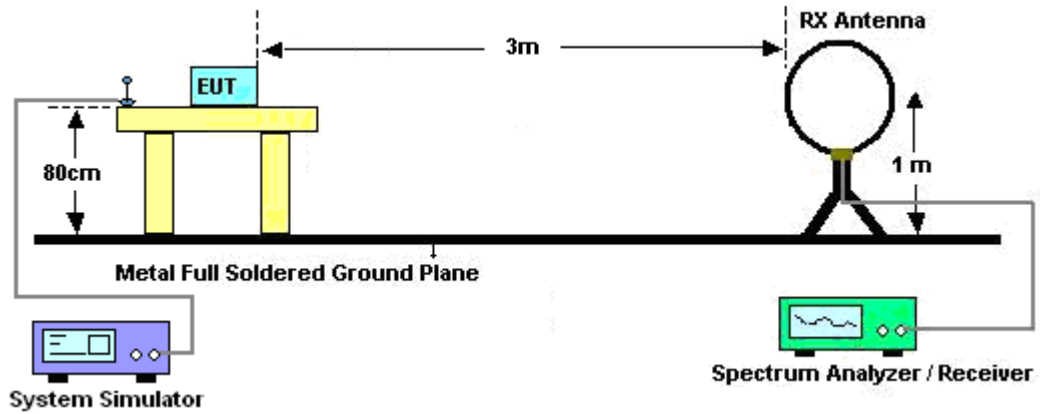

For radiated emissions from 30MHz to 1GHz

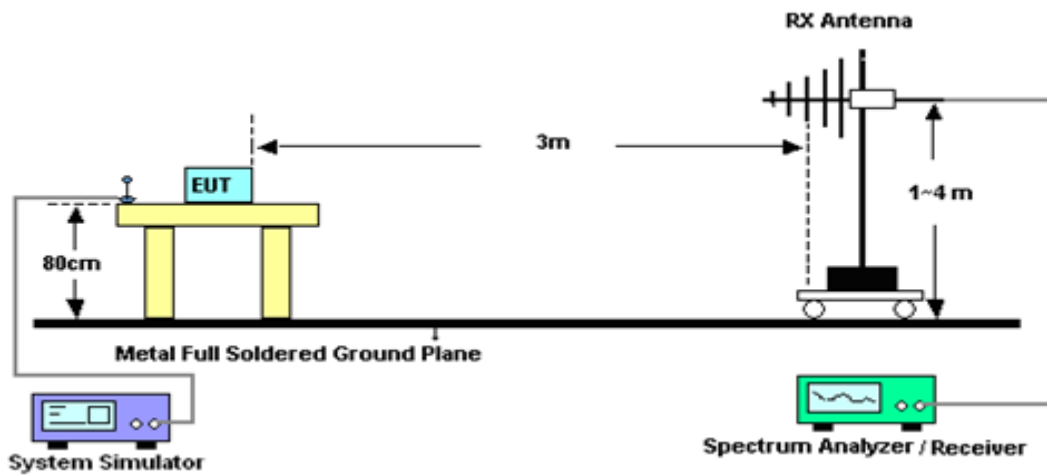

For radiated emissions from 1GHz to 18GHz

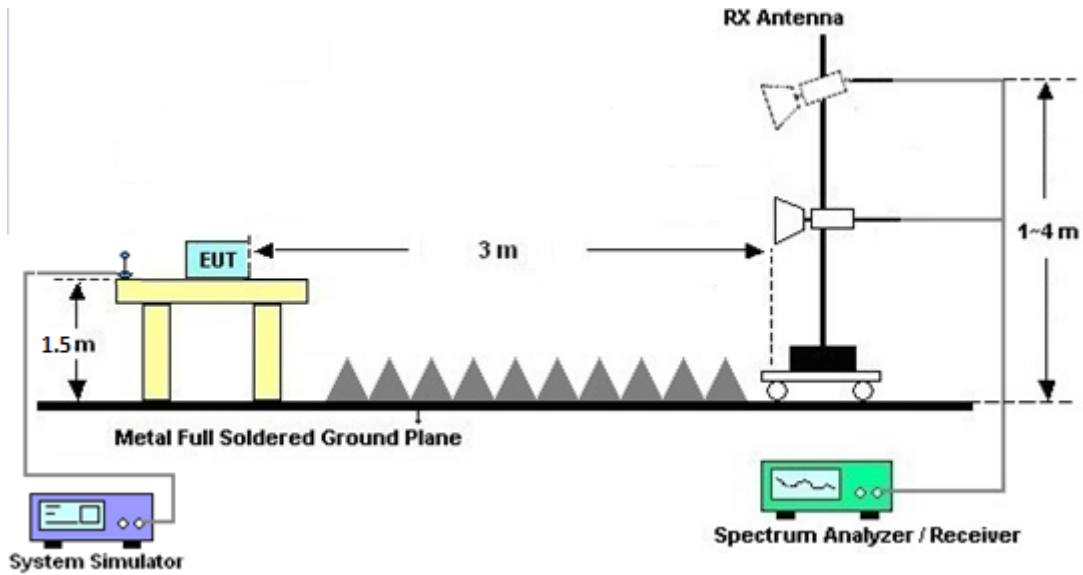

For radiated emissions above 18GHz

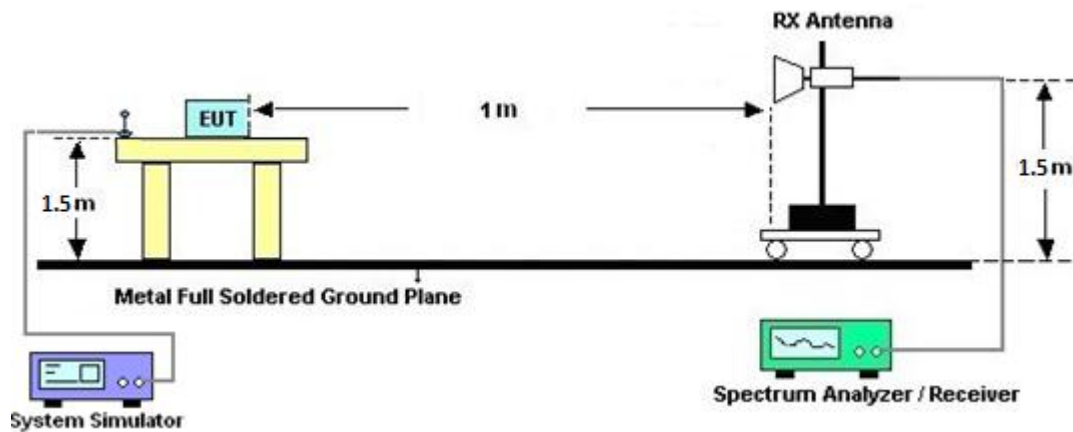



### **3.1.5 Test Results of Radiated Spurious Emissions (9 kHz ~ 30 MHz)**

The low frequency, which started from 9 kHz to 30MHz, was pre-scanned and the result which was 20dB lower than the limit line was not reported.

There is a comparison data of both open-field test site and alternative test site - semi-Anechoic chamber according to 414788 D01 Radiated Test Site v01r01, and the result came out very similar.

### **3.1.6 Test Result of Radiated Spurious at Band Edges**

Please refer to Appendix A and B.

### **3.1.7 Duty Cycle**

Please refer to Appendix C.

### **3.1.8 Test Result of Radiated Spurious Emissions**

Please refer to Appendix A and B.



## **3.2 Antenna Requirements**

### **3.2.1 Standard Applicable**

If transmitting antenna directional gain is greater than 6 dBi, both the peak transmit power and the peak power spectral density shall be reduced by the amount in dB that the directional gain of the antenna exceeds 6 dBi.

### **3.2.2 Antenna Anti-Replacement Construction**

An embedded-in antenna design is used.

### **3.2.3 Antenna Gain**

The antenna peak gain of EUT is less than 6 dBi. Therefore, it is not necessary to reduce maximum peak output power limit.



## 4 List of Measuring Equipment

Instrument	Brand Name	Model No.	Serial No.	Characteristics	Calibration Date	Test Date	Due Date	Remark
Loop Antenna	Rohde & Schwarz	HFH2-Z2	100488	9 kHz~30 MHz	Jul. 14, 2020	Jul. 02, 2021~ Jul. 06, 2021	Jul. 13, 2021	Radiation (03CH15-HY)
Bilog Antenna	TESEQ	CBL 6111D & 00800N1D01N -06	41912 & 05	30MHz~1GHz	Feb. 08, 2021	Jul. 02, 2021~ Jul. 06, 2021	Feb. 07, 2022	Radiation (03CH15-HY)
Amplifier	SONOMA	310N	363440	9kHz~1GHz	Dec. 28, 2020	Jul. 02, 2021~ Jul. 06, 2021	Dec. 27, 2021	Radiation (03CH15-HY)
Horn Antenna	SCHWARZBE CK	BBHA 9120 D	9120D-01620	1GHz~18GHz	Nov. 03, 2020	Jul. 02, 2021~ Jul. 06, 2021	Nov. 02, 2021	Radiation (03CH15-HY)
SHF-EHF Horn Antenna	SCHWARZBE CK	BBHA 9170	BBHA917025 1	18GHz~40GHz	Dec. 02, 2020	Jul. 02, 2021~ Jul. 06, 2021	Dec. 01, 2021	Radiation (03CH15-HY)
Preamplifier	Jet-Power	JPA0118-55-3 03	1710001800 055006	1GHz~18GHz	May 06, 2021	Jul. 02, 2021~ Jul. 06, 2021	May 05, 2022	Radiation (03CH15-HY)
Preamplifier	Keysight	83017A	MY53270195	1GHz~26.5GHz	Aug. 21, 2020	Jul. 02, 2021~ Jul. 06, 2021	Aug. 20, 2021	Radiation (03CH15-HY)
Preamplifier	EMEC	EM18G40G	0600789	18-40GHz	Oct. 27, 2020	Jul. 02, 2021~ Jul. 06, 2021	Oct. 26, 2021	Radiation (03CH15-HY)
EMI Test Receiver	Keysight	N9038A(MXE)	MY54130085	20MHz~8.4GHz	Nov. 02, 2020	Jul. 02, 2021~ Jul. 06, 2021	Nov. 01, 2021	Radiation (03CH15-HY)
Spectrum Analyzer	Agilent	N9010A	MY53470118	10Hz~44GHz	Jan. 15, 2021	Jul. 02, 2021~ Jul. 06, 2021	Jan. 14, 2022	Radiation (03CH15-HY)
Spectrum Analyzer	Keysight	N9010A	MY54200485	10Hz~44GHz	Mar. 05, 2021	Jul. 02, 2021~ Jul. 06, 2021	Mar. 04, 2022	Radiation (03CH15-HY)
Antenna Mast	ChainTek	MBS-520-1	N/A	1m~4m	N/A	Jul. 02, 2021~ Jul. 06, 2021	N/A	Radiation (03CH15-HY)
Turn Table	ChainTek	T-200-S-1	N/A	0~360 Degree	N/A	Jul. 02, 2021~ Jul. 06, 2021	N/A	Radiation (03CH15-HY)
Software	Audix	E3 6.2009-8-24(k 5)	RK-000451	N/A	N/A	Jul. 02, 2021~ Jul. 06, 2021	N/A	Radiation (03CH15-HY)
RF Cable	HUBER + SUHNER	SUCOFLEX 104, 102E	MY36980/4, MY9838/4PE ,508405/2E	30MHz~18G	Nov. 16, 2020	Jul. 02, 2021~ Jul. 06, 2021	Nov. 15, 2021	Radiation (03CH15-HY)
RF Cable	HUBER + SUHNER	SUCOFLEX 102	505134/2	30MHz-40GHz	Feb. 22, 2021	Jul. 02, 2021~ Jul. 06, 2021	Feb. 21, 2022	Radiation (03CH15-HY)
RF Cable	HUBER + SUHNER	SUCOFLEX 102	800740/2	30MHz-40GHz	Feb. 22, 2021	Jul. 02, 2021~ Jul. 06, 2021	Feb. 21, 2022	Radiation (03CH15-HY)
RF Cable	HUBER + SUHNER	SUCOFLEX 104	MY9837/4PE	9kHz~30MHz	Mar. 11, 2021	Jul. 02, 2021~ Jul. 06, 2021	Mar. 10, 2022	Radiation (03CH15-HY)
Filter	Wainwright	WLK4-1000-15 30-8000-40SS	SN12	1.53GHz Low Pass Filter	Sep. 15, 2020	Jul. 02, 2021~ Jul. 06, 2021	Sep. 14, 2021	Radiation (03CH15-HY)
Filter	Wainwright	WHKX12-2700 -3000-18000-6 0ST	SN4	3GHz High Pass Filter	Sep. 16, 2020	Jul. 02, 2021~ Jul. 06, 2021	Sep. 15, 2021	Radiation (03CH15-HY)
Filter	Wainwright	WHKX12-935- 1000-15000-4 0ST	SN1	1GHz High Pass Filter	Apr. 29, 2021	Jul. 02, 2021~ Jul. 06, 2021	Apr. 28, 2022	Radiation (03CH15-HY)
Filter	Wainwright	WHKX8-5872. 5-6750-18000- 40ST	SN5	6.75GHz High Pass Filter	Mar. 11, 2021	Jul. 02, 2021~ Jul. 06, 2021	Mar. 10, 2022	Radiation (03CH15-HY)





## 5 Uncertainty of Evaluation

### Uncertainty of Radiated Emission Measurement (30 MHz ~ 1000 MHz)

Measuring Uncertainty for a Level of Confidence of 95% ( $U = 2Uc(y)$ )	4.7
---	-----

### Uncertainty of Radiated Emission Measurement (1000 MHz ~ 18000 MHz)

Measuring Uncertainty for a Level of Confidence of 95% ( $U = 2Uc(y)$ )	5.3
---	-----

### Uncertainty of Radiated Emission Measurement (18000 MHz ~ 40000 MHz)

Measuring Uncertainty for a Level of Confidence of 95% ( $U = 2Uc(y)$ )	4.9
---	-----



## Appendix A. Radiated Spurious Emission

Test Engineer :	Leo Lee, Mancy Chou and Bigshow Wang	Temperature :	22.7~23.2°C
		Relative Humidity :	46~52%

### WLAN 802.11g\_Tx\_Ch01+ WWAN GSM850 CH 189 Link

#### 2.4GHz 2400~2483.5MHz

#### WIFI 802.11g (Band Edge @ 3m)

WIFI Chain 0+1	Note	Frequency ( MHz )	Level ( dBμV/m )	Over Limit ( dB )	Limit Line ( dBμV/m )	Read Level ( dBμV )	Antenna Factor ( dB/m )	Path Loss ( dB )	Preamp Factor ( dB )	Chain Pos ( cm )	Table Pos ( deg )	Peak Avg. ( P/A )	Pol. ( H/V )	
802.11g CH 01 2412MHz		2389.275	54.47	-19.53	74	40.98	27.54	16.87	30.92	100	161	P	H	
		2388.75	43.89	-10.11	54	30.39	27.55	16.87	30.92	100	161	A	H	
	*	2412	106.53	-	-	93.04	27.5	16.9	30.91	100	161	P	H	
	*	2412	99.07	-	-	85.58	27.5	16.9	30.91	100	161	A	H	
													H	
														H
			2357.145	53.01	-20.99	74	39.43	27.67	16.84	30.93	377	306	P	V
			2389.905	43.63	-10.37	54	30.14	27.54	16.87	30.92	377	306	A	V
	*		2412	105.46	-	-	91.97	27.5	16.9	30.91	377	306	P	V
	*		2412	97.66	-	-	84.17	27.5	16.9	30.91	377	306	A	V
														V
														V



WLAN 802.11g\_Tx\_Ch01+ WWAN GSM850 CH 189 Link

WIFI 802.11g (Harmonic @ 3m)

WIFI Chain 0+1	Note	Frequency ( MHz )	Level ( dBμV/m )	Over Limit ( dB )	Limit Line ( dBμV/m )	Read Level ( dBμV )	Antenna Factor ( dB/m )	Path Loss ( dB )	Preamp Factor ( dB )	Chain Pos ( cm )	Table Pos ( deg )	Peak Avg. ( P/A )	Pol. ( H/V )	
11g_Ch01		4824	37.83	-36.17	74	55.52	31.1	10.07	58.86	100	0	P	H	
		18000	59.03	-14.97	74	48.38	49	18.89	57.24	100	33	P	H	
		18000	49.29	-4.71	54	38.64	49	18.89	57.24	100	33	A	H	
													H	
													H	
													H	
			4824	39.35	-34.65	74	57.04	31.1	10.07	58.86	100	0	P	V
			18000	59.69	-14.31	74	49.04	49	18.89	57.24	100	23	P	V
			18000	49.71	-4.29	54	39.06	49	18.89	57.24	100	23	A	V
														V
														V
														V



**WLAN 802.11b\_Tx\_Ch01+ WWAN LTE B41 BW: 20MHz CH39750 Link**

**2.4GHz 2400~2483.5MHz**

**WIFI 802.11b (Band Edge @ 3m)**

WIFI Chain	Note	Frequency	Level	Over Limit	Limit Line	Read Level	Antenna Factor	Path Loss	Preamp Factor	Chain Pos	Table Pos	Peak Avg.	Pol.	
0+1		( MHz )	( dBμV/m )	( dB )	( dBμV/m )	( dBμV )	( dB/m )	( dB )	( dB )	( cm )	( deg )	( P/A )	( H/V )	
802.11b CH 01 2412MHz		2351.36	53.73	-20.27	74	40.47	27.69	16.5	30.93	329	323	P	H	
		2326.17	42.06	-11.94	54	28.79	27.75	16.46	30.94	329	323	A	H	
	*	2412	105.48	-	-	92.29	27.5	16.6	30.91	329	323	P	H	
	*	2412	102.38	-	-	89.19	27.5	16.6	30.91	329	323	A	H	
													H	
													H	
			2370.72	54.16	-19.84	74	40.93	27.62	16.53	30.92	106	268	P	V
			2326.83	42.42	-11.58	54	29.15	27.75	16.46	30.94	106	268	A	V
	*		2412	106.66	-	-	93.47	27.5	16.6	30.91	106	268	P	V
	*		2412	103.56	-	-	90.37	27.5	16.6	30.91	106	268	A	V
													V	
													V	



WLAN 802.11b\_Tx\_Ch01+ WWAN LTE B41 BW: 20MHz CH39750 Link

11b\_Ch01 (Harmonic @ 3m)

WIFI Chain 0+1	Note	Frequency ( MHz )	Level ( dBμV/m )	Over Limit ( dB )	Limit Line ( dBμV/m )	Read Level ( dBμV )	Antenna Factor ( dB/m )	Path Loss ( dB )	Preamp Factor ( dB )	Chain Pos ( cm )	Table Pos ( deg )	Peak Avg. (P/A)	Pol. (H/V)	
11b_Ch01		4824	38.23	-35.77	74	55.92	31.1	10.07	58.86	100	0	P	H	
		18000	58.59	-15.41	74	47.94	49	18.89	57.24	100	33	P	H	
		18000	50.22	-3.78	54	39.57	49	18.89	57.24	100	33	A	H	
													H	
													H	
													H	
			4824	37.86	-36.14	74	55.55	31.1	10.07	58.86	100	0	P	V
			17985	58.51	-15.49	74	48.17	48.73	18.88	57.27	100	23	P	V
			17985	48.59	-5.41	54	38.25	48.73	18.88	57.27	100	23	A	V
														V
														V
														V



WLAN 802.11b\_Tx\_Ch01+ WWAN GSM850 CH 189 Link

Emission above 18GHz

(SHF@ 3m)

WIFI Chain	Note	Frequency	Level	Over Limit	Limit Line	Read Level	Antenna Factor	Path Loss	Preamp Factor	Chain Pos	Table Pos	Peak Avg.	Pol.	
0+1		( MHz )	( dBμV/m )	( dB )	( dBμV/m )	( dBμV )	( dB/m )	( dB )	( dB )	( cm )	( deg )	( P/A )	( H/V )	
11g_Ch01		21608	39.29	-34.71	74	43.96	38.32	11.79	54.78	150	0	P	H	
													H	
													H	
													H	
													H	
													H	
														H
			22160	39.66	-34.34	74	43.47	38.62	12.21	54.64	150	0	P	V
														V
														V
														V
														V



WLAN 802.11b\_Tx\_Ch01+ WWAN GSM850 CH 189 Link

Emission below 1GHz

(LF@ 3m)

WIFI Chain	Note	Frequency	Level	Over Limit	Limit Line	Read Level	Antenna Factor	Path Loss	Preamp Factor	Chain Pos	Table Pos	Peak Avg.	Pol.
0+1		( MHz )	( dBμV/m )	( dB )	( dBμV/m )	( dBμV )	( dB/m )	( dB )	( dB )	( cm )	( deg )	( P/A )	( H/V )
11g_Ch01		43.58	25.86	-14.14	40	40.16	17.47	0.81	32.58	-	-	P	H
		139.61	29.98	-13.52	43.5	43.32	17.44	1.72	32.5	-	-	P	H
		220.12	21.93	-24.07	46	37.11	15.18	2.06	32.42	-	-	P	H
		563.5	25.89	-20.11	46	29.11	26.13	3.24	32.59	-	-	P	H
		831.22	30.09	-15.91	46	29.88	28.28	3.92	31.99	-	-	P	H
		958.29	33.05	-12.95	46	29	30.97	4.29	31.21	100	0	P	H
		46.49	33.78	-6.22	40	49.54	15.99	0.84	32.59	100	0	P	V
		141.55	19.67	-23.83	43.5	33.02	17.42	1.73	32.5	-	-	P	V
		187.14	22.6	-20.9	43.5	38.49	14.72	1.86	32.47	-	-	P	V
		411.21	22.6	-23.4	46	29.86	22.44	2.71	32.41	-	-	P	V
		565.44	26.46	-19.54	46	29.65	26.14	3.25	32.58	-	-	P	V
	824.43	35.5	-10.5	46	35.56	28.05	3.91	32.02	-	-	P	V	



WLAN 802.11a\_Tx\_Ch36+BT (1M) CH 39\_Tx+ WWAN GSM850 Ch189 Link

Band 1 - 5150~5250MHz

WIFI 802.11a (Band Edge @ 3m)

WIFI Chain	Note	Frequency	Level	Over Limit	Limit Line	Read Level	Antenna Factor	Path Loss	Preamp Factor	Chain Pos	Table Pos	Peak Avg.	Pol.	
0+1		( MHz )	( dBμV/m )	( dB )	( dBμV/m )	( dBμV )	( dB/m )	( dB )	( dB )	( cm )	( deg )	( P/A )	( H/V )	
802.11a CH 36 5180MHz		5100.36	50.06	-23.94	74	37.86	31.8	10.41	30.01	100	234	P	H	
		5105.3	39.7	-14.3	54	27.49	31.8	10.42	30.01	100	234	A	H	
	*	5180	106.48	-	-	94.3	31.62	10.57	30.01	100	234	P	H	
	*	5180	99.79	-	-	87.61	31.62	10.57	30.01	100	234	A	H	
													H	
													H	
													V	
			5137.02	50.93	-23.07	74	38.66	31.8	10.48	30.01	288	282	P	V
			5103.48	39.54	-14.46	54	27.34	31.8	10.41	30.01	288	282	A	V
	*		5180	103.85	-	-	91.67	31.62	10.57	30.01	288	282	P	V
	*		5180	95.72	-	-	83.54	31.62	10.57	30.01	288	282	A	V
													V	





2.4GHz 2400~2483.5MHz

BT (Band Edge @ 3m)

BT	Note	Frequency	Level	Over	Limit	Read	Antenna	Path	Preamp	Chain	Table	Peak	Pol.	
Ant.				Limit	Line	Level	Factor	Loss	Factor	Pos	Pos	Avg.		
0		( MHz )	( dBμV/m )	( dB )	( dBμV/m )	( dBμV )	( dB/m )	( dB )	( dB )	( cm )	( deg )	(P/A)	(H/V)	
BT CH 39 2441MHz		2319.38	44.48	-29.52	74	40.78	27.76	6.89	30.95	100	207	P	H	
		2319.38	19.69	-34.31	54	-	-	-	-	-	-	A	H	
	*	2441	107.43	-	-	103.79	27.5	7.03	30.89	100	207	P	H	
	*	2441	82.64	-	-	-	-	-	-	-	-	A	H	
		2491.11	44.24	-29.76	74	40.58	27.42	7.11	30.87	100	207	P	H	
		2491.11	19.45	-34.55	54	-	-	-	-	-	-	-	A	H
		2360.68	44.35	-29.65	74	40.69	27.66	6.93	30.93	368	277	P	V	
		2360.68	19.56	-34.44	54	-	-	-	-	-	-	-	A	V
	*	2441	104.19	-	-	100.55	27.5	7.03	30.89	368	277	P	V	
	*	2441	79.4	-	-	-	-	-	-	-	-	-	A	V
		2491.88	44.34	-29.66	74	40.68	27.42	7.11	30.87	368	277	P	V	
		2491.88	19.55	-34.45	54	-	-	-	-	-	-	-	A	V



WLAN 802.11a\_Tx\_Ch36+BT (1M) CH 39\_Tx+ WWAN GSM850 Ch189 Link

(Harmonic @ 3m)

WIFI	Note	Frequency	Level	Over	Limit	Read	Antenna	Path	Preamp	Chain	Table	Peak	Pol.	
Chain				Limit	Line	Level	Factor	Loss	Factor	Pos	Pos	Avg.		
0+1		( MHz )	( dBμV/m )	( dB )	( dBμV/m )	( dBμV )	( dB/m )	( dB )	( dB )	( cm )	( deg )	(P/A)	(H/V)	
11a_Ch36+ BT_Ch39+ GSM850 Link		2739	51.6	-22.4	74	46.9	27.98	7.57	30.85	100	236	P	H	
		2739	41.83	-12.17	54	37.13	27.98	7.57	30.85	100	236	A	H	
		4882	45.85	-28.15	74	34.75	31.04	10.11	30.05	100	0	P	H	
		4882	21.06	-32.94	54	-	-	-	-	-	-	A	H	
		7323	42.25	-31.75	74	51.72	36.3	12.64	58.41	100	0	P	H	
		7323	17.46	-36.54	54	-	-	-	-	-	-	-	A	H
		10360	51.4	-16.8	68.2	58.29	39.44	14.47	60.8	100	0	P	H	
		15540	47.18	-26.82	74	54.56	37.82	17.16	62.36	100	0	P	H	
		17989	60.08	-13.92	74	49.5	48.8	19.05	57.27	100	28	P	H	
		17989	50.16	-3.84	54	39.58	48.8	19.05	57.27	100	28	A	H	
		2739	48.71	-25.29	74	44.01	27.98	7.57	30.85	361	275	P	V	
		2739	38.76	-15.24	54	34.06	27.98	7.57	30.85	361	275	A	V	
		4882	45.8	-28.2	74	34.7	31.04	10.11	30.05	100	0	P	V	
		4882	21.01	-32.99	54	-	-	-	-	-	-	-	A	V
		7323	42.47	-31.53	74	51.94	36.3	12.64	58.41	100	0	P	V	
		7323	17.68	-36.32	54	-	-	-	-	-	-	-	A	V
		10360	57.99	-10.21	68.2	64.88	39.44	14.47	60.8	100	0	P	V	
		15540	47.64	-26.36	74	55.02	37.82	17.16	62.36	100	0	P	V	
	17989	59.87	-14.13	74	49.29	48.8	19.05	57.27	100	22	P	V		
	17989	50.14	-3.86	54	39.56	48.8	19.05	57.27	100	22	A	V		



WLAN 802.11a\_Tx\_Ch36+BT (1M) CH 39\_Tx+ WWAN LTE B41 BW: 20MHz CH39750 Link

Band 1 - 5150~5250MHz

WIFI 802.11a (Band Edge @ 3m)

WIFI Chain	Note	Frequency	Level	Over Limit	Limit Line	Read Level	Antenna Factor	Path Loss	Preamp Factor	Chain Pos	Table Pos	Peak Avg.	Pol.	
0+1		( MHz )	( dBμV/m )	( dB )	( dBμV/m )	( dBμV )	( dB/m )	( dB )	( dB )	( cm )	( deg )	( P/A )	( H/V )	
802.11a CH 36 5180MHz		5063.96	54.36	-19.64	74	42.32	31.73	10.33	30.02	100	237	P	H	
		5055.38	43.21	-10.79	54	31.2	31.71	10.32	30.02	100	237	A	H	
	*	5180	109.11	-	-	96.93	31.62	10.57	30.01	100	237	P	H	
	*	5180	101.85	-	-	89.67	31.62	10.57	30.01	100	237	A	H	
													H	
													H	
													V	
			5090.74	52.23	-21.77	74	40.07	31.78	10.39	30.01	341	277	P	V
			5060.32	42.73	-11.27	54	30.71	31.72	10.32	30.02	341	277	A	V
	*		5180	104.17	-	-	91.99	31.62	10.57	30.01	341	277	P	V
	*		5180	96.83	-	-	84.65	31.62	10.57	30.01	341	277	A	V
													V	



2.4GHz 2400~2483.5MHz

BT (Band Edge @ 3m)

BT	Note	Frequency	Level	Over	Limit	Read	Antenna	Path	Preamp	Chain	Table	Peak	Pol.	
Ant.				Limit	Line	Level	Factor	Loss	Factor	Pos	Pos	Avg.		
0		( MHz )	( dBμV/m )	( dB )	( dBμV/m )	( dBμV )	( dB/m )	( dB )	( dB )	( cm )	( deg )	(P/A)	(H/V)	
BT CH 39 2441MHz		2341.64	54.22	-19.78	74	50.88	27.72	6.56	30.94	100	243	P	H	
		2341.64	29.43	-24.57	54	-	-	-	-	-	-	A	H	
	*	2441	108.17	-	-	104.84	27.5	6.72	30.89	100	243	P	H	
	*	2441	83.38	-	-	-	-	-	-	-	-	A	H	
		2495.24	45.78	-28.22	74	42.43	27.41	6.81	30.87	100	243	P	H	
		2495.24	20.99	-33.01	54	-	-	-	-	-	-	-	A	H
		2381.96	43.16	-30.84	74	39.88	27.57	6.63	30.92	255	49	P	V	
		2381.96	18.37	-35.63	54	-	-	-	-	-	-	-	A	V
	*	2441	101.81	-	-	98.48	27.5	6.72	30.89	255	49	P	V	
	*	2441	77.02	-	-	-	-	-	-	-	-	-	A	V
		2485.09	43.57	-30.43	74	40.23	27.43	6.79	30.88	255	49	P	V	
		2485.09	18.78	-35.22	54	-	-	-	-	-	-	-	A	V



WLAN 802.11a\_Tx\_Ch36+BT (1M) CH 39\_Tx + WWAN LTE B41 BW: 20MHz CH39750 Link  
(Harmonic @ 3m)

WIFI Chain 0+1	Note	Frequency ( MHz )	Level ( dBμV/m )	Over Limit ( dB )	Limit Line ( dBμV/m )	Read Level ( dBμV )	Antenna Factor ( dB/m )	Path Loss ( dB )	Preamp Factor ( dB )	Chain Pos ( cm )	Table Pos ( deg )	Peak Avg. ( P/A )	Pol. ( H/V )	
11a_Ch36+ BT_Ch39+ LTE B41 Link		2683	58.57	-15.43	74	44.59	27.83	17	30.85	100	234	P	H	
		2683	48.2	-5.8	54	34.22	27.83	17	30.85	100	234	A	H	
		4882	53.1	-20.9	74	42	31.04	10.11	30.05	100	0	P	H	
		4882	28.31	-25.69	54	-	-	-	-	-	-	A	H	
		7323	41.82	-32.18	74	51.29	36.3	12.64	58.41	100	0	P	H	
		7323	17.03	-36.97	54	-	-	-	-	-	-	-	A	H
		10355	50.98	-17.22	68.2	57.88	39.42	14.47	60.79	100	0	P	H	
		15540	46.96	-27.04	74	54.34	37.82	17.16	62.36	100	0	P	H	
		17989	59.24	-14.76	74	48.66	48.8	19.05	57.27	100	30	P	H	
		17989	50.27	-3.73	54	39.69	48.8	19.05	57.27	100	30	A	H	
		2683	57.24	-16.76	74	43.26	27.83	17	30.85	200	189	P	V	
		2683	46.44	-7.56	54	32.46	27.83	17	30.85	200	189	A	V	
		4882	52.11	-21.89	74	41.01	31.04	10.11	30.05	100	0	P	V	
		4882	27.32	-26.68	54	-	-	-	-	-	-	-	A	V
		7323	41.63	-32.37	74	51.1	36.3	12.64	58.41	100	0	P	V	
		7323	16.84	-37.16	54	-	-	-	-	-	-	-	A	V
		10360	57.3	-10.9	68.2	64.19	39.44	14.47	60.8	100	0	P	V	
		15540	46.9	-27.1	74	54.28	37.82	17.16	62.36	100	0	P	V	
	17978	59.73	-14.27	74	49.37	48.6	19.05	57.29	100	20	P	V		
	17978	49.71	-4.29	54	39.35	48.6	19.05	57.29	100	20	A	V		



WLAN 802.11a\_Tx\_Ch36+BT (1M) CH 39\_Tx + WWAN LTE B41 BW: 20MHz CH39750 Link

Emission above 18GHz

WIFI Chain 0+1	Note	Frequency ( MHz )	Level ( dBμV/m )	Over Limit ( dB )	Limit Line ( dBμV/m )	Read Level (dBμV)	Antenna Factor ( dB/m )	Path Loss ( dB )	Preamp Factor ( dB )	Chain Pos ( cm )	Table Pos ( deg )	Peak Avg. (P/A)	Pol. (H/V)	
11a_Ch36+ BT_Ch39+ LTE B41 Link		26712	40.43	-33.57	74	39.24	39.84	14.73	53.38	150	0	P	H	
		33444	43.2	-30.8	74	42.03	41.03	17.81	57.67	150	0	P	H	
													H	
													H	
													H	
													H	
													H	
													H	
			26580	40.26	-33.74	74	39.14	39.82	14.63	53.33	150	0	P	V
			33290	42.3	-31.7	74	40.95	41.13	17.79	57.57	150	0	P	V
														V
														V
														V
														V
	<b>Remark</b>	1. No other spurious found. 2. All results are PASS against limit line.												



WLAN 802.11a\_Tx\_Ch36+BT (1M) CH 39\_Tx+ WWAN LTE B41 BW: 20MHz CH39750 Link

Emission below 1GHz

WIFI Chain 0+1	Note	Frequency ( MHz )	Level ( dBμV/m )	Over Limit ( dB )	Limit Line ( dBμV/m )	Read Level (dBμV)	Antenna Factor ( dB/m )	Path Loss ( dB )	Preamp Factor ( dB )	Chain Pos ( cm )	Table Pos ( deg )	Peak Avg. (P/A)	Pol. (H/V)	
11a_Ch36+ BT_Ch39+ LTE B41 Link		83.35	29.54	-10.46	40	47.07	13.74	1.22	32.49	100	0	P	H	
		103.72	31.33	-12.17	43.5	46.21	16.28	1.35	32.51	-	-	P	H	
		196.84	30.98	-12.52	43.5	46.68	14.83	1.92	32.45	-	-	P	H	
		460.68	26.41	-19.59	46	32.67	23.32	2.87	32.45	-	-	P	H	
		715.79	28.39	-17.61	46	30.57	26.66	3.61	32.45	-	-	P	H	
		868.08	30.94	-15.06	46	29.68	29.02	4.03	31.79	-	-	P	H	
														H
														H
														H
														H
														H
														H
			43.58	33.99	-6.01	40	48.29	17.47	0.81	32.58	100	279	Q	V
			103.72	27.47	-16.03	43.5	42.35	16.28	1.35	32.51	-	-	P	V
			202.66	25.5	-18	43.5	40.91	15.08	1.95	32.44	-	-	P	V
			245.34	25.28	-20.72	46	37.72	17.75	2.21	32.4	-	-	P	V
			476.2	27.26	-18.74	46	33.28	23.56	2.92	32.5	-	-	P	V
			745.86	31.87	-14.13	46	32.76	27.88	3.68	32.45	-	-	P	V
														V
														V
													V	
													V	
													V	
													V	
Remark	1. No other spurious found. 2. All results are PASS against limit line.													



802.11g\_Tx\_Ch01+ WLAN 802.11a\_Tx\_Ch36 + WWAN GSM850 Ch189 Link

2.4GHz 2400~2483.5MHz

WIFI 802.11g (Band Edge @ 3m)

WIFI Chain	Note	Frequency ( MHz )	Level ( dBμV/m )	Over Limit ( dB )	Limit Line ( dBμV/m )	Read Level ( dBμV )	Antenna Factor ( dB/m )	Path Loss ( dB )	Preamp Factor ( dB )	Chain Pos ( cm )	Table Pos ( deg )	Peak Avg. ( P/A )	Pol. ( H/V )	
802.11g CH 01 2412MHz		2333.1	53.96	-20.04	74	40.35	27.73	16.82	30.94	113	151	P	H	
		2389.17	42.9	-11.1	54	29.41	27.54	16.87	30.92	113	151	A	H	
	*	2412	106.34	-	-	92.85	27.5	16.9	30.91	113	151	P	H	
	*	2412	98.13	-	-	84.64	27.5	16.9	30.91	113	151	A	H	
													H	
														H
			2385.18	53.72	-20.28	74	40.21	27.56	16.87	30.92	335	302	P	V
			2389.38	42.46	-11.54	54	28.97	27.54	16.87	30.92	335	302	A	V
	*		2412	102.51	-	-	89.02	27.5	16.9	30.91	335	302	P	V
	*		2412	94.62	-	-	81.13	27.5	16.9	30.91	335	302	A	V
														V
														V





**Band 1 - 5150~5250MHz**  
**WIFI 802.11a (Band Edge @ 3m)**

WIFI	Note	Frequency	Level	Over	Limit	Read	Antenna	Path	Preamp	Chain	Table	Peak	Pol.	
Chain				Limit	Line	Level	Factor	Loss	Factor	Pos	Pos	Avg.		
0+1		( MHz )	( dBμV/m )	( dB )	( dBμV/m )	( dBμV )	( dB/m )	( dB )	( dB )	( cm )	( deg )	( P/A )	( H/V )	
<b>802.11a</b> <b>CH 36</b> <b>5180MHz</b>		5105.82	50.27	-23.73	74	38.06	31.8	10.42	30.01	100	239	P	H	
		5100.36	39.81	-14.19	54	27.61	31.8	10.41	30.01	100	239	A	H	
	*	5180	105.82	-	-	93.64	31.62	10.57	30.01	100	239	P	H	
	*	5180	97.8	-	-	85.62	31.62	10.57	30.01	100	239	A	H	
													H	
														H
														V
			5136.76	49.84	-24.16	74	37.57	31.8	10.48	30.01	306	280	P	V
			5103.74	39.54	-14.46	54	27.34	31.8	10.41	30.01	306	280	A	V
	*		5180	102.87	-	-	90.69	31.62	10.57	30.01	306	280	P	V
	*		5180	94.52	-	-	82.34	31.62	10.57	30.01	306	280	A	V
														V



**WLAN 802.11g\_Tx\_Ch01+802.11a\_Tx\_Ch36 + WWAN GSM850 Ch189 Link**

**(Harmonic @ 3m)**

WIFI Chain	Note	Frequency ( MHz )	Level ( dBµV/m )	Over Limit ( dB )	Limit Line ( dBµV/m )	Read Level ( dBµV )	Antenna Factor ( dB/m )	Path Loss ( dB )	Preamp Factor ( dB )	Chain Pos ( cm )	Table Pos ( deg )	Peak Avg. ( P/A )	Pol. ( H/V )	
11g_Ch01+		4824	49.76	-24.24	74	38.66	31.1	10.07	30.07	100	21	P	H	
		4824	39.14	-14.86	54	28.04	31.1	10.07	30.07	100	21	A	H	
		10360	50.05	-18.15	68.2	56.94	39.44	14.47	60.8	100	0	P	H	
		15540	47.17	-26.83	74	54.55	37.82	17.16	62.36	100	0	P	H	
		18000	61.01	-12.99	74	50.19	49	19.06	57.24	100	58	P	H	
		18000	50.34	-3.66	54	39.52	49	19.06	57.24	100	58	A	H	
														H
														H
														H
														H
11a_Ch36+														
GSM 850 Link		4824	50.48	-23.52	74	39.38	31.1	10.07	30.07	150	12	P	V	
		4824	39.15	-14.85	54	28.05	31.1	10.07	30.07	150	12	A	V	
		10360	56.13	-12.07	68.2	63.02	39.44	14.47	60.8	100	0	P	V	
		15540	46.7	-27.3	74	54.08	37.82	17.16	62.36	100	0	P	V	
		18000	59.92	-14.08	74	49.1	49	19.06	57.24	100	17	P	V	
		18000	50.38	-3.62	54	39.56	49	19.06	57.24	100	17	A	V	
														V
														V
														V
														V



WLAN 802.11b\_Tx\_Ch01+802.11a\_Tx\_Ch36 + WWAN LTE B41 BW: 20MHz CH37950 Link

2.4GHz 2400~2483.5MHz

WIFI 802.11b (Band Edge @ 3m)

WIFI Chain	Note	Frequency	Level	Over Limit	Limit Line	Read Level	Antenna Factor	Path Loss	Preamp Factor	Chain Pos	Table Pos	Peak Avg.	Pol.	
0+1		( MHz )	( dBμV/m )	( dB )	( dBμV/m )	( dBμV )	( dB/m )	( dB )	( dB )	( cm )	( deg )	( P/A )	( H/V )	
802.11b CH 01 2412MHz		2357.3	53.88	-20.12	74	40.63	27.67	16.51	30.93	100	252	P	H	
		2326.94	42.07	-11.93	54	28.8	27.75	16.46	30.94	100	252	A	H	
	*	2412	103.49	-	-	90.3	27.5	16.6	30.91	100	252	P	H	
	*	2412	100.39	-	-	87.2	27.5	16.6	30.91	100	252	A	H	
													H	
													H	
			2332.88	53.64	-20.36	74	40.38	27.73	16.47	30.94	289	273	P	V
			2330.13	41.96	-12.04	54	28.7	27.74	16.46	30.94	289	273	A	V
	*		2412	100.65	-	-	87.46	27.5	16.6	30.91	289	273	P	V
	*		2412	97.49	-	-	84.3	27.5	16.6	30.91	289	273	A	V
													V	
													V	



**Band 1 - 5150~5250MHz**  
**WIFI 802.11a (Band Edge @ 3m)**

WIFI	Note	Frequency	Level	Over	Limit	Read	Antenna	Path	Preamp	Chain	Table	Peak	Pol.	
Chain				Limit	Line	Level	Factor	Loss	Factor	Pos	Pos	Avg.		
0+1		( MHz )	( dBμV/m )	( dB )	( dBμV/m )	( dBμV )	( dB/m )	( dB )	( dB )	( cm )	( deg )	( P/A )	( H/V )	
802.11a CH 36 5180MHz		5100.62	50.51	-23.49	74	38.31	31.8	10.41	30.01	100	237	P	H	
		5100.1	39.44	-14.56	54	27.24	31.8	10.41	30.01	100	237	A	H	
	*	5180	105.8	-	-	93.62	31.62	10.57	30.01	100	237	P	H	
	*	5180	98.08	-	-	85.9	31.62	10.57	30.01	100	237	A	H	
													H	
													H	
													V	
			5148.2	49.91	-24.09	74	37.61	31.8	10.51	30.01	315	282	P	V
			5105.04	39.16	-14.84	54	26.95	31.8	10.42	30.01	315	282	A	V
	*		5180	101.42	-	-	89.24	31.62	10.57	30.01	315	282	P	V
	*		5180	93.47	-	-	81.29	31.62	10.57	30.01	315	282	A	V
													V	



WLAN 802.11b\_Tx\_Ch01+802.11a\_Tx\_Ch36 + WWAN LTE B41 BW: 20MHz CH37950 Link

(Harmonic @ 3m)

BT	Note	Frequency	Level	Over	Limit	Read	Antenna	Path	Preamp	Chain	Table	Peak	Pol.	
Ant.				Limit	Line	Level	Factor	Loss	Factor	Pos	Pos	Avg.		
0		( MHz )	( dBμV/m )	( dB )	( dBμV/m )	( dBμV )	( dB/m )	( dB )	( dB )	( cm )	( deg )	(P/A)	(H/V)	
11b_Ch01 +11a_Ch36 +LTE B41 Link		4824	53.01	-20.99	74	41.91	31.1	10.07	30.07	200	241	P	H	
		4824	42.05	-11.95	54	30.95	31.1	10.07	30.07	200	241	A	H	
		10355	51.07	-17.13	68.2	57.97	39.42	14.47	60.79	100	0	P	H	
		15540	46.19	-27.81	74	53.57	37.82	17.16	62.36	100	0	P	H	
		18000	60.75	-13.25	74	49.93	49	19.06	57.24	100	31	P	H	
		18000	50.78	-3.22	54	39.96	49	19.06	57.24	100	31	A	H	
														H
														H
			4824	52.98	-21.02	74	41.88	31.1	10.07	30.07	100	256	P	V
			4824	42.1	-11.9	54	31	31.1	10.07	30.07	100	256	A	V
			10360	56.11	-12.09	68.2	63	39.44	14.47	60.8	100	0	P	V
			15536	46.39	-27.61	74	53.77	37.83	17.16	62.37	100	0	P	V
			17989	59.71	-14.29	74	49.13	48.8	19.05	57.27	100	23	P	V
			17989	49.75	-4.25	54	39.17	48.8	19.05	57.27	100	23	A	V
													V	
													V	



WLAN 802.11b\_Tx\_Ch01+802.11a\_Tx\_Ch36 + WWAN LTE B41 BW: 20MHz CH37950 Link

Emission above 18GHz

WIFI	Note	Frequency	Level	Over	Limit	Read	Antenna	Path	Preamp	Chain	Table	Peak	Pol.
Chain				Limit	Line	Level	Factor	Loss	Factor	Pos	Pos	Avg.	
0+1		( MHz )	( dBμV/m )	( dB )	( dBμV/m )	(dBμV)	( dB/m )	( dB )	( dB )	( cm )	( deg )	(P/A)	(H/V)
11b_Ch01 +11a_Ch36+		26558	40.75	-33.25	74	39.65	39.81	14.61	53.32	150	0	P	H
		34984	45.38	-28.62	74	43.9	41.49	18.58	58.59	150	0	P	H
													H
													H
													H
													H
													H
													H
													H
													H
LTE B41 Link		23038	40.88	-33.12	74	44.09	38.61	12.46	54.28	150	0	P	V
		34984	45.36	-28.64	74	43.88	41.49	18.58	58.59	150	0	P	V
													V
													V
													V
													V
													V
													V
Remark	1. No other spurious found. 2. All results are PASS against limit line.												



WLAN 802.11b\_Tx\_Ch01+802.11a\_Tx\_Ch36 + WWAN LTE B41 BW: 20 MHz CH37950 Link

Emission below 1GHz

WIFI	Note	Frequency	Level	Over	Limit	Read	Antenna	Path	Preamp	Chain	Table	Peak	Pol.	
Chain				Limit	Line	Level	Factor	Loss	Factor	Pos	Pos	Avg.		
0+1		( MHz )	( dBμV/m )	( dB )	( dBμV/m )	( dBμV )	( dB/m )	( dB )	( dB )	( cm )	( deg )	(P/A)	(H/V)	
11b_Ch01 +11a_Ch36+ LTE B41 Link		84.32	29.38	-10.62	40	46.8	13.84	1.23	32.49	100	0	P	H	
		103.72	30.92	-12.58	43.5	45.8	16.28	1.35	32.51	-	-	P	H	
		204.6	30.45	-13.05	43.5	45.77	15.15	1.97	32.44	-	-	P	H	
		517.91	24.37	-21.63	46	29.93	23.97	3.07	32.6	-	-	P	H	
		719.67	31.65	-14.35	46	33.63	26.85	3.62	32.45	-	-	P	H	
		864.2	30.57	-15.43	46	29.35	29.01	4.02	31.81	-	-	P	H	
														H
														H
														H
														H
														H
														H
			39.7	33.92	-6.08	40	46.12	19.59	0.77	32.56	100	0	P	V
			111.48	27.8	-15.7	43.5	41.98	16.95	1.4	32.53	-	-	P	V
			181.32	24.81	-18.69	43.5	40.57	14.9	1.82	32.48	-	-	P	V
			426.73	23.61	-22.39	46	30.33	22.93	2.76	32.41	-	-	P	V
			710.94	26.98	-19.02	46	29.29	26.54	3.6	32.45	-	-	P	V
			864.2	31.09	-14.91	46	29.87	29.01	4.02	31.81	-	-	P	V
														V
														V
													V	
													V	
													V	
													V	
Remark	1. No other spurious found. 2. All results are PASS against limit line.													



**Note symbol**

*	<b>Fundamental Frequency</b> which can be ignored. However, the level of any unwanted emissions shall not exceed the level of the fundamental frequency.
-	The signal is <b>Unintentional Radiators</b> .
P/A	<b>Peak</b> or <b>Average</b>
H/V	<b>Horizontal</b> or <b>Vertical</b>





A calculation example for radiated spurious emission is shown as below:

WIFI	Note	Frequency	Level	Over	Limit	Read	Antenna	Path	Preamp	Chain	Table	Peak	Pol.
Chain.				Limit	Line	Level	Factor	Loss	Factor	Pos	Pos	Avg.	
Simultaneously		( MHz )	( dBμV/m )	( dB )	( dBμV/m )	( dBμV )	( dB/m )	( dB )	( dB )	( cm )	( deg )	( P/A )	( H/V )
802.11b		2390	55.45	-18.55	74	54.51	32.22	4.58	35.86	103	308	P	H
CH 01													
2412MHz		2390	43.54	-10.46	54	42.6	32.22	4.58	35.86	103	308	A	H

1. Path Loss(dB) = Cable loss(dB) + Filter loss(dB) + Attenuator loss(dB)
2. Level(dBμV/m) = Antenna Factor(dB/m) + Path Loss(dB) + Read Level(dBμV) - Preamp Factor(dB)
3. Over Limit(dB) = Level(dBμV/m) – Limit Line(dBμV/m)

**For Peak Limit @ 2390MHz:**

1. Level(dBμV/m)  
= Antenna Factor(dB/m) + Path Loss(dB) + Read Level(dBμV) - Preamp Factor(dB)  
= 32.22(dB/m) + 4.58(dB) + 54.51(dBμV) – 35.86 (dB)  
= 55.45 (dBμV/m)
2. Over Limit(dB)  
= Level(dBμV/m) – Limit Line(dBμV/m)  
= 55.45(dBμV/m) – 74(dBμV/m)  
= -18.55(dB)

**For Average Limit @ 2390MHz:**

1. Level(dBμV/m)  
= Antenna Factor(dB/m) + Path Loss(dB) + Read Level(dBμV) - Preamp Factor(dB)  
= 32.22(dB/m) + 4.58(dB) + 42.6(dBμV) – 35.86 (dB)  
= 43.54 (dBμV/m)
2. Over Limit(dB) = Level(dBμV/m) – Limit Line(dBμV/m)  
= 43.54(dBμV/m) – 54(dBμV/m)  
= -10.46(dB)

**Both peak and average measured complies with the limit line, so test result is “PASS”.**



## Appendix B. Radiated Spurious Emission

Test Engineer :	Leo Lee, Mancy Chou and Bigshow Wang	Temperature :	22.7~23.2°C
		Relative Humidity :	46~52%



WLAN 802.11g\_Tx\_Ch01+ WWAN GSM850 CH 189 Link

2.4GHz 2400~2483.5MHz

WIFI 802.11g (Band Edge @ 3m)

WIFI	2.4GHz 2400~2483.5MHz Band Edge @ 3m	
Chain	802.11g CH01 2412MHz	
0+1	Horizontal	Fundamental
Peak	<p>Site : 03CH15-HY Condition : PEAK_BE_74 3m 91200_15_1620 HORIZONTAL : RBW:1000.000kHz VBW:3000.000kHz SWT:Auto</p>	<p>Site : 03CH15-HY Condition : PEAK_74 3m 91200_15_1620 HORIZONTAL : RBW:1000.000kHz VBW:3000.000kHz SWT:Auto</p>
Avg.	<p>Site : 03CH15-HY Condition : AVG_BE_54 3m 91200_15_1620 HORIZONTAL : RBW:1000.000kHz VBW:1000kHz SWT:Auto</p>	<p>Site : 03CH15-HY Condition : AVG_54 3m 91200_15_1620 HORIZONTAL : RBW:1000.000kHz VBW:1000kHz SWT:Auto</p>

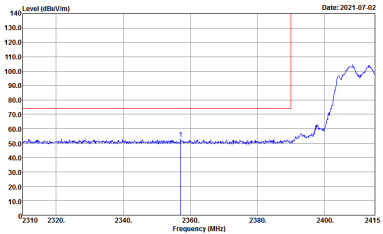
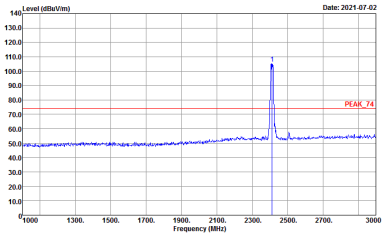
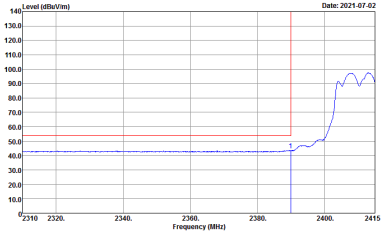
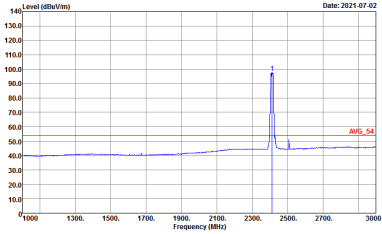

WIFI	2.4GHz 2400~2483.5MHz Band Edge @ 3m	
Chain	802.11b CH01 2412MHz	
0+1	Vertical	Fundamental
Peak	 <p>Site : 03CH15-HY Condition : PEAK_BE_74 3m 91200_15_1620 VERTICAL : RBW:1000.000KHz VBW:3000.000KHz SWT:Auto</p>	 <p>Site : 03CH15-HY Condition : PEAK_74 3m 91200_15_1620 VERTICAL : RBW:1000.000KHz VBW:3000.000KHz SWT:Auto</p>
Avg.	 <p>Site : 03CH15-HY Condition : AV6_BE_54 3m 91200_15_1620 VERTICAL : RBW:1000.000KHz VBW:1000KHz SWT:Auto</p>	 <p>Site : 03CH15-HY Condition : AV6_54 3m 91200_15_1620 VERTICAL : RBW:1000.000KHz VBW:1000KHz SWT:Auto</p>



WLAN 802.11g\_Tx\_Ch01+ WWAN GSM850 CH 189 Link

(Harmonic @ 3m)

Chain	WLAN 802.11g_Tx_Ch01+ WWAN GSM850 CH 189 Link	
0+1	Horizontal	Vertical
Peak Avg.	<p>Site : 03CH15-HY Condition : PEAK_74 3m 91200_15_1620 HORIZONTAL</p>	<p>Site : 03CH15-HY Condition : PEAK_74 3m 91200_15_1620 VERTICAL</p>



WLAN 802.11b\_Tx\_Ch01+ WWAN LTE B41 BW: 20MHz CH39750 Link

2.4GHz 2400~2483.5MHz

WIFI 802.11b (Band Edge @ 3m)

WIFI	2.4GHz 2400~2483.5MHz Band Edge @ 3m	
Chain	802.11b CH01 2412MHz	
0+1	Horizontal	Fundamental
Peak	<p>Site : 03CH15-HY Condition : PEAK_BE_74 3m 91200_15_1620 HORIZONTAL : RBW:1000.000KHz VBW:3000.000KHz SWT:Auto</p>	<p>Site : 03CH15-HY Condition : PEAK_74 3m 91200_15_1620 HORIZONTAL : RBW:1000.000KHz VBW:3000.000KHz SWT:Auto</p>
Avg.	<p>Site : 03CH15-HY Condition : AVG_BE_54 3m 91200_15_1620 HORIZONTAL : RBW:1000.000KHz VBW:0.010KHz SWT:Auto</p>	<p>Site : 03CH15-HY Condition : AVG_54 3m 91200_15_1620 HORIZONTAL : RBW:1000.000KHz VBW:0.010KHz SWT:Auto</p>



WIFI	2.4GHz 2400~2483.5MHz Band Edge @ 3m	
Chain	802.11b CH01 2412MHz	
0+1	Vertical	Fundamental
Peak	<p>Site : 03CH15-HY Condition : PEAK_BE_74 3m 91200_15_1620 VERTICAL : RBW:1000.000KHz VBW:3000.000KHz SWT:Auto</p>	<p>Site : 03CH15-HY Condition : PEAK_74 3m 91200_15_1620 VERTICAL : RBW:1000.000KHz VBW:3000.000KHz SWT:Auto</p>
Avg.	<p>Site : 03CH15-HY Condition : AV6_BE_54 3m 91200_15_1620 VERTICAL : RBW:1000.000KHz VBW:0.010KHz SWT:Auto</p>	<p>Site : 03CH15-HY Condition : AV6_54 3m 91200_15_1620 VERTICAL : RBW:1000.000KHz VBW:0.010KHz SWT:Auto</p>



WLAN 802.11b\_Tx\_Ch01+ WWAN LTE B41 BW: 20MHz CH39750 Link

(Harmonic @ 3m)

Chain	WLAN 802.11b_Tx_Ch01+ WWAN LTE B41 BW: 20MHz CH39750 Link	
0+1	Horizontal	Vertical
Peak Avg.	<p>Site Condition :03CH15-HY :PEAK_74 3m 91200_15_1620 HORIZONTAL</p>	<p>Site Condition :03CH15-HY :PEAK_74 3m 91200_15_1620 VERTICAL</p>





WLAN 802.11g\_Tx\_Ch01+ WWAN GSM850 CH 189 Link

Emission above 18GHz

(SHF @ 3m)

Chain	WLAN 802.11g_Tx_Ch01+ WWAN GSM850 CH 189 Link	
0+1	Horizontal	Vertical
<b>Peak</b>  <b>Avg.</b>	<p>Site : 03CH15-HY Condition : PEAK_74_1M 1m SHF HORN B8HA9170576 HORIZONTAL</p>	<p>Site : 03CH15-HY Condition : PEAK_74_1M 1m SHF HORN B8HA9170576 VERTICAL</p>



WLAN 802.11g\_Tx\_Ch01+ WWAN GSM850 CH 189 Link

Emission below 1GHz

(LF@ 3m)

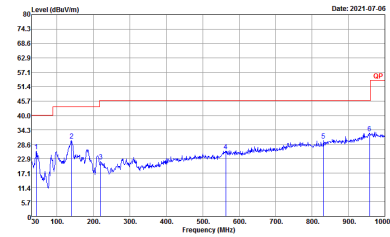
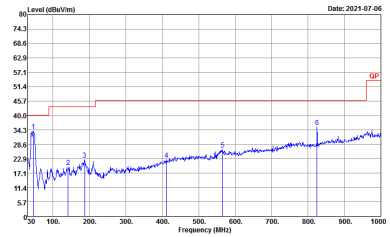
Chain	WLAN 802.11g_Tx_Ch01+ WWAN GSM850 CH 189 Link	
0+1	Horizontal	Vertical
Peak	 <p>Site : 03CH15-HY Condition : QP 3m 8IL06_41912_20210208 HORIZONTAL</p>	 <p>Site : 03CH15-HY Condition : QP 3m 8IL06_41912_20210208 VERTICAL</p>
Avg.		



WLAN 802.11a\_Tx\_Ch36+BT (1M) CH 39\_Tx+ WWAN GSM850 Ch189 Link

Band 1 - 5150~5250MHz

WIFI 802.11a (Band Edge @ 3m)

WIFI	Band 1 5150~5250MHz Band Edge @ 3m	
Chain	802.11a CH36 5180MHz	
0+1	Horizontal	Fundamental
Peak	<p>Site : 03CH15-HY Condition : PEAK_BE_74 3m 91200_15_1620 HORIZONTAL : RBW:1000.000KHz VBW:3000.000KHz SWT:Auto</p>	<p>Site : 03CH15-HY Condition : PEAK(LINB) 3m 91200_15_1620 HORIZONTAL : RBW:1000.000KHz VBW:3000.000KHz SWT:Auto</p>
Avg.	<p>Site : 03CH15-HY Condition : AVG_BE_54 3m 91200_15_1620 HORIZONTAL : RBW:1000.000KHz VBW:0.010KHz SWT:Auto</p>	Left blank

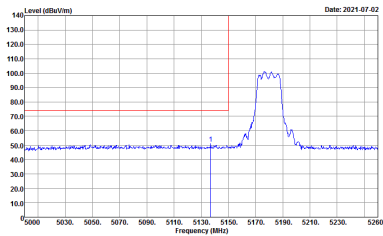
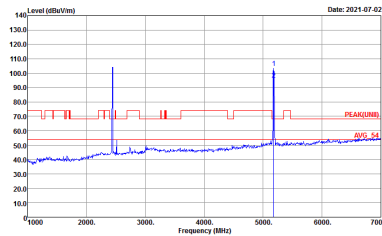
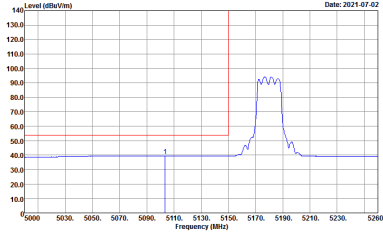

WIFI	Band 1 5150~5250MHz Band Edge @ 3m	
Chain	802.11a CH36 5180MHz	
0+1	Vertical	Fundamental
Peak	 <p>Site : 03CH15-HY Condition : PEAK_BE_74 3m 91200_15_1620 VERTICAL : RBW:1000.000KHz VBW:3000.000KHz SWT:Auto</p>	 <p>Site : 03CH15-HY Condition : PEAK(LINE) 3m 91200_15_1620 VERTICAL : RBW:1000.000KHz VBW:3000.000KHz SWT:Auto</p>
Avg.	 <p>Site : 03CH15-HY Condition : AV6_BE_54 3m 91200_15_1620 VERTICAL : RBW:1000.000KHz VBW:0.010KHz SWT:Auto</p>	Left blank



2.4GHz 2400~2483.5MHz

BT (Band Edge @ 3m)

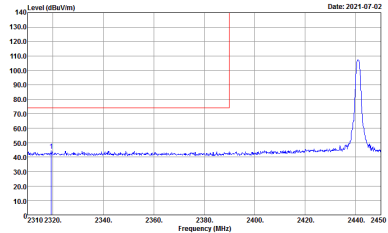
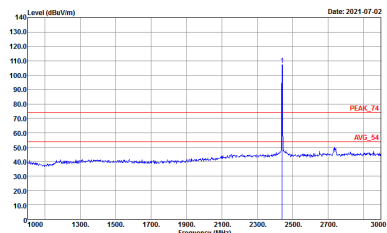
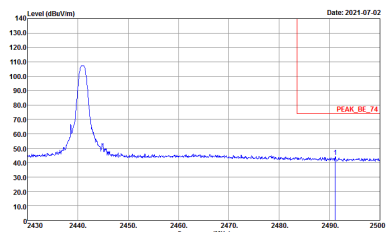
BT	2.4GHz 2400~2483.5MHz Band Edge @ 3m	
Ant.	BT CH39 2441MHz	
0	Horizontal	Fundamental
Peak	 <p>Date: 2021-07-02</p> <p>Site : 03CH15-HY Condition : PEAK_BE_74 3m 9120D_15_1620 HORIZONTAL : RBW:1000.000kHz VBW:3000.000kHz SWF:Auto</p>	 <p>Date: 2021-07-02</p> <p>Site : 03CH15-HY Condition : PEAK_74 3m 9120D_15_1620 HORIZONTAL</p>
Peak	 <p>Date: 2021-07-02</p> <p>Site : 03CH15-HY Condition : PEAK_BE_74 3m 9120D_15_1620 HORIZONTAL</p>	Left blank

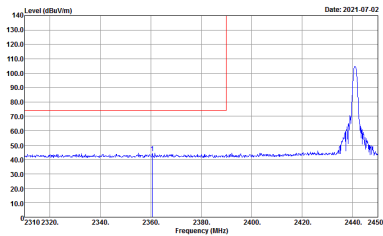
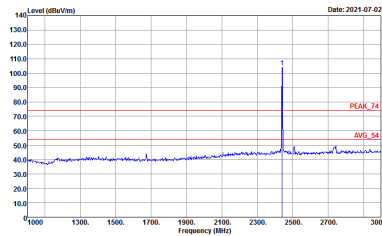
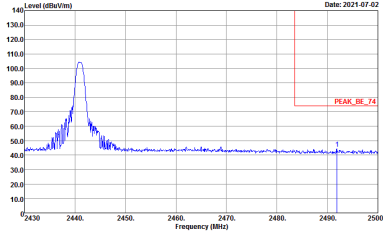

BT	2.4GHz 2400~2483.5MHz Band Edge @ 3m	
Ant.	BT CH39 2441MHz	
0	Vertical	Fundamental
Peak	 <p>Site : 03CH15-HY Condition : PEAK_BE_74 3m 91200_15_1620 VERTICAL : RBW:1000.000KHz VBW:3000.000KHz SWT:Auto</p>	 <p>Site : 03CH15-HY Condition : PEAK_74 3m 91200_15_1620 VERTICAL : RBW:1000.000KHz VBW:3000.000KHz SWT:Auto</p>
Peak	 <p>Site : 03CH15-HY Condition : PEAK_BE_74 3m 91200_15_1620 VERTICAL : RBW:1000.000KHz VBW:3000.000KHz SWT:Auto</p>	Left blank

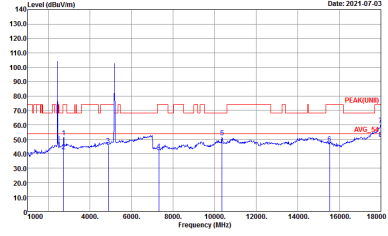
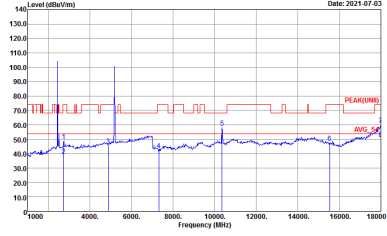

**WLAN 802.11a\_Tx\_Ch36+BT (1M) CH 39\_Tx + WWAN GSM850 Ch189 Link  
(Harmonic @ 3m)**

Chain	WLAN 802.11a_Tx_Ch36+BT (1M) CH 39_Tx+ WWAN GSM850 Ch189 Link	
0+1	Horizontal	Vertical
<p><b>Peak</b></p> <p><b>Avg.</b></p>	 <p>Site : 03CH15-HY Condition : PEAK(UNII) 3m 91200_15_1620 HORIZONTAL</p>	 <p>Site : 03CH15-HY Condition : PEAK(UNII) 3m 91200_15_1620 VERTICAL</p>



WLAN 802.11a\_Tx\_Ch36+BT (1M) CH 39\_Tx + WWAN LTE B41 BW: 20MHz CH39750 Link

Band 1 - 5150~5250MHz  
WIFI 802.11a (Band Edge @ 3m)

WIFI	Band 1 5150~5250MHz Band Edge @ 3m	
Chain	802.11a CH36 5180MHz	
0+1	Horizontal	Fundamental
Peak	<p>Site : 03CH15-HY Condition : PEAK_BE_74 3m 91200_15_1620 HORIZONTAL : RBW:1000.000KHz VBW:3000.000KHz SWT:Auto</p>	<p>Site : 03CH15-HY Condition : PEAK(FUND) 3m 91200_15_1620 HORIZONTAL : RBW:1000.000KHz VBW:3000.000KHz SWT:Auto</p>
Avg.	<p>Site : 03CH15-HY Condition : AVG_BE_54 3m 91200_15_1620 HORIZONTAL : RBW:1000.000KHz VBW:0.010KHz SWT:Auto</p>	Left blank



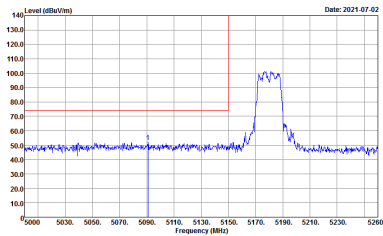
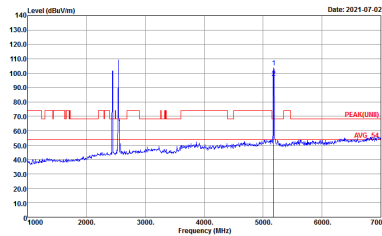
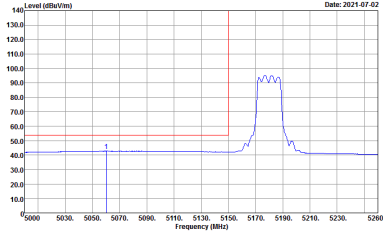

WIFI	Band 1 5150~5250MHz Band Edge @ 3m	
Chain	802.11a CH36 5180MHz	
0+1	Vertical	Fundamental
Peak	 <p>Site : 03CH15-HY Condition : PEAK_BE_74 3m 91200_15_1620 VERTICAL : RBW:1000.000KHz VBW:3000.000KHz SWT:Auto</p>	 <p>Site : 03CH15-HY Condition : PEAK(LINE) 3m 91200_15_1620 VERTICAL : RBW:1000.000KHz VBW:3000.000KHz SWT:Auto</p>
Avg.	 <p>Site : 03CH15-HY Condition : AV6_BE_54 3m 91200_15_1620 VERTICAL : RBW:1000.000KHz VBW:0.010KHz SWT:Auto</p>	Left blank



2.4GHz 2400~2483.5MHz

BT (Band Edge @ 3m)

BT	2.4GHz 2400~2483.5MHz Band Edge @ 3m	
Ant.	BT CH39 2441MHz	
0	Horizontal	Fundamental
Peak	<p>Date: 2021-07-02</p> <p>Site : 03CH15-HY            Condition : PEAK_BE_74 3m 91200_15_1620 HORIZONTAL            : RBW:1000.000kHz VBW:3000.000kHz SWT:Auto</p>	<p>Date: 2021-07-02</p> <p>Site : 03CH15-HY            Condition : PEAK_74 3m 91200_15_1620 HORIZONTAL            : RBW:1000.000kHz VBW:3000.000kHz SWT:Auto</p>
Peak	<p>Date: 2021-07-02</p> <p>Site : 03CH15-HY            Condition : PEAK_BE_74 3m 91200_15_1620 HORIZONTAL            : RBW:1000.000kHz VBW:3000.000kHz SWT:Auto</p>	Left blank



BT	2.4GHz 2400~2483.5MHz Band Edge @ 3m	
Ant.	BT CH39 2441MHz	
0	Vertical	Fundamental
Peak	<p>Site : 03CH15-HY Condition : PEAK_BE_74 3m 91200_15_1620 VERTICAL : RBW:1000.000KHz VBW:3000.000KHz SWT:Auto</p>	<p>Site : 03CH15-HY Condition : PEAK_74 3m 91200_15_1620 VERTICAL : RBW:1000.000KHz VBW:3000.000KHz SWT:Auto</p>
Peak	<p>Site : 03CH15-HY Condition : PEAK_BE_74 3m 91200_15_1620 HORIZONTAL : RBW:1000.000KHz VBW:3000.000KHz SWT:Auto</p>	Left blank



WLAN 802.11a\_Tx\_Ch36+BT (1M) CH 39\_Tx + WWAN LTE B41 BW: 20MHz CH39750 Link

(Harmonic @ 3m)

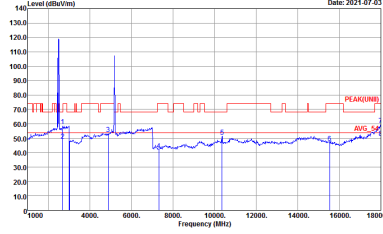
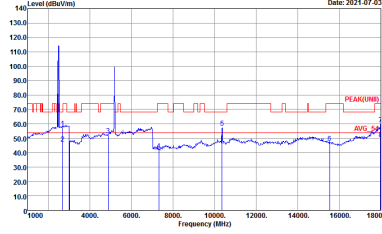
Chain	WLAN 802.11a_Tx_Ch36+BT (1M) CH 39_Tx+ WWAN LTE B41 BW: 20MHz CH39750 Link	
0+1	Horizontal	Vertical
<p>Peak</p> <p>Avg.</p>	 <p>Site : 03CH15-HY Condition : PEAK(UNII) 3m 91200_15_1620 HORIZONTAL</p>	 <p>Site : 03CH15-HY Condition : PEAK(UNII) 3m 91200_15_1620 VERTICAL</p>



WLAN 802.11a\_Tx\_Ch36+BT (1M) CH 39\_Tx + WWAN LTE B41 BW: 20MHz CH39750 Link

Emission above 18GHz

Chain	WLAN 802.11a_Tx_Ch36+BT (1M) CH 39_Tx+ WWAN LTE B41 BW: 20MHz CH39750 Link	
0+1	Horizontal	Vertical
QP / Peak	<p>Site : 03CH15-14Y Condition : PEAK_74_1M 1m SHF HORN 88H49170576 HORIZONTAL</p>	<p>Site : 03CH15-14Y Condition : PEAK_74_1M 1m SHF HORN 88H49170576 VERTICAL</p>



WLAN 802.11a\_Tx\_Ch36+BT (1M) CH 39\_Tx + WWAN LTE B41 BW: 20MHz CH39750 Link

Emission below 1GHz

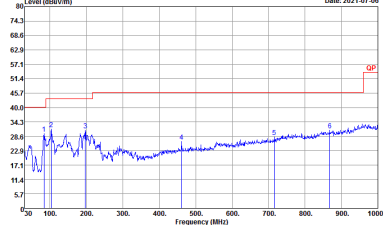
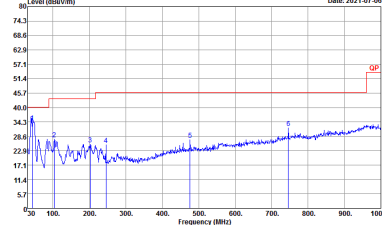
Chain	WLAN 802.11a_Tx_Ch36+BT (1M) CH 39_Tx+ WWAN LTE B41 BW: 20MHz CH39750 Link	
0+1	Horizontal	Vertical
QP / Peak	 <p>Site : 03CH15-HY Condition : QP 3m BIL06_41912_20210208 HORIZONTAL</p>	 <p>Site : 03CH15-HY Condition : QP 3m BIL06_41912_20210208 VERTICAL</p>



WLAN 802.11g\_Tx\_Ch01+802.11a\_Tx\_Ch36 + WWAN GSM850 Ch189 Link

2.4GHz 2400~2483.5MHz

WIFI 802.11g (Band Edge @ 3m)

WIFI	2.4GHz 2400~2483.5MHz Band Edge @ 3m	
Chain	802.11g CH01 2412MHz	
0+1	Horizontal	Fundamental
Peak	<p>Site : 03CH15-HY Condition : PEAK_BE_74 3m 91200_15_1620 HORIZONTAL : RBW:1000.000kHz VBW:3000.000kHz SWT:Auto</p>	<p>Site : 03CH15-HY Condition : PEAK_74 3m 91200_15_1620 HORIZONTAL : RBW:1000.000kHz VBW:3000.000kHz SWT:Auto</p>
Avg.	<p>Site : 03CH15-HY Condition : AVG_BE_54 3m 91200_15_1620 HORIZONTAL : RBW:1000.000kHz VBW:0.010kHz SWT:Auto</p>	<p>Site : 03CH15-HY Condition : AVG_54 3m 91200_15_1620 HORIZONTAL : RBW:1000.000kHz VBW:0.010kHz SWT:Auto</p>

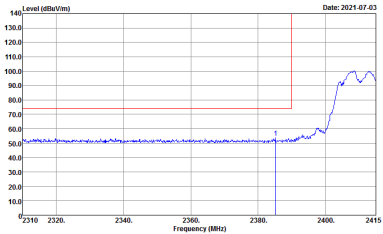
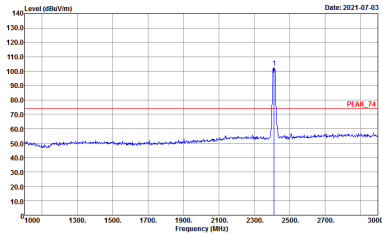
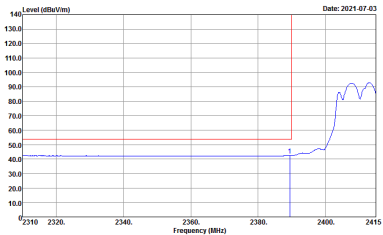
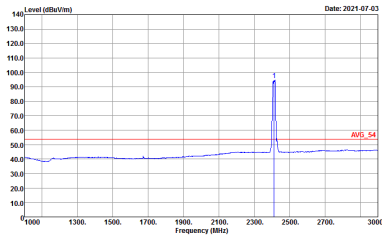

WIFI	2.4GHz 2400~2483.5MHz Band Edge @ 3m	
Chain	802.11g CH01 2412MHz	
0+1	Vertical	Fundamental
Peak	 <p>Level (dBu/m) vs Frequency (MHz) plot for Vertical Peak. The plot shows a baseline around 50 dBu/m with a sharp peak at approximately 2412 MHz reaching about 100 dBu/m. A red vertical line marks the peak. The x-axis ranges from 2310 to 2415 MHz, and the y-axis ranges from 10.0 to 140.0 dBu/m.</p> <p>Site : 03CH15-HY            Condition : PEAK_BE_74 3m 91200_15_1620 VERTICAL                          : RBW:1000.000KHz VBW:3000.000KHz SWT:Auto</p>	 <p>Level (dBu/m) vs Frequency (MHz) plot for Fundamental Peak. The plot shows a baseline around 50 dBu/m with a sharp peak at approximately 2412 MHz reaching about 100 dBu/m. A red vertical line marks the peak. The x-axis ranges from 1000 to 3000 MHz, and the y-axis ranges from 10.0 to 140.0 dBu/m.</p> <p>Site : 03CH15-HY            Condition : PEAK_74 3m 91200_15_1620 VERTICAL                          : RBW:1000.000KHz VBW:3000.000KHz SWT:Auto</p>
Avg.	 <p>Level (dBu/m) vs Frequency (MHz) plot for Vertical Avg. The plot shows a baseline around 50 dBu/m with a sharp peak at approximately 2412 MHz reaching about 100 dBu/m. A red vertical line marks the peak. The x-axis ranges from 2310 to 2415 MHz, and the y-axis ranges from 10.0 to 140.0 dBu/m.</p> <p>Site : 03CH15-HY            Condition : AV6_BE_54 3m 91200_15_1620 VERTICAL                          : RBW:1000.000KHz VBW:0.010KHz SWT:Auto</p>	 <p>Level (dBu/m) vs Frequency (MHz) plot for Fundamental Avg. The plot shows a baseline around 50 dBu/m with a sharp peak at approximately 2412 MHz reaching about 100 dBu/m. A red vertical line marks the peak. The x-axis ranges from 1000 to 3000 MHz, and the y-axis ranges from 10.0 to 140.0 dBu/m.</p> <p>Site : 03CH15-HY            Condition : AV6_54 3m 91200_15_1620 VERTICAL                          : RBW:1000.000KHz VBW:0.010KHz SWT:Auto</p>





**Band 1 - 5150~5250MHz**  
**WIFI 802.11a (Band Edge @ 3m)**

WIFI	Band 1 5150~5250MHz Band Edge @ 3m	
Chain	802.11a CH36 5180MHz	
0+1	Horizontal	Fundamental
<b>Peak</b>	<p>Date: 2021-07-03</p> <p>Site : 03CH15-HY            Condition : PEAK_BE_74 3m 91200_15_1620 HORIZONTAL            : RBW:1000.000kHz VBW:3000.000kHz SWT:Auto</p>	<p>Date: 2021-07-03</p> <p>Site : 03CH15-HY            Condition : PEAK(FUND) 3m 91200_15_1620 HORIZONTAL            : RBW:1000.000kHz VBW:3000.000kHz SWT:Auto</p>
<b>Avg.</b>	<p>Date: 2021-07-03</p> <p>Site : 03CH15-HY            Condition : AVG_BE_54 3m 91200_15_1620 HORIZONTAL            : RBW:1000.000kHz VBW:0.010kHz SWT:Auto</p>	<p>Left blank</p>

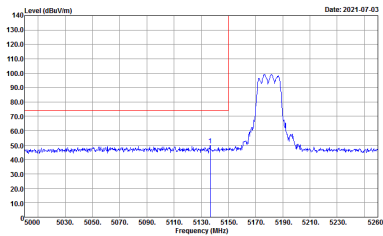
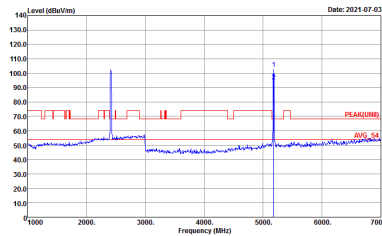
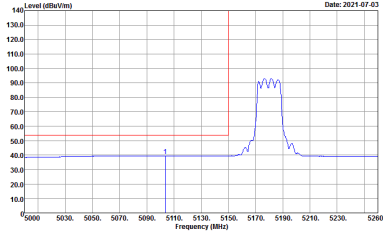

WIFI	Band 1 5150~5250MHz Band Edge @ 3m	
Chain	802.11a CH36 5180MHz	
0+1	Vertical	Fundamental
Peak	 <p>Site : 03CH15-HY Condition : PEAK_BE_74 3m 91200_15_1620 VERTICAL : RBW:1000.000KHz VBW:3000.000KHz SWT:Auto</p>	 <p>Site : 03CH15-HY Condition : PEAK(LINE) 3m 91200_15_1620 VERTICAL : RBW:1000.000KHz VBW:3000.000KHz SWT:Auto</p>
Avg.	 <p>Site : 03CH15-HY Condition : AV6_BE_54 3m 91200_15_1620 VERTICAL : RBW:1000.000KHz VBW:0.010KHz SWT:Auto</p>	Left blank



WLAN 802.11a\_Tx\_Ch36 + 802.11g\_Tx\_Ch01 + WWAN GSM850 Ch189 Link

(Harmonic @ 3m)

Chain	WLAN 802.11a_Tx_Ch36 + 802.11g_Tx_Ch01+ WWAN GSM850 Ch189 Link	
0+1	Horizontal	Vertical
<p>Peak</p> <p>Avg.</p>	<p>Site : 03CH15-HY Condition : PEAK(UNII) 3m 91200_15_1620 HORIZONTAL</p>	<p>Site : 03CH15-HY Condition : PEAK(UNII) 3m 91200_15_1620 VERTICAL</p>



WLAN 802.11b\_Tx\_Ch01+802.11a\_Tx\_Ch36 + WWAN LTE B41 BW: 20MHz CH39750 Link

2.4GHz 2400~2483.5MHz

WIFI 802.11b (Band Edge @ 3m)

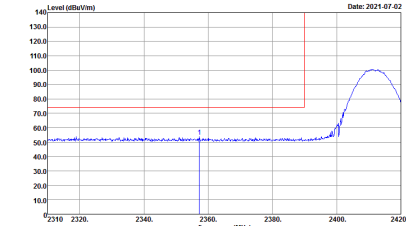
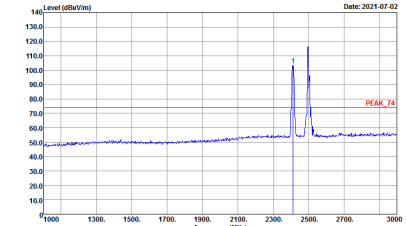
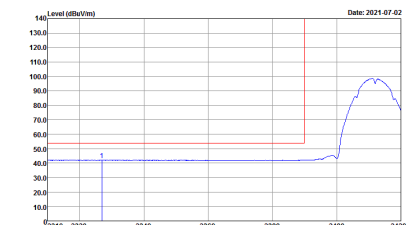
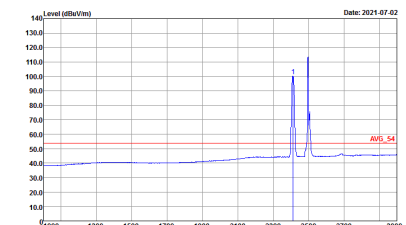
WIFI	2.4GHz 2400~2483.5MHz Band Edge @ 3m	
Chain	802.11b CH01 2412MHz	
0+1	Horizontal	Fundamental
Peak	 <p>Site : 03CH15-HY Condition : PEAK_BE_74 3m 91200_15_1620 HORIZONTAL : RBW:1000.000kHz VBW:3000.000kHz SWT:Auto</p>	 <p>Site : 03CH15-HY Condition : PEAK_74 3m 91200_15_1620 HORIZONTAL : RBW:1000.000kHz VBW:3000.000kHz SWT:Auto</p>
Avg.	 <p>Site : 03CH15-HY Condition : AVG_BE_54 3m 91200_15_1620 HORIZONTAL : RBW:1000.000kHz VBW:0.010kHz SWT:Auto</p>	 <p>Site : 03CH15-HY Condition : AVG_54 3m 91200_15_1620 HORIZONTAL : RBW:1000.000kHz VBW:0.010kHz SWT:Auto</p>

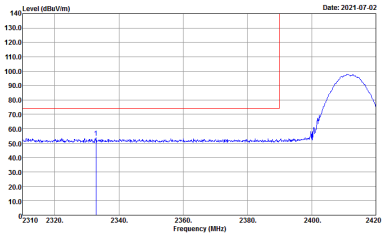
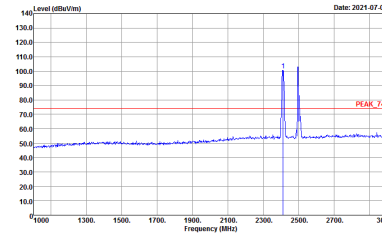
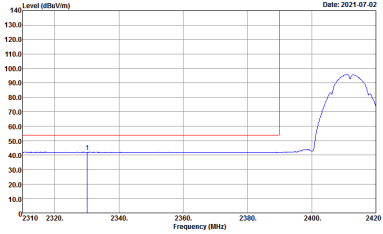
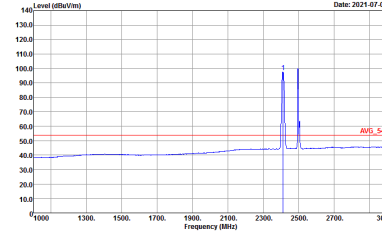

WIFI	2.4GHz 2400~2483.5MHz Band Edge @ 3m	
Chain	802.11b CH01 2412MHz	
0+1	Vertical	Fundamental
Peak	 <p>Site : 03CH15-HY Condition : PEAK_BE_74 3m 91200_15_1620 VERTICAL : RBW:1000.000KHz VBW:3000.000KHz SWT:Auto</p>	 <p>Site : 03CH15-HY Condition : PEAK_74 3m 91200_15_1620 VERTICAL : RBW:1000.000KHz VBW:3000.000KHz SWT:Auto</p>
Avg.	 <p>Site : 03CH15-HY Condition : AV6_BE_54 3m 91200_15_1620 VERTICAL : RBW:1000.000KHz VBW:0.010KHz SWT:Auto</p>	 <p>Site : 03CH15-HY Condition : AV6_54 3m 91200_15_1620 VERTICAL : RBW:1000.000KHz VBW:0.010KHz SWT:Auto</p>



**Band 1 - 5150~5250MHz**  
**WIFI 802.11a (Band Edge @ 3m)**

WIFI	Band 1 5150~5250MHz Band Edge @ 3m	
Chain	802.11a CH36 5180MHz	
0+1	Horizontal	Fundamental
<b>Peak</b>	<p>Site : 03CH15-HY            Condition : PEAK_BE_74 3m 91200_15_1620 HORIZONTAL            : RBW:1000.000kHz VBW:3000.000kHz SWT:Auto</p>	<p>Site : 03CH15-HY            Condition : PEAK(FUND) 3m 91200_15_1620 HORIZONTAL            : RBW:1000.000kHz VBW:3000.000kHz SWT:Auto</p>
<b>Avg.</b>	<p>Site : 03CH15-HY            Condition : AVG_BE_54 3m 91200_15_1620 HORIZONTAL            : RBW:1000.000kHz VBW:0.010kHz SWT:Auto</p>	<p>Left blank</p>



WIFI	Band 1 5150~5250MHz Band Edge @ 3m	
Chain	802.11a CH36 5180MHz	
0+1	Vertical	Fundamental
Peak	<p>Site : 03CH15-HY Condition : PEAK_BE_74 3m 91200_15_1620 VERTICAL : RBW:1000.000KHz VBW:3000.000KHz SWT:Auto</p>	<p>Site : 03CH15-HY Condition : PEAK(LINE) 3m 91200_15_1620 VERTICAL : RBW:1000.000KHz VBW:3000.000KHz SWT:Auto</p>
Avg.	<p>Site : 03CH15-HY Condition : AV6_BE_54 3m 91200_15_1620 VERTICAL : RBW:1000.000KHz VBW:0.010KHz SWT:Auto</p>	Left blank



WLAN 802.11b\_Tx\_Ch01+802.11a\_Tx\_Ch36 + WWAN LTE B41 BW: 20MHz CH39750 Link

(Harmonic @ 3m)

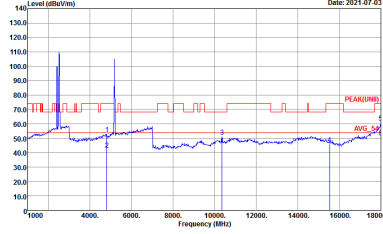
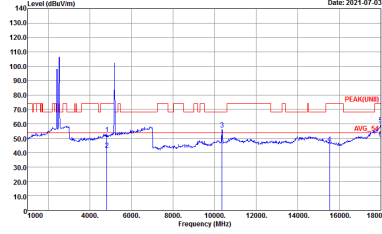
Chain	WLAN 802.11b_Tx_Ch01+ 802.11a_Tx_Ch36 + WWAN LTE B41 BW:20MHz CH39750 Link	
0+1	Horizontal	Vertical
<p><b>Peak</b></p> <p><b>Avg.</b></p>	 <p>Site : 03CH15-HY Condition : PEAK(UNII) 3m 91200_15_1620 HORIZONTAL</p>	 <p>Site : 03CH15-HY Condition : PEAK(UNII) 3m 91200_15_1620 VERTICAL</p>





WLAN 802.11b\_Tx\_Ch01+802.11a\_Tx\_Ch36 + WWAN LTE B41 BW: 20MHz CH39750 Link

Emission above 18GHz

Chain	WLAN 802.11b_Tx_Ch01+802.11a_Tx_Ch36 + WWAN LTE B41 BW:20MHz CH39750 Link	
0+1	Horizontal	Vertical
QP / Peak	<p>Site : 03CH15-14Y Condition : PEAK_74_1M 1m SHF HORN 88H49170576 HORIZONTAL</p>	<p>Site : 03CH15-14Y Condition : PEAK_74_1M 1m SHF HORN 88H49170576 VERTICAL</p>



WLAN 802.11b\_Tx\_Ch01+802.11a\_Tx\_Ch36 + WWAN LTE B41 BW: 20MHz CH39750 Link

Emission below 1GHz

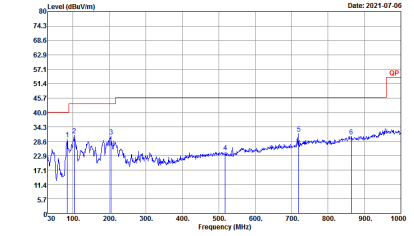
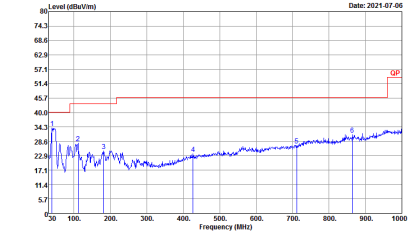
Chain	WLAN 802.11b_Tx_Ch01+802.11a_Tx_Ch36 + WWAN LTE B41 BW:20MHz CH39750 Link	
0+1	Horizontal	Vertical
QP / Peak	 <p>Site : 03CH15-HY Condition : QP 3m BIL06_41912_20210208 HORIZONTAL</p>	 <p>Site : 03CH15-HY Condition : QP 3m BIL06_41912_20210208 VERTICAL</p>



# Appendix C. Duty Cycle Plots

<Ant. 0>

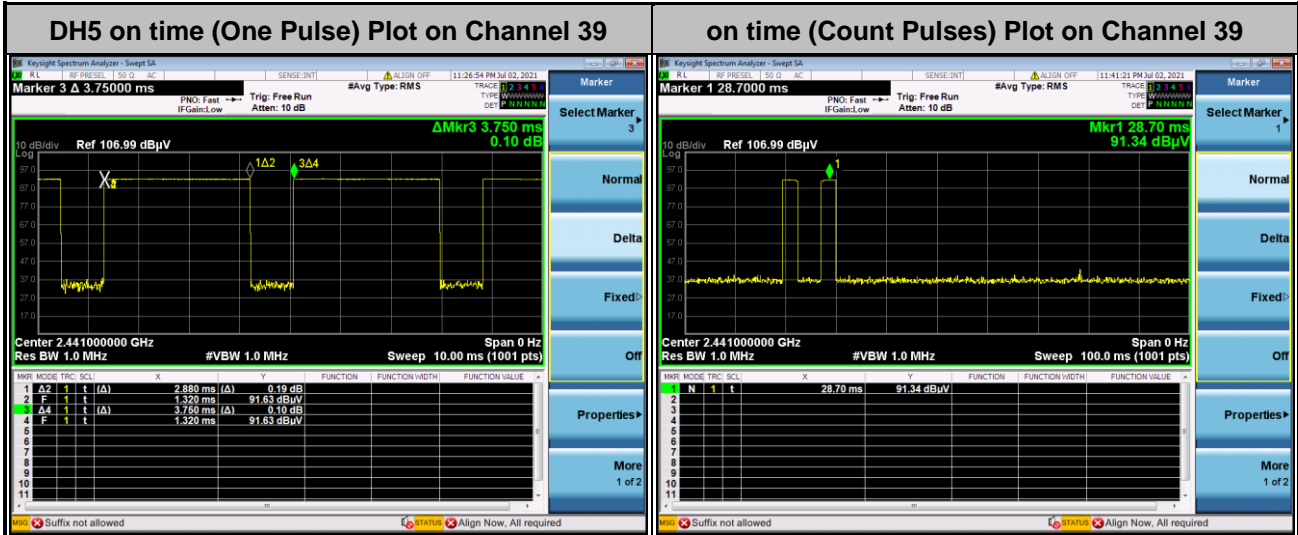

### Note:

1. Worst case Duty cycle = on time/100 milliseconds =  $2 * 2.88 / 100 = 5.76 \%$
2. Worst case Duty cycle correction factor =  $20 * \log(\text{Duty cycle}) = -24.79 \text{ dB}$
3. DH5 has the highest duty cycle worst case and is reported.

### Duty Cycle Correction Factor Consideration for AFH mode:

Bluetooth normal hopping rate is 1600Hz and reduced to 800Hz in AFH mode; due to the reduced number of hopping frequencies, with the same packet configuration the dwell time in each channel frequency within 100msec period is longer in AFH mode than normal mode.

In AFH mode, the minimum hopping frequencies are 20, to get the longest dwell time DH5 packet is observed; the period to have DH5 packet completing one hopping sequence is

$$2.88 \text{ ms} \times 20 \text{ channels} = 57.6 \text{ ms}$$

There cannot be 2 complete hopping sequences within 100ms period, considering the random hopping behavior, maximum 2 hops can be possibly observed within the period.  $[100 \text{ ms} / 57.6 \text{ ms}] = 2 \text{ hops}$

Thus, the maximum possible ON time:

$$2.88 \text{ ms} \times 2 = 5.76 \text{ ms}$$

Worst case Duty Cycle Correction factor, which is derived from the maximum possible ON time,

$$20 \times \log(5.76 \text{ ms}/100 \text{ ms}) = -24.79 \text{ dB}$$



Chain	Band	Duty Cycle(%)	T(us)	1/T(kHz)	VBW Setting	Duty Factor(dB)
0+1	2.4GHz 802.11b	100.00	-	-	10Hz	0.00
0+1	2.4GHz 802.11g	99.29	-	-	10Hz	0.03
0+1	5GHz 802.11a	99.05	-	-	10Hz	0.04

MIMO <Chain 0+1>

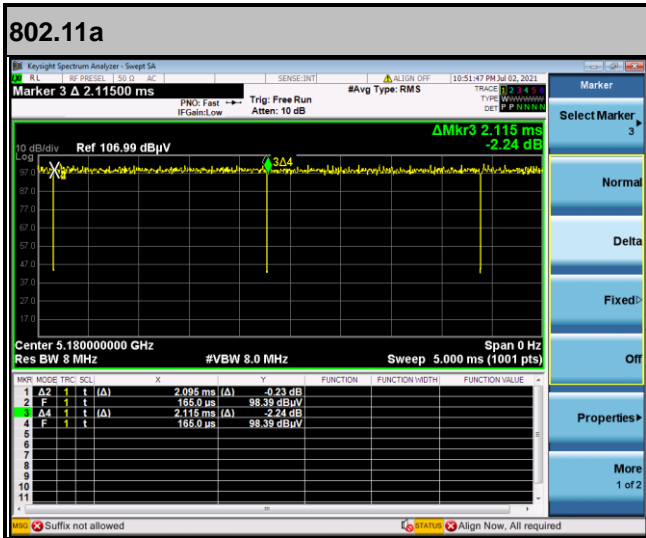
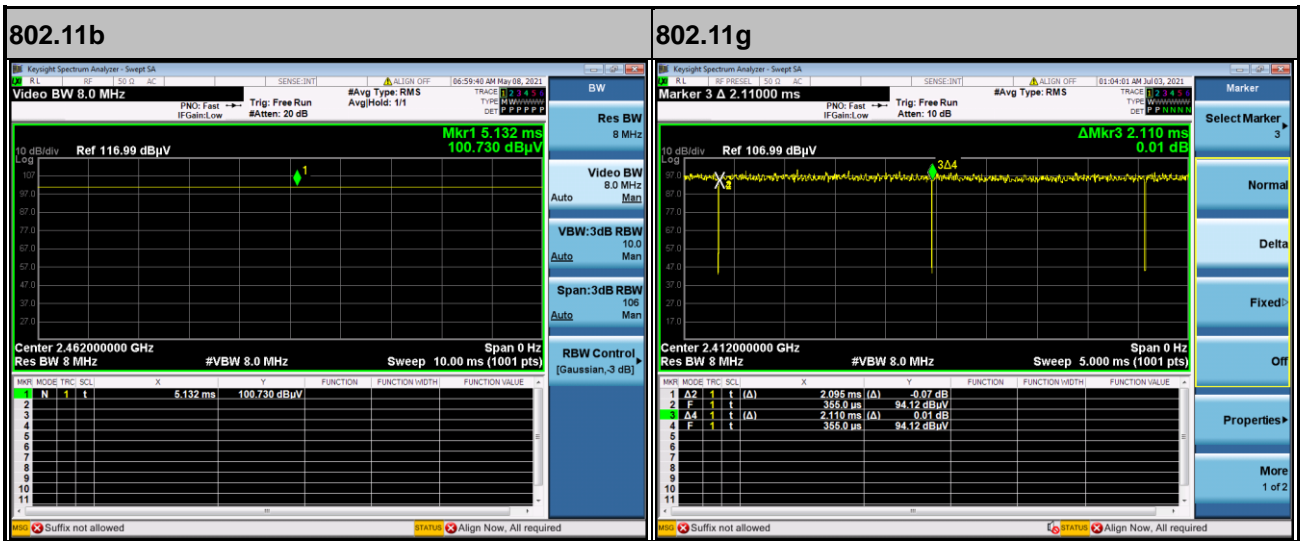

—THE END—