



FCC RADIO TEST REPORT

FCC ID : PY7-77089S
Equipment : GSM/WCDMA/LTE/5G Phone with BT, DTS/UNII a/b/g/n/ac/ax, GPS and NFC
Brand Name : Sony
Applicant : Sony Corporation
1-7-1 Konan Minato-ku Tokyo, 108-0075 Japan
Manufacturer : Sony Corporation
1-7-1 Konan Minato-ku Tokyo, 108-0075 Japan
Standard : FCC Part 15 Subpart C §15.247

The product was received on Jun. 08, 2021 and testing was started from Jun. 17, 2021 and completed on Jul. 07, 2021. We, Sporton International Inc. EMC & Wireless Communications Laboratory, would like to declare that the tested sample has been evaluated in accordance with the test procedures and has been in compliance with the applicable technical standards.

The test results in this spot check data report apply exclusively to the tested model / sample. Without written approval of Sporton International Inc. EMC & Wireless Communications Laboratory, the test report shall not be reproduced except in full.

Louis Wu

Approved by: Louis Wu

Sporton International Inc. EMC & Wireless Communications Laboratory

No. 52, Huaya 1st Rd., Guishan Dist., Taoyuan City 333, Taiwan (R.O.C.)



Table of Contents

History of this test report.....	3
Summary of Test Result.....	4
1 General Description	5
1.1 Product Feature of Equipment Under Test.....	5
1.2 Modification of EUT	5
1.3 Testing Location	6
1.4 Applicable Standards.....	6
2 Test Configuration of Equipment Under Test	7
2.1 Carrier Frequency and Channel	7
2.2 Test Mode.....	7
2.3 Connection Diagram of Test System.....	8
2.4 EUT Operation Test Setup	8
3 Test Result	9
3.1 Output Power Measurement.....	9
3.2 Radiated Band Edges and Spurious Emission Measurement	10
3.3 Antenna Requirements	15
4 List of Measuring Equipment.....	16
5 Uncertainty of Evaluation	17
Appendix A. Conducted Test Results	
Appendix B. Radiated Spurious Emission	
Appendix C. Radiated Spurious Emission Plots	
Appendix D. Duty Cycle Plots	



History of this test report

Report No.	Version	Description	Issued Date
FR133143C	01	Initial issue of report	Jul. 12, 2021



Summary of Test Result

Report Clause	Ref Std. Clause	Test Items	Result (PASS/FAIL)	Remark
-	15.247(a)(2)	6dB Bandwidth	-	See Note
-	2.1049	99% Occupied Bandwidth	-	See Note
3.1	15.247(b)	Power Output Measurement	Pass	-
-	15.247(e)	Power Spectral Density	-	See Note
-	15.247(d)	Conducted Band Edges	-	See Note
		Conducted Spurious Emission	-	See Note
3.2	15.247(d)	Radiated Band Edges and Radiated Spurious Emission	Pass	Under limit 3.73 dB at 18000.000 MHz
-	15.207	AC Conducted Emission	-	See Note
3.3	15.203 & 15.247(b)	Antenna Requirement	Pass	-

Note: The RF circuit, output power level and antenna performance is the same in Bluetooth function across all two FCC ID PY7-38061M and PY7-77089S, since the change, only verify RF output power and radiated spurious emission test data the worst mode was reported in this report.

Declaration of Conformity:
The test results with all measurement uncertainty excluded are presented in accordance with the regulation limits or requirements declared by manufacturers.
Comments and Explanations:
The declared of product specification for EUT presented in the report are provided by the manufacturer, and the manufacturer takes all the responsibilities for the accuracy of product specification.

Reviewed by: Keven Cheng

Report Producer: Tina Chuang



1 General Description

1.1 Product Feature of Equipment Under Test

GSM/WCDMA/LTE, Bluetooth, DTS/UNII a/b/g/n/ac/ax, NFC, FM Receiver and GNSS

Product Specification subjective to this standard	
Antenna Type / Gain	<Chain 0>: Loop Antenna with gain -2.3 dBi <Chain 1>: Loop Antenna with gain -7.0 dBi

Remark: The above EUT's information was declared by manufacturer. Please refer to Comments and Explanations in report summary.

EUT Information List			
HW Version	SW Version	S/N	Performed Test Item
A	3.46	QV72002H9B	RF conducted measurement
		QV72001G9B	Radiated Spurious Emission

Accessory List	
AC Adapter	Model Name : XQZ-UC1
	S/N : 0020W51300039
Earphone	Model Name : STH40D
	S/N : N/A
USB Cable	Model Name : XQZ-UB1
	S/N : N/A

Note:

1. Above EUT list used are electrically identical per declared by manufacturer.
2. Above the accessories list are used to exercise the EUT during test, and the serial number of each type of accessories is listed in each section of this report. .
3. For other wireless features of this EUT, test report will be issued separately.

1.2 Modification of EUT

No modifications are made to the EUT during all test items.



1.3 Testing Location

Test Site	Sporton International Inc. EMC & Wireless Communications Laboratory
Test Site Location	No.52, Huaya 1st Rd., Guishan Dist., Taoyuan City 333, Taiwan (R.O.C.) TEL: +886-3-327-3456 FAX: +886-3-328-4978
Test Site No.	Sporton Site No. TH02-HY
Test Site	Sporton International Inc. Wensan Laboratory
Test Site Location	No.58, Aly. 75, Ln. 564, Wenhua 3rd, Rd., Guishan Dist., Taoyuan City 333010, Taiwan (R.O.C.) TEL: +886-3-327-0868 FAX: +886-3-327-0855
Test Site No.	Sporton Site No. 03CH15-HY (TAF Code: 3786)
Remark	The Radiated Spurious Emission test item subcontracted to Sporton International Inc. Wensan Laboratory.

Note: The test site complies with ANSI C63.4 2014 requirement.

FCC designation No.: TW1190 and TW3786

1.4 Applicable Standards

According to the specifications of the manufacturer, the EUT must comply with the requirements of the following standards:

- ♦ FCC Part 15 Subpart C §15.247
- ♦ FCC KDB Publication No. 558074 D01 DTS Meas. Guidance v05r02
- ♦ FCC KDB 414788 D01 Radiated Test Site v01r01.
- ♦ FCC KDB 662911 D01 Multiple Transmitter Output v02r01.
- ♦ ANSI C63.10-2013

Remark:

1. All test items were verified and recorded according to the standards and without any deviation during the test.
2. The TAF code is not including all the FCC KDB listed without accreditation.
3. This EUT has also been tested and complied with the requirements of FCC Part 15, Subpart B, recorded in a separate test report.



2 Test Configuration of Equipment Under Test

The EUT has been associated with peripherals and configuration operated in a manner tended to maximize its emission characteristics in a typical application. Frequency range investigated: radiation emission (9 kHz to the 10th harmonic of the highest fundamental frequency or to 40 GHz, whichever is lower). For radiated measurement, the measured emission level of the EUT was maximized by rotating the EUT on a turntable, adjusting the orientation of the EUT and EUT antenna in three orthogonal axis (X: flat, Y: portrait, Z: landscape), and adjusting the measurement antenna orientation, following C63.10 exploratory test procedures and find Z plane as worst plane.

2.1 Carrier Frequency and Channel

Frequency Band	Channel	Freq. (MHz)	Channel	Freq. (MHz)
2400-2483.5 MHz	1	2412	7	2442
	2	2417	8	2447
	3	2422	9	2452
	4	2427	10	2457
	5	2432	11	2462
	6	2437		

2.2 Test Mode

Final test modes are considering the modulation and worse data rates as below table.

Modulation	Data Rate
802.11b	1 Mbps
802.11g	6 Mbps
802.11n HT20	MCS0
802.11ax HE20	MCS0

Ch. #	2400-2483.5 MHz		
	802.11b	802.11g	802.11ax HE20
Low	01	-	01
Middle	-	-	-
High	11	11	-

Remark: For radiation spurious emission, the final modulation and the worst data rate was reference the max RF conducted power.

2.3 Connection Diagram of Test System

<WLAN Tx Mode>

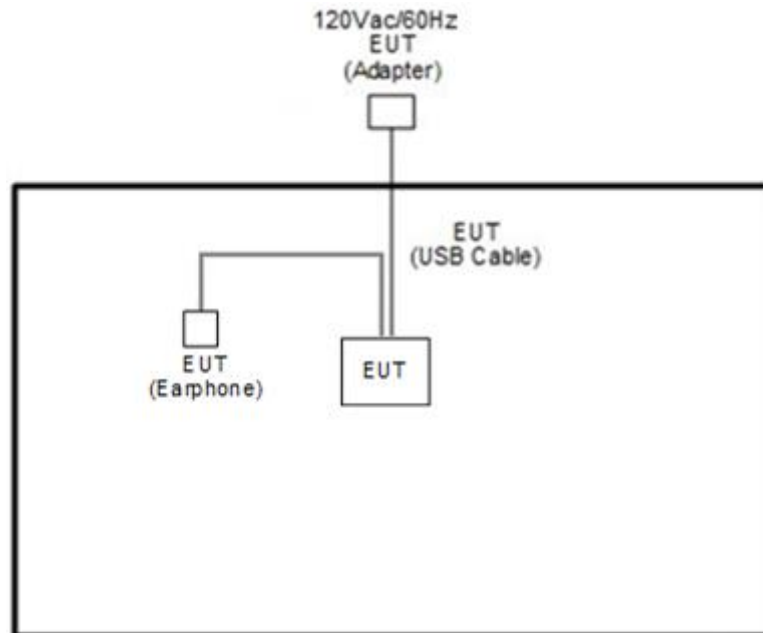

2.4 EUT Operation Test Setup

The RF test items, utility "FTMC_bridge V_0.39" was installed in Notebook which was programmed in order to make the EUT get into the engineering modes to provide channel selection, power level, data rate and the application type and for continuous transmitting signals.

3 Test Result

3.1 Output Power Measurement

3.1.1 Limit of Output Power

For systems using digital modulation in the 2400-2483.5 MHz, the limit for output power is 30 dBm. If transmitting antenna with directional gain greater than 6 dBi is used, the peak output power from the intentional radiator shall be reduced below the above stated value by the amount in dB that the directional gain of the antenna exceeds 6 dBi. In case of point-to-point operation, the limit has to be reduced by 1 dB for every 3 dB that the directional gain of the antenna exceeds 6 dBi.

3.1.2 Measuring Instruments

See list of measuring equipment of this test report.

3.1.3 Test Procedures

1. For Peak Power, the testing follows ANSI C63.10 Section 11.9.1.3 PKPM1
2. For Average Power, the testing follows ANSI C63.10 Section 11.9.2.3.1 Method AVGPM
3. The RF output of EUT was connected to the power meter by RF cable and attenuator. The path loss was compensated to the results for each measurement.
4. Set the maximum power setting and enable the EUT to transmit continuously.
5. Measure the conducted output power and record the results in the test report.
6. For MIMO mode, calculation method follows FCC KDB 662911 D01 Multiple Transmitter Output v02r01.

3.1.4 Test Setup

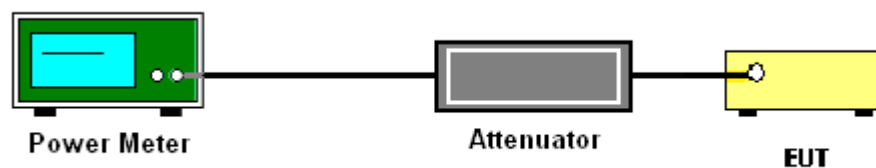

3.1.5 Test Result of Peak Output Power

Please refer to Appendix A.

3.1.6 Test Result of Average Output Power (Reporting Only)

Please refer to Appendix A.



3.2 Radiated Band Edges and Spurious Emission Measurement

3.2.1 Limit of Radiated band edge and Spurious Emission Measurement

In any 100 kHz bandwidth outside the intentional radiator frequency band, all harmonics/spurious must be at least 20 dB below the highest emission level within the authorized band. If the output power of this device was measured by spectrum analyzer, the attenuation under this paragraph shall be 30 dB instead of 20 dB. In addition, radiated emissions which fall in the restricted bands must also comply with the limits as below.

Frequency (MHz)	Field Strength (microvolts/meter)	Measurement Distance (meters)
0.009 – 0.490	2400/F(kHz)	300
0.490 – 1.705	24000/F(kHz)	30
1.705 – 30.0	30	30
30 – 88	100	3
88 – 216	150	3
216 - 960	200	3
Above 960	500	3

3.2.2 Measuring Instruments

See list of measuring equipment of this test report.



3.2.3 Test Procedures

1. The testing follows the ANSI C63.10 Section 11.12.1 Radiated emission measurements.
2. The EUT was arranged to its worst case and then tune the antenna tower (from 1 m to 4 m) and turntable (from 0 degree to 360 degrees) to find the maximum reading. A pre-amp and a high pass filter are used for the test in order to get better signal level.
3. The EUT was placed on a turntable with 0.8 meter for frequency below 1 GHz and 1.5 meter for frequency above 1 GHz respectively above ground.
4. The EUT was set 3 meters from the interference receiving antenna, which was mounted on the top of a variable height antenna tower.
5. Corrected Reading: Antenna Factor + Cable Loss + Read Level - Preamp Factor = Level
6. For testing below 1 GHz, if the emission level of the EUT in peak mode was 3 dB lower than the limit specified, then peak values of EUT will be reported, otherwise, the emissions will be repeated one by one using the CISPR quasi-peak method and reported.
7. For testing above 1 GHz, the emission level of the EUT in peak mode was 20 dB lower than average limit (that means the emission level in average mode also complies with the limit in average mode), then peak values of EUT will be reported, otherwise, the emissions will be measured in average mode again and reported.
8. Use the following spectrum analyzer settings:
 - (1) Span shall wide enough to fully capture the emission being measured;
 - (2) Set RBW = 100 kHz for $f < 1$ GHz; $VBW \geq RBW$; Sweep = auto; Detector function = peak; Trace = max hold;
 - (3) Set RBW = 1 MHz, $VBW = 3$ MHz for $f \geq 1$ GHz for peak measurement.
For average measurement:
 - $VBW = 10$ Hz, when duty cycle is no less than 98 percent.
 - $VBW \geq 1/T$, when duty cycle is less than 98 percent where T is the minimum transmission duration over which the transmitter is on and is transmitting at its maximum power control level for the tested mode of operation.

3.2.4 Test Setup

For radiated emissions below 30MHz

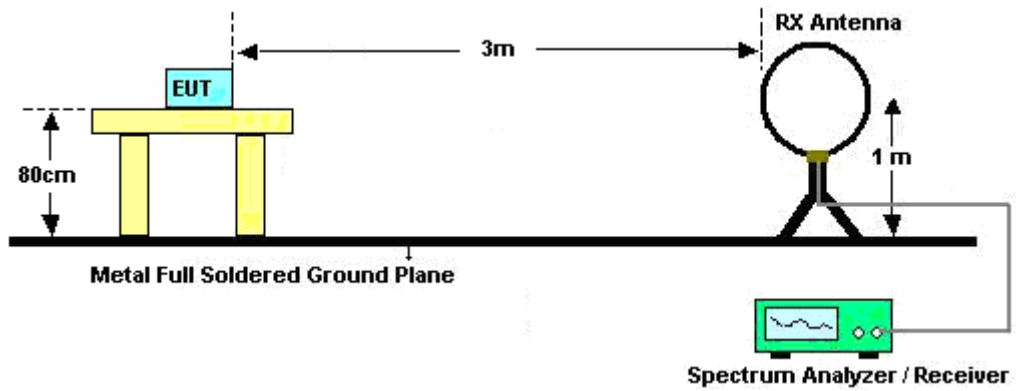

For radiated emissions from 30MHz to 1GHz

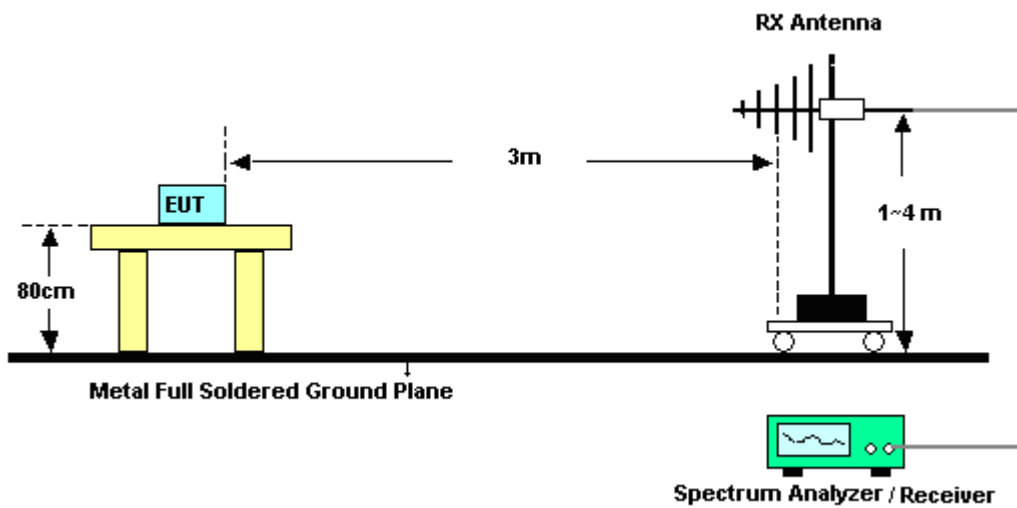

For radiated test from 1GHz to 18GHz

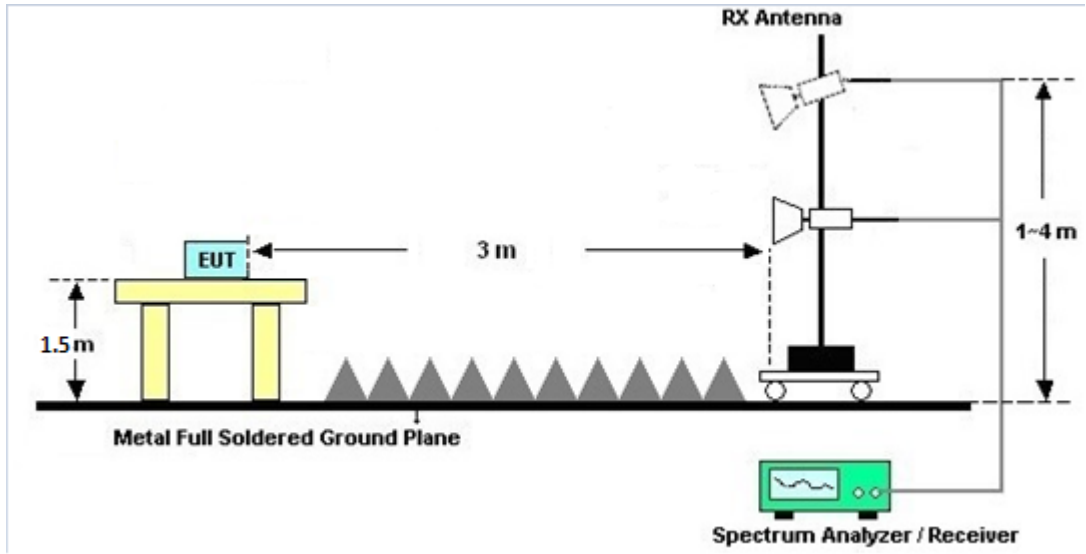

For radiated test above 18GHz

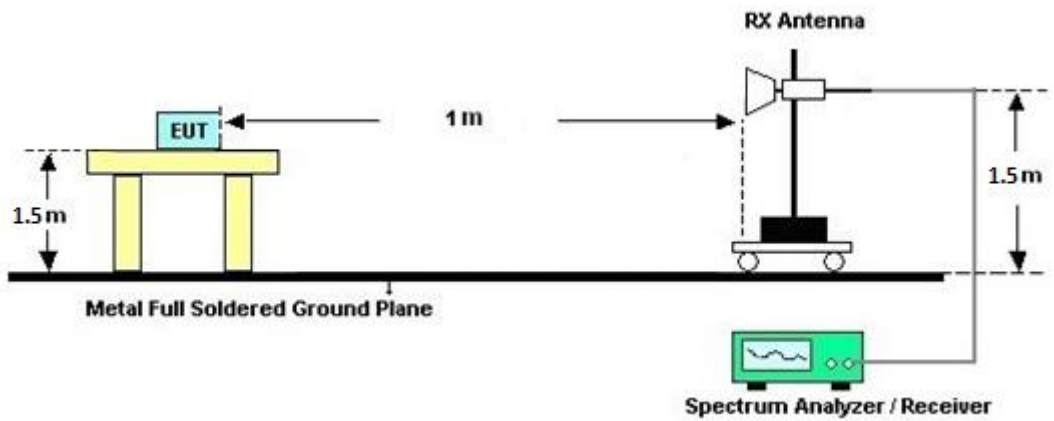



3.2.5 Test Results of Radiated Spurious Emissions (9kHz ~ 30MHz)

The low frequency, which started from 9 kHz to 30MHz, was pre-scanned and the result which was 20dB lower than the limit line was not reported.

There is adequate comparison measurement of both open-field test site and alternative test site - semi-Anechoic chamber according to 414788 D01 Radiated Test Site v01r01, and the result came out very similar.

3.2.6 Test Result of Radiated Spurious at Band Edges

Please refer to Appendix B and C.

3.2.7 Duty Cycle

Please refer to Appendix D.

3.2.8 Test Result of Radiated Spurious Emission (30MHz ~ 10th Harmonic)

Please refer to Appendix B and C.



3.3 Antenna Requirements

3.3.1 Standard Applicable

If directional gain of transmitting Antennas is greater than 6 dBi, the power shall be reduced by the same level in dB comparing to gain minus 6 dBi. The use of a permanently attached antenna or of an antenna that uses a unique coupling to the intentional radiator shall be considered sufficient to comply with the rule.

3.3.2 Antenna Anti-Replacement Construction

An embedded-in antenna design is used.

3.3.3 Antenna Gain

The antenna peak gain of EUT is less than 6 dBi. Therefore, it is not necessary to reduce maximum peak output power limit.



4 List of Measuring Equipment

Instrument	Brand Name	Model No.	Serial No.	Characteristics	Calibration Date	Test Date	Due Date	Remark
Hygrometer	TECEPEL	TR-32	HE17XB24 68	N/A	Mar. 09, 2021	Jun. 17, 2021	Mar. 08, 2022	Conducted (TH02-HY)
Power Sensor	DARE	RPR3006W	16100054S NO12	10MHz~6GHz	Dec. 16, 2020	Jun. 17, 2021	Dec. 15, 2021	Conducted (TH02-HY)
Signal Analyzer	Rohde & Schwarz	FSV40	101566	10Hz ~ 40GHz	Jul. 22, 2020	Jun. 17, 2021	Jul. 21, 2021	Conducted (TH02-HY)
Switch Box & RF Cable	Burgeon	ETF058	EC130048 4	N/A	Nov. 19, 2020	Jun. 17, 2021	Nov. 18, 2021	Conducted (TH02-HY)
Loop Antenna	Rohde & Schwarz	HFH2-Z2	100488	9 kHz~30 MHz	Jul. 14, 2020	Jul. 05, 2021~ Jul. 07, 2021	Jul. 13, 2021	Radiation (03CH15-HY)
Bilog Antenna	TESEQ	CBL 6111D & 00800N1D01 N-06	41912 & 05	30MHz~1GHz	Feb. 08, 2021	Jul. 05, 2021~ Jul. 07, 2021	Feb. 07, 2022	Radiation (03CH15-HY)
Amplifier	SONOMA	310N	363440	9kHz~1GHz	Dec. 28, 2020	Jul. 05, 2021~ Jul. 07, 2021	Dec. 27, 2021	Radiation (03CH15-HY)
Horn Antenna	SCHWARZBE CK	BBHA 9120 D	9120D-016 20	1GHz~18GHz	Nov. 03, 2020	Jul. 05, 2021~ Jul. 07, 2021	Nov. 02, 2021	Radiation (03CH15-HY)
SHF-EHF Horn Antenna	SCHWARZBE CK	BBHA 9170	BBHA9170 251	18GHz~40GHz	Dec. 02, 2020	Jul. 05, 2021~ Jul. 07, 2021	Dec. 01, 2021	Radiation (03CH15-HY)
Preamplifier	Jet-Power	JPA0118-55-3 03	171000180 0055006	1GHz~18GHz	May 06, 2021	Jul. 05, 2021~ Jul. 07, 2021	May 05, 2022	Radiation (03CH15-HY)
Preamplifier	Keysight	83017A	MY532701 95	1GHz~26.5GHz	Aug. 21, 2020	Jul. 05, 2021~ Jul. 07, 2021	Aug. 20, 2021	Radiation (03CH15-HY)
Preamplifier	EMEC	EM18G40G	0600789	18-40GHz	Oct. 27, 2020	Jul. 05, 2021~ Jul. 07, 2021	Oct. 26, 2021	Radiation (03CH15-HY)
EMI Test Receiver	Keysight	N9038A (MXE)	MY541300 85	20MHz~8.4GHz	Nov. 02, 2020	Jul. 05, 2021~ Jul. 07, 2021	Nov. 01, 2021	Radiation (03CH15-HY)
Spectrum Analyzer	Keysight	N9010A	MY542004 85	10Hz~44GHz	Mar. 05, 2021	Jul. 05, 2021~ Jul. 07, 2021	Mar. 04, 2022	Radiation (03CH15-HY)
Antenna Mast	ChainTek	MBS-520-1	N/A	1m~4m	N/A	Jul. 05, 2021~ Jul. 07, 2021	N/A	Radiation (03CH15-HY)
Turn Table	ChainTek	T-200-S-1	N/A	0~360 Degree	N/A	Jul. 05, 2021~ Jul. 07, 2021	N/A	Radiation (03CH15-HY)
Software	Audix	E3 6.2009-8-24(k 5)	RK-00045 1	N/A	N/A	Jul. 05, 2021~ Jul. 07, 2021	N/A	Radiation (03CH15-HY)
RF Cable	HUBER + SUHNER	SUCOFLEX 104, 102E	MY36980/ 4, MY9838/4 PE,508405 /2E	30MHz~18G	Nov. 16, 2020	Jul. 05, 2021~ Jul. 07, 2021	Nov. 15, 2021	Radiation (03CH15-HY)
RF Cable	HUBER + SUHNER	SUCOFLEX 102	505134/2	30MHz-40GHz	Feb. 22, 2021	Jul. 05, 2021~ Jul. 07, 2021	Feb. 21, 2022	Radiation (03CH15-HY)
RF Cable	HUBER + SUHNER	SUCOFLEX 102	800740/2	30MHz-40GHz	Feb. 22, 2021	Jul. 05, 2021~ Jul. 07, 2021	Feb. 21, 2022	Radiation (03CH15-HY)
RF Cable	HUBER + SUHNER	SUCOFLEX 104	MY9837/4 PE	9kHz~30MHz	Mar. 11, 2021	Jul. 05, 2021~ Jul. 07, 2021	Mar. 10, 2022	Radiation (03CH15-HY)
Filter	Wainwright	WLK4-1000-1 530-8000-40S S	SN12	1.53GHz Low Pass Filter	Sep. 15, 2020	Jul. 05, 2021~ Jul. 07, 2021	Sep. 14, 2021	Radiation (03CH15-HY)
Filter	Wainwright	WHKX12-270 0-3000-18000 -60ST	SN4	3GHz High Pass Filter	Sep. 16, 2020	Jul. 05, 2021~ Jul. 07, 2021	Sep. 15, 2021	Radiation (03CH15-HY)



5 Uncertainty of Evaluation

Uncertainty of Radiated Emission Measurement (30 MHz ~ 1000 MHz)

Measuring Uncertainty for a Level of Confidence of 95% ($U = 2Uc(y)$)	4.7 dB
---	--------

Uncertainty of Radiated Emission Measurement (1000 MHz ~ 18000 MHz)

Measuring Uncertainty for a Level of Confidence of 95% ($U = 2Uc(y)$)	5.3 dB
---	--------

Uncertainty of Radiated Emission Measurement (18000 MHz ~ 40000 MHz)

Measuring Uncertainty for a Level of Confidence of 95% ($U = 2Uc(y)$)	4.9 dB
---	--------

Appendix A. Test Result of Conducted Test Items

Test Engineer:	Eason Huang	Temperature:	21~25	°C
Test Date:	2021/6/17	Relative Humidity:	51~54	%

TEST RESULTS DATA
Peak Output Power

2.4GHz Band MIMO																
Mod.	Data Rate	NTX	CH.	Freq. (MHz)	Peak Conducted Power (dBm)			Conducted Power Limit (dBm)		DG (dBi)		EIRP Power (dBm)		EIRP Power Limit (dBm)		Pass /Fail
					Chain 0	Chain 1	SUM	Chain 0	Chain 1	Chain 0	Chain 1	Chain 0	Chain 1	Chain 0	Chain 1	
11b	1Mbps	2	1	2412	17.55	15.49	19.65	30.00		-2.30		17.35		36.00		Pass
11b	1Mbps	2	6	2437	17.59	15.50	19.68	30.00		-2.30		17.38		36.00		Pass
11b	1Mbps	2	11	2462	17.51	15.55	19.65	30.00		-2.30		17.35		36.00		Pass
11g	6Mbps	2	1	2412	22.81	22.56	25.70	30.00		-2.30		23.40		36.00		Pass
11g	6Mbps	2	6	2437	22.29	22.20	25.26	30.00		-2.30		22.96		36.00		Pass
11g	6Mbps	2	11	2462	22.36	22.39	25.39	30.00		-2.30		23.09		36.00		Pass
HT20	MCS0	2	1	2412	22.58	22.63	25.62	30.00		-2.30		23.32		36.00		Pass
HT20	MCS0	2	6	2437	22.89	22.80	25.86	30.00		-2.30		23.56		36.00		Pass
HT20	MCS0	2	11	2462	21.80	21.73	24.78	30.00		-2.30		22.48		36.00		Pass

Note: Measured power (dBm) has offset with cable loss.

TEST RESULTS DATA
Average Output Power

2.4GHz Band MIMO																
Mod.	Data Rate	NTX	CH.	Freq. (MHz)	Average Conducted Power with duty factor (dBm)			Conducted Power Limit (dBm)		DG (dBi)		EIRP Power (dBm)		EIRP Power Limit (dBm)		Pass /Fail
					Chain 0	Chain 1	SUM	Chain 0	Chain 1	Chain 0	Chain 1	Chain 0	Chain 1	Chain 0	Chain 1	
11b	1Mbps	2	1	2412	14.91	12.78	16.98	30.00		-2.30		14.68		36.00	Pass	
11b	1Mbps	2	6	2437	14.89	12.74	16.96	30.00		-2.30		14.66		36.00	Pass	
11b	1Mbps	2	11	2462	14.94	12.70	16.97	30.00		-2.30		14.67		36.00	Pass	
11g	6Mbps	2	1	2412	14.88	14.86	17.88	30.00		-2.30		15.58		36.00	Pass	
11g	6Mbps	2	6	2437	14.85	14.75	17.81	30.00		-2.30		15.51		36.00	Pass	
11g	6Mbps	2	11	2462	14.35	14.39	17.38	30.00		-2.30		15.08		36.00	Pass	
HT20	MCS0	2	1	2412	14.37	14.42	17.41	30.00		-2.30		15.11		36.00	Pass	
HT20	MCS0	2	6	2437	14.72	14.84	17.79	30.00		-2.30		15.49		36.00	Pass	
HT20	MCS0	2	11	2462	12.70	12.90	15.81	30.00		-2.30		13.51		36.00	Pass	

Note: Measured power (dBm) has offset with cable loss.

TEST RESULTS DATA
Peak Output Power

2.4GHz Band MIMO																	
Mod.	Data Rate	Ntx	CH.	Freq. (MHz)	RU Config	Peak Conducted Power (dBm)			Conducted Power Limit (dBm)		DG (dBi)		EIRP Power (dBm)		EIRP Power Limit (dBm)		Pass /Fail
						Chain 0	Chain 1	SUM	Chain 0	Chain 1	Chain 0	Chain 1	Chain 0	Chain 1	Chain 0	Chain 1	
HE20	MCS0	2	1	2412	Full	22.66	22.75	25.72	30.00		-2.30		23.42		36.00		Pass
HE20	MCS0	2	1	2412	26/0	19.92	20.86	23.43	30.00		-2.30		21.13		36.00		Pass
HE20	MCS0	2	1	2412	52/37	22.36	22.79	25.59	30.00		-2.30		23.29		36.00		Pass
HE20	MCS0	2	1	2412	106/53	23.16	23.16	26.17	30.00		-2.30		23.87		36.00		Pass
HE20	MCS0	2	6	2437	Full	22.99	22.88	25.95	30.00		-2.30		23.65		36.00		Pass
HE20	MCS0	2	6	2437	26/4	20.23	20.58	23.42	30.00		-2.30		21.12		36.00		Pass
HE20	MCS0	2	6	2437	52/39	22.35	22.52	25.45	30.00		-2.30		23.15		36.00		Pass
HE20	MCS0	2	6	2437	106/53	23.36	22.95	26.17	30.00		-2.30		23.87		36.00		Pass
HE20	MCS0	2	11	2462	Full	21.95	21.83	24.90	30.00		-2.30		22.60		36.00		Pass
HE20	MCS0	2	11	2462	26/8	20.34	20.83	23.60	30.00		-2.30		21.30		36.00		Pass
HE20	MCS0	2	11	2462	52/40	22.82	22.66	25.75	30.00		-2.30		23.45		36.00		Pass
HE20	MCS0	2	11	2462	106/54	22.53	22.72	25.64	30.00		-2.30		23.34		36.00		Pass

Note: Measured power (dBm) has offset with cable loss.

TEST RESULTS DATA
Average Output Power

2.4GHz Band MIMO																	
Mod.	Data Rate	NTX	CH.	Freq. (MHz)	RU Config	Average Conducted Power with duty factor (dBm)			Conducted Power Limit (dBm)		DG (dBi)		EIRP Power (dBm)		EIRP Power Limit (dBm)		Pass /Fail
						Chain 0	Chain 1	SUM	Chain 0	Chain 1	Chain 0	Chain 1	Chain 0	Chain 1	Chain 0	Chain 1	
HE20	MCS0	2	1	2412	Full	14.46	14.47	17.48	30.00		-2.30		15.18		36.00		Pass
HE20	MCS0	2	1	2412	26/0	9.46	9.42	12.45	30.00		-2.30		10.15		36.00		Pass
HE20	MCS0	2	1	2412	52/37	12.31	12.39	15.36	30.00		-2.30		13.06		36.00		Pass
HE20	MCS0	2	1	2412	106/53	14.40	14.32	17.37	30.00		-2.30		15.07		36.00		Pass
HE20	MCS0	2	6	2437	Full	14.91	14.90	17.92	30.00		-2.30		15.62		36.00		Pass
HE20	MCS0	2	6	2437	26/4	9.33	9.44	12.40	30.00		-2.30		10.10		36.00		Pass
HE20	MCS0	2	6	2437	52/39	12.32	12.36	15.35	30.00		-2.30		13.05		36.00		Pass
HE20	MCS0	2	6	2437	106/53	14.37	14.41	17.40	30.00		-2.30		15.10		36.00		Pass
HE20	MCS0	2	11	2462	Full	12.82	12.87	15.86	30.00		-2.30		13.56		36.00		Pass
HE20	MCS0	2	11	2462	26/8	9.36	9.36	12.37	30.00		-2.30		10.07		36.00		Pass
HE20	MCS0	2	11	2462	52/40	12.36	12.37	15.38	30.00		-2.30		13.08		36.00		Pass
HE20	MCS0	2	11	2462	106/54	12.32	12.40	15.37	30.00		-2.30		13.07		36.00		Pass

Note: Measured power (dBm) has offset with cable loss.



Appendix B. Radiated Spurious Emission

Test Engineer :	Leo Lee, Mancy Chou, and Bigshow Wang	Temperature :	22.7~23.7°C
		Relative Humidity :	46~52%

2.4GHz 2400~2483.5MHz

WIFI 802.11b (Band Edge @ 3m)

WIFI	Note	Frequency	Level	Over	Limit	Read	Antenna	Path	Preamp	Ant	Table	Peak	Pol.	
Chain				Limit	Line	Level	Factor	Loss	Factor	Pos	Pos	Avg.		
0+1		(MHz)	(dBμV/m)	(dB)	(dBμV/m)	(dBμV)	(dB/m)	(dB)	(dB)	(cm)	(deg)	(P/A)	(H/V)	
802.11b CH 11 2462MHz	*	2462	103.16	-	-	89.89	27.48	16.68	30.89	319	301	P	H	
	*	2462	100.18	-	-	86.91	27.48	16.68	30.89	319	301	A	H	
		2487.85	55.03	-18.97	74	41.77	27.42	16.72	30.88	319	301	P	H	
		2485.55	43.91	-10.09	54	30.65	27.43	16.71	30.88	319	301	A	H	
													H	
														H
	*	2462	104.06	-	-	90.79	27.48	16.68	30.89	100	230	P	V	
	*	2462	100.33	-	-	87.06	27.48	16.68	30.89	100	230	A	V	
		2491.9	55.85	-18.15	74	42.58	27.42	16.72	30.87	100	230	P	V	
		2487.3	43.91	-10.09	54	30.64	27.43	16.72	30.88	100	230	A	V	
														V
													V	
Remark	1. No other spurious found. 2. All results are PASS against Peak and Average limit line.													



2.4GHz 2400~2483.5MHz
WIFI 802.11b (Harmonic @ 3m)

Table with 14 columns: WIFI Chain 0+1, Note, Frequency (MHz), Level (dBµV/m), Over Limit (dB), Limit Line (dBµV/m), Read Level (dBµV), Antenna Factor (dB/m), Path Loss (dB), Preamp Factor (dB), Ant Pos (cm), Table Pos (deg), Peak Avg. (P/A), Pol. (H/V). Rows include data for 802.11b CH 01 2412MHz and a Remark section.



**2.4GHz 2400~2483.5MHz
WIFI 802.11g (Band Edge @ 3m)**

WIFI Chain 0+1	Note	Frequency (MHz)	Level (dBμV/m)	Over Limit (dB)	Limit Line (dBμV/m)	Read Level (dBμV)	Antenna Factor (dB/m)	Path Loss (dB)	Preamp Factor (dB)	Ant Pos (cm)	Table Pos (deg)	Peak Avg. (P/A)	Pol. (H/V)
802.11g CH 11 2462MHz	*	2462	107.32	-	-	94.05	27.48	16.68	30.89	148	321	P	H
	*	2462	99.63	-	-	86.36	27.48	16.68	30.89	148	321	A	H
		2483.75	58.42	-15.58	74	45.16	27.43	16.71	30.88	148	321	P	H
		2483.5	47.24	-6.76	54	33.98	27.43	16.71	30.88	148	321	A	H
													H
													H
	*	2462	107.88	-	-	94.61	27.48	16.68	30.89	100	235	P	V
	*	2462	99.68	-	-	86.41	27.48	16.68	30.89	100	235	A	V
		2483.55	59.6	-14.4	74	46.34	27.43	16.71	30.88	100	235	P	V
		2483.5	47.45	-6.55	54	34.19	27.43	16.71	30.88	100	235	A	V
													V
													V
Remark	1. No other spurious found. 2. All results are PASS against Peak and Average limit line.												



2.4GHz 2400~2483.5MHz

WIFI 802.11ax HE20 Partial 106 (Harmonic @ 3m)

WIFI Chain 0+1	Note	Frequency (MHz)	Level (dBμV/m)	Over Limit (dB)	Limit Line (dBμV/m)	Read Level (dBμV)	Antenna Factor (dB/m)	Path Loss (dB)	Preamp Factor (dB)	Ant Pos (cm)	Table Pos (deg)	Peak Avg. (P/A)	Pol. (H/V)	
802.11ax HE20 Partial 106/53 CH 01 2412MHz		4824	39.18	-34.82	74	56.87	31.1	10.07	58.86	100	0	P	H	
		18000	59.23	-14.77	74	48.58	49	18.89	57.24	100	36	P	H	
		18000	50.25	-3.75	54	39.6	49	18.89	57.24	100	36	A	H	
													H	
			4824	38.75	-35.25	74	56.44	31.1	10.07	58.86	100	0	P	V
			17985	58.36	-15.64	74	48.02	48.73	18.88	57.27	100	55	P	V
			17985	50.21	-3.79	54	39.87	48.73	18.88	57.27	100	55	A	V
Remark	1. No other spurious found. 2. All results are PASS against Peak and Average limit line.													



Emission below 1GHz
2.4GHz WIFI 802.11g (LF)

WIFI	Note	Frequency	Level	Over	Limit	Read	Antenna	Path	Preamp	Ant	Table	Peak	Pol.	
Chain				Limit	Line	Level	Factor	Loss	Factor	Pos	Pos	Avg.		
0+1		(MHz)	(dBμV/m)	(dB)	(dBμV/m)	(dBμV)	(dB/m)	(dB)	(dB)	(cm)	(deg)	(P/A)	(H/V)	
2.4GHz 802.11g LF		43.58	26.79	-13.21	40	41.09	17.47	0.81	32.58	100	0	P	H	
		113.42	25.24	-18.26	43.5	39.28	17.07	1.42	32.53	-	-	P	H	
		186.17	28.77	-14.73	43.5	44.63	14.76	1.85	32.47	-	-	P	H	
		422.85	23.74	-22.26	46	30.52	22.88	2.75	32.41	-	-	P	H	
		607.15	26.53	-19.47	46	30.12	25.48	3.37	32.44	-	-	P	H	
		870.02	30.26	-15.74	46	28.96	29.04	4.04	31.78	-	-	P	H	
														H
														H
														H
														H
														H
														H
			43.58	33.32	-6.68	40	47.62	17.47	0.81	32.58	100	0	P	V
			97.9	21.36	-22.14	43.5	36.98	15.57	1.3	32.49	-	-	P	V
			187.14	21.97	-21.53	43.5	37.86	14.72	1.86	32.47	-	-	P	V
			507.24	24.78	-21.22	46	30.4	23.94	3.03	32.59	-	-	P	V
			578.05	26.66	-19.34	46	30.15	25.76	3.28	32.53	-	-	P	V
			860.32	30.72	-15.28	46	29.49	29.05	4.01	31.83	-	-	P	V
														V
														V
													V	
													V	
													V	
													V	
Remark	1. No other spurious found. 2. All results are PASS against limit line.													



Emission above 18GHz

2.4GHz WIFI 802.11g (SHF)

WIFI	Note	Frequency	Level	Over	Limit	Read	Antenna	Path	Preamp	Ant	Table	Peak	Pol.	
Chain				Limit	Line	Level	Factor	Loss	Factor	Pos	Pos	Avg.		
0+1		(MHz)	(dBμV/m)	(dB)	(dBμV/m)	(dBμV)	(dB/m)	(dB)	(dB)	(cm)	(deg)	(P/A)	(H/V)	
2.4GHz 802.11g SHF		21496	39.07	-34.93	74	43.88	38.3	11.69	54.8	150	0	P	H	
													H	
													H	
													H	
													H	
													H	
													H	
													H	
			21080	37.92	-36.08	74	43.2	38.22	11.3	54.8	150	0	P	V
														V
														V
														V
														V
														V
	Remark	1. No other spurious found. 2. All results are PASS against limit line.												



Note symbol

*	Fundamental Frequency which can be ignored. However, the level of any unwanted emissions shall not exceed the level of the fundamental frequency.
!	Test result is over limit line.
P/A	Peak or Average
H/V	Horizontal or Vertical



A calculation example for radiated spurious emission is shown as below:

WIFI	Note	Frequency	Level	Over	Limit	Read	Antenna	Path	Preamp	Ant	Table	Peak	Pol.
Ant.				Limit	Line	Level	Factor	Loss	Factor	Pos	Pos	Avg.	
0+1		(MHz)	(dBµV/m)	(dB)	(dBµV/m)	(dBµV)	(dB/m)	(dB)	(dB)	(cm)	(deg)	(P/A)	(H/V)
802.11b		2390	55.45	-18.55	74	54.51	32.22	4.58	35.86	103	308	P	H
CH 01													
2412MHz		2390	43.54	-10.46	54	42.6	32.22	4.58	35.86	103	308	A	H

1. Path Loss(dB) = Cable loss(dB) + Filter loss(dB) + Attenuator loss(dB)
2. Level(dBµV/m) =
Antenna Factor(dB/m) + Path Loss(dB) + Read Level(dBµV) - Preamp Factor(dB)
3. Over Limit(dB) = Level(dBµV/m) – Limit Line(dBµV/m)

For Peak Limit @ 2390MHz:

1. Level(dBµV/m)
= Antenna Factor(dB/m) + Path Loss(dB) + Read Level(dBµV) - Preamp Factor(dB)
= 32.22(dB/m) + 4.58(dB) + 54.51(dBµV) – 35.86 (dB)
= 55.45 (dBµV/m)
2. Over Limit(dB)
= Level(dBµV/m) – Limit Line(dBµV/m)
= 55.45(dBµV/m) – 74(dBµV/m)
= -18.55(dB)

For Average Limit @ 2390MHz:

1. Level(dBµV/m)
= Antenna Factor(dB/m) + Path Loss(dB) + Read Level(dBµV) - Preamp Factor(dB)
= 32.22(dB/m) + 4.58(dB) + 42.6(dBµV) – 35.86 (dB)
= 43.54 (dBµV/m)
2. Over Limit(dB)
= Level(dBµV/m) – Limit Line(dBµV/m)
= 43.54(dBµV/m) – 54(dBµV/m)
= -10.46(dB)

Both peak and average measured complies with the limit line, so test result is “PASS”.



Appendix C. Radiated Spurious Emission Plots

Test Engineer :	Leo Lee, Mancy Chou, and Bigshow Wang	Temperature :	22.7~23.7°C
		Relative Humidity :	46~52%

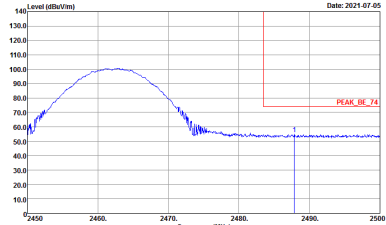
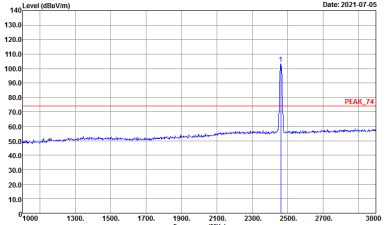
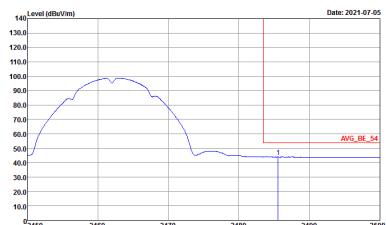
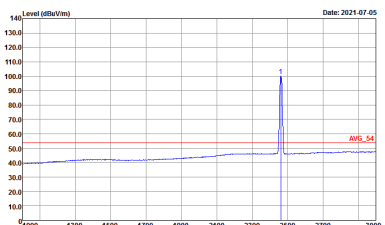

2.4GHz 2400~2483.5MHz
WIFI 802.11b (Band Edge @ 3m)

WIFI	2.4GHz 2400~2483.5MHz Band Edge @ 3m	
Chain	802.11b CH11 2462MHz	
0+1	Horizontal	Fundamental
Peak	 <p>Level (dBuV/m) vs Frequency (MHz) plot showing a peak at approximately 2462 MHz. The y-axis ranges from 10.0 to 140.0 dBuV/m, and the x-axis ranges from 2450 to 2500 MHz. A red horizontal line indicates the peak level at approximately 75 dBuV/m, labeled 'PEAK_BE_74'. The plot date is 2021-07-05.</p> <p>Site : 03CH15-HY Condition : PEAK_BE_74 3m 91200_15_1620 HORIZONTAL</p>	 <p>Level (dBuV/m) vs Frequency (MHz) plot showing a sharp peak at 2462 MHz. The y-axis ranges from 10.0 to 140.0 dBuV/m, and the x-axis ranges from 2450 to 2500 MHz. A red horizontal line indicates the peak level at approximately 75 dBuV/m, labeled 'PEAK_74'. The plot date is 2021-07-05.</p> <p>Site : 03CH15-HY Condition : PEAK_74 3m 91200_15_1620 HORIZONTAL</p>
	 <p>Level (dBuV/m) vs Frequency (MHz) plot showing the average spectrum. The y-axis ranges from 10.0 to 140.0 dBuV/m, and the x-axis ranges from 2450 to 2500 MHz. A red horizontal line indicates the average level at approximately 55 dBuV/m, labeled 'AVG_BE_54'. The plot date is 2021-07-05.</p> <p>Site : 03CH15-HY Condition : AVG_BE_54 3m 91200_15_1620 HORIZONTAL</p>	 <p>Level (dBuV/m) vs Frequency (MHz) plot showing the average spectrum with a sharp peak at 2462 MHz. The y-axis ranges from 10.0 to 140.0 dBuV/m, and the x-axis ranges from 2450 to 2500 MHz. A red horizontal line indicates the average level at approximately 55 dBuV/m, labeled 'AVG_54'. The plot date is 2021-07-05.</p> <p>Site : 03CH15-HY Condition : AVG_54 3m 91200_15_1620 HORIZONTAL</p>
Avg.		

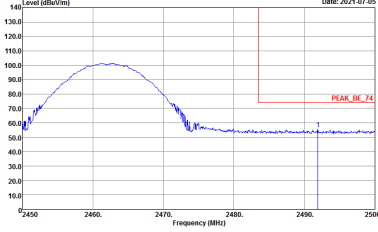
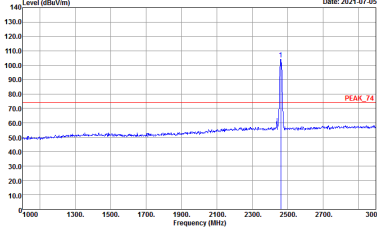
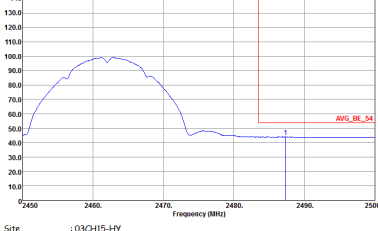
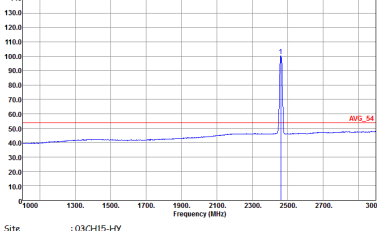

WIFI	2.4GHz 2400~2483.5MHz Band Edge @ 3m	
Chain	802.11b CH11 2462MHz	
0+1	Vertical	Fundamental
Peak	 <p>Level (dBuV/m) vs Frequency (MHz) plot for Vertical. The y-axis ranges from 10.0 to 140.0 dBuV/m, and the x-axis ranges from 2430 to 2500 MHz. A peak is labeled 'PEAK_BE_74' at approximately 2462 MHz. The plot shows a broad band of energy with a sharp peak at the channel center.</p> <p>Site : 03CH15-HY Condition : PEAK_BE_74 3m 91200_15_1620 VERTICAL</p>	 <p>Level (dBuV/m) vs Frequency (MHz) plot for Fundamental. The y-axis ranges from 10.0 to 140.0 dBuV/m, and the x-axis ranges from 1000 to 3000 MHz. A sharp peak is labeled 'PEAK_74' at approximately 2462 MHz. The rest of the spectrum is flat at a noise floor level.</p> <p>Site : 03CH15-HY Condition : PEAK_74 3m 91200_15_1620 VERTICAL</p>
Avg.	 <p>Level (dBuV/m) vs Frequency (MHz) plot for Vertical (Average). The y-axis ranges from 10.0 to 140.0 dBuV/m, and the x-axis ranges from 2430 to 2500 MHz. A peak is labeled 'AVG_BE_54' at approximately 2462 MHz. The plot shows a smoothed version of the peak.</p> <p>Site : 03CH15-HY Condition : AVG_BE_54 3m 91200_15_1620 VERTICAL</p>	 <p>Level (dBuV/m) vs Frequency (MHz) plot for Fundamental (Average). The y-axis ranges from 10.0 to 140.0 dBuV/m, and the x-axis ranges from 1000 to 3000 MHz. A sharp peak is labeled 'AVG_54' at approximately 2462 MHz. The rest of the spectrum is flat at a noise floor level.</p> <p>Site : 03CH15-HY Condition : AVG_54 3m 91200_15_1620 VERTICAL</p>



2.4GHz 2400~2483.5MHz
WIFI 802.11g (Band Edge @ 3m)

WIFI	2.4GHz 2400~2483.5MHz Band Edge @ 3m	
Chain	802.11g CH11 2462MHz	
0+1	Horizontal	Fundamental
Peak	<p>Site : 03CH15-HY Condition : PEAK_BE_74 3m 91200_15_1620 HORIZONTAL</p>	<p>Site : 03CH15-HY Condition : PEAK_74 3m 91200_15_1620 HORIZONTAL</p>
Avg.	<p>Site : 03CH15-HY Condition : AVG_BE_54 3m 91200_15_1620 HORIZONTAL</p>	<p>Site : 03CH15-HY Condition : AVG_54 3m 91200_15_1620 HORIZONTAL</p>

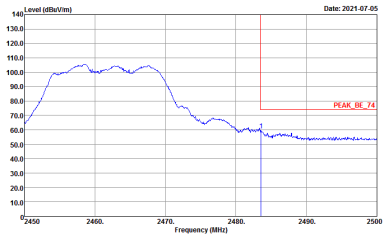
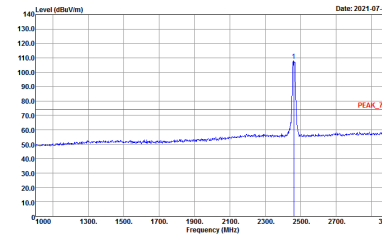
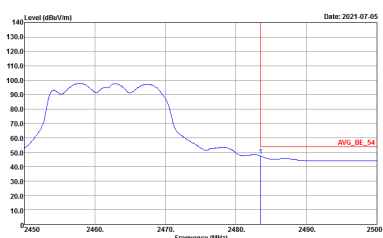
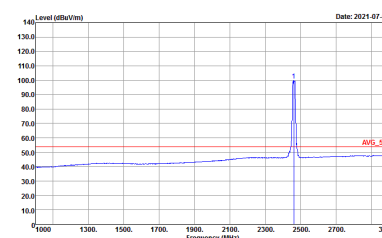

WIFI	2.4GHz 2400~2483.5MHz Band Edge @ 3m	
Chain	802.11g CH11 2462MHz	
0+1	Vertical	Fundamental
Peak	 <p>Level (dBuV/m) vs Frequency (MHz) plot showing a peak at 2462 MHz. The y-axis ranges from 10.0 to 140.0 dBuV/m, and the x-axis ranges from 2430 to 2500 MHz. A red vertical line marks the peak at 2462 MHz, with a label 'PEAK_BE_74'.</p> <p>Site : 03CH15-HY Condition : PEAK_BE_74 3m 91200_15_1620 VERTICAL</p>	 <p>Level (dBuV/m) vs Frequency (MHz) plot showing a sharp peak at 2462 MHz. The y-axis ranges from 10.0 to 140.0 dBuV/m, and the x-axis ranges from 2400 to 2500 MHz. A red vertical line marks the peak at 2462 MHz, with a label 'PEAK_74'.</p> <p>Site : 03CH15-HY Condition : PEAK_74 3m 91200_15_1620 VERTICAL</p>
Avg.	 <p>Level (dBuV/m) vs Frequency (MHz) plot showing the average spectrum. The y-axis ranges from 10.0 to 140.0 dBuV/m, and the x-axis ranges from 2430 to 2500 MHz. A red vertical line marks the peak at 2462 MHz, with a label 'AVG_BE_54'.</p> <p>Site : 03CH15-HY Condition : AVG_BE_54 3m 91200_15_1620 VERTICAL</p>	 <p>Level (dBuV/m) vs Frequency (MHz) plot showing the average spectrum. The y-axis ranges from 10.0 to 140.0 dBuV/m, and the x-axis ranges from 2400 to 2500 MHz. A red vertical line marks the peak at 2462 MHz, with a label 'AVG_54'.</p> <p>Site : 03CH15-HY Condition : AVG_54 3m 91200_15_1620 VERTICAL</p>



2.4GHz 2400~2483.5MHz

WIFI 802.11b (Harmonic @ 3m)

WIFI	2.4GHz 2400~2483.5MHz Harmonic @ 3m	
Chain	802.11b CH01 2412MHz	
0+1	Horizontal	Vertical
Peak Avg.	<p>Site : 03CH15-HY Condition : PEAK_74 3m 91200_15_1620 HORIZONTAL</p>	<p>Site : 03CH15-HY Condition : PEAK_74 3m 91200_15_1620 VERTICAL</p>



2.4GHz 2400~2483.5MHz

WIFI 802.11ax HE20 Partial 106 (Harmonic @ 3m)

WIFI	2.4GHz 2400~2483.5MHz Harmonic @ 3m	
Chain	802.11ax HE20 Partial 106/53 CH01 2412MHz	
0+1	Horizontal	Vertical
Peak Avg.	<p>Site : 03CH15-HY Condition : PEAK_74 3m 91200_15_1620 HORIZONTAL</p>	<p>Site : 03CH15-HY Condition : PEAK_74 3m 91200_15_1620 VERTICAL</p>



Emission below 1GHz
2.4GHz WIFI 802.11g (LF)

WIFI	2.4GHz 2400~2483.5MHz	
Chain	802.11g LF	
0+1	Horizontal	Vertical
QP / Peak	<p>Site : 03CH15-HY Condition : QP 3m BIL06_41912_20210208 HORIZONTAL</p>	<p>Site : 03CH15-HY Condition : QP 3m BIL06_41912_20210208 VERTICAL</p>



Emission above 18GHz
2.4GHz WIFI 802.11g (SHF)

WIFI	2.4GHz 2400~2483.5MHz	
Chain	802.11g SHF	
0+1	Horizontal	Vertical
Peak Avg.	<p>Site : 03CH15-HY Condition : PEAK_74_1M 1m SHF HORN 88HA9170576 HORIZONTAL</p>	<p>Site : 03CH15-HY Condition : PEAK_74_1M 1m SHF HORN 88HA9170576 VERTICAL</p>



Appendix D. Duty Cycle Plots

Chain	Band	Duty Cycle(%)	T(us)	1/T(kHz)	VBW Setting	Duty Factor(dB)
0+1	802.11b	100.00	-	-	10Hz	0.00
0+1	802.11g	99.05	-	-	10Hz	0.04
0+1	2.4GHz 802.11ax HE20 106 RU	99.39	-	-	10Hz	0.03

MIMO <Chain 0+1>

