



FCC RADIO TEST REPORT

FCC ID : PY7-45256F
Equipment : GSM/WCDMA/LTE/5G Phone with BT, DTS/UNII a/b/g/n/ac/ax, GPS and NFC
Brand Name : Sony
Applicant : Sony Corporation
1-7-1 Konan Minato-ku Tokyo, 108-0075 Japan
Manufacturer : Sony Corporation
1-7-1 Konan Minato-ku Tokyo, 108-0075 Japan
Standard : FCC Part 15 Subpart C §15.247

The product was received on Mar. 24, 2021 and testing was started from Mar. 30, 2021 and completed on Apr. 14, 2021. We, Sporton International Inc. EMC & Wireless Communications Laboratory, would like to declare that the tested sample has been evaluated in accordance with the test procedures and has been in compliance with the applicable technical standards.

The test results in this report apply exclusively to the tested model / sample. Without written approval of Sporton International Inc. EMC & Wireless Communications Laboratory, the test report shall not be reproduced except in full.

Louis Wu

Approved by: Louis Wu

Sporton International Inc. EMC & Wireless Communications Laboratory

No. 52, Huaya 1st Rd., Guishan Dist., Taoyuan City 333, Taiwan (R.O.C.)



Table of Contents

History of this test report..... 3

Summary of Test Result..... 4

1 General Description..... 5

 1.1 Product Feature of Equipment Under Test..... 5

 1.2 Modification of EUT 5

 1.3 Testing Location 6

 1.4 Applicable Standards..... 6

2 Test Configuration of Equipment Under Test 7

 2.1 Carrier Frequency Channel 7

 2.2 Test Mode..... 8

 2.3 Connection Diagram of Test System..... 9

 2.4 Support Unit used in test configuration and system 10

 2.5 EUT Operation Test Setup 10

 2.6 Measurement Results Explanation Example..... 10

3 Test Result..... 11

 3.1 Number of Channel Measurement 11

 3.2 Hopping Channel Separation Measurement 14

 3.3 Dwell Time Measurement..... 21

 3.4 20dB and 99% Bandwidth Measurement 23

 3.5 Output Power Measurement..... 36

 3.6 Conducted Band Edges Measurement 37

 3.7 Conducted Spurious Emission Measurement 46

 3.8 Radiated Band Edges and Spurious Emission Measurement 59

 3.9 AC Conducted Emission Measurement..... 64

 3.10 Antenna Requirements..... 66

4 List of Measuring Equipment 67

5 Uncertainty of Evaluation 69

Appendix A. Conducted Test Results

Appendix B. AC Conducted Emission Test Result

Appendix C. Radiated Spurious Emission

Appendix D. Radiated Spurious Emission Plots

Appendix E. Duty Cycle Plots



History of this test report

Report No.	Version	Description	Issued Date
FR132425A	01	Initial issue of report	Apr. 23, 2021



Summary of Test Result

Report Clause	Ref Std. Clause	Test Items	Result (PASS/FAIL)	Remark
3.1	15.247(a)(1)	Number of Channels	Pass	-
3.2	15.247(a)(1)	Hopping Channel Separation	Pass	-
3.3	15.247(a)(1)	Dwell Time of Each Channel	Pass	-
3.4	15.247(a)(1)	20dB Bandwidth	Pass	-
3.4	2.1049	99% Occupied Bandwidth	Reporting only	-
3.5	15.247(b)(1)	Peak Output Power	Pass	-
3.6	15.247(d)	Conducted Band Edges	Pass	-
3.7	15.247(d)	Conducted Spurious Emission	Pass	-
3.8	15.247(d)	Radiated Band Edges and Radiated Spurious Emission	Pass	Under limit 6.09 dB at 43.580 MHz
3.9	15.207	AC Conducted Emission	Pass	Under limit 11.39 dB at 0.335 MHz
3.10	15.203 & 15.247(b)	Antenna Requirement	Pass	-

Declaration of Conformity:

The test results with all measurement uncertainty excluded are presented in accordance with the regulation limits or requirements declared by manufacturers.

Comments and Explanations:

The declared of product specification for EUT presented in the report are provided by the manufacturer, and the manufacturer takes all the responsibilities for the accuracy of product specification.

Reviewed by: Wii Chang

Report Producer: Ruby Zou



1 General Description

1.1 Product Feature of Equipment Under Test

GSM/WCDMA/LTE, Bluetooth, DTS/UNII a/b/g/n/ac/ax, NFC, and GNSS.

Product Specification subjective to this standard	
Antenna Type / Gain	<Ant. 0>: Loop Type Antenna with gain -2.3 dBi <Ant. 1>: Loop Type Antenna with gain -7.0 dBi

Remark: The above EUT's information was declared by manufacturer. Please refer to Comments and Explanations in report summary.

EUT Information List			
HW Version	SW Version	S/N	Performed Test Item
A	0.325	QV72000A68	RF conducted measurement
	0.325	QV7200NJ7E	Radiated Spurious Emission
	0.747	QV7200P17E	AC Conducted Emission

Accessory List	
AC Adapter	Model Name : XQZ-UC1
	S/N : 0020W51300039 (for Radiated Spurious Emission) 0020W51300096 (for Conducted Emission)
Earphone	Model Name : MH750
	S/N : N/A
Bluetooth Earphone	Model Name : SBH82D
	S/N : N/A
USB Cable	Model Name : XQZ-UB1
	S/N : N/A

Note:

1. Above EUT list used are electrically identical per declared by manufacturer.
2. Above the accessories list are used to exercise the EUT during test, and the serial number of each type of accessories is listed in each section of this report.
3. For other wireless features of this EUT, test report will be issued separately.

1.2 Modification of EUT

No modifications are made to the EUT during all test items.



1.3 Testing Location

Test Site	Sporton International Inc. EMC & Wireless Communications Laboratory
Test Site Location	No.52, Huaya 1st Rd., Guishan Dist., Taoyuan City 333, Taiwan (R.O.C.) TEL: +886-3-327-3456 FAX: +886-3-328-4978
Test Site No.	Sporton Site No. TH02-HY; CO05-HY

Note: The test site complies with ANSI C63.4 2014 requirement.

Test Site	Sporton International Inc. Wensan Laboratory
Test Site Location	No.58, Aly. 75, Ln. 564, Wenhua 3rd, Rd., Guishan Dist., Taoyuan City 333010, Taiwan (R.O.C.) TEL: +886-3-327-0868 FAX: +886-3-327-0855
Test Site No.	Sporton Site No. 03CH15-HY (TAF Code: 3786)
Remark	The Radiated Spurious Emission test item subcontracted to Sporton International Inc. Wensan Laboratory

Note: The test site complies with ANSI C63.4 2014 requirement.

FCC designation No.: TW1190 and TW3786

1.4 Applicable Standards

According to the specifications of the manufacturer, the EUT must comply with the requirements of the following standards:

- ♦ FCC Part 15 Subpart C §15.247
- ♦ FCC KDB Publication No. 558074 D01 DTS Meas. Guidance v05r02
- ♦ FCC KDB 414788 D01 Radiated Test Site v01r01
- ♦ ANSI C63.10-2013

Remark:

1. All test items were verified and recorded according to the standards and without any deviation during the test.
2. The TAF code is not including all the FCC KDB listed without accreditation.
3. This EUT has also been tested and complied with the requirements of FCC Part 15, Subpart B, recorded in a separate test report.



2 Test Configuration of Equipment Under Test

2.1 Carrier Frequency Channel

Frequency Band	Channel	Freq. (MHz)	Channel	Freq. (MHz)	Channel	Freq. (MHz)
2400-2483.5 MHz	0	2402	27	2429	54	2456
	1	2403	28	2430	55	2457
	2	2404	29	2431	56	2458
	3	2405	30	2432	57	2459
	4	2406	31	2433	58	2460
	5	2407	32	2434	59	2461
	6	2408	33	2435	60	2462
	7	2409	34	2436	61	2463
	8	2410	35	2437	62	2464
	9	2411	36	2438	63	2465
	10	2412	37	2439	64	2466
	11	2413	38	2440	65	2467
	12	2414	39	2441	66	2468
	13	2415	40	2442	67	2469
	14	2416	41	2443	68	2470
	15	2417	42	2444	69	2471
	16	2418	43	2445	70	2472
	17	2419	44	2446	71	2473
	18	2420	45	2447	72	2474
	19	2421	46	2448	73	2475
	20	2422	47	2449	74	2476
	21	2423	48	2450	75	2477
	22	2424	49	2451	76	2478
	23	2425	50	2452	77	2479
	24	2426	51	2453	78	2480
	25	2427	52	2454	-	-
	26	2428	53	2455	-	-



2.2 Test Mode

- a. The EUT has been associated with peripherals and configuration operated in a manner tended to maximize its emission characteristics in a typical application. Frequency range investigated: conduction emission (150 kHz to 30 MHz), radiation emission (9 kHz to the 10th harmonic of the highest fundamental frequency or to 40 GHz, whichever is lower). For radiated measurement, pre-scanned in three orthogonal panels, X, Y, Z. The worst cases (X plane) were recorded in this report, and the worst mode of radiated spurious emissions is Bluetooth 3Mbps mode, and recorded in this report.
- b. AC power line Conducted Emission was tested under maximum output power.

The following summary table is showing all test modes to demonstrate in compliance with the standard.

Summary table of Test Cases			
Test Item	Data Rate / Modulation		
Conducted Test Cases	Bluetooth BR 1Mbps GFSK	Bluetooth EDR 2Mbps $\pi/4$ -DQPSK	Bluetooth EDR 3Mbps 8-DPSK
	Mode 1: CH00_2402 MHz	Mode 4: CH00_2402 MHz	Mode 7: CH00_2402 MHz
	Mode 2: CH39_2441 MHz	Mode 5: CH39_2441 MHz	Mode 8: CH39_2441 MHz
	Mode 3: CH78_2480 MHz	Mode 6: CH78_2480 MHz	Mode 9: CH78_2480 MHz
Radiated Test Cases	Bluetooth EDR 3Mbps 8-DPSK		
	Mode 1: CH00_2402 MHz for 1Mbps		
	Mode 2: CH39_2441 MHz for 1Mbps		
	Mode 3: CH78_2480 MHz for 1Mbps		
	Mode 4: CH00_2402 MHz for 2Mbps		
	Mode 5: CH39_2441 MHz for 2Mbps		
	Mode 6: CH78_2480 MHz for 2Mbps		
	Mode 7: CH00_2402 MHz for 3Mbps		
	Mode 8: CH39_2441 MHz for 3Mbps		
	Mode 9: CH78_2480 MHz for 3Mbps		
AC Conducted Emission	Mode 1 : GSM850 Idle + Bluetooth Link + WLAN (2.4GHz) Link + MPEG4 + Earphone + USB Cable (Charging from AC Adapter) + Battery		
Remark: For Radiated Test Cases, the worst mode data rate 3Mbps was reported only since the highest RF output power in the preliminary tests. The conducted spurious emissions and conducted band edge measurement for other data rates were not worse than 3Mbps, and no other significantly frequencies found in conducted spurious emission.			

2.3 Connection Diagram of Test System

<AC Conducted Emission>

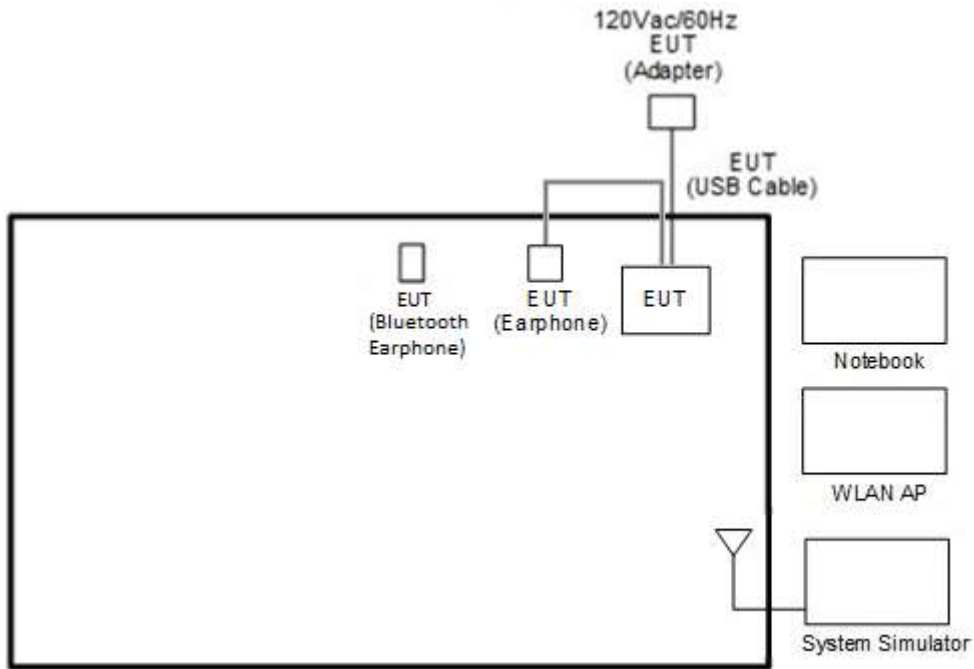

<Bluetooth Tx Mode>

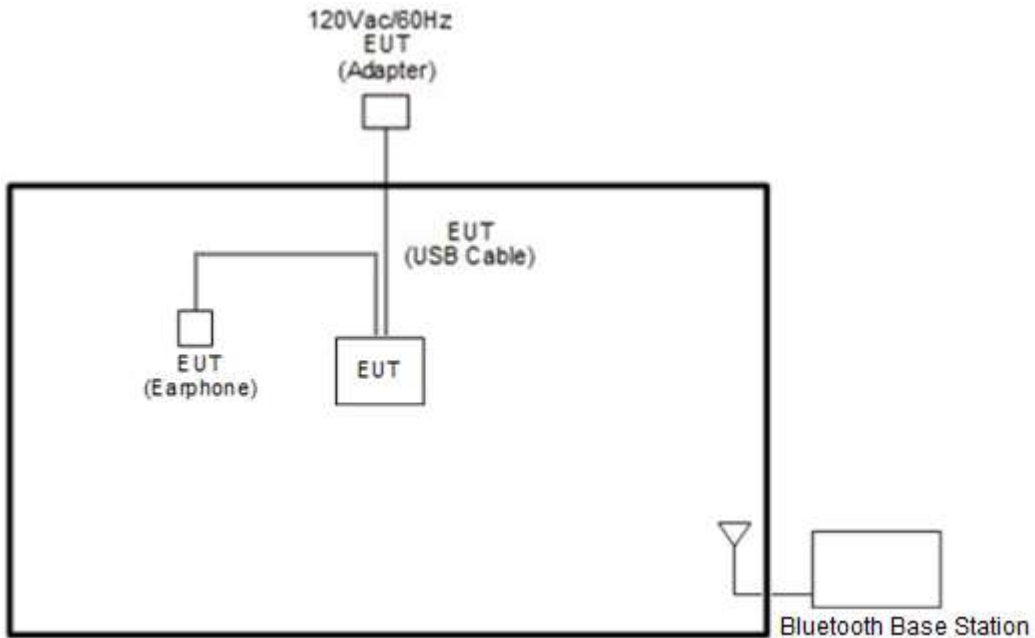



2.4 Support Unit used in test configuration and system

Item	Equipment	Brand Name	Model Name	FCC ID	Data Cable	Power Cord
1.	System Simulator	Anritsu	MT8820C	N/A	N/A	Unshielded, 1.8 m
2.	WLAN AP	ASUS	RT-AC66U	MSQ-RTAC66U	N/A	Unshielded, 1.8 m
3.	Notebook	Dell	Latitude 3400	FCC DOC	N/A	AC I/P : Unshielded, 1.2m DC O/P : Shielded, 1.8m
4.	SD Card	SanDisk	MicroSD HC	FCC DoC	N/A	N/A
5.	Bluetooth Base Station	R&S	CBT32	N/A	N/A	Unshielded, 1.8 m

2.5 EUT Operation Test Setup

The RF test items, utility “FTMC_bridge V.0.39” was installed in Notebook which was programmed in order to make the EUT get into the engineering modes to contact with base station to provide channel selection, power level, data rate and the application type and for continuous transmitting signals.

2.6 Measurement Results Explanation Example

For all conducted test items:

The offset level is set in the spectrum analyzer to compensate the RF cable loss and attenuator factor between EUT conducted output port and spectrum analyzer. With the offset compensation, the spectrum analyzer reading level is exactly the EUT RF output level.

Example:

The spectrum analyzer offset is derived from RF cable loss and attenuator factor.

$$\text{Offset} = \text{RF cable loss} + \text{attenuator factor}.$$

Following shows an offset computation example with cable loss 4.2 dB and 10 dB attenuator.

$$\begin{aligned} \text{Offset(dB)} &= \text{RF cable loss(dB)} + \text{attenuator factor(dB)}. \\ &= 4.2 + 10 = 14.2 \text{ (dB)} \end{aligned}$$

3 Test Result

3.1 Number of Channel Measurement

3.1.1 Limits of Number of Hopping Frequency

Frequency hopping systems in the 2400-2483.5 MHz band shall use at least 15 channels.

3.1.2 Measuring Instruments

See list of measuring equipment of this test report.

3.1.3 Test Procedure

1. The testing follows ANSI C63.10-2013 clause 7.8.3.
2. The RF output of EUT was connected to the spectrum analyzer by RF cable and attenuator. The path loss was compensated to the results for each measurement.
3. Set the maximum power setting and enable the EUT to transmit continuously.
4. Enable the EUT hopping function.
5. Use the following spectrum analyzer settings: Span = the frequency band of operation; RBW = 300 kHz; VBW \geq RBW; Sweep = auto; Detector function = peak; Trace = max hold.
6. The number of hopping frequency used is defined as the number of total channel.
7. Record the measurement data derived from spectrum analyzer.

3.1.4 Test Setup





3.1.5 Test Result of Number of Hopping Frequency

Please refer to Appendix A.

<Ant. 0>

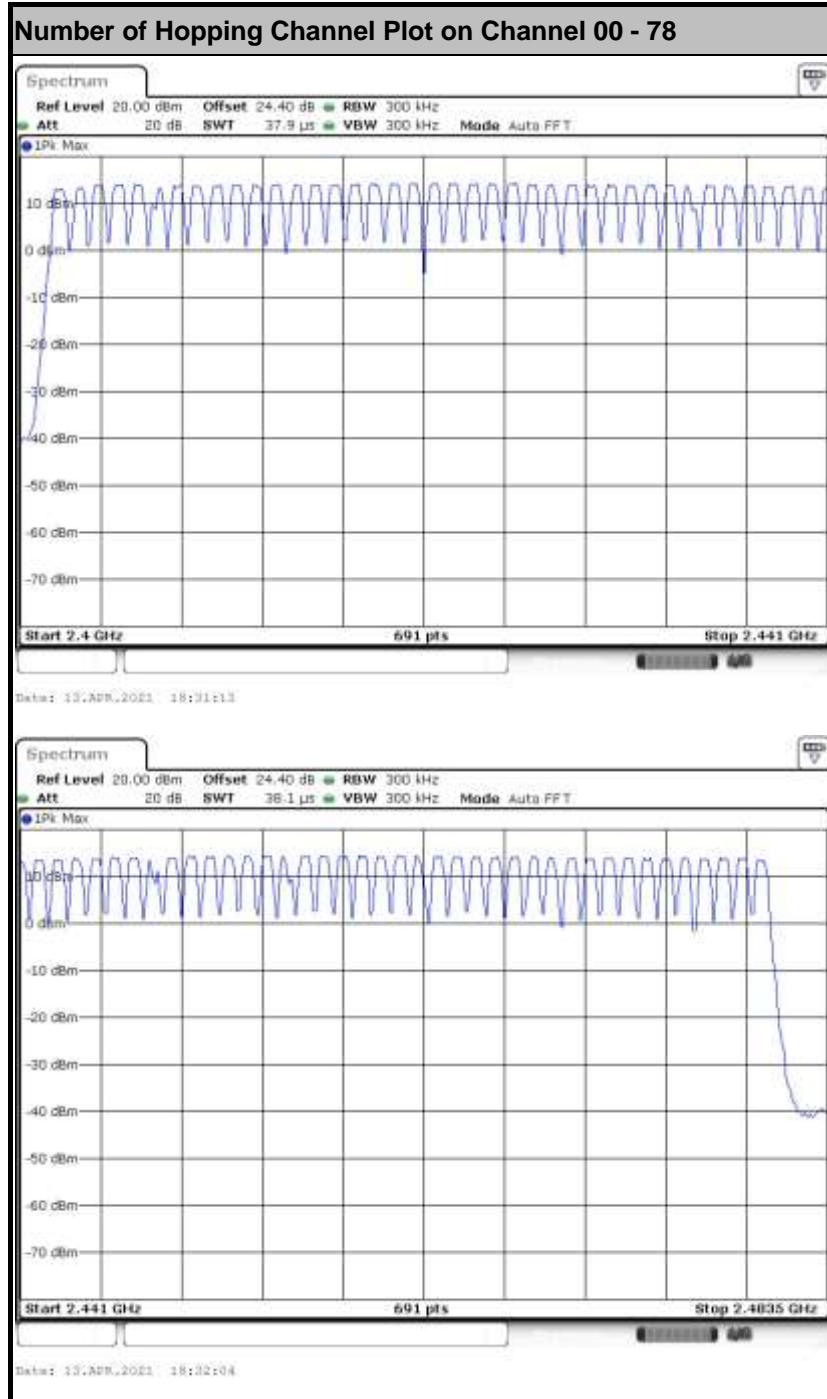



<Ant. 1>

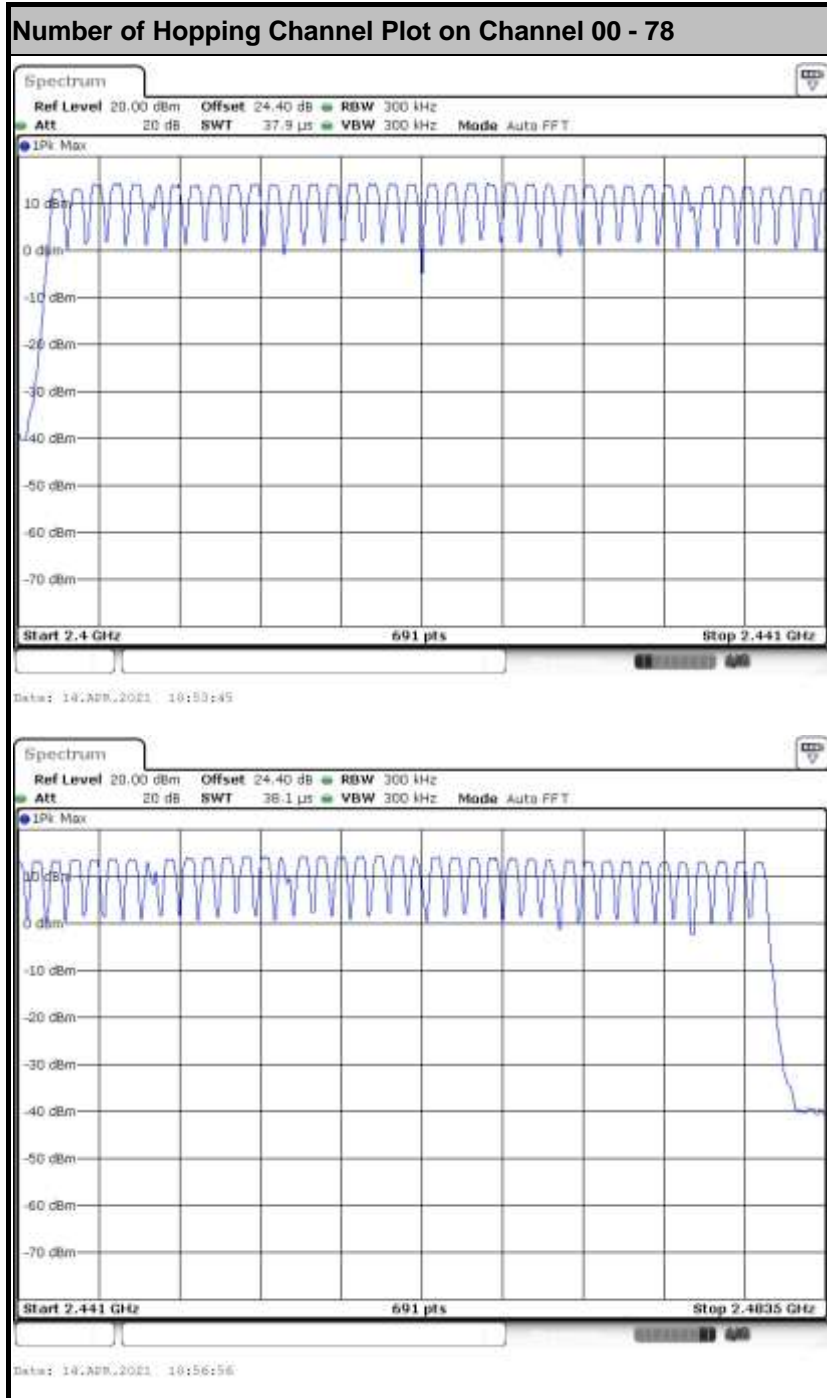

3.2 Hopping Channel Separation Measurement

3.2.1 Limit of Hopping Channel Separation

Frequency hopping systems operating in the 2400-2483.5 MHz band may have hopping channel carrier frequencies that are separated by 25 kHz or two-thirds of the 20 dB bandwidth of the hopping channel, whichever is greater.

3.2.2 Measuring Instruments

See list of measuring equipment of this test report.

3.2.3 Test Procedures

1. The testing follows ANSI C63.10-2013 clause 7.8.2.
2. The RF output of EUT was connected to the spectrum analyzer by RF cable and attenuator. The path loss was compensated to the results for each measurement.
3. Set the maximum power setting and enable the EUT to transmit continuously.
4. Enable the EUT hopping function.
5. Use the following spectrum analyzer settings:
Span = wide enough to capture the peaks of two adjacent channels;
RBW = 300 kHz; VBW \geq RBW; Sweep = auto; Detector function = peak; Trace = max hold.
6. Measure and record the results in the test report.

3.2.4 Test Setup



3.2.5 Test Result of Hopping Channel Separation

Please refer to Appendix A.



<Ant. 0>

<1Mbps>

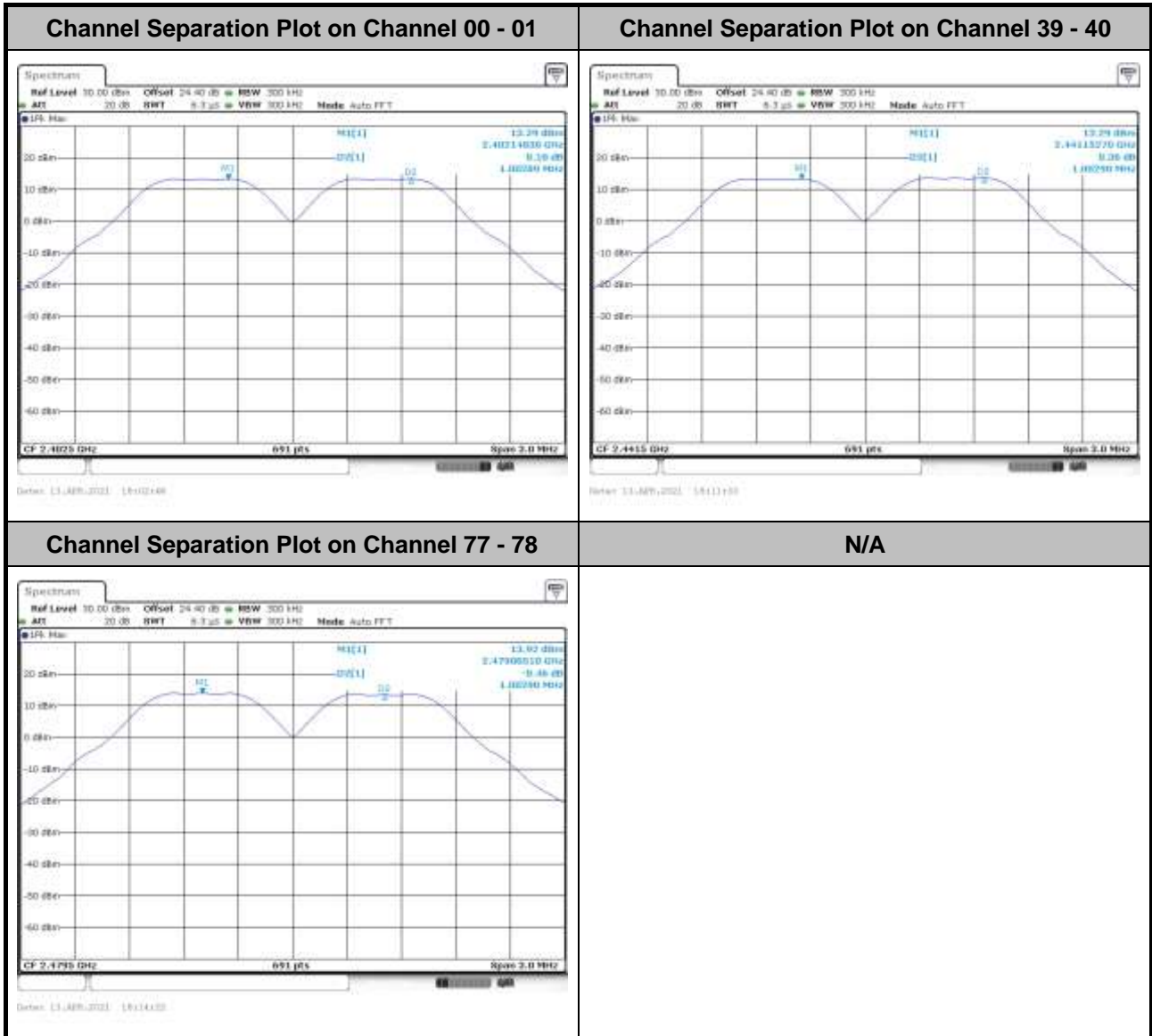



<2Mbps>

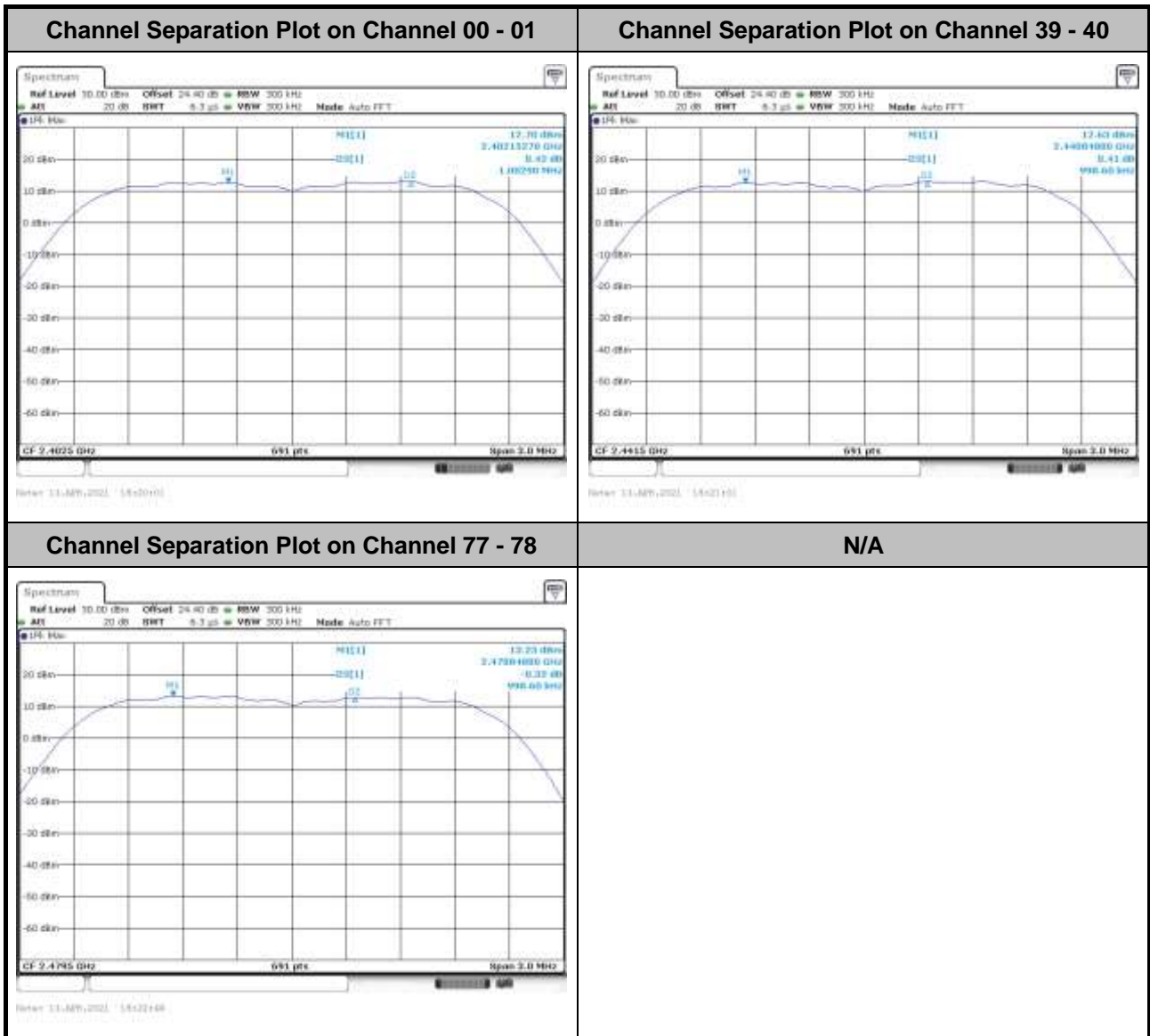



<3Mbps>

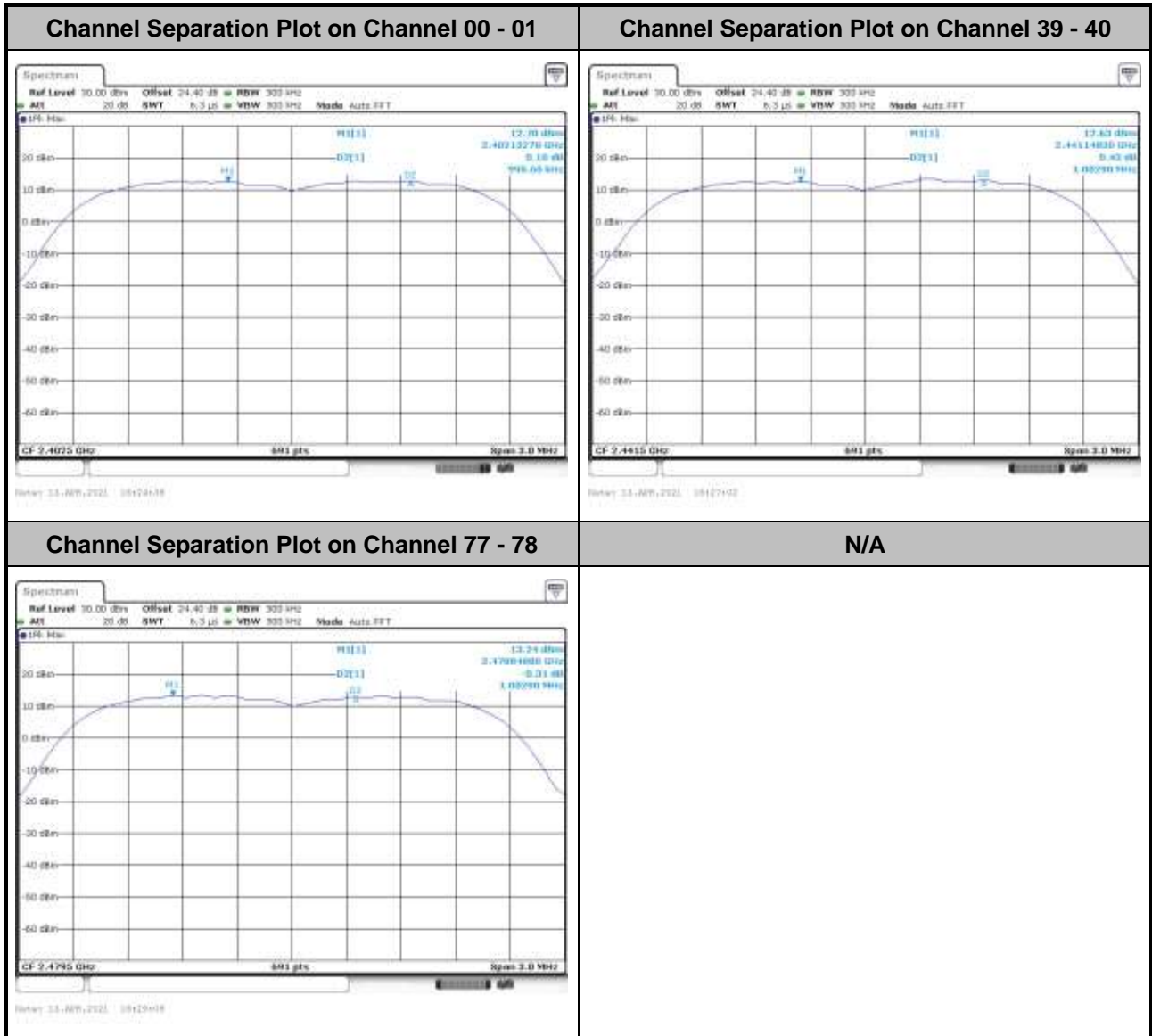



<Ant. 1>

<1Mbps>

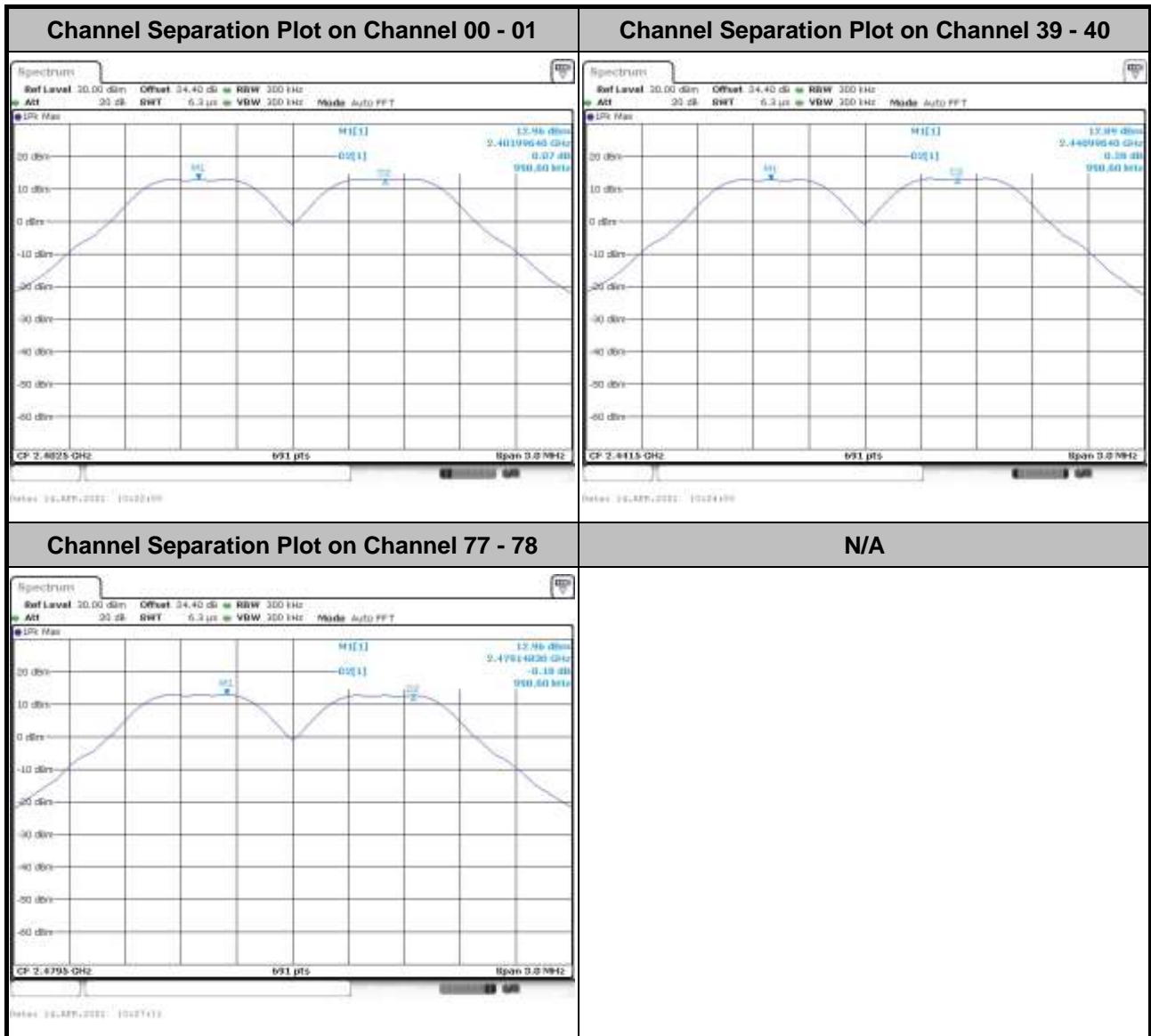



<2Mbps>

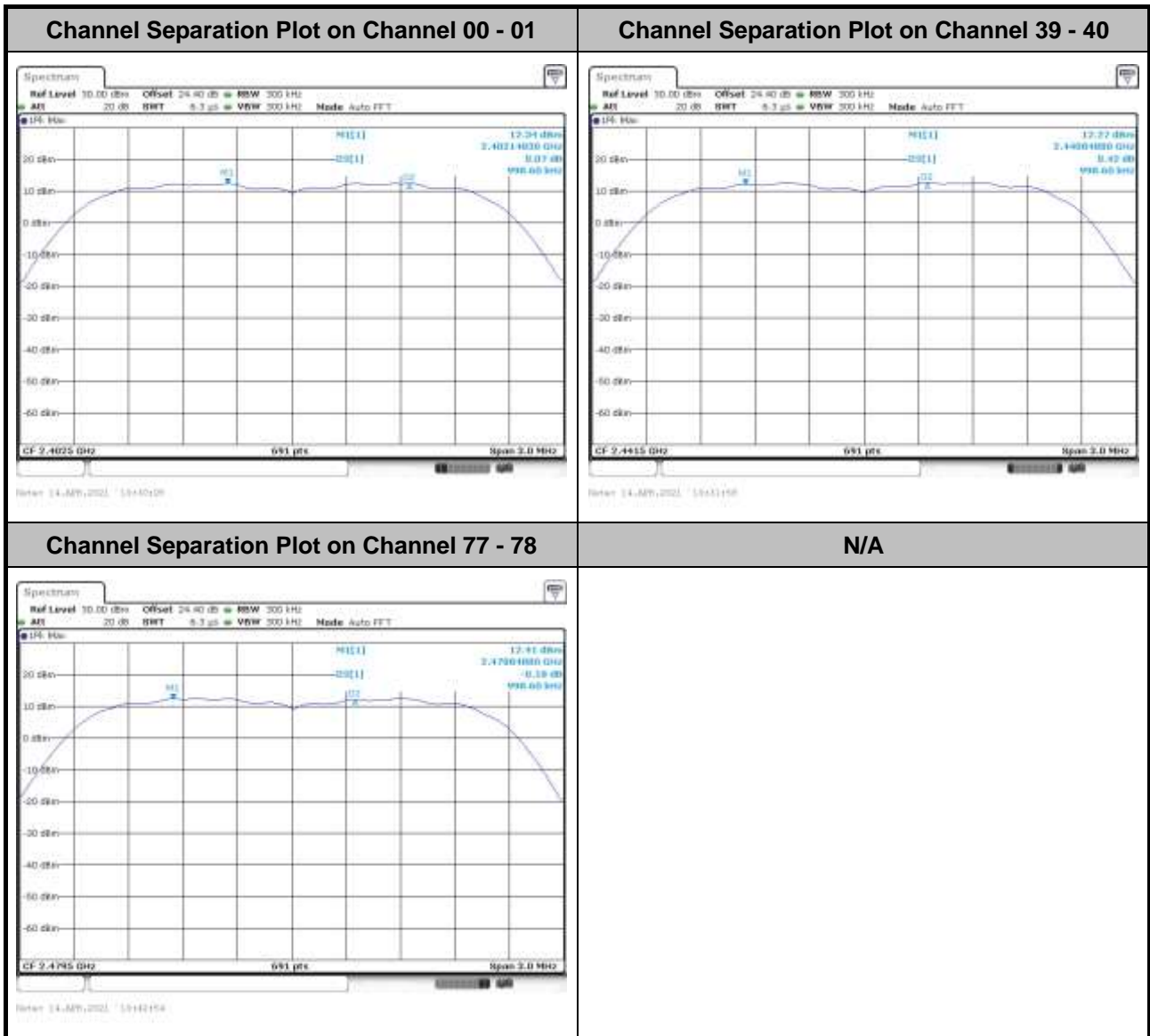



<3Mbps>

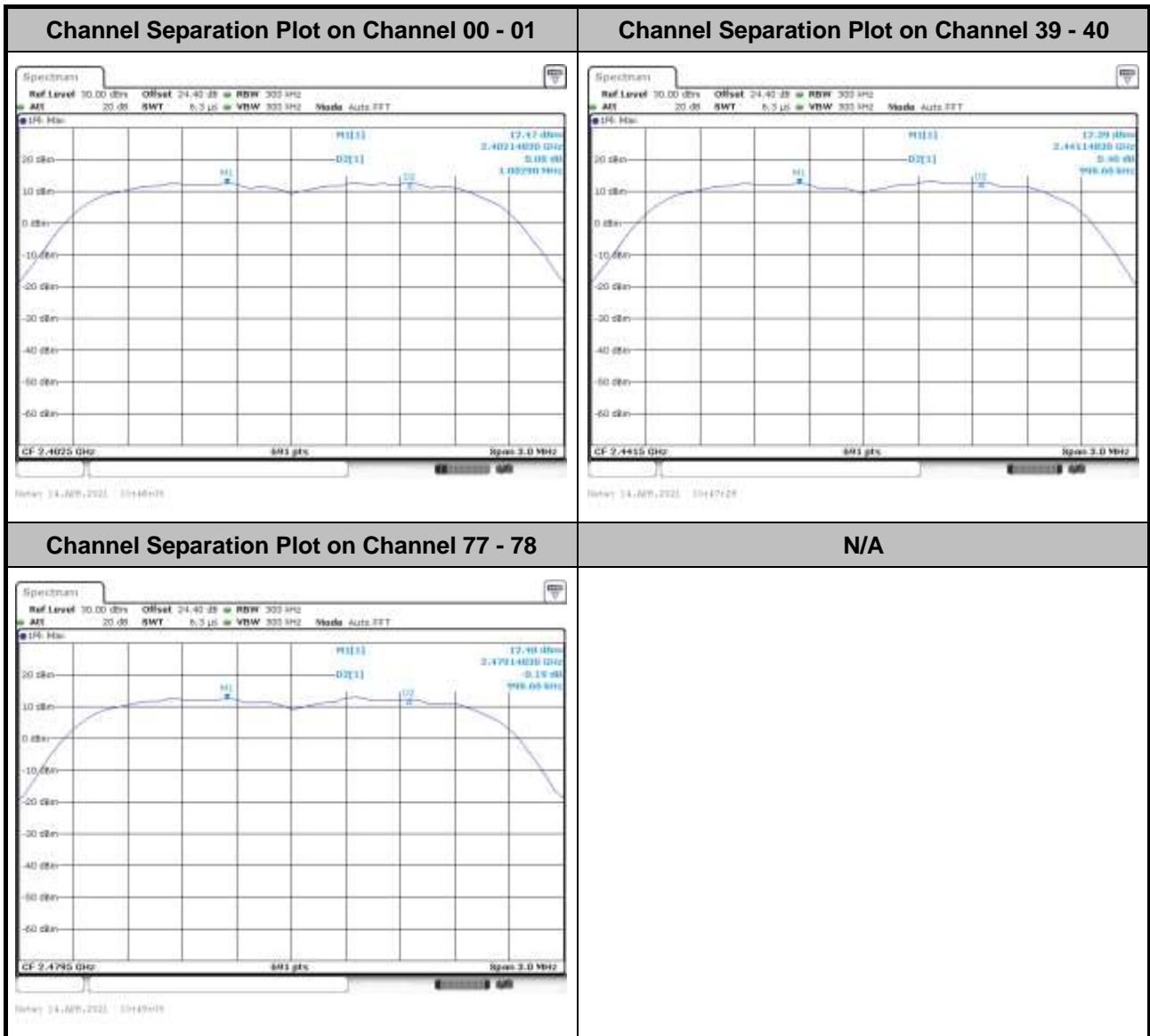

3.3 Dwell Time Measurement

3.3.1 Limit of Dwell Time

The average time of occupancy on any channel shall not be greater than 0.4 seconds within a period of 0.4 seconds multiplied by the number of hopping channels employed.

3.3.2 Measuring Instruments

See list of measuring equipment of this test report.

3.3.3 Test Procedures

1. The testing follows ANSI C63.10-2013 clause 7.8.4.
2. The RF output of EUT was connected to the spectrum analyzer by RF cable and attenuator. The path loss was compensated to the results for each measurement.
3. Set the maximum power setting and enable the EUT to transmit continuously.
4. Enable the EUT hopping function.
5. Use the following spectrum analyzer settings: Span = zero span, centered on a hopping channel; RBW = 1 MHz; VBW \geq RBW; Sweep = as necessary to capture the entire dwell time per hopping channel; Detector function = peak; Trace = max hold.
6. Measure and record the results in the test report.

3.3.4 Test Setup



3.3.5 Test Result of Dwell Time

Please refer to Appendix A.



<Ant. 0>

<Ant. 1>

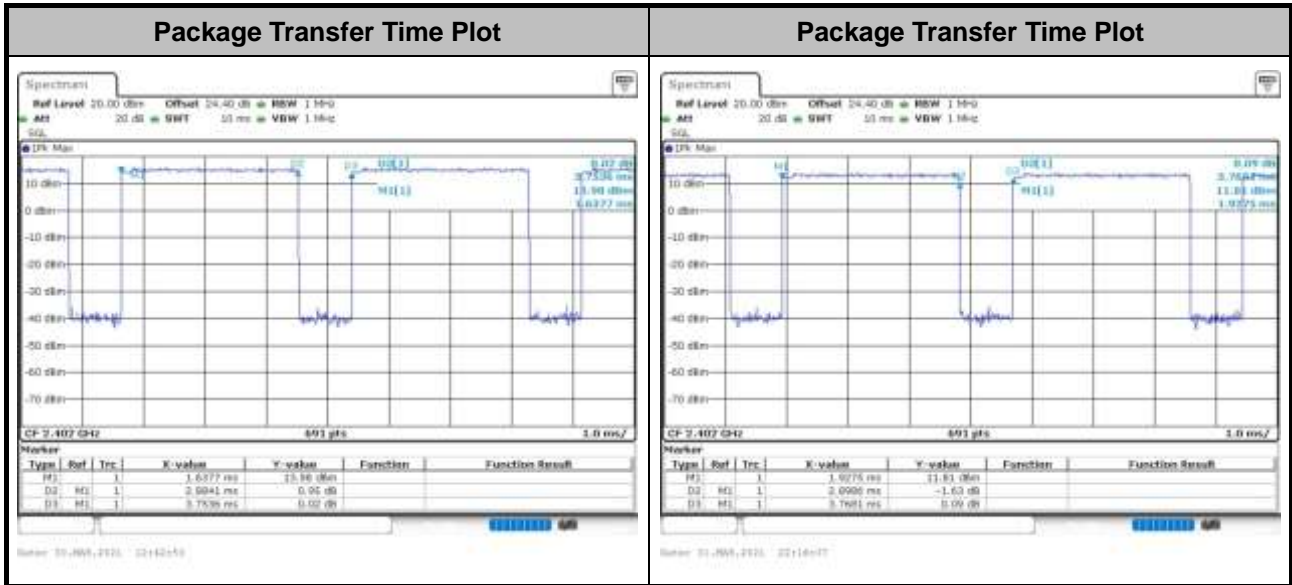

Remark:

1. In normal mode, hopping rate is 1600 hops/s with 6 slots in 79 hopping channels. With channel hopping rate (1600 / 6 / 79) in Occupancy Time Limit (0.4 x 79) (s), Hops Over Occupancy Time comes to (1600 / 6 / 79) x (0.4 x 79) = 106.67 hops.
2. In AFH mode, hopping rate is 800 hops/s with 6 slots in 20 hopping channels. With channel hopping rate (800 / 6 / 20) in Occupancy Time Limit (0.4 x 20) (s), Hops Over Occupancy Time comes to (800 / 6 / 20) x (0.4 x 20) = 53.33 hops.
3. Dwell Time(s) = Hops Over Occupancy Time (hops) x Package Transfer Time

3.4 20dB and 99% Bandwidth Measurement

3.4.1 Limit of 20dB and 99% Bandwidth

Reporting only

3.4.2 Measuring Instruments

See list of measuring equipment of this test report.

3.4.3 Test Procedures

1. The testing follows ANSI C63.10-2013 clause 6.9.2 and 6.9.3.
2. The RF output of EUT was connected to the spectrum analyzer by RF cable and attenuator. The path loss was compensated to the results for each measurement.
3. Set the maximum power setting and enable the EUT to transmit continuously.
4. Use the following spectrum analyzer settings for 20 dB Bandwidth measurement.
Span = approximately 2 to 5 times the 20 dB bandwidth, centered on a hopping channel;
RBW \geq 1% of the 20 dB bandwidth; VBW \geq RBW; Sweep = auto; Detector function = peak;
Trace = max hold.
5. Use the following spectrum analyzer settings for 99 % Bandwidth measurement.
Span = approximately 1.5 to 5 times the 99% bandwidth, centered on a hopping channel;
RBW \geq 1-5% of the 99% bandwidth; VBW \geq 3 * RBW; Sweep = auto; Detector function = peak;
Trace = max hold.
6. Measure and record the results in the test report.

3.4.4 Test Setup



3.4.5 Test Result of 20dB Bandwidth

Please refer to Appendix A.



<Ant. 0>

<1Mbps>

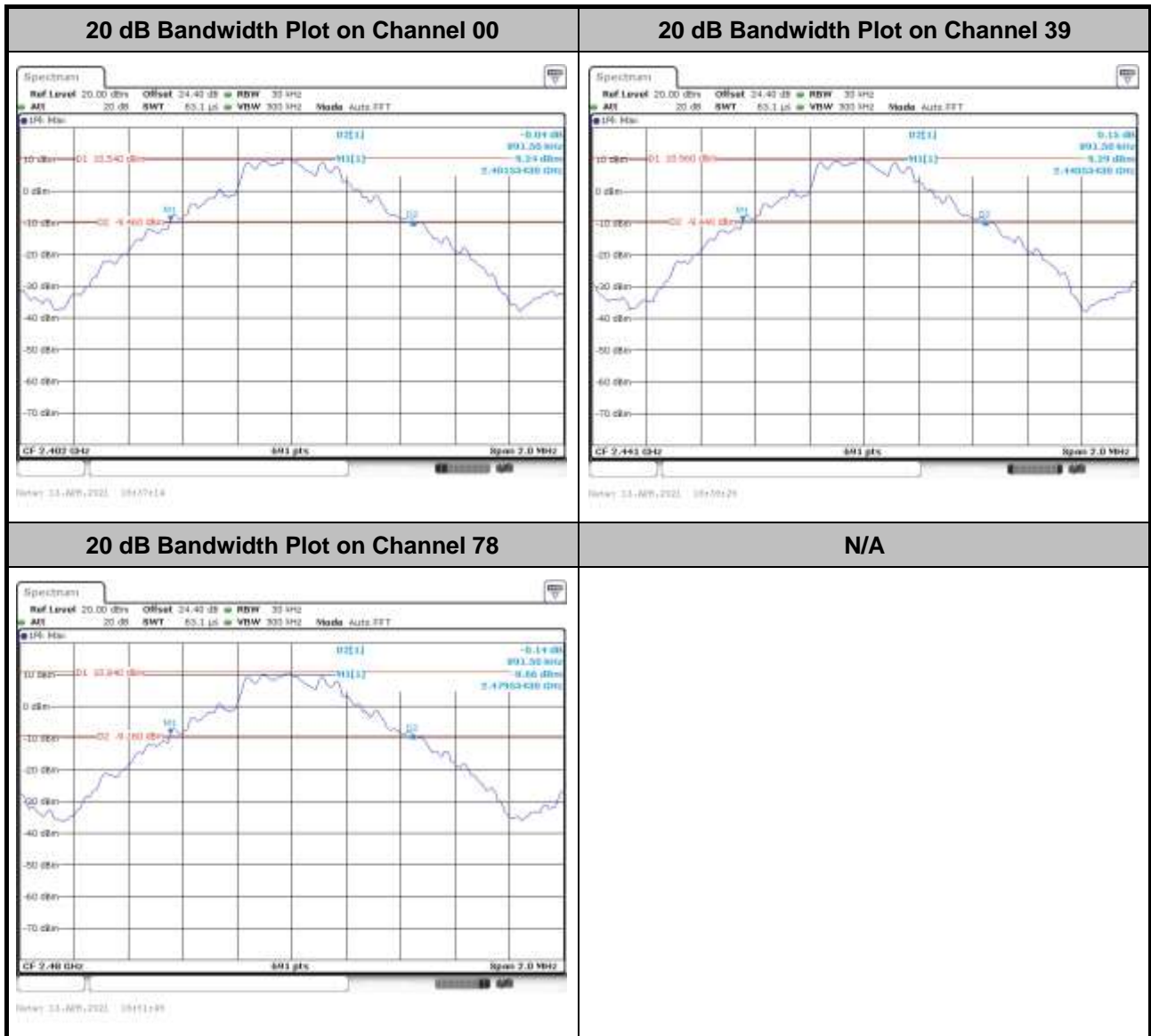



<2Mbps>

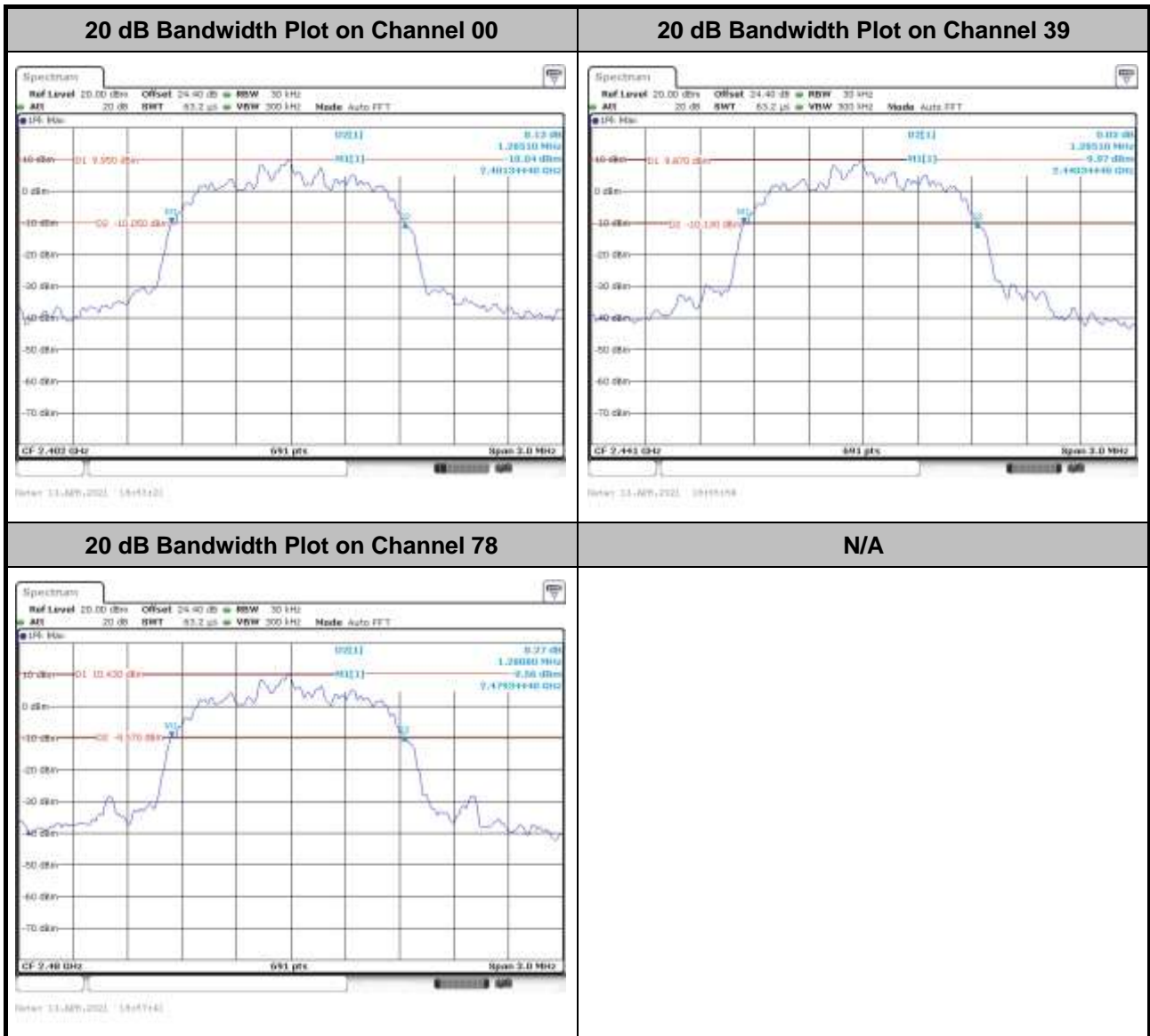



<3Mbps>

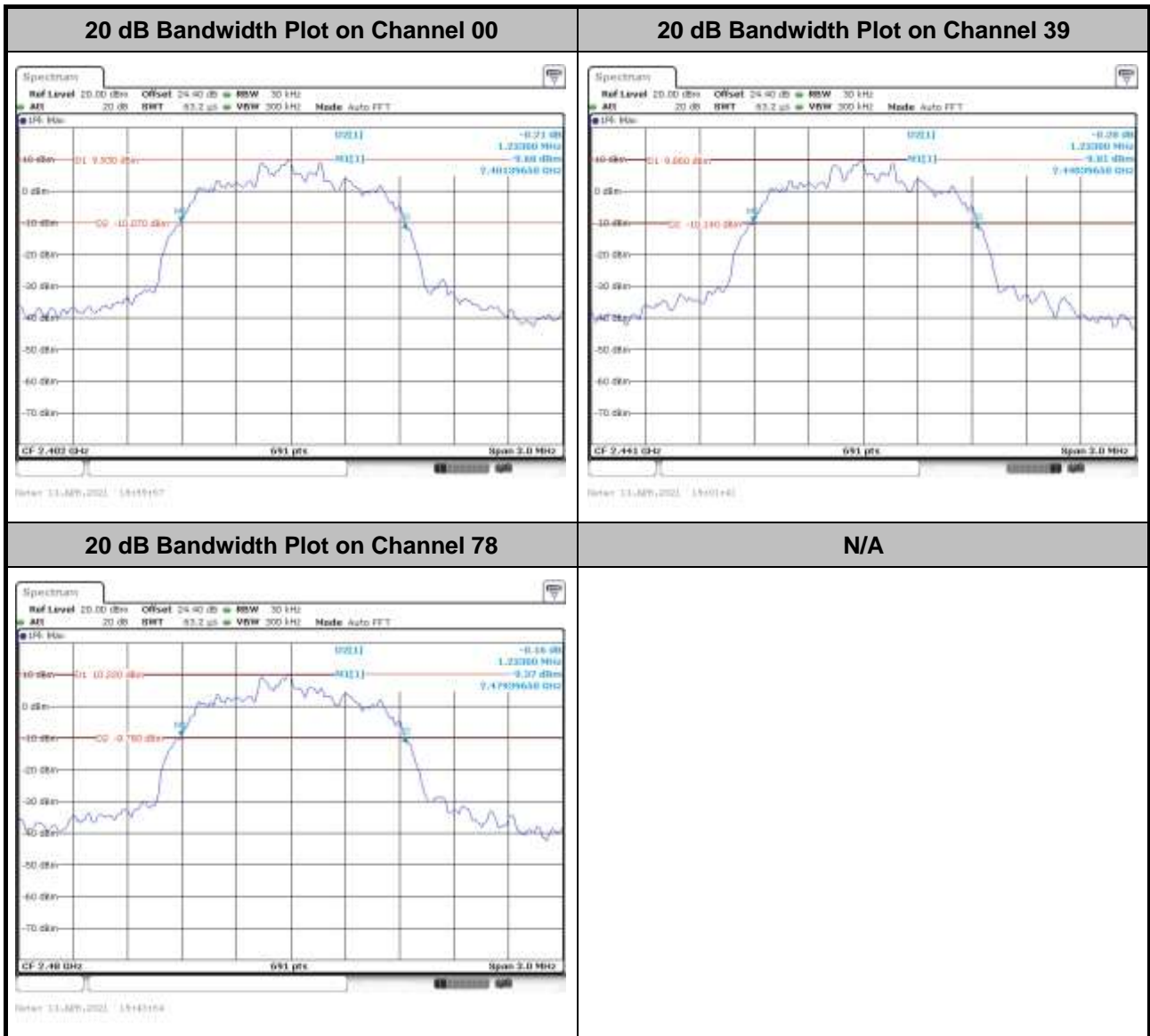



<Ant. 1>

<1Mbps>

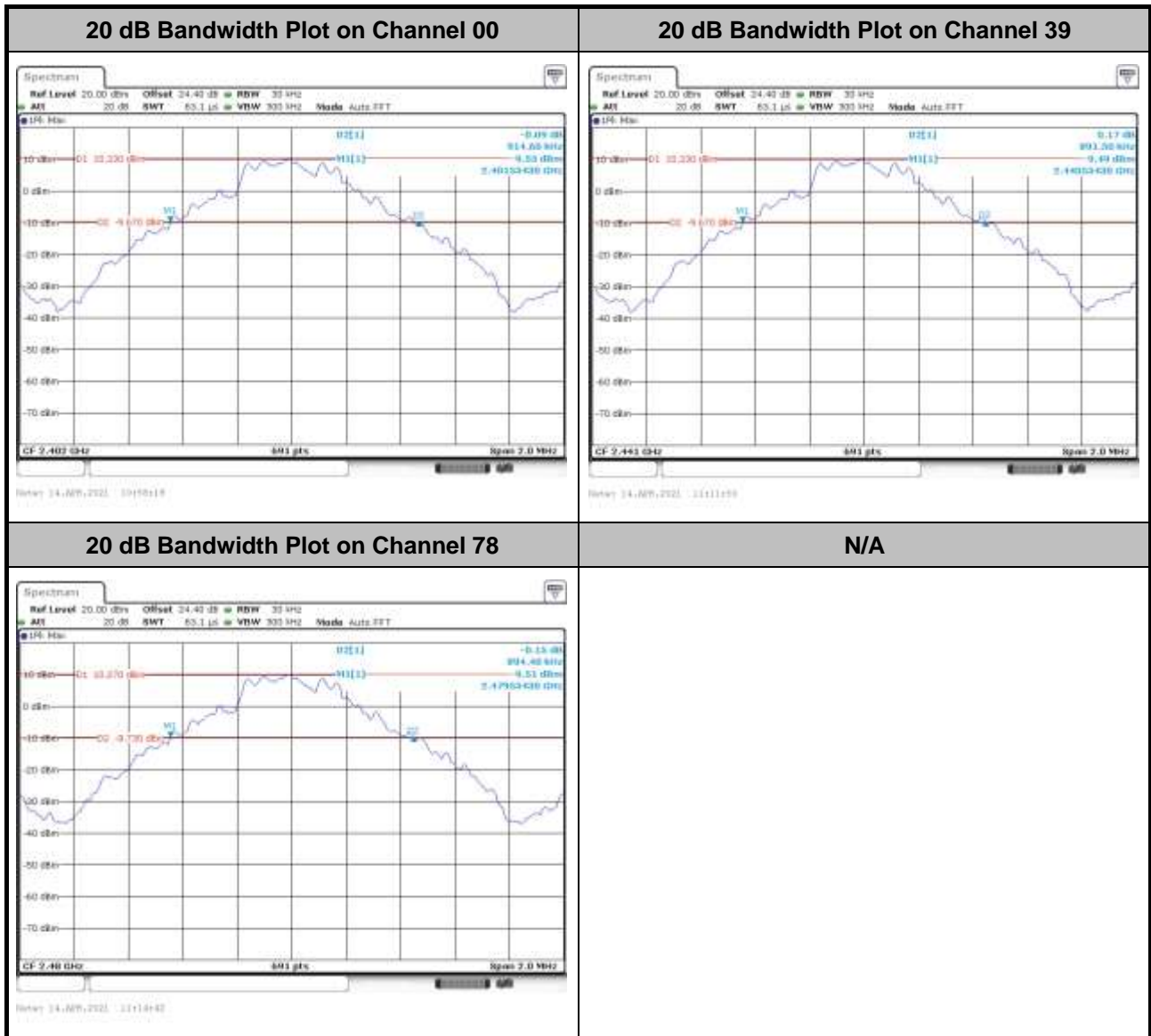



<2Mbps>

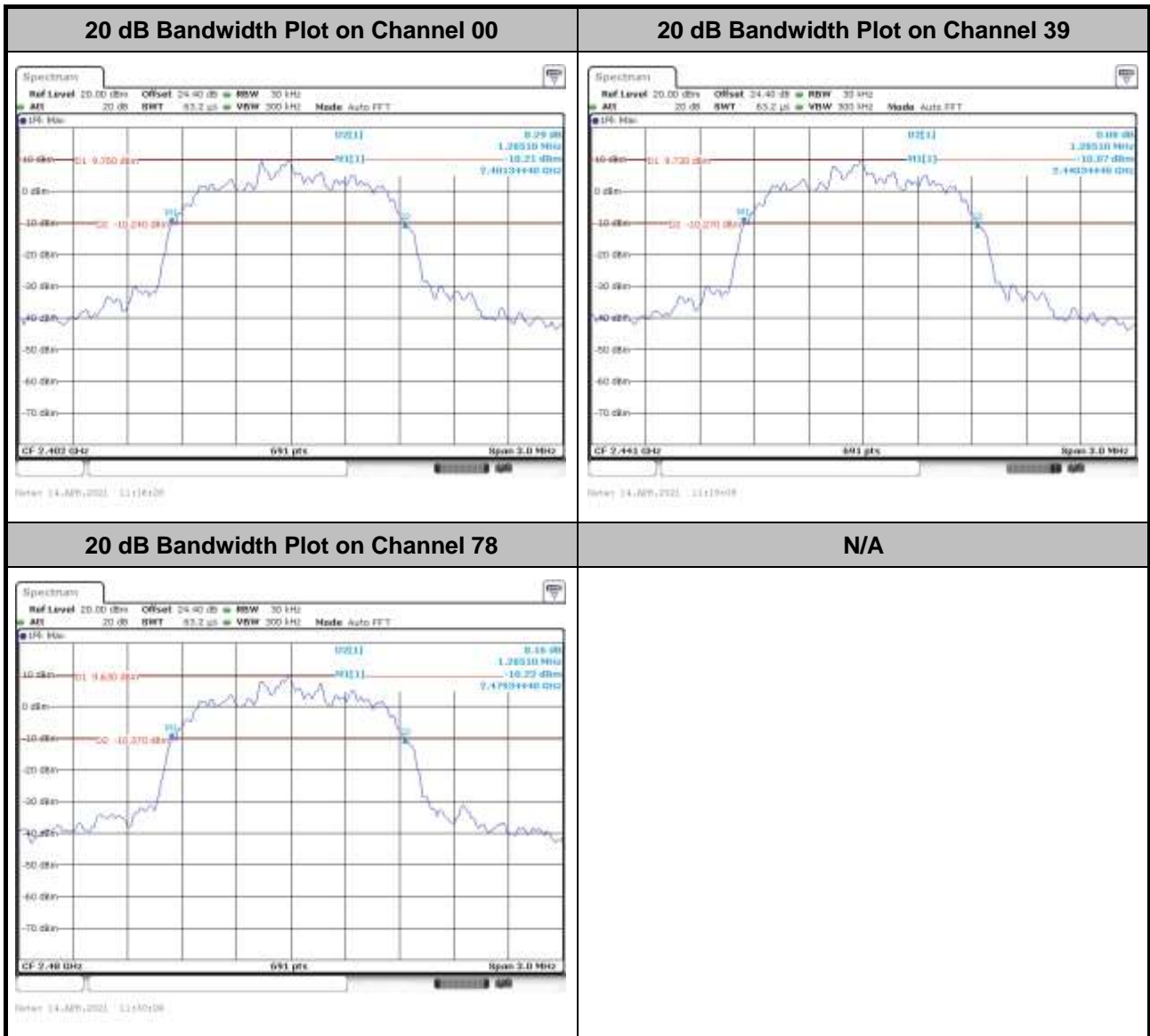



<3Mbps>

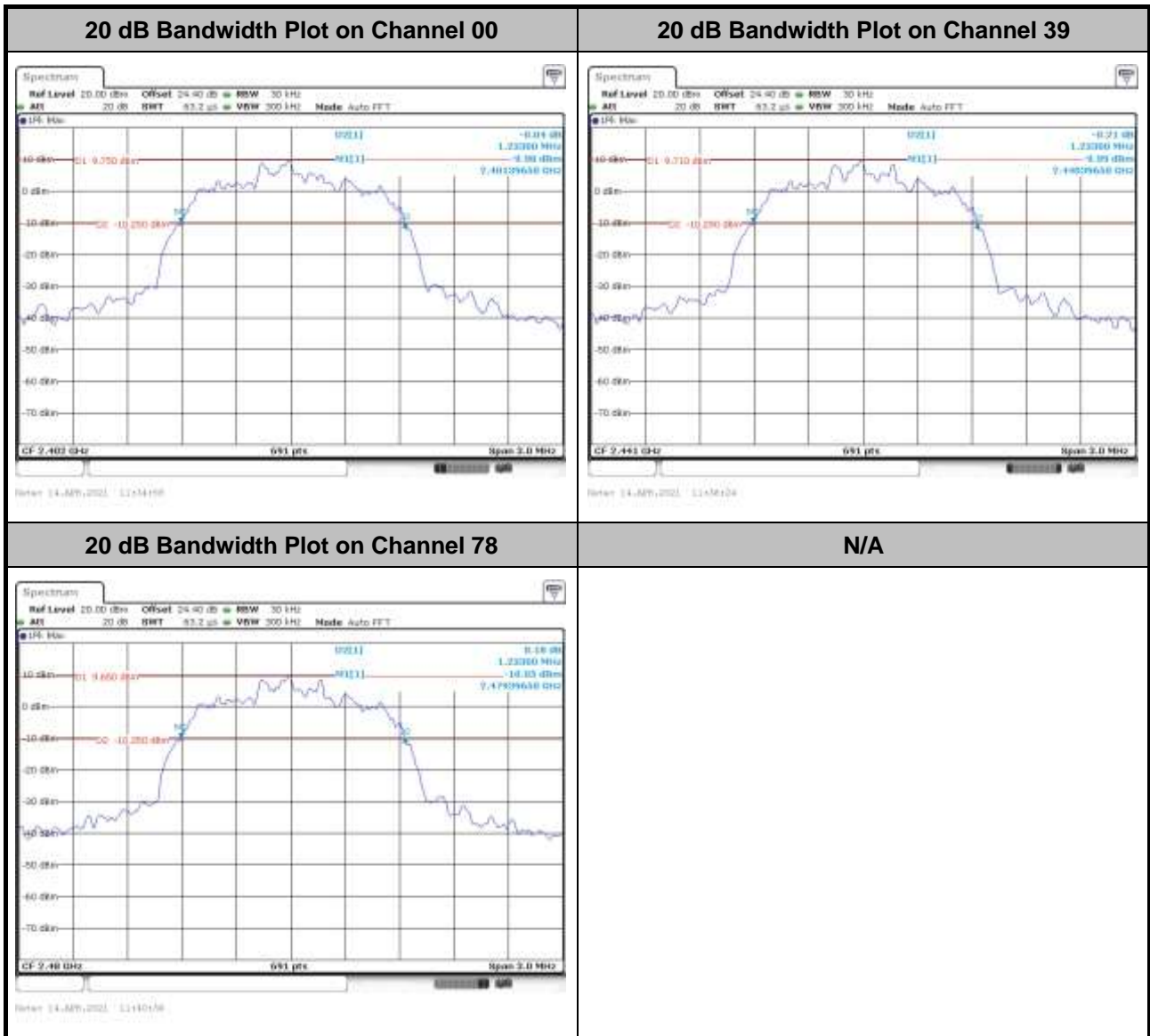



3.4.6 Test Result of 99% Occupied Bandwidth

Please refer to Appendix A.

<Ant. 0>

<1Mbps>

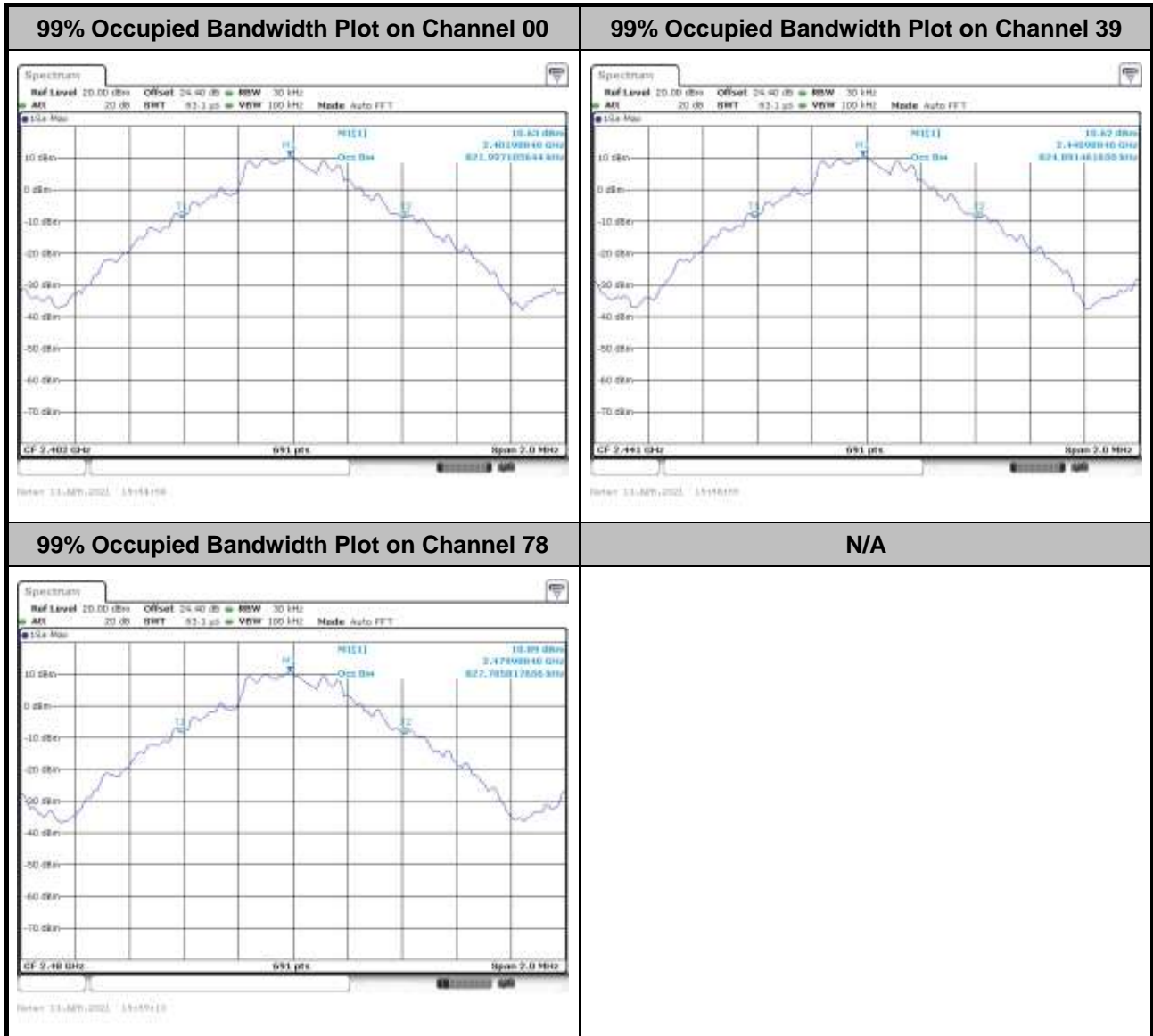

Note: The occupied channel bandwidth is maintained within the band of operation for all of the modulations.



<2Mbps>

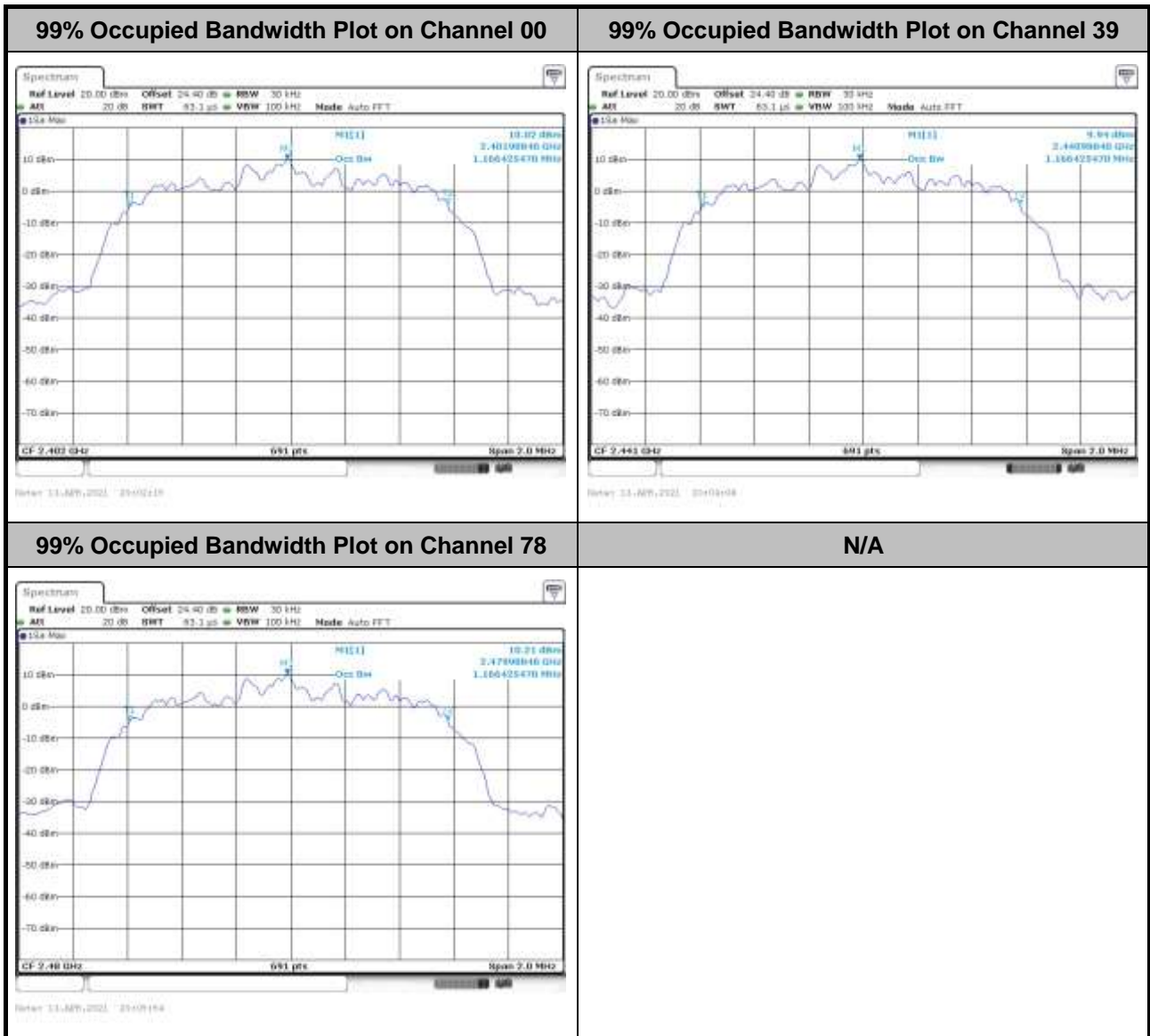

Note: The occupied channel bandwidth is maintained within the band of operation for all of the modulations.



<3Mbps>

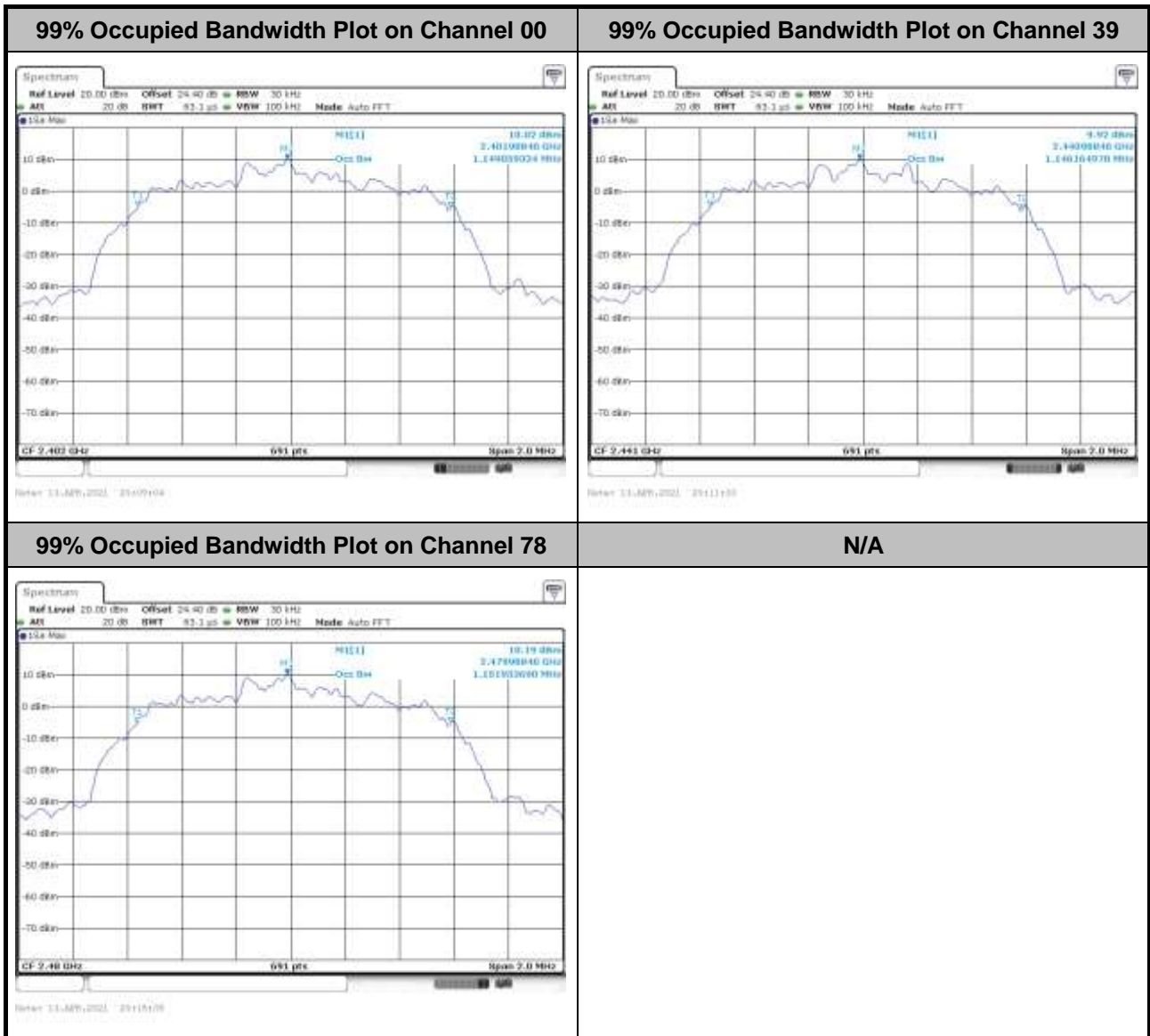

Note: The occupied channel bandwidth is maintained within the band of operation for all of the modulations.



<Ant. 1>

<1Mbps>

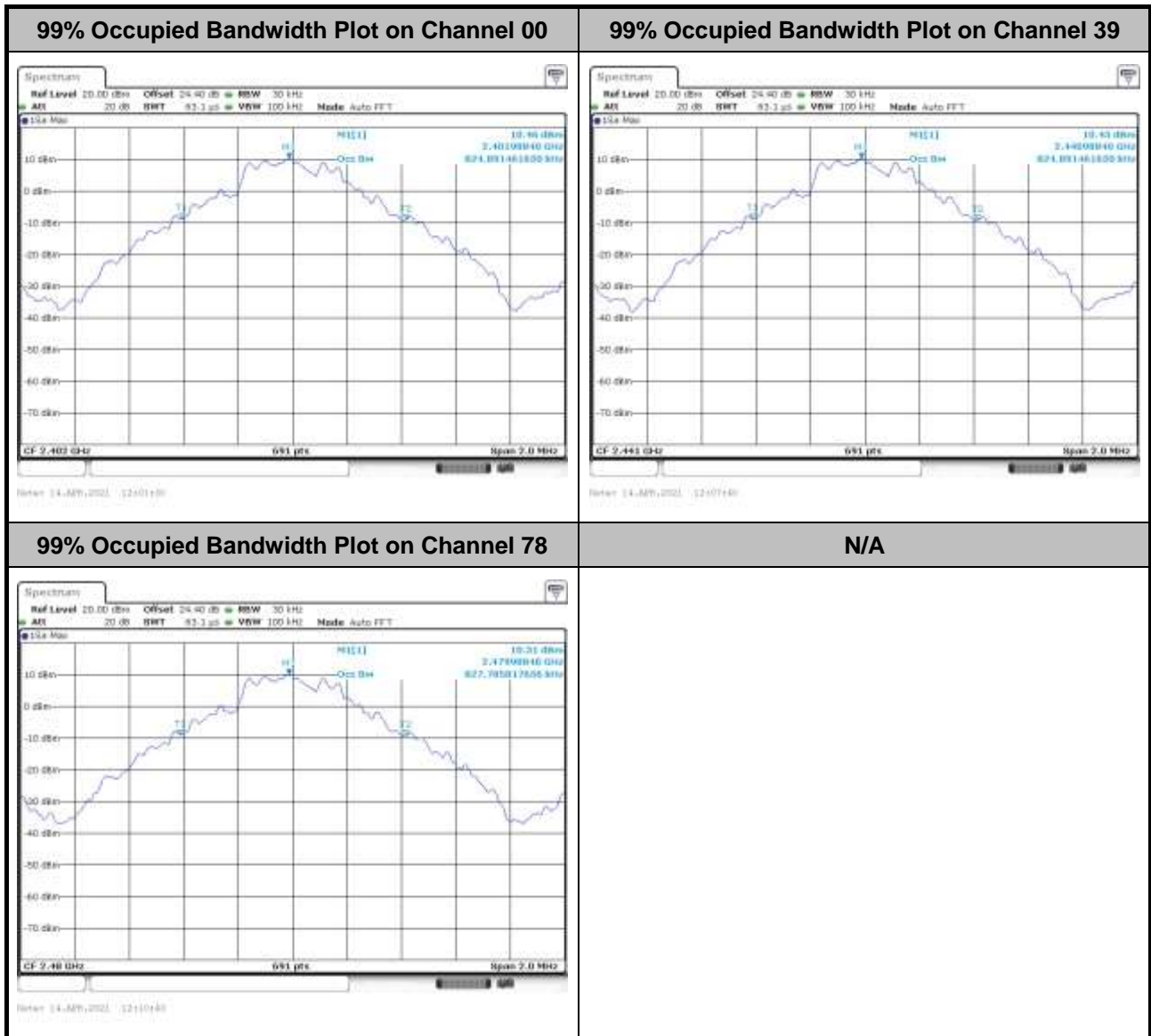

Note: The occupied channel bandwidth is maintained within the band of operation for all of the modulations.



<2Mbps>

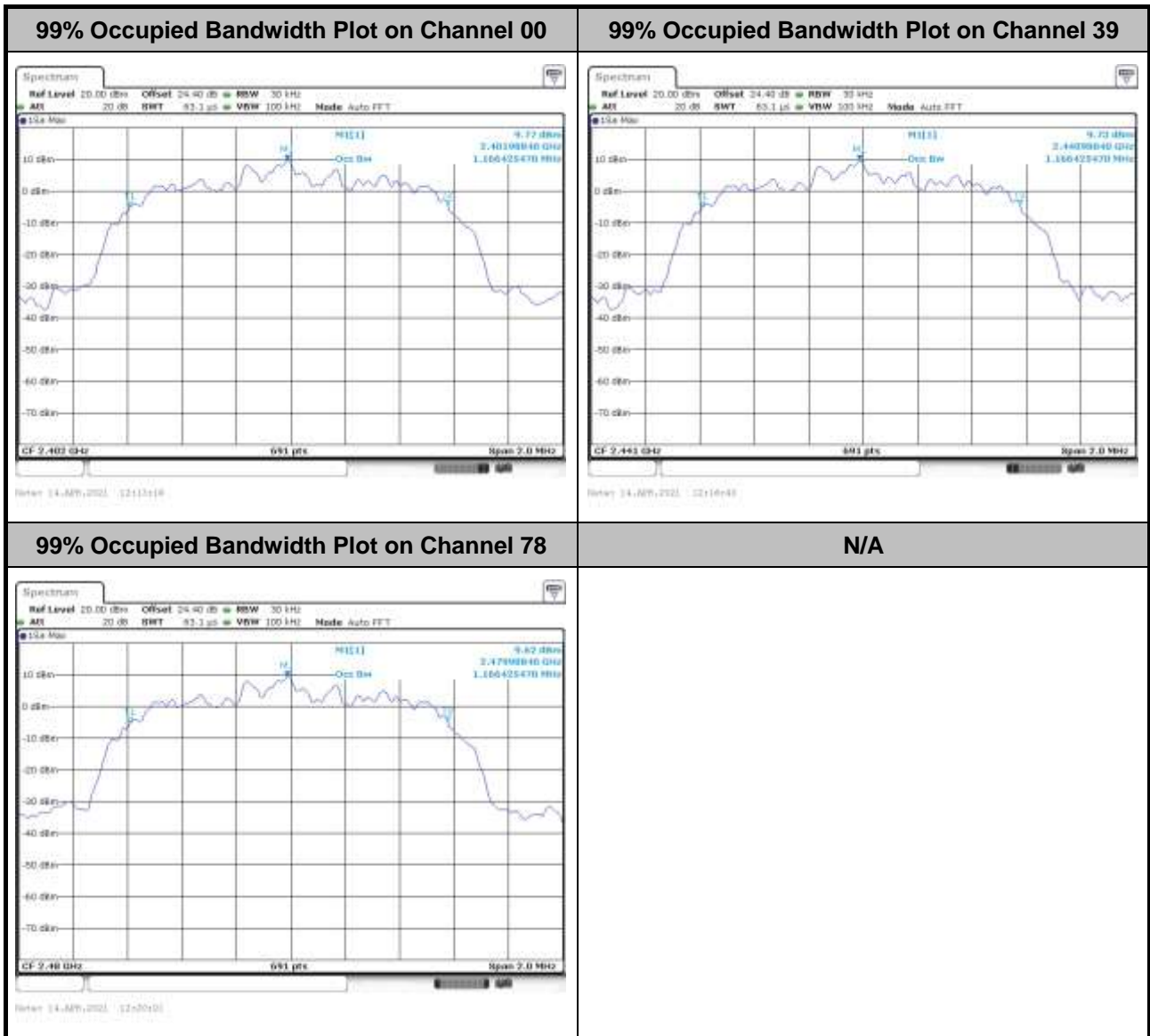

Note: The occupied channel bandwidth is maintained within the band of operation for all of the modulations.



<3Mbps>

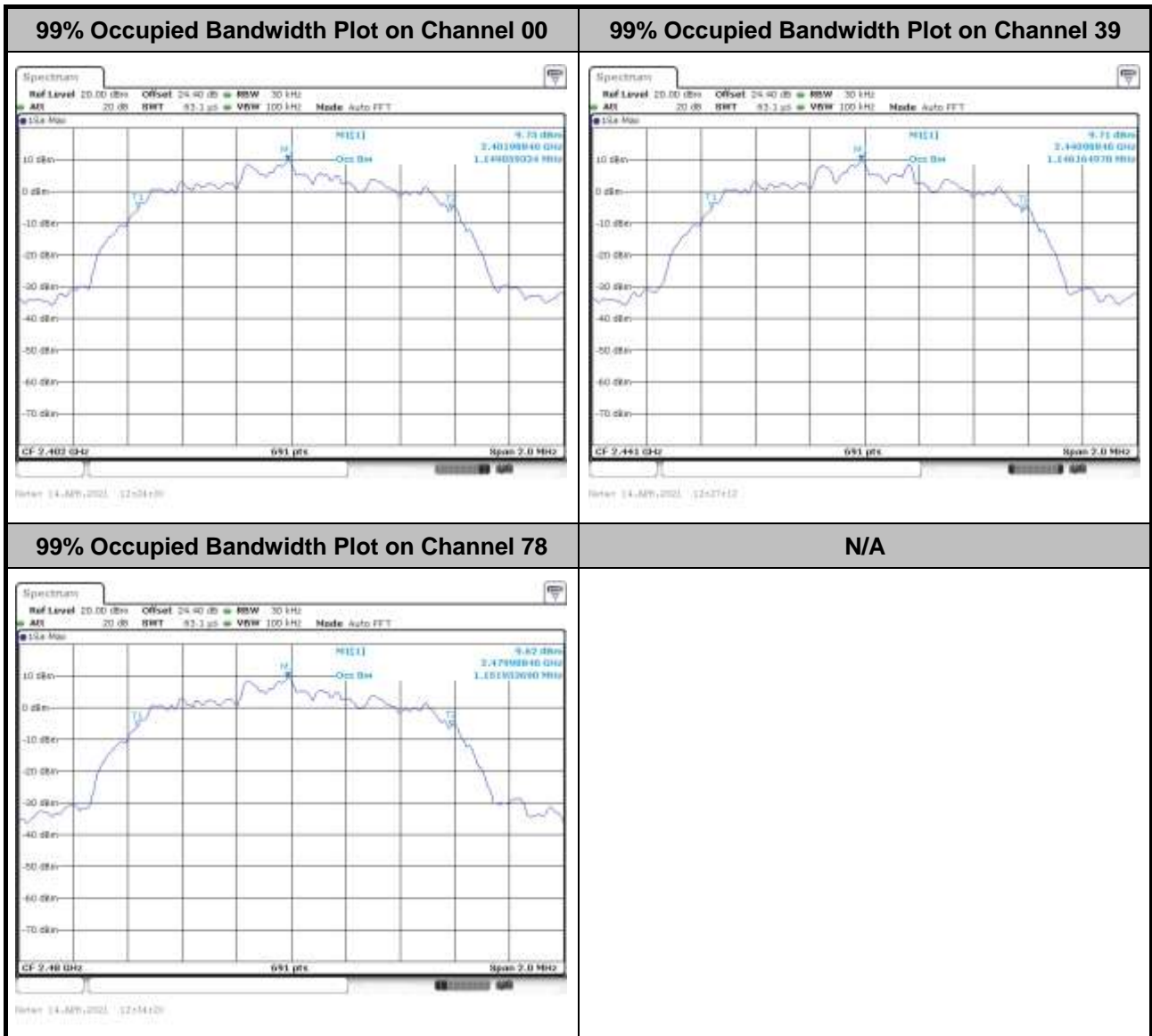

Note: The occupied channel bandwidth is maintained within the band of operation for all of the modulations.

3.5 Output Power Measurement

3.5.1 Limit of Output Power

The maximum peak conducted output power of the intentional radiator shall not exceed the following:
For frequency hopping systems operating in the 2400-2483.5 MHz band employing at least 75 non-overlapping hopping channels, and all frequency hopping systems in the 5725-5850 MHz band: 1 watt. For all other frequency hopping systems in the 2400-2483.5 MHz band 0.125 watts.

3.5.2 Measuring Instruments

See list of measuring equipment of this test report.

3.5.3 Test Procedures

1. The testing follows ANSI C63.10-2013 clause 7.8.5.
2. The RF output of EUT was connected to the power meter by RF cable and attenuator. The path loss was compensated to the results for each measurement.
3. Set the maximum power setting and enable the EUT to transmit continuously.
4. Measure the conducted output power with cable loss and record the results in the test report.
5. Measure and record the results in the test report.

3.5.4 Test Setup

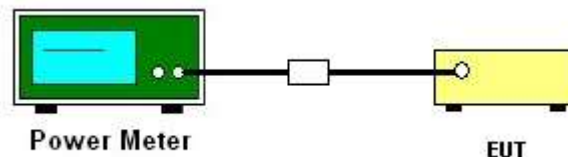

3.5.5 Test Result of Peak Output Power

Please refer to Appendix A.

3.5.6 Test Result of Average Output Power (Reporting Only)

Please refer to Appendix A.

3.6 Conducted Band Edges Measurement

3.6.1 Limit of Band Edges

In any 100 kHz bandwidth outside the intentional radiation frequency band, the radio frequency power shall be at least 20 dB below the highest level of the radiated power. In addition, radiated emissions which fall in the restricted bands must also comply with the radiated emission limits.

3.6.2 Measuring Instruments

See list of measuring equipment of this test report.

3.6.3 Test Procedures

1. The testing follows ANSI C63.10-2013 clause 7.8.6.
2. Set the maximum power setting and enable the EUT to transmit continuously.
3. Set RBW = 100 kHz, VBW = 300 kHz. Band edge emissions must be at least 20 dB down from the highest emission level within the authorized band as measured with a 100 kHz RBW. The attenuation shall be 30 dB instead of 20 dB when RMS conducted output power procedure is used.
4. Enable hopping function of the EUT and then repeat step 2 and 3.
5. Measure and record the results in the test report.

3.6.4 Test Setup





3.6.5 Test Result of Conducted Band Edges

<Ant. 0>

<1Mbps>

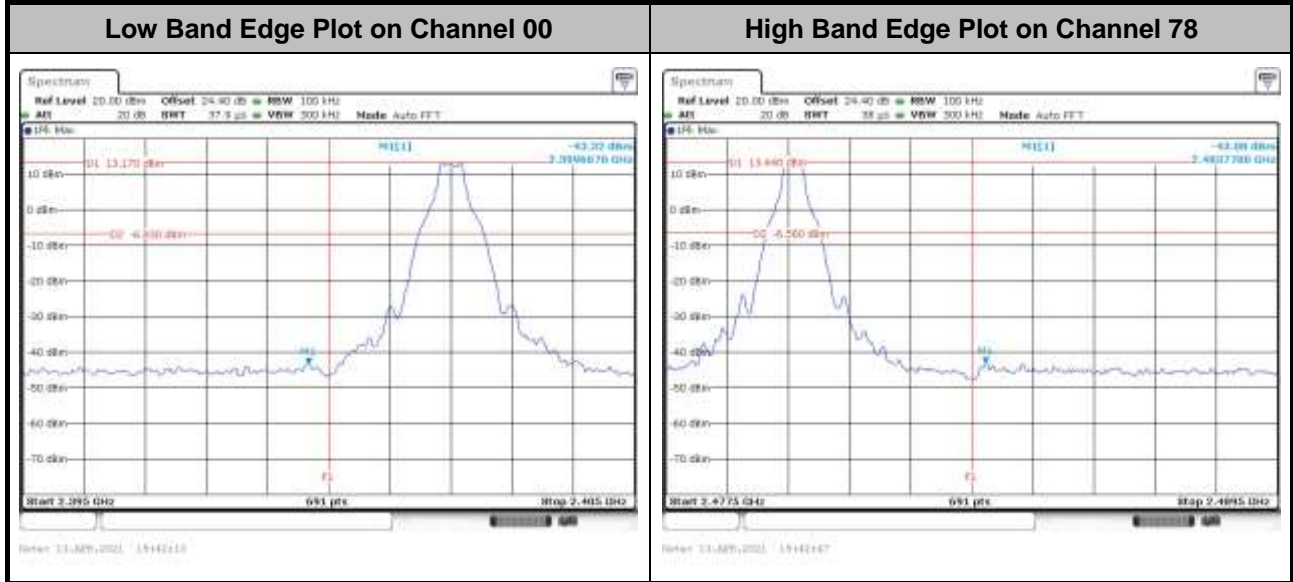

<2Mbps>

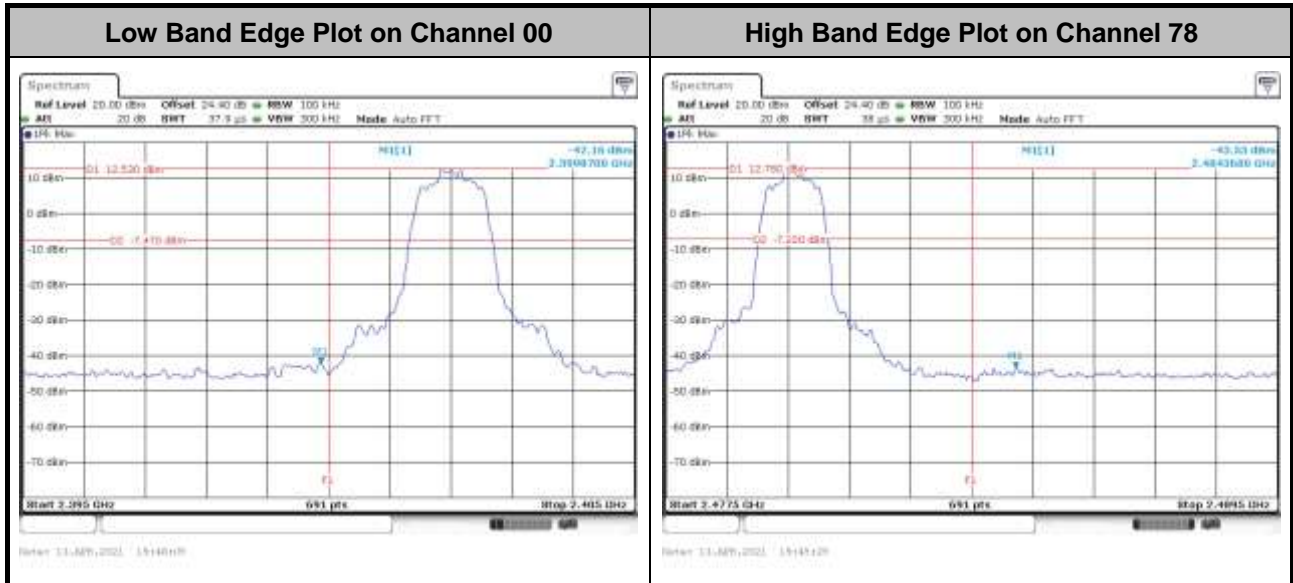



<3Mbps>

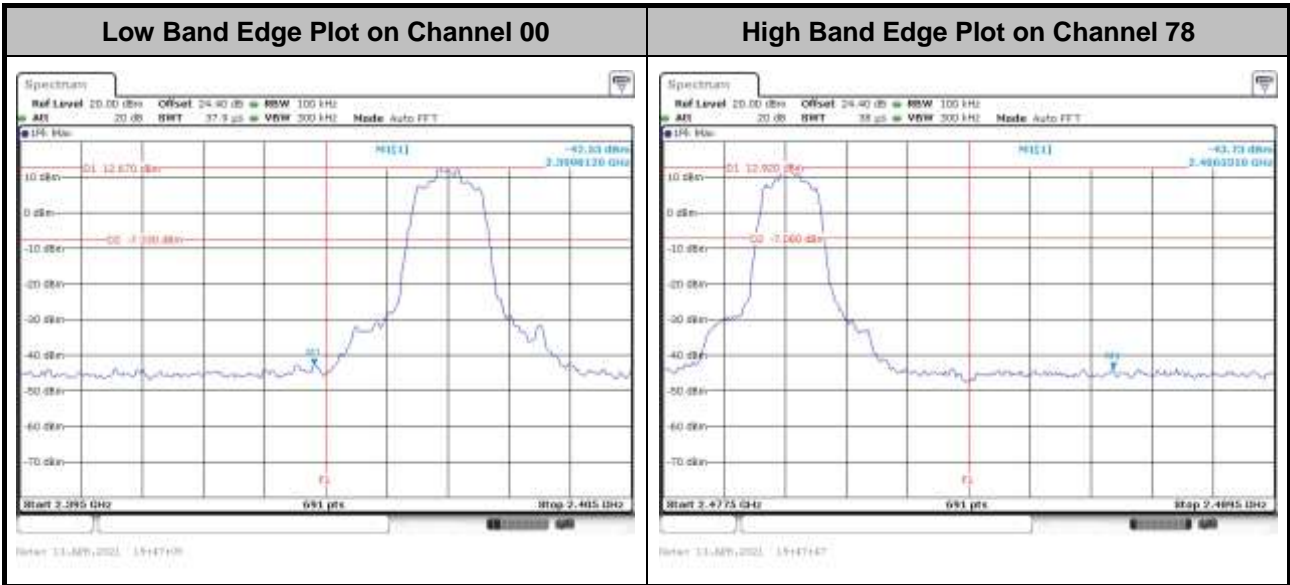



<Ant. 1>

<1Mbps>

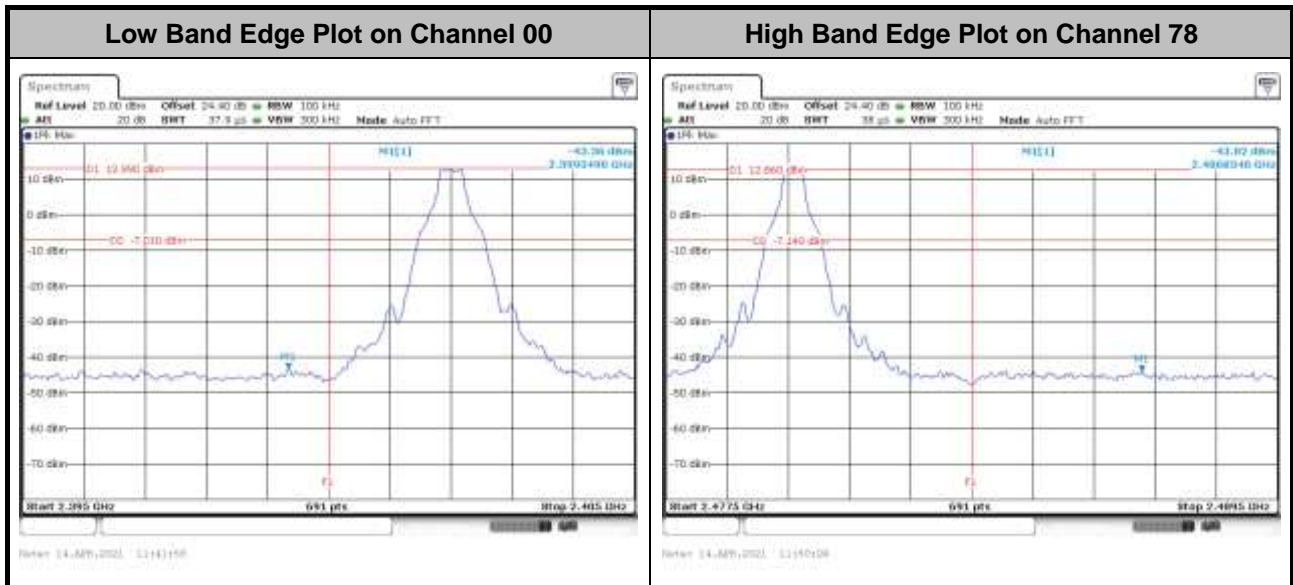

<2Mbps>

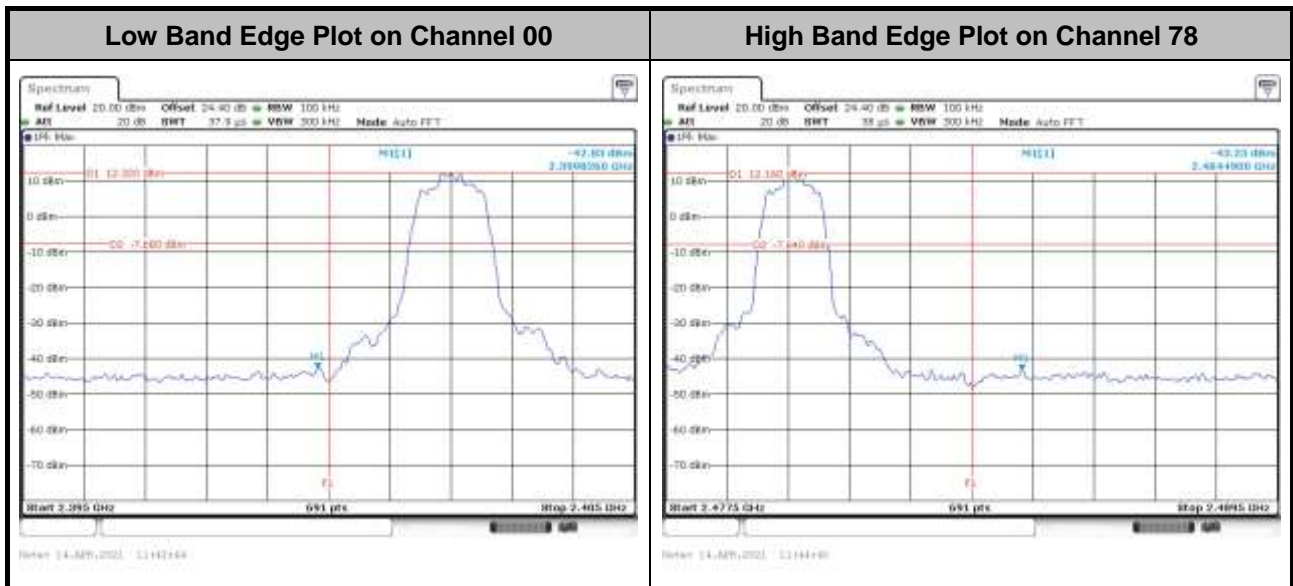



<3Mbps>

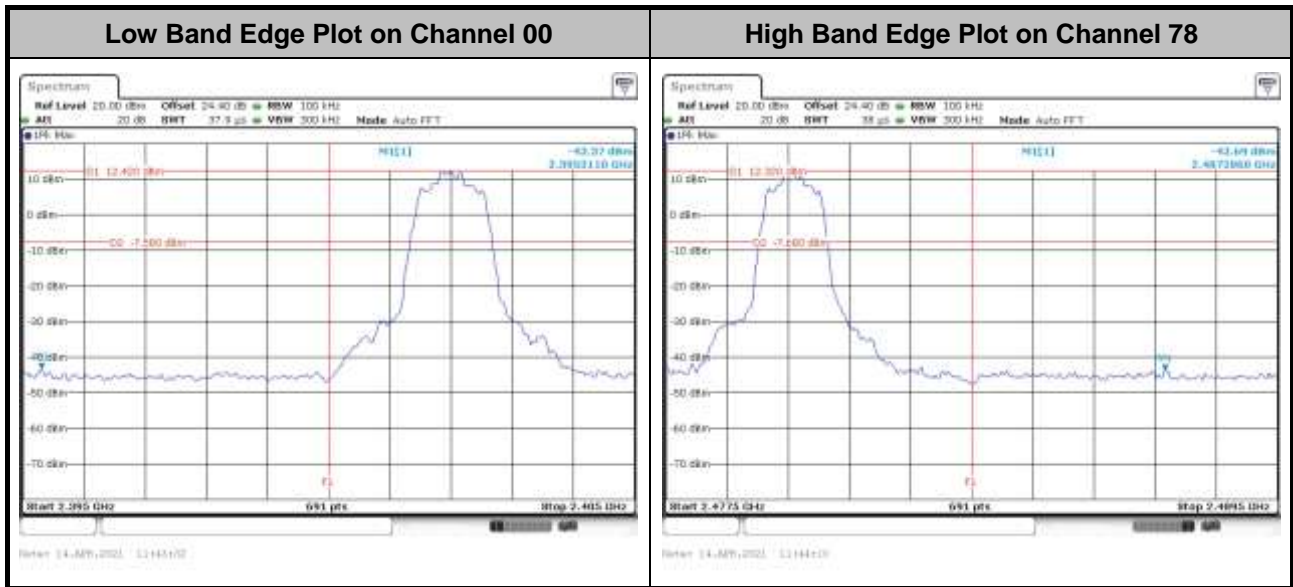



3.6.6 Test Result of Conducted Hopping Mode Band Edges

<Ant. 0>

<1Mbps>

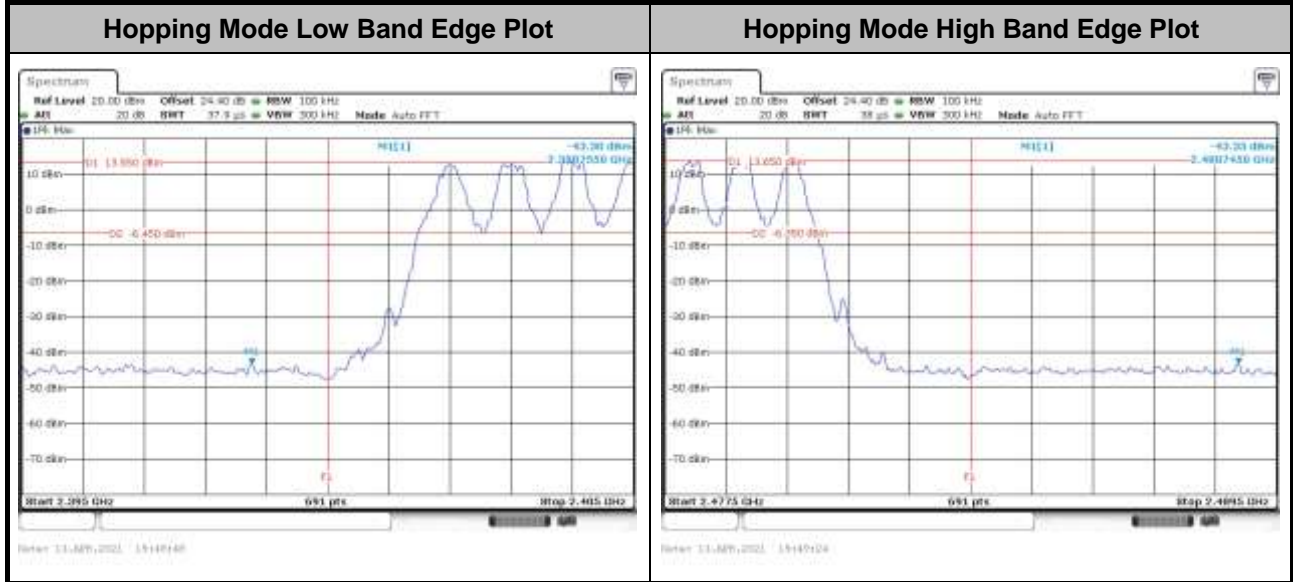

<2Mbps>

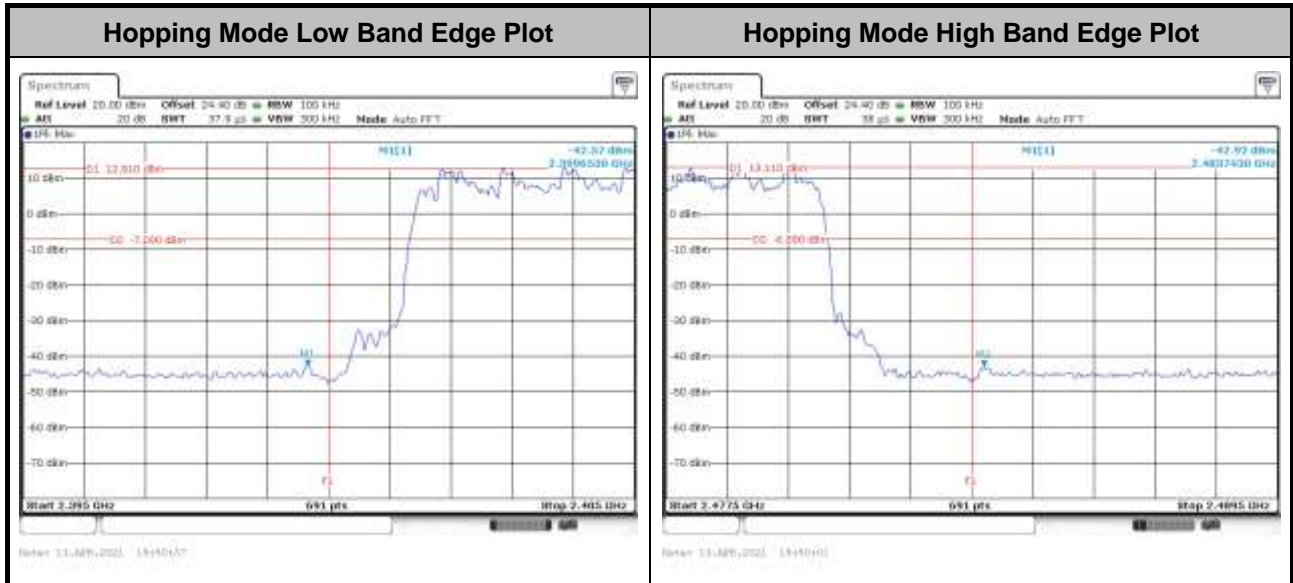



<3Mbps>

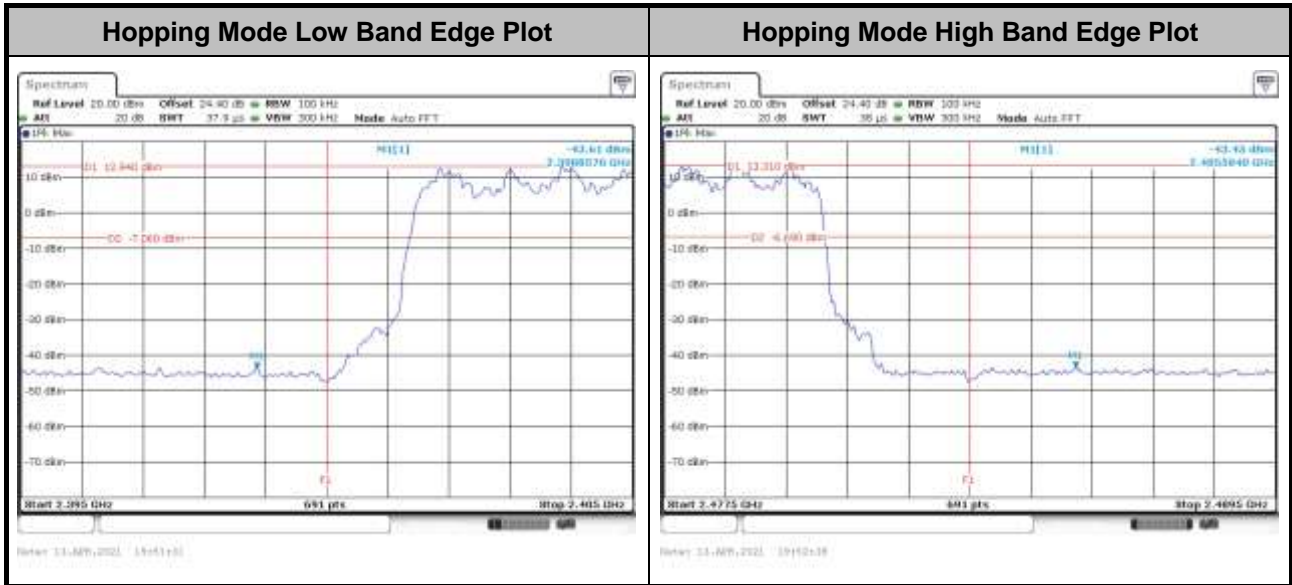



<Ant. 1>

<1Mbps>

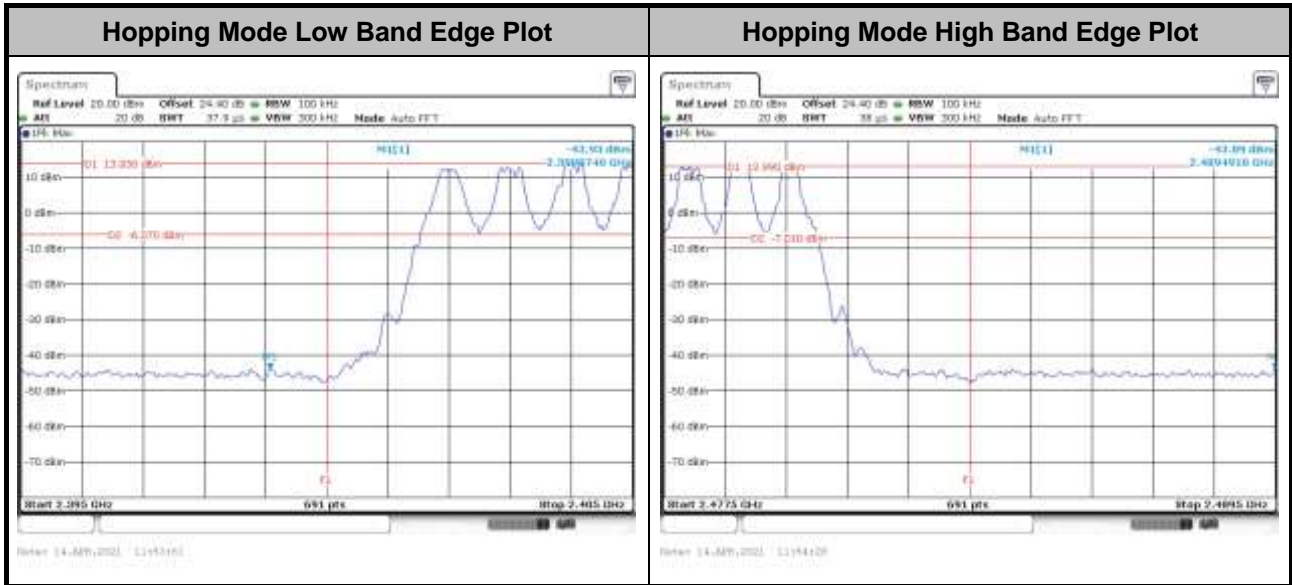

<2Mbps>

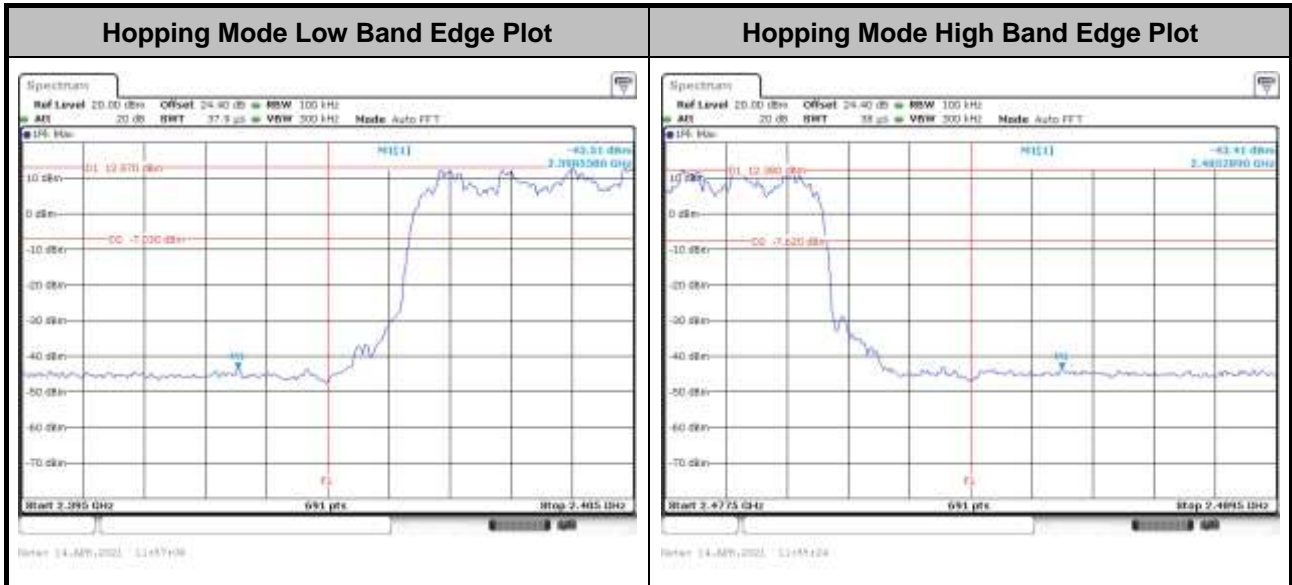



<3Mbps>

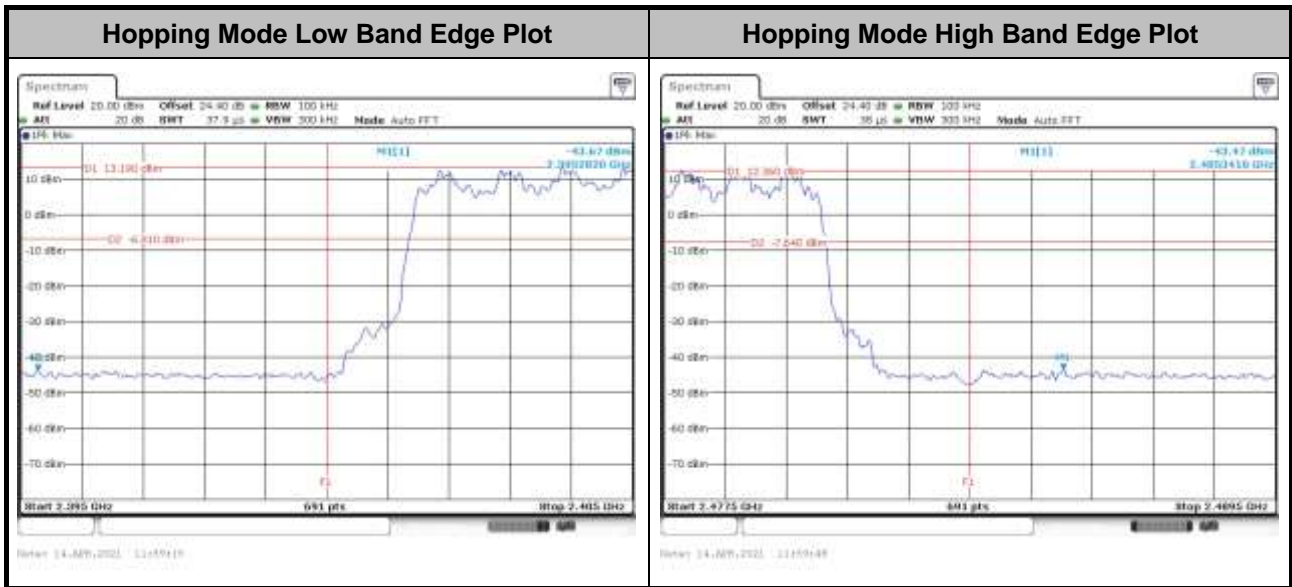

3.7 Conducted Spurious Emission Measurement

3.7.1 Limit of Spurious Emission Measurement

In any 100 kHz bandwidth outside the intentional radiation frequency band, the radio frequency power shall be at least 20 dB below the highest level of the radiated power. In addition, radiated emissions which fall in the restricted bands must also comply with the radiated emission limits.

3.7.2 Measuring Instruments

See list of measuring equipment of this test report.

3.7.3 Test Procedure

1. The testing follows ANSI C63.10-2013 clause 7.8.8.
2. The RF output of EUT was connected to the spectrum analyzer by RF cable and attenuator. The path loss was compensated to the results for each measurement.
3. Set the maximum power setting and enable the EUT to transmit continuously.
4. Set RBW = 100 kHz, VBW = 300 kHz, scan up through 10th harmonic. All harmonics / spurious must be at least 20 dB down from the highest emission level within the authorized band as measured with a 100 kHz RBW.
5. Measure and record the results in the test report.
6. The RF fundamental frequency should be excluded against the limit line in the operating frequency band.

3.7.4 Test Setup





3.7.5 Test Result of Conducted Spurious Emission

<Ant. 0>

<1Mbps>

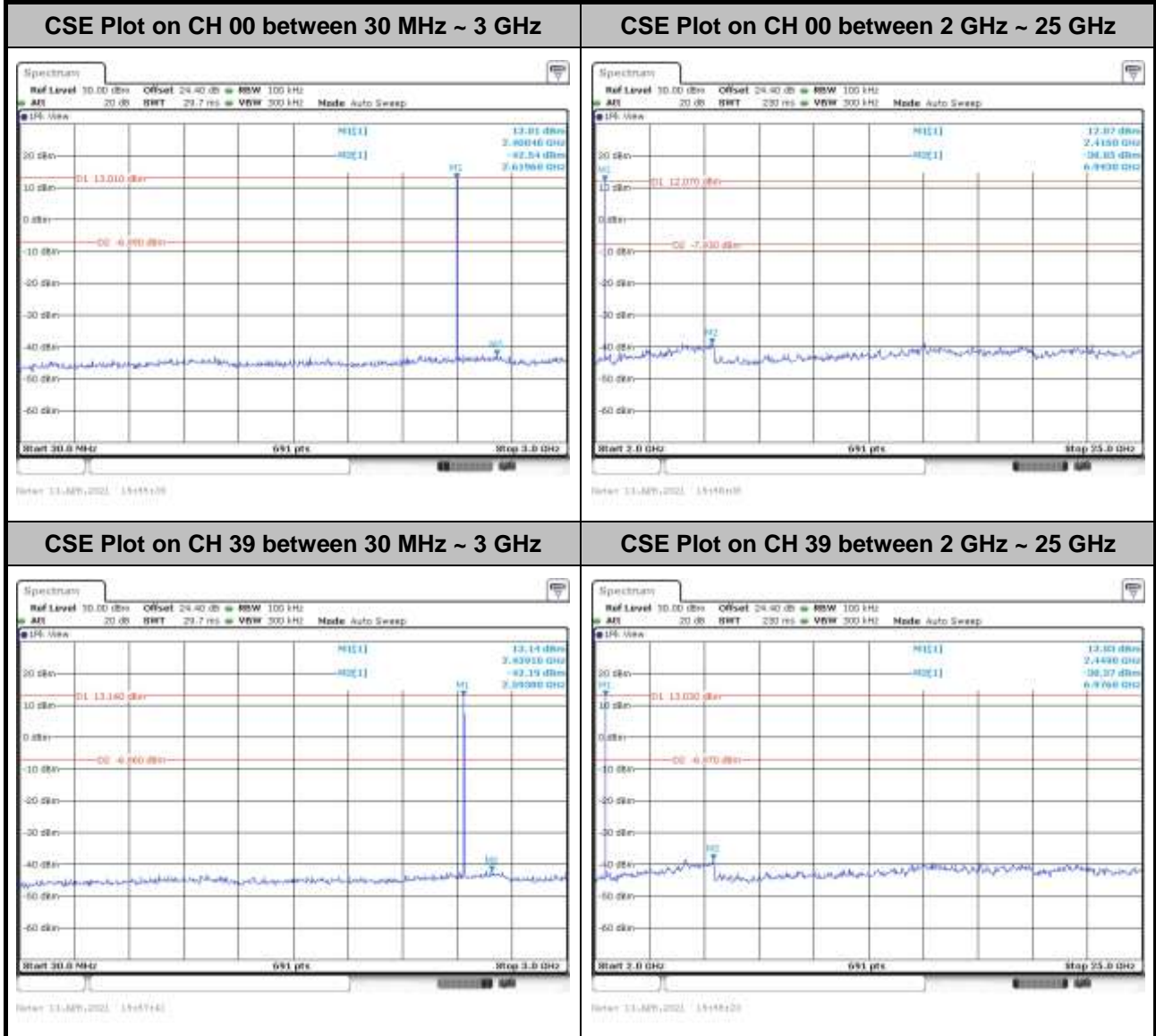



CSE Plot on CH 78 between 30 MHz ~ 3 GHz

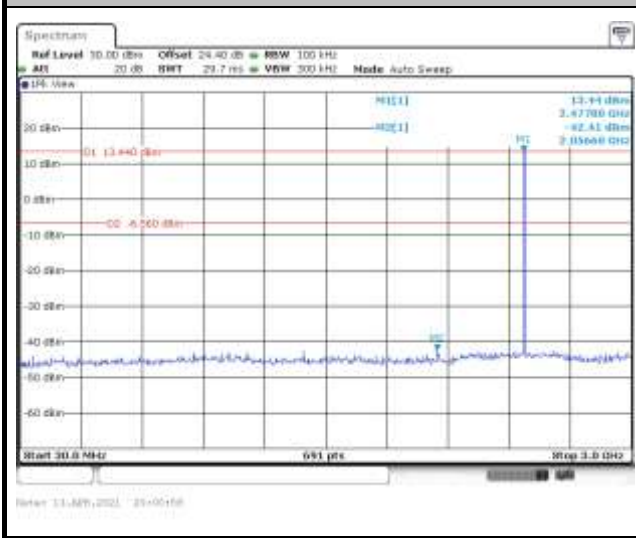

CSE Plot on CH 78 between 2 GHz ~ 25 GHz

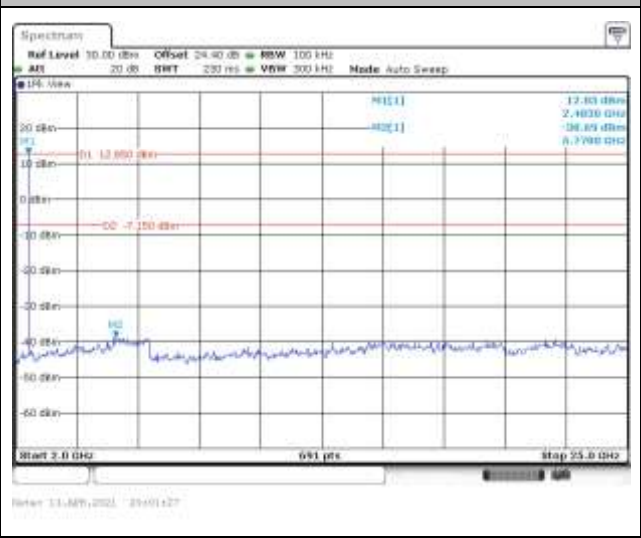



<2Mbps>

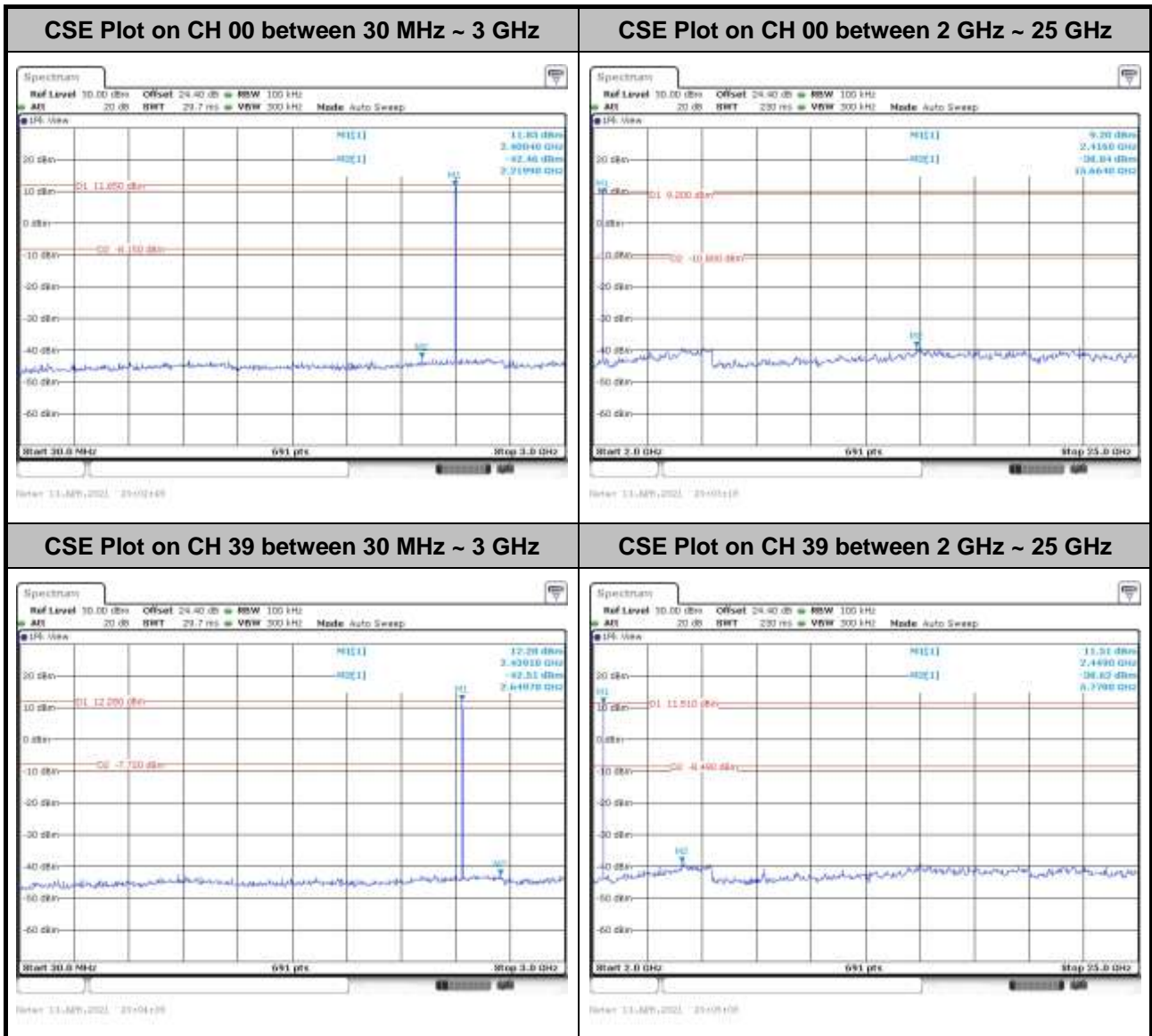

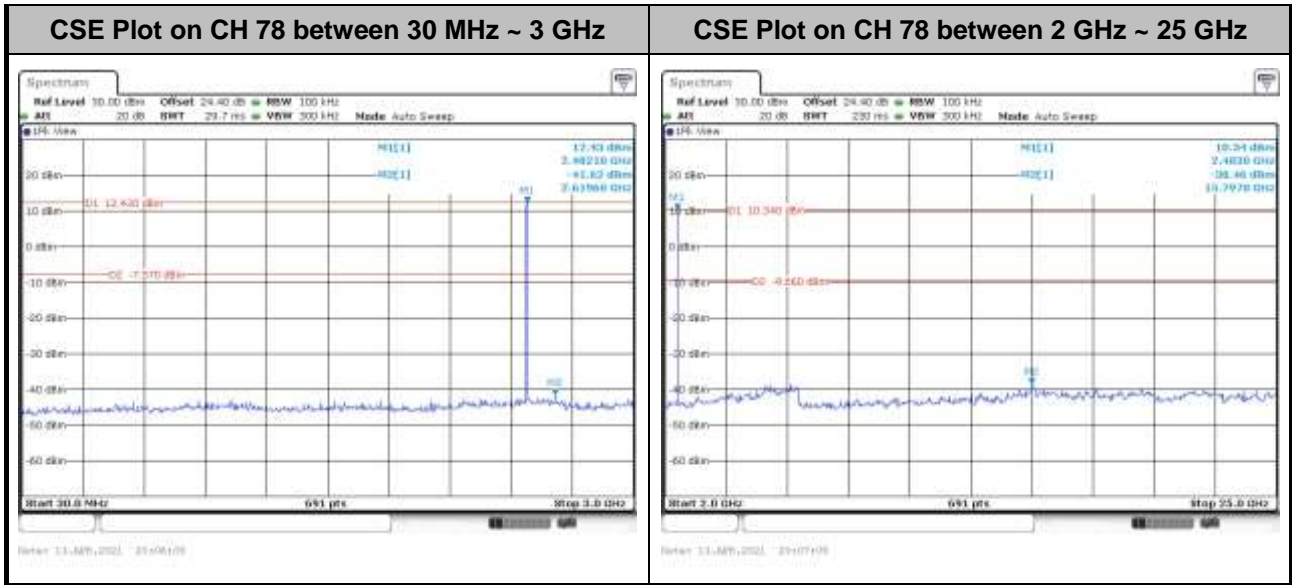



<3Mbps>

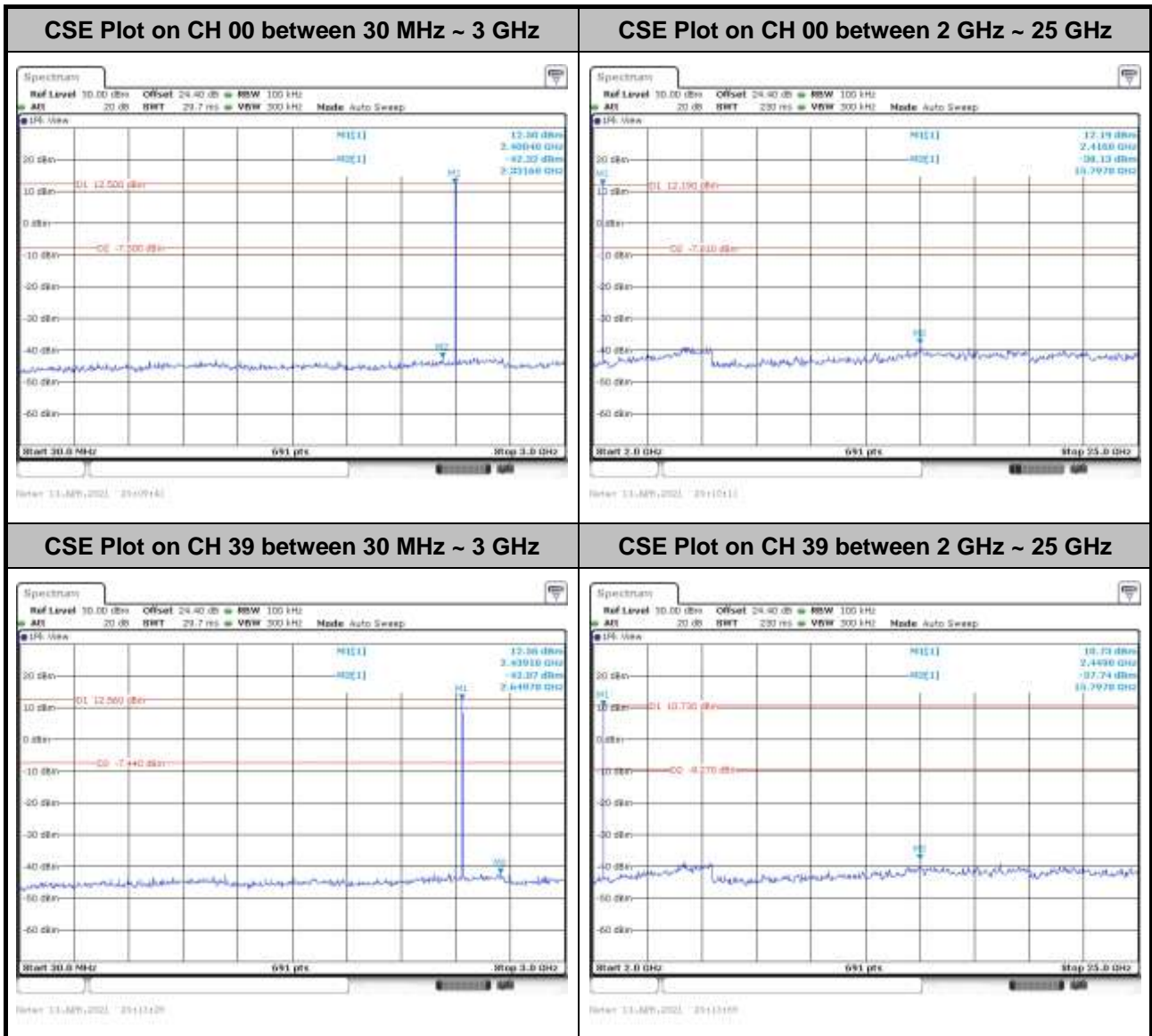

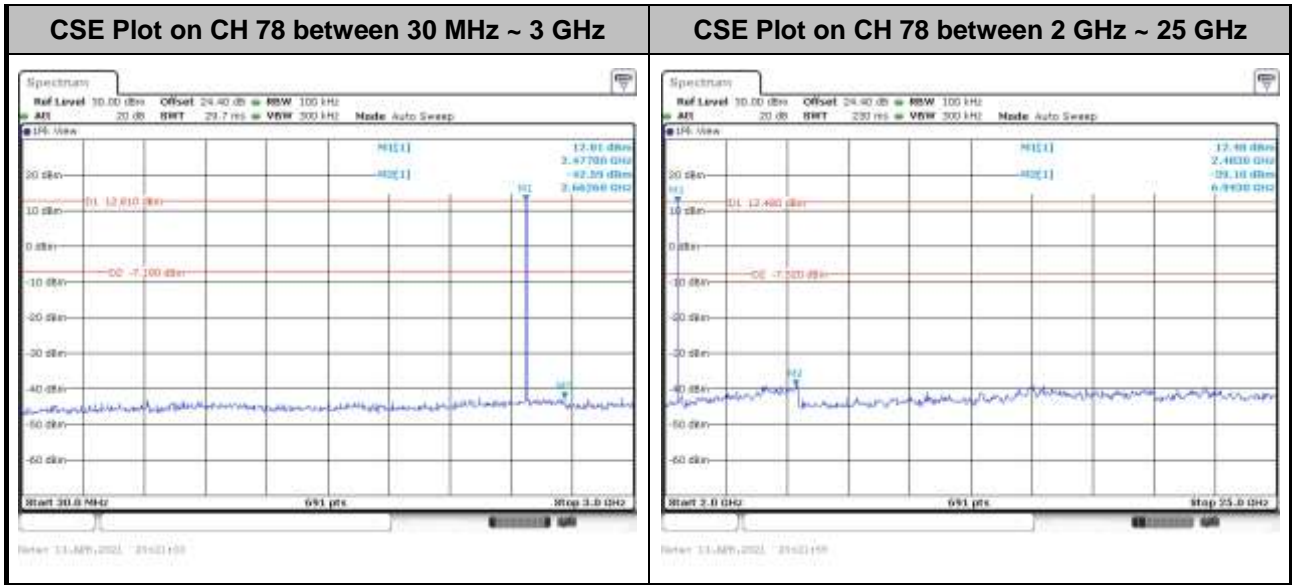



<Ant. 1>

<1Mbps>

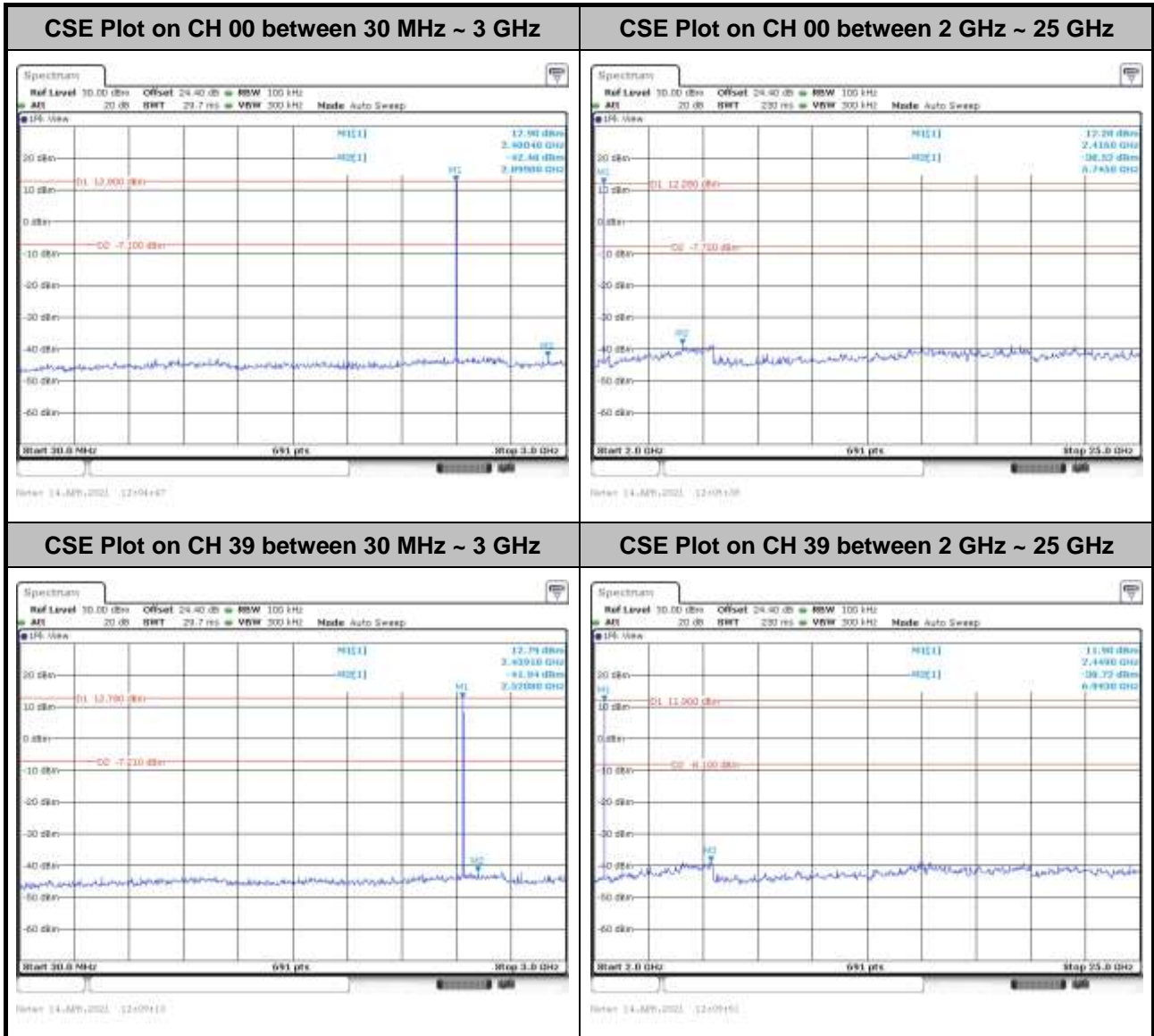

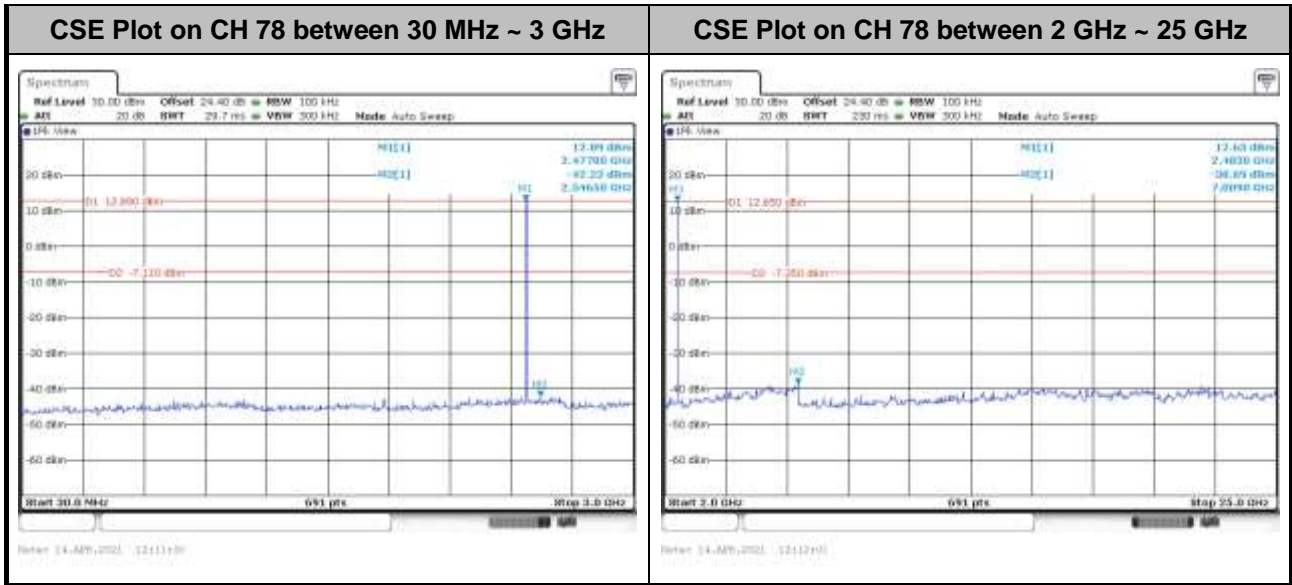



<2Mbps>

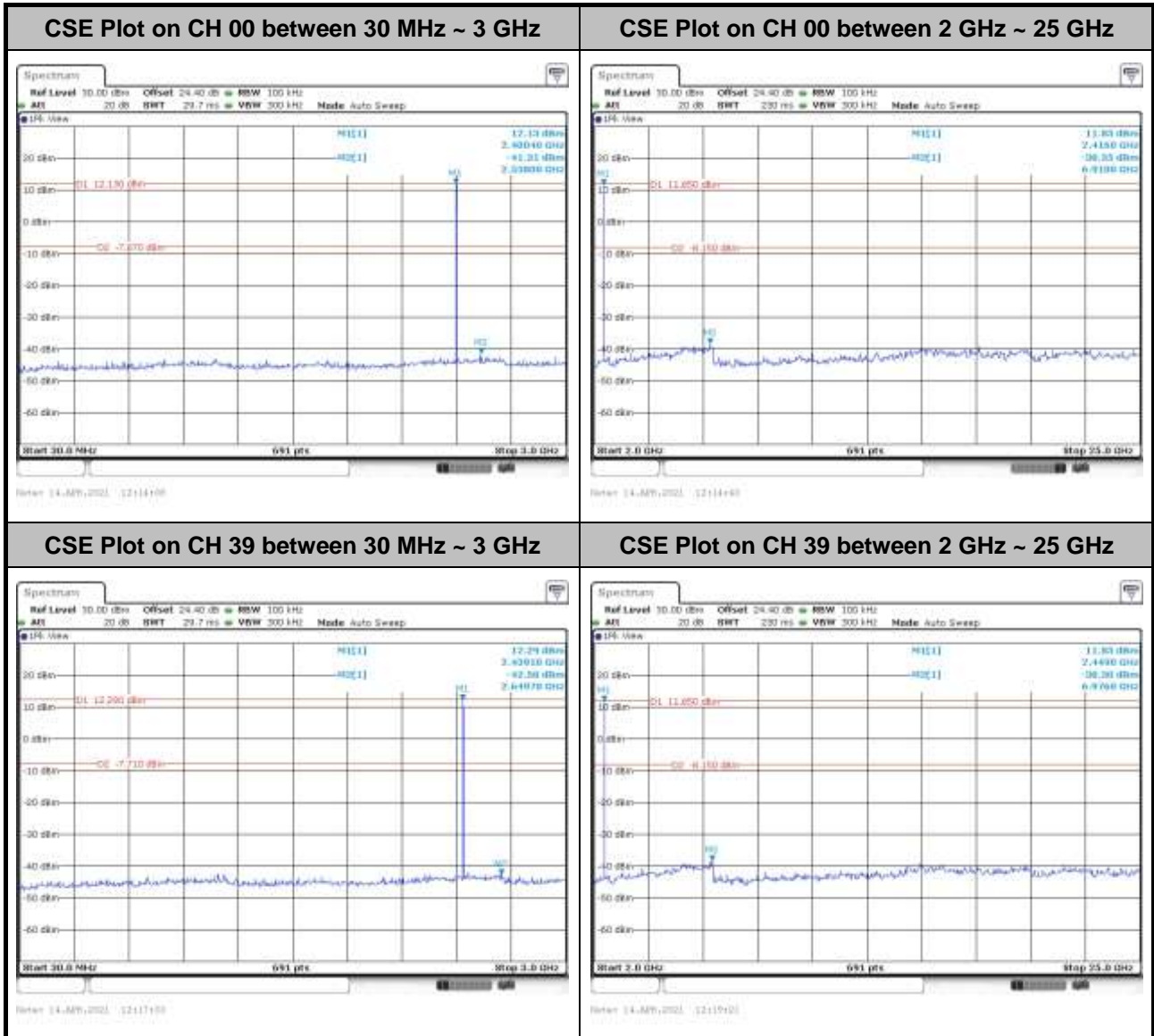



CSE Plot on CH 78 between 30 MHz ~ 3 GHz

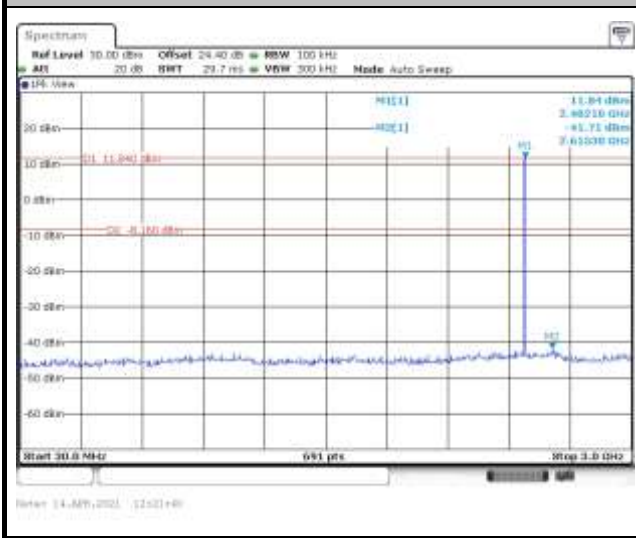

CSE Plot on CH 78 between 2 GHz ~ 25 GHz

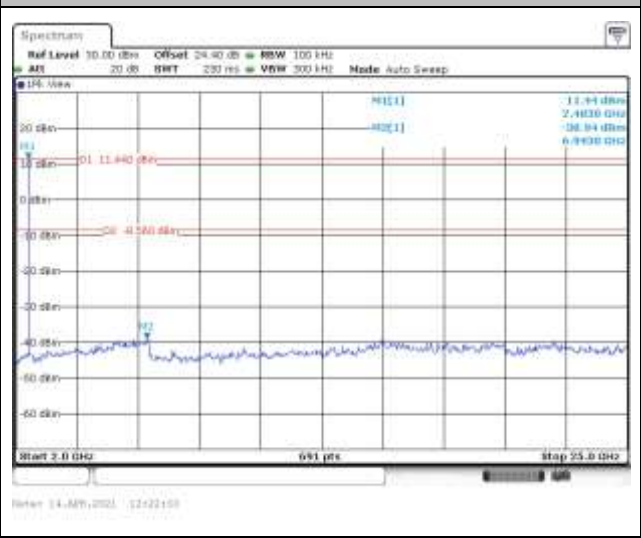



<3Mbps>

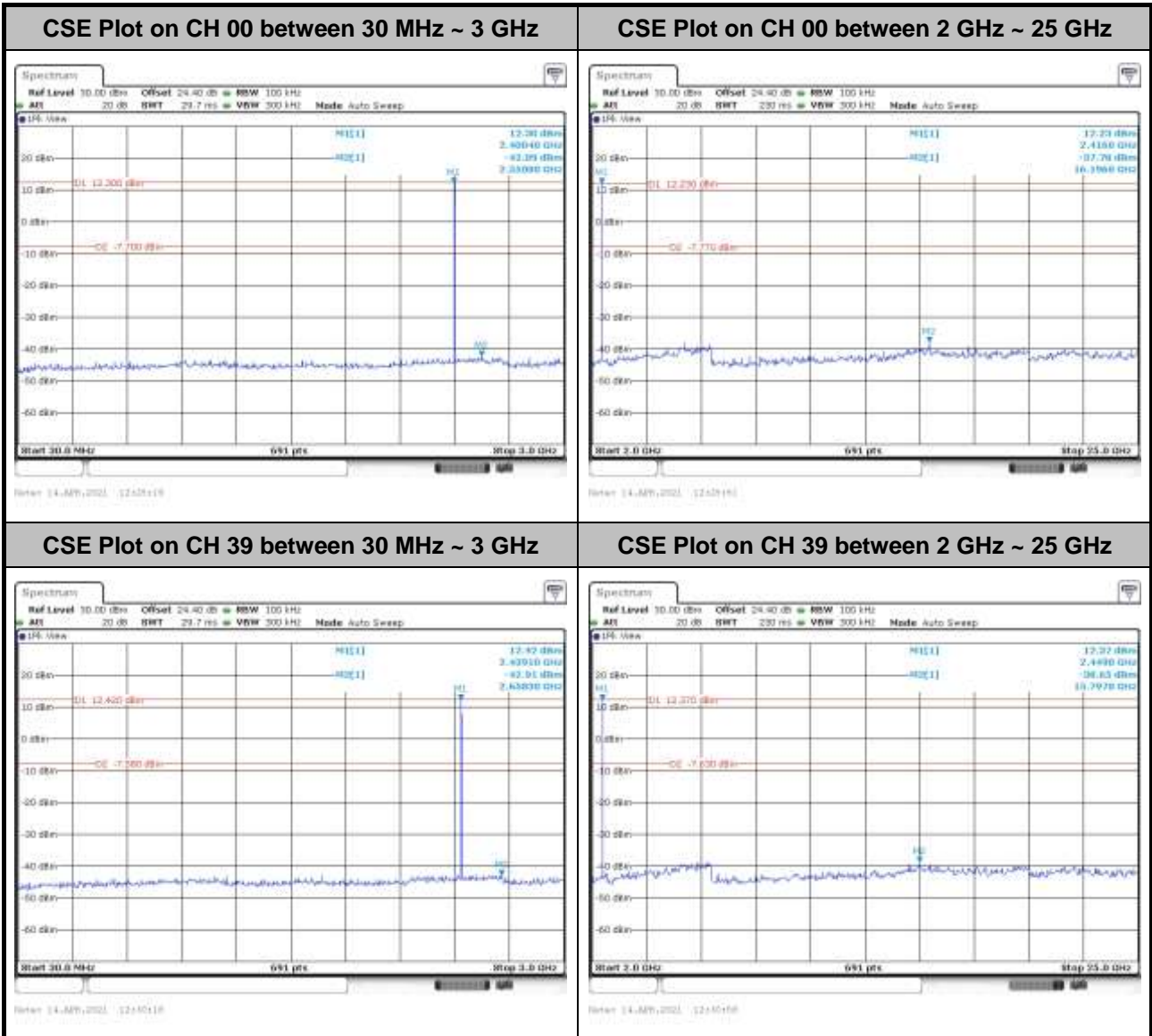

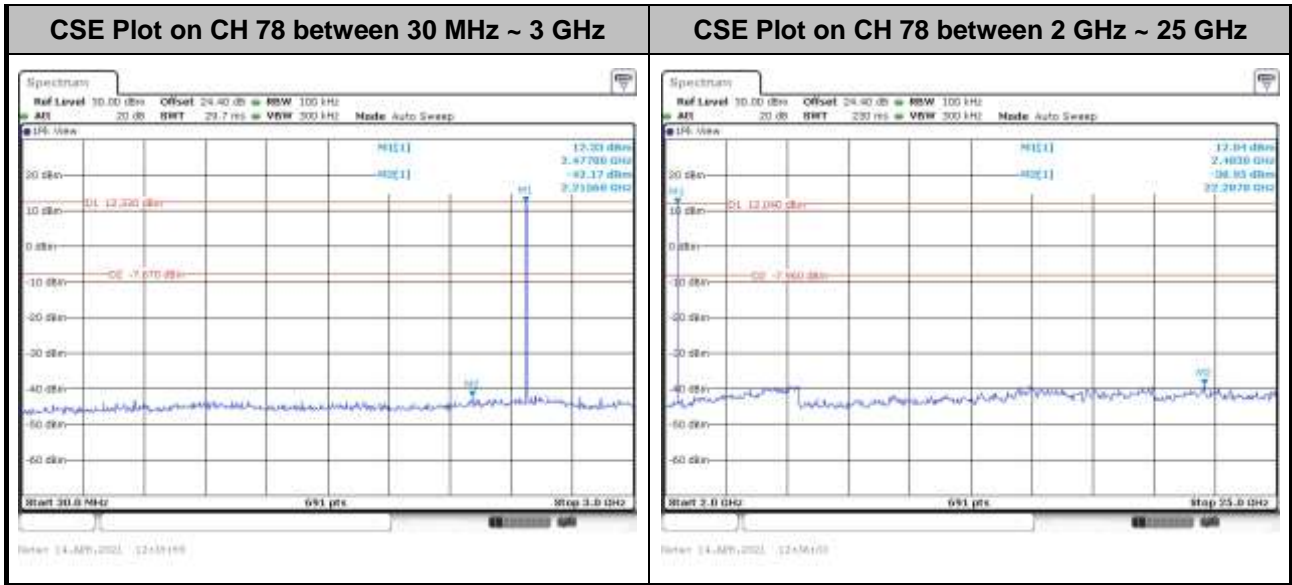



3.8 Radiated Band Edges and Spurious Emission Measurement

3.8.1 Limit of Radiated Band Edges and Spurious Emission

In any 100 kHz bandwidth outside the intentional radiator frequency band, all harmonics / spurious must be at least 20 dB below the highest emission level within the authorized band. In addition, radiated emissions which fall in the restricted bands must also comply with the limits as below.

Frequency (MHz)	Field Strength (microvolts/meter)	Measurement Distance (meters)
0.009 – 0.490	2400/F(kHz)	300
0.490 – 1.705	24000/F(kHz)	30
1.705 – 30.0	30	30
30 – 88	100	3
88 – 216	150	3
216 - 960	200	3
Above 960	500	3

3.8.2 Measuring Instruments

See list of measuring equipment of this test report.



3.8.3 Test Procedures

1. The EUT was placed on a turntable with 0.8 meter for frequency below 1 GHz and 1.5 meter for frequency above 1 GHz respectively above ground.
2. The EUT was set 3 meters from the interference receiving antenna, which was mounted on the top of a variable height antenna tower.
3. For each suspected emission, the EUT was arranged to its worst case and then tune the Antenna tower (from 1 m to 4 m) and turntable (from 0 degree to 360 degrees) to find the maximum reading. A pre-amp and a high pass filter are used for the test in order to get better signal level to comply with the guidelines.
4. Set the maximum power setting and enable the EUT to transmit continuously.
5. Use the following spectrum analyzer settings:
 - (1) Span shall wide enough to fully capture the emission being measured;
 - (2) Set RBW = 100 kHz for $f < 1$ GHz, RBW = 1 MHz for $f > 1$ GHz ; VBW \geq RBW; Sweep = auto; Detector function = peak; Trace = max hold for peak
 - (3) For average measurement: use duty cycle correction factor method per 15.35(c).
Duty cycle = On time/100 milliseconds
On time = $N_1 * L_1 + N_2 * L_2 + \dots + N_{n-1} * L_{n-1} + N_n * L_n$
Where N_1 is number of type 1 pulses, L_1 is length of type 1 pulses, etc.
Average Emission Level = Peak Emission Level + $20 * \log(\text{Duty cycle})$
6. Corrected Reading: Antenna Factor + Cable Loss + Read Level - Preamp Factor = Level
7. For testing below 1 GHz, if the emission level of the EUT in peak mode was 3 dB lower than the limit specified, then peak values of EUT will be reported, otherwise, the emissions will be repeated one by one using the CISPR quasi-peak method and reported.
8. For testing above 1 GHz, the emission level of the EUT in peak mode was 20 dB lower than average limit (that means the emission level in average mode also complies with the limit in average mode), then peak values of EUT will be reported, otherwise, the emissions will be measured in average mode again and reported.

Note: The average levels were calculated from the peak level corrected with duty cycle correction factor (-24.76dB) derived from $20 \log(\text{dwell time}/100\text{ms})$. This correction is only for signals that hop with the fundamental signal, such as band-edge and harmonic. Other spurious signals that are independent of the hopping signal would not use this correction.

3.8.4 Test Setup

For radiated test below 30MHz

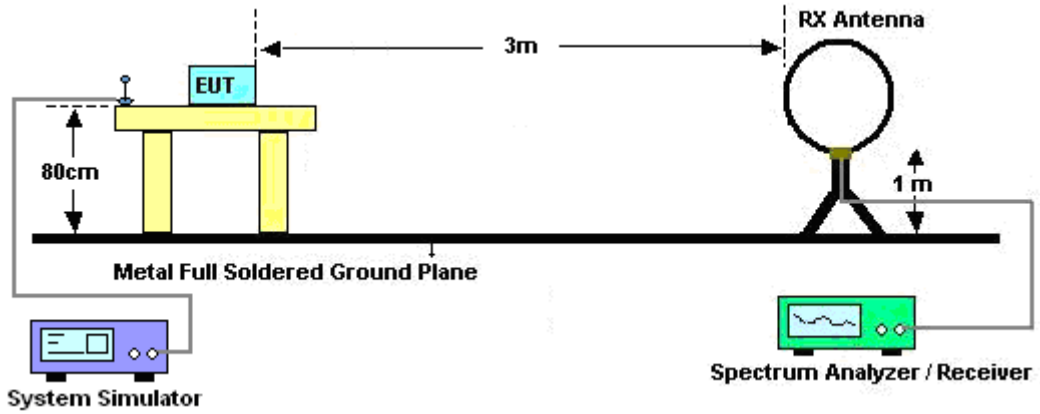

For radiated test from 30MHz to 1GHz

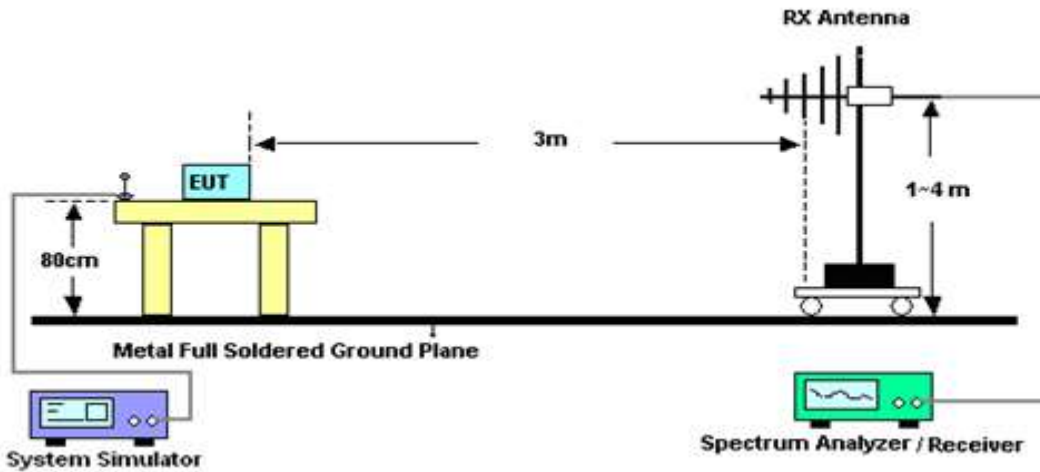

For radiated test from 1GHz to 18GHz

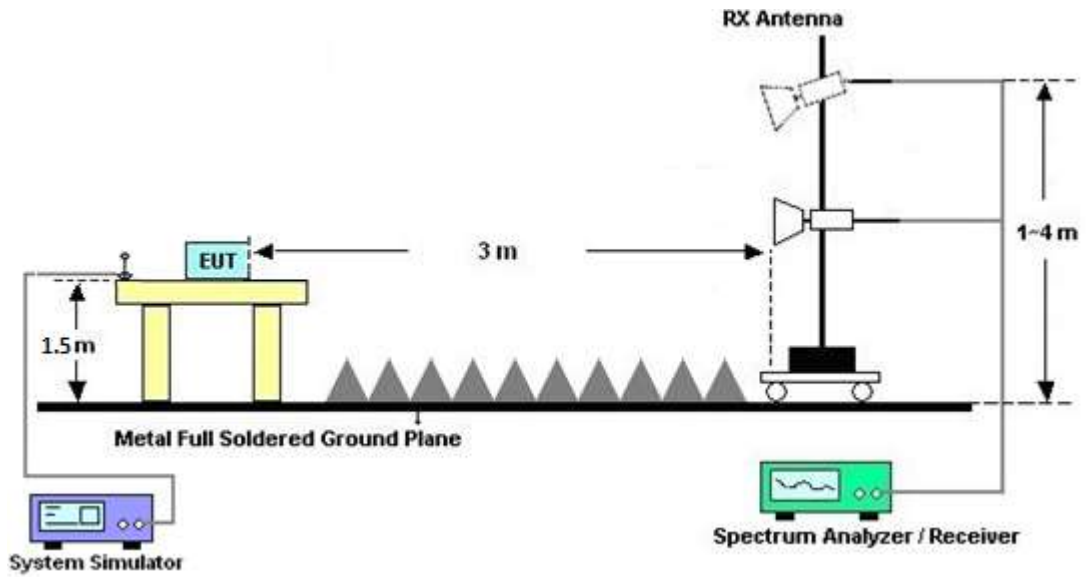

For radiated test above 18GHz

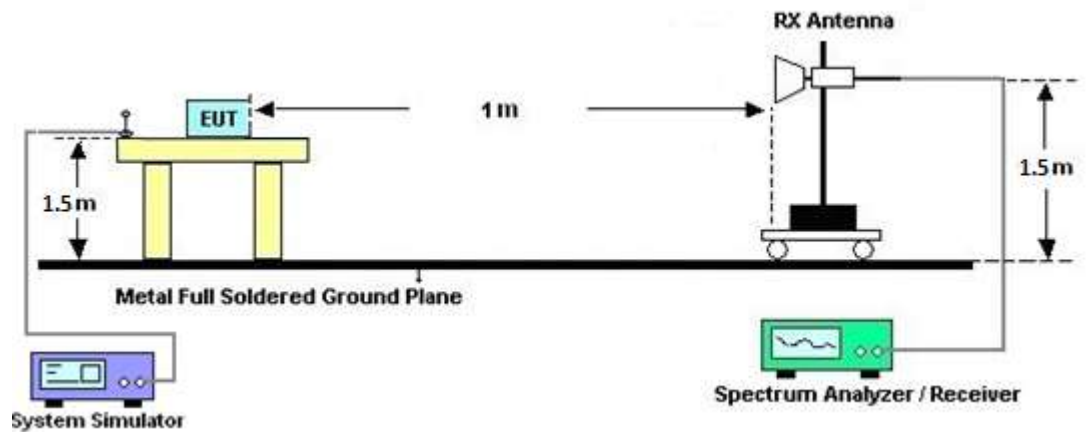



3.8.5 Test Results of Radiated Spurious Emissions (9 kHz ~ 30 MHz)

The low frequency, which started from 9 kHz to 30MHz, was pre-scanned and the result which was 20dB lower than the limit line was not reported.

There is a comparison data of both open-field test site and alternative test site - semi-Anechoic chamber according to 414788 D01 Radiated Test Site v01r01, and the result came out very similar.

3.8.6 Test Result of Radiated Spurious at Band Edges

Please refer to Appendix C and D.

3.8.7 Duty Cycle

Please refer to Appendix E.

3.8.8 Test Result of Radiated Spurious Emission (30MHz ~ 10th Harmonic)

Please refer to Appendix C and D.



3.9 AC Conducted Emission Measurement

3.9.1 Limit of AC Conducted Emission

For equipment that is designed to be connected to the public utility (AC) power line, the radio frequency voltage that is conducted back onto the AC power line on any frequency or frequencies within the band 150 kHz to 30 MHz shall not exceed the limits in the following table.

Frequency of emission (MHz)	Conducted limit (dBµV)	
	Quasi-peak	Average
0.15-0.5	66 to 56*	56 to 46*
0.5-5	56	46
5-30	60	50

*Decreases with the logarithm of the frequency.

3.9.2 Measuring Instruments

See list of measuring equipment of this test report.

3.9.3 Test Procedures

1. The EUT was placed 0.4 meter from the conducting wall of the shielding room was kept at least 80 centimeters from any other grounded conducting surface.
2. Connect EUT to the power mains through a line impedance stabilization network (LISN).
3. All the support units are connecting to the other LISN.
4. The LISN provides 50 ohm coupling impedance for the measuring instrument.
5. The FCC states that a 50 ohm, 50 microhenry LISN shall be used.
6. Both sides of AC line were checked for maximum conducted interference.
7. The frequency range from 150 kHz to 30 MHz was searched.
8. Set the test-receiver system to Peak Detect Function and specified bandwidth (IF Bandwidth = 9kHz) with Maximum Hold Mode. Then measurement is also conducted by Average Detector and Quasi-Peak Detector Function respectively.

3.9.4 Test Setup

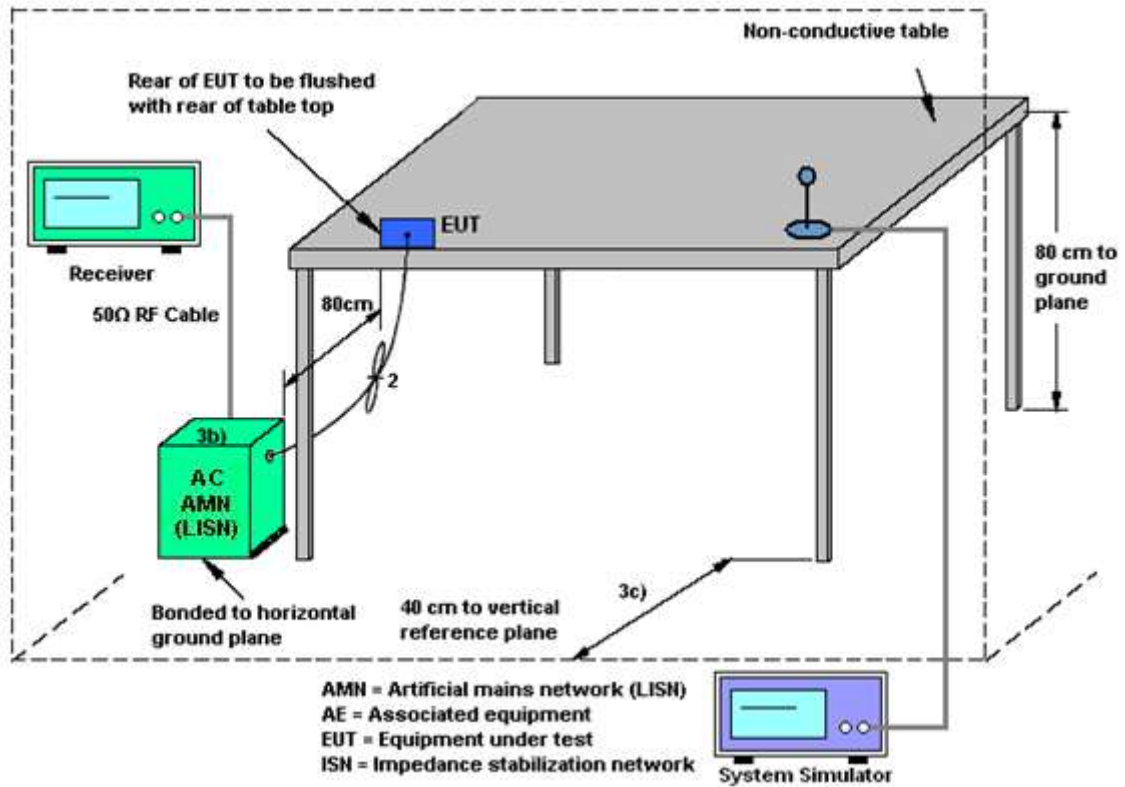

3.9.5 Test Result of AC Conducted Emission

Please refer to Appendix B.



3.10 Antenna Requirements

3.10.1 Standard Applicable

If directional gain of transmitting antennas is greater than 6 dBi, the power shall be reduced by the same level in dB comparing to gain minus 6 dBi. The use of a permanently attached antenna or of an antenna that uses a unique coupling to the intentional radiator shall be considered sufficient to comply with the rule.

3.10.2 Antenna Anti-Replacement Construction

An embedded-in antenna design is used.

3.10.3 Antenna Gain

The antenna peak gain of EUT is less than 6 dBi. Therefore, it is not necessary to reduce maximum peak output power limit.



4 List of Measuring Equipment

Instrument	Brand Name	Model No.	Serial No.	Characteristics	Calibration Date	Test Date	Due Date	Remark
Loop Antenna	Rohde & Schwarz	HFH2-Z2	100488	9 kHz~30 MHz	Jul. 14, 2020	Apr. 08, 2021~ Apr. 13, 2021	Jul. 13, 2021	Radiation (03CH15-HY)
Bilog Antenna	TESEQ	CBL 6111D & 00800N1D01 N-06	41912 & 05	30MHz~1GHz	Feb. 08, 2021	Apr. 08, 2021~ Apr. 13, 2021	Feb. 07, 2022	Radiation (03CH15-HY)
Amplifier	SONOMA	310N	363440	9kHz~1GHz	Dec. 28, 2020	Apr. 08, 2021~ Apr. 13, 2021	Dec. 27, 2021	Radiation (03CH15-HY)
Horn Antenna	SCHWARZBE CK	BBHA 9120 D	9120D-016 20	1GHz~18GHz	Nov. 03, 2020	Apr. 08, 2021~ Apr. 13, 2021	Nov. 02, 2021	Radiation (03CH15-HY)
SHF-EHF Horn Antenna	SCHWARZBE CK	BBHA 9170	BBHA9170 251	18GHz~40GHz	Dec. 02, 2020	Apr. 08, 2021~ Apr. 13, 2021	Dec. 01, 2021	Radiation (03CH15-HY)
Preamplifier	Jet-Power	JPA0118-55-3 03	171000180 0055006	1GHz~18GHz	May 07, 2020	Apr. 08, 2021~ Apr. 13, 2021	May 06, 2021	Radiation (03CH15-HY)
Preamplifier	Keysight	83017A	MY532701 95	1GHz~26.5GHz	Aug. 21, 2020	Apr. 08, 2021~ Apr. 13, 2021	Aug. 20, 2021	Radiation (03CH15-HY)
Preamplifier	EMEC	EM18G40G	0600789	18-40GHz	Oct. 27, 2020	Apr. 08, 2021~ Apr. 13, 2021	Oct. 26, 2021	Radiation (03CH15-HY)
EMI Test Receiver	Keysight	N9038A (MXE)	MY541300 85	20MHz~8.4GHz	Nov. 02, 2020	Apr. 08, 2021~ Apr. 13, 2021	Nov. 01, 2021	Radiation (03CH15-HY)
Spectrum Analyzer	Agilent	E4446A	MY501801 36	3Hz~44GHz	May 04, 2020	Apr. 08, 2021~ Apr. 13, 2021	May 03, 2021	Radiation (03CH15-HY)
Antenna Mast	ChainTek	MBS-520-1	N/A	1m~4m	N/A	Apr. 08, 2021~ Apr. 13, 2021	N/A	Radiation (03CH15-HY)
Turn Table	ChainTek	T-200-S-1	N/A	0~360 Degree	N/A	Apr. 08, 2021~ Apr. 13, 2021	N/A	Radiation (03CH15-HY)
Software	Audix	E3 6.2009-8-24 (k5)	RK-00045 1	N/A	N/A	Apr. 08, 2021~ Apr. 13, 2021	N/A	Radiation (03CH15-HY)
RF Cable	HUBER + SUHNER	SUCOFLEX 104, 102E	MY36980/ 4, MY9838/4 PE,508405 /2E	30MHz~18G	Nov. 16, 2020	Apr. 08, 2021~ Apr. 13, 2021	Nov. 15, 2021	Radiation (03CH15-HY)
RF Cable	HUBER + SUHNER	SUCOFLEX 102	505134/2	30MHz-40GHz	Feb. 22, 2021	Apr. 08, 2021~ Apr. 13, 2021	Feb. 21, 2022	Radiation (03CH15-HY)
RF Cable	HUBER + SUHNER	SUCOFLEX 102	800740/2	30MHz-40GHz	Feb. 22, 2021	Apr. 08, 2021~ Apr. 13, 2021	Feb. 21, 2022	Radiation (03CH15-HY)
RF Cable	HUBER + SUHNER	SUCOFLEX 104	MY9837/4 PE	9kHz~30MHz	Mar. 11, 2021	Apr. 08, 2021~ Apr. 13, 2021	Mar. 10, 2022	Radiation (03CH15-HY)
Filter	Wainwright	WLJ4-1000-1 530-6000-40S T	SN4	1.53GHz Low Pass Filter	Jul. 03, 2020	Apr. 08, 2021~ Apr. 13, 2021	Jul. 02, 2021	Radiation (03CH15-HY)
Filter	Wainwright	WHKX12-270 0-3000-18000 -60ST	SN4	3GHz High Pass Filter	Sep. 16, 2020	Apr. 08, 2021~ Apr. 13, 2021	Sep. 15, 2021	Radiation (03CH15-HY)



Instrument	Brand Name	Model No.	Serial No.	Characteristics	Calibration Date	Test Date	Due Date	Remark
Hygrometer	Testo	608-H1	34893241	N/A	Mar. 02, 2021	Mar. 30. 2021~ Apr. 14. 2021	Mar. 01, 2022	Conducted (TH02-HY)
Power Meter	Agilent	E4416A	GB41292344	N/A	Jan. 14, 2021	Mar. 30. 2021~ Apr. 14. 2021	Jan. 13, 2022	Conducted (TH02-HY)
Power Sensor	Agilent	E9327A	US40441548	50MHz~18GHz	Jan. 14, 2021	Mar. 30. 2021~ Apr. 14. 2021	Jan. 13, 2022	Conducted (TH02-HY)
Signal Analyzer	Rohde & Schwarz	FSV40	101566	10Hz ~ 40GHz	Jul. 22, 2020	Mar. 30. 2021~ Apr. 14. 2021	Jul. 21, 2021	Conducted (TH02-HY)
BT Base Station	Rohde & Schwarz	CBT	101135	BT 3.0	Sep. 15, 2020	Mar. 30. 2021~ Apr. 14. 2021	Sep. 14, 2022	Conducted (TH02-HY)
Switch Box & RF Cable	EM Electronics	EMSW18SE	SW200302	N/A	Mar. 17, 2021	Mar. 30. 2021~ Apr. 14. 2021	Mar. 16, 2022	Conducted (TH02-HY)
AC Power Source	ChainTek	APC-1000W	N/A	N/A	N/A	Apr. 08, 2021	N/A	Conduction (CO05-HY)
EMI Test Receiver	Rohde & Schwarz	ESR3	102388	9kHz~3.6GHz	Nov. 30, 2020	Apr. 08, 2021	Nov. 29, 2021	Conduction (CO05-HY)
Hygrometer	Testo	608-H1	34913912	N/A	Nov. 18, 2020	Apr. 08, 2021	Nov. 17, 2021	Conduction (CO05-HY)
LISN	Rohde & Schwarz	ENV216	100080	9kHz~30MHz	Dec. 01, 2020	Apr. 08, 2021	Nov. 30, 2021	Conduction (CO05-HY)
LISN	Rohde & Schwarz	ENV216	100081	9kHz~30MHz	Nov. 16, 2020	Apr. 08, 2021	Nov. 15, 2021	Conduction (CO05-HY)
Software	Rohde & Schwarz	EMC32 V10.30	N/A	N/A	N/A	Apr. 08, 2021	N/A	Conduction (CO05-HY)
Pulse Limiter	Rohde & Schwarz	ESH3-Z2	100851	N/A	Feb. 25, 2021	Apr. 08, 2021	Feb. 24, 2022	Conduction (CO05-HY)
LISN Cable	MVE	RG-400	260260	N/A	Dec. 31, 2020	Apr. 08, 2021	Dec. 30, 2021	Conduction (CO05-HY)



5 Uncertainty of Evaluation

Uncertainty of Conducted Emission Measurement (150 kHz ~ 30 MHz)

Measuring Uncertainty for a Level of Confidence of 95% ($U = 2Uc(y)$)	2.3
---	-----

Uncertainty of Radiated Emission Measurement (30 MHz ~ 1000 MHz)

Measuring Uncertainty for a Level of Confidence of 95% ($U = 2Uc(y)$)	4.7
---	-----

Uncertainty of Radiated Emission Measurement (1000 MHz ~ 18000 MHz)

Measuring Uncertainty for a Level of Confidence of 95% ($U = 2Uc(y)$)	5.3
---	-----

Uncertainty of Radiated Emission Measurement (18000 MHz ~ 40000 MHz)

Measuring Uncertainty for a Level of Confidence of 95% ($U = 2Uc(y)$)	4.9
---	-----

Appendix A. Test Result of Conducted Test Items

Test Engineer:	Eason Huang	Temperature:	21~25	°C
Test Date:	2021/3/30~2021/4/14	Relative Humidity:	51~54	%

<Ant. 0>

TEST RESULTS DATA									
20dB and 99% Occupied Bandwidth and Hopping Channel Separation									
Mod.	Data Rate	NTX	CH.	Freq. (MHz)	20db BW (MHz)	99% Bandwidth (MHz)	Hopping Channel Separation Measurement (MHz)	Hopping Channel Separation Measurement Limit (MHz)	Pass/Fail
DH	1Mbps	1	0	2402	0.892	0.822	1.003	0.5943	Pass
DH	1Mbps	1	39	2441	0.892	0.825	1.003	0.5943	Pass
DH	1Mbps	1	78	2480	0.892	0.828	1.003	0.5943	Pass
2DH	2Mbps	1	0	2402	1.285	1.166	1.003	0.8567	Pass
2DH	2Mbps	1	39	2441	1.285	1.166	0.999	0.8567	Pass
2DH	2Mbps	1	78	2480	1.281	1.166	0.999	0.8539	Pass
3DH	3Mbps	1	0	2402	1.233	1.149	0.999	0.8220	Pass
3DH	3Mbps	1	39	2441	1.233	1.146	1.003	0.8220	Pass
3DH	3Mbps	1	78	2480	1.233	1.151	1.003	0.8220	Pass

TEST RESULTS DATA						
Dwell Time						
Mod.	Hopping Channel Number Rate	Hops Over Occupancy Time(hops)	Package Transfer Time (msec)	Dwell Time (sec)	Limits (sec)	Pass/Fail
Nomal	79	106.67	2.88	0.31	0.4	Pass
AFH	20	53.33	2.88	0.15	0.4	Pass

TEST RESULTS DATA					
Peak Power Table					
DH	CH.	NTX	Peak Power (dBm)	Power Limit (dBm)	Test Result
DH1	0	1	13.43	20.97	Pass
	39	1	13.34	20.97	Pass
	78	1	13.54	20.97	Pass
2DH1	0	1	14.64	20.97	Pass
	39	1	14.44	20.97	Pass
	78	1	14.71	20.97	Pass
3DH1	0	1	14.93	20.97	Pass
	39	1	14.79	20.97	Pass
	78	1	14.99	20.97	Pass

TEST RESULTS DATA				
Average Power Table (Reporting Only)				
DH	CH.	NTX	Average Power (dBm)	Duty Factor (dB)
DH1	0	1	13.14	5.20
	39	1	13.08	5.20
	78	1	13.33	5.20
2DH1	0	1	12.16	5.20
	39	1	12.04	5.20
	78	1	12.37	5.20
3DH1	0	1	12.18	5.20
	39	1	12.06	5.20
	78	1	12.39	5.20

TEST RESULTS DATA			
Number of Hopping Frequency			
Number of Hopping (Channel)	Adaptive Frequency Hopping (Channel)	Limits (Channel)	Pass/Fail
79	20	> 15	Pass

<Ant. 1>

TEST RESULTS DATA									
20dB and 99% Occupied Bandwidth and Hopping Channel Separation									
Mod.	Data Rate	NTX	CH.	Freq. (MHz)	20db BW (MHz)	99% Bandwidth (MHz)	Hopping Channel Separation Measurement (MHz)	Hopping Channel Separation Measurement Limit (MHz)	Pass/Fail
DH	1Mbps	1	0	2402	0.915	0.825	0.999	0.6097	Pass
DH	1Mbps	1	39	2441	0.892	0.825	0.999	0.5943	Pass
DH	1Mbps	1	78	2480	0.894	0.828	0.999	0.5963	Pass
2DH	2Mbps	1	0	2402	1.285	1.166	0.999	0.8567	Pass
2DH	2Mbps	1	39	2441	1.285	1.166	0.999	0.8567	Pass
2DH	2Mbps	1	78	2480	1.285	1.166	0.999	0.8567	Pass
3DH	3Mbps	1	0	2402	1.233	1.149	1.003	0.8220	Pass
3DH	3Mbps	1	39	2441	1.233	1.146	0.999	0.8220	Pass
3DH	3Mbps	1	78	2480	1.233	1.151	0.999	0.8220	Pass

TEST RESULTS DATA						
Dwell Time						
Mod.	Hopping Channel Number Rate	Hops Over Occupancy Time(hops)	Package Transfer Time (msec)	Dwell Time (sec)	Limits (sec)	Pass/Fail
Nomal	79	106.67	2.90	0.31	0.4	Pass
AFH	20	53.33	2.90	0.15	0.4	Pass

TEST RESULTS DATA					
Peak Power Table					
DH	CH.	NTX	Peak Power (dBm)	Power Limit (dBm)	Test Result
DH1	0	1	13.17	20.97	Pass
	39	1	13.30	20.97	Pass
	78	1	13.20	20.97	Pass
2DH1	0	1	14.20	20.97	Pass
	39	1	14.32	20.97	Pass
	78	1	14.21	20.97	Pass
3DH1	0	1	14.54	20.97	Pass
	39	1	14.70	20.97	Pass
	78	1	14.56	20.97	Pass

TEST RESULTS DATA				
Average Power Table				
(Reporting Only)				
DH	CH.	NTX	Average Power (dBm)	Duty Factor (dB)
DH1	0	1	12.82	5.18
	39	1	13.03	5.18
	78	1	12.84	5.18
2DH1	0	1	11.80	5.12
	39	1	11.95	5.12
	78	1	11.82	5.12
3DH1	0	1	11.85	5.14
	39	1	11.99	5.14
	78	1	11.87	5.14

TEST RESULTS DATA			
Number of Hopping Frequency			
Number of Hopping (Channel)	Adaptive Frequency Hopping (Channel)	Limits (Channel)	Pass/Fail
79	20	> 15	Pass



Appendix B. AC Conducted Emission Test Results

Test Engineer :	Tom Lee	Temperature :	23~26°C
		Relative Humidity :	40~50%

EUT Information

Report NO : 132425
 Test Mode : Mode 1
 Test Voltage : 120Vac/60Hz
 Phase : Line

Full Spectrum

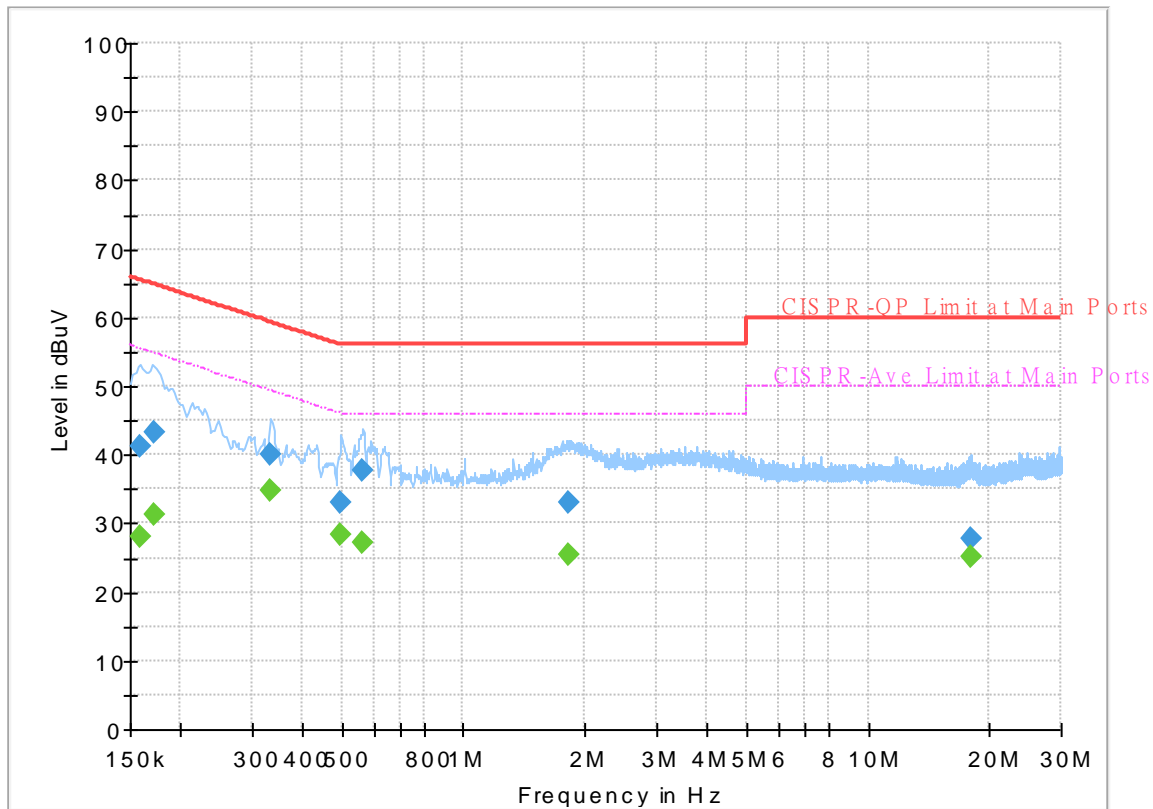

Final_Result

Frequency (MHz)	QuasiPeak (dBuV)	CAverage (dBuV)	Limit (dBuV)	Margin (dB)	Line	Filter	Corr. (dB)
0.159000	---	28.19	55.52	27.33	L1	OFF	19.7
0.159000	41.09	---	65.52	24.43	L1	OFF	19.7
0.172500	---	31.35	54.84	23.49	L1	OFF	19.7
0.172500	43.17	---	64.84	21.67	L1	OFF	19.7
0.334500	---	34.71	49.34	14.63	L1	OFF	19.7
0.334500	39.96	---	59.34	19.38	L1	OFF	19.7
0.498750	---	28.49	46.02	17.53	L1	OFF	19.9
0.498750	33.08	---	56.02	22.94	L1	OFF	19.9
0.564000	---	27.34	46.00	18.66	L1	OFF	19.9
0.564000	37.64	---	56.00	18.36	L1	OFF	19.9
1.826250	---	25.53	46.00	20.47	L1	OFF	20.2
1.826250	33.18	---	56.00	22.82	L1	OFF	20.2
18.044250	---	25.13	50.00	24.87	L1	OFF	20.5
18.044250	27.68	---	60.00	32.32	L1	OFF	20.5

EUT Information

Report NO : 132425
 Test Mode : Mode 1
 Test Voltage : 120Vac/60Hz
 Phase : Neutral

Full Spectrum

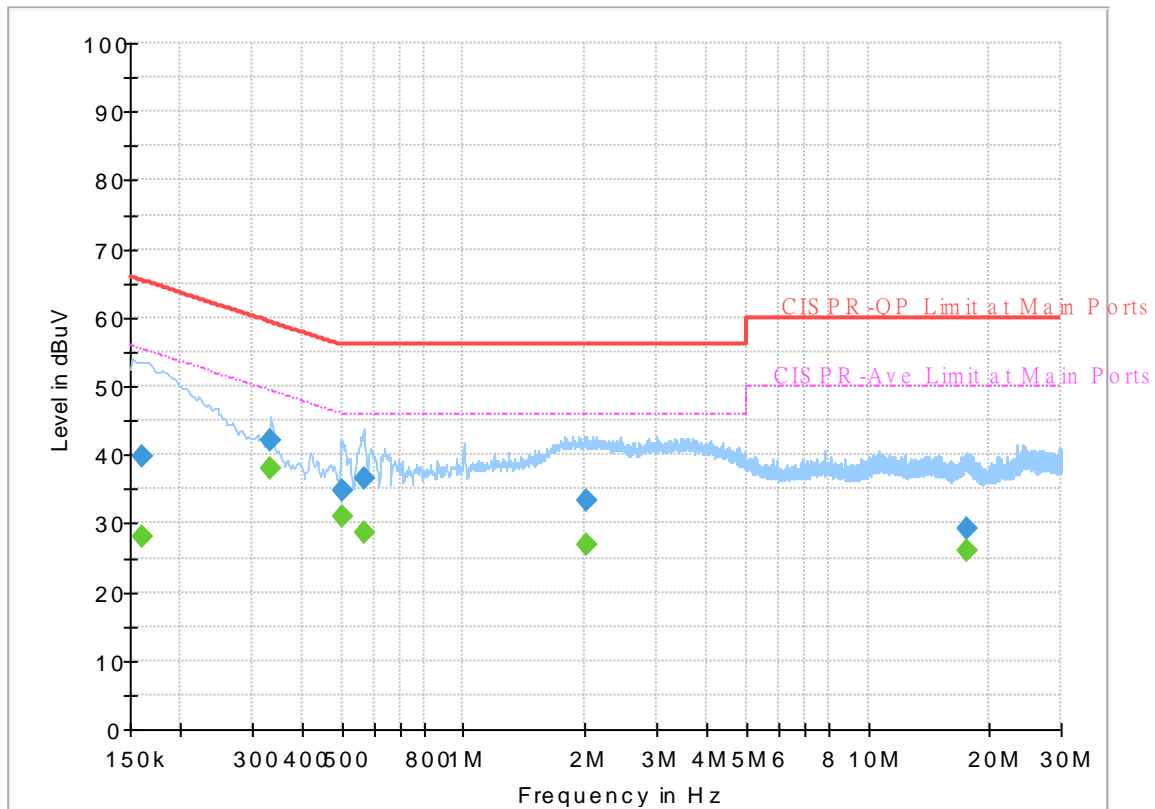

Final_Result

Frequency (MHz)	QuasiPeak (dBuV)	CAverage (dBuV)	Limit (dBuV)	Margin (dB)	Line	Filter	Corr. (dB)
0.161250	---	27.98	55.40	27.42	N	OFF	19.7
0.161250	39.79	---	65.40	25.61	N	OFF	19.7
0.334500	---	37.95	49.34	11.39	N	OFF	19.8
0.334500	42.19	---	59.34	17.15	N	OFF	19.8
0.501000	---	30.95	46.00	15.05	N	OFF	19.9
0.501000	34.86	---	56.00	21.14	N	OFF	19.9
0.566250	---	28.76	46.00	17.24	N	OFF	20.0
0.566250	36.64	---	56.00	19.36	N	OFF	20.0
2.008500	---	26.86	46.00	19.14	N	OFF	20.2
2.008500	33.46	---	56.00	22.54	N	OFF	20.2
17.553750	---	26.15	50.00	23.85	N	OFF	20.6
17.553750	29.15	---	60.00	30.85	N	OFF	20.6



Appendix C. Radiated Spurious Emission

Test Engineer :	Leo Lee, Mancy Chou and Bigshow Wang	Temperature :	22.5~23.5°C
		Relative Humidity :	45~55%

<Ant. 0>
<1Mbps>

2.4GHz 2400~2483.5MHz

BT (Band Edge @ 3m)

BT Ant	Note	Frequency (MHz)	Level (dBμV/m)	Over Limit (dB)	Limit Line (dBμV/m)	Read Level (dBμV)	Antenna Factor (dB/m)	Path Loss (dB)	Preamp Factor (dB)	Ant Pos (cm)	Table Pos (deg)	Peak Avg. (P/A)	Pol. (H/V)
BT CH00 2402MHz		2349.27	45.22	-28.78	74	41.87	27.7	6.58	30.93	100	216	P	H
		2349.27	20.43	-33.57	54	-	-	-	-	-	-	A	H
	*	2402	102.01	-	-	98.76	27.5	6.66	30.91	100	216	P	H
	*	2402	77.22	-	-	-	-	-	-	-	-	A	H
		2318.19	45.49	-28.51	74	42.15	27.76	6.53	30.95	392	268	P	V
		2318.19	20.7	-33.3	54	-	-	-	-	-	-	A	V
	*	2402	99.53	-	-	96.28	27.5	6.66	30.91	392	268	P	V
	*	2402	74.74	-	-	-	-	-	-	-	-	A	V
BT CH 39 2441MHz		2386.86	45.93	-28.07	74	42.66	27.55	6.64	30.92	100	215	P	H
		2386.86	21.14	-32.86	54	-	-	-	-	-	-	A	H
	*	2441	101.8	-	-	98.48	27.5	6.72	30.9	100	215	P	H
	*	2441	77.01	-	-	-	-	-	-	-	-	A	H
		2493.98	45.15	-28.85	74	41.8	27.41	6.81	30.87	100	215	P	H
		2493.98	20.36	-33.64	54	-	-	-	-	-	-	A	H
		2325.4	45.44	-28.56	74	42.09	27.75	6.54	30.94	375	272	P	V
		2325.4	20.65	-33.35	54	-	-	-	-	-	-	A	V
	*	2441	100.4	-	-	97.08	27.5	6.72	30.9	375	272	P	V
	*	2441	75.61	-	-	-	-	-	-	-	-	A	V
		2484.74	45.08	-28.92	74	41.74	27.43	6.79	30.88	375	272	P	V
		2484.74	20.29	-33.71	54	-	-	-	-	-	-	A	V



BT CH 78 2480MHz	*	2480	103.77	-	-	100.43	27.44	6.78	30.88	100	215	P	H
	*	2480	78.98	-	-	-	-	-	-	-	-	A	H
		2483.64	47.48	-26.52	74	44.14	27.43	6.79	30.88	100	215	P	H
		2483.64	22.69	-31.31	54	-	-	-	-	-	-	A	H
													H
													H
	*	2480	101.85	-	-	98.51	27.44	6.78	30.88	362	274	P	V
	*	2480	77.06	-	-	-	-	-	-	-	-	A	V
		2483.64	47.37	-26.63	74	44.03	27.43	6.79	30.88	362	274	P	V
		2483.64	22.58	-31.42	54	-	-	-	-	-	-	A	V
													V
													V
Remark	1. No other spurious found. 2. All results are PASS against Peak and Average limit line.												



2.4GHz 2400~2483.5MHz
BT (Harmonic @ 3m)

BT Ant 0	Note	Frequency (MHz)	Level (dBμV/m)	Over Limit (dB)	Limit Line (dBμV/m)	Read Level (dBμV)	Antenna Factor (dB/m)	Path Loss (dB)	Preamp Factor (dB)	Ant Pos (cm)	Table Pos (deg)	Peak Avg. (P/A)	Pol. (H/V)	
BT CH 00 2402MHz		4804	38.82	-35.18	74	56.75	31.1	10.05	59.08	100	0	P	H	
		4804	14.03	-39.97	54	-	-	-	-	-	-	A	H	
		17985	58.23	-15.77	74	48.54	48.73	18.88	57.92	400	0	P	H	
		17985	33.44	-20.56	54	-	-	-	-	-	-	A	H	
													H	
													H	
			4804	38.88	-35.12	74	56.81	31.1	10.05	59.08	100	0	P	V
			4804	14.09	-39.91	54	-	-	-	-	-	-	A	V
			18000	58.34	-15.66	74	48.35	49	18.89	57.9	100	0	P	V
			18000	33.55	-20.45	54	-	-	-	-	-	-	A	V
													V	
													V	
BT CH 39 2441MHz		4882	38.97	-35.03	74	56.95	31.04	10.11	59.13	100	0	P	H	
		4882	14.18	-39.82	54	-	-	-	-	-	-	A	H	
		7323	44.97	-29.03	74	54.9	36.3	12.32	58.55	100	0	P	H	
		7323	20.18	-33.82	54	-	-	-	-	-	-	A	H	
		17985	59.14	-14.86	74	49.45	48.73	18.88	57.92	400	0	P	H	
		17985	34.35	-19.65	54	-	-	-	-	-	-	A	H	
			4882	39.01	-34.99	74	56.99	31.04	10.11	59.13	100	0	P	V
			4882	14.22	-39.78	54	-	-	-	-	-	-	A	V
			7323	44.62	-29.38	74	54.55	36.3	12.32	58.55	100	0	P	V
			4882	19.83	-34.17	54	-	-	-	-	-	-	A	V
			17985	58.69	-15.31	74	49	48.73	18.88	57.92	100	0	P	V
			17985	33.9	-20.1	54	-	-	-	-	-	-	A	V



BT CH 78 2480MHz		4960	40.36	-33.64	74	58.15	31.22	10.17	59.18	100	0	P	H
		4960	15.57	-38.43	54	-	-	-	-	-	-	A	H
		7440	46.1	-27.9	74	55.79	36.3	12.39	58.38	100	0	P	H
		7440	21.31	-32.69	54	-	-	-	-	-	-	A	H
		17985	59.54	-14.46	74	49.85	48.73	18.88	57.92	400	0	P	H
		17985	34.75	-19.25	54	-	-	-	-	-	-	A	H
		4960	39.51	-34.49	74	57.3	31.22	10.17	59.18	100	0	P	V
		4960	14.72	-39.28	54	-	-	-	-	-	-	A	V
		7440	46.36	-27.64	74	56.05	36.3	12.39	58.38	100	0	P	V
		7440	21.57	-32.43	54	-	-	-	-	-	-	A	V
		18000	58.54	-15.46	74	48.55	49	18.89	57.9	100	0	P	V
		18000	33.75	-20.25	54	-	-	-	-	-	-	A	V
Remark	1. No other spurious found. 2. All results are PASS against Peak and Average limit line.												



<2Mbps>

2.4GHz 2400~2483.5MHz

BT (Band Edge @ 3m)

BT Ant	Note	Frequency	Level	Over Limit	Limit Line	Read Level	Antenna Factor	Path Loss	Preamp Factor	Ant Pos	Table Pos	Peak Avg.	Pol.	
0		(MHz)	(dBμV/m)	(dB)	(dBμV/m)	(dBμV)	(dB/m)	(dB)	(dB)	(cm)	(deg)	(P/A)	(H/V)	
BT CH00 2402MHz		2351.79	45.54	-28.46	74	42.2	27.69	6.58	30.93	100	214	P	H	
		2351.79	20.78	-33.22	54	-	-	-	-	-	-	A	H	
	*	2402	103.87	-	-	100.62	27.5	6.66	30.91	100	214	P	H	
	*	2402	79.11	-	-	-	-	-	-	-	-	A	H	
													H	
														H
			2333.31	45.9	-28.1	74	42.56	27.73	6.55	30.94	344	268	P	V
			2333.31	21.14	-32.86	54	-	-	-	-	-	-	A	V
	*		2402	102.08	-	-	98.83	27.5	6.66	30.91	344	268	P	V
	*		2402	77.32	-	-	-	-	-	-	-	-	A	V
														V
														V
BT CH 39 2441MHz		2389.52	45.4	-28.6	74	42.14	27.54	6.64	30.92	100	219	P	H	
		2389.52	20.64	-33.36	54	-	-	-	-	-	-	A	H	
	*	2441	104.24	-	-	100.92	27.5	6.72	30.9	100	219	P	H	
	*	2441	79.48	-	-	-	-	-	-	-	-	A	H	
			2492.16	45.28	-28.72	74	41.93	27.42	6.8	30.87	100	219	P	H
			2492.16	20.52	-33.48	54	-	-	-	-	-	-	A	H
			2354.8	45.91	-28.09	74	42.57	27.68	6.59	30.93	374	273	P	V
			2354.8	21.15	-32.85	54	-	-	-	-	-	-	A	V
	*		2441	102.11	-	-	98.79	27.5	6.72	30.9	374	273	P	V
	*		2441	77.35	-	-	-	-	-	-	-	-	A	V
			2485.37	45.17	-28.83	74	41.83	27.43	6.79	30.88	374	273	P	V
			2485.37	20.41	-33.59	54	-	-	-	-	-	-	A	V



BT CH 78 2480MHz		2480	105.8	-	-	102.46	27.44	6.78	30.88	100	215	P	H
		2480	81.04	-	-	-	-	-	-	-	-	P	H
		2483.6	48.13	-25.87	74	44.79	27.43	6.79	30.88	100	215	P	H
		2483.6	23.37	-30.63	54	-	-	-	-	-	-	A	H
													H
													H
		2480	103.92	-	-	100.58	27.44	6.78	30.88	399	275	P	V
		2480	79.16	-	-	-	-	-	-	-	-	P	V
		2483.56	47.92	-26.08	74	44.58	27.43	6.79	30.88	399	275	P	V
		2483.56	23.16	-30.84	54	-	-	-	-	-	-	A	V
													V
													V
Remark	1. No other spurious found. 2. All results are PASS against Peak and Average limit line.												



2.4GHz 2400~2483.5MHz
BT (Harmonic @ 3m)

BT Ant 0	Note	Frequency (MHz)	Level (dBμV/m)	Over Limit (dB)	Limit Line (dBμV/m)	Read Level (dBμV)	Antenna Factor (dB/m)	Path Loss (dB)	Preamp Factor (dB)	Ant Pos (cm)	Table Pos (deg)	Peak Avg. (P/A)	Pol. (H/V)	
BT CH 00 2402MHz		4804	38.62	-35.38	74	56.55	31.1	10.05	59.08	100	0	P	H	
		4804	13.86	-40.14	54	-	-	-	-	-	-	A	H	
		18000	59.49	-14.51	74	49.5	49	18.89	57.9	400	0	P	H	
		18000	34.73	-19.27	54	-	-	-	-	-	-	A	H	
													H	
													H	
			4804	38.81	-35.19	74	56.74	31.1	10.05	59.08	100	0	P	V
			4804	14.05	-39.95	54	-	-	-	-	-	-	A	V
			17985	58.91	-15.09	74	49.22	48.73	18.88	57.92	100	0	P	V
			17985	34.15	-19.85	54	-	-	-	-	-	-	A	V
													V	
													V	
BT CH 39 2441MHz		4882	39.94	-34.06	74	57.92	31.04	10.11	59.13	100	0	P	H	
		4882	15.18	-38.82	54	-	-	-	-	-	-	A	H	
		7323	45.89	-28.11	74	55.82	36.3	12.32	58.55	100	0	P	H	
		7323	21.13	-32.87	54	-	-	-	-	-	-	A	H	
		18000	58.08	-15.92	74	48.09	49	18.89	57.9	400	0	P	H	
		18000	33.32	-20.68	54	-	-	-	-	-	-	A	H	
			4882	39.45	-34.55	74	57.43	31.04	10.11	59.13	100	0	P	V
			4882	14.69	-39.31	54	-	-	-	-	-	-	A	V
			7323	44.89	-29.11	74	54.82	36.3	12.32	58.55	100	0	P	V
			7323	20.13	-33.87	54	-	-	-	-	-	-	A	V
			18000	58.99	-15.01	74	49	49	18.89	57.9	100	0	P	V
			18000	34.23	-19.77	54	-	-	-	-	-	-	A	V



BT CH 78 2480MHz	4960	39.75	-34.25	74	57.54	31.22	10.17	59.18	100	0	P	H
	4960	14.99	-39.01	54	-	-	-	-	-	-	A	H
	7440	45.59	-28.41	74	55.28	36.3	12.39	58.38	100	0	P	H
	7440	20.83	-33.17	54	-	-	-	-	-	-	A	H
	18000	58.43	-15.57	74	48.44	49	18.89	57.9	400	0	P	H
	18000	33.67	-20.33	54	-	-	-	-	-	-	A	H
	4960	40.79	-33.21	74	58.58	31.22	10.17	59.18	100	0	P	V
	4960	16.03	-37.97	54	-	-	-	-	-	-	A	V
	7440	46.24	-27.76	74	55.93	36.3	12.39	58.38	100	0	P	V
	7440	21.48	-32.52	54	-	-	-	-	-	-	A	V
	18000	59.15	-14.85	74	49.16	49	18.89	57.9	100	0	P	V
	18000	34.39	-19.61	54	-	-	-	-	-	-	A	V
Remark	1. No other spurious found. 2. All results are PASS against Peak and Average limit line.											



<3Mbps>

2.4GHz 2400~2483.5MHz

BT (Band Edge @ 3m)

BT Ant	Note	Frequency	Level	Over Limit	Limit Line	Read Level	Antenna Factor	Path Loss	Preamp Factor	Ant Pos	Table Pos	Peak Avg.	Pol.	
0		(MHz)	(dBµV/m)	(dB)	(dBµV/m)	(dBµV)	(dB/m)	(dB)	(dB)	(cm)	(deg)	(P/A)	(H/V)	
BT CH00 2402MHz		2314.41	46.1	-27.9	74	42.76	27.77	6.52	30.95	146	137	P	H	
		2314.41	21.31	-32.69	54	-	-	-	-	-	-	A	H	
	*	2402	103.22	-	-	99.97	27.5	6.66	30.91	146	137	P	H	
	*	2402	78.43	-	-	-	-	-	-	-	-	A	H	
													H	
													H	
			2384.235	45.8	-28.2	74	42.53	27.56	6.63	30.92	116	110	P	V
			2384.235	21.01	-32.99	54	-	-	-	-	-	-	A	V
	*		2402	98.24	-	-	94.99	27.5	6.66	30.91	116	110	P	V
	*		2402	73.45	-	-	-	-	-	-	-	-	A	V
													V	
													V	
BT CH 39 2441MHz		2314.76	45.3	-28.7	74	41.96	27.77	6.52	30.95	100	215	P	H	
		2314.76	20.54	-33.46	54	-	-	-	-	-	-	A	H	
	*	2441	104.69	-	-	101.36	27.5	6.72	30.89	100	215	P	H	
	*	2441	79.93	-	-	-	-	-	-	-	-	A	H	
			2493.49	45.48	-28.52	74	42.14	27.41	6.8	30.87	100	215	P	H
			2493.49	20.72	-33.28	54	-	-	-	-	-	-	A	H
			2372.72	45.35	-28.65	74	42.05	27.61	6.61	30.92	372	273	P	V
			2372.72	20.59	-33.41	54	-	-	-	-	-	-	A	V
	*		2441	102.01	-	-	98.68	27.5	6.72	30.89	372	273	P	V
	*		2441	77.25	-	-	-	-	-	-	-	-	A	V
		2492.23	45.07	-28.93	74	41.72	27.42	6.8	30.87	372	273	P	V	
		2492.23	20.31	-33.69	54	-	-	-	-	-	-	A	V	



BT CH 78 2480MHz	*	2480	106.18	-	-	102.84	27.44	6.78	30.88	100	212	P	H
	*	2480	81.42	-	-	-	-	-	-	-	-	A	H
		2483.64	50.11	-23.89	74	46.77	27.43	6.79	30.88	100	212	P	H
		2483.64	25.35	-28.65	54	-	-	-	-	-	-	A	H
													H
													H
	*	2480	104.02	-	-	100.68	27.44	6.78	30.88	399	275	P	V
	*	2480	79.26	-	-	-	-	-	-	-	-	A	V
		2483.52	48.15	-25.85	74	44.81	27.43	6.79	30.88	399	275	P	V
		2483.52	23.39	-30.61	54	-	-	-	-	-	-	A	V
													V
													V
Remark	1. No other spurious found. 2. All results are PASS against Peak and Average limit line.												



2.4GHz 2400~2483.5MHz
BT (Harmonic @ 3m)

BT Ant 0	Note	Frequency (MHz)	Level (dBμV/m)	Over Limit (dB)	Limit Line (dBμV/m)	Read Level (dBμV)	Antenna Factor (dB/m)	Path Loss (dB)	Preamp Factor (dB)	Ant Pos (cm)	Table Pos (deg)	Peak Avg. (P/A)	Pol. (H/V)	
BT CH 00 2402MHz		4804	39.72	-34.28	74	57.65	31.1	10.05	59.08	100	0	P	H	
		4804	14.93	-39.07	54	-	-	-	-	-	-	A	H	
		17985	59.97	-14.03	74	50.28	48.73	18.88	57.92	400	0	P	H	
		17985	35.18	-18.82	54	-	-	-	-	-	-	A	H	
													H	
													H	
			4804	39.81	-34.19	74	57.74	31.1	10.05	59.08	100	0	P	V
			4804	15.02	-38.98	54	-	-	-	-	-	-	A	V
			17970	60.02	-13.98	74	50.63	48.46	18.87	57.94	100	0	P	V
			17970	35.23	-18.77	54	-	-	-	-	-	-	A	V
													V	
													V	
BT CH 39 2441MHz		4882	39.54	-34.46	74	57.52	31.04	10.11	59.13	100	0	P	H	
		4882	14.75	-39.25	54	-	-	-	-	-	-	A	H	
		7323	45.4	-28.6	74	55.33	36.3	12.32	58.55	100	0	P	H	
		7323	20.61	-33.39	54	-	-	-	-	-	-	A	H	
		18000	59.42	-14.58	74	49.43	49	18.89	57.9	400	0	P	H	
		18000	34.63	-19.37	54	-	-	-	-	-	-	A	H	
			4882	39.38	-34.62	74	57.36	31.04	10.11	59.13	100	0	P	V
			4882	14.59	-39.41	54	-	-	-	-	-	-	A	V
			7323	46.06	-27.94	74	55.99	36.3	12.32	58.55	100	0	P	V
			7323	21.27	-32.73	54	-	-	-	-	-	-	A	V
			17985	59.37	-14.63	74	49.68	48.73	18.88	57.92	100	0	P	V
			17985	34.58	-19.42	54	-	-	-	-	-	-	A	V



BT CH 78 2480MHz		4960	40.39	-33.61	74	58.18	31.22	10.17	59.18	100	0	P	H
		4960	15.6	-38.4	54	-	-	-	-	-	-	A	H
		7440	46.35	-27.65	74	56.04	36.3	12.39	58.38	100	0	P	H
		7440	21.56	-32.44	54	-	-	-	-	-	-	A	H
		18000	59.89	-14.11	74	49.9	49	18.89	57.9	400	0	P	H
		18000	35.1	-18.9	54	-	-	-	-	-	-	A	H
		4960	40.84	-33.16	74	58.63	31.22	10.17	59.18	100	0	P	V
		4960	16.05	-37.95	54	-	-	-	-	-	-	A	V
		7440	45.31	-28.69	74	55	36.3	12.39	58.38	100	0	P	V
		7440	20.52	-33.48	54	-	-	-	-	-	-	A	V
		18000	60.74	-13.26	74	50.75	49	18.89	57.9	100	0	P	V
		18000	35.95	-18.05	54	-	-	-	-	-	-	A	V
Remark	1. No other spurious found. 2. All results are PASS against Peak and Average limit line.												



Emission above 18GHz

2.4GHz BT (SHF)

BT	Note	Frequency	Level	Over	Limit	Read	Antenna	Path	Preamp	Ant	Table	Peak	Pol.
Ant				Limit	Line	Level	Factor	Loss	Factor	Pos	Pos	Avg.	
0		(MHz)	(dBμV/m)	(dB)	(dBμV/m)	(dBμV)	(dB/m)	(dB)	(dB)	(cm)	(deg)	(P/A)	(H/V)
2.4GHz BT SHF		21496	39.07	-34.93	74	43.78	38.3	11.69	54.7	150	0	P	H
													H
													H
													H
													H
													H
													H
													H
													H
													H
													H
													H
													H
													H
													H
													H
													H
													H
													H
			21568	38.56	-35.44	74	43.2	38.31	11.75	54.7	150	0	P
													V
													V
													V
													V
													V
													V
													V
													V
													V
													V
													V
													V
													V
													V
Remark	1. No other spurious found. 2. All results are PASS against limit line.												



Emission below 1GHz

2.4GHz BT (LF)

BT	Note	Frequency	Level	Over	Limit	Read	Antenna	Path	Preamp	Ant	Table	Peak	Pol.	
Ant				Limit	Line	Level	Factor	Loss	Factor	Pos	Pos	Avg.		
0		(MHz)	(dBμV/m)	(dB)	(dBμV/m)	(dBμV)	(dB/m)	(dB)	(dB)	(cm)	(deg)	(P/A)	(H/V)	
2.4GHz BT LF		43.58	26.93	-13.07	40	41.21	17.47	0.83	32.58	-	-	P	H	
		105.66	25.11	-18.39	43.5	39.67	16.48	1.47	32.51	-	-	P	H	
		138.64	28.06	-15.44	43.5	41.47	17.41	1.68	32.5	-	-	P	H	
		224	25.41	-20.59	46	40.22	15.45	2.16	32.42	-	-	P	H	
		720.64	38.28	-7.72	46	40.2	26.89	3.64	32.45	-	-	P	H	
		746.83	38.96	-7.04	46	39.82	27.88	3.71	32.45	100	0	P	H	
														H
														H
														H
														H
														H
														H
														H
														H
														H
														H
														H
														H
														H
			43.58	33.91	-6.09	40	48.19	17.47	0.83	32.58	100	0	P	V
		105.66	25.17	-18.33	43.5	39.73	16.48	1.47	32.51	-	-	P	V	
		137.67	22.61	-20.89	43.5	36.06	17.39	1.67	32.51	-	-	P	V	
		172.59	22.6	-20.9	43.5	37.8	15.39	1.9	32.49	-	-	P	V	
		721.61	31.08	-14.92	46	32.96	26.93	3.64	32.45	-	-	P	V	
		917.55	32.92	-13.08	46	30.91	29.3	4.22	31.51	-	-	P	V	
													V	
													V	
													V	
													V	
													V	
													V	
													V	
													V	
													V	
Remark	1. No other spurious found. 2. All results are PASS against limit line.													



<Ant. 1>

<1Mbps>

2.4GHz 2400~2483.5MHz

BT (Band Edge @ 3m)

BT Ant	Note	Frequency	Level	Over Limit	Limit Line	Read Level	Antenna Factor	Path Loss	Preamp Factor	Ant Pos	Table Pos	Peak Avg.	Pol.	
1		(MHz)	(dBμV/m)	(dB)	(dBμV/m)	(dBμV)	(dB/m)	(dB)	(dB)	(cm)	(deg)	(P/A)	(H/V)	
BT CH00 2402MHz		2328.06	45.57	-28.43	74	42.23	27.74	6.54	30.94	124	256	P	H	
		2328.06	20.78	-33.22	54	-	-	-	-	-	-	A	H	
	*	2402	101.39	-	-	98.14	27.5	6.66	30.91	124	256	P	H	
	*	2402	76.6	-	-	-	-	-	-	-	-	A	H	
													H	
													H	
			2366.91	45.73	-28.27	74	42.42	27.63	6.61	30.93	345	281	P	V
			2366.91	20.94	-33.06	54	-	-	-	-	-	-	A	V
	*	2402	100.31	-	-	97.06	27.5	6.66	30.91	345	281	P	V	
	*	2402	75.52	-	-	-	-	-	-	-	-	-	A	V
														V
														V
BT CH 39 2441MHz		2354.94	46.14	-27.86	74	42.8	27.68	6.59	30.93	100	257	P	H	
		2354.94	21.35	-32.65	54	-	-	-	-	-	-	A	H	
	*	2441	101.77	-	-	98.44	27.5	6.72	30.89	100	257	P	H	
	*	2441	76.98	-	-	-	-	-	-	-	-	A	H	
			2495.59	45.66	-28.34	74	42.31	27.41	6.81	30.87	100	257	P	H
			2495.59	20.87	-33.13	54	-	-	-	-	-	-	A	H
			2361.66	45.62	-28.38	74	42.3	27.65	6.6	30.93	329	283	P	V
			2361.66	20.83	-33.17	54	-	-	-	-	-	-	A	V
	*	2441	101.1	-	-	97.77	27.5	6.72	30.89	329	283	P	V	
	*	2441	76.31	-	-	-	-	-	-	-	-	-	A	V
			2489.36	45.69	-28.31	74	42.34	27.42	6.8	30.87	329	283	P	V
			2489.36	20.9	-33.1	54	-	-	-	-	-	-	A	V



BT CH 78 2480MHz	*	2480	99.56	-	-	96.22	27.44	6.78	30.88	100	258	P	H
	*	2480	74.77	-	-	-	-	-	-	-	-	A	H
		2483.6	45.96	-28.04	74	42.62	27.43	6.79	30.88	100	258	P	H
		2483.6	21.17	-32.83	54	-	-	-	-	-	-	A	H
													H
													H
	*	2480	99.1	-	-	95.76	27.44	6.78	30.88	359	285	P	V
	*	2480	74.31	-	-	-	-	-	-	-	-	A	V
		2483.96	45.85	-28.15	74	42.51	27.43	6.79	30.88	359	285	P	V
		2483.96	21.06	-32.94	54	-	-	-	-	-	-	A	V
													V
													V
Remark	1. No other spurious found. 2. All results are PASS against Peak and Average limit line.												



2.4GHz 2400~2483.5MHz
BT (Harmonic @ 3m)

BT Ant 1	Note	Frequency (MHz)	Level (dBμV/m)	Over Limit (dB)	Limit Line (dBμV/m)	Read Level (dBμV)	Antenna Factor (dB/m)	Path Loss (dB)	Preamp Factor (dB)	Ant Pos (cm)	Table Pos (deg)	Peak Avg. (P/A)	Pol. (H/V)	
BT CH 00 2402MHz		4804	38.55	-35.45	74	56.48	31.1	10.05	59.08	100	0	P	H	
		4804	13.76	-40.24	54	-	-	-	-	-	-	A	H	
		17985	58.92	-15.08	74	49.23	48.73	18.88	57.92	400	0	P	H	
		17985	34.13	-19.87	54	-	-	-	-	-	-	A	H	
													H	
													H	
			4804	38.95	-35.05	74	56.88	31.1	10.05	59.08	100	0	P	V
			4804	14.16	-39.84	54	-	-	-	-	-	-	A	V
			18000	59.37	-14.63	74	49.38	49	18.89	57.9	100	0	P	V
			18000	34.58	-19.42	54	-	-	-	-	-	-	A	V
													V	
													V	
BT CH 39 2441MHz		4882	38.84	-35.16	74	56.82	31.04	10.11	59.13	100	0	P	H	
		4882	14.05	-39.95	54	-	-	-	-	-	-	A	H	
		7323	44.87	-29.13	74	54.8	36.3	12.32	58.55	100	0	P	H	
		7323	20.08	-33.92	54	-	-	-	-	-	-	A	H	
		18000	59.13	-14.87	74	49.14	49	18.89	57.9	400	0	P	H	
		18000	34.34	-19.66	54	-	-	-	-	-	-	A	H	
			4882	39.68	-34.32	74	57.66	31.04	10.11	59.13	100	0	P	V
			4882	14.89	-39.11	54	-	-	-	-	-	-	A	V
			7323	44.69	-29.31	74	54.62	36.3	12.32	58.55	100	0	P	V
			7323	19.9	-34.1	54	-	-	-	-	-	-	A	V
			18000	58.91	-15.09	74	48.92	49	18.89	57.9	100	0	P	V
			18000	34.12	-19.88	54	-	-	-	-	-	-	A	V



BT CH 78 2480MHz		4960	39.54	-34.46	74	57.33	31.22	10.17	59.18	100	0	P	H
		4960	14.75	-39.25	54	-	-	-	-	-	-	A	H
		7440	46.38	-27.62	74	56.07	36.3	12.39	58.38	100	0	P	H
		7440	21.59	-32.41	54	-	-	-	-	-	-	A	H
		18000	58.78	-15.22	74	48.79	49	18.89	57.9	400	0	P	H
		18000	33.99	-20.01	54	-	-	-	-	-	-	A	H
		4960	39.14	-34.86	74	56.93	31.22	10.17	59.18	100	0	P	V
		4960	14.35	-39.65	54	-	-	-	-	-	-	A	V
		7440	45.47	-28.53	74	55.16	36.3	12.39	58.38	100	0	P	V
		7440	20.68	-33.32	54	-	-	-	-	-	-	A	V
		18000	59.75	-14.25	74	49.76	49	18.89	57.9	100	0	P	V
		18000	34.96	-19.04	54	-	-	-	-	-	-	A	V
Remark	<ol style="list-style-type: none"> 1. No other spurious found. 2. All results are PASS against Peak and Average limit line. 												



<2Mbps>

2.4GHz 2400~2483.5MHz

BT (Band Edge @ 3m)

BT	Note	Frequency	Level	Over	Limit	Read	Antenna	Path	Preamp	Ant	Table	Peak	Pol.	
Ant				Limit	Line	Level	Factor	Loss	Factor	Pos	Pos	Avg.		
1		(MHz)	(dBμV/m)	(dB)	(dBμV/m)	(dBμV)	(dB/m)	(dB)	(dB)	(cm)	(deg)	(P/A)	(H/V)	
BT CH00 2402MHz		2349.27	45.01	-28.99	74	41.66	27.7	6.58	30.93	146	256	P	H	
		2349.27	20.22	-33.78	54	-	-	-	-	-	-	A	H	
	*	2402	103.2	-	-	99.95	27.5	6.66	30.91	146	256	P	H	
	*	2402	78.41	-	-	-	-	-	-	-	-	A	H	
													H	
														H
			2347.905	45.9	-28.1	74	42.56	27.7	6.57	30.93	342	281	P	V
			2347.905	21.11	-32.89	54	-	-	-	-	-	-	A	V
	*		2402	102.41	-	-	99.16	27.5	6.66	30.91	342	281	P	V
	*		2402	77.62	-	-	-	-	-	-	-	-	A	V
														V
														V
BT CH 39 2441MHz		2347.8	45.4	-28.6	74	42.06	27.7	6.57	30.93	168	258	P	H	
		2347.8	20.61	-33.39	54	-	-	-	-	-	-	A	H	
	*	2441	103.97	-	-	100.64	27.5	6.72	30.89	168	258	P	H	
	*	2441	79.18	-	-	-	-	-	-	-	-	A	H	
			2489.36	45.12	-28.88	74	41.77	27.42	6.8	30.87	168	258	P	H
			2489.36	20.33	-33.67	54	-	-	-	-	-	-	A	H
			2364.46	45.57	-28.43	74	42.26	27.64	6.6	30.93	327	282	P	V
			2364.46	20.78	-33.22	54	-	-	-	-	-	-	A	V
	*		2441	103.11	-	-	99.78	27.5	6.72	30.89	327	282	P	V
	*		2441	78.32	-	-	-	-	-	-	-	-	A	V
			2489.01	45.41	-28.59	74	42.06	27.42	6.8	30.87	327	282	P	V
			2489.01	20.62	-33.38	54	-	-	-	-	-	-	A	V



BT CH 78 2480MHz	*	2480	101.66	-	-	98.32	27.44	6.78	30.88	100	258	P	H
	*	2480	76.87	-	-	-	-	-	-	-	-	A	H
		2483.52	46.38	-27.62	74	43.04	27.43	6.79	30.88	100	258	P	H
		2483.52	21.59	-32.41	54	-	-	-	-	-	-	A	H
													H
													H
	*	2480	100.92	-	-	97.58	27.44	6.78	30.88	363	286	P	V
	*	2480	76.13	-	-	-	-	-	-	-	-	A	V
		2486.16	45.15	-28.85	74	41.81	27.43	6.79	30.88	363	286	P	V
		2486.16	20.36	-33.64	54	-	-	-	-	-	-	A	V
													V
													V
Remark	1. No other spurious found. 2. All results are PASS against Peak and Average limit line.												



2.4GHz 2400~2483.5MHz
BT (Harmonic @ 3m)

BT Ant 1	Note	Frequency (MHz)	Level (dBμV/m)	Over Limit (dB)	Limit Line (dBμV/m)	Read Level (dBμV)	Antenna Factor (dB/m)	Path Loss (dB)	Preamp Factor (dB)	Ant Pos (cm)	Table Pos (deg)	Peak Avg. (P/A)	Pol. (H/V)	
BT CH 00 2402MHz		4804	38.78	-35.22	74	56.71	31.1	10.05	59.08	100	0	P	H	
		4804	13.99	-40.01	54	-	-	-	-	-	-	A	H	
		17985	59.23	-14.77	74	49.54	48.73	18.88	57.92	400	0	P	H	
		17985	34.44	-19.56	54	-	-	-	-	-	-	A	H	
													H	
													H	
			4804	39.11	-34.89	74	57.04	31.1	10.05	59.08	100	0	P	V
			4804	14.32	-39.68	54	-	-	-	-	-	-	A	V
			18000	58.97	-15.03	74	48.98	49	18.89	57.9	100	0	P	V
			18000	34.18	-19.82	54	-	-	-	-	-	-	A	V
														V
														V
BT CH 39 2441MHz		4882	38.56	-35.44	74	56.54	31.04	10.11	59.13	100	0	P	H	
		4882	13.77	-40.23	54	-	-	-	-	-	-	A	H	
		7323	44.95	-29.05	74	54.88	36.3	12.32	58.55	100	0	P	H	
		7323	20.16	-33.84	54	-	-	-	-	-	-	A	H	
		17985	58.67	-15.33	74	48.98	48.73	18.88	57.92	400	0	P	H	
		17985	33.88	-20.12	54	-	-	-	-	-	-	A	H	
			4882	38.88	-35.12	74	56.86	31.04	10.11	59.13	100	0	P	V
			4882	14.09	-39.91	54	-	-	-	-	-	-	A	V
			7323	44.72	-29.28	74	54.65	36.3	12.32	58.55	100	0	P	V
			7323	19.93	-34.07	54	-	-	-	-	-	-	A	V
			18000	59.36	-14.64	74	49.37	49	18.89	57.9	100	0	P	V
			18000	34.57	-19.43	54	-	-	-	-	-	-	A	V



BT CH 78 2480MHz		4960	38.91	-35.09	74	56.7	31.22	10.17	59.18	100	0	P	H
		4960	14.12	-39.88	54	-	-	-	-	-	-	A	H
		7440	45.85	-28.15	74	55.54	36.3	12.39	58.38	100	0	P	H
		7440	21.06	-32.94	54	-	-	-	-	-	-	A	H
		18000	60.35	-13.65	74	50.36	49	18.89	57.9	400	0	P	H
		18000	35.56	-18.44	54	-	-	-	-	-	-	A	H
		4960	40.63	-33.37	74	58.42	31.22	10.17	59.18	100	0	P	V
		4960	15.84	-38.16	54	-	-	-	-	-	-	A	V
		7440	44.88	-29.12	74	54.57	36.3	12.39	58.38	100	0	P	V
		7440	20.09	-33.91	54	-	-	-	-	-	-	A	V
		18000	59.15	-14.85	74	49.16	49	18.89	57.9	100	0	P	V
		18000	34.36	-19.64	54	-	-	-	-	-	-	A	V
Remark	1. No other spurious found. 2. All results are PASS against Peak and Average limit line.												



<3Mbps>

2.4GHz 2400~2483.5MHz

BT (Band Edge @ 3m)

BT Ant	Note	Frequency	Level	Over Limit	Limit Line	Read Level	Antenna Factor	Path Loss	Preamp Factor	Ant Pos	Table Pos	Peak Avg.	Pol.	
1		(MHz)	(dBμV/m)	(dB)	(dBμV/m)	(dBμV)	(dB/m)	(dB)	(dB)	(cm)	(deg)	(P/A)	(H/V)	
BT CH00 2402MHz		2355.15	44.95	-29.05	74	41.61	27.68	6.59	30.93	124	256	P	H	
		2355.15	20.16	-33.84	54	-	-	-	-	-	-	A	H	
	*	2402	103.3	-	-	100.05	27.5	6.66	30.91	124	256	P	H	
	*	2402	78.51	-	-	-	-	-	-	-	-	A	H	
													H	
													H	
			2360.295	44.84	-29.16	74	41.52	27.66	6.59	30.93	388	282	P	V
			2360.295	20.05	-33.95	54	-	-	-	-	-	-	A	V
	*		2402	102.42	-	-	99.17	27.5	6.66	30.91	388	282	P	V
	*		2402	77.63	-	-	-	-	-	-	-	-	A	V
													V	
													V	
BT CH 39 2441MHz		2377.2	45.8	-28.2	74	42.51	27.59	6.62	30.92	142	256	P	H	
		2377.2	21.01	-32.99	54	-	-	-	-	-	-	A	H	
	*	2441	103.94	-	-	100.61	27.5	6.72	30.89	142	256	P	H	
	*	2441	79.15	-	-	-	-	-	-	-	-	A	H	
			2483.69	45.5	-28.5	74	42.16	27.43	6.79	30.88	142	256	P	H
			2483.69	20.71	-33.29	54	-	-	-	-	-	-	A	H
			2359.42	45.66	-28.34	74	42.34	27.66	6.59	30.93	329	282	P	V
			2359.42	20.87	-33.13	54	-	-	-	-	-	-	A	V
	*		2441	103.13	-	-	99.8	27.5	6.72	30.89	329	282	P	V
	*		2441	78.34	-	-	-	-	-	-	-	-	A	V
		2489.99	45.54	-28.46	74	42.19	27.42	6.8	30.87	329	282	P	V	
		2489.99	20.75	-33.25	54	-	-	-	-	-	-	A	V	



BT CH 78 2480MHz	*	2480	101.75	-	-	98.41	27.44	6.78	30.88	100	257	P	H
	*	2480	76.96	-	-	-	-	-	-	-	-	A	H
		2483.56	48.99	-25.01	74	45.65	27.43	6.79	30.88	100	257	P	H
		2483.56	24.2	-29.8	54	-	-	-	-	-	-	A	H
													H
													H
	*	2480	100.94	-	-	97.6	27.44	6.78	30.88	362	284	P	V
	*	2480	76.15	-	-	-	-	-	-	-	-	A	V
		2483.56	47.11	-26.89	74	43.77	27.43	6.79	30.88	362	284	P	V
		2483.56	22.32	-31.68	54	-	-	-	-	-	-	A	V
													V
													V
Remark	1. No other spurious found. 2. All results are PASS against Peak and Average limit line.												



2.4GHz 2400~2483.5MHz
BT (Harmonic @ 3m)

BT Ant 1	Note	Frequency (MHz)	Level (dBμV/m)	Over Limit (dB)	Limit Line (dBμV/m)	Read Level (dBμV)	Antenna Factor (dB/m)	Path Loss (dB)	Preamp Factor (dB)	Ant Pos (cm)	Table Pos (deg)	Peak Avg. (P/A)	Pol. (H/V)	
BT CH 00 2402MHz		4804	38.46	-35.54	74	56.39	31.1	10.05	59.08	100	0	P	H	
		4804	13.67	-40.33	54	-	-	-	-	-	-	A	H	
		17985	59.29	-14.71	74	49.6	48.73	18.88	57.92	400	0	P	H	
		17985	34.5	-19.5	54	-	-	-	-	-	-	A	H	
													H	
													H	
			4804	39	-35	74	56.93	31.1	10.05	59.08	100	0	P	V
			4804	14.21	-39.79	54	-	-	-	-	-	-	A	V
			18000	59.42	-14.58	74	49.43	49	18.89	57.9	100	0	P	V
			18000	34.63	-19.37	54	-	-	-	-	-	-	A	V
														V
														V
BT CH 39 2441MHz		4882	40.28	-33.72	74	58.26	31.04	10.11	59.13	100	0	P	H	
		4882	15.49	-38.51	54	-	-	-	-	-	-	A	H	
		7323	44.41	-29.59	74	54.34	36.3	12.32	58.55	100	0	P	H	
		7323	19.62	-34.38	54	-	-	-	-	-	-	A	H	
		17985	58.89	-15.11	74	49.2	48.73	18.88	57.92	400	0	P	H	
		17985	34.1	-19.9	54	-	-	-	-	-	-	A	H	
			4882	39.35	-34.65	74	57.33	31.04	10.11	59.13	100	0	P	V
			4882	14.56	-39.44	54	-	-	-	-	-	-	A	V
			7323	45.09	-28.91	74	55.02	36.3	12.32	58.55	100	0	P	V
			7323	20.3	-33.7	54	-	-	-	-	-	-	A	V
			17970	58.86	-15.14	74	49.47	48.46	18.87	57.94	100	0	P	V
			17970	34.07	-19.93	54	-	-	-	-	-	-	A	V



BT CH 78 2480MHz		4960	39.01	-34.99	74	56.8	31.22	10.17	59.18	100	0	P	H
		4960	14.22	-39.78	54	-	-	-	-	-	-	A	H
		7440	46.47	-27.53	74	56.16	36.3	12.39	58.38	100	0	P	H
		7440	21.68	-32.32	54	-	-	-	-	-	-	A	H
		18000	59.89	-14.11	74	49.9	49	18.89	57.9	400	0	P	H
		18000	35.1	-18.9	54	-	-	-	-	-	-	A	H
		4960	39.7	-34.3	74	57.49	31.22	10.17	59.18	100	0	P	V
		4960	14.91	-39.09	54	-	-	-	-	-	-	A	V
		7440	45.62	-28.38	74	55.31	36.3	12.39	58.38	100	0	P	V
		7440	20.83	-33.17	54	-	-	-	-	-	-	A	V
		18000	58.95	-15.05	74	48.96	49	18.89	57.9	100	0	P	V
		18000	34.16	-19.84	54	-	-	-	-	-	-	A	V
Remark	1. No other spurious found. 2. All results are PASS against Peak and Average limit line.												



Emission above 18GHz

2.4GHz BT (SHF)

BT	Note	Frequency	Level	Over	Limit	Read	Antenna	Path	Preamp	Ant	Table	Peak	Pol.
Ant				Limit	Line	Level	Factor	Loss	Factor	Pos	Pos	Avg.	
1		(MHz)	(dBμV/m)	(dB)	(dBμV/m)	(dBμV)	(dB/m)	(dB)	(dB)	(cm)	(deg)	(P/A)	(H/V)
2.4GHz BT SHF		21200	38.21	-35.79	74	43.26	38.24	11.41	54.7	150	0	P	H
													H
													H
													H
													H
													H
													H
													H
													H
													H
													H
													H
													H
													H
													H
													H
													H
													H
													H
			23696	40.5	-33.5	74	43.16	38.62	12.6	53.88	150	0	P
													V
													V
													V
													V
													V
													V
													V
													V
													V
													V
													V
													V
													V
													V
Remark	1. No other spurious found. 2. All results are PASS against limit line.												



Emission below 1GHz

2.4GHz BT (LF)

BT	Note	Frequency	Level	Over	Limit	Read	Antenna	Path	Preamp	Ant	Table	Peak	Pol.	
Ant				Limit	Line	Level	Factor	Loss	Factor	Pos	Pos	Avg.		
1		(MHz)	(dBμV/m)	(dB)	(dBμV/m)	(dBμV)	(dB/m)	(dB)	(dB)	(cm)	(deg)	(P/A)	(H/V)	
2.4GHz BT LF		43.58	26.61	-13.39	40	40.89	17.47	0.83	32.58	-	-	P	H	
		104.69	25.24	-18.26	43.5	39.89	16.39	1.47	32.51	-	-	P	H	
		138.64	27.74	-15.76	43.5	41.15	17.41	1.68	32.5	-	-	P	H	
		224.97	25.22	-20.78	46	39.96	15.52	2.16	32.42	-	-	P	H	
		746.83	35.82	-10.18	46	36.68	27.88	3.71	32.45	100	0	P	H	
		777.87	34	-12	46	34.4	28.07	3.82	32.29	-	-	P	H	
														H
														H
														H
														H
														H
														H
			43.58	32.92	-7.08	40	47.2	17.47	0.83	32.58	100	148	Q	V
			104.69	25.97	-17.53	43.5	40.62	16.39	1.47	32.51	-	-	P	V
			138.64	23.16	-20.34	43.5	36.57	17.41	1.68	32.5	-	-	P	V
			172.59	23.56	-19.94	43.5	38.76	15.39	1.9	32.49	-	-	P	V
			729.37	32.4	-13.6	46	33.87	27.31	3.67	32.45	-	-	P	V
			777.87	34.26	-11.74	46	34.66	28.07	3.82	32.29	-	-	P	V
													V	
													V	
													V	
													V	
													V	
													V	
Remark	1. No other spurious found. 2. All results are PASS against limit line.													



Note symbol

*	Fundamental Frequency which can be ignored. However, the level of any unwanted emissions shall not exceed the level of the fundamental frequency.
!	Test result is over limit line.
P/A	Peak or Average
H/V	Horizontal or Vertical



A calculation example for radiated spurious emission is shown as below:

BT	Note	Frequency	Level	Over	Limit	Read	Antenna	Path	Preamp	Ant	Table	Peak	Pol.
		(MHz)	(dBμV/m)	(dB)	(dBμV/m)	(dBμV)	(dB/m)	(dB)	(dB)	(cm)	(deg)	(P/A)	(H/V)
BT CH 00 2402MHz		2390	55.45	-18.55	74	54.51	32.22	4.58	35.86	103	308	P	H
		2390	43.54	-10.46	54	42.6	32.22	4.58	35.86	103	308	A	H

1. Path Loss(dB) = Cable loss(dB) + Filter loss(dB) + Attenuator loss(dB)
2. Level(dBμV/m) =
Antenna Factor(dB/m) + Path Loss(dB) + Read Level(dBμV) - Preamp Factor(dB)
3. Over Limit(dB) = Level(dBμV/m) – Limit Line(dBμV/m)

For Peak Limit @ 2390MHz:

1. Level(dBμV/m)
= Antenna Factor(dB/m) + Path Loss(dB) + Read Level(dBμV) - Preamp Factor(dB)
= 32.22(dB/m) + 4.58(dB) + 54.51(dBμV) – 35.86 (dB)
= 55.45 (dBμV/m)
2. Over Limit(dB)
= Level(dBμV/m) – Limit Line(dBμV/m)
= 55.45(dBμV/m) – 74(dBμV/m)
= -18.55(dB)

For Average Limit @ 2390MHz:

1. Level(dBμV/m)
= Antenna Factor(dB/m) + Path Loss(dB) + Read Level(dBμV) - Preamp Factor(dB)
= 32.22(dB/m) + 4.58(dB) + 42.6(dBμV) – 35.86 (dB)
= 43.54 (dBμV/m)
2. Over Limit(dB)
= Level(dBμV/m) – Limit Line(dBμV/m)
= 43.54(dBμV/m) – 54(dBμV/m)
= -10.46(dB)

Both peak and average measured complies with the limit line, so test result is “PASS”.



Appendix D. Radiated Spurious Emission Plots

Test Engineer :	Leo Lee, Mancy Chou and Bigshow Wang	Temperature :	22.5~23.5°C
		Relative Humidity :	45~55%

<Ant. 0>

<1Mbps>

2.4GHz 2400~2483.5MHz

BT (Band Edge @ 3m)

BT	2.4GHz 2400~2483.5MHz Band Edge @ 3m	
Ant	BT CH00 2402MHz	
0	Horizontal	Fundamental
Peak	<p>Site : 03CH15-HY Condition : PEAK_BE_74 3m 91200_15_1620 HORIZONTAL RBW:1000.000kHz VBW:3000.000kHz SWT:Auto Detector : Peak Project : 132425</p>	<p>Site : 03CH15-HY Condition : PEAK_74 3m 91200_15_1620 HORIZONTAL RBW:1000.000kHz VBW:3000.000kHz SWT:Auto Detector : Peak Project : 132425</p>

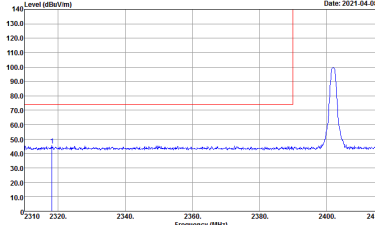
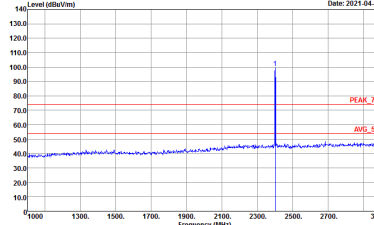

BT	2.4GHz 2400~2483.5MHz Band Edge @ 3m	
Ant	BT CH00 2402MHz	
0	Vertical	Fundamental
Peak	 <p>Date: 2021.04.08</p> <p>Site : 03CH15-HY Condition : PEAK_8E_74 3m 91200_15_1620 VERTICAL RBW:1000.000KHz VBW:3000.000KHz SWT:Auto Detector : Peak Project : 132425</p>	 <p>Date: 2021.04.08</p> <p>Site : 03CH15-HY Condition : PEAK_74 3m 91200_15_1620 VERTICAL RBW:1000.000KHz VBW:3000.000KHz SWT:Auto Detector : Peak Project : 132425</p>



BT	2.4GHz 2400~2483.5MHz Band Edge @ 3m	
Ant	BT CH39 2441MHz	
0	Horizontal	Fundamental
Peak	<p>Site : 03CH15-HY Condition : PEAK_BE_74 3m 91200_15_1620 HORIZONTAL RBW:1000.000KHz VBW:3000.000KHz SWT:Auto Detector : Peak Project : 132425</p>	<p>Site : 03CH15-HY Condition : PEAK_74 3m 91200_15_1620 HORIZONTAL RBW:1000.000KHz VBW:3000.000KHz SWT:Auto Detector : Peak Project : 132425</p>
Peak	<p>Site : 03CH15-HY Condition : PEAK_BE_74 3m 91200_15_1620 HORIZONTAL RBW:1000.000KHz VBW:3000.000KHz SWT:Auto Detector : Peak Project : 132425</p>	Left blank

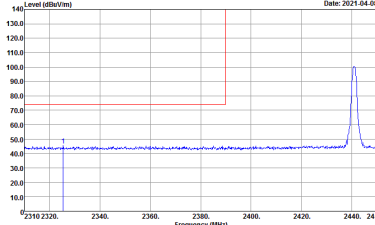
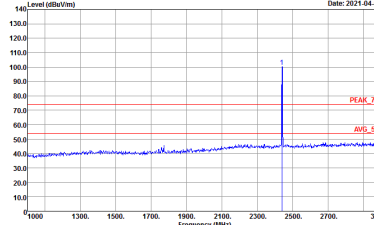
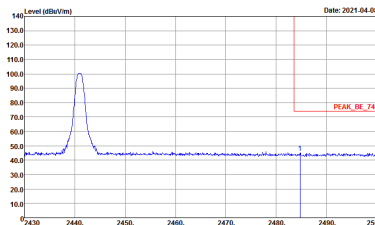

BT	2.4GHz 2400~2483.5MHz Band Edge @ 3m	
Ant	BT CH39 2441MHz	
0	Vertical	Fundamental
Peak	 <p>Site : 03CH15-HY Condition : PEAK_BE_74 3m 91200_15_1620 VERTICAL RBW:1000.000KHz VBW:3000.000KHz SWT:Auto Detector : Peak Project : 132425</p>	 <p>Site : 03CH15-HY Condition : PEAK_74 3m 91200_15_1620 VERTICAL RBW:1000.000KHz VBW:3000.000KHz SWT:Auto Detector : Peak Project : 132425</p>
Peak	 <p>Site : 03CH15-HY Condition : PEAK_BE_74 3m 91200_15_1620 VERTICAL RBW:1000.000KHz VBW:3000.000KHz SWT:Auto Detector : Peak Project : 132425</p>	Left blank



BT	2.4GHz 2400~2483.5MHz Band Edge @ 3m	
Ant	BT CH78 2480MHz	
0	Horizontal	Fundamental
Peak	<p> Site : 03CH15-HY Condition : PEAK_BE_74 3m 91200_15_1620 HORIZONTAL RBW:1000.000KHz VBW:3000.000KHz SWT:Auto Detector : Peak Project : 132425 </p>	<p> Site : 03CH15-HY Condition : PEAK_74 3m 91200_15_1620 HORIZONTAL RBW:1000.000KHz VBW:3000.000KHz SWT:Auto Detector : Peak Project : 132425 </p>



BT	2.4GHz 2400~2483.5MHz Band Edge @ 3m	
Ant	BT CH78 2480MHz	
0	Vertical	Fundamental
Peak	<p> Date: 2021-04-08 Site : 03CH15-HY Condition : PEAK_BE_74 3m 91200_15_1620 VERTICAL RBW:1000.000KHz VBW:3000.000KHz SWT:Auto Detector : Peak Project : 132425 </p>	<p> Date: 2021-04-08 Site : 03CH15-HY Condition : PEAK_74 3m 91200_15_1620 VERTICAL RBW:1000.000KHz VBW:3000.000KHz SWT:Auto Detector : Peak Project : 132425 </p>



2.4GHz 2400~2483.5MHz

BT (Harmonic @ 3m)

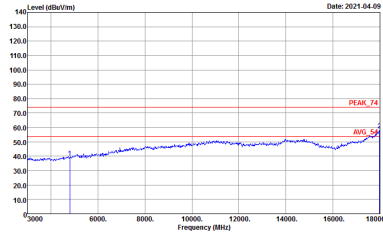
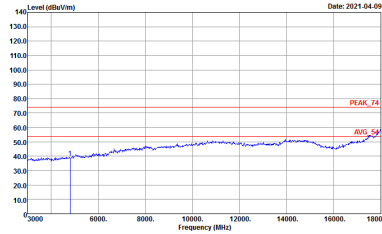
BT	2.4GHz 2400~2483.5MHz Harmonic @ 3m	
Ant	BT CH00 2402MHz	
0	Horizontal	Vertical
<p>Peak</p> <p>Avg.</p>	 <p>Site : 03CH15-1FY Condition : PEAK_74 3m 91200_15_1620 HORIZONTAL Detector : Peak Project : 132425</p>	 <p>Site : 03CH15-1FY Condition : PEAK_74 3m 91200_15_1620 VERTICAL Detector : Peak Project : 132425</p>



BT	2.4GHz 2400~2483.5MHz Harmonic @ 3m	
Ant	BT CH39 2441MHz	
0	Horizontal	Vertical
Peak Avg.	<p>Site : 03CH15-HY Condition : PEAK_74 3m 91200_15_1620 HORIZONTAL Detector : Peak Project : 132425</p>	<p>Site : 03CH15-HY Condition : PEAK_74 3m 91200_15_1620 VERTICAL Detector : Peak Project : 132425</p>



BT	2.4GHz 2400~2483.5MHz Harmonic @ 3m	
Ant	BT CH78 2480MHz	
0	Horizontal	Vertical
Peak Avg.	<p>Site : 03CH15-HY Condition : PEAK_74 3m 91200_15_1620 HORIZONTAL Detector : Peak Project : 132425</p>	<p>Site : 03CH15-HY Condition : PEAK_74 3m 91200_15_1620 VERTICAL Detector : Peak Project : 132425</p>



<2Mbps>

2.4GHz 2400~2483.5MHz

BT (Band Edge @ 3m)

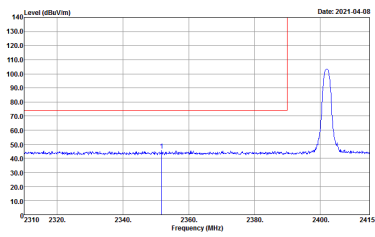
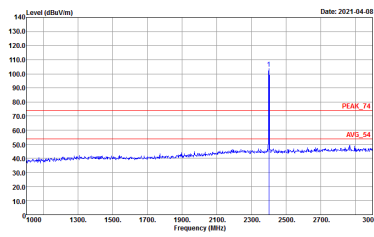
BT	2.4GHz 2400~2483.5MHz Band Edge @ 3m	
Ant	BT CH00 2402MHz	
0	Horizontal	Fundamental
Peak	 <p>Date: 2021-04-08</p> <p>Site : 03CH15-1FV Condition : PEAK_BE_74 3m 91200_15_1620 HORIZONTAL : RBW:1000.000KHz VBW:3000.000KHz SWT:Auto Detector : Peak Project : 132425</p>	 <p>Date: 2021-04-08</p> <p>Site : 03CH15-1FV Condition : PEAK_74 3m 91200_15_1620 HORIZONTAL : RBW:1000.000KHz VBW:3000.000KHz SWT:Auto Detector : Peak Project : 132425</p>

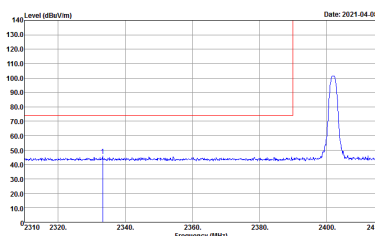
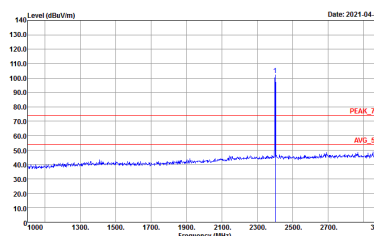

BT	2.4GHz 2400~2483.5MHz Band Edge @ 3m	
Ant	BT CH00 2402MHz	
0	Vertical	Fundamental
Peak	 <p data-bbox="430 705 702 772">Site : 03CH15-HY Condition : PEAK_8E_74 3m 91200_15_1620 VERTICAL RBW:1000.000KHz VBW:3000.000KHz SWT:Auto Detector : Peak Project : 132425</p>	 <p data-bbox="901 705 1173 772">Site : 03CH15-HY Condition : PEAK_74 3m 91200_15_1620 VERTICAL RBW:1000.000KHz VBW:3000.000KHz SWT:Auto Detector : Peak Project : 132425</p>



BT	2.4GHz 2400~2483.5MHz Band Edge @ 3m	
Ant	BT CH39 2441MHz	
0	Horizontal	Fundamental
Peak	<p>Site : 03CH15-HY Condition : PEAK_BE_74 3m 91200_15_1620 HORIZONTAL : RBW:1000.000KHz VBW:3000.000KHz SWT:Auto Detector : Peak Project : 132425</p>	<p>Site : 03CH15-HY Condition : PEAK_74 3m 91200_15_1620 HORIZONTAL : RBW:1000.000KHz VBW:3000.000KHz SWT:Auto Detector : Peak Project : 132425</p>
Peak	<p>Site : 03CH15-HY Condition : PEAK_BE_74 3m 91200_15_1620 HORIZONTAL : RBW:1000.000KHz VBW:3000.000KHz SWT:Auto Detector : Peak Project : 132425</p>	Left blank



BT	2.4GHz 2400~2483.5MHz Band Edge @ 3m	
Ant	BT CH39 2441MHz	
0	Vertical	Fundamental
Peak	<p>Site : 03CH15-HY Condition : PEAK_BE_74 3m 91200_15_1620 VERTICAL RBW:1000.000KHz VBW:3000.000KHz SWT:Auto Detector : Peak Project : 132425</p>	<p>Site : 03CH15-HY Condition : PEAK_74 3m 91200_15_1620 VERTICAL RBW:1000.000KHz VBW:3000.000KHz SWT:Auto Detector : Peak Project : 132425</p>
Peak	<p>Site : 03CH15-HY Condition : PEAK_BE_74 3m 91200_15_1620 VERTICAL RBW:1000.000KHz VBW:3000.000KHz SWT:Auto Detector : Peak Project : 132425</p>	Left blank

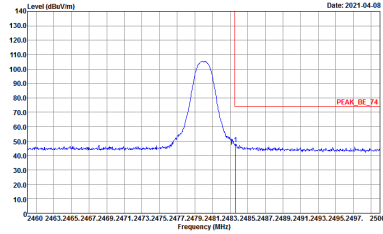
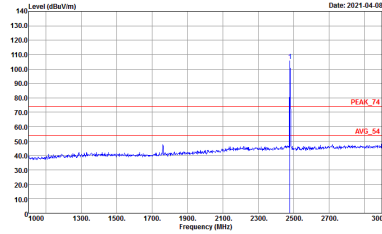

BT	2.4GHz 2400~2483.5MHz Band Edge @ 3m	
Ant	BT CH78 2480MHz	
0	Horizontal	Fundamental
Peak	 <p>Date: 2021.04.08</p> <p>Site : 03CH15-HY Condition : PEAK_BE_74 3m 91200_15_1620 HORIZONTAL RBW:1000.000KHz VBW:3000.000KHz SWT:Auto Detector : Peak Project : 132425</p>	 <p>Date: 2021.04.08</p> <p>Site : 03CH15-HY Condition : PEAK_74 3m 91200_15_1620 HORIZONTAL RBW:1000.000KHz VBW:3000.000KHz SWT:Auto Detector : Peak Project : 132425</p>



BT	2.4GHz 2400~2483.5MHz Band Edge @ 3m	
Ant	BT CH78 2480MHz	
0	Vertical	Fundamental
Peak	<p>Site : 03CH15-HY Condition : PEAK_BE_74 3m 91200_15_1620 VERTICAL RBW:1000.000KHz VBW:3000.000KHz SWT:Auto Detector : Peak Project : 132425</p>	<p>Site : 03CH15-HY Condition : PEAK_74 3m 91200_15_1620 VERTICAL RBW:1000.000KHz VBW:3000.000KHz SWT:Auto Detector : Peak Project : 132425</p>



2.4GHz 2400~2483.5MHz

BT (Harmonic @ 3m)

BT	2.4GHz 2400~2483.5MHz Harmonic @ 3m	
Ant	BT CH00 2402MHz	
0	Horizontal	Vertical
Peak Avg.	<p>Site : 03CH15-1FY Condition : PEAK_74 3m 91200_15_1620 HORIZONTAL Detector : Peak Project : 132425</p>	<p>Site : 03CH15-1FY Condition : PEAK_74 3m 91200_15_1620 VERTICAL Detector : Peak Project : 132425</p>

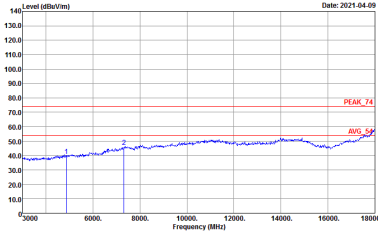
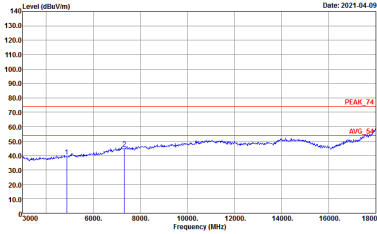

BT	2.4GHz 2400~2483.5MHz Harmonic @ 3m	
Ant	BT CH39 2441MHz	
0	Horizontal	Vertical
<p>Peak Avg.</p>	 <p>Site : 03CH15-HY Condition : PEAK_74 3m 91200_15_1620 HORIZONTAL Detector : Peak Project : 132425</p>	 <p>Site : 03CH15-HY Condition : PEAK_74 3m 91200_15_1620 VERTICAL Detector : Peak Project : 132425</p>

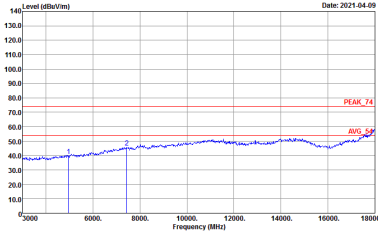
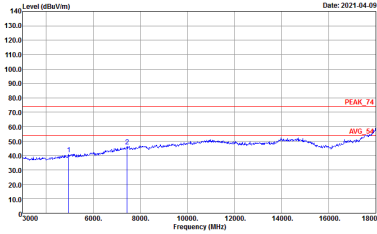

BT	2.4GHz 2400~2483.5MHz Harmonic @ 3m	
Ant	BT CH78 2480MHz	
0	Horizontal	Vertical
<p>Peak</p> <p>Avg.</p>	 <p>Site : 03CH15-HY Condition : PEAK_74 3m 91200_15_1620 HORIZONTAL Detector : Peak Project : 132425</p>	 <p>Site : 03CH15-HY Condition : PEAK_74 3m 91200_15_1620 VERTICAL Detector : Peak Project : 132425</p>



<3Mbps>

2.4GHz 2400~2483.5MHz

BT (Band Edge @ 3m)

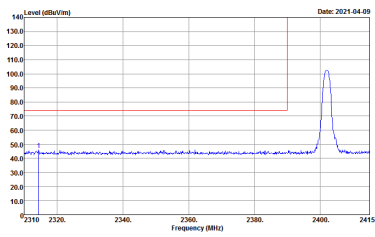
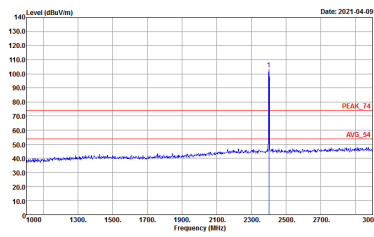
BT	2.4GHz 2400~2483.5MHz Band Edge @ 3m	
Ant	BT CH00 2402MHz	
0	Horizontal	Fundamental
Peak	 <p>Site : 03CH15-1RV Condition : PEAK_BE_74 3m 91200_15_1620 HORIZONTAL : RBW:1000.000KHz VBW:3000.000KHz SWT:Auto Detector : Peak Project : 132425</p>	 <p>Site : 03CH15-1RV Condition : PEAK_74 3m 91200_15_1620 HORIZONTAL : RBW:1000.000KHz VBW:3000.000KHz SWT:Auto Detector : Peak Project : 132425</p>



BT	2.4GHz 2400~2483.5MHz Band Edge @ 3m	
Ant	BT CH00 2402MHz	
0	Vertical	Fundamental
Peak	<p> Site : 03CH15-HY Condition : PEAK_8E_74 3m 91200_15_1620 VERTICAL RBW:1000.000KHz VBW:3000.000KHz SWT:Auto Detector : Peak Project : 132425 </p>	<p> Site : 03CH15-HY Condition : PEAK_74 3m 91200_15_1620 VERTICAL RBW:1000.000KHz VBW:3000.000KHz SWT:Auto Detector : Peak Project : 132425 </p>

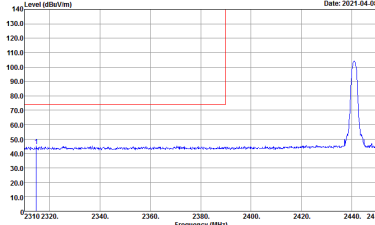
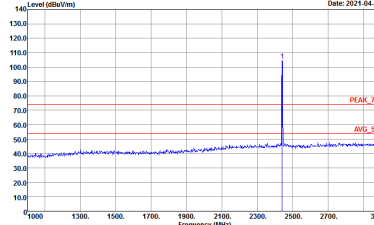
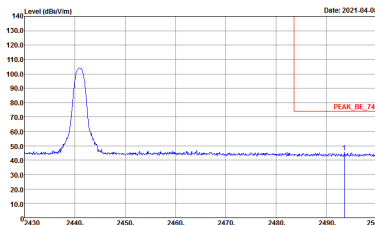

BT	2.4GHz 2400~2483.5MHz Band Edge @ 3m	
Ant	BT CH39 2441MHz	
0	Horizontal	Fundamental
<p>Peak</p>	 <p>Site : 03CH15-HY Condition : PEAK_BE_74 3m 91200_15_1620 HORIZONTAL RBW:1000.000KHz VBW:3000.000KHz SWT:Auto Detector : Peak Project : 132425</p>	 <p>Site : 03CH15-HY Condition : PEAK_74 3m 91200_15_1620 HORIZONTAL RBW:1000.000KHz VBW:3000.000KHz SWT:Auto Detector : Peak Project : 132425</p>
<p>Peak</p>	 <p>Site : 03CH15-HY Condition : PEAK_BE_74 3m 91200_15_1620 HORIZONTAL RBW:1000.000KHz VBW:3000.000KHz SWT:Auto Detector : Peak Project : 132425</p>	<p>Left blank</p>

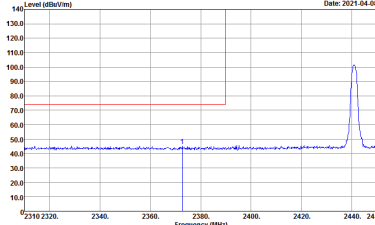
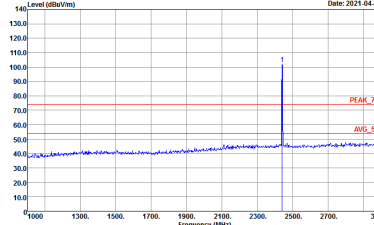
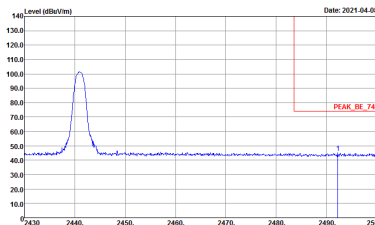

BT	2.4GHz 2400~2483.5MHz Band Edge @ 3m	
Ant	BT CH39 2441MHz	
0	Vertical	Fundamental
Peak	 <p>Site : 03CH15-HY Condition : PEAK_BE_74 3m 91200_15_1620 VERTICAL RBW:1000.000KHz VBW:3000.000KHz SWT:Auto Detector : Peak Project : 132425</p>	 <p>Site : 03CH15-HY Condition : PEAK_74 3m 91200_15_1620 VERTICAL RBW:1000.000KHz VBW:3000.000KHz SWT:Auto Detector : Peak Project : 132425</p>
Peak	 <p>Site : 03CH15-HY Condition : PEAK_BE_74 3m 91200_15_1620 VERTICAL RBW:1000.000KHz VBW:3000.000KHz SWT:Auto Detector : Peak Project : 132425</p>	Left blank

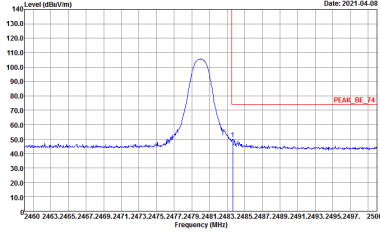
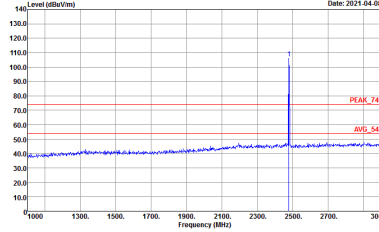

BT	2.4GHz 2400~2483.5MHz Band Edge @ 3m	
Ant	BT CH78 2480MHz	
0	Horizontal	Fundamental
Peak	 <p>Date: 2021-04-08</p> <p>Site : 03CH15-HY Condition : PEAK_BE_74 3m 91200_15_1620 HORIZONTAL RBW:1000.000KHz VBW:3000.000KHz SWT:Auto Detector : Peak Project : 132425</p>	 <p>Date: 2021-04-08</p> <p>Site : 03CH15-HY Condition : PEAK_74 3m 91200_15_1620 HORIZONTAL RBW:1000.000KHz VBW:3000.000KHz SWT:Auto Detector : Peak Project : 132425</p>



BT	2.4GHz 2400~2483.5MHz Band Edge @ 3m	
Ant	BT CH78 2480MHz	
0	Vertical	Fundamental
Peak	<p>Site : 03CH15-HY Condition : PEAK_BE_74 3m 91200_15_1620 VERTICAL RBW:1000.000KHz VBW:3000.000KHz SWT:Auto Detector : Peak Project : 132425</p>	<p>Site : 03CH15-HY Condition : PEAK_74 3m 91200_15_1620 VERTICAL RBW:1000.000KHz VBW:3000.000KHz SWT:Auto Detector : Peak Project : 132425</p>



2.4GHz 2400~2483.5MHz

BT (Harmonic @ 3m)

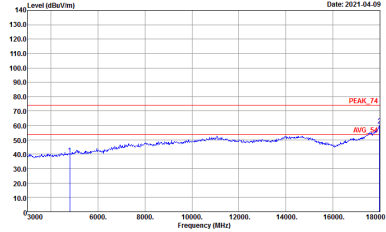
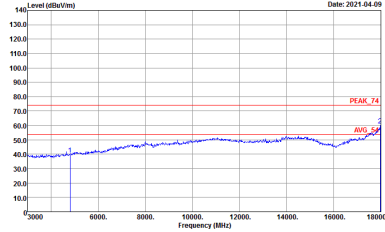
BT	2.4GHz 2400~2483.5MHz Harmonic @ 3m	
Ant	BT CH00 2402MHz	
0	Horizontal	Vertical
<p>Peak</p> <p>Avg.</p>	 <p>Site : 03CH15-1FY Condition : PEAK_74 3m 91200_15_1620 HORIZONTAL Detector : Peak Project : 132425</p>	 <p>Site : 03CH15-1FY Condition : PEAK_74 3m 91200_15_1620 VERTICAL Detector : Peak Project : 132425</p>

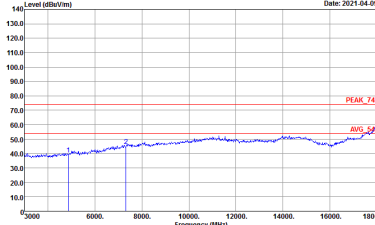
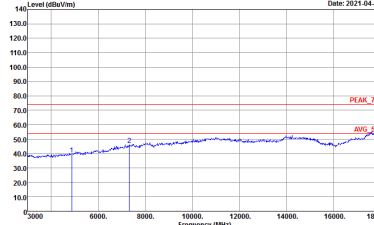

BT	2.4GHz 2400~2483.5MHz Harmonic @ 3m	
Ant	BT CH39 2441MHz	
0	Horizontal	Vertical
<p>Peak</p> <p>Avg.</p>	 <p>Site : 03CH15-HY Condition : PEAK_74 3m 91200_15_1620 HORIZONTAL Detector : Peak Project : 132425</p>	 <p>Site : 03CH15-HY Condition : PEAK_74 3m 91200_15_1620 VERTICAL Detector : Peak Project : 132425</p>

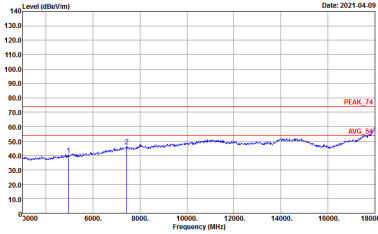
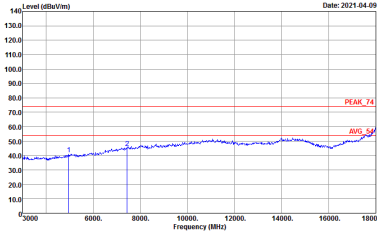

BT	2.4GHz 2400~2483.5MHz Harmonic @ 3m	
Ant	BT CH78 2480MHz	
0	Horizontal	Vertical
<p>Peak</p> <p>Avg.</p>	 <p>Site : 03CH15-HY Condition : PEAK_74 3m 91200_15_1620 HORIZONTAL Detector : Peak Project : 132425</p>	 <p>Site : 03CH15-HY Condition : PEAK_74 3m 91200_15_1620 VERTICAL Detector : Peak Project : 132425</p>



Emission above 18GHz
2.4GHz BT (SHF)

Table with 2 columns: BT (2.4GHz 2400~2483.5MHz), Ant (BT SHF). Sub-columns: Horizontal, Vertical. Includes two graphs showing Level (dBuV/m) vs Frequency (MHz) with peak and average values. Includes site and condition details for both orientations.

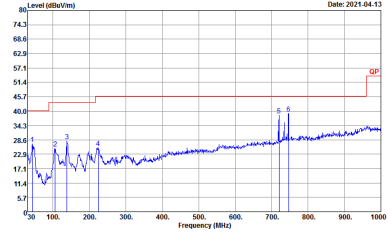
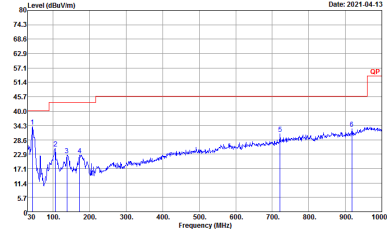

Emission below 1GHz
2.4GHz BT (LF)

BT	2.4GHz 2400~2483.5MHz	
Ant	BT LF	
0	Horizontal	Vertical
QP / Peak	 <p>Site : 03CH15-FY Condition : QP 3m BTLOG_41912_20210208 HORIZONTAL Detector : Peak Project : 132425</p>	 <p>Site : 03CH15-FY Condition : QP 3m BTLOG_41912_20210208 VERTICAL Detector : Peak Project : 132425</p>



<Ant. 1>
<1Mbps>

2.4GHz 2400~2483.5MHz
BT (Band Edge @ 3m)

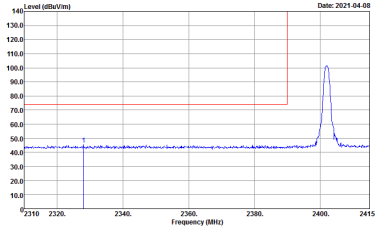
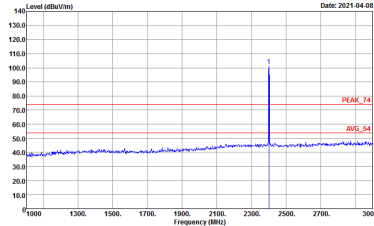
BT	2.4GHz 2400~2483.5MHz Band Edge @ 3m	
Ant	BT CH00 2402MHz	
1	Horizontal	Fundamental
Peak	 <p>Date: 2021-04-08</p> <p>Site : 03CH15-1FV Condition : PEAK_BE_74 3m 91200_15_1620 HORIZONTAL : RBW:1000.000KHz VBW:3000.000KHz SWT:Auto Detector : Peak Project : 132425</p>	 <p>Date: 2021-04-08</p> <p>Site : 03CH15-1FV Condition : PEAK_74 3m 91200_15_1620 HORIZONTAL : RBW:1000.000KHz VBW:3000.000KHz SWT:Auto Detector : Peak Project : 132425</p>

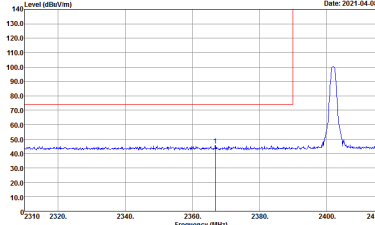
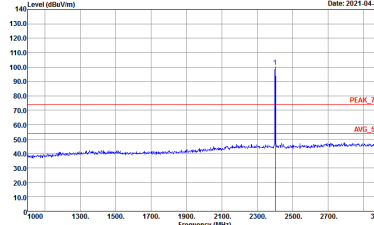

BT	2.4GHz 2400~2483.5MHz Band Edge @ 3m	
Ant	BT CH00 2402MHz	
1	Vertical	Fundamental
Peak	 <p>Date: 2021.04.08</p> <p>Site : 03CH15-HY Condition : PEAK_8E_74 3m 91200_15_1620 VERTICAL RBW:1000.000KHz VBW:3000.000KHz SWT:Auto Detector : Peak Project : 132425</p>	 <p>Date: 2021.04.08</p> <p>Site : 03CH15-HY Condition : PEAK_74 3m 91200_15_1620 VERTICAL RBW:1000.000KHz VBW:3000.000KHz SWT:Auto Detector : Peak Project : 132425</p>

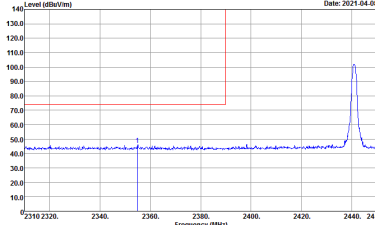
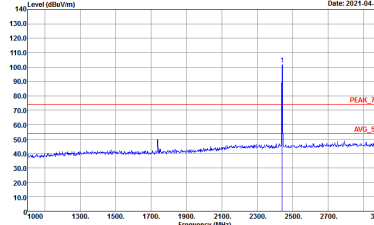
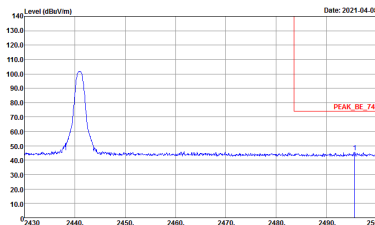

BT	2.4GHz 2400~2483.5MHz Band Edge @ 3m	
Ant	BT CH39 2441MHz	
1	Horizontal	Fundamental
<p>Peak</p>	 <p>Site : 03CH15-HY Condition : PEAK_BE_74 3m 91200_15_1620 HORIZONTAL RBW:1000.000KHz VBW:3000.000KHz SWT:Auto Detector : Peak Project : 132425</p>	 <p>Site : 03CH15-HY Condition : PEAK_74 3m 91200_15_1620 HORIZONTAL RBW:1000.000KHz VBW:3000.000KHz SWT:Auto Detector : Peak Project : 132425</p>
<p>Peak</p>	 <p>Site : 03CH15-HY Condition : PEAK_BE_74 3m 91200_15_1620 HORIZONTAL RBW:1000.000KHz VBW:3000.000KHz SWT:Auto Detector : Peak Project : 132425</p>	<p>Left blank</p>



BT	2.4GHz 2400~2483.5MHz Band Edge @ 3m	
Ant	BT CH39 2441MHz	
1	Vertical	Fundamental
Peak	<p>Site : 03CH15-HY Condition : PEAK_BE_74 3m 91200_15_1620 VERTICAL RBW:1000.000KHz VBW:3000.000KHz SWT:Auto Detector : Peak Project : 132425</p>	<p>Site : 03CH15-HY Condition : PEAK_74 3m 91200_15_1620 VERTICAL RBW:1000.000KHz VBW:3000.000KHz SWT:Auto Detector : Peak Project : 132425</p>
Peak	<p>Site : 03CH15-HY Condition : PEAK_BE_74 3m 91200_15_1620 VERTICAL RBW:1000.000KHz VBW:3000.000KHz SWT:Auto Detector : Peak Project : 132425</p>	Left blank

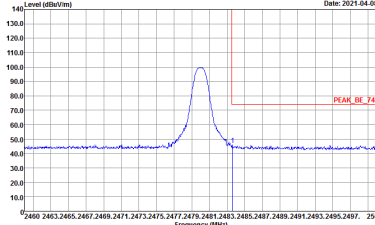
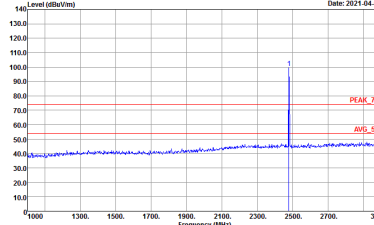

BT	2.4GHz 2400~2483.5MHz Band Edge @ 3m	
Ant	BT CH78 2480MHz	
1	Horizontal	Fundamental
Peak	 <p>Date: 2021-04-08</p> <p>Site : 03CH15-HY Condition : PEAK_BE_74 3m 91200_15_1620 HORIZONTAL RBW:1000.000KHz VBW:3000.000KHz SWT:Auto Detector : Peak Project : 132425</p>	 <p>Date: 2021-04-08</p> <p>Site : 03CH15-HY Condition : PEAK_74 3m 91200_15_1620 HORIZONTAL RBW:1000.000KHz VBW:3000.000KHz SWT:Auto Detector : Peak Project : 132425</p>

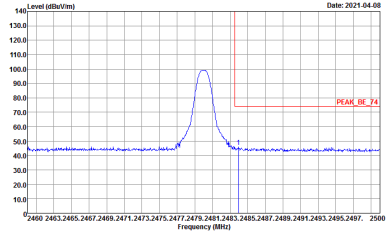
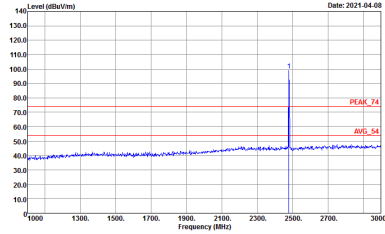

BT	2.4GHz 2400~2483.5MHz Band Edge @ 3m	
Ant	BT CH78 2480MHz	
1	Vertical	Fundamental
Peak	 <p>Date: 2021-04-08</p> <p>Site : 03CH15-HY Condition : PEAK_BE_74 3m 91200_15_1620 VERTICAL RBW:1000.000KHz VBW:3000.000KHz SWT:Auto Detector : Peak Project : 132425</p>	 <p>Date: 2021-04-08</p> <p>Site : 03CH15-HY Condition : PEAK_74 3m 91200_15_1620 VERTICAL RBW:1000.000KHz VBW:3000.000KHz SWT:Auto Detector : Peak Project : 132425</p>



2.4GHz 2400~2483.5MHz

BT (Harmonic @ 3m)

BT	2.4GHz 2400~2483.5MHz Harmonic @ 3m	
Ant	BT CH00 2402MHz	
1	Horizontal	Vertical
Peak Avg.	<p>Site : 03CH15-1FY Condition : PEAK_74 3m 91200_15_1620 HORIZONTAL Detector : Peak Project : 132425</p>	<p>Site : 03CH15-1FY Condition : PEAK_74 3m 91200_15_1620 VERTICAL Detector : Peak Project : 132425</p>



BT	2.4GHz 2400~2483.5MHz Harmonic @ 3m	
Ant	BT CH39 2441MHz	
1	Horizontal	Vertical
Peak Avg.	<p>Site : 03CH15-HY Condition : PEAK_74 3m 91200_15_1620 HORIZONTAL Detector : Peak Project : 132425</p>	<p>Site : 03CH15-HY Condition : PEAK_74 3m 91200_15_1620 VERTICAL Detector : Peak Project : 132425</p>

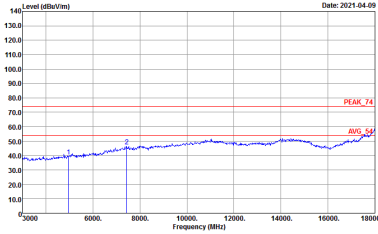
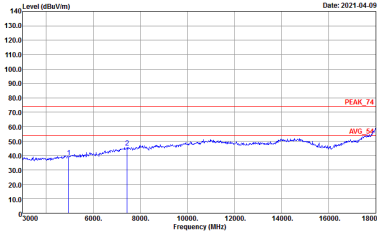

BT	2.4GHz 2400~2483.5MHz Harmonic @ 3m	
Ant	BT CH78 2480MHz	
1	Horizontal	Vertical
<p>Peak</p> <p>Avg.</p>	 <p>Site : 03CH15-HY Condition : PEAK_74 3m 91200_15_1620 HORIZONTAL Detector : Peak Project : 132425</p>	 <p>Site : 03CH15-HY Condition : PEAK_74 3m 91200_15_1620 VERTICAL Detector : Peak Project : 132425</p>



<2Mbps>

2.4GHz 2400~2483.5MHz
BT (Band Edge @ 3m)

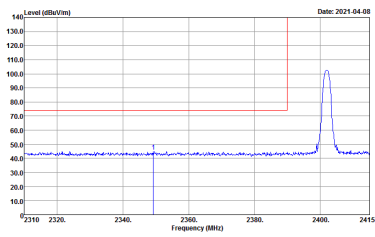
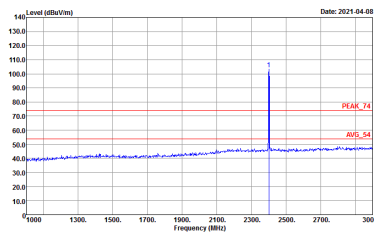
BT	2.4GHz 2400~2483.5MHz Band Edge @ 3m	
Ant	BT CH00 2402MHz	
1	Horizontal	Fundamental
Peak	 <p>Site : 03CH15-1V Condition : PEAK_BE_74 3m 91200_15_1620 HORIZONTAL Detector : Peak Project : 132425</p>	 <p>Site : 03CH15-1V Condition : PEAK_74 3m 91200_15_1620 HORIZONTAL Detector : Peak Project : 132425</p>

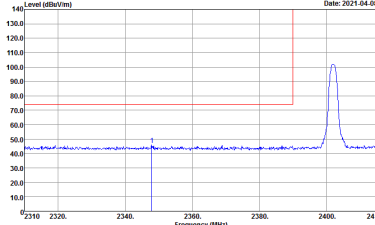
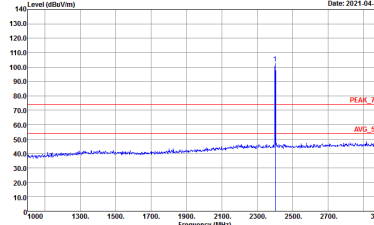

BT	2.4GHz 2400~2483.5MHz Band Edge @ 3m	
Ant	BT CH00 2402MHz	
1	Vertical	Fundamental
Peak	 <p>Site : 03CH15-HY Condition : PEAK_8E_74 3m 91200_15_1620 VERTICAL RBW:1000.000KHz VBW:3000.000KHz SWT:Auto Detector : Peak Project : 132425</p>	 <p>Site : 03CH15-HY Condition : PEAK_74 3m 91200_15_1620 VERTICAL RBW:1000.000KHz VBW:3000.000KHz SWT:Auto Detector : Peak Project : 132425</p>

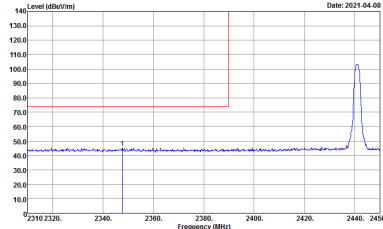
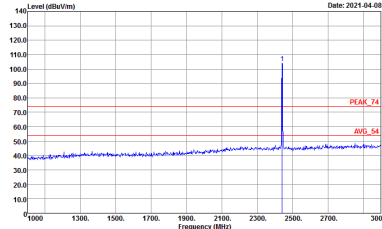
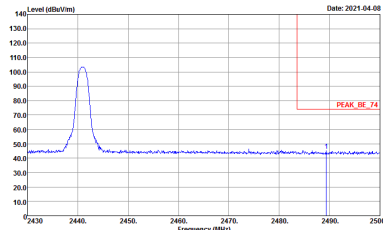

BT	2.4GHz 2400~2483.5MHz Band Edge @ 3m	
Ant	BT CH39 2441MHz	
1	Horizontal	Fundamental
<p>Peak</p>	 <p>Site : 03CH15-HY Condition : PEAK_BE_74 3m 91200_15_1620 HORIZONTAL RBW:1000.000KHz VBW:3000.000KHz SWT:Auto Detector : Peak Project : 132425</p>	 <p>Site : 03CH15-HY Condition : PEAK_74 3m 91200_15_1620 HORIZONTAL RBW:1000.000KHz VBW:3000.000KHz SWT:Auto Detector : Peak Project : 132425</p>
<p>Peak</p>	 <p>Site : 03CH15-HY Condition : PEAK_BE_74 3m 91200_15_1620 HORIZONTAL RBW:1000.000KHz VBW:3000.000KHz SWT:Auto Detector : Peak Project : 132425</p>	<p>Left blank</p>

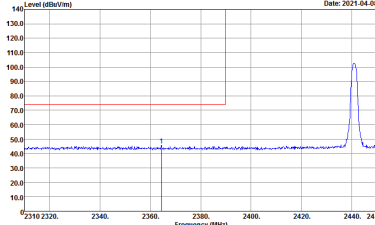
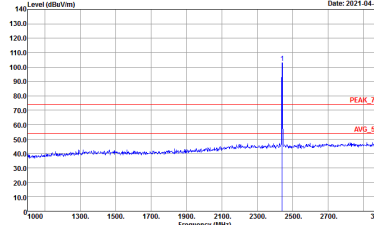
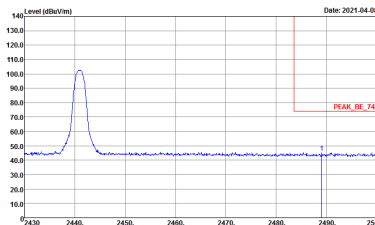

BT	2.4GHz 2400~2483.5MHz Band Edge @ 3m	
Ant	BT CH39 2441MHz	
1	Vertical	Fundamental
<p>Peak</p>	 <p>Site : 03CH15-HY Condition : PEAK_BE_74 3m 91200_15_1620 VERTICAL RBW:1000.000KHz VBW:3000.000KHz SWT:Auto Detector : Peak Project : 132425</p>	 <p>Site : 03CH15-HY Condition : PEAK_74 3m 91200_15_1620 VERTICAL RBW:1000.000KHz VBW:3000.000KHz SWT:Auto Detector : Peak Project : 132425</p>
<p>Peak</p>	 <p>Site : 03CH15-HY Condition : PEAK_BE_74 3m 91200_15_1620 VERTICAL RBW:1000.000KHz VBW:3000.000KHz SWT:Auto Detector : Peak Project : 132425</p>	<p>Left blank</p>

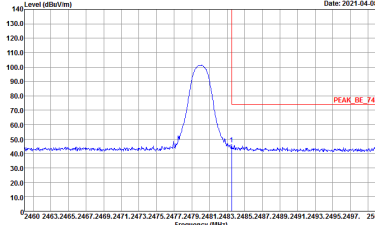
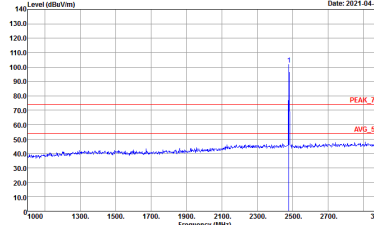

BT	2.4GHz 2400~2483.5MHz Band Edge @ 3m	
Ant	BT CH78 2480MHz	
1	Horizontal	Fundamental
Peak	 <p>Site : 03CH15-HY Condition : PEAK_BE_74 3m 91200_15_1620 HORIZONTAL RBW:1000.000KHz VBW:3000.000KHz SWT:Auto Detector : Peak Project : 132425</p>	 <p>Site : 03CH15-HY Condition : PEAK_74 3m 91200_15_1620 HORIZONTAL RBW:1000.000KHz VBW:3000.000KHz SWT:Auto Detector : Peak Project : 132425</p>

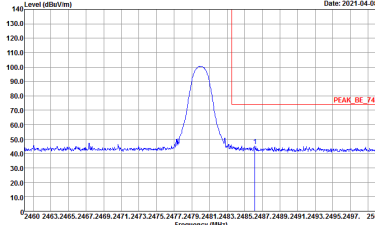
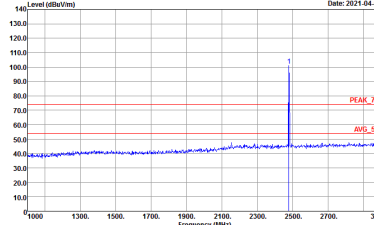

BT	2.4GHz 2400~2483.5MHz Band Edge @ 3m	
Ant	BT CH78 2480MHz	
1	Vertical	Fundamental
Peak	 <p>Date: 2021-04-08</p> <p>Site : 03CH15-HY Condition : PEAK_BE_74 3m 91200_15_1620 VERTICAL RBW:1000.000KHz VBW:3000.000KHz SWT:Auto Detector : Peak Project : 132425</p>	 <p>Date: 2021-04-08</p> <p>Site : 03CH15-HY Condition : PEAK_74 3m 91200_15_1620 VERTICAL RBW:1000.000KHz VBW:3000.000KHz SWT:Auto Detector : Peak Project : 132425</p>



2.4GHz 2400~2483.5MHz

BT (Harmonic @ 3m)

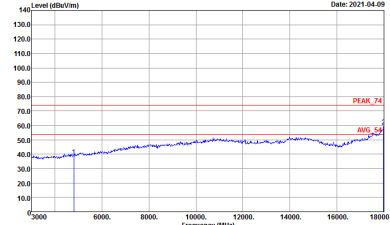
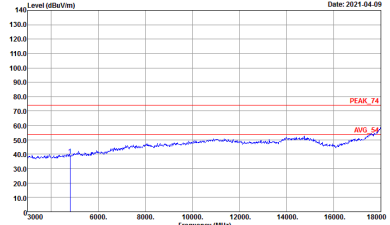
BT	2.4GHz 2400~2483.5MHz Harmonic @ 3m	
Ant	BT CH00 2402MHz	
1	Horizontal	Vertical
<p>Peak</p> <p>Avg.</p>	 <p>Site : 03CH15-1FY Condition : PEAK_74 3m 91200_15_1620 HORIZONTAL Detector : Peak Project : 132425</p>	 <p>Site : 03CH15-1FY Condition : PEAK_74 3m 91200_15_1620 VERTICAL Detector : Peak Project : 132425</p>

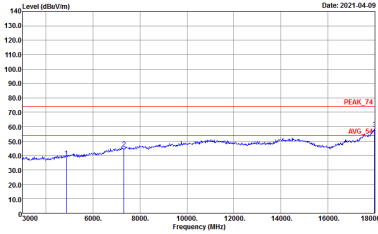
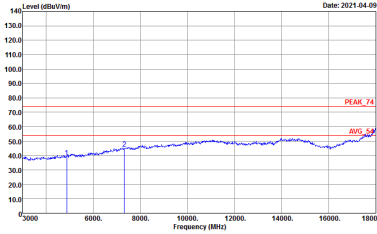

BT	2.4GHz 2400~2483.5MHz Harmonic @ 3m	
Ant	BT CH39 2441MHz	
1	Horizontal	Vertical
<p>Peak</p> <p>Avg.</p>	 <p>Site : 03CH15-HY Condition : PEAK_74 3m 91200_15_1620 HORIZONTAL Detector : Peak Project : 132425</p>	 <p>Site : 03CH15-HY Condition : PEAK_74 3m 91200_15_1620 VERTICAL Detector : Peak Project : 132425</p>

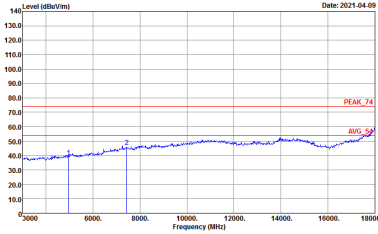
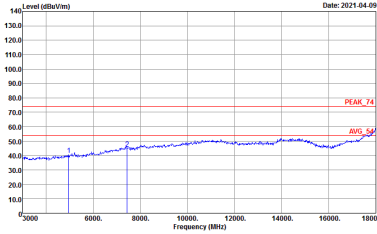

BT	2.4GHz 2400~2483.5MHz Harmonic @ 3m	
Ant	BT CH78 2480MHz	
1	Horizontal	Vertical
<p>Peak</p> <p>Avg.</p>	 <p>Site : 03CH15-HY Condition : PEAK_74 3m 91200_15_1620 HORIZONTAL Detector : Peak Project : 132425</p>	 <p>Site : 03CH15-HY Condition : PEAK_74 3m 91200_15_1620 VERTICAL Detector : Peak Project : 132425</p>



<3Mbps>

2.4GHz 2400~2483.5MHz

BT (Band Edge @ 3m)

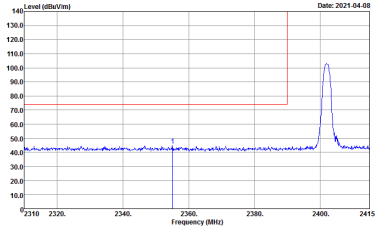
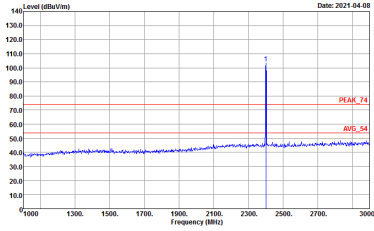
BT	2.4GHz 2400~2483.5MHz Band Edge @ 3m	
Ant	BT CH00 2402MHz	
1	Horizontal	Fundamental
Peak	 <p>Site : 03CH15-1V Condition : PEAK_BE_74 3m 91200_15_1620 HORIZONTAL : RBW:1000.000KHz VBW:3000.000KHz SWT:Auto Detector : Peak Project : 132425</p>	 <p>Site : 03CH15-1V Condition : PEAK_74 3m 91200_15_1620 HORIZONTAL : RBW:1000.000KHz VBW:3000.000KHz SWT:Auto Detector : Peak Project : 132425</p>

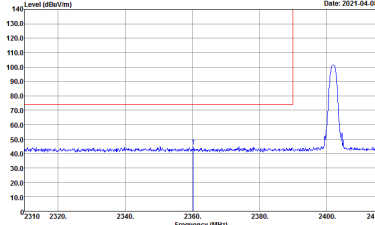
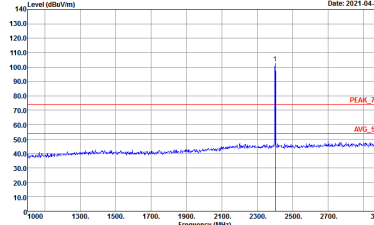

BT	2.4GHz 2400~2483.5MHz Band Edge @ 3m	
Ant	BT CH00 2402MHz	
1	Vertical	Fundamental
Peak	 <p>Date: 2021.04.08</p> <p>Site : 03CH15-HY Condition : PEAK_8E_74 3m 91200_15_1620 VERTICAL RBW:1000.000KHz VBW:3000.000KHz SWT:Auto Detector : Peak Project : 132425</p>	 <p>Date: 2021.04.08</p> <p>Site : 03CH15-HY Condition : PEAK_74 3m 91200_15_1620 VERTICAL RBW:1000.000KHz VBW:3000.000KHz SWT:Auto Detector : Peak Project : 132425</p>

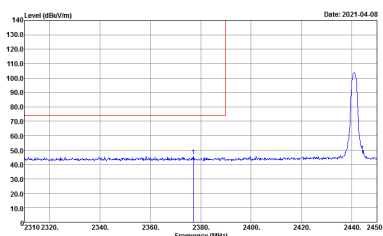
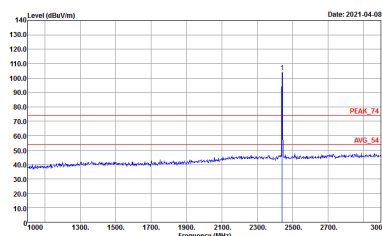
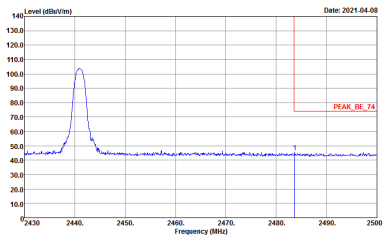

BT	2.4GHz 2400~2483.5MHz Band Edge @ 3m	
Ant	BT CH39 2441MHz	
1	Horizontal	Fundamental
<p>Peak</p>	 <p>Site : 03CH15-HY Condition : PEAK_BE_74 3m 91200_15_1620 HORIZONTAL RBW:1000.000KHz VBW:3000.000KHz SWT:Auto Detector : Peak Project : 132425</p>	 <p>Site : 03CH15-HY Condition : PEAK_74 3m 91200_15_1620 HORIZONTAL RBW:1000.000KHz VBW:3000.000KHz SWT:Auto Detector : Peak Project : 132425</p>
<p>Peak</p>	 <p>Site : 03CH15-HY Condition : PEAK_BE_74 3m 91200_15_1620 HORIZONTAL RBW:1000.000KHz VBW:3000.000KHz SWT:Auto Detector : Peak Project : 132425</p>	<p>Left blank</p>

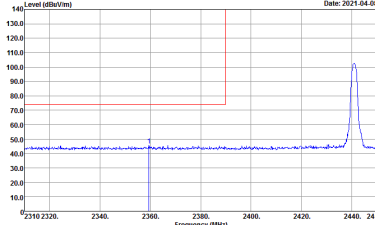
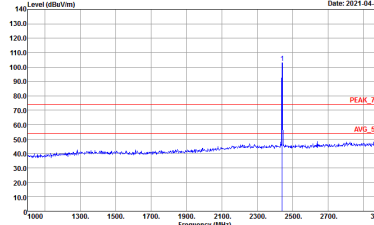
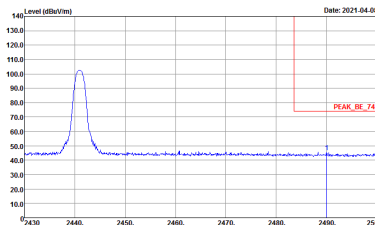

BT	2.4GHz 2400~2483.5MHz Band Edge @ 3m	
Ant	BT CH39 2441MHz	
1	Vertical	Fundamental
Peak	 <p>Site : 03CH15-HY Condition : PEAK_BE_74 3m 91200_15_1620 VERTICAL : RBW:1000.000KHz VBW:3000.000KHz SWT:Auto Detector : Peak Project : 132425</p>	 <p>Site : 03CH15-HY Condition : PEAK_74 3m 91200_15_1620 VERTICAL : RBW:1000.000KHz VBW:3000.000KHz SWT:Auto Detector : Peak Project : 132425</p>
Peak	 <p>Site : 03CH15-HY Condition : PEAK_BE_74 3m 91200_15_1620 VERTICAL : RBW:1000.000KHz VBW:3000.000KHz SWT:Auto Detector : Peak Project : 132425</p>	Left blank

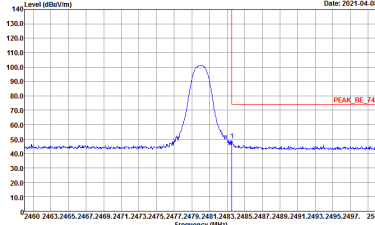
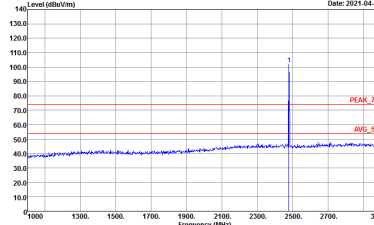

BT	2.4GHz 2400~2483.5MHz Band Edge @ 3m	
Ant	BT CH78 2480MHz	
1	Horizontal	Fundamental
Peak	 <p>Date: 2021-04-08</p> <p>Site : 03CH15-HY Condition : PEAK_BE_74 3m 91200_15_1620 HORIZONTAL RBW:1000.000KHz VBW:3000.000KHz SWT:Auto Detector : Peak Project : 132425</p>	 <p>Date: 2021-04-08</p> <p>Site : 03CH15-HY Condition : PEAK_74 3m 91200_15_1620 HORIZONTAL RBW:1000.000KHz VBW:3000.000KHz SWT:Auto Detector : Peak Project : 132425</p>

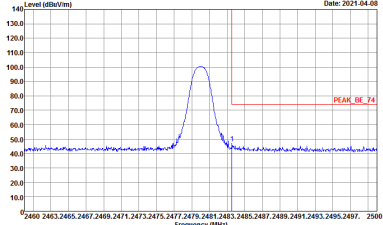
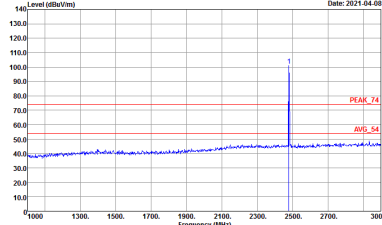

BT	2.4GHz 2400~2483.5MHz Band Edge @ 3m	
Ant	BT CH78 2480MHz	
1	Vertical	Fundamental
Peak	 <p>Date: 2021-04-08</p> <p>Site : 03CH15-HY Condition : PEAK_BE_74 3m 91200_15_1620 VERTICAL RBW:1000.000KHz VBW:3000.000KHz SWT:Auto Detector : Peak Project : 132425</p>	 <p>Date: 2021-04-08</p> <p>Site : 03CH15-HY Condition : PEAK_74 3m 91200_15_1620 VERTICAL RBW:1000.000KHz VBW:3000.000KHz SWT:Auto Detector : Peak Project : 132425</p>



2.4GHz 2400~2483.5MHz

BT (Harmonic @ 3m)

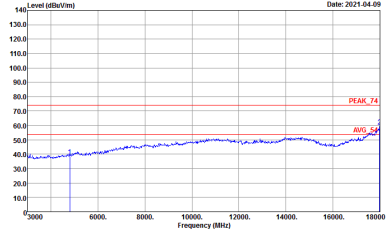
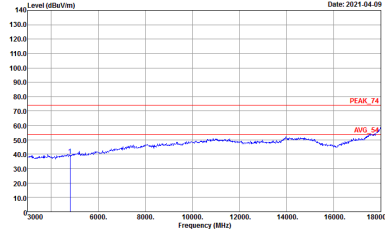
BT	2.4GHz 2400~2483.5MHz Harmonic @ 3m	
Ant	BT CH00 2402MHz	
1	Horizontal	Vertical
<p>Peak</p> <p>Avg.</p>	 <p>Site : 03CH15-1FY Condition : PEAK_74 3m 91200_15_1620 HORIZONTAL Detector : Peak Project : 132425</p>	 <p>Site : 03CH15-1FY Condition : PEAK_74 3m 91200_15_1620 VERTICAL Detector : Peak Project : 132425</p>



BT	2.4GHz 2400~2483.5MHz Harmonic @ 3m	
Ant	BT CH39 2441MHz	
1	Horizontal	Vertical
Peak Avg.	<p>Site : 03CH15-HY Condition : PEAK_74 3m 91200_15_1620 HORIZONTAL Detector : Peak Project : 132425</p>	<p>Site : 03CH15-HY Condition : PEAK_74 3m 91200_15_1620 VERTICAL Detector : Peak Project : 132425</p>



BT	2.4GHz 2400~2483.5MHz Harmonic @ 3m	
Ant	BT CH78 2480MHz	
1	Horizontal	Vertical
Peak Avg.	<p>Site : 03CH15-HY Condition : PEAK_74 3m 91200_15_1620 HORIZONTAL Detector : Peak Project : 132425</p>	<p>Site : 03CH15-HY Condition : PEAK_74 3m 91200_15_1620 VERTICAL Detector : Peak Project : 132425</p>

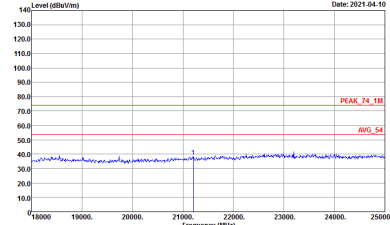
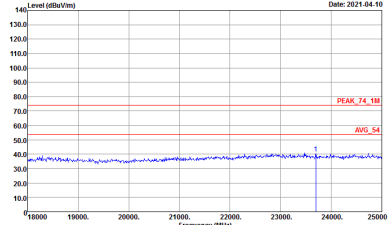

Emission above 18GHz
2.4GHz BT (SHF)

BT	2.4GHz 2400~2483.5MHz	
Ant	BT SHF	
1	Horizontal	Vertical
<p>QP / Peak</p>	 <p>Site : 03CH16-1FY Condition : PEAK_74_1M 1m SHF HORN BBH49170576 HORIZONTAL Detector : Peak Project : 132425</p>	 <p>Site : 03CH16-1FY Condition : PEAK_74_1M 1m SHF HORN BBH49170576 VERTICAL Detector : Peak Project : 132425</p>



Emission below 1GHz

2.4GHz BT (LF)

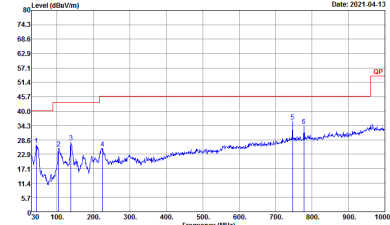
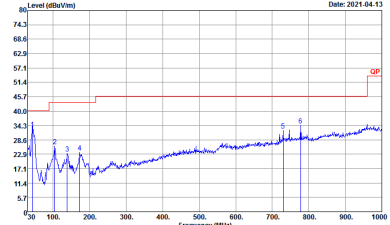
BT	2.4GHz 2400~2483.5MHz	
Ant	BT LF	
1	Horizontal	Vertical
QP / Peak	 <p>Site : 03CH15-FY Condition : QP 3m BTL06_41912_20210208 HORIZONTAL Detector : Peak Project : 132425</p>	 <p>Site : 03CH15-FY Condition : QP 3m BTL06_41912_20210208 VERTICAL Detector : Peak Project : 132425</p>



Appendix E. Duty Cycle Plots

<Ant. 0>

<1Mbps>

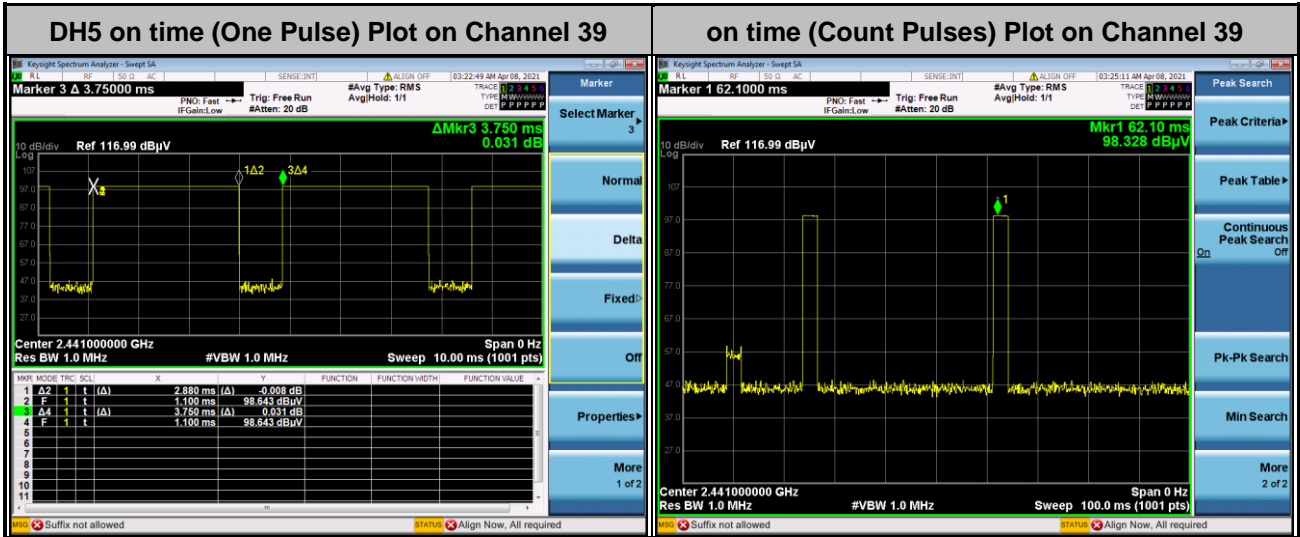

Note:

1. Worst case Duty cycle = on time/100 milliseconds = $2 * 2.88 / 100 = 5.76 \%$
2. Worst case Duty cycle correction factor = $20 * \log(\text{Duty cycle}) = -24.79 \text{ dB}$
3. DH5 has the highest duty cycle worst case and is reported.

<2Mbps>

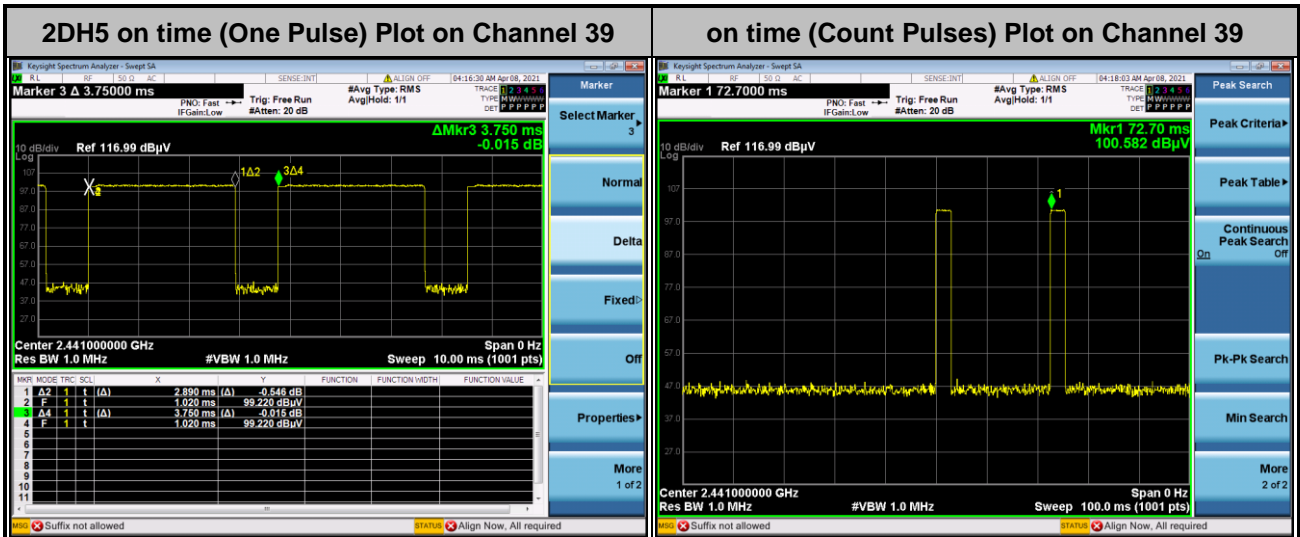

Note:

1. Worst case Duty cycle = on time/100 milliseconds = $2 * 2.89 / 100 = 5.78 \%$
2. Worst case Duty cycle correction factor = $20 * \log(\text{Duty cycle}) = -24.76 \text{ dB}$
3. 2DH5 has the highest duty cycle worst case and is reported.



<3Mbps>

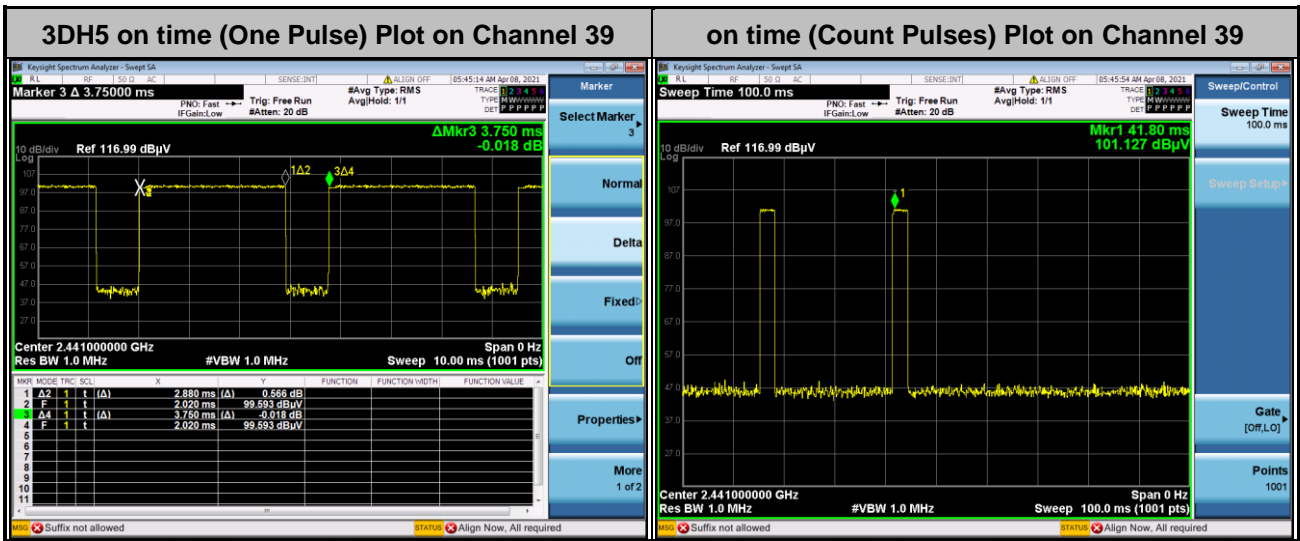

Note:

1. Worst case Duty cycle = on time/100 milliseconds = 2 * 2.88 / 100 = 5.76 %
2. Worst case Duty cycle correction factor = 20*log(Duty cycle) = -24.79 dB
3. 3DH5 has the highest duty cycle worst case and is reported.



<Ant. 1>
<1Mbps>

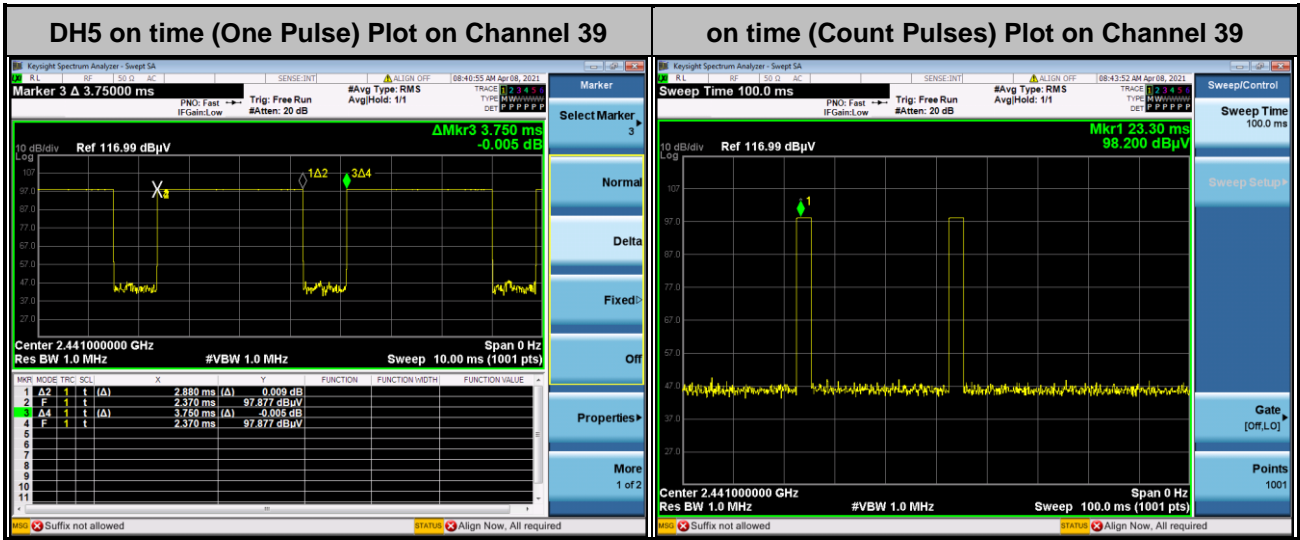

Note:

1. Worst case Duty cycle = on time/100 milliseconds = $2 * 2.88 / 100 = 5.76 \%$
2. Worst case Duty cycle correction factor = $20 * \log(\text{Duty cycle}) = -24.79 \text{ dB}$
3. DH5 has the highest duty cycle worst case and is reported.

<2Mbps>

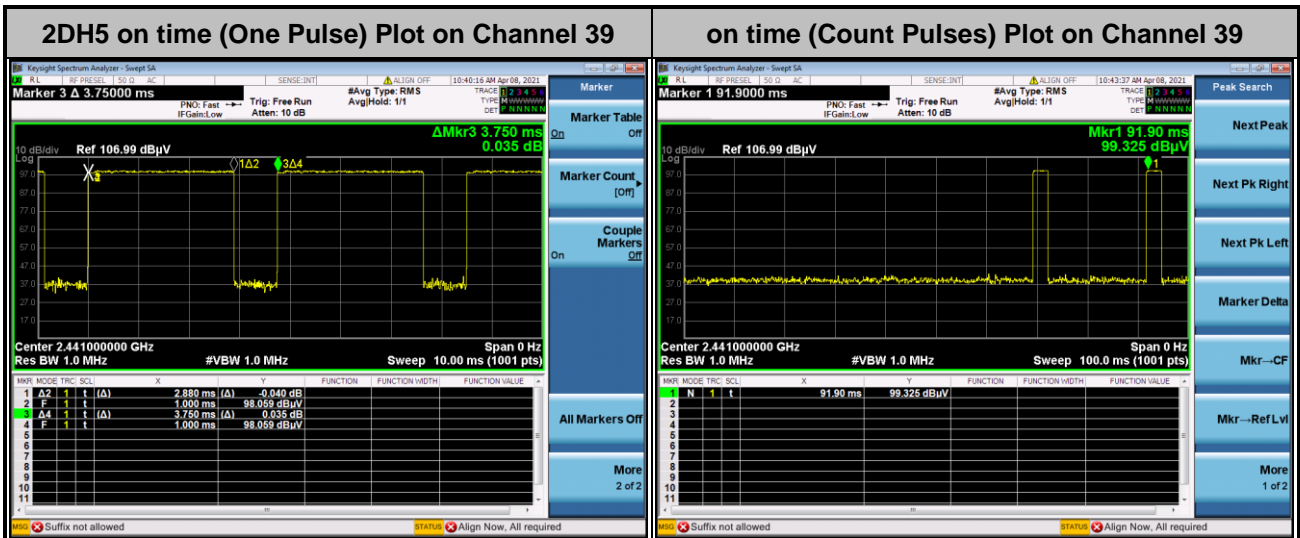

Note:

1. Worst case Duty cycle = on time/100 milliseconds = $2 * 2.88 / 100 = 5.76 \%$
2. Worst case Duty cycle correction factor = $20 * \log(\text{Duty cycle}) = -24.79 \text{ dB}$
3. 2DH5 has the highest duty cycle worst case and is reported.



<3Mbps>

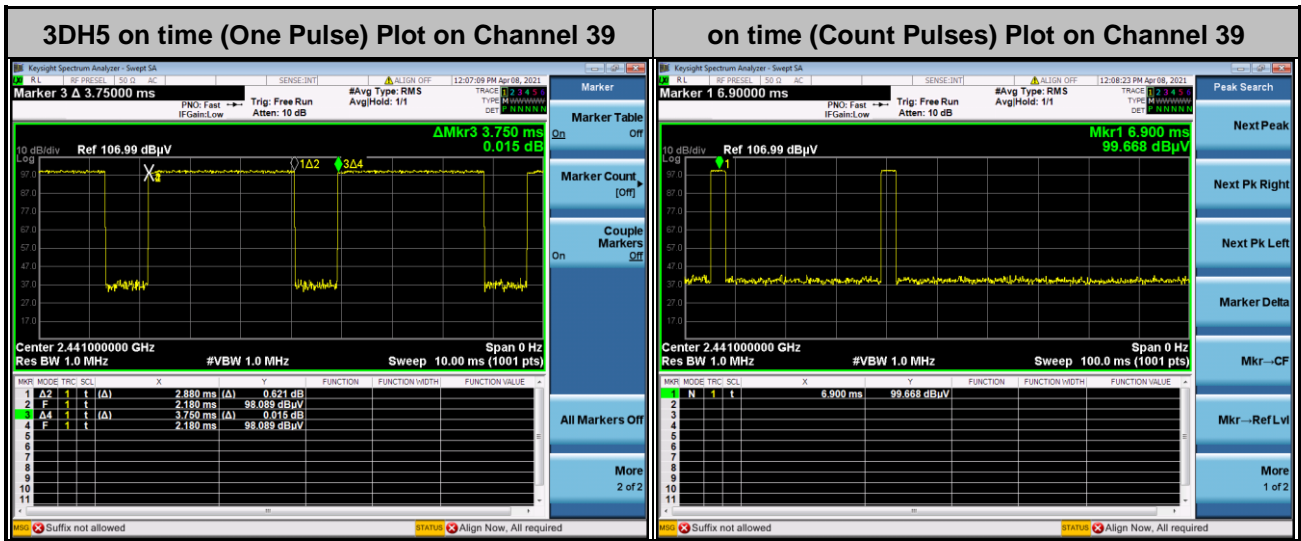

Note:

1. Worst case Duty cycle = on time/100 milliseconds = 2 * 2.88 / 100 = 5.76 %
2. Worst case Duty cycle correction factor = 20*log(Duty cycle) = -24.79 dB
3. 3DH5 has the highest duty cycle worst case and is reported.

Duty Cycle Correction Factor Consideration for AFH mode:

Bluetooth normal hopping rate is 1600Hz and reduced to 800Hz in AFH mode; due to the reduced number of hopping frequencies, with the same packet configuration the dwell time in each channel frequency within 100msec period is longer in AFH mode than normal mode.

In AFH mode, the minimum hopping frequencies are 20, to get the longest dwell time DH5 packet is observed; the period to have DH5 packet completing one hopping sequence is

$$2.88 \text{ ms} \times 20 \text{ channels} = 57.6 \text{ ms}$$

There cannot be 2 complete hopping sequences within 100ms period, considering the random hopping behavior, maximum 2 hops can be possibly observed within the period. [100 ms / 57.6 ms] = 2 hops

Thus, the maximum possible ON time:

$$2.88 \text{ ms} \times 2 = 5.76 \text{ ms}$$

Worst case Duty Cycle Correction factor, which is derived from the maximum possible ON time,

$$20 \times \log(5.76 \text{ ms}/100 \text{ ms}) = -24.79 \text{ dB}$$

—————THE END—————