



# FCC RF Test Report

**APPLICANT** : Sony Mobile Communications Inc.  
**EQUIPMENT** : GSM/WCDMA/LTE Phone+Bluetooth, DTS/UNII  
a/b/g/n and NFC  
**BRAND NAME** : Sony  
**FCC ID** : PY7-02885J  
**STANDARD** : FCC Part 15 Subpart E §15.407  
**CLASSIFICATION** : (NII) Unlicensed National Information Infrastructure

The product was received on Apr. 28, 2017 and testing was completed on Jun. 03, 2017. We, SPORTON INTERNATIONAL INC., would like to declare that the tested sample has been evaluated in accordance with the test procedures and has been in compliance with the applicable technical standards.

The test results in this report apply exclusively to the tested model / sample. Without written approval of SPORTON INTERNATIONAL INC., the test report shall not be reproduced except in full.

Reviewed by: Joseph Lin / Supervisor

Approved by: Jones Tsai / Manager



## SPORTON INTERNATIONAL INC.

No. 52, Hwa Ya 1<sup>st</sup> Rd., Hwa Ya Technology Park, Kwei-Shan District, Tao Yuan City, Taiwan, R.O.C.

SPORTON INTERNATIONAL INC.

TEL : 886-3-327-3456

FAX : 886-3-328-4978

FCC ID : PY7-02885J

Page Number : 1 of 34

Report Issued Date : Jul. 10, 2017

Report Version : Rev. 02

Report Template No.: BU5-FR15EWL Version 1.4



# TABLE OF CONTENTS

**REVISION HISTORY..... 3**

**SUMMARY OF TEST RESULT ..... 4**

**1 GENERAL DESCRIPTION ..... 5**

    1.1 Applicant ..... 5

    1.2 Manufacturer..... 5

    1.3 Product Feature of Equipment Under Test..... 5

    1.4 Modification of EUT ..... 6

    1.5 Testing Location ..... 7

    1.6 Applicable Standards..... 7

**2 TEST CONFIGURATION OF EQUIPMENT UNDER TEST ..... 8**

    2.1 Carrier Frequency Channel ..... 8

    2.2 Test Mode..... 9

    2.3 Connection Diagram of Test System..... 10

    2.4 Support Unit used in test configuration and system ..... 11

    2.5 EUT Operation Test Setup ..... 11

    2.6 Measurement Results Explanation Example..... 11

**3 TEST RESULT..... 12**

    3.1 26dB & 99% Occupied Bandwidth Measurement ..... 12

    3.2 Maximum Conducted Output Power Measurement ..... 14

    3.3 Power Spectral Density Measurement ..... 16

    3.4 Unwanted Radiated Emission Measurement ..... 19

    3.5 AC Conducted Emission Measurement..... 25

    3.6 Frequency Stability Measurement ..... 29

    3.7 Automatically Discontinue Transmission ..... 30

    3.8 Antenna Requirements..... 31

**4 LIST OF MEASURING EQUIPMENTS..... 32**

**5 UNCERTAINTY OF EVALUATION ..... 34**

**APPENDIX A. CONDUCTED TEST RESULTS**

**APPENDIX B. RADIATED SPURIOUS EMISSION**

**APPENDIX C. RADIATED SPURIOUS EMISSION PLOTS**

**APPENDIX D. DUTY CYCLE PLOTS**





### SUMMARY OF TEST RESULT

Report Section	FCC Rule	Description	Limit	Result	Remark
3.1	2.1049 15.403(i)	26dB & 99% Bandwidth	-	Pass	-
3.2	15.407(a)	Maximum Conducted Output Power	≤ 24 dBm (depend on band)	Pass	-
3.3	15.407(a)	Power Spectral Density	≤ 11 dBm (depend on band)	Pass	-
3.4	15.407(b)	Unwanted Emissions	15.407(b) 15.209(a)	Pass	Under limit 4.83 dB at 5150.000 MHz
3.5	15.207	AC Conducted Emission	15.207(a)	Pass	Under limit 14.80 dB at 0.470 MHz
3.6	15.407(g)	Frequency Stability	Within Operation Band	Pass	-
3.7	15.407(c)	Automatically Discontinue Transmission	Discontinue Transmission	Pass	-
3.8	15.203 & 15.407(a)	Antenna Requirement	N/A	Pass	-



# 1 General Description

## 1.1 Applicant

**Sony Mobile Communications Inc.**

4-12-3 Higashi-Shinagawa, Shinagawa-ku, Tokyo, 140-0002, Japan

## 1.2 Manufacturer

**Sony Mobile Communications Inc.**

4-12-3 Higashi-Shinagawa, Shinagawa-ku, Tokyo, 140-0002, Japan

## 1.3 Product Feature of Equipment Under Test

GSM/WCDMA/LTE, Bluetooth, DTS/UNII, a/b/g/n, NFC, and GPS

Standards-related Product Specification	
Antenna Type	PIFA Antenna
Antenna Gain	<5150 MHz ~ 5250 MHz> -0.85 dBi
	<5250 MHz ~ 5350 MHz> -0.72 dBi
	<5470 MHz ~ 5725 MHz> 0.42 dBi

EUT Information List			
HW Version	SW Version	S/N	Performed Test Item
A	0.32	RQ3004QXCU	RF conducted measurement
		RQ3004QXE8	Radiated Spurious Emission
		RQ3004R9RH	Conducted Emission



Accessory List	
AC Adapter 1	Model No. : UCH20
	S/N :
	1215W48600059 (for radiated spurious emission) 1215W48600011 (for conducted emission)
Earphone 1	Model No. : MH410c
	S/N: 1632A86600000E0
USB Cable	Model No. : UCB20
	S/N :
	1625A9110003BFA (for radiated spurious emission) 1625A9100003A98 (for conducted emission)

**Note:**

1. Above EUT list and accessory list used are electrically identical per declared by manufacturer.
2. Above the accessories list are used to exercise the EUT during test.
3. For other wireless features of this EUT, test report will be issued separately.

### 1.4 Modification of EUT

No modifications are made to the EUT during all test items.



### 1.5 Testing Location

Sporton Lab is accredited to ISO 17025 by Taiwan Accreditation Foundation (TAF code : 1190) and the FCC designation No. TW0007 under the FCC 2.948(e) by Mutual Recognition Agreement (MRA) in FCC Test.

<b>Test Site</b>	SPORTON INTERNATIONAL INC.	
<b>Test Site Location</b>	No. 52, Hwa Ya 1 <sup>st</sup> Rd., Hwa Ya Technology Park, Kwei-Shan District, Tao Yuan City, Taiwan, R.O.C. TEL: +886-3-327-3456 FAX: +886-3-328-4978	
<b>Test Site No.</b>	<b>Sporton Site No.</b>	
	TH05-HY	CO05-HY

**Note:** The test site complies with ANSI C63.4 2014 requirement.

<b>Test Site</b>	SPORTON INTERNATIONAL INC.	
<b>Test Site Location</b>	No.58, Aly. 75, Ln. 564, Wenhua 3rd Rd. Guishan Dist, Taoyuan City, Taiwan (R.O.C.) TEL: +886-3-327-0868 FAX: +886-3-327-0855	
<b>Test Site No.</b>	<b>Sporton Site No.</b>	
	03CH13-HY	

**Note:** The test site complies with ANSI C63.4 2014 requirement.

### 1.6 Applicable Standards

According to the specifications of the manufacturer, the EUT must comply with the requirements of the following standards:

- ♦ FCC Part 15 Subpart E
- ♦ FCC KDB 789033 D02 General UNII Test Procedures New Rules v01r04
- ♦ ANSI C63.10-2013

**Remark:**

1. All test items were verified and recorded according to the standards and without any deviation during the test.
2. This EUT has also been tested and complied with the requirements of FCC Part 15, Subpart B, recorded in a separate test report.



## 2 Test Configuration of Equipment Under Test

The EUT has been associated with peripherals and configuration operated in a manner tended to maximize its emission characteristics in a typical application. Frequency range investigated: conducted emission (150 kHz to 30 MHz) and radiated emission (9 kHz to the 10th harmonic of the highest fundamental frequency or to 40 GHz, whichever is lower). For radiated measurement, pre-scanned in three orthogonal panels, X, Y, Z. The worst cases (Y plane) were recorded in this report.

### 2.1 Carrier Frequency Channel

Frequency Band	Channel	Freq. (MHz)	Channel	Freq. (MHz)
5150-5250 MHz Band 1 (U-NII-1)	36	5180	44	5220
	38*	5190	46*	5230
	40	5200	48	5240
	-	-		

Frequency Band	Channel	Freq. (MHz)	Channel	Freq. (MHz)
5250-5350 MHz Band 2 (U-NII-2A)	52	5260	60	5300
	54*	5270	62*	5310
	56	5280	64	5320
	-	-		

Frequency Band	Channel	Freq. (MHz)	Channel	Freq. (MHz)
5470-5725 MHz Band 3 (U-NII-2C)	100	5500	112	5560
	102*	5510	116	5580
	104	5520	132	5660
	-	-	134*	5670
	108	5540	136	5680
	110*	5550	140	5700

Frequency Band	Channel	Freq. (MHz)	Channel	Freq. (MHz)
Straddle Channel	-	-	144	5720
	142*	5710		

**Note:** The above Frequency and Channel in "\*" were 802.11n HT40





## 2.2 Test Mode

Final test mode of conducted test items and radiated spurious emissions are considering the modulation and worse data rates as below table.

Modulation	Data Rate
802.11a	6 Mbps
802.11n HT20	MCS0
802.11n HT40	MCS0

Test Cases	
AC Conducted Emission	Mode 1 : GSM1900 Idle + Bluetooth Link + WLAN (5GHz) Link + MP3 + Earphone 1 + Battery + USB Cable (Charging from Adapter 1)

Ch. #		Band I : 5150-5250 MHz	Band II : 5250-5350 MHz	Band III : 5470-5725MHz
		802.11a	802.11a	802.11a
L	Low	36	52	100
M	Middle	44	60	116
H	High	48	64	140
Straddle		-	-	144

Ch. #		Band I : 5150-5250 MHz	Band II : 5250-5350 MHz	Band III : 5470-5725MHz
		802.11n HT20	802.11n HT20	802.11n HT20
L	Low	36	52	100
M	Middle	44	60	116
H	High	48	64	140
Straddle		-	-	144

Ch. #		Band I : 5150-5250 MHz	Band II : 5250-5350 MHz	Band III : 5470-5725MHz
		802.11n HT40	802.11n HT40	802.11n HT40
L	Low	38	54	102
M	Middle	-	-	110
H	High	46	62	134
Straddle		-	-	142

## 2.3 Connection Diagram of Test System

<WLAN Tx Mode>

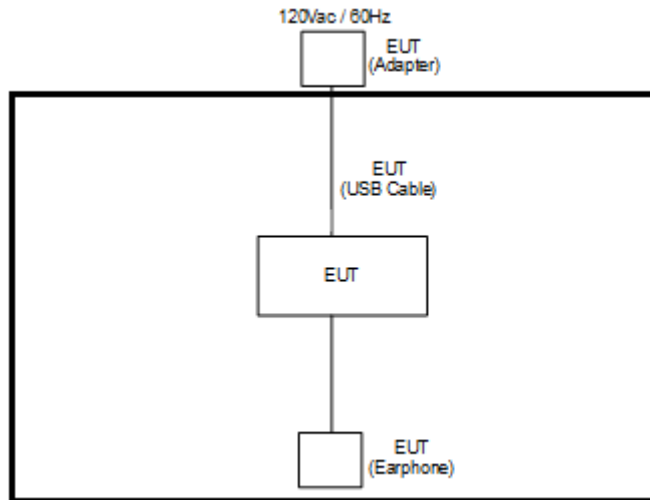

<AC Conducted Emission Mode>

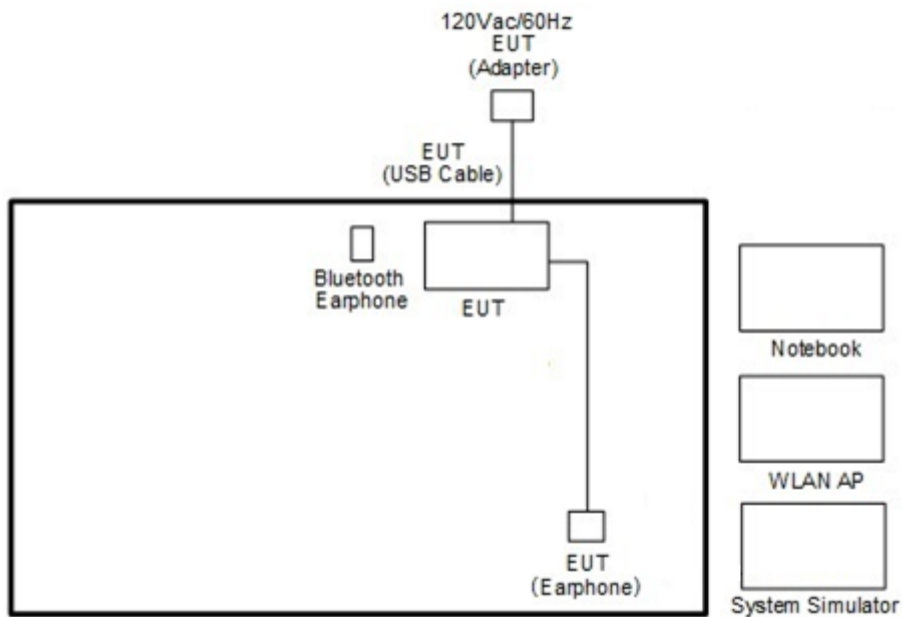



### 2.4 Support Unit used in test configuration and system

Item	Equipment	Trade Name	Model Name	FCC ID	Data Cable	Power Cord
1.	System Simulator	Anritsu	MT8820C	N/A	N/A	Unshielded, 1.8 m
2.	WLAN AP	ASUS	RT-AC66U	MSQ-RTAC66U	N/A	Unshielded, 1.8m
3.	Notebook	DELL	Latitude E6320	FCC DoC/ Contains FCC ID: QDS-BRCM1054	N/A	AC I/P: Unshielded, 1.2 m DC O/P: Shielded, 1.8 m
4.	Bluetooth Earphone	Sony	SBH20	PY7-RD0010	N/A	N/A
5.	SD Card	SanDisk	MicroSD HC	FCC DoC	N/A	N/A

### 2.5 EUT Operation Test Setup

For RF test items, an engineering test program was provided and enabled to make EUT transmitting signals.

### 2.6 Measurement Results Explanation Example

For all conducted test items:

The offset level is set in the spectrum analyzer to compensate the RF cable loss and attenuator factor between EUT conducted output port and spectrum analyzer. With the offset compensation, the spectrum analyzer reading level is exactly the EUT RF output level.

Example :

The spectrum analyzer offset is derived from RF cable loss and attenuator factor.

*Offset = RF cable loss + attenuator factor.*

Following shows an offset computation example with cable loss 4.2 dB and 10dB attenuator.

$$\begin{aligned}
 \text{Offset}(dB) &= \text{RF cable loss}(dB) + \text{attenuator factor}(dB). \\
 &= 4.2 + 10 = 14.2 \text{ (dB)}
 \end{aligned}$$

### 3 Test Result

#### 3.1 26dB & 99% Occupied Bandwidth Measurement

##### 3.1.1 Description of 26dB & 99% Occupied Bandwidth

This section is for reporting purpose only.

There is no restriction limits for bandwidth.

##### 3.1.2 Measuring Instruments

The measuring equipment is listed in the section 4 of this test report.

##### 3.1.3 Test Procedures

1. The testing follows FCC KDB 789033 D02 General UNII Test Procedures New Rules v01r04.  
Section C) Emission bandwidth
2. Set RBW = approximately 1% of the emission bandwidth.
3. Set the VBW > RBW.
4. Detector = Peak.
5. Trace mode = max hold
6. Measure the maximum width of the emission that is 26 dB down from the peak of the emission.  
Compare this with the RBW setting of the analyzer. Readjust RBW and repeat measurement as needed until the RBW/EBW ratio is approximately 1%.
7. For 99% Bandwidth Measurement, the spectrum analyzer's resolution bandwidth (RBW) is set 1MHz and set the Video bandwidth (VBW)  $\geq 3 * RBW$ .
8. Measure and record the results in the test report.

##### 3.1.4 Test Setup

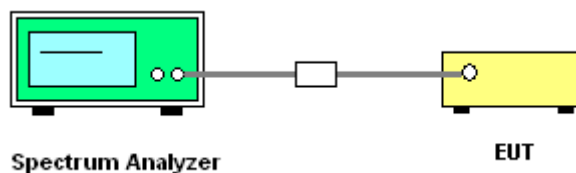



### 3.1.5 Test Result of 26dB & 99% Occupied Bandwidth Plots

Please refer to Appendix A.

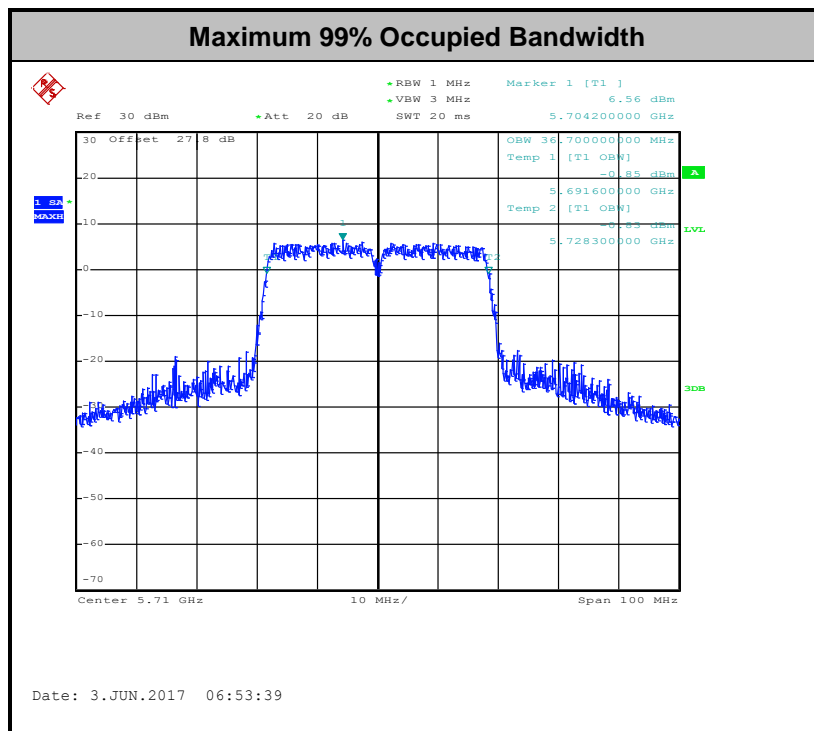
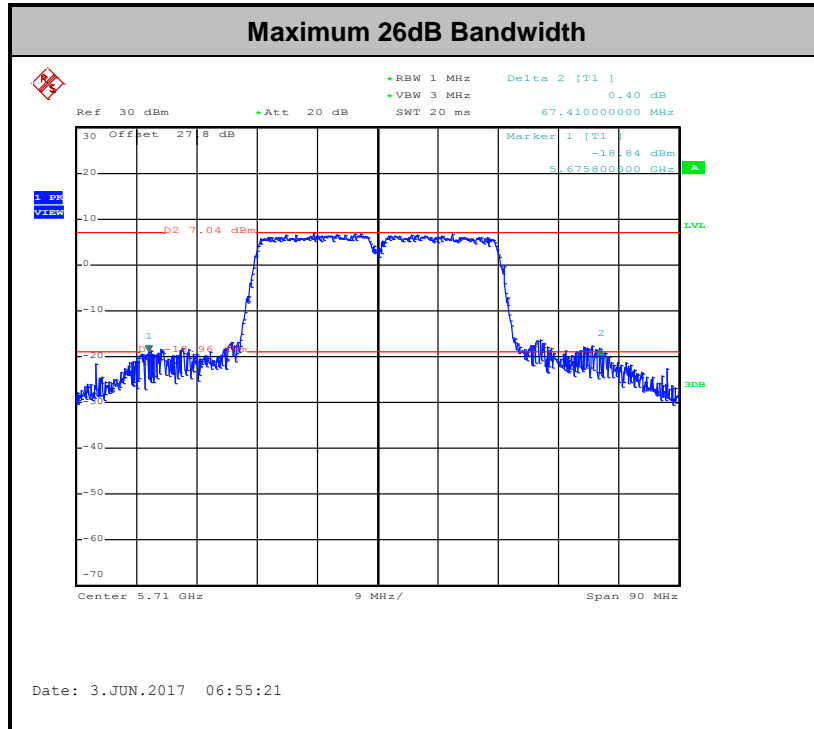



## 3.2 Maximum Conducted Output Power Measurement

### 3.2.1 Limit of Maximum Conducted Output Power

<FCC 14-30 CFR 15.407>

For mobile and portable client devices in the 5.15–5.25 GHz band, the maximum conducted output power over the frequency band of operation shall not exceed 250 mW.

For the 5.25–5.725 GHz bands, the maximum conducted output power over the frequency bands of operation shall not exceed the lesser of 250 mW or  $11 \text{ dBm} + 10 \log B$ , where B is the 26 dB emission bandwidth in megahertz.

If transmitting antennas of directional gain greater than 6 dBi are used, the peak output power shall be reduced by the amount in dB that the directional gain of the antenna exceeds 6 dBi.

Note that U-NII-2 band, devices with a maximum e.i.r.p. greater than 500 mW shall implement TPC in order to have the capability to operate at least 6 dB below the maximum permitted e.i.r.p. of 1 W.

### 3.2.2 Measuring Instruments

The measuring equipment is listed in the section 4 of this test report.

### 3.2.3 Test Procedures

The testing follows Method PM of FCC KDB 789033 D02 General UNII Test Procedures New Rules v01r04.

Method PM (Measurement using an RF average power meter):

1. Measurement is performed using a wideband RF power meter.
2. The EUT is configured to transmit continuously with a consistent duty cycle at its maximum power control level.
3. Measure the average power of the transmitter, and the average power is corrected with duty factor,  $10 \log(1/x)$ , where x is the duty cycle.

For straddle channel, the testing follows Method SA-3 (RMS detection with max hold) of FCC KDB 789033 D02 General UNII Test Procedures New Rules v01r04.

Compute power by integrating the spectrum across the 99% occupied bandwidth of the signal using the instrument's band power measurement function.

### 3.2.4 Test Setup

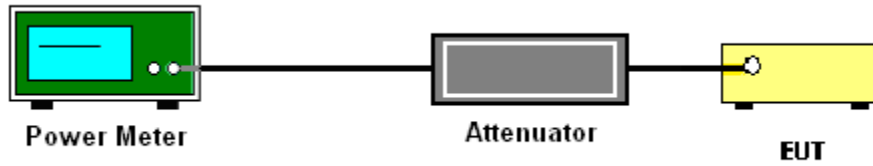

### 3.2.5 Test Result of Maximum Conducted Output Power

Please refer to Appendix A.



### **3.3 Power Spectral Density Measurement**

#### **3.3.1 Limit of Power Spectral Density**

**<FCC 14-30 CFR 15.407>**

For mobile and portable client devices in the 5.15–5.25 GHz band, the maximum power spectral density shall not exceed 11dBm in any 1 megahertz band.

For the 5.25–5.725 GHz bands, the maximum power spectral density shall not exceed 11 dBm in any 1 megahertz band.

If transmitting antennas of directional gain greater than 6 dBi are used, the peak output power shall be reduced by the amount in dB that the directional gain of the antenna exceeds 6 dBi.

#### **3.3.2 Measuring Instruments**

The measuring equipment is listed in the section 4 of this test report.



### 3.3.3 Test Procedures

The testing follows FCC KDB 789033 D02 General UNII Test Procedures New Rules v01r04.  
Section F) Maximum power spectral density.

#### # Method SA-2 #

(trace averaging across on and off times of the EUT transmissions, followed by duty cycle correction).

1. The testing follows Method SA-2 of FCC KDB 789033 D02 General UNII Test Procedures New Rules v01r04.
  - Measure the duty cycle.
  - Set span to encompass the entire emission bandwidth (EBW) of the signal.
  - Set RBW = 1 MHz.
  - Set VBW  $\geq$  3 MHz.
  - Number of points in sweep  $\geq$  2 Span / RBW.
  - Sweep time = auto.
  - Detector = RMS
  - Trace average at least 100 traces in power averaging mode.
  - Add  $10 \log(1/x)$ , where x is the duty cycle, to the measured power in order to compute the average power during the actual transmission times. For example, add  $10 \log(1/0.25) = 6$  dB if the duty cycle is 25 percent.
2. The RF output of EUT was connected to the spectrum analyzer by a low loss cable.
3. Each plot has already offset with cable loss, and attenuator loss. Measure the PPSD and record it.

### 3.3.4 Test Setup

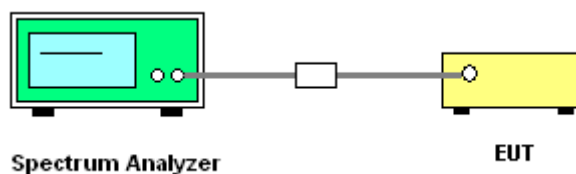



### 3.3.5 Test Result of Power Spectral Density

Please refer to Appendix A.

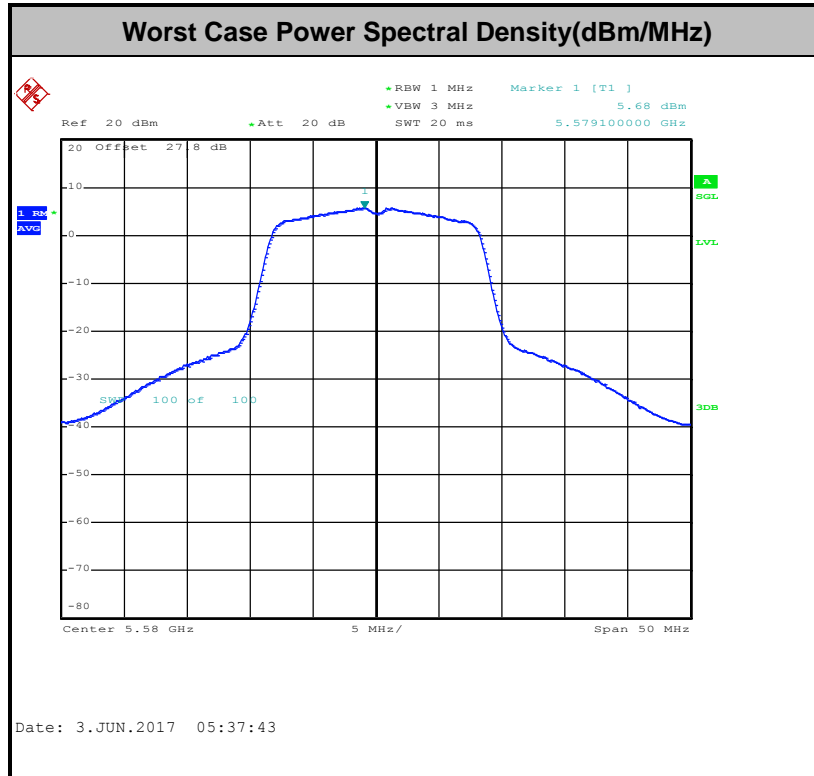

**Note:** Average Power Density (dB) = Measured value+ Duty Factor



### 3.4 Unwanted Radiated Emission Measurement

This section is to measure unwanted emissions through radiated measurement for band edge spurious emissions and out of band emissions measurement.

#### 3.4.1 Limit of Unwanted Emissions

- (1) For transmitters operating in the 5150-5250 MHz band: all emissions outside of the 5150-5350 MHz band shall not exceed an EIRP of -27dBm/MHz.

For transmitters operating in the 5250-5350 MHz band: all emissions outside of the 5150-5350 MHz band shall not exceed an EIRP of -27 dBm/MHz. Devices operating in the 5250-5350 MHz band that generate emissions in the 5150-5250 MHz band must meet all applicable technical requirements for operation in the 5150-5250 MHz band (including indoor use) or alternatively meet an out-of-band emission EIRP limit of -27 dBm/MHz in the 5150-5250 MHz band.

For transmitters operating in the 5470-5725MHz band: all emissions outside of the 5470-5725MHz band shall not exceed an EIRP of -27 dBm/MHz.

- (2) Unwanted spurious emissions fallen in restricted bands shall comply with the general field strength limits as below table,

Frequency (MHz)	Field Strength (microvolts/meter)	Measurement Distance (meters)
0.009 – 0.490	2400/F(kHz)	300
0.490 – 1.705	24000/F(kHz)	30
1.705 – 30.0	30	30
30 – 88	100	3
88 – 216	150	3
216 - 960	200	3
Above 960	500	3

**Note:** The following formula is used to convert the EIRP to field strength.

$$E = \frac{1000000\sqrt{30P}}{3} \mu\text{V/m, where P is the eirp (Watts)}$$



EIRP (dBm)	Field Strength at 3m (dBμV/m)
- 27	68.3

(3) KDB789033 D02 v01r04 G)2)c)

- (i) Sections 15.407(b)(1) to (b)(3) specify the unwanted emission limits for the U-NII-1 and U-NII-2 bands. As specified, emissions above 1000 MHz that are outside of the restricted bands are subject to a peak emission limit of -27 dBm/MHz.<sup>3</sup>
- (ii) Section 15.407(b)(4) specifies the unwanted emission limit for the U-NII-3 band. A band emissions mask is specified in Section 15.407(b)(4)(i). The emission limits are in terms of a Peak detector. An alternative to the band emissions mask is specified in Section 15.407(b)(4)(ii). The alternative limits are based on the highest antenna gain specified in the filing. There are also marketing and importation restrictions for the devices using the alternative limit.<sup>4</sup>

**Note 3:** An out-of-band emission that complies with both the average and peak limits of Section 15.209 is not required to satisfy the -27 dBm/MHz peak emission limit.

**Note 4:** Only devices with antenna gains of 10 dBi or less may be approved using the emission limits specified in Section 15.247(d) till March 2, 2018; all other devices operating in this band must use the mask specified in Section 15.407(b)(4)(i).

### 3.4.2 Measuring Instruments

The measuring equipment is listed in the section 4 of this test report.



### **3.4.3 Test Procedures**

1. The testing follows FCC KDB 789033 D02 General UNII Test Procedures New Rules v01r04. Section G) Unwanted emissions measurement.

(1) Procedure for Unwanted Emissions Measurements Below 1000MHz

- RBW = 120 kHz
- VBW = 300 kHz
- Detector = Peak
- Trace mode = max hold

(2) Procedure for Peak Unwanted Emissions Measurements Above 1000 MHz

- RBW = 1 MHz
- VBW  $\geq$  3 MHz
- Detector = Peak
- Sweep time = auto
- Trace mode = max hold

(3) Procedures for Average Unwanted Emissions Measurements Above 1000MHz

- RBW = 1 MHz
- VBW = 10 Hz, when duty cycle is no less than 98 percent.
- VBW  $\geq$  1/T, when duty cycle is less than 98 percent where T is the minimum transmission duration over which the transmitter is on and is transmitting at its maximum power control level for the tested mode of operation.

2. The EUT was placed on a turntable with 0.8 meter for frequency below 1GHz and 1.5 meter for frequency above 1GHz respectively above ground.
3. The EUT was set 3 meters from the interference receiving antenna which was mounted on the top of a variable height antenna tower.
4. The antenna is a broadband antenna and its height is adjusted between one meter and four meters above ground to find the maximum value of the field strength for both horizontal polarization and vertical polarization of the antenna.
5. For each suspected emission, the EUT was arranged to its worst case and then adjust the antenna tower (from 1 m to 4 m) and turntable (from 0 degree to 360 degrees) to find the maximum reading.
6. For testing below 1GHz, if the emission level of the EUT in peak mode was 3 dB lower than the limit specified, then peak values of EUT will be reported, otherwise, the emissions will be repeated one by one using the CISPR quasi-peak method and reported.
7. For testing above 1GHz, the emission level of the EUT in peak mode was 20dB lower than average limit (that means the emission level in average mode also complies with the limit in average mode), then peak values of EUT will be reported, otherwise, the emissions will be measured in average mode again and reported.

### 3.4.4 Test Setup

For radiated emissions below 30MHz

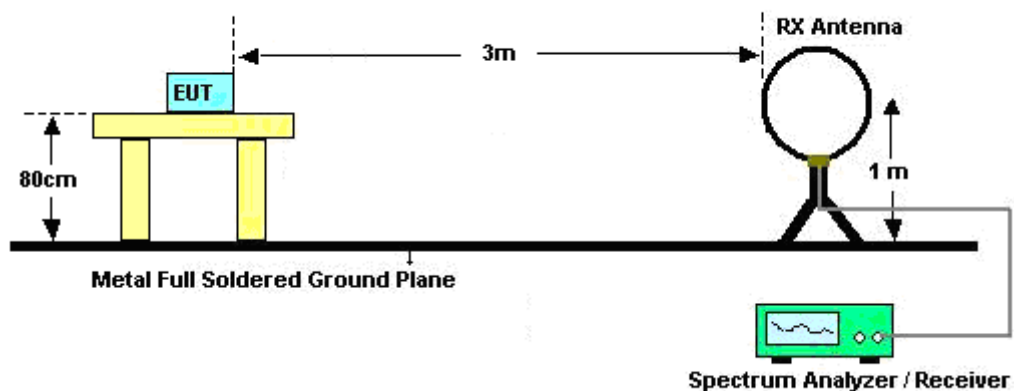

For radiated emissions from 30MHz to 1GHz

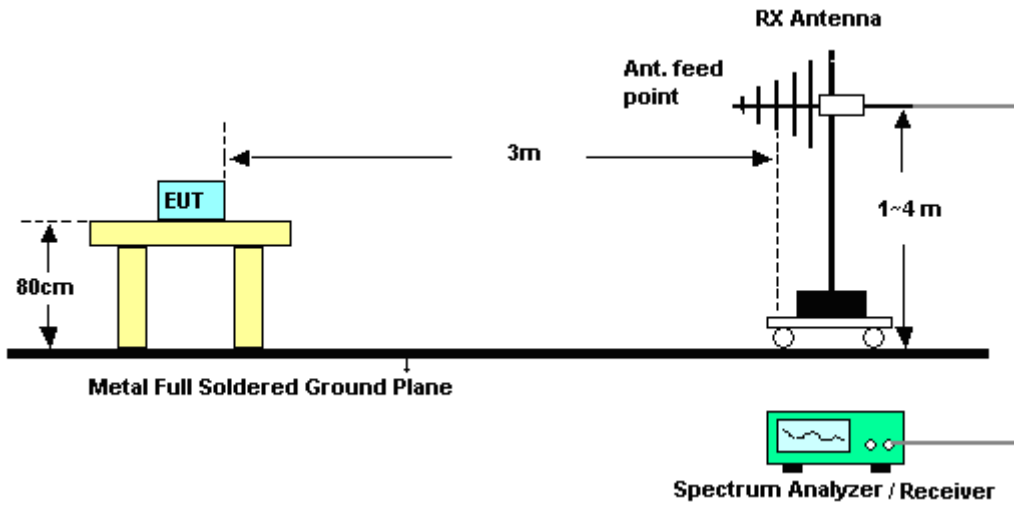

For radiated emissions above 1GHz

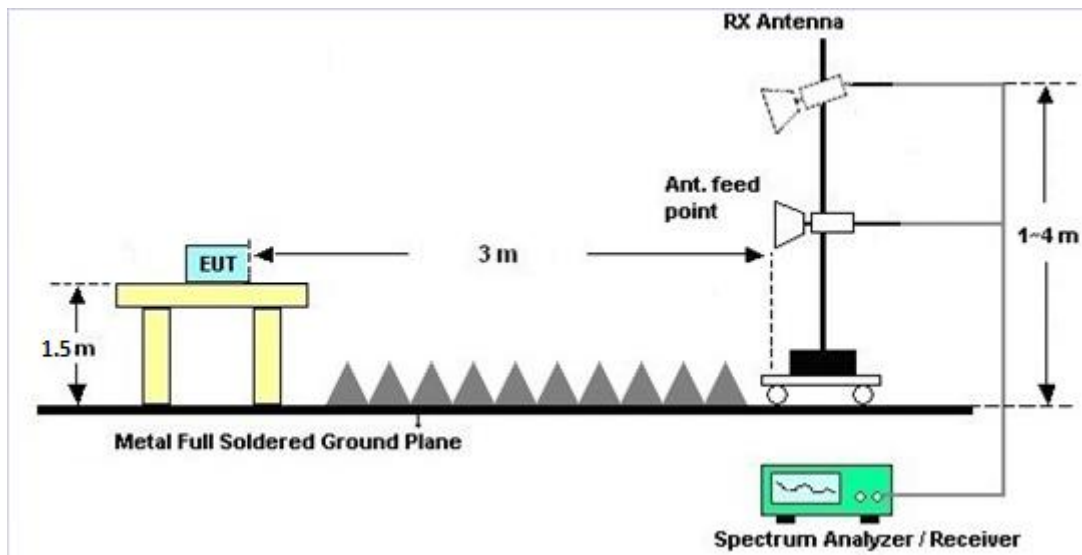



### **3.4.5 Test Results of Radiated Spurious Emissions (9 kHz ~ 30 MHz)**

The low frequency, which started from 9 kHz to 30MHz, was pre-scanned and the result which was 20dB lower than the limit line was not reported.

There is a comparison data of both open-field test site and semi-Anechoic chamber, and the result came out very similar.

### **3.4.6 Test Result of Radiated Spurious at Band Edges**

Please refer to Appendix B and C.

### **3.4.7 Duty Cycle**

Please refer to Appendix D.

### **3.4.8 Test Result of Radiated Spurious Emissions (30MHz ~ 10th Harmonic)**

Please refer to Appendix B and C.





### 3.5 AC Conducted Emission Measurement

#### 3.5.1 Limit of AC Conducted Emission

For equipment that is designed to be connected to the public utility (AC) power line, the radio frequency voltage that is conducted back onto the AC power line on any frequency or frequencies within the band 150 kHz to 30 MHz shall not exceed the limits in the following table.

Frequency of emission (MHz)	Conducted limit (dB $\mu$ V)	
	Quasi-peak	Average
0.15-0.5	66 to 56*	56 to 46*
0.5-5	56	46
5-30	60	50

\*Decreases with the logarithm of the frequency.

#### 3.5.2 Measuring Instruments

The measuring equipment is listed in the section 4 of this test report.

#### 3.5.3 Test Procedures

1. The EUT was placed 0.4 meter from the conducting wall of the shielding room was kept at least 80 centimeters from any other grounded conducting surface.
2. Connect EUT to the power mains through a line impedance stabilization network (LISN).
3. All the support units are connecting to the other LISN.
4. The LISN provides 50 ohm coupling impedance for the measuring instrument.
5. The FCC states that a 50 ohm, 50 microhenry LISN should be used.
6. Both sides of AC line were checked for maximum conducted interference.
7. The frequency range from 150 kHz to 30 MHz was searched.
8. Set the test-receiver system to Peak Detect Function and specified bandwidth with Maximum Hold Mode.

### 3.5.4 Test Setup

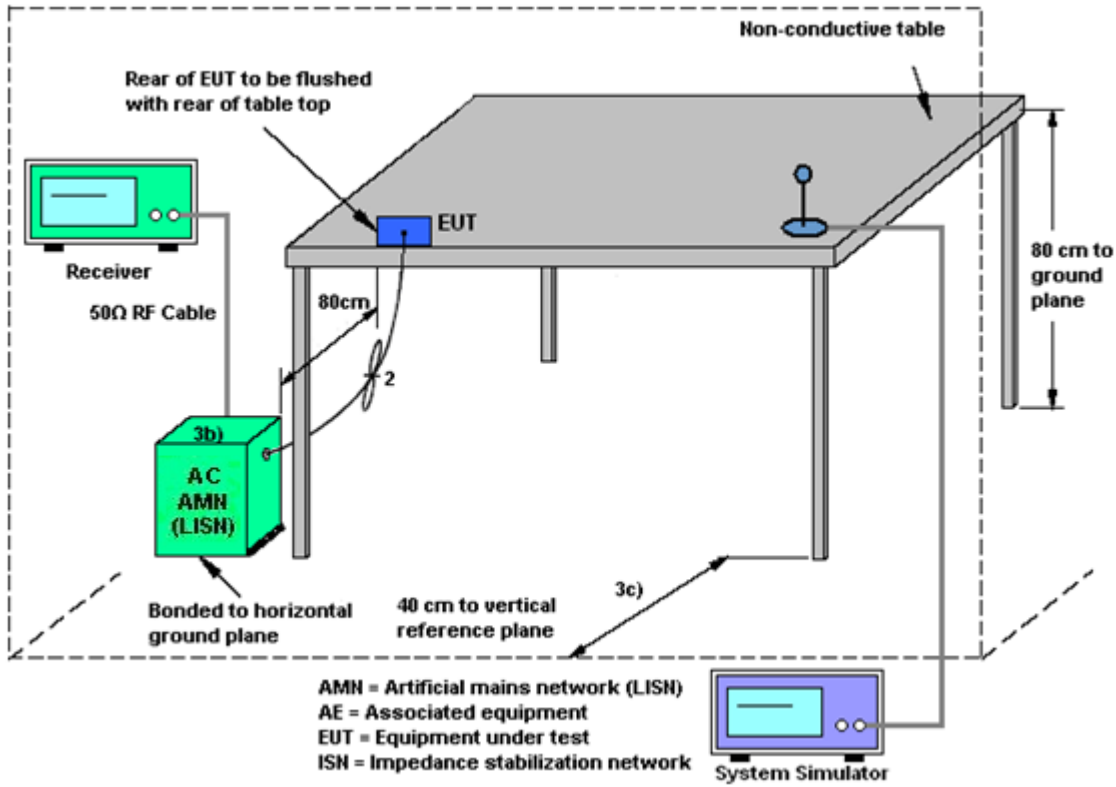



### 3.5.5 Test Result of AC Conducted Emission

Test Mode :	Mode 1	Temperature :	22~25°C
Test Engineer :	Arthur Hsieh	Relative Humidity :	51~55%
Test Voltage :	120Vac / 60Hz	Phase :	Line
Function Type :	GSM1900 Idle + Bluetooth Link + WLAN (5GHz) Link + MP3 + Earphone 1 + Battery + USB Cable (Charging from Adapter 1)		

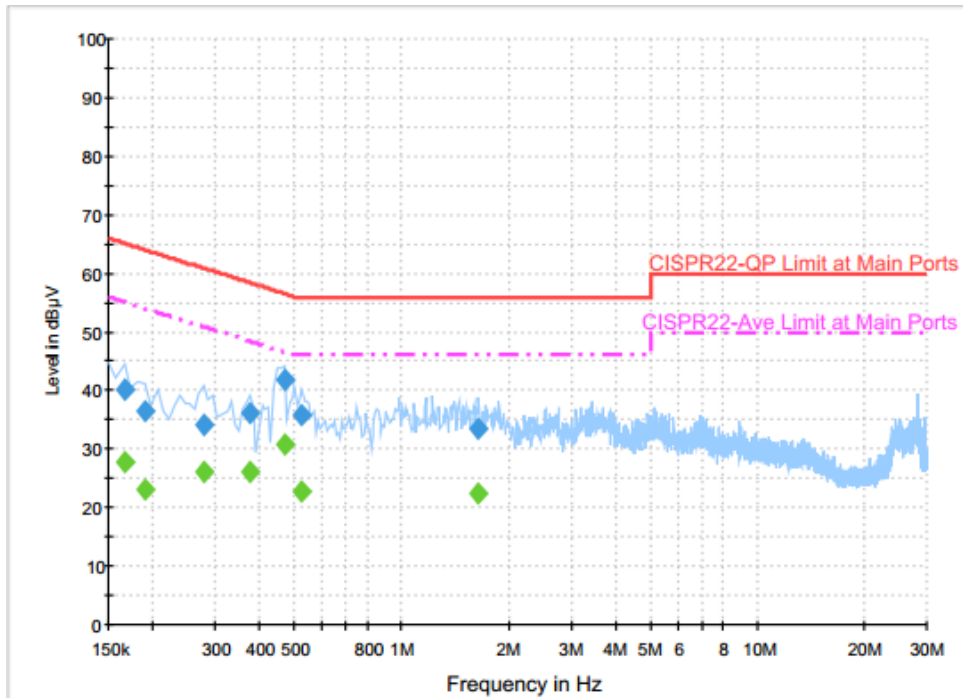

**Final Result : QuasiPeak**

Frequency (MHz)	QuasiPeak (dBµV)	Filter	Line	Corr. (dB)	Margin (dB)	Limit (dBµV)
0.166000	40.2	Off	L1	19.6	25.0	65.2
0.190000	36.6	Off	L1	19.6	27.4	64.0
0.278000	34.2	Off	L1	19.6	26.7	60.9
0.374000	36.0	Off	L1	19.6	22.4	58.4
0.470000	41.7	Off	L1	19.6	14.8	56.5
0.526000	35.9	Off	L1	19.6	20.1	56.0
1.646000	33.5	Off	L1	19.6	22.5	56.0

**Final Result : Average**

Frequency (MHz)	Average (dBµV)	Filter	Line	Corr. (dB)	Margin (dB)	Limit (dBµV)
0.166000	27.8	Off	L1	19.6	27.4	55.2
0.190000	23.2	Off	L1	19.6	30.8	54.0
0.278000	26.1	Off	L1	19.6	24.8	50.9
0.374000	26.2	Off	L1	19.6	22.2	48.4
0.470000	30.7	Off	L1	19.6	15.8	46.5
0.526000	22.6	Off	L1	19.6	23.4	46.0
1.646000	22.5	Off	L1	19.6	23.5	46.0



Test Mode :	Mode 1	Temperature :	22~25°C
Test Engineer :	Arthur Hsieh	Relative Humidity :	51~55%
Test Voltage :	120Vac / 60Hz	Phase :	Neutral
Function Type :	GSM1900 Idle + Bluetooth Link + WLAN (5GHz) Link + MP3 + Earphone 1 + Battery + USB Cable (Charging from Adapter 1)		

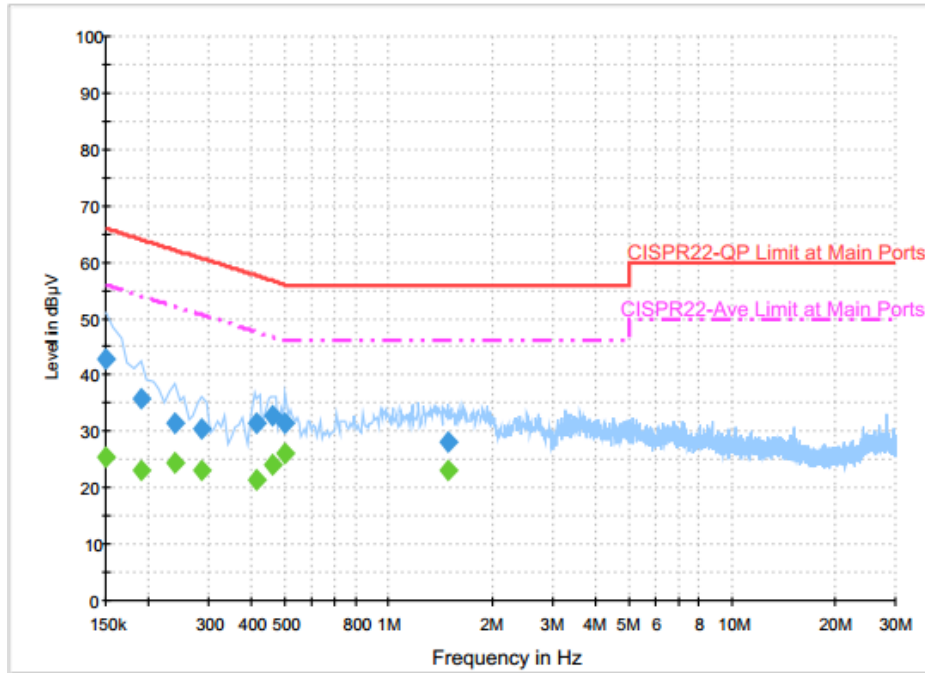

**Final Result : QuasiPeak**

Frequency (MHz)	QuasiPeak (dBµV)	Filter	Line	Corr. (dB)	Margin (dB)	Limit (dBµV)
0.150000	42.9	Off	N	19.5	23.1	66.0
0.190000	35.7	Off	N	19.5	28.3	64.0
0.238000	31.3	Off	N	19.5	30.9	62.2
0.286000	30.4	Off	N	19.5	30.2	60.6
0.414000	31.4	Off	N	19.5	26.2	57.6
0.462000	32.7	Off	N	19.5	24.0	56.7
0.502000	31.4	Off	N	19.5	24.6	56.0
1.486000	28.0	Off	N	19.6	28.0	56.0

**Final Result : Average**

Frequency (MHz)	Average (dBµV)	Filter	Line	Corr. (dB)	Margin (dB)	Limit (dBµV)
0.150000	25.4	Off	N	19.5	30.6	56.0
0.190000	23.1	Off	N	19.5	30.9	54.0
0.238000	24.4	Off	N	19.5	27.8	52.2
0.286000	23.0	Off	N	19.5	27.6	50.6
0.414000	21.5	Off	N	19.5	26.1	47.6
0.462000	24.2	Off	N	19.5	22.5	46.7
0.502000	26.0	Off	N	19.5	20.0	46.0
1.486000	23.0	Off	N	19.6	23.0	46.0

### 3.6 Frequency Stability Measurement

#### 3.6.1 Limit of Frequency Stability

Manufacturers of U-NII devices are responsible for ensuring frequency stability such that an emission is maintained within the band of operation under all conditions of normal operation as specified in the user's manual.

#### 3.6.2 Measuring Instruments

The measuring equipment is listed in the section 4 of this test report.

#### 3.6.3 Test Procedures

1. To ensure emission at the band edge is maintained within the authorized band, those values shall be measured by radiation emissions at upper and lower frequency points, and finally compensated by frequency deviation as procedures below.
2. The EUT was operated at the maximum output power, and connected to the spectrum analyzer, which is set to maximum hold function and peak detector. The peak value of the power envelope was measured and noted. The upper and lower frequency points were respectively measured relatively 10dB lower than the measured peak value.
3. The frequency deviation was calculated by adding the upper frequency point and the lower frequency point divided by two. Those detailed values of frequency deviation are provided in table below.

#### 3.6.4 Test Setup

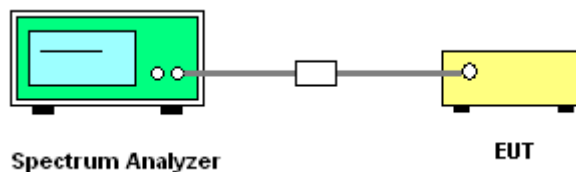

#### 3.6.5 Test Result of Frequency Stability

Please refer to Appendix A.



## **3.7 Automatically Discontinue Transmission**

### **3.7.1 Limit of Automatically Discontinue Transmission**

The device shall automatically discontinue transmission in case of either absence of information to transmit or operational failure. These provisions are not intended to preclude the transmission of control or signaling information or the use of repetitive codes used by certain digital technologies to complete frame or burst intervals. Applicants shall include in their application for equipment authorization to describe how this requirement is met.

### **3.7.2 Measuring Instruments**

The measuring equipment is listed in the section 4 of this test report.

### **3.7.3 Test Result of Automatically Discontinue Transmission**

While the EUT is not transmitting any information, the EUT can automatically discontinue transmission and become standby mode for power saving. The EUT can detect the controlling signal of ACK message transmitting from remote device and verify whether it shall resend or discontinue transmission.



## **3.8 Antenna Requirements**

### **3.8.1 Standard Applicable**

If transmitting antenna directional gain is greater than 6 dBi, both the peak transmit power and the peak power spectral density shall be reduced by the amount in dB that the directional gain of the antenna exceeds 6 dBi.

### **3.8.2 Antenna Anti-Replacement Construction**

An embedded-in antenna design is used.

### **3.8.3 Antenna Gain**

The antenna gain is less than 6 dBi. Therefore, it is not necessary to reduce maximum peak output power limit.



## 4 List of Measuring Equipments

Instrument	Manufacturer	Model No.	Serial No.	Characteristics	Calibration Date	Test Date	Due Date	Remark
Spectrum Analyzer	Rohde & Schwarz	FSP40	100055	9kHz-40GHz	Jul. 17, 2016	May 16, 2017~ Jun. 03, 2017	Jul. 16, 2017	Conducted (TH05-HY)
Power Meter	Anritsu	ML2495A	0932001	300MHz~40GHz	Sep. 29, 2016	May 16, 2017~ Jun. 03, 2017	Sep. 28, 2017	Conducted (TH05-HY)
Power Sensor	Anritsu	MA2411B	0846202	300MHz~40GHz	Sep. 29, 2016	May 16, 2017~ Jun. 03, 2017	Sep. 28, 2017	Conducted (TH05-HY)
Hygrometer	Testo	608-H2	41410069	N/A	Aug. 28, 2016	May 16, 2017~ Jun. 03, 2017	Aug. 27, 2017	Conducted (TH05-HY)
RF Cable	HUBER + SUHNER	SUCOFLEX 104	MY84209521	1GHz~26GHz	Dec. 02, 2016	May 16, 2017~ Jun. 03, 2017	Dec. 01, 2017	Conducted (TH05-HY)
Temperature Chamber	ESPEC	SH-641	92013720	-40°C ~90°C	Sep. 01, 2016	May 16, 2017~ Jun. 03, 2017	Aug. 31, 2017	Conducted (TH05-HY)
AC Power Source	ChainTek	APC-1000W	N/A	N/A	N/A	May 14, 2017	N/A	Conduction (CO05-HY)
EMI Test Receiver	Rohde & Schwarz	ESCI 7	100724	9kHz~7GHz	Aug. 30, 2016	May 14, 2017	Aug. 29, 2017	Conduction (CO05-HY)
Hygrometer	Testo	608-H1	34913912	N/A	May 02, 2017	May 14, 2017	May 01, 2018	Conduction (CO05-HY)
LISN	Rohde & Schwarz	ENV216	100080	9kHz~30MHz	Nov. 29, 2016	May 14, 2017	Nov. 28, 2017	Conduction (CO05-HY)
LF Cable	HUBER + SUHNER	RG-214/U	LF01	N/A	Jan. 05, 2017	May 14, 2017	Jan. 04, 2018	Conduction (CO05-HY)
Test Software	N/A	EMC32	8.40.0	N/A	N/A	May 14, 2017	N/A	Conduction (CO05-HY)
Loop Antenna	Rohde & Schwarz	HFH2-Z2	100315	9 kHz~30 MHz	May 15, 2017	May 19, 2017~ May 31, 2017	May 14, 2019	Radiation (03CH13-HY)
Amplifier	Sonoma-Instrument	310 N	187282	9KHz~1GHz	Dec. 21, 2016	May 19, 2017~ May 31, 2017	Dec. 20, 2017	Radiation (03CH13-HY)
Bilog Antenna	TESEQ	CBL 6111D&00800 N1D01N-06	40103&04	30MHz to 1GHz	Jan. 07, 2017	May 19, 2017~ May 31, 2017	Jan. 06, 2018	Radiation (03CH13-HY)
Horn Antenna	SCHWARZBECK	BBHA 9120 D	9120D-1522	1GHz ~ 18GHz	May 17, 2017	May 19, 2017~ May 31, 2017	May 16, 2018	Radiation (03CH13-HY)
SHF-EHF Horn Antenna	SCHWARZBECK	BBHA 9170	BBHA9170584	18GHz- 40GHz	Nov. 08, 2016	May 19, 2017~ May 31, 2017	Nov. 07, 2017	Radiation (03CH13-HY)
EMI Test Receiver	Agilent	N9038A(MXE)	MY53290053	20Hz to 26.5GHz	Jan. 12, 2017	May 19, 2017~ May 31, 2017	Jan. 11, 2018	Radiation (03CH13-HY)
Spectrum Analyzer	Keysight	N9010A	MY55370526	N/A	Mar. 15, 2017	May 19, 2017~ May 31, 2017	Mar. 14, 2018	Radiation (03CH13-HY)
Preamplifier	MITEQ	JS44-1800400 0-33-8P	1840917	18GHz ~ 40GHz	Jun. 14, 2016	May 19, 2017~ May 31, 2017	Jun. 13, 2017	Radiation (03CH13-HY)
Preamplifier	MITEQ	AMF-7D-0010 1800-30-10P	1590074	1GHz~18GHz	Jun. 27, 2016	May 19, 2017~ May 31, 2017	Jun. 26, 2017	Radiation (03CH13-HY)
Preamplifier	Keysight	83017A	MY53270147	1GHz~26.5GHz	Jan. 09, 2017	May 19, 2017~ May 31, 2017	Jan. 08, 2018	Radiation (03CH13-HY)





Instrument	Manufacturer	Model No.	Serial No.	Characteristics	Calibration Date	Test Date	Due Date	Remark
Hygrometer	TECEPEL	DTM-303B	TP140349	N/A	Nov. 14, 2016	May 19, 2017~ May 31, 2017	Nov. 13, 2017	Radiation (03CH13-HY)
RF Cable	HUBER + SUHNER	SUCOFLEX 104	MY335041/4 MY9840/4 MY9838/4	26G~40GHz	Mar. 27, 2017	May 19, 2017~ May 31, 2017	Mar. 26, 2018	Radiation (03CH13-HY)
RF Cable	HUBER + SUHNER	SUCOFLEX 104	MY335041/4 MY9840/4 MY9838/4	1G~26GHz	Jan. 27, 2017	May 19, 2017~ May 31, 2017	Jan. 26, 2018	Radiation (03CH13-HY)
RF Cable	HUBER + SUHNER	SUCOFLEX 104	MY335041/4 MY9840/4 MY9838/4	30M~1GHz	Jan. 27, 2017	May 19, 2017~ May 31, 2017	Jan. 26, 2018	Radiation (03CH13-HY)
RF Cable	HUBER + SUHNER	SUCOFLEX 104	MY24958/4, MY28653/4, MY9839/4PE	9K~30MHz	Jan. 10, 2017	May 19, 2017~ May 31, 2017	Jan. 09, 2018	Radiation (03CH13-HY)
Controller	EMEC	EM1000	N/A	Control Turn table & Ant Mast	N/A	May 19, 2017~ May 31, 2017	N/A	Radiation (03CH13-HY)
Antenna Mast	EMEC	AM-BS-4500-B	N/A	1m~4m	N/A	May 19, 2017~ May 31, 2017	N/A	Radiation (03CH13-HY)
Turn Table	EMEC	TT2000	N/A	0~360 Degree	N/A	May 19, 2017~ May 31, 2017	N/A	Radiation (03CH13-HY)
Test Software	Audix	E3	6.2009-8-24c	N/A	N/A	May 19, 2017~ May 31, 2017	N/A	Radiation (03CH13-HY)
Filter	Wainwright	WLKS4500-8S S	SN19	4.5G Low Pass	Sep. 19, 2016	May 19, 2017~ May 31, 2017	Sep. 18, 2017	Radiation (03CH13-HY)
Filter	Woken	WHKX8-5272. 5-6750-18000- 40ST	SN2	6.75G Highpass	Dec. 08, 2016	May 19, 2017~ May 31, 2017	Dec. 07, 2017	Radiation (03CH13-HY)
Filter	Woken	WHKX8-5272. 5-6750-18000- 40ST	SN2	6.75G Highpass	Dec. 08, 2016	May 19, 2017~ May 31, 2017	Dec. 07, 2017	Radiation (03CH13-HY)



## 5 Uncertainty of Evaluation

### Uncertainty of Conducted Emission Measurement (150kHz ~ 30MHz)

Measuring Uncertainty for a Level of Confidence of 95% ( $U = 2Uc(y)$ )	2.70
---	------

### Uncertainty of Radiated Emission Measurement (30 MHz ~ 1000 MHz)

Measuring Uncertainty for a Level of Confidence of 95% ( $U = 2Uc(y)$ )	4.90
---	------

### Uncertainty of Radiated Emission Measurement (1000 MHz ~ 18000 MHz)

Measuring Uncertainty for a Level of Confidence of 95% ( $U = 2Uc(y)$ )	5.40
---	------

### Uncertainty of Radiated Emission Measurement (18000 MHz ~ 40000 MHz)

Measuring Uncertainty for a Level of Confidence of 95% ( $U = 2Uc(y)$ )	4.30
---	------

**Appendix A. Test Result of Conducted Test Items**

Test Engineer:	Kai Liao / aking chang	Temperature:	21~25	°C
Test Date:	2017/05/16 ~2017/6/3	Relative Humidity:	51~54	%

**TEST RESULTS DATA**  
**26dB and 99% OBW**

Band I										
Mod.	Data Rate	NTX	CH.	Freq. (MHz)	99% Bandwidth (MHz)	26 dB Bandwidth (MHz)	IC 99% Bandwidth Power Limit (dBm)	IC 99% Bandwidth EIRP Limit (dBm)		
11a	6Mbps	1	36	5180	17.55	29.05	-	22.44		
11a	6Mbps	1	44	5220	17.45	23.80	-	22.42		
11a	6Mbps	1	48	5240	17.45	26.75	-	22.42		
HT20	MCS0	1	36	5180	18.35	32.55	-	22.64		
HT20	MCS0	1	44	5220	18.25	32.70	-	22.61		
HT20	MCS0	1	48	5240	18.25	27.55	-	22.61		
HT40	MCS0	1	38	5190	36.70	44.73	-	23.01		
HT40	MCS0	1	46	5230	36.70	45.45	-	23.01		

**TEST RESULTS DATA**  
**Average Power Table**

FCC Band I										
Mod.	Data Rate	NTX	CH.	Freq. (MHz)	Duty Factor (dB)	Average Conducted Power (dBm)	FCC Conducted Power Limit (dBm)	DG (dBi)		Pass/Fail
11a	6Mbps	1	36	5180	97.20	14.99	24.00	-0.85		Pass
11a	6Mbps	1	44	5220	97.20	14.67	24.00	-0.85		Pass
11a	6Mbps	1	48	5240	97.20	14.60	24.00	-0.85		Pass
HT20	MCS0	1	36	5180	97.04	14.99	24.00	-0.85		Pass
HT20	MCS0	1	44	5220	97.04	14.98	24.00	-0.85		Pass
HT20	MCS0	1	48	5240	97.04	14.48	24.00	-0.85		Pass
HT40	MCS0	1	38	5190	93.86	12.30	24.00	-0.85		Pass
HT40	MCS0	1	46	5230	93.86	12.28	24.00	-0.85		Pass

**TEST RESULTS DATA**  
**Power Spectral Density**

FCC Band I										
Mod.	Data Rate	NTX	CH.	Freq. (MHz)	Duty Factor (dB)	Average Power Density (dBm/MHz)	Average PSD Limit (dBm/MHz)	DG (dBi)	-	Pass/Fail
11a	6Mbps	1	36	5180	0.12	5.09	11.00	-0.85		Pass
11a	6Mbps	1	44	5220	0.12	4.40	11.00	-0.85		Pass
11a	6Mbps	1	48	5240	0.12	4.67	11.00	-0.85		Pass
HT20	MCS0	1	36	5180	0.13	4.85	11.00	-0.85		Pass
HT20	MCS0	1	44	5220	0.13	4.96	11.00	-0.85		Pass
HT20	MCS0	1	48	5240	0.13	4.32	11.00	-0.85		Pass
HT40	MCS0	1	38	5190	0.28	-2.06	11.00	-0.85		Pass
HT40	MCS0	1	46	5230	0.28	-1.94	11.00	-0.85		Pass

**TEST RESULTS DATA**  
**26dB and 99% OBW**

Band II										
Mod.	Data Rate	NTX	CH.	Freq. (MHz)	99% Bandwidth (MHz)	26 dB Bandwidth (MHz)	IC 99% Bandwidth Power Limit (dBm)	IC 99% Bandwidth EIRP Limit (dBm)	FCC 26dB Bandwidth Power Limit (dBm)	Note
11a	6M bps	1	52	5260	17.45	26.15	23.42	29.42	23.98	
11a	6M bps	1	60	5300	17.50	27.00	23.43	29.43	23.98	
11a	6M bps	1	64	5320	17.55	26.10	23.44	29.44	23.98	
HT20	MCS 0	1	52	5260	18.35	28.30	23.64	29.64	23.98	
HT20	MCS 0	1	60	5300	18.30	33.75	23.62	29.62	23.98	
HT20	MCS 0	1	64	5320	18.45	31.90	23.66	29.66	23.98	
HT40	MCS 0	1	54	5270	36.60	41.40	23.98	30.00	23.98	
HT40	MCS 0	1	62	5310	36.70	41.04	23.98	30.00	23.98	

**TEST RESULTS DATA**  
**Average Power Table**

FCC Band II										
Mod.	Data Rate	NTX	CH.	Freq. (MHz)	Duty Factor (dB)	Average Conducted Power (dBm)	FCC Conducted Power Limit (dBm)	DG (dBi)	EIRP Power Limit (dBm)	Pass/Fail
11a	6M bps	1	52	5260	97.20	14.94	23.98	-0.72	26.99	Pass
11a	6M bps	1	60	5300	97.20	14.96	23.98	-0.72	26.99	Pass
11a	6M bps	1	64	5320	97.20	14.97	23.98	-0.72	26.99	Pass
HT20	MCS 0	1	52	5260	97.04	14.49	23.98	-0.72	26.99	Pass
HT20	MCS 0	1	60	5300	97.04	14.97	23.98	-0.72	26.99	Pass
HT20	MCS 0	1	64	5320	97.04	14.98	23.98	-0.72	26.99	Pass
HT40	MCS 0	1	54	5270	93.86	12.19	23.98	-0.72	26.99	Pass
HT40	MCS 0	1	62	5310	93.86	10.78	23.98	-0.72	26.99	Pass



**TEST RESULTS DATA**  
**Power Spectral Density**

Band II										
Mod.	Data Rate	NTX	CH.	Freq. (MHz)	Duty Factor (dB)	Average Power Density (dBm/MHz)	Average PSD Limit (dBm/MHz)	DG (dBi)		Pass/Fail
11a	6M bps	1	52	5260	0.12	4.55	11.00	-0.72		Pass
11a	6M bps	1	60	5300	0.12	4.12	11.00	-0.72		Pass
11a	6M bps	1	64	5320	0.12	4.29	11.00	-0.72		Pass
HT20	MCS 0	1	52	5260	0.13	4.37	11.00	-0.72		Pass
HT20	MCS 0	1	60	5300	0.13	4.18	11.00	-0.72		Pass
HT20	MCS 0	1	64	5320	0.13	4.16	11.00	-0.72		Pass
HT40	MCS 0	1	54	5270	0.28	-2.52	11.00	-0.72		Pass
HT40	MCS 0	1	62	5310	0.28	-4.31	11.00	-0.72		Pass

**TEST RESULTS DATA**  
**26dB and 99% OBW**

Band III										
Mod.	Data Rate	NTX	CH.	Freq. (MHz)	99% Bandwidth (MHz)	26 dB Bandwidth (MHz)	IC 99% Bandwidth Power Limit (dBm)	IC 99% Bandwidth EIRP Limit (dBm)	FCC 26dB Bandwidth Power Limit (dBm)	Note
11a	6M bps	1	100	5500	17.45	31.10	23.42	29.42	23.98	
11a	6M bps	1	116	5580	17.60	30.40	23.46	29.46	23.98	
11a	6M bps	1	140	5700	17.60	32.50	23.46	29.46	23.98	
11a	6Mbps	1	144	5720	17.65	33.70	23.47	29.47	23.98	
HT20	MCS 0	1	100	5500	18.40	31.35	23.65	29.65	23.98	
HT20	MCS 0	1	116	5580	18.40	31.45	23.65	29.65	23.98	
HT20	MCS 0	1	140	5700	18.45	33.50	23.66	29.66	23.98	
HT20	MCS0	1	144	5720	18.50	34.10	23.67	29.67	23.98	
HT40	MCS 0	1	102	5510	36.60	55.89	23.98	30.00	23.98	
HT40	MCS 0	1	110	5550	36.70	55.08	23.98	30.00	23.98	
HT40	MCS 0	1	134	5670	36.60	64.71	23.98	30.00	23.98	
HT40	MCS0	1	142	5710	36.70	67.41	23.98	30.00	23.98	

**TEST RESULTS DATA**  
**Average Power Table**

FCC Band III										
Mod.	Data Rate	NTX	CH.	Freq. (MHz)	Duty Factor (dB)	Average Conducted Power (dBm)	FCC Conducted Power Limit (dBm)	DG (dBi)	EIRP Power Limit (dBm)	Pass/Fail
11a	6M bps	1	100	5500	97.20	14.77	23.98	0.42	26.99	Pass
11a	6M bps	1	116	5580	97.20	14.72	23.98	0.42	26.99	Pass
11a	6M bps	1	140	5700	97.20	14.69	23.98	0.42	26.99	Pass
11a	6M bps	1	144	5720	97.20	14.67	23.98	0.42	26.99	Pass
HT20	MCS 0	1	100	5500	97.04	14.73	23.98	0.42	26.99	Pass
HT20	MCS 0	1	116	5580	97.04	14.71	23.98	0.42	26.99	Pass
HT20	MCS 0	1	140	5700	97.04	14.65	23.98	0.42	26.99	Pass
HT20	MCS 0	1	144	5720	97.04	14.81	23.98	0.42	26.99	Pass
HT40	MCS 0	1	102	5510	93.86	12.48	23.98	0.42	26.99	Pass
HT40	MCS 0	1	110	5550	93.86	12.46	23.98	0.42	26.99	Pass
HT40	MCS 0	1	134	5670	93.86	12.31	23.98	0.42	26.99	Pass
HT40	MCS 0	1	142	5710	93.86	12.19	23.98	0.42	26.99	Pass

**TEST RESULTS DATA**  
**Power Spectral Density**

Band III										
Mod.	Data Rate	NTX	CH.	Freq. (MHz)	Duty Factor (dB)	Average Power Density (dBm/MHz)	Average PSD Limit (dBm/MHz)	DG (dBi)		Pass/Fail
11a	6M bps	1	100	5500	0.12	5.18	11.00	0.42		Pass
11a	6M bps	1	116	5580	0.12	5.80	11.00	0.42		Pass
11a	6M bps	1	140	5700	0.12	4.59	11.00	0.42		Pass
11a	6Mbps	1	144	5720	0.12	4.57	11.00	0.42		Pass
HT20	MCS 0	1	100	5500	0.13	5.16	11.00	0.42		Pass
HT20	MCS 0	1	116	5580	0.13	5.58	11.00	0.42		Pass
HT20	MCS 0	1	140	5700	0.13	4.51	11.00	0.42		Pass
HT20	MCS0	1	144	5720	0.13	4.36	11.00	0.42		Pass
HT40	MCS 0	1	102	5510	0.28	-1.60	11.00	0.42		Pass
HT40	MCS 0	1	110	5550	0.28	-1.31	11.00	0.42		Pass
HT40	MCS 0	1	134	5670	0.28	-2.09	11.00	0.42		Pass
HT40	MCS0	1	142	5710	0.28	-1.84	11.00	0.42		Pass

**TEST RESULTS DATA**  
**Frequency Stability**

Band I										
Mod.	Data Rate	NTX	CH.	Freq. (MHz)	Center Frequency (MHz)	Frequency Deviation (MHz)	Frequency Stability (ppm)	Temperature (°C)	Voltage (V)	Note
11a	6Mbps	1	36	5180	5180.000	0.000	0.00	50	3.8	
11a	6Mbps	1	36	5180	5180.000	0.000	0.00	-30	3.8	
11a	6Mbps	1	36	5180	5180.000	0.000	0.00	20	4.35	
11a	6Mbps	1	36	5180	5180.000	0.000	0.00	20	3.4	
11a	6Mbps	1	36	5180	5180.000	0.000	0.00	20	3.8	

Band II										
Mod.	Data Rate	NTX	CH.	Freq. (MHz)	Center Frequency (MHz)	Frequency Deviation (MHz)	Frequency Stability (ppm)	Temperature (°C)	Voltage (V)	Note
11a	6Mbps	1	64	5320	5320.000	0.000	0.00	50	3.8	
11a	6Mbps	1	64	5320	5320.000	0.000	0.00	-30	3.8	
11a	6Mbps	1	64	5320	5320.000	0.000	0.00	20	4.35	
11a	6Mbps	1	64	5320	5320.050	0.050	9.40	20	3.4	
11a	6Mbps	1	64	5320	5320.050	0.050	9.40	20	3.8	

Band III										
Mod.	Data Rate	NTX	CH.	Freq. (MHz)	Center Frequency (MHz)	Frequency Deviation (MHz)	Frequency Stability (ppm)	Temperature (°C)	Voltage (V)	Note
11a	6Mbps	1	100	5500	5500.025	0.025	4.55	50	3.8	
11a	6Mbps	1	100	5500	5500.025	0.025	4.55	-30	3.8	
11a	6Mbps	1	100	5500	5500.075	0.075	13.64	20	4.35	
11a	6Mbps	1	100	5500	5500.000	0.000	0.00	20	3.4	
11a	6Mbps	1	100	5500	5500.050	0.050	9.09	20	3.8	



## Appendix B. Radiated Spurious Emission

Test Engineer :	Peter Chiu, Karl Hou, Nick Yu, and Citta Ke	Temperature :	21~23°C
		Relative Humidity :	54~58%

### Band 1 - 5150~5250MHz

#### WiFi 802.11a (Band Edge @ 3m)

WiFi Ant. 1	Note	Frequency ( MHz )	Level ( dBμV/m )	Over Limit ( dB )	Limit Line ( dBμV/m )	Read Level ( dBμV )	Antenna Factor ( dB/m )	Cable Loss ( dB )	Preamp Factor ( dB )	Ant Pos ( cm )	Table Pos ( deg )	Peak Avg. ( P/A )	Pol. ( H/V )	
802.11a CH 36 5180MHz		5146.64	51.89	-22.11	74	42.76	32.34	7.35	30.56	190	341	P	H	
		5149.76	43.26	-10.74	54	34.13	32.34	7.35	30.56	190	341	A	H	
	*	5180	103.3	-	-	94.1	32.39	7.37	30.56	190	341	P	H	
	*	5180	96.08	-	-	86.88	32.39	7.37	30.56	190	341	A	H	
													H	
														H
			5150	53.39	-20.61	74	44.26	32.34	7.35	30.56	160	17	P	V
			5149.76	45.12	-8.88	54	35.99	32.34	7.35	30.56	160	17	A	V
	*		5180	106.08	-	-	96.88	32.39	7.37	30.56	160	17	P	V
	*		5180	98.23	-	-	89.03	32.39	7.37	30.56	160	17	A	V
														V
														V
802.11a CH 44 5220MHz		5068.64	50.73	-23.27	74	41.77	32.21	7.3	30.55	187	325	P	H	
		5139.88	42.62	-11.38	54	33.5	32.34	7.34	30.56	187	325	A	H	
	*	5220	104.92	-	-	95.65	32.45	7.39	30.57	187	325	P	H	
	*	5220	97.29	-	-	88.02	32.45	7.39	30.57	187	325	A	H	
			5454.96	50.51	-23.49	74	40.75	32.82	7.54	30.6	187	325	P	H
			5372.08	41.34	-12.66	54	31.77	32.69	7.47	30.59	187	325	A	H
			5147.16	50.46	-23.54	74	41.33	32.34	7.35	30.56	127	0	P	V
			5139.88	42.75	-11.25	54	33.63	32.34	7.34	30.56	127	0	A	V
	*		5220	103.64	-	-	94.37	32.45	7.39	30.57	127	0	P	V
	*		5220	95.81	-	-	86.54	32.45	7.39	30.57	127	0	A	V
			5416.6	49.66	-24.34	74	39.98	32.77	7.51	30.6	127	0	P	V
			5458.32	40.7	-13.3	54	30.94	32.82	7.54	30.6	127	0	A	V



<b>802.11a CH 48 5240MHz</b>		5024.96	50.51	-23.49	74	41.62	32.15	7.28	30.54	209	334	P	H
		5148.72	41.71	-12.29	54	32.58	32.34	7.35	30.56	209	334	A	H
	*	5240	103.85	-	-	94.56	32.47	7.4	30.58	209	334	P	H
	*	5240	95.86	-	-	86.57	32.47	7.4	30.58	209	334	A	H
		5452.44	49.26	-24.74	74	39.5	32.82	7.54	30.6	209	334	P	H
		5458.6	40.82	-13.18	54	31.06	32.82	7.54	30.6	209	334	A	H
		5043.68	49.92	-24.08	74	41	32.18	7.29	30.55	125	0	P	V
		5132.08	41.8	-12.2	54	32.71	32.31	7.34	30.56	125	0	A	V
	*	5240	103.28	-	-	93.99	32.47	7.4	30.58	125	0	P	V
	*	5240	95.5	-	-	86.21	32.47	7.4	30.58	125	0	A	V
		5428.92	49.68	-24.32	74	39.98	32.79	7.51	30.6	125	0	P	V
		5451.6	40.78	-13.22	54	31.02	32.82	7.54	30.6	125	0	A	V
<b>Remark</b>	1. No other spurious found. 2. All results are PASS against Peak and Average limit line.												



**Band 1 5150~5250MHz**  
**WIFI 802.11a (Harmonic @ 3m)**

WIFI Ant. 1	Note	Frequency ( MHz )	Level ( dBμV/m )	Over Limit ( dB )	Limit Line ( dBμV/m )	Read Level (dBμV)	Antenna Factor ( dB/m )	Cable Loss ( dB )	Preamp Factor ( dB )	Ant Pos ( cm )	Table Pos ( deg )	Peak Avg. (P/A)	Pol. (H/V)
802.11a CH 36 5180MHz		10360	51.41	-22.59	74	58.58	38.57	10.75	57.03	107	59	P	H
		10360	42.62	-11.38	54	49.79	38.57	10.75	57.03	107	59	A	H
		15540	46.27	-27.73	74	50.31	38.68	13	56.48	100	0	P	H
													H
		10360	48.85	-25.15	74	56.02	38.57	10.75	57.03	100	0	P	V
		15540	45.91	-28.09	74	49.95	38.68	13	56.48	100	0	P	V
													V
802.11a CH 44 5220MHz		10440	48.87	-25.13	74	55.95	38.59	10.8	57.01	100	0	P	H
		15660	45.36	-28.64	74	49.71	38.24	13.07	56.41	100	0	P	H
													H
													H
		10440	48.06	-25.94	74	55.14	38.59	10.8	57.01	100	0	P	V
		15660	46.16	-27.84	74	50.51	38.24	13.07	56.41	100	0	P	V
													V
802.11a CH 48 5240MHz		10480	49.06	-24.94	74	56.09	38.6	10.83	57	100	0	P	H
		15720	45.63	-28.37	74	50.17	37.99	13.1	56.37	100	0	P	H
													H
													H
		10480	48.5	-25.5	74	55.53	38.6	10.83	57	100	0	P	V
		15720	45.21	-28.79	74	49.75	37.99	13.1	56.37	100	0	P	V
													V
Remark	1. No other spurious found.												
	2. All results are PASS against Peak and Average limit line.												





**Band 1 5150~5250MHz**  
**WIFI 802.11n HT20 (Band Edge @ 3m)**

WIFI Ant. 1	Note	Frequency ( MHz )	Level ( dBμV/m )	Over Limit ( dB )	Limit Line ( dBμV/m )	Read Level ( dBμV )	Antenna Factor ( dB/m )	Cable Loss ( dB )	Preamp Factor ( dB )	Ant Pos ( cm )	Table Pos ( deg )	Peak Avg. ( P/A )	Pol. ( H/V )	
802.11n HT20 CH 36 5180MHz		5129.22	51.31	-22.69	74	42.22	32.31	7.34	30.56	190	332	P	H	
		5150	43.34	-10.66	54	34.21	32.34	7.35	30.56	190	332	A	H	
	*	5180	102.42	-	-	93.22	32.39	7.37	30.56	190	332	P	H	
	*	5180	95.34	-	-	86.14	32.39	7.37	30.56	190	332	A	H	
													H	
														H
			5127.14	53.08	-20.92	74	43.99	32.31	7.34	30.56	139	19	P	V
			5150	45.23	-8.77	54	36.1	32.34	7.35	30.56	139	19	A	V
		*	5180	105.14	-	-	95.94	32.39	7.37	30.56	139	19	P	V
		*	5180	98.11	-	-	88.91	32.39	7.37	30.56	139	19	A	V
													V	
													V	
802.11n HT20 CH 44 5220MHz		5125.58	50.51	-23.49	74	41.42	32.31	7.34	30.56	188	340	P	H	
		5139.88	42.24	-11.76	54	33.12	32.34	7.34	30.56	188	340	A	H	
	*	5220	103.59	-	-	94.32	32.45	7.39	30.57	188	340	P	H	
	*	5220	96.25	-	-	86.98	32.45	7.39	30.57	188	340	A	H	
			5368.44	48.68	-25.32	74	39.11	32.69	7.47	30.59	188	340	P	H
			5453.28	40.75	-13.25	54	30.99	32.82	7.54	30.6	188	340	A	H
			5123.76	51.52	-22.48	74	42.44	32.31	7.33	30.56	149	17	P	V
			5140.14	43.52	-10.48	54	34.4	32.34	7.34	30.56	149	17	A	V
		*	5220	104.8	-	-	95.53	32.45	7.39	30.57	149	17	P	V
		*	5220	97.4	-	-	88.13	32.45	7.39	30.57	149	17	A	V
		5453.84	49.6	-24.4	74	39.84	32.82	7.54	30.6	149	17	P	V	
		5455.52	40.97	-13.03	54	31.21	32.82	7.54	30.6	149	17	A	V	



<b>802.11n</b>  <b>HT20</b>  <b>CH 48</b>  <b>5240MHz</b>		5107.9	50.02	-23.98	74	40.95	32.29	7.33	30.55	211	332	P	H
		5140.4	41.48	-12.52	54	32.36	32.34	7.34	30.56	211	332	A	H
	*	5240	104.12	-	-	94.83	32.47	7.4	30.58	211	332	P	H
	*	5240	96.38	-	-	87.09	32.47	7.4	30.58	211	332	A	H
		5364.52	49.06	-24.94	74	39.49	32.69	7.47	30.59	211	332	P	H
		5391.68	40.9	-13.1	54	31.31	32.71	7.48	30.6	211	332	A	H
		5145.6	50.77	-23.23	74	41.64	32.34	7.35	30.56	147	16	P	V
		5087.1	42.12	-11.88	54	33.13	32.23	7.31	30.55	147	16	A	V
	*	5240	104.18	-	-	94.89	32.47	7.4	30.58	147	16	P	V
	*	5240	97.15	-	-	87.86	32.47	7.4	30.58	147	16	A	V
		5382.16	49.92	-24.08	74	40.32	32.71	7.48	30.59	147	16	P	V
		5442.08	40.69	-13.31	54	30.98	32.79	7.52	30.6	147	16	A	V
<b>Remark</b>	1. No other spurious found. 2. All results are PASS against Peak and Average limit line.												



**Band 1 5150~5250MHz**  
**WIFI 802.11n HT20 (Harmonic @ 3m)**

WIFI Ant. 1	Note	Frequency ( MHz )	Level ( dBμV/m )	Over Limit ( dB )	Limit Line ( dBμV/m )	Read Level ( dBμV )	Antenna Factor ( dB/m )	Cable Loss ( dB )	Preamp Factor ( dB )	Ant Pos ( cm )	Table Pos ( deg )	Peak Avg. ( P/A )	Pol. ( H/V )
802.11n HT20 CH 36 5180MHz		10360	49.99	-24.01	74	57.16	38.57	10.75	57.03	100	0	P	H
		15540	48.21	-25.79	74	52.25	38.68	13	56.48	100	0	P	H
													H
													H
		10360	49.22	-24.78	74	56.39	38.57	10.75	57.03	100	0	P	V
		15540	46.85	-27.15	74	50.89	38.68	13	56.48	100	0	P	V
													V
802.11n HT20 CH 44 5220MHz		10440	49.26	-24.74	74	56.34	38.59	10.8	57.01	100	0	P	H
		15660	46.62	-27.38	74	50.97	38.24	13.07	56.41	100	0	P	H
													H
													H
		10440	49.81	-24.19	74	56.89	38.59	10.8	57.01	100	0	P	V
		15660	47.58	-26.42	74	51.93	38.24	13.07	56.41	100	0	P	V
													V
802.11n HT20 CH 48 5240MHz		10480	49.29	-24.71	74	56.32	38.6	10.83	57	100	0	P	H
		15720	45.25	-28.75	74	49.79	37.99	13.1	56.37	100	0	P	H
													H
													H
		10480	49.16	-24.84	74	56.19	38.6	10.83	57	100	0	P	V
		15720	46.79	-27.21	74	51.33	37.99	13.1	56.37	100	0	P	V
													V
Remark	1. No other spurious found.												
	2. All results are PASS against Peak and Average limit line.												



**Band 1 5150~5250MHz**  
**WIFI 802.11n HT40 (Band Edge @ 3m)**

WIFI Ant. 1	Note	Frequency ( MHz )	Level ( dBμV/m )	Over Limit ( dB )	Limit Line ( dBμV/m )	Read Level ( dBμV )	Antenna Factor ( dB/m )	Cable Loss ( dB )	Preamp Factor ( dB )	Ant Pos ( cm )	Table Pos ( deg )	Peak Avg. ( P/A )	Pol. ( H/V )
802.11n HT40 CH 38 5190MHz		5147.94	51.58	-22.42	74	42.45	32.34	7.35	30.56	166	352	P	H
		5150	46.75	-7.25	54	37.62	32.34	7.35	30.56	166	352	A	H
	*	5190	96.59	-	-	87.4	32.39	7.37	30.57	166	352	P	H
	*	5190	88.48	-	-	79.29	32.39	7.37	30.57	166	352	A	H
		5415.2	49.68	-24.32	74	40	32.77	7.51	30.6	166	352	P	H
		5432	41.33	-12.67	54	31.62	32.79	7.52	30.6	166	352	A	H
		5144.3	59.74	-14.26	74	50.61	32.34	7.35	30.56	148	17	P	V
		5150	49.17	-4.83	54	40.04	32.34	7.35	30.56	148	17	A	V
	*	5190	98.45	-	-	89.26	32.39	7.37	30.57	148	17	P	V
	*	5190	90.86	-	-	81.67	32.39	7.37	30.57	148	17	A	V
		5396.16	49.88	-24.12	74	40.25	32.74	7.49	30.6	148	17	P	V
		5455.8	41.58	-12.42	54	31.82	32.82	7.54	30.6	148	17	A	V
802.11n HT40 CH 46 5230MHz		5061.62	50.21	-23.79	74	41.25	32.21	7.3	30.55	196	331	P	H
		5108.42	42.03	-11.97	54	32.96	32.29	7.33	30.55	196	331	A	H
	*	5230	96.69	-	-	87.4	32.47	7.39	30.57	196	331	P	H
	*	5230	89.19	-	-	79.9	32.47	7.39	30.57	196	331	A	H
		5375.16	49.75	-24.25	74	40.18	32.69	7.47	30.59	196	331	P	H
		5379.92	41.42	-12.58	54	31.82	32.71	7.48	30.59	196	331	A	H
		5082.68	50.59	-23.41	74	41.6	32.23	7.31	30.55	158	15	P	V
		5147.42	42.84	-11.16	54	33.71	32.34	7.35	30.56	158	15	A	V
	*	5230	98.3	-	-	89.01	32.47	7.39	30.57	158	15	P	V
	*	5230	90.67	-	-	81.38	32.47	7.39	30.57	158	15	A	V
	5452.16	49.49	-24.51	74	39.73	32.82	7.54	30.6	158	15	P	V	
	5453.56	41.49	-12.51	54	31.73	32.82	7.54	30.6	158	15	A	V	
Remark	1. No other spurious found. 2. All results are PASS against Peak and Average limit line.												



**Band 1 5150~5250MHz**  
**WIFI 802.11n HT40 (Harmonic @ 3m)**

WIFI Ant. 1	Note	Frequency ( MHz )	Level ( dBμV/m )	Over Limit ( dB )	Limit Line ( dBμV/m )	Read Level (dBμV)	Antenna Factor ( dB/m )	Cable Loss ( dB )	Preamp Factor ( dB )	Ant Pos ( cm )	Table Pos ( deg )	Peak Avg. (P/A)	Pol. (H/V)	
802.11n HT40 CH 38 5190MHz		10380	47.49	-26.51	74	54.63	38.58	10.76	57.02	100	0	P	H	
		15570	47.26	-26.74	74	51.4	38.55	13.02	56.46	100	0	P	H	
													H	
													H	
			10380	47.74	-26.26	74	54.88	38.58	10.76	57.02	100	0	P	V
			15570	46.57	-27.43	74	50.71	38.55	13.02	56.46	100	0	P	V
														V
802.11n HT40 CH 46 5230MHz		10460	46.28	-27.72	74	53.35	38.59	10.81	57.01	100	0	P	H	
		15690	45.45	-28.55	74	49.9	38.12	13.08	56.39	100	0	P	H	
													H	
													H	
			10460	46.4	-27.6	74	53.47	38.59	10.81	57.01	100	0	P	V
			15690	46.12	-27.88	74	50.57	38.12	13.08	56.39	100	0	P	V
														V
Remark	1. No other spurious found.													
	2. All results are PASS against Peak and Average limit line.													



**Band 2 - 5250~5350MHz**  
**WIFI 802.11a (Band Edge @ 3m)**

WIFI	Note	Frequency	Level	Over	Limit	Read	Antenna	Cable	Preamp	Ant	Table	Peak	Pol.
Ant.				Limit	Line	Level	Factor	Loss	Factor	Pos	Pos	Avg.	
1		( MHz )	( dBμV/m )	( dB )	( dBμV/m )	( dBμV )	( dB/m )	( dB )	( dB )	( cm )	( deg )	( P/A )	( H/V )
802.11a CH 52 5260MHz		5086.7	49.54	-24.46	74	40.55	32.23	7.31	30.55	173	345	P	H
		5106.76	41.46	-12.54	54	32.39	32.29	7.33	30.55	173	345	A	H
	*	5260	104.31	-	-	94.95	32.53	7.41	30.58	173	345	P	H
	*	5260	97.32	-	-	87.96	32.53	7.41	30.58	173	345	A	H
		5363.52	49.16	-24.84	74	39.59	32.69	7.47	30.59	173	345	P	H
		5351.04	41.11	-12.89	54	31.58	32.66	7.46	30.59	173	345	A	H
		5053.04	50.29	-23.71	74	41.36	32.18	7.3	30.55	146	15	P	V
		5147.22	41.73	-12.27	54	32.6	32.34	7.35	30.56	146	15	A	V
	*	5260	103.11	-	-	93.75	32.53	7.41	30.58	146	15	P	V
	*	5260	96.21	-	-	86.85	32.53	7.41	30.58	146	15	A	V
		5408.88	49.04	-24.96	74	39.41	32.74	7.49	30.6	146	15	P	V
		5426.4	41.09	-12.91	54	31.41	32.77	7.51	30.6	146	15	A	V
802.11a CH 60 5300MHz		5028.22	51.15	-22.85	74	42.26	32.15	7.28	30.54	223	325	P	H
		5076.84	41.52	-12.48	54	32.53	32.23	7.31	30.55	223	325	A	H
	*	5300	103.53	-	-	94.1	32.58	7.43	30.58	223	325	P	H
	*	5300	96.43	-	-	87	32.58	7.43	30.58	223	325	A	H
		5366.64	52.15	-21.85	74	42.58	32.69	7.47	30.59	223	325	P	H
		5351.04	43.25	-10.75	54	33.72	32.66	7.46	30.59	223	325	A	H
		5144.5	51.16	-22.84	74	42.03	32.34	7.35	30.56	144	15	P	V
		5129.2	42.02	-11.98	54	32.93	32.31	7.34	30.56	144	15	A	V
	*	5300	102	-	-	92.57	32.58	7.43	30.58	144	15	P	V
	*	5300	95.08	-	-	85.65	32.58	7.43	30.58	144	15	A	V
		5432.16	50.39	-23.61	74	40.68	32.79	7.52	30.6	144	15	P	V
		5353.92	42.01	-11.99	54	32.48	32.66	7.46	30.59	144	15	A	V



<b>802.11a</b>  <b>CH 64</b>  <b>5320MHz</b>	*	5320	104.04	-	-	94.58	32.61	7.44	30.59	184	308	P	H
	*	5320	97.19	-	-	87.73	32.61	7.44	30.59	184	308	A	H
		5351.04	52.29	-21.71	74	42.76	32.66	7.46	30.59	184	308	P	H
		5350.24	44.8	-9.2	54	35.27	32.66	7.46	30.59	184	308	A	H
													H
													H
	*	5320	102.01	-	-	92.55	32.61	7.44	30.59	115	14	P	V
	*	5320	94.85	-	-	85.39	32.61	7.44	30.59	115	14	A	V
		5356.64	51.37	-22.63	74	41.84	32.66	7.46	30.59	115	14	P	V
		5350.08	42.65	-11.35	54	33.12	32.66	7.46	30.59	115	14	A	V
													V
													V
<b>Remark</b>	1. No other spurious found. 2. All results are PASS against Peak and Average limit line.												



**Band 2 5250~5350MHz**  
**WIFI 802.11a (Harmonic @ 3m)**

WIFI Ant. 1	Note	Frequency ( MHz )	Level ( dBμV/m )	Over Limit ( dB )	Limit Line ( dBμV/m )	Read Level ( dBμV )	Antenna Factor ( dB/m )	Cable Loss ( dB )	Preamp Factor ( dB )	Ant Pos ( cm )	Table Pos ( deg )	Peak Avg. ( P/A )	Pol. ( H/V )
802.11a CH 52 5260MHz		10520	49.13	-24.87	74	56.08	38.64	10.86	56.99	100	0	P	H
		15780	44.84	-29.16	74	49.49	37.81	13.13	56.33	100	0	P	H
													H
													H
		10520	47.85	-26.15	74	54.8	38.64	10.86	56.99	100	0	P	V
		15780	44.71	-29.29	74	49.36	37.81	13.13	56.33	100	0	P	V
													V
													V
802.11a CH 60 5300MHz		10600	46.88	-27.12	74	53.51	38.85	10.9	56.92	100	0	P	H
		15900	43.47	-30.53	74	48.43	37.37	13.2	56.26	100	0	P	H
													H
													H
		10600	46.96	-27.04	74	53.59	38.85	10.9	56.92	100	0	P	V
		15900	44.01	-29.99	74	48.97	37.37	13.2	56.26	100	0	P	V
													V
													V
802.11a CH 64 5320MHz		10640	46.91	-27.09	74	53.41	38.93	10.93	56.89	100	0	P	H
		15960	45.04	-28.96	74	50.19	37.12	13.23	56.22	100	0	P	H
													H
													H
		10640	47.25	-26.75	74	53.75	38.93	10.93	56.89	100	0	P	V
		15960	45.82	-28.18	74	50.97	37.12	13.23	56.22	100	0	P	V
													V
													V
<b>Remark</b>	1. No other spurious found. 2. All results are PASS against Peak and Average limit line.												





**Band 2 5250~5350MHz**  
**WIFI 802.11n HT20 (Band Edge @ 3m)**

WIFI Ant. 1	Note	Frequency ( MHz )	Level ( dBμV/m )	Over Limit ( dB )	Limit Line ( dBμV/m )	Read Level ( dBμV )	Antenna Factor ( dB/m )	Cable Loss ( dB )	Preamp Factor ( dB )	Ant Pos ( cm )	Table Pos ( deg )	Peak Avg. ( P/A )	Pol. ( H/V )
802.11n HT20 CH 52 5260MHz		5126.48	50.05	-23.95	74	40.96	32.31	7.34	30.56	199	332	P	H
		5058.48	41.42	-12.58	54	32.46	32.21	7.3	30.55	199	332	A	H
	*	5260	104.08	-	-	94.72	32.53	7.41	30.58	199	332	P	H
	*	5260	96.41	-	-	87.05	32.53	7.41	30.58	199	332	A	H
		5386.8	50.46	-23.54	74	40.86	32.71	7.48	30.59	199	332	P	H
		5351.04	41.45	-12.55	54	31.92	32.66	7.46	30.59	199	332	A	H
		5055.08	50.11	-23.89	74	41.15	32.21	7.3	30.55	159	15	P	V
		5106.08	41.82	-12.18	54	32.76	32.29	7.32	30.55	159	15	A	V
	*	5260	103.7	-	-	94.34	32.53	7.41	30.58	159	15	P	V
	*	5260	96.13	-	-	86.77	32.53	7.41	30.58	159	15	A	V
		5445.84	49.76	-24.24	74	40.02	32.82	7.52	30.6	159	15	P	V
		5458.08	40.7	-13.3	54	30.94	32.82	7.54	30.6	159	15	A	V
802.11n HT20 CH 60 5300MHz		5045.56	50.38	-23.62	74	41.46	32.18	7.29	30.55	196	330	P	H
		5120.02	41.6	-12.4	54	32.54	32.29	7.33	30.56	196	330	A	H
	*	5300	103.52	-	-	94.09	32.58	7.43	30.58	196	330	P	H
	*	5300	96.3	-	-	86.87	32.58	7.43	30.58	196	330	A	H
		5358.24	50.72	-23.28	74	41.18	32.66	7.47	30.59	196	330	P	H
		5355.12	42.84	-11.16	54	33.31	32.66	7.46	30.59	196	330	A	H
		5115.94	51.78	-22.22	74	42.72	32.29	7.33	30.56	138	16	P	V
		5148.24	42.14	-11.86	54	33.01	32.34	7.35	30.56	138	16	A	V
	*	5300	103.49	-	-	94.06	32.58	7.43	30.58	138	16	P	V
	*	5300	95.34	-	-	85.91	32.58	7.43	30.58	138	16	A	V
	5444.16	50.15	-23.85	74	40.44	32.79	7.52	30.6	138	16	P	V	
	5350.8	42.32	-11.68	54	32.79	32.66	7.46	30.59	138	16	A	V	



<b>802.11n</b> <b>HT20</b> <b>CH 64</b> <b>5320MHz</b>	*	5320	104.87	-	-	95.41	32.61	7.44	30.59	182	323	P	H
	*	5320	97.03	-	-	87.57	32.61	7.44	30.59	182	323	A	H
		5350.08	52.83	-21.17	74	43.3	32.66	7.46	30.59	182	323	P	H
		5350.08	44.7	-9.3	54	35.17	32.66	7.46	30.59	182	323	A	H
													H
													H
	*	5320	102.34	-	-	92.88	32.61	7.44	30.59	132	19	P	V
	*	5320	94.7	-	-	85.24	32.61	7.44	30.59	132	19	A	V
		5367.52	50.95	-23.05	74	41.38	32.69	7.47	30.59	132	19	P	V
		5350.08	43.08	-10.92	54	33.55	32.66	7.46	30.59	132	19	A	V
													V
													V
<b>Remark</b>	1. No other spurious found. 2. All results are PASS against Peak and Average limit line.												



**Band 2 5250~5350MHz**  
**WIFI 802.11n HT20 (Harmonic @ 3m)**

WIFI Ant. 1	Note	Frequency ( MHz )	Level ( dBμV/m )	Over Limit ( dB )	Limit Line ( dBμV/m )	Read Level ( dBμV )	Antenna Factor ( dB/m )	Cable Loss ( dB )	Preamp Factor ( dB )	Ant Pos ( cm )	Table Pos ( deg )	Peak Avg. ( P/A )	Pol. ( H/V )
802.11n HT20 CH 52 5260MHz		10520	48.84	-25.16	74	55.79	38.64	10.86	56.99	100	0	P	H
		15780	45.96	-28.04	74	50.61	37.81	13.13	56.33	100	0	P	H
													H
													H
		10520	48.39	-25.61	74	55.34	38.64	10.86	56.99	100	0	P	V
		15780	45.63	-28.37	74	50.28	37.81	13.13	56.33	100	0	P	V
													V
802.11n HT20 CH 60 5300MHz		10600	47.51	-26.49	74	54.14	38.85	10.9	56.92	100	0	P	H
		15900	45.43	-28.57	74	50.39	37.37	13.2	56.26	100	0	P	H
													H
													H
		10600	47.19	-26.81	74	53.82	38.85	10.9	56.92	100	0	P	V
		15900	45.84	-28.16	74	50.8	37.37	13.2	56.26	100	0	P	V
													V
802.11n HT20 CH 64 5320MHz		10640	47.96	-26.04	74	54.46	38.93	10.93	56.89	100	0	P	H
		15960	46.06	-27.94	74	51.21	37.12	13.23	56.22	100	0	P	H
													H
													H
		10640	47.24	-26.76	74	53.74	38.93	10.93	56.89	100	0	P	V
		15960	46.45	-27.55	74	51.6	37.12	13.23	56.22	100	0	P	V
													V
Remark	1. No other spurious found.												
	2. All results are PASS against Peak and Average limit line.												



**Band 2 5250~5350MHz**  
**WIFI 802.11n HT40 (Band Edge @ 3m)**

WIFI Ant. 1	Note	Frequency ( MHz )	Level ( dBμV/m )	Over Limit ( dB )	Limit Line ( dBμV/m )	Read Level ( dBμV )	Antenna Factor ( dB/m )	Cable Loss ( dB )	Preamp Factor ( dB )	Ant Pos ( cm )	Table Pos ( deg )	Peak Avg. ( P/A )	Pol. ( H/V )
802.11n HT40 CH 54 5270MHz		5031.96	51.27	-22.73	74	42.38	32.15	7.28	30.54	198	333	P	H
		5122.06	42.02	-11.98	54	32.96	32.29	7.33	30.56	198	333	A	H
	*	5270	97.98	-	-	88.61	32.53	7.42	30.58	198	333	P	H
	*	5270	90.61	-	-	81.24	32.53	7.42	30.58	198	333	A	H
		5418.48	50.36	-23.64	74	40.68	32.77	7.51	30.6	198	333	P	H
		5351.52	41.78	-12.22	54	32.25	32.66	7.46	30.59	198	333	A	H
		5015.64	50.54	-23.46	74	41.68	32.13	7.27	30.54	159	15	P	V
		5118.32	42.43	-11.57	54	33.37	32.29	7.33	30.56	159	15	A	V
	*	5270	97.61	-	-	88.24	32.53	7.42	30.58	159	15	P	V
	*	5270	89.74	-	-	80.37	32.53	7.42	30.58	159	15	A	V
		5420.88	48.91	-25.09	74	39.23	32.77	7.51	30.6	159	15	P	V
		5456.4	42.14	-11.86	54	32.38	32.82	7.54	30.6	159	15	A	V
802.11n HT40 CH 62 5310MHz		5091.46	50.07	-23.93	74	41.04	32.26	7.32	30.55	171	320	P	H
		5067.66	42.27	-11.73	54	33.31	32.21	7.3	30.55	171	320	A	H
	*	5310	97.2	-	-	87.73	32.61	7.44	30.58	171	320	P	H
	*	5310	89.58	-	-	80.11	32.61	7.44	30.58	171	320	A	H
		5354.4	58.3	-15.7	74	48.77	32.66	7.46	30.59	171	320	P	H
		5350.08	48.85	-5.15	54	39.32	32.66	7.46	30.59	171	320	A	H
		5032.98	49.79	-24.21	74	40.9	32.15	7.28	30.54	131	17	P	V
		5095.88	42.29	-11.71	54	33.26	32.26	7.32	30.55	131	17	A	V
	*	5310	95.69	-	-	86.22	32.61	7.44	30.58	131	17	P	V
	*	5310	88.04	-	-	78.57	32.61	7.44	30.58	131	17	A	V
	5350.08	55.11	-18.89	74	45.58	32.66	7.46	30.59	131	17	P	V	
	5350.08	46.43	-7.57	54	36.9	32.66	7.46	30.59	131	17	A	V	
<b>Remark</b>	1. No other spurious found. 2. All results are PASS against Peak and Average limit line.												



**Band 2 5250~5350MHz**  
**WIFI 802.11n HT40 (Harmonic @ 3m)**

WIFI Ant. 1	Note	Frequency ( MHz )	Level ( dBμV/m )	Over Limit ( dB )	Limit Line ( dBμV/m )	Read Level (dBμV)	Antenna Factor ( dB/m )	Cable Loss ( dB )	Preamp Factor ( dB )	Ant Pos ( cm )	Table Pos ( deg )	Peak Avg. (P/A)	Pol. (H/V)
802.11n HT40 CH 54 5270MHz		10540	47.14	-26.86	74	54.02	38.68	10.87	56.97	100	0	P	H
		15810	46.38	-27.62	74	51.12	37.68	13.15	56.31	100	0	P	H
													H
													H
		10540	47.97	-26.03	74	54.85	38.68	10.87	56.97	100	0	P	V
		15810	46.69	-27.31	74	51.43	37.68	13.15	56.31	100	0	P	V
													V
													V
802.11n HT40 CH 62 5310MHz		10620	46.23	-27.77	74	52.79	38.89	10.92	56.9	100	0	P	H
		15930	43.71	-30.29	74	48.75	37.25	13.22	56.24	100	0	P	H
													H
													H
		10620	47.11	-26.89	74	53.67	38.89	10.92	56.9	100	0	P	V
		15930	44.25	-29.75	74	49.29	37.25	13.22	56.24	100	0	P	V
													V
													V
<b>Remark</b>	1. No other spurious found. 2. All results are PASS against Peak and Average limit line.												



**Band 3 - 5470~5725MHz**  
**WIFI 802.11a (Band Edge @ 3m)**

WIFI	Note	Frequency	Level	Over	Limit	Read	Antenna	Cable	Preamp	Ant	Table	Peak	Pol.	
Ant.				Limit	Line	Level	Factor	Loss	Factor	Pos	Pos	Avg.		
1		( MHz )	( dBμV/m )	( dB )	( dBμV/m )	( dBμV )	( dB/m )	( dB )	( dB )	( cm )	( deg )	( P/A )	( H/V )	
802.11a CH 100 5500MHz		5419.92	52.18	-21.82	74	42.5	32.77	7.51	30.6	227	305	P	H	
		5468.4	51.98	-16.22	68.2	42.18	32.85	7.56	30.61	227	305	P	H	
		5420.08	43.82	-10.18	54	34.14	32.77	7.51	30.6	227	305	A	H	
	*	5500	104.24	-	-	94.37	32.9	7.58	30.61	227	305	P	H	
	*	5500	97.15	-	-	87.28	32.9	7.58	30.61	227	305	A	H	
														H
			5444.4	52.97	-21.03	74	43.26	32.79	7.52	30.6	350	93	P	V
			5469.52	51.12	-17.08	68.2	41.32	32.85	7.56	30.61	350	93	P	V
			5456.72	43.07	-10.93	54	33.31	32.82	7.54	30.6	350	93	A	V
	*		5500	103.65	-	-	93.78	32.9	7.58	30.61	350	93	P	V
	*		5500	96.51	-	-	86.64	32.9	7.58	30.61	350	93	A	V
														V
802.11a CH 116 5580MHz		5428	51.04	-22.96	74	41.36	32.77	7.51	30.6	182	298	P	H	
		5470	51.06	-17.14	68.2	41.26	32.85	7.56	30.61	182	298	P	H	
		5427.76	42.22	-11.78	54	32.54	32.77	7.51	30.6	182	298	A	H	
	*	5580	105.2	-	-	95.29	32.89	7.66	30.64	182	298	P	H	
	*	5580	98.12	-	-	88.21	32.89	7.66	30.64	182	298	A	H	
			5726.885	50.37	-17.83	68.2	40.41	32.86	7.81	30.71	182	298	P	H
			5382.16	49.39	-24.61	74	39.79	32.71	7.48	30.59	366	84	P	V
			5468.8	50.72	-17.48	68.2	40.92	32.85	7.56	30.61	366	84	P	V
			5458.48	41.87	-12.13	54	32.11	32.82	7.54	30.6	366	84	A	V
	*		5580	104.69	-	-	94.78	32.89	7.66	30.64	366	84	P	V
	*		5580	97.75	-	-	87.84	32.89	7.66	30.64	366	84	A	V
			5751.455	50.03	-18.17	68.2	40.08	32.85	7.83	30.73	366	84	P	V



<b>802.11a</b> <b>CH 140</b> <b>5700MHz</b>	*	5700	105.25	-	-	95.3	32.86	7.79	30.7	147	288	P	H
	*	5700	98.31	-	-	88.36	32.86	7.79	30.7	147	288	A	H
		5734.12	53.38	-14.82	68.2	43.42	32.86	7.81	30.71	147	288	P	H
													H
													H
													H
	*	5700	104.66	-	-	94.71	32.86	7.79	30.7	329	84	P	V
	*	5700	97.89	-	-	87.94	32.86	7.79	30.7	329	84	A	V
		5732.76	52.12	-16.08	68.2	42.16	32.86	7.81	30.71	329	84	P	V
													V
													V
													V
<b>Remark</b>	1. No other spurious found. 2. All results are PASS against Peak and Average limit line.												



**Band 3 - 5470~5725MHz**  
**WIFI 802.11a (Harmonic @ 3m)**

WIFI Ant. 1	Note	Frequency ( MHz )	Level ( dBμV/m )	Over Limit ( dB )	Limit Line ( dBμV/m )	Read Level ( dBμV )	Antenna Factor ( dB/m )	Cable Loss ( dB )	Preamp Factor ( dB )	Ant Pos ( cm )	Table Pos ( deg )	Peak Avg. ( P/A )	Pol. ( H/V )
802.11a CH 100 5500MHz		11000	48.65	-25.35	74	53.77	39.8	11.16	56.6	100	0	P	H
		16500	48.79	-19.41	68.2	52.82	37.7	13.28	55.7	100	0	P	H
													H
													H
		11000	48.5	-25.5	74	53.62	39.8	11.16	56.6	100	0	P	V
		16500	49.48	-18.72	68.2	53.51	37.7	13.28	55.7	100	0	P	V
													V
													V
802.11a CH 116 5580MHz		11160	47.87	-26.13	74	52.68	40	11.2	56.53	100	0	P	H
		16740	48.28	-19.92	68.2	50.15	39.97	13.29	55.8	100	0	P	H
													H
													H
		11160	46.76	-27.24	74	51.57	40	11.2	56.53	100	0	P	V
		16740	48.35	-19.85	68.2	50.22	39.97	13.29	55.8	100	0	P	V
													V
													V
802.11a CH 140 5700MHz		11400	49.22	-24.78	74	53.59	40.28	11.27	56.44	100	0	P	H
		17100	51.27	-16.93	68.2	50.91	42.4	13.37	56.06	100	0	P	H
													H
													H
		11400	49.83	-24.17	74	54.2	40.28	11.27	56.44	100	0	P	V
		17100	51.24	-16.96	68.2	50.88	42.4	13.37	56.06	100	0	P	V
													V
													V
<b>Remark</b>	1. No other spurious found. 2. All results are PASS against Peak and Average limit line.												





**Band 3 - 5470~5725MHz**  
**WIFI 802.11n HT20 (Band Edge @ 3m)**

WIFI Ant. 1	Note	Frequency ( MHz )	Level ( dBμV/m )	Over Limit ( dB )	Limit Line ( dBμV/m )	Read Level ( dBμV )	Antenna Factor ( dB/m )	Cable Loss ( dB )	Preamp Factor ( dB )	Ant Pos ( cm )	Table Pos ( deg )	Peak Avg. ( P/A )	Pol. ( H/V )	
802.11n HT20 CH 100 5500MHz		5459.92	53.2	-20.8	74	43.44	32.82	7.54	30.6	174	296	P	H	
		5466	53.17	-15.03	68.2	43.37	32.85	7.56	30.61	174	296	P	H	
		5458.96	44.4	-9.6	54	34.64	32.82	7.54	30.6	174	296	A	H	
	*	5500	105.32	-	-	95.45	32.9	7.58	30.61	174	296	P	H	
	*	5500	97.52	-	-	87.65	32.9	7.58	30.61	174	296	A	H	
														H
			5458.8	51.26	-22.74	74	41.5	32.82	7.54	30.6	329	73	P	V
			5469.36	54.59	-13.61	68.2	44.79	32.85	7.56	30.61	329	73	P	V
			5459.76	43.85	-10.15	54	34.09	32.82	7.54	30.6	329	73	A	V
	*		5500	105.33	-	-	95.46	32.9	7.58	30.61	329	73	P	V
	*		5500	97.19	-	-	87.32	32.9	7.58	30.61	329	73	A	V
														V
802.11n HT20 CH 116 5580MHz		5427.76	51.87	-22.13	74	42.19	32.77	7.51	30.6	176	299	P	H	
		5470	50.29	-17.91	68.2	40.49	32.85	7.56	30.61	176	299	P	H	
		5428	42.17	-11.83	54	32.49	32.77	7.51	30.6	176	299	A	H	
	*	5580	106.15	-	-	96.24	32.89	7.66	30.64	176	299	P	H	
	*	5580	98.71	-	-	88.8	32.89	7.66	30.64	176	299	A	H	
			5746.1	50.68	-17.52	68.2	40.73	32.85	7.83	30.73	176	299	P	H
			5451.28	51.58	-22.42	74	41.82	32.82	7.54	30.6	301	81	P	V
			5465.92	51.43	-16.77	68.2	41.65	32.85	7.54	30.61	301	81	P	V
			5459.2	41.8	-12.2	54	32.04	32.82	7.54	30.6	301	81	A	V
	*		5580	105.55	-	-	95.64	32.89	7.66	30.64	301	81	P	V
	*		5580	97.67	-	-	87.76	32.89	7.66	30.64	301	81	A	V
			5754.29	50.24	-17.96	68.2	40.28	32.85	7.84	30.73	301	81	P	V



<b>802.11n</b>  <b>HT20</b>  <b>CH 140</b>  <b>5700MHz</b>	*	5700	105.75	-	-	95.8	32.86	7.79	30.7	158	288	P	H
	*	5700	98.2	-	-	88.25	32.86	7.79	30.7	158	288	A	H
		5725.48	53.28	-14.92	68.2	43.32	32.86	7.81	30.71	158	288	P	H
													H
													H
													H
	*	5700	105.05	-	-	95.1	32.86	7.79	30.7	288	92	P	V
	*	5700	97.57	-	-	87.62	32.86	7.79	30.7	288	92	A	V
		5725.16	55.64	-12.56	68.2	45.68	32.86	7.81	30.71	288	92	P	V
													V
													V
													V
<b>Remark</b>	1. No other spurious found. 2. All results are PASS against Peak and Average limit line.												



**Band 3 - 5470~5725MHz**  
**WIFI 802.11n HT20 (Harmonic @ 3m)**

WIFI Ant. 1	Note	Frequency ( MHz )	Level ( dBμV/m )	Over Limit ( dB )	Limit Line ( dBμV/m )	Read Level ( dBμV )	Antenna Factor ( dB/m )	Cable Loss ( dB )	Preamp Factor ( dB )	Ant Pos ( cm )	Table Pos ( deg )	Peak Avg. ( P/A )	Pol. ( H/V )	
802.11n HT20 CH 100 5500MHz		11000	48	-26	74	53.12	39.8	11.16	56.6	100	0	P	H	
		16500	47.87	-20.33	68.2	51.9	37.7	13.28	55.7	100	0	P	H	
													H	
													H	
			11000	47.63	-26.37	74	52.75	39.8	11.16	56.6	100	0	P	V
			16500	48.82	-19.38	68.2	52.85	37.7	13.28	55.7	100	0	P	V
														V
802.11n HT20 CH 116 5580MHz		11160	48.25	-25.75	74	53.06	40	11.2	56.53	100	0	P	H	
		16740	49.87	-18.33	68.2	51.74	39.97	13.29	55.8	100	0	P	H	
													H	
													H	
			11160	48.53	-25.47	74	53.34	40	11.2	56.53	100	0	P	V
			16740	48.92	-19.28	68.2	50.79	39.97	13.29	55.8	100	0	P	V
														V
802.11n HT20 CH 140 5700MHz		11400	50.09	-23.91	74	54.46	40.28	11.27	56.44	100	0	P	H	
		17100	52.57	-15.63	68.2	52.21	42.4	13.37	56.06	100	0	P	H	
													H	
													H	
			11400	49.14	-24.86	74	53.51	40.28	11.27	56.44	100	0	P	V
			17100	51.48	-16.72	68.2	51.12	42.4	13.37	56.06	100	0	P	V
														V
Remark	1. No other spurious found.													
	2. All results are PASS against Peak and Average limit line.													



**Band 3 - 5470~5725MHz**  
**WIFI 802.11n HT40 (Band Edge @ 3m)**

WIFI Ant. 1	Note	Frequency ( MHz )	Level ( dBμV/m )	Over Limit ( dB )	Limit Line ( dBμV/m )	Read Level ( dBμV )	Antenna Factor ( dB/m )	Cable Loss ( dB )	Preamp Factor ( dB )	Ant Pos ( cm )	Table Pos ( deg )	Peak Avg. ( P/A )	Pol. ( H/V )
802.11n HT40 CH 102 5510MHz		5459.2	53.41	-20.59	74	43.65	32.82	7.54	30.6	172	296	P	H
		5466.16	62.09	-6.11	68.2	52.29	32.85	7.56	30.61	172	296	P	H
		5459.68	46.81	-7.19	54	37.05	32.82	7.54	30.6	172	296	A	H
	*	5510	99.61	-	-	89.73	32.9	7.59	30.61	172	296	P	H
	*	5510	91.02	-	-	81.14	32.9	7.59	30.61	172	296	A	H
		5760.275	50.09	-18.11	68.2	40.13	32.85	7.84	30.73	172	296	P	H
		5458.72	52.46	-21.54	74	42.7	32.82	7.54	30.6	310	82	P	V
		5467.84	59.75	-8.45	68.2	49.95	32.85	7.56	30.61	310	82	P	V
		5459.92	44.99	-9.01	54	35.23	32.82	7.54	30.6	310	82	A	V
	*	5510	98.06	-	-	88.18	32.9	7.59	30.61	310	82	P	V
	*	5510	90.18	-	-	80.3	32.9	7.59	30.61	310	82	A	V
		5742.005	49.74	-18.46	68.2	39.79	32.85	7.83	30.73	310	82	P	V
802.11n HT40 CH 110 5550MHz		5405.68	51.04	-22.96	74	41.41	32.74	7.49	30.6	174	314	P	H
		5467.36	49.94	-18.26	68.2	40.14	32.85	7.56	30.61	174	314	P	H
		5459.68	42.27	-11.73	54	32.51	32.82	7.54	30.6	174	314	A	H
	*	5550	99.76	-	-	89.87	32.89	7.63	30.63	174	314	P	H
	*	5550	91.52	-	-	81.63	32.89	7.63	30.63	174	314	A	H
		5733.5	49.42	-18.78	68.2	39.46	32.86	7.81	30.71	174	314	P	H
		5434.24	49.4	-24.6	74	39.69	32.79	7.52	30.6	337	92	P	V
		5461.84	49.12	-19.08	68.2	39.36	32.82	7.54	30.6	337	92	P	V
		5453.68	41.85	-12.15	54	32.09	32.82	7.54	30.6	337	92	A	V
	*	5550	99.31	-	-	89.42	32.89	7.63	30.63	337	92	P	V
	*	5550	91.02	-	-	81.13	32.89	7.63	30.63	337	92	A	V
		5735.705	49.91	-18.29	68.2	39.94	32.85	7.83	30.71	337	92	P	V



<b>802.11n</b>  <b>HT40</b>  <b>CH 134</b>  <b>5670MHz</b>		5431.55	50.13	-23.87	74	40.42	32.79	7.52	30.6	165	292	P	H
		5461.3	47.88	-20.32	68.2	38.12	32.82	7.54	30.6	165	292	P	H
		5454.65	41.58	-12.42	54	31.82	32.82	7.54	30.6	165	292	A	H
	*	5670	99.42	-	-	89.49	32.87	7.75	30.69	165	292	P	H
	*	5670	91.37	-	-	81.44	32.87	7.75	30.69	165	292	A	H
		5735.705	50.95	-17.25	68.2	40.98	32.85	7.83	30.71	165	292	P	H
		5459.55	50.27	-23.73	74	40.51	32.82	7.54	30.6	308	81	P	V
		5469.7	47.66	-20.54	68.2	37.86	32.85	7.56	30.61	308	81	P	V
		5457.8	41.38	-12.62	54	31.62	32.82	7.54	30.6	308	81	A	V
	*	5670	98.39	-	-	88.46	32.87	7.75	30.69	308	81	P	V
	*	5670	91.02	-	-	81.09	32.87	7.75	30.69	308	81	A	V
		5727.83	50.9	-17.3	68.2	40.94	32.86	7.81	30.71	308	81	P	V
<b>Remark</b>	1. No other spurious found. 2. All results are PASS against Peak and Average limit line.												



**Band 3 - 5470~5725MHz**  
**WIFI 802.11n HT40 (Harmonic @ 3m)**

WIFI Ant. 1	Note	Frequency ( MHz )	Level ( dBμV/m )	Over Limit ( dB )	Limit Line ( dBμV/m )	Read Level ( dBμV )	Antenna Factor ( dB/m )	Cable Loss ( dB )	Preamp Factor ( dB )	Ant Pos ( cm )	Table Pos ( deg )	Peak Avg. ( P/A )	Pol. ( H/V )	
802.11n HT40 CH 102 5510MHz		11020	46.78	-27.22	74	51.86	39.82	11.17	56.59	100	0	P	H	
		16530	46.46	-21.74	68.2	50.18	38.02	13.28	55.71	100	0	P	H	
													H	
													H	
			11020	46.75	-27.25	74	51.83	39.82	11.17	56.59	100	0	P	V
			16530	46.84	-21.36	68.2	50.56	38.02	13.28	55.71	100	0	P	V
														V
802.11n HT40 CH 110 5550MHz		11100	47.62	-26.38	74	52.55	39.92	11.19	56.56	100	0	P	H	
		16650	46.76	-21.44	68.2	49.39	39.16	13.29	55.76	100	0	P	H	
													H	
													H	
			11100	47.4	-26.6	74	52.33	39.92	11.19	56.56	100	0	P	V
			16650	47.39	-20.81	68.2	50.02	39.16	13.29	55.76	100	0	P	V
														V
802.11n HT40 CH 134 5670MHz		11340	48.22	-25.78	74	52.72	40.2	11.25	56.47	100	0	P	H	
		17010	49.6	-18.6	68.2	49.17	42.4	13.31	55.93	100	0	P	H	
													H	
													H	
			11340	47.48	-26.52	74	51.98	40.2	11.25	56.47	100	0	P	V
			17010	49.36	-18.84	68.2	48.93	42.4	13.31	55.93	100	0	P	V
														V
Remark	1. No other spurious found.													
	2. All results are PASS against Peak and Average limit line.													



**Band 3 - 5470~5725MHz**

**Emission below 1GHz**

**WIFI 802.11a (LF @ 3m)**

WIFI Ant.	Note	Frequency	Level	Over Limit	Limit Line	Read Level	Antenna Factor	Cable Loss	Preamp Factor	Ant Pos	Table Pos	Peak Avg.	Pol.	
1		( MHz )	( dBμV/m )	( dB )	( dBμV/m )	( dBμV )	( dB/m )	( dB )	( dB )	( cm )	( deg )	( P/A )	( H/V )	
802.11a LF		30.81	21.73	-18.27	40	31.7	21.8	0.59	32.34			P	H	
		142.05	23.14	-20.36	43.5	39.47	14.72	1.19	32.28			P	H	
		223.59	25.41	-20.59	46	43.76	12.28	1.53	32.24			P	H	
		560.4	23.09	-22.91	46	30.03	22.81	2.36	32.21			P	H	
		829.2	29.3	-16.7	46	32.52	25.69	2.81	31.85			P	H	
		951.7	30.52	-15.48	46	30.34	28.02	3.06	31.04	100	0	P	H	
														H
														H
														H
														H
														H
														H
			30.54	29.64	-10.36	40	39.61	21.8	0.59	32.34	100	0	P	V
			100.74	23.61	-19.89	43.5	41.7	13.06	1	32.29			P	V
			227.91	23.27	-22.73	46	41.34	12.55	1.53	32.23			P	V
			507.9	22.14	-23.86	46	31.2	20.82	2.24	32.2			P	V
			829.2	31.49	-14.51	46	34.71	25.69	2.81	31.85			P	V
			955.9	30.67	-15.33	46	30.13	28.33	3.07	31			P	V
													V	
													V	
													V	
													V	
													V	
													V	
Remark	1. No other spurious found. 2. All results are PASS against limit line.													



**Emission below 1GHz**  
**WIFI 802.11n HT20 (LF @ 3m)**

WIFI	Note	Frequency	Level	Over	Limit	Read	Antenna	Cable	Preamp	Ant	Table	Peak	Pol.	
Ant.				Limit	Line	Level	Factor	Loss	Factor	Pos	Pos	Avg.		
1		( MHz )	( dBμV/m )	( dB )	( dBμV/m )	( dBμV )	( dB/m )	( dB )	( dB )	( cm )	( deg )	( P/A )	( H/V )	
802.11n HT20 LF		30.27	20.69	-19.31	40	29.83	22.63	0.59	32.34			P	H	
		142.05	26.65	-16.85	43.5	42.98	14.72	1.19	32.28			P	H	
		226.56	25.21	-20.79	46	43.35	12.48	1.53	32.23			P	H	
		491.8	21.29	-24.71	46	30.58	20.63	2.2	32.2			P	H	
		722.1	25.84	-20.16	46	30.78	24.43	2.66	32.13			P	H	
		955.2	30.01	-15.99	46	29.55	28.27	3.06	31.01	100	0	P	H	
														H
														H
														H
														H
														H
														H
			31.08	29.94	-10.06	40	39.91	21.8	0.59	32.34	100	0	P	V
			100.47	24.12	-19.38	43.5	42.21	13.06	1	32.29			P	V
			224.94	22.45	-23.55	46	40.73	12.35	1.53	32.24			P	V
			439.3	20.21	-25.79	46	30.72	19.48	2.1	32.17			P	V
			638.1	25	-21	46	31.16	23.44	2.48	32.19			P	V
			843.9	29.7	-16.3	46	32.2	26.31	2.84	31.78			P	V
														V
														V
													V	
													V	
													V	
													V	
													V	
<b>Remark</b>	1. No other spurious found. 2. All results are PASS against limit line.													





**Emission below 1GHz**  
**WIFI 802.11n HT40 (LF @ 3m)**

WIFI	Note	Frequency	Level	Over	Limit	Read	Antenna	Cable	Preamp	Ant	Table	Peak	Pol.	
Ant.				Limit	Line	Level	Factor	Loss	Factor	Pos	Pos	Avg.		
1		( MHz )	( dBμV/m )	( dB )	( dBμV/m )	( dBμV )	( dB/m )	( dB )	( dB )	( cm )	( deg )	( P/A )	( H/V )	
802.11n HT40 LF		38.37	21.19	-18.81	40	37.71	15.22	0.59	32.33			P	H	
		140.43	30.24	-13.26	43.5	46.68	14.61	1.19	32.28	100	0	P	H	
		220.35	28.7	-17.3	46	47.34	12	1.53	32.24			P	H	
		506.5	21.56	-24.44	46	30.6	20.84	2.24	32.2			P	H	
		751.5	26.95	-19.05	46	31.18	25.07	2.68	32.08			P	H	
		937	30.15	-15.85	46	30.99	27.18	3.02	31.17			P	H	
													H	
													H	
													H	
													H	
													H	
													H	
			30.81	29.74	-10.26	40	39.71	21.8	0.59	32.34	100	0	P	V
			101.01	26.57	-16.93	43.5	44.66	13.06	1	32.29			P	V
			228.18	24.63	-21.37	46	42.7	12.55	1.53	32.23			P	V
			552.7	23.25	-22.75	46	30.68	22.35	2.33	32.21			P	V
			836.9	29.79	-16.21	46	32.47	26.16	2.84	31.81			P	V
			904.1	34.74	-11.26	46	36.62	26.5	2.98	31.47			P	V
														V
														V
													V	
													V	
													V	
													V	
<b>Remark</b>	1. No other spurious found. 2. All results are PASS against limit line.													



**Note symbol**

*	<b>Fundamental Frequency</b> which can be ignored. However, the level of any unwanted emissions shall not exceed the level of the fundamental frequency.
!	Test result is <b>over limit</b> line.
P/A	<b>Peak</b> or <b>Average</b>
H/V	<b>Horizontal</b> or <b>Vertical</b>



A calculation example for radiated spurious emission is shown as below:

WIFI	Note	Frequency	Level	Over	Limit	Read	Antenna	Cable	Preamp	Ant	Table	Peak	Pol.
Ant.				Limit	Line	Level	Factor	Loss	Factor	Pos	Pos	Avg.	
1		( MHz )	( dBμV/m )	( dB )	( dBμV/m )	( dBμV )	( dB/m )	( dB )	( dB )	( cm )	( deg )	( P/A )	( H/V )
802.11b		2390	55.45	-18.55	74	54.51	32.22	4.58	35.86	103	308	P	H
CH 01													
2412MHz		2390	43.54	-10.46	54	42.6	32.22	4.58	35.86	103	308	A	H

- Level(dBμV/m) =  
Antenna Factor(dB/m) + Cable Loss(dB) + Read Level(dBμV) - Preamp Factor(dB)
- Over Limit(dB) = Level(dBμV/m) – Limit Line(dBμV/m)

**For Peak Limit @ 2390MHz:**

- Level(dBμV/m)  
= Antenna Factor(dB/m) + Cable Loss(dB) + Read Level(dBμV) - Preamp Factor(dB)  
= 32.22(dB/m) + 4.58(dB) + 54.51(dBμV) – 35.86 (dB)  
= 55.45 (dBμV/m)
- Over Limit(dB)  
= Level(dBμV/m) – Limit Line(dBμV/m)  
= 55.45(dBμV/m) – 74(dBμV/m)  
= -18.55(dB)

**For Average Limit @ 2390MHz:**

- Level(dBμV/m)  
= Antenna Factor(dB/m) + Cable Loss(dB) + Read Level(dBμV) - Preamp Factor(dB)  
= 32.22(dB/m) + 4.58(dB) + 42.6(dBμV) – 35.86 (dB)  
= 43.54 (dBμV/m)
- Over Limit(dB)  
= Level(dBμV/m) – Limit Line(dBμV/m)  
= 43.54(dBμV/m) – 54(dBμV/m)  
= -10.46(dB)

Both peak and average measured complies with the limit line, so test result is “PASS”.



### Appendix C. Radiated Spurious Emission

<b>Test Engineer :</b>	Peter Chiu, Karl Hou, Nick Yu, and Citta Ke	<b>Temperature :</b>	21~23°C
		<b>Relative Humidity :</b>	54~58%

#### Note symbol

-L	Low channel location
-R	High channel location



**Band 1 - 5150~5250MHz**  
**WIFI 802.11a (Band Edge @ 3m)**

WIFI	Band 1 5150~5250MHz Band Edge @ 3m	
ANT	802.11a CH36 5180MHz	
<b>1</b>	<b>Horizontal</b>	<b>Fundamental</b>
<b>Peak</b>	<p>Site : 03CH13-HY            Condition : PEAK_BE_74 3m HORN_9120D_1522 HORIZONTAL            : RBW:1000.000KHz VBW:3000.000KHz SWT:Auto</p>	<p>Site : 03CH13-HY            Condition : PEAK_74 3m HORN_9120D_1522 HORIZONTAL            : RBW:1000.000KHz VBW:3000.000KHz SWT:Auto</p>
<b>Avg.</b>	<p>Site : 03CH13-HY            Condition : AVG_BE_54 3m HORN_9120D_1522 HORIZONTAL            : RBW:1000.000KHz VBW:1.000KHz SWT:Auto</p>	<b>Left blank</b>



WIFI	Band 1 5150~5250MHz Band Edge @ 3m	
ANT	802.11a CH36 5180MHz	
1	Vertical	Fundamental
Peak	<p>Date: 2017-05-28</p> <p>Site : 03CH13-HY Condition : PEAK_BE_74 3m HORN_9120D_1522 VERTICAL : RBW:1000.000KHz VBW:3000.000KHz SWT:Auto</p>	<p>Date: 2017-05-28</p> <p>Site : 03CH13-HY Condition : PEAK_74 3m HORN_9120D_1522 VERTICAL : RBW:1000.000KHz VBW:3000.000KHz SWT:Auto</p>
Avg.	<p>Date: 2017-05-28</p> <p>Site : 03CH13-HY Condition : AV6_BE_54 3m HORN_9120D_1522 VERTICAL : RBW:1000.000KHz VBW:1.000KHz SWT:Auto</p>	Left blank

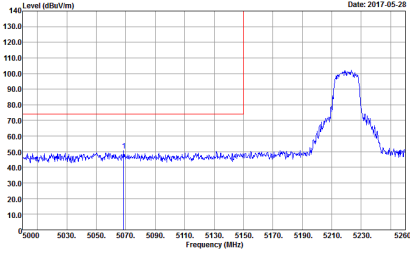
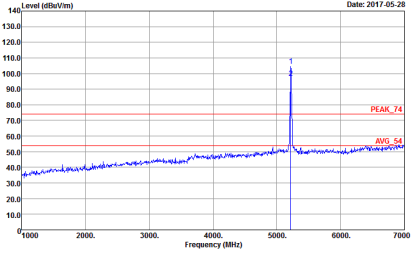
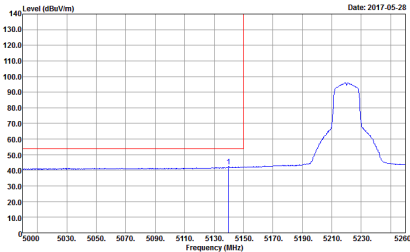

WIFI	Band 1 5150~5250MHz Band Edge @ 3m	
ANT	802.11a CH44 5220MHz - L	
1	Horizontal	Fundamental
Peak	 <p>Date: 2017-05-28</p> <p>Site : 03CH13-HY Condition : PEAK_BE_74 3m HORN_9120D_1522 HORIZONTAL : RBW:1000.000KHz VBW:3000.000KHz SWT:Auto</p>	 <p>Date: 2017-05-28</p> <p>Site : 03CH13-HY Condition : PEAK_74 3m HORN_9120D_1522 HORIZONTAL : RBW:1000.000KHz VBW:3000.000KHz SWT:Auto</p>
Avg.	 <p>Date: 2017-05-28</p> <p>Site : 03CH13-HY Condition : AV6_BE_54 3m HORN_9120D_1522 HORIZONTAL : RBW:1000.000KHz VBW:1.000KHz SWT:Auto</p>	Left blank

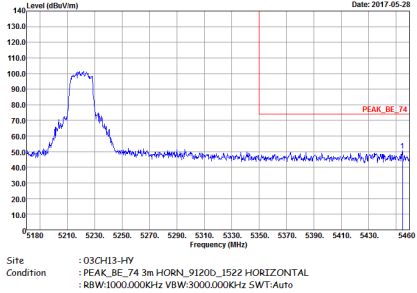
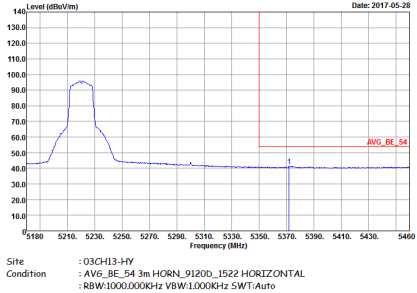

WIFI	Band 1 5150~5250MHz Band Edge @ 3m	
ANT	802.11a CH44 5220MHz - R	
1	Horizontal	Fundamental
Peak	 <p>Site : 03CH13-HY Condition : PEAK_BE_74 3m HORN_9120D_1522 HORIZONTAL RBW:1000.000KHz VBW:3000.000KHz SWT:Auto</p>	Left blank
Avg.	 <p>Site : 03CH13-HY Condition : AVG_BE_54 3m HORN_9120D_1522 HORIZONTAL RBW:1000.000KHz VBW:1.000KHz SWT:Auto</p>	Left blank



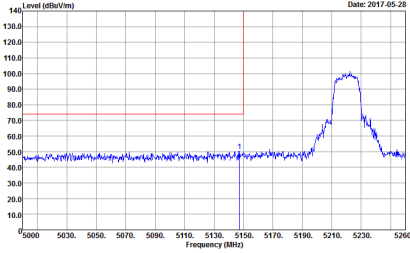
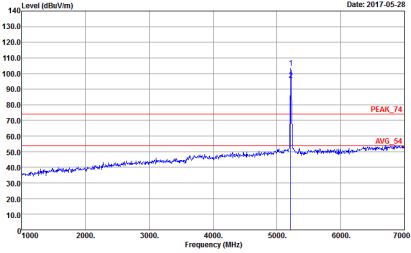
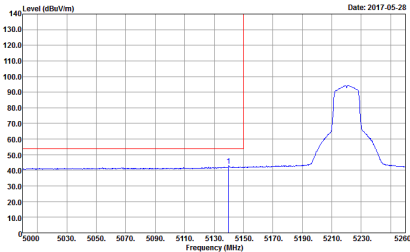

WIFI	Band 1 5150~5250MHz Band Edge @ 3m	
ANT	802.11a CH44 5220MHz - L	
1	Vertical	Fundamental
Peak	 <p>Date: 2017-05-28</p> <p>Site : 03CH13-HY Condition : PEAK_BE_74 3m HORN_9120D_1522 VERTICAL : RBW:1000.000KHz VBW:3000.000KHz SWT:Auto</p>	 <p>Date: 2017-05-28</p> <p>Site : 03CH13-HY Condition : PEAK_74 3m HORN_9120D_1522 VERTICAL : RBW:1000.000KHz VBW:3000.000KHz SWT:Auto</p>
Avg.	 <p>Date: 2017-05-28</p> <p>Site : 03CH13-HY Condition : AV6_BE_54 3m HORN_9120D_1522 VERTICAL : RBW:1000.000KHz VBW:1.000KHz SWT:Auto</p>	Left blank

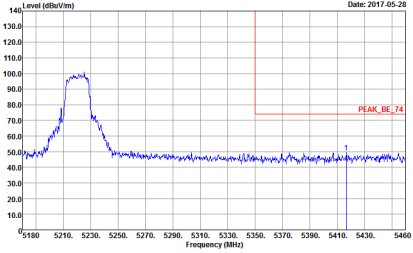
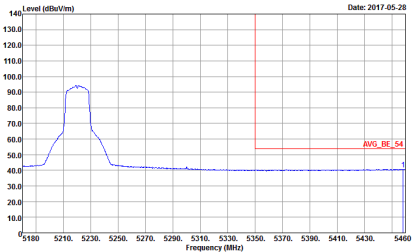

WIFI	Band 1 5150~5250MHz Band Edge @ 3m	
ANT	802.11a CH44 5220MHz - R	
1	Vertical	Fundamental
Peak	 <p>Site : 03CH13-HY Condition : PEAK_BE_74 3m HORN_9120D_1522 VERTICAL RBW:1000.000KHz VBW:3000.000KHz SWT:Auto</p>	Left blank
Avg.	 <p>Site : 03CH13-HY Condition : AVG_BE_54 3m HORN_9120D_1522 VERTICAL RBW:1000.000KHz VBW:1.000KHz SWT:Auto</p>	Left blank

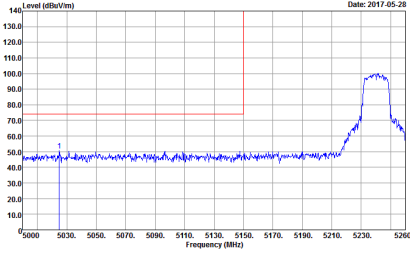
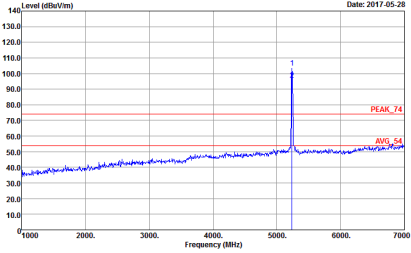
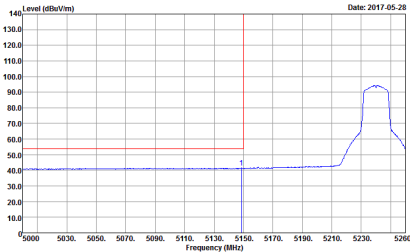

WIFI	Band 1 5150~5250MHz Band Edge @ 3m	
ANT	802.11a CH48 5240MHz - L	
1	Horizontal	Fundamental
Peak	 <p>Date: 2017-05-28</p> <p>Site : 03CH13-HY Condition : PEAK_BE_74 3m HORN_9120D_1522 HORIZONTAL : RBW:1000.000KHz VBW:3000.000KHz SWT:Auto</p>	 <p>Date: 2017-05-28</p> <p>Site : 03CH13-HY Condition : PEAK_74 3m HORN_9120D_1522 HORIZONTAL : RBW:1000.000KHz VBW:3000.000KHz SWT:Auto</p>
Avg.	 <p>Date: 2017-05-28</p> <p>Site : 03CH13-HY Condition : AV6_BE_54 3m HORN_9120D_1522 HORIZONTAL : RBW:1000.000KHz VBW:1.000KHz SWT:Auto</p>	Left blank

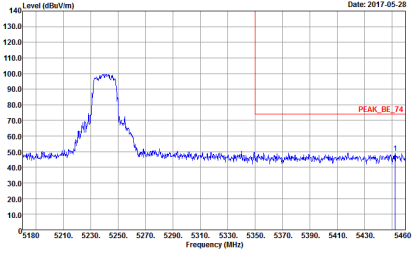
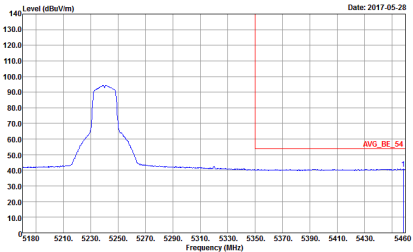

WIFI	Band 1 5150~5250MHz Band Edge @ 3m	
ANT	802.11a CH48 5240MHz - R	
1	Horizontal	Fundamental
Peak	 <p>Date: 2017-05-28</p> <p>Site : 03CH13-HY Condition : PEAK_BE_74 3m HORN_9120D_1522 HORIZONTAL : RBW:1000.000KHz VBW:3000.000KHz SWT:Auto</p>	Left blank
Avg.	 <p>Date: 2017-05-28</p> <p>Site : 03CH13-HY Condition : AVG_BE_54 3m HORN_9120D_1522 HORIZONTAL : RBW:1000.000KHz VBW:1.000KHz SWT:Auto</p>	Left blank



WIFI	Band 1 5150~5250MHz Band Edge @ 3m	
ANT	802.11a CH48 5240MHz - L	
1	Vertical	Fundamental
Peak	<p>Date: 2017-05-28</p> <p>Site : 03CH13-HY Condition : PEAK_BE_74 3m HORN_9120D_1522 VERTICAL : RBW:1000.000KHz VBW:3000.000KHz SWT:Auto</p>	<p>Date: 2017-05-28</p> <p>Site : 03CH13-HY Condition : PEAK_74 3m HORN_9120D_1522 VERTICAL : RBW:1000.000KHz VBW:3000.000KHz SWT:Auto</p>
Avg.	<p>Date: 2017-05-28</p> <p>Site : 03CH13-HY Condition : AV6_BE_54 3m HORN_9120D_1522 VERTICAL : RBW:1000.000KHz VBW:1.000KHz SWT:Auto</p>	Left blank

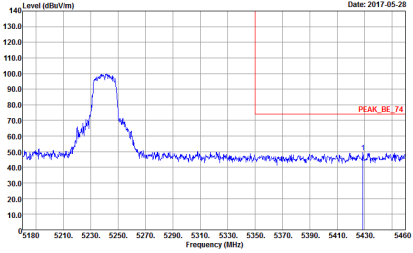
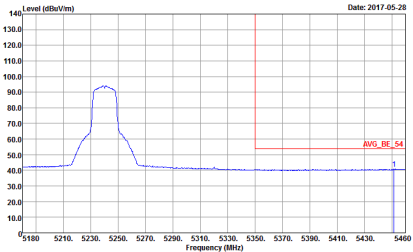

WIFI	Band 1 5150~5250MHz Band Edge @ 3m	
ANT	802.11a CH48 5240MHz - R	
1	Vertical	Fundamental
Peak	 <p>Site : 03CH13-HY Condition : PEAK_BE_74 3m HORN_9120D_1522 VERTICAL : RBW:1000.000KHz VBW:3000.000KHz SWT:Auto</p>	Left blank
Avg.	 <p>Site : 03CH13-HY Condition : AVG_BE_54 3m HORN_9120D_1522 VERTICAL : RBW:1000.000KHz VBW:1.000KHz SWT:Auto</p>	Left blank

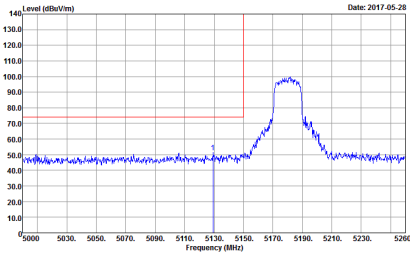
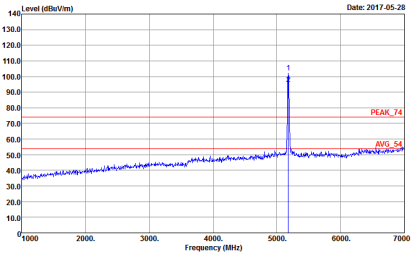
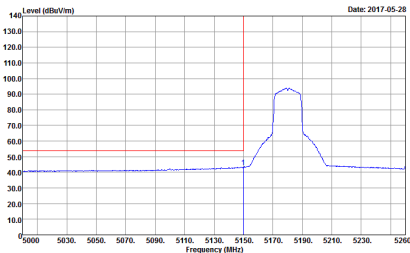

**Band 1 5150~5250MHz  
WIFI 802.11n HT20 (Band Edge @ 3m)**

WIFI	Band 1 5150~5250MHz Band Edge @ 3m	
ANT	802.11n HT20 CH36 5180MHz	
1	Horizontal	Fundamental
Peak	 <p>Site : 03CH13-HY Condition : PEAK_BE_74 3m HORN_9120D_1522 HORIZONTAL : RBW:1000.000KHz VBW:3000.000KHz SWT:Auto</p>	 <p>Site : 03CH13-HY Condition : PEAK_74 3m HORN_9120D_1522 HORIZONTAL : RBW:1000.000KHz VBW:3000.000KHz SWT:Auto</p>
Avg.	 <p>Site : 03CH13-HY Condition : AVG_BE_54 3m HORN_9120D_1522 HORIZONTAL : RBW:1000.000KHz VBW:1000KHz SWT:Auto</p>	Left blank

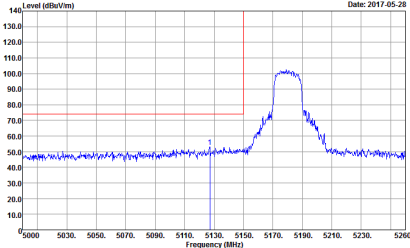
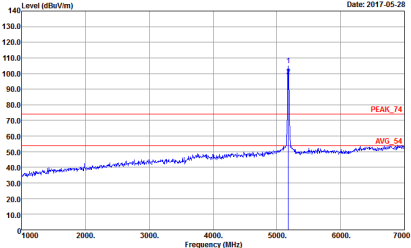
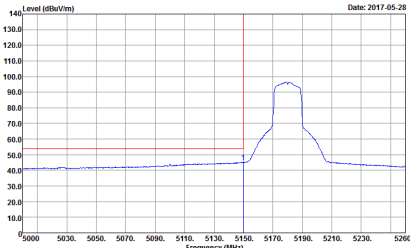

WIFI	Band 1 5150~5250MHz Band Edge @ 3m	
ANT	802.11n HT20 CH36 5180MHz	
1	Vertical	Fundamental
Peak	 <p>Date: 2017-05-28</p> <p>Site : 03CH13-HY Condition : PEAK_BE_74 3m HORN_9120D_1522 VERTICAL : RBW:1000.000KHz VBW:3000.000KHz SWT:Auto</p>	 <p>Date: 2017-05-28</p> <p>Site : 03CH13-HY Condition : PEAK_74 3m HORN_9120D_1522 VERTICAL : RBW:1000.000KHz VBW:3000.000KHz SWT:Auto</p>
Avg.	 <p>Date: 2017-05-28</p> <p>Site : 03CH13-HY Condition : AV6_BE_54 3m HORN_9120D_1522 VERTICAL : RBW:1000.000KHz VBW:1.000KHz SWT:Auto</p>	Left blank



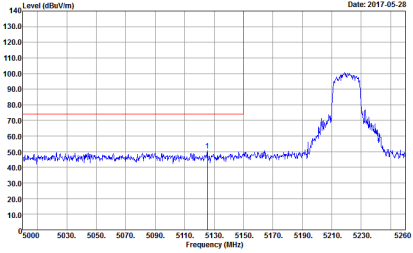
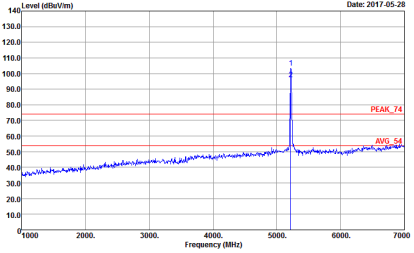
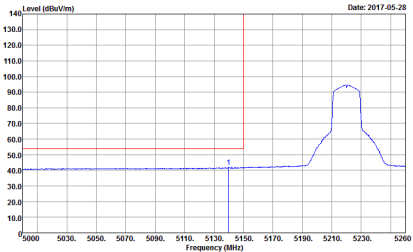

WIFI	Band 1 5150~5250MHz Band Edge @ 3m	
ANT	802.11n HT20 CH44 5220MHz - L	
1	Horizontal	Fundamental
Peak	 <p>Date: 2017-05-28</p> <p>Site : 03CH13-HY Condition : PEAK_BE_74 3m HORN_9120D_1522 HORIZONTAL : RBW:1000.000KHz VBW:3000.000KHz SWT:Auto</p>	 <p>Date: 2017-05-28</p> <p>Site : 03CH13-HY Condition : PEAK_74 3m HORN_9120D_1522 HORIZONTAL : RBW:1000.000KHz VBW:3000.000KHz SWT:Auto</p>
Avg.	 <p>Date: 2017-05-28</p> <p>Site : 03CH13-HY Condition : AV6_BE_54 3m HORN_9120D_1522 HORIZONTAL : RBW:1000.000KHz VBW:1.000KHz SWT:Auto</p>	Left blank

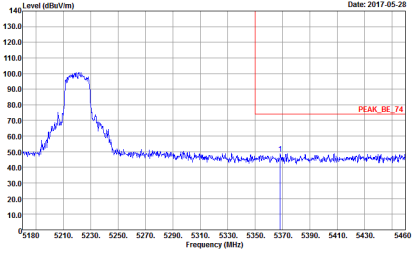
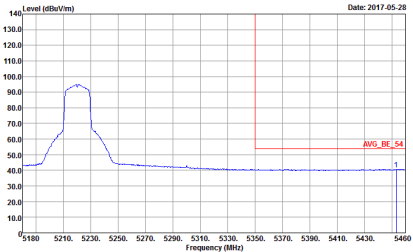

WIFI	Band 1 5150~5250MHz Band Edge @ 3m	
ANT	802.11n HT20 CH44 5220MHz - R	
1	Horizontal	Fundamental
Peak	 <p>Site : 03CH13-HY Condition : PEAK_BE_74 3m HORN_9120D_1522 HORIZONTAL RBW:1000.000KHz VBW:3000.000KHz SWT:Auto</p>	Left blank
Avg.	 <p>Site : 03CH13-HY Condition : AVG_BE_54 3m HORN_9120D_1522 HORIZONTAL RBW:1000.000KHz VBW:1.000KHz SWT:Auto</p>	Left blank

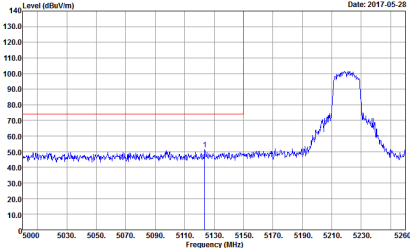
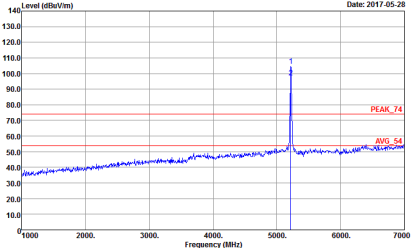
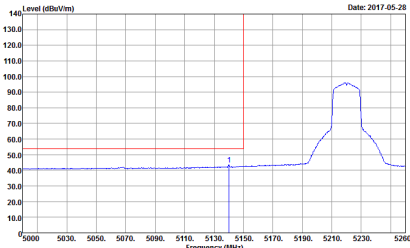

WIFI	Band 1 5150~5250MHz Band Edge @ 3m	
ANT	802.11n HT20 CH44 5220MHz - L	
1	Vertical	Fundamental
Peak	 <p>Date: 2017-05-28</p> <p>Site : 03CH13-HY Condition : PEAK_BE_74 3m HORN_9120D_1522 VERTICAL : RBW:1000.000KHz VBW:3000.000KHz SWT:Auto</p>	 <p>Date: 2017-05-28</p> <p>Site : 03CH13-HY Condition : PEAK_74 3m HORN_9120D_1522 VERTICAL : RBW:1000.000KHz VBW:3000.000KHz SWT:Auto</p>
Avg.	 <p>Date: 2017-05-28</p> <p>Site : 03CH13-HY Condition : AV6_BE_54 3m HORN_9120D_1522 VERTICAL : RBW:1000.000KHz VBW:1.000KHz SWT:Auto</p>	Left blank

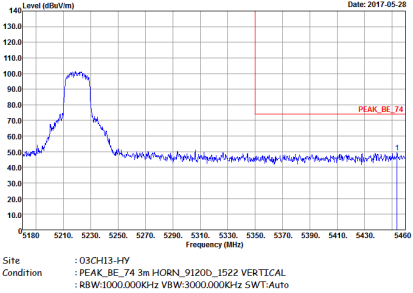
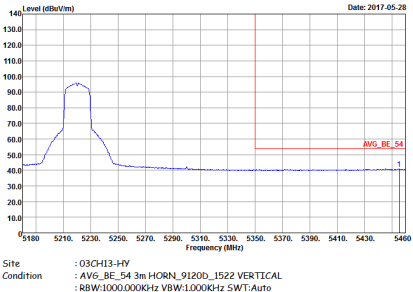

WIFI	Band 1 5150~5250MHz Band Edge @ 3m	
ANT	802.11n HT20 CH44 5220MHz - R	
1	Vertical	Fundamental
Peak		Left blank
Avg.		Left blank

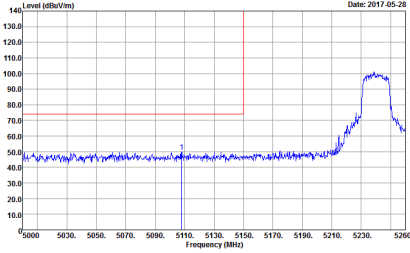
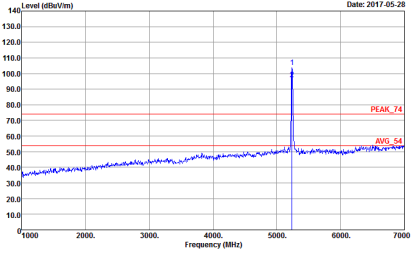
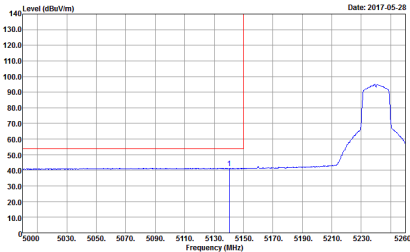

WIFI	Band 1 5150~5250MHz Band Edge @ 3m	
ANT	802.11n HT20 CH48 5240MHz - L	
1	Horizontal	Fundamental
Peak	 <p>Date: 2017-05-28</p> <p>Site : 03CH13-HY Condition : PEAK_BE_74 3m HORN_9120D_1522 HORIZONTAL : RBW:1000.000KHz VBW:3000.000KHz SWT:Auto</p>	 <p>Date: 2017-05-28</p> <p>Site : 03CH13-HY Condition : PEAK_74 3m HORN_9120D_1522 HORIZONTAL : RBW:1000.000KHz VBW:3000.000KHz SWT:Auto</p>
Avg.	 <p>Date: 2017-05-28</p> <p>Site : 03CH13-HY Condition : AV6_BE_54 3m HORN_9120D_1522 HORIZONTAL : RBW:1000.000KHz VBW:1.000KHz SWT:Auto</p>	Left blank



WIFI	Band 1 5150~5250MHz Band Edge @ 3m	
ANT	802.11n HT20 CH48 5240MHz - R	
1	Horizontal	Fundamental
Peak	<p>Site : 03CH13-HY Condition : PEAK_BE_74 3m HORN_9120D_1522 HORIZONTAL RBW:1000.000KHz VBW:3000.000KHz SWT:Auto</p>	Left blank
Avg.	<p>Site : 03CH13-HY Condition : AVG_BE_54 3m HORN_9120D_1522 HORIZONTAL RBW:1000.000KHz VBW:1.000KHz SWT:Auto</p>	Left blank



WIFI	Band 1 5150~5250MHz Band Edge @ 3m	
ANT	802.11n HT20 CH48 5240MHz - L	
1	Vertical	Fundamental
Peak	<p>Site : 03CH13-HY Condition : PEAK_BE_74 3m HORN_9120D_1522 VERTICAL : RBW:1000.000KHz VBW:3000.000KHz SWT:Auto</p>	<p>Site : 03CH13-HY Condition : PEAK_74 3m HORN_9120D_1522 VERTICAL : RBW:1000.000KHz VBW:3000.000KHz SWT:Auto</p>
Avg.	<p>Site : 03CH13-HY Condition : AV6_BE_54 3m HORN_9120D_1522 VERTICAL : RBW:1000.000KHz VBW:1.000KHz SWT:Auto</p>	Left blank



WIFI	Band 1 5150~5250MHz Band Edge @ 3m	
ANT	802.11n HT20 CH48 5240MHz - R	
1	Vertical	Fundamental
Peak		Left blank
Avg.		Left blank





Band 1 5150~5250MHz
WIFI 802.11n HT40 (Band Edge @ 3m)

Table with 2 columns (WIFI, ANT) and 2 rows (Peak, Avg.). It contains spectral analysis plots for 'Horizontal' and 'Fundamental' views. The 'Peak' row shows a sharp peak at 5170 MHz, and the 'Avg.' row shows the average signal level. The 'Fundamental' view shows a peak at 5170 MHz and an average level around 50 dBm.



WIFI	Band 1 5150~5250MHz Band Edge @ 3m	
ANT	802.11n HT40 CH38 5190MHz - R	
1	Horizontal	Fundamental
Peak	<p>Site : 03CH13-HY Condition : PEAK_BE_74 3m HORN_9120D_1522 HORIZONTAL : RBW:1000.000KHz VBW:3000.000KHz SWT:Auto</p>	Left blank
Avg.	<p>Site : 03CH13-HY Condition : AVG_BE_54 3m HORN_9120D_1522 HORIZONTAL : RBW:1000.000KHz VBW:3.000KHz SWT:Auto</p>	Left blank

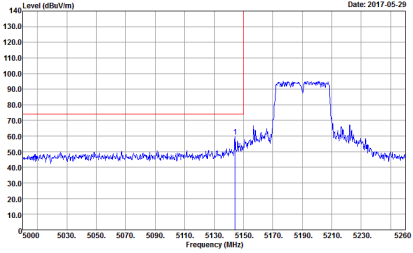
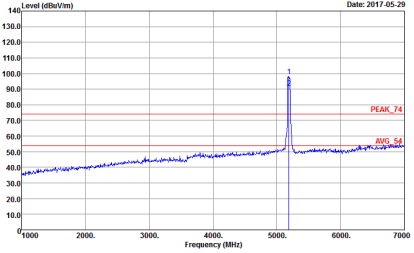
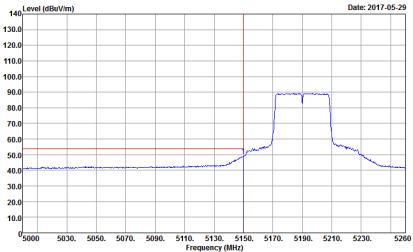

WIFI	Band 1 5150~5250MHz Band Edge @ 3m	
ANT	802.11n HT40 CH38 5190MHz - L	
1	Vertical	Fundamental
Peak	 <p>Date: 2017-05-29</p> <p>Site : 03CH13-HY Condition : PEAK_BE_74 3m HORN_9120D_1522 VERTICAL : RBW:1000.000KHz VBW:3000.000KHz SWT:Auto</p>	 <p>Date: 2017-05-29</p> <p>Site : 03CH13-HY Condition : PEAK_74 3m HORN_9120D_1522 VERTICAL : RBW:1000.000KHz VBW:3000.000KHz SWT:Auto</p>
Avg.	 <p>Date: 2017-05-29</p> <p>Site : 03CH13-HY Condition : AV6_BE_54 3m HORN_9120D_1522 VERTICAL : RBW:1000.000KHz VBW:3.000KHz SWT:Auto</p>	Left blank

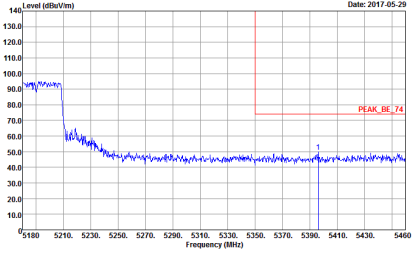
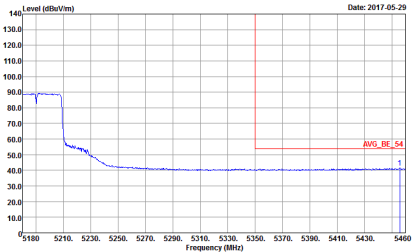

WIFI	Band 1 5150~5250MHz Band Edge @ 3m	
ANT	802.11n HT40 CH38 5190MHz - R	
1	Vertical	Fundamental
Peak	 <p>Date: 2017-05-29</p> <p>Site : 03CH13-HY Condition : PEAK_BE_74 3m HORN_9120D_1522 VERTICAL : RBW:1000.000KHz VBW:3000.000KHz SWT:Auto</p>	Left blank
Avg.	 <p>Date: 2017-05-29</p> <p>Site : 03CH13-HY Condition : AVG_BE_54 3m HORN_9120D_1522 VERTICAL : RBW:1000.000KHz VBW:3.000KHz SWT:Auto</p>	Left blank

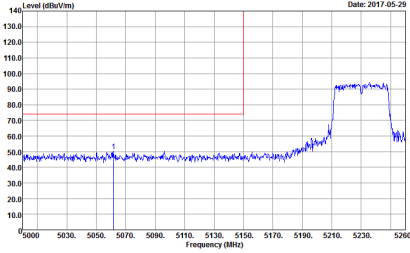
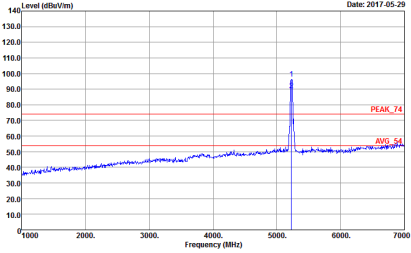
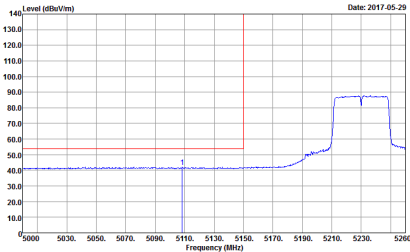

WIFI	Band 1 5150~5250MHz Band Edge @ 3m	
ANT	802.11n HT40 CH46 5230MHz - L	
1	Horizontal	Fundamental
Peak	 <p>Date: 2017-05-29</p> <p>Site : 03CH13-HY Condition : PEAK_BE_74 3m HORN_9120D_1522 HORIZONTAL : RBW:1000.000KHz VBW:3000.000KHz SWT:Auto</p>	 <p>Date: 2017-05-29</p> <p>Site : 03CH13-HY Condition : PEAK_74 3m HORN_9120D_1522 HORIZONTAL : RBW:1000.000KHz VBW:3000.000KHz SWT:Auto</p>
Avg.	 <p>Date: 2017-05-29</p> <p>Site : 03CH13-HY Condition : AV6_BE_54 3m HORN_9120D_1522 HORIZONTAL : RBW:1000.000KHz VBW:3.000KHz SWT:Auto</p>	Left blank



WIFI	Band 1 5150~5250MHz Band Edge @ 3m	
ANT	802.11n HT40 CH46 5230MHz - R	
1	Horizontal	Fundamental
Peak	<p>Date: 2017.05.29</p> <p>Site : 03CH13-HY Condition : PEAK_BE_74 3m HORN_9120D_1522 HORIZONTAL : RBW:1000.000KHz VBW:3000.000KHz SWT:Auto</p>	Left blank
Avg.	<p>Date: 2017.05.29</p> <p>Site : 03CH13-HY Condition : AVG_BE_54 3m HORN_9120D_1522 HORIZONTAL : RBW:1000.000KHz VBW:3.000KHz SWT:Auto</p>	Left blank

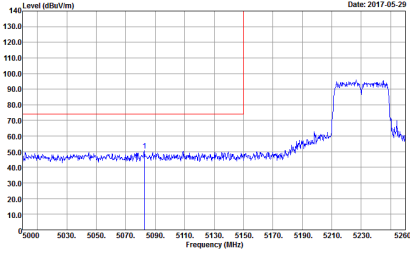
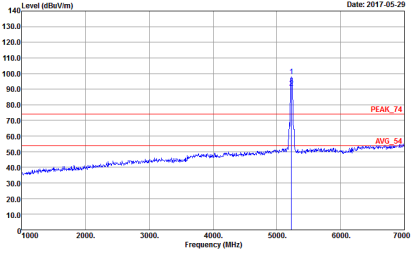
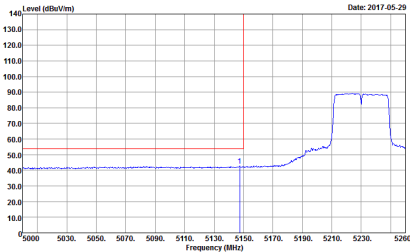

WIFI	Band 1 5150~5250MHz Band Edge @ 3m	
ANT	802.11n HT40 CH46 5230MHz - L	
1	Vertical	Fundamental
Peak	 <p>Date: 2017-05-29</p> <p>Site : 03CH13-HY Condition : PEAK_BE_74 3m HORN_9120D_1522 VERTICAL : RBW:1000.000KHz VBW:3000.000KHz SWT:Auto</p>	 <p>Date: 2017-05-29</p> <p>Site : 03CH13-HY Condition : PEAK_74 3m HORN_9120D_1522 VERTICAL : RBW:1000.000KHz VBW:3000.000KHz SWT:Auto</p>
Avg.	 <p>Date: 2017-05-29</p> <p>Site : 03CH13-HY Condition : AV6_BE_54 3m HORN_9120D_1522 VERTICAL : RBW:1000.000KHz VBW:3.000KHz SWT:Auto</p>	Left blank



WIFI	Band 1 5150~5250MHz Band Edge @ 3m	
ANT	802.11n HT40 CH46 5230MHz - R	
1	Vertical	Fundamental
Peak	<p>Date: 2017.05.29</p> <p>Site : 03CH13-HY Condition : PEAK_BE_74 3m HORN_9120D_1522 VERTICAL : RBW:1000.000KHz VBW:3000.000KHz SWT:Auto</p>	Left blank
Avg.	<p>Date: 2017.05.29</p> <p>Site : 03CH13-HY Condition : AVG_BE_54 3m HORN_9120D_1522 VERTICAL : RBW:1000.000KHz VBW:3.000KHz SWT:Auto</p>	Left blank





Band 1 - 5150~5250MHz

WIFI 802.11a (Harmonic @ 3m)

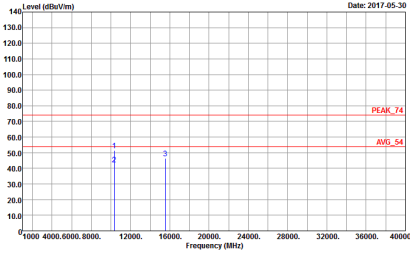
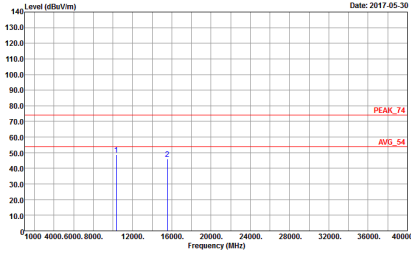
WIFI	Band 1 5150~5250MHz Harmonic @ 3m	
ANT	802.11a CH36 5180MHz	
1	Horizontal	Vertical
<p>Peak</p> <p>Avg.</p>	 <p>Site : 03CH13-HY Condition : PEAK_74 3m SHF_HORN_584 HORIZONTAL Detector : Peak</p>	 <p>Site : 03CH13-HY Condition : PEAK_74 3m SHF_HORN_584 VERTICAL Detector : Peak</p>

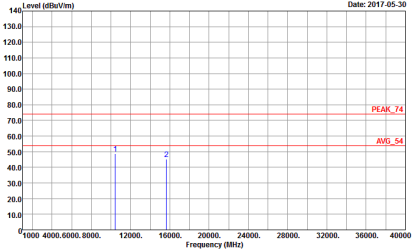
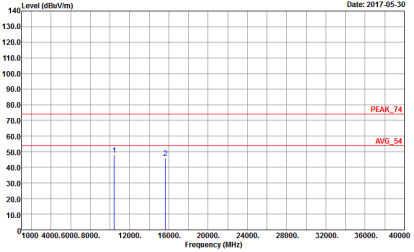

WIFI	Band 1 5150-5250MHz Harmonic @ 3m	
ANT	802.11a CH44 5220MHz	
1	Horizontal	Vertical
<p><b>Peak</b></p> <p><b>Avg.</b></p>	 <p>Date: 2017-05-30</p> <p>Site : 03CH13-HY Condition : PEAK_74 3m SHF_HORN_584 HORIZONTAL Detector : Peak</p>	 <p>Date: 2017-05-30</p> <p>Site : 03CH13-HY Condition : PEAK_74 3m SHF_HORN_584 VERTICAL Detector : Peak</p>

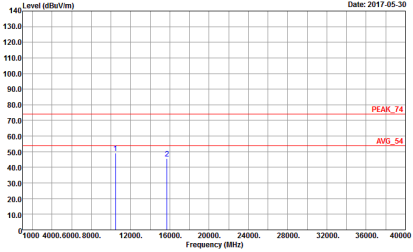
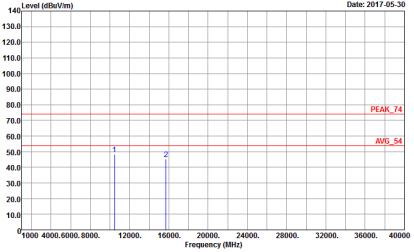

WIFI	Band 1 5150-5250MHz Harmonic @ 3m	
ANT	802.11a CH48 5240MHz	
1	Horizontal	Vertical
<p><b>Peak</b></p> <p><b>Avg.</b></p>	 <p>Date: 2017-05-30</p> <p>Site : 03CH13-HY Condition : PEAK_74 3m SHF_HORN_584 HORIZONTAL Detector : Peak</p>	 <p>Date: 2017-05-30</p> <p>Site : 03CH13-HY Condition : PEAK_74 3m SHF_HORN_584 VERTICAL Detector : Peak</p>



**Band 1 5150~5250MHz**  
**WIFI 802.11n HT20 (Harmonic @ 3m)**

WIFI	Band 1 5150~5250MHz Harmonic @ 3m	
ANT	802.11n HT20 CH36 5180MHz	
1	Horizontal	Vertical
<b>Peak</b> <b>Avg.</b>	<p>Site : 03CH13-HY Condition : PEAK_74 3m SHF_HORN_584 HORIZONTAL Detector : Peak</p>	<p>Site : 03CH13-HY Condition : PEAK_74 3m SHF_HORN_584 VERTICAL Detector : Peak</p>

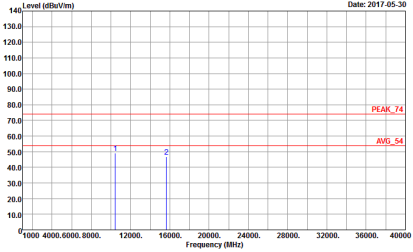
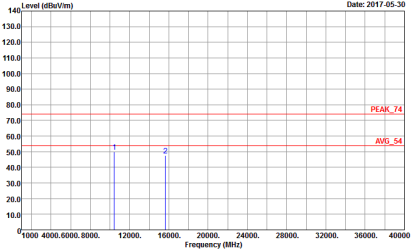

WIFI	Band 1 5150-5250MHz Harmonic @ 3m	
ANT	802.11n HT20 CH44 5220MHz	
1	Horizontal	Vertical
<p><b>Peak</b></p> <p><b>Avg.</b></p>	 <p>Date: 2017-05-30</p> <p>Site : 03CH13-HY Condition : PEAK_74 3m SHF_HORN_584 HORIZONTAL Detector : Peak</p>	 <p>Date: 2017-05-30</p> <p>Site : 03CH13-HY Condition : PEAK_74 3m SHF_HORN_584 VERTICAL Detector : Peak</p>



WIFI	Band 1 5150-5250MHz Harmonic @ 3m	
ANT	802.11n HT20 CH48 5240MHz	
1	Horizontal	Vertical
Peak Avg.	<p>Site : 03CH13-HY Condition : PEAK_74 3m SHF_HORN_584 HORIZONTAL Detector : Peak</p>	<p>Site : 03CH13-HY Condition : PEAK_74 3m SHF_HORN_584 VERTICAL Detector : Peak</p>



Band 1 5150~5250MHz  
WIFI 802.11n HT40 (Harmonic @ 3m)

WIFI	Band 1 5150~5250MHz Harmonic @ 3m	
ANT	802.11n HT40 CH38 5190MHz	
1	Horizontal	Vertical
Peak Avg.	<p>Site : 03CH13-HY Condition : PEAK_74 3m SHF_HORN_584 HORIZONTAL Detector : Peak</p>	<p>Site : 03CH13-HY Condition : PEAK_74 3m SHF_HORN_584 VERTICAL Detector : Peak</p>

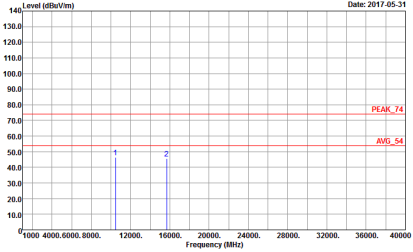
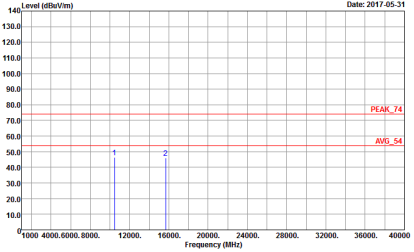

WIFI	Band 1 5150-5250MHz Harmonic @ 3m	
ANT	802.11n HT40 CH46 5230MHz	
1	Horizontal	Vertical
<p><b>Peak</b></p> <p><b>Avg.</b></p>	 <p>Date: 2017-05-31</p> <p>Site : 03CH13-HY Condition : PEAK_74 3m SHF_HORN_584 HORIZONTAL Detector : Peak</p>	 <p>Date: 2017-05-31</p> <p>Site : 03CH13-HY Condition : PEAK_74 3m SHF_HORN_584 VERTICAL Detector : Peak</p>



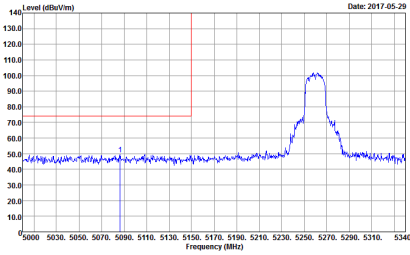
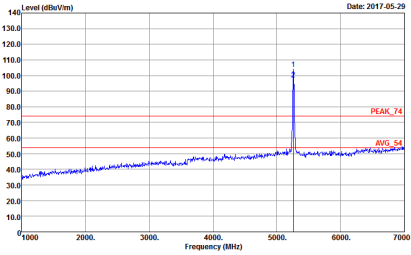
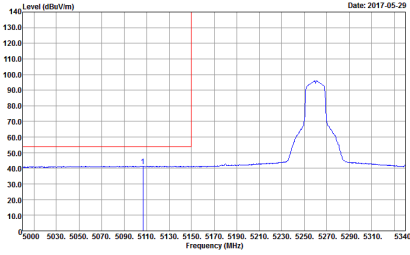

**Band 2 - 5250~5350MHz**  
**WIFI 802.11a (Band Edge @ 3m)**

WIFI	Band 2 5250~5350MHz Band Edge @ 3m	
ANT	802.11a CH52 5260MHz - L	
1	Horizontal	Fundamental
Peak	 <p>Date: 2017-05-29</p> <p>Site : 03CH13-HY            Condition : PEAK_BE_74 3m HORN_9120D_1522 HORIZONTAL            : RBW:1000.000KHz VBW:3000.000KHz SWT:Auto</p>	 <p>Date: 2017-05-29</p> <p>Site : 03CH13-HY            Condition : PEAK_74 3m HORN_9120D_1522 HORIZONTAL            : RBW:1000.000KHz VBW:3000.000KHz SWT:Auto</p>
Avg.	 <p>Date: 2017-05-29</p> <p>Site : 03CH13-HY            Condition : AVG_BE_54 3m HORN_9120D_1522 HORIZONTAL            : RBW:1000.000KHz VBW:1.000KHz SWT:Auto</p>	Left blank

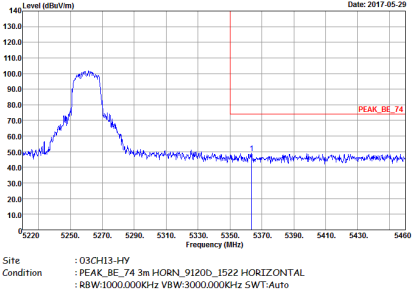
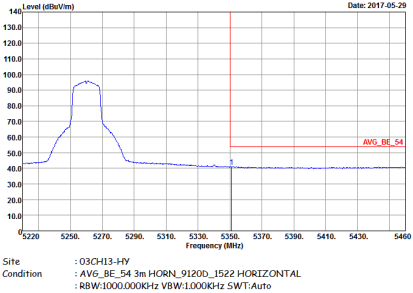

WIFI	Band 2 5250~5350MHz Band Edge @ 3m	
ANT	802.11a CH52 5260MHz - R	
1	Horizontal	Fundamental
Peak		Left blank
Avg.		Left blank

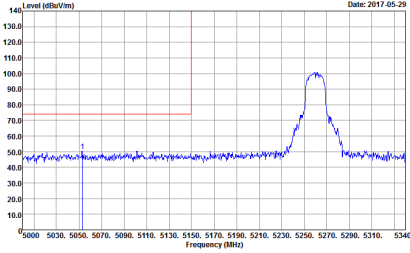
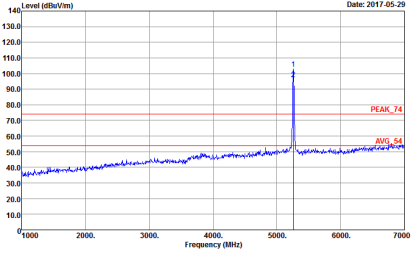
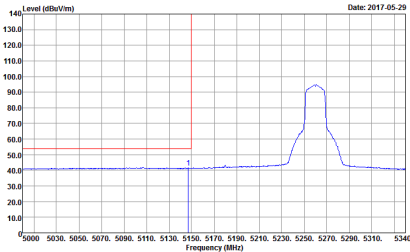

WIFI	Band 2 5250~5350MHz Band Edge @ 3m	
ANT	802.11a CH52 5260MHz - L	
1	Vertical	Fundamental
Peak	 <p>Date: 2017-05-29</p> <p>Site : 03CH13-HY Condition : PEAK_BE_74 3m HORN_9120D_1522 VERTICAL : RBW:1000.000KHz VBW:3000.000KHz SWT:Auto</p>	 <p>Date: 2017-05-29</p> <p>Site : 03CH13-HY Condition : PEAK_74 3m HORN_9120D_1522 VERTICAL : RBW:1000.000KHz VBW:3000.000KHz SWT:Auto</p>
Avg.	 <p>Date: 2017-05-29</p> <p>Site : 03CH13-HY Condition : AV6_BE_54 3m HORN_9120D_1522 VERTICAL : RBW:1000.000KHz VBW:1.000KHz SWT:Auto</p>	Left blank



WIFI	Band 2 5250~5350MHz Band Edge @ 3m	
ANT	802.11a CH52 5260MHz - R	
1	Vertical	Fundamental
Peak		Left blank
Avg.		Left blank

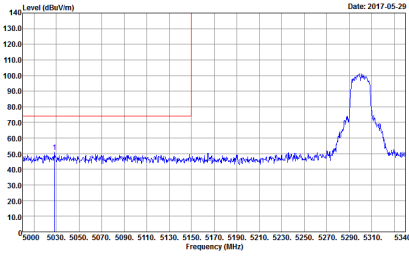
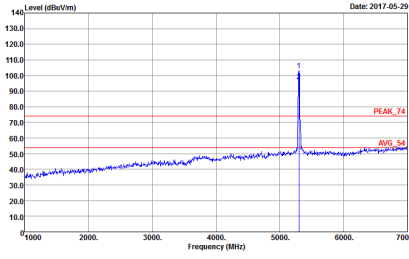
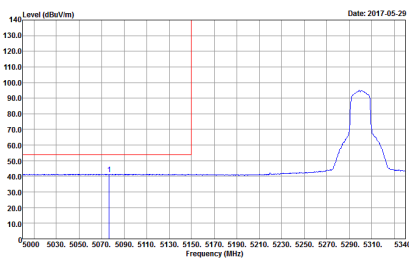

WIFI	Band 2 5250~5350MHz Band Edge @ 3m	
ANT	802.11a CH60 5300MHz - L	
1	Horizontal	Fundamental
Peak	 <p>Date: 2017-05-29</p> <p>Site : 03CH13-HY Condition : PEAK_BE_74 3m HORN_9120D_1522 HORIZONTAL : RBW:1000.000KHz VBW:3000.000KHz SWT:Auto</p>	 <p>Date: 2017-05-29</p> <p>Site : 03CH13-HY Condition : PEAK_74 3m HORN_9120D_1522 HORIZONTAL : RBW:1000.000KHz VBW:3000.000KHz SWT:Auto</p>
Avg.	 <p>Date: 2017-05-29</p> <p>Site : 03CH13-HY Condition : AV6_BE_54 3m HORN_9120D_1522 HORIZONTAL : RBW:1000.000KHz VBW:1.000KHz SWT:Auto</p>	Left blank



WIFI	Band 2 5250~5350MHz Band Edge @ 3m	
ANT	802.11a CH60 5300MHz - R	
1	Horizontal	Fundamental
Peak	<p>Site : 03CH13-HY Condition : PEAK_BE_74 3m HORN_9120D_1522 HORIZONTAL : RBW:1000.000KHz VBW:3000.000KHz SWT:Auto</p>	Left blank
Avg.	<p>Site : 03CH13-HY Condition : AVG_BE_54 3m HORN_9120D_1522 HORIZONTAL : RBW:1000.000KHz VBW:1.000KHz SWT:Auto</p>	Left blank

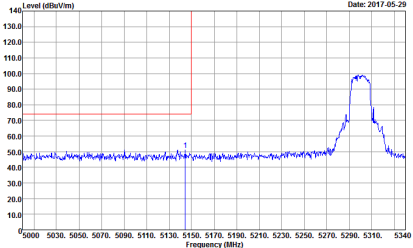
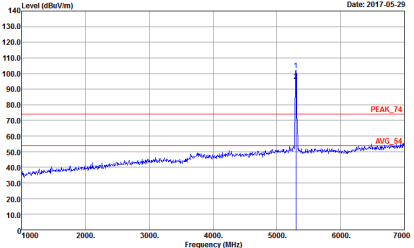
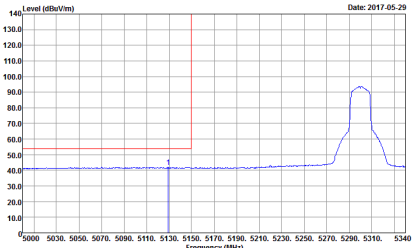

WIFI	Band 2 5250~5350MHz Band Edge @ 3m	
ANT	802.11a CH60 5300MHz - L	
1	Vertical	Fundamental
Peak	 <p>Site : 03CH13-HY Condition : PEAK_BE_74 3m HORN_9120D_1522 VERTICAL : RBW:1000.000KHz VBW:3000.000KHz SWT:Auto</p>	 <p>Site : 03CH13-HY Condition : PEAK_74 3m HORN_9120D_1522 VERTICAL : RBW:1000.000KHz VBW:3000.000KHz SWT:Auto</p>
Avg.	 <p>Site : 03CH13-HY Condition : AV6_BE_54 3m HORN_9120D_1522 VERTICAL : RBW:1000.000KHz VBW:1.000KHz SWT:Auto</p>	Left blank

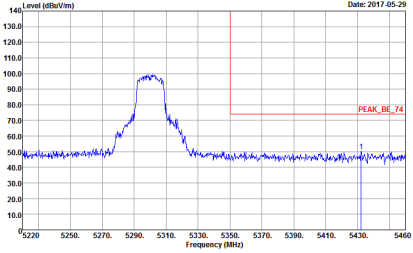
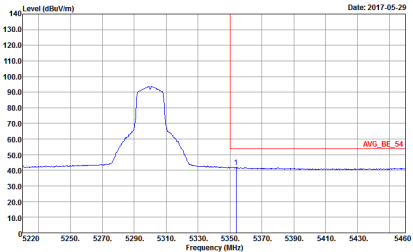

WIFI	Band 2 5250~5350MHz Band Edge @ 3m	
ANT	802.11a CH60 5300MHz - R	
1	Vertical	Fundamental
Peak		Left blank
Avg.		Left blank



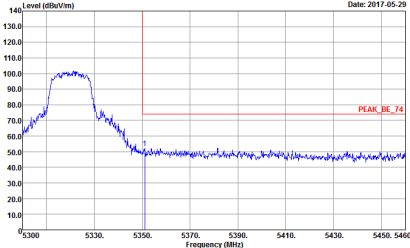
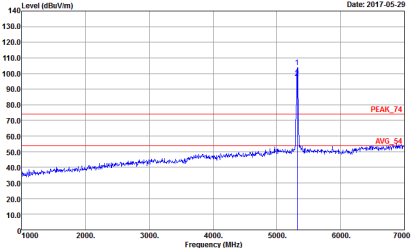
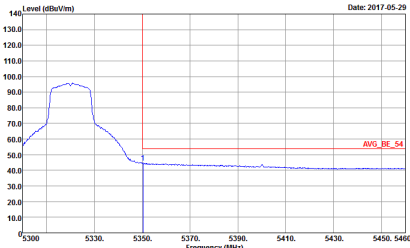

WIFI	Band 2 5250~5350MHz Band Edge @ 3m	
ANT	802.11a CH64 5320MHz	
1	Horizontal	Fundamental
Peak	 <p>Date: 2017-05-29</p> <p>Level (dBuV/m)</p> <p>Frequency (MHz)</p> <p>PEAK_BE_74</p> <p>Site : 03CH13-HY Condition : PEAK_BE_74 3m HORN_9120D_1522 HORIZONTAL : RBW:1000.000KHz VBW:3000.000KHz SWT:Auto</p>	 <p>Date: 2017-05-29</p> <p>Level (dBuV/m)</p> <p>Frequency (MHz)</p> <p>PEAK_74</p> <p>BUC_54</p> <p>Site : 03CH13-HY Condition : PEAK_74 3m HORN_9120D_1522 HORIZONTAL : RBW:1000.000KHz VBW:3000.000KHz SWT:Auto</p>
Avg.	 <p>Date: 2017-05-29</p> <p>Level (dBuV/m)</p> <p>Frequency (MHz)</p> <p>AVG_BE_54</p> <p>Site : 03CH13-HY Condition : AVG_BE_54 3m HORN_9120D_1522 HORIZONTAL : RBW:1000.000KHz VBW:1.000KHz SWT:Auto</p>	Left blank

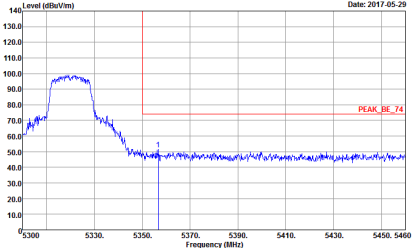
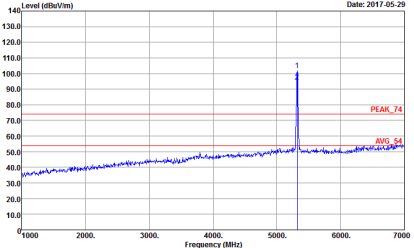
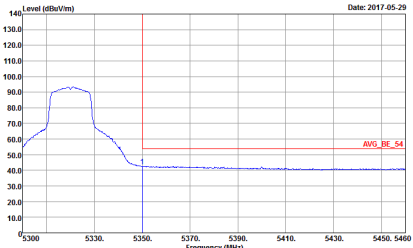

WIFI	Band 2 5250~5350MHz Band Edge @ 3m	
ANT	802.11a CH64 5320MHz	
1	Vertical	Fundamental
Peak	 <p>Date: 2017-05-29</p> <p>Site : 03CH13-HY Condition : PEAK_BE_74 3m HORN_9120D_1522 VERTICAL : RBW:1000.000KHz VBW:3000.000KHz SWT:Auto</p>	 <p>Date: 2017-05-29</p> <p>Site : 03CH13-HY Condition : PEAK_74 3m HORN_9120D_1522 VERTICAL : RBW:1000.000KHz VBW:3000.000KHz SWT:Auto</p>
Avg.	 <p>Date: 2017-05-29</p> <p>Site : 03CH13-HY Condition : AVG_BE_54 3m HORN_9120D_1522 VERTICAL : RBW:1000.000KHz VBW:1.000KHz SWT:Auto</p>	Left blank

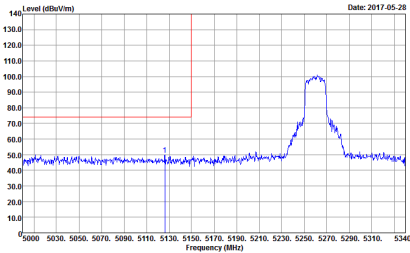
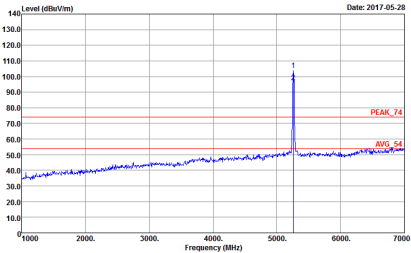
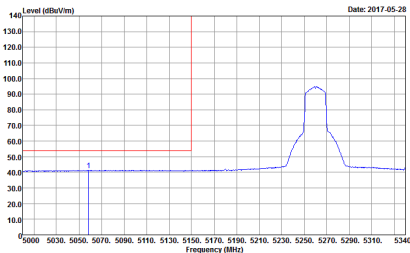

**Band 2 5250~5350MHz**  
**WIFI 802.11n HT20 (Band Edge @ 3m)**

WIFI	Band 2 5250~5350MHz Band Edge @ 3m	
ANT	802.11n HT20 CH52 5260MHz - L	
1	Horizontal	Fundamental
Peak	 <p>Site : 03CH13-HY Condition : PEAK_BE_74 3m HORN_9120D_1522 HORIZONTAL : RBW:1000.000KHz VBW:3000.000KHz SWT:Auto</p>	 <p>Site : 03CH13-HY Condition : PEAK_74 3m HORN_9120D_1522 HORIZONTAL : RBW:1000.000KHz VBW:3000.000KHz SWT:Auto</p>
Avg.	 <p>Site : 03CH13-HY Condition : AV6_BE_54 3m HORN_9120D_1522 HORIZONTAL : RBW:1000.000KHz VBW:1000KHz SWT:Auto</p>	Left blank

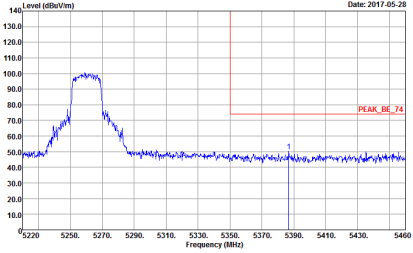
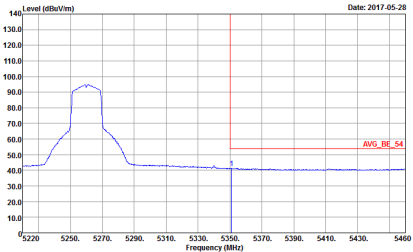

WIFI	Band 2 5250~5350MHz Band Edge @ 3m	
ANT	802.11n HT20 CH52 5260MHz - R	
1	Horizontal	Fundamental
Peak		Left blank
Avg.		Left blank

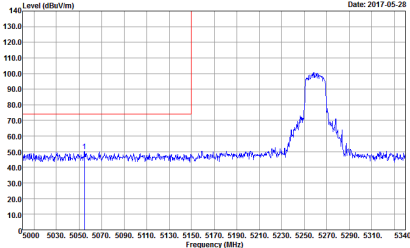
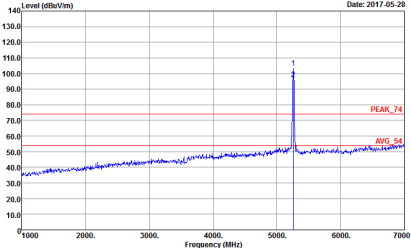
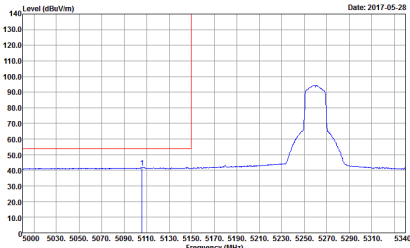

WIFI	Band 2 5250~5350MHz Band Edge @ 3m	
ANT	802.11n HT20 CH52 5260MHz - L	
1	Vertical	Fundamental
Peak	 <p>Date: 2017-05-28</p> <p>Site : 03CH13-HY Condition : PEAK_BE_74 3m HORN_9120D_1522 VERTICAL : RBW:1000.000KHz VBW:3000.000KHz SWT:Auto</p>	 <p>Date: 2017-05-28</p> <p>Site : 03CH13-HY Condition : PEAK_74 3m HORN_9120D_1522 VERTICAL : RBW:1000.000KHz VBW:3000.000KHz SWT:Auto</p>
Avg.	 <p>Date: 2017-05-28</p> <p>Site : 03CH13-HY Condition : AV6_BE_54 3m HORN_9120D_1522 VERTICAL : RBW:1000.000KHz VBW:1.000KHz SWT:Auto</p>	Left blank

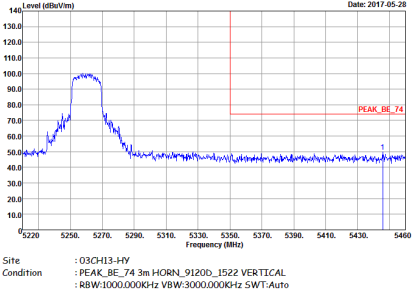
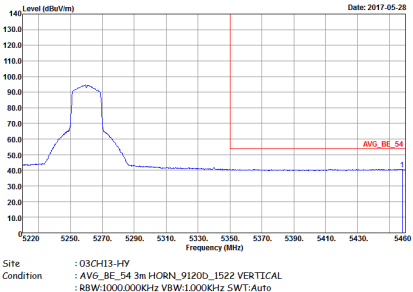

WIFI	Band 2 5250~5350MHz Band Edge @ 3m	
ANT	802.11n HT20 CH52 5260MHz - R	
1	Vertical	Fundamental
Peak		Left blank
Avg.		Left blank

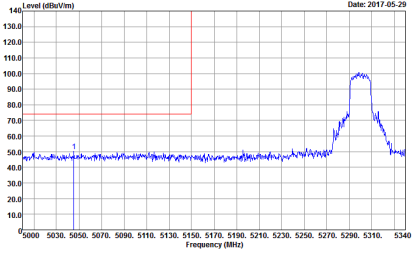
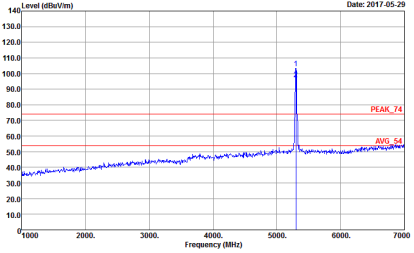
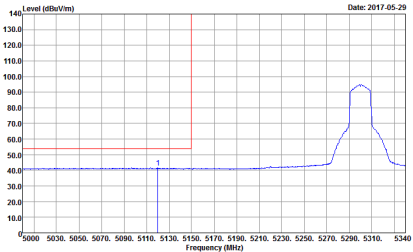

WIFI	Band 2 5250~5350MHz Band Edge @ 3m	
ANT	802.11n HT20 CH60 5300MHz - L	
1	Horizontal	Fundamental
Peak	 <p>Site : 03CH13-HY Condition : PEAK_BE_74 3m HORN_9120D_1522 HORIZONTAL : RBW:1000.000KHz VBW:3000.000KHz SWT:Auto</p>	 <p>Site : 03CH13-HY Condition : PEAK_74 3m HORN_9120D_1522 HORIZONTAL : RBW:1000.000KHz VBW:3000.000KHz SWT:Auto</p>
Avg.	 <p>Site : 03CH13-HY Condition : AV6_BE_54 3m HORN_9120D_1522 HORIZONTAL : RBW:1000.000KHz VBW:1.000KHz SWT:Auto</p>	Left blank



WIFI	Band 2 5250~5350MHz Band Edge @ 3m	
ANT	802.11n HT20 CH60 5300MHz - R	
1	Horizontal	Vertical
Peak	<p>Site : 03CH13-HY Condition : PEAK_BE_74 3m HORN_9120D_1522 HORIZONTAL : RBW:1000.000KHz VBW:3000.000KHz SWT:Auto</p>	Left blank
Avg.	<p>Site : 03CH13-HY Condition : AVG_BE_54 3m HORN_9120D_1522 HORIZONTAL : RBW:1000.000KHz VBW:1.000KHz SWT:Auto</p>	Left blank





WIFI	Band 2 5250~5350MHz Band Edge @ 3m	
ANT	802.11n HT20 CH60 5300MHz - L	
1	Vertical	Fundamental
Peak	<p>Date: 2017-05-29</p> <p>Site : 03CH13-HY Condition : PEAK_BE_74 3m HORN_9120D_1522 VERTICAL : RBW:1000.000KHz VBW:3000.000KHz SWT:Auto</p>	<p>Date: 2017-05-29</p> <p>Site : 03CH13-HY Condition : PEAK_74 3m HORN_9120D_1522 VERTICAL : RBW:1000.000KHz VBW:3000.000KHz SWT:Auto</p>
Avg.	<p>Date: 2017-05-29</p> <p>Site : 03CH13-HY Condition : AV6_BE_54 3m HORN_9120D_1522 VERTICAL : RBW:1000.000KHz VBW:1.000KHz SWT:Auto</p>	Left blank

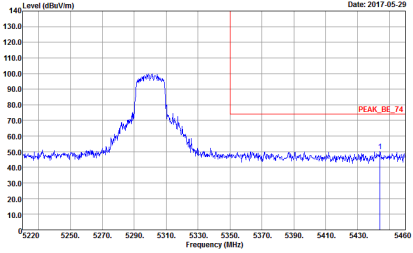
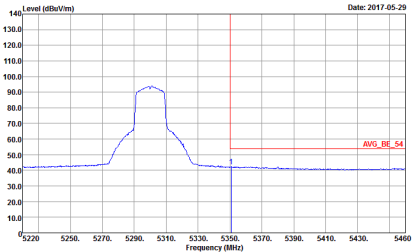

WIFI	Band 2 5250~5350MHz Band Edge @ 3m	
ANT	802.11n HT20 CH60 5300MHz - R	
1	Vertical	Fundamental
Peak	 <p>Date: 2017.05.29</p> <p>Site : 03CH13-HY Condition : PEAK_BE_74 3m HORN_9120D_1522 VERTICAL : RBW:1000.000KHz VBW:3000.000KHz SWT:Auto</p>	Left blank
Avg.	 <p>Date: 2017.05.29</p> <p>Site : 03CH13-HY Condition : AVG_BE_54 3m HORN_9120D_1522 VERTICAL : RBW:1000.000KHz VBW:1.000KHz SWT:Auto</p>	Left blank

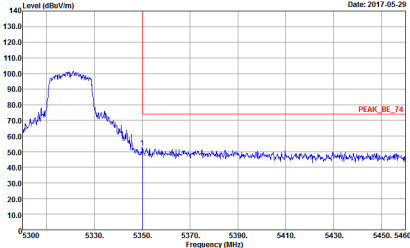
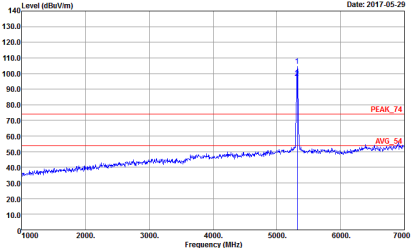
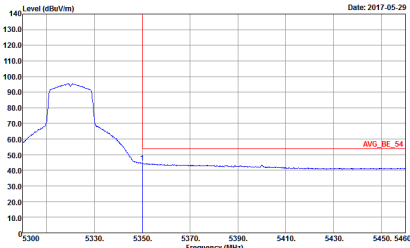

WIFI	Band 2 5250~5350MHz Band Edge @ 3m	
ANT	802.11n HT20 CH64 5320MHz	
1	Horizontal	Fundamental
Peak	 <p>Date: 2017-05-29</p> <p>Level (dBuV/m)</p> <p>Frequency (MHz)</p> <p>PEAK_BE_74</p> <p>Site : 03CH13-HY Condition : PEAK_BE_74 3m HORN_9120D_1522 HORIZONTAL : RBW:1000.000KHz VBW:3000.000KHz SWT:Auto</p>	 <p>Date: 2017-05-29</p> <p>Level (dBuV/m)</p> <p>Frequency (MHz)</p> <p>PEAK_74</p> <p>Site : 03CH13-HY Condition : PEAK_74 3m HORN_9120D_1522 HORIZONTAL : RBW:1000.000KHz VBW:3000.000KHz SWT:Auto</p>
Avg.	 <p>Date: 2017-05-29</p> <p>Level (dBuV/m)</p> <p>Frequency (MHz)</p> <p>AVG_BE_54</p> <p>Site : 03CH13-HY Condition : AVG_BE_54 3m HORN_9120D_1522 HORIZONTAL : RBW:1000.000KHz VBW:1.000KHz SWT:Auto</p>	Left blank

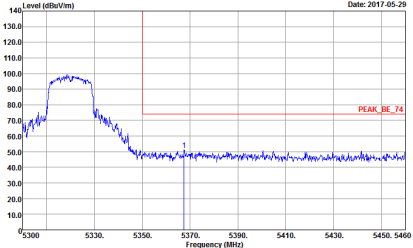
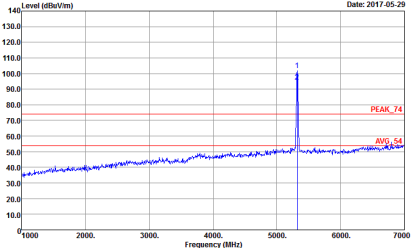
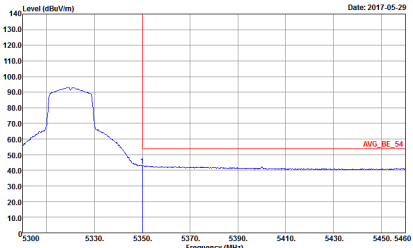

WIFI	Band 2 5250~5350MHz Band Edge @ 3m	
ANT	802.11n HT20 CH64 5320MHz	
1	Vertical	Fundamental
<p><b>Peak</b></p>	 <p>Date: 2017-05-29</p> <p>Site : 03CH13-HY Condition : PEAK_BE_74 3m HORN_9120D_1522 VERTICAL : RBW:1000.000KHz VBW:3000.000KHz SWT:Auto</p>	 <p>Date: 2017-05-29</p> <p>Site : 03CH13-HY Condition : PEAK_74 3m HORN_9120D_1522 VERTICAL : RBW:1000.000KHz VBW:3000.000KHz SWT:Auto</p>
<p><b>Avg.</b></p>	 <p>Date: 2017-05-29</p> <p>Site : 03CH13-HY Condition : AVG_BE_54 3m HORN_9120D_1522 VERTICAL : RBW:1000.000KHz VBW:1.000KHz SWT:Auto</p>	<p>Left blank</p>



**Band 2 5250~5350MHz  
WIFI 802.11n HT40 (Band Edge @ 3m)**

WIFI	Band 2 5250~5350MHz Band Edge @ 3m	
ANT	802.11n HT40 CH54 5270MHz - L	
1	Horizontal	Fundamental
Peak	<p>Site : 03CH13-HY Condition : PEAK_BE_74 3m HORN_9120D_1522 HORIZONTAL : RBW:1000.000KHz VBW:3000.000KHz SWT:Auto</p>	<p>Site : 03CH13-HY Condition : PEAK_74 3m HORN_9120D_1522 HORIZONTAL : RBW:1000.000KHz VBW:3000.000KHz SWT:Auto</p>
Avg.	<p>Site : 03CH13-HY Condition : AVG_BE_54 3m HORN_9120D_1522 HORIZONTAL : RBW:1000.000KHz VBW:3.000KHz SWT:Auto</p>	Left blank



WIFI	Band 2 5250~5350MHz Band Edge @ 3m	
ANT	802.11n HT40 CH54 5270MHz - R	
1	Horizontal	Fundamental
Peak	<p>Site : 03CH13-HY Condition : PEAK_BE_74 3m HORN_9120D_1522 HORIZONTAL : RBW:1000.000KHz VBW:3000.000KHz SWT:Auto</p>	Left blank
Avg.	<p>Site : 03CH13-HY Condition : AVG_BE_54 3m HORN_9120D_1522 HORIZONTAL : RBW:1000.000KHz VBW:3.000KHz SWT:Auto</p>	Left blank

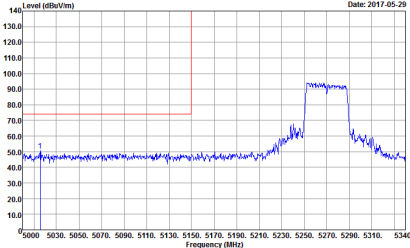
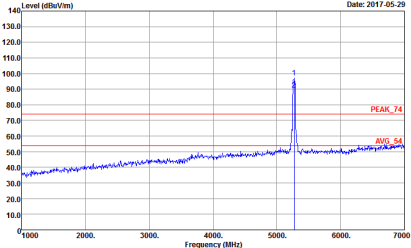
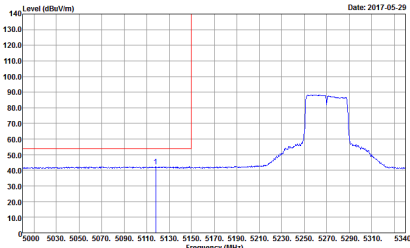

WIFI	Band 2 5250~5350MHz Band Edge @ 3m	
ANT	802.11n HT40 CH54 5270MHz - L	
1	Vertical	Vertical
Peak	 <p>Date: 2017-05-29</p> <p>Site : 03CH13-HY Condition : PEAK_BE_74 3m HORN_9120D_1522 VERTICAL : RBW:1000.000KHz VBW:3000.000KHz SWT:Auto</p>	 <p>Date: 2017-05-29</p> <p>Site : 03CH13-HY Condition : PEAK_74 3m HORN_9120D_1522 VERTICAL : RBW:1000.000KHz VBW:3000.000KHz SWT:Auto</p>
Avg.	 <p>Date: 2017-05-29</p> <p>Site : 03CH13-HY Condition : AV6_BE_54 3m HORN_9120D_1522 VERTICAL : RBW:1000.000KHz VBW:3.000KHz SWT:Auto</p>	Left blank

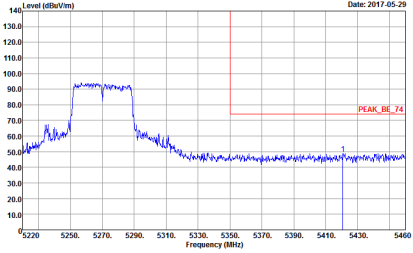
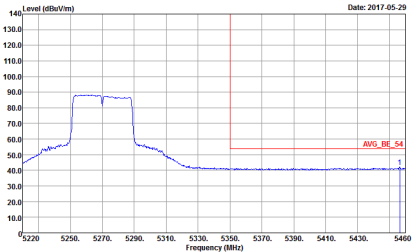

WIFI	Band 2 5250~5350MHz Band Edge @ 3m	
ANT	802.11n HT40 CH54 5270MHz - R	
1	Vertical	Vertical
Peak	 <p>Date: 2017.05.29</p> <p>Site : 03CH13-HY Condition : PEAK_BE_74 3m HORN_9120D_1522 VERTICAL : RBW:1000.000KHz VBW:3000.000KHz SWT:Auto</p>	Left blank
Avg.	 <p>Date: 2017.05.29</p> <p>Site : 03CH13-HY Condition : AVG_BE_54 3m HORN_9120D_1522 VERTICAL : RBW:1000.000KHz VBW:3.000KHz SWT:Auto</p>	Left blank





WIFI	Band 2 5250~5350MHz Band Edge @ 3m	
ANT	802.11n HT40 CH62 5310MHz - L	
1	Horizontal	Fundamental
Peak	<p>Site : 03CH13-HY Condition : PEAK_BE_74 3m HORN_9120D_1522 HORIZONTAL : RBW:1000.000KHz VBW:3000.000KHz SWT:Auto</p>	<p>Site : 03CH13-HY Condition : PEAK_74 3m HORN_9120D_1522 HORIZONTAL : RBW:1000.000KHz VBW:3000.000KHz SWT:Auto</p>
Avg.	<p>Site : 03CH13-HY Condition : AV6_BE_54 3m HORN_9120D_1522 HORIZONTAL : RBW:1000.000KHz VBW:3.000KHz SWT:Auto</p>	Left blank

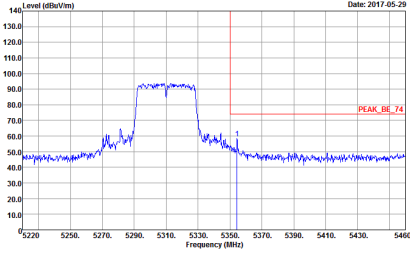
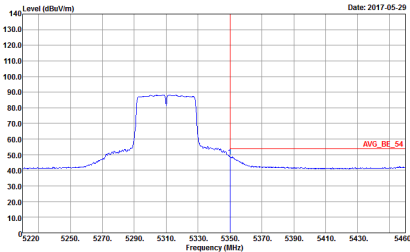

WIFI	Band 2 5250~5350MHz Band Edge @ 3m	
ANT	802.11n HT40 CH62 5310MHz - R	
1	Horizontal	Fundamental
Peak	 <p>Date: 2017.05.29</p> <p>Site : 03CH13-HY Condition : PEAK_BE_74 3m HORN_9120D_1522 HORIZONTAL : RBW:1000.000KHz VBW:3000.000KHz SWT:Auto</p>	Left blank
Avg.	 <p>Date: 2017.05.29</p> <p>Site : 03CH13-HY Condition : AVG_BE_54 3m HORN_9120D_1522 HORIZONTAL : RBW:1000.000KHz VBW:3.000KHz SWT:Auto</p>	Left blank

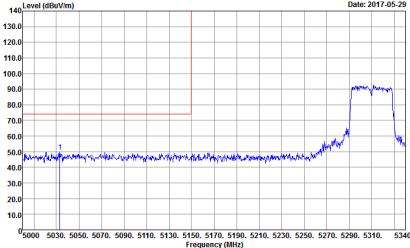
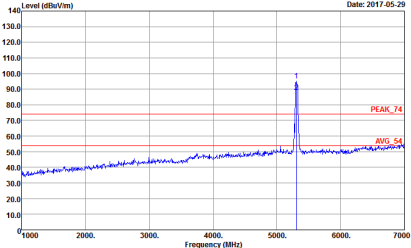
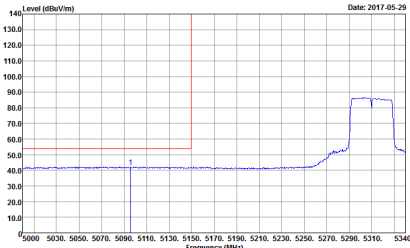

WIFI	Band 2 5250~5350MHz Band Edge @ 3m	
ANT	802.11n HT40 CH62 5310MHz - L	
1	Vertical	Fundamental
Peak	 <p>Date: 2017-05-29</p> <p>Site : 03CH13-HY Condition : PEAK_BE_74 3m HORN_9120D_1522 VERTICAL : RBW:1000.000KHz VBW:3000.000KHz SWT:Auto</p>	 <p>Date: 2017-05-29</p> <p>Site : 03CH13-HY Condition : PEAK_74 3m HORN_9120D_1522 VERTICAL : RBW:1000.000KHz VBW:3000.000KHz SWT:Auto</p>
Avg.	 <p>Date: 2017-05-29</p> <p>Site : 03CH13-HY Condition : AV6_BE_54 3m HORN_9120D_1522 VERTICAL : RBW:1000.000KHz VBW:3.000KHz SWT:Auto</p>	Left blank



WIFI	Band 2 5250~5350MHz Band Edge @ 3m	
ANT	802.11n HT40 CH62 5310MHz - R	
1	Vertical	Fundamental
Peak	<p>Site : 03CH13-HY Condition : PEAK_BE_74 3m HORN_9120D_1522 VERTICAL : RBW:1000.000KHz VBW:3000.000KHz SWT:Auto</p>	Left blank
Avg.	<p>Site : 03CH13-HY Condition : AVG_BE_54 3m HORN_9120D_1522 VERTICAL : RBW:1000.000KHz VBW:3.000KHz SWT:Auto</p>	Left blank

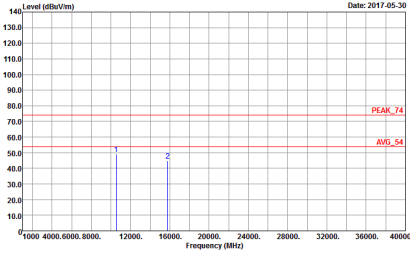
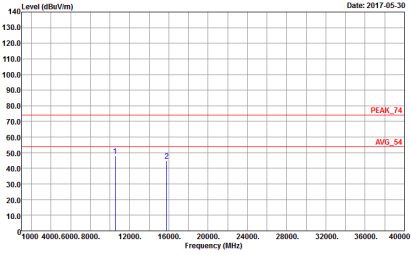

**Band 2 - 5250~5350MHz**  
**WIFI 802.11a (Harmonic @ 3m)**

WIFI	Band 2 5250~5350MHz Harmonic @ 3m	
ANT	802.11a CH52 5260MHz	
1	Horizontal	Vertical
<p><b>Peak</b></p> <p><b>Avg.</b></p>	 <p>Site : 03CH13-HY            Condition : PEAK_74 3m SHF_HORN_584 HORIZONTAL            Detector : Peak</p>	 <p>Site : 03CH13-HY            Condition : PEAK_74 3m SHF_HORN_584 VERTICAL            Detector : Peak</p>



WIFI	Band 2 5250-5350MHz Harmonic @ 3m	
ANT	802.11a CH60 5300MHz	
1	Horizontal	Vertical
Peak Avg.	<p>Site : 03CH13-HY Condition : PEAK_74 3m SHF_HORN_584 HORIZONTAL Detector : Peak</p>	<p>Site : 03CH13-HY Condition : PEAK_74 3m SHF_HORN_584 VERTICAL Detector : Peak</p>

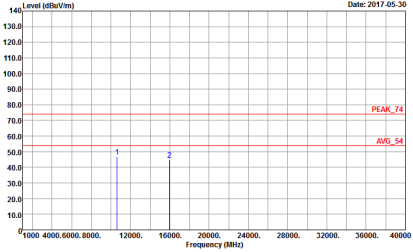
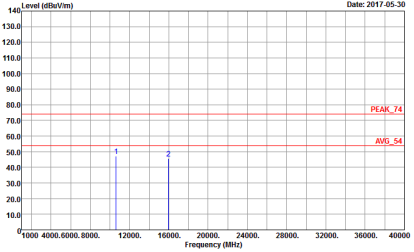

WIFI	Band 2 5250-5350MHz Harmonic @ 3m	
ANT	802.11a CH64 5320MHz	
1	Horizontal	Vertical
<p><b>Peak</b></p> <p><b>Avg.</b></p>	 <p>Date: 2017-05-30</p> <p>Site : 03CH13-HY Condition : PEAK_74 3m SHF_HORN_584 HORIZONTAL Detector : Peak</p>	 <p>Date: 2017-05-30</p> <p>Site : 03CH13-HY Condition : PEAK_74 3m SHF_HORN_584 VERTICAL Detector : Peak</p>

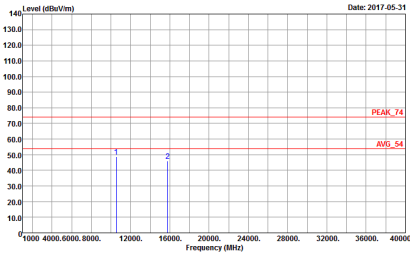
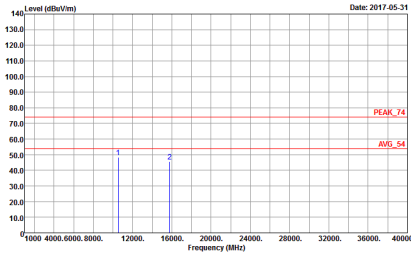

**Band 2 5250~5350MHz**  
**WIFI 802.11n HT20 (Harmonic @ 3m)**

WIFI	Band 2 5250~5350MHz Harmonic @ 3m	
ANT	802.11n HT20 CH52 5260MHz	
1	Horizontal	Vertical
<p><b>Peak</b> <b>Avg.</b></p>	 <p>Site : 03CH13-HY            Condition : PEAK_74 3m SHF_HORN_584 HORIZONTAL            Detector : Peak</p>	 <p>Site : 03CH13-HY            Condition : PEAK_74 3m SHF_HORN_584 VERTICAL            Detector : Peak</p>





WIFI	Band 2 5250-5350MHz Harmonic @ 3m	
ANT	802.11n HT20 CH60 5300MHz	
1	Horizontal	Vertical
Peak Avg.	<p>Site : 03CH13-HY Condition : PEAK_74 3m SHF_HORN_584 HORIZONTAL Detector : Peak</p>	<p>Site : 03CH13-HY Condition : PEAK_74 3m SHF_HORN_584 VERTICAL Detector : Peak</p>

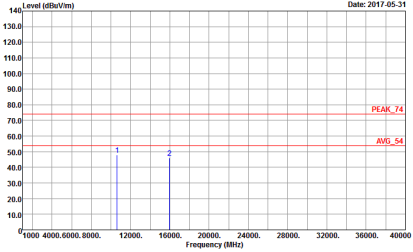
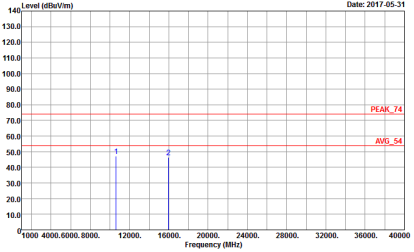

WIFI	Band 2 5250-5350MHz Harmonic @ 3m	
ANT	802.11n HT20 CH64 5320MHz	
1	Horizontal	Vertical
<p><b>Peak</b></p> <p><b>Avg.</b></p>	 <p>Date: 2017-05-31</p> <p>Site : 03CH13-HY Condition : PEAK_74 3m SHF_HORN_584 HORIZONTAL Detector : Peak</p>	 <p>Date: 2017-05-31</p> <p>Site : 03CH13-HY Condition : PEAK_74 3m SHF_HORN_584 VERTICAL Detector : Peak</p>



Band 2 5250~5350MHz
WIFI 802.11n HT40 (Harmonic @ 3m)

Table with 2 columns: Horizontal and Vertical. Each column contains a graph of Level (dBuV/m) vs Frequency (MHz) with peak and average markers. Includes site and condition details for both orientations.



WIFI	Band 2 5250-5350MHz Harmonic @ 3m	
ANT	802.11n HT40 CH62 5310MHz	
1	Horizontal	Vertical
Peak Avg.	<p>Site : 03CH13-HY Condition : PEAK_74 3m SHF_HORN_584 HORIZONTAL Detector : Peak</p>	<p>Site : 03CH13-HY Condition : PEAK_74 3m SHF_HORN_584 VERTICAL Detector : Peak</p>

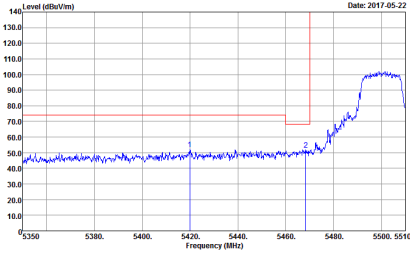
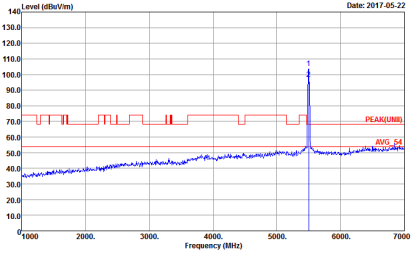
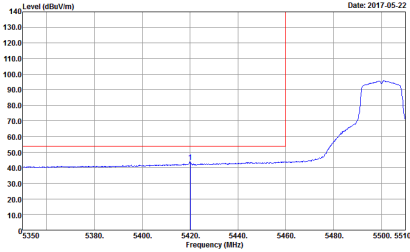

**Band 3 - 5470~5725MHz**  
**WIFI 802.11a (Band Edge @ 3m)**

WIFI	Band 3 5470~5725MHz Band Edge @ 3m	
ANT	802.11a CH100 5500MHz	
1	Horizontal	Fundamental
Peak	 <p>Date: 2017-05-22</p> <p>Site : 03CH13-HY            Condition : PEAK_BE(UNII)_B3 3m HORN_9120D_1522 HORIZONTAL            : RBW:1000.000KHz VBW:3000.000KHz SWT:Auto</p>	 <p>Date: 2017-05-22</p> <p>Site : 03CH13-HY            Condition : PEAK(UNII) 3m HORN_9120D_1522 HORIZONTAL            : RBW:1000.000KHz VBW:3000.000KHz SWT:Auto</p>
Avg.	 <p>Date: 2017-05-22</p> <p>Site : 03CH13-HY            Condition : AVG_BE(UNII)_B3 3m HORN_9120D_1522 HORIZONTAL            : RBW:1000.000KHz VBW:1000KHz SWT:Auto</p>	Left blank

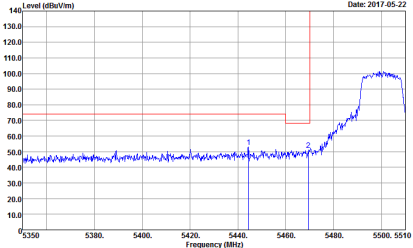
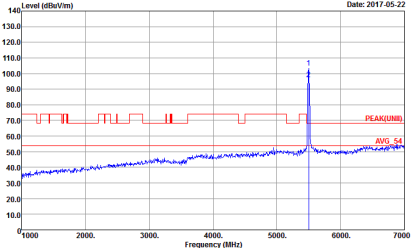
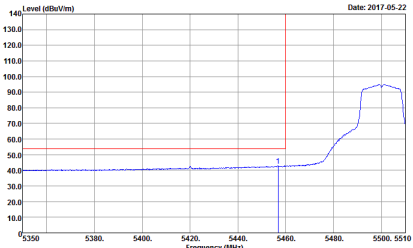

WIFI	Band 3 5470~5725MHz Band Edge @ 3m	
ANT	802.11a CH100 5500MHz	
1	Vertical	Fundamental
Peak	 <p>Date: 2017-05-22</p> <p>Site : 03CH13-HY Condition : PEAK_BE(UNIT1)_B3 3m HORN_9120D_1522 VERTICAL : RBW:1000.000KHz VBW:3000.000KHz SWT:Auto</p>	 <p>Date: 2017-05-22</p> <p>Site : 03CH13-HY Condition : PEAK(UNIT1) 3m HORN_9120D_1522 VERTICAL : RBW:1000.000KHz VBW:3000.000KHz SWT:Auto</p>
Avg.	 <p>Date: 2017-05-22</p> <p>Site : 03CH13-HY Condition : AV6_BE(UNIT1)_B3 3m HORN_9120D_1522 VERTICAL : RBW:1000.000KHz VBW:1.000KHz SWT:Auto</p>	Left blank



WIFI	Band 3 5470~5725MHz Band Edge @ 3m	
ANT	802.11a CH116 5580MHz - L	
1	Horizontal	Fundamental
Peak	<p>Site : 03CH13-HY Condition : PEAK_BE(UNIT)_B3 3m HORN_9120D_1522 HORIZONTAL : RBW:1000.000KHz VBW:3000.000KHz SWT:Auto</p>	<p>Site : 03CH13-HY Condition : PEAK(UNIT) 3m HORN_9120D_1522 HORIZONTAL : RBW:1000.000KHz VBW:3000.000KHz SWT:Auto</p>
Avg.	<p>Site : 03CH13-HY Condition : AV6_BE(UNIT)_B3 3m HORN_9120D_1522 HORIZONTAL : RBW:1000.000KHz VBW:1.000KHz SWT:Auto</p>	Left blank



WIFI	Band 3 5470~5725MHz Band Edge @ 3m	
ANT	802.11a CH116 5580MHz - R	
1	Horizontal	Fundamental
Peak	<p>Site : 03CH13-HY Condition : PEAK_BE(UNIT)_B3 3m HORN_9120D_1522 HORIZONTAL : RBW:1000.000KHz VBW:3000.000KHz SWT-Auto</p>	Left blank



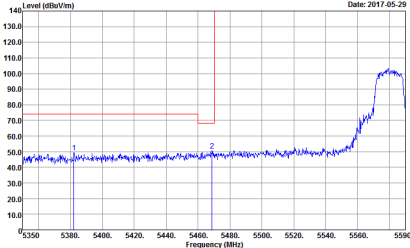
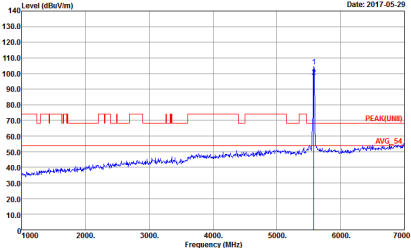
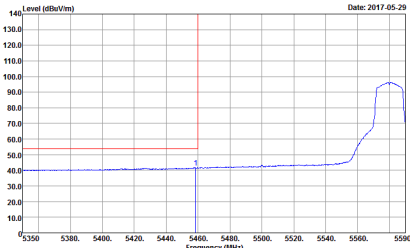

WIFI	Band 3 5470~5725MHz Band Edge @ 3m	
ANT	802.11a CH116 5580MHz - L	
1	Vertical	Fundamental
Peak	 <p>Date: 2017-05-29</p> <p>Site : 03CH13-HY Condition : PEAK_BE(UNIT1)_B3 3m HORN_9120D_1522 VERTICAL : RBW:1000.000KHz VBW:3000.000KHz SWT:Auto</p>	 <p>Date: 2017-05-29</p> <p>Site : 03CH13-HY Condition : PEAK(UNIT1) 3m HORN_9120D_1522 VERTICAL : RBW:1000.000KHz VBW:3000.000KHz SWT:Auto</p>
Avg.	 <p>Date: 2017-05-29</p> <p>Site : 03CH13-HY Condition : AV6_BE(UNIT1)_B3 3m HORN_9120D_1522 VERTICAL : RBW:1000.000KHz VBW:1.000KHz SWT:Auto</p>	Left blank



WIFI	Band 3 5470~5725MHz Band Edge @ 3m	
ANT	802.11a CH116 5580MHz - R	
1	Vertical	Fundamental
Peak	<p>Date: 2017.05.29</p> <p>Site : 03CH13-HY Condition : PEAK_BE(UNIT)_B3 3m HORN_9120D_1522 VERTICAL : RBW:1000.000KHz VBW:3000.000KHz SWT-Auto</p>	Left blank

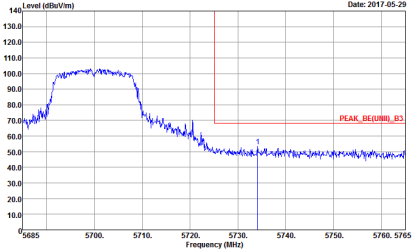
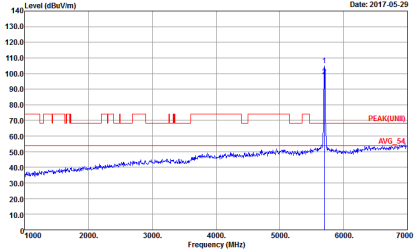

WIFI	Band 3 5470~5725MHz Band Edge @ 3m	
ANT	802.11a CH140 5700MHz	
1	Horizontal	Fundamental
Peak	 <p>Date: 2017-05-29</p> <p>Site : 03CH13-HY Condition : PEAK_BE(UNI)_B3 3m HORN_9120D_1522 HORIZONTAL : RBW:1000.000KHz VBW:3000.000KHz SWT:Auto</p>	 <p>Date: 2017-05-29</p> <p>Site : 03CH13-HY Condition : PEAK(UNI) 3m HORN_9120D_1522 HORIZONTAL : RBW:1000.000KHz VBW:3000.000KHz SWT:Auto</p>



WIFI	Band 3 5470~5725MHz Band Edge @ 3m	
ANT	802.11a CH140 5700MHz	
1	Vertical	Fundamental
Peak	<p>Date: 2017-05-29</p> <p>Site : 03CH13-HY Condition : PEAK_BE(UNIT)_B3 3m HORN_9120D_1522 VERTICAL : RBW:1000.000KHz VBW:3000.000KHz SWT:Auto</p>	<p>Date: 2017-05-29</p> <p>Site : 03CH13-HY Condition : PEAK(UNIT) 3m HORN_9120D_1522 VERTICAL : RBW:1000.000KHz VBW:3000.000KHz SWT:Auto</p>



**Band 3 5470~5725MHz  
WIFI 802.11n HT20 (Band Edge @ 3m)**

WIFI	Band 3 5470~5725MHz Band Edge @ 3m	
ANT	802.11n HT20 CH100 5500MHz	
1	Horizontal	Fundamental
<b>Peak</b>	<p>Site : 03CH13-HY Condition : PEAK_BE(UNIT)_83 3m HORN_9120D_1522 HORIZONTAL : RBW:1000.000KHz VBW:3000.000KHz SWT:Auto</p>	<p>Site : 03CH13-HY Condition : PEAK(UNIT) 3m HORN_9120D_1522 HORIZONTAL : RBW:1000.000KHz VBW:3000.000KHz SWT:Auto</p>
<b>Avg.</b>	<p>Site : 03CH13-HY Condition : AVG_BE(UNIT)_83 3m HORN_9120D_1522 HORIZONTAL : RBW:1000.000KHz VBW:1.000KHz SWT:Auto</p>	<b>Left blank</b>

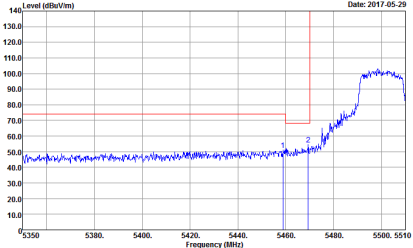
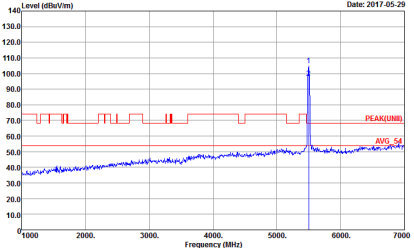
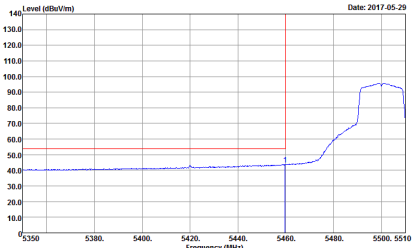

WIFI	Band 3 5470~5725MHz Band Edge @ 3m	
ANT	802.11n HT20 CH100 5500MHz	
1	Vertical	Fundamental
Peak	 <p>Date: 2017-05-29</p> <p>Site : 03CH13-HY Condition : PEAK_BE(UNIT1)_B3 3m HORN_9120D_1522 VERTICAL : RBW:1000.000KHz VBW:3000.000KHz SWT:Auto</p>	 <p>Date: 2017-05-29</p> <p>Site : 03CH13-HY Condition : PEAK(UNIT1) 3m HORN_9120D_1522 VERTICAL : RBW:1000.000KHz VBW:3000.000KHz SWT:Auto</p>
Avg.	 <p>Date: 2017-05-29</p> <p>Site : 03CH13-HY Condition : AV6_BE(UNIT1)_B3 3m HORN_9120D_1522 VERTICAL : RBW:1000.000KHz VBW:1.000KHz SWT:Auto</p>	Left blank

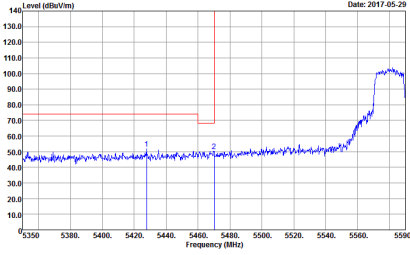
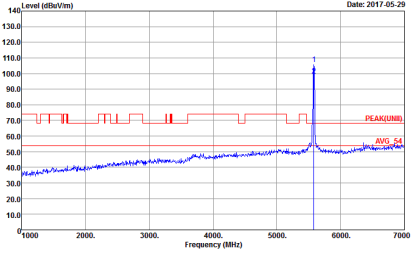
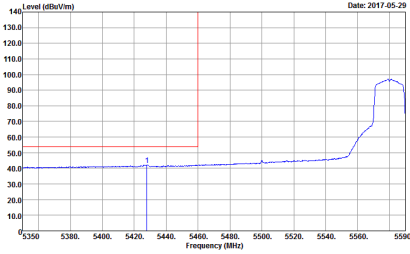

WIFI	Band 3 5470~5725MHz Band Edge @ 3m	
ANT	802.11n HT20 CH116 5580MHz - L	
1	Horizontal	Fundamental
Peak	 <p>Date: 2017-05-29</p> <p>Site : 03CH13-HY Condition : PEAK_BE(UNITI)_B3 3m HORN_9120D_1522 HORIZONTAL : RBW:1000.000KHz VBW:3000.000KHz SWT:Auto</p>	 <p>Date: 2017-05-29</p> <p>Site : 03CH13-HY Condition : PEAK(UNITI) 3m HORN_9120D_1522 HORIZONTAL : RBW:1000.000KHz VBW:3000.000KHz SWT:Auto</p>
Avg.	 <p>Date: 2017-05-29</p> <p>Site : 03CH13-HY Condition : AV6_BE(UNITI)_B3 3m HORN_9120D_1522 HORIZONTAL : RBW:1000.000KHz VBW:1.000KHz SWT:Auto</p>	Left blank

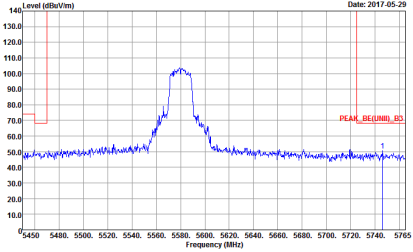

WIFI	Band 3 5470~5725MHz Band Edge @ 3m	
ANT	802.11n HT20 CH116 5580MHz - R	
1	Horizontal	Fundamental
Peak	 <p data-bbox="347 788 686 824">Date: 2017.05.29 Site : 03CH13-HY Condition : PEAK_BE(UNIT)_B3 3m HORN_9120D_1522 HORIZONTAL : RBW:1000.000KHz VBW:3000.000KHz SWT:Auto</p>	Left blank



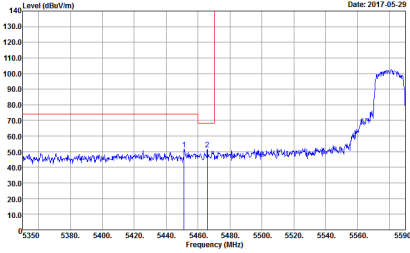
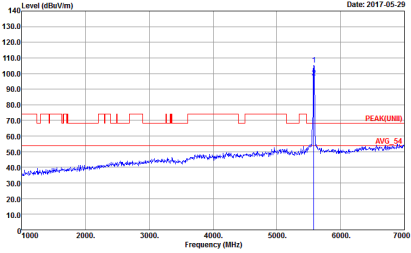
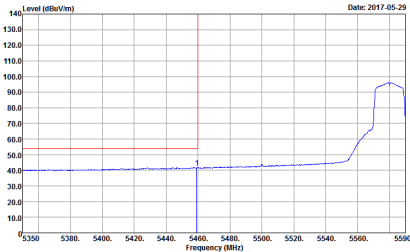

WIFI	Band 3 5470~5725MHz Band Edge @ 3m	
ANT	802.11n HT20 CH116 5580MHz - L	
1	Vertical	Fundamental
Peak	 <p>Date: 2017-05-29</p> <p>Site : 03CH13-HY Condition : PEAK_BE(UNIT1)_B3 3m HORN_9120D_1522 VERTICAL : RBW:1000.000KHz VBW:3000.000KHz SWT:Auto</p>	 <p>Date: 2017-05-29</p> <p>Site : 03CH13-HY Condition : PEAK(UNIT1) 3m HORN_9120D_1522 VERTICAL : RBW:1000.000KHz VBW:3000.000KHz SWT:Auto</p>
Avg.	 <p>Date: 2017-05-29</p> <p>Site : 03CH13-HY Condition : AV6_BE(UNIT1)_B3 3m HORN_9120D_1522 VERTICAL : RBW:1000.000KHz VBW:1.000KHz SWT:Auto</p>	Left blank



WIFI	Band 3 5470~5725MHz Band Edge @ 3m	
ANT	802.11n HT20 CH116 5580MHz - R	
1	Vertical	Fundamental
Peak	<p>Date: 2017.05.29</p> <p>Site : 03CH13-HY Condition : PEAK_BE(UNIT)_B3 3m HORN_9120D_1522 VERTICAL : RBW:1000.000KHz VBW:3000.000KHz SWT-Auto</p>	Left blank

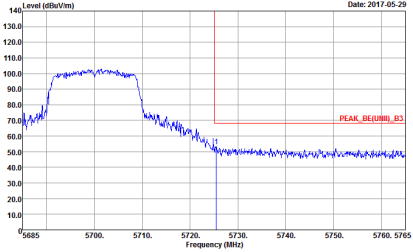
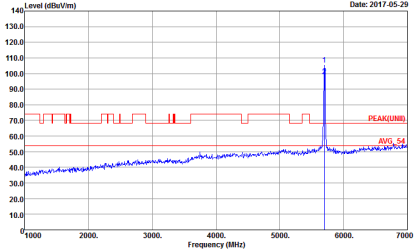

WIFI	Band 3 5470~5725MHz Band Edge @ 3m	
ANT	802.11n HT20 CH140 5700MHz	
1	Horizontal	Fundamental
Peak	 <p>Date: 2017-05-29</p> <p>Site : 03CH13-HY Condition : PEAK_BE(UNI)_B3 3m HORN_9120D_1522 HORIZONTAL : RBW:1000.000KHz VBW:3000.000KHz SWT:Auto</p>	 <p>Date: 2017-05-29</p> <p>Site : 03CH13-HY Condition : PEAK(UNI) 3m HORN_9120D_1522 HORIZONTAL : RBW:1000.000KHz VBW:3000.000KHz SWT:Auto</p>

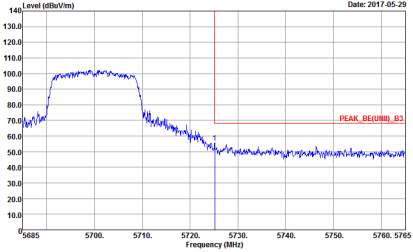
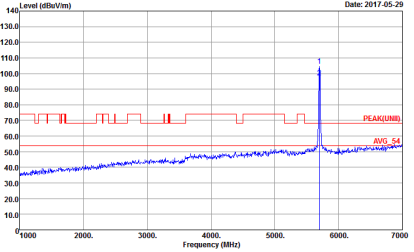

WIFI	Band 3 5470~5725MHz Band Edge @ 3m	
ANT	802.11n HT20 CH140 5700MHz	
1	Vertical	Fundamental
Peak.	 <p>Date: 2017-05-29</p> <p>Site : 03CH13-HY Condition : PEAK_BE(UNIT)_B3 3m HORN_9120D_1522 VERTICAL : RBW:1000.000KHz VBW:3000.000KHz SWT:Auto</p>	 <p>Date: 2017-05-29</p> <p>Site : 03CH13-HY Condition : PEAK(UNIT) 3m HORN_9120D_1522 VERTICAL : RBW:1000.000KHz VBW:3000.000KHz SWT:Auto</p>



Band 3 5470~5725MHz
WIFI 802.11n HT40 (Band Edge @ 3m)

Table with 2 columns (WIFI, ANT) and 2 rows (Peak, Avg.). It contains spectral analysis plots for 'Horizontal' and 'Fundamental' views, showing Level (dBuV/m) vs Frequency (MHz) with various annotations and site conditions.

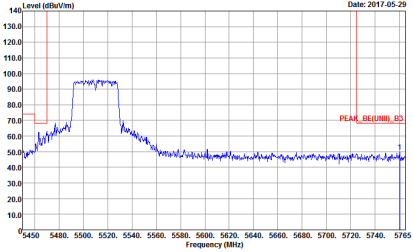

WIFI	Band 3 5470~5725MHz Band Edge @ 3m	
ANT	802.11n HT40 CH102 5510MHz - R	
1	Horizontal	Fundamental
Peak	 <p>Site : 03CH13-HY Condition : PEAK_BE(UNIT)_B3 3m HORN_9120D_1522 HORIZONTAL : RBW:1000.000KHz VBW:3000.000KHz SWT-Auto</p>	Left blank

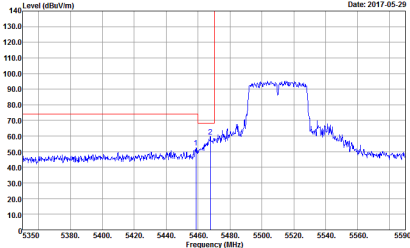
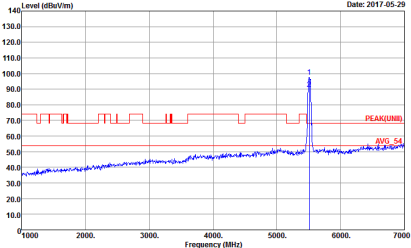
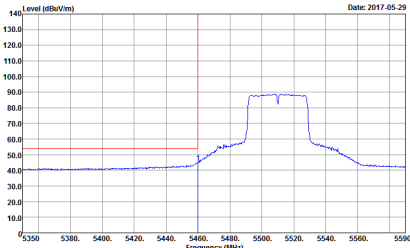

WIFI	Band 3 5470~5725MHz Band Edge @ 3m	
ANT	802.11n HT40 CH102 5510MHz - L	
1	Vertical	Fundamental
Peak	 <p>Date: 2017-05-29</p> <p>Site : 03CH13-HY Condition : PEAK_BE(UNIT1)_B3 3m HORN_9120D_1522 VERTICAL : RBW:1000.000KHz VBW:3000.000KHz SWT:Auto</p>	 <p>Date: 2017-05-29</p> <p>Site : 03CH13-HY Condition : PEAK(UNIT1) 3m HORN_9120D_1522 VERTICAL : RBW:1000.000KHz VBW:3000.000KHz SWT:Auto</p>
Avg.	 <p>Date: 2017-05-29</p> <p>Site : 03CH13-HY Condition : AV6_BE(UNIT1)_B3 3m HORN_9120D_1522 VERTICAL : RBW:1000.000KHz VBW:3.000KHz SWT:Auto</p>	Left blank



WIFI	Band 3 5470~5725MHz Band Edge @ 3m	
ANT	802.11n HT40 CH102 5510MHz - R	
1	Vertical	Fundamental
Peak	<p>Site : 03CH13-HY Condition : PEAK_BE(UNIT)_B3 3m HORN_9120D_1522 VERTICAL : RBW:1000.000KHz VBW:3000.000KHz SWT-Auto</p>	Left blank



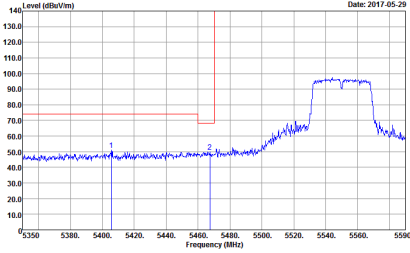
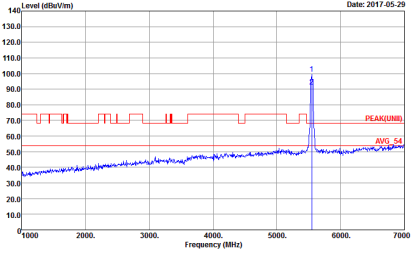
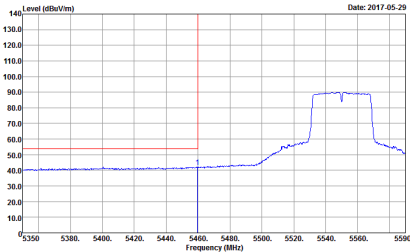

WIFI	Band 3 5470~5725MHz Band Edge @ 3m	
ANT	802.11n HT40 CH110 5550MHz - L	
1	Horizontal	Fundamental
Peak	 <p>Date: 2017-05-29</p> <p>Site : 03CH13-HY Condition : PEAK_BE(UNIT1)_B3 3m HORN_9120D_1522 HORIZONTAL : RBW:1000.000KHz VBW:3000.000KHz SWT:Auto</p>	 <p>Date: 2017-05-29</p> <p>Site : 03CH13-HY Condition : PEAK(UNIT1) 3m HORN_9120D_1522 HORIZONTAL : RBW:1000.000KHz VBW:3000.000KHz SWT:Auto</p>
Avg.	 <p>Date: 2017-05-29</p> <p>Site : 03CH13-HY Condition : AV6_BE(UNIT1)_B3 3m HORN_9120D_1522 HORIZONTAL : RBW:1000.000KHz VBW:3.000KHz SWT:Auto</p>	Left blank



WIFI	Band 3 5470~5725MHz Band Edge @ 3m	
ANT	802.11n HT40 CH110 5550MHz - R	
1	Horizontal	Fundamental
Peak	<p>Site : 03CH13-HY Condition : PEAK_BE(UNIT)_B3 3m HORN_9120D_1522 HORIZONTAL : RBW:1000.000KHz VBW:3000.000KHz SWT-Auto</p>	Left blank

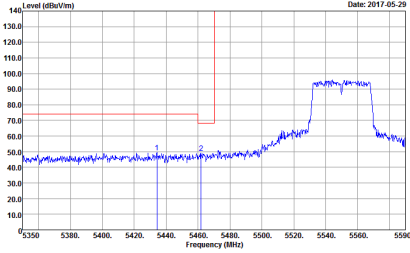
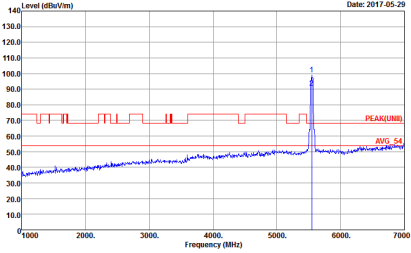
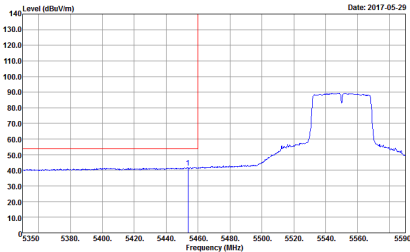

WIFI	Band 3 5470~5725MHz Band Edge @ 3m	
ANT	802.11n HT40 CH110 5550MHz - L	
1	Vertical	Fundamental
Peak	 <p>Date: 2017-05-29</p> <p>Site : 03CH13-HY Condition : PEAK_BE(UNIT1)_B3 3m HORN_9120D_1522 VERTICAL : RBW:1000.000KHz VBW:3000.000KHz SWT:Auto</p>	 <p>Date: 2017-05-29</p> <p>Site : 03CH13-HY Condition : PEAK(UNIT1) 3m HORN_9120D_1522 VERTICAL : RBW:1000.000KHz VBW:3000.000KHz SWT:Auto</p>
Avg.	 <p>Date: 2017-05-29</p> <p>Site : 03CH13-HY Condition : AV6_BE(UNIT1)_B3 3m HORN_9120D_1522 VERTICAL : RBW:1000.000KHz VBW:3.000KHz SWT:Auto</p>	Left blank



WIFI	Band 3 5470~5725MHz Band Edge @ 3m	
ANT	802.11n HT40 CH110 5550MHz - R	
1	Vertical	Fundamental
Peak	<p>Site : 03CH13-HY Condition : PEAK_BE(UNIT)_B3 3m HORN_9120D_1522 VERTICAL : RBW:1000.000KHz VBW:3000.000KHz SWT-Auto</p>	Left blank

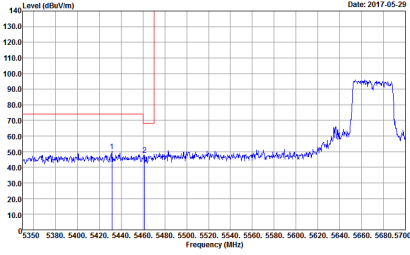
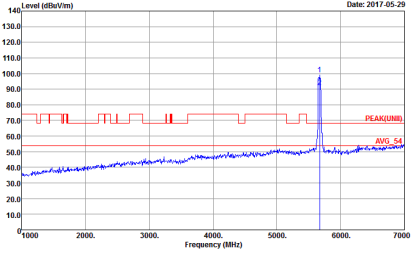
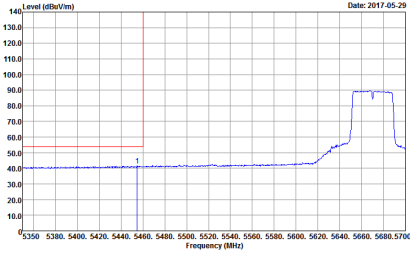

WIFI	Band 3 5470~5725MHz Band Edge @ 3m	
ANT	802.11n HT40 CH134 5670MHz - L	
1	Horizontal	Fundamental
Peak	 <p>Date: 2017-05-29</p> <p>Site : 03CH13-HY Condition : PEAK_BE(UNIT)_B3 3m HORN_9120D_1522 HORIZONTAL : RBW:1000.000KHz VBW:3000.000KHz SWT:Auto</p>	 <p>Date: 2017-05-29</p> <p>Site : 03CH13-HY Condition : PEAK(UNIT) 3m HORN_9120D_1522 HORIZONTAL : RBW:1000.000KHz VBW:3000.000KHz SWT:Auto</p>
Avg.	 <p>Date: 2017-05-29</p> <p>Site : 03CH13-HY Condition : AV6_BE(UNIT)_B3 3m HORN_9120D_1522 HORIZONTAL : RBW:1000.000KHz VBW:3.000KHz SWT:Auto</p>	Left blank

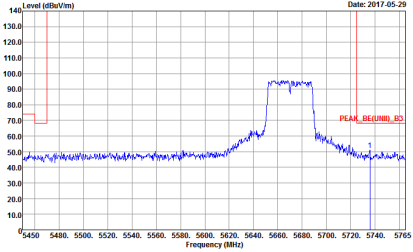

WIFI	Band 3 5470~5725MHz Band Edge @ 3m	
ANT	802.11n HT40 CH134 5670MHz - R	
1	Horizontal	Fundamental
Peak	 <p>Site : 03CH13-HY Condition : PEAK_BE(UNIT)_B3 3m HORN_9120D_1522 HORIZONTAL : RBW:1000.000KHz VBW:3000.000KHz SWT:Auto</p>	Left blank

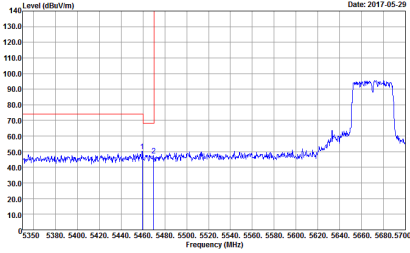
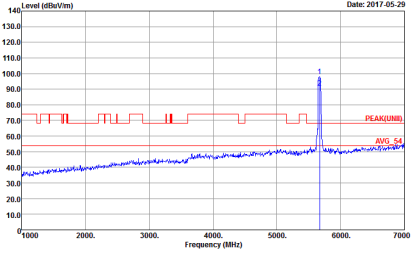
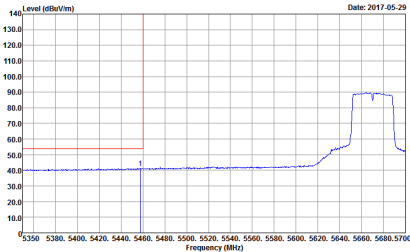

WIFI	Band 3 5470~5725MHz Band Edge @ 3m	
ANT	802.11n HT40 CH134 5670MHz - L	
1	Vertical	Fundamental
Peak	 <p>Date: 2017-05-29</p> <p>Site : 03CH13-HY Condition : PEAK_BE(UNIT)_B3 3m HORN_9120D_1522 VERTICAL : RBW:1000.000KHz VBW:3000.000KHz SWT:Auto</p>	 <p>Date: 2017-05-29</p> <p>Site : 03CH13-HY Condition : PEAK(UNIT) 3m HORN_9120D_1522 VERTICAL : RBW:1000.000KHz VBW:3000.000KHz SWT:Auto</p>
Avg.	 <p>Date: 2017-05-29</p> <p>Site : 03CH13-HY Condition : AV6_BE(UNIT)_B3 3m HORN_9120D_1522 VERTICAL : RBW:1000.000KHz VBW:3.000KHz SWT:Auto</p>	Left blank



WIFI	Band 3 5470~5725MHz Band Edge @ 3m	
ANT	802.11n HT40 CH134 5670MHz - R	
1	Vertical	Fundamental
Peak	<p>Site : 03CH13-HY Condition : PEAK_BE(UNIT)_B3 3m HORN_9120D_1522 VERTICAL : RBW:1000.000KHz VBW:3000.000KHz SWT-Auto</p>	Left blank





Band 3 - 5470~5725MHz
WIFI 802.11a (Harmonic @ 3m)

Table with 3 columns: WIFI, ANT, and measurement results for Horizontal and Vertical orientations. Includes sub-headers '1', 'Horizontal', and 'Vertical'. The main content area contains two graphs showing Level (dBuV/m) vs Frequency (MHz) for Peak and Avg. measurements. The graphs show a signal level around 70-80 dBuV/m with a noise floor around 50 dBuV/m. Two peaks are marked at approximately 12000 MHz and 16000 MHz.

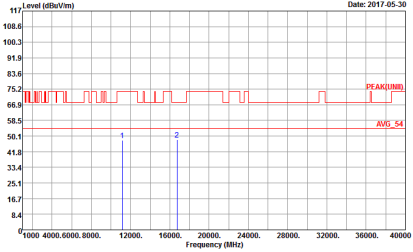
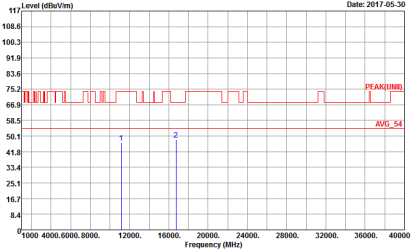

WIFI	Band 3 5470-5725MHz Harmonic @ 3m	
ANT	802.11a CH116 5580MHz	
1	Horizontal	Vertical
<p>Peak</p> <p>Avg.</p>	 <p>Site : 03CH13-HY          Condition : PEAK(UNII) 3m SHF_HORN_584 HORIZONTAL          Detector : Peak</p>	 <p>Site : 03CH13-HY          Condition : PEAK(UNII) 3m SHF_HORN_584 VERTICAL          Detector : Peak</p>

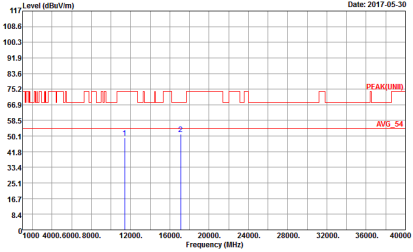
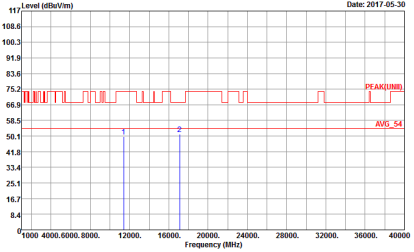

WIFI	Band 3 5470~5725MHz Harmonic @ 3m	
ANT	802.11a CH140 5700MHz	
1	Horizontal	Vertical
Peak Avg.	 <p>Site : 03CH13-HY Condition : PEAK(UNII) 3m SHF_HORN_584 HORIZONTAL Detector : Peak</p>	 <p>Site : 03CH13-HY Condition : PEAK(UNII) 3m SHF_HORN_584 VERTICAL Detector : Peak</p>

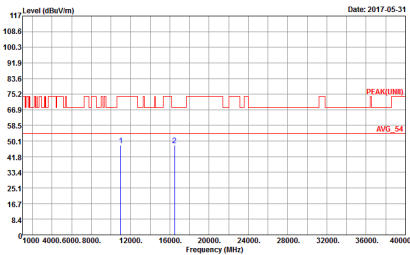
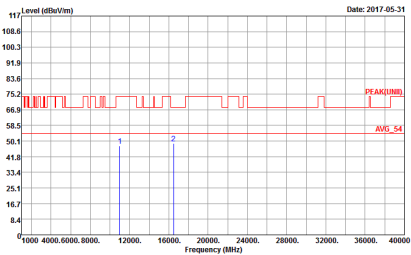

**Band 3 5470~5725MHz  
WIFI 802.11n HT20 (Harmonic @ 3m)**

WIFI	Band 3 5470~5725MHz Harmonic @ 3m	
ANT	802.11n HT20 CH100 5500MHz	
1	Horizontal	Vertical
<p><b>Peak</b> <b>Avg.</b></p>	 <p>Site : 03CH13-HY Condition : PEAK(UNII) 3m SHF_HORN_584 HORIZONTAL Detector : Peak</p>	 <p>Site : 03CH13-HY Condition : PEAK(UNII) 3m SHF_HORN_584 VERTICAL Detector : Peak</p>



WIFI	Band 3 5470-5725MHz Harmonic @ 3m	
ANT	802.11n HT20 CH116 5580MHz	
1	Horizontal	Vertical
Peak Avg.	<p>Site : 03CH13-HY Condition : PEAK(UNII) 3m SHF_HORN_584 HORIZONTAL Detector : Peak</p>	<p>Site : 03CH13-HY Condition : PEAK(UNII) 3m SHF_HORN_584 VERTICAL Detector : Peak</p>

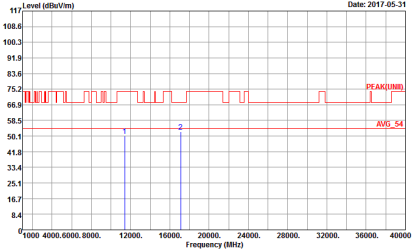
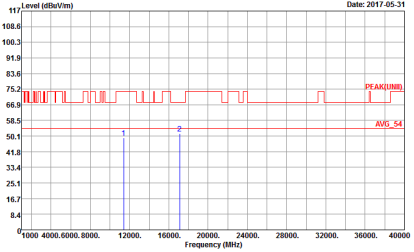

WIFI	Band 3 5470~5725MHz Harmonic @ 3m	
ANT	802.11n HT20 CH140 5700MHz	
1	Horizontal	Vertical
Peak Avg.	 <p>Date: 2017-05-31</p> <p>Site : 03CH13-HY Condition : PEAK(UNII) 3m SHF_HORN_584 HORIZONTAL Detector : Peak</p>	 <p>Date: 2017-05-31</p> <p>Site : 03CH13-HY Condition : PEAK(UNII) 3m SHF_HORN_584 VERTICAL Detector : Peak</p>



Band 3 5470~5725MHz
WIFI 802.11n HT40 (Harmonic @ 3m)

Table with 2 columns: Horizontal and Vertical. Each column contains a graph of Level (dBuV/m) vs Frequency (MHz) for Peak and Avg. measurements. Includes site and condition details for both orientations.



WIFI	Band 3 5470-5725MHz Harmonic @ 3m	
ANT	802.11n HT40 CH110 5550MHz	
1	Horizontal	Vertical
Peak Avg.	<p>Site : 03CH13-HY Condition : PEAK(UNII) 3m SHF_HORN_584 HORIZONTAL Detector : Peak</p>	<p>Site : 03CH13-HY Condition : PEAK(UNII) 3m SHF_HORN_584 VERTICAL Detector : Peak</p>



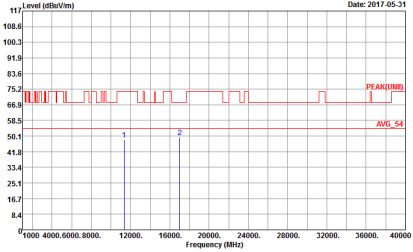
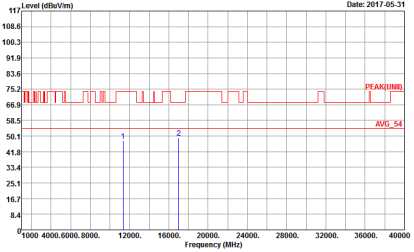

WIFI	Band 3 5470~5725MHz Harmonic @ 3m	
ANT	802.11n HT40 CH134 5670MHz	
1	Horizontal	Vertical
<p>Peak</p> <p>Avg.</p>	 <p>Site : 03CH13-HY Condition : PEAK(UNII) 3m SHF_HORN_584 HORIZONTAL Detector : Peak</p>	 <p>Site : 03CH13-HY Condition : PEAK(UNII) 3m SHF_HORN_584 VERTICAL Detector : Peak</p>



Emission below 1GHz  
5GHz WIFI 802.11a (LF)

WIFI	5GHz WIFI	
ANT	802.11a LF	
1	Horizontal	Vertical
QP / Peak	<p>Site : 03CH13-HY Condition : QP 3m BILO6_40103 HORIZONTAL Detector : Peak</p>	<p>Site : 03CH13-HY Condition : QP 3m BILO6_40103 VERTICAL Detector : Peak</p>



Emission below 1GHz  
5GHz WIFI 802.11n HT20 (LF)

WIFI	5GHz WIFI	
ANT	802.11n HT20 LF	
1	Horizontal	Vertical
QP / Peak	<p>Site : 03CH13-HY Condition : QP 3m BILO6_40103 HORIZONTAL Detector : Peak</p>	<p>Site : 03CH13-HY Condition : QP 3m BILO6_40103 VERTICAL Detector : Peak</p>



Emission below 1GHz  
5GHz WIFI 802.11n HT40 (LF)

WIFI	5GHz WIFI	
ANT	802.11n HT40 LF	
1	Horizontal	Vertical
QP / Peak	<p>Site : 03CH13-HY Condition : QP 3m BILO6_40103 HORIZONTAL Detector : Peak</p>	<p>Site : 03CH13-HY Condition : QP 3m BILO6_40103 VERTICAL Detector : Peak</p>

## Appendix D Duty Cycle Plots

Band	Duty Cycle(%)	T(us)	1/T(kHz)	VBW Setting
802.11a	97.20	1390	0.72	1kHz
5GHz 802.11n HT20	97.04	1310	0.76	1kHz
5GHz 802.11n HT40	93.86	642	1.56	3kHz

### 802.11a

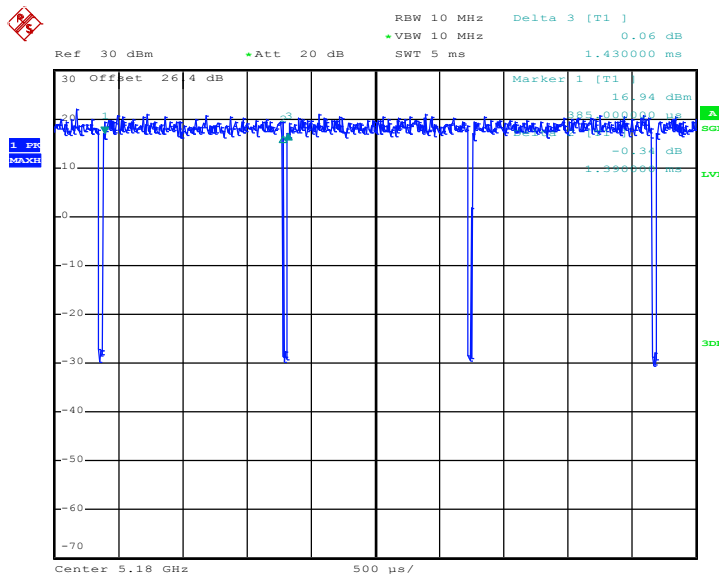

Date: 17.MAY.2017 02:30:01



5GHz 802.11n HT20

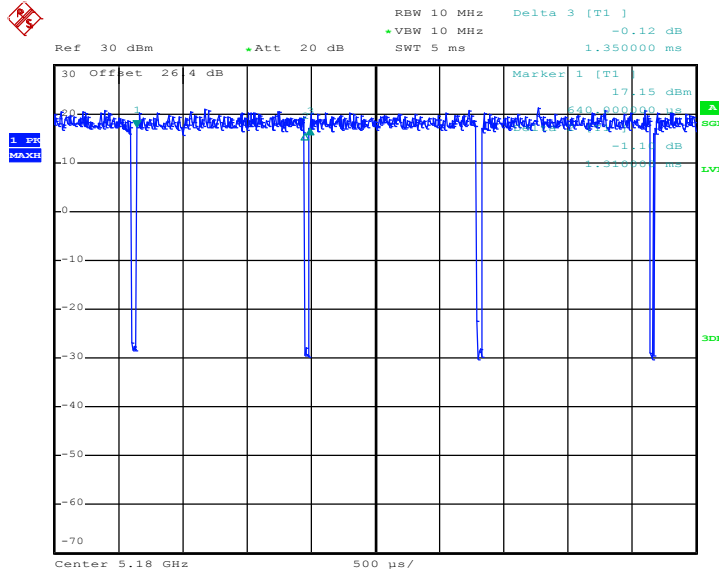

Date: 17.MAY.2017 02:31:07

5GHz 802.11n HT40

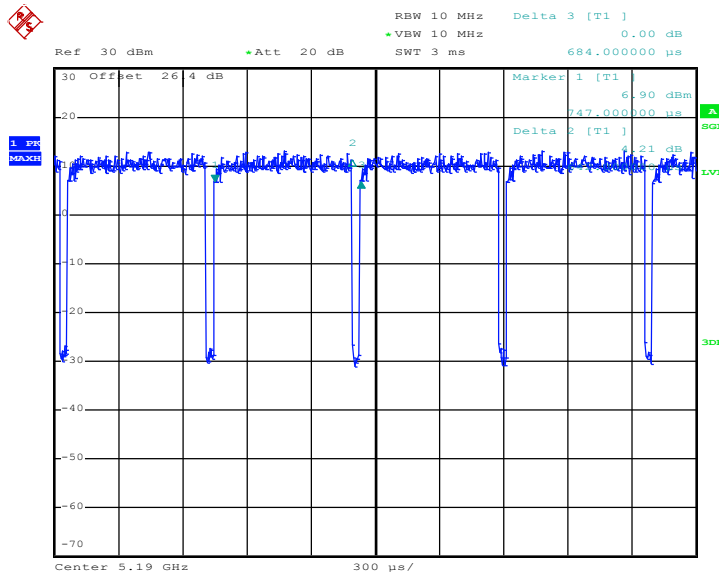

Date: 17.MAY.2017 02:31:56