



# FCC RF Test Report

**APPLICANT** : Sony Mobile Communications Inc.  
**EQUIPMENT** : GSM/WCDMA/LTE Phone+Bluetooth, DTS/UNII a/b/g/n and NFC  
**BRAND NAME** : Sony  
**FCC ID** : PY7-76476N  
**STANDARD** : FCC Part 15 Subpart C §15.225  
**CLASSIFICATION** : (DXX) Low Power Communication Device Transmitter

This is a variant report which is only valid together with the original test report. The testing was completed on May 29, 2017. We, SPORTON INTERNATIONAL INC., would like to declare that the tested sample has been evaluated in accordance with the test procedures and has been in compliance with the applicable technical standards.

The test results in this report apply exclusively to the tested model / sample. Without written approval of SPORTON INTERNATIONAL INC., the test report shall not be reproduced except in full.

Reviewed by: Joseph Lin / Supervisor

Approved by: Jones Tsai / Manager



**SPORTON INTERNATIONAL INC.**

No. 52, Hwa Ya 1<sup>st</sup> Rd., Hwa Ya Technology Park, Kwei-Shan District, Tao Yuan City, Taiwan, R.O.C.



# TABLE OF CONTENTS

**SUMMARY OF THE TEST RESULT .....4**

**1. GENERAL INFORMATION.....5**

1.1 Applicant..... 5

1.2 Manufacturer ..... 5

1.3 Product Feature of Equipment Under Test ..... 5

1.4 Product Specification of Equipment Under Test ..... 6

1.5 Modification of EUT ..... 6

1.6 Testing Location ..... 7

1.7 Applicable Standards..... 7

**2. TEST CONFIGURATION OF EQUIPMENT UNDER TEST .....8**

2.1 Descriptions of Test Mode ..... 8

2.2 Connection Diagram of Test System ..... 8

2.3 EUT Operation Test Setup ..... 8

**3. TEST RESULTS.....9**

3.1 Radiated Emissions Measurement ..... 9

3.2 Antenna Requirements..... 12

**4. LIST OF MEASURING EQUIPMENT .....13**

**APPENDIX A. TEST RESULTS OF RADIATED TEST ITEMS**

A1. Results of Radiated Emissions (9 kHz~30MHz)

A2. Results of Radiated Emissions (30MHz~1GHz)

**APPENDIX B. ORIGINAL REPORT**



## REVISION HISTORY

| REPORT NO.   | VERSION | DESCRIPTION             | ISSUED DATE   |
|--------------|---------|-------------------------|---------------|
| FR742210-01D | Rev. 01 | Initial issue of report | Jul. 25, 2017 |
|              |         |                         |               |
|              |         |                         |               |
|              |         |                         |               |
|              |         |                         |               |
|              |         |                         |               |
|              |         |                         |               |
|              |         |                         |               |
|              |         |                         |               |
|              |         |                         |               |
|              |         |                         |               |
|              |         |                         |               |
|              |         |                         |               |
|              |         |                         |               |
|              |         |                         |               |
|              |         |                         |               |



### SUMMARY OF THE TEST RESULT

| Applied Standard: 47 CFR FCC Part 15 Subpart C |                     |                      |          |                           |
|--|---------------------|----------------------|----------|---------------------------|
| Part   | FCC Rule            | Description of Test  | Result   | Under Limit               |
| 3.1  | 15.225(d)<br>15.209 | Radiated Emissions   | Complies | 7.72 dB at<br>137.460 MHz |
| 3.2  | 15.203              | Antenna Requirements | Complies | -                         |

| Test Items                         | Uncertainty | Remark                   |
|------------------------------------|-------------|--------------------------|
| Radiated Emissions (30MHz~1000MHz) | ±5.70dB     | Confidence levels of 95% |



# 1. GENERAL INFORMATION

## 1.1 Applicant

Sony Mobile Communications Inc.

4-12-3 Higashi-Shinagawa, Shinagawa-ku, Tokyo, 140-0002, Japan

## 1.2 Manufacturer

Sony Mobile Communications Inc.

4-12-3 Higashi-Shinagawa, Shinagawa-ku, Tokyo, 140-0002, Japan

## 1.3 Product Feature of Equipment Under Test

GSM/WCDMA/LTE, Bluetooth, DTS/UNII, a/b/g/n, NFC, and GPS

| Standards-related Product Specification |              |
|---|--------------|
| Antenna Type / Gain                     | Loop Antenna |

Remark: This is a variant report. All the test cases were performed on original report which can be referred to Sporton Report Number FR742206-01D.

| EUT Information List |            |            |                            |
|----------------------|------------|------------|----------------------------|
| HW Version           | SW Version | S/N        | Performed Test Item        |
| A                    | 0.32       | RQ3004WLD3 | Radiated Spurious Emission |

| Accessory List |                       |
|----------------|-----------------------|
| AC Adapter 1   | Model No. : UCH20     |
|                | S/N : 1215W48600039   |
| Earphone 1     | Model No. : MH410C    |
|                | S/N : 1632A8640000088 |
| USB Cable      | Model No. : UCB20     |
|                | S/N : 1625A91900007E2 |

Note:

- Above EUT list and accessory list used are electrically identical per declared by manufacturer.
- Above the accessories list are used to exercise the EUT during test.
- For other wireless features of this EUT, test report will be issued separately.



### 1.4 Product Specification of Equipment Under Test

| Standards-related Product Specification |                    |
|---|--------------------|
| Tx/Rx Frequency Range                   | 13.553 ~ 13.567MHz |
| Channel Number                          | 1                  |
| Type of Modulation                      | ASK                |

**Remark:** The above EUT's information was declared by manufacturer. Please refer to the specifications or user's manual for more detailed description.

### 1.5 Modification of EUT

No modifications are made to the EUT during all test items.



### 1.6 Testing Location

Sporton Lab is accredited to ISO 17025 by Taiwan Accreditation Foundation (TAF code : 1190) and the FCC designation No. TW1190 under the FCC 2.948(e) by Mutual Recognition Agreement (MRA) in FCC Test.

|                           |   |
|---------------------------|---|
| <b>Test Site</b>          | SPORTON INTERNATIONAL INC.  |
| <b>Test Site Location</b> | No. 52, Hwa Ya 1 <sup>st</sup> Rd., Hwa Ya Technology Park,<br>Kwei-Shan District, Tao Yuan City, Taiwan, R.O.C.<br>TEL: +886-3-3273456 / FAX: +886-3-3284978 |
| <b>Test Site No.</b>      | <b>Sporton Site No.</b><br>03CH07-HY  |
| <b>Test Engineer</b>      | Jess Wang   |
| <b>Temperature</b>        | 23~24°C   |
| <b>Relative Humidity</b>  | 53~54%  |

**Note:** The test site complies with ANSI C63.4 2014 requirement.

### 1.7 Applicable Standards

According to the specifications of the manufacturer, the EUT must comply with the requirements of the following standards:

- ♦ FCC Part 15 Subpart C §15.225
- ♦ FCC KDB 414788 D01 Radiated Test Site v01
- ♦ ANSI C63.10-2013

## 2. TEST CONFIGURATION OF EQUIPMENT UNDER TEST

### 2.1 Descriptions of Test Mode

Investigation has been done on all the possible configurations.

The following table is a list of the test modes shown in this test report.

| Test Items                    |                               |
|-------------------------------|-------------------------------|
| Radiated Emissions 9kHz~30MHz | Radiated Emissions 30MHz~1GHz |

The EUT pre-scanned in four NFC type, A, B, F, V. The worst type (type F) was recorded in this report. Pre-scanned tests, X, Y, Z in three orthogonal panels to determine the final configuration (Y plane as worst plane) from all possible combinations.

### 2.2 Connection Diagram of Test System

< For Radiated Emissions Measurement >

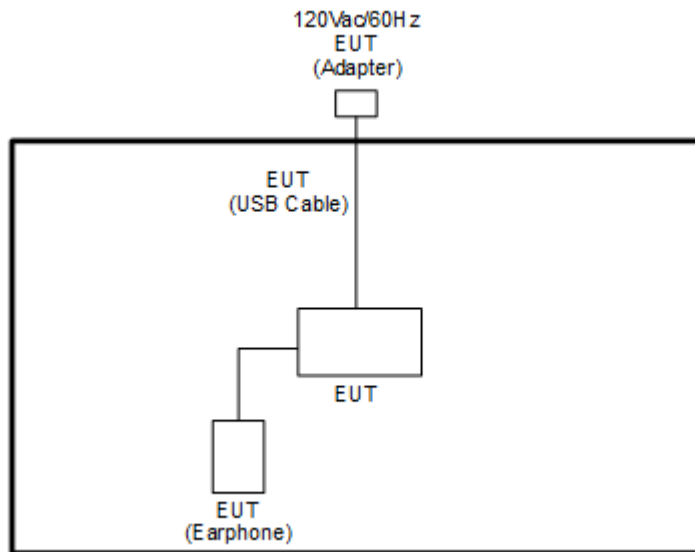

### 2.3 EUT Operation Test Setup

The EUT was programmed to be in continuously transmitting mode.

The ancillary equipment, NFC card, is used to make the EUT (NFC) continuously transmit at 13.56MHz and is placed around 0 cm gap to the EUT.





### 3. TEST RESULTS

#### 3.1 Radiated Emissions Measurement

##### 3.1.1 Limit

The field strength of any emissions which appear outside of 13.110 ~14.010MHz band shall not exceed the general radiated emissions limits.

| Frequencies (MHz) | Field Strength (µV/m) | Measurement Distance (meters) |
|-------------------|-----------------------|-------------------------------|
| 0.009~0.490       | 2400/F(kHz)           | 300                           |
| 0.490~1.705       | 24000/F(kHz)          | 30                            |
| 1.705~30.0        | 30                    | 30                            |
| 30~88             | 100                   | 3                             |
| 88~216            | 150                   | 3                             |
| 216~960           | 200                   | 3                             |
| Above 960         | 500                   | 3                             |

##### 3.1.2 Measuring Instruments

See list of measuring instruments of this test report.

##### 3.1.3 Measuring Instrument Setting

The following table is the setting of receiver.

| Receiver Parameter             | Setting             |
|--------------------------------|---------------------|
| Attenuation                    | Auto                |
| Frequency Range: 9kHz~150kHz   | RBW 200Hz for QP    |
| Frequency Range: 150kHz~30MHz  | RBW 9kHz for QP     |
| Frequency Range: 30MHz~1000MHz | RBW 120kHz for Peak |

**Note:** The emission limits shown in the above table are based on measurements employing a CISPR quasi-peak detector except for the frequency bands 9-90 kHz, 110-490 kHz. Radiated emission limits in these two bands are based on measurements employing an average detector.



### **3.1.4 Test Procedures**

1. Configure the EUT according to ANSI C63.10. The EUT was placed on the top of the turntable 0.8 meter above ground. The phase center of the receiving antenna mounted on the top of a height-variable antenna tower was placed 3 meters far away from the turntable.
2. Power on the EUT and all the supporting units. The turntable was rotated by 360 degrees to determine the position of the highest radiation.
3. The height of the broadband receiving antenna was varied between one meter and four meters above ground to find the maximum emissions field strength of both horizontal and vertical polarization.
4. For each suspected emissions, the antenna tower was scan (from 1 M to 4 M) and then the turntable was rotated (from 0 degree to 360 degrees) to find the maximum reading.
5. Set the test-receiver system to Peak or CISPR quasi-peak Detect Function with specified bandwidth under Maximum Hold Mode.
6. When the radiated emissions limits are expressed in terms of the average value of the emissions, and pulsed operation is employed, the measurement field strength shall be determined by averaging over one complete pulse train, including blanking intervals, as long as the pulse train does not exceed 0.1 seconds. As an alternative (provided the transmitter operates for longer than 0.1 seconds) or in cases where the pulse train exceeds 0.1 seconds, the measured field strength shall be determined from the average absolute voltage during a 0.1 second interval during which the field strength is at its maximum value.
7. In case the emission is lower than 30MHz, loop antenna has to be used for measurement and the recorded data should be QP measured by receiver. Antenna Requirements

### 3.1.5 Test Setup

For radiated emissions below 30MHz

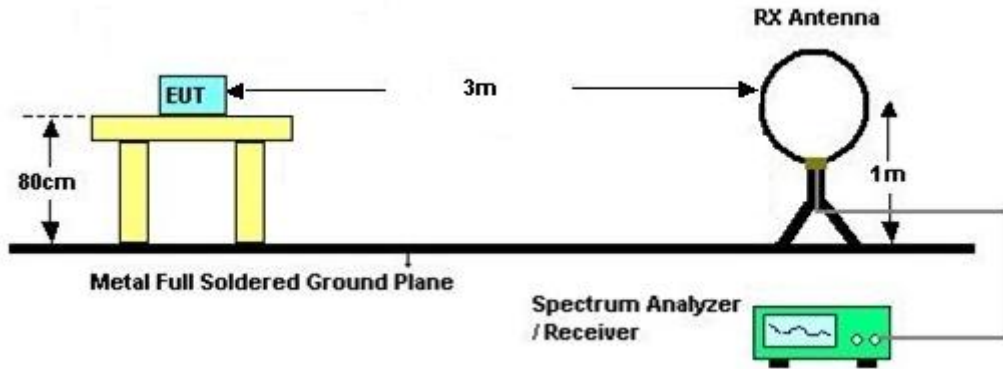

For radiated emissions above 30MHz

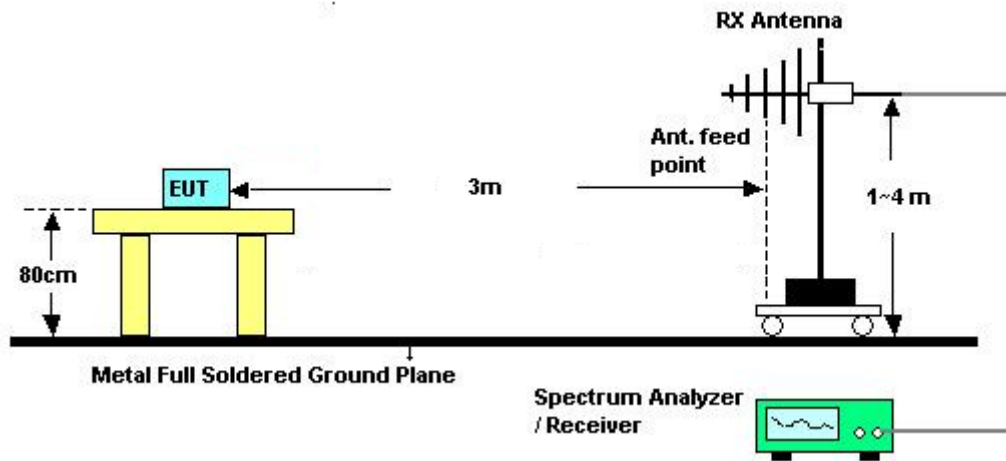

### 3.1.6 Test Result of Radiated Emissions Measurement

Please refer to Appendix A.

**Note:** There is a comparison data of both open-field test site and semi-Anechoic chamber, and the result came out very similar.



## **3.2 Antenna Requirements**

### **3.2.1 Standard Applicable**

Except for special regulations, the Low-power Radio-frequency Devices must not be equipped with any jacket for installing an antenna with extension cable. An intentional radiator shall be designed to ensure that no antenna other than that furnished by the responsible party shall be used with the device. The use of a permanently attached antenna or of an antenna that uses a unique coupling to the intentional radiator shall be considered sufficient to comply with the provisions of this Section. The manufacturer may design the unit so that the user can replace a broken antenna, but the use of a standard antenna jack or electrical connector is prohibited.

The use of a permanently attached antenna or of an antenna that uses a unique coupling to the intentional radiator shall be considered sufficient to comply with the rule.

### **3.2.2 Antenna Anti-Replacement Construction**

An embedded-in antenna design is used.



### 4. LIST OF MEASURING EQUIPMENT

| Instrument        | Manufacturer      | Model No.                       | Serial No.                   | Characteristics       | Calibration Date | Test Date    | Due Date      | Remark                   |
|-------------------|-------------------|---------------------------------|------------------------------|-----------------------|------------------|--------------|---------------|--------------------------|
| Bilog Antenna     | TESEQ             | CBL<br>6111D&0080<br>0N1D01N-06 | 35419&03                     | 30MHz to 1GHz         | Jan. 07, 2017    | May 29, 2017 | Jan. 06, 2018 | Radiation<br>(03CH07-HY) |
| Loop Antenna      | Rohde & Schwarz   | HFH2-Z2                         | 100315                       | 9 kHz~30 MHz          | May 15, 2017     | May 29, 2017 | May 14, 2019  | Radiation<br>(03CH07-HY) |
| EMI Test Receiver | Keysight          | N9038A(MX<br>E)                 | MY5413008<br>5               | 20Hz ~ 8.4GHz         | Oct. 26, 2016    | May 29, 2017 | Oct. 25, 2017 | Radiation<br>(03CH07-HY) |
| Preamplifier      | COM-POWER         | PA-103A                         | 161241                       | 10MHz-1GHz            | Mar. 14, 2017    | May 29, 2017 | Mar. 13, 2018 | Radiation<br>(03CH07-HY) |
| Spectrum Analyzer | Agilent           | N9010A                          | MY5347011<br>8               | 10Hz~44GHz            | Apr. 17, 2017    | May 29, 2017 | Apr. 16, 2018 | Radiation<br>(03CH07-HY) |
| Hygrometer        | Testo             | 608-H1                          | 34897197                     | N/A                   | N/A              | May 29, 2017 | N/A           | Radiation<br>(03CH07-HY) |
| Filter            | Wainwright        | WHK20<br>/1000C7/40S<br>S       | SN1                          | 20M High Pass         | Sep. 26, 2016    | May 29, 2017 | Sep. 25, 2017 | Radiation<br>(03CH07-HY) |
| RF Cable          | HUBER +<br>SUHNER | SUCOFLEX<br>104                 | Y84209521+<br>MY8420952<br>1 | 9KHz~30MHz            | Jan. 03, 2017    | May 29, 2017 | Jan. 02, 2018 | Radiation<br>(03CH07-HY) |
| RF Cable          | HUBER +<br>SUHNER | SUCOFLEX<br>104                 | MY8420952<br>1               | 30MHz~1GHz            | Jan. 03, 2017    | May 29, 2017 | Jan. 02, 2018 | Radiation<br>(03CH07-HY) |
| Controller        | ChainTek          | Chaintek<br>3000                | N/A                          | Control Turn<br>table | N/A              | May 29, 2017 | N/A           | Radiation<br>(03CH07-HY) |
| Controller        | Max-Full          | MF7802                          | MF7802083<br>68              | Control Ant<br>Mast   | N/A              | May 29, 2017 | N/A           | Radiation<br>(03CH07-HY) |
| Antenna Mast      | Max-Full          | MFA520BS                        | N/A                          | 1m~4m                 | N/A              | May 29, 2017 | N/A           | Radiation<br>(03CH07-HY) |
| Turn Table        | ChainTek          | Chaintek<br>3000                | N/A                          | 0~360 Degree          | N/A              | May 29, 2017 | N/A           | Radiation<br>(03CH07-HY) |
| Test Software     | Audix             | E3                              | 6.2009-8-24<br>(sporton)     | N/A                   | N/A              | May 29, 2017 | N/A           | Radiation<br>(03CH07-HY) |



# Appendix A. Test Results of Radiated Test Items

## A1. Results of Radiated Spurious Emissions (9 kHz~30MHz)

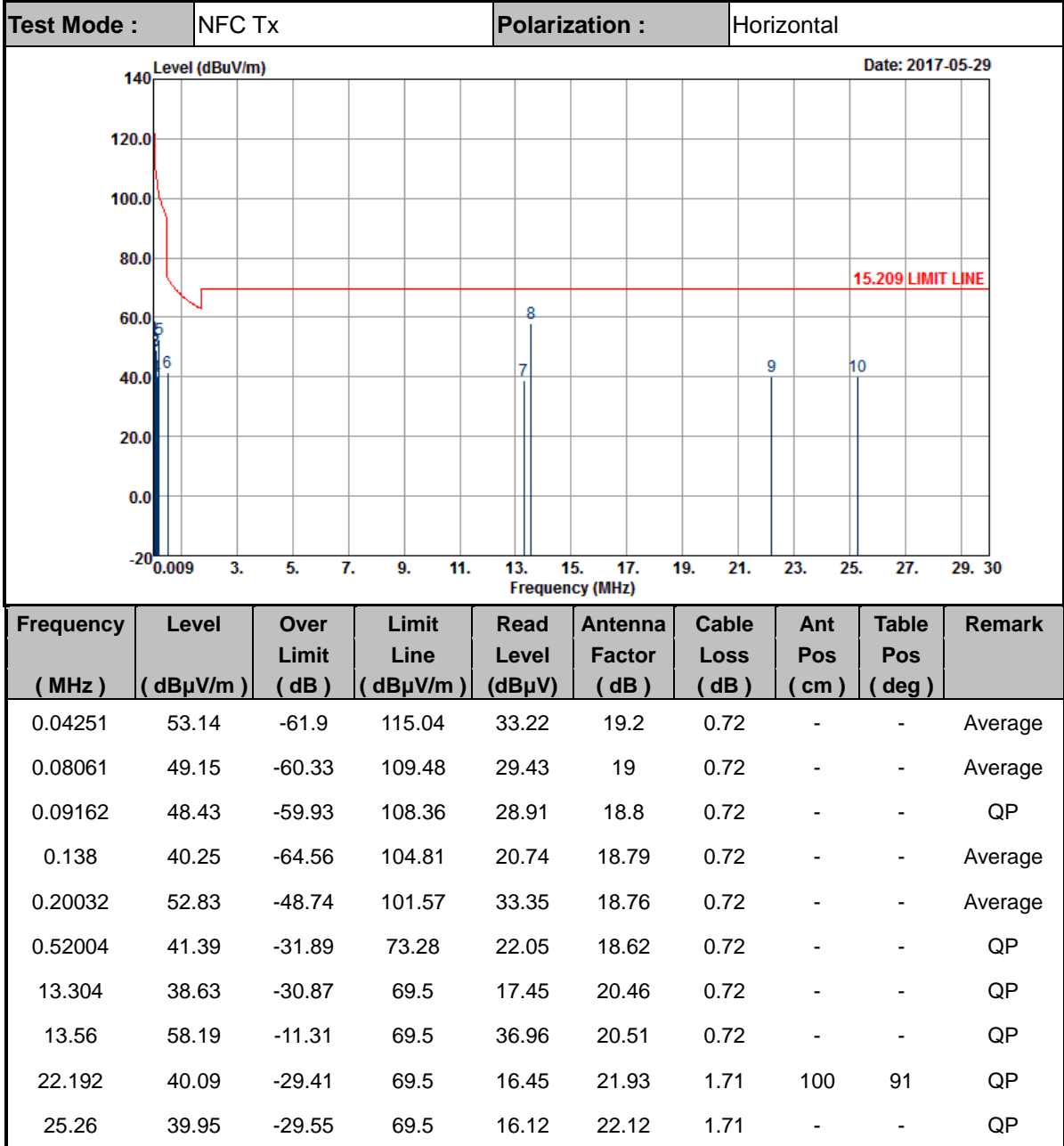

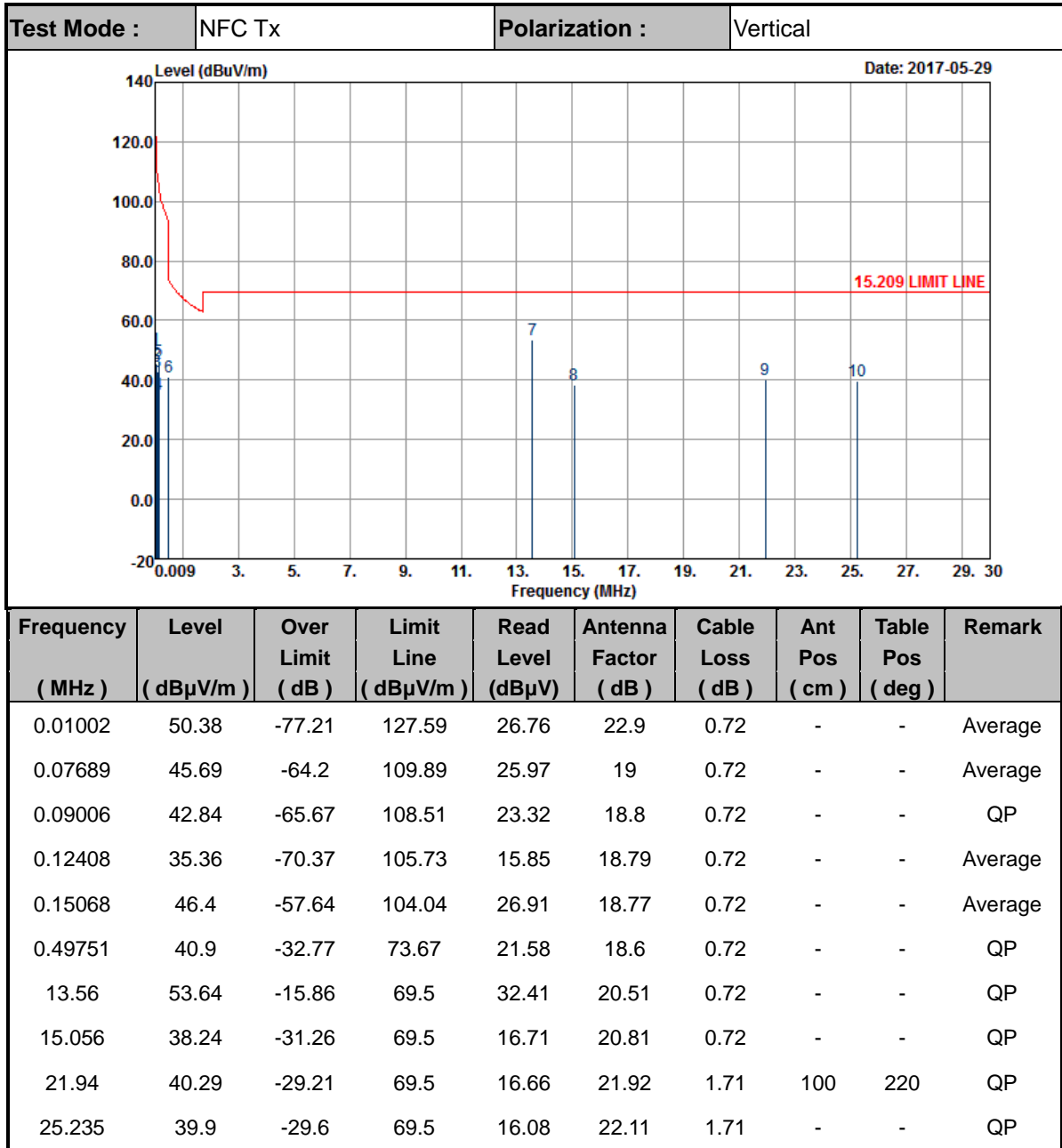

**Note:**

1. 13.56 MHz is fundamental signal which can be ignored.
2. The amplitude of spurious emissions which are attenuated by more than 20dB below the permissible value has no need to be reported.
3. Distance extrapolation factor = 40 log (specific distance / test distance) (dB);
4. Limit line = specific limits (dBμV) + distance extrapolation factor.



**A2. Results of Radiated Spurious Emissions (30MHz~1GHz)**

|                    |        |                       |            |
|--------------------|--------|-----------------------|------------|
| <b>Test Mode :</b> | NFC Tx | <b>Polarization :</b> | Horizontal |
|--------------------|--------|-----------------------|------------|

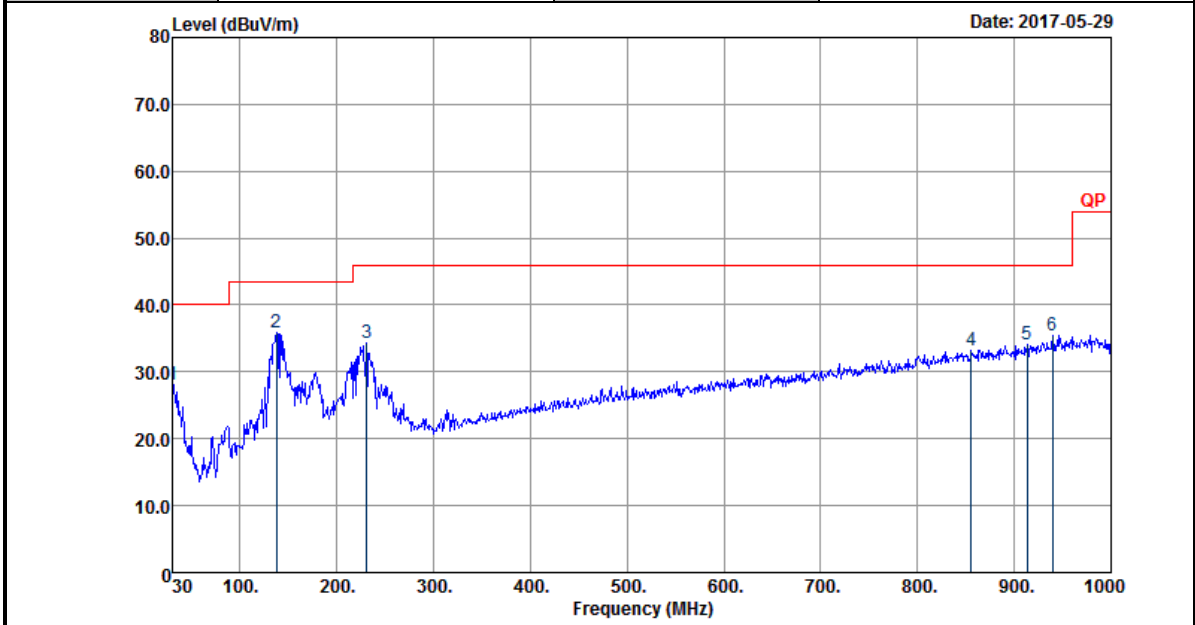

| Frequency ( MHz ) | Level ( dB $\mu$ V/m ) | Over Limit ( dB ) | Limit Line ( dB $\mu$ V/m ) | Read Level ( dB $\mu$ V ) | Antenna Factor ( dB ) | Cable Loss ( dB ) | Preamp Factor ( dB ) | Ant Pos ( cm ) | Table Pos ( deg ) | Remark |
|-------------------|------------------------|-------------------|-----------------------------|---------------------------|-----------------------|-------------------|----------------------|----------------|-------------------|--------|
| 30                | 28.09                  | -11.91            | 40                          | 31.73                     | 26                    | 1.71              | 31.35                | -              | -                 | Peak   |
| 137.46            | 35.78                  | -7.72             | 43.5                        | 46.9                      | 18.06                 | 2.34              | 31.52                | 100            | 132               | Peak   |
| 230.61            | 34.27                  | -11.73            | 46                          | 45.36                     | 17.28                 | 3.03              | 31.4                 | -              | -                 | Peak   |
| 855.1             | 33.25                  | -12.75            | 46                          | 29.87                     | 28.73                 | 5.2               | 30.55                | -              | -                 | Peak   |
| 913.2             | 34.07                  | -11.93            | 46                          | 29.93                     | 29.33                 | 5.33              | 30.52                | -              | -                 | Peak   |
| 939.8             | 35.38                  | -10.62            | 46                          | 30.61                     | 29.96                 | 5.33              | 30.52                | -              | -                 | Peak   |



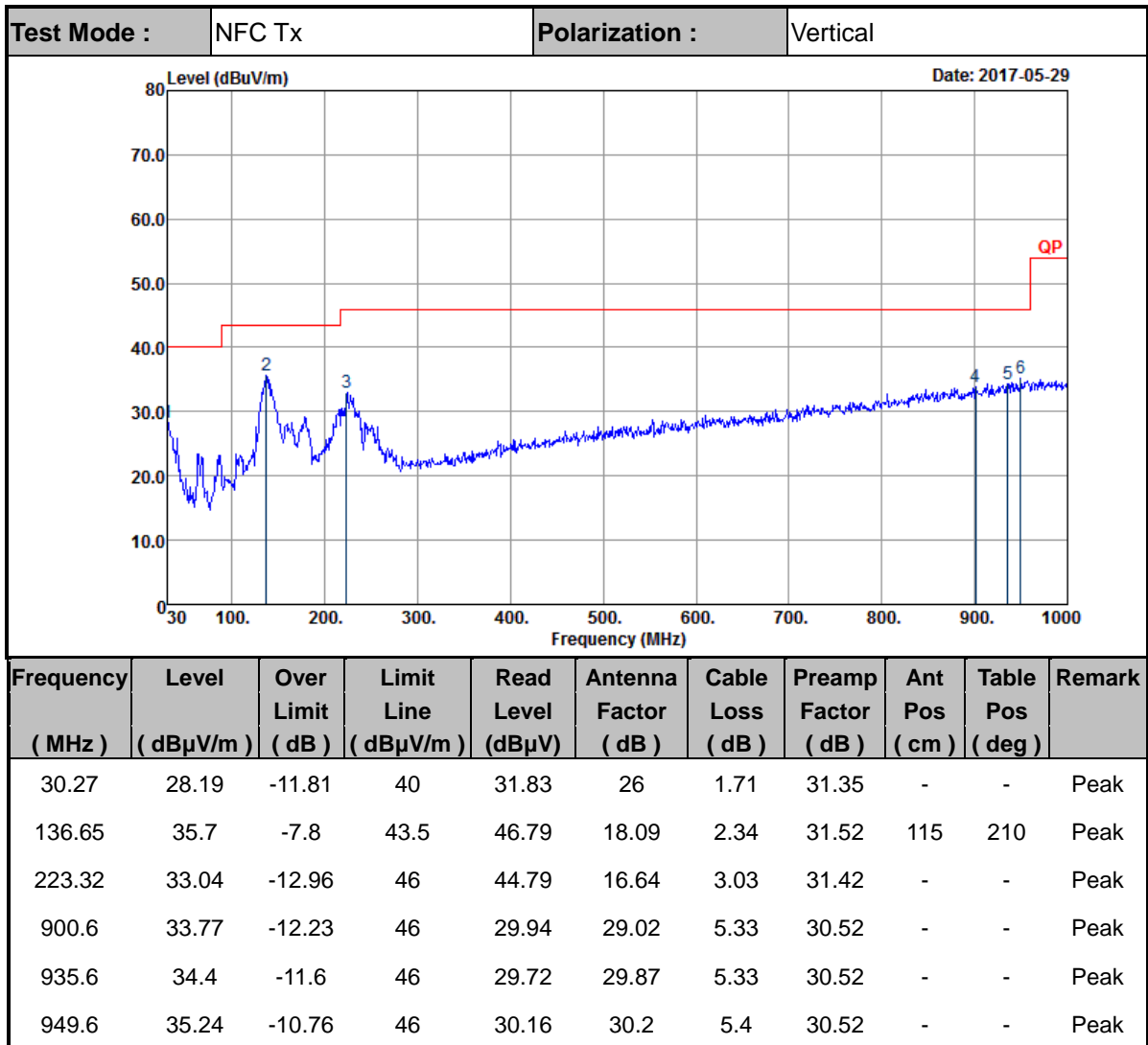

**Note:**

1. The amplitude of spurious emissions which are attenuated by more than 20dB below the permissible value has no need to be reported.
2. Emission level (dBμV/m) = 20 log Emission level (μV/m).
3. Corrected Reading: Antenna Factor + Cable Loss + Read Level - Preamp Factor= Level.



## **Appendix B. Original Report**

Please refer to Sporton report number FR742206-01D