



FCC RF Test Report

APPLICANT : Sony Mobile Communications Inc.
EQUIPMENT : GSM/WCDMA/LTE Phone+Bluetooth,
DTS/UNII a/b/g/n and NFC
BRAND NAME : Sony
FCC ID : PY7-76476N
STANDARD : FCC 47 CFR Part 2, 22(H), 24(E), 27(L)
CLASSIFICATION : PCS Licensed Transmitter Held to Ear (PCE)

The product was received on May 01, 2017 and testing was completed on Jun. 07, 2017. We, SPORTON INTERNATIONAL INC., would like to declare that the tested sample has been evaluated in accordance with the test procedures given in ANSI / TIA / EIA-603-D-2010 and has been in compliance with the applicable technical standards.

The test results in this report apply exclusively to the tested model / sample. Without written approval of SPORTON INTERNATIONAL INC., the test report shall not be reproduced except in full.

Reviewed by: Joseph Lin / Supervisor

Approved by: Jones Tsai / Manager



SPORTON INTERNATIONAL INC.

No. 52, Hwa Ya 1st Rd., Hwa Ya Technology Park, Kwei-Shan District, Tao Yuan City, Taiwan, R.O.C.

SPORTON INTERNATIONAL INC.

TEL : 886-3-327-3456

FAX : 886-3-328-4978

FCC ID : PY7-76476N

Page Number : 1 of 22

Report Issued Date : Jul. 25, 2017

Report Version : Rev. 01

Report Template No.: BU5-FG22/24/27 Version 1.2



TABLE OF CONTENTS

REVISION HISTORY.....3

SUMMARY OF TEST RESULT4

1 GENERAL DESCRIPTION5

 1.1 Applicant.....5

 1.2 Manufacturer5

 1.3 Product Feature of Equipment Under Test5

 1.4 Modification of EUT5

 1.5 Maximum ERP/EIRP Power, Frequency Tolerance, and Emission Designator6

 1.6 Testing Location7

 1.7 Applicable Standards7

2 TEST CONFIGURATION OF EQUIPMENT UNDER TEST8

 2.1 Test Mode.....8

 2.2 Connection Diagram of Test System9

 2.3 Support Unit used in test configuration9

 2.4 Measurement Results Explanation Example9

 2.5 Frequency List of Low/Middle/High Channels.....10

3 CONDUCTED TEST RESULT.....11

 3.1 Measuring Instruments.....11

 3.2 Test Setup11

 3.3 Test Result of Conducted Test.....11

 3.4 Conducted Output Power and ERP/EIRP12

 3.5 Peak-to-Average Ratio13

 3.6 99% Occupied Bandwidth and 26dB Bandwidth Measurement.....14

 3.7 Conducted Band Edge15

 3.8 Conducted Spurious Emission16

 3.9 Frequency Stability.....17

4 RADIATED TEST ITEMS18

 4.1 Measuring Instruments.....18

 4.2 Test Setup18

 4.3 Test Result of Radiated Test.....18

 4.4 Field Strength of Spurious Radiation Measurement19

5 LIST OF MEASURING EQUIPMENT20

6 UNCERTAINTY OF EVALUATION22

APPENDIX A. TEST RESULTS OF CONDUCTED TEST

APPENDIX B. TEST RESULTS OF ERP/EIRP AND RADIATED TEST



SUMMARY OF TEST RESULT

| Report Section | FCC Rule | Description | Limit | Result | Remark |
|----------------|--|---|------------------------|--------|--------------------------------------|
| 3.4 | §2.1046 | Conducted Output Power | Reporting Only | PASS | - |
| | §22.913(a)(2) | Effective Radiated Power | < 7 Watts | PASS | - |
| | §24.232(c) | Equivalent Isotropic Radiated Power | < 2 Watts | PASS | - |
| | §27.50(d)(4) | Equivalent Isotropic Radiated Power | < 1 Watts | PASS | - |
| 3.5 | §24.232(d) | Peak-to-Average Ratio | < 13 dB | PASS | - |
| 3.6 | §2.1049 §22.917(b) §24.238(b) §27.53(g) | Occupied Bandwidth | Reporting Only | PASS | - |
| 3.7 | §2.1051 §22.917(a) §24.238(a) §27.53(h) | Band Edge Measurement | < 43+10log10(P[Watts]) | PASS | - |
| 3.8 | §2.1051 §22.917(a) §24.238(a) §27.53(h) | Conducted Emission | < 43+10log10(P[Watts]) | PASS | - |
| 3.9 | §2.1055 §22.355 | Frequency Stability for Temperature & Voltage | < 2.5 ppm for Part 22 | PASS | - |
| | §2.1055 §24.235 §27.54 | | Within Authorized Band | | |
| 4.4 | §2.1053 §22.917(a) §24.238(a) §27.53(h) | Field Strength of Spurious Radiation | < 43+10log10(P[Watts]) | PASS | Under limit 19.97 dB at 5550.000 MHz |



1 General Description

1.1 Applicant

Sony Mobile Communications Inc.

4-12-3 Higashi-Shinagawa, Shinagawa-ku, Tokyo, 140-0002, Japan

1.2 Manufacturer

Sony Mobile Communications Inc.

4-12-3 Higashi-Shinagawa, Shinagawa-ku, Tokyo, 140-0002, Japan

1.3 Product Feature of Equipment Under Test

GSM/WCDMA/LTE, Bluetooth, DTS/UNII, a/b/g/n, NFC and GPS

| Product Specification subjective to this standard | |
|---|----------------|
| Antenna Type | C-feed Antenna |

| EUT Information List | | | |
|----------------------|------------|------------|--|
| HW Version | SW Version | S/N | Performed Test Item |
| A | 0.32 | RQ3004U10C | Conducted Measurement ERP/EIRP Test Radiated Spurious Emission |

| Accessory List | |
|----------------|-----------------------|
| AC Adapter 1 | Model No. : UCH20 |
| | S/N : 1215W48600059 |
| Earphone 1 | Model No. : MH410c |
| | S/N : 1632A86900000FC |
| USB Cable | Model No. : UCB20 |
| | S/N : 1625A91900007E2 |

Note:

1. Above EUT list and accessory list used are electrically identical per declared by manufacturer.
2. Above the accessories list are used to exercise the EUT during test.
3. For other wireless features of this EUT, test report will be issued separately.
4. For conducted test items except conducted output power is carrying out, FG742210-01A report reuses test data from the FG692213-01A report.

1.4 Modification of EUT

No modifications are made to the EUT during all test items.



1.5 Maximum ERP/EIRP Power, Frequency Tolerance, and Emission Designator

| FCC Rule | Frequency Range (MHz) | System | Type of Modulation | Maximum ERP/EIRP (W) | Frequency Tolerance (ppm) | Emission Designator |
|----------|-----------------------|-------------------------------|--------------------|----------------------|---------------------------|---------------------|
| Part 22 | 824.2 ~848.8 | GSM850 GPRS class 8 | GMSK | 0.4887 | 0.0227 ppm | 246KGXW |
| Part 22 | 824.2 ~848.8 | GSM850 EDGE class 8 | 8PSK | 0.1225 | 0.0670 ppm | 245KG7W |
| Part 22 | 826.4 ~846.6 | WCDMA Band V RMC 12.2Kbps | BPSK | 0.0624 | 0.0167 ppm | 4M21F9W |
| Part 24 | 1850.2 ~1909.8 | GSM1900 GPRS class 8 | GMSK | 0.7780 | 0.0117 ppm | 247KGXW |
| Part 24 | 1850.2 ~1909.8 | GSM1900 EDGE class 8 | 8PSK | 0.2600 | 0.0266 ppm | 248KG7W |
| Part 24 | 1852.4 ~ 1907.6 | WCDMA Band II RMC 12.2Kbps | BPSK | 0.1795 | 0.0027 ppm | 4M18F9W |
| Part 27 | 1712.4 ~ 1752.6 | WCDMA Band IV RMC 12.2Kbps | BPSK | 0.1000 | 0.0121 ppm | 4M17F9W |



1.6 Testing Location

Sporton Lab is accredited to ISO 17025 by Taiwan Accreditation Foundation (TAF code : 1190) and the FCC designation No. TW0007 under the FCC 2.948(e) by Mutual Recognition Agreement (MRA) in FCC Test.

| | |
|---------------------------|--|
| Test Site | SPORTON INTERNATIONAL INC. |
| Test Site Location | No. 52, Hwa Ya 1 st Rd., Hwa Ya Technology Park, Kwei-Shan District, Tao Yuan City, Taiwan, R.O.C. TEL: +886-3-327-3456 FAX: +886-3-328-4978 |
| Test Site No. | Sporton Site No. |
| | TH03-HY |

| | |
|---------------------------|--|
| Test Site | SPORTON INTERNATIONAL INC. |
| Test Site Location | No.58, Aly. 75, Ln. 564, Wenhua 3rd Rd. Guishan Dist, Taoyuan City, Taiwan (R.O.C.) TEL: +886-3-327-0868 FAX: +886-3-327-0855 |
| Test Site No. | Sporton Site No. |
| | 03CH10-HY |

1.7 Applicable Standards

According to the specifications of the manufacturer, the EUT must comply with the requirements of the following standards:

- 47 CFR Part 2, 22(H), 24(E), 27(L)
- ANSI / TIA / EIA-603-D-2010
- FCC KDB 971168 D01 Power Meas. License Digital Systems v02r02
- FCC KDB 412172 D01 Determining ERP and EIRP v01r01

Remark:

1. All test items were verified and recorded according to the standards and without any deviation during the test.
2. This EUT has also been tested and complied with the requirements of FCC Part 15, Subpart B, recorded in a separate test report.



2 Test Configuration of Equipment Under Test

2.1 Test Mode

Antenna port conducted and radiated test items were performed according to KDB 971168 D01 Power Meas. License Digital Systems v02r02 with maximum output power.

Radiated measurements were performed with rotating EUT in different three orthogonal test planes to find the maximum emission.

Radiated emissions were investigated as following frequency range:

1. 30 MHz to 9000 MHz for GSM850 and WCDMA Band V.
2. 30 MHz to 18000 MHz for WCDMA Band IV.
3. 30 MHz to 19100 MHz for GSM1900 and WCDMA Band II.

All modes and data rates and positions were investigated.

Test modes are chosen to be reported as the worst case configuration below:

| Test Modes | | |
|---------------|--|--|
| Band | Radiated TCs | Conducted TCs |
| GSM 850 | <ul style="list-style-type: none"> ■ GPRS class 8 Link ■ EDGE class 8 Link | <ul style="list-style-type: none"> ■ GPRS class 8 Link ■ EDGE class 8 Link |
| GSM 1900 | <ul style="list-style-type: none"> ■ GPRS class 8 Link ■ EDGE class 8 Link | <ul style="list-style-type: none"> ■ GPRS class 8 Link ■ EDGE class 8 Link |
| WCDMA Band V | <ul style="list-style-type: none"> ■ RMC 12.2Kbps Link | <ul style="list-style-type: none"> ■ RMC 12.2Kbps Link |
| WCDMA Band II | <ul style="list-style-type: none"> ■ RMC 12.2Kbps Link | <ul style="list-style-type: none"> ■ RMC 12.2Kbps Link |
| WCDMA Band IV | <ul style="list-style-type: none"> ■ RMC 12.2Kbps Link | <ul style="list-style-type: none"> ■ RMC 12.2Kbps Link |

2.2 Connection Diagram of Test System

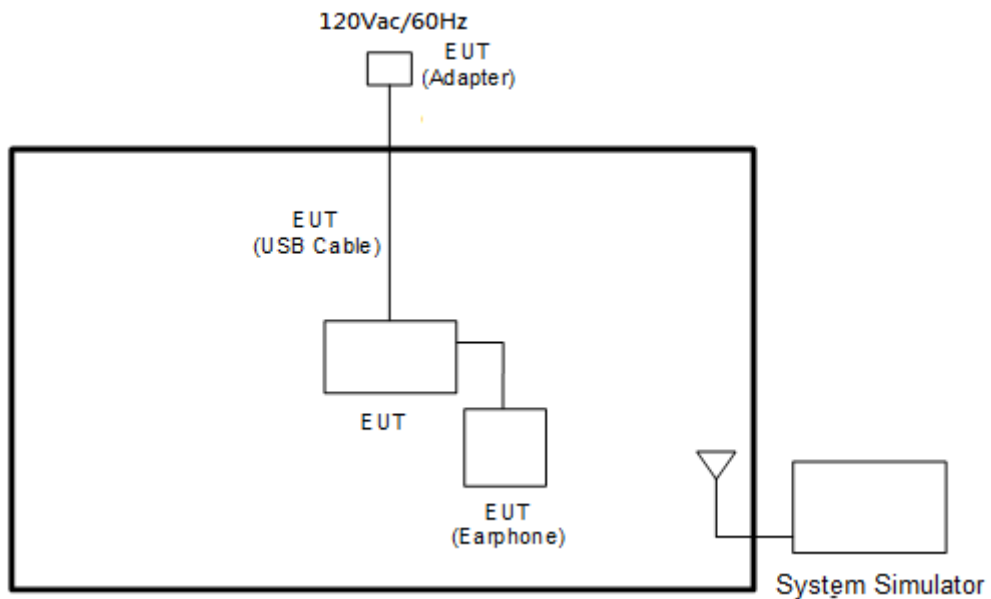

2.3 Support Unit used in test configuration

| Item | Equipment | Trade Name | Model No. | FCC ID | Data Cable | Power Cord |
|------|------------------|------------|-----------|--------|------------|-------------------|
| 1. | System Simulator | R&S | CMU 200 | N/A | N/A | Unshielded, 1.8 m |

2.4 Measurement Results Explanation Example

For all conducted test items:

The offset level is set in the spectrum analyzer to compensate the RF cable loss and attenuator factor between RF conducted output port and spectrum analyzer. With the offset compensation, the spectrum analyzer reading level will be exactly the RF output level.

The spectrum analyzer offset is derived from RF cable loss and attenuator factor.

Offset = RF cable loss + attenuator factor.

The following shows an offset computation example with RF cable loss 4.2 dB and a 10dB attenuator.

Example :

Offset(dB) = RF cable loss(dB) + attenuator factor(dB).

= 4.2 + 10 = 14.2 (dB)



2.5 Frequency List of Low/Middle/High Channels

| Frequency List | | | | |
|------------------|------------------------|--------|--------|---------|
| Band | Channel/Frequency(MHz) | Lowest | Middle | Highest |
| GSM850 | Channel | 128 | 189 | 251 |
| | Frequency | 824.2 | 836.4 | 848.8 |
| WCDMA Band V | Channel | 4132 | 4182 | 4233 |
| | Frequency | 826.4 | 836.4 | 846.6 |
| GSM1900 | Channel | 512 | 661 | 810 |
| | Frequency | 1850.2 | 1880.0 | 1909.8 |
| WCDMA Band II | Channel | 9262 | 9400 | 9538 |
| | Frequency | 1852.4 | 1880.0 | 1907.6 |
| WCDMA Band IV | Channel | 1312 | 1413 | 1513 |
| | Frequency | 1712.4 | 1732.6 | 1752.6 |

3 Conducted Test Result

3.1 Measuring Instruments

See list of measuring instruments of this test report.

3.2 Test Setup

3.2.1 Conducted Output Power

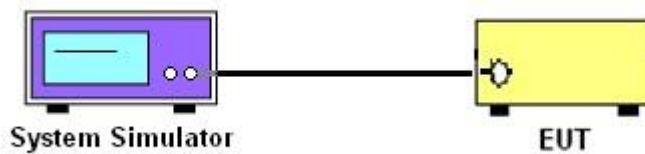

3.2.2 Peak-to-Average Ratio, Occupied Bandwidth, Conducted Band-Edge and Conducted Spurious Emission

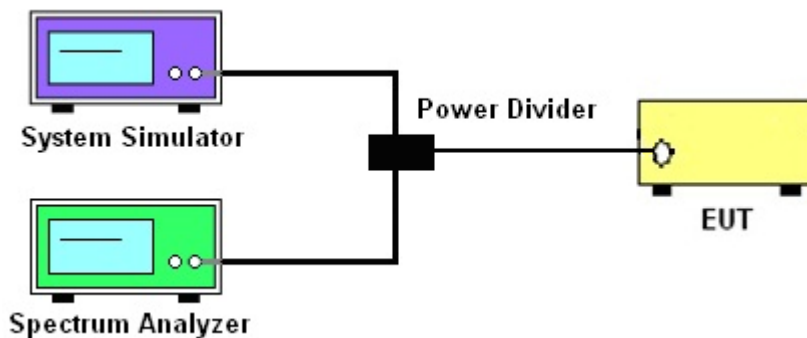

3.2.3 Frequency Stability

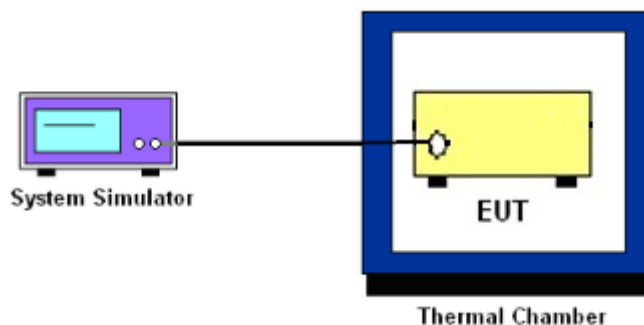

3.3 Test Result of Conducted Test

Please refer to Appendix A.



3.4 Conducted Output Power and ERP/EIRP

3.4.1 Description of the Conducted Output Power and ERP/EIRP

A system simulator was used to establish communication with the EUT. Its parameters were set to enforce EUT transmitting at the maximum power. The measured power in the radio frequency on the transmitter output terminals shall be reported.

The ERP of mobile transmitters must not exceed 7 Watts for GSM850 and WCDMA Band V.

The EIRP of mobile transmitters must not exceed 2 Watts for GSM1900 and WCDMA Band II.

The EIRP of mobile transmitters must not exceed 1 Watts for WCDMA Band IV.

According to KDB 412172 D01 Power Approach,

$EIRP = P_T + G_T - L_C$, $ERP = EIRP - 2.15$, where

P_T = transmitter output power in dBm

G_T = gain of the transmitting antenna in dBi

L_C = signal attenuation in the connecting cable between the transmitter and antenna in dB

3.4.2 Test Procedures

1. The transmitter output port was connected to the system simulator.
2. Set EUT at maximum power through system simulator.
3. Select lowest, middle, and highest channels for each band and different modulation.
4. Measure the maximum burst average power for GSM and maximum average power for other modulation signal.



3.5 Peak-to-Average Ratio

3.5.1 Description of the PAR Measurement

The peak-to-average ratio (PAR) of the transmission may not exceed 13 dB.

3.5.2 Test Procedures

1. The testing follows FCC KDB 971168 D01 v02r02 Section 5.7.1.
2. The EUT was connected to spectrum analyzer and system simulator via a power divider.
3. Set EUT to transmit at maximum output power.
4. When the duty cycle is less than 98%, then signal gating will be implemented on the spectrum analyzer by triggering from the system simulator.
5. Set the CCDF (Complementary Cumulative Distribution Function) option of the spectrum analyzer.
Record the maximum PAPR level associated with a probability of 0.1%.



3.6 99% Occupied Bandwidth and 26dB Bandwidth Measurement

3.6.1 Description of 99% Occupied Bandwidth and 26dB Bandwidth Measurement

The occupied bandwidth is the width of a frequency band such that, below the lower and above the upper frequency limits, the mean powers emitted are each equal to a specified percentage 0.5% of the total mean transmitted power.

The 26 dB emission bandwidth is defined as the frequency range between two points, one above and one below the carrier frequency, at which the spectral density of the emission is attenuated 26 dB below the maximum in-band spectral density of the modulated signal. Spectral density (power per unit bandwidth) is to be measured with a detector of resolution bandwidth equal to approximately 1.0% of the emission bandwidth.

3.6.2 Test Procedures

1. The testing follows FCC KDB 971168 v02r02 Section 4.2.
2. The EUT was connected to spectrum analyzer and system simulator via a power divider.
3. The spectrum analyzer center frequency is set to the nominal EUT channel center frequency. The span range for the spectrum analyzer shall be between two and five times the anticipated OBW.
4. The nominal resolution bandwidth (RBW) shall be in the range of 1 to 5 % of the anticipated OBW, and the VBW shall be at least 3 times the RBW.
5. Set the detection mode to peak, and the trace mode to max hold.
6. Determine the reference value: Set the EUT to transmit a modulated signal. Allow the trace to stabilize. Set the spectrum analyzer marker to the highest level of the displayed trace.
(this is the reference value)
7. Determine the “-26 dB down amplitude” as equal to (Reference Value – X).
8. Place two markers, one at the lowest and the other at the highest frequency of the envelope of the spectral display such that each marker is at or slightly below the “-X dB down amplitude” determined in step 6. If a marker is below this “-X dB down amplitude” value it shall be placed as close as possible to this value. The OBW is the positive frequency difference between the two markers.
9. Use the 99 % power bandwidth function of the spectrum analyzer and report the measured bandwidth.



3.7 Conducted Band Edge

3.7.1 Description of Conducted Band Edge Measurement

The power of any emission outside of the authorized operating frequency ranges must be lower than the transmitter power (P) by a factor of at least $43 + 10 \log (P)$ dB.

3.7.2 Test Procedures

1. The testing follows FCC KDB 971168 D01 v02r02 Section 6.0.
2. The EUT was connected to the spectrum analyzer and system simulator via a power divider.
3. The RF output of EUT was connected to the spectrum analyzer by an RF cable and attenuator. The path loss was compensated to the results for each measurement.
4. The band edges of low and high channels for the highest RF powers were measured.
5. The RF fundamental frequency should be excluded against the limit line in the operating frequency band.
6. The limit line is derived from $43 + 10\log(P)$ dB below the transmitter power P(Watts)



3.8 Conducted Spurious Emission

3.8.1 Description of Conducted Spurious Emission Measurement

The power of any emission outside of the authorized operating frequency ranges must be lower than the transmitter power (P) by a factor of at least $43 + 10 \log (P)$ dB.

It is measured by means of a calibrated spectrum analyzer and scanned from 30 MHz up to a frequency including its 10th harmonic.

3.8.2 Test Procedures

1. The testing follows FCC KDB 971168 D01 v02r02 Section 6.0.
2. The EUT was connected to the spectrum analyzer and system simulator via a power divider.
3. The RF output of EUT was connected to the spectrum analyzer by an RF cable and attenuator. The path loss was compensated to the results for each measurement.
4. The middle channel for the highest RF power within the transmitting frequency was measured.
5. The conducted spurious emission for the whole frequency range was taken.
6. The RF fundamental frequency should be excluded against the limit line in the operating frequency band.
7. The limit line is derived from $43 + 10\log(P)$ dB below the transmitter power P(Watts)



3.9 Frequency Stability

3.9.1 Description of Frequency Stability Measurement

The frequency stability shall be measured by variation of ambient temperature and variation of primary supply voltage to ensure that the fundamental emission stays within the authorized frequency block. The frequency stability of the transmitter shall be maintained within $\pm 0.00025\%$ ($\pm 2.5\text{ppm}$) of the center frequency.

3.9.2 Test Procedures for Temperature Variation

1. The testing follows FCC KDB 971168 D01 v02r02 Section 9.0.
2. The EUT was set up in the thermal chamber and connected with the system simulator.
3. With power OFF, the temperature was decreased to -30°C and the EUT was stabilized before testing. Power was applied and the maximum change in frequency was recorded within one minute.
4. With power OFF, the temperature was raised in 10°C steps up to 50°C . The EUT was stabilized at each step for at least half an hour. Power was applied and the maximum frequency change was recorded within one minute.

3.9.3 Test Procedures for Voltage Variation

1. The testing follows FCC KDB 971168 D01 v02r02 Section 9.0.
2. The EUT was placed in a temperature chamber at $20\pm 5^{\circ}\text{C}$ and connected with the system simulator.
3. The power supply voltage to the EUT was varied from 85% to 115% of the nominal value measured at the input to the EUT.
4. The variation in frequency was measured for the worst case.

4 Radiated Test Items

4.1 Measuring Instruments

See list of measuring instruments of this test report.

4.2 Test Setup

4.2.1 For radiated test from 30MHz to 1GHz

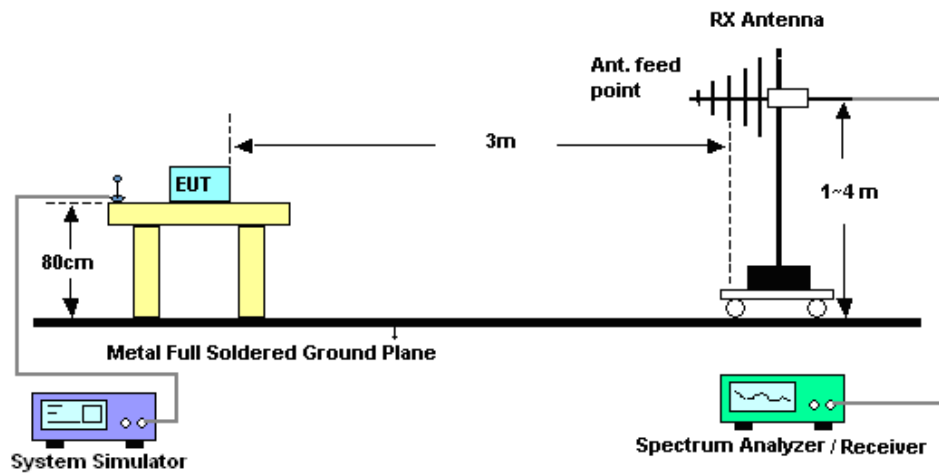

4.2.2 For radiated test above 1GHz

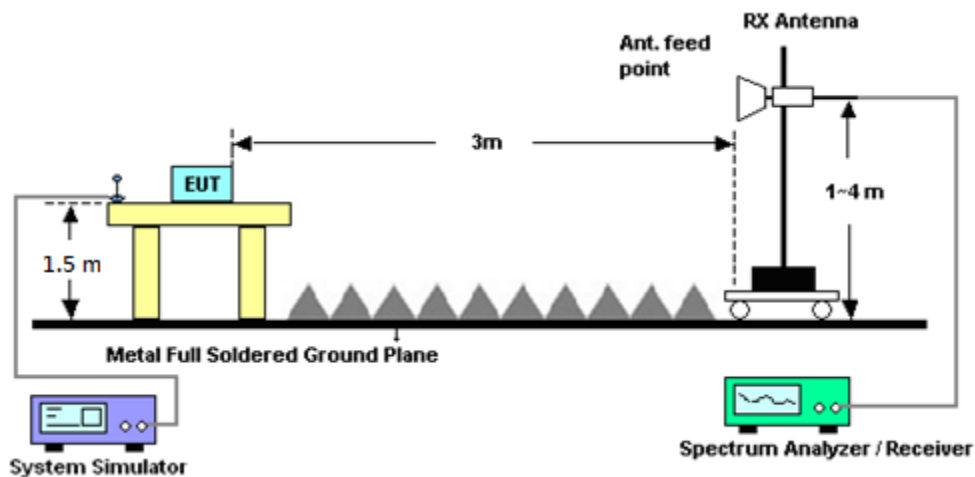

4.3 Test Result of Radiated Test

Please refer to Appendix B.



4.4 Field Strength of Spurious Radiation Measurement

4.4.1 Description of Field Strength of Spurious Radiated Measurement

The power of any emission outside of the authorized operating frequency ranges must be attenuated below the transmitter power (P) by a factor of at least $43 + 10 \log (P)$ dB. The spectrum is scanned from 30 MHz up to a frequency including its 10th harmonic.

4.4.2 Test Procedures

1. The testing follows FCC KDB 971168 D01 v02r02 Section 5.8 and ANSI / TIA-603-D-2010 Section 2.2.12.
2. The EUT was placed on a rotatable wooden table 0.8 meters for frequency below 1GHz and 1.5 meter for frequency above 1GHz above the ground.
3. The EUT was set 3 meters from the receiving antenna, which was mounted on the antenna tower.
4. The table was rotated 360 degrees to determine the position of the highest spurious emission.
5. The height of the receiving antenna is varied between one meter and four meters to search for the maximum spurious emission for both horizontal and vertical polarizations.
6. Make the measurement with the spectrum analyzer's RBW = 1MHz, VBW = 3MHz, taking record of maximum spurious emission.
7. A horn antenna was substituted in place of the EUT and was driven by a signal generator.
8. Tune the output power of signal generator to the same emission level with EUT maximum spurious emission.
9. Taking the record of output power at antenna port.
10. Repeat step 7 to step 8 for another polarization.
11. $EIRP \text{ (dBm)} = S.G. \text{ Power} - Tx \text{ Cable Loss} + Tx \text{ Antenna Gain}$
12. $ERP \text{ (dBm)} = EIRP - 2.15$
13. The RF fundamental frequency should be excluded against the limit line in the operating frequency band.
14. The limit line is derived from $43 + 10\log(P)$ dB below the transmitter power P(Watts)



5 List of Measuring Equipment

| Instrument | Manufacturer | Model No. | Serial No. | Characteristics | Calibration Date | Test Date | Due Date | Remark |
|---------------------------|-----------------|---------------------|-------------|----------------------------|------------------|----------------------------|---------------|-----------------------|
| Hygrometer | Testo | 608-H1 | 34893241 | N/A | Mar. 20, 2017 | May 11, 2017 | Mar. 19, 2018 | Conducted (TH03-HY) |
| Spectrum Analyzer | Rohde & Schwarz | FSP30 | 101329 | 9kHz~30GHz | Jun. 27, 2016 | May 11, 2017 | Jun. 26, 2017 | Conducted (TH03-HY) |
| Temperature Chamber | ESPEC | SU-641 | 92013721 | -30℃ ~70℃ | Nov. 16, 2016 | May 11, 2017 | Nov. 15, 2017 | Conducted (TH03-HY) |
| Programmable Power Supply | GW Instek | PSS-2005 | EL883644 | Voltage:0~20V;Current:0~5A | Nov. 22, 2016 | May 11, 2017 | Nov. 21, 2017 | Conducted (TH03-HY) |
| Base Station(Measure) | Rohde & Schwarz | CMU200 | 117995 | GSM / GPRS / WCDMA / CDMA | Aug. 05, 2016 | May 11, 2017 | Aug. 04, 2017 | Conducted (TH03-HY) |
| RF Cable | HUBER + SUHNER | SUCOFLEX 104 | MY84209521 | 1GHz~26GHz | Dec. 02, 2016 | May 11, 2017 | Dec. 01, 2017 | Conducted (TH03-HY) |
| Bilog Antenna | TESEQ | CBL 6111D&00800N | 35413&02 | 30MHz~1GHz | Jan. 07, 2017 | May 30, 2017~Jun. 07, 2017 | Jan. 06, 2018 | Radiation (03CH10-HY) |
| Horn Antenna | SCHWARZBECK | BBHA 9120 D | 9120D-1325 | 1GHz ~ 18GHz | Sep. 30, 2016 | May 30, 2017~Jun. 07, 2017 | Sep. 29, 2017 | Radiation (03CH10-HY) |
| Horn Antenna | SCHWARZBECK | BBHA 9120 D | 9120D-1326 | 1GHz ~ 18GHz | Oct. 07, 2016 | May 30, 2017~Jun. 07, 2017 | Oct. 06, 2017 | Radiation (03CH10-HY) |
| SHF-EHF Horn Antenna | SCHWARZBECK | BBHA 9170 | BBHA9170576 | 18GHz ~ 40GHz | Apr. 27, 2017 | May 30, 2017~Jun. 07, 2017 | Apr. 26, 2018 | Radiation (03CH10-HY) |
| SHF-EHF Horn Antenna | SCHWARZBECK | BBHA 9170 | BBHA9170584 | 18GHz- 40GHz | Nov. 08, 2016 | May 30, 2017~Jun. 07, 2017 | Nov. 07, 2017 | Radiation (03CH10-HY) |
| Amplifier | SONOMA | 310N | 187311 | 9kHz~1GHz | Oct. 26, 2016 | May 30, 2017~Jun. 07, 2017 | Oct. 25, 2017 | Radiation (03CH10-HY) |
| Preamplifier | Keysight | 83017A | MY53270078 | 1GHz~26.5GHz | Oct. 26, 2016 | May 30, 2017~Jun. 07, 2017 | Oct. 25, 2017 | Radiation (03CH10-HY) |
| Preamplifier | MITEQ | JS44-18004000-33-8P | 1840917 | 18GHz ~ 40GHz | Jun. 14, 2016 | May 30, 2017~Jun. 07, 2017 | Jun. 13, 2017 | Radiation (03CH10-HY) |
| Spectrum Analyzer | Keysight | N9010A | MY54200485 | 10Hz ~ 44GHz | Oct. 17, 2016 | May 30, 2017~Jun. 07, 2017 | Oct. 16, 2017 | Radiation (03CH10-HY) |



| Instrument | Manufacturer | Model No. | Serial No. | Characteristics | Calibration Date | Test Date | Due Date | Remark |
|------------------|-----------------|---------------------------|----------------------|-------------------------------|------------------|--------------------------------|---------------|--------------------------|
| Controller | EMEC | EM 1000 | N/A | Control Turn table & Ant Mast | N/A | May 30, 2017~ Jun. 07, 2017 | N/A | Radiation (03CH10-HY) |
| Antenna Mast | EMEC | AM-BS-4500-B | N/A | 1~4m | N/A | May 30, 2017~ Jun. 07, 2017 | N/A | Radiation (03CH10-HY) |
| Turn Table | EMEC | TT 2200 | N/A | 0~360 Degree | N/A | May 30, 2017~ Jun. 07, 2017 | N/A | Radiation (03CH10-HY) |
| Hygrometer | TECPEL | DTM-303B | TP140320 | N/A | Nov. 14, 2016 | May 30, 2017~ Jun. 07, 2017 | Nov. 13, 2017 | Radiation (03CH10-HY) |
| Signal Generator | Rohde & Schwarz | SMF100A | 101107 | 100kHz~40GHz | May 22, 2017 | May 30, 2017~ Jun. 07, 2017 | May 21, 2018 | Radiation (03CH10-HY) |
| RF Cable | HUBER + SUHNER | SUCOFLEX 104 | MY249564 MY249524 | 25GHz~40GHz | Sep. 30, 2016 | May 30, 2017~ Jun. 07, 2017 | Sep. 29, 2017 | Radiation (03CH10-HY) |
| RF Cable | HUBER + SUHNER | SUCOFLEX 104 | MY249564 MY249524 | 30MHz~1GHz | Sep. 30, 2016 | May 30, 2017~ Jun. 07, 2017 | Sep. 29, 2017 | Radiation (03CH10-HY) |
| RF Cable | HUBER + SUHNER | SUCOFLEX 104 | MY249564 MY249524 | 1GHz~25GHz | Sep. 30, 2016 | May 30, 2017~ Jun. 07, 2017 | Sep. 29, 2017 | Radiation (03CH10-HY) |
| Filter | Wainwright | WHKX12-1080-1200-1500-60S | SN2 | 1.2G High Pass | Sep. 19, 2016 | May 30, 2017~ Jun. 07, 2017 | Sep. 18, 2017 | Radiation (03CH10-HY) |
| Filter | Wainwright | H3G018G1 | SN477221 | 3.0 G High Pass | N/A | May 30, 2017~ Jun. 07, 2017 | N/A | Radiation (03CH10-HY) |
| Notch Filter | Wainwright | WRCG824/849-40/8SS | SN35 | CDMA 850 | Nov. 22, 2016 | May 30, 2017~ Jun. 07, 2017 | Nov. 21, 2017 | Radiation (03CH10-HY) |
| Notch Filter | Wainwright | WRCT1850/1910-40/8SS | SN21 | 1900 | Nov. 22, 2016 | May 30, 2017~ Jun. 07, 2017 | Nov. 21, 2017 | Radiation (03CH10-HY) |
| Notch Filter | Wainwright | WRCG1710/1755-1690-4 | SN2 | AWS Band | Nov. 21, 2016 | May 30, 2017~ Jun. 07, 2017 | Nov. 20, 2017 | Radiation (03CH10-HY) |
| Test Software | N/A | E3 | 6.2009-8-24 | N/A | N/A | May 30, 2017~ Jun. 07, 2017 | N/A | Radiation (03CH10-HY) |



6 Uncertainty of Evaluation

Uncertainty of Radiated Emission Measurement (30 MHz ~ 1000 MHz)

| | |
|---|------|
| Measuring Uncertainty for a Level of Confidence of 95% ($U = 2Uc(y)$) | 3.17 |
|---|------|

Uncertainty of Radiated Emission Measurement (1 GHz ~ 18 GHz)

| | |
|---|------|
| Measuring Uncertainty for a Level of Confidence of 95% ($U = 2Uc(y)$) | 3.48 |
|---|------|

Uncertainty of Radiated Emission Measurement (18 GHz ~ 40 GHz)

| | |
|---|------|
| Measuring Uncertainty for a Level of Confidence of 95% ($U = 2Uc(y)$) | 4.00 |
|---|------|



Appendix A. Test Results of Conducted Test

Conducted Output Power(Average power)

| Conducted Power (*Unit: dBm) | | | | | | |
|------------------------------|--------------|-------|--------------|---------|-------|--------------|
| Band | GSM850 | | | GSM1900 | | |
| Channel | 128 | 189 | 251 | 512 | 661 | 810 |
| Frequency | 824.2 | 836.4 | 848.8 | 1850.2 | 1880 | 1909.8 |
| GSM | 33.22 | 33.21 | 33.20 | 30.15 | 30.23 | 30.30 |
| GPRS class 8 | 33.24 | 33.22 | 33.21 | 30.15 | 30.24 | 30.31 |
| GPRS class 10 | 30.61 | 30.54 | 30.55 | 27.28 | 27.44 | 27.59 |
| GPRS class 11 | 28.62 | 28.62 | 28.62 | 25.61 | 25.79 | 25.97 |
| GPRS class 12 | 27.51 | 27.43 | 27.45 | 24.37 | 24.56 | 24.73 |
| EGPRS class 8 | 27.10 | 27.16 | 27.23 | 25.30 | 25.51 | 25.55 |
| EGPRS class 10 | 26.88 | 26.93 | 27.04 | 25.23 | 25.45 | 25.44 |
| EGPRS class 11 | 26.64 | 26.71 | 26.83 | 24.76 | 24.91 | 24.96 |
| EGPRS class 12 | 26.38 | 26.41 | 26.55 | 24.57 | 24.64 | 24.67 |

| Conducted Power (*Unit: dBm) | | | | | | |
|------------------------------|--------------|-------|--------------|---------------|-------|--------------|
| Band | WCDMA Band V | | | WCDMA Band II | | |
| Channel | 4132 | 4182 | 4233 | 9262 | 9400 | 9538 |
| Frequency | 826.4 | 836.4 | 846.6 | 1852.4 | 1880 | 1907.6 |
| RMC 12.2K | 24.26 | 24.28 | 24.30 | 23.88 | 23.87 | 23.94 |
| HSDPA Subtest-1 | 23.33 | 23.35 | 23.36 | 22.89 | 22.92 | 22.98 |
| HSDPA Subtest-2 | 23.32 | 23.31 | 23.24 | 22.90 | 22.94 | 22.97 |
| HSDPA Subtest-3 | 22.84 | 22.82 | 22.93 | 22.38 | 22.46 | 22.49 |
| HSDPA Subtest-4 | 22.81 | 22.84 | 22.91 | 22.41 | 22.47 | 22.48 |
| HSUPA Subtest-1 | 21.51 | 21.57 | 21.59 | 20.95 | 20.94 | 20.98 |
| HSUPA Subtest-2 | 21.31 | 21.37 | 21.41 | 20.91 | 20.93 | 20.99 |
| HSUPA Subtest-3 | 22.28 | 22.33 | 22.36 | 21.89 | 21.91 | 21.95 |
| HSUPA Subtest-4 | 20.84 | 20.89 | 20.91 | 20.41 | 20.43 | 20.49 |
| HSUPA Subtest-5 | 22.30 | 22.36 | 22.41 | 21.82 | 21.91 | 22.00 |

| Conducted Power (*Unit: dBm) | | | |
|------------------------------|---------------|--------|--------------|
| Band | WCDMA Band IV | | |
| Channel | 1312 | 1413 | 1513 |
| Frequency | 1712.4 | 1732.6 | 1752.6 |
| RMC 12.2K | 23.27 | 23.29 | 23.30 |
| HSDPA Subtest-1 | 22.32 | 22.28 | 22.34 |
| HSDPA Subtest-2 | 22.33 | 22.31 | 22.33 |
| HSDPA Subtest-3 | 21.86 | 21.82 | 21.89 |
| HSDPA Subtest-4 | 21.87 | 21.85 | 21.86 |
| HSUPA Subtest-1 | 20.53 | 20.52 | 20.51 |
| HSUPA Subtest-2 | 20.33 | 20.29 | 20.35 |
| HSUPA Subtest-3 | 21.28 | 21.31 | 21.36 |
| HSUPA Subtest-4 | 19.85 | 19.87 | 19.84 |
| HSUPA Subtest-5 | 21.34 | 21.31 | 21.33 |



A2. GSM

Peak-to-Average Ratio

| Mode | GSM850 | | Limit: 13dB |
|------------|--------------|--------------|-------------|
| Mod. | GPRS class 8 | EDGE class 8 | Result |
| Lowest CH | 0.16 | 3.36 | PASS |
| Middle CH | 0.16 | 3.16 | |
| Highest CH | 0.12 | 3.08 | |

| Mode | GSM1900 | | Limit: 13dB |
|------------|--------------|--------------|-------------|
| Mod. | GPRS class 8 | EDGE class 8 | Result |
| Lowest CH | 0.12 | 3.48 | PASS |
| Middle CH | 0.16 | 3.40 | |
| Highest CH | 0.12 | 3.40 | |



| GSM850 (GPRS class 8) | GSM850 (EDGE class 8) |
|---|---|
| <p align="center">Lowest Channel</p> <p>Ref: 35 dBm *Att: 30 dB RBW: 10 MHz AQT: 3.125 ms</p> <p>Center: 824.2 MHz 2 dB/ Mean Pwr: +20 dB</p> <p>Complementary Cumulative Distribution Function (100000 samples)</p> <p>Trace 1</p> <p>Mean: 31.94 dBm Peak: 32.08 dBm Crest: 0.14 dB</p> <p>10 %: 0.08 dB 1 %: 0.16 dB .1 %: 0.16 dB .01 %: 0.16 dB</p> <p>Date: 15.OCT.2016 04:43:37</p> | <p align="center">Lowest Channel</p> <p>Ref: 35 dBm *Att: 30 dB RBW: 10 MHz AQT: 3.125 ms</p> <p>Center: 824.2 MHz 2 dB/ Mean Pwr: +20 dB</p> <p>Complementary Cumulative Distribution Function (100000 samples)</p> <p>Trace 1</p> <p>Mean: 26.04 dBm Peak: 29.47 dBm Crest: 3.43 dB</p> <p>10 %: 2.52 dB 1 %: 3.16 dB .1 %: 3.36 dB .01 %: 3.44 dB</p> <p>Date: 15.OCT.2016 05:00:11</p> |
| <p align="center">Middle Channel</p> <p>Ref: 35 dBm *Att: 30 dB RBW: 10 MHz AQT: 3.125 ms</p> <p>Center: 836.4 MHz 2 dB/ Mean Pwr: +20 dB</p> <p>Complementary Cumulative Distribution Function (100000 samples)</p> <p>Trace 1</p> <p>Mean: 32.09 dBm Peak: 32.22 dBm Crest: 0.13 dB</p> <p>10 %: 0.08 dB 1 %: 0.16 dB .1 %: 0.16 dB .01 %: 0.16 dB</p> <p>Date: 15.OCT.2016 04:44:30</p> | <p align="center">Middle Channel</p> <p>Ref: 35 dBm *Att: 30 dB RBW: 10 MHz AQT: 3.125 ms</p> <p>Center: 836.4 MHz 2 dB/ Mean Pwr: +20 dB</p> <p>Complementary Cumulative Distribution Function (100000 samples)</p> <p>Trace 1</p> <p>Mean: 26.34 dBm Peak: 29.61 dBm Crest: 3.27 dB</p> <p>10 %: 2.48 dB 1 %: 3.04 dB .1 %: 3.16 dB .01 %: 3.28 dB</p> <p>Date: 15.OCT.2016 05:01:18</p> |
| <p align="center">Highest Channel</p> <p>Ref: 35 dBm *Att: 30 dB RBW: 10 MHz AQT: 3.125 ms</p> <p>Center: 848.8 MHz 2 dB/ Mean Pwr: +20 dB</p> <p>Complementary Cumulative Distribution Function (100000 samples)</p> <p>Trace 1</p> <p>Mean: 32.12 dBm Peak: 32.22 dBm Crest: 0.10 dB</p> <p>10 %: 0.12 dB 1 %: 0.12 dB .1 %: 0.12 dB .01 %: 0.12 dB</p> <p>Date: 15.OCT.2016 04:45:16</p> | <p align="center">Highest Channel</p> <p>Ref: 35 dBm *Att: 30 dB RBW: 10 MHz AQT: 3.125 ms</p> <p>Center: 848.8 MHz 2 dB/ Mean Pwr: +20 dB</p> <p>Complementary Cumulative Distribution Function (100000 samples)</p> <p>Trace 1</p> <p>Mean: 26.42 dBm Peak: 29.54 dBm Crest: 3.12 dB</p> <p>10 %: 2.44 dB 1 %: 3.00 dB .1 %: 3.08 dB .01 %: 3.16 dB</p> <p>Date: 15.OCT.2016 05:02:15</p> |

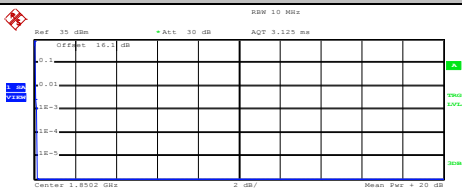
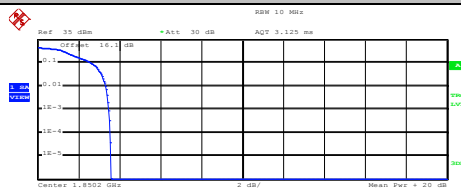
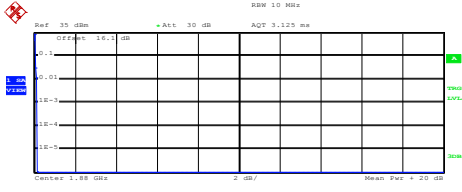
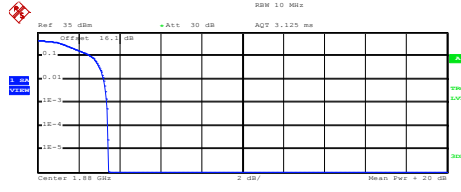
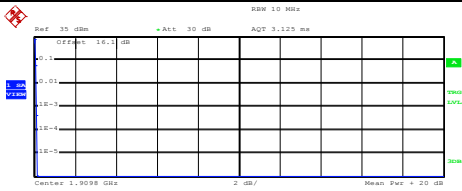
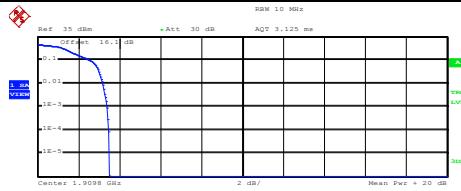

| GSM1900 (GPRS class 8) | GSM1900 (EDGE class 8) | | | | | | | | | | | | | | | | | | | | | | | | | | | | |
|--|------------------------|-----------|------|-----------|-------|---------|------|---------|-----|---------|------|---------|-------|---------|--|------|-----------|------|-----------|-------|---------|------|---------|-----|---------|------|---------|-------|---------|
| <p align="center">Lowest Channel</p>  <p>Ref: 35 dBm, Att: 30 dB, AQT: 3.125 ms, RBW: 10 MHz, Offset: 16.3 dB</p> <p>Center: 1.8502 GHz, 2 dB, Mean Pwr: +20 dB</p> <p>Complementary Cumulative Distribution Function (100000 samples)</p> <p>Trace 1</p> <table border="1"> <tr><td>Mean</td><td>28.47 dBm</td></tr> <tr><td>Peak</td><td>28.62 dBm</td></tr> <tr><td>Crest</td><td>0.15 dB</td></tr> </table> <table border="1"> <tr><td>10 %</td><td>0.08 dB</td></tr> <tr><td>1 %</td><td>0.08 dB</td></tr> <tr><td>.1 %</td><td>0.12 dB</td></tr> <tr><td>.01 %</td><td>0.16 dB</td></tr> </table> <p>Date: 15.OCT.2016 05:17:24</p> | Mean | 28.47 dBm | Peak | 28.62 dBm | Crest | 0.15 dB | 10 % | 0.08 dB | 1 % | 0.08 dB | .1 % | 0.12 dB | .01 % | 0.16 dB | <p align="center">Lowest Channel</p>  <p>Ref: 35 dBm, Att: 30 dB, AQT: 3.125 ms, RBW: 10 MHz, Offset: 16.3 dB</p> <p>Center: 1.8502 GHz, 2 dB, Mean Pwr: +20 dB</p> <p>Complementary Cumulative Distribution Function (100000 samples)</p> <p>Trace 1</p> <table border="1"> <tr><td>Mean</td><td>23.02 dBm</td></tr> <tr><td>Peak</td><td>26.57 dBm</td></tr> <tr><td>Crest</td><td>3.56 dB</td></tr> </table> <table border="1"> <tr><td>10 %</td><td>2.64 dB</td></tr> <tr><td>1 %</td><td>3.32 dB</td></tr> <tr><td>.1 %</td><td>3.48 dB</td></tr> <tr><td>.01 %</td><td>3.56 dB</td></tr> </table> <p>Date: 5.NOV.2016 09:24:19</p> | Mean | 23.02 dBm | Peak | 26.57 dBm | Crest | 3.56 dB | 10 % | 2.64 dB | 1 % | 3.32 dB | .1 % | 3.48 dB | .01 % | 3.56 dB |
| Mean | 28.47 dBm | | | | | | | | | | | | | | | | | | | | | | | | | | | | |
| Peak | 28.62 dBm | | | | | | | | | | | | | | | | | | | | | | | | | | | | |
| Crest | 0.15 dB | | | | | | | | | | | | | | | | | | | | | | | | | | | | |
| 10 % | 0.08 dB | | | | | | | | | | | | | | | | | | | | | | | | | | | | |
| 1 % | 0.08 dB | | | | | | | | | | | | | | | | | | | | | | | | | | | | |
| .1 % | 0.12 dB | | | | | | | | | | | | | | | | | | | | | | | | | | | | |
| .01 % | 0.16 dB | | | | | | | | | | | | | | | | | | | | | | | | | | | | |
| Mean | 23.02 dBm | | | | | | | | | | | | | | | | | | | | | | | | | | | | |
| Peak | 26.57 dBm | | | | | | | | | | | | | | | | | | | | | | | | | | | | |
| Crest | 3.56 dB | | | | | | | | | | | | | | | | | | | | | | | | | | | | |
| 10 % | 2.64 dB | | | | | | | | | | | | | | | | | | | | | | | | | | | | |
| 1 % | 3.32 dB | | | | | | | | | | | | | | | | | | | | | | | | | | | | |
| .1 % | 3.48 dB | | | | | | | | | | | | | | | | | | | | | | | | | | | | |
| .01 % | 3.56 dB | | | | | | | | | | | | | | | | | | | | | | | | | | | | |
| <p align="center">Middle Channel</p>  <p>Ref: 35 dBm, Att: 30 dB, AQT: 3.125 ms, RBW: 10 MHz, Offset: 16.3 dB</p> <p>Center: 1.88 GHz, 2 dB, Mean Pwr: +20 dB</p> <p>Complementary Cumulative Distribution Function (100000 samples)</p> <p>Trace 1</p> <table border="1"> <tr><td>Mean</td><td>28.27 dBm</td></tr> <tr><td>Peak</td><td>28.41 dBm</td></tr> <tr><td>Crest</td><td>0.14 dB</td></tr> </table> <table border="1"> <tr><td>10 %</td><td>0.08 dB</td></tr> <tr><td>1 %</td><td>0.12 dB</td></tr> <tr><td>.1 %</td><td>0.16 dB</td></tr> <tr><td>.01 %</td><td>0.16 dB</td></tr> </table> <p>Date: 15.OCT.2016 05:18:18</p> | Mean | 28.27 dBm | Peak | 28.41 dBm | Crest | 0.14 dB | 10 % | 0.08 dB | 1 % | 0.12 dB | .1 % | 0.16 dB | .01 % | 0.16 dB | <p align="center">Middle Channel</p>  <p>Ref: 35 dBm, Att: 30 dB, AQT: 3.125 ms, RBW: 10 MHz, Offset: 16.3 dB</p> <p>Center: 1.88 GHz, 2 dB, Mean Pwr: +20 dB</p> <p>Complementary Cumulative Distribution Function (100000 samples)</p> <p>Trace 1</p> <table border="1"> <tr><td>Mean</td><td>23.14 dBm</td></tr> <tr><td>Peak</td><td>26.57 dBm</td></tr> <tr><td>Crest</td><td>3.43 dB</td></tr> </table> <table border="1"> <tr><td>10 %</td><td>2.60 dB</td></tr> <tr><td>1 %</td><td>3.24 dB</td></tr> <tr><td>.1 %</td><td>3.40 dB</td></tr> <tr><td>.01 %</td><td>3.44 dB</td></tr> </table> <p>Date: 5.NOV.2016 09:24:57</p> | Mean | 23.14 dBm | Peak | 26.57 dBm | Crest | 3.43 dB | 10 % | 2.60 dB | 1 % | 3.24 dB | .1 % | 3.40 dB | .01 % | 3.44 dB |
| Mean | 28.27 dBm | | | | | | | | | | | | | | | | | | | | | | | | | | | | |
| Peak | 28.41 dBm | | | | | | | | | | | | | | | | | | | | | | | | | | | | |
| Crest | 0.14 dB | | | | | | | | | | | | | | | | | | | | | | | | | | | | |
| 10 % | 0.08 dB | | | | | | | | | | | | | | | | | | | | | | | | | | | | |
| 1 % | 0.12 dB | | | | | | | | | | | | | | | | | | | | | | | | | | | | |
| .1 % | 0.16 dB | | | | | | | | | | | | | | | | | | | | | | | | | | | | |
| .01 % | 0.16 dB | | | | | | | | | | | | | | | | | | | | | | | | | | | | |
| Mean | 23.14 dBm | | | | | | | | | | | | | | | | | | | | | | | | | | | | |
| Peak | 26.57 dBm | | | | | | | | | | | | | | | | | | | | | | | | | | | | |
| Crest | 3.43 dB | | | | | | | | | | | | | | | | | | | | | | | | | | | | |
| 10 % | 2.60 dB | | | | | | | | | | | | | | | | | | | | | | | | | | | | |
| 1 % | 3.24 dB | | | | | | | | | | | | | | | | | | | | | | | | | | | | |
| .1 % | 3.40 dB | | | | | | | | | | | | | | | | | | | | | | | | | | | | |
| .01 % | 3.44 dB | | | | | | | | | | | | | | | | | | | | | | | | | | | | |
| <p align="center">Highest Channel</p>  <p>Ref: 35 dBm, Att: 30 dB, AQT: 3.125 ms, RBW: 10 MHz, Offset: 16.3 dB</p> <p>Center: 1.9098 GHz, 2 dB, Mean Pwr: +20 dB</p> <p>Complementary Cumulative Distribution Function (100000 samples)</p> <p>Trace 1</p> <table border="1"> <tr><td>Mean</td><td>28.32 dBm</td></tr> <tr><td>Peak</td><td>28.48 dBm</td></tr> <tr><td>Crest</td><td>0.16 dB</td></tr> </table> <table border="1"> <tr><td>10 %</td><td>0.08 dB</td></tr> <tr><td>1 %</td><td>0.12 dB</td></tr> <tr><td>.1 %</td><td>0.12 dB</td></tr> <tr><td>.01 %</td><td>0.16 dB</td></tr> </table> <p>Date: 15.OCT.2016 05:19:05</p> | Mean | 28.32 dBm | Peak | 28.48 dBm | Crest | 0.16 dB | 10 % | 0.08 dB | 1 % | 0.12 dB | .1 % | 0.12 dB | .01 % | 0.16 dB | <p align="center">Highest Channel</p>  <p>Ref: 35 dBm, Att: 30 dB, AQT: 3.125 ms, RBW: 10 MHz, Offset: 16.3 dB</p> <p>Center: 1.9098 GHz, 2 dB, Mean Pwr: +20 dB</p> <p>Complementary Cumulative Distribution Function (100000 samples)</p> <p>Trace 1</p> <table border="1"> <tr><td>Mean</td><td>23.15 dBm</td></tr> <tr><td>Peak</td><td>26.64 dBm</td></tr> <tr><td>Crest</td><td>3.49 dB</td></tr> </table> <table border="1"> <tr><td>10 %</td><td>2.56 dB</td></tr> <tr><td>1 %</td><td>3.20 dB</td></tr> <tr><td>.1 %</td><td>3.40 dB</td></tr> <tr><td>.01 %</td><td>3.48 dB</td></tr> </table> <p>Date: 5.NOV.2016 09:25:14</p> | Mean | 23.15 dBm | Peak | 26.64 dBm | Crest | 3.49 dB | 10 % | 2.56 dB | 1 % | 3.20 dB | .1 % | 3.40 dB | .01 % | 3.48 dB |
| Mean | 28.32 dBm | | | | | | | | | | | | | | | | | | | | | | | | | | | | |
| Peak | 28.48 dBm | | | | | | | | | | | | | | | | | | | | | | | | | | | | |
| Crest | 0.16 dB | | | | | | | | | | | | | | | | | | | | | | | | | | | | |
| 10 % | 0.08 dB | | | | | | | | | | | | | | | | | | | | | | | | | | | | |
| 1 % | 0.12 dB | | | | | | | | | | | | | | | | | | | | | | | | | | | | |
| .1 % | 0.12 dB | | | | | | | | | | | | | | | | | | | | | | | | | | | | |
| .01 % | 0.16 dB | | | | | | | | | | | | | | | | | | | | | | | | | | | | |
| Mean | 23.15 dBm | | | | | | | | | | | | | | | | | | | | | | | | | | | | |
| Peak | 26.64 dBm | | | | | | | | | | | | | | | | | | | | | | | | | | | | |
| Crest | 3.49 dB | | | | | | | | | | | | | | | | | | | | | | | | | | | | |
| 10 % | 2.56 dB | | | | | | | | | | | | | | | | | | | | | | | | | | | | |
| 1 % | 3.20 dB | | | | | | | | | | | | | | | | | | | | | | | | | | | | |
| .1 % | 3.40 dB | | | | | | | | | | | | | | | | | | | | | | | | | | | | |
| .01 % | 3.48 dB | | | | | | | | | | | | | | | | | | | | | | | | | | | | |



26dB Bandwidth

| Mode | GSM850 : 26dB BW(MHz) | |
|------------|-----------------------|--------------|
| Mod. | GPRS class 8 | EDGE class 8 |
| Lowest CH | 0.314 | 0.284 |
| Middle CH | 0.291 | 0.260 |
| Highest CH | 0.297 | 0.291 |

| Mode | GSM1900 : 26dB BW(MHz) | |
|------------|------------------------|--------------|
| Mod. | GPRS class 8 | EDGE class 8 |
| Lowest CH | 0.301 | 0.302 |
| Middle CH | 0.304 | 0.306 |
| Highest CH | 0.312 | 0.304 |

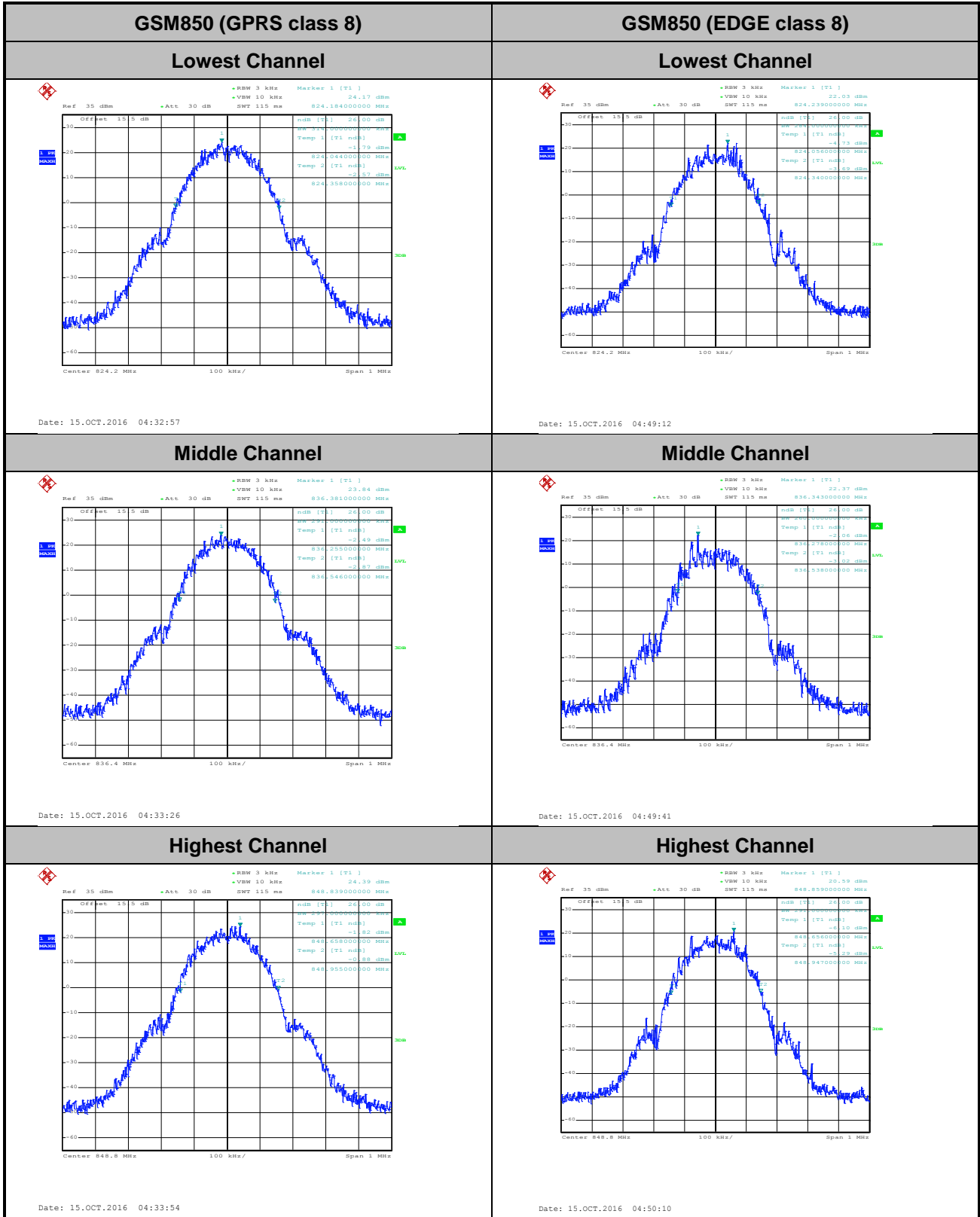

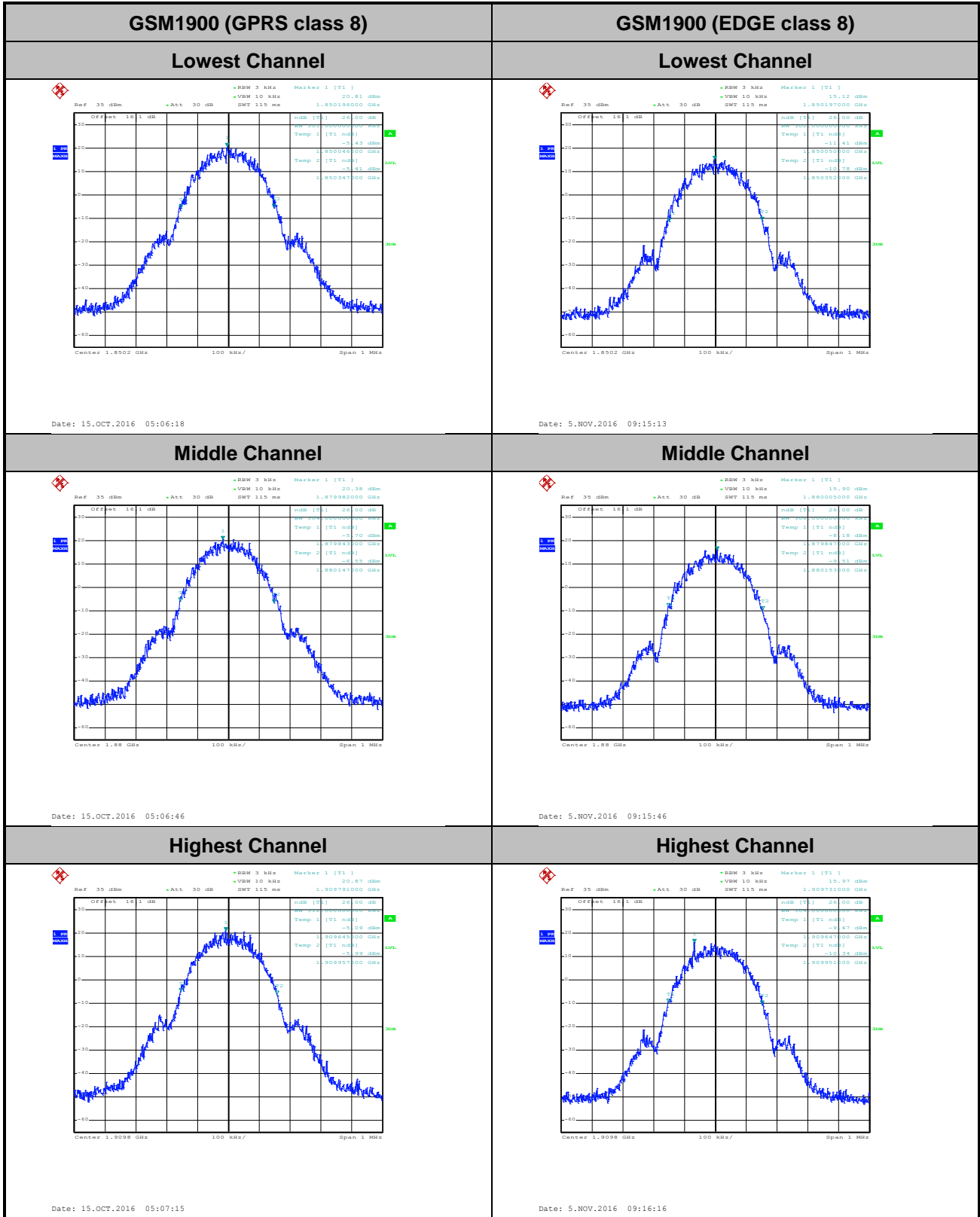



Occupied Bandwidth

| Mode | GSM850 : 99%OBW(MHz) | |
|------------|----------------------|--------------|
| Mod. | GPRS class 8 | EDGE class 8 |
| Lowest CH | 0.244 | 0.242 |
| Middle CH | 0.246 | 0.245 |
| Highest CH | 0.245 | 0.241 |

| Mode | GSM1900 : 99%OBW(MHz) | |
|------------|-----------------------|--------------|
| Mod. | GPRS class 8 | EDGE class 8 |
| Lowest CH | 0.247 | 0.248 |
| Middle CH | 0.245 | 0.246 |
| Highest CH | 0.242 | 0.241 |

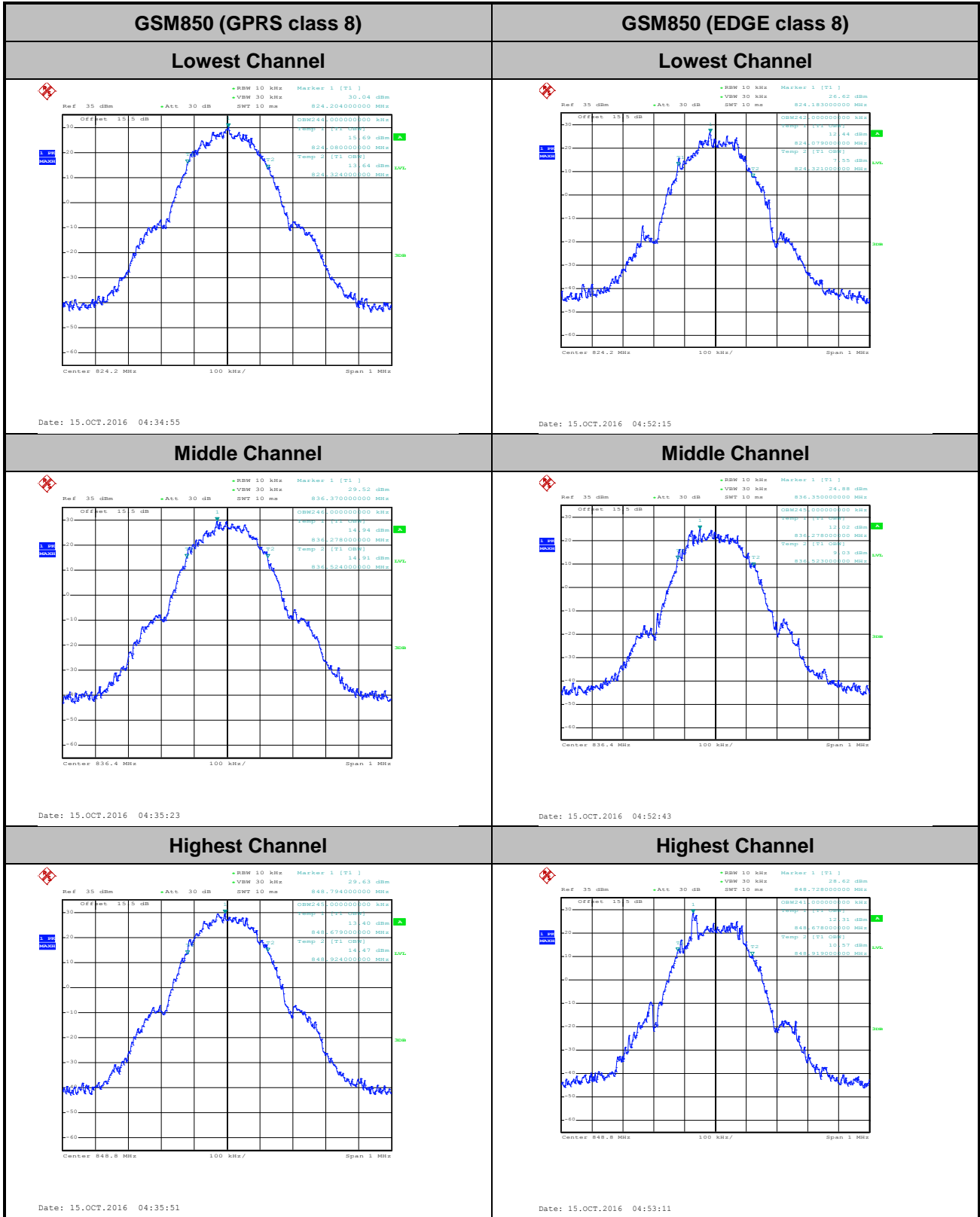

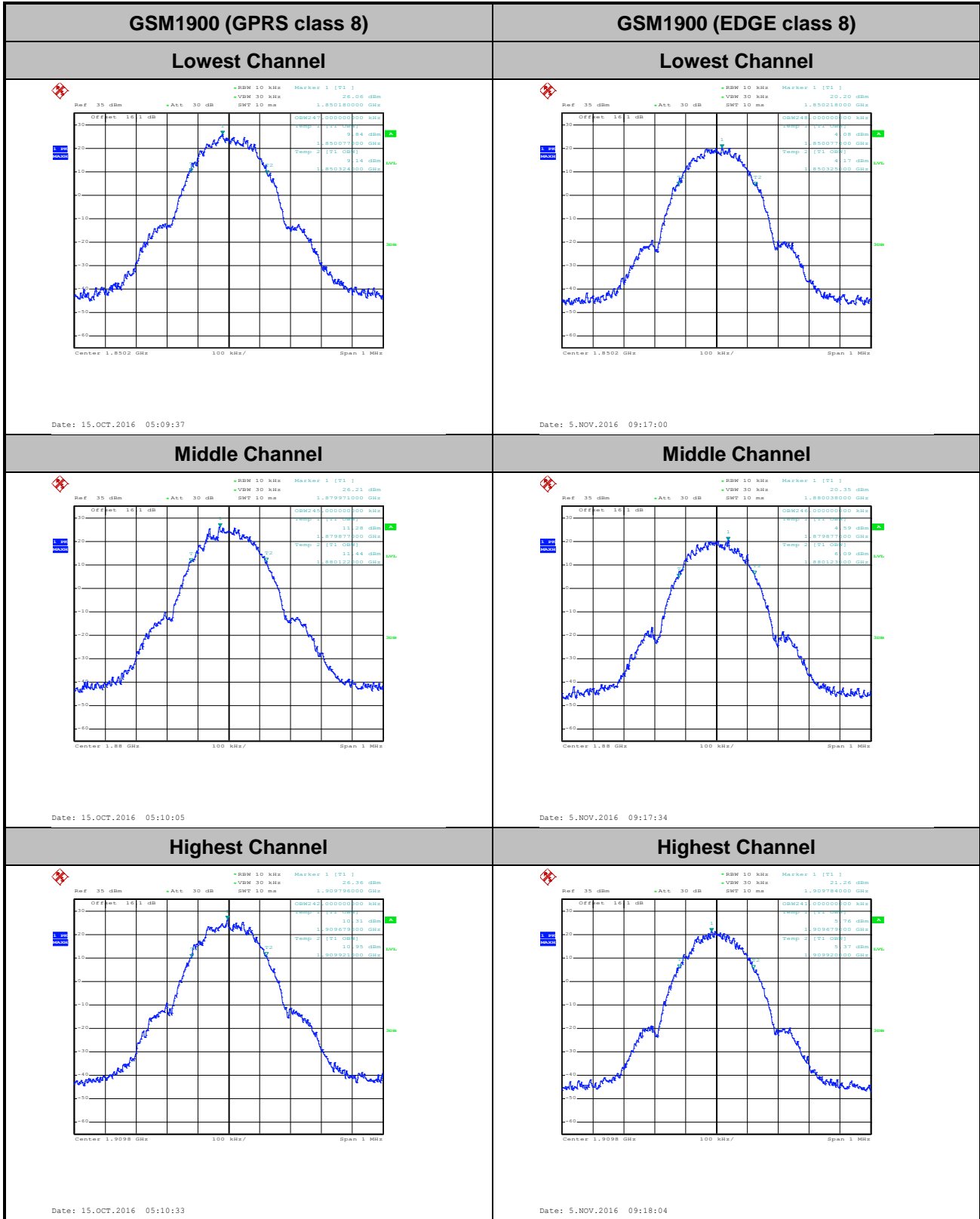



Conducted Band Edge

GSM850 (GPRS class 8)

Lowest Band Edge

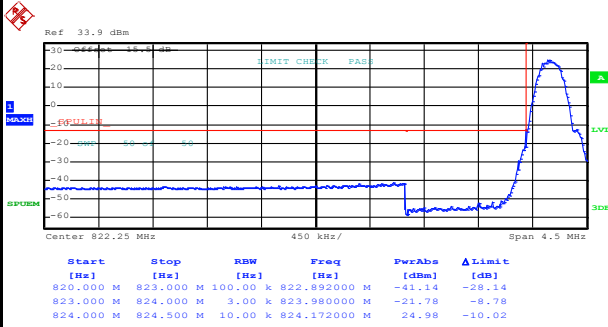

Date: 15.OCT.2016 04:37:30

Highest Band Edge

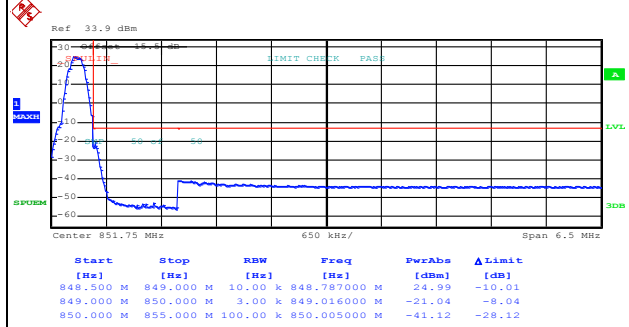

Date: 15.OCT.2016 04:38:58

GSM850 (EDGE class 8)

Lowest Band Edge

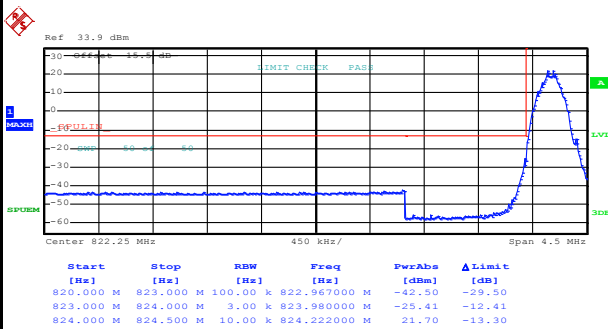

Date: 15.OCT.2016 04:54:42

Highest Band Edge

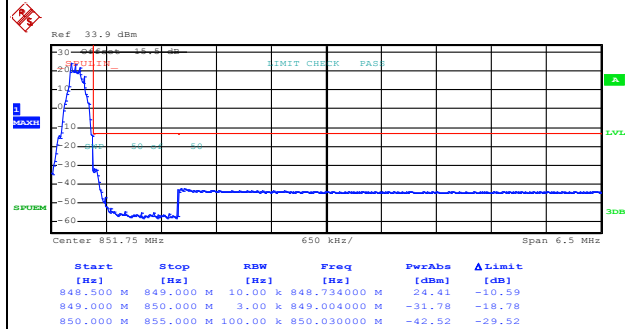

Date: 15.OCT.2016 04:56:10



GSM1900 (GPRS class 8)

Lowest Band Edge

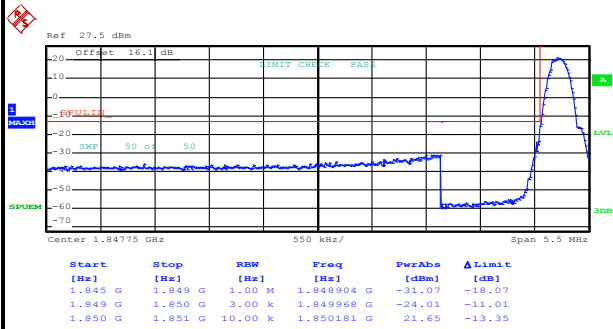

Date: 15.OCT.2016 05:12:12

Highest Band Edge

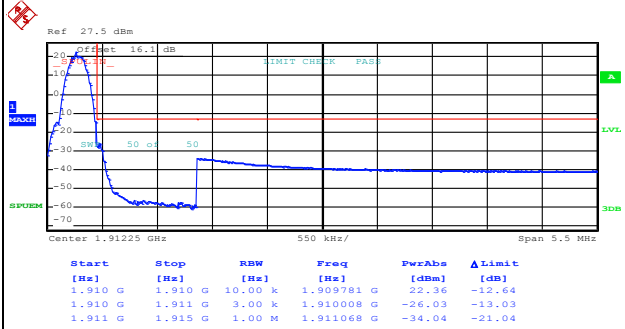

Date: 15.OCT.2016 05:13:40

GSM1900 (EDGE class 8)

Lowest Band Edge

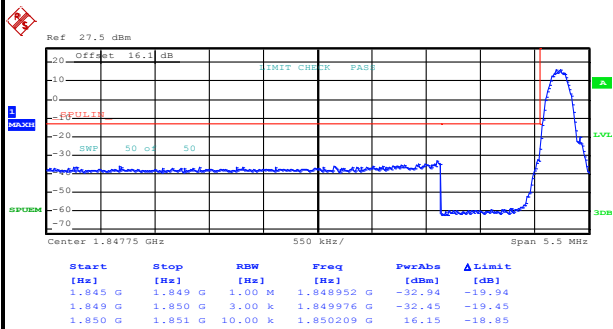

Date: 5.NOV.2016 09:19:37

Highest Band Edge

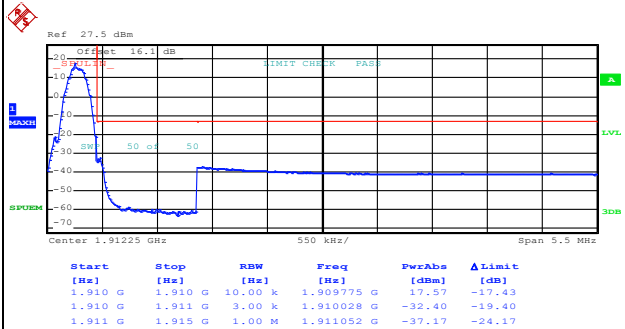

Date: 5.NOV.2016 09:21:06



Conducted Spurious Emission

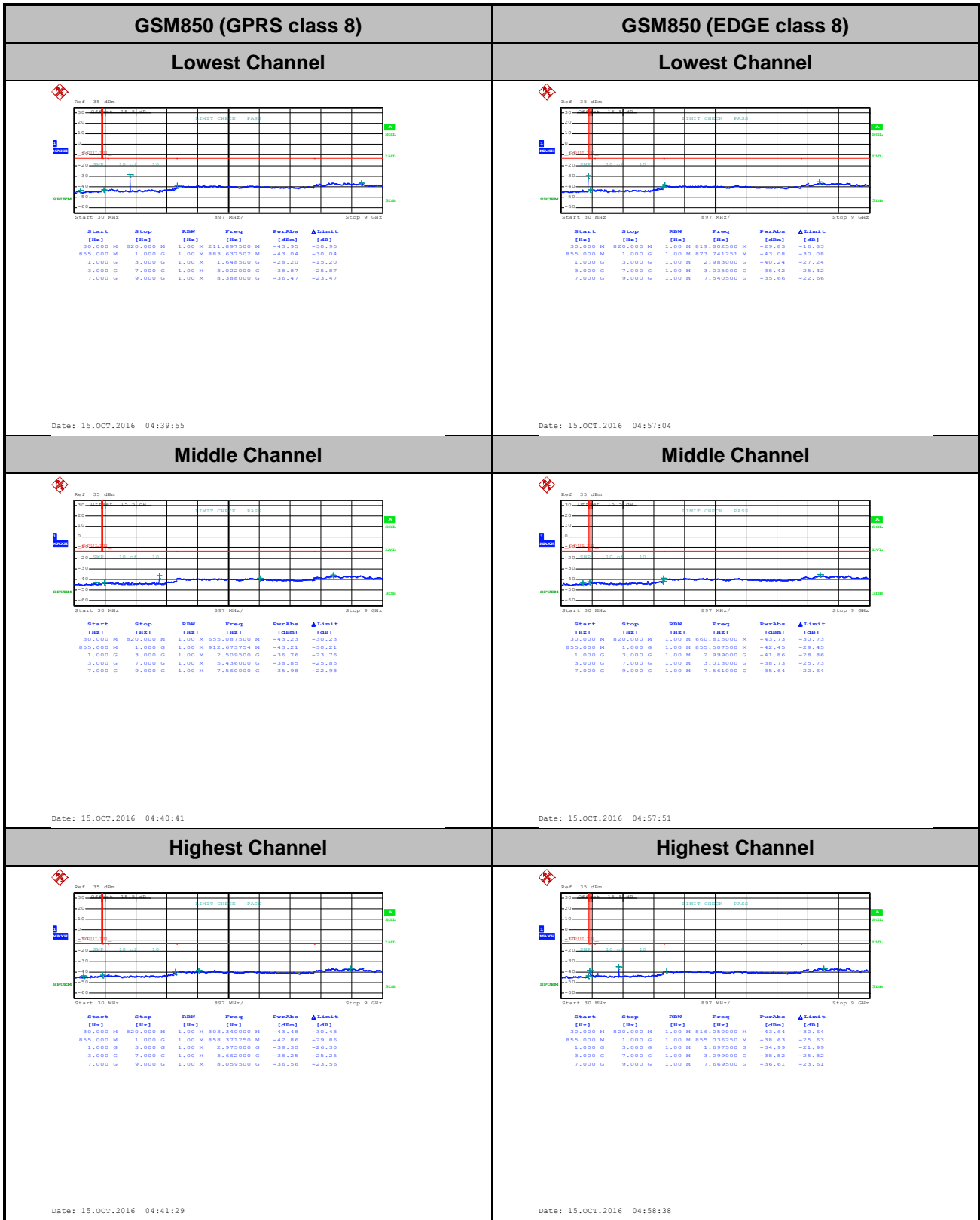

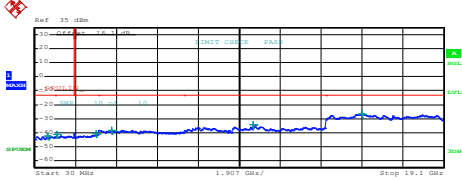
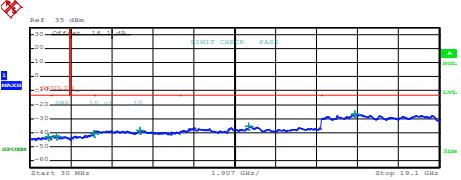
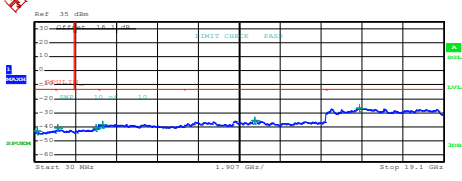
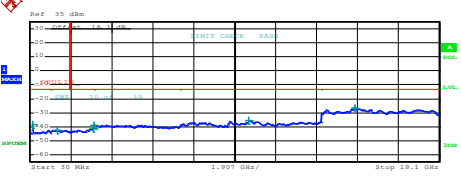
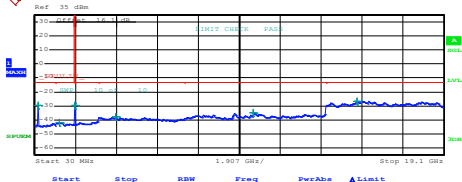
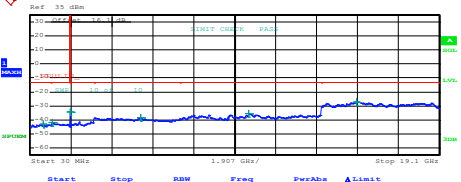

| GSM1900 (GPRS class 8) | GSM1900 (EDGE class 8) | | | | | | | | | | | | | | | | | | | | | | | | | | | | | | | | | | | | | | | | | | | | | | | | | | | | | | | | | | | | | | | | | | | | | | | | | | | | | | | | | | | | |
|---|------------------------|-----------|--------------|--------------|--------------|-------------|-----------|----------|---------|--------------|--------|--------|----------|---------|---------|------------|--------|--------|---------|----------|---------|-------------|--------|--------|----------|----------|---------|------------|--------|--------|----------|-----------|---------|-------------|--------|--------|-----------|-----------|---------|--------------|--------|--------|--|------------|-----------|----------|-----------|--------------|-------------|-----------|----------|---------|--------------|--------|--------|----------|---------|---------|------------|--------|--------|---------|----------|---------|------------|--------|--------|----------|----------|---------|------------|--------|--------|----------|-----------|---------|-------------|--------|--------|-----------|-----------|---------|-------------|--------|--------|
| Lowest Channel | Lowest Channel | | | | | | | | | | | | | | | | | | | | | | | | | | | | | | | | | | | | | | | | | | | | | | | | | | | | | | | | | | | | | | | | | | | | | | | | | | | | | | | | | | | | |
|  <table border="1" data-bbox="239 571 638 672"> <thead> <tr> <th>Start [Hz]</th> <th>Stop [Hz]</th> <th>RBW [Hz]</th> <th>Freq [Hz]</th> <th>PwrAve [dBm]</th> <th>ΔLimit [dB]</th> </tr> </thead> <tbody> <tr><td>30.0000 M</td><td>1.0000 G</td><td>1.000 M</td><td>626.030000 M</td><td>-42.93</td><td>-29.93</td></tr> <tr><td>1.0000 G</td><td>1.845 G</td><td>1.000 M</td><td>1.073304 G</td><td>-41.97</td><td>-28.97</td></tr> <tr><td>1.845 G</td><td>3.0000 G</td><td>1.000 M</td><td>2.1884719 G</td><td>-40.82</td><td>-27.82</td></tr> <tr><td>3.0000 G</td><td>7.0000 G</td><td>1.000 M</td><td>3.606000 G</td><td>-38.45</td><td>-25.45</td></tr> <tr><td>7.0000 G</td><td>13.6000 G</td><td>1.000 M</td><td>10.224925 G</td><td>-34.42</td><td>-21.42</td></tr> <tr><td>13.6000 G</td><td>19.1000 G</td><td>1.000 M</td><td>15.1296750 G</td><td>-26.83</td><td>-13.83</td></tr> </tbody> </table> <p>Date: 15.OCT.2016 05:14:52</p> | Start [Hz] | Stop [Hz] | RBW [Hz] | Freq [Hz] | PwrAve [dBm] | ΔLimit [dB] | 30.0000 M | 1.0000 G | 1.000 M | 626.030000 M | -42.93 | -29.93 | 1.0000 G | 1.845 G | 1.000 M | 1.073304 G | -41.97 | -28.97 | 1.845 G | 3.0000 G | 1.000 M | 2.1884719 G | -40.82 | -27.82 | 3.0000 G | 7.0000 G | 1.000 M | 3.606000 G | -38.45 | -25.45 | 7.0000 G | 13.6000 G | 1.000 M | 10.224925 G | -34.42 | -21.42 | 13.6000 G | 19.1000 G | 1.000 M | 15.1296750 G | -26.83 | -13.83 |  <table border="1" data-bbox="893 571 1292 672"> <thead> <tr> <th>Start [Hz]</th> <th>Stop [Hz]</th> <th>RBW [Hz]</th> <th>Freq [Hz]</th> <th>PwrAve [dBm]</th> <th>ΔLimit [dB]</th> </tr> </thead> <tbody> <tr><td>30.0000 M</td><td>1.0000 G</td><td>1.000 M</td><td>600.071800 M</td><td>-43.09</td><td>-30.09</td></tr> <tr><td>1.0000 G</td><td>1.845 G</td><td>1.000 M</td><td>1.266899 G</td><td>-42.41</td><td>-29.41</td></tr> <tr><td>1.845 G</td><td>3.0000 G</td><td>1.000 M</td><td>2.986980 G</td><td>-40.61</td><td>-27.61</td></tr> <tr><td>3.0000 G</td><td>7.0000 G</td><td>1.000 M</td><td>5.147000 G</td><td>-38.29</td><td>-25.29</td></tr> <tr><td>7.0000 G</td><td>13.6000 G</td><td>1.000 M</td><td>10.216675 G</td><td>-35.36</td><td>-22.36</td></tr> <tr><td>13.6000 G</td><td>19.1000 G</td><td>1.000 M</td><td>15.159250 G</td><td>-26.92</td><td>-13.92</td></tr> </tbody> </table> <p>Date: 5.NOV.2016 09:22:00</p> | Start [Hz] | Stop [Hz] | RBW [Hz] | Freq [Hz] | PwrAve [dBm] | ΔLimit [dB] | 30.0000 M | 1.0000 G | 1.000 M | 600.071800 M | -43.09 | -30.09 | 1.0000 G | 1.845 G | 1.000 M | 1.266899 G | -42.41 | -29.41 | 1.845 G | 3.0000 G | 1.000 M | 2.986980 G | -40.61 | -27.61 | 3.0000 G | 7.0000 G | 1.000 M | 5.147000 G | -38.29 | -25.29 | 7.0000 G | 13.6000 G | 1.000 M | 10.216675 G | -35.36 | -22.36 | 13.6000 G | 19.1000 G | 1.000 M | 15.159250 G | -26.92 | -13.92 |
| Start [Hz] | Stop [Hz] | RBW [Hz] | Freq [Hz] | PwrAve [dBm] | ΔLimit [dB] | | | | | | | | | | | | | | | | | | | | | | | | | | | | | | | | | | | | | | | | | | | | | | | | | | | | | | | | | | | | | | | | | | | | | | | | | | | | | | | | |
| 30.0000 M | 1.0000 G | 1.000 M | 626.030000 M | -42.93 | -29.93 | | | | | | | | | | | | | | | | | | | | | | | | | | | | | | | | | | | | | | | | | | | | | | | | | | | | | | | | | | | | | | | | | | | | | | | | | | | | | | | | |
| 1.0000 G | 1.845 G | 1.000 M | 1.073304 G | -41.97 | -28.97 | | | | | | | | | | | | | | | | | | | | | | | | | | | | | | | | | | | | | | | | | | | | | | | | | | | | | | | | | | | | | | | | | | | | | | | | | | | | | | | | |
| 1.845 G | 3.0000 G | 1.000 M | 2.1884719 G | -40.82 | -27.82 | | | | | | | | | | | | | | | | | | | | | | | | | | | | | | | | | | | | | | | | | | | | | | | | | | | | | | | | | | | | | | | | | | | | | | | | | | | | | | | | |
| 3.0000 G | 7.0000 G | 1.000 M | 3.606000 G | -38.45 | -25.45 | | | | | | | | | | | | | | | | | | | | | | | | | | | | | | | | | | | | | | | | | | | | | | | | | | | | | | | | | | | | | | | | | | | | | | | | | | | | | | | | |
| 7.0000 G | 13.6000 G | 1.000 M | 10.224925 G | -34.42 | -21.42 | | | | | | | | | | | | | | | | | | | | | | | | | | | | | | | | | | | | | | | | | | | | | | | | | | | | | | | | | | | | | | | | | | | | | | | | | | | | | | | | |
| 13.6000 G | 19.1000 G | 1.000 M | 15.1296750 G | -26.83 | -13.83 | | | | | | | | | | | | | | | | | | | | | | | | | | | | | | | | | | | | | | | | | | | | | | | | | | | | | | | | | | | | | | | | | | | | | | | | | | | | | | | | |
| Start [Hz] | Stop [Hz] | RBW [Hz] | Freq [Hz] | PwrAve [dBm] | ΔLimit [dB] | | | | | | | | | | | | | | | | | | | | | | | | | | | | | | | | | | | | | | | | | | | | | | | | | | | | | | | | | | | | | | | | | | | | | | | | | | | | | | | | |
| 30.0000 M | 1.0000 G | 1.000 M | 600.071800 M | -43.09 | -30.09 | | | | | | | | | | | | | | | | | | | | | | | | | | | | | | | | | | | | | | | | | | | | | | | | | | | | | | | | | | | | | | | | | | | | | | | | | | | | | | | | |
| 1.0000 G | 1.845 G | 1.000 M | 1.266899 G | -42.41 | -29.41 | | | | | | | | | | | | | | | | | | | | | | | | | | | | | | | | | | | | | | | | | | | | | | | | | | | | | | | | | | | | | | | | | | | | | | | | | | | | | | | | |
| 1.845 G | 3.0000 G | 1.000 M | 2.986980 G | -40.61 | -27.61 | | | | | | | | | | | | | | | | | | | | | | | | | | | | | | | | | | | | | | | | | | | | | | | | | | | | | | | | | | | | | | | | | | | | | | | | | | | | | | | | |
| 3.0000 G | 7.0000 G | 1.000 M | 5.147000 G | -38.29 | -25.29 | | | | | | | | | | | | | | | | | | | | | | | | | | | | | | | | | | | | | | | | | | | | | | | | | | | | | | | | | | | | | | | | | | | | | | | | | | | | | | | | |
| 7.0000 G | 13.6000 G | 1.000 M | 10.216675 G | -35.36 | -22.36 | | | | | | | | | | | | | | | | | | | | | | | | | | | | | | | | | | | | | | | | | | | | | | | | | | | | | | | | | | | | | | | | | | | | | | | | | | | | | | | | |
| 13.6000 G | 19.1000 G | 1.000 M | 15.159250 G | -26.92 | -13.92 | | | | | | | | | | | | | | | | | | | | | | | | | | | | | | | | | | | | | | | | | | | | | | | | | | | | | | | | | | | | | | | | | | | | | | | | | | | | | | | | |
| Middle Channel | Middle Channel | | | | | | | | | | | | | | | | | | | | | | | | | | | | | | | | | | | | | | | | | | | | | | | | | | | | | | | | | | | | | | | | | | | | | | | | | | | | | | | | | | | | |
|  <table border="1" data-bbox="239 1097 638 1198"> <thead> <tr> <th>Start [Hz]</th> <th>Stop [Hz]</th> <th>RBW [Hz]</th> <th>Freq [Hz]</th> <th>PwrAve [dBm]</th> <th>ΔLimit [dB]</th> </tr> </thead> <tbody> <tr><td>30.0000 M</td><td>1.0000 G</td><td>1.000 M</td><td>143.000000 M</td><td>-43.06</td><td>-30.06</td></tr> <tr><td>1.0000 G</td><td>3.845 G</td><td>1.000 M</td><td>1.100766 G</td><td>-41.00</td><td>-28.00</td></tr> <tr><td>1.915 G</td><td>3.0000 G</td><td>1.000 M</td><td>2.892385 G</td><td>-41.00</td><td>-28.00</td></tr> <tr><td>3.0000 G</td><td>7.0000 G</td><td>1.000 M</td><td>3.207000 G</td><td>-38.21</td><td>-25.21</td></tr> <tr><td>7.0000 G</td><td>13.6000 G</td><td>1.000 M</td><td>10.212375 G</td><td>-39.93</td><td>-26.93</td></tr> <tr><td>13.6000 G</td><td>19.1000 G</td><td>1.000 M</td><td>15.182625 G</td><td>-26.87</td><td>-13.87</td></tr> </tbody> </table> <p>Date: 15.OCT.2016 05:15:38</p> | Start [Hz] | Stop [Hz] | RBW [Hz] | Freq [Hz] | PwrAve [dBm] | ΔLimit [dB] | 30.0000 M | 1.0000 G | 1.000 M | 143.000000 M | -43.06 | -30.06 | 1.0000 G | 3.845 G | 1.000 M | 1.100766 G | -41.00 | -28.00 | 1.915 G | 3.0000 G | 1.000 M | 2.892385 G | -41.00 | -28.00 | 3.0000 G | 7.0000 G | 1.000 M | 3.207000 G | -38.21 | -25.21 | 7.0000 G | 13.6000 G | 1.000 M | 10.212375 G | -39.93 | -26.93 | 13.6000 G | 19.1000 G | 1.000 M | 15.182625 G | -26.87 | -13.87 |  <table border="1" data-bbox="893 1097 1292 1198"> <thead> <tr> <th>Start [Hz]</th> <th>Stop [Hz]</th> <th>RBW [Hz]</th> <th>Freq [Hz]</th> <th>PwrAve [dBm]</th> <th>ΔLimit [dB]</th> </tr> </thead> <tbody> <tr><td>30.0000 M</td><td>1.0000 G</td><td>1.000 M</td><td>141.792500 M</td><td>-38.57</td><td>-25.57</td></tr> <tr><td>1.0000 G</td><td>3.845 G</td><td>1.000 M</td><td>1.238000 G</td><td>-42.23</td><td>-29.23</td></tr> <tr><td>1.915 G</td><td>3.0000 G</td><td>1.000 M</td><td>2.954701 G</td><td>-41.45</td><td>-28.45</td></tr> <tr><td>3.0000 G</td><td>7.0000 G</td><td>1.000 M</td><td>3.013000 G</td><td>-38.77</td><td>-25.77</td></tr> <tr><td>7.0000 G</td><td>13.6000 G</td><td>1.000 M</td><td>10.227400 G</td><td>-35.42</td><td>-22.42</td></tr> <tr><td>13.6000 G</td><td>19.1000 G</td><td>1.000 M</td><td>15.171625 G</td><td>-26.87</td><td>-13.87</td></tr> </tbody> </table> <p>Date: 5.NOV.2016 09:22:56</p> | Start [Hz] | Stop [Hz] | RBW [Hz] | Freq [Hz] | PwrAve [dBm] | ΔLimit [dB] | 30.0000 M | 1.0000 G | 1.000 M | 141.792500 M | -38.57 | -25.57 | 1.0000 G | 3.845 G | 1.000 M | 1.238000 G | -42.23 | -29.23 | 1.915 G | 3.0000 G | 1.000 M | 2.954701 G | -41.45 | -28.45 | 3.0000 G | 7.0000 G | 1.000 M | 3.013000 G | -38.77 | -25.77 | 7.0000 G | 13.6000 G | 1.000 M | 10.227400 G | -35.42 | -22.42 | 13.6000 G | 19.1000 G | 1.000 M | 15.171625 G | -26.87 | -13.87 |
| Start [Hz] | Stop [Hz] | RBW [Hz] | Freq [Hz] | PwrAve [dBm] | ΔLimit [dB] | | | | | | | | | | | | | | | | | | | | | | | | | | | | | | | | | | | | | | | | | | | | | | | | | | | | | | | | | | | | | | | | | | | | | | | | | | | | | | | | |
| 30.0000 M | 1.0000 G | 1.000 M | 143.000000 M | -43.06 | -30.06 | | | | | | | | | | | | | | | | | | | | | | | | | | | | | | | | | | | | | | | | | | | | | | | | | | | | | | | | | | | | | | | | | | | | | | | | | | | | | | | | |
| 1.0000 G | 3.845 G | 1.000 M | 1.100766 G | -41.00 | -28.00 | | | | | | | | | | | | | | | | | | | | | | | | | | | | | | | | | | | | | | | | | | | | | | | | | | | | | | | | | | | | | | | | | | | | | | | | | | | | | | | | |
| 1.915 G | 3.0000 G | 1.000 M | 2.892385 G | -41.00 | -28.00 | | | | | | | | | | | | | | | | | | | | | | | | | | | | | | | | | | | | | | | | | | | | | | | | | | | | | | | | | | | | | | | | | | | | | | | | | | | | | | | | |
| 3.0000 G | 7.0000 G | 1.000 M | 3.207000 G | -38.21 | -25.21 | | | | | | | | | | | | | | | | | | | | | | | | | | | | | | | | | | | | | | | | | | | | | | | | | | | | | | | | | | | | | | | | | | | | | | | | | | | | | | | | |
| 7.0000 G | 13.6000 G | 1.000 M | 10.212375 G | -39.93 | -26.93 | | | | | | | | | | | | | | | | | | | | | | | | | | | | | | | | | | | | | | | | | | | | | | | | | | | | | | | | | | | | | | | | | | | | | | | | | | | | | | | | |
| 13.6000 G | 19.1000 G | 1.000 M | 15.182625 G | -26.87 | -13.87 | | | | | | | | | | | | | | | | | | | | | | | | | | | | | | | | | | | | | | | | | | | | | | | | | | | | | | | | | | | | | | | | | | | | | | | | | | | | | | | | |
| Start [Hz] | Stop [Hz] | RBW [Hz] | Freq [Hz] | PwrAve [dBm] | ΔLimit [dB] | | | | | | | | | | | | | | | | | | | | | | | | | | | | | | | | | | | | | | | | | | | | | | | | | | | | | | | | | | | | | | | | | | | | | | | | | | | | | | | | |
| 30.0000 M | 1.0000 G | 1.000 M | 141.792500 M | -38.57 | -25.57 | | | | | | | | | | | | | | | | | | | | | | | | | | | | | | | | | | | | | | | | | | | | | | | | | | | | | | | | | | | | | | | | | | | | | | | | | | | | | | | | |
| 1.0000 G | 3.845 G | 1.000 M | 1.238000 G | -42.23 | -29.23 | | | | | | | | | | | | | | | | | | | | | | | | | | | | | | | | | | | | | | | | | | | | | | | | | | | | | | | | | | | | | | | | | | | | | | | | | | | | | | | | |
| 1.915 G | 3.0000 G | 1.000 M | 2.954701 G | -41.45 | -28.45 | | | | | | | | | | | | | | | | | | | | | | | | | | | | | | | | | | | | | | | | | | | | | | | | | | | | | | | | | | | | | | | | | | | | | | | | | | | | | | | | |
| 3.0000 G | 7.0000 G | 1.000 M | 3.013000 G | -38.77 | -25.77 | | | | | | | | | | | | | | | | | | | | | | | | | | | | | | | | | | | | | | | | | | | | | | | | | | | | | | | | | | | | | | | | | | | | | | | | | | | | | | | | |
| 7.0000 G | 13.6000 G | 1.000 M | 10.227400 G | -35.42 | -22.42 | | | | | | | | | | | | | | | | | | | | | | | | | | | | | | | | | | | | | | | | | | | | | | | | | | | | | | | | | | | | | | | | | | | | | | | | | | | | | | | | |
| 13.6000 G | 19.1000 G | 1.000 M | 15.171625 G | -26.87 | -13.87 | | | | | | | | | | | | | | | | | | | | | | | | | | | | | | | | | | | | | | | | | | | | | | | | | | | | | | | | | | | | | | | | | | | | | | | | | | | | | | | | |
| Highest Channel | Highest Channel | | | | | | | | | | | | | | | | | | | | | | | | | | | | | | | | | | | | | | | | | | | | | | | | | | | | | | | | | | | | | | | | | | | | | | | | | | | | | | | | | | | | |
|  <table border="1" data-bbox="239 1624 638 1724"> <thead> <tr> <th>Start [Hz]</th> <th>Stop [Hz]</th> <th>RBW [Hz]</th> <th>Freq [Hz]</th> <th>PwrAve [dBm]</th> <th>ΔLimit [dB]</th> </tr> </thead> <tbody> <tr><td>30.0000 M</td><td>1.0000 G</td><td>1.000 M</td><td>171.600000 M</td><td>-39.98</td><td>-26.98</td></tr> <tr><td>1.0000 G</td><td>1.845 G</td><td>1.000 M</td><td>1.189703 G</td><td>-41.82</td><td>-28.82</td></tr> <tr><td>1.845 G</td><td>3.0000 G</td><td>1.000 M</td><td>1.932071 G</td><td>-39.79</td><td>-26.79</td></tr> <tr><td>3.0000 G</td><td>7.0000 G</td><td>1.000 M</td><td>3.819000 G</td><td>-37.57</td><td>-24.57</td></tr> <tr><td>7.0000 G</td><td>13.6000 G</td><td>1.000 M</td><td>10.213375 G</td><td>-34.97</td><td>-21.97</td></tr> <tr><td>13.6000 G</td><td>19.1000 G</td><td>1.000 M</td><td>15.072625 G</td><td>-26.49</td><td>-13.49</td></tr> </tbody> </table> <p>Date: 15.OCT.2016 05:16:23</p> | Start [Hz] | Stop [Hz] | RBW [Hz] | Freq [Hz] | PwrAve [dBm] | ΔLimit [dB] | 30.0000 M | 1.0000 G | 1.000 M | 171.600000 M | -39.98 | -26.98 | 1.0000 G | 1.845 G | 1.000 M | 1.189703 G | -41.82 | -28.82 | 1.845 G | 3.0000 G | 1.000 M | 1.932071 G | -39.79 | -26.79 | 3.0000 G | 7.0000 G | 1.000 M | 3.819000 G | -37.57 | -24.57 | 7.0000 G | 13.6000 G | 1.000 M | 10.213375 G | -34.97 | -21.97 | 13.6000 G | 19.1000 G | 1.000 M | 15.072625 G | -26.49 | -13.49 |  <table border="1" data-bbox="893 1624 1292 1724"> <thead> <tr> <th>Start [Hz]</th> <th>Stop [Hz]</th> <th>RBW [Hz]</th> <th>Freq [Hz]</th> <th>PwrAve [dBm]</th> <th>ΔLimit [dB]</th> </tr> </thead> <tbody> <tr><td>30.0000 M</td><td>1.0000 G</td><td>1.000 M</td><td>650.037800 M</td><td>-43.08</td><td>-30.08</td></tr> <tr><td>1.0000 G</td><td>1.845 G</td><td>1.000 M</td><td>1.072881 G</td><td>-42.11</td><td>-29.11</td></tr> <tr><td>1.845 G</td><td>3.0000 G</td><td>1.000 M</td><td>1.932071 G</td><td>-39.66</td><td>-27.66</td></tr> <tr><td>3.0000 G</td><td>7.0000 G</td><td>1.000 M</td><td>5.182000 G</td><td>-38.61</td><td>-25.61</td></tr> <tr><td>7.0000 G</td><td>13.6000 G</td><td>1.000 M</td><td>10.211725 G</td><td>-35.26</td><td>-22.26</td></tr> <tr><td>13.6000 G</td><td>19.1000 G</td><td>1.000 M</td><td>15.247925 G</td><td>-26.99</td><td>-13.99</td></tr> </tbody> </table> <p>Date: 5.NOV.2016 09:23:50</p> | Start [Hz] | Stop [Hz] | RBW [Hz] | Freq [Hz] | PwrAve [dBm] | ΔLimit [dB] | 30.0000 M | 1.0000 G | 1.000 M | 650.037800 M | -43.08 | -30.08 | 1.0000 G | 1.845 G | 1.000 M | 1.072881 G | -42.11 | -29.11 | 1.845 G | 3.0000 G | 1.000 M | 1.932071 G | -39.66 | -27.66 | 3.0000 G | 7.0000 G | 1.000 M | 5.182000 G | -38.61 | -25.61 | 7.0000 G | 13.6000 G | 1.000 M | 10.211725 G | -35.26 | -22.26 | 13.6000 G | 19.1000 G | 1.000 M | 15.247925 G | -26.99 | -13.99 |
| Start [Hz] | Stop [Hz] | RBW [Hz] | Freq [Hz] | PwrAve [dBm] | ΔLimit [dB] | | | | | | | | | | | | | | | | | | | | | | | | | | | | | | | | | | | | | | | | | | | | | | | | | | | | | | | | | | | | | | | | | | | | | | | | | | | | | | | | |
| 30.0000 M | 1.0000 G | 1.000 M | 171.600000 M | -39.98 | -26.98 | | | | | | | | | | | | | | | | | | | | | | | | | | | | | | | | | | | | | | | | | | | | | | | | | | | | | | | | | | | | | | | | | | | | | | | | | | | | | | | | |
| 1.0000 G | 1.845 G | 1.000 M | 1.189703 G | -41.82 | -28.82 | | | | | | | | | | | | | | | | | | | | | | | | | | | | | | | | | | | | | | | | | | | | | | | | | | | | | | | | | | | | | | | | | | | | | | | | | | | | | | | | |
| 1.845 G | 3.0000 G | 1.000 M | 1.932071 G | -39.79 | -26.79 | | | | | | | | | | | | | | | | | | | | | | | | | | | | | | | | | | | | | | | | | | | | | | | | | | | | | | | | | | | | | | | | | | | | | | | | | | | | | | | | |
| 3.0000 G | 7.0000 G | 1.000 M | 3.819000 G | -37.57 | -24.57 | | | | | | | | | | | | | | | | | | | | | | | | | | | | | | | | | | | | | | | | | | | | | | | | | | | | | | | | | | | | | | | | | | | | | | | | | | | | | | | | |
| 7.0000 G | 13.6000 G | 1.000 M | 10.213375 G | -34.97 | -21.97 | | | | | | | | | | | | | | | | | | | | | | | | | | | | | | | | | | | | | | | | | | | | | | | | | | | | | | | | | | | | | | | | | | | | | | | | | | | | | | | | |
| 13.6000 G | 19.1000 G | 1.000 M | 15.072625 G | -26.49 | -13.49 | | | | | | | | | | | | | | | | | | | | | | | | | | | | | | | | | | | | | | | | | | | | | | | | | | | | | | | | | | | | | | | | | | | | | | | | | | | | | | | | |
| Start [Hz] | Stop [Hz] | RBW [Hz] | Freq [Hz] | PwrAve [dBm] | ΔLimit [dB] | | | | | | | | | | | | | | | | | | | | | | | | | | | | | | | | | | | | | | | | | | | | | | | | | | | | | | | | | | | | | | | | | | | | | | | | | | | | | | | | |
| 30.0000 M | 1.0000 G | 1.000 M | 650.037800 M | -43.08 | -30.08 | | | | | | | | | | | | | | | | | | | | | | | | | | | | | | | | | | | | | | | | | | | | | | | | | | | | | | | | | | | | | | | | | | | | | | | | | | | | | | | | |
| 1.0000 G | 1.845 G | 1.000 M | 1.072881 G | -42.11 | -29.11 | | | | | | | | | | | | | | | | | | | | | | | | | | | | | | | | | | | | | | | | | | | | | | | | | | | | | | | | | | | | | | | | | | | | | | | | | | | | | | | | |
| 1.845 G | 3.0000 G | 1.000 M | 1.932071 G | -39.66 | -27.66 | | | | | | | | | | | | | | | | | | | | | | | | | | | | | | | | | | | | | | | | | | | | | | | | | | | | | | | | | | | | | | | | | | | | | | | | | | | | | | | | |
| 3.0000 G | 7.0000 G | 1.000 M | 5.182000 G | -38.61 | -25.61 | | | | | | | | | | | | | | | | | | | | | | | | | | | | | | | | | | | | | | | | | | | | | | | | | | | | | | | | | | | | | | | | | | | | | | | | | | | | | | | | |
| 7.0000 G | 13.6000 G | 1.000 M | 10.211725 G | -35.26 | -22.26 | | | | | | | | | | | | | | | | | | | | | | | | | | | | | | | | | | | | | | | | | | | | | | | | | | | | | | | | | | | | | | | | | | | | | | | | | | | | | | | | |
| 13.6000 G | 19.1000 G | 1.000 M | 15.247925 G | -26.99 | -13.99 | | | | | | | | | | | | | | | | | | | | | | | | | | | | | | | | | | | | | | | | | | | | | | | | | | | | | | | | | | | | | | | | | | | | | | | | | | | | | | | | |



Frequency Stability

| Test Conditions | Middle Channel | GSM850 (GPRS class 8) | GSM850 (EDGE class 8) | Limit 2.5ppm |
|------------------|-------------------|--------------------------|--------------------------|-----------------|
| Temperature (°C) | Voltage (Volt) | Deviation (ppm) | | Result |
| 50 | Normal Voltage | 0.0096 | 0.0024 | PASS |
| 40 | Normal Voltage | 0.0072 | 0.0096 | |
| 30 | Normal Voltage | 0.0048 | 0.0024 | |
| 20(Ref.) | Normal Voltage | 0.0000 | 0.0000 | |
| 10 | Normal Voltage | 0.0036 | 0.0502 | |
| 0 | Normal Voltage | 0.0203 | 0.0478 | |
| -10 | Normal Voltage | 0.0167 | 0.0562 | |
| -20 | Normal Voltage | 0.0227 | 0.0646 | |
| -30 | Normal Voltage | 0.0191 | 0.0670 | |
| 20 | Maximum Voltage | 0.0048 | 0.0012 | |
| 20 | Normal Voltage | 0.0000 | 0.0000 | |
| 20 | Battery End Point | 0.0000 | 0.0036 | |

| Test Conditions | Middle Channel | GSM1900 (GPRS class 8) | GSM1900 (EDGE class 8) | Limit Note 2. |
|------------------|-------------------|---------------------------|---------------------------|------------------|
| Temperature (°C) | Voltage (Volt) | Deviation (ppm) | | Result |
| 50 | Normal Voltage | 0.0005 | 0.0048 | PASS |
| 40 | Normal Voltage | 0.0016 | 0.0011 | |
| 30 | Normal Voltage | 0.0005 | 0.0027 | |
| 20(Ref.) | Normal Voltage | 0.0000 | 0.0000 | |
| 10 | Normal Voltage | 0.0032 | 0.0043 | |
| 0 | Normal Voltage | 0.0074 | 0.0128 | |
| -10 | Normal Voltage | 0.0074 | 0.0160 | |
| -20 | Normal Voltage | 0.0096 | 0.0266 | |
| -30 | Normal Voltage | 0.0117 | 0.0170 | |
| 20 | Maximum Voltage | 0.0027 | 0.0005 | |
| 20 | Normal Voltage | 0.0000 | 0.0000 | |
| 20 | Battery End Point | 0.0011 | 0.0021 | |

Note:

1. Normal Voltage = 3.8V. ; Battery End Point (BEP) = 3.4 V. ; Maximum Voltage =4.35 V
2. The frequency fundamental emissions stay within the authorized frequency block.



A2. WCDMA

Peak-to-Average Ratio

| Mode | WCDMA Band V | WCDMA Band II | WCDMA Band IV | Limit: 13dB |
|------------|--------------|---------------|---------------|-------------|
| Mod. | RMC 12.2Kbps | RMC 12.2Kbps | RMC 12.2Kbps | Result |
| Lowest CH | 2.16 | 2.28 | 2.64 | PASS |
| Middle CH | 2.24 | 2.52 | 2.56 | |
| Highest CH | 1.96 | 2.40 | 2.48 | |

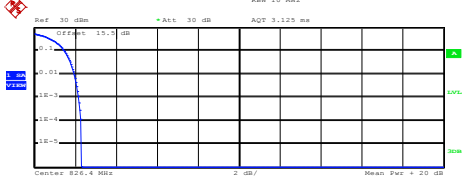
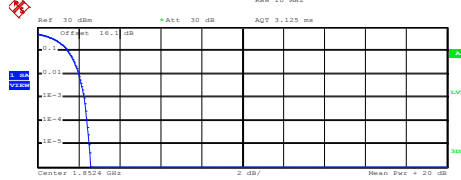
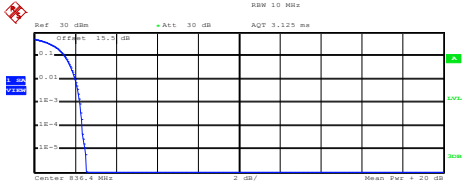
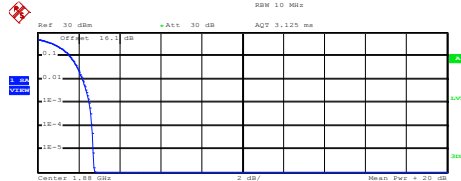
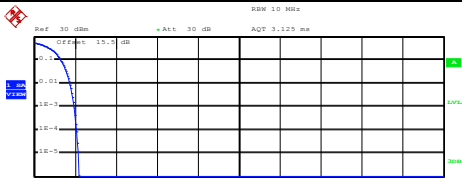
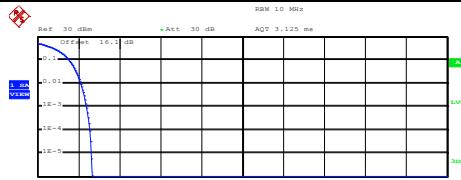

| WCDMA Band V (RMC 12.2Kbps) | WCDMA Band II (RMC 12.2Kbps) | | | | | | | | | | | | | | | | |
|---|------------------------------|---------|-----|---------|------|---------|-------|---------|---|------|---------|-----|---------|------|---------|-------|---------|
| <p align="center">Lowest Channel</p>  <p>Center 826.4 MHz 2 dB/ Mean Pwr + 20 dB</p> <p>Complementary Cumulative Distribution Function (100000 samples) Trace 1 Mean 23.99 dBm Peak 26.30 dBm Crest 2.32 dB</p> <table border="1"> <tr><td>10 %</td><td>1.48 dB</td></tr> <tr><td>1 %</td><td>1.96 dB</td></tr> <tr><td>.1 %</td><td>2.16 dB</td></tr> <tr><td>.01 %</td><td>2.28 dB</td></tr> </table> <p>Date: 5.NOV.2016 10:34:33</p> | 10 % | 1.48 dB | 1 % | 1.96 dB | .1 % | 2.16 dB | .01 % | 2.28 dB | <p align="center">Lowest Channel</p>  <p>Center 1.8524 GHz 2 dB/ Mean Pwr + 20 dB</p> <p>Complementary Cumulative Distribution Function (100000 samples) Trace 1 Mean 22.30 dBm Peak 24.89 dBm Crest 2.59 dB</p> <table border="1"> <tr><td>10 %</td><td>1.48 dB</td></tr> <tr><td>1 %</td><td>2.00 dB</td></tr> <tr><td>.1 %</td><td>2.28 dB</td></tr> <tr><td>.01 %</td><td>2.40 dB</td></tr> </table> <p>Date: 5.NOV.2016 09:41:49</p> | 10 % | 1.48 dB | 1 % | 2.00 dB | .1 % | 2.28 dB | .01 % | 2.40 dB |
| 10 % | 1.48 dB | | | | | | | | | | | | | | | | |
| 1 % | 1.96 dB | | | | | | | | | | | | | | | | |
| .1 % | 2.16 dB | | | | | | | | | | | | | | | | |
| .01 % | 2.28 dB | | | | | | | | | | | | | | | | |
| 10 % | 1.48 dB | | | | | | | | | | | | | | | | |
| 1 % | 2.00 dB | | | | | | | | | | | | | | | | |
| .1 % | 2.28 dB | | | | | | | | | | | | | | | | |
| .01 % | 2.40 dB | | | | | | | | | | | | | | | | |
| <p align="center">Middle Channel</p>  <p>Center 836.4 MHz 2 dB/ Mean Pwr + 20 dB</p> <p>Complementary Cumulative Distribution Function (100000 samples) Trace 1 Mean 23.88 dBm Peak 26.44 dBm Crest 2.56 dB</p> <table border="1"> <tr><td>10 %</td><td>1.48 dB</td></tr> <tr><td>1 %</td><td>2.00 dB</td></tr> <tr><td>.1 %</td><td>2.24 dB</td></tr> <tr><td>.01 %</td><td>2.36 dB</td></tr> </table> <p>Date: 5.NOV.2016 10:34:40</p> | 10 % | 1.48 dB | 1 % | 2.00 dB | .1 % | 2.24 dB | .01 % | 2.36 dB | <p align="center">Middle Channel</p>  <p>Center 1.88 GHz 2 dB/ Mean Pwr + 20 dB</p> <p>Complementary Cumulative Distribution Function (100000 samples) Trace 1 Mean 22.33 dBm Peak 25.10 dBm Crest 2.77 dB</p> <table border="1"> <tr><td>10 %</td><td>1.56 dB</td></tr> <tr><td>1 %</td><td>2.20 dB</td></tr> <tr><td>.1 %</td><td>2.52 dB</td></tr> <tr><td>.01 %</td><td>2.64 dB</td></tr> </table> <p>Date: 5.NOV.2016 09:42:00</p> | 10 % | 1.56 dB | 1 % | 2.20 dB | .1 % | 2.52 dB | .01 % | 2.64 dB |
| 10 % | 1.48 dB | | | | | | | | | | | | | | | | |
| 1 % | 2.00 dB | | | | | | | | | | | | | | | | |
| .1 % | 2.24 dB | | | | | | | | | | | | | | | | |
| .01 % | 2.36 dB | | | | | | | | | | | | | | | | |
| 10 % | 1.56 dB | | | | | | | | | | | | | | | | |
| 1 % | 2.20 dB | | | | | | | | | | | | | | | | |
| .1 % | 2.52 dB | | | | | | | | | | | | | | | | |
| .01 % | 2.64 dB | | | | | | | | | | | | | | | | |
| <p align="center">Highest Channel</p>  <p>Center 846.6 MHz 2 dB/ Mean Pwr + 20 dB</p> <p>Complementary Cumulative Distribution Function (100000 samples) Trace 1 Mean 23.91 dBm Peak 26.09 dBm Crest 2.18 dB</p> <table border="1"> <tr><td>10 %</td><td>1.32 dB</td></tr> <tr><td>1 %</td><td>1.76 dB</td></tr> <tr><td>.1 %</td><td>1.96 dB</td></tr> <tr><td>.01 %</td><td>2.08 dB</td></tr> </table> <p>Date: 5.NOV.2016 10:34:50</p> | 10 % | 1.32 dB | 1 % | 1.76 dB | .1 % | 1.96 dB | .01 % | 2.08 dB | <p align="center">Highest Channel</p>  <p>Center 1.9076 GHz 2 dB/ Mean Pwr + 20 dB</p> <p>Complementary Cumulative Distribution Function (100000 samples) Trace 1 Mean 22.53 dBm Peak 25.17 dBm Crest 2.64 dB</p> <table border="1"> <tr><td>10 %</td><td>1.56 dB</td></tr> <tr><td>1 %</td><td>2.12 dB</td></tr> <tr><td>.1 %</td><td>2.40 dB</td></tr> <tr><td>.01 %</td><td>2.56 dB</td></tr> </table> <p>Date: 5.NOV.2016 09:42:10</p> | 10 % | 1.56 dB | 1 % | 2.12 dB | .1 % | 2.40 dB | .01 % | 2.56 dB |
| 10 % | 1.32 dB | | | | | | | | | | | | | | | | |
| 1 % | 1.76 dB | | | | | | | | | | | | | | | | |
| .1 % | 1.96 dB | | | | | | | | | | | | | | | | |
| .01 % | 2.08 dB | | | | | | | | | | | | | | | | |
| 10 % | 1.56 dB | | | | | | | | | | | | | | | | |
| 1 % | 2.12 dB | | | | | | | | | | | | | | | | |
| .1 % | 2.40 dB | | | | | | | | | | | | | | | | |
| .01 % | 2.56 dB | | | | | | | | | | | | | | | | |



WCDMA Band IV (RMC 12.2Kbps)

Lowest Channel

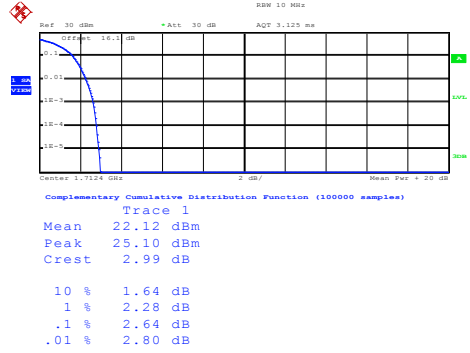

Date: 5.NOV.2016 10:07:53

Middle Channel

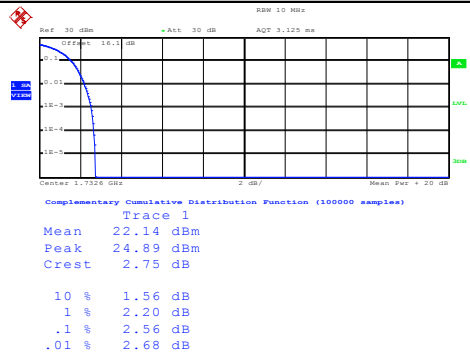

Date: 5.NOV.2016 10:08:03

Highest Channel

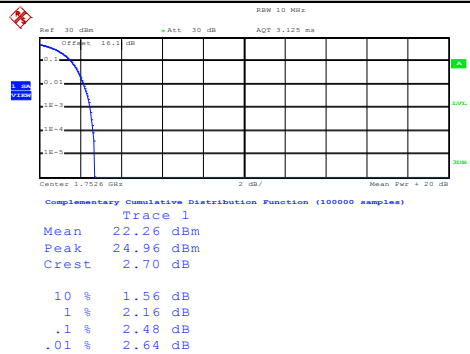

Date: 5.NOV.2016 10:08:13



26dB Bandwidth

| Mode | WCDMA Band V 26dB BW(MHz) | WCDMA Band II 26dB BW(MHz) | WCDMA Band IV 26dB BW(MHz) |
|------------|------------------------------|-------------------------------|-------------------------------|
| Mod. | RMC 12.2Kbps | RMC 12.2Kbps | RMC 12.2Kbps |
| Lowest CH | 4.74 | 4.72 | 4.69 |
| Middle CH | 4.75 | 4.71 | 4.71 |
| Highest CH | 4.77 | 4.72 | 4.70 |



WCDMA Band V (RMC 12.2Kbps)

WCDMA Band II (RMC 12.2Kbps)

Lowest Channel

Lowest Channel

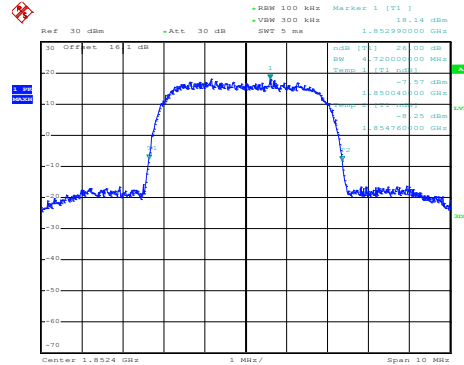
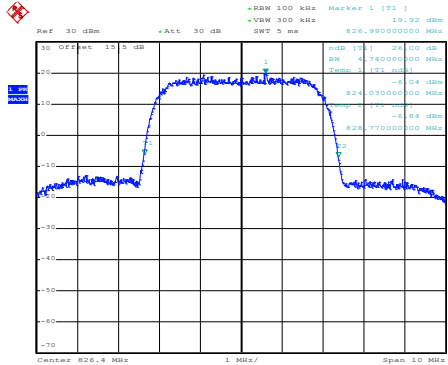

Date: 5.NOV.2016 10:23:19

Date: 5.NOV.2016 09:29:28

Middle Channel

Middle Channel

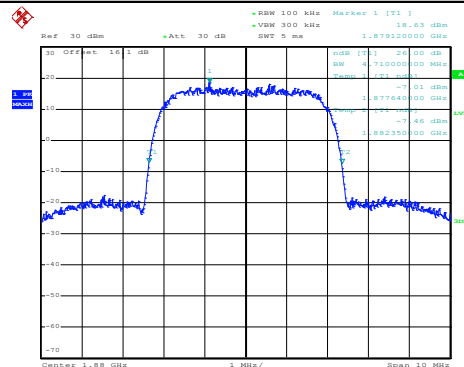
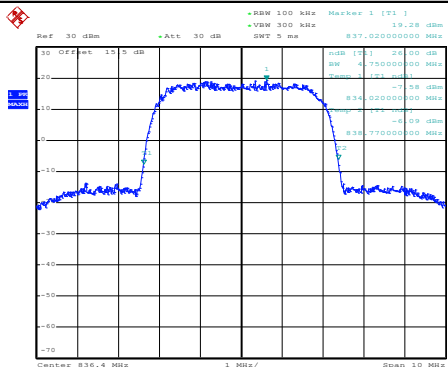

Date: 5.NOV.2016 10:23:47

Date: 5.NOV.2016 09:30:42

Highest Channel

Highest Channel

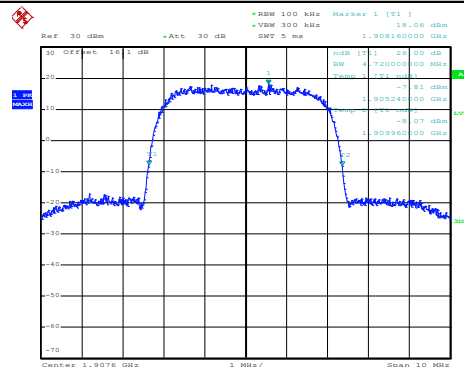
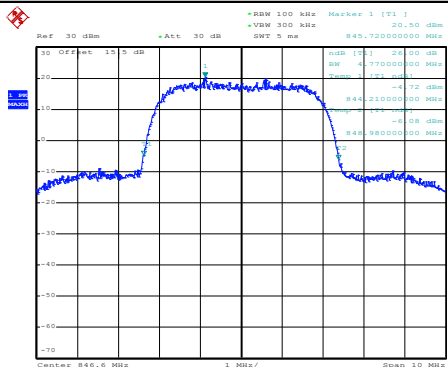

Date: 5.NOV.2016 10:24:15

Date: 5.NOV.2016 09:31:30



WCDMA Band IV (RMC 12.2Kbps)

Lowest Channel

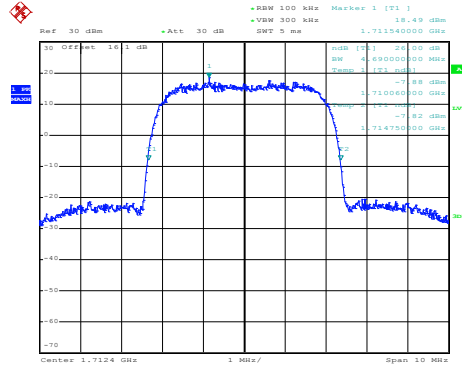

Date: 5.NOV.2016 09:57:04

Middle Channel

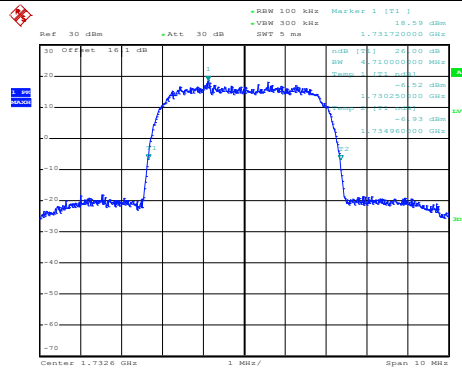

Date: 5.NOV.2016 09:57:32

Highest Channel

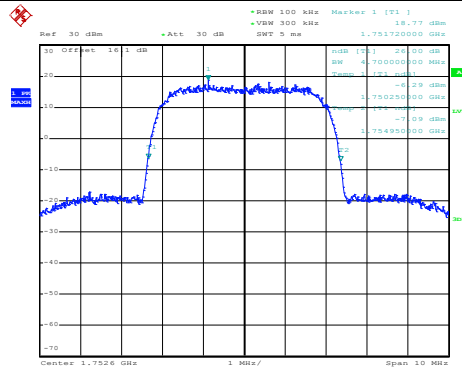

Date: 5.NOV.2016 09:58:00



Occupied Bandwidth

| Mode | WCDMA Band V 99%OBW(MHz) | WCDMA Band II 99%OBW(MHz) | WCDMA Band IV 99%OBW(MHz) |
|------------|-----------------------------|------------------------------|------------------------------|
| Mod. | RMC 12.2Kbps | RMC 12.2Kbps | RMC 12.2Kbps |
| Lowest CH | 4.18 | 4.18 | 4.16 |
| Middle CH | 4.19 | 4.17 | 4.17 |
| Highest CH | 4.21 | 4.17 | 4.17 |

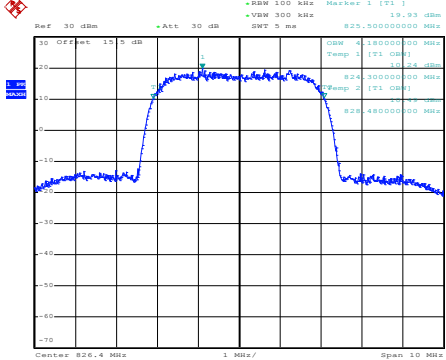
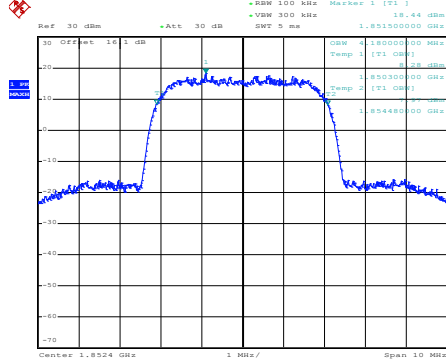
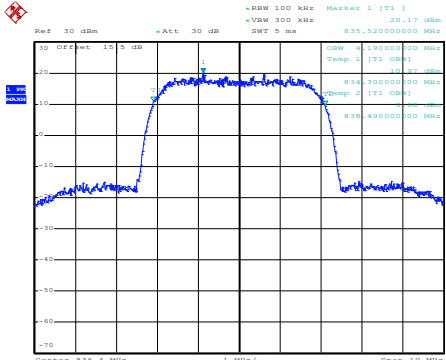
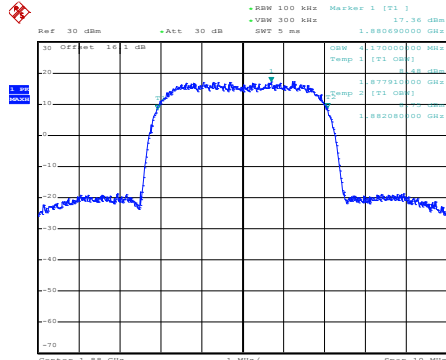
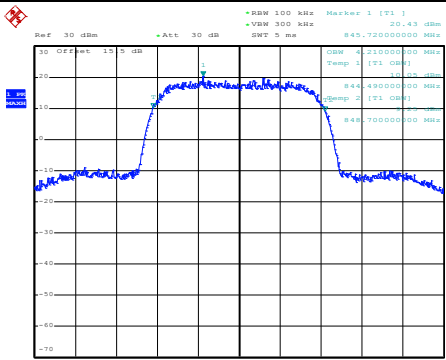
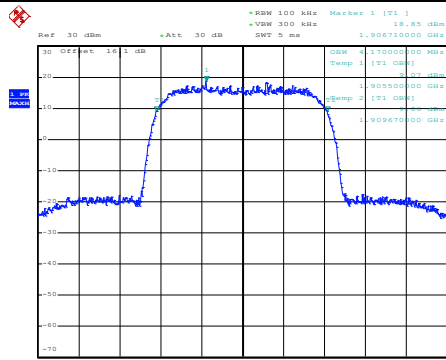

| WCDMA Band V (RMC 12.2Kbps) | WCDMA Band II (RMC 12.2Kbps) |
|---|--|
| <p style="text-align: center;">Lowest Channel</p>  <p style="text-align: right;">Date: 5.NOV.2016 10:24:51</p> | <p style="text-align: center;">Lowest Channel</p>  <p style="text-align: right;">Date: 5.NOV.2016 09:32:41</p> |
| <p style="text-align: center;">Middle Channel</p>  <p style="text-align: right;">Date: 5.NOV.2016 10:25:19</p> | <p style="text-align: center;">Middle Channel</p>  <p style="text-align: right;">Date: 5.NOV.2016 09:33:09</p> |
| <p style="text-align: center;">Highest Channel</p>  <p style="text-align: right;">Date: 5.NOV.2016 10:25:47</p> | <p style="text-align: center;">Highest Channel</p>  <p style="text-align: right;">Date: 5.NOV.2016 09:33:37</p> |



WCDMA Band IV (RMC 12.2Kbps)

Lowest Channel

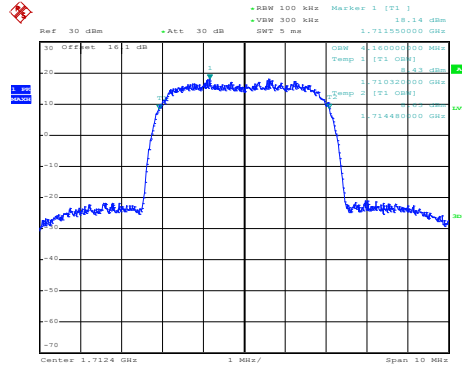

Date: 5.NOV.2016 09:58:45

Middle Channel

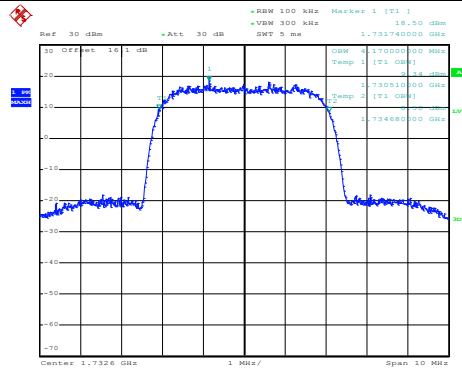

Date: 5.NOV.2016 09:59:13

Highest Channel

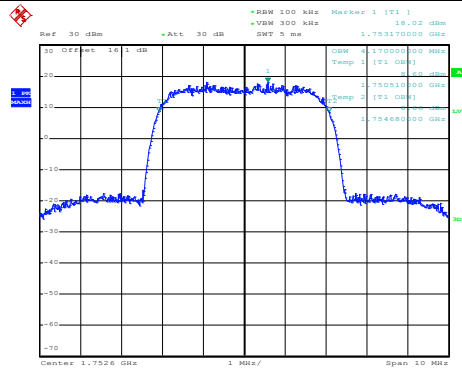

Date: 5.NOV.2016 09:59:41



Conducted Band Edge

WCDMA Band V (RMC 12.2Kbps)

Lowest Band Edge

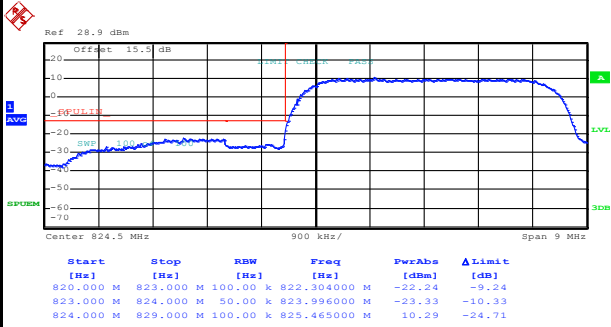

Date: 5.NOV.2016 10:28:33

Highest Band Edge

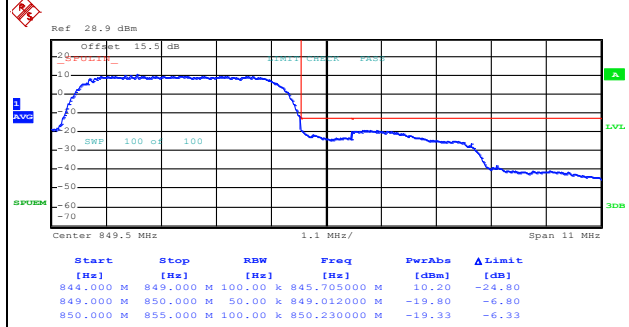

Date: 5.NOV.2016 10:31:15

WCDMA Band II (RMC 12.2Kbps)

Lowest Band Edge

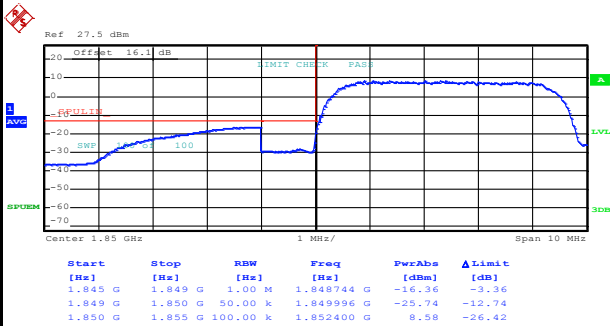

Date: 5.NOV.2016 09:36:26

Highest Band Edge

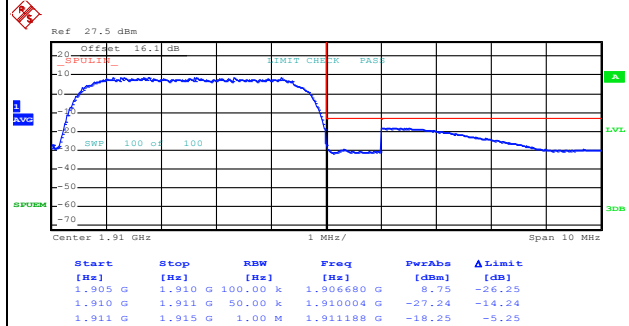

Date: 5.NOV.2016 09:39:08



WCDMA Band IV (RMC 12.2Kbps)

Lowest Band Edge

Highest Band Edge

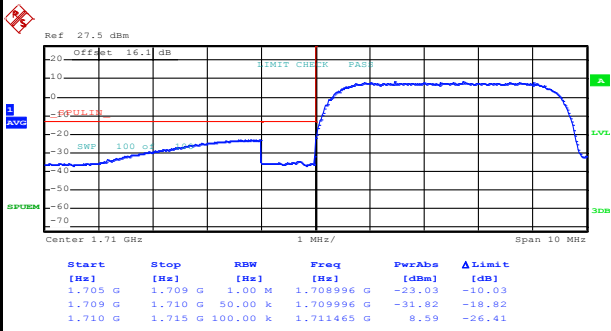

Date: 5.NOV.2016 10:02:31

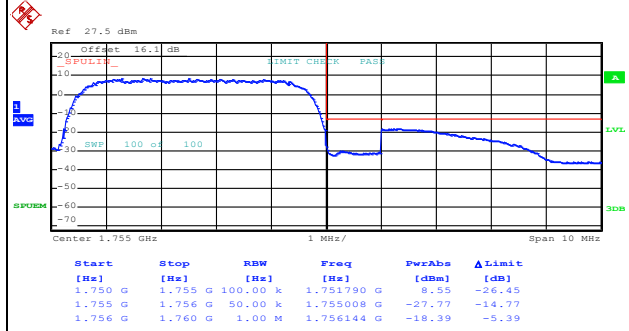

Date: 5.NOV.2016 10:05:13



Conducted Spurious Emission

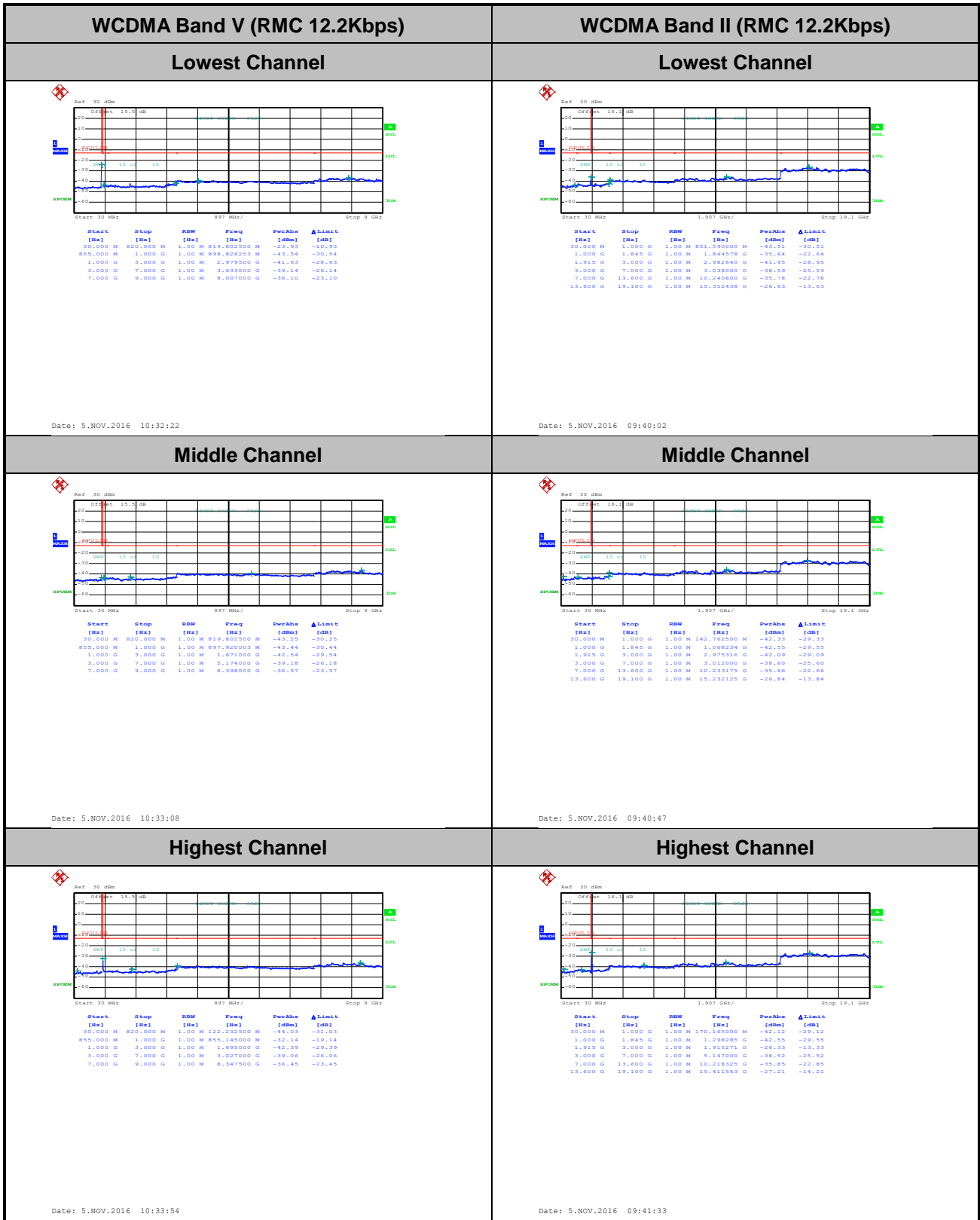



WCDMA Band IV (RMC 12.2Kbps)

Lowest Channel

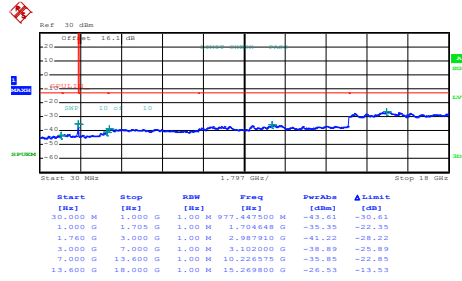

Date: 5.NOV.2016 10:06:03

Middle Channel

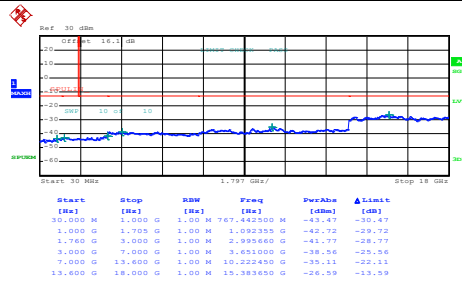

Date: 5.NOV.2016 10:06:49

Highest Channel

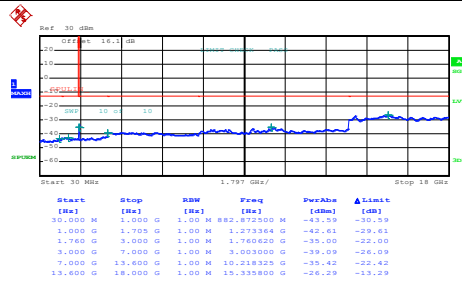

Date: 5.NOV.2016 10:07:35



Frequency Stability

| Test Conditions | Middle Channel | WCDMA Band V (RMC 12.2Kbps) | Limit 2.5ppm |
|------------------|-------------------|--------------------------------|-----------------|
| Temperature (°C) | Voltage (Volt) | Deviation (ppm) | Result |
| 50 | Normal Voltage | 0.0012 | PASS |
| 40 | Normal Voltage | 0.0024 | |
| 30 | Normal Voltage | 0.0012 | |
| 20(Ref.) | Normal Voltage | 0.0000 | |
| 10 | Normal Voltage | 0.0108 | |
| 0 | Normal Voltage | 0.0143 | |
| -10 | Normal Voltage | 0.0167 | |
| -20 | Normal Voltage | 0.0167 | |
| -30 | Normal Voltage | 0.0155 | |
| 20 | Maximum Voltage | 0.0024 | |
| 20 | Normal Voltage | 0.0000 | |
| 20 | Battery End Point | 0.0024 | |

| Test Conditions | Middle Channel | WCDMA Band II (RMC 12.2Kbps) | Limit Note 2. |
|------------------|-------------------|---------------------------------|------------------|
| Temperature (°C) | Voltage (Volt) | Deviation (ppm) | Result |
| 50 | Normal Voltage | 0.0011 | PASS |
| 40 | Normal Voltage | 0.0011 | |
| 30 | Normal Voltage | 0.0016 | |
| 20(Ref.) | Normal Voltage | 0.0000 | |
| 10 | Normal Voltage | 0.0011 | |
| 0 | Normal Voltage | 0.0011 | |
| -10 | Normal Voltage | 0.0021 | |
| -20 | Normal Voltage | 0.0005 | |
| -30 | Normal Voltage | 0.0016 | |
| 20 | Maximum Voltage | 0.0027 | |
| 20 | Normal Voltage | 0.0000 | |
| 20 | Battery End Point | 0.0000 | |



| Test Conditions | Middle Channel | WCDMA Band IV (RMC 12.2Kbps) | Limit Note 2. |
|------------------|-------------------|---------------------------------|------------------|
| Temperature (°C) | Voltage (Volt) | Deviation (ppm) | Result |
| 50 | Normal Voltage | 0.0006 | PASS |
| 40 | Normal Voltage | 0.0006 | |
| 30 | Normal Voltage | 0.0012 | |
| 20(Ref.) | Normal Voltage | 0.0000 | |
| 10 | Normal Voltage | 0.0006 | |
| 0 | Normal Voltage | 0.0000 | |
| -10 | Normal Voltage | 0.0121 | |
| -20 | Normal Voltage | 0.0115 | |
| -30 | Normal Voltage | 0.0023 | |
| 20 | Maximum Voltage | 0.0006 | |
| 20 | Normal Voltage | 0.0000 | |
| 20 | Battery End Point | 0.0006 | |

Note:

1. Normal Voltage = 3.85V. ; Battery End Point (BEP) = 3.4 V. ; Maximum Voltage =4.35 V
2. The frequency fundamental emissions stay within the authorized frequency block.



Appendix B. Test Results of ERP/EIRP and Radiated Test

ERP/EIRP

| Channel | Mode | Conducted | | ERP | |
|---------|---------------------|-------------|---------------|----------|--------|
| | | Power (dBm) | Power (Watts) | ERP(dBm) | ERP(W) |
| Lowest | GSM850 | 33.24 | 2.1086 | 26.89 | 0.4887 |
| Middle | GPRS class 8 | 33.22 | 2.0989 | 26.87 | 0.4864 |
| Highest | (GT - LC = -4.2 dB) | 33.21 | 2.0941 | 26.86 | 0.4853 |
| Lowest | GSM850 | 27.10 | 0.5129 | 20.75 | 0.1189 |
| Middle | EDGE class 8 | 27.16 | 0.5200 | 20.81 | 0.1205 |
| Highest | (GT - LC = -4.2 dB) | 27.23 | 0.5284 | 20.88 | 0.1225 |
| Lowest | WCDMA Band V | 24.26 | 0.2667 | 17.91 | 0.0618 |
| Middle | RMC 12.2Kbps | 24.28 | 0.2679 | 17.93 | 0.0621 |
| Highest | (GT - LC = -4.2 dB) | 24.30 | 0.2692 | 17.95 | 0.0624 |
| Limit | ERP < 7W | Result | | PASS | |

| Channel | Mode | Conducted | | EIRP | |
|---------|---------------------|-------------|---------------|-----------|---------|
| | | Power (dBm) | Power (Watts) | EIRP(dBm) | EIRP(W) |
| Lowest | GSM1900 | 30.15 | 1.0351 | 28.75 | 0.7499 |
| Middle | GPRS class 8 | 30.24 | 1.0568 | 28.84 | 0.7656 |
| Highest | (GT - LC = -1.4 dB) | 30.31 | 1.0740 | 28.91 | 0.7780 |
| Lowest | GSM1900 | 25.30 | 0.3388 | 23.90 | 0.2455 |
| Middle | EDGE class 8 | 25.51 | 0.3556 | 24.11 | 0.2576 |
| Highest | (GT - LC = -1.4 dB) | 25.55 | 0.3589 | 24.15 | 0.2600 |
| Lowest | WCDMA Band II | 23.88 | 0.2443 | 22.48 | 0.1770 |
| Middle | RMC 12.2Kbps | 23.87 | 0.2438 | 22.47 | 0.1766 |
| Highest | (GT - LC = -1.4 dB) | 23.94 | 0.2477 | 22.54 | 0.1795 |
| Limit | EIRP < 2W | Result | | PASS | |

| Channel | Mode | Conducted | | EIRP | |
|---------|---------------------|-------------|---------------|-----------|---------|
| | | Power (dBm) | Power (Watts) | EIRP(dBm) | EIRP(W) |
| Lowest | WCDMA Band IV | 23.27 | 0.2123 | 19.97 | 0.0993 |
| Middle | RMC 12.2Kbps | 23.29 | 0.2133 | 19.99 | 0.0998 |
| Highest | (GT - LC = -3.3 dB) | 23.30 | 0.2138 | 20.00 | 0.1000 |
| Limit | EIRP < 1W | Result | | PASS | |



Radiated Spurious Emission

Part22H GPRS 850

| Mode 1_GPRS 850 | | | | | | | | | |
|-----------------|-------------------|-------------|---------------|-------------------|-------------------|--------------------|----------------------|-----------------------|--------------------|
| Channel | Frequency (MHz) | ERP (dBm) | Limit (dBm) | Over Limit (dB) | SPA Reading (dBm) | S.G. Power (dBm) | TX Cable loss (dB) | TX Antenna Gain (dBi) | Polarization (H/V) |
| Lowest | 1648 | -48.36 | -13 | -35.36 | -57.25 | -55.31 | 0.53 | 9.63 | H |
| | 2472 | -44.94 | -13 | -31.94 | -56.91 | -52.92 | 0.65 | 10.78 | H |
| | 4120 | -43.57 | -13 | -30.57 | -59.41 | -52.91 | 0.86 | 12.35 | H |
| | | | | | | | | | |
| | | | | | | | | | |
| | 1648 | -50.06 | -13 | -37.06 | -58.72 | -57.01 | 0.53 | 9.63 | V |
| | 2472 | -46.61 | -13 | -33.61 | -59.43 | -54.59 | 0.65 | 10.78 | V |
| | 4120 | -45.68 | -13 | -32.68 | -62.41 | -55.02 | 0.86 | 12.35 | V |
| | | | | | | | | | |
| | | | | | | | | | |
| Middle | 1672 | -50.90 | -13 | -37.90 | -59.83 | -57.9 | 0.53 | 9.68 | H |
| | 2512 | -43.25 | -13 | -30.25 | -55.08 | -51.25 | 0.66 | 10.81 | H |
| | 4184 | -43.32 | -13 | -30.32 | -59.22 | -52.66 | 0.84 | 12.33 | H |
| | | | | | | | | | |
| | | | | | | | | | |
| | 1672 | -51.83 | -13 | -38.83 | -60.51 | -58.83 | 0.53 | 9.68 | V |
| | 2512 | -44.96 | -13 | -31.96 | -57.68 | -52.96 | 0.66 | 10.81 | V |
| | 4184 | -44.53 | -13 | -31.53 | -61.32 | -53.87 | 0.84 | 12.33 | V |
| | | | | | | | | | |
| | | | | | | | | | |



| | | | | | | | | | |
|---------|------|--------|-----|--------|--------|--------|------|-------|---|
| Highest | 1696 | -48.56 | -13 | -35.56 | -57.54 | -55.61 | 0.53 | 9.73 | H |
| | 2544 | -40.82 | -13 | -27.82 | -52.74 | -48.83 | 0.67 | 10.83 | H |
| | 4248 | -44.16 | -13 | -31.16 | -60.24 | -53.47 | 0.84 | 12.30 | H |
| | | | | | | | | | |
| | | | | | | | | | |
| | | | | | | | | | |
| | 1696 | -49.56 | -13 | -36.56 | -58.26 | -56.61 | 0.53 | 9.73 | V |
| | 2544 | -43.00 | -13 | -30.00 | -55.62 | -51.01 | 0.67 | 10.83 | V |
| | 4248 | -46.06 | -13 | -33.06 | -63.01 | -55.37 | 0.84 | 12.30 | V |
| | | | | | | | | | |
| | | | | | | | | | |
| | | | | | | | | | |

Remark: Spurious emissions within 30-1000MHz were found more than 20dB below limit line.



Part22H EDGE 850

| Mode 2_EDGE 850 | | | | | | | | | |
|-----------------|-------------------|-------------|---------------|-------------------|-------------------|--------------------|----------------------|-----------------------|--------------------|
| Channel | Frequency (MHz) | ERP (dBm) | Limit (dBm) | Over Limit (dB) | SPA Reading (dBm) | S.G. Power (dBm) | TX Cable loss (dB) | TX Antenna Gain (dBi) | Polarization (H/V) |
| Lowest | 1648 | -53.01 | -13 | -40.01 | -61.9 | -59.96 | 0.53 | 9.63 | H |
| | 2472 | -51.95 | -13 | -38.95 | -63.89 | -59.93 | 0.65 | 10.78 | H |
| | 3296 | -54.44 | -13 | -41.44 | -68.74 | -63.52 | 0.76 | 11.99 | H |
| | | | | | | | | | |
| | | | | | | | | | |
| | | | | | | | | | |
| | 1648 | -55.82 | -13 | -42.82 | -64.49 | -62.77 | 0.53 | 9.63 | V |
| | 2472 | -50.78 | -13 | -37.78 | -63.6 | -58.76 | 0.65 | 10.78 | V |
| | 3296 | -55.54 | -13 | -42.54 | -69.85 | -64.62 | 0.76 | 11.99 | V |
| | | | | | | | | | |
| | | | | | | | | | |
| | Middle | 1672 | -54.08 | -13 | -41.08 | -63.01 | -61.08 | 0.53 | 9.68 |
| 2512 | | -54.46 | -13 | -41.46 | -66.29 | -62.46 | 0.66 | 10.81 | H |
| 3344 | | -54.85 | -13 | -41.85 | -69.02 | -64.07 | 0.76 | 12.13 | H |
| | | | | | | | | | |
| | | | | | | | | | |
| | | | | | | | | | |
| 1672 | | -56.38 | -13 | -43.38 | -65.06 | -63.38 | 0.53 | 9.68 | V |
| 2512 | | -54.58 | -13 | -41.58 | -67.3 | -62.58 | 0.66 | 10.81 | V |
| 3344 | | -55.06 | -13 | -42.06 | -69.26 | -64.28 | 0.76 | 12.13 | V |
| | | | | | | | | | |
| | | | | | | | | | |



| | | | | | | | | | |
|---------|------|--------|-----|--------|--------|--------|------|-------|---|
| Highest | 1696 | -55.37 | -13 | -42.37 | -64.35 | -62.42 | 0.53 | 9.73 | H |
| | 2544 | -49.49 | -13 | -36.49 | -61.41 | -57.5 | 0.67 | 10.83 | H |
| | 3392 | -55.19 | -13 | -42.19 | -69.16 | -64.55 | 0.77 | 12.28 | H |
| | | | | | | | | | |
| | | | | | | | | | |
| | | | | | | | | | |
| | 1696 | -55.62 | -13 | -42.62 | -64.32 | -62.67 | 0.53 | 9.73 | V |
| | 2544 | -48.85 | -13 | -35.85 | -61.47 | -56.86 | 0.67 | 10.83 | V |
| | 3392 | -55.65 | -13 | -42.65 | -69.45 | -65.01 | 0.77 | 12.28 | V |
| | | | | | | | | | |
| | | | | | | | | | |
| | | | | | | | | | |

Remark: Spurious emissions within 30-1000MHz were found more than 20dB below limit line.



Part22H WCDMA 850

| Mode 3_WCDMA 850 | | | | | | | | | |
|------------------|-------------------|-------------|---------------|-------------------|-------------------|--------------------|----------------------|-----------------------|--------------------|
| Channel | Frequency (MHz) | ERP (dBm) | Limit (dBm) | Over Limit (dB) | SPA Reading (dBm) | S.G. Power (dBm) | TX Cable loss (dB) | TX Antenna Gain (dBi) | Polarization (H/V) |
| Lowest | 1648 | -58.69 | -13 | -45.69 | -67.53 | -65.64 | 0.53 | 9.63 | H |
| | 2472 | -56.44 | -13 | -43.44 | -68.43 | -64.42 | 0.65 | 10.78 | H |
| | 3296 | -54.63 | -13 | -41.63 | -68.9 | -63.71 | 0.76 | 11.99 | H |
| | | | | | | | | | |
| | | | | | | | | | |
| | 1648 | -58.40 | -13 | -45.40 | -67.01 | -65.35 | 0.53 | 9.63 | V |
| | 2472 | -50.27 | -13 | -37.27 | -63.05 | -58.25 | 0.65 | 10.78 | V |
| | 3296 | -54.60 | -13 | -41.60 | -69 | -63.68 | 0.76 | 11.99 | V |
| | | | | | | | | | |
| | | | | | | | | | |
| | | | | | | | | | |
| | Middle | 1672 | -57.36 | -13 | -44.36 | -66.29 | -64.36 | 0.53 | 9.68 |
| 2512 | | -47.15 | -13 | -34.15 | -58.98 | -55.15 | 0.66 | 10.81 | H |
| 3344 | | -54.56 | -13 | -41.56 | -68.81 | -63.78 | 0.76 | 12.13 | H |
| | | | | | | | | | |
| | | | | | | | | | |
| 1672 | | -56.83 | -13 | -43.83 | -65.51 | -63.83 | 0.53 | 9.68 | V |
| 2512 | | -50.51 | -13 | -37.51 | -63.23 | -58.51 | 0.66 | 10.81 | V |
| 3344 | | -54.80 | -13 | -41.80 | -69.01 | -64.02 | 0.76 | 12.13 | V |
| | | | | | | | | | |
| | | | | | | | | | |
| | | | | | | | | | |



| | | | | | | | | | |
|---------|------|--------|-----|--------|--------|--------|------|-------|---|
| Highest | 1696 | -57.99 | -13 | -44.99 | -66.97 | -65.04 | 0.53 | 9.73 | H |
| | 2536 | -56.26 | -13 | -43.26 | -68.15 | -64.27 | 0.66 | 10.82 | H |
| | 3384 | -55.68 | -13 | -42.68 | -69.59 | -65.01 | 0.77 | 12.25 | H |
| | | | | | | | | | |
| | | | | | | | | | |
| | | | | | | | | | |
| | 1696 | -58.40 | -13 | -45.40 | -67.14 | -65.45 | 0.53 | 9.73 | V |
| | 2536 | -56.27 | -13 | -43.27 | -68.94 | -64.28 | 0.66 | 10.82 | V |
| | 3384 | -55.34 | -13 | -42.34 | -69.43 | -64.67 | 0.77 | 12.25 | V |
| | | | | | | | | | |
| | | | | | | | | | |
| | | | | | | | | | |

Remark: Spurious emissions within 30-1000MHz were found more than 20dB below limit line.



Part24E GSM 1900

| Mode 1_GSM 1900 | | | | | | | | | |
|-----------------|-------------------|--------------|---------------|-------------------|-------------------|--------------------|----------------------|-----------------------|--------------------|
| Channel | Frequency (MHz) | EIRP (dBm) | Limit (dBm) | Over Limit (dB) | SPA Reading (dBm) | S.G. Power (dBm) | TX Cable loss (dB) | TX Antenna Gain (dBi) | Polarization (H/V) |
| Lowest | 3702 | -38.03 | -13 | -25.03 | -54.12 | -49.82 | 0.72 | 12.52 | H |
| | 5550 | -36.52 | -13 | -23.52 | -55.9 | -48.69 | 1.00 | 13.17 | H |
| | 7398 | -45.66 | -13 | -32.66 | -67.41 | -55.06 | 1.18 | 10.58 | H |
| | | | | | | | | | |
| | | | | | | | | | |
| | 3702 | -43.26 | -13 | -30.26 | -59.5 | -55.05 | 0.72 | 12.52 | V |
| | 5550 | -32.97 | -13 | -19.97 | -52.56 | -45.14 | 1.00 | 13.17 | V |
| | 7398 | -46.62 | -13 | -33.62 | -68.43 | -56.02 | 1.18 | 10.58 | V |
| | | | | | | | | | |
| | | | | | | | | | |
| | | | | | | | | | |
| | Middle | 3762 | -39.83 | -13 | -26.83 | -55.98 | -51.64 | 0.69 | 12.50 |
| 5640 | | -37.55 | -13 | -24.55 | -56.75 | -49.68 | 0.98 | 13.12 | H |
| 7518 | | -46.46 | -13 | -33.46 | -69.36 | -55.73 | 1.18 | 10.45 | H |
| | | | | | | | | | |
| | | | | | | | | | |
| 3762 | | -40.86 | -13 | -27.86 | -57.34 | -52.67 | 0.69 | 12.50 | V |
| 5640 | | -40.81 | -13 | -27.81 | -60.3 | -52.94 | 0.98 | 13.12 | V |
| 7518 | | -46.01 | -13 | -33.01 | -68.99 | -55.28 | 1.18 | 10.45 | V |
| | | | | | | | | | |
| | | | | | | | | | |
| | | | | | | | | | |



| | | | | | | | | | |
|---------|------|--------|-----|--------|--------|--------|------|-------|---|
| Highest | 3822 | -37.44 | -13 | -24.44 | -53.59 | -49.22 | 0.69 | 12.47 | H |
| | 5730 | -44.51 | -13 | -31.51 | -63.96 | -56.58 | 0.99 | 13.06 | H |
| | 7638 | -46.15 | -13 | -33.15 | -68.96 | -55.75 | 1.18 | 10.79 | H |
| | | | | | | | | | |
| | | | | | | | | | |
| | | | | | | | | | |
| | 3822 | -38.76 | -13 | -25.76 | -55.26 | -50.54 | 0.69 | 12.47 | V |
| | 5730 | -43.93 | -13 | -30.93 | -63.46 | -56 | 0.99 | 13.06 | V |
| | 7638 | -46.05 | -13 | -33.05 | -68.84 | -55.65 | 1.18 | 10.79 | V |
| | | | | | | | | | |
| | | | | | | | | | |
| | | | | | | | | | |
| | | | | | | | | | |
| | | | | | | | | | |

Remark: Spurious emissions within 30-1000MHz were found more than 20dB below limit line.



Part24E EDGE 1900

| Mode 2_EDGE 1900 | | | | | | | | | |
|------------------|-------------------|--------------|---------------|-------------------|-------------------|--------------------|----------------------|-----------------------|--------------------|
| Channel | Frequency (MHz) | EIRP (dBm) | Limit (dBm) | Over Limit (dB) | SPA Reading (dBm) | S.G. Power (dBm) | TX Cable loss (dB) | TX Antenna Gain (dBi) | Polarization (H/V) |
| Lowest | 3702 | -47.65 | -13 | -34.65 | -63.66 | -59.44 | 0.72 | 12.52 | H |
| | 5550 | -50.22 | -13 | -37.22 | -69.46 | -62.39 | 1.00 | 13.17 | H |
| | 7398 | -47.18 | -13 | -34.18 | -69.07 | -56.58 | 1.18 | 10.58 | H |
| | | | | | | | | | |
| | | | | | | | | | |
| | 3702 | -48.76 | -13 | -35.76 | -64.93 | -60.55 | 0.72 | 12.52 | V |
| | 5550 | -37.10 | -13 | -24.10 | -56.73 | -49.27 | 1.00 | 13.17 | V |
| | 7398 | -47.06 | -13 | -34.06 | -69 | -56.46 | 1.18 | 10.58 | V |
| | | | | | | | | | |
| | | | | | | | | | |
| | | | | | | | | | |
| | Middle | 3762 | -46.62 | -13 | -33.62 | -62.65 | -58.43 | 0.69 | 12.50 |
| 5640 | | -49.74 | -13 | -36.74 | -68.82 | -61.87 | 0.98 | 13.12 | H |
| 7518 | | -45.93 | -13 | -32.93 | -68.81 | -55.2 | 1.18 | 10.45 | H |
| | | | | | | | | | |
| | | | | | | | | | |
| 3762 | | -46.73 | -13 | -33.73 | -63.03 | -58.54 | 0.69 | 12.50 | V |
| 5640 | | -49.06 | -13 | -36.06 | -68.62 | -61.19 | 0.98 | 13.12 | V |
| 7518 | | -45.78 | -13 | -32.78 | -68.66 | -55.05 | 1.18 | 10.45 | V |
| | | | | | | | | | |
| | | | | | | | | | |
| | | | | | | | | | |



| | | | | | | | | | |
|---------|------|--------|-----|--------|--------|--------|------|-------|---|
| Highest | 3822 | -45.45 | -13 | -32.45 | -61.58 | -57.23 | 0.69 | 12.47 | H |
| | 5730 | -48.07 | -13 | -35.07 | -67.43 | -60.14 | 0.99 | 13.06 | H |
| | 7638 | -46.09 | -13 | -33.09 | -68.9 | -55.69 | 1.18 | 10.79 | H |
| | | | | | | | | | |
| | | | | | | | | | |
| | | | | | | | | | |
| | 3822 | -45.51 | -13 | -32.51 | -62.06 | -57.29 | 0.69 | 12.47 | V |
| | 5730 | -48.28 | -13 | -35.28 | -67.84 | -60.35 | 0.99 | 13.06 | V |
| | 7638 | -45.43 | -13 | -32.43 | -68.19 | -55.03 | 1.18 | 10.79 | V |
| | | | | | | | | | |
| | | | | | | | | | |

Remark: Spurious emissions within 30-1000MHz were found more than 20dB below limit line.



Part24E WCDMA 1900

| Mode 3_WCDMA 1900 | | | | | | | | | |
|-------------------|-------------------|--------------|---------------|-------------------|-------------------|--------------------|----------------------|-----------------------|--------------------|
| Channel | Frequency (MHz) | EIRP (dBm) | Limit (dBm) | Over Limit (dB) | SPA Reading (dBm) | S.G. Power (dBm) | TX Cable loss (dB) | TX Antenna Gain (dBi) | Polarization (H/V) |
| Lowest | 3702 | -52.09 | -13 | -39.09 | -68.18 | -63.88 | 0.72 | 12.52 | H |
| | 5550 | -50.27 | -13 | -37.27 | -69.57 | -62.44 | 1.00 | 13.17 | H |
| | 7410 | -46.78 | -13 | -33.78 | -68.71 | -56.16 | 1.18 | 10.56 | H |
| | | | | | | | | | |
| | | | | | | | | | |
| | 3702 | -52.68 | -13 | -39.68 | -68.82 | -64.47 | 0.72 | 12.52 | V |
| | 5550 | -49.89 | -13 | -36.89 | -69.55 | -62.06 | 1.00 | 13.17 | V |
| | 7410 | -40.86 | -13 | -27.86 | -62.9 | -50.24 | 1.18 | 10.56 | V |
| | | | | | | | | | |
| | | | | | | | | | |
| | | | | | | | | | |
| | Middle | 3762 | -49.63 | -13 | -36.63 | -65.65 | -61.44 | 0.69 | 12.50 |
| 5640 | | -50.49 | -13 | -37.49 | -69.79 | -62.62 | 0.98 | 13.12 | H |
| 7518 | | -45.17 | -13 | -32.17 | -68.07 | -54.44 | 1.18 | 10.45 | H |
| | | | | | | | | | |
| | | | | | | | | | |
| 3762 | | -51.80 | -13 | -38.80 | -68.34 | -63.61 | 0.69 | 12.50 | V |
| 5640 | | -49.97 | -13 | -36.97 | -69.52 | -62.1 | 0.98 | 13.12 | V |
| 7518 | | -40.28 | -13 | -27.28 | -63.27 | -49.55 | 1.18 | 10.45 | V |
| | | | | | | | | | |
| | | | | | | | | | |
| | | | | | | | | | |



| | | | | | | | | | |
|---------|------|--------|-----|--------|--------|--------|------|-------|---|
| Highest | 3816 | -52.23 | -13 | -39.23 | -68.33 | -64.02 | 0.69 | 12.47 | H |
| | 5724 | -49.54 | -13 | -36.54 | -68.99 | -61.61 | 0.99 | 13.07 | H |
| | 7638 | -43.69 | -13 | -30.69 | -66.5 | -53.29 | 1.18 | 10.79 | H |
| | | | | | | | | | |
| | | | | | | | | | |
| | | | | | | | | | |
| | 3816 | -52.09 | -13 | -39.09 | -68.57 | -63.88 | 0.69 | 12.47 | V |
| | 5724 | -48.69 | -13 | -35.69 | -68.3 | -60.76 | 0.99 | 13.07 | V |
| | 7638 | -38.23 | -13 | -25.23 | -61.04 | -47.83 | 1.18 | 10.79 | V |
| | | | | | | | | | |
| | | | | | | | | | |
| | | | | | | | | | |

Remark: Spurious emissions within 30-1000MHz were found more than 20dB below limit line.



Part27L WCDMA 1700

| Mode 1_WCDMA 1700 | | | | | | | | | |
|-------------------|-------------------|--------------|---------------|-------------------|-------------------|--------------------|----------------------|-----------------------|--------------------|
| Channel | Frequency (MHz) | EIRP (dBm) | Limit (dBm) | Over Limit (dB) | SPA Reading (dBm) | S.G. Power (dBm) | TX Cable loss (dB) | TX Antenna Gain (dBi) | Polarization (H/V) |
| Lowest | 3426 | -51.85 | -13 | -38.85 | -66.79 | -63.45 | 0.77 | 12.38 | H |
| | 5142 | -46.59 | -13 | -33.59 | -64.8 | -58.1 | 0.97 | 12.48 | H |
| | 6852 | -40.82 | -13 | -27.82 | -62.35 | -51.61 | 0.83 | 11.63 | H |
| | | | | | | | | | |
| | | | | | | | | | |
| | | | | | | | | | |
| | 3426 | -51.26 | -13 | -38.26 | -66.25 | -62.86 | 0.77 | 12.38 | V |
| | 5142 | -44.90 | -13 | -31.90 | -63.69 | -56.41 | 0.97 | 12.48 | V |
| | 6852 | -47.24 | -13 | -34.24 | -68.87 | -58.03 | 0.83 | 11.63 | V |
| | | | | | | | | | |
| | | | | | | | | | |
| | | | | | | | | | |
| Middle | 3468 | -50.48 | -13 | -37.48 | -65.87 | -62.21 | 0.78 | 12.50 | H |
| | 5196 | -47.88 | -13 | -34.88 | -66.34 | -59.48 | 0.99 | 12.59 | H |
| | 6930 | -40.69 | -13 | -27.69 | -62.24 | -51.14 | 1.01 | 11.45 | H |
| | | | | | | | | | |
| | | | | | | | | | |
| | | | | | | | | | |
| | 3468 | -51.84 | -13 | -38.84 | -67.41 | -63.57 | 0.78 | 12.50 | V |
| | 5196 | -47.81 | -13 | -34.81 | -66.81 | -59.41 | 0.99 | 12.59 | V |
| | 6930 | -46.99 | -13 | -33.99 | -68.59 | -57.44 | 1.01 | 11.45 | V |
| | | | | | | | | | |
| | | | | | | | | | |
| | | | | | | | | | |



| | | | | | | | | | |
|---------|------|--------|-----|--------|--------|--------|------|-------|---|
| Highest | 3504 | -51.20 | -13 | -38.20 | -66.99 | -63.02 | 0.78 | 12.60 | H |
| | 5262 | -46.76 | -13 | -33.76 | -65.37 | -58.47 | 1.01 | 12.72 | H |
| | 7008 | -40.86 | -13 | -27.86 | -62.62 | -50.98 | 1.17 | 11.29 | H |
| | | | | | | | | | |
| | | | | | | | | | |
| | | | | | | | | | |
| | 3504 | -51.75 | -13 | -38.75 | -67.69 | -63.57 | 0.78 | 12.60 | V |
| | 5256 | -47.19 | -13 | -34.19 | -66.5 | -58.89 | 1.01 | 12.71 | V |
| | 7008 | -46.89 | -13 | -33.89 | -68.61 | -57.01 | 1.17 | 11.29 | V |
| | | | | | | | | | |
| | | | | | | | | | |

Remark: Spurious emissions within 30-1000MHz were found more than 20dB below limit line.