



FCC RF Test Report

APPLICANT : Sony Mobile Communications Inc.
EQUIPMENT : GSM/WCDMA/LTE Phone+Bluetooth,
DTS/UNII a/b/g/n and NFC
BRAND NAME : Sony
FCC ID : PY7-98591H
STANDARD : FCC 47 CFR Part 2, 22(H), 24(E), 27(L)
CLASSIFICATION : PCS Licensed Transmitter Held to Ear (PCE)

The product was received on Sep. 23, 2016 and testing was completed on Nov. 19, 2016. We, SPORTON INTERNATIONAL INC., would like to declare that the tested sample has been evaluated in accordance with the test procedures given in ANSI / TIA / EIA-603-D-2010 and has been in compliance with the applicable technical standards.

The test results in this report apply exclusively to the tested model / sample. Without written approval of SPORTON INTERNATIONAL INC., the test report shall not be reproduced except in full.

Reviewed by: Joseph Lin / Supervisor

Approved by: Jones Tsai / Manager



SPORTON INTERNATIONAL INC.

No. 52, Hwa Ya 1st Rd., Hwa Ya Technology Park, Kwei-Shan District, Tao Yuan City, Taiwan, R.O.C.

SPORTON INTERNATIONAL INC.

TEL : 886-3-327-3456

FAX : 886-3-328-4978

FCC ID : PY7-98591H

Page Number : 1 of 23

Report Issued Date : Feb. 13, 2017

Report Version : Rev. 03

Report Template No.: BU5-FG22/24/27 Version 1.2



TABLE OF CONTENTS

REVISION HISTORY.....3

SUMMARY OF TEST RESULT4

1 GENERAL DESCRIPTION5

1.1 Applicant.....5

1.2 Manufacturer5

1.3 Product Feature of Equipment Under Test5

1.4 Modification of EUT5

1.5 Maximum ERP/EIRP Power, Frequency Tolerance, and Emission Designator6

1.6 Testing Location7

1.7 Applicable Standards8

2 TEST CONFIGURATION OF EQUIPMENT UNDER TEST9

2.1 Test Mode.....9

2.2 Connection Diagram of Test System10

2.3 Support Unit used in test configuration10

2.4 Measurement Results Explanation Example10

2.5 Frequency List of Low/Middle/High Channels.....11

3 CONDUCTED TEST RESULT.....12

3.1 Measuring Instruments.....12

3.2 Test Setup12

3.3 Test Result of Conducted Test.....12

3.4 Conducted Output Power and ERP/EIRP13

3.5 Peak-to-Average Ratio14

3.6 99% Occupied Bandwidth and 26dB Bandwidth Measurement.....15

3.7 Conducted Band Edge16

3.8 Conducted Spurious Emission17

3.9 Frequency Stability.....18

4 RADIATED TEST ITEMS19

4.1 Measuring Instruments.....19

4.2 Test Setup19

4.3 Test Result of Radiated Test.....19

4.4 Field Strength of Spurious Radiation Measurement20

5 LIST OF MEASURING EQUIPMENT21

6 UNCERTAINTY OF EVALUATION23

APPENDIX A. TEST RESULTS OF CONDUCTED TEST

APPENDIX B. TEST RESULTS OF ERP/EIRP AND RADIATED TEST



REVISION HISTORY

REPORT NO.	VERSION	DESCRIPTION	ISSUED DATE
FG692213-01A	Rev. 01	Initial issue of report	Feb. 06, 2017
FG692213-01A	Rev. 02	Adding units of measurement for Occupied BW and 26dB Bandwidth in appendix a.	Feb. 10, 2017
FG692213-01A	Rev. 03	Revising calibration due date for equipment list in section 5 and revising description in section 2.4, section 3.7.2, section 3.8.2, and section 4.4.2, and add frequency range in section 1.5 and channel list in section 2.5.	Feb. 13, 2017



SUMMARY OF TEST RESULT

Report Section	FCC Rule	Description	Limit	Result	Remark
3.4	§2.1046	Conducted Output Power	Reporting Only	PASS	-
	§22.913(a)(2)	Effective Radiated Power	< 7 Watts	PASS	-
	§24.232(c)	Equivalent Isotropic Radiated Power	< 2 Watts	PASS	-
	§27.50(d)(4)	Equivalent Isotropic Radiated Power	< 1 Watts	PASS	-
3.5	§24.232(d)	Peak-to-Average Ratio	< 13 dB	PASS	-
3.6	§2.1049 §22.917(b) §24.238(b) §27.53(g)	Occupied Bandwidth	Reporting Only	PASS	-
3.7	§2.1051 §22.917(a) §24.238(a) §27.53(h)	Band Edge Measurement	< 43+10log10(P[Watts])	PASS	-
3.8	§2.1051 §22.917(a) §24.238(a) §27.53(h)	Conducted Emission	< 43+10log10(P[Watts])	PASS	-
3.9	§2.1055 §22.355	Frequency Stability for Temperature & Voltage	< 2.5 ppm for Part 22	PASS	-
	§2.1055 §24.235 §27.54		Within Authorized Band		
4.4	§2.1053 §22.917(a) §24.238(a) §27.53(h)	Field Strength of Spurious Radiation	< 43+10log10(P[Watts])	PASS	Under limit 28.72 dB at 2472.000 MHz



1 General Description

1.1 Applicant

Sony Mobile Communications Inc.

4-12-3 Higashi-Shinagawa, Shinagawa-ku, Tokyo, 140-0002, Japan

1.2 Manufacturer

Sony Mobile Communications Inc.

4-12-3 Higashi-Shinagawa, Shinagawa-ku, Tokyo, 140-0002, Japan

1.3 Product Feature of Equipment Under Test

GSM/WCDMA/LTE, Bluetooth, DTS/UNII, a/b/g/n, GPS and NFC

Product Specification subjective to this standard	
Antenna Type	Coupling type (LDS) Antenna

EUT Information List			
HW Version	SW Version	S/N	Performed Test Item
A	0.85	RQ3002L5TA	Conducted Measurement ERP/EIRP Test
		RQ3002L5TB	Radiated Spurious Emission

Accessory List	
AC Adapter 1	Model No. : UCH20
	S/N : 1215W48600014
Earphone 1	Model No. : MH410c
	S/N : 1632A86300007A6
USB Cable	Model No. : UCB20
	S/N : 1632A86300007A6

Note:

1. Above EUT list and accessory list used are electrically identical per declared by manufacturer.
2. Above the accessories list are used to exercise the EUT during test.
3. For other wireless features of this EUT, test report will be issued separately.

1.4 Modification of EUT

No modifications are made to the EUT during all test items.



1.5 Maximum ERP/EIRP Power, Frequency Tolerance, and Emission Designator

FCC Rule	Frequency Range (MHz)	System	Type of Modulation	Maximum ERP/EIRP (W)	Frequency Tolerance (ppm)	Emission Designator
Part 22	824.2 ~848.8	GSM850 GSM	GMSK	0.6592	0.0227 ppm	246KGXW
Part 22	824.2 ~848.8	GSM850 EDGE class 8	8PSK	0.1303	0.0670 ppm	245KG7W
Part 22	826.4 ~846.6	WCDMA Band V RMC 12.2Kbps	BPSK	0.0843	0.0167 ppm	4M21F9W
Part 24	1850.2 ~1909.8	GSM1900 GSM	GMSK	1.5488	0.0117 ppm	247KGXW
Part 24	1850.2 ~1909.8	GSM1900 EDGE class 8	8PSK	0.4064	0.0266 ppm	248KG7W
Part 24	1852.4 ~ 1907.6	WCDMA Band II RMC 12.2Kbps	BPSK	0.3459	0.0027 ppm	4M18F9W
Part 27	1712.4 ~ 1752.6	WCDMA Band IV RMC 12.2Kbps	BPSK	0.2570	0.0121 ppm	4M17F9W



1.6 Testing Location

Sporton Lab is accredited to ISO 17025 by Taiwan Accreditation Foundation (TAF code : 1190) and the FCC designation No. TW1022 under the FCC 2.948(e) by Mutual Recognition Agreement (MRA) in FCC Test.

Test Site	SPORTON INTERNATIONAL INC.
Test Site Location	No. 52, Hwa Ya 1 st Rd., Hwa Ya Technology Park, Kwei-Shan District, Tao Yuan City, Taiwan, R.O.C. TEL: +886-3-327-3456 FAX: +886-3-328-4978
Test Site No.	Sporton Site No.
	TH03-HY

Test Site	SPORTON INTERNATIONAL INC.
Test Site Location	No.58, Aly. 75, Ln. 564, Wenhua 3rd Rd. Guishan Dist, Taoyuan City, Taiwan (R.O.C.) TEL: +886-3-327-0868 FAX: +886-3-327-0855
Test Site No.	Sporton Site No.
	03CH13-HY



1.7 Applicable Standards

According to the specifications of the manufacturer, the EUT must comply with the requirements of the following standards:

- ♦ 47 CFR Part 2, 22(H), 24(E), 27(L)
- ♦ ANSI / TIA / EIA-603-D-2010
- ♦ FCC KDB 971168 D01 Power Meas. License Digital Systems v02r02
- ♦ FCC KDB 412172 D01 Determining ERP and EIRP v01r01

Remark:

1. All test items were verified and recorded according to the standards and without any deviation during the test.
2. This EUT has also been tested and complied with the requirements of FCC Part 15, Subpart B, recorded in a separate test report.



2 Test Configuration of Equipment Under Test

2.1 Test Mode

Antenna port conducted and radiated test items were performed according to KDB 971168 D01 Power Meas. License Digital Systems v02r02 with maximum output power.

Radiated measurements were performed with rotating EUT in different three orthogonal test planes to find the maximum emission.

Radiated emissions were investigated as following frequency range:

1. 30 MHz to 9000 MHz for GSM850 and WCDMA Band V.
2. 30 MHz to 18000 MHz for WCDMA Band IV.
3. 30 MHz to 19100 MHz for GSM1900 and WCDMA Band II.

All modes and data rates and positions were investigated.

Test modes are chosen to be reported as the worst case configuration below:

Test Modes		
Band	Radiated TCs	Conducted TCs
GSM 850	<ul style="list-style-type: none"> ■ GSM Link ■ EDGE class 8 Link 	<ul style="list-style-type: none"> ■ GSM Link ■ EDGE class 8 Link
GSM 1900	<ul style="list-style-type: none"> ■ GSM Link ■ EDGE class 8 Link 	<ul style="list-style-type: none"> ■ GSM Link ■ EDGE class 8 Link
WCDMA Band V	<ul style="list-style-type: none"> ■ RMC 12.2Kbps Link 	<ul style="list-style-type: none"> ■ RMC 12.2Kbps Link
WCDMA Band II	<ul style="list-style-type: none"> ■ RMC 12.2Kbps Link 	<ul style="list-style-type: none"> ■ RMC 12.2Kbps Link
WCDMA Band IV	<ul style="list-style-type: none"> ■ RMC 12.2Kbps Link 	<ul style="list-style-type: none"> ■ RMC 12.2Kbps Link

2.2 Connection Diagram of Test System

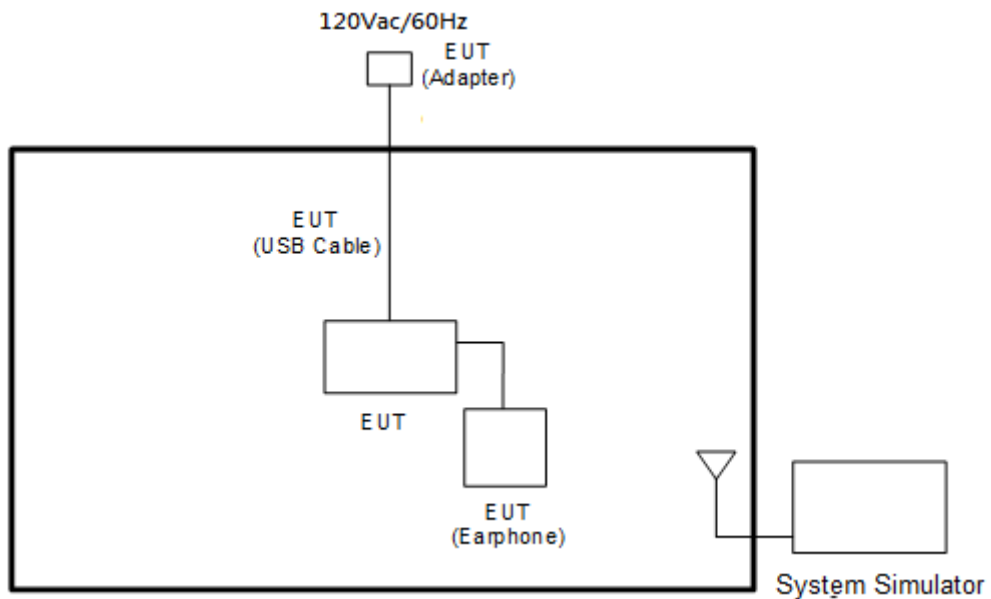

2.3 Support Unit used in test configuration

Item	Equipment	Trade Name	Model No.	FCC ID	Data Cable	Power Cord
1.	System Simulator	R&S	CMU 200	N/A	N/A	Unshielded, 1.8 m

2.4 Measurement Results Explanation Example

For all conducted test items:

The offset level is set in the spectrum analyzer to compensate the RF cable loss and attenuator factor between RF conducted output port and spectrum analyzer. With the offset compensation, the spectrum analyzer reading level will be exactly the RF output level.

The spectrum analyzer offset is derived from RF cable loss and attenuator factor.

Offset = RF cable loss + attenuator factor.

The following shows an offset computation example with RF cable loss 4.2 dB and a 10dB attenuator.

Example :

Offset(dB) = RF cable loss(dB) + attenuator factor(dB).

= 4.2 + 10 = 14.2 (dB)



2.5 Frequency List of Low/Middle/High Channels

Frequency List				
Band	Channel/Frequency(MHz)	Lowest	Middle	Highest
GSM850	Channel	128	189	251
	Frequency	824.2	836.4	848.8
WCDMA Band V	Channel	4132	4182	4233
	Frequency	826.4	836.4	846.6
GSM1900	Channel	512	661	810
	Frequency	1850.2	1880.0	1909.8
WCDMA Band II	Channel	9262	9400	9538
	Frequency	1852.4	1880.0	1907.6
WCDMA Band IV	Channel	1312	1413	1513
	Frequency	1712.4	1732.6	1752.6

3 Conducted Test Result

3.1 Measuring Instruments

See list of measuring instruments of this test report.

3.2 Test Setup

3.2.1 Conducted Output Power



3.2.2 Peak-to-Average Ratio, Occupied Bandwidth, Conducted Band-Edge and Conducted Spurious Emission

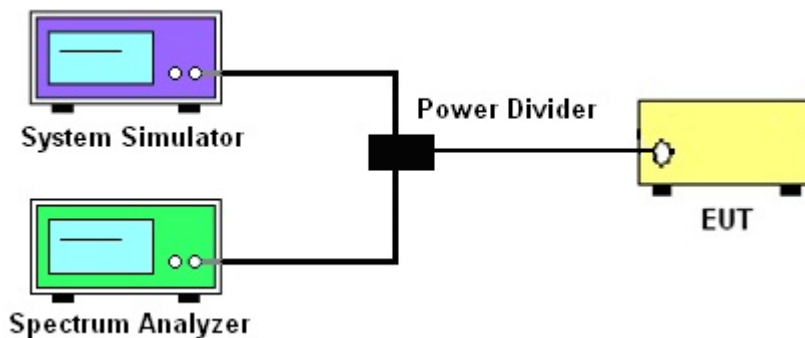

3.2.3 Frequency Stability

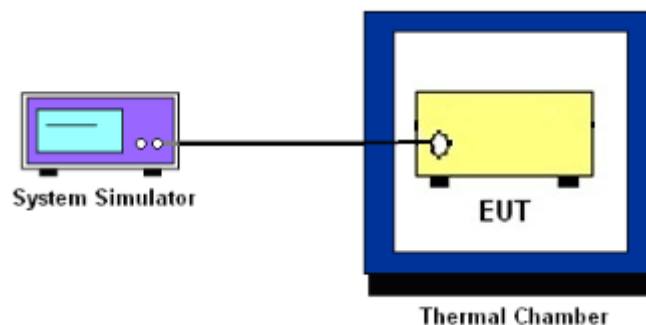

3.3 Test Result of Conducted Test

Please refer to Appendix A.



3.4 Conducted Output Power and ERP/EIRP

3.4.1 Description of the Conducted Output Power and ERP/EIRP

A system simulator was used to establish communication with the EUT. Its parameters were set to enforce EUT transmitting at the maximum power. The measured power in the radio frequency on the transmitter output terminals shall be reported.

The ERP of mobile transmitters must not exceed 7 Watts for GSM850 and WCDMA Band V.

The EIRP of mobile transmitters must not exceed 2 Watts for GSM1900 and WCDMA Band II.

The EIRP of mobile transmitters must not exceed 1 Watts for WCDMA Band IV.

According to KDB 412172 D01 Power Approach,

$EIRP = P_T + G_T - L_C$, $ERP = EIRP - 2.15$, where

P_T = transmitter output power in dBm

G_T = gain of the transmitting antenna in dBi

L_C = signal attenuation in the connecting cable between the transmitter and antenna in dB

3.4.2 Test Procedures

1. The transmitter output port was connected to the system simulator.
2. Set EUT at maximum power through system simulator.
3. Select lowest, middle, and highest channels for each band and different modulation.
4. Measure the maximum burst average power for GSM and maximum average power for other modulation signal.



3.5 Peak-to-Average Ratio

3.5.1 Description of the PAR Measurement

The peak-to-average ratio (PAR) of the transmission may not exceed 13 dB.

3.5.2 Test Procedures

1. The testing follows FCC KDB 971168 D01 v02r02 Section 5.7.1.
2. The EUT was connected to spectrum analyzer and system simulator via a power divider.
3. Set EUT to transmit at maximum output power.
4. When the duty cycle is less than 98%, then signal gating will be implemented on the spectrum analyzer by triggering from the system simulator.
5. Set the CCDF (Complementary Cumulative Distribution Function) option of the spectrum analyzer.
Record the maximum PAPR level associated with a probability of 0.1%.



3.6 99% Occupied Bandwidth and 26dB Bandwidth Measurement

3.6.1 Description of 99% Occupied Bandwidth and 26dB Bandwidth Measurement

The occupied bandwidth is the width of a frequency band such that, below the lower and above the upper frequency limits, the mean powers emitted are each equal to a specified percentage 0.5% of the total mean transmitted power.

The 26 dB emission bandwidth is defined as the frequency range between two points, one above and one below the carrier frequency, at which the spectral density of the emission is attenuated 26 dB below the maximum in-band spectral density of the modulated signal. Spectral density (power per unit bandwidth) is to be measured with a detector of resolution bandwidth equal to approximately 1.0% of the emission bandwidth.

3.6.2 Test Procedures

1. The testing follows FCC KDB 971168 v02r02 Section 4.2.
2. The EUT was connected to spectrum analyzer and system simulator via a power divider.
3. The spectrum analyzer center frequency is set to the nominal EUT channel center frequency. The span range for the spectrum analyzer shall be between two and five times the anticipated OBW.
4. The nominal resolution bandwidth (RBW) shall be in the range of 1 to 5 % of the anticipated OBW, and the VBW shall be at least 3 times the RBW.
5. Set the detection mode to peak, and the trace mode to max hold.
6. Determine the reference value: Set the EUT to transmit a modulated signal. Allow the trace to stabilize. Set the spectrum analyzer marker to the highest level of the displayed trace.
(this is the reference value)
7. Determine the “-26 dB down amplitude” as equal to (Reference Value – X).
8. Place two markers, one at the lowest and the other at the highest frequency of the envelope of the spectral display such that each marker is at or slightly below the “-X dB down amplitude” determined in step 6. If a marker is below this “-X dB down amplitude” value it shall be placed as close as possible to this value. The OBW is the positive frequency difference between the two markers.
9. Use the 99 % power bandwidth function of the spectrum analyzer and report the measured bandwidth.



3.7 Conducted Band Edge

3.7.1 Description of Conducted Band Edge Measurement

The power of any emission outside of the authorized operating frequency ranges must be lower than the transmitter power (P) by a factor of at least $43 + 10 \log (P)$ dB.

3.7.2 Test Procedures

1. The testing follows FCC KDB 971168 D01 v02r02 Section 6.0.
2. The EUT was connected to the spectrum analyzer and system simulator via a power divider.
3. The RF output of EUT was connected to the spectrum analyzer by an RF cable and attenuator. The path loss was compensated to the results for each measurement.
4. The band edges of low and high channels for the highest RF powers were measured.
5. The RF fundamental frequency should be excluded against the limit line in the operating frequency band.
6. The limit line is derived from $43 + 10\log(P)$ dB below the transmitter power P(Watts)



3.8 Conducted Spurious Emission

3.8.1 Description of Conducted Spurious Emission Measurement

The power of any emission outside of the authorized operating frequency ranges must be lower than the transmitter power (P) by a factor of at least $43 + 10 \log (P)$ dB.

It is measured by means of a calibrated spectrum analyzer and scanned from 30 MHz up to a frequency including its 10th harmonic.

3.8.2 Test Procedures

1. The testing follows FCC KDB 971168 D01 v02r02 Section 6.0.
2. The EUT was connected to the spectrum analyzer and system simulator via a power divider.
3. The RF output of EUT was connected to the spectrum analyzer by an RF cable and attenuator. The path loss was compensated to the results for each measurement.
4. The middle channel for the highest RF power within the transmitting frequency was measured.
5. The conducted spurious emission for the whole frequency range was taken.
6. The RF fundamental frequency should be excluded against the limit line in the operating frequency band.
7. The limit line is derived from $43 + 10\log(P)$ dB below the transmitter power P(Watts)



3.9 Frequency Stability

3.9.1 Description of Frequency Stability Measurement

The frequency stability shall be measured by variation of ambient temperature and variation of primary supply voltage to ensure that the fundamental emission stays within the authorized frequency block. The frequency stability of the transmitter shall be maintained within $\pm 0.00025\%$ ($\pm 2.5\text{ppm}$) of the center frequency.

3.9.2 Test Procedures for Temperature Variation

1. The testing follows FCC KDB 971168 D01 v02r02 Section 9.0.
2. The EUT was set up in the thermal chamber and connected with the system simulator.
3. With power OFF, the temperature was decreased to -30°C and the EUT was stabilized before testing. Power was applied and the maximum change in frequency was recorded within one minute.
4. With power OFF, the temperature was raised in 10°C steps up to 50°C . The EUT was stabilized at each step for at least half an hour. Power was applied and the maximum frequency change was recorded within one minute.

3.9.3 Test Procedures for Voltage Variation

1. The testing follows FCC KDB 971168 D01 v02r02 Section 9.0.
2. The EUT was placed in a temperature chamber at $20\pm 5^{\circ}\text{C}$ and connected with the system simulator.
3. The power supply voltage to the EUT was varied from 85% to 115% of the nominal value measured at the input to the EUT.
4. The variation in frequency was measured for the worst case.

4 Radiated Test Items

4.1 Measuring Instruments

See list of measuring instruments of this test report.

4.2 Test Setup

4.2.1 For radiated test from 30MHz to 1GHz

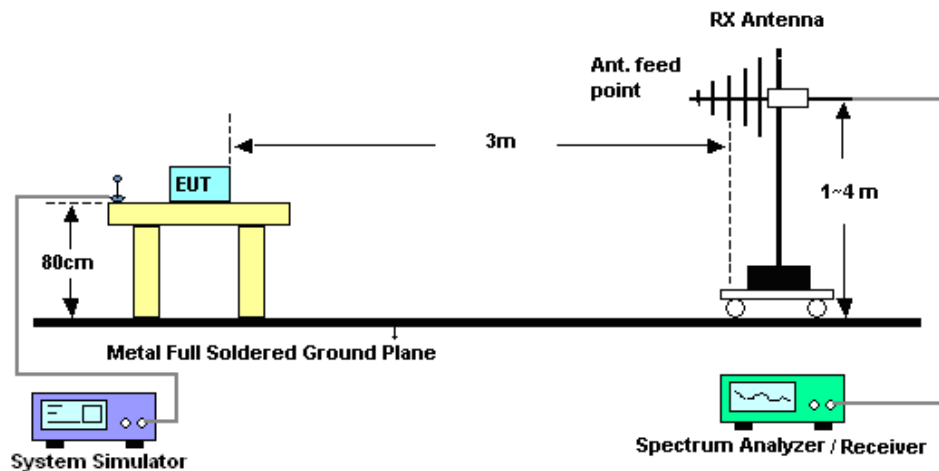

4.2.2 For radiated test above 1GHz

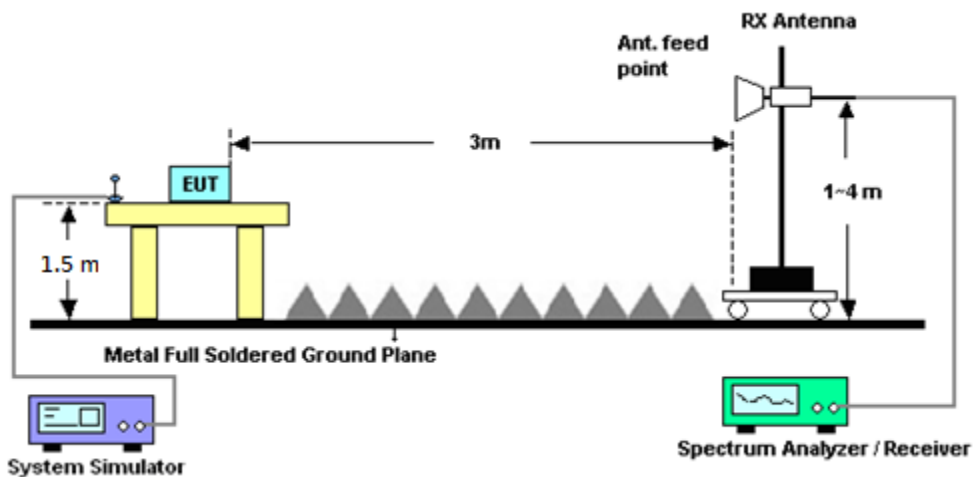

4.3 Test Result of Radiated Test

Please refer to Appendix B.



4.4 Field Strength of Spurious Radiation Measurement

4.4.1 Description of Field Strength of Spurious Radiated Measurement

The power of any emission outside of the authorized operating frequency ranges must be attenuated below the transmitter power (P) by a factor of at least $43 + 10 \log (P)$ dB. The spectrum is scanned from 30 MHz up to a frequency including its 10th harmonic.

4.4.2 Test Procedures

1. The testing follows FCC KDB 971168 D01 v02r02 Section 5.8 and ANSI / TIA-603-D-2010 Section 2.2.12.
2. The EUT was placed on a rotatable wooden table 0.8 meters for frequency below 1GHz and 1.5 meter for frequency above 1GHz above the ground.
3. The EUT was set 3 meters from the receiving antenna, which was mounted on the antenna tower.
4. The table was rotated 360 degrees to determine the position of the highest spurious emission.
5. The height of the receiving antenna is varied between one meter and four meters to search for the maximum spurious emission for both horizontal and vertical polarizations.
6. Make the measurement with the spectrum analyzer's RBW = 1MHz, VBW = 3MHz, taking record of maximum spurious emission.
7. A horn antenna was substituted in place of the EUT and was driven by a signal generator.
8. Tune the output power of signal generator to the same emission level with EUT maximum spurious emission.
9. Taking the record of output power at antenna port.
10. Repeat step 7 to step 8 for another polarization.
11. $EIRP \text{ (dBm)} = S.G. \text{ Power} - Tx \text{ Cable Loss} + Tx \text{ Antenna Gain}$
12. $ERP \text{ (dBm)} = EIRP - 2.15$
13. The RF fundamental frequency should be excluded against the limit line in the operating frequency band.
14. The limit line is derived from $43 + 10\log(P)$ dB below the transmitter power P(Watts)



5 List of Measuring Equipment

Instrument	Manufacturer	Model No.	Serial No.	Characteristics	Calibration Date	Test Date	Due Date	Remark
Hygrometer	Testo	608-H1	34893241	N/A	May 03, 2016	Oct. 15, 2016 ~ Nov. 05, 2016	May 02, 2017	Conducted (TH03-HY)
Spectrum Analyzer	Rohde & Schwarz	FSP30	101329	9kHz~30GHz	Jun. 27, 2016	Oct. 15, 2016 ~ Nov. 05, 2016	Jun. 26, 2017	Conducted (TH03-HY)
Temperature Chamber	ESPEC	SU-641	92013721	-30℃ ~70℃	Nov. 20, 2015	Oct. 15, 2016 ~ Nov. 05, 2016	Nov. 19, 2016	Conducted (TH03-HY)
Programmable Power Supply	GW Instek	PSS-2005	EL883644	Voltage:0~20V;Current:0~5A	Nov. 26, 2015	Oct. 15, 2016 ~ Nov. 05, 2016	Nov. 25, 2016	Conducted (TH03-HY)
Base Station(Measure)	Rohde & Schwarz	CMU200	117995	GSM / GPRS / WCDMA / CDMA	Aug. 03, 2016	Oct. 15, 2016 ~ Nov. 05, 2016	Aug. 04, 2017	Conducted (TH03-HY)
RF Cable	HUBER + SUHNER	SUCOFLEX 104	MY84209521	1GHz~26GHz	Dec. 03, 2015	Oct. 15, 2016 ~ Nov. 05, 2016	Dec. 02, 2016	Conducted (TH03-HY)
Bilog Antenna	TESEQ	CBL 6111D&00800N	40103&04	30MHz to 1GHz	Jan. 13, 2016	Nov. 15, 2016 ~ Nov. 19, 2016	Jan. 12, 2017	Radiation (03CH13-HY)
Horn Antenna	SCHWARZBECK	BBHA 9120 D	9120D-1241	1GHz ~ 18GHz	Apr. 25, 2016	Nov. 15, 2016 ~ Nov. 19, 2016	Apr. 24, 2017	Radiation (03CH13-HY)
Horn Antenna	SCHWARZBECK	BBHA 9120 D	9120D-1522	1GHz ~ 18GHz	Mar. 30, 2016	Nov. 15, 2016 ~ Nov. 19, 2016	Mar. 31, 2017	Radiation (03CH13-HY)
SHF-EHF Horn Antenna	SCHWARZBECK	BBHA 9170	BBHA9170251	18GHz- 40GHz	Nov. 08, 2016	Nov. 15, 2016 ~ Nov. 19, 2016	Nov. 07, 2017	Radiation (03CH13-HY)
SHF-EHF Horn Antenna	SCHWARZBECK	BBHA 9170	BBHA9170584	18GHz- 40GHz	Nov. 08, 2016	Nov. 15, 2016 ~ Nov. 19, 2016	Nov. 07, 2017	Radiation (03CH13-HY)
Amplifier	Sonoma-Instrument	310 N	187282	10MHz~1GHz	Dec. 31, 2015	Nov. 15, 2016 ~ Nov. 19, 2016	Dec. 30, 2016	Radiation (03CH13-HY)
Preamplifier	MITEQ	AMF-7D-00101 800-30-10P	1590074	1GHz~18GHz	Jun. 27, 2016	Nov. 15, 2016 ~ Nov. 19, 2016	Jun. 26, 2017	Radiation (03CH13-HY)
Preamplifier	MITEQ	JS44-18004000 -33-8P	1840917	18GHz ~ 40GHz	Jun. 14, 2016	Nov. 15, 2016 ~ Nov. 19, 2016	Jun. 13, 2017	Radiation (03CH13-HY)
Preamplifier	Keysight	83017A	MY53270147	1GHz~26.5GHz	Jan. 30, 2016	Nov. 15, 2016 ~ Nov. 19, 2016	Jan. 29, 2017	Radiation (03CH13-HY)
Spectrum Analyzer	Keysight	N9010A	MY55370526	N/A	Mar. 14, 2016	Nov. 15, 2016 ~ Nov. 19, 2016	Mar. 13, 2017	Radiation (03CH13-HY)



Instrument	Manufacturer	Model No.	Serial No.	Characteristics	Calibration Date	Test Date	Due Date	Remark
Controller	EMEC	EM1000	N/A	Control Turn table & Ant Mast	N/A	Nov. 15, 2016 ~ Nov. 19, 2016	N/A	Radiation (03CH13-HY)
Antenna Mast	EMEC	AM-BS-4500-B	N/A	1m~4m	N/A	Nov. 15, 2016 ~ Nov. 19, 2016	N/A	Radiation (03CH13-HY)
Turn Table	EMEC	TT2000	N/A	0~360 Degree	N/A	Nov. 15, 2016 ~ Nov. 19, 2016	N/A	Radiation (03CH13-HY)
Hygrometer	TECPEL	DTM-303B	TP157151	N/A	Mar. 04, 2016	Nov. 15, 2016 ~ Nov. 19, 2016	Mar. 03, 2017	Radiation (03CH13-HY)
Signal Generator	Rohde & Schwarz	SMF100A	101107	100kHz~40GHz	May 19, 2016	Nov. 15, 2016 ~ Nov. 19, 2016	May 18, 2017	Radiation (03CH13-HY)
RF Cable	HUBER + SUHNER	SUCOFLEX 104	MY335041/4M Y9840/4	30M~1GHz	Jan. 28, 2016	Nov. 15, 2016 ~ Nov. 19, 2016	Jan. 27, 2017	Radiation (03CH13-HY)
RF Cable	HUBER + SUHNER	SUCOFLEX 104	MY335041/4M Y9840/4	1G~26GHz	Jan. 29, 2016	Nov. 15, 2016 ~ Nov. 19, 2016	Jan. 28, 2017	Radiation (03CH13-HY)
RF Cable	HUBER + SUHNER	SUCOFLEX 104	MY335041/4M Y9840/4	26G~40GHz	Jan. 29, 2016	Nov. 15, 2016 ~ Nov. 19, 2016	Jan. 28, 2017	Radiation (03CH13-HY)
Filter	Wainwright	WHKX12-1080-1200-1500-60S	SN2	1.2G High Pass	Sep. 19, 2016	Nov. 15, 2016 ~ Nov. 19, 2016	Sep. 18, 2017	Radiation (03CH13-HY)
Filter	Wainwright	WHK1.5/15G-10SS	SN32	1.5G High Pass	Sep. 19, 2016	Nov. 15, 2016 ~ Nov. 19, 2016	Sep. 18, 2017	Radiation (03CH13-HY)
Filter	Microwave	H3G018G1	SN477220	3.0G High Pass	Oct. 27, 2016	Nov. 15, 2016 ~ Nov. 19, 2016	Oct. 26, 2017	Radiation (03CH13-HY)
Notch Filter	Wainwright	WRCT/800/960-0.2/40-8SSK	SN11	GSM850	Apr. 25, 2016	Nov. 15, 2016 ~ Nov. 19, 2016	Apr. 24, 2017	Radiation (03CH13-HY)
Notch Filter	Wainwright	WRCT1850/1910-40/8SS	SN21	1900	Apr. 25, 2016	Nov. 15, 2016 ~ Nov. 19, 2016	Apr. 24, 2017	Radiation (03CH13-HY)
Test Software	N/A	E3	6.2009-8-24c	N/A	N/A	Nov. 15, 2016 ~ Nov. 19, 2016	N/A	Radiation (03CH13-HY)



6 Uncertainty of Evaluation

Uncertainty of Radiated Emission Measurement (30 MHz ~ 1000 MHz)

Measuring Uncertainty for a Level of Confidence of 95% ($U = 2Uc(y)$)	3.07
---	------

Uncertainty of Radiated Emission Measurement (1 GHz ~ 18 GHz)

Measuring Uncertainty for a Level of Confidence of 95% ($U = 2Uc(y)$)	3.48
---	------

Uncertainty of Radiated Emission Measurement (18 GHz ~ 40 GHz)

Measuring Uncertainty for a Level of Confidence of 95% ($U = 2Uc(y)$)	3.92
---	------



Appendix A. Test Results of Conducted Test

Conducted Output Power(Average power)

Conducted Power (*Unit: dBm)						
Band	GSM850			GSM1900		
Channel	128	189	251	512	661	810
Frequency	824.2	836.4	848.8	1850.2	1880.0	1909.8
GSM	33.34	33.31	33.25	30.24	30.25	30.40
GPRS class 8	33.34	33.31	33.25	30.24	30.25	30.40
GPRS class 10	30.74	30.82	30.65	27.51	27.51	27.73
GPRS class 11	29.13	29.16	28.97	26.02	26.06	26.26
GPRS class 12	27.77	27.82	27.65	24.76	24.83	25.00
EGPRS class 8	26.30	26.28	26.21	24.28	24.45	24.59
EGPRS class 10	26.10	26.15	26.00	24.00	24.00	24.17
EGPRS class 11	25.92	26.00	25.85	24.00	24.00	24.20
EGPRS class 12	25.65	25.70	25.67	23.35	23.35	23.46

Conducted Power (*Unit: dBm)									
Band	WCDMA Band V			WCDMA Band II			WCDMA Band IV		
Channel	4132	4182	4233	9262	9400	9538	1312	1413	1513
Frequency	826.4	836.4	846.6	1852.4	1880	1907.6	1712.4	1732.6	1752.6
RMC 12.2K	24.41	24.36	24.33	23.58	23.57	23.89	23.40	23.42	23.50
HSDPA Subtest-1	23.55	23.53	23.54	22.59	22.60	22.92	22.42	22.44	22.58
HSDPA Subtest-2	23.52	23.48	23.50	22.57	22.58	22.87	22.43	22.41	22.57
HSDPA Subtest-3	23.07	23.08	23.05	22.18	22.15	22.48	21.98	22.06	22.15
HSDPA Subtest-4	23.03	22.96	22.99	22.17	22.16	22.42	21.96	22.02	22.10
HSUPA Subtest-1	21.62	21.54	21.51	20.63	20.65	20.91	20.56	20.60	20.69
HSUPA Subtest-2	21.43	21.34	21.32	20.55	20.59	20.74	20.32	20.36	20.43
HSUPA Subtest-3	22.45	22.38	22.36	21.63	21.56	21.88	21.42	21.45	21.49
HSUPA Subtest-4	21.08	21.02	21.04	20.15	20.13	20.40	20.01	20.02	20.10
HSUPA Subtest-5	22.54	22.46	22.47	21.55	21.53	21.88	21.47	21.52	21.54



A1. GSM

Peak-to-Average Ratio

Mode	GSM850		Limit: 13dB
Mod.	GPRS class 8	EDGE class 8	Result
Lowest CH	0.16	3.36	PASS
Middle CH	0.16	3.16	
Highest CH	0.12	3.08	

Mode	GSM1900		Limit: 13dB
Mod.	GPRS class 8	EDGE class 8	Result
Lowest CH	0.12	3.48	PASS
Middle CH	0.16	3.40	
Highest CH	0.12	3.40	

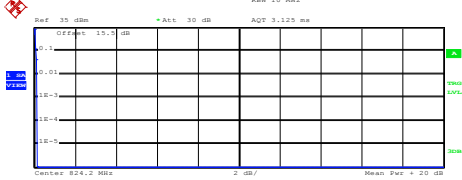
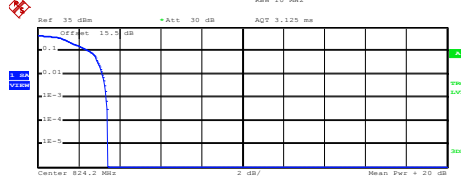
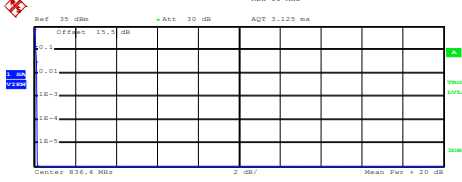
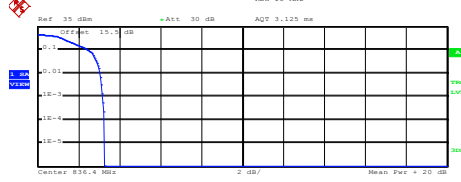
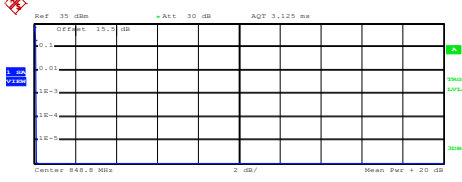
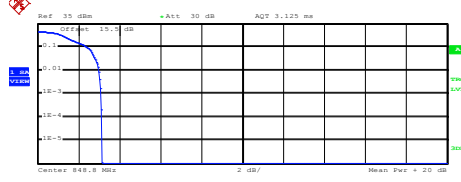

GSM850 (GPRS class 8)	GSM850 (EDGE class 8)																
<p align="center">Lowest Channel</p>  <p>Complementary Cumulative Distribution Function (100000 samples) Trace 1 Mean 31.94 dBm Peak 32.08 dBm Crest 0.14 dB</p> <table border="1"> <tr><td>10 %</td><td>0.08 dB</td></tr> <tr><td>1 %</td><td>0.16 dB</td></tr> <tr><td>.1 %</td><td>0.16 dB</td></tr> <tr><td>.01 %</td><td>0.16 dB</td></tr> </table> <p>Date: 15.OCT.2016 04:43:37</p>	10 %	0.08 dB	1 %	0.16 dB	.1 %	0.16 dB	.01 %	0.16 dB	<p align="center">Lowest Channel</p>  <p>Complementary Cumulative Distribution Function (100000 samples) Trace 1 Mean 26.04 dBm Peak 29.47 dBm Crest 3.43 dB</p> <table border="1"> <tr><td>10 %</td><td>2.52 dB</td></tr> <tr><td>1 %</td><td>3.16 dB</td></tr> <tr><td>.1 %</td><td>3.36 dB</td></tr> <tr><td>.01 %</td><td>3.44 dB</td></tr> </table> <p>Date: 15.OCT.2016 05:00:11</p>	10 %	2.52 dB	1 %	3.16 dB	.1 %	3.36 dB	.01 %	3.44 dB
10 %	0.08 dB																
1 %	0.16 dB																
.1 %	0.16 dB																
.01 %	0.16 dB																
10 %	2.52 dB																
1 %	3.16 dB																
.1 %	3.36 dB																
.01 %	3.44 dB																
<p align="center">Middle Channel</p>  <p>Complementary Cumulative Distribution Function (100000 samples) Trace 1 Mean 32.09 dBm Peak 32.22 dBm Crest 0.13 dB</p> <table border="1"> <tr><td>10 %</td><td>0.08 dB</td></tr> <tr><td>1 %</td><td>0.16 dB</td></tr> <tr><td>.1 %</td><td>0.16 dB</td></tr> <tr><td>.01 %</td><td>0.16 dB</td></tr> </table> <p>Date: 15.OCT.2016 04:44:30</p>	10 %	0.08 dB	1 %	0.16 dB	.1 %	0.16 dB	.01 %	0.16 dB	<p align="center">Middle Channel</p>  <p>Complementary Cumulative Distribution Function (100000 samples) Trace 1 Mean 26.34 dBm Peak 29.61 dBm Crest 3.27 dB</p> <table border="1"> <tr><td>10 %</td><td>2.48 dB</td></tr> <tr><td>1 %</td><td>3.04 dB</td></tr> <tr><td>.1 %</td><td>3.16 dB</td></tr> <tr><td>.01 %</td><td>3.28 dB</td></tr> </table> <p>Date: 15.OCT.2016 05:01:18</p>	10 %	2.48 dB	1 %	3.04 dB	.1 %	3.16 dB	.01 %	3.28 dB
10 %	0.08 dB																
1 %	0.16 dB																
.1 %	0.16 dB																
.01 %	0.16 dB																
10 %	2.48 dB																
1 %	3.04 dB																
.1 %	3.16 dB																
.01 %	3.28 dB																
<p align="center">Highest Channel</p>  <p>Complementary Cumulative Distribution Function (100000 samples) Trace 1 Mean 32.12 dBm Peak 32.22 dBm Crest 0.10 dB</p> <table border="1"> <tr><td>10 %</td><td>0.12 dB</td></tr> <tr><td>1 %</td><td>0.12 dB</td></tr> <tr><td>.1 %</td><td>0.12 dB</td></tr> <tr><td>.01 %</td><td>0.12 dB</td></tr> </table> <p>Date: 15.OCT.2016 04:45:16</p>	10 %	0.12 dB	1 %	0.12 dB	.1 %	0.12 dB	.01 %	0.12 dB	<p align="center">Highest Channel</p>  <p>Complementary Cumulative Distribution Function (100000 samples) Trace 1 Mean 26.42 dBm Peak 29.54 dBm Crest 3.12 dB</p> <table border="1"> <tr><td>10 %</td><td>2.44 dB</td></tr> <tr><td>1 %</td><td>3.00 dB</td></tr> <tr><td>.1 %</td><td>3.08 dB</td></tr> <tr><td>.01 %</td><td>3.16 dB</td></tr> </table> <p>Date: 15.OCT.2016 05:02:15</p>	10 %	2.44 dB	1 %	3.00 dB	.1 %	3.08 dB	.01 %	3.16 dB
10 %	0.12 dB																
1 %	0.12 dB																
.1 %	0.12 dB																
.01 %	0.12 dB																
10 %	2.44 dB																
1 %	3.00 dB																
.1 %	3.08 dB																
.01 %	3.16 dB																

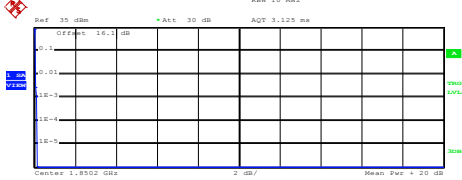
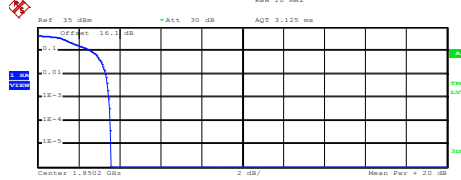
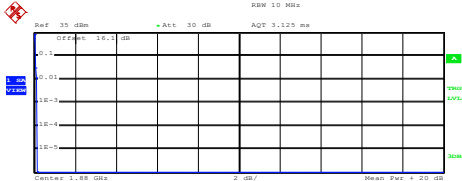
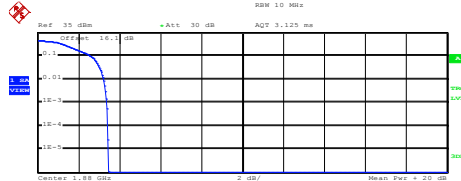
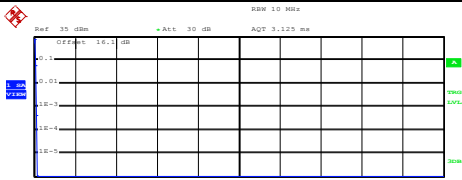
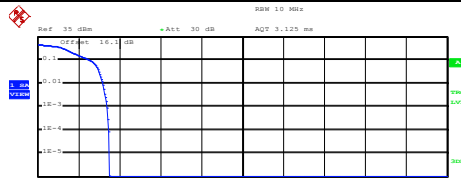

GSM1900 (GPRS class 8)	GSM1900 (EDGE class 8)																
<p align="center">Lowest Channel</p>  <p>Complementary Cumulative Distribution Function (100000 samples) Trace 1 Mean 28.47 dBm Peak 28.62 dBm Crest 0.15 dB</p> <table border="1"> <tr><td>10 %</td><td>0.08 dB</td></tr> <tr><td>1 %</td><td>0.08 dB</td></tr> <tr><td>.1 %</td><td>0.12 dB</td></tr> <tr><td>.01 %</td><td>0.16 dB</td></tr> </table> <p>Date: 15.OCT.2016 05:17:24</p>	10 %	0.08 dB	1 %	0.08 dB	.1 %	0.12 dB	.01 %	0.16 dB	<p align="center">Lowest Channel</p>  <p>Complementary Cumulative Distribution Function (100000 samples) Trace 1 Mean 23.02 dBm Peak 26.57 dBm Crest 3.56 dB</p> <table border="1"> <tr><td>10 %</td><td>2.64 dB</td></tr> <tr><td>1 %</td><td>3.32 dB</td></tr> <tr><td>.1 %</td><td>3.48 dB</td></tr> <tr><td>.01 %</td><td>3.56 dB</td></tr> </table> <p>Date: 5.NOV.2016 09:24:19</p>	10 %	2.64 dB	1 %	3.32 dB	.1 %	3.48 dB	.01 %	3.56 dB
10 %	0.08 dB																
1 %	0.08 dB																
.1 %	0.12 dB																
.01 %	0.16 dB																
10 %	2.64 dB																
1 %	3.32 dB																
.1 %	3.48 dB																
.01 %	3.56 dB																
<p align="center">Middle Channel</p>  <p>Complementary Cumulative Distribution Function (100000 samples) Trace 1 Mean 28.27 dBm Peak 28.41 dBm Crest 0.14 dB</p> <table border="1"> <tr><td>10 %</td><td>0.08 dB</td></tr> <tr><td>1 %</td><td>0.12 dB</td></tr> <tr><td>.1 %</td><td>0.16 dB</td></tr> <tr><td>.01 %</td><td>0.16 dB</td></tr> </table> <p>Date: 15.OCT.2016 05:18:18</p>	10 %	0.08 dB	1 %	0.12 dB	.1 %	0.16 dB	.01 %	0.16 dB	<p align="center">Middle Channel</p>  <p>Complementary Cumulative Distribution Function (100000 samples) Trace 1 Mean 23.14 dBm Peak 26.57 dBm Crest 3.43 dB</p> <table border="1"> <tr><td>10 %</td><td>2.60 dB</td></tr> <tr><td>1 %</td><td>3.24 dB</td></tr> <tr><td>.1 %</td><td>3.40 dB</td></tr> <tr><td>.01 %</td><td>3.44 dB</td></tr> </table> <p>Date: 5.NOV.2016 09:24:57</p>	10 %	2.60 dB	1 %	3.24 dB	.1 %	3.40 dB	.01 %	3.44 dB
10 %	0.08 dB																
1 %	0.12 dB																
.1 %	0.16 dB																
.01 %	0.16 dB																
10 %	2.60 dB																
1 %	3.24 dB																
.1 %	3.40 dB																
.01 %	3.44 dB																
<p align="center">Highest Channel</p>  <p>Complementary Cumulative Distribution Function (100000 samples) Trace 1 Mean 28.32 dBm Peak 28.48 dBm Crest 0.16 dB</p> <table border="1"> <tr><td>10 %</td><td>0.08 dB</td></tr> <tr><td>1 %</td><td>0.12 dB</td></tr> <tr><td>.1 %</td><td>0.12 dB</td></tr> <tr><td>.01 %</td><td>0.16 dB</td></tr> </table> <p>Date: 15.OCT.2016 05:19:05</p>	10 %	0.08 dB	1 %	0.12 dB	.1 %	0.12 dB	.01 %	0.16 dB	<p align="center">Highest Channel</p>  <p>Complementary Cumulative Distribution Function (100000 samples) Trace 1 Mean 23.15 dBm Peak 26.64 dBm Crest 3.49 dB</p> <table border="1"> <tr><td>10 %</td><td>2.56 dB</td></tr> <tr><td>1 %</td><td>3.20 dB</td></tr> <tr><td>.1 %</td><td>3.40 dB</td></tr> <tr><td>.01 %</td><td>3.48 dB</td></tr> </table> <p>Date: 5.NOV.2016 09:25:14</p>	10 %	2.56 dB	1 %	3.20 dB	.1 %	3.40 dB	.01 %	3.48 dB
10 %	0.08 dB																
1 %	0.12 dB																
.1 %	0.12 dB																
.01 %	0.16 dB																
10 %	2.56 dB																
1 %	3.20 dB																
.1 %	3.40 dB																
.01 %	3.48 dB																



26dB Bandwidth

Mode	GSM850 : 26dB BW(MHz)	
Mod.	GPRS class 8	EDGE class 8
Lowest CH	0.314	0.284
Middle CH	0.291	0.260
Highest CH	0.297	0.291

Mode	GSM1900 : 26dB BW(MHz)	
Mod.	GPRS class 8	EDGE class 8
Lowest CH	0.301	0.302
Middle CH	0.304	0.306
Highest CH	0.312	0.304

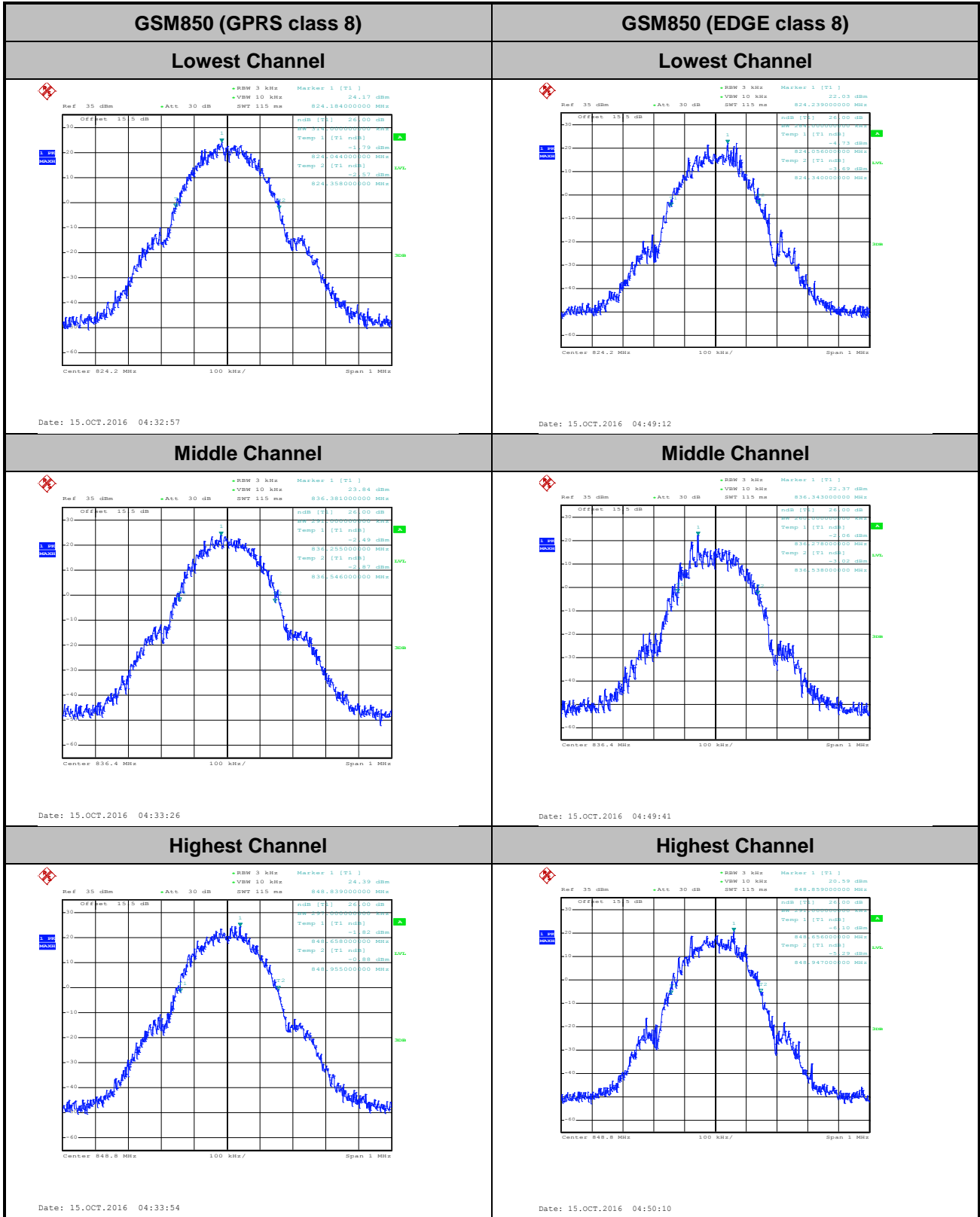

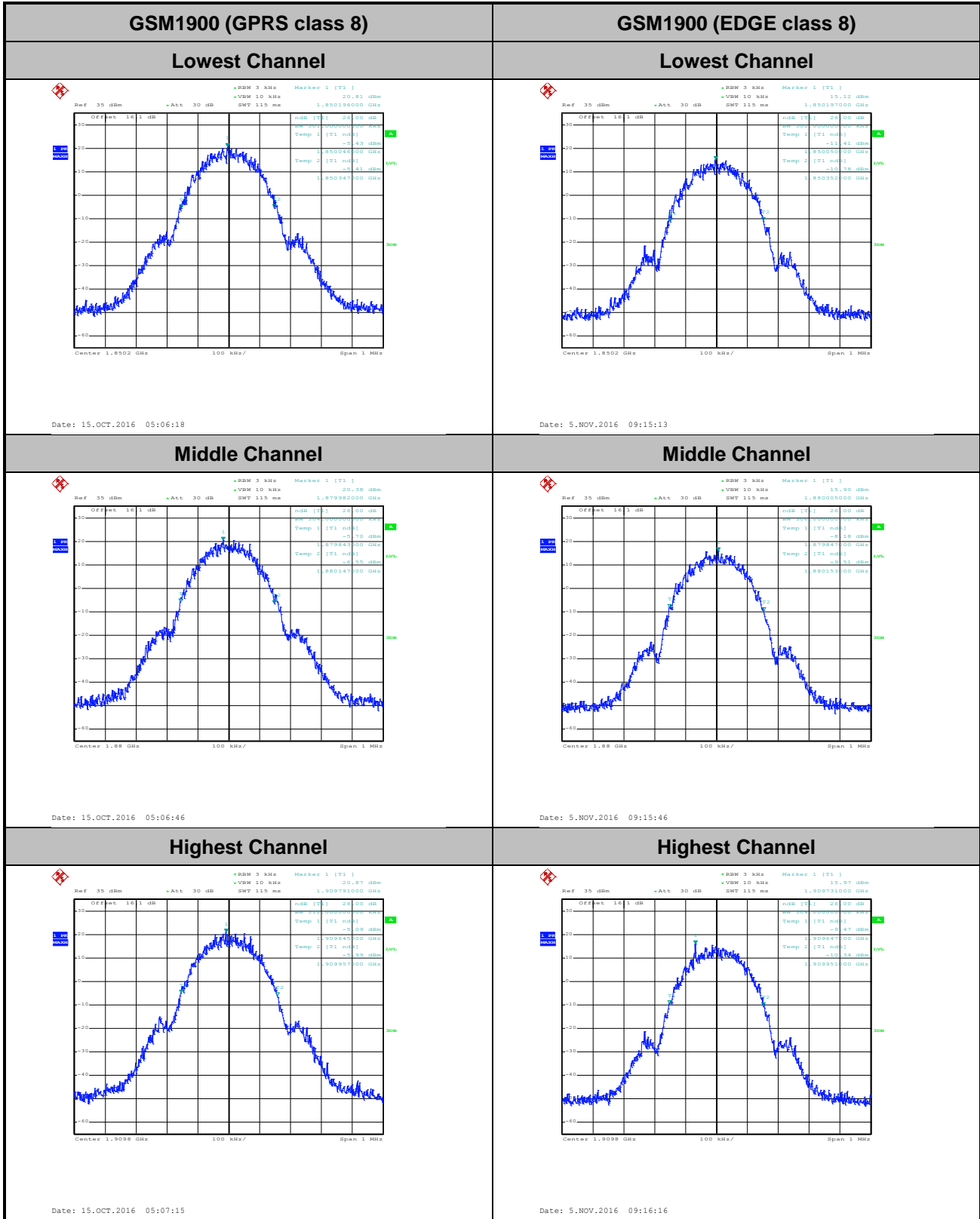



Occupied Bandwidth

Mode	GSM850 : 99%OBW(MHz)	
Mod.	GPRS class 8	EDGE class 8
Lowest CH	0.244	0.242
Middle CH	0.246	0.245
Highest CH	0.245	0.241

Mode	GSM1900 : 99%OBW(MHz)	
Mod.	GPRS class 8	EDGE class 8
Lowest CH	0.247	0.248
Middle CH	0.245	0.246
Highest CH	0.242	0.241

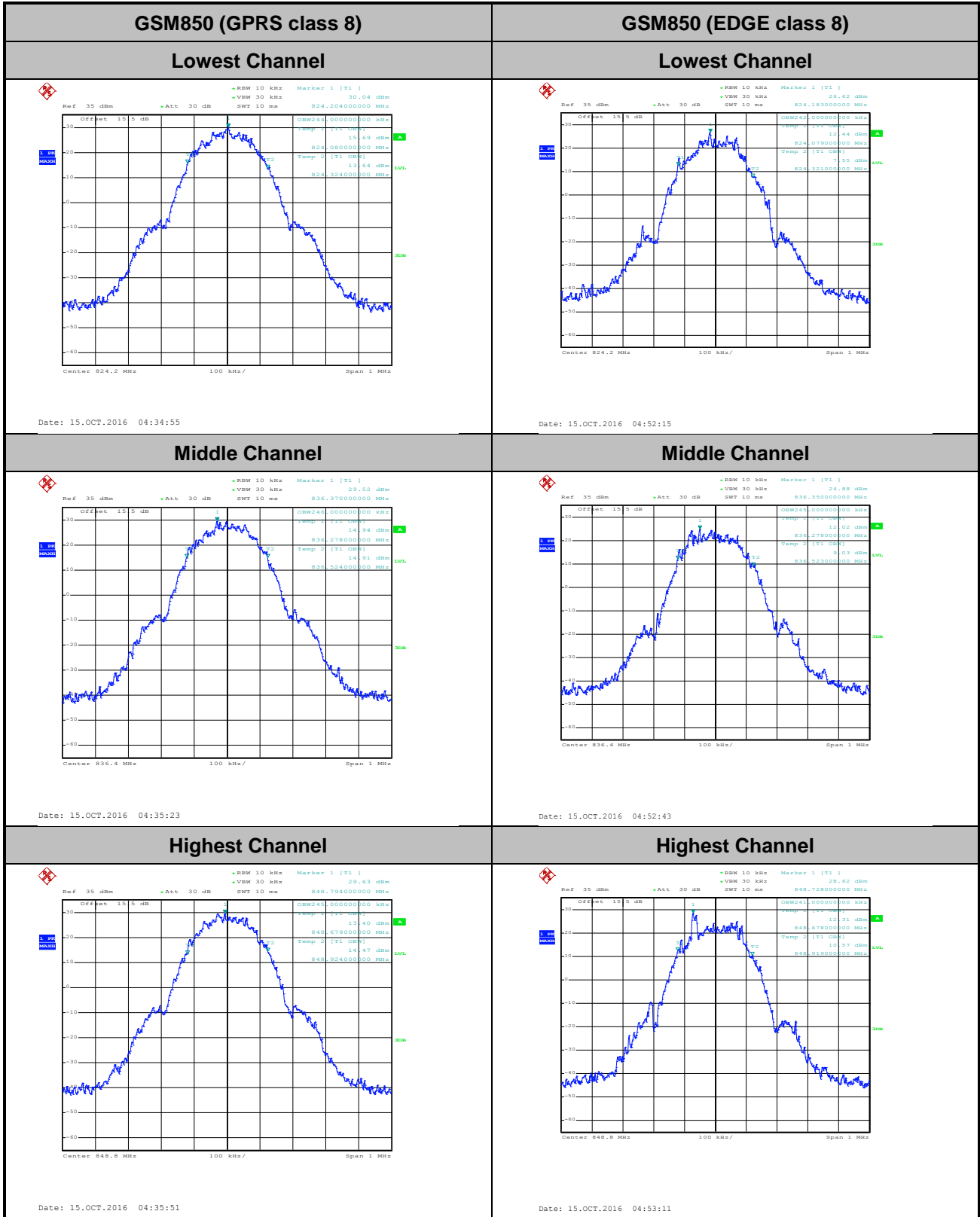

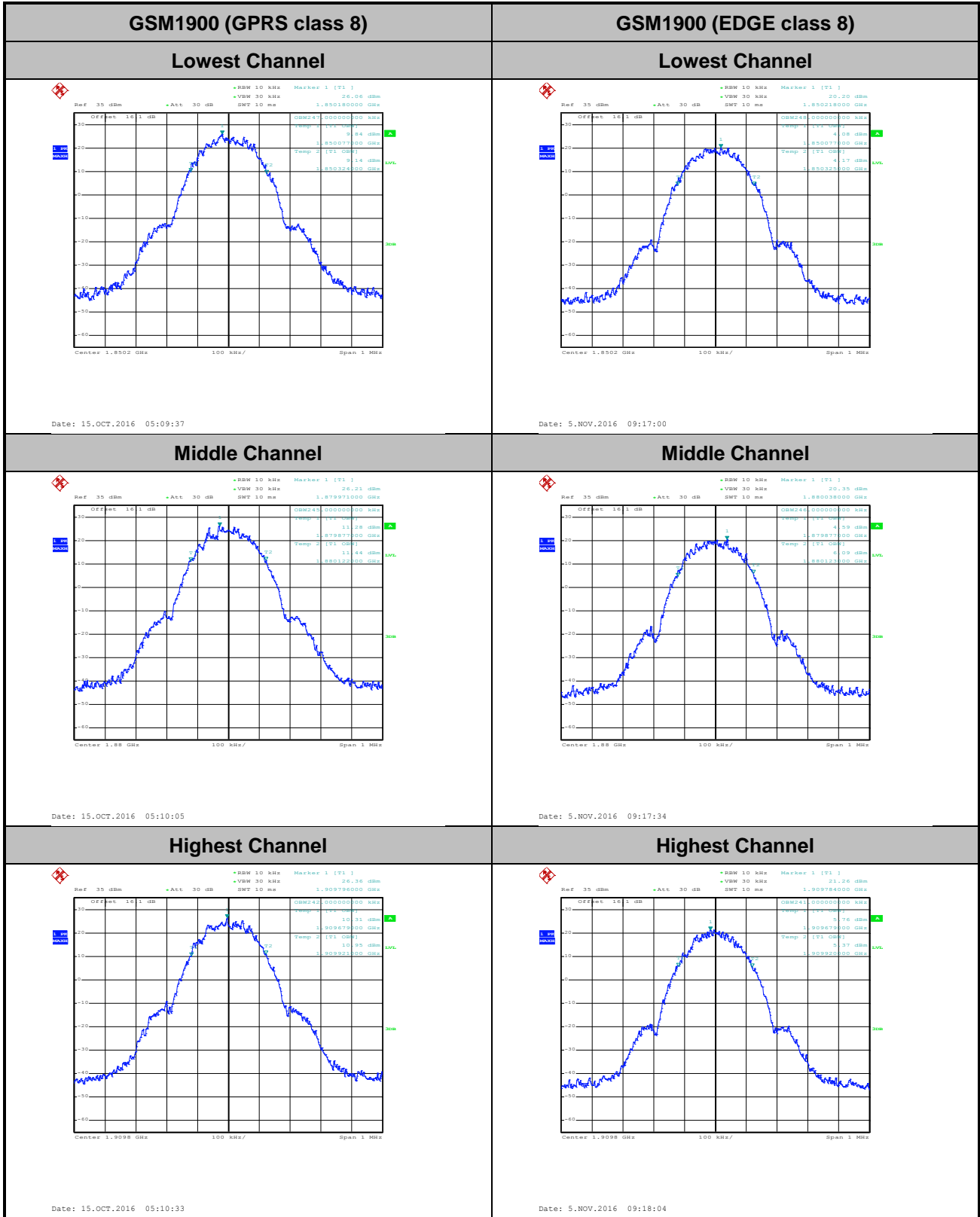



Conducted Band Edge

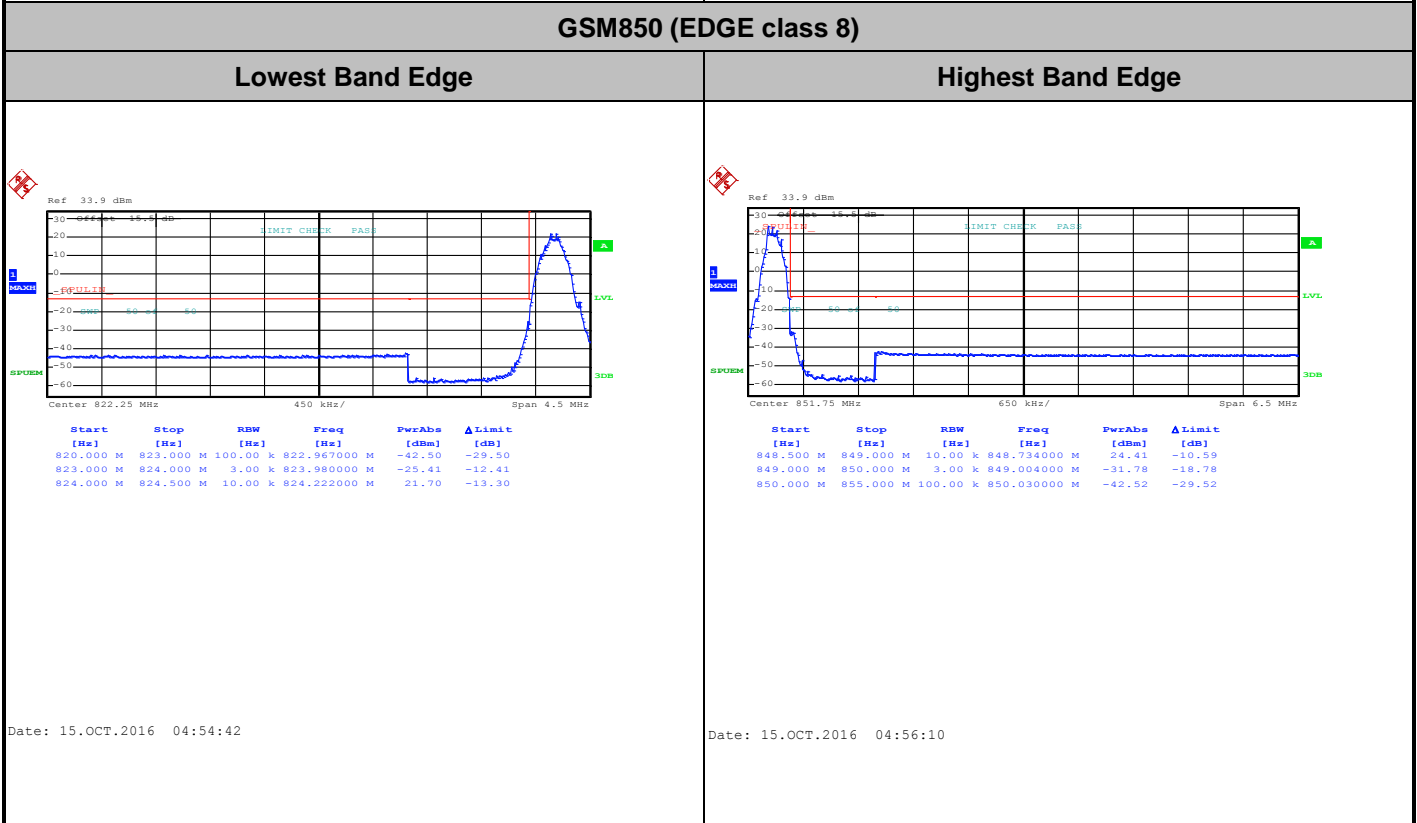
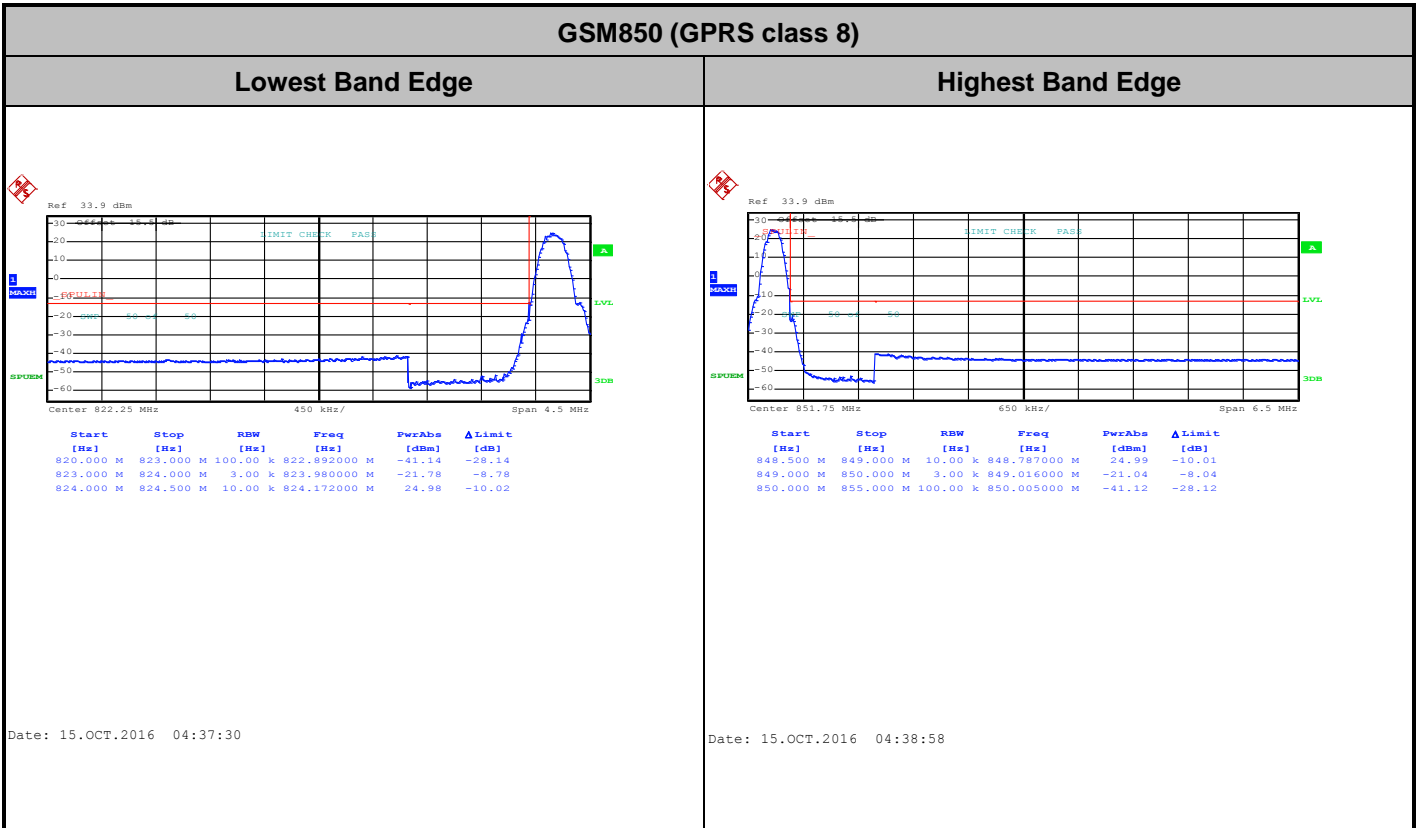



GSM1900 (GPRS class 8)

Lowest Band Edge

Highest Band Edge

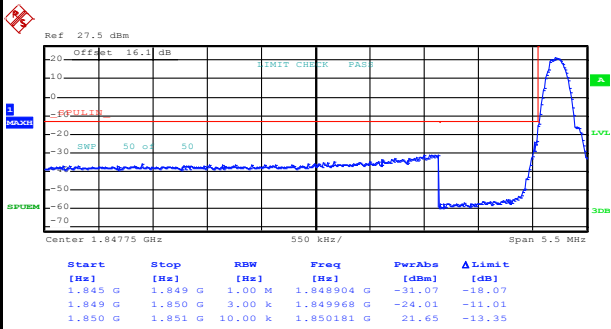

Date: 15.OCT.2016 05:12:12

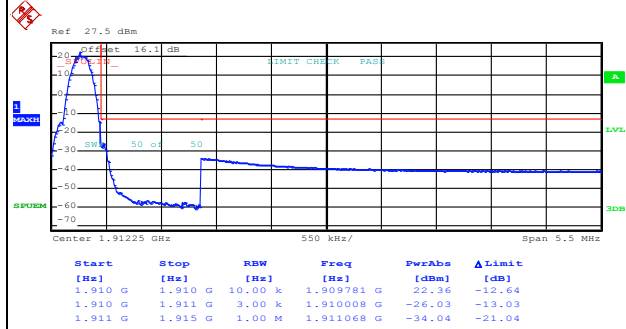

Date: 15.OCT.2016 05:13:40

GSM1900 (EDGE class 8)

Lowest Band Edge

Highest Band Edge

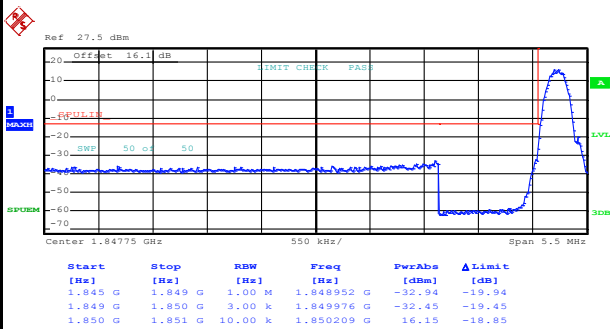

Date: 5.NOV.2016 09:19:37

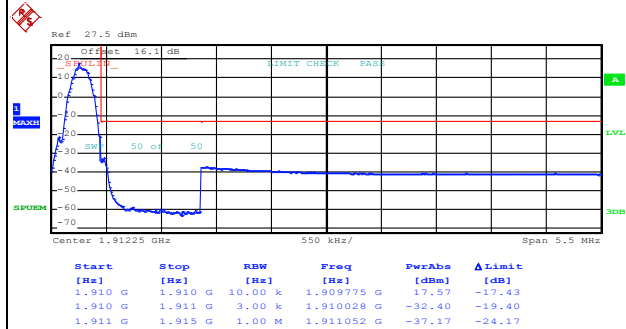

Date: 5.NOV.2016 09:21:06

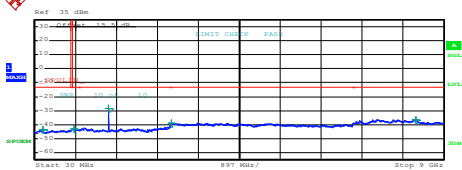
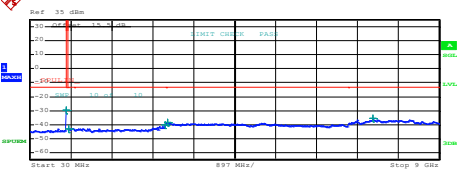
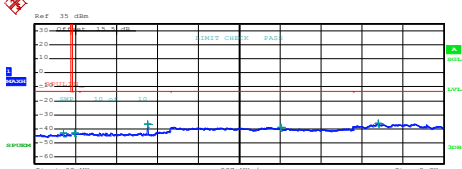
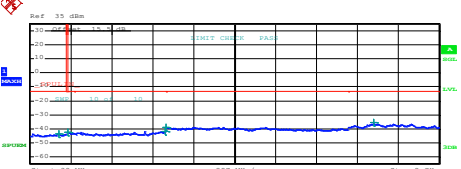
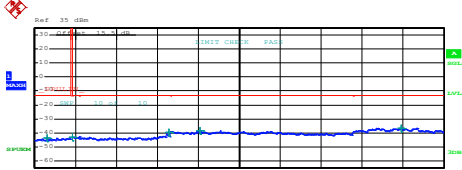
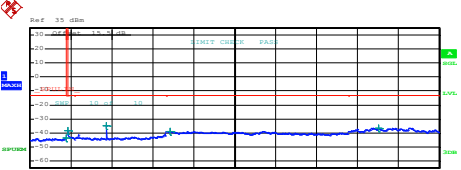

Conducted Spurious Emission

GSM850 (GPRS class 8)	GSM850 (EDGE class 8)																																																																								
Lowest Channel	Lowest Channel																																																																								
 <table border="1" data-bbox="239 660 654 739"> <thead> <tr> <th>Start [Hz]</th> <th>Stop [Hz]</th> <th>RBW [Hz]</th> <th>Freq [Hz]</th> <th>PwrAbs [dBm]</th> <th>ΔLimit [dB]</th> </tr> </thead> <tbody> <tr> <td>35,000 M</td> <td>820,000 M</td> <td>1,000 M</td> <td>211,897500 M</td> <td>-43.95</td> <td>-30.25</td> </tr> <tr> <td>855,000 M</td> <td>1,000 G</td> <td>1,000 M</td> <td>883,637500 M</td> <td>-43.04</td> <td>-30.04</td> </tr> <tr> <td>1,000 G</td> <td>3,000 G</td> <td>1,000 M</td> <td>1,648500 G</td> <td>-28.20</td> <td>-25.20</td> </tr> <tr> <td>3,000 G</td> <td>7,000 G</td> <td>1,000 M</td> <td>3,022000 G</td> <td>-38.87</td> <td>-25.87</td> </tr> <tr> <td>7,000 G</td> <td>9,000 G</td> <td>1,000 M</td> <td>8,388000 G</td> <td>-36.47</td> <td>-23.47</td> </tr> </tbody> </table> <p>Date: 15.OCT.2016 04:39:55</p>	Start [Hz]	Stop [Hz]	RBW [Hz]	Freq [Hz]	PwrAbs [dBm]	ΔLimit [dB]	35,000 M	820,000 M	1,000 M	211,897500 M	-43.95	-30.25	855,000 M	1,000 G	1,000 M	883,637500 M	-43.04	-30.04	1,000 G	3,000 G	1,000 M	1,648500 G	-28.20	-25.20	3,000 G	7,000 G	1,000 M	3,022000 G	-38.87	-25.87	7,000 G	9,000 G	1,000 M	8,388000 G	-36.47	-23.47	 <table border="1" data-bbox="893 660 1308 739"> <thead> <tr> <th>Start [Hz]</th> <th>Stop [Hz]</th> <th>RBW [Hz]</th> <th>Freq [Hz]</th> <th>PwrAbs [dBm]</th> <th>ΔLimit [dB]</th> </tr> </thead> <tbody> <tr> <td>35,000 M</td> <td>820,000 M</td> <td>1,000 M</td> <td>819,802500 M</td> <td>-29.83</td> <td>-16.83</td> </tr> <tr> <td>855,000 M</td> <td>1,000 G</td> <td>1,000 M</td> <td>873,741251 M</td> <td>-43.08</td> <td>-30.08</td> </tr> <tr> <td>1,000 G</td> <td>3,000 G</td> <td>1,000 M</td> <td>2,983000 G</td> <td>-40.24</td> <td>-27.24</td> </tr> <tr> <td>3,000 G</td> <td>7,000 G</td> <td>1,000 M</td> <td>3,035000 G</td> <td>-38.42</td> <td>-25.42</td> </tr> <tr> <td>7,000 G</td> <td>9,000 G</td> <td>1,000 M</td> <td>7,540500 G</td> <td>-35.66</td> <td>-22.66</td> </tr> </tbody> </table> <p>Date: 15.OCT.2016 04:57:04</p>	Start [Hz]	Stop [Hz]	RBW [Hz]	Freq [Hz]	PwrAbs [dBm]	ΔLimit [dB]	35,000 M	820,000 M	1,000 M	819,802500 M	-29.83	-16.83	855,000 M	1,000 G	1,000 M	873,741251 M	-43.08	-30.08	1,000 G	3,000 G	1,000 M	2,983000 G	-40.24	-27.24	3,000 G	7,000 G	1,000 M	3,035000 G	-38.42	-25.42	7,000 G	9,000 G	1,000 M	7,540500 G	-35.66	-22.66
Start [Hz]	Stop [Hz]	RBW [Hz]	Freq [Hz]	PwrAbs [dBm]	ΔLimit [dB]																																																																				
35,000 M	820,000 M	1,000 M	211,897500 M	-43.95	-30.25																																																																				
855,000 M	1,000 G	1,000 M	883,637500 M	-43.04	-30.04																																																																				
1,000 G	3,000 G	1,000 M	1,648500 G	-28.20	-25.20																																																																				
3,000 G	7,000 G	1,000 M	3,022000 G	-38.87	-25.87																																																																				
7,000 G	9,000 G	1,000 M	8,388000 G	-36.47	-23.47																																																																				
Start [Hz]	Stop [Hz]	RBW [Hz]	Freq [Hz]	PwrAbs [dBm]	ΔLimit [dB]																																																																				
35,000 M	820,000 M	1,000 M	819,802500 M	-29.83	-16.83																																																																				
855,000 M	1,000 G	1,000 M	873,741251 M	-43.08	-30.08																																																																				
1,000 G	3,000 G	1,000 M	2,983000 G	-40.24	-27.24																																																																				
3,000 G	7,000 G	1,000 M	3,035000 G	-38.42	-25.42																																																																				
7,000 G	9,000 G	1,000 M	7,540500 G	-35.66	-22.66																																																																				
Middle Channel	Middle Channel																																																																								
 <table border="1" data-bbox="239 1176 654 1254"> <thead> <tr> <th>Start [Hz]</th> <th>Stop [Hz]</th> <th>RBW [Hz]</th> <th>Freq [Hz]</th> <th>PwrAbs [dBm]</th> <th>ΔLimit [dB]</th> </tr> </thead> <tbody> <tr> <td>35,000 M</td> <td>820,000 M</td> <td>1,000 M</td> <td>655,087500 M</td> <td>-43.23</td> <td>-30.23</td> </tr> <tr> <td>855,000 M</td> <td>1,000 G</td> <td>1,000 M</td> <td>912,673754 M</td> <td>-43.23</td> <td>-30.23</td> </tr> <tr> <td>1,000 G</td> <td>3,000 G</td> <td>1,000 M</td> <td>2,509500 G</td> <td>-36.76</td> <td>-23.76</td> </tr> <tr> <td>3,000 G</td> <td>7,000 G</td> <td>1,000 M</td> <td>3,436000 G</td> <td>-38.85</td> <td>-25.85</td> </tr> <tr> <td>7,000 G</td> <td>9,000 G</td> <td>1,000 M</td> <td>7,368000 G</td> <td>-35.98</td> <td>-22.98</td> </tr> </tbody> </table> <p>Date: 15.OCT.2016 04:40:41</p>	Start [Hz]	Stop [Hz]	RBW [Hz]	Freq [Hz]	PwrAbs [dBm]	ΔLimit [dB]	35,000 M	820,000 M	1,000 M	655,087500 M	-43.23	-30.23	855,000 M	1,000 G	1,000 M	912,673754 M	-43.23	-30.23	1,000 G	3,000 G	1,000 M	2,509500 G	-36.76	-23.76	3,000 G	7,000 G	1,000 M	3,436000 G	-38.85	-25.85	7,000 G	9,000 G	1,000 M	7,368000 G	-35.98	-22.98	 <table border="1" data-bbox="893 1176 1308 1254"> <thead> <tr> <th>Start [Hz]</th> <th>Stop [Hz]</th> <th>RBW [Hz]</th> <th>Freq [Hz]</th> <th>PwrAbs [dBm]</th> <th>ΔLimit [dB]</th> </tr> </thead> <tbody> <tr> <td>35,000 M</td> <td>820,000 M</td> <td>1,000 M</td> <td>660,815000 M</td> <td>-43.73</td> <td>-30.73</td> </tr> <tr> <td>855,000 M</td> <td>1,000 G</td> <td>1,000 M</td> <td>820,307500 M</td> <td>-42.45</td> <td>-29.45</td> </tr> <tr> <td>1,000 G</td> <td>3,000 G</td> <td>1,000 M</td> <td>2,999000 G</td> <td>-41.86</td> <td>-28.86</td> </tr> <tr> <td>3,000 G</td> <td>7,000 G</td> <td>1,000 M</td> <td>3,013000 G</td> <td>-38.73</td> <td>-25.73</td> </tr> <tr> <td>7,000 G</td> <td>9,000 G</td> <td>1,000 M</td> <td>7,361000 G</td> <td>-35.64</td> <td>-22.64</td> </tr> </tbody> </table> <p>Date: 15.OCT.2016 04:57:51</p>	Start [Hz]	Stop [Hz]	RBW [Hz]	Freq [Hz]	PwrAbs [dBm]	ΔLimit [dB]	35,000 M	820,000 M	1,000 M	660,815000 M	-43.73	-30.73	855,000 M	1,000 G	1,000 M	820,307500 M	-42.45	-29.45	1,000 G	3,000 G	1,000 M	2,999000 G	-41.86	-28.86	3,000 G	7,000 G	1,000 M	3,013000 G	-38.73	-25.73	7,000 G	9,000 G	1,000 M	7,361000 G	-35.64	-22.64
Start [Hz]	Stop [Hz]	RBW [Hz]	Freq [Hz]	PwrAbs [dBm]	ΔLimit [dB]																																																																				
35,000 M	820,000 M	1,000 M	655,087500 M	-43.23	-30.23																																																																				
855,000 M	1,000 G	1,000 M	912,673754 M	-43.23	-30.23																																																																				
1,000 G	3,000 G	1,000 M	2,509500 G	-36.76	-23.76																																																																				
3,000 G	7,000 G	1,000 M	3,436000 G	-38.85	-25.85																																																																				
7,000 G	9,000 G	1,000 M	7,368000 G	-35.98	-22.98																																																																				
Start [Hz]	Stop [Hz]	RBW [Hz]	Freq [Hz]	PwrAbs [dBm]	ΔLimit [dB]																																																																				
35,000 M	820,000 M	1,000 M	660,815000 M	-43.73	-30.73																																																																				
855,000 M	1,000 G	1,000 M	820,307500 M	-42.45	-29.45																																																																				
1,000 G	3,000 G	1,000 M	2,999000 G	-41.86	-28.86																																																																				
3,000 G	7,000 G	1,000 M	3,013000 G	-38.73	-25.73																																																																				
7,000 G	9,000 G	1,000 M	7,361000 G	-35.64	-22.64																																																																				
Highest Channel	Highest Channel																																																																								
 <table border="1" data-bbox="239 1691 654 1769"> <thead> <tr> <th>Start [Hz]</th> <th>Stop [Hz]</th> <th>RBW [Hz]</th> <th>Freq [Hz]</th> <th>PwrAbs [dBm]</th> <th>ΔLimit [dB]</th> </tr> </thead> <tbody> <tr> <td>35,000 M</td> <td>820,000 M</td> <td>1,000 M</td> <td>303,310500 M</td> <td>-43.48</td> <td>-30.48</td> </tr> <tr> <td>855,000 M</td> <td>1,000 G</td> <td>1,000 M</td> <td>858,371250 M</td> <td>-42.86</td> <td>-29.86</td> </tr> <tr> <td>1,000 G</td> <td>3,000 G</td> <td>1,000 M</td> <td>2,979500 G</td> <td>-39.30</td> <td>-26.30</td> </tr> <tr> <td>3,000 G</td> <td>7,000 G</td> <td>1,000 M</td> <td>3,462000 G</td> <td>-38.25</td> <td>-25.25</td> </tr> <tr> <td>7,000 G</td> <td>9,000 G</td> <td>1,000 M</td> <td>8,059500 G</td> <td>-36.56</td> <td>-23.56</td> </tr> </tbody> </table> <p>Date: 15.OCT.2016 04:41:29</p>	Start [Hz]	Stop [Hz]	RBW [Hz]	Freq [Hz]	PwrAbs [dBm]	ΔLimit [dB]	35,000 M	820,000 M	1,000 M	303,310500 M	-43.48	-30.48	855,000 M	1,000 G	1,000 M	858,371250 M	-42.86	-29.86	1,000 G	3,000 G	1,000 M	2,979500 G	-39.30	-26.30	3,000 G	7,000 G	1,000 M	3,462000 G	-38.25	-25.25	7,000 G	9,000 G	1,000 M	8,059500 G	-36.56	-23.56	 <table border="1" data-bbox="893 1691 1308 1769"> <thead> <tr> <th>Start [Hz]</th> <th>Stop [Hz]</th> <th>RBW [Hz]</th> <th>Freq [Hz]</th> <th>PwrAbs [dBm]</th> <th>ΔLimit [dB]</th> </tr> </thead> <tbody> <tr> <td>35,000 M</td> <td>820,000 M</td> <td>1,000 M</td> <td>816,050500 M</td> <td>-43.64</td> <td>-30.64</td> </tr> <tr> <td>855,000 M</td> <td>1,000 G</td> <td>1,000 M</td> <td>855,036250 M</td> <td>-38.63</td> <td>-25.63</td> </tr> <tr> <td>1,000 G</td> <td>3,000 G</td> <td>1,000 M</td> <td>1,637500 G</td> <td>-34.99</td> <td>-21.99</td> </tr> <tr> <td>3,000 G</td> <td>7,000 G</td> <td>1,000 M</td> <td>3,099000 G</td> <td>-38.82</td> <td>-25.82</td> </tr> <tr> <td>7,000 G</td> <td>9,000 G</td> <td>1,000 M</td> <td>7,669500 G</td> <td>-36.61</td> <td>-23.61</td> </tr> </tbody> </table> <p>Date: 15.OCT.2016 04:58:38</p>	Start [Hz]	Stop [Hz]	RBW [Hz]	Freq [Hz]	PwrAbs [dBm]	ΔLimit [dB]	35,000 M	820,000 M	1,000 M	816,050500 M	-43.64	-30.64	855,000 M	1,000 G	1,000 M	855,036250 M	-38.63	-25.63	1,000 G	3,000 G	1,000 M	1,637500 G	-34.99	-21.99	3,000 G	7,000 G	1,000 M	3,099000 G	-38.82	-25.82	7,000 G	9,000 G	1,000 M	7,669500 G	-36.61	-23.61
Start [Hz]	Stop [Hz]	RBW [Hz]	Freq [Hz]	PwrAbs [dBm]	ΔLimit [dB]																																																																				
35,000 M	820,000 M	1,000 M	303,310500 M	-43.48	-30.48																																																																				
855,000 M	1,000 G	1,000 M	858,371250 M	-42.86	-29.86																																																																				
1,000 G	3,000 G	1,000 M	2,979500 G	-39.30	-26.30																																																																				
3,000 G	7,000 G	1,000 M	3,462000 G	-38.25	-25.25																																																																				
7,000 G	9,000 G	1,000 M	8,059500 G	-36.56	-23.56																																																																				
Start [Hz]	Stop [Hz]	RBW [Hz]	Freq [Hz]	PwrAbs [dBm]	ΔLimit [dB]																																																																				
35,000 M	820,000 M	1,000 M	816,050500 M	-43.64	-30.64																																																																				
855,000 M	1,000 G	1,000 M	855,036250 M	-38.63	-25.63																																																																				
1,000 G	3,000 G	1,000 M	1,637500 G	-34.99	-21.99																																																																				
3,000 G	7,000 G	1,000 M	3,099000 G	-38.82	-25.82																																																																				
7,000 G	9,000 G	1,000 M	7,669500 G	-36.61	-23.61																																																																				

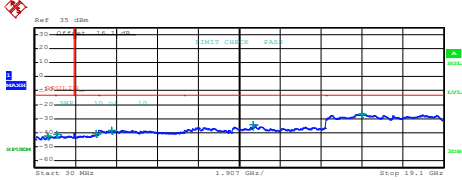
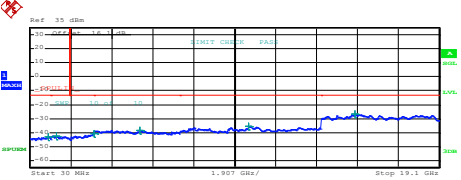
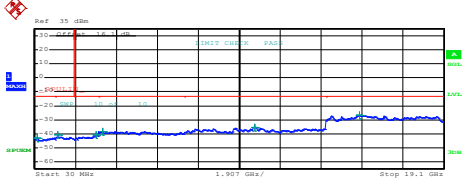
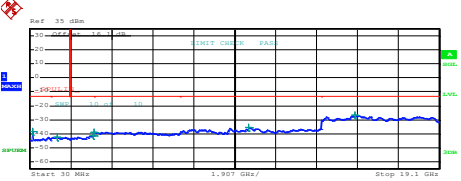
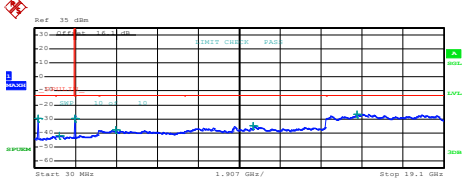
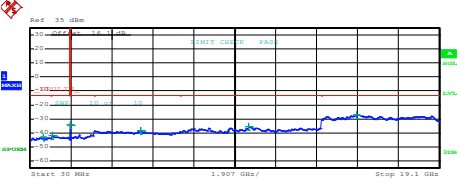

GSM1900 (GPRS class 8)	GSM1900 (EDGE class 8)																																																																																				
Lowest Channel	Lowest Channel																																																																																				
 <table border="1" data-bbox="239 571 638 672"> <thead> <tr> <th>Start [Hz]</th> <th>Stop [Hz]</th> <th>RBW [Hz]</th> <th>Freq [Hz]</th> <th>PwrAve [dBm]</th> <th>ΔLimit [dB]</th> </tr> </thead> <tbody> <tr><td>30.000 M</td><td>1.000 G</td><td>1.00 M</td><td>626.030000 M</td><td>-42.93</td><td>-29.93</td></tr> <tr><td>1.000 G</td><td>1.845 G</td><td>1.00 M</td><td>1.073304 G</td><td>-41.97</td><td>-28.97</td></tr> <tr><td>1.845 G</td><td>3.000 G</td><td>1.00 M</td><td>2.1884719 G</td><td>-40.82</td><td>-27.82</td></tr> <tr><td>3.000 G</td><td>7.000 G</td><td>1.00 M</td><td>3.606000 G</td><td>-38.45</td><td>-25.45</td></tr> <tr><td>7.000 G</td><td>13.600 G</td><td>1.00 M</td><td>10.224925 G</td><td>-34.42</td><td>-21.42</td></tr> <tr><td>13.600 G</td><td>19.100 G</td><td>1.00 M</td><td>15.1296750 G</td><td>-26.83</td><td>-13.83</td></tr> </tbody> </table> <p>Date: 15.OCT.2016 05:14:52</p>	Start [Hz]	Stop [Hz]	RBW [Hz]	Freq [Hz]	PwrAve [dBm]	ΔLimit [dB]	30.000 M	1.000 G	1.00 M	626.030000 M	-42.93	-29.93	1.000 G	1.845 G	1.00 M	1.073304 G	-41.97	-28.97	1.845 G	3.000 G	1.00 M	2.1884719 G	-40.82	-27.82	3.000 G	7.000 G	1.00 M	3.606000 G	-38.45	-25.45	7.000 G	13.600 G	1.00 M	10.224925 G	-34.42	-21.42	13.600 G	19.100 G	1.00 M	15.1296750 G	-26.83	-13.83	 <table border="1" data-bbox="893 571 1292 672"> <thead> <tr> <th>Start [Hz]</th> <th>Stop [Hz]</th> <th>RBW [Hz]</th> <th>Freq [Hz]</th> <th>PwrAve [dBm]</th> <th>ΔLimit [dB]</th> </tr> </thead> <tbody> <tr><td>30.000 M</td><td>1.000 G</td><td>1.00 M</td><td>650.037500 M</td><td>-43.09</td><td>-30.09</td></tr> <tr><td>1.000 G</td><td>1.845 G</td><td>1.00 M</td><td>1.266899 G</td><td>-42.41</td><td>-29.41</td></tr> <tr><td>1.845 G</td><td>3.000 G</td><td>1.00 M</td><td>2.986980 G</td><td>-40.61</td><td>-27.61</td></tr> <tr><td>3.000 G</td><td>7.000 G</td><td>1.00 M</td><td>5.147000 G</td><td>-38.29</td><td>-25.29</td></tr> <tr><td>7.000 G</td><td>13.600 G</td><td>1.00 M</td><td>10.216675 G</td><td>-35.36</td><td>-22.36</td></tr> <tr><td>13.600 G</td><td>19.100 G</td><td>1.00 M</td><td>15.159250 G</td><td>-26.92</td><td>-13.92</td></tr> </tbody> </table> <p>Date: 5.NOV.2016 09:22:00</p>	Start [Hz]	Stop [Hz]	RBW [Hz]	Freq [Hz]	PwrAve [dBm]	ΔLimit [dB]	30.000 M	1.000 G	1.00 M	650.037500 M	-43.09	-30.09	1.000 G	1.845 G	1.00 M	1.266899 G	-42.41	-29.41	1.845 G	3.000 G	1.00 M	2.986980 G	-40.61	-27.61	3.000 G	7.000 G	1.00 M	5.147000 G	-38.29	-25.29	7.000 G	13.600 G	1.00 M	10.216675 G	-35.36	-22.36	13.600 G	19.100 G	1.00 M	15.159250 G	-26.92	-13.92
Start [Hz]	Stop [Hz]	RBW [Hz]	Freq [Hz]	PwrAve [dBm]	ΔLimit [dB]																																																																																
30.000 M	1.000 G	1.00 M	626.030000 M	-42.93	-29.93																																																																																
1.000 G	1.845 G	1.00 M	1.073304 G	-41.97	-28.97																																																																																
1.845 G	3.000 G	1.00 M	2.1884719 G	-40.82	-27.82																																																																																
3.000 G	7.000 G	1.00 M	3.606000 G	-38.45	-25.45																																																																																
7.000 G	13.600 G	1.00 M	10.224925 G	-34.42	-21.42																																																																																
13.600 G	19.100 G	1.00 M	15.1296750 G	-26.83	-13.83																																																																																
Start [Hz]	Stop [Hz]	RBW [Hz]	Freq [Hz]	PwrAve [dBm]	ΔLimit [dB]																																																																																
30.000 M	1.000 G	1.00 M	650.037500 M	-43.09	-30.09																																																																																
1.000 G	1.845 G	1.00 M	1.266899 G	-42.41	-29.41																																																																																
1.845 G	3.000 G	1.00 M	2.986980 G	-40.61	-27.61																																																																																
3.000 G	7.000 G	1.00 M	5.147000 G	-38.29	-25.29																																																																																
7.000 G	13.600 G	1.00 M	10.216675 G	-35.36	-22.36																																																																																
13.600 G	19.100 G	1.00 M	15.159250 G	-26.92	-13.92																																																																																
Middle Channel	Middle Channel																																																																																				
 <table border="1" data-bbox="239 1090 638 1191"> <thead> <tr> <th>Start [Hz]</th> <th>Stop [Hz]</th> <th>RBW [Hz]</th> <th>Freq [Hz]</th> <th>PwrAve [dBm]</th> <th>ΔLimit [dB]</th> </tr> </thead> <tbody> <tr><td>30.000 M</td><td>1.000 G</td><td>1.00 M</td><td>143.000000 M</td><td>-43.06</td><td>-30.06</td></tr> <tr><td>1.000 G</td><td>1.845 G</td><td>1.00 M</td><td>1.100766 G</td><td>-41.00</td><td>-28.00</td></tr> <tr><td>1.845 G</td><td>3.000 G</td><td>1.00 M</td><td>2.892385 G</td><td>-41.00</td><td>-28.00</td></tr> <tr><td>3.000 G</td><td>7.000 G</td><td>1.00 M</td><td>3.207000 G</td><td>-38.21</td><td>-25.21</td></tr> <tr><td>7.000 G</td><td>13.600 G</td><td>1.00 M</td><td>10.212375 G</td><td>-39.93</td><td>-26.93</td></tr> <tr><td>13.600 G</td><td>19.100 G</td><td>1.00 M</td><td>15.182625 G</td><td>-26.87</td><td>-13.87</td></tr> </tbody> </table> <p>Date: 15.OCT.2016 05:15:38</p>	Start [Hz]	Stop [Hz]	RBW [Hz]	Freq [Hz]	PwrAve [dBm]	ΔLimit [dB]	30.000 M	1.000 G	1.00 M	143.000000 M	-43.06	-30.06	1.000 G	1.845 G	1.00 M	1.100766 G	-41.00	-28.00	1.845 G	3.000 G	1.00 M	2.892385 G	-41.00	-28.00	3.000 G	7.000 G	1.00 M	3.207000 G	-38.21	-25.21	7.000 G	13.600 G	1.00 M	10.212375 G	-39.93	-26.93	13.600 G	19.100 G	1.00 M	15.182625 G	-26.87	-13.87	 <table border="1" data-bbox="893 1090 1292 1191"> <thead> <tr> <th>Start [Hz]</th> <th>Stop [Hz]</th> <th>RBW [Hz]</th> <th>Freq [Hz]</th> <th>PwrAve [dBm]</th> <th>ΔLimit [dB]</th> </tr> </thead> <tbody> <tr><td>30.000 M</td><td>1.000 G</td><td>1.00 M</td><td>141.792500 M</td><td>-38.57</td><td>-25.57</td></tr> <tr><td>1.000 G</td><td>1.845 G</td><td>1.00 M</td><td>1.237800 G</td><td>-42.23</td><td>-29.23</td></tr> <tr><td>1.845 G</td><td>3.000 G</td><td>1.00 M</td><td>2.954701 G</td><td>-41.45</td><td>-28.45</td></tr> <tr><td>3.000 G</td><td>7.000 G</td><td>1.00 M</td><td>3.013000 G</td><td>-38.77</td><td>-25.77</td></tr> <tr><td>7.000 G</td><td>13.600 G</td><td>1.00 M</td><td>10.227400 G</td><td>-35.42</td><td>-22.42</td></tr> <tr><td>13.600 G</td><td>19.100 G</td><td>1.00 M</td><td>15.171625 G</td><td>-26.87</td><td>-13.87</td></tr> </tbody> </table> <p>Date: 5.NOV.2016 09:22:56</p>	Start [Hz]	Stop [Hz]	RBW [Hz]	Freq [Hz]	PwrAve [dBm]	ΔLimit [dB]	30.000 M	1.000 G	1.00 M	141.792500 M	-38.57	-25.57	1.000 G	1.845 G	1.00 M	1.237800 G	-42.23	-29.23	1.845 G	3.000 G	1.00 M	2.954701 G	-41.45	-28.45	3.000 G	7.000 G	1.00 M	3.013000 G	-38.77	-25.77	7.000 G	13.600 G	1.00 M	10.227400 G	-35.42	-22.42	13.600 G	19.100 G	1.00 M	15.171625 G	-26.87	-13.87
Start [Hz]	Stop [Hz]	RBW [Hz]	Freq [Hz]	PwrAve [dBm]	ΔLimit [dB]																																																																																
30.000 M	1.000 G	1.00 M	143.000000 M	-43.06	-30.06																																																																																
1.000 G	1.845 G	1.00 M	1.100766 G	-41.00	-28.00																																																																																
1.845 G	3.000 G	1.00 M	2.892385 G	-41.00	-28.00																																																																																
3.000 G	7.000 G	1.00 M	3.207000 G	-38.21	-25.21																																																																																
7.000 G	13.600 G	1.00 M	10.212375 G	-39.93	-26.93																																																																																
13.600 G	19.100 G	1.00 M	15.182625 G	-26.87	-13.87																																																																																
Start [Hz]	Stop [Hz]	RBW [Hz]	Freq [Hz]	PwrAve [dBm]	ΔLimit [dB]																																																																																
30.000 M	1.000 G	1.00 M	141.792500 M	-38.57	-25.57																																																																																
1.000 G	1.845 G	1.00 M	1.237800 G	-42.23	-29.23																																																																																
1.845 G	3.000 G	1.00 M	2.954701 G	-41.45	-28.45																																																																																
3.000 G	7.000 G	1.00 M	3.013000 G	-38.77	-25.77																																																																																
7.000 G	13.600 G	1.00 M	10.227400 G	-35.42	-22.42																																																																																
13.600 G	19.100 G	1.00 M	15.171625 G	-26.87	-13.87																																																																																
Highest Channel	Highest Channel																																																																																				
 <table border="1" data-bbox="239 1610 638 1711"> <thead> <tr> <th>Start [Hz]</th> <th>Stop [Hz]</th> <th>RBW [Hz]</th> <th>Freq [Hz]</th> <th>PwrAve [dBm]</th> <th>ΔLimit [dB]</th> </tr> </thead> <tbody> <tr><td>30.000 M</td><td>1.000 G</td><td>1.00 M</td><td>171.600000 M</td><td>-39.98</td><td>-26.98</td></tr> <tr><td>1.000 G</td><td>1.845 G</td><td>1.00 M</td><td>1.189703 G</td><td>-41.82</td><td>-28.82</td></tr> <tr><td>1.845 G</td><td>3.000 G</td><td>1.00 M</td><td>1.932071 G</td><td>-39.79</td><td>-26.79</td></tr> <tr><td>3.000 G</td><td>7.000 G</td><td>1.00 M</td><td>3.819000 G</td><td>-37.57</td><td>-24.57</td></tr> <tr><td>7.000 G</td><td>13.600 G</td><td>1.00 M</td><td>10.213375 G</td><td>-34.97</td><td>-21.97</td></tr> <tr><td>13.600 G</td><td>19.100 G</td><td>1.00 M</td><td>15.072625 G</td><td>-26.49</td><td>-13.49</td></tr> </tbody> </table> <p>Date: 15.OCT.2016 05:16:23</p>	Start [Hz]	Stop [Hz]	RBW [Hz]	Freq [Hz]	PwrAve [dBm]	ΔLimit [dB]	30.000 M	1.000 G	1.00 M	171.600000 M	-39.98	-26.98	1.000 G	1.845 G	1.00 M	1.189703 G	-41.82	-28.82	1.845 G	3.000 G	1.00 M	1.932071 G	-39.79	-26.79	3.000 G	7.000 G	1.00 M	3.819000 G	-37.57	-24.57	7.000 G	13.600 G	1.00 M	10.213375 G	-34.97	-21.97	13.600 G	19.100 G	1.00 M	15.072625 G	-26.49	-13.49	 <table border="1" data-bbox="893 1610 1292 1711"> <thead> <tr> <th>Start [Hz]</th> <th>Stop [Hz]</th> <th>RBW [Hz]</th> <th>Freq [Hz]</th> <th>PwrAve [dBm]</th> <th>ΔLimit [dB]</th> </tr> </thead> <tbody> <tr><td>30.000 M</td><td>1.000 G</td><td>1.00 M</td><td>650.037500 M</td><td>-43.08</td><td>-30.08</td></tr> <tr><td>1.000 G</td><td>1.845 G</td><td>1.00 M</td><td>1.072881 G</td><td>-42.11</td><td>-29.11</td></tr> <tr><td>1.845 G</td><td>3.000 G</td><td>1.00 M</td><td>1.932071 G</td><td>-39.66</td><td>-26.66</td></tr> <tr><td>3.000 G</td><td>7.000 G</td><td>1.00 M</td><td>5.182000 G</td><td>-38.61</td><td>-25.61</td></tr> <tr><td>7.000 G</td><td>13.600 G</td><td>1.00 M</td><td>10.211725 G</td><td>-35.26</td><td>-22.26</td></tr> <tr><td>13.600 G</td><td>19.100 G</td><td>1.00 M</td><td>15.247925 G</td><td>-26.99</td><td>-13.99</td></tr> </tbody> </table> <p>Date: 5.NOV.2016 09:23:50</p>	Start [Hz]	Stop [Hz]	RBW [Hz]	Freq [Hz]	PwrAve [dBm]	ΔLimit [dB]	30.000 M	1.000 G	1.00 M	650.037500 M	-43.08	-30.08	1.000 G	1.845 G	1.00 M	1.072881 G	-42.11	-29.11	1.845 G	3.000 G	1.00 M	1.932071 G	-39.66	-26.66	3.000 G	7.000 G	1.00 M	5.182000 G	-38.61	-25.61	7.000 G	13.600 G	1.00 M	10.211725 G	-35.26	-22.26	13.600 G	19.100 G	1.00 M	15.247925 G	-26.99	-13.99
Start [Hz]	Stop [Hz]	RBW [Hz]	Freq [Hz]	PwrAve [dBm]	ΔLimit [dB]																																																																																
30.000 M	1.000 G	1.00 M	171.600000 M	-39.98	-26.98																																																																																
1.000 G	1.845 G	1.00 M	1.189703 G	-41.82	-28.82																																																																																
1.845 G	3.000 G	1.00 M	1.932071 G	-39.79	-26.79																																																																																
3.000 G	7.000 G	1.00 M	3.819000 G	-37.57	-24.57																																																																																
7.000 G	13.600 G	1.00 M	10.213375 G	-34.97	-21.97																																																																																
13.600 G	19.100 G	1.00 M	15.072625 G	-26.49	-13.49																																																																																
Start [Hz]	Stop [Hz]	RBW [Hz]	Freq [Hz]	PwrAve [dBm]	ΔLimit [dB]																																																																																
30.000 M	1.000 G	1.00 M	650.037500 M	-43.08	-30.08																																																																																
1.000 G	1.845 G	1.00 M	1.072881 G	-42.11	-29.11																																																																																
1.845 G	3.000 G	1.00 M	1.932071 G	-39.66	-26.66																																																																																
3.000 G	7.000 G	1.00 M	5.182000 G	-38.61	-25.61																																																																																
7.000 G	13.600 G	1.00 M	10.211725 G	-35.26	-22.26																																																																																
13.600 G	19.100 G	1.00 M	15.247925 G	-26.99	-13.99																																																																																



Frequency Stability

Test Conditions	Middle Channel	GSM850 (GPRS class 8)	GSM850 (EDGE class 8)	Limit 2.5ppm
Temperature (°C)	Voltage (Volt)	Deviation (ppm)		Result
50	Normal Voltage	0.0096	0.0024	PASS
40	Normal Voltage	0.0072	0.0096	
30	Normal Voltage	0.0048	0.0024	
20(Ref.)	Normal Voltage	0.0000	0.0000	
10	Normal Voltage	0.0036	0.0502	
0	Normal Voltage	0.0203	0.0478	
-10	Normal Voltage	0.0167	0.0562	
-20	Normal Voltage	0.0227	0.0646	
-30	Normal Voltage	0.0191	0.0670	
20	Maximum Voltage	0.0048	0.0012	
20	Normal Voltage	0.0000	0.0000	
20	Battery End Point	0.0000	0.0036	

Test Conditions	Middle Channel	GSM1900 (GPRS class 8)	GSM1900 (EDGE class 8)	Limit Note 2.
Temperature (°C)	Voltage (Volt)	Deviation (ppm)		Result
50	Normal Voltage	0.0005	0.0048	PASS
40	Normal Voltage	0.0016	0.0011	
30	Normal Voltage	0.0005	0.0027	
20(Ref.)	Normal Voltage	0.0000	0.0000	
10	Normal Voltage	0.0032	0.0043	
0	Normal Voltage	0.0074	0.0128	
-10	Normal Voltage	0.0074	0.0160	
-20	Normal Voltage	0.0096	0.0266	
-30	Normal Voltage	0.0117	0.0170	
20	Maximum Voltage	0.0027	0.0005	
20	Normal Voltage	0.0000	0.0000	
20	Battery End Point	0.0011	0.0021	

Note:

1. Normal Voltage = 3.8V. ; Battery End Point (BEP) = 3.4 V. ; Maximum Voltage =4.35 V
2. The frequency fundamental emissions stay within the authorized frequency block.



A2. WCDMA

Peak-to-Average Ratio

Mode	WCDMA Band V	WCDMA Band II	WCDMA Band IV	Limit: 13dB
Mod.	RMC 12.2Kbps	RMC 12.2Kbps	RMC 12.2Kbps	Result
Lowest CH	2.16	2.28	2.64	PASS
Middle CH	2.24	2.52	2.56	
Highest CH	1.96	2.40	2.48	

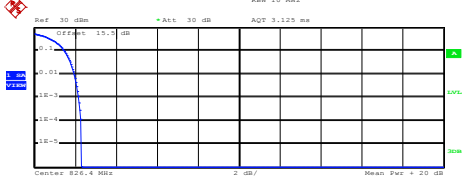
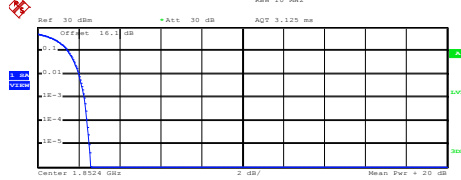
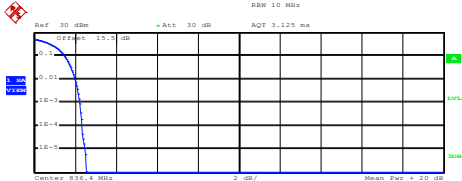
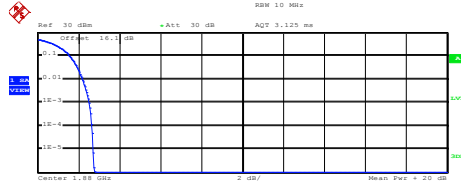
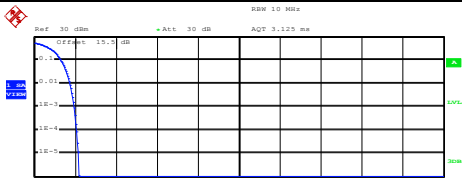
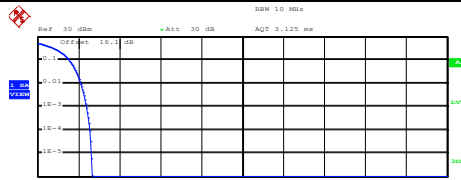

WCDMA Band V (RMC 12.2Kbps)	WCDMA Band II (RMC 12.2Kbps)																
<p align="center">Lowest Channel</p>  <p>Center 826.4 MHz</p> <p>Complementary Cumulative Distribution Function (100000 samples) Trace 1 Mean 23.99 dBm Peak 26.30 dBm Crest 2.32 dB</p> <table border="1"> <tr><td>10 %</td><td>1.48 dB</td></tr> <tr><td>1 %</td><td>1.96 dB</td></tr> <tr><td>.1 %</td><td>2.16 dB</td></tr> <tr><td>.01 %</td><td>2.28 dB</td></tr> </table> <p>Date: 5.NOV.2016 10:34:33</p>	10 %	1.48 dB	1 %	1.96 dB	.1 %	2.16 dB	.01 %	2.28 dB	<p align="center">Lowest Channel</p>  <p>Center 1.8524 GHz</p> <p>Complementary Cumulative Distribution Function (100000 samples) Trace 1 Mean 22.30 dBm Peak 24.89 dBm Crest 2.59 dB</p> <table border="1"> <tr><td>10 %</td><td>1.48 dB</td></tr> <tr><td>1 %</td><td>2.00 dB</td></tr> <tr><td>.1 %</td><td>2.28 dB</td></tr> <tr><td>.01 %</td><td>2.40 dB</td></tr> </table> <p>Date: 5.NOV.2016 09:41:49</p>	10 %	1.48 dB	1 %	2.00 dB	.1 %	2.28 dB	.01 %	2.40 dB
10 %	1.48 dB																
1 %	1.96 dB																
.1 %	2.16 dB																
.01 %	2.28 dB																
10 %	1.48 dB																
1 %	2.00 dB																
.1 %	2.28 dB																
.01 %	2.40 dB																
<p align="center">Middle Channel</p>  <p>Center 836.4 MHz</p> <p>Complementary Cumulative Distribution Function (100000 samples) Trace 1 Mean 23.88 dBm Peak 26.44 dBm Crest 2.56 dB</p> <table border="1"> <tr><td>10 %</td><td>1.48 dB</td></tr> <tr><td>1 %</td><td>2.00 dB</td></tr> <tr><td>.1 %</td><td>2.24 dB</td></tr> <tr><td>.01 %</td><td>2.36 dB</td></tr> </table> <p>Date: 5.NOV.2016 10:34:40</p>	10 %	1.48 dB	1 %	2.00 dB	.1 %	2.24 dB	.01 %	2.36 dB	<p align="center">Middle Channel</p>  <p>Center 1.88 GHz</p> <p>Complementary Cumulative Distribution Function (100000 samples) Trace 1 Mean 22.33 dBm Peak 25.10 dBm Crest 2.77 dB</p> <table border="1"> <tr><td>10 %</td><td>1.56 dB</td></tr> <tr><td>1 %</td><td>2.20 dB</td></tr> <tr><td>.1 %</td><td>2.52 dB</td></tr> <tr><td>.01 %</td><td>2.64 dB</td></tr> </table> <p>Date: 5.NOV.2016 09:42:00</p>	10 %	1.56 dB	1 %	2.20 dB	.1 %	2.52 dB	.01 %	2.64 dB
10 %	1.48 dB																
1 %	2.00 dB																
.1 %	2.24 dB																
.01 %	2.36 dB																
10 %	1.56 dB																
1 %	2.20 dB																
.1 %	2.52 dB																
.01 %	2.64 dB																
<p align="center">Highest Channel</p>  <p>Center 846.6 MHz</p> <p>Complementary Cumulative Distribution Function (100000 samples) Trace 1 Mean 23.91 dBm Peak 26.09 dBm Crest 2.18 dB</p> <table border="1"> <tr><td>10 %</td><td>1.32 dB</td></tr> <tr><td>1 %</td><td>1.76 dB</td></tr> <tr><td>.1 %</td><td>1.96 dB</td></tr> <tr><td>.01 %</td><td>2.08 dB</td></tr> </table> <p>Date: 5.NOV.2016 10:34:50</p>	10 %	1.32 dB	1 %	1.76 dB	.1 %	1.96 dB	.01 %	2.08 dB	<p align="center">Highest Channel</p>  <p>Center 1.9076 GHz</p> <p>Complementary Cumulative Distribution Function (100000 samples) Trace 1 Mean 22.53 dBm Peak 25.17 dBm Crest 2.64 dB</p> <table border="1"> <tr><td>10 %</td><td>1.56 dB</td></tr> <tr><td>1 %</td><td>2.12 dB</td></tr> <tr><td>.1 %</td><td>2.40 dB</td></tr> <tr><td>.01 %</td><td>2.56 dB</td></tr> </table> <p>Date: 5.NOV.2016 09:42:10</p>	10 %	1.56 dB	1 %	2.12 dB	.1 %	2.40 dB	.01 %	2.56 dB
10 %	1.32 dB																
1 %	1.76 dB																
.1 %	1.96 dB																
.01 %	2.08 dB																
10 %	1.56 dB																
1 %	2.12 dB																
.1 %	2.40 dB																
.01 %	2.56 dB																



WCDMA Band IV (RMC 12.2Kbps)

Lowest Channel

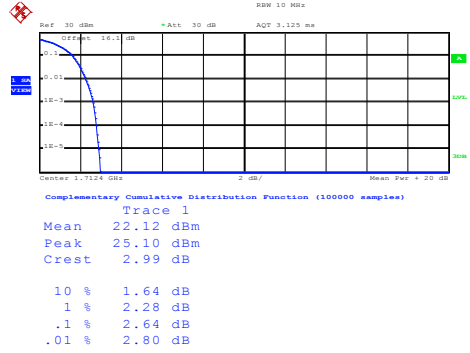

Date: 5.NOV.2016 10:07:53

Middle Channel

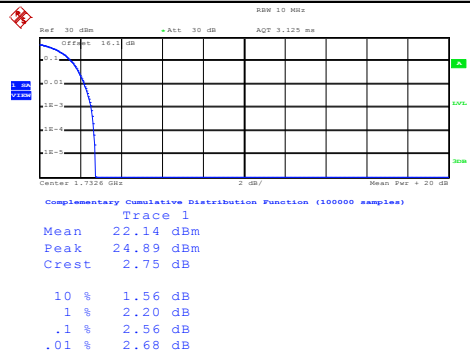

Date: 5.NOV.2016 10:08:03

Highest Channel

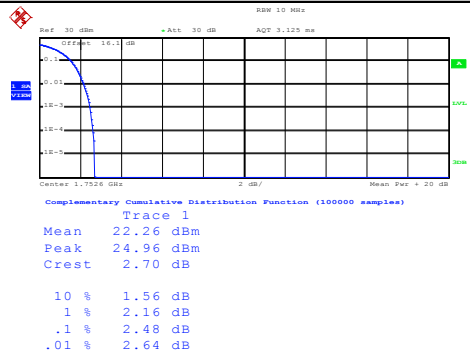

Date: 5.NOV.2016 10:08:13



26dB Bandwidth

Mode	WCDMA Band V 26dB BW(MHz)	WCDMA Band II 26dB BW(MHz)	WCDMA Band IV 26dB BW(MHz)
Mod.	RMC 12.2Kbps	RMC 12.2Kbps	RMC 12.2Kbps
Lowest CH	4.74	4.72	4.69
Middle CH	4.75	4.71	4.71
Highest CH	4.77	4.72	4.70



WCDMA Band V (RMC 12.2Kbps)

WCDMA Band II (RMC 12.2Kbps)

Lowest Channel

Lowest Channel

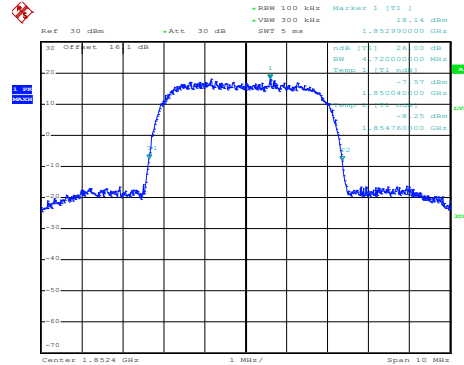
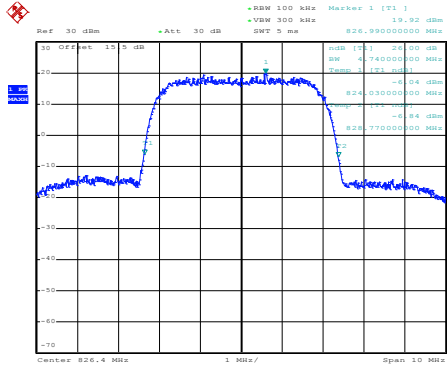

Date: 5.NOV.2016 10:23:19

Date: 5.NOV.2016 09:29:28

Middle Channel

Middle Channel

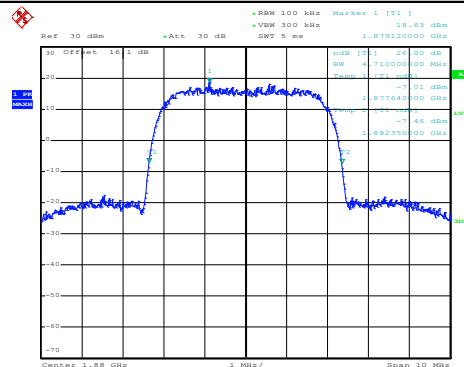
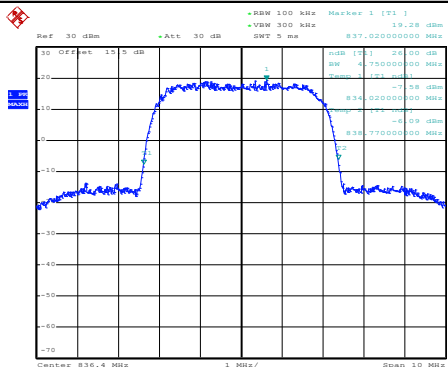

Date: 5.NOV.2016 10:23:47

Date: 5.NOV.2016 09:30:42

Highest Channel

Highest Channel

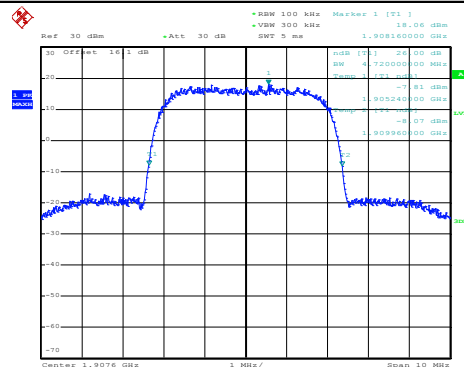
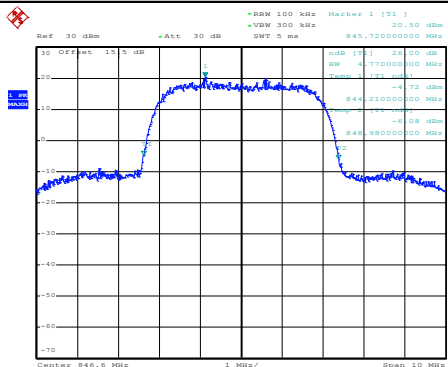

Date: 5.NOV.2016 10:24:15

Date: 5.NOV.2016 09:31:30



WCDMA Band IV (RMC 12.2Kbps)

Lowest Channel

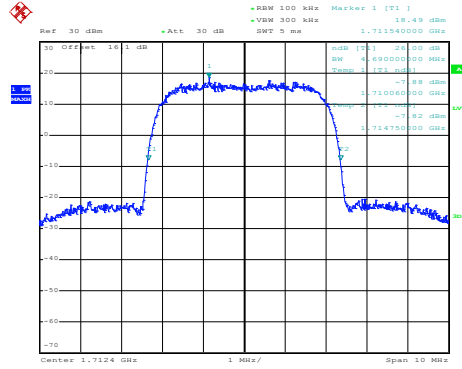

Date: 5.NOV.2016 09:57:04

Middle Channel

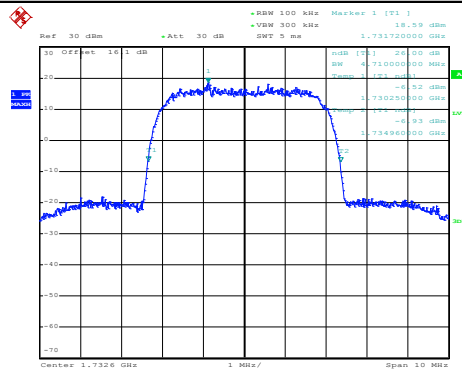

Date: 5.NOV.2016 09:57:32

Highest Channel

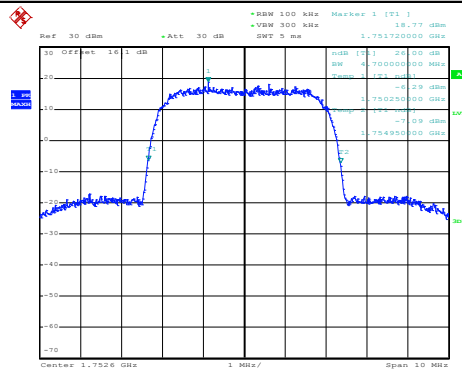

Date: 5.NOV.2016 09:58:00



Occupied Bandwidth

Mode	WCDMA Band V 99%OBW(MHz)	WCDMA Band II 99%OBW(MHz)	WCDMA Band IV 99%OBW(MHz)
Mod.	RMC 12.2Kbps	RMC 12.2Kbps	RMC 12.2Kbps
Lowest CH	4.18	4.18	4.16
Middle CH	4.19	4.17	4.17
Highest CH	4.21	4.17	4.17



WCDMA Band V (RMC 12.2Kbps)

WCDMA Band II (RMC 12.2Kbps)

Lowest Channel

Lowest Channel

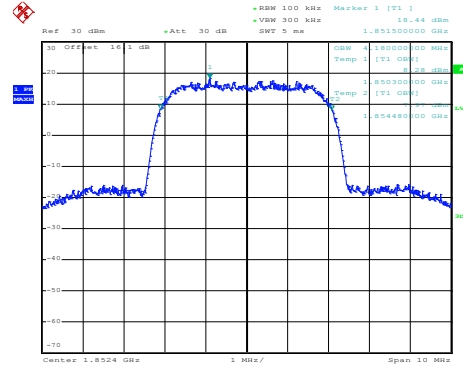
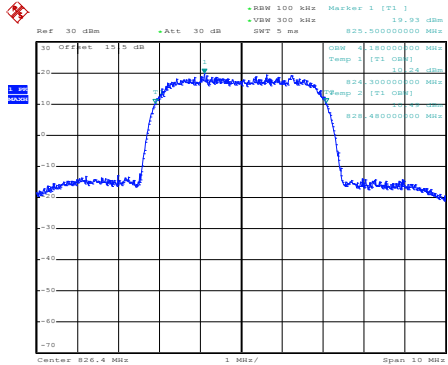

Date: 5.NOV.2016 10:24:51

Date: 5.NOV.2016 09:32:41

Middle Channel

Middle Channel

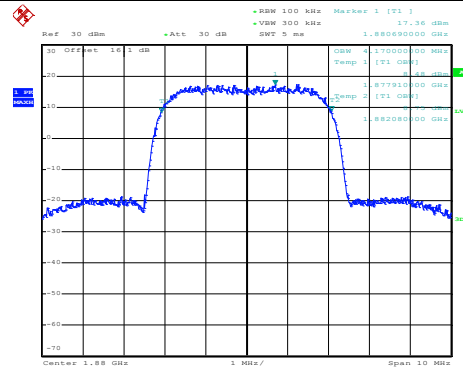
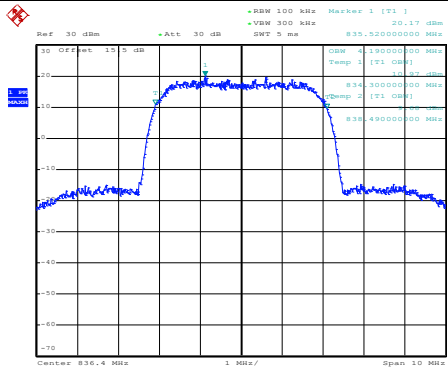

Date: 5.NOV.2016 10:25:19

Date: 5.NOV.2016 09:33:09

Highest Channel

Highest Channel

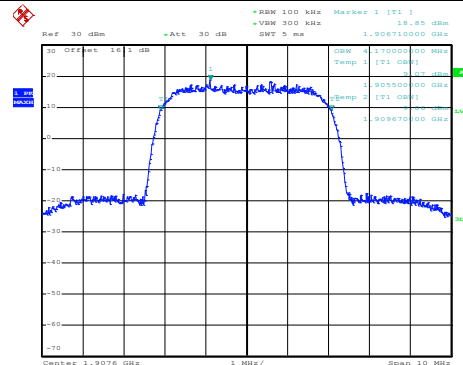
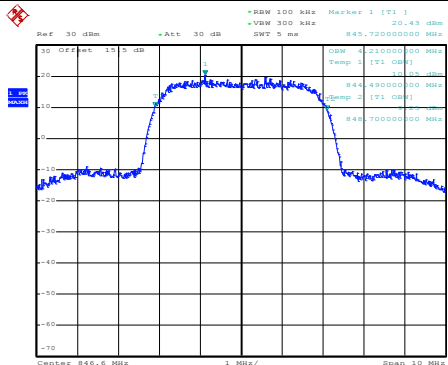

Date: 5.NOV.2016 10:25:47

Date: 5.NOV.2016 09:33:37

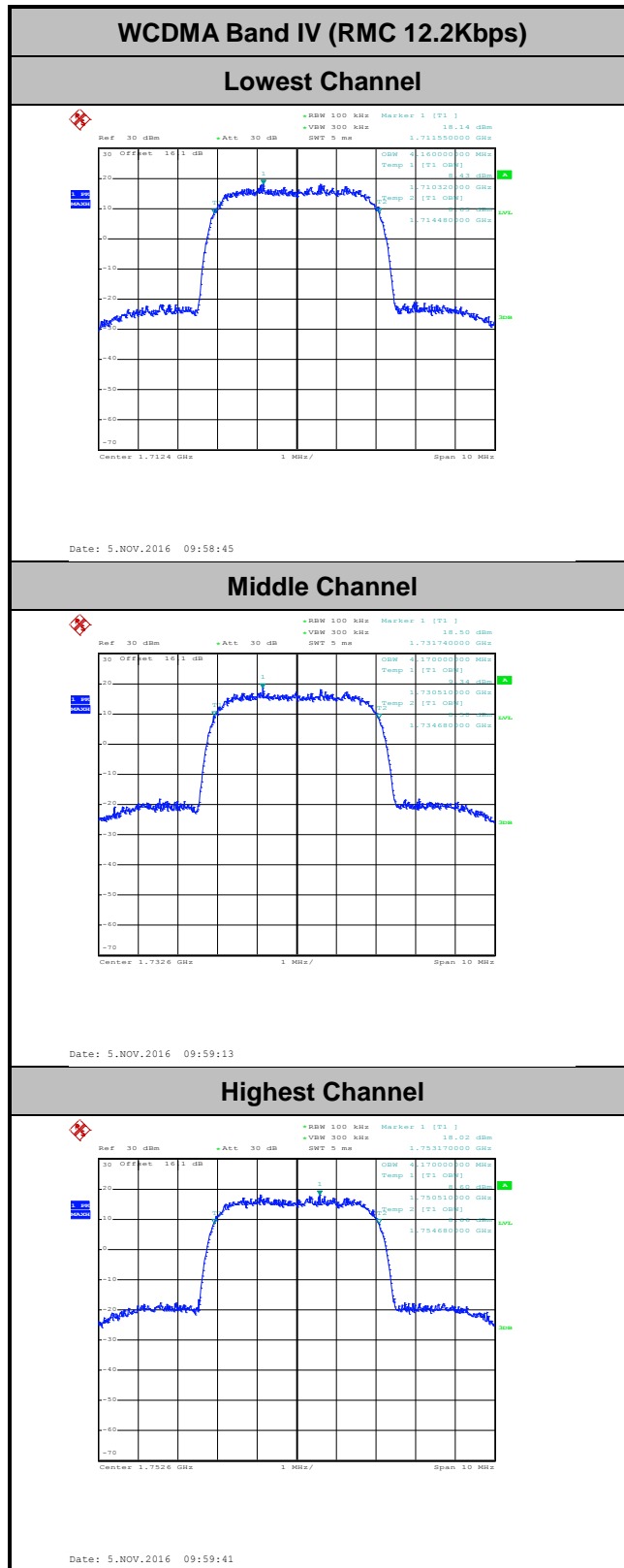



Conducted Band Edge

WCDMA Band V (RMC 12.2Kbps)

Lowest Band Edge

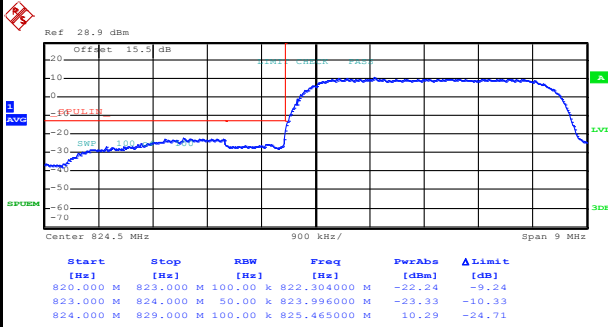

Date: 5.NOV.2016 10:28:33

Highest Band Edge

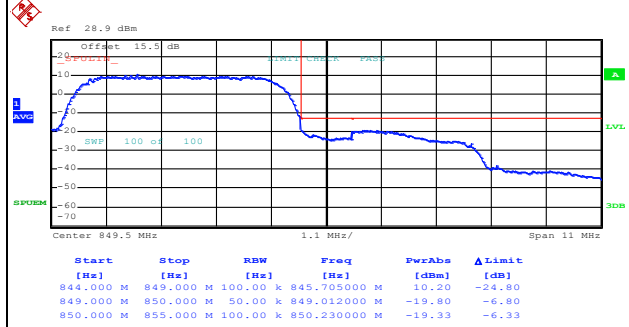

Date: 5.NOV.2016 10:31:15

WCDMA Band II (RMC 12.2Kbps)

Lowest Band Edge

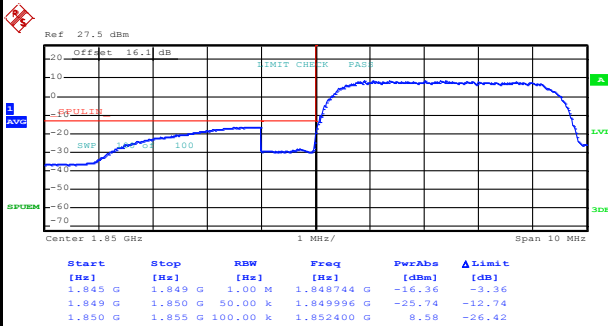

Date: 5.NOV.2016 09:36:26

Highest Band Edge

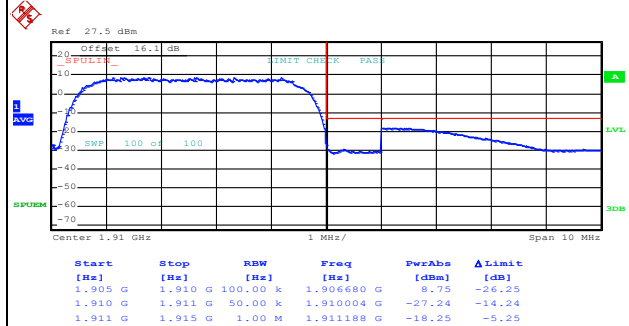

Date: 5.NOV.2016 09:39:08



WCDMA Band IV (RMC 12.2Kbps)

Lowest Band Edge

Highest Band Edge

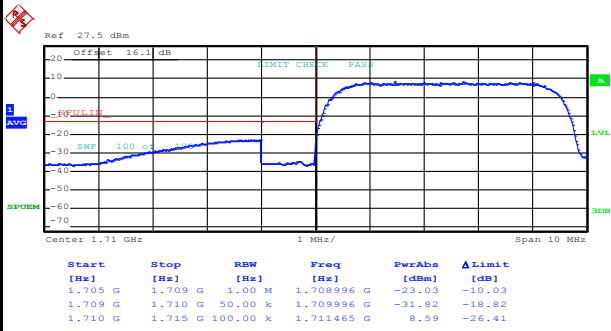

Date: 5.NOV.2016 10:02:31

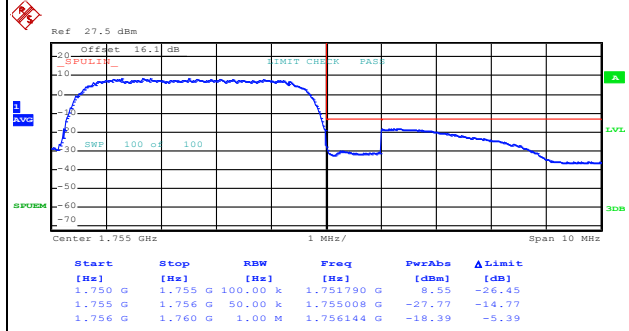

Date: 5.NOV.2016 10:05:13



Conducted Spurious Emission

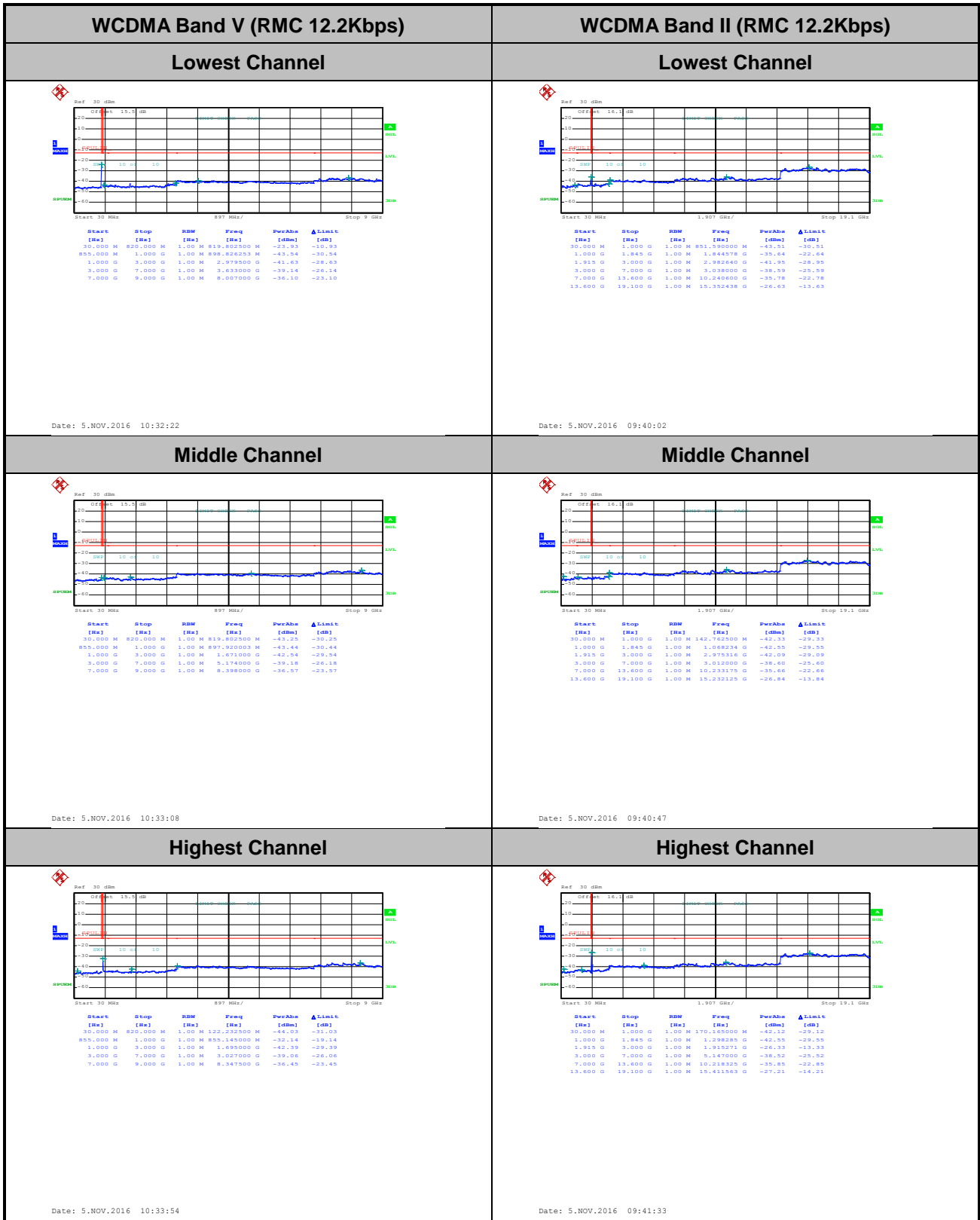



WCDMA Band IV (RMC 12.2Kbps)

Lowest Channel

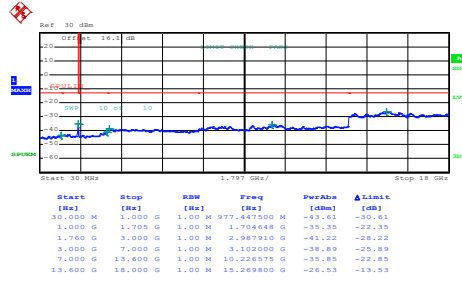

Date: 5.NOV.2016 10:06:03

Middle Channel

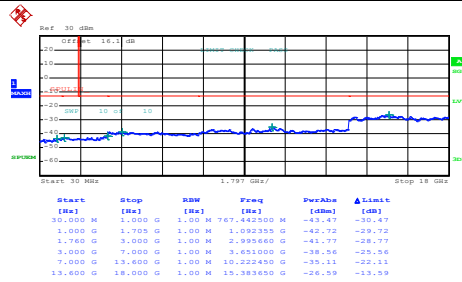

Date: 5.NOV.2016 10:06:49

Highest Channel

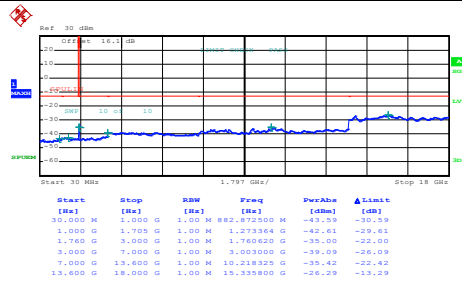

Date: 5.NOV.2016 10:07:35



Frequency Stability

Test Conditions	Middle Channel	WCDMA Band V (RMC 12.2Kbps)	Limit 2.5ppm
Temperature (°C)	Voltage (Volt)	Deviation (ppm)	Result
50	Normal Voltage	0.0012	PASS
40	Normal Voltage	0.0024	
30	Normal Voltage	0.0012	
20(Ref.)	Normal Voltage	0.0000	
10	Normal Voltage	0.0108	
0	Normal Voltage	0.0143	
-10	Normal Voltage	0.0167	
-20	Normal Voltage	0.0167	
-30	Normal Voltage	0.0155	
20	Maximum Voltage	0.0024	
20	Normal Voltage	0.0000	
20	Battery End Point	0.0024	

Test Conditions	Middle Channel	WCDMA Band II (RMC 12.2Kbps)	Limit Note 2.
Temperature (°C)	Voltage (Volt)	Deviation (ppm)	Result
50	Normal Voltage	0.0011	PASS
40	Normal Voltage	0.0011	
30	Normal Voltage	0.0016	
20(Ref.)	Normal Voltage	0.0000	
10	Normal Voltage	0.0011	
0	Normal Voltage	0.0011	
-10	Normal Voltage	0.0021	
-20	Normal Voltage	0.0005	
-30	Normal Voltage	0.0016	
20	Maximum Voltage	0.0027	
20	Normal Voltage	0.0000	
20	Battery End Point	0.0000	



Test Conditions	Middle Channel	WCDMA Band IV (RMC 12.2Kbps)	Limit Note 2.
Temperature (°C)	Voltage (Volt)	Deviation (ppm)	Result
50	Normal Voltage	0.0006	PASS
40	Normal Voltage	0.0006	
30	Normal Voltage	0.0012	
20(Ref.)	Normal Voltage	0.0000	
10	Normal Voltage	0.0006	
0	Normal Voltage	0.0000	
-10	Normal Voltage	0.0121	
-20	Normal Voltage	0.0115	
-30	Normal Voltage	0.0023	
20	Maximum Voltage	0.0006	
20	Normal Voltage	0.0000	
20	Battery End Point	0.0006	

Note:

1. Normal Voltage = 3.85V. ; Battery End Point (BEP) = 3.4 V. ; Maximum Voltage =4.35 V
2. The frequency fundamental emissions stay within the authorized frequency block.



Appendix B. Test Results of ERP/EIRP and Radiated Test

ERP/EIRP

Channel	Mode	Conducted		ERP	
		Power (dBm)	Power (Watts)	ERP(dBm)	ERP(W)
Lowest	GSM850	33.34	2.1577	28.19	0.6592
Middle	GSM	33.31	2.1429	28.16	0.6546
Highest	(GT - LC = -3 dB)	33.25	2.1135	28.10	0.6457
Lowest	GSM850	26.30	0.4266	21.15	0.1303
Middle	EDGE class 8	26.28	0.4246	21.13	0.1297
Highest	(GT - LC = -3 dB)	26.21	0.4178	21.06	0.1276
Lowest	WCDMA Band V	24.41	0.2761	19.26	0.0843
Middle	RMC 12.2Kbps	24.36	0.2729	19.21	0.0834
Highest	(GT - LC = -3 dB)	24.33	0.2710	19.18	0.0828
Limit	ERP < 7W	Result		PASS	

Channel	Mode	Conducted		EIRP	
		Power (dBm)	Power (Watts)	EIRP(dBm)	EIRP(W)
Lowest	GSM1900	30.24	1.0568	31.74	1.4928
Middle	GSM	30.25	1.0593	31.75	1.4962
Highest	(GT - LC = 1.5 dB)	30.40	1.0965	31.90	1.5488
Lowest	GSM1900	24.28	0.2679	25.78	0.3784
Middle	EDGE class 8	24.45	0.2786	25.95	0.3936
Highest	(GT - LC = 1.5 dB)	24.59	0.2877	26.09	0.4064
Lowest	WCDMA Band II	23.58	0.2280	25.08	0.3221
Middle	RMC 12.2Kbps	23.57	0.2275	25.07	0.3214
Highest	(GT - LC = 1.5 dB)	23.89	0.2449	25.39	0.3459
Limit	EIRP < 2W	Result		PASS	

Channel	Mode	Conducted		EIRP	
		Power (dBm)	Power (Watts)	EIRP(dBm)	EIRP(W)
Lowest	WCDMA Band IV	23.40	0.2188	24.00	0.2512
Middle	RMC 12.2Kbps	23.42	0.2198	24.02	0.2523
Highest	(GT - LC = 0.6 dB)	23.50	0.2239	24.10	0.2570
Limit	EIRP < 1W	Result		PASS	



Radiated Spurious Emission

GSM850 (GSM)									
Channel	Frequency (MHz)	ERP (dBm)	Limit (dBm)	Over Limit (dB)	SPA Reading (dBm)	S.G. Power (dBm)	TX Cable loss (dB)	TX Antenna Gain (dBi)	Polarization (H/V)
Lowest	1648	-56.07	-13	-43.07	-69.24	-57.83	0.98	4.89	H
	2472	-44.73	-13	-31.73	-61.08	-46.61	1.28	5.32	H
	3296	-55.21	-13	-42.21	-74.89	-58.62	1.54	7.10	H
	4120	-47.20	-13	-34.20	-68.66	-51.84	1.83	8.62	H
	1648	-54.21	-13	-41.21	-67.38	-55.97	0.98	4.89	V
	2472	-41.72	-13	-28.72	-58.07	-43.6	1.28	5.32	V
	3296	-57.44	-13	-44.44	-77.12	-60.85	1.54	7.10	V
	4120	-48.77	-13	-35.77	-70.23	-53.41	1.83	8.62	V
Middle	1672	-57.70	-13	-44.70	-70.94	-59.38	0.99	4.82	H
	2512	-46.40	-13	-33.40	-62.92	-48.37	1.29	5.41	H
	3344	-51.52	-13	-38.52	-71.33	-55.13	1.56	7.31	H
	4184	-50.61	-13	-37.61	-72.29	-55.23	1.87	8.64	H
	5016	-51.95	-13	-38.95	-77.18	-57.15	2.35	9.70	H
	1672	-54.57	-13	-41.57	-67.81	-56.25	0.99	4.82	V
	2512	-42.17	-13	-29.17	-58.69	-44.14	1.29	5.41	V
	3344	-56.26	-13	-43.26	-76.07	-59.87	1.56	7.31	V
	4184	-49.67	-13	-36.67	-71.35	-54.29	1.87	8.64	V
	5016	-53.99	-13	-40.99	-79.22	-59.19	2.35	9.70	V
Highest	1696	-57.89	-13	-44.89	-71.19	-59.49	1.00	4.75	H
	2544	-46.27	-13	-33.27	-62.96	-48.25	1.30	5.44	H
	3392	-53.18	-13	-40.18	-73.13	-56.98	1.57	7.52	H
	4248	-54.57	-13	-41.57	-76.51	-59.17	1.90	8.65	H
	1696	-55.59	-13	-42.59	-68.89	-57.19	1.00	4.75	V
	2544	-44.49	-13	-31.49	-61.18	-46.47	1.30	5.44	V
	3392	-57.18	-13	-44.18	-77.13	-60.98	1.57	7.52	V
	4248	-53.13	-13	-40.13	-75.07	-57.73	1.90	8.65	V

Remark: Spurious emissions within 30-1000MHz were found more than 20dB below limit line.



GSM850 (EDGE class 8)									
Channel	Frequency (MHz)	ERP (dBm)	Limit (dBm)	Over Limit (dB)	SPA Reading (dBm)	S.G. Power (dBm)	TX Cable loss (dB)	TX Antenna Gain (dBi)	Polarization (H/V)
Lowest	1648	-62.41	-13	-49.41	-75.58	-64.17	0.98	4.89	H
	2472	-60.26	-13	-47.26	-76.61	-62.14	1.28	5.32	H
	3296	-59.31	-13	-46.31	-78.99	-62.72	1.54	7.10	H
	1648	-63.00	-13	-50.00	-76.17	-64.76	0.98	4.89	V
	2472	-58.57	-13	-45.57	-74.92	-60.45	1.28	5.32	V
	3296	-59.39	-13	-46.39	-79.07	-62.8	1.54	7.10	V
Middle	1672	-63.64	-13	-50.64	-76.88	-65.32	0.99	4.82	H
	2512	-61.19	-13	-48.19	-77.71	-63.16	1.29	5.41	H
	3344	-59.07	-13	-46.07	-78.88	-62.68	1.56	7.31	H
	1672	-62.61	-13	-49.61	-75.85	-64.29	0.99	4.82	V
	2512	-61.39	-13	-48.39	-77.91	-63.36	1.29	5.41	V
	3344	-58.86	-13	-45.86	-78.67	-62.47	1.56	7.31	V
Highest	1696	-62.36	-13	-49.36	-75.66	-63.96	1.00	4.75	H
	2544	-61.38	-13	-48.38	-78.07	-63.36	1.30	5.44	H
	3392	-59.09	-13	-46.09	-79.04	-62.89	1.57	7.52	H
	1696	-62.86	-13	-49.86	-76.16	-64.46	1.00	4.75	V
	2544	-61.55	-13	-48.55	-78.24	-63.53	1.30	5.44	V
	3392	-58.75	-13	-45.75	-78.7	-62.55	1.57	7.52	V

Remark: Spurious emissions within 30-1000MHz were found more than 20dB below limit line.



GSM1900 (GSM)									
Channel	Frequency (MHz)	EIRP (dBm)	Limit (dBm)	Over Limit (dB)	SPA Reading (dBm)	S.G. Power (dBm)	TX Cable loss (dB)	TX Antenna Gain (dBi)	Polarization (H/V)
Lowest	3700	-54.78	-13	-41.78	-74.94	-61.35	1.67	8.24	H
	5548	-46.61	-13	-33.61	-73.45	-53.68	2.65	9.72	H
	7396	-47.01	-13	-34.01	-80.63	-56.14	2.46	11.59	H
	3700	-56.62	-13	-43.62	-76.76	-63.19	1.67	8.24	V
	5548	-48.21	-13	-35.21	-75.17	-55.28	2.65	9.72	V
	7396	-47.29	-13	-34.29	-80.62	-56.42	2.46	11.59	V
Middle	3763	-55.72	-13	-42.72	-75.92	-62.35	1.69	8.32	H
	5639	-46.13	-13	-33.13	-73.02	-53.18	2.71	9.76	H
	7529	-47.76	-13	-34.76	-80.77	-57.16	2.42	11.82	H
	3763	-55.75	-13	-42.75	-75.67	-62.38	1.69	8.32	V
	5639	-49.06	-13	-36.06	-76.23	-56.11	2.71	9.76	V
	7529	-46.54	-13	-33.54	-80.28	-55.94	2.42	11.82	V
Highest	3819	-49.61	-13	-36.61	-70.03	-56.29	1.70	8.38	H
	5730	-46.30	-13	-33.30	-73.43	-53.33	2.76	9.79	H
	7641	-46.42	-13	-33.42	-80.35	-55.92	2.38	11.88	H
	3819	-50.61	-13	-37.61	-71.22	-57.29	1.70	8.38	V
	5730	-47.11	-13	-34.11	-74.39	-54.14	2.76	9.79	V
	7641	-46.31	-13	-33.31	-80.26	-55.81	2.38	11.88	V

Remark: Spurious emissions within 30-1000MHz were found more than 20dB below limit line.



GSM1900 (EDGE class 8)									
Channel	Frequency (MHz)	EIRP (dBm)	Limit (dBm)	Over Limit (dB)	SPA Reading (dBm)	S.G. Power (dBm)	TX Cable loss (dB)	TX Antenna Gain (dBi)	Polarization (H/V)
Lowest	3700	-54.95	-13	-41.95	-74.75	-61.52	1.67	8.24	H
	5548	-43.27	-13	-30.27	-70.62	-50.34	2.65	9.72	H
	7396	-47.16	-13	-34.16	-80.74	-56.29	2.46	11.59	H
	3700	-57.80	-13	-44.80	-78.22	-64.37	1.67	8.24	V
	5548	-49.74	-13	-36.74	-75.7	-56.81	2.65	9.72	V
	7396	-47.49	-13	-34.49	-80.84	-56.62	2.46	11.59	V
Middle	3763	-53.19	-13	-40.19	-74.28	-59.82	1.69	8.32	H
	5639	-46.86	-13	-33.86	-73.73	-53.91	2.71	9.76	H
	7529	-47.96	-13	-34.96	-80.67	-57.36	2.42	11.82	H
	3763	-53.62	-13	-40.62	-73.96	-60.25	1.69	8.32	V
	5639	-50.11	-13	-37.11	-76.96	-57.16	2.71	9.76	V
	7529	-47.22	-13	-34.22	-80.75	-56.62	2.42	11.82	V
Highest	3819	-49.60	-13	-36.60	-69.79	-56.28	1.70	8.38	H
	5730	-44.10	-13	-31.10	-72.06	-51.13	2.76	9.79	H
	7641	-46.34	-13	-33.34	-80.06	-55.84	2.38	11.88	H
	3819	-49.63	-13	-36.63	-70.48	-56.31	1.70	8.38	V
	5730	-45.64	-13	-32.64	-72.27	-52.67	2.76	9.79	V
	7641	-46.01	-13	-33.01	-80.41	-55.51	2.38	11.88	V

Remark: Spurious emissions within 30-1000MHz were found more than 20dB below limit line.



WCDMA Band V (RMC 12.2Kbps)									
Channel	Frequency (MHz)	ERP (dBm)	Limit (dBm)	Over Limit (dB)	SPA Reading (dBm)	S.G. Power (dBm)	TX Cable loss (dB)	TX Antenna Gain (dBi)	Polarization (H/V)
Lowest	1656	-63.90	-13	-50.90	-77.12	-65.63	0.98	4.86	H
	2480	-61.56	-13	-48.56	-77.91	-63.47	1.28	5.34	H
	3304	-59.30	-13	-46.30	-79.02	-62.74	1.54	7.14	H
	1656	-63.75	-13	-50.75	-76.97	-65.48	0.98	4.86	V
	2480	-61.43	-13	-48.43	-77.78	-63.34	1.28	5.34	V
	3304	-59.27	-13	-46.27	-78.99	-62.71	1.54	7.14	V
Middle	1672	-63.71	-13	-50.71	-76.95	-65.39	0.99	4.82	H
	2512	-61.39	-13	-48.39	-77.91	-63.36	1.29	5.41	H
	3344	-59.02	-13	-46.02	-78.83	-62.63	1.56	7.31	H
	1672	-63.83	-13	-50.83	-77.07	-65.51	0.99	4.82	V
	2512	-61.09	-13	-48.09	-77.61	-63.06	1.29	5.41	V
	3344	-59.30	-13	-46.30	-79.11	-62.91	1.56	7.31	V
Highest	1696	-63.75	-13	-50.75	-77.05	-65.35	1.00	4.75	H
	2536	-61.35	-13	-48.35	-77.95	-63.33	1.30	5.43	H
	3384	-59.32	-13	-46.32	-79.23	-63.09	1.57	7.49	H
	1696	-63.30	-13	-50.30	-76.6	-64.9	1.00	4.75	V
	2536	-61.13	-13	-48.13	-77.73	-63.11	1.30	5.43	V
	3384	-59.21	-13	-46.21	-79.12	-62.98	1.57	7.49	V

Remark: Spurious emissions within 30-1000MHz were found more than 20dB below limit line.



WCDMA Band II (RMC 12.2Kbps)									
Channel	Frequency (MHz)	EIRP (dBm)	Limit (dBm)	Over Limit (dB)	SPA Reading (dBm)	S.G. Power (dBm)	TX Cable loss (dB)	TX Antenna Gain (dBi)	Polarization (H/V)
Lowest	3704.8	-57.87	-13	-44.87	-78.38	-64.45	1.67	8.24	H
	5557.2	-53.33	-13	-40.33	-79.96	-60.39	2.66	9.72	H
	7409.6	-47.67	-13	-34.67	-80.9	-56.83	2.46	11.62	H
	3704.8	-58.21	-13	-45.21	-78.72	-64.79	1.67	8.24	V
	5557.2	-53.89	-13	-40.89	-80.52	-60.95	2.66	9.72	V
	7409.6	-47.65	-13	-34.65	-80.88	-56.81	2.46	11.62	V
Middle	3760	-57.62	-13	-44.62	-78.47	-64.25	1.69	8.31	H
	5640	-53.78	-13	-40.78	-80.02	-60.83	2.71	9.76	H
	7520	-47.52	-13	-34.52	-80.73	-56.91	2.42	11.81	H
	3760	-57.86	-13	-44.86	-78.52	-64.49	1.69	8.31	V
	5640	-53.79	-13	-40.79	-80.19	-60.84	2.71	9.76	V
	7520	-47.63	-13	-34.63	-80.7	-57.02	2.42	11.81	V
Highest	3815.2	-57.75	-13	-44.75	-78.42	-64.42	1.70	8.38	H
	5722.8	-53.17	-13	-40.17	-80.32	-60.21	2.75	9.79	H
	7630.4	-46.87	-13	-33.87	-80.47	-56.36	2.39	11.88	H
	3815.2	-58.00	-13	-45.00	-78.67	-64.67	1.70	8.38	V
	5722.8	-53.21	-13	-40.21	-80.36	-60.25	2.75	9.79	V
	7630.4	-46.78	-13	-33.78	-80.38	-56.27	2.39	11.88	V

Remark: Spurious emissions within 30-1000MHz were found more than 20dB below limit line.



WCDMA Band IV (RMC 12.2Kbps)									
Channel	Frequency (MHz)	EIRP (dBm)	Limit (dBm)	Over Limit (dB)	SPA Reading (dBm)	S.G. Power (dBm)	TX Cable loss (dB)	TX Antenna Gain (dBi)	Polarization (H/V)
Lowest	3424.8	-58.68	-13	-45.68	-78.72	-64.77	1.58	7.67	H
	5137.2	-54.18	-13	-41.18	-79.72	-61.46	2.42	9.70	H
	6849.6	-48.93	-13	-35.93	-80.9	-56.91	2.64	10.62	H
	3424.8	-58.95	-13	-45.95	-78.99	-65.04	1.58	7.67	V
	5137.2	-54.33	-13	-41.33	-79.87	-61.61	2.42	9.70	V
	6849.6	-49.01	-13	-36.01	-80.9	-56.99	2.64	10.62	V
Middle	3465.2	-59.03	-13	-46.03	-79.17	-65.28	1.59	7.85	H
	5197.8	-54.51	-13	-41.51	-80.22	-61.76	2.45	9.70	H
	6930.4	-48.35	-13	-35.35	-80.56	-56.45	2.61	10.72	H
	3465.2	-59.07	-13	-46.07	-79.21	-65.32	1.59	7.85	V
	5197.8	-54.62	-13	-41.62	-80.33	-61.87	2.45	9.70	V
	6930.4	-48.63	-13	-35.63	-80.84	-56.73	2.61	10.72	V
Highest	3505.2	-58.36	-13	-45.36	-78.58	-64.76	1.61	8.01	H
	5257.8	-54.57	-13	-41.57	-80.4	-61.78	2.49	9.70	H
	7010.4	-47.97	-13	-34.97	-80.44	-56.2	2.59	10.82	H
	3505.2	-59.39	-13	-46.39	-79.61	-65.79	1.61	8.01	V
	5555	-54.70	-13	-41.70	-80.53	-61.77	2.66	9.72	V
	7010.4	-47.91	-13	-34.91	-80.38	-56.14	2.59	10.82	V

Remark: Spurious emissions within 30-1000MHz were found more than 20dB below limit line.