



SAR EVALUATION REPORT

Applicant Name:
Sony Corporation
1-7-1 Konan Minato-ku
Tokyo, 108-0075, Japan

Date of Testing:
06/27/2022 – 07/28/2022
Test Site/Location:
Element, Columbia, MD, USA
Document Serial No.:
1M2205240063-03.PY7

FCC ID: PY7-76056F

APPLICANT: SONY CORPORATION

DUT Type: Portable Handset
Application Type: Certification
FCC Rule Part(s): CFR §2.1093

Equipment Class	Band & Mode	Tx Frequency	SAR			
			1g Head (W/kg)	1g Body-Worn (W/kg)	1g Hotspot (W/kg)	10g Phablet (W/kg)
PCE	GSM/DTM/GPRS/EDGE 850	824.20 - 848.80 MHz	0.21	0.19	0.22	N/A
PCE	GSM/DTM/GPRS/EDGE 1900	1850.20 - 1909.80 MHz	< 0.1	0.23	0.35	N/A
PCE	UMTS 850	826.40 - 846.60 MHz	0.13	0.22	0.22	N/A
PCE	UMTS 1750	1712.4 - 1752.6 MHz	< 0.1	0.25	0.33	N/A
PCE	UMTS 1900	1852.4 - 1907.6 MHz	< 0.1	0.28	0.38	N/A
PCE	LTE Band 71	665.5 - 695.5 MHz	0.11	0.13	0.13	N/A
PCE	LTE Band 12	699.7 - 715.3 MHz	0.20	0.29	0.35	N/A
PCE	LTE Band 17	706.5 - 713.5 MHz	N/A	N/A	N/A	N/A
PCE	LTE Band 13	779.5 - 784.5 MHz	< 0.1	0.39	0.48	N/A
PCE	LTE Band 5 (Cell)	824.7 - 848.3 MHz	0.20	0.31	0.38	N/A
PCE	LTE Band 66 (AWS)	1710.7 - 1779.3 MHz	0.51	0.22	0.30	0.67
PCE	LTE Band 4 (AWS)	1710.7 - 1754.3 MHz	N/A	N/A	N/A	N/A
PCE	LTE Band 25 (PCS)	1850.7 - 1914.3 MHz	0.16	0.23	0.47	0.70
PCE	LTE Band 2 (PCS)	1850.7 - 1909.3 MHz	0.43	< 0.1	< 0.1	N/A
PCE	LTE Band 41	2498.5 - 2687.5 MHz	< 0.1	0.12	0.21	N/A
CBE	LTE Band 48	3552.5 - 3697.5 MHz	0.14	0.14	0.18	N/A
PCE	NR Band n71	665.5 - 695.5 MHz	0.11	0.26	0.26	N/A
PCE	NR Band n5 (Cell)	826.5 - 846.5 MHz	0.28	0.33	0.41	N/A
PCE	NR Band n66 (AWS)	1712.5 - 1777.5 MHz	0.20	0.29	0.40	1.03
PCE	NR Band n2 (PCS)	1852.5 - 1907.5 MHz	0.18	0.39	0.58	1.29
PCE	NR Band n41	2506.02 - 2679.99 MHz	0.95	0.36	0.53	2.25
PCE	NR Band n77	3710.01 - 3969.99 MHz	0.44	0.46	0.46	1.39
DTS	2.4 GHz WLAN	2412 - 2462 MHz	0.65	0.12	0.18	N/A
NII	U-NII-1	5180 - 5240 MHz	N/A	N/A	< 0.1	N/A
NII	U-NII-2A	5260 - 5320 MHz	0.40	< 0.1	N/A	0.42
NII	U-NII-2C	5500 - 5720 MHz	0.17	< 0.1	N/A	0.52
NII	U-NII-3	5745 - 5825 MHz	0.23	< 0.1	0.11	N/A
DSSDTS	Bluetooth	2402 - 2480 MHz	0.17	< 0.1	< 0.1	N/A
DXX	NFC	13.56 MHz	N/A	N/A	N/A	< 0.1
Simultaneous SAR per KDB 690783 D01v01r03:			1.59	1.21	1.31	3.92

This wireless portable device has been shown to be capable of compliance for localized specific absorption rate (SAR) for uncontrolled environment/general population exposure limits specified in ANSI/IEEE C95.1-1992 and has been tested in accordance with the measurement procedures specified in Section 1.7 of this report; for North American frequency bands only.

I attest to the accuracy of data. All measurements reported herein were performed by me or were made under my supervision and are correct to the best of my knowledge and belief. I assume full responsibility for the completeness of these measurements and vouch for the qualifications of all persons taking them. Test results reported herein relate only to the item(s) tested.

RJ Ortanez
Executive Vice President



The SAR Tick is an initiative of the Mobile & Wireless Forum (MWF). While a product may be considered eligible, use of the SAR Tick logo requires an agreement with the MWF. Further details can be obtained by emailing: sartick@mwfai.info.

FCC ID: PY7-76056F	SAR EVALUATION REPORT	Approved by: Technical Manager
Document S/N: 1M2205240063-03.PY7	DUT Type: Portable Handset	Page 1 of 111

REV 22.0
03/30/2022

T A B L E O F C O N T E N T S

1	DEVICE UNDER TEST	3
2	LTE AND NR INFORMATION	15
3	INTRODUCTION	17
4	DOSIMETRIC ASSESSMENT	18
5	DEFINITION OF REFERENCE POINTS.....	19
6	TEST CONFIGURATION POSITIONS.....	20
7	RF EXPOSURE LIMITS	24
8	FCC MEASUREMENT PROCEDURES.....	25
9	RF CONDUCTED POWERS	31
10	SYSTEM VERIFICATION.....	71
11	SAR DATA SUMMARY	77
12	SAR MEASUREMENT VARIABILITY	106
13	EQUIPMENT LIST.....	107
14	MEASUREMENT UNCERTAINTIES.....	108
15	CONCLUSION.....	109
16	REFERENCES	110
APPENDIX A: SAR TEST PLOTS		
APPENDIX B: SAR DIPOLE VERIFICATION PLOTS		
APPENDIX C: PROBE AND DIPOLE CALIBRATION CERTIFICATES		
APPENDIX D: SAR TISSUE SPECIFICATIONS		
APPENDIX E: DUT ANTENNA DIAGRAM AND SAR TEST SETUP PHOTOGRAPHS		
APPENDIX F: MULTI-TX AND ANTENNA SAR CONSIDERATIONS		
APPENDIX G: POWER REDUCTION VERIFICATION		
APPENDIX H: SAR SYSTEM VALIDATION		
APPENDIX I: LTE AND NR LOWER BANDWIDTH RF CONDUCTED POWERS		
APPENDIX J: DOWNLINK LTE CA RF CONDUCTED POWERS		
APPENDIX K: IEEE 802.11ax RU SAR EXCLUSION		

FCC ID: PY7-76056F	SAR EVALUATION REPORT	Approved by: Technical Manager
Document S/N: 1M2205240063-03.PY7	DUT Type: Portable Handset	Page 2 of 111

REV 22.0
03/30/2022

1 DEVICE UNDER TEST

1.1 Device Overview

Band & Mode	Operating Modes	Tx Frequency
GSM/DTM/GPRS/EDGE 850	Voice/Data	824.20 - 848.80 MHz
GSM/DTM/GPRS/EDGE 1900	Voice/Data	1850.20 - 1909.80 MHz
UMTS 850	Voice/Data	826.40 - 846.60 MHz
UMTS 1750	Voice/Data	1712.4 - 1752.6 MHz
UMTS 1900	Voice/Data	1852.4 - 1907.6 MHz
LTE Band 71	Voice/Data	665.5 - 695.5 MHz
LTE Band 12	Voice/Data	699.7 - 715.3 MHz
LTE Band 17	Voice/Data	706.5 - 713.5 MHz
LTE Band 13	Voice/Data	779.5 - 784.5 MHz
LTE Band 5 (Cell)	Voice/Data	824.7 - 848.3 MHz
LTE Band 66 (AWS)	Voice/Data	1710.7 - 1779.3 MHz
LTE Band 4 (AWS)	Voice/Data	1710.7 - 1754.3 MHz
LTE Band 25 (PCS)	Voice/Data	1850.7 - 1914.3 MHz
LTE Band 2 (PCS)	Voice/Data	1850.7 - 1909.3 MHz
LTE Band 41	Voice/Data	2498.5 - 2687.5 MHz
LTE Band 48	Voice/Data	3552.5 - 3697.5 MHz
NR Band n71	Data	665.5 - 695.5 MHz
NR Band n5 (Cell)	Data	826.5 - 846.5 MHz
NR Band n66 (AWS)	Data	1712.5 - 1777.5 MHz
NR Band n2 (PCS)	Data	1852.5 - 1907.5 MHz
NR Band n41	Data	2506.02 - 2679.99 MHz
NR Band n77	Data	3710.01 - 3969.99 MHz
2.4 GHz WLAN	Data	2412 - 2462 MHz
U-NII-1	Data	5180 - 5240 MHz
U-NII-2A	Data	5260 - 5320 MHz
U-NII-2C	Data	5500 - 5720 MHz
U-NII-3	Data	5745 - 5825 MHz
U-NII-5	Data	5955 - 6415 MHz
U-NII-6	Data	6435 - 6515 MHz
U-NII-7	Data	6535 - 6875 MHz
U-NII-8	Data	6895 - 7115 MHz
Bluetooth	Data	2402 - 2480 MHz
NFC	Data	13.56 MHz

FCC ID: PY7-76056F	SAR EVALUATION REPORT	Approved by: Technical Manager
Document S/N: 1M2205240063-03.PY7	DUT Type: Portable Handset	Page 3 of 111

REV 22.0
03/30/2022

1.2 Time-Averaging Algorithm for RF Exposure Compliance

This Device is enabled with the Qualcomm® Smart Transmit Gen2 feature. This feature performs time averaging algorithm in real time to control and manage transmitting power and ensure the time-averaged RF exposure is in compliance with FCC requirements all the time. Refer to Compliance Summary document for detailed description of Qualcomm® Smart Transmit feature (report SN could be found in Section 1.11 – Bibliography).

Note that WLAN operations are not enabled with Smart Transmit.

The Smart Transmit algorithm maintains the time-averaged transmit power, in turn, time-averaged RF exposure of SAR_{design_target} , below the predefined time-averaged power limit (i.e., P_{limit} for sub-6 radio) for each characterized technology and band (see RF Exposure Part 0 Test Report, report SN can be found in Section 1.11 - Bibliography).

Smart Transmit allows the device to transmit at higher power instantaneously, as high as P_{max} , when needed, but enforces power limiting to maintain time-averaged transmit power to P_{limit} . Below table shows P_{limit} EFS settings and maximum tune up output power P_{max} configured for this EUT for various transmit conditions (Device State Index DSI). Note that the device uncertainty for sub-6GHz WWAN is 1.0dB for this EUT.

Exposure Scenario			Body-Worn, Hotspot	Extremity	Head	Maximum Tune-Up Output Power*
Averaging Volume			1g	10g	1g	
Spacing			10 mm	0 mm	0 mm	
DSI			3	3	2	
Technology/Band	Antenna	Antenna Group	P _{limit}			P _{max}
GSM/DTM/GPRS/EDGE 850	Main 1	AG0	23.3		23.3	23.3
GSM/DTM/GPRS/EDGE 1900	Main 2	AG0	17.8		17.8	17.8
UMTS 850	Main 1	AG0	22.0		22.0	22.0
UMTS 1750	Main 2	AG0	18.0		18.0	18.0
UMTS 1900	Main 2	AG0	19.0		19.0	19.0
LTE Band 71	Main 1	AG0	22.0		24.0	24.0
LTE Band 12/17	Main 1	AG0	21.0		24.0	24.0
LTE Band 12/17	Sub	AG1	23.5		N/A	23.5
LTE Band 13	Main 1	AG0	21.0		24.0	24.0
LTE Band 13	Sub	AG1	23.5		N/A	23.5
LTE Band 5 (Cell)	Main 1	AG0	21.0		24.0	24.0
LTE Band 5 (Cell)	Sub	AG1	23.5		N/A	23.5
LTE Band 66/4 (AWS)	Main 2	AG0	18.0		24.0	24.0
LTE Band 66 (AWS)	Sub	AG1	16.0		16.0	23.0
LTE Band 25/2 (PCS)	Main 2	AG0	19.0		24.0	24.0
LTE Band 2 (PCS)	Sub	AG1	15.0		15.0	23.0
LTE Band 41 PC3	Main 2	AG0	17.0		22.0	22.0
LTE Band 48	Main 1	AG0	17.0		22.0	22.0
NR Band n71	Main 1	AG0	23.0		24.0	24.0
NR Band n5 (Cell)	Main 1	AG0	21.0		24.0	24.0
NR Band n5 (Cell)	Sub	AG1	23.5		N/A	23.5
NR Band n66 (AWS)	Main 2	AG0	18.0		24.0	24.0
NR Band n2 (PCS)	Main 2	AG0	19.0		24.0	24.0
NR Band n41 (PC3)	Main 2	AG0	19.0		27.0	24.0
NR Band n41 (PC2)	Main 2	AG0	19.0		27.0	26.0
NR Band n41 (PC3, UL-MIMO)	Sub	AG1	17.0		17.0	19.5
NR Band n77 (PC3)	Main 1	AG0	17.0		27.0	24.5
NR Band n77 (PC2)	Main 1	AG0	17.0		27.0	26.0
NR Band n77 (PC3, UL-MIMO)	Sub	AG1	15.0		15.0	20.0
NR Band n77 (PC3)	4th path	AG1	16.3		N/A	22.8
NR Band n77 (PC2)	4th path	AG1	16.3		N/A	24.3

*Note all P_{limit} EFS and maximum tune up output power P_{max} levels entered in above Table correspond to average power levels after accounting for duty cycle in the case of TDD modulation schemes (e.g. GSM and LTE TDD).

*Maximum tune up output power P_{max} is used to configure EUT during RF tune up procedure. The maximum allowed output power is equal to maximum Tune up output power + 1dB device design uncertainty.

FCC ID: PY7-76056F	SAR EVALUATION REPORT	Approved by: Technical Manager
Document S/N: 1M2205240063-03.PY7	DUT Type: Portable Handset	Page 4 of 111

The maximum time-averaged output power (dBm) for any 2G/3G/4G/5G Sub6 WWAN technology, band, and DSI = minimum of " P_{limit} EFS" and "Maximum tune up output power P_{max} " + 1dB device uncertainty. SAR values in this report were scaled to this maximum time-averaged output power to determine compliance per KDB Publication 447498 D04v01.

The purpose of this report (Part 1 test) is to demonstrate that the EUT meets FCC SAR limits when transmitting in static transmission scenario at maximum allowable time-averaged power levels.

Measurement Condition: All conducted power and SAR measurements in this report (Part 1 test) were performed by setting *Reserve_power_margin* (Smart Transmit EFS entry) to 0dB.

1.3 Nominal and Maximum Output Power Specifications

This device operates using the following maximum and nominal output power specifications. SAR values were scaled to the maximum allowed power to determine compliance per KDB Publication 447498 D04v01.

1.3.1 2G/3G/4G/5G Output Power

GSM/GPRS/EDGE 850										
Power Level		Voice (in dBm)	Data - Burst Average GMSK (in dBm)				Data - Burst Average 8-PSK (in dBm)			
		1 TX Slot	1 TX Slots	2 TX Slots	3 TX Slots	4 TX Slots	1 TX Slots	2 TX Slots	3 TX Slots	4 TX Slots
All DSI	Max Allowed Power	33.2	33.2	30.2	28.4	27.2	27.7	24.7	22.9	21.7
	Nominal	32.5	32.5	29.5	27.7	26.5	27.0	24.0	22.2	21.0
GSM/GPRS/EDGE 1900										
Power Level		Voice (in dBm)	Data - Burst Average GMSK (in dBm)				Data - Burst Average 8-PSK (in dBm)			
		1 TX Slot	1 TX Slots	2 TX Slots	3 TX Slots	4 TX Slots	1 TX Slots	2 TX Slots	3 TX Slots	4 TX Slots
All DSI	Max Allowed Power	27.7	27.7	24.7	22.9	21.7	26.7	23.7	21.9	20.7
	Nominal	27.0	27.0	24.0	22.2	21.0	26.0	23.0	21.2	20.0
GSM/DTM 850										
Power Level		Voice (in dBm)	DTM - Burst Average (in dBm)				DTM - Burst Average (in dBm)			
		1 TX Slot	2 TX Slots		3 TX Slots		2 TX Slots		3 TX Slots	
		CS GMSK	CS GMSK	PS GMSK	CS GMSK	PS GMSK	CS GMSK	PS 8PSK	CS GMSK	PS 8PSK
All DSI	Max Allowed Power	33.2	30.2	30.2	28.4	28.4	30.2	24.7	28.4	22.9
	Nominal	32.5	29.5	29.5	27.7	27.7	29.5	24.0	27.7	22.2
GSM/DTM 1900										
Power Level		Voice (in dBm)	DTM - Burst Average (in dBm)				DTM - Burst Average (in dBm)			
		1 TX Slot	2 TX Slots		3 TX Slots		2 TX Slots		3 TX Slots	
		CS GMSK	CS GMSK	PS GMSK	CS GMSK	PS GMSK	CS GMSK	PS 8PSK	CS GMSK	PS 8PSK
All DSI	Max Allowed Power	27.7	24.7	24.7	22.9	22.9	24.7	23.7	22.9	21.9
	Nominal	27.0	24.0	24.0	22.2	22.2	24.0	23.0	22.2	21.2

For GSM/DTM, the above powers listed are GSM/DTM burst average values.

UMTS Band 5 (850 MHz)					
Power Level		Modulated Average Output Power (in dBm)			
		3GPP WCDMA Rel 99	3GPP HSDPA Rel 5	3GPP HSUPA Rel 6	3GPP DC-HSDPA Rel 8
All DSI	Max Allowed Power	22.7	22.0	22.0	22.0
	Nominal	22.0	21.0	21.0	21.0
UMTS Band 4 (1750 MHz)					
Power Level		Modulated Average Output Power (in dBm)			
		3GPP WCDMA Rel 99	3GPP HSDPA Rel 5	3GPP HSUPA Rel 6	3GPP DC-HSDPA Rel 8
All DSI	Max Allowed Power	18.7	18.0	18.0	18.0
	Nominal	18.0	17.0	17.0	17.0
UMTS Band 2 (1900 MHz)					
Power Level		Modulated Average Output Power (in dBm)			
		3GPP WCDMA Rel 99	3GPP HSDPA Rel 5	3GPP HSUPA Rel 6	3GPP DC-HSDPA Rel 8
All DSI	Max Allowed Power	19.7	19.0	19.0	19.0
	Nominal	19.0	18.0	18.0	18.0

FCC ID: PY7-76056F	SAR EVALUATION REPORT	Approved by: Technical Manager
Document S/N: 1M2205240063-03.PY7	DUT Type: Portable Handset	Page 5 of 111

Mode / Band	Antenna		Modulated Average Output Power (in dBm)	
			DSI =2 (Head)	DSI =3 (Body Worn, Hotspot, Phablet)
LTE Band 71	Main 1	Max Allowed Power	25.0	23.0
		Nominal	24.0	22.0
LTE Band 12	Main 1	Max Allowed Power	25.0	22.0
		Nominal	24.0	21.0
LTE Band 12	Sub	Max Allowed Power	N/A	24.5
		Nominal	N/A	23.5
LTE Band 17	Main 1	Max Allowed Power	25.0	22.0
		Nominal	24.0	21.0
LTE Band 17	Sub	Max Allowed Power	N/A	24.5
		Nominal	N/A	23.5
LTE Band 13	Main 1	Max Allowed Power	25.0	22.0
		Nominal	24.0	21.0
LTE Band 13	Sub	Max Allowed Power	N/A	24.5
		Nominal	N/A	23.5
LTE Band 5 (Cell)	Main 1	Max Allowed Power	25.0	22.0
		Nominal	24.0	21.0
LTE Band 5 (Cell)	Sub	Max Allowed Power	N/A	24.5
		Nominal	N/A	23.5
LTE Band 66 (AWS)	Main 2	Max Allowed Power	25.0	19.0
		Nominal	24.0	18.0
LTE Band 66 (AWS)	Sub	Max Allowed Power	17.0	17.0
		Nominal	16.0	16.0
LTE Band 4	Main 2	Max Allowed Power	25.0	19.0
		Nominal	24.0	18.0
LTE Band 25 (PCS)	Main 2	Max Allowed Power	25.0	20.0
		Nominal	24.0	19.0
LTE Band 2 (PCS)	Main 2	Max Allowed Power	25.0	20.0
		Nominal	24.0	19.0
LTE Band 2 (PCS)	Sub	Max Allowed Power	16.0	16.0
		Nominal	15.0	15.0
LTE Band 41	Main 2	Max Allowed Power	25.0	20.0
		Nominal	24.0	19.0
LTE Band 48	Main 1	Max Allowed Power	25.0	20.0
		Nominal	24.0	19.0

Mode / Band	Antenna		Modulated Average Output Power (in dBm)	
			DSI =2 (Head)	DSI =3 (Body Worn, Hotspot, Phablet)
NR Band n71	Main 1	Max Allowed Power	25.0	24.0
		Nominal	24.0	23.0
NR Band n5 (Cell)	Main 1	Max Allowed Power	25.0	22.0
		Nominal	24.0	21.0
NR Band n5 (Cell)	Sub	Max Allowed Power	N/A	24.5
		Nominal	N/A	23.5
NR Band n66 (AWS)	Main 2	Max Allowed Power	25.0	19.0
		Nominal	24.0	18.0
NR Band n2 (PCS)	Main 2	Max Allowed Power	25.0	20.0
		Nominal	24.0	19.0
NR Band n41 (PC2)	Main 2	Max Allowed Power	27.0	20.0
		Nominal	26.0	19.0
NR Band n41 (PC3)	Main 2	Max Allowed Power	25.0	20.0
		Nominal	24.0	19.0
NR Band n41 (PC3, UL-MIMO)	Sub	Max Allowed Power	18.0	18.0
		Nominal	17.0	17.0
NR Band n77 (PC2)	Main 1	Max Allowed Power	27.0	18.0
		Nominal	26.0	17.0
NR Band n77 (PC3)	Main 1	Max Allowed Power	25.5	18.0
		Nominal	24.5	17.0
NR Band n77 (PC3, UL-MIMO)	Sub	Max Allowed Power	16.0	16.0
		Nominal	15.0	15.0
NR Band n77 (PC2)	4th path	Max Allowed Power	N/A	17.3
		Nominal	N/A	16.3
NR Band n77 (PC3)	4th path	Max Allowed Power	N/A	17.3
		Nominal	N/A	16.3

For LTE TDD and NR TDD, the above powers listed are TDD burst average values.

FCC ID: PY7-76056F	SAR EVALUATION REPORT	Approved by: Technical Manager
Document S/N: 1M2205240063-03.PY7	DUT Type: Portable Handset	Page 6 of 111

1.3.2 2.4 GHz Maximum SISO/MIMO WLAN Output Power

Note: Targets for 802.11ax RU operations can be found in 802.11ax RU SAR Exclusion Appendix.

Mode	Band	IEEE 802.11 (in dBm)							
		SISO				MIMO			
		Chain 0							
		b	g	n	ax (SU)	b (CDD+STBC)	g (CDD+STBC)	n (CDD+STBC,SDM)	ax (SU) (CDD+STBC,SDM)
Maximum/ Nominal Power		Max	Max	Max	Max	Max	Max	Max	Max
2.4 GHz WIFI	2.45 GHz	14.5	15.0 ch. 1: 14.0 ch. 11: 13.5	15.0 ch. 1: 13.5 ch. 11: 13.0	15.0 ch. 1: 13.5 ch. 11: 13.0	14.5	15.0 ch. 1: 14.0 ch. 11: 13.5	15.0 ch. 1: 13.5 ch. 11: 13.0	15.0 ch. 1: 13.5 ch. 11: 13.0

Mode	Band	IEEE 802.11 (in dBm)							
		SISO				MIMO			
		Chain 1							
		b	g	n	ax (SU)	b (CDD+STBC)	g (CDD+STBC)	n (CDD+STBC,SDM)	ax (SU) (CDD+STBC,SDM)
Maximum/ Nominal Power		Max	Max	Max	Max	Max	Max	Max	Max
2.4 GHz WIFI	2.45 GHz	12.7	15.0 ch. 1: 14.0 ch. 11: 13.5	15.0 ch. 1: 13.5 ch. 11: 13.0	15.0 ch. 1: 13.5 ch. 11: 13.0	12.7	15.0 ch. 1: 14.0 ch. 11: 13.5	15.0 ch. 1: 13.5 ch. 11: 13.0	15.0 ch. 1: 13.5 ch. 11: 13.0

Note: in MIMO operations, each Chain 0 and Chain 1 transmits at maximum allowed powers as indicated above.

1.3.3 2.4 GHz Reduced MIMO WLAN Output Powers

The below table is applicable during Simultaneous Conditions with 2.4 GHz and 5/6 GHz WLAN

Mode	Band	IEEE 802.11 (in dBm)							
		MIMO							
		Chain 0				Chain 1			
		b (CDD+STBC)	g (CDD+STBC)	n (CDD+STBC,SDM)	ax (SU) (CDD+STBC,SDM)	b (CDD+STBC)	g (CDD+STBC)	n (CDD+STBC,SDM)	ax (SU) (CDD+STBC,SDM)
Maximum/ Nominal Power		Max	Max	Max	Max	Max	Max	Max	Max
2.4 GHz WIFI	2.45 GHz	11.0	11.0	11.0	11.0	11.0	11.0	11.0	11.0

Note: in MIMO operations, each Chain 0 and Chain 1 transmits at maximum allowed powers as indicated above.

FCC ID: PY7-76056F	SAR EVALUATION REPORT	Approved by: Technical Manager
Document S/N: 1M2205240063-03.PY7	DUT Type: Portable Handset	Page 7 of 111

1.3.4 5 GHz Maximum SISO/MIMO WLAN Output Power

Mode	Band	IEEE 802.11 (in dBm)							
		SISO				MIMO			
		Chain 0							
		a	n (CDD+STBC, SDM)	ac (CDD+STBC, SDM)	ax (SU) (CDD+STBC, SDM)	a (CDD+STBC)	n (CDD+STBC, SDM)	ac (CDD+STBC, SDM)	ax (SU) (CDD+STBC, SDM)
Maximum/ Nominal Power		Max	Max	Max	Max	Max	Max	Max	Max
5 GHz WIFI (20MHz BW)	UNII-1	11.5	11.5	11.5	11.5	11.5	11.5	11.5	11.5
	UNII-2A	11.5	11.5	11.5	11.5	11.5	11.5	11.5	11.5
	UNII-2C	11.5	11.5	11.5	11.5	11.5	11.5	11.5	11.5
	UNII-3	11.5	11.5 ch. 149: 11.0	11.5 ch. 149: 11.0	11.5 ch. 149: 11.0	11.5	11.5 ch. 149: 11.0	11.5 ch. 149: 11.0	11.5 ch. 149: 11.0
5 GHz WIFI (40MHz BW)	UNII-1		11.5	11.5	11.5		11.5	11.5	11.5
	UNII-2A		11.5	11.5	11.5		11.5	11.5	11.5
	UNII-2C		11.5	11.5	11.5		11.5	11.5	11.5
	UNII-3		11.5 ch. 151: 11.0	11.5 ch. 151: 11.0	11.5 ch. 151: 11.0		11.5 ch. 151: 11.0	11.5 ch. 151: 11.0	11.5 ch. 151: 11.0
5 GHz WIFI (80MHz BW)	UNII-1			11.5	11.5			11.5	11.5
	UNII-2A			11.5	11.5			11.5	11.5
	UNII-2C			11.5	11.5			11.5	11.5
	UNII-3			11.5	11.5			11.5	11.5
5 GHz WIFI (160MHz BW)	UNII-1/2A			11.5	11.5			11.5	11.5
	UNII-2C			11.5	11.5			11.5	11.5
Mode	Band	IEEE 802.11 (in dBm)							
		SISO				MIMO			
		Chain 1							
		a	n (CDD+STBC, SDM)	ac (CDD+STBC, SDM)	ax (SU) (CDD+STBC, SDM)	a (CDD+STBC)	n (CDD+STBC, SDM)	ac (CDD+STBC, SDM)	ax (SU) (CDD+STBC, SDM)
Maximum/ Nominal Power		Max	Max	Max	Max	Max	Max	Max	Max
5 GHz WIFI (20MHz BW)	UNII-1	11.5	11.5	11.5	11.5	11.5	11.5	11.5	11.5
	UNII-2A	11.5	11.5	11.5	11.5	11.5	11.5	11.5	11.5
	UNII-2C	11.5	11.5	11.5	11.5	11.5	11.5	11.5	11.5
	UNII-3	11.5	11.5 ch. 149: 11.0	11.5 ch. 149: 11.0	11.5 ch. 149: 11.0	11.5	11.5 ch. 149: 11.0	11.5 ch. 149: 11.0	11.5 ch. 149: 11.0
5 GHz WIFI (40MHz BW)	UNII-1		11.5	11.5	11.5		11.5	11.5	11.5
	UNII-2A		11.5	11.5	11.5		11.5	11.5	11.5
	UNII-2C		11.5	11.5	11.5		11.5	11.5	11.5
	UNII-3		11.5 ch. 151: 11.0	11.5 ch. 151: 11.0	11.5 ch. 151: 11.0		11.5 ch. 151: 11.0	11.5 ch. 151: 11.0	11.5 ch. 151: 11.0
5 GHz WIFI (80MHz BW)	UNII-1			11.5	11.5			11.5	11.5
	UNII-2A			11.5	11.5			11.5	11.5
	UNII-2C			11.5	11.5			11.5	11.5
	UNII-3			11.5	11.5			11.5	11.5
5 GHz WIFI (160MHz BW)	UNII-1/2A			11.5	11.5			11.5	11.5
	UNII-2C			11.5	11.5			11.5	11.5

Note: in MIMO operations, each Chain 0 and Chain 1 transmits at maximum allowed powers as indicated above.

FCC ID: PY7-76056F	SAR EVALUATION REPORT	Approved by: Technical Manager
Document S/N: 1M2205240063-03.PY7	DUT Type: Portable Handset	Page 8 of 111

1.3.5 5 GHz Reduced MIMO WLAN Output Powers

The below table is applicable during Simultaneous Conditions with 2.4 GHz

Mode	Band	IEEE 802.11 (in dBm)							
		MIMO							
		Chain 0				Chain 1			
		a (CDD+STBC)	n (CDD+STBC, SDM)	ac (CDD+STBC, SDM)	ax (SU) (CDD+STBC, SDM)	a (CDD+STBC)	n (CDD+STBC, SDM)	ac (CDD+STBC, SDM)	ax (SU) (CDD+STBC, SDM)
Maximum/ Nominal Power		Max	Max	Max	Max	Max	Max	Max	Max
5 GHz WiFi (20MHz BW)	UNII-1	9.5	9.5	9.5	9.5	9.5	9.5	9.5	9.5
	UNII-2A	9.5	9.5	9.5	9.5	9.5	9.5	9.5	9.5
	UNII-2C	9.5	9.5	9.5	9.5	9.5	9.5	9.5	9.5
	UNII-3	9.5	9.5	9.5	9.5	9.5	9.5	9.5	9.5
5 GHz WiFi (40MHz BW)	UNII-1		9.5	9.5	9.5		9.5	9.5	9.5
	UNII-2A		9.5	9.5	9.5		9.5	9.5	9.5
	UNII-2C		9.5	9.5	9.5		9.5	9.5	9.5
	UNII-3		9.5	9.5	9.5		9.5	9.5	9.5
5 GHz WiFi (80MHz BW)	UNII-1			9.5	9.5			9.5	9.5
	UNII-2A			9.5	9.5			9.5	9.5
	UNII-2C			9.5	9.5			9.5	9.5
	UNII-3			9.5	9.5			9.5	9.5
5 GHz WiFi (160MHz BW)	UNII-1/2A			9.5	9.5			9.5	9.5
	UNII-2C			9.5	9.5			9.5	9.5

Note: in MIMO operations, each Chain 0 and Chain 1 transmits at maximum allowed powers as indicated above.

1.3.6 2.4 GHz Maximum Bluetooth Output Power

Chain 0 / Chain 1
Bluetooth (in dBm)
14
EDR (in dBm)
13
BLE 1Mbps (in dBm)
10.79
BLE 2Mbps (in dBm)
10.79

1.4 DUT Antenna Locations

The overall dimensions of this device are > 9 x 5 cm. A diagram showing the location of the device antennas can be found in the DUT Antenna Diagram and SAR Test Setup Photographs Appendix. Since the diagonal dimension of this device is > 160 mm and <200 mm, it is considered a “phablet.”

FCC ID: PY7-76056F	SAR EVALUATION REPORT	Approved by: Technical Manager
Document S/N: 1M2205240063-03.PY7	DUT Type: Portable Handset	Page 9 of 111

REV 22.0
03/30/2022

**Table 1-1
Device Edges/Sides for SAR Testing**

Mode	Antenna	Back	Front	Top	Bottom	Right	Left
UMTS 1750	Main 2	Yes	Yes	No	Yes	Yes	No
UMTS 1900	Main 2	Yes	Yes	No	Yes	Yes	No
LTE Band 71	Main 1	Yes	Yes	No	Yes	No	Yes
LTE Band 12	Main 1	Yes	Yes	No	Yes	No	Yes
LTE Band 12	Sub	Yes	Yes	Yes	No	Yes	Yes
LTE Band 13	Main 1	Yes	Yes	No	Yes	No	Yes
LTE Band 13	Sub	Yes	Yes	Yes	No	Yes	Yes
LTE Band 5 (Cell)	Main 1	Yes	Yes	No	Yes	No	Yes
LTE Band 66 (AWS)	Sub	Yes	Yes	Yes	No	Yes	Yes
LTE Band 25 (PCS)	Main 2	Yes	Yes	No	Yes	Yes	No
LTE Band 2	Sub	Yes	Yes	Yes	No	Yes	Yes
LTE Band 41	Main 2	Yes	Yes	No	Yes	Yes	No
LTE Band 48	Main 1	Yes	Yes	No	Yes	No	Yes
NR Band n71	Main 1	Yes	Yes	No	Yes	No	Yes
NR Band n5 (Cell)	Main 1	Yes	Yes	No	Yes	No	Yes
NR Band n5 (Cell)	Sub	Yes	Yes	Yes	No	Yes	Yes
NR Band n66 (AWS)	Main 2	Yes	Yes	No	Yes	Yes	No
NR Band n2 (PCS)	Main 2	Yes	Yes	No	Yes	Yes	No
NR Band n41	Main 2	Yes	Yes	No	Yes	Yes	No
NR Band n41	Sub	Yes	Yes	Yes	No	Yes	Yes
NR Band n77	Main 1	Yes	Yes	No	Yes	No	Yes
NR Band n77	Sub	Yes	Yes	Yes	No	Yes	Yes
NR Band n77	4th	Yes	Yes	Yes	No	No	Yes
2.4 GHz WLAN	WLAN Main +	Yes	Yes	Yes	No	No	Yes
2.4 GHz WLAN	Wifi Sub /BT Div	Yes	Yes	No	Yes	No	Yes
5 GHz WLAN	WLAN Main +	Yes	Yes	Yes	No	No	Yes
5 GHz WLAN	Wifi Sub /BT Div	Yes	Yes	No	Yes	No	Yes
Bluetooth	WLAN Main +	Yes	Yes	Yes	No	No	Yes
Bluetooth	Wifi Sub /BT Div	Yes	Yes	No	Yes	No	Yes
NFC	NFC/Felicia	Yes	Yes	Yes	No	Yes	Yes

Note: Particular DUT edges were not required to be evaluated for wireless router SAR or phablet SAR if the edges were greater than 2.5 cm from the transmitting antenna according to FCC KDB Publication 941225 D06v02r01 Section III and FCC KDB Publication 648474 D04v01r03. The distances between the transmit antennas and the edges of the device are included in the filing. When wireless router mode is enabled, U-NII-2A, U-NII-2C operations are disabled.

1.5 Near Field Communications (NFC) Antenna

This DUT has NFC operations. The NFC antenna is integrated into the device for this model. Therefore, all SAR tests were performed with the device which already incorporates the NFC antenna. A diagram showing the location of the NFC antenna can be found in the DUT Antenna Diagram and SAR Test Setup Photographs Appendix.

FCC ID: PY7-76056F	SAR EVALUATION REPORT	Approved by: Technical Manager
Document S/N: 1M2205240063-03.PY7	DUT Type: Portable Handset	Page 10 of 111

1.6 Simultaneous Transmission Capabilities

According to FCC KDB Publication 447498 D04v01, transmitters are considered to be operating simultaneously when there is overlapping transmission, with the exception of transmissions during network hand-offs with maximum hand-off duration less than 30 seconds.

This device contains multiple transmitters that may operate simultaneously, and therefore requires a simultaneous transmission analysis according to FCC KDB Publication 447498 D04v01 4.3.2 procedures.

**Table 1-2
Simultaneous Transmission Scenarios**

No.	Capable Transmit Configuration	Head	Body-Worn Accessory	Wireless Router	Phablet	Notes
1	GSM voice + 2.4 GHz Bluetooth Ant 1	Yes*	Yes	N/A	Yes	* Bluetooth Tethering is considered
2	GSM voice + 2.4 GHz Bluetooth Ant 2	Yes*	Yes	N/A	Yes	* Bluetooth Tethering is considered
3	GSM voice + 2.4 GHz WLAN Ant 1 + 2.4 GHz WLAN Ant 2	Yes	Yes	N/A	Yes	
4	GSM voice + 5 GHz WLAN Ant 1 + 5 GHz WLAN Ant 2	Yes	Yes	N/A	Yes	
5	GSM voice + 6 GHz WLAN Ant 1 + 6 GHz WLAN Ant 2	Yes	Yes	N/A	Yes	
6	GSM voice + 2.4 GHz WLAN Ant 1 + 2.4 GHz WLAN Ant 2 + 5 GHz WLAN Ant 1 + 5 GHz WLAN Ant 2	Yes	Yes	N/A	Yes	
7	GSM voice + 2.4 GHz WLAN Ant 1 + 2.4 GHz WLAN Ant 2 + 6 GHz WLAN Ant 1 + 6 GHz WLAN Ant 2	Yes	Yes	N/A	Yes	
8	GSM voice + 2.4 GHz Bluetooth Ant 1 + 5 GHz WLAN Ant 1 + 5 GHz WLAN Ant 2	Yes*	Yes	N/A	Yes	* Bluetooth Tethering is considered
9	GSM voice + 2.4 GHz Bluetooth Ant 2 + 5 GHz WLAN Ant 1 + 5 GHz WLAN Ant 2	Yes*	Yes	N/A	Yes	* Bluetooth Tethering is considered
10	GSM voice + 2.4 GHz Bluetooth Ant 1 + 6 GHz WLAN Ant 1 + 6 GHz WLAN Ant 2	Yes*	Yes	N/A	Yes	* Bluetooth Tethering is considered
11	GSM voice + 2.4 GHz Bluetooth Ant 2 + 6 GHz WLAN Ant 1 + 6 GHz WLAN Ant 2	Yes*	Yes	N/A	Yes	* Bluetooth Tethering is considered
12	UMTS + 2.4 GHz Bluetooth Ant 1	Yes*	Yes	Yes*	Yes	* Bluetooth Tethering is considered
13	UMTS + 2.4 GHz Bluetooth Ant 2	Yes*	Yes	Yes*	Yes	* Bluetooth Tethering is considered
14	UMTS + 2.4 GHz WLAN Ant 1 + 2.4 GHz WLAN Ant 2	Yes	Yes	Yes	Yes	
15	UMTS + 5 GHz WLAN Ant 1 + 5 GHz WLAN Ant 2	Yes	Yes	Yes	Yes	
16	UMTS + 6 GHz WLAN Ant 1 + 6 GHz WLAN Ant 2	Yes	Yes	Yes	Yes	
17	UMTS + 2.4 GHz WLAN Ant 1 + 2.4 GHz WLAN Ant 2 + 5 GHz WLAN Ant 1 + 5 GHz WLAN Ant 2	Yes	Yes	Yes	Yes	
18	UMTS + 2.4 GHz WLAN Ant 1 + 2.4 GHz WLAN Ant 2 + 6 GHz WLAN Ant 1 + 6 GHz WLAN Ant 2	Yes	Yes	Yes	Yes	
19	UMTS + 2.4 GHz Bluetooth Ant 1 + 5 GHz WLAN Ant 1 + 5 GHz WLAN Ant 2	Yes*	Yes	Yes*	Yes	* Bluetooth Tethering is considered
20	UMTS + 2.4 GHz Bluetooth Ant 2 + 5 GHz WLAN Ant 1 + 5 GHz WLAN Ant 2	Yes*	Yes	Yes*	Yes	* Bluetooth Tethering is considered
21	UMTS + 2.4 GHz Bluetooth Ant 1 + 6 GHz WLAN Ant 1 + 6 GHz WLAN Ant 2	Yes*	Yes	Yes*	Yes	* Bluetooth Tethering is considered
22	UMTS + 2.4 GHz Bluetooth Ant 2 + 6 GHz WLAN Ant 1 + 6 GHz WLAN Ant 2	Yes*	Yes	Yes*	Yes	* Bluetooth Tethering is considered
23	LTE + 2.4 GHz Bluetooth Ant 1	Yes*	Yes	Yes*	Yes	* Bluetooth Tethering is considered
24	LTE + 2.4 GHz Bluetooth Ant 2	Yes*	Yes	Yes*	Yes	* Bluetooth Tethering is considered
25	LTE + 2.4 GHz WLAN Ant 1 + 2.4 GHz WLAN Ant 2	Yes	Yes	Yes	Yes	
26	LTE + 5 GHz WLAN Ant 1 + 5 GHz WLAN Ant 2	Yes	Yes	Yes	Yes	
27	LTE + 6 GHz WLAN Ant 1 + 6 GHz WLAN Ant 2	Yes	Yes	Yes	Yes	
28	LTE + 2.4 GHz WLAN Ant 1 + 2.4 GHz WLAN Ant 2 + 5 GHz WLAN Ant 1 + 5 GHz WLAN Ant 2	Yes	Yes	Yes	Yes	
29	LTE + 2.4 GHz WLAN Ant 1 + 2.4 GHz WLAN Ant 2 + 6 GHz WLAN Ant 1 + 6 GHz WLAN Ant 2	Yes	Yes	Yes	Yes	
30	LTE + 2.4 GHz Bluetooth Ant 1 + 5 GHz WLAN Ant 1 + 5 GHz WLAN Ant 2	Yes*	Yes	Yes*	Yes	* Bluetooth Tethering is considered
31	LTE + 2.4 GHz Bluetooth Ant 2 + 5 GHz WLAN Ant 1 + 5 GHz WLAN Ant 2	Yes*	Yes	Yes*	Yes	* Bluetooth Tethering is considered
32	LTE + 2.4 GHz Bluetooth Ant 1 + 6 GHz WLAN Ant 1 + 6 GHz WLAN Ant 2	Yes*	Yes	Yes*	Yes	* Bluetooth Tethering is considered
33	LTE + 2.4 GHz Bluetooth Ant 2 + 6 GHz WLAN Ant 1 + 6 GHz WLAN Ant 2	Yes*	Yes	Yes*	Yes	* Bluetooth Tethering is considered
34	LTE + NR	Yes	Yes	N/A	Yes	
35	LTE + NR + 2.4 GHz Bluetooth Ant 1	Yes*	Yes	Yes*	Yes	* Bluetooth Tethering is considered
36	LTE + NR + 2.4 GHz Bluetooth Ant 2	Yes*	Yes	Yes*	Yes	* Bluetooth Tethering is considered
37	LTE + NR + 2.4 GHz WLAN Ant 1 + 2.4 GHz WLAN Ant 2	Yes	Yes	Yes	Yes	
38	LTE + NR + 5 GHz WLAN Ant 1 + 5 GHz WLAN Ant 2	Yes	Yes	Yes	Yes	
39	LTE + NR + 6 GHz WLAN Ant 1 + 6 GHz WLAN Ant 2	Yes	Yes	Yes	Yes	
40	LTE + NR + 2.4 GHz WLAN Ant 1 + 2.4 GHz WLAN Ant 2 + 5 GHz WLAN Ant 1 + 5 GHz WLAN Ant 2	Yes	Yes	Yes	Yes	
41	LTE + NR + 2.4 GHz WLAN Ant 1 + 2.4 GHz WLAN Ant 2 + 6 GHz WLAN Ant 1 + 6 GHz WLAN Ant 2	Yes	Yes	Yes	Yes	
42	LTE + NR + 2.4 GHz Bluetooth Ant 1 + 5 GHz WLAN Ant 1 + 5 GHz WLAN Ant 2	Yes*	Yes	Yes*	Yes	* Bluetooth Tethering is considered
43	LTE + NR + 2.4 GHz Bluetooth Ant 2 + 5 GHz WLAN Ant 1 + 5 GHz WLAN Ant 2	Yes*	Yes	Yes*	Yes	* Bluetooth Tethering is considered
44	LTE + NR + 2.4 GHz Bluetooth Ant 1 + 6 GHz WLAN Ant 1 + 6 GHz WLAN Ant 2	Yes*	Yes	Yes*	Yes	* Bluetooth Tethering is considered
45	LTE + NR + 2.4 GHz Bluetooth Ant 2 + 6 GHz WLAN Ant 1 + 6 GHz WLAN Ant 2	Yes*	Yes	Yes*	Yes	* Bluetooth Tethering is considered
46	NR + 2.4 GHz Bluetooth Ant 1	Yes*	Yes*	Yes*	Yes	* Bluetooth Tethering is considered * Pre-installed VoIP applications are considered
47	NR + 2.4 GHz Bluetooth Ant 2	Yes*	Yes*	Yes*	Yes	* Bluetooth Tethering is considered * Pre-installed VoIP applications are considered
48	NR + 2.4 GHz WLAN Ant 1 + 2.4 GHz WLAN Ant 2	Yes*	Yes*	Yes*	Yes	* Pre-installed VoIP applications are considered
49	NR + 5 GHz WLAN Ant 1 + 5 GHz WLAN Ant 2	Yes*	Yes*	Yes*	Yes	* Pre-installed VoIP applications are considered
50	NR + 6 GHz WLAN Ant 1 + 6 GHz WLAN Ant 2	Yes*	Yes*	Yes*	Yes	* Pre-installed VoIP applications are considered
51	NR + 2.4 GHz WLAN Ant 1 + 2.4 GHz WLAN Ant 2 + 5 GHz WLAN Ant 1 + 5 GHz WLAN Ant 2	Yes*	Yes*	Yes*	Yes	* Pre-installed VoIP applications are considered
52	NR + 2.4 GHz WLAN Ant 1 + 2.4 GHz WLAN Ant 2 + 6 GHz WLAN Ant 1 + 6 GHz WLAN Ant 2	Yes*	Yes*	Yes*	Yes	* Pre-installed VoIP applications are considered
53	NR + 2.4 GHz Bluetooth Ant 1 + 5 GHz WLAN Ant 1 + 5 GHz WLAN Ant 2	Yes*	Yes*	Yes*	Yes	* Bluetooth Tethering is considered * Pre-installed VoIP applications are considered
54	NR + 2.4 GHz Bluetooth Ant 2 + 5 GHz WLAN Ant 1 + 5 GHz WLAN Ant 2	Yes*	Yes*	Yes*	Yes	* Bluetooth Tethering is considered * Pre-installed VoIP applications are considered
55	NR + 2.4 GHz Bluetooth Ant 1 + 6 GHz WLAN Ant 1 + 6 GHz WLAN Ant 2	Yes*	Yes*	Yes*	Yes	* Bluetooth Tethering is considered * Pre-installed VoIP applications are considered
56	NR + 2.4 GHz Bluetooth Ant 2 + 6 GHz WLAN Ant 1 + 6 GHz WLAN Ant 2	Yes*	Yes*	Yes*	Yes	* Bluetooth Tethering is considered * Pre-installed VoIP applications are considered
57	GPRS/DTM/EDGE + 2.4 GHz Bluetooth Ant 1	Yes*	Yes	Yes*	Yes	* Bluetooth Tethering is considered
58	GPRS/DTM/EDGE + 2.4 GHz Bluetooth Ant 2	Yes*	Yes	Yes*	Yes	* Bluetooth Tethering is considered
59	GPRS/DTM/EDGE + 2.4 GHz WLAN Ant 1 + 2.4 GHz WLAN Ant 2	Yes	Yes	Yes	Yes	
60	GPRS/DTM/EDGE + 5 GHz WLAN Ant 1 + 5 GHz WLAN Ant 2	Yes	Yes	Yes	Yes	
61	GPRS/DTM/EDGE + 6 GHz WLAN Ant 1 + 6 GHz WLAN Ant 2	Yes	Yes	Yes	Yes	
62	GPRS/DTM/EDGE + 2.4 GHz WLAN Ant 1 + 2.4 GHz WLAN Ant 2 + 5 GHz WLAN Ant 1 + 5 GHz WLAN Ant 2	Yes	Yes	Yes	Yes	
63	GPRS/DTM/EDGE + 2.4 GHz WLAN Ant 1 + 2.4 GHz WLAN Ant 2 + 6 GHz WLAN Ant 1 + 6 GHz WLAN Ant 2	Yes	Yes	Yes	Yes	
64	GPRS/DTM/EDGE + 2.4 GHz Bluetooth Ant 1 + 5 GHz WLAN Ant 1 + 5 GHz WLAN Ant 2	Yes*	Yes	Yes*	Yes	* Bluetooth Tethering is considered
65	GPRS/DTM/EDGE + 2.4 GHz Bluetooth Ant 2 + 5 GHz WLAN Ant 1 + 5 GHz WLAN Ant 2	Yes*	Yes	Yes*	Yes	* Bluetooth Tethering is considered
66	GPRS/DTM/EDGE + 2.4 GHz Bluetooth Ant 1 + 6 GHz WLAN Ant 1 + 6 GHz WLAN Ant 2	Yes*	Yes	Yes*	Yes	* Bluetooth Tethering is considered
67	GPRS/DTM/EDGE + 2.4 GHz Bluetooth Ant 2 + 6 GHz WLAN Ant 1 + 6 GHz WLAN Ant 2	Yes*	Yes	Yes*	Yes	* Bluetooth Tethering is considered

FCC ID: PY7-76056F	SAR EVALUATION REPORT	Approved by: Technical Manager
Document S/N: 1M2205240063-03.PY7	DUT Type: Portable Handset	Page 11 of 111

1. When the user utilizes multiple services in UMTS 3G mode it uses multi-Radio Access Bearer or multi-RAB. The power control is based on a physical control channel (Dedicated Physical Control Channel [DPCCH]) and power control will be adjusted to meet the needs of both services. Therefore, the UMTS+WLAN scenario also represents the UMTS Voice/DATA + WLAN Hotspot scenario.
2. Per the manufacturer, WIFI Direct is not expected to be used in conjunction with a held-to-ear or body-worn accessory voice call. Therefore, there are no simultaneous transmission scenarios involving WIFI direct beyond that listed in the above table.
3. 5 GHz Wireless Router is only supported for the U-NII-1 and U-NII-3 by S/W, therefore U-NII-2A, and U-NII-2C were not evaluated for wireless router conditions.
4. This device supports 2x2 MIMO Tx for WLAN 802.11a/b/g/n/ac/ax. 802.11a/b/g/n/ac/ax supports CDD and STBC and 802.11n/ac/ax additionally supports SDM.
5. This device supports VoLTE.
6. This device supports Bluetooth Tethering.
7. LTE + 5G NR FR1 Scenarios are limited to EN-DC combinations with anchor bands as shown in the NR FR1 checklist.
8. 5 GHz WLAN and 6 GHz WLAN share the same antenna path and cannot transmit simultaneously.
9. 6 GHz Wireless Router is not supported, therefore it was not evaluated for wireless router conditions.
10. 2.4 GHz WLAN and 2.4 GHz Bluetooth share the same antenna path and cannot transmit simultaneously.
11. NFC was evaluated for phablet based on expected usage conditions

1.7 Miscellaneous SAR Test Considerations

(A) WIFI/BT

Since U-NII-1 and U-NII-2A bands have the same maximum output power and the highest reported SAR for U-NII-2A is less than 1.2 W/kg, SAR is not required for U-NII-1 band according to FCC KDB Publication 248227 D01v02r02.

Since Wireless Router operations are not allowed by the chipset firmware using U-NII-2A and U-NII-2C WIFI, only 2.4 GHz, U-NII-1, Bluetooth and U-NII-3 WIFI Hotspot SAR tests and combinations are considered for SAR with respect to Wireless Router configurations according to FCC KDB 941225 D06v02r01.

This device supports IEEE 802.11ax with the following features:

- a) Up to 160 MHz Bandwidth only for 5/6 GHz
- b) Up to 20 MHz Bandwidth only for 2.4 GHz
- c) 2 Tx antenna output
- d) Up to 4096 QAM is supported
- e) TDWR and Band gap channels are supported for 5 GHz
- f) MU-MIMO UL Operations are not supported

Per FCC KDB Publication 648474 D04v01r03, this device is considered a "phablet" since the diagonal dimension is greater than 160mm and less than 200mm. Phablet SAR tests are required when wireless router mode does not apply or if wireless router 1g SAR > 1.2 W/kg. Because wireless router operations are not supported for U-NII-2A and U-NII-2C WLAN, phablet SAR tests were performed. Phablet SAR was not evaluated for 2.4 GHz, Bluetooth, U-NII-1 and U-NII-3 WLAN operations since wireless router 1g SAR was < 1.2 W/kg.

Per April 2019 TCB Workshop Notes, SAR testing was not required for 802.11ax when applying the initial test configuration procedures of KDB 248227, with 802.11ax considered a higher order 802.11 mode.

This device supports 6 GHz WIFI Operations. RF Exposure assessment for these bands can be found in the WIFI6E RF Exposure Report (report SN can be found in Section 1.11 – Bibliography). Simultaneous transmission analysis is addressed in the Simultaneous Numerical Calculations Appendix of this report.

FCC ID: PY7-76056F	SAR EVALUATION REPORT	Approved by: Technical Manager
Document S/N: 1M2205240063-03.PY7	DUT Type: Portable Handset	Page 12 of 111

REV 22.0
03/30/2022

(B) Licensed Transmitter(s)

This device is only capable of QPSK HSUPA in the uplink. Therefore, no additional SAR tests are required beyond that described for devices with HSUPA in KDB 941225 D01v03r01.

LTE SAR for the higher modulations and lower bandwidths were not tested since the maximum average output power of all required channels and configurations was not more than 0.5 dB higher than the highest bandwidth; and the reported LTE SAR for the highest bandwidth was less than 1.45 W/kg for all configurations according to FCC KDB 941225 D05v02r04.

This device supports LTE Carrier Aggregation (CA) in the downlink. All uplink communications are identical to Release 8 specifications. Per FCC KDB Publication 941225 D05A v01r02, SAR for LTE CA operations was not needed since the maximum average output power in LTE CA mode was not >0.25 dB higher than the maximum output power when downlink carrier aggregation was inactive. The downlink carrier aggregation exclusion analysis can be found in the Downlink LTE CA RF Conducted Powers Appendix.

Per FCC KDB Publication 648474 D04v01r03, this device is considered a "phablet" since the diagonal dimension is greater than 160mm and less than 200mm. Therefore, phablet SAR tests are required when wireless router mode does not apply or if wireless router 1g SAR > 1.2 W/kg.

This device supports downlink 4x4 MIMO operations for some LTE Bands. Per May 2017 TCB Workshop Notes, SAR for 4x4 DL MIMO was not needed since the maximum average output power in 4x4 DL MIMO mode was not more than 0.25 dB higher than the maximum output power with 4x4 DL MIMO inactive. Additionally, SAR for 4x4 MIMO Downlink Carrier Aggregation was not needed since the maximum average output power in 4x4 MIMO Downlink Carrier Aggregation mode was not more than 0.25 dB higher than the maximum output power with 4x4 MIMO Downlink and downlink carrier aggregation inactive.

This device supports LTE capabilities with overlapping transmission frequency ranges. When the supported frequency range of an LTE Band falls completely within an LTE band with a larger transmission frequency range, both LTE bands have the same target power (or the band with the larger transmission frequency range has a higher target power), and both LTE bands share the same transmission path and signal characteristics, SAR was only assessed for the band with the larger transmission frequency range.

NR implementation supports SA and NSA mode. In EN-DC mode, NR operates with the LTE Bands shown in the NR FR1 checklist acting as anchor bands. Per FCC guidance, SAR tests for NR Bands and LTE Anchors Bands were performed separately due to limitations in SAR probe calibration factors.

1.8 Guidance Applied

- IEEE 1528-2013
- FCC KDB Publication 941225 D01v03r01, D05v02r05, D05Av01r02, D06v02r01(2G/3G/4G and Hotspot)
- FCC KDB Publication 248227 D01v02r02 (SAR Considerations for 802.11 Devices)
- FCC KDB Publication 447498 D04v01 (General SAR Guidance)
- FCC KDB Publication 865664 D01v01r04, D02v01r02 (SAR Measurements up to 6 GHz)
- FCC KDB Publication 648474 D04v01r03 (Phablet Procedures)
- October 2013 TCB Workshop Notes (GPRS Testing Considerations)
- November 2017, April 2018, October 2018 TCB Workshop Notes (LTE Carrier Aggregation)

FCC ID: PY7-76056F	SAR EVALUATION REPORT	Approved by: Technical Manager
Document S/N: 1M2205240063-03.PY7	DUT Type: Portable Handset	Page 13 of 111

REV 22.0
03/30/2022

1.9 Device Serial Numbers

Several samples with identical hardware were used to support SAR testing. The manufacturer has confirmed that the device(s) tested have the same physical, mechanical and thermal characteristics and are within operational tolerances expected for production units. The serial numbers used for each test are indicated alongside the results in Section 11.

Report Type	Report Serial Number
RF Exposure Part 2 Test Report	1M2205240063-27.PY7
RF Exposure Compliance Summary Report	1M2205240063-26.PY7
WIFI 6GHz RF exposure	1M2205240063-24.PY7
SAR Part 0 Test Report	Rev05

FCC ID: PY7-76056F	SAR EVALUATION REPORT	Approved by: Technical Manager
Document S/N: 1M2205240063-03.PY7	DUT Type: Portable Handset	Page 14 of 111

REV 22.0
03/30/2022

2 LTE AND NR INFORMATION

LTE Information																																																																																																																																																																																																																																																																																																																																									
Form Factor	Portable Handset																																																																																																																																																																																																																																																																																																																																								
Frequency Range of each LTE transmission band	LTE Band 71 (665.5 - 695.5 MHz)																																																																																																																																																																																																																																																																																																																																								
	LTE Band 12 (699.7 - 715.3 MHz)																																																																																																																																																																																																																																																																																																																																								
	LTE Band 17 (706.5 - 713.5 MHz)																																																																																																																																																																																																																																																																																																																																								
	LTE Band 13 (779.5 - 784.5 MHz)																																																																																																																																																																																																																																																																																																																																								
	LTE Band 5 (Cell) (824.7 - 848.3 MHz)																																																																																																																																																																																																																																																																																																																																								
	LTE Band 66 (AWS) (1710.7 - 1779.3 MHz)																																																																																																																																																																																																																																																																																																																																								
	LTE Band 4 (AWS) (1710.7 - 1754.3 MHz)																																																																																																																																																																																																																																																																																																																																								
	LTE Band 25 (PCS) (1850.7 - 1914.3 MHz)																																																																																																																																																																																																																																																																																																																																								
	LTE Band 2 (PCS) (1850.7 - 1909.3 MHz)																																																																																																																																																																																																																																																																																																																																								
	LTE Band 41 (2498.5 - 2687.5 MHz)																																																																																																																																																																																																																																																																																																																																								
	LTE Band 48 (3552.5 - 3697.5 MHz)																																																																																																																																																																																																																																																																																																																																								
	Channel Bandwidths	LTE Band 71: 5 MHz, 10 MHz, 15 MHz, 20 MHz																																																																																																																																																																																																																																																																																																																																							
		LTE Band 12: 1.4 MHz, 3 MHz, 5 MHz, 10 MHz																																																																																																																																																																																																																																																																																																																																							
		LTE Band 17: 5 MHz, 10 MHz																																																																																																																																																																																																																																																																																																																																							
LTE Band 13: 5 MHz, 10 MHz																																																																																																																																																																																																																																																																																																																																									
LTE Band 5 (Cell): 1.4 MHz, 3 MHz, 5 MHz, 10 MHz																																																																																																																																																																																																																																																																																																																																									
LTE Band 66 (AWS): 1.4 MHz, 3 MHz, 5 MHz, 10 MHz, 15 MHz, 20 MHz																																																																																																																																																																																																																																																																																																																																									
LTE Band 4 (AWS): 1.4 MHz, 3 MHz, 5 MHz, 10 MHz, 15 MHz, 20 MHz																																																																																																																																																																																																																																																																																																																																									
LTE Band 25 (PCS): 1.4 MHz, 3 MHz, 5 MHz, 10 MHz, 15 MHz, 20 MHz																																																																																																																																																																																																																																																																																																																																									
LTE Band 2 (PCS): 1.4 MHz, 3 MHz, 5 MHz, 10 MHz, 15 MHz, 20 MHz																																																																																																																																																																																																																																																																																																																																									
LTE Band 41: 5 MHz, 10 MHz, 15 MHz, 20 MHz																																																																																																																																																																																																																																																																																																																																									
LTE Band 48: 5 MHz, 10 MHz, 15 MHz, 20 MHz																																																																																																																																																																																																																																																																																																																																									
Channel Numbers and Frequencies (MHz)		Low	Low-Mid	Mid	Mid-High	High																																																																																																																																																																																																																																																																																																																																			
		<table border="1"> <tbody> <tr><td>LTE Band 71: 5 MHz</td><td>665.5 (133147)</td><td></td><td>680.5 (133297)</td><td></td><td>695.5 (133447)</td></tr> <tr><td>LTE Band 71: 10 MHz</td><td>668 (133172)</td><td></td><td>680.5 (133297)</td><td></td><td>693 (133422)</td></tr> <tr><td>LTE Band 71: 15 MHz</td><td>670.5 (133197)</td><td></td><td>680.5 (133297)</td><td></td><td>690.5 (133397)</td></tr> <tr><td>LTE Band 71: 20 MHz</td><td>673 (133222)</td><td></td><td>680.5 (133297)</td><td></td><td>688 (133372)</td></tr> <tr><td>LTE Band 12: 1.4 MHz</td><td>699.7 (23017)</td><td></td><td>707.5 (23095)</td><td></td><td>715.3 (23173)</td></tr> <tr><td>LTE Band 12: 3 MHz</td><td>700.5 (23025)</td><td></td><td>707.5 (23095)</td><td></td><td>714.5 (23165)</td></tr> <tr><td>LTE Band 12: 5 MHz</td><td>701.5 (23035)</td><td></td><td>707.5 (23095)</td><td></td><td>713.5 (23155)</td></tr> <tr><td>LTE Band 12: 10 MHz</td><td>704 (23060)</td><td></td><td>707.5 (23095)</td><td></td><td>711 (23130)</td></tr> <tr><td>LTE Band 17: 5 MHz</td><td>706.5 (23755)</td><td></td><td>710 (23790)</td><td></td><td>713.5 (23825)</td></tr> <tr><td>LTE Band 17: 10 MHz</td><td>709 (23780)</td><td></td><td>710 (23790)</td><td></td><td>711 (23800)</td></tr> <tr><td>LTE Band 13: 5 MHz</td><td>779.5 (23205)</td><td></td><td>782 (23230)</td><td></td><td>784.5 (23255)</td></tr> <tr><td>LTE Band 13: 10 MHz</td><td>N/A</td><td></td><td>782 (23230)</td><td></td><td>N/A</td></tr> <tr><td>LTE Band 5 (Cell): 1.4 MHz</td><td>824.7 (20407)</td><td></td><td>836.5 (20525)</td><td></td><td>848.3 (20643)</td></tr> <tr><td>LTE Band 5 (Cell): 3 MHz</td><td>825.5 (20415)</td><td></td><td>836.5 (20525)</td><td></td><td>847.5 (20635)</td></tr> <tr><td>LTE Band 5 (Cell): 5 MHz</td><td>826.5 (20425)</td><td></td><td>836.5 (20525)</td><td></td><td>846.5 (20625)</td></tr> <tr><td>LTE Band 5 (Cell): 10 MHz</td><td>829 (20450)</td><td></td><td>836.5 (20525)</td><td></td><td>844 (20600)</td></tr> <tr><td>LTE Band 66 (AWS): 1.4 MHz</td><td>1710.7 (131979)</td><td></td><td>1745 (132322)</td><td></td><td>1779.3 (132665)</td></tr> <tr><td>LTE Band 66 (AWS): 3 MHz</td><td>1711.5 (131987)</td><td></td><td>1745 (132322)</td><td></td><td>1778.5 (132657)</td></tr> <tr><td>LTE Band 66 (AWS): 5 MHz</td><td>1712.5 (131997)</td><td></td><td>1745 (132322)</td><td></td><td>1777.5 (132647)</td></tr> <tr><td>LTE Band 66 (AWS): 10 MHz</td><td>1715 (132022)</td><td></td><td>1745 (132322)</td><td></td><td>1775 (132622)</td></tr> <tr><td>LTE Band 66 (AWS): 15 MHz</td><td>1717.5 (132047)</td><td></td><td>1745 (132322)</td><td></td><td>1772.5 (132597)</td></tr> <tr><td>LTE Band 66 (AWS): 20 MHz</td><td>1720 (132072)</td><td></td><td>1745 (132322)</td><td></td><td>1770 (132572)</td></tr> <tr><td>LTE Band 4 (AWS): 1.4 MHz</td><td>1710.7 (19957)</td><td></td><td>1732.5 (20175)</td><td></td><td>1754.3 (20393)</td></tr> <tr><td>LTE Band 4 (AWS): 3 MHz</td><td>1711.5 (19965)</td><td></td><td>1732.5 (20175)</td><td></td><td>1753.5 (20385)</td></tr> <tr><td>LTE Band 4 (AWS): 5 MHz</td><td>1712.5 (19975)</td><td></td><td>1732.5 (20175)</td><td></td><td>1752.5 (20375)</td></tr> <tr><td>LTE Band 4 (AWS): 10 MHz</td><td>1715 (20000)</td><td></td><td>1732.5 (20175)</td><td></td><td>1750 (20350)</td></tr> <tr><td>LTE Band 4 (AWS): 15 MHz</td><td>1717.5 (20025)</td><td></td><td>1732.5 (20175)</td><td></td><td>1747.5 (20325)</td></tr> <tr><td>LTE Band 4 (AWS): 20 MHz</td><td>1720 (20050)</td><td></td><td>1732.5 (20175)</td><td></td><td>1745 (20300)</td></tr> <tr><td>LTE Band 25 (PCS): 1.4 MHz</td><td>1850.7 (26047)</td><td></td><td>1882.5 (26365)</td><td></td><td>1914.3 (26683)</td></tr> <tr><td>LTE Band 25 (PCS): 3 MHz</td><td>1851.5 (26055)</td><td></td><td>1882.5 (26365)</td><td></td><td>1913.5 (26675)</td></tr> <tr><td>LTE Band 25 (PCS): 5 MHz</td><td>1852.5 (26065)</td><td></td><td>1882.5 (26365)</td><td></td><td>1912.5 (26665)</td></tr> <tr><td>LTE Band 25 (PCS): 10 MHz</td><td>1855 (26090)</td><td></td><td>1882.5 (26365)</td><td></td><td>1910 (26640)</td></tr> <tr><td>LTE Band 25 (PCS): 15 MHz</td><td>1857.5 (26115)</td><td></td><td>1882.5 (26365)</td><td></td><td>1907.5 (26615)</td></tr> <tr><td>LTE Band 25 (PCS): 20 MHz</td><td>1860 (26140)</td><td></td><td>1882.5 (26365)</td><td></td><td>1905 (26590)</td></tr> <tr><td>LTE Band 2 (PCS): 1.4 MHz</td><td>1850.7 (18607)</td><td></td><td>1880 (18900)</td><td></td><td>1909.3 (19193)</td></tr> <tr><td>LTE Band 2 (PCS): 3 MHz</td><td>1851.5 (18615)</td><td></td><td>1880 (18900)</td><td></td><td>1908.5 (19185)</td></tr> <tr><td>LTE Band 2 (PCS): 5 MHz</td><td>1852.5 (18625)</td><td></td><td>1880 (18900)</td><td></td><td>1907.5 (19175)</td></tr> <tr><td>LTE Band 2 (PCS): 10 MHz</td><td>1855 (18650)</td><td></td><td>1880 (18900)</td><td></td><td>1905 (19150)</td></tr> <tr><td>LTE Band 2 (PCS): 15 MHz</td><td>1857.5 (18675)</td><td></td><td>1880 (18900)</td><td></td><td>1902.5 (19125)</td></tr> <tr><td>LTE Band 2 (PCS): 20 MHz</td><td>1860 (18700)</td><td></td><td>1880 (18900)</td><td></td><td>1900 (19100)</td></tr> <tr><td>LTE Band 41: 5 MHz</td><td>2506 (39750)</td><td>2549.5 (40185)</td><td>2549.5 (40185)</td><td>2593 (40620)</td><td>2636.5 (41055)</td></tr> <tr><td>LTE Band 41: 10 MHz</td><td>2506 (39750)</td><td>2549.5 (40185)</td><td>2549.5 (40185)</td><td>2593 (40620)</td><td>2636.5 (41055)</td></tr> <tr><td>LTE Band 41: 15 MHz</td><td>2506 (39750)</td><td>2549.5 (40185)</td><td>2549.5 (40185)</td><td>2593 (40620)</td><td>2636.5 (41055)</td></tr> <tr><td>LTE Band 41: 20 MHz</td><td>2506 (39750)</td><td>2549.5 (40185)</td><td>2549.5 (40185)</td><td>2593 (40620)</td><td>2636.5 (41055)</td></tr> <tr><td>LTE Band 48: 5 MHz</td><td>3552.5 (55265)</td><td>3600.8 (55748)</td><td>N/A</td><td>3649.2 (56232)</td><td>3697.5 (56715)</td></tr> <tr><td>LTE Band 48: 10 MHz</td><td>3555 (55290)</td><td>3601.7 (55757)</td><td>N/A</td><td>3648.3 (56223)</td><td>3695 (56690)</td></tr> <tr><td>LTE Band 48: 15 MHz</td><td>3557.5 (55315)</td><td>3602.5 (55765)</td><td>N/A</td><td>3647.5 (56215)</td><td>3692.5 (56665)</td></tr> <tr><td>LTE Band 48: 20 MHz</td><td>3560 (55340)</td><td>3603.3 (55773)</td><td>N/A</td><td>3646.7 (56207)</td><td>3690 (56640)</td></tr> <tr><td>UE Category</td><td colspan="5">DL UE Cat 20, UL UE Cat 13</td></tr> <tr><td>Modulations Supported in UL</td><td colspan="5">QPSK, 16QAM, 64QAM</td></tr> <tr><td>LTE MPR Permanently implemented per 3GPP TS 36.101 section 6.2.3-6.2.5? (manufacturer attestation to be provided)</td><td colspan="5">YES</td></tr> <tr><td>A-MPR (Additional MPR) disabled for SAR Testing?</td><td colspan="5">YES</td></tr> <tr><td>LTE Carrier Aggregation Possible Combinations</td><td colspan="5">The technical description includes all the possible carrier aggregation combinations</td></tr> <tr><td>LTE Additional Information</td><td colspan="5">This device does not support full CA features on 3GPP Release 15. It supports carrier aggregation, downlink MIMO, LAA features as shown in Downlink LTE CA RF Conductive Powers Appendix. All uplink communications are identical to the Release 8 Specifications. Uplink communications are done on the PCC. The following LTE Release 15 Features are not supported: Relay, HetNet, Enhanced MIMO, eCIC, eMBMS, Cross-Carrier Scheduling, Enhanced SC-FDMA.</td></tr> </tbody> </table>					LTE Band 71: 5 MHz	665.5 (133147)		680.5 (133297)		695.5 (133447)	LTE Band 71: 10 MHz	668 (133172)		680.5 (133297)		693 (133422)	LTE Band 71: 15 MHz	670.5 (133197)		680.5 (133297)		690.5 (133397)	LTE Band 71: 20 MHz	673 (133222)		680.5 (133297)		688 (133372)	LTE Band 12: 1.4 MHz	699.7 (23017)		707.5 (23095)		715.3 (23173)	LTE Band 12: 3 MHz	700.5 (23025)		707.5 (23095)		714.5 (23165)	LTE Band 12: 5 MHz	701.5 (23035)		707.5 (23095)		713.5 (23155)	LTE Band 12: 10 MHz	704 (23060)		707.5 (23095)		711 (23130)	LTE Band 17: 5 MHz	706.5 (23755)		710 (23790)		713.5 (23825)	LTE Band 17: 10 MHz	709 (23780)		710 (23790)		711 (23800)	LTE Band 13: 5 MHz	779.5 (23205)		782 (23230)		784.5 (23255)	LTE Band 13: 10 MHz	N/A		782 (23230)		N/A	LTE Band 5 (Cell): 1.4 MHz	824.7 (20407)		836.5 (20525)		848.3 (20643)	LTE Band 5 (Cell): 3 MHz	825.5 (20415)		836.5 (20525)		847.5 (20635)	LTE Band 5 (Cell): 5 MHz	826.5 (20425)		836.5 (20525)		846.5 (20625)	LTE Band 5 (Cell): 10 MHz	829 (20450)		836.5 (20525)		844 (20600)	LTE Band 66 (AWS): 1.4 MHz	1710.7 (131979)		1745 (132322)		1779.3 (132665)	LTE Band 66 (AWS): 3 MHz	1711.5 (131987)		1745 (132322)		1778.5 (132657)	LTE Band 66 (AWS): 5 MHz	1712.5 (131997)		1745 (132322)		1777.5 (132647)	LTE Band 66 (AWS): 10 MHz	1715 (132022)		1745 (132322)		1775 (132622)	LTE Band 66 (AWS): 15 MHz	1717.5 (132047)		1745 (132322)		1772.5 (132597)	LTE Band 66 (AWS): 20 MHz	1720 (132072)		1745 (132322)		1770 (132572)	LTE Band 4 (AWS): 1.4 MHz	1710.7 (19957)		1732.5 (20175)		1754.3 (20393)	LTE Band 4 (AWS): 3 MHz	1711.5 (19965)		1732.5 (20175)		1753.5 (20385)	LTE Band 4 (AWS): 5 MHz	1712.5 (19975)		1732.5 (20175)		1752.5 (20375)	LTE Band 4 (AWS): 10 MHz	1715 (20000)		1732.5 (20175)		1750 (20350)	LTE Band 4 (AWS): 15 MHz	1717.5 (20025)		1732.5 (20175)		1747.5 (20325)	LTE Band 4 (AWS): 20 MHz	1720 (20050)		1732.5 (20175)		1745 (20300)	LTE Band 25 (PCS): 1.4 MHz	1850.7 (26047)		1882.5 (26365)		1914.3 (26683)	LTE Band 25 (PCS): 3 MHz	1851.5 (26055)		1882.5 (26365)		1913.5 (26675)	LTE Band 25 (PCS): 5 MHz	1852.5 (26065)		1882.5 (26365)		1912.5 (26665)	LTE Band 25 (PCS): 10 MHz	1855 (26090)		1882.5 (26365)		1910 (26640)	LTE Band 25 (PCS): 15 MHz	1857.5 (26115)		1882.5 (26365)		1907.5 (26615)	LTE Band 25 (PCS): 20 MHz	1860 (26140)		1882.5 (26365)		1905 (26590)	LTE Band 2 (PCS): 1.4 MHz	1850.7 (18607)		1880 (18900)		1909.3 (19193)	LTE Band 2 (PCS): 3 MHz	1851.5 (18615)		1880 (18900)		1908.5 (19185)	LTE Band 2 (PCS): 5 MHz	1852.5 (18625)		1880 (18900)		1907.5 (19175)	LTE Band 2 (PCS): 10 MHz	1855 (18650)		1880 (18900)		1905 (19150)	LTE Band 2 (PCS): 15 MHz	1857.5 (18675)		1880 (18900)		1902.5 (19125)	LTE Band 2 (PCS): 20 MHz	1860 (18700)		1880 (18900)		1900 (19100)	LTE Band 41: 5 MHz	2506 (39750)	2549.5 (40185)	2549.5 (40185)	2593 (40620)	2636.5 (41055)	LTE Band 41: 10 MHz	2506 (39750)	2549.5 (40185)	2549.5 (40185)	2593 (40620)	2636.5 (41055)	LTE Band 41: 15 MHz	2506 (39750)	2549.5 (40185)	2549.5 (40185)	2593 (40620)	2636.5 (41055)	LTE Band 41: 20 MHz	2506 (39750)	2549.5 (40185)	2549.5 (40185)	2593 (40620)	2636.5 (41055)	LTE Band 48: 5 MHz	3552.5 (55265)	3600.8 (55748)	N/A	3649.2 (56232)	3697.5 (56715)	LTE Band 48: 10 MHz	3555 (55290)	3601.7 (55757)	N/A	3648.3 (56223)	3695 (56690)	LTE Band 48: 15 MHz	3557.5 (55315)	3602.5 (55765)	N/A	3647.5 (56215)	3692.5 (56665)	LTE Band 48: 20 MHz	3560 (55340)	3603.3 (55773)	N/A	3646.7 (56207)	3690 (56640)	UE Category	DL UE Cat 20, UL UE Cat 13					Modulations Supported in UL	QPSK, 16QAM, 64QAM					LTE MPR Permanently implemented per 3GPP TS 36.101 section 6.2.3-6.2.5? (manufacturer attestation to be provided)	YES					A-MPR (Additional MPR) disabled for SAR Testing?	YES					LTE Carrier Aggregation Possible Combinations	The technical description includes all the possible carrier aggregation combinations					LTE Additional Information	This device does not support full CA features on 3GPP Release 15. It supports carrier aggregation, downlink MIMO, LAA features as shown in Downlink LTE CA RF Conductive Powers Appendix. All uplink communications are identical to the Release 8 Specifications. Uplink communications are done on the PCC. The following LTE Release 15 Features are not supported: Relay, HetNet, Enhanced MIMO, eCIC, eMBMS, Cross-Carrier Scheduling, Enhanced SC-FDMA.			
LTE Band 71: 5 MHz		665.5 (133147)		680.5 (133297)		695.5 (133447)																																																																																																																																																																																																																																																																																																																																			
LTE Band 71: 10 MHz	668 (133172)		680.5 (133297)		693 (133422)																																																																																																																																																																																																																																																																																																																																				
LTE Band 71: 15 MHz	670.5 (133197)		680.5 (133297)		690.5 (133397)																																																																																																																																																																																																																																																																																																																																				
LTE Band 71: 20 MHz	673 (133222)		680.5 (133297)		688 (133372)																																																																																																																																																																																																																																																																																																																																				
LTE Band 12: 1.4 MHz	699.7 (23017)		707.5 (23095)		715.3 (23173)																																																																																																																																																																																																																																																																																																																																				
LTE Band 12: 3 MHz	700.5 (23025)		707.5 (23095)		714.5 (23165)																																																																																																																																																																																																																																																																																																																																				
LTE Band 12: 5 MHz	701.5 (23035)		707.5 (23095)		713.5 (23155)																																																																																																																																																																																																																																																																																																																																				
LTE Band 12: 10 MHz	704 (23060)		707.5 (23095)		711 (23130)																																																																																																																																																																																																																																																																																																																																				
LTE Band 17: 5 MHz	706.5 (23755)		710 (23790)		713.5 (23825)																																																																																																																																																																																																																																																																																																																																				
LTE Band 17: 10 MHz	709 (23780)		710 (23790)		711 (23800)																																																																																																																																																																																																																																																																																																																																				
LTE Band 13: 5 MHz	779.5 (23205)		782 (23230)		784.5 (23255)																																																																																																																																																																																																																																																																																																																																				
LTE Band 13: 10 MHz	N/A		782 (23230)		N/A																																																																																																																																																																																																																																																																																																																																				
LTE Band 5 (Cell): 1.4 MHz	824.7 (20407)		836.5 (20525)		848.3 (20643)																																																																																																																																																																																																																																																																																																																																				
LTE Band 5 (Cell): 3 MHz	825.5 (20415)		836.5 (20525)		847.5 (20635)																																																																																																																																																																																																																																																																																																																																				
LTE Band 5 (Cell): 5 MHz	826.5 (20425)		836.5 (20525)		846.5 (20625)																																																																																																																																																																																																																																																																																																																																				
LTE Band 5 (Cell): 10 MHz	829 (20450)		836.5 (20525)		844 (20600)																																																																																																																																																																																																																																																																																																																																				
LTE Band 66 (AWS): 1.4 MHz	1710.7 (131979)		1745 (132322)		1779.3 (132665)																																																																																																																																																																																																																																																																																																																																				
LTE Band 66 (AWS): 3 MHz	1711.5 (131987)		1745 (132322)		1778.5 (132657)																																																																																																																																																																																																																																																																																																																																				
LTE Band 66 (AWS): 5 MHz	1712.5 (131997)		1745 (132322)		1777.5 (132647)																																																																																																																																																																																																																																																																																																																																				
LTE Band 66 (AWS): 10 MHz	1715 (132022)		1745 (132322)		1775 (132622)																																																																																																																																																																																																																																																																																																																																				
LTE Band 66 (AWS): 15 MHz	1717.5 (132047)		1745 (132322)		1772.5 (132597)																																																																																																																																																																																																																																																																																																																																				
LTE Band 66 (AWS): 20 MHz	1720 (132072)		1745 (132322)		1770 (132572)																																																																																																																																																																																																																																																																																																																																				
LTE Band 4 (AWS): 1.4 MHz	1710.7 (19957)		1732.5 (20175)		1754.3 (20393)																																																																																																																																																																																																																																																																																																																																				
LTE Band 4 (AWS): 3 MHz	1711.5 (19965)		1732.5 (20175)		1753.5 (20385)																																																																																																																																																																																																																																																																																																																																				
LTE Band 4 (AWS): 5 MHz	1712.5 (19975)		1732.5 (20175)		1752.5 (20375)																																																																																																																																																																																																																																																																																																																																				
LTE Band 4 (AWS): 10 MHz	1715 (20000)		1732.5 (20175)		1750 (20350)																																																																																																																																																																																																																																																																																																																																				
LTE Band 4 (AWS): 15 MHz	1717.5 (20025)		1732.5 (20175)		1747.5 (20325)																																																																																																																																																																																																																																																																																																																																				
LTE Band 4 (AWS): 20 MHz	1720 (20050)		1732.5 (20175)		1745 (20300)																																																																																																																																																																																																																																																																																																																																				
LTE Band 25 (PCS): 1.4 MHz	1850.7 (26047)		1882.5 (26365)		1914.3 (26683)																																																																																																																																																																																																																																																																																																																																				
LTE Band 25 (PCS): 3 MHz	1851.5 (26055)		1882.5 (26365)		1913.5 (26675)																																																																																																																																																																																																																																																																																																																																				
LTE Band 25 (PCS): 5 MHz	1852.5 (26065)		1882.5 (26365)		1912.5 (26665)																																																																																																																																																																																																																																																																																																																																				
LTE Band 25 (PCS): 10 MHz	1855 (26090)		1882.5 (26365)		1910 (26640)																																																																																																																																																																																																																																																																																																																																				
LTE Band 25 (PCS): 15 MHz	1857.5 (26115)		1882.5 (26365)		1907.5 (26615)																																																																																																																																																																																																																																																																																																																																				
LTE Band 25 (PCS): 20 MHz	1860 (26140)		1882.5 (26365)		1905 (26590)																																																																																																																																																																																																																																																																																																																																				
LTE Band 2 (PCS): 1.4 MHz	1850.7 (18607)		1880 (18900)		1909.3 (19193)																																																																																																																																																																																																																																																																																																																																				
LTE Band 2 (PCS): 3 MHz	1851.5 (18615)		1880 (18900)		1908.5 (19185)																																																																																																																																																																																																																																																																																																																																				
LTE Band 2 (PCS): 5 MHz	1852.5 (18625)		1880 (18900)		1907.5 (19175)																																																																																																																																																																																																																																																																																																																																				
LTE Band 2 (PCS): 10 MHz	1855 (18650)		1880 (18900)		1905 (19150)																																																																																																																																																																																																																																																																																																																																				
LTE Band 2 (PCS): 15 MHz	1857.5 (18675)		1880 (18900)		1902.5 (19125)																																																																																																																																																																																																																																																																																																																																				
LTE Band 2 (PCS): 20 MHz	1860 (18700)		1880 (18900)		1900 (19100)																																																																																																																																																																																																																																																																																																																																				
LTE Band 41: 5 MHz	2506 (39750)	2549.5 (40185)	2549.5 (40185)	2593 (40620)	2636.5 (41055)																																																																																																																																																																																																																																																																																																																																				
LTE Band 41: 10 MHz	2506 (39750)	2549.5 (40185)	2549.5 (40185)	2593 (40620)	2636.5 (41055)																																																																																																																																																																																																																																																																																																																																				
LTE Band 41: 15 MHz	2506 (39750)	2549.5 (40185)	2549.5 (40185)	2593 (40620)	2636.5 (41055)																																																																																																																																																																																																																																																																																																																																				
LTE Band 41: 20 MHz	2506 (39750)	2549.5 (40185)	2549.5 (40185)	2593 (40620)	2636.5 (41055)																																																																																																																																																																																																																																																																																																																																				
LTE Band 48: 5 MHz	3552.5 (55265)	3600.8 (55748)	N/A	3649.2 (56232)	3697.5 (56715)																																																																																																																																																																																																																																																																																																																																				
LTE Band 48: 10 MHz	3555 (55290)	3601.7 (55757)	N/A	3648.3 (56223)	3695 (56690)																																																																																																																																																																																																																																																																																																																																				
LTE Band 48: 15 MHz	3557.5 (55315)	3602.5 (55765)	N/A	3647.5 (56215)	3692.5 (56665)																																																																																																																																																																																																																																																																																																																																				
LTE Band 48: 20 MHz	3560 (55340)	3603.3 (55773)	N/A	3646.7 (56207)	3690 (56640)																																																																																																																																																																																																																																																																																																																																				
UE Category	DL UE Cat 20, UL UE Cat 13																																																																																																																																																																																																																																																																																																																																								
Modulations Supported in UL	QPSK, 16QAM, 64QAM																																																																																																																																																																																																																																																																																																																																								
LTE MPR Permanently implemented per 3GPP TS 36.101 section 6.2.3-6.2.5? (manufacturer attestation to be provided)	YES																																																																																																																																																																																																																																																																																																																																								
A-MPR (Additional MPR) disabled for SAR Testing?	YES																																																																																																																																																																																																																																																																																																																																								
LTE Carrier Aggregation Possible Combinations	The technical description includes all the possible carrier aggregation combinations																																																																																																																																																																																																																																																																																																																																								
LTE Additional Information	This device does not support full CA features on 3GPP Release 15. It supports carrier aggregation, downlink MIMO, LAA features as shown in Downlink LTE CA RF Conductive Powers Appendix. All uplink communications are identical to the Release 8 Specifications. Uplink communications are done on the PCC. The following LTE Release 15 Features are not supported: Relay, HetNet, Enhanced MIMO, eCIC, eMBMS, Cross-Carrier Scheduling, Enhanced SC-FDMA.																																																																																																																																																																																																																																																																																																																																								

FCC ID: PY7-76056F	SAR EVALUATION REPORT	Approved by: Technical Manager
Document S/N: 1M2205240063-03.PY7	DUT Type: Portable Handset	Page 15 of 111

NR Information						
Form Factor	Portable Handset					
Frequency Range of each NR transmission band	NR Band n71 (665.5 - 695.5 MHz)					
	NR Band n5 (Cell) (826.5 - 846.5 MHz)					
	NR Band n66 (AWS) (1712.5 - 1777.5 MHz)					
	NR Band n2 (PCS) (1852.5 - 1907.5 MHz)					
	NR Band n41 (2506.02 - 2679.99 MHz)					
	NR Band n77 (3710.01 - 3969.99 MHz)					
Channel Bandwidths	NR Band n71: 5 MHz, 10 MHz, 15 MHz, 20 MHz					
	NR Band n5 (Cell): 5 MHz, 10 MHz, 15 MHz, 20 MHz					
	NR Band n66 (AWS): 5 MHz, 10 MHz, 15 MHz, 20 MHz					
	NR Band n2 (PCS): 5 MHz, 10 MHz, 15 MHz, 20 MHz					
	NR Band n41: 20 MHz, 30 MHz, 40 MHz, 50 MHz, 60 MHz, 80 MHz, 90 MHz, 100 MHz					
	NR Band n77: 20 MHz, 30 MHz, 40 MHz, 60 MHz, 80 MHz, 100 MHz					
Channel Numbers and Frequencies (MHz)						
NR Band n71: 5 MHz	665.5 (133147)		680.5 (136100)		695.5 (133447)	
NR Band n71: 10 MHz	668 (133600)		680.5 (136100)		693 (138600)	
NR Band n71: 15 MHz	670.5 (134100)		680.5 (136100)		690.5 (138100)	
NR Band n71: 20 MHz	673 (134600)		680.5 (136100)		688 (137600)	
NR Band n5 (Cell): 5 MHz	826.5 (165300)		836.5 (167300)		846.5 (169300)	
NR Band n5 (Cell): 10 MHz	829 (165800)		836.5 (167300)		844 (168800)	
NR Band n5 (Cell): 15 MHz	831.5 (166300)		836.5 (167300)		841.5 (168300)	
NR Band n5 (Cell): 20 MHz	834 (166800)		836.5 (167300)		839 (167800)	
NR Band n66 (AWS): 5 MHz	1712.5 (342500)		1745 (349000)		1777.5 (355500)	
NR Band n66 (AWS): 10 MHz	1715 (343000)		1745 (349000)		1775 (355000)	
NR Band n66 (AWS): 15 MHz	1717.5 (343500)		1745 (349000)		1772.5 (354500)	
NR Band n66 (AWS): 20 MHz	1720 (344000)		1745 (349000)		1770 (354000)	
NR Band n2 (PCS): 5 MHz	1852.5 (370500)		1880 (376000)		1907.5 (381500)	
NR Band n2 (PCS): 10 MHz	1855 (371000)		1880 (376000)		1905 (381000)	
NR Band n2 (PCS): 15 MHz	1857.5 (371500)		1880 (376000)		1902.5 (380500)	
NR Band n2 (PCS): 20 MHz	1860 (372000)		1880 (376000)		1900 (380000)	
NR Band n41: 20 MHz	2506.02 (501204)	2549.49 (509898)	2592.99 (518598)		2636.49 (527298)	2679.99 (535998)
NR Band n41: 30 MHz	2511 (502200)	2552.01 (510402)	2592.99 (518598)		2634 (526800)	2674.98 (534996)
NR Band n41: 40 MHz	2516.01 (503202)	2567.34 (513468)	N/A		2618.67 (523734)	2670 (534000)
NR Band n41: 50 MHz	2521.02 (504204)		2592.99 (518598)		2664.99 (532998)	
NR Band n41: 60 MHz	2526 (505200)		2592.99 (518598)		2659.98 (531996)	
NR Band n41: 80 MHz	2536.02 (507204)		N/A		2649.99 (529998)	
NR Band n41: 90 MHz	2541 (508200)		N/A		2644.98 (528996)	
NR Band n41: 100 MHz	2546.01 (509202)		2592.99 (518598)		2640 (528000)	
NR Band n77: 20 MHz	3710.01 (647334)	3762 (650800)	3813.99 (654266)	3866.01 (657734)	3918 (661200)	3969.99 (664666)
NR Band n77: 30 MHz	3715.02 (647668)	3765 (651000)	3815.01 (654334)	3864.99 (657666)	3915 (661000)	3964.98 (664332)
NR Band n77: 40 MHz	3720 (648000)	3768 (651200)	3816 (654400)	3864 (657600)	3912 (660800)	3960 (664000)
NR Band n77: 60 MHz	3730.02 (648668)	3803.34 (653556)	N/A	N/A	3876.66 (658444)	3949.98 (663332)
NR Band n77: 80 MHz	3740.01 (649334)	N/A	3840 (656000)		N/A	3939.99 (662666)
NR Band n77: 100 MHz	3750 (650000)	N/A	N/A	N/A	N/A	3930 (662000)
SCS for NR Band n71/n5/n66/n2	15 kHz					
SCS for NR Band n41/n77	30 kHz					
Modulations Supported in UL	DFT-s-OFDM: 11/2 BPSK, QPSK, 16QAM, 64QAM, 256QAM CP-OFDM: QPSK, 16QAM, 64QAM, 256QAM					
A-MPR (Additional MPR) disabled for SAR Testing?	YES					
EN-DC Carrier Aggregation Possible Combinations	The technical description includes all the possible carrier aggregation combinations					
LTE Anchor Bands for NR Band n71	LTE Band 66/2					
LTE Anchor Bands for NR Band n5 (Cell)	LTE Band 66/2					
LTE Anchor Bands for NR Band n66 (AWS)	LTE Band 12/13/2/5					
LTE Anchor Bands for NR Band n2 (PCS)	LTE Band 12/13/66/5					
LTE Anchor Bands for NR Band n41	LTE Band 12/2					
LTE Anchor Bands for NR Band n77	LTE Band 12/13/66/5/2					

FCC ID: PY7-76056F	SAR EVALUATION REPORT	Approved by: Technical Manager
Document S/N: 1M2205240063-03.PY7	DUT Type: Portable Handset	Page 16 of 111

3 INTRODUCTION

The FCC and Innovation, Science, and Economic Development Canada have adopted the guidelines for evaluating the environmental effects of radio frequency (RF) radiation in ET Docket 93-62 on Aug. 6, 1996 and Health Canada Safety Code 6 to protect the public and workers from the potential hazards of RF emissions due to FCC-regulated portable devices. [1]

The safety limits used for the environmental evaluation measurements are based on the criteria published by the American National Standards Institute (ANSI) for localized specific absorption rate (SAR) in IEEE/ANSI C95.1-1992 Standard for Safety Levels with Respect to Human Exposure to Radio Frequency Electromagnetic Fields, 3 kHz to 300 GHz [3] and Health Canada RF Exposure Guidelines Safety Code 6 [22]. The measurement procedure described in IEEE/ANSI C95.3-2002 Recommended Practice for the Measurement of Potentially Hazardous Electromagnetic Fields - RF and Microwave [4] is used for guidance in measuring the Specific Absorption Rate (SAR) due to the RF radiation exposure from the Equipment Under Test (EUT). These criteria for SAR evaluation are similar to those recommended by the International Committee for Non-Ionizing Radiation Protection (ICNIRP) in Biological Effects and Exposure Criteria for Radiofrequency Electromagnetic Fields,” Report No. Vol 74. SAR is a measure of the rate of energy absorption due to exposure to an RF transmitting source. SAR values have been related to threshold levels for potential biological hazards.

3.1 SAR Definition

Specific Absorption Rate is defined as the time derivative (rate) of the incremental energy (dU) absorbed by (dissipated in) an incremental mass (dm) contained in a volume element (dV) of a given density (ρ). It is also defined as the rate of RF energy absorption per unit mass at a point in an absorbing body (see Equation 3-1).

Equation 3-1
SAR Mathematical Equation

$$SAR = \frac{d}{dt} \left(\frac{dU}{dm} \right) = \frac{d}{dt} \left(\frac{dU}{\rho dv} \right)$$

SAR is expressed in units of Watts per Kilogram (W/kg).

$$SAR = \frac{\sigma \cdot E^2}{\rho}$$

where:

- σ = conductivity of the tissue-simulating material (S/m)
- ρ = mass density of the tissue-simulating material (kg/m³)
- E = Total RMS electric field strength (V/m)

NOTE: The primary factors that control rate of energy absorption were found to be the wavelength of the incident field in relation to the dimensions and geometry of the irradiated organism, the orientation of the organism in relation to the polarity of field vectors, the presence of reflecting surfaces, and whether conductive contact is made by the organism with a ground plane.[6]

FCC ID: PY7-76056F	SAR EVALUATION REPORT	Approved by: Technical Manager
Document S/N: 1M2205240063-03.PY7	DUT Type: Portable Handset	Page 17 of 111

4 DOSIMETRIC ASSESSMENT

4.1 Measurement Procedure

The evaluation was performed using the following procedure compliant to FCC KDB Publication 865664 D01v01r04 and IEEE 1528-2013:

1. The SAR distribution at the exposed side of the head or body was measured at a distance no greater than 5.0 mm from the inner surface of the shell. The area covered the entire dimension of the device-head and body interface and the horizontal grid resolution was determined per FCC KDB Publication 865664 D01v01r04 (See Table 4-1) and IEEE 1528-2013.
2. The point SAR measurement was taken at the maximum SAR region determined from Step 1 to enable the monitoring of SAR fluctuations/drifts during the 1g/10g cube evaluation. SAR at this fixed point was measured and used as a reference value.
3. Based on the area scan data, the peak of the region with maximum SAR was determined by spline interpolation. Around this point, a volume was assessed according to the measurement resolution and volume size requirements of FCC KDB Publication 865664 D01v01r04 (See Table 4-1) and IEEE 1528-2013. On the basis of this data set, the spatial peak SAR value was evaluated with the following procedure (see references or the DASY manual online for more details):
 - a. SAR values at the inner surface of the phantom are extrapolated from the measured values along the line away from the surface with spacing no greater than that in Table 4-1. The extrapolation was based on a least-squares algorithm. A polynomial of the fourth order was calculated through the points in the z-axis (normal to the phantom shell).
 - b. After the maximum interpolated values were calculated between the points in the cube, the SAR was averaged over the spatial volume (1g or 10g) using a 3D-Spline interpolation algorithm. The 3D-spline is composed of three one-dimensional splines with the “Not a knot” condition (in x, y, and z directions). The volume was then integrated with the trapezoidal algorithm. One thousand points (10 x 10 x 10) were obtained through interpolation, in order to calculate the averaged SAR.
 - c. All neighboring volumes were evaluated until no neighboring volume with a higher average value was found.
4. The SAR reference value, at the same location as step 2, was re-measured after the zoom scan was complete to calculate the SAR drift. If the drift deviated by more than 5%, the SAR test and drift measurements were repeated.

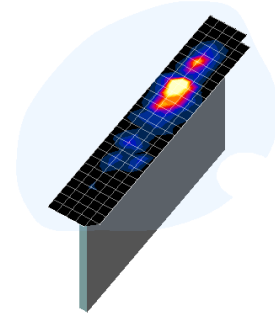

Figure 4-1
Sample SAR Area Scan

Table 4-1
Area and Zoom Scan Resolutions per FCC KDB Publication 865664 D01v01r04*

Frequency	Maximum Area Scan Resolution (mm) ($\Delta x_{\text{area}}, \Delta y_{\text{area}}$)	Maximum Zoom Scan Resolution (mm) ($\Delta x_{\text{zoom}}, \Delta y_{\text{zoom}}$)	Maximum Zoom Scan Spatial Resolution (mm)			Minimum Zoom Scan Volume (mm) (x,y,z)
			Uniform Grid	Graded Grid		
			$\Delta z_{\text{zoom}}(n)$	$\Delta z_{\text{zoom}}(1)^*$	$\Delta z_{\text{zoom}}(n>1)^*$	
≤ 2 GHz	≤ 15	≤ 8	≤ 5	≤ 4	≤ 1.5* $\Delta z_{\text{zoom}}(n-1)$	≥ 30
2-3 GHz	≤ 12	≤ 5	≤ 5	≤ 4	≤ 1.5* $\Delta z_{\text{zoom}}(n-1)$	≥ 30
3-4 GHz	≤ 12	≤ 5	≤ 4	≤ 3	≤ 1.5* $\Delta z_{\text{zoom}}(n-1)$	≥ 28
4-5 GHz	≤ 10	≤ 4	≤ 3	≤ 2.5	≤ 1.5* $\Delta z_{\text{zoom}}(n-1)$	≥ 25
5-6 GHz	≤ 10	≤ 4	≤ 2	≤ 2	≤ 1.5* $\Delta z_{\text{zoom}}(n-1)$	≥ 22

*Also compliant to IEEE 1528-2013 Table 6

FCC ID: PY7-76056F	SAR EVALUATION REPORT	Approved by: Technical Manager
Document S/N: 1M2205240063-03.PY7	DUT Type: Portable Handset	Page 18 of 111

REV 22.0
03/30/2022

5 DEFINITION OF REFERENCE POINTS

5.1 EAR REFERENCE POINT

Figure 5-2 shows the front, back and side views of the SAM Twin Phantom. The point “M” is the reference point for the center of the mouth, “LE” is the left ear reference point (ERP), and “RE” is the right ERP. The ERP is 15mm posterior to the entrance to the ear canal (EEC) along the B-M line (Back-Mouth), as shown in Figure 5-1. The plane passing through the two ear canals and M is defined as the Reference Plane. The line N-F (Neck-Front), also called the Reference Pivoting Line, is not perpendicular to the reference plane (see Figure 5-1). Line B-M is perpendicular to the N-F line. Both N-F and B-M lines are marked on the external phantom shell to facilitate handset positioning [5].

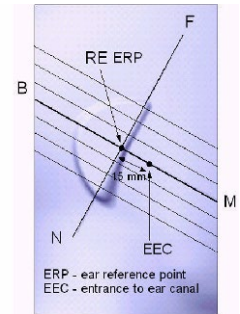

Figure 5-1
Close-Up Side view of ERP

5.2 HANDSET REFERENCE POINTS

Two imaginary lines on the handset were established: the vertical centerline and the horizontal line. The test device was placed in a normal operating position with the acoustic output located along the “vertical centerline” on the front of the device aligned to the “ear reference point” (See Figure 5-3). The acoustic output was then located at the same level as the center of the ear reference point. The test device was positioned so that the “vertical centerline” was bisecting the front surface of the handset at its top and bottom edges, positioning the “ear reference point” on the outer surface of the both the left and right head phantoms on the ear reference point.

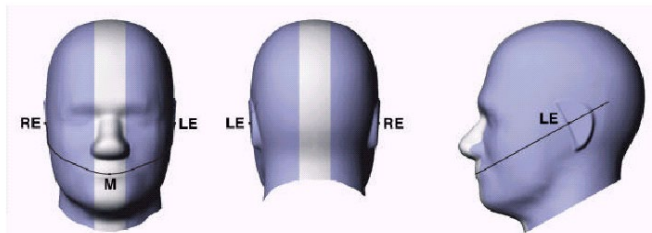

Figure 5-2
Front, back and side view of SAM Twin Phantom

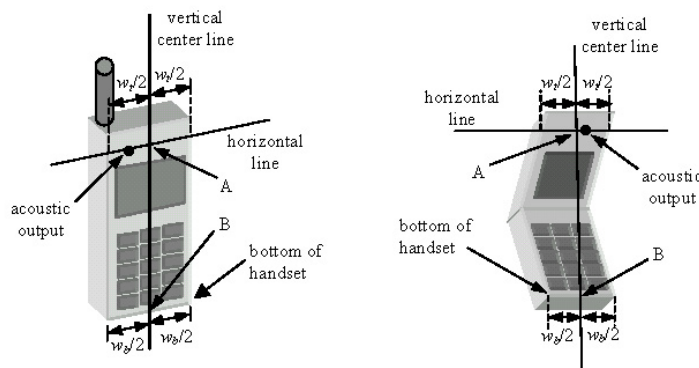

Figure 5-3
Handset Vertical Center & Horizontal Line Reference Points

FCC ID: PY7-76056F	SAR EVALUATION REPORT	Approved by: Technical Manager
Document S/N: 1M2205240063-03.PY7	DUT Type: Portable Handset	Page 19 of 111

REV 22.0
03/30/2022

6 TEST CONFIGURATION POSITIONS

6.1 Device Holder

The device holder is made out of low-loss POM material having the following dielectric parameters: relative permittivity $\epsilon = 3$ and loss tangent $\delta = 0.02$.

6.2 Positioning for Cheek

1. The test device was positioned with the device close to the surface of the phantom such that point A is on the (virtual) extension of the line passing through points RE and LE on the phantom (see Figure 6-1), such that the plane defined by the vertical center line and the horizontal line of the phone is approximately parallel to the sagittal plane of the phantom.

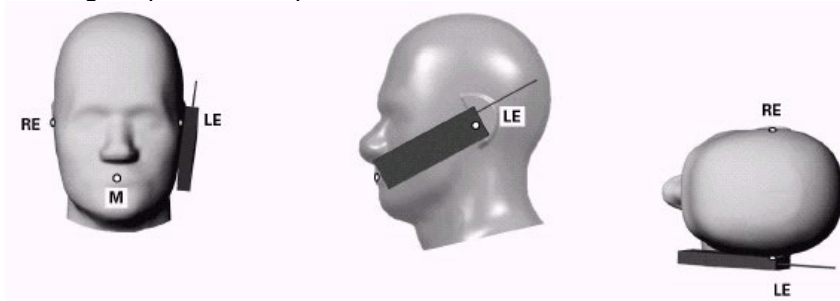

Figure 6-1 Front, Side and Top View of Cheek Position

2. The handset was translated towards the phantom along the line passing through RE & LE until the handset touches the pinna.
3. While maintaining the handset in this plane, the handset was rotated around the LE-RE line until the vertical centerline was in the reference plane.
4. The phone was then rotated around the vertical centerline until the phone (horizontal line) was symmetrical with respect to the line NF.
5. While maintaining the vertical centerline in the reference plane, keeping point A on the line passing through RE and LE, and maintaining the device contact with the ear, the device was rotated about the NF line until any point on the handset made contact with a phantom point below the ear (cheek) (See Figure 6-2).

6.3 Positioning for Ear / 15° Tilt

With the test device aligned in the “Cheek Position”:

1. While maintaining the orientation of the phone, the phone was retracted parallel to the reference plane far enough to enable a rotation of the phone by 15 degrees.
2. The phone was then rotated around the horizontal line by 15 degrees.
3. While maintaining the orientation of the phone, the phone was moved parallel to the reference plane until any part of the handset touched the head. (In this position, point A was located on the line RE-LE). The tilted position is obtained when the contact is on the pinna. If the contact was at any location other than the pinna, the angle of the phone would then be reduced. In this situation, the tilted position was obtained when any part of the phone was in contact of the ear as well as a second part of the phone was in contact with the head (see Figure 6-2).

FCC ID: PY7-76056F	SAR EVALUATION REPORT	Approved by: Technical Manager
Document S/N: 1M2205240063-03.PY7	DUT Type: Portable Handset	Page 20 of 111

REV 22.0
03/30/2022

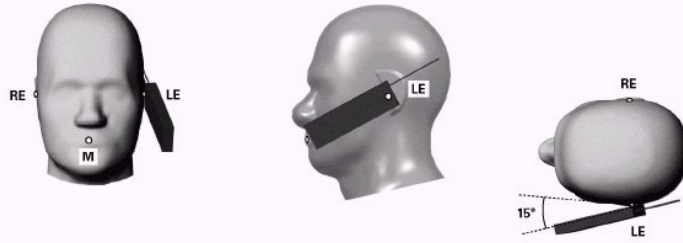

Figure 6-2 Front, Side and Top View of Ear/15° Tilt Position

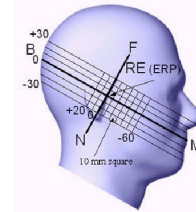

Figure 6-3 Side view w/ relevant markings

6.4 SAR Evaluations near the Mouth/Jaw Regions of the SAM Phantom

Antennas located near the bottom of a phone may require SAR measurements around the mouth and jaw regions of the SAM head phantom. This typically applies to clam-shell style phones that are generally longer in the unfolded normal use positions or to certain older style long rectangular phones. Per IEEE 1528-2013, a rotated SAM phantom is necessary to allow probe access to such regions. Both SAM heads of the TwinSAM-Chin20 are rotated 20 degrees around the NF line. Each head can be removed from the table for emptying and cleaning.

Under these circumstances, the following procedures apply, adopted from the FCC guidance on SAR handsets document FCC KDB Publication 648474 D04v01r03. The SAR required in these regions of SAM should be measured using a flat phantom. The phone should be positioned with a separation distance of 4 mm between the ear reference point (ERP) and the outer surface of the flat phantom shell. While maintaining this distance at the ERP location, the low (bottom) edge of the phone should be lowered from the phantom to establish the same separation distance between the peak SAR location identified by the truncated partial SAR distribution measured with the SAM phantom. The distance from the peak SAR location to the phone is determined by the straight line passing perpendicularly through the phantom surface. When it is not feasible to maintain 4 mm separation at the ERP while also establishing the required separation at the peak SAR location, the top edge of the phone will be allowed to touch the phantom with a separation < 4 mm at the ERP. The phone should not be tilted to the left or right while placed in this inclined position to the flat phantom.

6.5 Body-Worn Accessory Configurations

Body-worn operating configurations are tested with the belt-clips and holsters attached to the device and positioned against a flat phantom in a normal use configuration (see Figure 6-4). Per FCC KDB Publication 648474 D04v01r03, Body-worn accessory exposure is typically related to voice mode operations when handsets are carried in body-worn accessories. The body-worn accessory procedures in FCC KDB Publication 447498 D04v01 should be used to test for body-worn accessory SAR compliance, without a headset connected to it. This enables the test results for such configuration to be compatible with that required for hotspot mode when the body-worn accessory test separation distance is greater than or equal to that required for hotspot mode, when applicable. When the reported SAR for a body-worn accessory, measured without a headset connected to the handset, is > 1.2 W/kg, the highest reported SAR configuration for that wireless mode and frequency band should be repeated for that body-worn accessory with a headset attached to the handset.

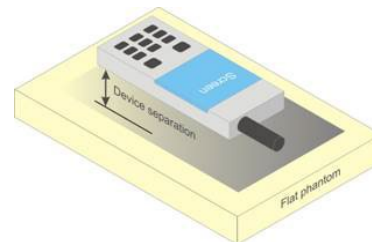

Figure 6-4 Sample Body-Worn Diagram

Accessories for Body-worn operation configurations are divided into two categories: those that do not contain metallic components and those that do contain metallic components. When multiple accessories that do not contain metallic components are supplied with the device, the device is tested with only the accessory that

FCC ID: PY7-76056F	SAR EVALUATION REPORT	Approved by: Technical Manager
Document S/N: 1M2205240063-03.PY7	DUT Type: Portable Handset	Page 21 of 111

REV 22.0
03/30/2022

dictates the closest spacing to the body. Then multiple accessories that contain metallic components are tested with the device with each accessory. If multiple accessories share an identical metallic component (i.e. the same metallic belt-clip used with different holsters with no other metallic components) only the accessory that dictates the closest spacing to the body is tested.

Body-worn accessories may not always be supplied or available as options for some devices intended to be authorized for body-worn use. In this case, a test configuration with a separation distance between the back of the device and the flat phantom is used. Test position spacing was documented. Transmitters that are designed to operate in front of a person’s face, as in push-to-talk configurations, are tested for SAR compliance with the front of the device positioned to face the flat phantom in head fluid. For devices that are carried next to the body such as a shoulder, waist or chest-worn transmitters, SAR compliance is tested with the accessories, including headsets and microphones, attached to the device and positioned against a flat phantom in a normal use configuration.

6.6 Extremity Exposure Configurations

Devices that are designed or intended for use on extremities or mainly operated in extremity only exposure conditions; i.e., hands, wrists, feet and ankles, may require extremity SAR evaluation. When the device also operates in close proximity to the user’s body, SAR compliance for the body is also required. The 1g body and 10g extremity SAR Exclusion Thresholds found in KDB Publication 447498 D04v01 should be applied to determine SAR test requirements.

Per KDB Publication 447498 D04v01, Cell phones (handsets) are not normally designed to be used on extremities or operated in extremity only exposure conditions. The maximum output power levels of handsets generally do not require extremity SAR testing to show compliance. Therefore, extremity SAR was not evaluated for this device.

6.7 Wireless Router Configurations

Some battery-operated handsets have the capability to transmit and receive user data through simultaneous transmission of WIFI simultaneously with a separate licensed transmitter. The FCC has provided guidance in FCC KDB Publication 941225 D06v02r01 where SAR test considerations for handsets (L x W ≥ 9 cm x 5 cm) are based on a composite test separation distance of 10 mm from the front, back and edges of the device containing transmitting antennas within 2.5 cm of their edges, determined from general mixed use conditions for this type of devices. Since the hotspot SAR results may overlap with the body-worn accessory SAR requirements, the more conservative configurations can be considered, thus excluding some body-worn accessory SAR tests.

When the user enables the personal wireless router functions for the handset, actual operations include simultaneous transmission of both the WIFI transmitter and another licensed transmitter. Both transmitters often do not transmit at the same transmitting frequency and thus cannot be evaluated for SAR under actual use conditions due to the limitations of the SAR assessment probes. Therefore, SAR must be evaluated for each frequency transmission and mode separately and spatially summed with the WIFI transmitter according to FCC KDB Publication 447498 D04v01 procedures. The “Portable Hotspot” feature on the handset was NOT activated during SAR assessments, to ensure the SAR measurements were evaluated for a single transmission frequency RF signal at a time.

6.8 Phablet Configurations

For smart phones with a display diagonal dimension > 150 mm or an overall diagonal dimension > 160 mm that provide similar mobile web access and multimedia support found in mini-tablets or UMPC mini-tablets that support voice calls next to the ear, the phablets procedures outlined in KDB Publication 648474 D04v01r03 should be applied to evaluate SAR compliance. A device marketed as phablets, regardless of form factors and operating characteristics must be tested as a phablet to determine SAR compliance. In addition to the normally

FCC ID: PY7-76056F	SAR EVALUATION REPORT	Approved by: Technical Manager
Document S/N: 1M2205240063-03.PY7	DUT Type: Portable Handset	Page 22 of 111



required head and body-worn accessory SAR test procedures required for handsets, the UMPC mini-tablet procedures must also be applied to test the SAR of all surfaces and edges with an antenna ≤ 25 mm from that surface or edge, in direct contact with the phantom, for 10g SAR. The UMPC mini-tablet 1g SAR at 5 mm is not required. When hotspot mode applies, 10g SAR is required only for the surfaces and edges with hotspot mode 1g SAR > 1.2 W/kg.

FCC ID: PY7-76056F	SAR EVALUATION REPORT	Approved by: Technical Manager
Document S/N: 1M2205240063-03.PY7	DUT Type: Portable Handset	Page 23 of 111

REV 22.0
03/30/2022

7 RF EXPOSURE LIMITS

7.1 Uncontrolled Environment

UNCONTROLLED ENVIRONMENTS are defined as locations where there is the exposure of individuals who have no knowledge or control of their exposure. The general population/uncontrolled exposure limits are applicable to situations in which the general public may be exposed or in which persons who are exposed as a consequence of their employment may not be made fully aware of the potential for exposure or cannot exercise control over their exposure. Members of the general public would come under this category when exposure is not employment-related; for example, in the case of a wireless transmitter that exposes persons in its vicinity.

7.2 Controlled Environment

CONTROLLED ENVIRONMENTS are defined as locations where there is exposure that may be incurred by persons who are aware of the potential for exposure, (i.e. as a result of employment or occupation). In general, occupational/controlled exposure limits are applicable to situations in which persons are exposed as a consequence of their employment, who have been made fully aware of the potential for exposure and can exercise control over their exposure. This exposure category is also applicable when the exposure is of a transient nature due to incidental passage through a location where the exposure levels may be higher than the general population/uncontrolled limits, but the exposed person is fully aware of the potential for exposure and can exercise control over his or her exposure by leaving the area or by some other appropriate means.

**Table 7-1
SAR Human Exposure Specified in ANSI/IEEE C95.1-1992 and Health Canada Safety Code 6**

HUMAN EXPOSURE LIMITS		
	UNCONTROLLED ENVIRONMENT <i>General Population</i> (W/kg) or (mW/g)	CONTROLLED ENVIRONMENT <i>Occupational</i> (W/kg) or (mW/g)
Peak Spatial Average SAR Head	1.6	8.0
Whole Body SAR	0.08	0.4
Peak Spatial Average SAR Hands, Feet, Ankle, Wrists, etc.	4.0	20

1. The Spatial Peak value of the SAR averaged over any 1 gram of tissue (defined as a tissue volume in the shape of a cube) and over the appropriate averaging time.
2. The Spatial Average value of the SAR averaged over the whole body.
3. The Spatial Peak value of the SAR averaged over any 10 grams of tissue (defined as a tissue volume in the shape of a cube) and over the appropriate averaging time.

FCC ID: PY7-76056F	SAR EVALUATION REPORT	Approved by: Technical Manager
Document S/N: 1M2205240063-03.PY7	DUT Type: Portable Handset	Page 24 of 111

REV 22.0
03/30/2022

8 FCC MEASUREMENT PROCEDURES

Power measurements for licensed transmitters are performed using a base station simulator under digital average power.

8.1 Measured and Reported SAR

Per FCC KDB Publication 447498 D04v01, when SAR is not measured at the maximum power level allowed for production units, the results must be scaled to the maximum tune-up tolerance limit according to the power applied to the individual channels tested to determine compliance. For simultaneous transmission, the measured aggregate SAR must be scaled according to the sum of the differences between the maximum tune-up tolerance and actual power used to test each transmitter. When SAR is measured at or scaled to the maximum tune-up tolerance limit, the results are referred to as *reported* SAR. The highest *reported* SAR results are identified on the grant of equipment authorization according to procedures in KDB 690783 D01v01r03.

8.2 3G SAR Test Reduction Procedure

In FCC KDB Publication 941225 D01v03r01, certain transmission modes within a frequency band and wireless mode evaluated for SAR are defined as primary modes. The equivalent modes considered for SAR test reduction are denoted as secondary modes. When the maximum output power including tune-up tolerance specified for production units in a secondary mode is ≤ 0.25 dB higher than the primary mode or when the highest reported SAR of the primary mode, scaled by the ratio of specified maximum output power and tune-up tolerance of secondary to primary mode, is ≤ 1.2 W/kg, SAR measurements are not required for the secondary mode. These criteria are referred to as the 3G SAR test reduction procedure. When the 3G SAR test reduction procedure is not satisfied, SAR measurements are additionally required for the secondary mode.

8.3 Procedures Used to Establish RF Signal for SAR

The following procedures are according to FCC KDB Publication 941225 D01v03r01 “3G SAR Measurement Procedures.”

The device is placed into a simulated call using a base station simulator in a RF shielded chamber. Establishing connections in this manner ensure a consistent means for testing SAR and are recommended for evaluating SAR [4]. Devices under test are evaluated prior to testing, with a fully charged battery and were configured to operate at maximum output power. In order to verify that the device is tested throughout the SAR test at maximum output power, the SAR measurement system measures a “point SAR” at an arbitrary reference point at the start and end of the 1 gram SAR evaluation, to assess for any power drifts during the evaluation. If the power drift deviates by more than 5%, the SAR test and drift measurements are repeated.

8.4 SAR Measurement Conditions for UMTS

8.4.1 Output Power Verification

Maximum output power is verified on the High, Middle and Low channels according to the general descriptions in section 5.2 of 3GPP TS 34.121, using the appropriate RMC with TPC (transmit power control) set to all “1s” or applying the required inner loop power control procedures to maintain maximum output power while HSUPA is active. Results for all applicable physical channel configurations (DPCCH, DPDCHn and spreading codes, HS-DPCCH etc) are tabulated in this test report. All configurations that are not supported by the DUT or cannot be measured due to technical or equipment limitations are identified.

FCC ID: PY7-76056F	SAR EVALUATION REPORT	Approved by: Technical Manager
Document S/N: 1M2205240063-03.PY7	DUT Type: Portable Handset	Page 25 of 111

REV 22.0
03/30/2022

8.4.2 Head SAR Measurements

SAR for next to the ear head exposure is measured using a 12.2 kbps RMC with TPC bits configured to all “1’s”. The 3G SAR test reduction procedure is applied to AMR configurations with 12.2 kbps RMC as the primary mode. Otherwise, SAR is measured for 12.2 kbps AMR in 3.4 kbps SRB (signaling radio bearer) using the highest reported SAR configuration in 12.2 kbps RMC for head exposure.

8.4.3 Body SAR Measurements

SAR for body exposure configurations is measured using the 12.2 kbps RMC with the TPC bits all “1s”. The 3G SAR test reduction procedure is applied to other spreading codes and multiple DPDCH_n configurations supported by the handset with 12.2 kbps RMC as the primary mode. Otherwise, SAR is measured using an applicable RMC configuration with the corresponding spreading code or DPDCH_n, for the highest reported SAR configuration in 12.2 kbps RMC.

8.4.4 SAR Measurements with Rel 5 HSDPA

The 3G SAR test reduction procedure is applied to HSDPA body configurations with 12.2 kbps RMC as the primary mode. Otherwise, Body SAR for HSDPA is measured using an FRC with H-Set 1 in Sub-test 1 and a 12.2 kbps RMC configured in Test Loop Mode 1, for the highest reported SAR configuration in 12.2 kbps RMC without HSDPA. Handsets with both HSDPA and HSUPA are tested according to Release 6 HSPA test procedures.

8.4.5 SAR Measurements with Rel 6 HSUPA

The 3G SAR test reduction procedure is applied to HSPA (HSUPA/HSDPA with RMC) body configurations with 12.2 kbps RMC as the primary mode. Otherwise, Body SAR for HSPA is measured with E-DCH Sub-test 5, using H-Set 1 and QPSK for FRC and a 12.2 kbps RMC configured in Test Loop Mode 1 and power control algorithm 2, according to the highest reported body SAR configuration in 12.2 kbps RMC without HSPA.

When VOIP applies to head exposure, the 3G SAR test reduction procedure is applied with 12.2 kbps RMC as the primary mode; otherwise, the same HSPA configuration used for body SAR measurements are applied to head exposure testing.

8.4.6 SAR Measurement Conditions for DC-HSDPA

SAR is required for Rel. 8 DC-HSDPA when SAR is required for Rel. 5 HSDPA; otherwise, the 3G SAR test reduction procedure is applied to DC-HSDPA with 12.2 kbps RMC as the primary mode. Power is measured for DC-HSDPA according to the H-Set 12, FRC configuration in Table C.8.1.12 of 3GPP TS 34.121-1 to determine SAR test reduction. A primary and a secondary serving HS-DSCH Cell are required to perform the power measurement and for the results to be acceptable.

8.5 SAR Measurement Conditions for LTE

LTE modes are tested according to FCC KDB 941225 D05v02r04 publication. Establishing connections with base station simulators ensure a consistent means for testing SAR and are recommended for evaluating SAR [4]. The R&S CMW500 or Anritsu MT8820C simulators are used for LTE output power measurements and SAR testing. Closed loop power control was used so the UE transmits with maximum output power during SAR testing. SAR tests were performed with the same number of RB and RB offsets transmitting on all TTI frames (maximum TTI).

8.5.1 Spectrum Plots for RB Configurations

A properly configured base station simulator was used for SAR tests and power measurements. Therefore, spectrum plots for RB configurations were not required to be included in this report.

FCC ID: PY7-76056F	SAR EVALUATION REPORT	Approved by: Technical Manager
Document S/N: 1M2205240063-03.PY7	DUT Type: Portable Handset	Page 26 of 111

REV 22.0
03/30/2022

8.5.2 MPR

MPR is permanently implemented for this device by the manufacturer. The specific manufacturer target MPR is indicated alongside the SAR results. MPR is enabled for this device, according to 3GPP TS36.101 Section 6.2.3 – 6.2.5 under Table 6.2.3-1.

8.5.3 A-MPR

A-MPR (Additional MPR) has been disabled for all SAR tests by setting NS=01 on the base station simulator.

8.5.4 Required RB Size and RB Offsets for SAR Testing

According to FCC KDB 941225 D05v02r04:

- a. Per Section 5.2.1, SAR is required for QPSK 1 RB Allocation for the largest bandwidth
 - i. The required channel and offset combination with the highest maximum output power is required for SAR.
 - ii. When the reported SAR is ≤ 0.8 W/kg, testing of the remaining RB offset configurations and required test channels is not required. Otherwise, SAR is required for the remaining required test channels using the RB offset configuration with highest output power for that channel.
 - iii. When the reported SAR for a required test channel is > 1.45 W/kg, SAR is required for all RB offset configurations for that channel.
- b. Per Section 5.2.2, SAR is required for 50% RB allocation using the largest bandwidth following the same procedures outlined in Section 5.2.1.
- c. Per Section 5.2.3, QPSK SAR is not required for the 100% allocation when the highest maximum output power for the 100% allocation is less than the highest maximum output power of the 1 RB and 50% RB allocations and the reported SAR for the 1 RB and 50% RB allocations is < 0.8 W/kg.
- d. Per Section 5.2.4 and 5.3, SAR tests for higher order modulations and lower bandwidths configurations are not required when the conducted power of the required test configurations determined by Sections 5.2.1 through 5.2.3 is less than or equal to $\frac{1}{2}$ dB higher than the equivalent configuration using QPSK modulation and when the QPSK SAR for those configurations is < 1.45 W/kg.

8.5.5 TDD

LTE TDD testing is performed using the SAR test guidance provided in FCC KDB 941225 D05v02r04. TDD is tested at the highest duty factor using UL-DL configuration 0 with special subframe configuration 6 and applying the FDD LTE procedures in KDB 941225 D05v02r04. SAR testing is performed using the extended cyclic prefix listed in 3GPP TS 36.211 Section 4.

8.5.6 Downlink Only Carrier Aggregation

Conducted power measurements with LTE Carrier Aggregation (CA) (downlink only) active are made in accordance to KDB Publication 941225 D05Av01r02. The RRC connection is only handled by one cell, the primary component carrier (PCC) for downlink and uplink communications. After making a data connection to the PCC, the UE device adds secondary component carrier(s) (SCC) on the downlink only. All uplink communications and acknowledgements remain identical to specifications when downlink carrier aggregation is inactive on the PCC. Additional conducted output powers are measured with the downlink carrier aggregation active for the configuration with highest measured maximum conducted power with downlink carrier aggregation inactive measured among the channel bandwidth, modulation, and RB combinations in each frequency band. Per FCC KDB Publication 941225 D05Av01r02, no SAR measurements are required for downlink only carrier aggregation configurations when the average output

FCC ID: PY7-76056F	SAR EVALUATION REPORT	Approved by: Technical Manager
Document S/N: 1M2205240063-03.PY7	DUT Type: Portable Handset	Page 27 of 111

REV 22.0
03/30/2022

power with downlink only carrier aggregation active is not more than 0.25 dB higher than the average output power with downlink only carrier aggregation inactive.

8.6 SAR Testing with 802.11 Transmitters

The normal network operating configurations of 802.11 transmitters are not suitable for SAR measurements. Unpredictable fluctuations in network traffic and antenna diversity conditions can introduce undesirable variations in SAR results. The SAR for these devices should be measured using chipset based test mode software to ensure the results are consistent and reliable. See KDB Publication 248227 D01v02r02 for more details.

8.6.1 General Device Setup

Chipset based test mode software is hardware dependent and generally varies among manufacturers. The device operating parameters established in test mode for SAR measurements must be identical to those programmed in production units, including output power levels, amplifier gain settings and other RF performance tuning parameters.

A periodic duty factor is required for current generation SAR systems to measure SAR. When 802.11 frame gaps are accounted for in the transmission, a maximum transmission duty factor of 92 - 96% is typically achievable in most test mode configurations. A minimum transmission duty factor of 85% is required to avoid certain hardware and device implementation issues related to wide range SAR scaling. The reported SAR is scaled to 100% transmission duty factor to determine compliance at the maximum tune-up tolerance limit.

8.6.2 U-NII-1 and U-NII-2A

For devices that operate in both U-NII-1 and U-NII-2A bands, when the same maximum output power is specified for both bands, SAR measurement using OFDM SAR test procedures is not required for U-NII-1 unless the highest reported SAR for U-NII-2A is > 1.2 W/kg. When different maximum output powers are specified for the bands, SAR measurement for the U-NII band with the lower maximum output power is not required unless the highest reported SAR for the U-NII band with the higher maximum output power, adjusted by the ratio of lower to higher specified maximum output power for the two bands, is > 1.2 W/kg. When 10g SAR measurement is considered, a factor of 2.5 is applied to the thresholds above.

8.6.3 U-NII-2C and U-NII-3

The frequency range covered by U-NII-2C and U-NII-3 is 380 MHz (5.47 – 5.85 GHz), which requires a minimum of at least two SAR probe calibration frequency points to support SAR measurements. When Terminal Doppler Weather Radar (TDWR) restriction applies, the channels at 5.60 – 5.65 GHz in U-NII-2C band must be disabled with acceptable mechanisms and documented in the equipment certification. Unless band gap channels are permanently disabled, SAR must be considered for these channels. Each band is tested independently according to the normally required OFDM SAR measurement and probe calibration frequency points requirements.

8.6.4 Initial Test Position Procedure

For exposure conditions with multiple test positions, such as handset operating next to the ear, devices with hotspot mode or UMPC mini-tablet, procedures for initial test position can be applied. Using the transmission mode determined by the DSSS procedure or initial test configuration, area scans are measured for all positions in an exposure condition. The test position with the highest extrapolated (peak) SAR is used as the initial test position. When reported SAR for the initial test position is ≤ 0.4 W/kg, no additional testing for the remaining test positions is required. Otherwise, SAR is evaluated at the subsequent highest peak SAR positions until the reported SAR result is ≤ 0.8 W/kg or all test positions are measured. When 10g SAR measurement is considered, a factor of 2.5 is applied to the thresholds above.

FCC ID: PY7-76056F	SAR EVALUATION REPORT	Approved by: Technical Manager
Document S/N: 1M2205240063-03.PY7	DUT Type: Portable Handset	Page 28 of 111

REV 22.0
03/30/2022

8.6.5 2.4 GHz SAR Test Requirements

SAR is measured for 2.4 GHz 802.11b DSSS using either the fixed test position or, when applicable, the initial test position procedure. SAR test reduction is determined according to the following:

- 1) When the reported SAR of the highest measured maximum output power channel for the exposure configuration is ≤ 0.8 W/kg, no further SAR testing is required for 802.11b DSSS in that exposure configuration.
- 2) When the reported SAR is > 0.8 W/kg, SAR is required for that position using the next highest measured output power channel. When any reported SAR is > 1.2 W/kg, SAR is required for the third channel; i.e., all channels require testing.

2.4 GHz 802.11 g/n/ax OFDM are additionally evaluated for SAR if the highest reported SAR for 802.11b, adjusted by the ratio of the OFDM to DSSS specified maximum output power, is > 1.2 W/kg. When SAR is required for OFDM modes in 2.4 GHz band, the Initial Test Configuration Procedures should be followed. When 10g SAR measurement is considered, a factor of 2.5 is applied to the thresholds above.

8.6.6 OFDM Transmission Mode and SAR Test Channel Selection

When the same maximum output power was specified for multiple OFDM transmission mode configurations in a frequency band or aggregated band, SAR is measured using the configuration with the largest channel bandwidth, lowest order modulation and lowest data rate. When the maximum output power of a channel is the same for equivalent OFDM configurations; for example, 802.11a, 802.11n and 802.11ac or 802.11g and 802.11n with the same channel bandwidth, modulation and data rate etc., the lower order 802.11 mode i.e., 802.11a, then 802.11n and 802.11ac or 802.11g then 802.11n, is used for SAR measurement. Per April 2019 TCB Workshop guidance, 802.11ax was considered the highest order 802.11 mode. When the maximum output power are the same for multiple test channels, either according to the default or additional power measurement requirements, SAR is measured using the channel closest to the middle of the frequency band or aggregated band. When there are multiple channels with the same maximum output power, SAR is measured using the higher number channel.

8.6.7 Initial Test Configuration Procedure

For OFDM, an initial test configuration is determined for each frequency band and aggregated band, according to the transmission mode with the highest maximum output power specified for SAR measurements. When the same maximum output power is specified for multiple OFDM transmission mode configurations in a frequency band or aggregated band, SAR is measured using the configuration(s) with the largest channel bandwidth, lowest order modulation, lowest data rate and lowest order IEEE 802.11 mode. The channel of the transmission mode with the highest average RF output conducted power will be the initial test configuration.

When the reported SAR is ≤ 0.8 W/kg, no additional measurements on other test channels are required. Otherwise, SAR is evaluated using the subsequent highest average RF output channel until the reported SAR result is ≤ 1.2 W/kg or all channels are measured. When there are multiple untested channels having the same subsequent highest average RF output power, the channel with higher frequency from the lowest 802.11 mode is considered for SAR measurements (See Section 8.6.6). When 10g SAR measurement is considered, a factor of 2.5 is applied to the thresholds above.

8.6.8 Subsequent Test Configuration Procedures

For OFDM configurations in each frequency band and aggregated band, SAR is evaluated for initial test configuration using the fixed test position or the initial test position procedure. When the highest reported SAR

FCC ID: PY7-76056F	SAR EVALUATION REPORT	Approved by: Technical Manager
Document S/N: 1M2205240063-03.PY7	DUT Type: Portable Handset	Page 29 of 111

REV 22.0
03/30/2022

(for the initial test configuration), adjusted by the ratio of the specified maximum output power of the subsequent test configuration to initial test configuration, is ≤ 1.2 W/kg, no additional SAR tests for the subsequent test configurations are required. When 10g SAR measurement is considered, a factor of 2.5 is applied to the thresholds above.

8.6.9 MIMO SAR considerations

Per KDB Publication 248227 D01v02r02, the simultaneous SAR provisions in KDB Publication 447498 D04v01 should be applied to determine simultaneous transmission SAR test exclusion for WIFI MIMO. If the sum of 1g single transmission chain SAR measurements is < 1.6 W/kg, no additional SAR measurements for MIMO are required. Alternatively, SAR for MIMO can be measured with all antennas transmitting simultaneously at the specified maximum output power of MIMO operation. When 10g SAR measurement is considered, a factor of 2.5 is applied to the thresholds above.

FCC ID: PY7-76056F	SAR EVALUATION REPORT	Approved by: Technical Manager
Document S/N: 1M2205240063-03.PY7	DUT Type: Portable Handset	Page 30 of 111

REV 22.0
03/30/2022

9 RF CONDUCTED POWERS

All conducted power measurements for 2G/3G/4G/5G Sub6 WWAN technologies and bands in this section were performed by setting *Reserve_power_margin* (Qualcomm® Smart Transmit EFS entry) to 0dB, so that the EUT transmits continuously at minimum (P_{limit} , maximum tune up output power P_{max}).

9.1 GSM Conducted Powers

Table 9-1
GSM/GPRS/EDGE Measured P_{Max} for all DSI

Maximum Burst-Averaged Output Power										
Band	Channel	Voice	GPRS/EDGE Data (GMSK)				EDGE Data (8-PSK)			
		GSM [dBm] CS (1 Slot)	GPRS [dBm] 1 Tx Slot	GPRS [dBm] 2 Tx Slot	GPRS [dBm] 3 Tx Slot	GPRS [dBm] 4 Tx Slot	EDGE [dBm] 1 Tx Slot	EDGE [dBm] 2 Tx Slot	EDGE [dBm] 3 Tx Slot	EDGE [dBm] 4 Tx Slot
GSM 850	128	32.15	32.17	28.91	27.11	26.00	26.69	23.53	21.66	20.60
	190	32.22	32.42	29.04	27.23	26.19	26.76	23.50	21.70	20.59
	251	32.51	32.55	29.10	27.26	26.20	26.78	23.71	21.79	20.69
GSM 1900	512	26.53	26.45	23.39	21.78	20.53	25.74	22.66	20.62	19.49
	661	26.42	26.70	23.46	21.54	20.54	25.66	22.44	20.78	19.44
	810	26.64	26.56	23.36	21.49	20.44	25.73	22.55	20.67	19.47

Calculated Maximum Frame-Averaged Output Power										
Band	Channel	Voice	GPRS/EDGE Data (GMSK)				EDGE Data (8-PSK)			
		GSM [dBm] CS (1 Slot)	GPRS [dBm] 1 Tx Slot	GPRS [dBm] 2 Tx Slot	GPRS [dBm] 3 Tx Slot	GPRS [dBm] 4 Tx Slot	EDGE [dBm] 1 Tx Slot	EDGE [dBm] 2 Tx Slot	EDGE [dBm] 3 Tx Slot	EDGE [dBm] 4 Tx Slot
GSM 850	128	22.95	22.97	22.72	22.68	22.82	17.49	17.34	17.23	17.42
	190	23.02	23.22	22.85	22.80	23.01	17.56	17.31	17.27	17.41
	251	23.31	23.35	22.91	22.83	23.02	17.58	17.52	17.36	17.51
GSM 1900	512	17.33	17.25	17.20	17.35	17.35	16.54	16.47	16.19	16.31
	661	17.22	17.50	17.27	17.11	17.36	16.46	16.25	16.35	16.26
	810	17.44	17.36	17.17	17.06	17.26	16.53	16.36	16.24	16.29

GSM 850	Frame	23.30	23.30	23.31	23.27	23.32	17.80	17.81	17.77	17.82
GSM 1900	Avg.Targets:	17.80	17.80	17.81	17.77	17.82	16.80	16.81	16.77	16.82

FCC ID: PY7-76056F	SAR EVALUATION REPORT						Approved by: Technical Manager			
Document S/N: 1M2205240063-03.PY7	DUT Type: Portable Handset						Page 31 of 111			

**Table 9-2
DTM Measured *P*_{max} for all DSI**

Maximum Burst-Averaged Output Power					
Band	Channel	DTM (GSM + GPRS)		DTM (GSM + EGPRS)	
		DTM [dBm]	DTM [dBm]	DTM [dBm]	DTM [dBm]
		CS + PS (2 Slots)	CS + 2PS (3 Slots)	CS + PS (2 Slots)	CS + 2PS (3 Slots)
GSM 850	128	29.26	27.32	23.81	21.86
	190	29.50	27.28	23.79	21.92
	251	29.42	27.44	23.82	21.91
GSM 1900	512	23.58	21.95	22.76	20.99
	661	23.61	21.89	22.74	20.93
	810	23.54	21.92	22.75	20.94

Calculated Maximum Frame-Averaged Output Power					
Band	Channel	GPRS/EDGE Data (GMSK)		EDGE Data (8-PSK)	
		GPRS [dBm]	GPRS [dBm]	EDGE [dBm]	EDGE [dBm]
		2 Tx Slot	3 Tx Slot	2 Tx Slot	3 Tx Slot
GSM 850	128	23.07	22.89	17.62	17.43
	190	23.31	22.85	17.60	17.49
	251	23.23	23.01	17.63	17.48
GSM 1900	512	17.39	17.52	16.57	16.56
	661	17.42	17.46	16.55	16.50
	810	17.35	17.49	16.56	16.51

GSM 850	Frame Avg.Targets:	23.31	23.27	17.81	17.77
GSM 1900		17.81	17.77	16.81	16.77

Note:

- Both burst-averaged and calculated frame-averaged powers are included. Frame-averaged power was calculated from the measured burst-averaged power by converting the slot powers into linear units and calculating the energy over 8 timeslots.
- GPRS/EDGE (GMSK) output powers were measured with coding scheme setting of 1 (CS1) on the base station simulator. CS1 was configured to measure GPRS output power measurements and SAR to ensure GMSK modulation in the signal. Our Investigation has shown that CS1 - CS4 settings do not have any impact on the output levels or modulation in the GPRS modes.

FCC ID: PY7-76056F	SAR EVALUATION REPORT	Approved by: Technical Manager
Document S/N: 1M2205240063-03.PY7	DUT Type: Portable Handset	Page 32 of 111

3. EDGE (8-PSK) output powers were measured with MCS7 on the base station simulator. MCS7 coding scheme was used to measure the output powers for EDGE since investigation has shown that choosing MCS7 coding scheme will ensure 8-PSK modulation. It has been shown that MCS levels that produce 8-PSK modulation do not have an impact on output power.
4. DTM output powers were measured with a communication test set with DTM supported when the device was operating in DTM using one CS slot plus PS multislots. The bolded DTM modes were selected for SAR testing according to the according to the maximum CS and PS slots according to KDB 941225 D04v01.

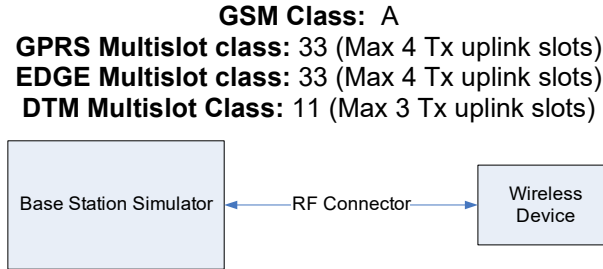

Figure 9-1
Power Measurement Setup

FCC ID: PY7-76056F	SAR EVALUATION REPORT	Approved by: Technical Manager
Document S/N: 1M2205240063-03.PY7	DUT Type: Portable Handset	Page 33 of 111

9.2 UMTS Conducted Powers

Table 9-3
Measured P_{Max} for all DSI

3GPP Release Version	Mode	3GPP 34.121 Subtest	Cellular Band [dBm]			AWS Band [dBm]			PCS Band [dBm]			3GPP MPR [dB]
			4132	4183	4233	1312	1412	1513	9262	9400	9538	
99	WCDMA	12.2 kbps RMC	21.68	21.72	21.70	17.51	17.54	17.65	18.57	18.54	18.54	-
99		12.2 kbps AMR	21.79	21.60	21.71	17.50	17.54	17.64	18.51	18.57	18.62	-
6	HSDPA	Subtest 1	20.78	20.87	20.89	16.62	16.60	16.69	17.42	17.60	17.70	0
6		Subtest 2	20.85	20.83	20.70	16.65	16.72	16.69	17.58	17.58	17.65	0
6		Subtest 3	20.35	20.20	20.34	16.09	16.22	16.18	17.09	17.10	17.19	0.5
6		Subtest 4	20.29	20.38	20.36	16.07	15.82	16.18	17.09	17.07	17.20	0.5
6	HSUPA	Subtest 1	20.79	20.65	20.86	16.63	16.72	16.68	17.59	17.57	17.71	0
6		Subtest 2	18.79	18.88	18.90	14.61	14.65	14.68	15.56	15.59	15.67	2
6		Subtest 3	19.78	19.85	19.89	15.60	15.70	15.68	16.57	16.58	16.67	1
6		Subtest 4	18.82	18.87	18.91	14.64	14.72	14.70	15.59	15.61	15.67	2
6		Subtest 5	20.85	20.88	20.92	16.62	16.70	16.72	17.62	17.62	17.70	0
8	DC-HSDPA	Subtest 1	20.76	20.74	20.77	16.63	16.73	16.71	17.61	17.61	17.71	0
8		Subtest 2	20.70	20.71	20.70	16.61	16.70	16.70	17.57	17.62	17.69	0
8		Subtest 3	20.30	20.34	20.42	16.10	16.24	16.20	17.06	17.09	17.22	0.5
8		Subtest 4	20.27	20.35	20.37	16.14	16.19	16.17	17.10	17.07	17.19	0.5

DC-HSDPA considerations

- 3GPP Specification 34.121-1 Release 8 Ver 8.10.0 was used for DC-HSDPA guidance
- H-Set 12 (QPSK) was confirmed to be used during DC-HSDPA measurements
- The DUT supports UE category 24 for HSDPA



Figure 9-2
Power Measurement Setup

FCC ID: PY7-76056F	SAR EVALUATION REPORT	Approved by: Technical Manager
Document S/N: 1M2205240063-03.PY7	DUT Type: Portable Handset	Page 34 of 111

9.3 LTE Conducted Powers

Note: Per FCC KDB Publication 941225 D05v02r05, LTE SAR for the lower bandwidths was not required for testing since the maximum average output power of all required channels and configurations was not more than 0.5 dB higher than the highest bandwidth and the reported LTE SAR for the highest bandwidth was less than 1.45 W/kg. Lower bandwidth conducted powers for all LTE bands can be found in the LTE and NR Lower Bandwidth Conducted Power Appendix.

Note: Some bands do not support three non-overlapping channels. Per KDB Publication 941225 D05v02, when a device supports overlapping channel assignment in a channel bandwidth configuration, the middle channel of the group of overlapping channels should be selected for testing.

9.3.1 LTE Band 71

Table 9-4
LTE Band 71 Cellular Main 1 Antenna Measured P_{Max} for DSI=2 (Head) - 20 MHz Bandwidth

LTE Band 71 20 MHz Bandwidth					
Modulation	RB Size	RB Offset	Mid Channel	MPR Allowed per 3GPP [dB]	MPR [dB]
			133297 (680.5 MHz)		
			Conducted Power [dBm]		
QPSK	1	0	23.87	0	0
	1	50	23.76		0
	1	99	23.86		0
	50	0	22.75	0-1	1
	50	25	22.72		1
	50	50	22.68		1
	100	0	22.67		1
16QAM	1	0	23.18	0-1	1
	1	50	23.26		1
	1	99	22.92		1
	50	0	21.78	0-2	2
	50	25	21.80		2
	50	50	21.69		2
	100	0	21.70		2
64QAM	1	0	21.64	0-2	2
	1	50	21.91		2
	1	99	21.97		2
	50	0	20.80	0-3	3
	50	25	20.73		3
	50	50	20.73		3
	100	0	20.79		3

FCC ID: PY7-76056F	SAR EVALUATION REPORT	Approved by: Technical Manager
Document S/N: 1M2205240063-03.PY7	DUT Type: Portable Handset	Page 35 of 111

REV 22.0
03/30/2022

Table 9-5
LTE Band 71 Cellular Main 1 Antenna Measured P_{limit} for DSI = 3 (Body-worn, Hotspot or Phablet)
- 20 MHz Bandwidth

LTE Band 71 20 MHz Bandwidth					
Modulation	RB Size	RB Offset	Mid Channel	MPR Allowed per 3GPP [dB]	MPR [dB]
			133297 (680.5 MHz)		
			Conducted Power [dBm]		
QPSK	1	0	22.31	0	0
	1	50	21.92		0
	1	99	21.90		0
	50	0	22.25	0-1	0
	50	25	22.19		0
	50	50	22.18		0
	100	0	21.72		0
16QAM	1	0	22.28	0-1	0
	1	50	22.15		0
	1	99	21.86		0
	50	0	21.89	0-2	0
	50	25	21.85		0
	50	50	21.80		0
	100	0	21.32		0
64QAM	1	0	22.13	0-2	0
	1	50	21.66		0
	1	99	21.64		0
	50	0	20.82	0-3	1
	50	25	20.85		1
	50	50	20.76		1
	100	0	21.30		1

FCC ID: PY7-76056F	SAR EVALUATION REPORT	Approved by: Technical Manager
Document S/N: 1M2205240063-03.PY7	DUT Type: Portable Handset	Page 36 of 111

9.3.2 LTE Band 12

Table 9-6
LTE Band 12 Cellular Main 1 Antenna Measured P_{Max} for DSI=2 (Head) - 10 MHz Bandwidth

LTE Band 12 10 MHz Bandwidth					
Modulation	RB Size	RB Offset	Mid Channel	MPR Allowed per 3GPP [dB]	MPR [dB]
			23095 (707.5 MHz)		
			Conducted Power [dBm]		
QPSK	1	0	23.71	0	0
	1	25	23.88		0
	1	49	23.87		0
	25	0	22.82	0-1	1
	25	12	22.87		1
	25	25	22.86		1
	50	0	22.80		1
16QAM	1	0	22.96	0-1	1
	1	25	22.96		1
	1	49	23.07		1
	25	0	21.91	0-2	2
	25	12	21.89		2
	25	25	21.93		2
	50	0	21.87		2
64QAM	1	0	22.21	0-2	2
	1	25	21.93		2
	1	49	22.27		2
	25	0	20.98	0-3	3
	25	12	20.88		3
	25	25	20.96		3
	50	0	20.83		3

FCC ID: PY7-76056F	SAR EVALUATION REPORT	Approved by: Technical Manager
Document S/N: 1M2205240063-03.PY7	DUT Type: Portable Handset	Page 37 of 111

Table 9-7
LTE Band 12 Cellular Main 1 Antenna Measured P_{limit} for DSI = 3 (Body-worn, Hotspot or Phablet)
- 10 MHz Bandwidth

LTE Band 12 10 MHz Bandwidth					
Modulation	RB Size	RB Offset	Mid Channel	MPR Allowed per 3GPP [dB]	MPR [dB]
			23095 (707.5 MHz)		
			Conducted Power [dBm]		
QPSK	1	0	21.16	0	0
	1	25	21.08		0
	1	49	21.17		0
	25	0	21.13	0-1	0
	25	12	21.15		0
	25	25	21.11		0
	50	0	21.14		0
16QAM	1	0	21.50	0-1	0
	1	25	21.36		0
	1	49	21.45		0
	25	0	21.14	0-2	0
	25	12	21.17		0
	25	25	21.12		0
	50	0	21.16		0
64QAM	1	0	21.46	0-2	0
	1	25	21.34		0
	1	49	21.35		0
	25	0	20.67	0-3	0
	25	12	20.71		0
	25	25	20.64		0
	50	0	20.69		0

FCC ID: PY7-76056F	SAR EVALUATION REPORT	Approved by: Technical Manager
Document S/N: 1M2205240063-03.PY7	DUT Type: Portable Handset	Page 38 of 111

Table 9-8
LTE Band 12 Cellular Sub Antenna Measured P_{limit} for DSI = 3 (Body-worn, Hotspot or Phablet)
- 10 MHz Bandwidth

LTE Band 12 10 MHz Bandwidth					
Modulation	RB Size	RB Offset	Mid Channel	MPR Allowed per 3GPP [dB]	MPR [dB]
			23095 (707.5 MHz)		
			Conducted Power [dBm]		
QPSK	1	0	23.31	0	0
	1	25	23.29		0
	1	49	23.21		0
	25	0	22.28	0-1	1
	25	12	22.30		1
	25	25	22.27		1
	50	0	22.26		1
16QAM	1	0	22.60	0-1	1
	1	25	22.68		1
	1	49	22.59		1
	25	0	21.26	0-2	2
	25	12	21.28		2
	25	25	21.28		2
	50	0	21.28		2
64QAM	1	0	21.28	0-2	2
	1	25	21.28		2
	1	49	21.28		2
	25	0	20.33	0-3	3
	25	12	20.21		3
	25	25	20.30		3
	50	0	20.21		3

FCC ID: PY7-76056F	SAR EVALUATION REPORT	Approved by: Technical Manager
Document S/N: 1M2205240063-03.PY7	DUT Type: Portable Handset	Page 39 of 111

9.3.3 LTE Band 13

Table 9-9
LTE Band 13 Cellular Main 1 Antenna Measured P_{max} for DSI = 2 (Head) - 10 MHz Bandwidth

LTE Band 13 10 MHz Bandwidth					
Modulation	RB Size	RB Offset	Mid Channel	MPR Allowed per 3GPP [dB]	MPR [dB]
			23230 (782.0 MHz)		
			Conducted Power [dBm]		
QPSK	1	0	24.06	0	0
	1	25	24.08		0
	1	49	24.09		0
	25	0	23.03	0-1	1
	25	12	23.09		1
	25	25	23.10		1
	50	0	22.97		1
16QAM	1	0	23.41	0-1	1
	1	25	23.28		1
	1	49	23.31		1
	25	0	22.00	0-2	2
	25	12	22.13		2
	25	25	21.98		2
	50	0	22.05		2
64QAM	1	0	22.01	0-2	2
	1	25	22.21		2
	1	49	22.39		2
	25	0	21.50	0-3	3
	25	12	21.03		3
	25	25	21.00		3
	50	0	21.05		3

FCC ID: PY7-76056F	SAR EVALUATION REPORT	Approved by: Technical Manager
Document S/N: 1M2205240063-03.PY7	DUT Type: Portable Handset	Page 40 of 111

Table 9-10
LTE Band 13 Cellular Main 1 Antenna Measured P_{limit} for DSI = 3 (Body-worn, Hotspot or Phablet)
- 10 MHz Bandwidth

LTE Band 13 10 MHz Bandwidth					
Modulation	RB Size	RB Offset	Mid Channel	MPR Allowed per 3GPP [dB]	MPR [dB]
			23230 (782.0 MHz)		
			Conducted Power [dBm]		
QPSK	1	0	21.04	0	0
	1	25	21.02		0
	1	49	20.98		0
	25	0	21.42	0-1	0
	25	12	21.46		0
	25	25	21.39		0
	50	0	20.92		0
16QAM	1	0	21.53	0-1	0
	1	25	21.48		0
	1	49	21.30		0
	25	0	21.50	0-2	0
	25	12	21.48		0
	25	25	21.46		0
	50	0	21.00		0
64QAM	1	0	20.81	0-2	0
	1	25	21.26		0
	1	49	21.03		0
	25	0	21.09	0-3	0
	25	12	21.00		0
	25	25	21.07		0
	50	0	21.01		0

FCC ID: PY7-76056F	SAR EVALUATION REPORT	Approved by: Technical Manager
Document S/N: 1M2205240063-03.PY7	DUT Type: Portable Handset	Page 41 of 111

Table 9-11
LTE Band 13 Cellular Sub Antenna Measured P_{limit} for DSI = 3 (Body-worn, Hotspot or Phablet)
- 10 MHz Bandwidth

LTE Band 13 10 MHz Bandwidth					
Modulation	RB Size	RB Offset	Mid Channel	MPR Allowed per 3GPP [dB]	MPR [dB]
			23230 (782.0 MHz)		
			Conducted Power [dBm]		
QPSK	1	0	23.33	0	0
	1	25	23.28		0
	1	49	23.41		0
	25	0	22.40	0-1	1
	25	12	22.35		1
	25	25	22.36		1
	50	0	22.31		1
16QAM	1	0	22.71	0-1	1
	1	25	22.77		1
	1	49	22.48		1
	25	0	21.35	0-2	2
	25	12	21.31		2
	25	25	21.33		2
	50	0	21.34		2
64QAM	1	0	21.47	0-2	2
	1	25	21.59		2
	1	49	21.37		2
	25	0	20.43	0-3	3
	25	12	20.35		3
	25	25	20.34		3
	50	0	20.42		3

FCC ID: PY7-76056F	SAR EVALUATION REPORT	Approved by: Technical Manager
Document S/N: 1M2205240063-03.PY7	DUT Type: Portable Handset	Page 42 of 111

9.3.4 LTE Band 5

Table 9-12
LTE Band 5 (Cell) Cellular Main 1 Antenna Measured P_{Max} for DSI=2 (Head) - 10 MHz Bandwidth

LTE Band 5 (Cell) 10 MHz Bandwidth					
Modulation	RB Size	RB Offset	Mid Channel	MPR Allowed per 3GPP [dB]	MPR [dB]
			20525 (836.5 MHz)		
			Conducted Power [dBm]		
QPSK	1	0	23.88	0	0
	1	25	23.89		0
	1	49	23.85		0
	25	0	23.00	0-1	1
	25	12	22.95		1
	25	25	22.92		1
	50	0	22.96		1
16QAM	1	0	23.32	0-1	1
	1	25	23.17		1
	1	49	23.20		1
	25	0	21.95	0-2	2
	25	12	22.05		2
	25	25	22.00		2
	50	0	21.99		2
64QAM	1	0	22.17	0-2	2
	1	25	22.19		2
	1	49	22.09		2
	25	0	20.93	0-3	3
	25	12	20.97		3
	25	25	21.06		3
	50	0	20.97		3

FCC ID: PY7-76056F	SAR EVALUATION REPORT	Approved by: Technical Manager
Document S/N: 1M2205240063-03.PY7	DUT Type: Portable Handset	Page 43 of 111

Table 9-13
LTE Band 5 (Cell) Cellular Main 1 Antenna Measured P_{limit} for DSI = 3 (Body-worn, Hotspot or Phablet)
- 10 MHz Bandwidth

LTE Band 5 (Cell) 10 MHz Bandwidth					
Modulation	RB Size	RB Offset	Mid Channel	MPR Allowed per 3GPP [dB]	MPR [dB]
			20525 (836.5 MHz)		
			Conducted Power [dBm]		
QPSK	1	0	21.22	0	0
	1	25	21.24		0
	1	49	21.25		0
	25	0	21.22	0-1	0
	25	12	21.25		0
	25	25	21.26		0
	50	0	21.19		0
16QAM	1	0	21.55	0-1	0
	1	25	21.50		0
	1	49	21.54		0
	25	0	21.24	0-2	0
	25	12	21.25		0
	25	25	21.27		0
	50	0	21.22		0
64QAM	1	0	21.46	0-2	0
	1	25	21.59		0
	1	49	21.53		0
	25	0	20.73	0-3	0
	25	12	20.76		0
	25	25	20.78		0
	50	0	20.75		0

FCC ID: PY7-76056F	SAR EVALUATION REPORT	Approved by: Technical Manager
Document S/N: 1M2205240063-03.PY7	DUT Type: Portable Handset	Page 44 of 111

Table 9-14
LTE Band 5 (Cell) Cellular Sub Antenna Measured P_{limit} for DSI = 3 (Body-worn, Hotspot or Phablet)
- 10 MHz Bandwidth

LTE Band 5 (Cell) 10 MHz Bandwidth					
Modulation	RB Size	RB Offset	Mid Channel	MPR Allowed per 3GPP [dB]	MPR [dB]
			20525 (836.5 MHz)		
			Conducted Power [dBm]		
QPSK	1	0	23.15	0	0
	1	25	23.14		0
	1	49	23.11		0
	25	0	22.22	0-1	1
	25	12	22.20		1
	25	25	22.19		1
	50	0	22.20		1
16QAM	1	0	22.56	0-1	1
	1	25	22.50		1
	1	49	22.40		1
	25	0	21.22	0-2	2
	25	12	21.22		2
	25	25	21.30		2
	50	0	21.18		2
64QAM	1	0	21.35	0-2	2
	1	25	21.42		2
	1	49	21.44		2
	25	0	20.17	0-3	3
	25	12	20.24		3
	25	25	20.22		3
	50	0	20.21		3

FCC ID: PY7-76056F	SAR EVALUATION REPORT	Approved by: Technical Manager
Document S/N: 1M2205240063-03.PY7	DUT Type: Portable Handset	Page 45 of 111

9.3.5 LTE Band 66

Table 9-15
LTE Band 66 (AWS) Cellular Main 2 Antenna Measured P_{Max} for DSI=2 (Head) - 20 MHz Bandwidth

LTE Band 66 (AWS) 20 MHz Bandwidth							
Modulation	RB Size	RB Offset	Low Channel	Mid Channel	High Channel	MPR Allowed per 3GPP [dB]	MPR [dB]
			132072 (1720.0 MHz)	132322 (1745.0 MHz)	132572 (1770.0 MHz)		
			Conducted Power [dBm]				
QPSK	1	0	23.88	23.95	23.63	0	0
	1	50	24.00	23.96	23.68		0
	1	99	23.90	23.99	23.56		0
	50	0	22.96	22.82	22.85	0-1	1
	50	25	23.02	23.00	22.95		1
	50	50	22.94	22.90	22.93		1
100	0	22.91	22.92	22.91	1		
16QAM	1	0	23.06	23.10	23.15	0-1	1
	1	50	23.37	23.45	23.30		1
	1	99	23.15	23.33	23.20		1
	50	0	21.98	21.93	21.95	0-2	2
	50	25	21.97	21.92	21.96		2
	50	50	21.92	21.95	21.89		2
100	0	21.98	21.95	21.97	2		
64QAM	1	0	22.02	22.27	22.09	0-2	2
	1	50	22.23	22.39	22.26		2
	1	99	22.10	22.25	22.12		2
	50	0	20.96	20.86	20.93	0-3	3
	50	25	20.96	20.88	20.96		3
	50	50	20.93	20.78	20.95		3
100	0	20.96	20.82	20.99	3		

Table 9-16
LTE Band 66 (AWS) Cellular Main 2 Antenna Measured P_{limit} for DSI = 3 (Body-worn, Hotspot or Phablet) - 20 MHz Bandwidth

LTE Band 66 (AWS) 20 MHz Bandwidth							
Modulation	RB Size	RB Offset	Low Channel	Mid Channel	High Channel	MPR Allowed per 3GPP [dB]	MPR [dB]
			132072 (1720.0 MHz)	132322 (1745.0 MHz)	132572 (1770.0 MHz)		
			Conducted Power [dBm]				
QPSK	1	0	18.03	17.78	17.97	0	0
	1	50	18.10	17.88	17.85		0
	1	99	17.92	17.83	17.92		0
	50	0	18.08	17.85	17.75	0-1	0
	50	25	18.09	17.92	17.83		0
	50	50	18.06	17.88	17.83		0
100	0	18.04	17.87	17.78	0		
16QAM	1	0	18.40	18.06	18.05	0-1	0
	1	50	18.50	18.35	18.38		0
	1	99	18.30	17.92	18.32		0
	50	0	18.18	17.87	17.81	0-2	0
	50	25	18.11	17.90	17.85		0
	50	50	18.11	17.89	17.91		0
100	0	18.06	17.89	17.91	0		
64QAM	1	0	18.29	18.00	18.01	0-2	0
	1	50	18.41	18.11	18.15		0
	1	99	18.18	17.90	18.06		0
	50	0	18.16	17.89	17.84	0-3	0
	50	25	18.13	17.97	17.79		0
	50	50	18.09	17.86	17.87		0
100	0	18.04	17.89	17.94	0		

FCC ID: PY7-76056F	SAR EVALUATION REPORT	Approved by: Technical Manager
Document S/N: 1M2205240063-03.PY7	DUT Type: Portable Handset	Page 46 of 111

Table 9-17
LTE Band 66 Cellular Sub Antenna (AWS) Measured P_{Max} for all DSI – 20 MHz Bandwidth

LTE Band 66 (AWS) 20 MHz Bandwidth							
Modulation	RB Size	RB Offset	Low Channel	Mid Channel	High Channel	MPR Allowed per 3GPP [dB]	MPR [dB]
			132072 (1720.0 MHz)	132322 (1745.0 MHz)	132572 (1770.0 MHz)		
			Conducted Power [dBm]				
QPSK	1	0	15.83	15.85	15.76	0	0
	1	50	15.71	15.72	15.87		0
	1	99	15.85	15.86	15.66		0
	50	0	15.70	15.71	15.70	0-1	0
	50	25	15.67	15.68	15.73		0
	50	50	15.69	15.72	15.78		0
100	0	15.68	15.68	15.73	0		
16QAM	1	0	15.99	15.98	16.00	0-1	0
	1	50	15.98	15.97	15.98		0
	1	99	15.92	15.87	15.85		0
	50	0	15.75	15.73	15.72	0-2	0
	50	25	15.72	15.71	15.76		0
	50	50	15.68	15.72	15.78		0
100	0	15.74	15.75	15.76	0		
64QAM	1	0	15.88	15.88	15.80	0-2	0
	1	50	15.97	15.88	15.89		0
	1	99	15.87	15.78	15.79		0
	50	0	15.68	15.76	15.74	0-3	0
	50	25	15.71	15.69	15.74		0
	50	50	15.70	15.68	15.76		0
100	0	15.73	15.66	15.71	0		

9.3.1 LTE Band 25

Table 9-18
LTE Band 25 (PCS) Measured P_{Max} for DSI=2 (Head) - 20 MHz Bandwidth

LTE Band 25 (PCS) 20 MHz Bandwidth							
Modulation	RB Size	RB Offset	Low Channel	Mid Channel	High Channel	MPR Allowed per 3GPP [dB]	MPR [dB]
			26140 (1860.0 MHz)	26365 (1882.5 MHz)	26590 (1905.0 MHz)		
			Conducted Power [dBm]				
QPSK	1	0	23.86	23.45	23.65	0	0
	1	50	23.95	23.55	23.72		0
	1	99	23.82	23.48	23.61		0
	50	0	22.82	22.78	22.75	0-1	1
	50	25	22.88	22.81	22.77		1
	50	50	22.87	22.84	22.74		1
100	0	22.86	22.81	22.76	1		
16QAM	1	0	23.09	22.92	22.89	0-1	1
	1	50	23.29	23.25	23.05		1
	1	99	23.02	23.05	22.85		1
	50	0	21.85	21.85	21.77	0-2	2
	50	25	21.90	21.86	21.76		2
	50	50	21.85	21.82	21.79		2
100	0	21.90	21.79	21.74	2		
64QAM	1	0	22.12	21.95	21.69	0-2	2
	1	50	22.25	22.12	21.84		2
	1	99	22.05	21.90	21.95		2
	50	0	20.81	20.79	20.73	0-3	3
	50	25	20.89	20.81	20.76		3
	50	50	20.87	20.86	20.70		3
100	0	20.86	20.84	20.72	3		

FCC ID: PY7-76056F	SAR EVALUATION REPORT	Approved by: Technical Manager
Document S/N: 1M2205240063-03.PY7	DUT Type: Portable Handset	Page 47 of 111

Table 9-19

LTE Band 25 (PCS) Measured P_{Limit} for DSI = 3 (Body-worn, Hotspot or Phablet) - 20 MHz Bandwidth

LTE Band 25 (PCS) 20 MHz Bandwidth							
Modulation	RB Size	RB Offset	Low Channel	Mid Channel	High Channel	MPR Allowed per 3GPP [dB]	MPR [dB]
			26140 (1860.0 MHz)	26365 (1882.5 MHz)	26590 (1905.0 MHz)		
			Conducted Power [dBm]				
QPSK	1	0	18.62	18.40	18.62	0	0
	1	50	18.59	18.41	18.61		0
	1	99	18.52	18.32	18.43		0
	50	0	18.66	18.63	18.70	0-1	0
	50	25	18.66	18.65	18.58		0
	50	50	18.64	18.59	18.52		0
	100	0	18.60	18.61	18.60		0
16QAM	1	0	18.73	18.81	18.87	0-1	0
	1	50	18.81	18.98	18.86		0
	1	99	18.72	18.87	18.69		0
	50	0	18.66	18.66	18.61	0-2	0
	50	25	18.71	18.68	18.61		0
	50	50	18.68	18.61	18.54		0
	100	0	18.71	18.61	18.62		0
64QAM	1	0	18.85	18.72	18.86	0-2	0
	1	50	19.03	18.99	18.81		0
	1	99	18.77	18.74	18.77		0
	50	0	18.67	18.64	18.60	0-3	0
	50	25	18.73	18.67	18.61		0
	50	50	18.66	18.60	18.57		0
	100	0	18.73	18.62	18.62		0

9.3.1 LTE Band 2

Table 9-20

LTE Band 2 Cellular Sub Antenna (AWS) Measured P_{Max} for all DSI – 20 MHz Bandwidth

LTE Band 2 (PCS) 20 MHz Bandwidth							
Modulation	RB Size	RB Offset	Low Channel	Mid Channel	High Channel	MPR Allowed per 3GPP [dB]	MPR [dB]
			18700 (1860.0 MHz)	18900 (1880.0 MHz)	19100 (1900.0 MHz)		
			Conducted Power [dBm]				
QPSK	1	0	14.65	14.76	14.62	0	0
	1	50	14.78	14.71	14.79		0
	1	99	14.86	14.67	14.61		0
	50	0	14.71	14.72	14.77	0-1	0
	50	25	14.82	14.73	14.81		0
	50	50	14.84	14.69	14.69		0
	100	0	14.81	14.72	14.80		0
16QAM	1	0	14.89	15.07	14.98	0-1	0
	1	50	15.05	15.05	15.06		0
	1	99	15.01	14.97	14.81		0
	50	0	14.74	14.81	14.77	0-2	0
	50	25	14.81	14.78	14.82		0
	50	50	14.82	14.75	14.73		0
	100	0	14.80	14.81	14.74		0
64QAM	1	0	14.90	14.93	14.94	0-2	0
	1	50	14.96	14.94	15.07		0
	1	99	14.86	14.86	14.80		0
	50	0	14.69	14.76	14.79	0-3	0
	50	25	14.78	14.77	14.84		0
	50	50	14.81	14.72	14.73		0
	100	0	14.80	14.75	14.76		0

FCC ID: PY7-76056F	SAR EVALUATION REPORT	Approved by: Technical Manager
Document S/N: 1M2205240063-03.PY7	DUT Type: Portable Handset	Page 48 of 111

9.3.2 LTE Band 41

Table 9-21
LTE Band 41 PC3 Measured P_{Max} for DSI=2 (Head) - 20 MHz Bandwidth

LTE Band 41 20 MHz Bandwidth									
Modulation	RB Size	RB Offset	Low Channel	Low-Mid Channel	Mid Channel	Mid-High Channel	High Channel	MPR Allowed per 3GPP [dB]	MPR [dB]
			39750 (2506.0 MHz)	40185 (2549.5 MHz)	40620 (2593.0 MHz)	41055 (2636.5 MHz)	41490 (2680.0 MHz)		
			Conducted Power [dBm]						
QPSK	1	0	23.29	23.26	23.45	23.00	23.00	0	0
	1	50	23.25	23.39	23.40	23.21	23.27		0
	1	99	23.20	23.33	23.41	23.00	23.16		0
	50	0	22.36	22.32	22.45	22.19	22.01	0-1	1
	50	25	22.39	22.35	22.42	22.28	22.30		1
	50	50	22.35	22.31	22.43	22.16	22.31		1
16QAM	100	0	22.37	22.38	22.44	22.15	22.11	1	
	1	0	22.16	22.15	22.43	22.14	22.02	0-1	1
	1	50	22.25	22.44	22.37	22.78	22.63		1
	1	99	22.19	22.19	22.40	22.08	22.38		1
	50	0	21.39	21.30	21.42	21.21	21.06	0-2	2
	50	25	21.36	21.33	21.45	21.26	21.27		2
50	50	21.35	21.34	21.39	21.18	21.28	2		
64QAM	100	0	21.33	21.35	21.41	21.15	21.08	2	
	1	0	21.15	21.14	21.30	20.99	20.72	0-2	2
	1	50	21.34	21.35	21.31	21.44	21.35		2
	1	99	21.26	21.26	21.38	20.99	21.15		2
	50	0	20.42	20.36	20.41	20.24	20.05	0-3	3
	50	25	20.39	20.37	20.38	20.32	20.23		3
50	50	20.39	20.34	20.39	20.25	20.29	3		
100	0	20.41	20.36	20.40	20.29	20.13	3		

Table 9-22
LTE Band 41 PC3 Measured P_{Limit} DSI = 3 (Body-worn, Hotspot or Phablet) – 20 MHz Bandwidth

LTE Band 41 20 MHz Bandwidth									
Modulation	RB Size	RB Offset	Low Channel	Low-Mid Channel	Mid Channel	Mid-High Channel	High Channel	MPR Allowed per 3GPP [dB]	MPR [dB]
			39750 (2506.0 MHz)	40185 (2549.5 MHz)	40620 (2593.0 MHz)	41055 (2636.5 MHz)	41490 (2680.0 MHz)		
			Conducted Power [dBm]						
QPSK	1	0	18.81	18.58	18.98	18.51	18.40	0	0
	1	50	18.87	18.65	18.70	18.71	18.89		0
	1	99	18.70	18.56	18.81	18.27	18.86		0
	50	0	18.74	18.67	18.98	18.70	18.70	0-1	0
	50	25	18.73	18.76	18.94	18.78	18.82		0
	50	50	18.68	18.69	18.89	18.51	18.95		0
16QAM	100	0	18.76	18.73	18.94	18.63	18.77	0	
	1	0	19.16	18.80	18.91	18.58	18.56	0-1	0
	1	50	18.93	18.85	18.91	18.60	19.12		0
	1	99	19.06	18.76	18.99	18.22	18.57		0
	50	0	18.85	18.66	18.97	18.72	18.76	0-2	0
	50	25	18.78	18.77	18.99	18.71	18.87		0
50	50	18.67	18.77	18.94	18.61	18.93	0		
64QAM	100	0	18.82	18.76	18.89	18.73	18.79	0	
	1	0	19.12	18.86	19.01	18.60	18.48	0-2	0
	1	50	19.01	18.92	18.88	18.87	18.91		0
	1	99	18.80	18.64	18.86	18.38	18.97		0
	50	0	18.89	18.66	18.98	18.67	18.61	0-3	0
	50	25	18.71	18.81	18.84	18.74	18.79		0
50	50	18.69	18.68	18.85	18.68	18.87	0		
100	0	18.85	18.83	18.88	18.66	18.81	0		

FCC ID: PY7-76056F	SAR EVALUATION REPORT	Approved by: Technical Manager
Document S/N: 1M2205240063-03.PY7	DUT Type: Portable Handset	Page 49 of 111

9.3.1 LTE Band 48

Table 9-23
LTE Band 48 Measured P_{Max} for DSI=2 (Head) - 20 MHz Bandwidth

LTE Band 48 20 MHz Bandwidth								
Modulation	RB Size	RB Offset	Low Channel	Low-Mid Channel	Mid-High Channel	High Channel	MPR Allowed per 3GPP [dB]	MPR [dB]
			55340 (3560.0 MHz)	55773 (3603.3 MHz)	56207 (3646.7 MHz)	56640 (3690.0 MHz)		
			Conducted Power [dBm]					
QPSK	1	0	23.34	23.27	23.57	23.66	0	0
	1	50	23.39	23.40	23.57	23.69		0
	1	99	23.38	23.42	23.58	23.65		0
	50	0	22.46	22.38	22.58	22.73	0-1	1
	50	25	22.49	22.51	22.67	22.83		1
	50	50	22.51	22.50	22.67	22.84		1
16QAM	100	0	22.49	22.47	22.65	22.81	0-1	1
	1	0	22.45	22.24	22.48	22.76		1
	1	50	22.73	22.65	22.73	23.05		1
	1	99	22.44	22.38	22.47	22.75	0-2	1
	50	0	21.48	21.38	21.55	21.69		2
	50	25	21.51	21.50	21.64	21.81		2
64QAM	50	50	21.50	21.51	21.66	21.78	0-2	2
	100	0	21.49	21.50	21.64	21.79		2
	1	0	21.26	21.22	21.56	21.51		0-2
	1	50	21.45	21.45	21.73	21.63	2	
	1	99	21.26	21.40	21.67	21.55	0-3	
	50	0	20.47	20.40	20.52	20.69		3
50	25	20.49	20.47	20.65	20.80	3		
64QAM	50	50	20.50	20.48	20.61	20.79	0-3	3
	100	0	20.48	20.49	20.61	20.78		3

Table 9-24
LTE Band 48 Measured P_{Limit} DSI = 3 (Body-worn, Hotspot or Phablet) – 20 MHz Bandwidth

LTE Band 48 20 MHz Bandwidth								
Modulation	RB Size	RB Offset	Low Channel	Low-Mid Channel	Mid-High Channel	High Channel	MPR Allowed per 3GPP [dB]	MPR [dB]
			55340 (3560.0 MHz)	55773 (3603.3 MHz)	56207 (3646.7 MHz)	56640 (3690.0 MHz)		
			Conducted Power [dBm]					
QPSK	1	0	18.58	18.56	18.76	18.73	0	0
	1	50	18.61	18.52	18.98	18.75		0
	1	99	18.50	18.58	18.81	18.68		0
	50	0	18.77	18.58	18.77	18.88	0-1	0
	50	25	18.79	18.66	18.99	18.94		0
	50	50	18.80	18.75	18.95	18.96		0
16QAM	100	0	18.78	18.65	18.97	18.83	0-1	0
	1	0	18.80	18.60	18.72	18.65		0
	1	50	18.86	18.82	18.83	18.81		0
	1	99	18.58	18.74	18.87	18.89	0-2	0
	50	0	18.77	18.58	18.75	18.82		0
	50	25	18.87	18.73	18.94	19.02		0
64QAM	50	50	18.76	18.66	18.99	18.94	0-2	0
	100	0	18.78	18.69	19.01	19.01		0
	1	0	18.75	18.52	18.61	18.70		0-2
	1	50	18.68	18.81	18.84	18.80	0	
	1	99	18.57	18.64	18.83	18.71	0-3	
	50	0	18.80	18.66	18.77	18.87		0
50	25	18.72	18.73	18.91	18.90	0		
64QAM	50	50	18.75	18.69	18.88	19.01	0-3	0
	100	0	18.85	18.68	18.97	18.91		0

FCC ID: PY7-76056F	SAR EVALUATION REPORT		Approved by: Technical Manager
Document S/N: 1M2205240063-03.PY7	DUT Type: Portable Handset		Page 50 of 111



**Figure 9-3
Power Measurement Setup**

9.4 NR Conducted Powers

Per October 2020 TCB Workshop Guidance, NR FR1 SAR evaluations are being generally based on adapting the existing LTE SAR procedures (FCC KDB Publication 941225 D05v02r05). Therefore, NR SAR for the lower bandwidths was not required for testing based on the measured output power and the reported NR SAR for the highest bandwidth. Lower bandwidth conducted powers for all NR bands can be found in the LTE and NR Lower Bandwidth Conducted Powers Appendix.

Note: Some bands do not support non-overlapping channels. Per FCC Guidance, when a device supports overlapping channel assignment in a channel bandwidth configuration, the middle channel of the group of overlapping channels should be selected for testing.

FCC ID: PY7-76056F	SAR EVALUATION REPORT	Approved by: Technical Manager
Document S/N: 1M2205240063-03.PY7	DUT Type: Portable Handset	Page 51 of 111

REV 22.0
03/30/2022

9.4.1 NR Band n71

**Table 9-25
NR Band n71 Measured P_{Max} for DSI=2 (Head) - 20 MHz Bandwidth**

NR Band n71 20 MHz Bandwidth					
Modulation	RB Size	RB Offset	Channel	MPR Allowed per 3GPP [dB]	MPR [dB]
			136100 (680.5 MHz) Conducted Power [dBm]		
DFT-s-OFDM $\pi/2$ BPSK	1	1	23.53	0	0.0
	1	53	23.46		0.0
	1	104	23.53		0.0
	50	0	23.09	0-0.5	0.5
	50	28	23.52	0	0.0
	50	56	23.13	0-0.5	0.5
	100	0	23.07		0.5
DFT-s-OFDM QPSK	1	1	23.61	0	0.0
	1	53	23.54		0.0
	1	104	23.51		0.0
	50	0	22.61	0-1	1.0
	50	28	23.52	0	0.0
	50	56	22.63	0-1	1.0
	100	0	22.58		1.0
DFT-s-OFDM 16QAM	1	1	22.60	0-1	1.0
CP-OFDM QPSK	1	1	22.20	0-1.5	1.5

FCC ID: PY7-76056F	SAR EVALUATION REPORT	Approved by: Technical Manager
Document S/N: 1M2205240063-03.PY7	DUT Type: Portable Handset	Page 52 of 111

**Table 9-26
NR Band n71 Measured P_{Limit} DSI = 3 (Body-worn, Hotspot or Phablet) - 20 MHz Bandwidth**

NR Band n71 20 MHz Bandwidth					
Modulation	RB Size	RB Offset	Channel	MPR Allowed per 3GPP [dB]	MPR [dB]
			136100 (680.5 MHz) Conducted Power [dBm]		
DFT-s-OFDM $\pi/2$ BPSK	1	1	22.36	0	0.0
	1	53	22.24		0.0
	1	104	22.38		0.0
	50	0	22.43	0-0.5	0.0
	50	28	22.35	0	0.0
	50	56	22.46	0-0.5	0.0
	100	0	22.40		0.0
DFT-s-OFDM QPSK	1	1	22.41	0	0.0
	1	53	22.42		0.0
	1	104	22.48		0.0
	50	0	22.40	0-1	0.0
	50	28	22.33	0	0.0
	50	56	22.48	0-1	0.0
	100	0	22.39		0.0
DFT-s-OFDM 16QAM	1	1	22.38	0-1	0.0
CP-OFDM QPSK	1	1	21.95	0-1.5	0.5

FCC ID: PY7-76056F	SAR EVALUATION REPORT	Approved by: Technical Manager
Document S/N: 1M2205240063-03.PY7	DUT Type: Portable Handset	Page 53 of 111

9.4.2 NR Band n5

Table 9-27
NR Band n5 Cellular Main 1 Antenna Measured P_{Max} for DSI=2 (Head) - 20 MHz Bandwidth

NR Band n5 20 MHz Bandwidth					
Modulation	RB Size	RB Offset	Channel	MPR Allowed per 3GPP [dB]	MPR [dB]
			167300 (836.5 MHz) Conducted Power [dBm]		
DFT-s-OFDM $\pi/2$ BPSK	1	1	23.71	0	0.0
	1	53	23.56		0.0
	1	104	23.56		0.0
	50	0	23.29	0-0.5	0.5
	50	28	23.66	0	0.0
	50	56	23.20	0-0.5	0.5
	100	0	23.22		0.5
DFT-s-OFDM QPSK	1	1	23.76	0	0.0
	1	53	23.64		0.0
	1	104	23.66		0.0
	50	0	22.75	0-1	1.0
	50	28	23.71	0	0.0
	50	56	22.68	0-1	1.0
	100	0	22.68		1.0
DFT-s-OFDM 16QAM	1	1	22.63	0-1	1.0
CP-OFDM QPSK	1	1	22.31	0-1.5	1.5

FCC ID: PY7-76056F	SAR EVALUATION REPORT	Approved by: Technical Manager
Document S/N: 1M2205240063-03.PY7	DUT Type: Portable Handset	Page 54 of 111

REV 22.0
03/30/2022

Table 9-28
NR Band n5 Cellular Main 1 Antenna Measured P_{Limit} DSI = 3 (Body-worn, Hotspot or Phablet)
- 20 MHz Bandwidth

NR Band n5 20 MHz Bandwidth					
Modulation	RB Size	RB Offset	Channel	MPR Allowed per 3GPP [dB]	MPR [dB]
			167300 (836.5 MHz)		
			Conducted Power [dBm]		
DFT-s-OFDM $\pi/2$ BPSK	1	1	20.66	0	0.0
	1	53	20.54		0.0
	1	104	20.60		0.0
	50	0	20.69	0-0.5	0.0
	50	28	20.61	0	0.0
	50	56	20.64	0-0.5	0.0
	100	0	20.63		0.0
DFT-s-OFDM QPSK	1	1	20.69	0	0.0
	1	53	20.60		0.0
	1	104	20.60		0.0
	50	0	20.71	0-1	0.0
	50	28	20.62	0	0.0
	50	56	20.63	0-1	0.0
	100	0	20.67		0.0
DFT-s-OFDM 16QAM	1	1	20.64	0-1	0.0
CP-OFDM QPSK	1	1	20.66	0-1.5	0.0

FCC ID: PY7-76056F	SAR EVALUATION REPORT	Approved by: Technical Manager
Document S/N: 1M2205240063-03.PY7	DUT Type: Portable Handset	Page 55 of 111

Table 9-29
NR Band n5 Cellular Sub Antenna Measured P_{Limit} DSI = 3 (Body-worn, Hotspot or Phablet)
- 20 MHz Bandwidth

NR Band n5 20 MHz Bandwidth					
Modulation	RB Size	RB Offset	Channel	MPR Allowed per 3GPP [dB]	MPR [dB]
			167300 (836.5 MHz) Conducted Power [dBm]		
DFT-s-OFDM $\pi/2$ BPSK	1	1	22.73	0	0.0
	1	53	22.69		0.0
	1	104	22.67		0.0
	50	0	22.75	0-0.5	0.5
	50	28	22.74	0	0.0
	50	56	22.62	0-0.5	0.5
	100	0	22.75		0.5
DFT-s-OFDM QPSK	1	1	22.70	0	0.0
	1	53	22.69		0.0
	1	104	22.74		0.0
	50	0	22.19	0-1	1.0
	50	28	22.72	0	0.0
	50	56	22.25	0-1	1.0
	100	0	22.27		1.0
DFT-s-OFDM 16QAM	1	1	22.34	0-1	1.0
CP-OFDM QPSK	1	1	21.53	0-1.5	1.5

FCC ID: PY7-76056F	SAR EVALUATION REPORT	Approved by: Technical Manager
Document S/N: 1M2205240063-03.PY7	DUT Type: Portable Handset	Page 56 of 111

9.4.3 NR Band n66

Table 9-30
NR Band n66 Measured P_{Max} for DSI=2 (Head) - 20 MHz Bandwidth

NR Band n66 20 MHz Bandwidth							
Modulation	RB Size	RB Offset	Channel			MPR Allowed per 3GPP [dB]	MPR [dB]
			344000 (1720 MHz)	349000 (1745 MHz)	354000 (1770 MHz)		
			Conducted Power [dBm]				
DFT-s-OFDM $\pi/2$ BPSK	1	1	23.18	23.40	23.30	0	0.0
	1	53	23.06	23.36	23.17		0.0
	1	104	23.17	23.37	23.19		0.0
	50	0	22.77	22.90	22.82	0-0.5	0.5
	50	28	23.23	23.37	23.32	0	0.0
	50	56	22.70	22.96	22.70	0-0.5	0.5
	100	0	22.72	22.87	22.73		0.5
DFT-s-OFDM QPSK	1	1	23.26	23.34	23.30	0	0.0
	1	53	23.17	23.33	23.10		0.0
	1	104	23.24	23.36	23.20		0.0
	50	0	22.27	22.41	22.20	0-1	1.0
	50	28	23.17	23.40	23.14	0	0.0
	50	56	22.22	22.44	22.13	0-1	1.0
	100	0	22.25	22.35	22.20		1.0
DFT-s-OFDM 16QAM	1	1	22.23	22.35	22.46	0-1	1.0
CP-OFDM QPSK	1	1	21.93	22.15	21.93	0-1.5	1.5

FCC ID: PY7-76056F	SAR EVALUATION REPORT	Approved by: Technical Manager
Document S/N: 1M2205240063-03.PY7	DUT Type: Portable Handset	Page 57 of 111

Table 9-31
NR Band n66 Measured P_{Limit} DSI = 3 (Body-worn, Hotspot or Phablet) - 20 MHz Bandwidth

NR Band n66 20 MHz Bandwidth							
Modulation	RB Size	RB Offset	Channel			MPR Allowed per 3GPP [dB]	MPR [dB]
			344000 (1720 MHz)	349000 (1745 MHz)	354000 (1770 MHz)		
			Conducted Power [dBm]				
DFT-s-OFDM $\pi/2$ BPSK	1	1	17.64	17.60	17.51	0	0.0
	1	53	17.58	17.63	17.42		0.0
	1	104	17.66	17.59	17.36		0.0
	50	0	17.70	17.69	17.48	0-0.5	0.0
	50	28	17.63	17.67	17.44	0	0.0
	50	56	17.60	17.65	17.42	0-0.5	0.0
	100	0	17.71	17.71	17.47		0.0
DFT-s-OFDM QPSK	1	1	17.70	17.65	17.52	0	0.0
	1	53	17.58	17.65	17.42		0.0
	1	104	17.67	17.68	17.44		0.0
	50	0	17.68	17.70	17.48	0-1	0.0
	50	28	17.63	17.70	17.41	0	0.0
	50	56	17.71	17.64	17.42	0-1	0.0
	100	0	17.66	17.69	17.49		0.0
DFT-s-OFDM 16QAM	1	1	17.60	17.53	17.48	0-1	0.0
CP-OFDM QPSK	1	1	17.85	17.62	17.53	0-1.5	0.0

FCC ID: PY7-76056F	SAR EVALUATION REPORT	Approved by: Technical Manager
Document S/N: 1M2205240063-03.PY7	DUT Type: Portable Handset	Page 58 of 111

9.4.4 NR Band n2

Table 9-32
NR Band n2 Measured P_{Max} for DSI=2 (Head) - 20 MHz Bandwidth

NR Band n2 20 MHz Bandwidth							
Modulation	RB Size	RB Offset	Channel			MPR Allowed per 3GPP [dB]	MPR [dB]
			372000 (1860 MHz)	376000 (1880 MHz)	380000 (1900 MHz)		
			Conducted Power [dBm]				
DFT-s-OFDM $\pi/2$ BPSK	1	1	23.38	23.10	23.30	0	0.0
	1	53	23.29	23.07	23.27		0.0
	1	104	23.12	23.18	23.21		0.0
	50	0	22.58	22.60	22.72	0-0.5	0.5
	50	28	23.02	23.11	23.30	0	0.0
	50	56	22.55	22.63	22.74	0-0.5	0.5
	100	0	22.56	22.60	22.77		0.5
DFT-s-OFDM QPSK	1	1	23.10	23.15	23.19	0	0.0
	1	53	23.03	23.14	23.31		0.0
	1	104	23.11	23.10	23.24		0.0
	50	0	22.06	22.01	22.15	0-1	1.0
	50	28	23.05	23.11	23.24	0	0.0
	50	56	22.06	22.07	22.24	0-1	1.0
	100	0	22.08	22.22	22.30		1.0
DFT-s-OFDM 16QAM	1	1	22.05	22.14	22.20	0-1	1.0
CP-OFDM QPSK	1	1	21.62	21.95	21.84	0-1.5	1.5

FCC ID: PY7-76056F	SAR EVALUATION REPORT	Approved by: Technical Manager
Document S/N: 1M2205240063-03.PY7	DUT Type: Portable Handset	Page 59 of 111

Table 9-33
NR Band n2 Measured P_{Limit} for DSI = 3 (Body-worn, Hotspot or Phablet) - 20 MHz Bandwidth

NR Band n2 20 MHz Bandwidth							
Modulation	RB Size	RB Offset	Channel			MPR Allowed per 3GPP [dB]	MPR [dB]
			372000 (1860 MHz)	376000 (1880 MHz)	380000 (1900 MHz)		
			Conducted Power [dBm]				
DFT-s-OFDM $\pi/2$ BPSK	1	1	18.31	18.16	18.30	0	0.0
	1	53	18.31	18.18	18.35		0.0
	1	104	18.23	18.22	18.34		0.0
	50	0	18.29	18.14	18.27	0-0.5	0.0
	50	28	18.34	18.15	18.37	0	0.0
	50	56	18.25	18.23	18.40	0-0.5	0.0
	100	0	18.33	18.15	18.39		0.0
DFT-s-OFDM QPSK	1	1	18.37	18.17	18.34	0	0.0
	1	53	18.34	18.17	18.36		0.0
	1	104	18.31	18.25	18.35		0.0
	50	0	18.30	18.17	18.26	0-1	0.0
	50	28	18.34	18.16	18.33	0	0.0
	50	56	18.27	18.24	18.30	0-1	0.0
	100	0	18.31	18.23	18.33		0.0
DFT-s-OFDM 16QAM	1	1	18.36	18.17	18.32	0-1	0.0
CP-OFDM QPSK	1	1	18.30	18.35	18.35	0-1.5	0.0

FCC ID: PY7-76056F	SAR EVALUATION REPORT	Approved by: Technical Manager
Document S/N: 1M2205240063-03.PY7	DUT Type: Portable Handset	Page 60 of 111

9.4.5 NR Band n41

Table 9-34

NR Band n41 PC2 Cellular Main 2 Antenna Measured P_{Max} for DSI = 2 (Head) - 100 MHz Bandwidth

NR Band n41 100 MHz Bandwidth					
Modulation	RB Size	RB Offset	Channel	MPR Allowed per 3GPP [dB]	MPR [dB]
			518598 (2592.99 MHz) Conducted Power [dBm]		
DFT-s-OFDM $\pi/2$ BPSK	1	1	25.43	0	0.0
	1	137	25.58		0.0
	1	271	25.21		0.0
	135	0	24.98	0-0.5	0.5
	135	69	25.48	0	0.0
	135	138	24.80	0-0.5	0.5
	270	0	24.96		0.5
DFT-s-OFDM QPSK	1	1	25.54	0	0.0
	1	137	25.53		0.0
	1	271	25.13		0.0
	135	0	24.31	0-1	1.0
	135	69	25.32	0	0.0
	135	138	24.24	0-1	1.0
	270	0	24.42		1.0
DFT-s-OFDM 16QAM	1	1	24.15	0-1	1.0
CP-OFDM QPSK	1	1	23.84	0-1.5	1.5

FCC ID: PY7-76056F	SAR EVALUATION REPORT	Approved by: Technical Manager
Document S/N: 1M2205240063-03.PY7	DUT Type: Portable Handset	Page 61 of 111

Table 9-35
NR Band n41 PC2 Cellular Main 2 Antenna Measured P_{Limit} for DSI = 3 (Body-worn, Hotspot or Phablet) -
100 MHz Bandwidth

NR Band n41 100 MHz Bandwidth					
Modulation	RB Size	RB Offset	Channel	MPR Allowed per 3GPP [dB]	MPR [dB]
			518598 (2592.99 MHz)		
			Conducted Power [dBm]		
DFT-s-OFDM $\pi/2$ BPSK	1	1	19.30	0	0.0
	1	137	19.36		0.0
	1	271	19.21		0.0
	135	0	19.33	0-0.5	0.0
	135	69	19.32	0	0.0
	135	138	19.25	0-0.5	0.0
	270	0	19.26		0.0
DFT-s-OFDM QPSK	1	1	19.31	0	0.0
	1	137	19.34		0.0
	1	271	19.22		0.0
	135	0	19.33	0-1	0.0
	135	69	19.35	0	0.0
	135	138	19.31	0-1	0.0
	270	0	19.23		0.0
DFT-s-OFDM 16QAM	1	1	19.55	0-1	0.0
CP-OFDM QPSK	1	1	19.13	0-1.5	0.0

FCC ID: PY7-76056F	SAR EVALUATION REPORT	Approved by: Technical Manager
Document S/N: 1M2205240063-03.PY7	DUT Type: Portable Handset	Page 62 of 111

Table 9-36
NR Band n41 Sub Antenna Measured P_{Max} for all DSI - 100 MHz Bandwidth

NR Band n41 100 MHz Bandwidth						
Modulation	RB Size	RB Offset	Channel		MPR Allowed per 3GPP [dB]	MPR [dB]
			518598 (2592.99 MHz)	Conducted Power [dBm]		
CP-OFDM QPSK	1	1	17.50		0-1.5	0.0
	1	137	17.59			0.0
	1	271	17.66			0.0
	1	272	17.44		0-3	0.0
	137	0	17.51			0.0
	137	68	17.70		0-1.5	0.0
	137	136	17.50		0-3	0.0
	273	0	17.90			0.0

9.4.6 NR Band n77 C-Band

Table 9-37
NR Band n77 PC2 Cellular Main 1 Antenna Measured P_{Max} for DSI = 2 (Head) - 100 MHz Bandwidth

NR Band n77 100 MHz Bandwidth						
Modulation	RB Size	RB Offset	Channel		MPR Allowed per 3GPP [dB]	MPR [dB]
			650000 (3750 MHz)	662000 (3930 MHz)		
			Conducted Power [dBm]			
DFT-s-OFDM $\pi/2$ BPSK	1	1	25.10	25.26	0	0.0
	1	137	25.30	25.82		0.0
	1	271	25.01	25.22		0.0
	135	0	24.79	25.15	0-0.5	0.5
	135	69	25.28	25.61	0	0.0
	135	138	24.57	24.86	0-0.5	0.5
	270	0	24.70	25.03		0.5
DFT-s-OFDM QPSK	1	1	25.09	25.27	0	0.0
	1	137	25.30	25.65		0.0
	1	271	25.07	25.10		0.0
	135	0	24.30	24.51	0-1	1.0
	135	69	25.23	25.60	0	0.0
	135	138	24.07	24.36	0-1	1.0
	270	0	24.14	24.46		1.0
DFT-s-OFDM 16QAM	1	1	24.35	24.61	0-1	1.0
CP-OFDM QPSK	1	1	23.55	23.56	0-1.5	1.5

FCC ID: PY7-76056F	SAR EVALUATION REPORT	Approved by: Technical Manager
Document S/N: 1M2205240063-03.PY7	DUT Type: Portable Handset	Page 63 of 111

Table 9-38
NR Band n77 PC2 Cellular Main 1 Antenna Measured P_{Limit} for DSI = 3 (Body-worn, Hotspot or Phablet) - 100 MHz Bandwidth

NR Band n77 100 MHz Bandwidth						
Modulation	RB Size	RB Offset	Channel		MPR Allowed per 3GPP [dB]	MPR [dB]
			650000 (3750 MHz)	662000 (3930 MHz)		
			Conducted Power [dBm]			
DFT-s-OFDM $\pi/2$ BPSK	1	1	17.28	17.16	0	0.0
	1	137	17.23	17.58		0.0
	1	271	17.05	17.25		0.0
	135	0	17.35	17.39	0-0.5	0.0
	135	69	17.19	17.43	0	0.0
	135	138	17.01	17.30	0-0.5	0.0
	270	0	17.21	17.32		0.0
DFT-s-OFDM QPSK	1	1	17.27	17.12	0	0.0
	1	137	17.24	17.52		0.0
	1	271	16.78	17.12		0.0
	135	0	17.36	17.42	0-1	0.0
	135	69	17.15	17.39	0	0.0
	135	138	17.11	17.26	0-1	0.0
	270	0	17.17	17.31		0.0
DFT-s-OFDM 16QAM	1	1	17.28	17.43	0-1	0.0
CP-OFDM QPSK	1	1	16.96	17.10	0-1.5	0.0

Table 9-39
NR Band n77 Sub Antenna Measured P_{max} for all DSI - 100 MHz Bandwidth

NR Band n77 100 MHz Bandwidth						
Modulation	RB Size	RB Offset	Channel		MPR Allowed per 3GPP [dB]	MPR [dB]
			650000 (3750 MHz)	662000 (3930 MHz)		
			Conducted Power [dBm]			
CP-OFDM QPSK	1	1	14.60	14.70	0-1.5	0.0
	1	137	14.78	14.79		0.0
	1	271	14.35	14.65		0.0
	1	272	14.56	14.71	0-3	0.0
	137	0	14.69	14.94		0.0
	137	68	14.65	15.00	0-1.5	0.0
	137	136	14.63	14.97	0-3	0.0
	273	0	14.66	14.76		0.0

FCC ID: PY7-76056F	SAR EVALUATION REPORT	Approved by: Technical Manager
Document S/N: 1M2205240063-03.PY7	DUT Type: Portable Handset	Page 64 of 111

Table I- 40
NR Band n77 Cellular 4th path Antenna Measured P_{Limit} for DSI = 3 (Body-worn, Hotspot or Phablet)
- 100 MHz Bandwidth

NR Band n77 100 MHz Bandwidth						
Modulation	RB Size	RB Offset	Channel		MPR Allowed per 3GPP [dB]	MPR [dB]
			650000 (3750 MHz)	662000 (3930 MHz)		
			Conducted Power [dBm]			
DFT-s-OFDM $\pi/2$ BPSK	1	1	16.49	16.88	0	0.0
	1	137	16.78	17.30		0.0
	1	271	16.81	16.89		0.0
	135	0	16.75	17.12	0-0.5	0.0
	135	69	16.76	17.27	0	0.0
	135	138	16.65	17.06	0-0.5	0.0
	270	0	16.70	17.05		0.0
DFT-s-OFDM QPSK	1	1	16.65	16.95	0	0.0
	1	137	16.87	17.30		0.0
	1	271	16.77	16.85		0.0
	135	0	16.81	17.11	0-1	0.0
	135	69	16.77	17.30	0	0.0
	135	138	16.70	17.10	0-1	0.0
	270	0	16.72	17.09		0.0
DFT-s-OFDM 16QAM	1	1	16.46	17.30	0-1	0.0
CP-OFDM QPSK	1	1	16.57	17.07	0-1.5	0.0

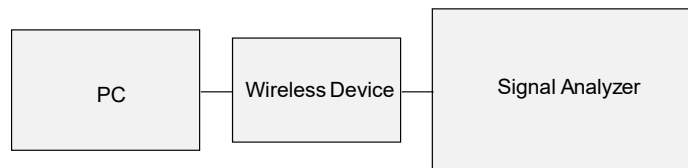

Figure 9-4
Power Measurement Setup

FCC ID: PY7-76056F	SAR EVALUATION REPORT	Approved by: Technical Manager
Document S/N: 1M2205240063-03.PY7	DUT Type: Portable Handset	Page 65 of 111

9.5 WLAN Conducted Powers

Table 9-41
2.4 GHz WLAN Maximum Average RF Power – Chain 0

2.4GHz Conducted Power [dBm]					
Freq [MHz]	Channel	IEEE Transmission Mode			
		802.11b	802.11g	802.11n	802.11ax
		Average	Average	Average	Average
2412	1	14.13	13.72	13.08	13.10
2417	2	14.08	N/A	14.42	14.42
2437	6	13.99	14.64	14.58	14.57
2457	10	13.92	N/A	14.66	14.55
2462	11	13.97	12.92	12.22	12.27

Table 9-42
2.4 GHz WLAN Maximum Average RF Power – Chain 1

2.4GHz Conducted Power [dBm]					
Freq [MHz]	Channel	IEEE Transmission Mode			
		802.11b	802.11g	802.11n	802.11ax
		Average	Average	Average	Average
2412	1	12.60	13.78	13.30	13.28
2417	2	12.57	N/A	14.50	14.55
2437	6	12.50	14.68	14.58	14.63
2457	10	12.39	N/A	14.77	14.47
2462	11	12.27	13.32	12.71	12.67

Table 9-43
2.4 GHz WLAN Reduced Average RF Power During Conditions with 5/6 GHz WLAN – Chain 0

2.4GHz Conducted Power [dBm]					
Freq [MHz]	Channel	IEEE Transmission Mode			
		802.11b	802.11g	802.11n	802.11ax
		Average	Average	Average	Average
2412	1	10.81	10.83	10.78	10.74
2437	6	10.52	10.39	10.94	10.76
2462	11	10.91	10.72	10.60	10.55

FCC ID: PY7-76056F	SAR EVALUATION REPORT	Approved by: Technical Manager
Document S/N: 1M2205240063-03.PY7	DUT Type: Portable Handset	Page 66 of 111

REV 22.0
03/30/2022

Table 9-44
5 GHz WLAN Maximum Average RF Power – Chain 0

5GHz (80MHz) Conducted Power [dBm]			
Freq [MHz]	Channel	IEEE Transmission Mode	
		802.11ac	802.11ax
		Average	Average
5210	42	10.96	11.05
5290	58	10.73	10.81
5530	106	10.65	10.71
5610	122	10.73	10.80
5690	138	11.28	11.40
5775	155	10.52	10.60

Table 9-45
5 GHz WLAN Maximum Average RF Power – Chain 1

5GHz (80MHz) Conducted Power [dBm]			
Freq [MHz]	Channel	IEEE Transmission Mode	
		802.11ac	802.11ax
		Average	Average
5210	42	11.38	11.12
5290	58	11.20	10.78
5530	106	11.36	11.03
5610	122	11.24	10.71
5690	138	11.12	11.13
5775	155	11.22	10.84

FCC ID: PY7-76056F	SAR EVALUATION REPORT	Approved by: Technical Manager
Document S/N: 1M2205240063-03.PY7	DUT Type: Portable Handset	Page 67 of 111

9.6 Bluetooth Conducted Powers

Table 9-46
Bluetooth Average RF Power – Chain 0

Frequency [MHz]	Data Rate [Mbps]	Mod.	Power Scheme	Channel No.	Avg Conducted Power	
					[dBm]	[mW]
2402	1.0	GFSK	ePA	0	12.29	16.924
2441	1.0	GFSK	ePA	39	12.44	17.545
2480	1.0	GFSK	ePA	78	13.88	24.444

Table 9-47
Bluetooth Average RF Power – Chain 1

Frequency [MHz]	Data Rate [Mbps]	Mod.	Power Scheme	Channel No.	Avg Conducted Power	
					[dBm]	[mW]
2402	1.0	GFSK	ePA	0	12.31	17.006
2441	1.0	GFSK	ePA	39	12.08	16.155
2480	1.0	GFSK	ePA	78	13.48	22.274

FCC ID: PY7-76056F	SAR EVALUATION REPORT	Approved by: Technical Manager
Document S/N: 1M2205240063-03.PY7	DUT Type: Portable Handset	Page 68 of 111

REV 22.0
03/30/2022

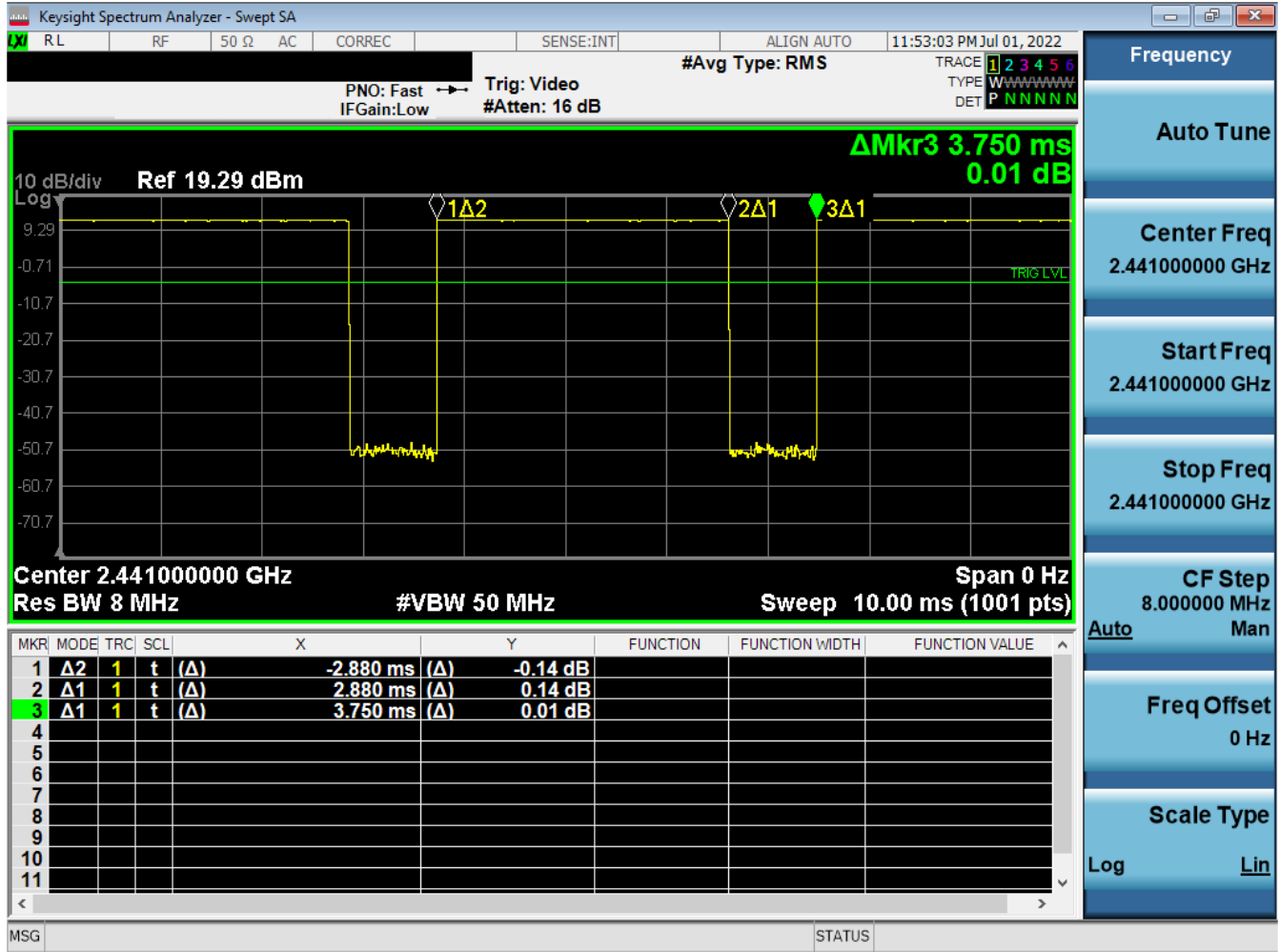

Figure 9-5
Bluetooth Chain 0 Transmission Plot

Equation 9-1
Bluetooth Chain 0 Duty Cycle Calculation

$$Duty\ Cycle = \frac{Pulse\ Width}{Period} * 100\% = \frac{2.88ms}{3.75ms} * 100\% = 76.8\%$$

FCC ID: PY7-76056F	SAR EVALUATION REPORT	Approved by: Technical Manager
Document S/N: 1M2205240063-03.PY7	DUT Type: Portable Handset	Page 69 of 111

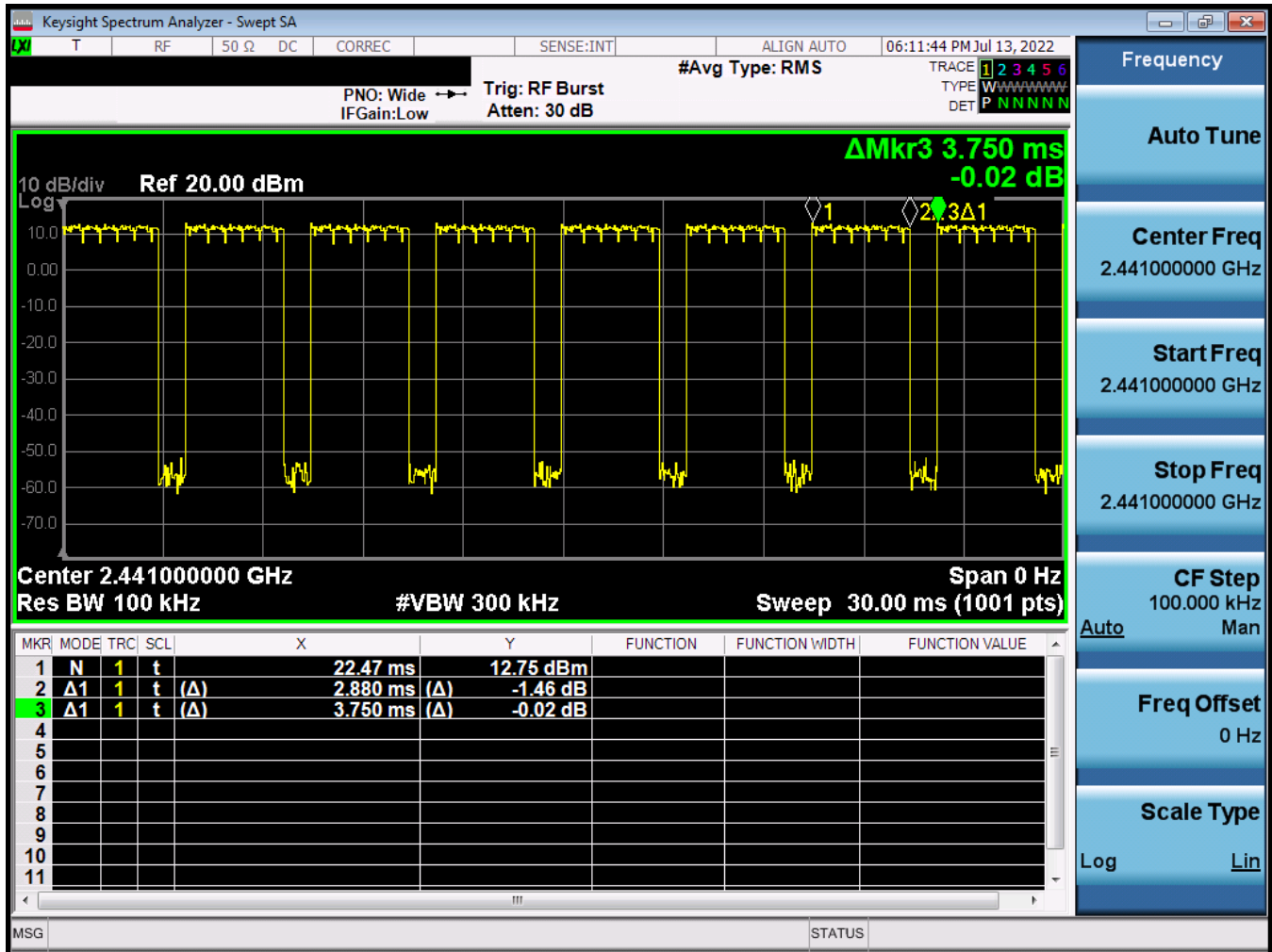

Figure 9-6
Bluetooth Chain 1 Transmission Plot

Equation 9-2
Bluetooth Chain 1 Duty Cycle Calculation

$$Duty\ Cycle = \frac{Pulse\ Width}{Period} * 100\% = \frac{2.88ms}{3.75ms} * 100\% = 76.8\%$$

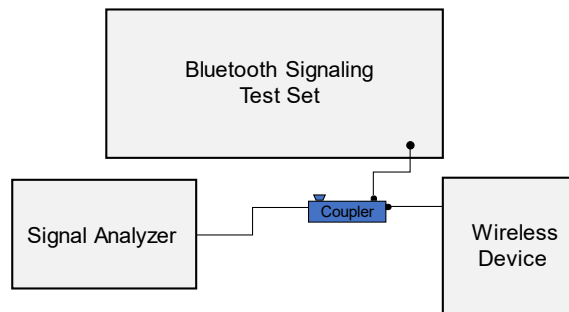

Figure 9-7
Power Measurement Setup

FCC ID: PY7-76056F	SAR EVALUATION REPORT	Approved by: Technical Manager
Document S/N: 1M2205240063-03.PY7	DUT Type: Portable Handset	Page 70 of 111

10 SYSTEM VERIFICATION

10.1 Tissue Verification

**Table 10-1
Measured Head Tissue Properties**

Calibrated for Tests Performed on:	Tissue Type	Tissue Temp During Calibration (°C)	Measured Frequency (MHz)	Measured Conductivity, σ (S/m)	Measured Dielectric Constant, ϵ	TARGET Conductivity, σ (S/m)	TARGET Dielectric Constant, ϵ	% dev σ	% dev ϵ
07/10/2022	30 Head	23.6	12	0.758	53.134	0.750	55.000	1.07%	-3.39%
			13	0.758	53.080	0.750	55.000	1.07%	-3.49%
			14	0.758	53.076	0.750	55.000	1.07%	-3.50%
			30	0.760	52.804	0.750	55.000	1.33%	-3.99%
			60	0.767	52.147	0.753	54.325	1.86%	-4.01%
			65	0.768	52.084	0.753	54.213	1.99%	-3.93%
07/20/2022	750 Head	20.4	680	0.869	44.008	0.888	42.305	-2.14%	4.03%
			695	0.875	43.953	0.889	42.227	-1.57%	4.09%
			700	0.876	43.932	0.889	42.201	-1.46%	4.10%
			710	0.879	43.892	0.890	42.149	-1.24%	4.14%
			725	0.884	43.835	0.891	42.071	-0.79%	4.19%
			750	0.892	43.778	0.894	41.942	-0.22%	4.38%
			770	0.899	43.728	0.895	41.838	0.45%	4.52%
			785	0.905	43.674	0.896	41.760	1.00%	4.58%
			800	0.911	43.621	0.897	41.682	1.56%	4.65%
			815	0.872	40.595	0.898	41.594	-2.90%	-2.40%
07/18/2022	835 Head	20.0	820	0.877	40.526	0.899	41.578	-2.45%	-2.53%
			835	0.892	40.330	0.900	41.500	-0.89%	-2.82%
			850	0.906	40.145	0.916	41.500	-1.09%	-3.27%
			815	0.917	43.565	0.898	41.594	2.12%	4.74%
07/21/2022	835 Head	20.7	820	0.919	43.548	0.899	41.578	2.22%	4.74%
			835	0.925	43.508	0.900	41.500	2.78%	4.84%
			850	0.931	43.473	0.916	41.500	1.64%	4.75%
07/17/2022	1750 Head	20.7	1710	1.376	39.830	1.348	40.142	2.08%	-0.78%
			1720	1.387	39.785	1.354	40.126	2.44%	-0.85%
			1745	1.415	39.686	1.368	40.087	3.44%	-1.00%
			1750	1.420	39.663	1.371	40.079	3.57%	-1.04%
			1770	1.440	39.560	1.383	40.047	4.12%	-1.22%
			1790	1.459	39.437	1.394	40.016	4.66%	-1.45%
07/21/2022	1750 Head	20.7	1710	1.353	41.826	1.348	40.142	0.37%	4.20%
			1720	1.360	41.817	1.354	40.126	0.44%	4.21%
			1745	1.376	41.801	1.368	40.087	0.58%	4.28%
			1750	1.379	41.797	1.371	40.079	0.58%	4.29%
			1770	1.390	41.778	1.383	40.047	0.51%	4.32%
			1790	1.403	41.758	1.394	40.016	0.65%	4.35%
07/26/2022	1750 Head	19.6	1710	1.317	41.262	1.348	40.142	-2.30%	2.79%
			1720	1.324	41.247	1.354	40.126	-2.22%	2.79%
			1745	1.338	41.210	1.368	40.087	-2.19%	2.80%
			1750	1.341	41.203	1.371	40.079	-2.19%	2.80%
			1770	1.352	41.159	1.383	40.047	-2.24%	2.78%
			1790	1.364	41.110	1.394	40.016	-2.15%	2.73%
07/13/2022	1900 Head	22.8	1850	1.396	38.416	1.400	40.000	-0.29%	-3.96%
			1860	1.405	38.367	1.400	40.000	0.36%	-4.08%
			1880	1.425	38.255	1.400	40.000	1.79%	-4.36%
			1900	1.449	38.155	1.400	40.000	3.50%	-4.61%
			1905	1.454	38.132	1.400	40.000	3.86%	-4.67%
			1910	1.460	38.110	1.400	40.000	4.29%	-4.73%
07/28/2022	1900 Head	20.9	1850	1.399	39.895	1.400	40.000	-0.07%	-0.26%
			1860	1.405	39.878	1.400	40.000	0.36%	-0.31%
			1880	1.416	39.833	1.400	40.000	1.14%	-0.42%
			1900	1.429	39.794	1.400	40.000	2.07%	-0.52%
			1905	1.432	39.788	1.400	40.000	2.29%	-0.53%
			1910	1.435	39.783	1.400	40.000	2.50%	-0.54%
07/11/2022	2450 Head	22.5	2300	1.595	40.086	1.670	39.500	-4.49%	1.48%
			2310	1.606	40.059	1.679	39.480	-4.35%	1.47%
			2320	1.616	40.031	1.687	39.460	-4.21%	1.45%
			2400	1.707	39.747	1.756	39.289	-2.79%	1.17%
			2450	1.757	39.544	1.800	39.200	-2.39%	0.88%
			2480	1.796	39.441	1.833	39.162	-2.02%	0.71%
			2500	1.818	39.390	1.855	39.136	-1.99%	0.65%
			2510	1.828	39.359	1.866	39.123	-2.04%	0.60%
			2535	1.852	39.245	1.893	39.092	-2.17%	0.39%
			2550	1.871	39.173	1.909	39.073	-1.99%	0.26%
			2560	1.884	39.135	1.920	39.060	-1.88%	0.19%
			2600	1.933	39.030	1.964	39.009	-1.58%	0.05%
			2650	1.989	38.781	2.018	38.945	-1.44%	-0.42%
			2680	2.030	38.708	2.051	38.907	-1.02%	-0.51%
			2700	2.048	38.652	2.073	38.882	-1.21%	-0.59%
07/18/2022	2450 Head	22.3	2300	1.661	41.234	1.670	39.500	-0.54%	4.39%
			2310	1.673	41.204	1.679	39.480	-0.36%	4.37%
			2320	1.683	41.168	1.687	39.460	-0.24%	4.33%
			2400	1.776	40.850	1.756	39.289	1.14%	3.97%
			2450	1.828	40.626	1.800	39.200	1.56%	3.64%
			2480	1.868	40.529	1.833	39.162	1.91%	3.49%
			2500	1.891	40.483	1.855	39.136	1.94%	3.44%
			2510	1.901	40.448	1.866	39.123	1.88%	3.39%
			2535	1.926	40.318	1.893	39.092	1.74%	3.14%
			2550	1.945	40.237	1.909	39.073	1.89%	2.98%
			2560	1.959	40.199	1.920	39.060	2.03%	2.92%
			2600	2.009	40.103	1.964	39.009	2.29%	2.80%
			2650	2.064	39.842	2.018	38.945	2.28%	2.30%
			2680	2.105	39.773	2.051	38.907	2.63%	2.23%
			2700	2.124	39.722	2.073	38.882	2.46%	2.16%

FCC ID: PY7-76056F	SAR EVALUATION REPORT	Approved by: Technical Manager
Document S/N: 1M2205240063-03.PY7	DUT Type: Portable Handset	Page 71 of 111

**Table 10-2
Measured Head Tissue Properties (Cont.)**

Calibrated for Tests Performed on:	Tissue Type	Tissue Temp During Calibration (°C)	Measured Frequency (MHz)	Measured Conductivity, σ (S/m)	Measured Dielectric Constant, ϵ	TARGET Conductivity, σ (S/m)	TARGET Dielectric Constant, ϵ	% dev σ	% dev ϵ
07/21/2022	2450 Head	21.5	2300	1.692	40.267	1.670	39.500	1.32%	1.94%
			2310	1.703	40.222	1.679	39.480	1.43%	1.88%
			2320	1.714	40.179	1.687	39.460	1.60%	1.82%
			2400	1.807	39.860	1.756	39.289	2.90%	1.45%
			2450	1.865	39.655	1.800	39.200	3.61%	1.16%
			2480	1.901	39.540	1.833	39.162	3.71%	0.97%
			2500	1.922	39.461	1.855	39.136	3.61%	0.83%
			2510	1.933	39.420	1.866	39.123	3.59%	0.76%
			2535	1.962	39.317	1.893	39.092	3.65%	0.58%
			2550	1.982	39.257	1.909	39.073	3.82%	0.47%
			2560	1.995	39.221	1.920	39.060	3.91%	0.41%
			2600	2.041	39.084	1.964	39.009	3.92%	0.19%
			2650	2.102	38.856	2.018	38.945	4.16%	-0.23%
			2680	2.138	38.757	2.051	38.907	4.24%	-0.39%
			2700	2.158	38.685	2.073	38.882	4.10%	-0.51%
			2300	1.749	40.584	1.670	39.500	4.73%	2.74%
			2310	1.756	40.567	1.679	39.480	4.59%	2.75%
2320	1.764	40.551	1.687	39.460	4.56%	2.76%			
2400	1.827	40.433	1.756	39.289	4.04%	2.91%			
2450	1.866	40.348	1.800	39.200	3.67%	2.93%			
2480	1.890	40.300	1.833	39.162	3.11%	2.91%			
2500	1.906	40.270	1.855	39.136	2.75%	2.90%			
2510	1.914	40.254	1.866	39.123	2.57%	2.89%			
2535	1.934	40.203	1.893	39.092	2.17%	2.84%			
2550	1.947	40.171	1.909	39.073	1.99%	2.81%			
2560	1.956	40.154	1.920	39.060	1.88%	2.80%			
2600	1.988	40.104	1.964	39.009	1.22%	2.81%			
2650	2.030	39.992	2.018	38.945	0.59%	2.69%			
2680	2.056	39.960	2.051	38.907	0.24%	2.71%			
2700	2.070	39.935	2.073	38.882	-0.14%	2.71%			
3300	2.601	38.745	2.708	38.157	-3.95%	1.54%			
3350	2.643	38.623	2.759	38.100	-4.20%	1.37%			
3450	2.735	38.438	2.861	37.986	-4.40%	1.19%			
3500	2.780	38.382	2.913	37.929	-4.57%	1.19%			
3550	2.828	38.254	2.964	37.871	-4.59%	1.01%			
3560	2.840	38.252	2.974	37.860	-4.51%	1.04%			
3600	2.873	38.209	3.015	37.814	-4.71%	1.04%			
3650	2.930	38.092	3.066	37.757	-4.44%	0.89%			
3690	2.959	38.067	3.107	37.711	-4.76%	0.94%			
3700	2.966	38.032	3.117	37.700	-4.84%	0.88%			
3750	3.029	37.927	3.169	37.643	-4.42%	0.75%			
3900	3.165	37.672	3.323	37.471	-4.75%	0.54%			
3930	3.208	37.610	3.353	37.437	-4.32%	0.46%			
4100	3.378	37.300	3.528	37.243	-4.25%	0.15%			
4150	3.433	37.300	3.579	37.186	-4.08%	0.31%			
5180	4.475	35.206	4.635	36.009	-3.45%	-2.23%			
5190	4.487	35.181	4.645	35.998	-3.40%	-2.27%			
5200	4.500	35.150	4.655	35.986	-3.33%	-2.32%			
5210	4.511	35.126	4.666	35.975	-3.32%	-2.36%			
5220	4.525	35.099	4.676	35.963	-3.23%	-2.40%			
5240	4.546	35.072	4.696	35.940	-3.19%	-2.42%			
5250	4.558	35.064	4.706	35.929	-3.14%	-2.41%			
5260	4.566	35.042	4.717	35.917	-3.20%	-2.44%			
5270	4.577	35.023	4.727	35.906	-3.17%	-2.46%			
5280	4.587	35.008	4.737	35.894	-3.17%	-2.47%			
5290	4.597	34.993	4.748	35.883	-3.18%	-2.48%			
5300	4.608	34.975	4.758	35.871	-3.15%	-2.50%			
5310	4.616	34.947	4.768	35.860	-3.19%	-2.55%			
5320	4.628	34.930	4.778	35.849	-3.14%	-2.56%			
5500	4.820	34.631	4.963	35.643	-2.70%	-2.84%			
5510	4.841	34.617	4.973	35.632	-2.65%	-2.85%			
5520	4.851	34.602	4.983	35.620	-2.65%	-2.86%			
5530	4.863	34.593	4.994	35.609	-2.62%	-2.85%			
5540	4.875	34.582	5.004	35.597	-2.58%	-2.85%			
5550	4.885	34.566	5.014	35.586	-2.57%	-2.87%			
5560	4.896	34.545	5.024	35.574	-2.55%	-2.89%			
5580	4.922	34.493	5.045	35.551	-2.44%	-2.98%			
5600	4.944	34.466	5.065	35.529	-2.39%	-2.99%			
5610	4.953	34.453	5.076	35.518	-2.42%	-3.00%			
5620	4.966	34.431	5.086	35.506	-2.36%	-3.03%			
5640	4.984	34.403	5.106	35.483	-2.39%	-3.04%			
5660	5.007	34.358	5.127	35.460	-2.34%	-3.11%			
5670	5.021	34.343	5.137	35.449	-2.26%	-3.12%			
5680	5.036	34.324	5.147	35.437	-2.16%	-3.14%			
5690	5.048	34.311	5.158	35.426	-2.13%	-3.15%			
5700	5.061	34.290	5.168	35.414	-2.07%	-3.17%			
5710	5.071	34.275	5.178	35.403	-2.07%	-3.19%			
5720	5.085	34.261	5.188	35.391	-1.99%	-3.19%			
5745	5.110	34.207	5.214	35.363	-1.99%	-3.27%			
5750	5.114	34.195	5.219	35.357	-2.01%	-3.29%			
5755	5.118	34.188	5.224	35.351	-2.03%	-3.29%			
5765	5.128	34.175	5.234	35.340	-2.03%	-3.30%			
5775	5.142	34.164	5.245	35.329	-1.96%	-3.30%			
5785	5.153	34.145	5.255	35.317	-1.94%	-3.32%			
5795	5.167	34.131	5.265	35.305	-1.86%	-3.33%			
5805	5.178	34.113	5.275	35.294	-1.84%	-3.35%			
5825	5.200	34.066	5.296	35.271	-1.81%	-3.42%			
5835	5.212	34.046	5.305	35.230	-1.75%	-3.36%			
5845	5.224	34.033	5.315	35.210	-1.71%	-3.34%			
5855	5.235	34.026	5.325	35.197	-1.69%	-3.33%			
5875	5.255	34.012	5.347	35.183	-1.72%	-3.33%			
5885	5.269	33.986	5.357	35.177	-1.64%	-3.39%			
5905	5.290	33.946	5.379	35.163	-1.65%	-3.46%			

FCC ID: PY7-76056F	SAR EVALUATION REPORT	Approved by: Technical Manager
Document S/N: 1M2205240063-03.PY7	DUT Type: Portable Handset	Page 72 of 111

**Table 10-3
Measured Body Tissue Properties**

Calibrated for Tests Performed on:	Tissue Type	Tissue Temp During Calibration (°C)	Measured Frequency (MHz)	Measured Conductivity, σ (S/m)	Measured Dielectric Constant, ϵ	TARGET Conductivity, σ (S/m)	TARGET Dielectric Constant, ϵ	% dev σ	% dev ϵ
07/13/2022	750 Body	22.2	680	0.912	56.669	0.958	55.804	-4.80%	1.55%
			695	0.917	56.650	0.959	55.745	-4.38%	1.62%
			700	0.918	56.644	0.959	55.726	-4.28%	1.65%
			710	0.922	56.628	0.960	55.687	-3.96%	1.69%
			725	0.927	56.606	0.961	55.629	-3.54%	1.76%
			750	0.936	56.571	0.964	55.531	-2.90%	1.87%
			770	0.943	56.523	0.965	55.453	-2.28%	1.93%
			785	0.948	56.482	0.966	55.395	-1.85%	1.96%
			800	0.954	56.433	0.967	55.336	-1.34%	1.98%
			680	0.942	54.944	0.958	55.804	-1.67%	-1.54%
695	0.948	54.895	0.959	55.745	-1.15%	-1.52%			
700	0.950	54.878	0.959	55.726	-0.94%	-1.52%			
710	0.954	54.841	0.960	55.687	-0.63%	-1.52%			
725	0.959	54.797	0.961	55.629	-0.21%	-1.50%			
750	0.968	54.742	0.964	55.531	0.41%	-1.42%			
770	0.975	54.704	0.965	55.453	1.04%	-1.35%			
785	0.981	54.669	0.966	55.395	1.55%	-1.31%			
800	0.987	54.628	0.967	55.336	2.07%	-1.28%			
815	0.925	55.270	0.968	55.271	-4.44%	0.00%			
820	0.930	55.230	0.969	55.258	-4.02%	0.00%			
835	0.946	55.108	0.970	55.200	-2.47%	-0.17%			
850	0.962	54.974	0.988	55.154	-2.63%	-0.33%			
1710	1.481	51.479	1.463	53.537	1.23%	-3.84%			
1720	1.493	51.442	1.469	53.511	1.63%	-3.87%			
1745	1.520	51.355	1.485	53.445	2.36%	-3.91%			
1750	1.526	51.339	1.488	53.432	2.65%	-3.92%			
1770	1.547	51.267	1.501	53.379	3.06%	-3.96%			
1790	1.570	51.186	1.514	53.326	3.70%	-4.01%			
1710	1.495	51.438	1.463	53.537	2.19%	-3.92%			
1720	1.507	51.396	1.469	53.511	2.59%	-3.95%			
1745	1.535	51.294	1.485	53.445	3.37%	-4.02%			
1750	1.540	51.272	1.488	53.432	3.49%	-4.04%			
1770	1.562	51.183	1.501	53.379	4.06%	-4.11%			
1790	1.583	51.085	1.514	53.326	4.56%	-4.20%			
1710	1.433	54.771	1.463	53.537	-2.05%	2.30%			
1720	1.441	54.761	1.469	53.511	-1.91%	2.34%			
1745	1.459	54.730	1.485	53.445	-1.75%	2.40%			
1750	1.463	54.724	1.488	53.432	-1.68%	2.42%			
1770	1.477	54.688	1.501	53.379	-1.60%	2.45%			
1790	1.491	54.648	1.514	53.326	-1.52%	2.48%			
1710	1.455	52.819	1.463	53.537	-0.55%	-1.34%			
1720	1.463	52.815	1.469	53.511	-0.41%	-1.30%			
1745	1.479	52.784	1.485	53.445	-0.40%	-1.24%			
1750	1.482	52.773	1.488	53.432	-0.40%	-1.23%			
1770	1.494	52.715	1.501	53.379	-0.47%	-1.24%			
1790	1.505	52.662	1.514	53.326	-0.53%	-1.25%			
1850	1.524	51.231	1.520	53.300	0.26%	-3.88%			
1860	1.535	51.201	1.520	53.300	0.99%	-3.94%			
1880	1.556	51.139	1.520	53.300	2.37%	-4.05%			
1900	1.578	51.067	1.520	53.300	3.82%	-4.19%			
1905	1.584	51.051	1.520	53.300	4.21%	-4.22%			
1910	1.589	51.034	1.520	53.300	4.54%	-4.25%			
1850	1.508	52.210	1.520	53.300	-0.79%	-2.05%			
1860	1.517	52.158	1.520	53.300	-0.20%	-2.14%			
1880	1.542	52.046	1.520	53.300	1.45%	-2.35%			
1900	1.571	51.983	1.520	53.300	3.36%	-2.47%			
1905	1.577	51.978	1.520	53.300	3.75%	-2.48%			
1910	1.583	51.976	1.520	53.300	4.14%	-2.48%			
1850	1.531	51.501	1.520	53.300	0.72%	-3.39%			
1860	1.542	51.466	1.520	53.300	1.45%	-3.44%			
1880	1.563	51.383	1.520	53.300	2.83%	-3.60%			
1900	1.584	51.293	1.520	53.300	4.21%	-3.77%			
1905	1.590	51.270	1.520	53.300	4.61%	-3.81%			
1910	1.596	51.246	1.520	53.300	5.00%	-3.85%			
1850	1.501	53.074	1.520	53.300	-1.25%	-0.42%			
1860	1.507	53.064	1.520	53.300	-0.86%	-0.44%			
1880	1.519	53.029	1.520	53.300	-0.07%	-0.51%			
1900	1.533	52.974	1.520	53.300	0.86%	-0.61%			
1905	1.536	52.960	1.520	53.300	1.05%	-0.64%			
1910	1.540	52.948	1.520	53.300	1.32%	-0.66%			
2300	1.722	51.414	1.809	52.900	-4.81%	-2.81%			
2310	1.735	51.382	1.816	52.887	-4.46%	-2.85%			
2320	1.740	51.351	1.825	52.873	-4.38%	-2.88%			
2400	1.840	51.106	1.902	52.767	-2.79%	-3.16%			
2450	1.912	50.902	1.950	52.700	-1.95%	-3.41%			
2480	1.954	50.810	1.993	52.662	-1.96%	-3.52%			
2500	1.979	50.756	2.021	52.636	-2.08%	-3.57%			
2510	1.991	50.724	2.035	52.623	-2.16%	-3.61%			
2535	2.023	50.604	2.071	52.592	-2.32%	-3.78%			
2550	2.046	50.534	2.092	52.573	-2.20%	-3.88%			
2560	2.061	50.499	2.106	52.560	-2.14%	-3.92%			
2600	2.114	50.395	2.163	52.509	-2.27%	-4.03%			
2650	2.183	50.145	2.234	52.445	-2.28%	-4.39%			
2680	2.226	50.072	2.277	52.407	-2.24%	-4.46%			
2700	2.246	50.004	2.305	52.382	-2.56%	-4.54%			
2300	1.786	51.643	1.809	52.900	-0.72%	-2.38%			
2310	1.810	51.608	1.816	52.887	-0.33%	-2.42%			
2320	1.823	51.589	1.826	52.873	-0.16%	-2.47%			
2400	1.929	51.311	1.902	52.767	1.42%	-2.76%			
2450	1.998	51.129	1.950	52.700	2.46%	-2.98%			
2480	2.039	51.022	1.993	52.662	2.31%	-3.11%			
2500	2.065	50.944	2.021	52.636	2.18%	-3.21%			
2510	2.079	50.906	2.035	52.623	2.16%	-3.26%			
2535	2.114	50.809	2.071	52.592	2.08%	-3.39%			
2550	2.136	50.753	2.092	52.573	2.10%	-3.46%			
2560	2.151	50.721	2.106	52.560	2.14%	-3.50%			
2600	2.205	50.569	2.163	52.509	1.94%	-3.69%			
2650	2.278	50.356	2.234	52.445	1.97%	-3.99%			
2680	2.320	50.246	2.277	52.407	1.89%	-4.12%			
2700	2.346	50.165	2.305	52.382	1.78%	-4.23%			

FCC ID: PY7-76056F	SAR EVALUATION REPORT	Approved by: Technical Manager
Document S/N: 1M2205240063-03.PY7	DUT Type: Portable Handset	Page 73 of 111

**Table 10-4
Measured Body Tissue Properties (Cont.)**

Calibrated for Tests Performed on:	Tissue Type	Tissue Temp During Calibration (°C)	Measured Frequency (MHz)	Measured Conductivity, σ (S/m)	Measured Dielectric Constant, ϵ	TARGET Conductivity, σ (S/m)	TARGET Dielectric Constant, ϵ	% dev σ	% dev ϵ
07/03/2022	3600 Body	20.5	3300	2.983	53.538	3.080	51.593	-3.15%	3.77%
			3350	3.042	53.413	3.139	51.525	-3.09%	3.66%
			3450	3.163	53.227	3.256	51.389	-2.86%	3.58%
			3500	3.218	53.159	3.314	51.321	-2.90%	3.58%
			3550	3.288	53.033	3.372	51.254	-2.49%	3.47%
			3560	3.302	53.028	3.384	51.240	-2.42%	3.49%
			3600	3.343	52.980	3.431	51.186	-2.56%	3.50%
			3650	3.411	52.871	3.489	51.118	-2.24%	3.43%
			3690	3.451	52.817	3.536	51.063	-2.40%	3.43%
			3700	3.466	52.788	3.548	51.050	-2.31%	3.40%
			3750	3.540	52.687	3.606	50.982	-1.83%	3.34%
			3900	3.727	52.412	3.781	50.779	-1.43%	3.22%
			3930	3.778	52.370	3.816	50.738	-1.00%	3.22%
			4100	4.003	52.037	4.015	50.507	-0.30%	3.03%
			4150	4.074	52.032	4.073	50.439	0.02%	3.16%
07/18/2022	3600 Body	21.0	3300	2.945	50.579	3.080	51.593	-4.38%	-1.97%
			3350	3.005	50.503	3.139	51.525	-4.27%	-1.98%
			3450	3.115	50.332	3.256	51.389	-4.33%	-2.06%
			3500	3.171	50.252	3.314	51.321	-4.32%	-2.08%
			3550	3.225	50.169	3.372	51.254	-4.36%	-2.12%
			3560	3.237	50.154	3.384	51.240	-4.34%	-2.12%
			3600	3.285	50.101	3.431	51.186	-4.26%	-2.12%
			3650	3.338	50.019	3.489	51.118	-4.33%	-2.15%
			3690	3.386	49.944	3.536	51.063	-4.24%	-2.19%
			3700	3.396	49.927	3.548	51.050	-4.28%	-2.20%
			3750	3.452	49.863	3.606	50.982	-4.27%	-2.19%
			3900	3.634	49.583	3.781	50.779	-3.89%	-2.36%
			3930	3.674	49.520	3.816	50.738	-3.72%	-2.40%
			4100	3.897	49.227	4.015	50.507	-2.94%	-2.53%
			4150	3.965	49.144	4.073	50.439	-2.65%	-2.57%
07/05/2022	5200-5800 Body	20.8	5180	5.306	48.577	5.276	49.041	0.57%	-0.95%
			5190	5.323	48.566	5.288	49.028	0.66%	-0.94%
			5200	5.341	48.557	5.299	49.014	0.79%	-0.93%
			5210	5.356	48.540	5.311	49.001	0.85%	-0.94%
			5220	5.370	48.520	5.323	48.987	0.88%	-0.95%
			5240	5.400	48.477	5.346	48.960	1.01%	-0.99%
			5250	5.414	48.457	5.358	48.947	1.05%	-1.00%
			5260	5.431	48.450	5.369	48.933	1.15%	-0.99%
			5270	5.449	48.435	5.381	48.919	1.26%	-0.99%
			5280	5.463	48.413	5.393	48.906	1.30%	-1.01%
			5290	5.473	48.371	5.404	48.892	1.28%	-1.07%
			5300	5.485	48.340	5.416	48.879	1.27%	-1.10%
			5310	5.498	48.316	5.428	48.865	1.29%	-1.12%
			5320	5.520	48.301	5.439	48.851	1.49%	-1.13%
			5500	5.780	47.953	5.650	48.607	2.30%	-1.35%
			5510	5.796	47.920	5.661	48.594	2.38%	-1.39%
			5520	5.809	47.911	5.673	48.580	2.40%	-1.38%
			5530	5.822	47.892	5.685	48.566	2.41%	-1.39%
			5540	5.836	47.873	5.696	48.553	2.46%	-1.40%
			5550	5.852	47.862	5.708	48.539	2.52%	-1.39%
			5560	5.870	47.852	5.720	48.526	2.62%	-1.39%
			5580	5.898	47.813	5.743	48.499	2.70%	-1.41%
			5600	5.927	47.759	5.766	48.471	2.79%	-1.47%
			5610	5.944	47.748	5.778	48.458	2.87%	-1.47%
			5620	5.956	47.725	5.790	48.444	2.87%	-1.48%
			5640	5.992	47.678	5.813	48.417	3.08%	-1.53%
			5660	6.029	47.626	5.837	48.390	3.29%	-1.58%
			5670	6.038	47.608	5.848	48.376	3.25%	-1.59%
			5680	6.055	47.592	5.860	48.363	3.33%	-1.59%
			5690	6.073	47.575	5.872	48.349	3.42%	-1.60%
			5700	6.091	47.550	5.883	48.336	3.54%	-1.63%
			5710	6.109	47.542	5.895	48.322	3.63%	-1.61%
			5720	6.120	47.519	5.907	48.309	3.61%	-1.64%
			5745	6.151	47.465	5.936	48.275	3.62%	-1.68%
			5750	6.161	47.458	5.942	48.268	3.69%	-1.68%
			5755	6.170	47.454	5.947	48.261	3.75%	-1.67%
			5765	6.186	47.445	5.959	48.248	3.81%	-1.66%
			5775	6.201	47.413	5.971	48.234	3.85%	-1.70%
			5785	6.214	47.395	5.982	48.220	3.88%	-1.71%
			5795	6.233	47.377	5.994	48.207	3.99%	-1.72%
			5800	6.242	47.356	6.000	48.200	4.03%	-1.75%
			5805	6.249	47.351	6.006	48.193	4.05%	-1.75%
			5825	6.278	47.322	6.029	48.166	4.13%	-1.75%
			5835	6.290	47.304	6.042	48.130	4.10%	-1.72%
			5845	6.306	47.280	6.054	48.110	4.16%	-1.73%
5855	6.325	47.249	6.066	48.093	4.27%	-1.75%			
5865	6.345	47.237	6.077	48.080	4.41%	-1.75%			
5875	6.365	47.217	6.088	48.067	4.55%	-1.77%			
5885	6.378	47.199	6.100	48.053	4.56%	-1.78%			
5905	6.396	47.172	6.122	48.027	4.48%	-1.78%			

The above measured tissue parameters were used in the DASY software. The DASY software was used to perform interpolation to determine the dielectric parameters at the SAR test device frequencies (per KDB Publication 865664 D01v01r04 and IEEE 1528-2013 6.6.1.2). The tissue parameters listed in the SAR test plots may slightly differ from the table above due to significant digit rounding in the software.

FCC ID: PY7-76056F	SAR EVALUATION REPORT	Approved by: Technical Manager
Document S/N: 1M2205240063-03.PY7	DUT Type: Portable Handset	Page 74 of 111

10.2 Test System Verification

Prior to SAR assessment, the system is verified to $\pm 10\%$ of the SAR measurement on the reference dipole at the time of calibration by the calibration facility. Full system validation status and result summary can be found in the SAR System Validation Appendix.

**Table 10-5
System Verification Results – 1g**

System Verification TARGET & MEASURED												
SAR System	Tissue Frequency (MHz)	Tissue Type	Date	Amb. Temp. (C)	Liquid Temp. (C)	Input Power (W)	Source SN	Probe SN	Measured SAR1g (W/kg)	1W Target SAR1g (W/kg)	1W Normalized SAR 1g (W/kg)	Deviation1g (%)
S	750	HEAD	07/20/2022	21.0	20.5	0.20	1054	7552	1.740	8.52	8.700	2.11%
S	835	HEAD	07/18/2022	20.7	20.1	0.20	4d132	7552	2.000	9.66	10.000	3.52%
S	835	HEAD	07/21/2022	20.4	22.7	0.20	4d132	7552	2.020	9.66	10.100	4.55%
S	1750	HEAD	07/17/2022	21.0	20.5	0.10	1008	7552	3.790	37.40	37.900	1.34%
S	1750	HEAD	07/21/2022	20.4	22.7	0.10	1008	7552	3.570	37.40	35.700	-4.55%
L	1750	HEAD	07/26/2022	21.5	20.0	0.10	1148	7670	3.630	37.20	36.300	-2.42%
S	1900	HEAD	07/13/2022	22.2	22.3	0.10	5d148	7552	3.970	40.10	39.700	-1.00%
L	1900	HEAD	07/28/2022	23.4	21.4	0.10	5d148	7670	4.220	40.10	42.200	5.24%
P	2450	HEAD	07/11/2022	23.2	21.5	0.10	981	7409	5.110	53.90	51.100	-5.19%
E	2450	HEAD	07/28/2022	21.9	21.7	0.10	797	7538	5.510	52.40	55.100	5.15%
P	2600	HEAD	07/18/2022	23.1	21.6	0.10	1071	7409	5.570	56.10	55.700	-0.71%
P	2600	HEAD	07/21/2022	23.1	22.1	0.10	1071	7409	5.820	56.10	58.200	3.74%
L	3700	HEAD	07/25/2022	20.9	19.8	0.10	1018	7670	6.820	67.00	68.200	1.79%
L	3900	HEAD	07/25/2022	20.9	19.8	0.10	1073	7670	7.150	69.70	71.500	2.58%
O	5250	HEAD	07/11/2022	23.3	21.7	0.05	1057	7417	3.710	81.20	74.200	-8.62%
O	5600	HEAD	07/11/2022	23.3	21.7	0.05	1057	7417	4.130	84.20	82.600	-1.90%
O	5750	HEAD	07/11/2022	23.3	21.7	0.05	1057	7417	3.980	80.80	79.600	-1.49%
L	750	BODY	07/13/2022	20.9	20.5	0.20	1054	7670	1.790	8.63	8.950	3.71%
K	750	BODY	07/18/2022	23.0	22.5	0.20	1161	7659	1.760	8.79	8.800	0.11%
I	835	BODY	07/14/2022	21.9	21.3	0.20	4d047	7660	2.010	9.68	10.050	3.82%
I	1750	BODY	07/07/2022	21.6	21.3	0.10	1150	7660	3.770	37.80	37.700	-0.26%
I	1750	BODY	07/11/2022	20.5	20.1	0.10	1150	7660	3.800	37.80	38.000	0.53%
L	1750	BODY	07/20/2022	21.6	20.9	0.10	1148	7670	3.830	37.10	38.300	3.23%
E	1900	BODY	06/27/2022	21.5	21.3	0.10	5d149	7538	4.040	40.40	40.400	0.00%
E	1900	BODY	07/18/2022	21.3	21.1	0.10	5d080	7538	4.220	40.70	42.200	3.69%
O	1900	BODY	07/20/2022	25.0	22.9	0.10	5d148	7417	4.280	39.90	42.800	7.27%
K	1900	BODY	07/26/2022	22.4	21.2	0.10	5d149	7659	4.140	40.40	41.400	2.48%
S	2450	BODY	07/12/2022	21.5	21.2	0.10	981	7552	5.030	50.30	50.300	0.00%
S	2600	BODY	06/28/2022	21.3	24.0	0.10	1071	7552	5.280	54.30	52.800	-2.76%
L	3700	BODY	07/03/2022	22.2	20.8	0.10	1018	7670	6.010	63.50	60.100	-5.35%
I	3700	BODY	07/18/2022	21.3	20.6	0.10	1018	7660	6.440	63.50	64.400	1.42%
I	3900	BODY	07/18/2022	21.3	20.6	0.10	1073	7660	6.670	64.30	66.700	3.73%
O	5250	BODY	07/05/2022	22.1	20.8	0.05	1057	7417	3.380	74.20	67.600	-8.89%
O	5600	BODY	07/05/2022	22.1	20.8	0.05	1057	7417	3.640	77.00	72.800	-5.45%
O	5750	BODY	07/05/2022	22.1	20.8	0.05	1057	7417	3.390	74.90	67.800	-9.48%

FCC ID: PY7-76056F	SAR EVALUATION REPORT	Approved by: Technical Manager
Document S/N: 1M2205240063-03.PY7	DUT Type: Portable Handset	Page 75 of 111

**Table 10-6
System Verification Results – 10g**

System Verification TARGET & MEASURED												
SAR System	Tissue Frequency (MHz)	Tissue Type	Date	Amb. Temp. (C)	Liquid Temp. (C)	Input Power (W)	Source SN	Probe SN	Measured SAR10g (W/kg)	1W Target SAR10g (W/kg)	1W Normalized SAR10g (W/kg)	Deviation10g (%)
G	13	HEAD	07/10/2022	22.1	22.0	1.00	1002	7527	0.328	0.344	0.328	-4.65%
I	1750	BODY	07/07/2022	21.6	21.3	0.10	1150	7660	1.980	20.00	19.800	-1.00%
I	1750	BODY	07/26/2022	21.9	21.6	0.10	1150	7660	1.920	20.00	19.200	-4.00%
O	1900	BODY	07/20/2022	25.0	22.9	0.10	5d148	7417	2.220	20.90	22.200	6.22%
K	1900	BODY	07/26/2022	22.4	21.2	0.10	5d149	7659	2.170	21.10	21.700	2.84%
S	2600	BODY	06/28/2022	21.3	24.0	0.10	1071	7552	2.360	24.10	23.600	-2.07%
I	3700	BODY	07/18/2022	21.3	20.6	0.10	1018	7660	2.380	22.50	23.800	5.78%
I	3900	BODY	07/18/2022	21.3	20.6	0.10	1073	7660	2.330	22.00	23.300	5.91%
O	5250	BODY	07/05/2022	22.1	20.8	0.05	1057	7417	0.958	20.60	19.160	-6.99%
O	5600	BODY	07/05/2022	22.1	20.8	0.05	1057	7417	1.020	21.20	20.400	-3.77%
O	5750	BODY	07/05/2022	22.1	20.8	0.05	1057	7417	0.958	20.70	19.160	-7.44%

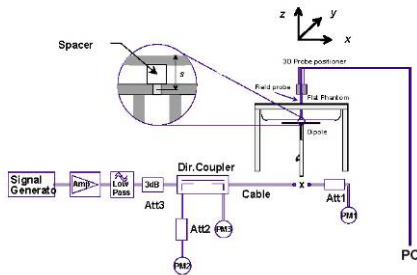

**Figure 10-1
System Verification Setup Diagram**



**Figure 10-2
System Verification Setup Photo**

FCC ID: PY7-76056F	SAR EVALUATION REPORT	Approved by: Technical Manager
Document S/N: 1M2205240063-03.PY7	DUT Type: Portable Handset	Page 76 of 111

11 SAR DATA SUMMARY

11.1 Standalone Head SAR Data

**Table 11-1
GSM/DTM 850 Head SAR**

MEASUREMENT RESULTS																
FREQUENCY		Side	Test Position	Mode	Service	Antenna Config.	Device Serial Number	# of Time Slots	Maximum Allowed Power [dBm]	Conducted Power [dBm]	Power Drift [dB]	Duty Cycle	SAR (1g)	Scaling Factor	Reported SAR (1g)	Plot #
MHz	Ch.												(W/kg)		(W/kg)	
848.80	251	Right	Cheek	GSM 850	GSM	Main 1	00043	1	33.2	32.51	0.08	1:8.3	0.176	1.172	0.206	A1
848.80	251	Right	Tilt	GSM 850	GSM	Main 1	00043	1	33.2	32.51	0.03	1:8.3	0.050	1.172	0.059	
848.80	251	Left	Cheek	GSM 850	GSM	Main 1	00043	1	33.2	32.51	0.00	1:8.3	0.166	1.172	0.195	
848.80	251	Left	Tilt	GSM 850	GSM	Main 1	00043	1	33.2	32.51	-0.19	1:8.3	0.050	1.172	0.059	
848.80	251	Right	Cheek	GSM 850	DTM	Main 1	99948	3	28.4	27.44	0.00	1:2.76	0.094	1.247	0.117	
848.80	251	Right	Tilt	GSM 850	DTM	Main 1	99948	3	28.4	27.44	-0.04	1:2.76	0.039	1.247	0.049	
848.80	251	Left	Cheek	GSM 850	DTM	Main 1	99948	3	28.4	27.44	0.04	1:2.76	0.129	1.247	0.161	
848.80	251	Left	Tilt	GSM 850	DTM	Main 1	99948	3	28.4	27.44	-0.01	1:2.76	0.048	1.247	0.060	
ICNIRP 1998 - SAFETY LIMIT Spatial Peak Uncontrolled Exposure/General Population								Head 1.6 W/kg (mW/g) averaged over 1 gram								

**Table 11-2
GSM/DTM 1900 Head SAR**

MEASUREMENT RESULTS																
FREQUENCY		Side	Test Position	Mode	Service	Antenna Config.	Device Serial Number	# of Time Slots	Maximum Allowed Power [dBm]	Conducted Power [dBm]	Power Drift [dB]	Duty Cycle	SAR (1g)	Scaling Factor	Reported SAR (1g)	Plot #
MHz	Ch.												(W/kg)		(W/kg)	
1909.80	810	Right	Cheek	GSM 1900	GSM	Main 2	99948	1	27.7	26.64	0.04	1:8.3	0.024	1.276	0.031	
1909.80	810	Right	Tilt	GSM 1900	GSM	Main 2	99948	1	27.7	26.64	0.04	1:8.3	0.005	1.276	0.006	
1909.80	810	Left	Cheek	GSM 1900	GSM	Main 2	99948	1	27.7	26.64	0.04	1:8.3	0.020	1.276	0.026	
1909.80	810	Left	Tilt	GSM 1900	GSM	Main 2	99948	1	27.7	26.64	0.05	1:8.3	0.003	1.276	0.004	
1850.20	512	Right	Cheek	GSM 1900	DTM	Main 2	99989	3	22.9	21.95	-0.12	1:2.76	0.030	1.245	0.037	A2
1850.20	512	Right	Tilt	GSM 1900	DTM	Main 2	99989	3	22.9	21.95	0.02	1:2.76	0.013	1.245	0.016	
1850.20	512	Left	Cheek	GSM 1900	DTM	Main 2	99989	3	22.9	21.95	-0.07	1:2.76	0.027	1.245	0.034	
1850.20	512	Left	Tilt	GSM 1900	DTM	Main 2	99989	3	22.9	21.95	0.20	1:2.76	0.014	1.245	0.017	
ANSI / IEEE C95.1 1992 - SAFETY LIMIT Spatial Peak Uncontrolled Exposure/General Population								Head 1.6 W/kg (mW/g) averaged over 1 gram								

FCC ID: PY7-76056F	SAR EVALUATION REPORT		Approved by: Technical Manager
Document S/N: 1M2205240063-03.PY7	DUT Type: Portable Handset	Page 77 of 111	

**Table 11-3
UMTS 850 Head SAR**

MEASUREMENT RESULTS															
FREQUENCY		Side	Test Position	Mode	Service	Antenna Config.	Device Serial Number	Maximum Allowed Power [dBm]	Conducted Power [dBm]	Power Drift [dB]	Duty Cycle	SAR (1g)	Scaling Factor	Reported SAR (1g)	Plot #
MHz	Ch.											(W/kg)		(W/kg)	
836.60	4183	Right	Cheek	UMTS 850	RMC	Main 1	00043	22.7	21.72	-0.19	1:1	0.077	1.253	0.096	
836.60	4183	Right	Tilt	UMTS 850	RMC	Main 1	00043	22.7	21.72	-0.09	1:1	0.037	1.253	0.046	
836.60	4183	Left	Cheek	UMTS 850	RMC	Main 1	00043	22.7	21.72	0.04	1:1	0.107	1.253	0.134	A3
836.60	4183	Left	Tilt	UMTS 850	RMC	Main 1	00043	22.7	21.72	0.09	1:1	0.044	1.253	0.055	
ANSI / IEEE C95.1 1992 - SAFETY LIMIT Spatial Peak Uncontrolled Exposure/General Population							Head 1.6 W/kg (mW/g) averaged over 1 gram								

**Table 11-4
UMTS 1750 Head SAR**

MEASUREMENT RESULTS															
FREQUENCY		Side	Test Position	Mode	Service	Antenna Config.	Device Serial Number	Maximum Allowed Power [dBm]	Conducted Power [dBm]	Power Drift [dB]	Duty Cycle	SAR (1g)	Scaling Factor	Reported SAR (1g)	Plot #
MHz	Ch.											(W/kg)		(W/kg)	
1752.60	1513	Right	Cheek	UMTS 1750	RMC	Main 2	99948	18.7	17.65	-0.18	1:1	0.037	1.274	0.047	A4
1752.60	1513	Right	Tilt	UMTS 1750	RMC	Main 2	99948	18.7	17.65	0.20	1:1	0.022	1.274	0.028	
1752.60	1513	Left	Cheek	UMTS 1750	RMC	Main 2	99948	18.7	17.65	0.11	1:1	0.020	1.274	0.025	
1752.60	1513	Left	Tilt	UMTS 1750	RMC	Main 2	99948	18.7	17.65	-0.15	1:1	0.019	1.274	0.024	
ANSI / IEEE C95.1 1992 - SAFETY LIMIT Spatial Peak Uncontrolled Exposure/General Population							Head 1.6 W/kg (mW/g) averaged over 1 gram								

**Table 11-5
UMTS 1900 Head SAR**

MEASUREMENT RESULTS															
FREQUENCY		Side	Test Position	Mode	Service	Antenna Config.	Device Serial Number	Maximum Allowed Power [dBm]	Conducted Power [dBm]	Power Drift [dB]	Duty Cycle	SAR (1g)	Scaling Factor	Reported SAR (1g)	Plot #
MHz	Ch.											(W/kg)		(W/kg)	
1852.40	9262	Right	Cheek	UMTS 1900	RMC	Main 2	99948	19.7	18.57	0.05	1:1	0.038	1.297	0.049	A5
1852.40	9262	Right	Tilt	UMTS 1900	RMC	Main 2	99948	19.7	18.57	0.06	1:1	0.011	1.297	0.014	
1852.40	9262	Left	Cheek	UMTS 1900	RMC	Main 2	99948	19.7	18.57	-0.13	1:1	0.028	1.297	0.036	
1852.40	9262	Left	Tilt	UMTS 1900	RMC	Main 2	99948	19.7	18.57	0.08	1:1	0.021	1.297	0.027	
ANSI / IEEE C95.1 1992 - SAFETY LIMIT Spatial Peak Uncontrolled Exposure/General Population							Head 1.6 W/kg (mW/g) averaged over 1 gram								

FCC ID: PY7-76056F	SAR EVALUATION REPORT	Approved by: Technical Manager
Document S/N: 1M2205240063-03.PY7	DUT Type: Portable Handset	Page 78 of 111

**Table 11-6
LTE Band 71 Head SAR**

MEASUREMENT RESULTS																				
FREQUENCY		Side	Test Position	Mode	Antenna Config.	Device Serial Number	Bandwidth [MHz]	Modulation	RB Size	RB Offset	Maximum Allowed Power [dBm]	Conducted Power [dBm]	MPR [dB]	Power Drift [dB]	Duty Cycle	SAR (1g)	Scaling Factor	Reported SAR (1g)	Plot #	
MHz	Ch.															(W/kg)		(W/kg)		
680.50	133297	Mid	Right	Cheek	LTE Band 71	Main 1	99948	20	QPSK	1	0	25.0	23.87	0	-0.08	1:1	0.081	1.297	0.105	A6
680.50	133297	Mid	Right	Cheek	LTE Band 71	Main 1	99948	20	QPSK	50	0	24.0	22.75	1	0.00	1:1	0.068	1.334	0.091	
680.50	133297	Mid	Right	Tilt	LTE Band 71	Main 1	99948	20	QPSK	1	0	25.0	23.87	0	0.04	1:1	0.036	1.297	0.047	
680.50	133297	Mid	Right	Tilt	LTE Band 71	Main 1	99948	20	QPSK	50	0	24.0	22.75	1	-0.01	1:1	0.032	1.334	0.043	
680.50	133297	Mid	Left	Cheek	LTE Band 71	Main 1	99948	20	QPSK	1	0	25.0	23.87	0	0.10	1:1	0.080	1.297	0.104	
680.50	133297	Mid	Left	Cheek	LTE Band 71	Main 1	99948	20	QPSK	50	0	24.0	22.75	1	0.05	1:1	0.072	1.334	0.096	
680.50	133297	Mid	Left	Tilt	LTE Band 71	Main 1	99948	20	QPSK	1	0	25.0	23.87	0	-0.01	1:1	0.037	1.297	0.048	
680.50	133297	Mid	Left	Tilt	LTE Band 71	Main 1	99948	20	QPSK	50	0	24.0	22.75	1	-0.01	1:1	0.036	1.334	0.048	
ANSI / IEEE C95.1 1992 - SAFETY LIMIT Spatial Peak Uncontrolled Exposure/General Population											Head 1.6 W/kg (mW/g) averaged over 10 grams									

**Table 11-7
LTE Band 12 Head SAR**

MEASUREMENT RESULTS																				
FREQUENCY		Side	Test Position	Mode	Antenna Config.	Device Serial Number	Bandwidth [MHz]	Modulation	RB Size	RB Offset	Maximum Allowed Power [dBm]	Conducted Power [dBm]	MPR [dB]	Power Drift [dB]	Duty Cycle	SAR (1g)	Scaling Factor	Reported SAR (1g)	Plot #	
MHz	Ch.															(W/kg)		(W/kg)		
707.50	23095	Mid	Right	Cheek	LTE Band 12	Main 1	99948	10	QPSK	1	25	25.0	23.88	0	0.01	1:1	0.156	1.294	0.202	A7
707.50	23095	Mid	Right	Cheek	LTE Band 12	Main 1	99948	10	QPSK	25	12	24.0	22.87	1	0.05	1:1	0.109	1.297	0.141	
707.50	23095	Mid	Right	Tilt	LTE Band 12	Main 1	99948	10	QPSK	1	25	25.0	23.88	0	-0.06	1:1	0.067	1.294	0.087	
707.50	23095	Mid	Right	Tilt	LTE Band 12	Main 1	99948	10	QPSK	25	12	24.0	22.87	1	-0.04	1:1	0.050	1.297	0.065	
707.50	23095	Mid	Left	Cheek	LTE Band 12	Main 1	99948	10	QPSK	1	25	25.0	23.88	0	-0.08	1:1	0.139	1.294	0.180	
707.50	23095	Mid	Left	Cheek	LTE Band 12	Main 1	99948	10	QPSK	25	12	24.0	22.87	1	-0.06	1:1	0.112	1.297	0.145	
707.50	23095	Mid	Left	Tilt	LTE Band 12	Main 1	99948	10	QPSK	1	25	25.0	23.88	0	0.03	1:1	0.063	1.294	0.082	
707.50	23095	Mid	Left	Tilt	LTE Band 12	Main 1	99948	10	QPSK	25	12	24.0	22.87	1	-0.20	1:1	0.046	1.297	0.060	
ANSI / IEEE C95.1 1992 - SAFETY LIMIT Spatial Peak Uncontrolled Exposure/General Population											Head 1.6 W/kg (mW/g) averaged over 1 gram									

**Table 11-8
LTE Band 13 Head SAR**

MEASUREMENT RESULTS																				
FREQUENCY		Side	Test Position	Mode	Antenna Config.	Device Serial Number	Bandwidth [MHz]	Modulation	RB Size	RB Offset	Maximum Allowed Power [dBm]	Conducted Power [dBm]	MPR [dB]	Power Drift [dB]	Duty Cycle	SAR (1g)	Scaling Factor	Reported SAR (1g)	Plot #	
MHz	Ch.															(W/kg)		(W/kg)		
782.00	23230	Mid	Right	Cheek	LTE Band 13	Main 1	99948	10	QPSK	1	49	25.0	24.09	0	-0.05	1:1	0.058	1.233	0.072	
782.00	23230	Mid	Right	Cheek	LTE Band 13	Main 1	99948	10	QPSK	25	25	24.0	23.10	1	-0.14	1:1	0.049	1.230	0.060	
782.00	23230	Mid	Right	Tilt	LTE Band 13	Main 1	99948	10	QPSK	1	49	25.0	24.09	0	0.11	1:1	0.025	1.233	0.031	
782.00	23230	Mid	Right	Tilt	LTE Band 13	Main 1	99948	10	QPSK	25	25	24.0	23.10	1	0.04	1:1	0.022	1.230	0.027	
782.00	23230	Mid	Left	Cheek	LTE Band 13	Main 1	99948	10	QPSK	1	49	25.0	24.09	0	-0.02	1:1	0.074	1.233	0.091	A8
782.00	23230	Mid	Left	Cheek	LTE Band 13	Main 1	99948	10	QPSK	25	25	24.0	23.10	1	-0.04	1:1	0.050	1.230	0.062	
782.00	23230	Mid	Left	Tilt	LTE Band 13	Main 1	99948	10	QPSK	1	49	25.0	24.09	0	0.03	1:1	0.036	1.233	0.044	
782.00	23230	Mid	Left	Tilt	LTE Band 13	Main 1	99948	10	QPSK	25	12	24.0	23.09	1	0.06	1:1	0.033	1.233	0.041	
ANSI / IEEE C95.1 1992 - SAFETY LIMIT Spatial Peak Uncontrolled Exposure/General Population											Head 1.6 W/kg (mW/g) averaged over 1 gram									

FCC ID: PY7-76056F	SAR EVALUATION REPORT	Approved by: Technical Manager
Document S/N: 1M2205240063-03.PY7	DUT Type: Portable Handset	Page 79 of 111

**Table 11-9
LTE Band 5 (Cell) Head SAR**

MEASUREMENT RESULTS																				
FREQUENCY		Side	Test Position	Mode	Antenna Config.	Device Serial Number	Bandwidth [MHz]	Modulation	RB Size	RB Offset	Maximum Allowed Power [dBm]	Conducted Power [dBm]	MPR [dB]	Power Drift [dB]	Duty Cycle	SAR (1g)	Scaling Factor	Reported SAR (1g)	Plot #	
MHz	Ch.															(W/kg)		(W/kg)		
836.50	20525	Mid	Right	Cheek	LTE Band 5 (Cell)	Main 1	99948	10	QPSK	1	25	25.0	23.89	0	0.06	1:1	0.120	1.291	0.155	
836.50	20525	Mid	Right	Cheek	LTE Band 5 (Cell)	Main 1	99948	10	QPSK	25	0	24.0	23.00	1	0.05	1:1	0.091	1.259	0.115	
836.50	20525	Mid	Right	Tilt	LTE Band 5 (Cell)	Main 1	99948	10	QPSK	1	25	25.0	23.89	0	-0.08	1:1	0.048	1.291	0.062	
836.50	20525	Mid	Right	Tilt	LTE Band 5 (Cell)	Main 1	99948	10	QPSK	25	0	24.0	23.00	1	-0.02	1:1	0.034	1.259	0.043	
836.50	20525	Mid	Left	Cheek	LTE Band 5 (Cell)	Main 1	99948	10	QPSK	1	25	25.0	23.89	0	-0.08	1:1	0.155	1.291	0.200	A9
836.50	20525	Mid	Left	Cheek	LTE Band 5 (Cell)	Main 1	99948	10	QPSK	25	0	24.0	23.00	1	-0.01	1:1	0.125	1.259	0.157	
836.50	20525	Mid	Left	Tilt	LTE Band 5 (Cell)	Main 1	99948	10	QPSK	1	25	25.0	23.89	0	0.00	1:1	0.049	1.291	0.063	
836.50	20525	Mid	Left	Tilt	LTE Band 5 (Cell)	Main 1	99948	10	QPSK	25	0	24.0	23.00	1	0.03	1:1	0.043	1.259	0.054	
ANSI / IEEE C95.1 1992 - SAFETY LIMIT Spatial Peak Uncontrolled Exposure/General Population											Head 1.6 W/kg (mW/g) averaged over 1 gram									

**Table 11-10
LTE Band 66 (AWS) Head SAR**

MEASUREMENT RESULTS																				
FREQUENCY		Side	Test Position	Mode	Antenna Config.	Device Serial Number	Bandwidth [MHz]	Modulation	RB Size	RB Offset	Maximum Allowed Power [dBm]	Conducted Power [dBm]	MPR [dB]	Power Drift [dB]	Duty Cycle	SAR (1g)	Scaling Factor	Reported SAR (1g)	Plot #	
MHz	Ch.															(W/kg)		(W/kg)		
1720.00	132072	Low	Right	Cheek	LTE Band 66 (AWS)	Main 2	99948	20	QPSK	1	50	25.0	24.00	0	0.17	1:1	0.126	1.259	0.159	
1720.00	132072	Low	Right	Cheek	LTE Band 66 (AWS)	Main 2	99948	20	QPSK	50	25	24.0	23.02	1	0.02	1:1	0.099	1.253	0.124	
1720.00	132072	Low	Right	Tilt	LTE Band 66 (AWS)	Main 2	99948	20	QPSK	1	50	25.0	24.00	0	0.05	1:1	0.073	1.259	0.092	
1720.00	132072	Low	Right	Tilt	LTE Band 66 (AWS)	Main 2	99948	20	QPSK	50	25	24.0	23.02	1	-0.08	1:1	0.058	1.253	0.073	
1720.00	132072	Low	Left	Cheek	LTE Band 66 (AWS)	Main 2	99948	20	QPSK	1	50	25.0	24.00	0	0.05	1:1	0.089	1.259	0.112	
1720.00	132072	Low	Left	Cheek	LTE Band 66 (AWS)	Main 2	99948	20	QPSK	50	25	24.0	23.02	1	0.01	1:1	0.072	1.253	0.090	
1720.00	132072	Low	Left	Tilt	LTE Band 66 (AWS)	Main 2	99948	20	QPSK	1	50	25.0	24.00	0	-0.14	1:1	0.068	1.259	0.086	
1720.00	132072	Low	Left	Tilt	LTE Band 66 (AWS)	Main 2	99948	20	QPSK	50	25	24.0	23.02	1	0.09	1:1	0.054	1.253	0.068	
1770.00	132572	High	Right	Cheek	LTE Band 66 (AWS)	Sub	99864	20	QPSK	1	50	17.0	15.87	0	-0.02	1:1	0.148	1.297	0.192	
1770.00	132572	High	Right	Cheek	LTE Band 66 (AWS)	Sub	99864	20	QPSK	50	50	17.0	15.78	0	-0.08	1:1	0.150	1.324	0.199	
1770.00	132572	High	Right	Tilt	LTE Band 66 (AWS)	Sub	99864	20	QPSK	1	50	17.0	15.87	0	0.11	1:1	0.138	1.297	0.179	
1770.00	132572	High	Right	Tilt	LTE Band 66 (AWS)	Sub	99864	20	QPSK	50	50	17.0	15.78	0	-0.07	1:1	0.118	1.324	0.156	
1770.00	132572	High	Left	Cheek	LTE Band 66 (AWS)	Sub	99864	20	QPSK	1	50	17.0	15.87	0	0.02	1:1	0.383	1.297	0.497	
1770.00	132572	High	Left	Cheek	LTE Band 66 (AWS)	Sub	99864	20	QPSK	50	50	17.0	15.78	0	0.01	1:1	0.385	1.324	0.510	A10
1770.00	132572	High	Left	Tilt	LTE Band 66 (AWS)	Sub	99864	20	QPSK	1	50	17.0	15.87	0	0.01	1:1	0.220	1.297	0.285	
1770.00	132572	High	Left	Tilt	LTE Band 66 (AWS)	Sub	99864	20	QPSK	50	50	17.0	15.78	0	0.07	1:1	0.215	1.324	0.285	
ANSI / IEEE C95.1 1992 - SAFETY LIMIT Spatial Peak Uncontrolled Exposure/General Population											Head 1.6 W/kg (mW/g) averaged over 1 gram									

FCC ID: PY7-76056F	SAR EVALUATION REPORT	Approved by: Technical Manager
Document S/N: 1M2205240063-03.PY7	DUT Type: Portable Handset	Page 80 of 111

**Table 11-11
LTE Band 25 (PCS) Head SAR**

MEASUREMENT RESULTS																				
FREQUENCY		Side	Test Position	Mode	Antenna Config.	Device Serial Number	Bandwidth [MHz]	Modulation	RB Size	RB Offset	Maximum Allowed Power [dBm]	Conducted Power [dBm]	MPR [dB]	Power Drift [dB]	Duty Cycle	SAR (1g)	Scaling Factor	Reported SAR (1g)	Plot #	
MHz	Ch.															(W/kg)		(W/kg)		
1860.00	26140	Low	Right	Cheek	LTE Band 25 (PCS)	Main 2	99948	20	QPSK	1	50	25.0	23.95	0	0.11	1:1	0.122	1.274	0.155	A11
1860.00	26140	Low	Right	Cheek	LTE Band 25 (PCS)	Main 2	99948	20	QPSK	50	25	24.0	22.88	1	-0.16	1:1	0.102	1.294	0.132	
1860.00	26140	Low	Right	Tilt	LTE Band 25 (PCS)	Main 2	99948	20	QPSK	1	50	25.0	23.95	0	0.20	1:1	0.051	1.274	0.065	
1860.00	26140	Low	Right	Tilt	LTE Band 25 (PCS)	Main 2	99948	20	QPSK	50	25	24.0	22.88	1	0.06	1:1	0.025	1.294	0.032	
1860.00	26140	Low	Left	Cheek	LTE Band 25 (PCS)	Main 2	99948	20	QPSK	1	50	25.0	23.95	0	-0.01	1:1	0.091	1.274	0.116	
1860.00	26140	Low	Left	Cheek	LTE Band 25 (PCS)	Main 2	99948	20	QPSK	50	25	24.0	22.88	1	0.06	1:1	0.079	1.294	0.102	
1860.00	26140	Low	Left	Tilt	LTE Band 25 (PCS)	Main 2	99948	20	QPSK	1	50	25.0	23.95	0	0.01	1:1	0.067	1.274	0.085	
1860.00	26140	Low	Left	Tilt	LTE Band 25 (PCS)	Main 2	99948	20	QPSK	50	25	24.0	22.88	1	0.01	1:1	0.056	1.294	0.072	
ANSI / IEEE C95.1 1992 - SAFETY LIMIT Spatial Peak Uncontrolled Exposure/General Population											Head 1.6 W/kg (mW/g) averaged over 1 gram									

**Table 11-12
LTE Band 2 (PCS) Head SAR**

MEASUREMENT RESULTS																				
FREQUENCY		Side	Test Position	Mode	Antenna Config.	Device Serial Number	Bandwidth [MHz]	Modulation	RB Size	RB Offset	Maximum Allowed Power [dBm]	Conducted Power [dBm]	MPR [dB]	Power Drift [dB]	Duty Cycle	SAR (1g)	Scaling Factor	Reported SAR (1g)	Plot #	
MHz	Ch.															(W/kg)		(W/kg)		
1860.00	18700	Low	Right	Cheek	LTE Band 2 (PCS)	Sub	99864	20	QPSK	1	99	16.0	14.86	0	0.04	1:1	0.146	1.300	0.190	
1860.00	18700	Low	Right	Cheek	LTE Band 2 (PCS)	Sub	99864	20	QPSK	50	50	16.0	14.84	0	0.04	1:1	0.145	1.306	0.189	
1860.00	18700	Low	Right	Tilt	LTE Band 2 (PCS)	Sub	99864	20	QPSK	1	99	16.0	14.86	0	-0.12	1:1	0.078	1.300	0.101	
1860.00	18700	Low	Right	Tilt	LTE Band 2 (PCS)	Sub	99864	20	QPSK	50	50	16.0	14.84	0	-0.13	1:1	0.085	1.306	0.111	
1860.00	18700	Low	Left	Cheek	LTE Band 2 (PCS)	Sub	99864	20	QPSK	1	99	16.0	14.86	0	-0.01	1:1	0.333	1.300	0.433	A12
1860.00	18700	Low	Left	Cheek	LTE Band 2 (PCS)	Sub	99864	20	QPSK	50	50	16.0	14.84	0	-0.01	1:1	0.330	1.306	0.431	
1860.00	18700	Low	Left	Tilt	LTE Band 2 (PCS)	Sub	99864	20	QPSK	1	99	16.0	14.86	0	-0.08	1:1	0.232	1.300	0.302	
1860.00	18700	Low	Left	Tilt	LTE Band 2 (PCS)	Sub	99864	20	QPSK	50	50	16.0	14.84	0	0.08	1:1	0.224	1.306	0.293	
ANSI / IEEE C95.1 1992 - SAFETY LIMIT Spatial Peak Uncontrolled Exposure/General Population											Head 1.6 W/kg (mW/g) averaged over 1 gram									

**Table 11-13
LTE Band 41 Head SAR**

MEASUREMENT RESULTS																				
FREQUENCY		Side	Test Position	Mode	Antenna Config.	Device Serial Number	Bandwidth [MHz]	Modulation	RB Size	RB Offset	Maximum Allowed Power [dBm]	Conducted Power [dBm]	MPR [dB]	Power Drift [dB]	Duty Cycle	SAR (1g)	Scaling Factor	Reported SAR (1g)	Plot #	
MHz	Ch.															(W/kg)		(W/kg)		
2593.00	40620	Mid	Right	Cheek	LTE Band 41	Main 2	99948	20	QPSK	1	0	25.0	23.45	0	0.09	1:1.58	0.026	1.429	0.037	
2593.00	40620	Mid	Right	Cheek	LTE Band 41	Main 2	99948	20	QPSK	50	0	24.0	22.45	1	-0.17	1:1.58	0.019	1.429	0.027	
2593.00	40620	Mid	Right	Tilt	LTE Band 41	Main 2	99948	20	QPSK	1	0	25.0	23.45	0	0.08	1:1.58	0.016	1.429	0.023	
2593.00	40620	Mid	Right	Tilt	LTE Band 41	Main 2	99948	20	QPSK	50	0	24.0	22.45	1	-0.05	1:1.58	0.012	1.429	0.017	
2593.00	40620	Mid	Left	Cheek	LTE Band 41	Main 2	99948	20	QPSK	1	0	25.0	23.45	0	0.14	1:1.58	0.051	1.429	0.073	A13
2593.00	40620	Mid	Left	Cheek	LTE Band 41	Main 2	99948	20	QPSK	50	0	24.0	22.45	1	0.02	1:1.58	0.042	1.429	0.060	
2593.00	40620	Mid	Left	Tilt	LTE Band 41	Main 2	99948	20	QPSK	1	0	25.0	23.45	0	0.04	1:1.58	0.023	1.429	0.033	
2593.00	40620	Mid	Left	Tilt	LTE Band 41	Main 2	99948	20	QPSK	50	0	24.0	22.45	1	0.04	1:1.58	0.015	1.429	0.021	
ANSI / IEEE C95.1 1992 - SAFETY LIMIT Spatial Peak Uncontrolled Exposure/General Population											Head 1.6 W/kg (mW/g) averaged over 1 gram									

FCC ID: PY7-76056F	SAR EVALUATION REPORT	Approved by: Technical Manager
Document S/N: 1M2205240063-03.PY7	DUT Type: Portable Handset	Page 81 of 111

**Table 11-14
LTE Band 48 Head SAR**

MEASUREMENT RESULTS																				
FREQUENCY			Side	Test Position	Mode	Antenna Config.	Device Serial Number	Bandwidth [MHz]	Modulation	RB Size	RB Offset	Maximum Allowed Power [dBm]	Conducted Power [dBm]	MPR [dB]	Power Drift [dB]	Duty Cycle	SAR (1g) (W/kg)	Scaling Factor	Reported SAR (1g) (W/kg)	Plot #
MHz	Ch.																			
3690.00	56640	High	Right	Cheek, Mouth-Jaw	LTE Band 48	Main 1	99948	20	QPSK	1	50	25.0	23.69	0	0.01	1:1.58	0.100	1.351	0.135	A14
3690.00	56640	High	Right	Cheek, Mouth-Jaw	LTE Band 48	Main 1	99948	20	QPSK	50	50	24.0	22.84	1	-0.06	1:1.58	0.081	1.306	0.106	
3690.00	56640	High	Right	Tilt	LTE Band 48	Main 1	99948	20	QPSK	1	50	25.0	23.69	0	0.01	1:1.58	0.046	1.351	0.062	
3690.00	56640	High	Right	Tilt	LTE Band 48	Main 1	99948	20	QPSK	50	50	24.0	22.84	1	-0.06	1:1.58	0.030	1.306	0.039	
3690.00	56640	High	Left	Cheek, Mouth-Jaw	LTE Band 48	Main 1	99948	20	QPSK	1	50	25.0	23.69	0	0.00	1:1.58	0.089	1.351	0.120	
3690.00	56640	High	Left	Cheek, Mouth-Jaw	LTE Band 48	Main 1	99948	20	QPSK	50	50	24.0	22.84	1	-0.04	1:1.58	0.078	1.306	0.102	
3690.00	56640	High	Left	Tilt	LTE Band 48	Main 1	99948	20	QPSK	1	50	25.0	23.69	0	-0.12	1:1.58	0.060	1.351	0.081	
3690.00	56640	High	Left	Tilt	LTE Band 48	Main 1	99948	20	QPSK	50	50	24.0	22.84	1	0.16	1:1.58	0.048	1.306	0.063	
ANSI / IEEE C95.1 1992 - SAFETY LIMIT Spatial Peak Uncontrolled Exposure/General Population												Head 1.6 W/kg (mW/g) averaged over 1 gram								

**Table 11-15
NR Band n71 Head SAR**

MEASUREMENT RESULTS																					
FREQUENCY			Side	Test Position	Mode	Antenna Config.	Serial Number	Bandwidth [MHz]	Waveform	Modulation	RB Size	RB Offset	Maximum Allowed Power [dBm]	Conducted Power [dBm]	MPR [dB]	Power Drift [dB]	Duty Cycle	SAR (1g) (W/kg)	Scaling Factor	Reported SAR (1g) (W/kg)	Plot #
MHz	Ch.																				
680.50	136100	Mid	Right	Cheek	NR Band n71	Main 1	99641	20	DFT-S-OFDM	QPSK	1	1	25.0	23.61	0	-0.04	1:1	0.071	1.377	0.098	
680.50	136100	Mid	Right	Cheek	NR Band n71	Main 1	99641	20	DFT-S-OFDM	QPSK	50	28	25.0	23.52	0	-0.05	1:1	0.073	1.406	0.103	
680.50	136100	Mid	Right	Tilt	NR Band n71	Main 1	99641	20	DFT-S-OFDM	QPSK	1	1	25.0	23.61	0	0.07	1:1	0.030	1.377	0.041	
680.50	136100	Mid	Right	Tilt	NR Band n71	Main 1	99641	20	DFT-S-OFDM	QPSK	50	28	25.0	23.52	0	0.03	1:1	0.036	1.406	0.051	
680.50	136100	Mid	Left	Cheek	NR Band n71	Main 1	99641	20	DFT-S-OFDM	QPSK	1	1	25.0	23.61	0	-0.02	1:1	0.072	1.377	0.099	
680.50	136100	Mid	Left	Cheek	NR Band n71	Main 1	99641	20	DFT-S-OFDM	QPSK	50	28	25.0	23.52	0	0.00	1:1	0.080	1.406	0.112	A15
680.50	136100	Mid	Left	Cheek	NR Band n71	Main 1	99641	20	CP-OFDM	QPSK	1	1	23.5	22.20	1.5	0.00	1:1	0.050	1.349	0.067	
680.50	136100	Mid	Left	Tilt	NR Band n71	Main 1	99641	20	DFT-S-OFDM	QPSK	1	1	25.0	23.61	0	-0.11	1:1	0.034	1.377	0.047	
680.50	136100	Mid	Left	Tilt	NR Band n71	Main 1	99641	20	DFT-S-OFDM	QPSK	50	28	25.0	23.52	0	0.02	1:1	0.040	1.406	0.056	
ANSI / IEEE C95.1 1992 - SAFETY LIMIT Spatial Peak Uncontrolled Exposure/General Population												Head 1.6 W/kg (mW/g) averaged over 1 gram									

**Table 11-16
NR Band n5 Head SAR**

MEASUREMENT RESULTS																					
FREQUENCY			Side	Test Position	Mode	Antenna Config.	Serial Number	Bandwidth [MHz]	Waveform	Modulation	RB Size	RB Offset	Maximum Allowed Power [dBm]	Conducted Power [dBm]	MPR [dB]	Power Drift [dB]	Duty Cycle	SAR (1g) (W/kg)	Scaling Factor	Reported SAR (1g) (W/kg)	Plot #
MHz	Ch.																				
836.50	167300	Mid	Right	Cheek	NR Band n5 (Cell)	Main 1	99641	20	DFT-S-OFDM	QPSK	1	1	25.0	23.76	0	0.10	1:1	0.105	1.330	0.140	
836.50	167300	Mid	Right	Cheek	NR Band n5 (Cell)	Main 1	99641	20	DFT-S-OFDM	QPSK	50	28	25.0	23.71	0	-0.10	1:1	0.131	1.346	0.176	
836.50	167300	Mid	Right	Tilt	NR Band n5 (Cell)	Main 1	99641	20	DFT-S-OFDM	QPSK	1	1	25.0	23.76	0	0.05	1:1	0.045	1.330	0.060	
836.50	167300	Mid	Right	Tilt	NR Band n5 (Cell)	Main 1	99641	20	DFT-S-OFDM	QPSK	50	28	25.0	23.71	0	-0.02	1:1	0.045	1.346	0.061	
836.50	167300	Mid	Left	Cheek	NR Band n5 (Cell)	Main 1	99641	20	DFT-S-OFDM	QPSK	1	1	25.0	23.76	0	-0.02	1:1	0.180	1.330	0.213	
836.50	167300	Mid	Left	Cheek	NR Band n5 (Cell)	Main 1	99641	20	DFT-S-OFDM	QPSK	50	28	25.0	23.71	0	-0.05	1:1	0.210	1.346	0.283	A16
836.50	167300	Mid	Left	Cheek	NR Band n5 (Cell)	Main 1	99641	20	CP-OFDM	QPSK	1	1	23.5	22.31	1.5	0.01	1:1	0.109	1.315	0.143	
836.50	167300	Mid	Left	Tilt	NR Band n5 (Cell)	Main 1	99641	20	DFT-S-OFDM	QPSK	1	1	25.0	23.76	0	0.07	1:1	0.057	1.330	0.076	
836.50	167300	Mid	Left	Tilt	NR Band n5 (Cell)	Main 1	99641	20	DFT-S-OFDM	QPSK	50	28	25.0	23.71	0	-0.09	1:1	0.065	1.346	0.087	
ANSI / IEEE C95.1 1992 - SAFETY LIMIT Spatial Peak Uncontrolled Exposure/General Population												Head 1.6 W/kg (mW/g) averaged over 1 gram									

FCC ID: PY7-76056F	SAR EVALUATION REPORT	Approved by: Technical Manager
Document S/N: 1M2205240063-03.PY7	DUT Type: Portable Handset	Page 82 of 111



Table 11-17 NR Band n66 Head SAR

MEASUREMENT RESULTS																					
FREQUENCY		Side	Test Position	Mode	Antenna Config	Serial Number	Bandwidth [MHz]	Waveform	Modulation	RB Size	RB Offset	Maximum Allowed Power [dBm]	Conducted Power [dBm]	MPR [dB]	Power Drift [dB]	Duty Cycle	SAR (1g) [W/kg]	Scaling Factor	Reported SAR (1g) [W/kg]	Plot #	
Mhz	Ch.																				
1745.00	349000	Mid	Right	Cheek	NR Band n66 (AWS)	Main 2	99641	20	DFT-S-OFDM	QPSK	1	104	25.0	23.36	0	0.04	1:1	0.116	1.459	0.169	
1745.00	349000	Mid	Right	Cheek	NR Band n66 (AWS)	Main 2	99641	20	DFT-S-OFDM	QPSK	50	28	25.0	23.40	0	0.03	1:1	0.136	1.445	0.197	A17
1745.00	349000	Mid	Right	Cheek	NR Band n66 (AWS)	Main 2	99641	20	CP-OFDM	QPSK	1	1	23.5	22.15	1.5	-0.02	1:1	0.084	1.365	0.115	
1745.00	349000	Mid	Right	Tilt	NR Band n66 (AWS)	Main 2	99641	20	DFT-S-OFDM	QPSK	1	104	25.0	23.36	0	0.02	1:1	0.038	1.459	0.055	
1745.00	349000	Mid	Right	Tilt	NR Band n66 (AWS)	Main 2	99641	20	DFT-S-OFDM	QPSK	50	28	25.0	23.40	0	-0.06	1:1	0.039	1.445	0.056	
1745.00	349000	Mid	Right	Cheek	NR Band n66 (AWS)	Main 2	99641	20	DFT-S-OFDM	QPSK	1	104	25.0	23.36	0	-0.01	1:1	0.114	1.459	0.166	
1745.00	349000	Mid	Left	Cheek	NR Band n66 (AWS)	Main 2	99641	20	DFT-S-OFDM	QPSK	50	28	25.0	23.40	0	-0.02	1:1	0.101	1.445	0.146	
1745.00	349000	Mid	Left	Tilt	NR Band n66 (AWS)	Main 2	99641	20	DFT-S-OFDM	QPSK	1	104	25.0	23.36	0	0.01	1:1	0.080	1.459	0.117	
1745.00	349000	Mid	Left	Tilt	NR Band n66 (AWS)	Main 2	99641	20	DFT-S-OFDM	QPSK	50	28	25.0	23.40	0	0.03	1:1	0.070	1.445	0.101	
ANSI / IEEE C95.1 1992 - SAFETY LIMIT												Head									
Spatial Peak												1.6 W/kg (mW/g)									
Uncontrolled Exposure/General Population												averaged over 1 gram									

Table 11-18 NR Band n2 Head SAR

MEASUREMENT RESULTS																					
FREQUENCY		Side	Test Position	Mode	Antenna Config	Serial Number	Bandwidth [MHz]	Waveform	Modulation	RB Size	RB Offset	Maximum Allowed Power [dBm]	Conducted Power [dBm]	MPR [dB]	Power Drift [dB]	Duty Cycle	SAR (1g) [W/kg]	Scaling Factor	Reported SAR (1g) [W/kg]	Plot #	
Mhz	Ch.																				
1900.00	380000	High	Right	Cheek	NR Band n2 (PCS)	Main 2	99641	20	DFT-S-OFDM	QPSK	1	53	25.0	23.31	0	0.03	1:1	0.114	1.476	0.168	
1900.00	380000	High	Right	Cheek	NR Band n2 (PCS)	Main 2	99641	20	DFT-S-OFDM	QPSK	50	28	25.0	23.24	0	-0.07	1:1	0.118	1.500	0.177	A18
1880.00	376000	Mid	Right	Cheek	NR Band n2 (PCS)	Main 2	99641	20	CP-OFDM	QPSK	1	1	23.5	21.95	1.5	0.01	1:1	0.088	1.429	0.126	
1900.00	380000	High	Right	Tilt	NR Band n2 (PCS)	Main 2	99641	20	DFT-S-OFDM	QPSK	1	53	25.0	23.31	0	0.07	1:1	0.038	1.476	0.056	
1900.00	380000	High	Right	Tilt	NR Band n2 (PCS)	Main 2	99641	20	DFT-S-OFDM	QPSK	50	28	25.0	23.24	0	0.03	1:1	0.037	1.500	0.056	
1900.00	380000	High	Left	Cheek	NR Band n2 (PCS)	Main 2	99641	20	DFT-S-OFDM	QPSK	1	53	25.0	23.31	0	0.01	1:1	0.103	1.476	0.152	
1900.00	380000	High	Left	Cheek	NR Band n2 (PCS)	Main 2	99641	20	DFT-S-OFDM	QPSK	50	28	25.0	23.24	0	-0.16	1:1	0.100	1.500	0.150	
1900.00	380000	High	Left	Tilt	NR Band n2 (PCS)	Main 2	99641	20	DFT-S-OFDM	QPSK	1	53	25.0	23.31	0	0.08	1:1	0.048	1.476	0.071	
1900.00	380000	High	Left	Tilt	NR Band n2 (PCS)	Main 2	99641	20	DFT-S-OFDM	QPSK	50	28	25.0	23.24	0	0.06	1:1	0.051	1.500	0.077	
ANSI / IEEE C95.1 1992 - SAFETY LIMIT												Head									
Spatial Peak												1.6 W/kg (mW/g)									
Uncontrolled Exposure/General Population												averaged over 1 gram									

Table 11-19 NR Band n41 Head SAR

MEASUREMENT RESULTS																					
FREQUENCY		Side	Test Position	Mode	Antenna Config	Serial Number	Bandwidth [MHz]	Waveform	Modulation	RB Size	RB Offset	Maximum Allowed Power [dBm]	Conducted Power [dBm]	MPR [dB]	Power Drift [dB]	Duty Cycle	SAR (1g) [W/kg]	Scaling Factor	Reported SAR (1g) [W/kg]	Plot #	
Mhz	Ch.																				
2592.99	518598	Mid	Right	Cheek, Mouth-Jaw	NR Band n41	Main 2	99641	100	DFT-S-OFDM	QPSK	1	1	27.0	25.54	0	0.10	1:1	0.134	1.400	0.188	
2592.99	518598	Mid	Right	Cheek, Mouth-Jaw	NR Band n41	Main 2	99641	100	DFT-S-OFDM	QPSK	135	69	27.0	25.32	0	-0.02	1:1	0.129	1.472	0.190	
2592.99	518598	Mid	Right	Cheek, Mouth-Jaw	NR Band n41	Main 2	99641	100	CP-OFDM	QPSK	1	1	25.5	23.94	1.5	-0.05	1:1	0.123	1.486	0.180	
2592.99	518598	Mid	Right	Tilt	NR Band n41	Main 2	99641	100	DFT-S-OFDM	QPSK	1	1	27.0	25.54	0	0.04	1:1	0.036	1.400	0.050	
2592.99	518598	Mid	Right	Tilt	NR Band n41	Main 2	99641	100	DFT-S-OFDM	QPSK	135	69	27.0	25.32	0	0.06	1:1	0.033	1.472	0.049	
2592.99	518598	Mid	Left	Cheek	NR Band n41	Main 2	99641	100	DFT-S-OFDM	QPSK	1	1	27.0	25.54	0	0.15	1:1	0.114	1.400	0.160	
2592.99	518598	Mid	Left	Cheek	NR Band n41	Main 2	99641	100	DFT-S-OFDM	QPSK	135	69	27.0	25.32	0	0.05	1:1	0.097	1.472	0.143	
2592.99	518598	Mid	Left	Tilt	NR Band n41	Main 2	99641	100	DFT-S-OFDM	QPSK	1	1	27.0	25.54	0	-0.15	1:1	0.076	1.400	0.106	
2592.99	518598	Mid	Left	Tilt	NR Band n41	Main 2	99641	100	DFT-S-OFDM	QPSK	135	69	27.0	25.32	0	0.20	1:1	0.049	1.472	0.072	
2592.99	518598	Mid	Right	Cheek	NR Band n41	Sub	99542	100	CP-OFDM	QPSK	1	271	18.0	17.66	0	0.01	1:1	0.227	1.081	0.245	
2592.99	518598	Mid	Right	Cheek	NR Band n41	Sub	99542	100	CP-OFDM	QPSK	137	68	18.0	17.70	0	0.00	1:1	0.217	1.072	0.233	
2592.99	518598	Mid	Right	Tilt	NR Band n41	Sub	99542	100	CP-OFDM	QPSK	1	271	18.0	17.66	0	0.18	1:1	0.141	1.081	0.152	
2592.99	518598	Mid	Right	Tilt	NR Band n41	Sub	99542	100	CP-OFDM	QPSK	137	68	18.0	17.70	0	-0.01	1:1	0.196	1.072	0.210	
2592.99	518598	Mid	Left	Cheek	NR Band n41	Sub	99542	100	CP-OFDM	QPSK	1	271	18.0	17.66	0	0.03	1:1	0.868	1.081	0.938	
2592.99	518598	Mid	Left	Cheek	NR Band n41	Sub	99542	100	CP-OFDM	QPSK	137	68	18.0	17.70	0	0.02	1:1	0.874	1.072	0.937	
2592.99	518598	Mid	Left	Cheek	NR Band n41	Sub	99542	100	CP-OFDM	QPSK	273	0	18.0	17.90	0	0.02	1:1	0.928	1.023	0.949	A19
2592.99	518598	Mid	Left	Tilt	NR Band n41	Sub	99542	100	CP-OFDM	QPSK	1	271	18.0	17.66	0	0.06	1:1	0.666	1.081	0.720	
2592.99	518598	Mid	Left	Tilt	NR Band n41	Sub	99542	100	CP-OFDM	QPSK	137	68	18.0	17.70	0	0.03	1:1	0.676	1.072	0.725	
2592.99	518598	Mid	Left	Tilt	NR Band n41	Sub	99542	100	CP-OFDM	QPSK	273	0	18.0	17.90	0	0.02	1:1	0.608	1.023	0.622	
2592.99	518598	Mid	Left	Cheek	NR Band n41	Sub	99542	100	CP-OFDM	QPSK	273	0	18.0	17.90	0	0.04	1:1	0.865	1.023	0.885	
ANSI / IEEE C95.1 1992 - SAFETY LIMIT												Head									
Spatial Peak												1.6 W/kg (mW/g)									
Uncontrolled Exposure/General Population												averaged over 1 gram									

Note: Blue Entry represents variability measurement.

FCC ID: PY7-76056F	SAR EVALUATION REPORT	Approved by: Technical Manager
Document S/N: 1M2205240063-03.PY7	DUT Type: Portable Handset	Page 83 of 111

REV 22.0
03/30/2022

Unless otherwise specified, no part of this report may be reproduced or utilized in any part, form or by any means, electronic or mechanical, including photocopying and microfilm, without permission in writing from Element. If you have any questions or have an enquiry about obtaining additional rights to this report or assembly of contents thereof, please contact CT.INFO@ELEMENT.COM.

**Table 11-20
NR Band n77 Head SAR**

MEASUREMENT RESULTS																					
FREQUENCY		Side	Test Position	Mode	Antenna Config	Serial Number	Bandwidth [MHz]	Waveform	Modulation	RB Size	RB Offset	Maximum Allowed Power [dBm]	Conducted Power [dBm]	MPR [dB]	Power Drift [dB]	Duty Cycle	SAR (1g) (W/kg)	Scaling Factor	Reported SAR (1g) (W/kg)	Plot #	
MHz	Ch.																				
3930.00	662000	High	Right	Cheek, Mouth-Jaw	NR Band n77	Main 1	99849	100	DFT-S-OFDM	QPSK	1	137	27.0	25.65	0	-0.14	1:1	0.274	1.365	0.374	
3750.00	650000	Low	Right	Cheek, Mouth-Jaw	NR Band n77	Main 1	99849	100	DFT-S-OFDM	QPSK	135	69	27.0	25.23	0	-0.03	1:1	0.213	1.503	0.320	
3930.00	662000	High	Right	Cheek, Mouth-Jaw	NR Band n77	Main 1	99849	100	DFT-S-OFDM	QPSK	135	69	27.0	25.60	0	-0.14	1:1	0.318	1.380	0.439	A20
3930.00	662000	High	Right	Cheek, Mouth-Jaw	NR Band n77	Main 1	99849	100	DFT-S-OFDM	QPSK	270	0	26.0	24.46	1	-0.01	1:1	0.187	1.426	0.267	
3930.00	662000	High	Right	Tilt	NR Band n77	Main 1	99849	100	DFT-S-OFDM	QPSK	1	137	27.0	25.65	0	0.02	1:1	0.072	1.365	0.098	
3930.00	662000	High	Right	Tilt	NR Band n77	Main 1	99849	100	DFT-S-OFDM	QPSK	135	69	27.0	25.60	0	-0.06	1:1	0.091	1.380	0.126	
3750.00	650000	Low	Left	Cheek, Mouth-Jaw	NR Band n77	Main 1	99849	100	DFT-S-OFDM	QPSK	1	137	27.0	25.30	0	0.03	1:1	0.210	1.479	0.311	
3930.00	662000	High	Left	Cheek, Mouth-Jaw	NR Band n77	Main 1	99849	100	DFT-S-OFDM	QPSK	1	137	27.0	25.65	0	-0.04	1:1	0.309	1.365	0.422	
3750.00	650000	Low	Left	Cheek, Mouth-Jaw	NR Band n77	Main 1	99849	100	DFT-S-OFDM	QPSK	135	69	27.0	25.23	0	-0.09	1:1	0.223	1.503	0.335	
3930.00	662000	High	Left	Cheek, Mouth-Jaw	NR Band n77	Main 1	99849	100	DFT-S-OFDM	QPSK	135	69	27.0	25.60	0	-0.09	1:1	0.305	1.380	0.421	
3930.00	662000	High	Left	Cheek, Mouth-Jaw	NR Band n77	Main 1	99849	100	DFT-S-OFDM	QPSK	270	0	26.0	24.46	1	0.04	1:1	0.186	1.426	0.265	
3930.00	662000	High	Left	Cheek, Mouth-Jaw	NR Band n77	Main 1	99849	100	CP-OFDM	QPSK	1	1	25.5	23.55	1.5	0.08	1:1	0.166	1.567	0.260	
3930.00	662000	High	Left	Tilt	NR Band n77	Main 1	99849	100	DFT-S-OFDM	QPSK	1	137	27.0	25.65	0	-0.05	1:1	0.130	1.365	0.177	
3930.00	662000	High	Left	Tilt	NR Band n77	Main 1	99849	100	DFT-S-OFDM	QPSK	135	69	27.0	25.60	0	-0.13	1:1	0.123	1.380	0.170	
3930.00	662000	High	Right	Cheek	NR Band n77	Sub	99765	100	CP-OFDM	QPSK	1	137	16.0	14.79	0	-0.03	1:1	0.055	1.321	0.073	
3930.00	662000	High	Right	Cheek	NR Band n77	Sub	99765	100	CP-OFDM	QPSK	137	68	16.0	15.00	0	-0.11	1:1	0.054	1.259	0.068	
3930.00	662000	High	Right	Tilt	NR Band n77	Sub	99765	100	CP-OFDM	QPSK	1	137	16.0	14.79	0	0.09	1:1	0.043	1.321	0.057	
3930.00	662000	High	Right	Tilt	NR Band n77	Sub	99765	100	CP-OFDM	QPSK	137	68	16.0	15.00	0	-0.15	1:1	0.047	1.259	0.059	
3930.00	662000	High	Left	Cheek	NR Band n77	Sub	99765	100	CP-OFDM	QPSK	1	1	16.0	14.70	0	0.01	1:1	0.073	1.349	0.098	
3930.00	662000	High	Left	Cheek	NR Band n77	Sub	99765	100	CP-OFDM	QPSK	137	68	16.0	15.00	0	0.03	1:1	0.062	1.259	0.078	
3930.00	662000	High	Left	Tilt	NR Band n77	Sub	99765	100	CP-OFDM	QPSK	1	137	16.0	14.79	0	0.06	1:1	0.033	1.321	0.044	
3930.00	662000	High	Left	Tilt	NR Band n77	Sub	99765	100	CP-OFDM	QPSK	137	68	16.0	15.00	0	0.03	1:1	0.031	1.259	0.039	
ANSI / IEEE C95.1 1992 - SAFETY LIMIT Spatial Peak Uncontrolled Exposure/General Population												Head 1.6 W/kg (mW/g) averaged over 1 gram									

**Table 11-21
DTS Head SAR**

MEASUREMENT RESULTS																			
FREQUENCY		Side	Test Position	Mode	Service	Antenna Config.	Device Serial Number	Bandwidth [MHz]	Data Rate (Mbps)	Maximum Allowed Power [dBm]	Conducted Power [dBm]	Power Drift [dB]	Duty Cycle (%)	Peak SAR of Area Scan (W/kg)	SAR (1g) (W/kg)	Scaling Factor (Power)	Scaling Factor (Duty Cycle)	Reported SAR (1g) (W/kg)	Plot #
MHz	Ch.																		
2412	1	Right	Cheek	802.11b	DSSS	Chain 0	99609	22	1	14.5	14.13	-0.03	99.80	0.615	0.570	1.089	1.002	0.622	
2437	6	Right	Cheek	802.11b	DSSS	Chain 0	99609	22	1	14.5	13.99	-0.13	99.80	0.723	0.538	1.125	1.002	0.606	
2462	11	Right	Cheek	802.11b	DSSS	Chain 0	99609	22	1	14.5	13.97	0.11	99.80	0.737	0.571	1.130	1.002	0.647	A21
2412	1	Right	Tilt	802.11b	DSSS	Chain 0	99609	22	1	14.5	14.13	0.00	99.80	0.153	0.103	1.089	1.002	0.112	
2412	1	Left	Cheek	802.11b	DSSS	Chain 0	99609	22	1	14.5	14.13	0.01	99.80	0.137	0.116	1.089	1.002	0.127	
2412	1	Left	Tilt	802.11b	DSSS	Chain 0	99609	22	1	14.5	14.13	0.18	99.80	0.039	-	1.089	1.002	-	
2412	1	Right	Cheek	802.11b	DSSS	Chain 1	99567	22	1	12.7	12.60	0.08	99.50	0.003	-	1.023	1.005	-	
2412	1	Right	Tilt	802.11b	DSSS	Chain 1	99567	22	1	12.7	12.60	0.04	99.50	0.002	-	1.023	1.005	-	
2412	1	Left	Cheek	802.11b	DSSS	Chain 1	99567	22	1	12.7	12.60	0.03	99.50	0.005	0.000	1.023	1.005	0.000	
2412	1	Left	Tilt	802.11b	DSSS	Chain 1	99567	22	1	12.7	12.60	0.08	99.50	0.003	-	1.023	1.005	-	
ANSI / IEEE C95.1 1992 - SAFETY LIMIT Spatial Peak Uncontrolled Exposure/General Population												Head 1.6 W/kg (mW/g) averaged over 1 gram							

FCC ID: PY7-76056F	SAR EVALUATION REPORT	Approved by: Technical Manager
Document S/N: 1M2205240063-03.PY7	DUT Type: Portable Handset	Page 84 of 111

**Table 11-22
DTS Head SAR during conditions with 5 GHz WLAN and/or 5G NR**

MEASUREMENT RESULTS																			
FREQUENCY		Side	Test Position	Mode	Service	Antenna Config.	Device Serial Number	Bandwidth [MHz]	Data Rate (Mbps)	Maximum Allowed Power [dBm]	Conducted Power [dBm]	Power Drift [dB]	Duty Cycle (%)	Peak SAR of Area Scan	SAR (1g)	Scaling Factor (Power)	Scaling Factor (Duty Cycle)	Reported SAR (1g)	Plot #
MHz	Ch.													W/kg	(W/kg)	(W/kg)	(W/kg)		
2462	11	Right	Cheek	802.11b	DSSS	Chain 0	99583	22	1	11.0	10.91	-0.02	99.8	0.276	0.184	1.021	1.002	0.188	
2462	11	Right	Tilt	802.11b	DSSS	Chain 0	99583	22	1	11.0	10.91	0.11	99.8	0.044	-	1.021	1.002	-	
2462	11	Left	Cheek	802.11b	DSSS	Chain 0	99583	22	1	11.0	10.91	0.01	99.8	0.056	0.041	1.021	1.002	0.042	
2462	11	Left	Tilt	802.11b	DSSS	Chain 0	99583	22	1	11.0	10.91	0.06	99.8	0.014	-	1.021	1.002	-	
ANSI / IEEE C95.1 1992 - SAFETY LIMIT Spatial Peak Uncontrolled Exposure/General Population											Head 1.6 W/kg (mW/g) averaged over 1 gram								

**Table 11-23
NII Head SAR**

MEASUREMENT RESULTS																			
FREQUENCY		Side	Test Position	Mode	Service	Antenna Config.	Device Serial Number	Bandwidth [MHz]	Data Rate (Mbps)	Maximum Allowed Power [dBm]	Conducted Power [dBm]	Power Drift [dB]	Duty Cycle (%)	Peak SAR of Area Scan	SAR (1g)	Scaling Factor (Power)	Scaling Factor (Duty Cycle)	Reported SAR (1g)	Plot #
MHz	Ch.													W/kg	(W/kg)	(W/kg)	(W/kg)		
5290	58	Right	Cheek	802.11ac	OFDM	Chain 0	99823	80	29.3	11.5	10.73	-0.02	98.90	0.473	0.332	1.194	1.011	0.401	A22
5290	58	Right	Tilt	802.11ac	OFDM	Chain 0	99823	80	29.3	11.5	10.73	0.05	98.90	0.106	-	1.194	1.011	-	
5290	58	Left	Cheek	802.11ac	OFDM	Chain 0	99823	80	29.3	11.5	10.73	-0.06	98.90	0.195	0.147	1.194	1.011	0.177	
5290	58	Left	Tilt	802.11ac	OFDM	Chain 0	99823	80	29.3	11.5	10.73	0.03	98.90	0.051	0.030	1.194	1.011	0.036	
5290	58	Right	Cheek	802.11ac	OFDM	Chain 1	99823	80	29.3	11.5	11.20	0.06	99.00	0.009	0.000	1.072	1.010	0.000	
5290	58	Right	Tilt	802.11ac	OFDM	Chain 1	99823	80	29.3	11.5	11.20	0.08	99.00	0.003	-	1.072	1.010	-	
5290	58	Left	Cheek	802.11ac	OFDM	Chain 1	99823	80	29.3	11.5	11.20	0.08	99.00	0.000	0.000	1.072	1.010	0.000	
5290	58	Left	Tilt	802.11ac	OFDM	Chain 1	99823	80	29.3	11.5	11.20	0.09	99.00	0.000	0.000	1.072	1.010	0.000	
5690	138	Right	Cheek	802.11ac	OFDM	Chain 0	99823	80	29.3	11.5	11.28	0.04	98.90	0.149	0.157	1.052	1.011	0.167	
5690	138	Right	Tilt	802.11ac	OFDM	Chain 0	99823	80	29.3	11.5	11.28	-0.20	98.90	0.074	-	1.052	1.011	-	
5690	138	Left	Cheek	802.11ac	OFDM	Chain 0	99823	80	29.3	11.5	11.28	-0.13	98.90	0.095	0.066	1.052	1.011	0.070	
5690	138	Left	Tilt	802.11ac	OFDM	Chain 0	99823	80	29.3	11.5	11.28	0.08	98.90	0.028	0.014	1.052	1.011	0.015	
5530	106	Right	Cheek	802.11ac	OFDM	Chain 1	99823	80	29.3	11.5	11.36	0.05	99.00	0.006	-	1.033	1.010	-	
5530	106	Right	Tilt	802.11ac	OFDM	Chain 1	99823	80	29.3	11.5	11.36	-0.03	99.00	0.011	0.000	1.033	1.010	0.000	
5530	106	Left	Cheek	802.11ac	OFDM	Chain 1	99823	80	29.3	11.5	11.36	0.09	99.00	0.000	0.000	1.033	1.010	0.000	
5530	106	Left	Tilt	802.11ac	OFDM	Chain 1	99823	80	29.3	11.5	11.36	-0.02	99.00	0.000	0.000	1.033	1.010	0.000	
5775	155	Right	Cheek	802.11ac	OFDM	Chain 0	99823	80	29.3	11.5	10.52	0.08	98.90	0.151	0.179	1.253	1.011	0.227	
5775	155	Right	Tilt	802.11ac	OFDM	Chain 0	99823	80	29.3	11.5	10.52	0.04	98.90	0.060	-	1.253	1.011	-	
5775	155	Left	Cheek	802.11ac	OFDM	Chain 0	99823	80	29.3	11.5	10.52	0.12	98.90	0.139	0.097	1.253	1.011	0.123	
5775	155	Left	Tilt	802.11ac	OFDM	Chain 0	99823	80	29.3	11.5	10.52	0.05	98.90	0.048	0.031	1.253	1.011	0.039	
5775	155	Right	Cheek	802.11ac	OFDM	Chain 1	99823	80	29.3	11.5	11.22	0.05	99.00	0.011	-	1.067	1.010	-	
5775	155	Right	Tilt	802.11ac	OFDM	Chain 1	99823	80	29.3	11.5	11.22	0.02	99.00	0.013	-	1.067	1.010	-	
5775	155	Left	Cheek	802.11ac	OFDM	Chain 1	99823	80	29.3	11.5	11.22	0.09	99.00	0.018	0.001	1.067	1.010	0.001	
5775	155	Left	Tilt	802.11ac	OFDM	Chain 1	99823	80	29.3	11.5	11.22	0.20	99.00	0.014	0.000	1.067	1.010	0.000	
ANSI / IEEE C95.1 1992 - SAFETY LIMIT Spatial Peak Uncontrolled Exposure/General Population											Head 1.6 W/kg (mW/g) averaged over 1 gram								

FCC ID: PY7-76056F	SAR EVALUATION REPORT	Approved by: Technical Manager
Document S/N: 1M2205240063-03.PY7	DUT Type: Portable Handset	Page 85 of 111

**Table 11-24
DSS Head SAR**

MEASUREMENT RESULTS																	
FREQUENCY		Side	Test Position	Mode	Service	Antenna Config.	Device Serial Number	Data Rate (Mbps)	Maximum Allowed Power [dBm]	Conducted Power [dBm]	Power Drift [dB]	Duty Cycle (%)	SAR (1g)	Scaling Factor (Cond Power)	Scaling Factor (Duty Cycle)	Reported SAR (1g)	Plot #
MHz	Ch.												(W/kg)			(W/kg)	
2480	78	Right	Cheek	Bluetooth	FHSS	Chain 0	99666	1	14.0	13.88	0.00	76.80	0.148	1.028	1.085	0.165	A23
2480	78	Right	Tilt	Bluetooth	FHSS	Chain 0	99666	1	14.0	13.88	-0.18	76.80	0.031	1.028	1.085	0.035	
2480	78	Left	Cheek	Bluetooth	FHSS	Chain 0	99666	1	14.0	13.88	-0.04	76.80	0.023	1.028	1.085	0.026	
2480	78	Left	Tilt	Bluetooth	FHSS	Chain 0	99666	1	14.0	13.88	0.09	76.80	0.006	1.028	1.085	0.007	
2480	78	Right	Cheek	Bluetooth	FHSS	Chain 1	99666	1	14.0	13.48	0.02	76.80	0.000	1.127	1.085	0.000	
2480	78	Right	Tilt	Bluetooth	FHSS	Chain 1	99666	1	14.0	13.48	0.03	76.80	0.000	1.127	1.085	0.000	
2480	78	Left	Cheek	Bluetooth	FHSS	Chain 1	99666	1	14.0	13.48	0.20	76.80	0.000	1.127	1.085	0.000	
2480	78	Left	Tilt	Bluetooth	FHSS	Chain 1	99666	1	14.0	13.48	0.09	76.80	0.000	1.127	1.085	0.000	
ANSI / IEEE C95.1 1992 - SAFETY LIMIT Spatial Peak Uncontrolled Exposure/General Population									Head 1.6 W/kg (mW/g) averaged over 1 gram								

Note: The reported SAR was scaled to the 83.3% transmission duty factor to determine compliance since the duty factor of the device is permanently limited to 83.3% per the manufacturer.

11.2 Standalone Body-Worn SAR Data

**Table 11-25
GSM/DTM Body-Worn SAR Data**

MEASUREMENT RESULTS																
FREQUENCY		Side	Spacing	Mode	Service	Antenna Config.	Device Serial Number	# of Time Slots	Maximum Allowed Power [dBm]	Conducted Power [dBm]	Power Drift [dB]	Duty Cycle	SAR (1g)	Scaling Factor	Reported SAR (1g)	Plot #
MHz	Ch.												(W/kg)		(W/kg)	
848.80	251	back	10 mm	GSM 850	GSM	Main 1	99948	1	33.2	32.51	0.00	1:8.3	0.165	1.172	0.193	A24
848.80	251	back	10 mm	GSM 850	DTM	Main 1	99948	3	28.4	27.44	-0.07	1:2.76	0.152	1.247	0.190	
1909.80	810	back	10 mm	GSM 1900	GSM	Main 2	99948	1	27.7	26.64	0.01	1:8.3	0.126	1.276	0.161	
1850.20	512	back	10 mm	GSM 1900	DTM	Main 2	99948	3	22.9	21.95	0.06	1:2.76	0.182	1.245	0.227	A25
ANSI / IEEE C95.1 1992 - SAFETY LIMIT Spatial Peak Uncontrolled Exposure/General Population									Body 1.6 W/kg (mW/g) averaged over 10 grams							

**Table 11-26
UMTS Body-Worn SAR Data**

MEASUREMENT RESULTS																
FREQUENCY		Side	Spacing	Mode	Service	Antenna Config.	Device Serial Number	Maximum Allowed Power [dBm]	Conducted Power [dBm]	Power Drift [dB]	Duty Cycle	SAR (1g)	Scaling Factor	Reported SAR (1g)	Plot #	
MHz	Ch.											(W/kg)		(W/kg)		
836.60	4183	back	10 mm	UMTS 850	RMC	Main 1	99948	22.7	21.72	-0.01	1:1	0.176	1.253	0.221	A26	
1752.60	1513	back	10 mm	UMTS 1750	RMC	Main 2	99948	18.7	17.65	0.00	1:1	0.198	1.274	0.252	A27	
1852.40	9262	back	10 mm	UMTS 1900	RMC	Main 2	99948	19.7	18.57	-0.05	1:1	0.217	1.297	0.281	A28	
ANSI / IEEE C95.1 1992 - SAFETY LIMIT Spatial Peak Uncontrolled Exposure/General Population									Body 1.6 W/kg (mW/g) averaged over 10 grams							

FCC ID: PY7-76056F	SAR EVALUATION REPORT		Approved by: Technical Manager
Document S/N: 1M2205240063-03.PY7	DUT Type: Portable Handset		Page 86 of 111

**Table 11-27
LTE Body-Worn SAR**

MEASUREMENT RESULTS																				
FREQUENCY		Side	Spacing	Mode	Antenna Config.	Device Serial Number	Bandwidth [MHz]	Modulation	RB Size	RB Offset	Maximum Allowed Power [dBm]	Conducted Power [dBm]	MPR [dB]	Power Drift [dB]	Duty Cycle	SAR (1g)	Scaling Factor	Reported SAR (1g)	Plot #	
MHz	Ch.															(W/kg)		(W/kg)		
680.50	133297	Mid	back	10 mm	LTE Band 71	Main 1	00043	20	QPSK	1	0	23.0	22.31	0	0.00	1:1	0.098	1.172	0.115	
680.50	133297	Mid	back	10 mm	LTE Band 71	Main 1	00043	20	QPSK	50	0	23.0	22.25	0	-0.02	1:1	0.105	1.189	0.125	A29
707.50	23095	Mid	back	10 mm	LTE Band 12	Main 1	00043	10	QPSK	1	49	22.0	21.17	0	0.02	1:1	0.165	1.211	0.200	
707.50	23095	Mid	back	10 mm	LTE Band 12	Main 1	00043	10	QPSK	25	12	22.0	21.15	0	-0.01	1:1	0.159	1.216	0.193	
707.50	23095	Mid	back	10 mm	LTE Band 12	Sub	00068	10	QPSK	1	0	24.5	23.31	0	0.00	1:1	0.223	1.315	0.293	A30
707.50	23095	Mid	back	10 mm	LTE Band 12	Sub	00068	10	QPSK	25	12	23.5	22.30	1	0.01	1:1	0.186	1.318	0.245	
782.00	23230	Mid	back	10 mm	LTE Band 13	Main 1	00043	10	QPSK	1	0	22.0	21.04	0	0.06	1:1	0.256	1.247	0.319	
782.00	23230	Mid	back	10 mm	LTE Band 13	Main 1	00043	10	QPSK	25	12	22.0	21.46	0	-0.03	1:1	0.270	1.132	0.306	
782.00	23230	Mid	back	10 mm	LTE Band 13	Sub	00068	10	QPSK	1	49	24.5	23.41	0	0.06	1:1	0.305	1.285	0.392	A31
782.00	23230	Mid	back	10 mm	LTE Band 13	Sub	00068	10	QPSK	25	0	23.5	22.40	1	0.02	1:1	0.234	1.288	0.301	
836.50	20525	Mid	back	10 mm	LTE Band 5 (Cell)	Main 1	99989	10	QPSK	1	49	22.0	21.25	0	0.00	1:1	0.103	1.189	0.122	
836.50	20525	Mid	back	10 mm	LTE Band 5 (Cell)	Main 1	99989	10	QPSK	25	25	22.0	21.26	0	-0.01	1:1	0.110	1.186	0.130	
836.50	20525	Mid	back	10 mm	LTE Band 5 (Cell)	Sub	00068	10	QPSK	1	0	24.5	23.15	0	-0.01	1:1	0.226	1.365	0.308	A32
836.50	20525	Mid	back	10 mm	LTE Band 5 (Cell)	Sub	00068	10	QPSK	25	0	23.5	22.22	1	0.00	1:1	0.184	1.343	0.247	
1720.00	132072	Low	back	10 mm	LTE Band 66 (AWS)	Main 2	00043	20	QPSK	1	50	19.0	18.10	0	0.14	1:1	0.181	1.230	0.223	A33
1720.00	132072	Low	back	10 mm	LTE Band 66 (AWS)	Main 2	00043	20	QPSK	50	25	19.0	18.09	0	0.02	1:1	0.176	1.233	0.217	
1770.00	132572	High	back	10 mm	LTE Band 66 (AWS)	Sub	99864	20	QPSK	1	50	17.0	15.87	0	-0.06	1:1	0.037	1.297	0.048	
1770.00	132572	High	back	10 mm	LTE Band 66 (AWS)	Sub	99864	20	QPSK	50	50	17.0	15.78	0	-0.03	1:1	0.036	1.324	0.048	
1905.00	26590	High	back	10 mm	LTE Band 25 (PCS)	Main 2	99989	20	QPSK	1	0	20.0	18.62	0	0.01	1:1	0.168	1.373	0.231	A34
1905.00	26590	High	back	10 mm	LTE Band 25 (PCS)	Main 2	99989	20	QPSK	50	0	20.0	18.70	0	-0.01	1:1	0.159	1.349	0.214	
1860.00	18700	Low	back	10 mm	LTE Band 2 (PCS)	Sub	99864	20	QPSK	1	99	16.0	14.86	0	-0.02	1:1	0.024	1.300	0.031	
1860.00	18700	Low	back	10 mm	LTE Band 2 (PCS)	Sub	99864	20	QPSK	50	50	16.0	14.84	0	0.06	1:1	0.026	1.306	0.034	A35
2593.00	40620	Mid	back	10 mm	LTE Band 41	Main 2	99989	20	QPSK	1	0	20.0	18.98	0	-0.18	1:1.58	0.091	1.265	0.115	
2593.00	40620	Mid	back	10 mm	LTE Band 41	Main 2	99989	20	QPSK	50	0	20.0	18.98	0	0.01	1:1.58	0.094	1.265	0.119	A36
3646.70	56207	Mid-High	back	10 mm	LTE Band 48	Main 1	99989	20	QPSK	1	50	20.0	18.98	0	0.08	1:1.58	0.104	1.265	0.132	
3646.70	56207	Mid-High	back	10 mm	LTE Band 48	Main 1	99989	20	QPSK	50	25	20.0	18.99	0	0.03	1:1.58	0.107	1.262	0.135	A37
ANSI / IEEE C95.1 1992 - SAFETY LIMIT Spatial Peak Uncontrolled Exposure/General Population											Body 1.6 W/kg (mW/g) averaged over 10 grams									

FCC ID: PY7-76056F	SAR EVALUATION REPORT	Approved by: Technical Manager
Document S/N: 1M2205240063-03.PY7	DUT Type: Portable Handset	Page 87 of 111

**Table 11-28
NR Body-Worn SAR**

MEASUREMENT RESULTS																					
FREQUENCY		Side	Spacing	Mode	Antenna Config	Serial Number	Bandwidth [MHz]	Waveform	Modulation	RB Size	RB Offset	Maximum Allowed Power [dBm]	Conducted Power [dBm]	MPR [dB]	Power Drift [dB]	Duty Cycle	SAR (1g) (W/kg)	Scaling Factor	Reported SAR (1g) (W/kg)	Plot #	
MHz	Ch.																				
680.50	136100	Mid	back	10 mm	NR Band n71	Main 1	99807	20	DFT-S-OFDM	QPSK	1	104	24.0	22.48	0	-0.01	1:1	0.181	1.419	0.257	A38
680.50	136100	Mid	back	10 mm	NR Band n71	Main 1	99807	20	DFT-S-OFDM	QPSK	50	56	24.0	22.48	0	-0.11	1:1	0.171	1.419	0.243	
680.50	136100	Mid	back	10 mm	NR Band n71	Main 1	99807	20	CP-OFDM	QPSK	1	1	23.5	21.95	0.5	0.01	1:1	0.118	1.429	0.169	
836.50	167300	Mid	back	10 mm	NR Band n5 (Cell)	Main 1	99807	20	DFT-S-OFDM	QPSK	1	1	22.0	20.69	0	0.01	1:1	0.133	1.352	0.180	
836.50	167300	Mid	back	10 mm	NR Band n5 (Cell)	Main 1	99807	20	DFT-S-OFDM	QPSK	50	0	22.0	20.71	0	-0.02	1:1	0.123	1.346	0.166	
836.50	167300	Mid	back	10 mm	NR Band n5 (Cell)	Main 1	99807	20	CP-OFDM	QPSK	1	1	22.0	20.66	0	-0.02	1:1	0.136	1.361	0.185	
836.50	167300	Mid	back	10 mm	NR Band n5 (Cell)	Sub	99849	20	DFT-S-OFDM	QPSK	1	104	24.5	22.74	0	-0.04	1:1	0.222	1.500	0.333	A39
836.50	167300	Mid	back	10 mm	NR Band n5 (Cell)	Sub	99849	20	DFT-S-OFDM	QPSK	50	28	24.5	22.72	0	-0.02	1:1	0.216	1.507	0.326	
836.50	167300	Mid	back	10 mm	NR Band n5 (Cell)	Sub	99849	20	CP-OFDM	QPSK	1	1	23.0	21.53	1.5	0.01	1:1	0.161	1.403	0.228	
1720.00	344000	Low	back	10 mm	NR Band n66 (AWS)	Main 2	99542	20	DFT-S-OFDM	QPSK	1	1	19.0	17.70	0	-0.05	1:1	0.195	1.349	0.263	
1720.00	344000	Low	back	10 mm	NR Band n66 (AWS)	Main 2	99542	20	DFT-S-OFDM	QPSK	50	56	19.0	17.71	0	0.02	1:1	0.212	1.346	0.285	A40
1720.00	344000	Low	back	10 mm	NR Band n66 (AWS)	Main 2	99542	20	CP-OFDM	QPSK	1	1	19.0	17.85	0	-0.01	1:1	0.190	1.303	0.248	
1860.00	372000	Low	back	10 mm	NR Band n2 (PCS)	Main 2	99542	20	DFT-S-OFDM	QPSK	1	1	20.0	18.37	0	0.10	1:1	0.266	1.455	0.387	
1860.00	372000	Low	back	10 mm	NR Band n2 (PCS)	Main 2	99542	20	DFT-S-OFDM	QPSK	50	28	20.0	18.34	0	0.05	1:1	0.268	1.466	0.393	A41
1880.00	376000	Mid	back	10 mm	NR Band n2 (PCS)	Main 2	99542	20	CP-OFDM	QPSK	1	1	20.0	18.35	0	-0.01	1:1	0.201	1.462	0.294	
ANSI / IEEE C95.1 1992 - SAFETY LIMIT Spatial Peak Uncontrolled Exposure/General Population												Body 1.6 W/kg (mW/g) averaged over 1 gram									

**Table 11-29
NR Band n41 Body-Worn SAR**

MEASUREMENT RESULTS																					
FREQUENCY		Side	Spacing	Mode	Antenna Config	Serial Number	Bandwidth [MHz]	Waveform	Modulation	RB Size	RB Offset	Maximum Allowed Power [dBm]	Conducted Power [dBm]	MPR [dB]	Power Drift [dB]	Duty Cycle	SAR (1g) (W/kg)	Scaling Factor	Reported SAR (1g) (W/kg)	Plot #	
MHz	Ch.																				
2592.99	518598	Mid	back	10 mm	NR Band n41	Main 2	99765	100	DFT-S-OFDM	QPSK	1	1	25.0	24.10	0	-0.01	1:1	0.246	1.230	0.303	
2592.99	518598	Mid	back	10 mm	NR Band n41	Main 2	99765	100	DFT-S-OFDM	QPSK	135	69	25.0	24.17	0	-0.02	1:1	0.258	1.211	0.312	
2592.99	518598	Mid	back	10 mm	NR Band n41	Main 2	99765	100	CP-OFDM	QPSK	1	1	23.5	23.17	1.5	-0.03	1:1	0.298	1.222	0.364	A42
2592.99	518598	Mid	back	10 mm	NR Band n41	Sub	99765	100	CP-OFDM	QPSK	1	271	18.0	17.66	0	0.01	1:1	0.051	1.081	0.055	
2592.99	518598	Mid	back	10 mm	NR Band n41	Sub	99765	100	CP-OFDM	QPSK	137	68	18.0	17.70	0	-0.14	1:1	0.060	1.072	0.064	
ANSI / IEEE C95.1 1992 - SAFETY LIMIT Spatial Peak Uncontrolled Exposure/General Population												Body 1.6 W/kg (mW/g) averaged over 1 gram									

**Table 11-30
NR Band n77 Body-Worn SAR**

MEASUREMENT RESULTS																					
FREQUENCY		Side	Spacing	Mode	Antenna Config	Serial Number	Bandwidth [MHz]	Waveform	Modulation	RB Size	RB Offset	Maximum Allowed Power [dBm]	Conducted Power [dBm]	MPR [dB]	Power Drift [dB]	Duty Cycle	SAR (1g) (W/kg)	Scaling Factor	Reported SAR (1g) (W/kg)	Plot #	
MHz	Ch.																				
3930.00	662000	High	back	10 mm	NR Band n77	Main 1	99765	100	DFT-S-OFDM	QPSK	1	137	18.0	17.52	0	-0.13	1:1	0.106	1.117	0.118	
3930.00	662000	High	back	10 mm	NR Band n77	Main 1	99765	100	DFT-S-OFDM	QPSK	135	0	18.0	17.42	0	0.00	1:1	0.110	1.143	0.126	
3930.00	662000	High	back	10 mm	NR Band n77	Main 1	99765	100	CP-OFDM	QPSK	1	1	18.0	17.10	0	-0.06	1:1	0.127	1.230	0.156	
3930.00	662000	High	back	10 mm	NR Band n77	Sub	99765	100	CP-OFDM	QPSK	1	137	16.0	14.79	0	0.15	1:1	0.029	1.321	0.038	
3930.00	662000	High	back	10 mm	NR Band n77	Sub	99765	100	CP-OFDM	QPSK	137	68	16.0	15.00	0	-0.07	1:1	0.025	1.259	0.031	
3750.00	650000	Low	back	10 mm	NR Band n77	4th path	99765	100	DFT-S-OFDM	QPSK	1	137	17.3	16.87	0	-0.05	1:1	0.333	1.104	0.368	
3930.00	662000	High	back	10 mm	NR Band n77	4th path	99765	100	DFT-S-OFDM	QPSK	1	137	17.3	17.30	0	0.03	1:1	0.451	1.000	0.451	A43
3750.00	650000	Low	back	10 mm	NR Band n77	4th path	99765	100	DFT-S-OFDM	QPSK	135	0	17.3	16.81	0	-0.03	1:1	0.300	1.119	0.336	
3930.00	662000	High	back	10 mm	NR Band n77	4th path	99765	100	DFT-S-OFDM	QPSK	135	69	17.3	17.30	0	-0.03	1:1	0.441	1.000	0.441	
3930.00	662000	High	back	10 mm	NR Band n77	4th path	99765	100	DFT-S-OFDM	QPSK	270	0	17.3	17.09	0	-0.08	1:1	0.440	1.050	0.462	
3930.00	662000	High	back	10 mm	NR Band n77	4th path	99765	100	CP-OFDM	QPSK	1	1	17.3	17.07	0	-0.02	1:1	0.389	1.054	0.410	
ANSI / IEEE C95.1 1992 - SAFETY LIMIT Spatial Peak Uncontrolled Exposure/General Population												Body 1.6 W/kg (mW/g) averaged over 1 gram									

FCC ID: PY7-76056F	SAR EVALUATION REPORT		Approved by: Technical Manager
Document S/N: 1M2205240063-03.PY7	DUT Type: Portable Handset		Page 88 of 111

**Table 11-31
DTS Body-Worn SAR**

MEASUREMENT RESULTS																			
FREQUENCY		Side	Spacing	Mode	Service	Antenna Config.	Device Serial Number	Bandwidth [MHz]	Data Rate (Mbps)	Maximum Allowed Power [dBm]	Conducted Power [dBm]	Power Drift [dB]	Duty Cycle (%)	Peak SAR of Area Scan	SAR (1g)	Scaling Factor (Power)	Scaling Factor (Duty Cycle)	Reported SAR (1g)	Plot #
MHz	Ch.													W/kg	(W/kg)	(W/kg)	(W/kg)		
2412	1	back	10 mm	802.11b	DSSS	Chain 0	99583	22	1	14.5	14.13	-0.01	99.80	0.138	0.111	1.089	1.002	0.121	A44
2412	1	back	10 mm	802.11b	DSSS	Chain 1	99583	22	1	12.7	12.60	0.01	99.50	0.088	0.082	1.023	1.005	0.084	
ANSI / IEEE C95.1 1992 - SAFETY LIMIT Spatial Peak Uncontrolled Exposure/General Population											Body 1.6 W/kg (mW/g) averaged over 1 gram								

**Table 11-32
NII Body-Worn SAR**

MEASUREMENT RESULTS																			
FREQUENCY		Side	Spacing	Mode	Service	Antenna Config.	Device Serial Number	Bandwidth [MHz]	Data Rate (Mbps)	Maximum Allowed Power [dBm]	Conducted Power [dBm]	Power Drift [dB]	Duty Cycle (%)	Peak SAR of Area Scan	SAR (1g)	Scaling Factor (Power)	Scaling Factor (Duty Cycle)	Reported SAR (1g)	Plot #
MHz	Ch.													W/kg	(W/kg)	(W/kg)	(W/kg)		
5290	58	back	10 mm	802.11ac	OFDM	Chain 0	99823	80	29.3	11.5	10.73	0.18	98.90	0.078	0.053	1.194	1.011	0.064	
5290	58	back	10 mm	802.11ac	OFDM	Chain 1	99823	80	29.3	11.5	11.20	0.05	99.00	0.044	0.037	1.072	1.010	0.040	
5690	138	back	10 mm	802.11ac	OFDM	Chain 0	99823	80	29.3	11.5	11.28	0.06	98.90	0.063	0.040	1.052	1.011	0.043	
5530	106	back	10 mm	802.11ac	OFDM	Chain 1	99823	80	29.3	11.5	11.36	0.09	99.00	0.057	0.049	1.033	1.010	0.051	
5775	155	back	10 mm	802.11ac	OFDM	Chain 0	99823	80	29.3	11.5	10.52	0.04	98.90	0.096	0.051	1.253	1.011	0.065	
5775	155	back	10 mm	802.11ac	OFDM	Chain 1	99823	80	29.3	11.5	11.22	-0.11	99.00	0.098	0.078	1.067	1.010	0.084	A45
ANSI / IEEE C95.1 1992 - SAFETY LIMIT Spatial Peak Uncontrolled Exposure/General Population											Body 1.6 W/kg (mW/g) averaged over 1 gram								

**Table 11-33
DSS Body-Worn SAR**

MEASUREMENT RESULTS																	
FREQUENCY		Side	Spacing	Mode	Service	Antenna Config.	Device Serial Number	Data Rate (Mbps)	Maximum Allowed Power [dBm]	Conducted Power [dBm]	Power Drift [dB]	Duty Cycle (%)	SAR (1g)	Scaling Factor (Cond Power)	Scaling Factor (Duty Cycle)	Reported SAR (1g)	Plot #
MHz	Ch.												(W/kg)	(W/kg)	(W/kg)		
2480	78	back	10 mm	Bluetooth	FHSS	Chain 0	99583	1	14.0	13.88	0.06	76.80	0.032	1.028	1.085	0.036	A46
2480	78	back	10 mm	Bluetooth	FHSS	Chain 1	99583	1	14.0	13.48	-0.08	76.80	0.018	1.127	1.085	0.022	
ANSI / IEEE C95.1 1992 - SAFETY LIMIT Spatial Peak Uncontrolled Exposure/General Population											Body 1.6 W/kg (mW/g) averaged over 1 gram						

Note: The reported SAR was scaled to the 83.3% transmission duty factor to determine compliance since the duty factor of the device is permanently limited to 83.3% per the manufacturer.

FCC ID: PY7-76056F	SAR EVALUATION REPORT	Approved by: Technical Manager
Document S/N: 1M2205240063-03.PY7	DUT Type: Portable Handset	Page 89 of 111

11.3 Standalone Hotspot SAR Data

**Table 11-34
GPRS/DTM Hotspot SAR Data**

MEASUREMENT RESULTS																
FREQUENCY		Side	Spacing	Mode	Service	Antenna Config.	Device Serial Number	# of Time Slots	Maximum Allowed Power [dBm]	Conducted Power [dBm]	Power Drift [dB]	Duty Cycle	SAR (1g)	Scaling Factor	Reported SAR (1g)	Plot #
MHz	Ch.												(W/kg)		(W/kg)	
848.80	251	back	10 mm	GSM 850	GPRS	Main 1	99948	4	27.2	26.20	0.20	1:2.076	0.144	1.259	0.181	
848.80	251	front	10 mm	GSM 850	GPRS	Main 1	99948	4	27.2	26.20	-0.04	1:2.076	0.115	1.259	0.145	
848.80	251	bottom	10 mm	GSM 850	GPRS	Main 1	99948	4	27.2	26.20	0.11	1:2.076	0.029	1.259	0.037	
848.80	251	left	10 mm	GSM 850	GPRS	Main 1	99948	4	27.2	26.20	-0.01	1:2.076	0.165	1.259	0.208	
848.80	251	back	10 mm	GSM 850	DTM	Main 1	99948	3	28.4	27.44	-0.07	1:2.76	0.152	1.247	0.190	
848.80	251	front	10 mm	GSM 850	DTM	Main 1	99948	3	28.4	27.44	0.02	1:2.76	0.125	1.247	0.156	
848.80	251	bottom	10 mm	GSM 850	DTM	Main 1	99948	3	28.4	27.44	0.04	1:2.76	0.027	1.247	0.034	
848.80	251	left	10 mm	GSM 850	DTM	Main 1	99948	3	28.4	27.44	-0.01	1:2.76	0.173	1.247	0.216	A47
1880.00	661	back	10 mm	GSM 1900	GPRS	Main 2	99948	4	21.7	20.54	-0.03	1:2.076	0.134	1.306	0.175	
1880.00	661	front	10 mm	GSM 1900	GPRS	Main 2	99948	4	21.7	20.54	-0.01	1:2.076	0.133	1.306	0.174	
1880.00	661	bottom	10 mm	GSM 1900	GPRS	Main 2	99948	4	21.7	20.54	0.01	1:2.076	0.264	1.306	0.345	A48
1880.00	661	right	10 mm	GSM 1900	GPRS	Main 2	99948	4	21.7	20.54	0.04	1:2.076	0.092	1.306	0.120	
1850.20	512	back	10 mm	GSM 1900	DTM	Main 2	99948	3	22.9	21.95	0.06	1:2.76	0.182	1.245	0.227	
1850.20	512	front	10 mm	GSM 1900	DTM	Main 2	99948	3	22.9	21.95	0.03	1:2.76	0.158	1.245	0.197	
1850.20	512	bottom	10 mm	GSM 1900	DTM	Main 2	99948	3	22.9	21.95	0.00	1:2.76	0.259	1.245	0.322	
1850.20	512	right	10 mm	GSM 1900	DTM	Main 2	99948	3	22.9	21.95	0.06	1:2.76	0.086	1.245	0.107	
ANSI / IEEE C95.1 1992 - SAFETY LIMIT							Body									
Spatial Peak							1.6 W/kg (mW/g)									
Uncontrolled Exposure/General Population							averaged over 1 gram									

FCC ID: PY7-76056F	SAR EVALUATION REPORT	Approved by: Technical Manager
Document S/N: 1M2205240063-03.PY7	DUT Type: Portable Handset	Page 90 of 111

**Table 11-35
UMTS Hotspot SAR Data**

MEASUREMENT RESULTS															
FREQUENCY		Side	Spacing	Mode	Service	Antenna Config.	Device Serial Number	Maximum Allowed Power [dBm]	Conducted Power [dBm]	Power Drift [dB]	Duty Cycle	SAR (1g)	Scaling Factor	Reported SAR (1g)	Plot #
MHz	Ch.											(W/kg)		(W/kg)	
836.60	4183	back	10 mm	UMTS 850	RMC	Main 1	99948	22.7	21.72	-0.01	1:1	0.176	1.253	0.221	A26
836.60	4183	front	10 mm	UMTS 850	RMC	Main 1	99948	22.7	21.72	-0.04	1:1	0.125	1.253	0.157	
836.60	4183	bottom	10 mm	UMTS 850	RMC	Main 1	99948	22.7	21.72	0.03	1:1	0.027	1.253	0.034	
836.60	4183	left	10 mm	UMTS 850	RMC	Main 1	99948	22.7	21.72	0.00	1:1	0.166	1.253	0.208	
1752.60	1513	back	10 mm	UMTS 1750	RMC	Main 2	99948	18.7	17.65	0.00	1:1	0.198	1.274	0.252	
1752.60	1513	front	10 mm	UMTS 1750	RMC	Main 2	99948	18.7	17.65	-0.01	1:1	0.163	1.274	0.208	
1752.60	1513	bottom	10 mm	UMTS 1750	RMC	Main 2	99948	18.7	17.65	0.00	1:1	0.255	1.274	0.325	A49
1752.60	1513	right	10 mm	UMTS 1750	RMC	Main 2	99948	18.7	17.65	-0.02	1:1	0.099	1.274	0.126	
1852.40	9262	back	10 mm	UMTS 1900	RMC	Main 2	99948	19.7	18.57	-0.05	1:1	0.217	1.297	0.281	
1852.40	9262	front	10 mm	UMTS 1900	RMC	Main 2	99948	19.7	18.57	-0.01	1:1	0.178	1.297	0.231	
1852.40	9262	bottom	10 mm	UMTS 1900	RMC	Main 2	99948	19.7	18.57	0.00	1:1	0.289	1.297	0.375	A50
1852.40	9262	right	10 mm	UMTS 1900	RMC	Main 2	99948	19.7	18.57	-0.01	1:1	0.101	1.297	0.131	
ANSI / IEEE C95.1 1992 - SAFETY LIMIT Spatial Peak Uncontrolled Exposure/General Population								Body 1.6 W/kg (mW/g) averaged over 1 gram							

**Table 11-36
LTE Band 71 Hotspot SAR**

MEASUREMENT RESULTS																				
FREQUENCY		Side	Spacing	Mode	Antenna Config.	Device Serial Number	Bandwidth [MHz]	Modulation	RB Size	RB Offset	Maximum Allowed Power [dBm]	Conducted Power [dBm]	MPR [dB]	Power Drift [dB]	Duty Cycle	SAR (1g)	Scaling Factor	Reported SAR (1g)	Plot #	
MHz	Ch.															(W/kg)		(W/kg)		
680.50	133297	Mid	back	10 mm	LTE Band 71	Main 1	00043	20	QPSK	1	0	23.0	22.31	0	0.00	1:1	0.098	1.172	0.115	
680.50	133297	Mid	back	10 mm	LTE Band 71	Main 1	00043	20	QPSK	50	0	23.0	22.25	0	-0.02	1:1	0.105	1.189	0.125	A29
680.50	133297	Mid	front	10 mm	LTE Band 71	Main 1	00043	20	QPSK	1	0	23.0	22.31	0	0.04	1:1	0.069	1.172	0.081	
680.50	133297	Mid	front	10 mm	LTE Band 71	Main 1	00043	20	QPSK	50	0	23.0	22.25	0	-0.01	1:1	0.075	1.189	0.089	
680.50	133297	Mid	bottom	10 mm	LTE Band 71	Main 1	00043	20	QPSK	1	0	23.0	22.31	0	0.01	1:1	0.014	1.172	0.016	
680.50	133297	Mid	bottom	10 mm	LTE Band 71	Main 1	00043	20	QPSK	50	0	23.0	22.25	0	-0.08	1:1	0.017	1.189	0.020	
680.50	133297	Mid	left	10 mm	LTE Band 71	Main 1	00043	20	QPSK	1	0	23.0	22.31	0	0.03	1:1	0.085	1.172	0.100	
680.50	133297	Mid	left	10 mm	LTE Band 71	Main 1	00043	20	QPSK	50	0	23.0	22.25	0	0.01	1:1	0.098	1.189	0.117	
ANSI / IEEE C95.1 1992 - SAFETY LIMIT Spatial Peak Uncontrolled Exposure/General Population											Body 1.6 W/kg (mW/g) averaged over 1 gram									

FCC ID: PY7-76056F	SAR EVALUATION REPORT	Approved by: Technical Manager
Document S/N: 1M2205240063-03.PY7	DUT Type: Portable Handset	Page 91 of 111

**Table 11-37
LTE Band 12 Hotspot SAR**

MEASUREMENT RESULTS																				
FREQUENCY		Side	Spacing	Mode	Antenna Config.	Device Serial Number	Bandwidth [MHz]	Modulation	RB Size	RB Offset	Maximum Allowed Power [dBm]	Conducted Power [dBm]	MPR [dB]	Power Drift [dB]	Duty Cycle	SAR (1g) (W/kg)	Scaling Factor	Reported SAR (1g) (W/kg)	Plot #	
MHz	Ch.																			
707.50	23095	Mid	back	10 mm	LTE Band 12	Main 1	00043	10	QPSK	1	49	22.0	21.17	0	0.02	1:1	0.165	1.211	0.200	
707.50	23095	Mid	back	10 mm	LTE Band 12	Main 1	00043	10	QPSK	25	12	22.0	21.15	0	-0.01	1:1	0.159	1.216	0.193	
707.50	23095	Mid	front	10 mm	LTE Band 12	Main 1	00043	10	QPSK	1	49	22.0	21.17	0	0.02	1:1	0.119	1.211	0.144	
707.50	23095	Mid	front	10 mm	LTE Band 12	Main 1	00043	10	QPSK	25	12	22.0	21.15	0	0.01	1:1	0.112	1.216	0.136	
707.50	23095	Mid	bottom	10 mm	LTE Band 12	Main 1	00043	10	QPSK	1	49	22.0	21.17	0	0.07	1:1	0.035	1.211	0.042	
707.50	23095	Mid	bottom	10 mm	LTE Band 12	Main 1	00043	10	QPSK	25	12	22.0	21.15	0	0.06	1:1	0.032	1.216	0.039	
707.50	23095	Mid	left	10 mm	LTE Band 12	Main 1	00043	10	QPSK	1	49	22.0	21.17	0	0.01	1:1	0.144	1.211	0.174	
707.50	23095	Mid	left	10 mm	LTE Band 12	Main 1	00043	10	QPSK	25	12	22.0	21.15	0	0.05	1:1	0.126	1.216	0.153	
707.50	23095	Mid	back	10 mm	LTE Band 12	Sub	00068	10	QPSK	1	0	24.5	23.31	0	0.00	1:1	0.223	1.315	0.293	
707.50	23095	Mid	back	10 mm	LTE Band 12	Sub	00068	10	QPSK	25	12	23.5	22.30	1	0.01	1:1	0.186	1.318	0.245	
707.50	23095	Mid	front	10 mm	LTE Band 12	Sub	00068	10	QPSK	1	0	24.5	23.31	0	0.00	1:1	0.240	1.315	0.316	
707.50	23095	Mid	front	10 mm	LTE Band 12	Sub	00068	10	QPSK	25	12	23.5	22.30	1	-0.04	1:1	0.203	1.318	0.268	
707.50	23095	Mid	top	10 mm	LTE Band 12	Sub	00068	10	QPSK	1	0	24.5	23.31	0	0.11	1:1	0.056	1.315	0.074	
707.50	23095	Mid	top	10 mm	LTE Band 12	Sub	00068	10	QPSK	25	12	23.5	22.30	1	-0.01	1:1	0.045	1.318	0.059	
707.50	23095	Mid	right	10 mm	LTE Band 12	Sub	00068	10	QPSK	1	0	24.5	23.31	0	-0.12	1:1	0.267	1.315	0.351	A51
707.50	23095	Mid	right	10 mm	LTE Band 12	Sub	00068	10	QPSK	25	12	23.5	22.30	1	-0.01	1:1	0.238	1.318	0.314	
707.50	23095	Mid	left	10 mm	LTE Band 12	Sub	00068	10	QPSK	1	0	24.5	23.31	0	-0.09	1:1	0.198	1.315	0.260	
707.50	23095	Mid	left	10 mm	LTE Band 12	Sub	00068	10	QPSK	25	12	23.5	22.30	1	0.07	1:1	0.157	1.318	0.207	
ANSI / IEEE C95.1 1992 - SAFETY LIMIT Spatial Peak Uncontrolled Exposure/General Population											Body 1.6 W/kg (mW/g) averaged over 1 gram									

**Table 11-38
LTE Band 13 Hotspot SAR**

MEASUREMENT RESULTS																				
FREQUENCY		Side	Spacing	Mode	Antenna Config.	Device Serial Number	Bandwidth [MHz]	Modulation	RB Size	RB Offset	Maximum Allowed Power [dBm]	Conducted Power [dBm]	MPR [dB]	Power Drift [dB]	Duty Cycle	SAR (1g) (W/kg)	Scaling Factor	Reported SAR (1g) (W/kg)	Plot #	
MHz	Ch.																			
782.00	23230	Mid	back	10 mm	LTE Band 13	Main 1	00043	10	QPSK	1	0	22.0	21.04	0	0.06	1:1	0.256	1.247	0.319	
782.00	23230	Mid	back	10 mm	LTE Band 13	Main 1	00043	10	QPSK	25	12	22.0	21.46	0	-0.03	1:1	0.270	1.132	0.306	
782.00	23230	Mid	front	10 mm	LTE Band 13	Main 1	00043	10	QPSK	1	0	22.0	21.04	0	-0.01	1:1	0.177	1.247	0.221	
782.00	23230	Mid	front	10 mm	LTE Band 13	Main 1	00043	10	QPSK	25	12	22.0	21.46	0	-0.02	1:1	0.178	1.132	0.201	
782.00	23230	Mid	bottom	10 mm	LTE Band 13	Main 1	00043	10	QPSK	1	0	22.0	21.04	0	-0.01	1:1	0.066	1.247	0.082	
782.00	23230	Mid	bottom	10 mm	LTE Band 13	Main 1	00043	10	QPSK	25	12	22.0	21.46	0	0.05	1:1	0.063	1.132	0.071	
782.00	23230	Mid	left	10 mm	LTE Band 13	Main 1	00043	10	QPSK	1	0	22.0	21.04	0	-0.03	1:1	0.081	1.247	0.101	
782.00	23230	Mid	left	10 mm	LTE Band 13	Main 1	00043	10	QPSK	25	12	22.0	21.46	0	0.02	1:1	0.071	1.132	0.080	
782.00	23230	Mid	back	10 mm	LTE Band 13	Sub	00068	10	QPSK	1	49	24.5	23.41	0	0.06	1:1	0.305	1.285	0.392	
782.00	23230	Mid	back	10 mm	LTE Band 13	Sub	00068	10	QPSK	25	0	23.5	22.40	1	0.02	1:1	0.234	1.288	0.301	
782.00	23230	Mid	front	10 mm	LTE Band 13	Sub	00068	10	QPSK	1	49	24.5	23.41	0	0.00	1:1	0.342	1.285	0.439	
782.00	23230	Mid	front	10 mm	LTE Band 13	Sub	00068	10	QPSK	25	0	23.5	22.40	1	-0.03	1:1	0.261	1.288	0.336	
782.00	23230	Mid	top	10 mm	LTE Band 13	Sub	00068	10	QPSK	1	49	24.5	23.41	0	-0.11	1:1	0.043	1.285	0.055	
782.00	23230	Mid	top	10 mm	LTE Band 13	Sub	00068	10	QPSK	25	0	23.5	22.40	1	-0.03	1:1	0.034	1.288	0.044	
782.00	23230	Mid	right	10 mm	LTE Band 13	Sub	00068	10	QPSK	1	49	24.5	23.41	0	-0.14	1:1	0.373	1.285	0.479	A52
782.00	23230	Mid	right	10 mm	LTE Band 13	Sub	00068	10	QPSK	25	0	23.5	22.40	1	-0.05	1:1	0.284	1.288	0.366	
782.00	23230	Mid	left	10 mm	LTE Band 13	Sub	00068	10	QPSK	1	49	24.5	23.41	0	0.01	1:1	0.264	1.285	0.339	
782.00	23230	Mid	left	10 mm	LTE Band 13	Sub	00068	10	QPSK	25	0	23.5	22.40	1	-0.03	1:1	0.215	1.288	0.277	
ANSI / IEEE C95.1 1992 - SAFETY LIMIT Spatial Peak Uncontrolled Exposure/General Population											Body 1.6 W/kg (mW/g) averaged over 1 gram									

FCC ID: PY7-76056F	SAR EVALUATION REPORT	Approved by: Technical Manager
Document S/N: 1M2205240063-03.PY7	DUT Type: Portable Handset	Page 92 of 111

**Table 11-39
LTE Band 5 (Cell) Hotspot SAR**

MEASUREMENT RESULTS																				
FREQUENCY		Side	Spacing	Mode	Antenna Config.	Device Serial Number	Bandwidth [MHz]	Modulation	RB Size	RB Offset	Maximum Allowed Power [dBm]	Conducted Power [dBm]	MPR [dB]	Power Drift [dB]	Duty Cycle	SAR (1g)	Scaling Factor	Reported SAR (1g)	Plot #	
MHz	Ch.															(W/kg)		(W/kg)		
836.50	20525	Mid	back	10 mm	LTE Band 5 (Cell)	Main 1	99989	10	QPSK	1	49	22.0	21.25	0	0.00	1:1	0.103	1.189	0.122	
836.50	20525	Mid	back	10 mm	LTE Band 5 (Cell)	Main 1	99989	10	QPSK	25	25	22.0	21.26	0	-0.01	1:1	0.110	1.186	0.130	
836.50	20525	Mid	front	10 mm	LTE Band 5 (Cell)	Main 1	99989	10	QPSK	1	49	22.0	21.25	0	0.00	1:1	0.068	1.189	0.081	
836.50	20525	Mid	front	10 mm	LTE Band 5 (Cell)	Main 1	99989	10	QPSK	25	25	22.0	21.26	0	-0.01	1:1	0.075	1.186	0.089	
836.50	20525	Mid	bottom	10 mm	LTE Band 5 (Cell)	Main 1	99989	10	QPSK	1	49	22.0	21.25	0	-0.06	1:1	0.018	1.189	0.021	
836.50	20525	Mid	bottom	10 mm	LTE Band 5 (Cell)	Main 1	99989	10	QPSK	25	25	22.0	21.26	0	-0.05	1:1	0.018	1.186	0.021	
836.50	20525	Mid	left	10 mm	LTE Band 5 (Cell)	Main 1	99989	10	QPSK	1	49	22.0	21.25	0	0.05	1:1	0.099	1.189	0.118	
836.50	20525	Mid	left	10 mm	LTE Band 5 (Cell)	Main 1	99989	10	QPSK	25	25	22.0	21.26	0	0.00	1:1	0.104	1.186	0.123	
836.50	20525	Mid	back	10 mm	LTE Band 5 (Cell)	Sub	00068	10	QPSK	1	0	24.5	23.15	0	-0.01	1:1	0.226	1.365	0.308	
836.50	20525	Mid	back	10 mm	LTE Band 5 (Cell)	Sub	00068	10	QPSK	25	0	23.5	22.22	1	0.00	1:1	0.184	1.343	0.247	
836.50	20525	Mid	front	10 mm	LTE Band 5 (Cell)	Sub	00068	10	QPSK	1	0	24.5	23.15	0	0.03	1:1	0.276	1.365	0.377	A53
836.50	20525	Mid	front	10 mm	LTE Band 5 (Cell)	Sub	00068	10	QPSK	25	0	23.5	22.22	1	0.02	1:1	0.225	1.343	0.302	
836.50	20525	Mid	top	10 mm	LTE Band 5 (Cell)	Sub	00068	10	QPSK	1	0	24.5	23.15	0	-0.08	1:1	0.032	1.365	0.044	
836.50	20525	Mid	top	10 mm	LTE Band 5 (Cell)	Sub	00068	10	QPSK	25	0	23.5	22.22	1	-0.12	1:1	0.027	1.343	0.036	
836.50	20525	Mid	right	10 mm	LTE Band 5 (Cell)	Sub	00068	10	QPSK	1	0	24.5	23.15	0	-0.02	1:1	0.274	1.365	0.374	
836.50	20525	Mid	right	10 mm	LTE Band 5 (Cell)	Sub	00068	10	QPSK	25	0	23.5	22.22	1	0.00	1:1	0.220	1.343	0.295	
836.50	20525	Mid	left	10 mm	LTE Band 5 (Cell)	Sub	00068	10	QPSK	1	0	24.5	23.15	0	-0.02	1:1	0.183	1.365	0.250	
836.50	20525	Mid	left	10 mm	LTE Band 5 (Cell)	Sub	00068	10	QPSK	25	0	23.5	22.22	1	0.01	1:1	0.152	1.343	0.204	
ANSI / IEEE C95.1 1992 - SAFETY LIMIT Spatial Peak Uncontrolled Exposure/General Population											Body 1.6 W/kg (mW/g) averaged over 1 gram									

**Table 11-40
LTE Band 66 (AWS) Hotspot SAR**

MEASUREMENT RESULTS																				
FREQUENCY		Side	Spacing	Mode	Antenna Config.	Device Serial Number	Bandwidth [MHz]	Modulation	RB Size	RB Offset	Maximum Allowed Power [dBm]	Conducted Power [dBm]	MPR [dB]	Power Drift [dB]	Duty Cycle	SAR (1g)	Scaling Factor	Reported SAR (1g)	Plot #	
MHz	Ch.															(W/kg)		(W/kg)		
1720.00	132072	Low	back	10 mm	LTE Band 66 (AWS)	Main 2	00043	20	QPSK	1	50	19.0	18.10	0	0.14	1:1	0.181	1.230	0.223	
1720.00	132072	Low	back	10 mm	LTE Band 66 (AWS)	Main 2	00043	20	QPSK	50	25	19.0	18.09	0	0.02	1:1	0.176	1.233	0.217	
1720.00	132072	Low	front	10 mm	LTE Band 66 (AWS)	Main 2	00043	20	QPSK	1	50	19.0	18.10	0	0.04	1:1	0.144	1.230	0.177	
1720.00	132072	Low	front	10 mm	LTE Band 66 (AWS)	Main 2	00043	20	QPSK	50	25	19.0	18.09	0	-0.05	1:1	0.145	1.233	0.179	
1720.00	132072	Low	bottom	10 mm	LTE Band 66 (AWS)	Main 2	00043	20	QPSK	1	50	19.0	18.10	0	0.18	1:1	0.246	1.230	0.303	A54
1720.00	132072	Low	bottom	10 mm	LTE Band 66 (AWS)	Main 2	00043	20	QPSK	50	25	19.0	18.09	0	0.00	1:1	0.241	1.233	0.297	
1720.00	132072	Low	right	10 mm	LTE Band 66 (AWS)	Main 2	00043	20	QPSK	1	50	19.0	18.10	0	-0.11	1:1	0.118	1.230	0.145	
1720.00	132072	Low	right	10 mm	LTE Band 66 (AWS)	Main 2	00043	20	QPSK	50	25	19.0	18.09	0	0.00	1:1	0.118	1.233	0.145	
1770.00	132572	High	back	10 mm	LTE Band 66 (AWS)	Sub	99864	20	QPSK	1	50	17.0	15.87	0	-0.06	1:1	0.037	1.297	0.048	
1770.00	132572	High	back	10 mm	LTE Band 66 (AWS)	Sub	99864	20	QPSK	50	50	17.0	15.78	0	-0.03	1:1	0.036	1.324	0.048	
1770.00	132572	High	front	10 mm	LTE Band 66 (AWS)	Sub	99864	20	QPSK	1	50	17.0	15.87	0	0.10	1:1	0.043	1.297	0.056	
1770.00	132572	High	front	10 mm	LTE Band 66 (AWS)	Sub	99864	20	QPSK	50	50	17.0	15.78	0	-0.03	1:1	0.042	1.324	0.056	
1770.00	132572	High	top	10 mm	LTE Band 66 (AWS)	Sub	99864	20	QPSK	1	50	17.0	15.87	0	0.07	1:1	0.061	1.297	0.079	
1770.00	132572	High	top	10 mm	LTE Band 66 (AWS)	Sub	99864	20	QPSK	50	50	17.0	15.78	0	0.02	1:1	0.060	1.324	0.079	
1770.00	132572	High	right	10 mm	LTE Band 66 (AWS)	Sub	99864	20	QPSK	1	50	17.0	15.87	0	-0.07	1:1	0.058	1.297	0.075	
1770.00	132572	High	right	10 mm	LTE Band 66 (AWS)	Sub	99864	20	QPSK	50	50	17.0	15.78	0	0.04	1:1	0.054	1.324	0.071	
1770.00	132572	High	left	10 mm	LTE Band 66 (AWS)	Sub	99864	20	QPSK	1	50	17.0	15.87	0	0.13	1:1	0.000	1.297	0.000	
1770.00	132572	High	left	10 mm	LTE Band 66 (AWS)	Sub	99864	20	QPSK	50	50	17.0	15.78	0	-0.03	1:1	0.002	1.324	0.003	
ANSI / IEEE C95.1 1992 - SAFETY LIMIT Spatial Peak Uncontrolled Exposure/General Population											Body 1.6 W/kg (mW/g) averaged over 1 gram									

FCC ID: PY7-76056F	SAR EVALUATION REPORT	Approved by: Technical Manager
Document S/N: 1M2205240063-03.PY7	DUT Type: Portable Handset	Page 93 of 111

**Table 11-41
LTE Band 25 (PCS) Hotspot SAR**

MEASUREMENT RESULTS																				
FREQUENCY		Side	Spacing	Mode	Antenna Config.	Device Serial Number	Bandwidth [MHz]	Modulation	RB Size	RB Offset	Maximum Allowed Power [dBm]	Conducted Power [dBm]	MPR [dB]	Power Drift [dB]	Duty Cycle	SAR (1g)	Scaling Factor	Reported SAR (1g)	Plot #	
MHz	Ch.															(W/kg)		(W/kg)		
1905.00	26590	High	back	10 mm	LTE Band 25 (PCS)	Main 2	99989	20	QPSK	1	0	20.0	18.62	0	0.01	1:1	0.168	1.373	0.231	
1905.00	26590	High	back	10 mm	LTE Band 25 (PCS)	Main 2	99989	20	QPSK	50	0	20.0	18.70	0	-0.01	1:1	0.159	1.349	0.214	
1905.00	26590	High	front	10 mm	LTE Band 25 (PCS)	Main 2	99989	20	QPSK	1	0	20.0	18.62	0	-0.04	1:1	0.194	1.373	0.266	
1905.00	26590	High	front	10 mm	LTE Band 25 (PCS)	Main 2	99989	20	QPSK	50	0	20.0	18.70	0	-0.01	1:1	0.187	1.349	0.252	
1905.00	26590	High	bottom	10 mm	LTE Band 25 (PCS)	Main 2	99989	20	QPSK	1	0	20.0	18.62	0	0.02	1:1	0.344	1.373	0.472	A55
1905.00	26590	High	bottom	10 mm	LTE Band 25 (PCS)	Main 2	99989	20	QPSK	50	0	20.0	18.70	0	-0.01	1:1	0.332	1.349	0.448	
1905.00	26590	High	right	10 mm	LTE Band 25 (PCS)	Main 2	99989	20	QPSK	1	0	20.0	18.62	0	0.17	1:1	0.117	1.373	0.161	
1905.00	26590	High	right	10 mm	LTE Band 25 (PCS)	Main 2	99989	20	QPSK	50	0	20.0	18.70	0	-0.05	1:1	0.114	1.349	0.154	
ANSI / IEEE C95.1 1992 - SAFETY LIMIT Spatial Peak Uncontrolled Exposure/General Population											Body 1.6 W/kg (mW/g) averaged over 1 gram									

**Table 11-42
LTE Band 2 (PCS) Hotspot SAR**

MEASUREMENT RESULTS																				
FREQUENCY		Side	Spacing	Mode	Antenna Config.	Device Serial Number	Bandwidth [MHz]	Modulation	RB Size	RB Offset	Maximum Allowed Power [dBm]	Conducted Power [dBm]	MPR [dB]	Power Drift [dB]	Duty Cycle	SAR (1g)	Scaling Factor	Reported SAR (1g)	Plot #	
MHz	Ch.															(W/kg)		(W/kg)		
1860.00	18700	Low	back	10 mm	LTE Band 2 (PCS)	Sub	99864	20	QPSK	1	99	16.0	14.86	0	-0.02	1:1	0.024	1.300	0.031	
1860.00	18700	Low	back	10 mm	LTE Band 2 (PCS)	Sub	99864	20	QPSK	50	50	16.0	14.84	0	0.06	1:1	0.026	1.306	0.034	
1860.00	18700	Low	front	10 mm	LTE Band 2 (PCS)	Sub	99864	20	QPSK	1	99	16.0	14.86	0	0.04	1:1	0.032	1.300	0.042	
1860.00	18700	Low	front	10 mm	LTE Band 2 (PCS)	Sub	99864	20	QPSK	50	50	16.0	14.84	0	-0.07	1:1	0.031	1.306	0.040	
1860.00	18700	Low	top	10 mm	LTE Band 2 (PCS)	Sub	99864	20	QPSK	1	99	16.0	14.86	0	0.17	1:1	0.049	1.300	0.064	A56
1860.00	18700	Low	top	10 mm	LTE Band 2 (PCS)	Sub	99864	20	QPSK	50	50	16.0	14.84	0	-0.07	1:1	0.049	1.306	0.064	
1860.00	18700	Low	right	10 mm	LTE Band 2 (PCS)	Sub	99864	20	QPSK	1	99	16.0	14.86	0	-0.13	1:1	0.043	1.300	0.056	
1860.00	18700	Low	right	10 mm	LTE Band 2 (PCS)	Sub	99864	20	QPSK	50	50	16.0	14.84	0	-0.02	1:1	0.047	1.306	0.061	
1860.00	18700	Low	left	10 mm	LTE Band 2 (PCS)	Sub	99864	20	QPSK	1	99	16.0	14.86	0	0.09	1:1	0.002	1.300	0.003	
1860.00	18700	Low	left	10 mm	LTE Band 2 (PCS)	Sub	99864	20	QPSK	50	50	16.0	14.84	0	0.06	1:1	0.000	1.306	0.000	
ANSI / IEEE C95.1 1992 - SAFETY LIMIT Spatial Peak Uncontrolled Exposure/General Population											Body 1.6 W/kg (mW/g) averaged over 1 gram									

**Table 11-43
LTE Band 41 Hotspot SAR**

MEASUREMENT RESULTS																				
FREQUENCY		Side	Spacing	Mode	Antenna Config.	Device Serial Number	Bandwidth [MHz]	Modulation	RB Size	RB Offset	Maximum Allowed Power [dBm]	Conducted Power [dBm]	MPR [dB]	Power Drift [dB]	Duty Cycle	SAR (1g)	Scaling Factor	Reported SAR (1g)	Plot #	
MHz	Ch.															(W/kg)		(W/kg)		
2593.00	40620	Mid	back	10 mm	LTE Band 41	Main 2	99989	20	QPSK	1	0	20.0	18.98	0	-0.18	1:1.58	0.091	1.265	0.115	
2593.00	40620	Mid	back	10 mm	LTE Band 41	Main 2	99989	20	QPSK	50	0	20.0	18.98	0	0.01	1:1.58	0.094	1.265	0.119	
2593.00	40620	Mid	front	10 mm	LTE Band 41	Main 2	99989	20	QPSK	1	0	20.0	18.98	0	-0.06	1:1.58	0.088	1.265	0.111	
2593.00	40620	Mid	front	10 mm	LTE Band 41	Main 2	99989	20	QPSK	50	0	20.0	18.98	0	0.03	1:1.58	0.086	1.265	0.109	
2593.00	40620	Mid	bottom	10 mm	LTE Band 41	Main 2	99989	20	QPSK	1	0	20.0	18.98	0	0.02	1:1.58	0.165	1.265	0.209	A57
2593.00	40620	Mid	bottom	10 mm	LTE Band 41	Main 2	99989	20	QPSK	50	0	20.0	18.98	0	0.00	1:1.58	0.161	1.265	0.204	
2593.00	40620	Mid	right	10 mm	LTE Band 41	Main 2	99989	20	QPSK	1	0	20.0	18.98	0	-0.12	1:1.58	0.039	1.265	0.049	
2593.00	40620	Mid	right	10 mm	LTE Band 41	Main 2	99989	20	QPSK	50	0	20.0	18.98	0	0.01	1:1.58	0.039	1.265	0.049	
ANSI / IEEE C95.1 1992 - SAFETY LIMIT Spatial Peak Uncontrolled Exposure/General Population											Body 1.6 W/kg (mW/g) averaged over 1 gram									

FCC ID: PY7-76056F	SAR EVALUATION REPORT		Approved by: Technical Manager
Document S/N: 1M2205240063-03.PY7	DUT Type: Portable Handset	Page 94 of 111	

Table 11-44
LTE Band 48 Hotspot SAR

MEASUREMENT RESULTS																				
FREQUENCY		Side	Spacing	Mode	Antenna Config.	Device Serial Number	Bandwidth [MHz]	Modulation	RB Size	RB Offset	Maximum Allowed Power [dBm]	Conducted Power [dBm]	MPR [dB]	Power Drift [dB]	Duty Cycle	SAR (1g) (W/kg)	Scaling Factor	Reported SAR (1g) (W/kg)	Plot #	
MHz	Ch.																			
3646.70	56207	Mid-High	back	10 mm	LTE Band 48	Main 1	99989	20	QPSK	1	50	20.0	18.98	0	0.08	1:1.58	0.104	1.265	0.132	
3646.70	56207	Mid-High	back	10 mm	LTE Band 48	Main 1	99989	20	QPSK	50	25	20.0	18.99	0	0.03	1:1.58	0.107	1.262	0.135	
3646.70	56207	Mid-High	front	10 mm	LTE Band 48	Main 1	99989	20	QPSK	1	50	20.0	18.98	0	-0.19	1:1.58	0.104	1.265	0.132	
3646.70	56207	Mid-High	front	10 mm	LTE Band 48	Main 1	99989	20	QPSK	50	25	20.0	18.99	0	-0.14	1:1.58	0.107	1.262	0.135	
3646.70	56207	Mid-High	bottom	10 mm	LTE Band 48	Main 1	99989	20	QPSK	1	50	20.0	18.98	0	0.10	1:1.58	0.138	1.265	0.175	A58
3646.70	56207	Mid-High	bottom	10 mm	LTE Band 48	Main 1	99989	20	QPSK	50	25	20.0	18.99	0	0.08	1:1.58	0.137	1.262	0.173	
3646.70	56207	Mid-High	left	10 mm	LTE Band 48	Main 1	99989	20	QPSK	1	50	20.0	18.98	0	0.02	1:1.58	0.029	1.265	0.037	
3646.70	56207	Mid-High	left	10 mm	LTE Band 48	Main 1	99989	20	QPSK	50	25	20.0	18.99	0	0.08	1:1.58	0.029	1.262	0.037	
ANSI / IEEE C95.1 1992 - SAFETY LIMIT Spatial Peak Uncontrolled Exposure/General Population											Body 1.6 W/kg (mW/g) averaged over 1 gram									

Table 11-45
NR Band n71 Hotspot SAR

MEASUREMENT RESULTS																					
FREQUENCY		Side	Spacing	Mode	Antenna Config.	Serial Number	Bandwidth [MHz]	Waveform	Modulation	RB Size	RB Offset	Maximum Allowed Power [dBm]	Conducted Power [dBm]	MPR [dB]	Power Drift [dB]	Duty Cycle	SAR (1g) (W/kg)	Scaling Factor	Reported SAR (1g) (W/kg)	Plot #	
MHz	Ch.																				
680.50	136100	Mid	back	10 mm	NR Band n71	Main 1	99807	20	DFT-S-OFDM	QPSK	1	104	24.0	22.48	0	-0.01	1:1	0.181	1.419	0.257	A38
680.50	136100	Mid	back	10 mm	NR Band n71	Main 1	99807	20	DFT-S-OFDM	QPSK	50	56	24.0	22.48	0	-0.11	1:1	0.171	1.419	0.243	
680.50	136100	Mid	back	10 mm	NR Band n71	Main 1	99807	20	CP-OFDM	QPSK	1	1	23.5	21.95	0.5	0.01	1:1	0.118	1.429	0.169	
680.50	136100	Mid	front	10 mm	NR Band n71	Main 1	99807	20	DFT-S-OFDM	QPSK	1	104	24.0	22.48	0	0.01	1:1	0.128	1.419	0.182	
680.50	136100	Mid	front	10 mm	NR Band n71	Main 1	99807	20	DFT-S-OFDM	QPSK	50	56	24.0	22.48	0	0.00	1:1	0.120	1.419	0.170	
680.50	136100	Mid	bottom	10 mm	NR Band n71	Main 1	99807	20	DFT-S-OFDM	QPSK	1	104	24.0	22.48	0	0.18	1:1	0.039	1.419	0.055	
680.50	136100	Mid	bottom	10 mm	NR Band n71	Main 1	99807	20	DFT-S-OFDM	QPSK	50	56	24.0	22.48	0	0.06	1:1	0.035	1.419	0.050	
680.50	136100	Mid	left	10 mm	NR Band n71	Main 1	99807	20	DFT-S-OFDM	QPSK	1	104	24.0	22.48	0	-0.02	1:1	0.168	1.419	0.238	
680.50	136100	Mid	left	10 mm	NR Band n71	Main 1	99807	20	DFT-S-OFDM	QPSK	50	56	24.0	22.48	0	0.02	1:1	0.163	1.419	0.231	
ANSI / IEEE C95.1 1992 - SAFETY LIMIT Spatial Peak Uncontrolled Exposure/General Population											Body 1.6 W/kg (mW/g) averaged over 1 gram										

FCC ID: PY7-76056F	SAR EVALUATION REPORT	Approved by: Technical Manager
Document S/N: 1M2205240063-03.PY7	DUT Type: Portable Handset	Page 95 of 111

**Table 11-46
NR Band n5 Hotspot SAR**

MEASUREMENT RESULTS																					
FREQUENCY		Side	Spacing	Mode	Antenna Config	Serial Number	Bandwidth [MHz]	Waveform	Modulation	RB Size	RB Offset	Maximum Allowed Power [dBm]	Conducted Power [dBm]	MPR [dB]	Power Drift [dB]	Duty Cycle	SAR (1g) (W/kg)	Scaling Factor	Reported SAR (1g) (W/kg)	Plot #	
MHz	Ch.																				
836.50	167300	Md	back	10 mm	NR Band n5 (Cell)	Main 1	99807	20	DFT-S-OFDM	QPSK	1	1	22.0	20.69	0	0.01	1:1	0.133	1.352	0.180	
836.50	167300	Md	back	10 mm	NR Band n5 (Cell)	Main 1	99807	20	DFT-S-OFDM	QPSK	50	0	22.0	20.71	0	-0.02	1:1	0.123	1.346	0.166	
836.50	167300	Md	back	10 mm	NR Band n5 (Cell)	Main 1	99807	20	CP-OFDM	QPSK	1	1	22.0	20.66	0	-0.02	1:1	0.136	1.361	0.185	
836.50	167300	Md	front	10 mm	NR Band n5 (Cell)	Main 1	99807	20	DFT-S-OFDM	QPSK	1	1	22.0	20.69	0	-0.03	1:1	0.099	1.352	0.134	
836.50	167300	Md	front	10 mm	NR Band n5 (Cell)	Main 1	99807	20	DFT-S-OFDM	QPSK	50	0	22.0	20.71	0	-0.01	1:1	0.091	1.346	0.122	
836.50	167300	Md	bottom	10 mm	NR Band n5 (Cell)	Main 1	99807	20	DFT-S-OFDM	QPSK	1	1	22.0	20.69	0	-0.04	1:1	0.020	1.352	0.027	
836.50	167300	Md	bottom	10 mm	NR Band n5 (Cell)	Main 1	99807	20	DFT-S-OFDM	QPSK	50	0	22.0	20.71	0	0.12	1:1	0.018	1.346	0.024	
836.50	167300	Md	left	10 mm	NR Band n5 (Cell)	Main 1	99807	20	DFT-S-OFDM	QPSK	1	1	22.0	20.69	0	0.01	1:1	0.114	1.352	0.154	
836.50	167300	Md	left	10 mm	NR Band n5 (Cell)	Main 1	99807	20	DFT-S-OFDM	QPSK	50	0	22.0	20.71	0	-0.04	1:1	0.118	1.346	0.159	
836.50	167300	Md	back	10 mm	NR Band n5 (Cell)	Sub	99849	20	DFT-S-OFDM	QPSK	1	104	24.5	22.74	0	-0.04	1:1	0.222	1.500	0.333	
836.50	167300	Md	back	10 mm	NR Band n5 (Cell)	Sub	99849	20	DFT-S-OFDM	QPSK	50	28	24.5	22.72	0	-0.02	1:1	0.216	1.507	0.326	
836.50	167300	Md	front	10 mm	NR Band n5 (Cell)	Sub	99849	20	DFT-S-OFDM	QPSK	1	104	24.5	22.74	0	0.06	1:1	0.263	1.500	0.395	
836.50	167300	Md	front	10 mm	NR Band n5 (Cell)	Sub	99849	20	DFT-S-OFDM	QPSK	50	28	24.5	22.72	0	-0.01	1:1	0.258	1.507	0.389	
836.50	167300	Md	top	10 mm	NR Band n5 (Cell)	Sub	99849	20	DFT-S-OFDM	QPSK	1	104	24.5	22.74	0	-0.17	1:1	0.029	1.500	0.044	
836.50	167300	Md	top	10 mm	NR Band n5 (Cell)	Sub	99849	20	DFT-S-OFDM	QPSK	50	28	24.5	22.72	0	-0.04	1:1	0.027	1.507	0.041	
836.50	167300	Md	right	10 mm	NR Band n5 (Cell)	Sub	99849	20	DFT-S-OFDM	QPSK	1	104	24.5	22.74	0	-0.03	1:1	0.259	1.500	0.389	
836.50	167300	Md	right	10 mm	NR Band n5 (Cell)	Sub	99849	20	DFT-S-OFDM	QPSK	50	28	24.5	22.72	0	-0.04	1:1	0.270	1.507	0.407	A59
836.50	167300	Md	right	10 mm	NR Band n5 (Cell)	Sub	99849	20	CP-OFDM	QPSK	1	1	23.0	21.53	1.5	0.00	1:1	0.217	1.403	0.304	
836.50	167300	Md	left	10 mm	NR Band n5 (Cell)	Sub	99849	20	DFT-S-OFDM	QPSK	1	104	24.5	22.74	0	-0.02	1:1	0.219	1.500	0.329	
836.50	167300	Md	left	10 mm	NR Band n5 (Cell)	Sub	99849	20	DFT-S-OFDM	QPSK	50	28	24.5	22.72	0	-0.03	1:1	0.199	1.507	0.300	
ANSI / IEEE C95.1 1992 - SAFETY LIMIT Spatial Peak Uncontrolled Exposure/General Population												Body 1.6 W/kg (mW/g) averaged over 1 gram									

**Table 11-47
NR Band n66 Hotspot SAR**

MEASUREMENT RESULTS																					
FREQUENCY		Side	Spacing	Mode	Antenna Config	Serial Number	Bandwidth [MHz]	Waveform	Modulation	RB Size	RB Offset	Maximum Allowed Power [dBm]	Conducted Power [dBm]	MPR [dB]	Power Drift [dB]	Duty Cycle	SAR (1g) (W/kg)	Scaling Factor	Reported SAR (1g) (W/kg)	Plot #	
MHz	Ch.																				
1720.00	344000	Low	back	10 mm	NR Band n66 (AWS)	Main 2	99542	20	DFT-S-OFDM	QPSK	1	1	19.0	17.70	0	-0.05	1:1	0.195	1.349	0.263	
1720.00	344000	Low	back	10 mm	NR Band n66 (AWS)	Main 2	99542	20	DFT-S-OFDM	QPSK	50	56	19.0	17.71	0	0.02	1:1	0.212	1.346	0.285	
1720.00	344000	Low	front	10 mm	NR Band n66 (AWS)	Main 2	99542	20	DFT-S-OFDM	QPSK	1	1	19.0	17.70	0	0.01	1:1	0.165	1.349	0.223	
1720.00	344000	Low	front	10 mm	NR Band n66 (AWS)	Main 2	99542	20	DFT-S-OFDM	QPSK	50	56	19.0	17.71	0	0.01	1:1	0.182	1.346	0.245	
1720.00	344000	Low	bottom	10 mm	NR Band n66 (AWS)	Main 2	99542	20	DFT-S-OFDM	QPSK	1	1	19.0	17.70	0	0.03	1:1	0.290	1.349	0.391	
1720.00	344000	Low	bottom	10 mm	NR Band n66 (AWS)	Main 2	99542	20	DFT-S-OFDM	QPSK	50	56	19.0	17.71	0	-0.03	1:1	0.300	1.346	0.404	A60
1720.00	344000	Low	bottom	10 mm	NR Band n66 (AWS)	Main 2	99542	20	CP-OFDM	QPSK	1	1	19.0	17.85	0	0.06	1:1	0.298	1.303	0.388	
1720.00	344000	Low	right	10 mm	NR Band n66 (AWS)	Main 2	99542	20	DFT-S-OFDM	QPSK	1	1	19.0	17.70	0	-0.01	1:1	0.110	1.349	0.148	
1720.00	344000	Low	right	10 mm	NR Band n66 (AWS)	Main 2	99542	20	DFT-S-OFDM	QPSK	50	56	19.0	17.71	0	0.00	1:1	0.122	1.346	0.164	
ANSI / IEEE C95.1 1992 - SAFETY LIMIT Spatial Peak Uncontrolled Exposure/General Population												Body 1.6 W/kg (mW/g) averaged over 1 gram									

FCC ID: PY7-76056F	SAR EVALUATION REPORT	Approved by: Technical Manager
Document S/N: 1M2205240063-03.PY7	DUT Type: Portable Handset	Page 96 of 111

**Table 11-48
NR Band n2 Hotspot SAR**

MEASUREMENT RESULTS																					
FREQUENCY			Side	Spacing	Mode	Antenna Config	Serial Number	Bandwidth [MHz]	Waveform	Modulation	RB Size	RB Offset	Maximum Allowed Power [dBm]	Conducted Power [dBm]	MPR [dB]	Power Drift [dB]	Duty Cycle	SAR (1g) (W/kg)	Scaling Factor	Reported SAR (1g) (W/kg)	Plot #
Mhz	Ch.																				
1860.00	372000	Low	back	10 mm	NR Band n2 (PCS)	Main 2	99542	20	DFT-S-OFDM	QPSK	1	1	20.0	18.37	0	0.10	1:1	0.266	1.455	0.387	
1860.00	372000	Low	back	10 mm	NR Band n2 (PCS)	Main 2	99542	20	DFT-S-OFDM	QPSK	50	28	20.0	18.34	0	0.05	1:1	0.268	1.466	0.393	
1860.00	372000	Low	front	10 mm	NR Band n2 (PCS)	Main 2	99542	20	DFT-S-OFDM	QPSK	1	1	20.0	18.37	0	-0.03	1:1	0.218	1.455	0.317	
1860.00	372000	Low	front	10 mm	NR Band n2 (PCS)	Main 2	99542	20	DFT-S-OFDM	QPSK	50	28	20.0	18.34	0	0.05	1:1	0.218	1.466	0.320	
1860.00	372000	Low	bottom	10 mm	NR Band n2 (PCS)	Main 2	99542	20	DFT-S-OFDM	QPSK	1	1	20.0	18.37	0	0.03	1:1	0.372	1.455	0.541	
1860.00	372000	Low	bottom	10 mm	NR Band n2 (PCS)	Main 2	99542	20	DFT-S-OFDM	QPSK	50	28	20.0	18.34	0	-0.01	1:1	0.394	1.466	0.578	A61
1880.00	376000	Mid	bottom	10 mm	NR Band n2 (PCS)	Main 2	99542	20	CP-OFDM	QPSK	1	1	20.0	18.35	0	-0.03	1:1	0.389	1.462	0.539	
1860.00	372000	Low	right	10 mm	NR Band n2 (PCS)	Main 2	99542	20	DFT-S-OFDM	QPSK	1	1	20.0	18.37	0	0.03	1:1	0.150	1.455	0.218	
1860.00	372000	Low	right	10 mm	NR Band n2 (PCS)	Main 2	99542	20	DFT-S-OFDM	QPSK	50	28	20.0	18.34	0	0.01	1:1	0.141	1.466	0.207	
ANSI / IEEE C95.1 1992 - SAFETY LIMIT Spatial Peak Uncontrolled Exposure/General Population													Body 1.6 W/kg (mW/g) averaged over 1 gram								

**Table 11-49
NR Band n41 Hotspot SAR**

MEASUREMENT RESULTS																					
FREQUENCY			Side	Spacing	Mode	Antenna Config	Serial Number	Bandwidth [MHz]	Waveform	Modulation	RB Size	RB Offset	Maximum Allowed Power [dBm]	Conducted Power [dBm]	MPR [dB]	Power Drift [dB]	Duty Cycle	SAR (1g) (W/kg)	Scaling Factor	Reported SAR (1g) (W/kg)	Plot #
Mhz	Ch.																				
2592.99	518598	Mid	back	10 mm	NR Band n41	Main 2	99765	100	DFT-S-OFDM	QPSK	1	1	20.0	19.31	0	-0.01	1:1	0.246	1.172	0.288	
2592.99	518598	Mid	back	10 mm	NR Band n41	Main 2	99765	100	DFT-S-OFDM	QPSK	135	69	20.0	19.35	0	-0.02	1:1	0.258	1.161	0.300	
2592.99	518598	Mid	front	10 mm	NR Band n41	Main 2	99765	100	DFT-S-OFDM	QPSK	1	137	20.0	19.34	0	-0.05	1:1	0.239	1.164	0.278	
2592.99	518598	Mid	front	10 mm	NR Band n41	Main 2	99765	100	DFT-S-OFDM	QPSK	135	69	20.0	19.35	0	-0.05	1:1	0.254	1.161	0.295	
2592.99	518598	Mid	bottom	10 mm	NR Band n41	Main 2	99765	100	DFT-S-OFDM	QPSK	1	137	20.0	19.34	0	-0.06	1:1	0.393	1.164	0.457	
2592.99	518598	Mid	bottom	10 mm	NR Band n41	Main 2	99765	100	DFT-S-OFDM	QPSK	135	69	20.0	19.35	0	-0.03	1:1	0.378	1.161	0.439	
2592.99	518598	Mid	bottom	10 mm	NR Band n41	Main 2	99765	100	CP-OFDM	QPSK	1	1	20.0	19.13	0	0.00	1:1	0.434	1.222	0.530	A62
2592.99	518598	Mid	right	10 mm	NR Band n41	Main 2	99765	100	DFT-S-OFDM	QPSK	1	137	20.0	19.34	0	0.04	1:1	0.092	1.164	0.107	
2592.99	518598	Mid	right	10 mm	NR Band n41	Main 2	99765	100	DFT-S-OFDM	QPSK	135	69	20.0	19.35	0	0.00	1:1	0.092	1.161	0.107	
2592.99	518598	Mid	back	10 mm	NR Band n41	Sub	99765	100	CP-OFDM	QPSK	1	271	18.0	17.66	0	0.01	1:1	0.051	1.081	0.055	
2592.99	518598	Mid	back	10 mm	NR Band n41	Sub	99765	100	CP-OFDM	QPSK	137	68	18.0	17.70	0	-0.14	1:1	0.060	1.072	0.064	
2592.99	518598	Mid	front	10 mm	NR Band n41	Sub	99765	100	CP-OFDM	QPSK	1	271	18.0	17.66	0	0.07	1:1	0.086	1.081	0.093	
2592.99	518598	Mid	front	10 mm	NR Band n41	Sub	99765	100	CP-OFDM	QPSK	137	68	18.0	17.70	0	-0.06	1:1	0.088	1.072	0.094	
2592.99	518598	Mid	top	10 mm	NR Band n41	Sub	99765	100	CP-OFDM	QPSK	1	271	18.0	17.66	0	-0.11	1:1	0.058	1.081	0.063	
2592.99	518598	Mid	top	10 mm	NR Band n41	Sub	99765	100	CP-OFDM	QPSK	137	68	18.0	17.70	0	-0.12	1:1	0.053	1.072	0.057	
2592.99	518598	Mid	right	10 mm	NR Band n41	Sub	99765	100	CP-OFDM	QPSK	1	271	18.0	17.66	0	-0.01	1:1	0.131	1.081	0.142	
2592.99	518598	Mid	right	10 mm	NR Band n41	Sub	99765	100	CP-OFDM	QPSK	137	68	18.0	17.70	0	-0.04	1:1	0.147	1.072	0.158	
2592.99	518598	Mid	left	10 mm	NR Band n41	Sub	99765	100	CP-OFDM	QPSK	1	271	18.0	17.66	0	0.14	1:1	0.009	1.081	0.010	
2592.99	518598	Mid	left	10 mm	NR Band n41	Sub	99765	100	CP-OFDM	QPSK	137	68	18.0	17.70	0	0.03	1:1	0.006	1.072	0.006	
ANSI / IEEE C95.1 1992 - SAFETY LIMIT Spatial Peak Uncontrolled Exposure/General Population													Body 1.6 W/kg (mW/g) averaged over 1 gram								

FCC ID: PY7-76056F	SAR EVALUATION REPORT		Approved by: Technical Manager
Document S/N: 1M2205240063-03.PY7	DUT Type: Portable Handset	Page 97 of 111	

**Table 11-50
NR Band n77 Hotspot SAR**

MEASUREMENT RESULTS																				
FREQUENCY		Side	Spacing	Mode	Antenna Config	Serial Number	Bandwidth [MHz]	Waveform	Modulation	RB Size	RB Offset	Maximum Allowed Power [dBm]	Conducted Power [dBm]	MPR [dB]	Power Drift [dB]	Duty Cycle	SAR (1g) (W/kg)	Scaling Factor	Reported SAR (1g) (W/kg)	Plot #
Mhz	Ch.																			
3930.00	662000	High	back	NR Band n77	Main 1	99765	100	DFT-S-OFDM	QPSK	1	137	18.0	17.52	0	-0.13	1:1	0.106	1.117	0.118	
3930.00	662000	High	back	NR Band n77	Main 1	99765	100	DFT-S-OFDM	QPSK	135	0	18.0	17.42	0	0.00	1:1	0.110	1.143	0.126	
3930.00	662000	High	front	NR Band n77	Main 1	99765	100	DFT-S-OFDM	QPSK	1	137	18.0	17.52	0	-0.08	1:1	0.151	1.117	0.169	
3930.00	662000	High	front	NR Band n77	Main 1	99765	100	DFT-S-OFDM	QPSK	135	0	18.0	17.42	0	-0.11	1:1	0.142	1.143	0.162	
3930.00	662000	High	bottom	NR Band n77	Main 1	99765	100	DFT-S-OFDM	QPSK	1	137	18.0	17.52	0	-0.09	1:1	0.186	1.117	0.208	
3930.00	662000	High	bottom	NR Band n77	Main 1	99765	100	DFT-S-OFDM	QPSK	135	0	18.0	17.42	0	-0.03	1:1	0.177	1.143	0.202	
3930.00	662000	High	bottom	NR Band n77	Main 1	99765	100	CP-OFDM	QPSK	1	1	18.0	17.10	0	0.01	1:1	0.180	1.230	0.221	
3930.00	662000	High	left	NR Band n77	Main 1	99765	100	DFT-S-OFDM	QPSK	1	137	18.0	17.52	0	-0.04	1:1	0.020	1.117	0.022	
3930.00	662000	High	left	NR Band n77	Main 1	99765	100	DFT-S-OFDM	QPSK	135	0	18.0	17.42	0	-0.09	1:1	0.023	1.143	0.028	
3930.00	662000	High	back	NR Band n77	Sub	99765	100	CP-OFDM	QPSK	1	137	16.0	14.79	0	0.15	1:1	0.029	1.321	0.038	
3930.00	662000	High	back	NR Band n77	Sub	99765	100	CP-OFDM	QPSK	137	68	16.0	15.00	0	-0.07	1:1	0.025	1.259	0.031	
3930.00	662000	High	front	NR Band n77	Sub	99765	100	CP-OFDM	QPSK	1	137	16.0	14.79	0	0.03	1:1	0.010	1.321	0.013	
3930.00	662000	High	front	NR Band n77	Sub	99765	100	CP-OFDM	QPSK	137	68	16.0	15.00	0	0.01	1:1	0.010	1.259	0.013	
3930.00	662000	High	top	NR Band n77	Sub	99765	100	CP-OFDM	QPSK	1	137	16.0	14.79	0	0.04	1:1	0.004	1.321	0.005	
3930.00	662000	High	top	NR Band n77	Sub	99765	100	CP-OFDM	QPSK	137	68	16.0	15.00	0	0.04	1:1	0.004	1.259	0.005	
3930.00	662000	High	right	NR Band n77	Sub	99765	100	CP-OFDM	QPSK	1	137	16.0	14.79	0	0.05	1:1	0.025	1.321	0.033	
3930.00	662000	High	right	NR Band n77	Sub	99765	100	CP-OFDM	QPSK	137	68	16.0	15.00	0	0.08	1:1	0.024	1.259	0.030	
3930.00	662000	High	left	NR Band n77	Sub	99765	100	CP-OFDM	QPSK	1	137	16.0	14.79	0	0.06	1:1	0.000	1.321	0.000	
3930.00	662000	High	left	NR Band n77	Sub	99765	100	CP-OFDM	QPSK	137	68	16.0	15.00	0	0.07	1:1	0.000	1.259	0.000	
3750.00	650000	Low	back	NR Band n77	4th path	99765	100	DFT-s-OFDM	QPSK	1	137	17.3	16.87	0	-0.05	1:1	0.333	1.104	0.368	
3930.00	662000	High	back	NR Band n77	4th path	99765	100	DFT-S-OFDM	QPSK	1	137	17.3	17.30	0	0.03	1:1	0.451	1.000	0.451	A43
3750.00	650000	Low	back	NR Band n77	4th path	99765	100	DFT-s-OFDM	QPSK	135	0	17.3	16.81	0	-0.03	1:1	0.300	1.119	0.336	
3930.00	662000	High	back	NR Band n77	4th path	99765	100	DFT-s-OFDM	QPSK	135	69	17.3	17.30	0	-0.03	1:1	0.441	1.000	0.441	
3930.00	662000	High	back	NR Band n77	4th path	99765	100	DFT-s-OFDM	QPSK	270	0	17.3	17.09	0	-0.08	1:1	0.440	1.050	0.462	
3930.00	662000	High	back	NR Band n77	4th path	99765	100	CP-OFDM	QPSK	1	1	17.3	17.07	0	-0.02	1:1	0.389	1.054	0.410	
3930.00	662000	High	front	NR Band n77	4th path	99765	100	DFT-s-OFDM	QPSK	1	137	17.3	17.30	0	-0.14	1:1	0.020	1.000	0.020	
3930.00	662000	High	front	NR Band n77	4th path	99765	100	DFT-s-OFDM	QPSK	135	69	17.3	17.30	0	0.03	1:1	0.021	1.000	0.021	
3930.00	662000	High	top	NR Band n77	4th path	99765	100	DFT-s-OFDM	QPSK	1	137	17.3	17.30	0	0.12	1:1	0.035	1.000	0.035	
3930.00	662000	High	top	NR Band n77	4th path	99765	100	DFT-s-OFDM	QPSK	135	69	17.3	17.30	0	0.07	1:1	0.033	1.000	0.033	
3930.00	662000	High	left	NR Band n77	4th path	99765	100	DFT-s-OFDM	QPSK	1	137	17.3	17.30	0	0.01	1:1	0.051	1.000	0.051	
3930.00	662000	High	left	NR Band n77	4th path	99765	100	DFT-s-OFDM	QPSK	135	69	17.3	17.30	0	0.14	1:1	0.051	1.000	0.051	
ANSI / IEEE C95.1 1992 - SAFETY LIMIT										Body										
Spatial Peak										1.6 W/kg (mW/g)										
Uncontrolled Exposure/General Population										averaged over 1 gram										

FCC ID: PY7-76056F	SAR EVALUATION REPORT	Approved by: Technical Manager
Document S/N: 1M2205240063-03.PY7	DUT Type: Portable Handset	Page 98 of 111

**Table 11-51
WLAN Hotspot SAR**

MEASUREMENT RESULTS																			
FREQUENCY		Side	Spacing	Mode	Service	Antenna Config.	Device Serial Number	Bandwidth [MHz]	Data Rate (Mbps)	Maximum Allowed Power [dBm]	Conducted Power [dBm]	Power Drift [dB]	Duty Cycle (%)	Peak SAR of Area Scan	SAR (1g)	Scaling Factor (Power)	Scaling Factor (Duty Cycle)	Reported SAR (1g)	Plot #
MHz	Ch.													W/kg	(W/kg)	(Power)	(Duty Cycle)	(W/kg)	
2412	1	back	10 mm	802.11b	DSSS	Chain 0	99583	22	1	14.5	14.13	-0.01	99.80	0.138	-	1.089	1.002	-	
2412	1	front	10 mm	802.11b	DSSS	Chain 0	99583	22	1	14.5	14.13	0.00	99.80	0.076	-	1.089	1.002	-	
2412	1	top	10 mm	802.11b	DSSS	Chain 0	99583	22	1	14.5	14.13	-0.18	99.80	0.016	-	1.089	1.002	-	
2412	1	left	10 mm	802.11b	DSSS	Chain 0	99583	22	1	14.5	14.13	-0.05	99.80	0.214	0.161	1.089	1.002	0.176	A63
2412	1	back	10 mm	802.11b	DSSS	Chain 1	99583	22	1	12.7	12.60	0.01	99.50	0.088	0.082	1.023	1.005	0.084	
2412	1	front	10 mm	802.11b	DSSS	Chain 1	99583	22	1	12.7	12.60	0.20	99.50	0.004	-	1.023	1.005	-	
2412	1	bottom	10 mm	802.11b	DSSS	Chain 1	99583	22	1	12.7	12.60	0.06	99.50	0.016	-	1.023	1.005	-	
2412	1	left	10 mm	802.11b	DSSS	Chain 1	99583	22	1	12.7	12.60	0.01	99.50	0.006	-	1.023	1.005	-	
5210	42	back	10 mm	802.11ac	OFDM	Chain 0	99823	80	29.3	11.5	10.96	0.00	98.90	0.083	-	1.132	1.011	-	
5210	42	front	10 mm	802.11ac	OFDM	Chain 0	99823	80	29.3	11.5	10.96	0.06	98.90	0.058	-	1.132	1.011	-	
5210	42	top	10 mm	802.11ac	OFDM	Chain 0	99823	80	29.3	11.5	10.96	0.01	98.90	0.032	-	1.132	1.011	-	
5210	42	left	10 mm	802.11ac	OFDM	Chain 0	99823	80	29.3	11.5	10.96	0.07	98.90	0.136	0.086	1.132	1.011	0.098	
5210	42	back	10 mm	802.11ac	OFDM	Chain 1	99823	80	29.3	11.5	11.38	0.07	99.00	0.032	0.021	1.028	1.010	0.022	
5210	42	front	10 mm	802.11ac	OFDM	Chain 1	99823	80	29.3	11.5	11.38	0.07	99.00	0.008	-	1.028	1.010	-	
5210	42	bottom	10 mm	802.11ac	OFDM	Chain 1	99823	80	29.3	11.5	11.38	0.05	99.00	0.006	-	1.028	1.010	-	
5210	42	left	10 mm	802.11ac	OFDM	Chain 1	99823	80	29.3	11.5	11.38	0.05	99.00	0.012	-	1.028	1.010	-	
5775	155	back	10 mm	802.11ac	OFDM	Chain 0	99823	80	29.3	11.5	10.52	0.04	98.90	0.096	-	1.253	1.011	-	
5775	155	front	10 mm	802.11ac	OFDM	Chain 0	99823	80	29.3	11.5	10.52	0.06	98.90	0.041	-	1.253	1.011	-	
5775	155	top	10 mm	802.11ac	OFDM	Chain 0	99823	80	29.3	11.5	10.52	0.20	98.90	0.027	-	1.253	1.011	-	
5775	155	left	10 mm	802.11ac	OFDM	Chain 0	99823	80	29.3	11.5	10.52	-0.09	98.90	0.120	0.087	1.253	1.011	0.110	A64
5775	155	back	10 mm	802.11ac	OFDM	Chain 1	99823	80	29.3	11.5	11.22	-0.11	99.00	0.098	0.078	1.067	1.010	0.084	
5775	155	front	10 mm	802.11ac	OFDM	Chain 1	99823	80	29.3	11.5	11.22	-0.11	99.00	0.018	-	1.067	1.010	-	
5775	155	bottom	10 mm	802.11ac	OFDM	Chain 1	99823	80	29.3	11.5	11.22	-0.15	99.00	0.021	-	1.067	1.010	-	
5775	155	left	10 mm	802.11ac	OFDM	Chain 1	99823	80	29.3	11.5	11.22	0.05	99.00	0.018	-	1.067	1.010	-	
ANSI / IEEE C95.1 1992 - SAFETY LIMIT Spatial Peak Uncontrolled Exposure/General Population											Body 1.6 W/kg (mW/g) averaged over 1 gram								

**Table 11-52
DSS Hotspot SAR**

MEASUREMENT RESULTS																			
FREQUENCY		Side	Spacing	Mode	Service	Antenna Config.	Device Serial Number	Data Rate (Mbps)	Maximum Allowed Power [dBm]	Conducted Power [dBm]	Power Drift [dB]	Duty Cycle (%)	SAR (1g)	Scaling Factor (Cond Power)	Scaling Factor (Duty Cycle)	Reported SAR (1g)	Plot #		
MHz	Ch.												(W/kg)	(Power)	(Duty Cycle)	(W/kg)			
2480	78	back	10 mm	Bluetooth	FHSS	Chain 0	99583	1	14.0	13.88	0.06	76.80	0.032	1.028	1.085	0.036			
2480	78	front	10 mm	Bluetooth	FHSS	Chain 0	99583	1	14.0	13.88	-0.13	76.80	0.022	1.028	1.085	0.025			
2480	78	top	10 mm	Bluetooth	FHSS	Chain 0	99583	1	14.0	13.88	0.05	76.80	0.002	1.028	1.085	0.002			
2480	78	left	10 mm	Bluetooth	FHSS	Chain 0	99583	1	14.0	13.88	-0.09	76.80	0.060	1.028	1.085	0.067	A65		
2480	78	back	10 mm	Bluetooth	FHSS	Chain 1	99583	1	14.0	13.48	-0.08	76.80	0.018	1.127	1.085	0.022			
2480	78	front	10 mm	Bluetooth	FHSS	Chain 1	99583	1	14.0	13.48	0.09	76.80	0.000	1.127	1.085	0.000			
2480	78	bottom	10 mm	Bluetooth	FHSS	Chain 1	99583	1	14.0	13.48	0.07	76.80	0.001	1.127	1.085	0.001			
2480	78	left	10 mm	Bluetooth	FHSS	Chain 1	99583	1	14.0	13.48	0.04	76.80	0.000	1.127	1.085	0.000			
ANSI / IEEE C95.1 1992 - SAFETY LIMIT Spatial Peak Uncontrolled Exposure/General Population											Body 1.6 W/kg (mW/g) averaged over 1 gram								

Note: The reported SAR was scaled to the 83.3% transmission duty factor to determine compliance since the duty factor of the device is permanently limited to 83.3% per the manufacturer.

FCC ID: PY7-76056F	SAR EVALUATION REPORT	Approved by: Technical Manager
Document S/N: 1M2205240063-03.PY7	DUT Type: Portable Handset	Page 99 of 111

11.4 Standalone Phablet SAR Data

Table 11-53
LTE Band 66 (AWS) Phablet SAR

MEASUREMENT RESULTS																				
FREQUENCY		Side	Spacing	Mode	Antenna Config.	Serial Number	Bandwidth [MHz]	Modulation	RB Size	RB Offset	Maximum Allowed Power [dBm]	Conducted Power [dBm]	MPR [dB]	Power Drift [dB]	Duty Cycle	SAR (10g) (W/kg)	Scaling Factor	Reported SAR (10g) (W/kg)	Plot #	
MHz	Ch.																			
1720.00	132072	Low	bottom	0 mm	LTE Band 66 (AWS)	Main 2	00043	20	QPSK	1	50	19.0	18.10	0	0.01	1:1	0.536	1.230	0.659	
1720.00	132072	Low	bottom	0 mm	LTE Band 66 (AWS)	Main 2	00043	20	QPSK	50	25	19.0	18.09	0	0.03	1:1	0.543	1.233	0.670	A66
ANSI / IEEE C95.1 1992 - SAFETY LIMIT Spatial Peak Uncontrolled Exposure/General Population												Phablet 4.0 W/kg (mW/g) averaged over 10 grams								

Table 11-54
LTE Band 25 (PCS) Phablet SAR

MEASUREMENT RESULTS																				
FREQUENCY		Side	Spacing	Mode	Antenna Config.	Serial Number	Bandwidth [MHz]	Modulation	RB Size	RB Offset	Maximum Allowed Power [dBm]	Conducted Power [dBm]	MPR [dB]	Power Drift [dB]	Duty Cycle	SAR (10g) (W/kg)	Scaling Factor	Reported SAR (10g) (W/kg)	Plot #	
MHz	Ch.																			
1905.00	26590	High	bottom	0 mm	LTE Band 25 (PCS)	Main 2	99989	20	QPSK	1	0	20.0	18.62	0	0.04	1:1	0.512	1.373	0.703	
1905.00	26590	High	bottom	0 mm	LTE Band 25 (PCS)	Main 2	99989	20	QPSK	50	0	20.0	18.70	0	0.00	1:1	0.522	1.349	0.704	A67
ANSI / IEEE C95.1 1992 - SAFETY LIMIT Spatial Peak Uncontrolled Exposure/General Population												Phablet 4.0 W/kg (mW/g) averaged over 10 grams								

Table 11-55
NR Band n66 Phablet SAR

MEASUREMENT RESULTS																					
FREQUENCY		Side	Spacing	Mode	Antenna Config.	Serial Number	Bandwidth [MHz]	Waveform	Modulation	RB Size	RB Offset	Maximum Allowed Power [dBm]	Conducted Power [dBm]	MPR [dB]	Power Drift [dB]	Duty Cycle	SAR (10g) (W/kg)	Scaling Factor	Reported SAR (10g) (W/kg)	Plot #	
MHz	Ch.																				
1720.00	344000	Low	bottom	0 mm	NR Band n66 (AWS)	Main 2	99542	20	DFT-S-OFDM	QPSK	1	1	19.0	17.70	0	-0.14	1:1	0.763	1.349	1.029	A68
1720.00	344000	Low	bottom	0 mm	NR Band n66 (AWS)	Main 2	99542	20	DFT-S-OFDM	QPSK	50	56	19.0	17.71	0	-0.03	1:1	0.701	1.346	0.944	
1720.00	344000	Low	bottom	0 mm	NR Band n66 (AWS)	Main 2	99542	20	CP-OFDM	QPSK	1	1	19.0	17.85	0	-0.10	1:1	0.749	1.303	0.976	
ANSI / IEEE C95.1 1992 - SAFETY LIMIT Spatial Peak Uncontrolled Exposure/General Population												Phablet 4.0 W/kg (mW/g) averaged over 10 grams									

Table 11-56
NR Band n2 Phablet SAR

MEASUREMENT RESULTS																					
FREQUENCY		Side	Spacing	Mode	Antenna Config.	Serial Number	Bandwidth [MHz]	Waveform	Modulation	RB Size	RB Offset	Maximum Allowed Power [dBm]	Conducted Power [dBm]	MPR [dB]	Power Drift [dB]	Duty Cycle	SAR (10g) (W/kg)	Scaling Factor	Reported SAR (10g) (W/kg)	Plot #	
MHz	Ch.																				
1860.00	372000	Low	back	0 mm	NR Band n2 (PCS)	Main 2	99542	20	DFT-S-OFDM	QPSK	1	1	20.0	18.37	0	-0.15	1:1	0.746	1.455	1.085	
1860.00	372000	Low	back	0 mm	NR Band n2 (PCS)	Main 2	99542	20	DFT-S-OFDM	QPSK	50	28	20.0	18.34	0	-0.01	1:1	0.820	1.466	1.202	
1880.00	376000	Mid	back	0 mm	NR Band n2 (PCS)	Main 2	99542	20	CP-OFDM	QPSK	1	1	20.0	18.35	0	0.00	1:1	0.885	1.462	1.294	A69
1860.00	372000	Low	bottom	0 mm	NR Band n2 (PCS)	Main 2	99542	20	DFT-S-OFDM	QPSK	1	1	20.0	18.37	0	0.02	1:1	0.658	1.455	0.957	
1860.00	372000	Low	bottom	0 mm	NR Band n2 (PCS)	Main 2	99542	20	DFT-S-OFDM	QPSK	50	28	20.0	18.34	0	-0.01	1:1	0.626	1.466	0.918	
ANSI / IEEE C95.1 1992 - SAFETY LIMIT Spatial Peak Uncontrolled Exposure/General Population												Phablet 4.0 W/kg (mW/g) averaged over 10 grams									

FCC ID: PY7-76056F	SAR EVALUATION REPORT		Approved by: Technical Manager
Document S/N: 1M2205240063-03.PY7	DUT Type: Portable Handset		Page 100 of 111

**Table 11-57
NR Band n41 Phablet SAR**

MEASUREMENT RESULTS																					
FREQUENCY			Side	Spacing	Mode	Antenna Config	Serial Number	Bandwidth [MHz]	Waveform	Modulation	RB Size	RB Offset	Maximum Allowed Power [dBm]	Conducted Power [dBm]	MPR [dB]	Power Drift [dB]	Duty Cycle	SAR (10g) (W/kg)	Scaling Factor	Reported SAR (10g) (W/kg)	Plot #
MHz	Ch.																				
2592.99	518598	Md	back	0 mm	NR Band n41	Main 2	99641	100	DFT-S-OFDM	QPSK	1	137	20.0	19.34	0	0.01	1:1	1.380	1.164	1.606	
2592.99	518598	Md	back	0 mm	NR Band n41	Main 2	99641	100	DFT-S-OFDM	QPSK	135	69	20.0	19.35	0	-0.02	1:1	1.390	1.161	1.614	
2592.99	518598	Md	back	0 mm	NR Band n41	Main 2	99641	100	DFT-S-OFDM	QPSK	270	0	20.0	19.23	0	0.00	1:1	1.160	1.194	1.385	
2592.99	518598	Md	front	0 mm	NR Band n41	Main 2	99765	100	DFT-S-OFDM	QPSK	1	137	20.0	19.34	0	0.04	1:1	1.150	1.164	1.339	
2592.99	518598	Md	front	0 mm	NR Band n41	Main 2	99765	100	DFT-S-OFDM	QPSK	135	69	20.0	19.35	0	0.01	1:1	1.190	1.161	1.382	
2592.99	518598	Md	bottom	0 mm	NR Band n41	Main 2	99765	100	DFT-S-OFDM	QPSK	1	137	20.0	19.34	0	-0.01	1:1	1.380	1.164	1.606	
2592.99	518598	Md	bottom	0 mm	NR Band n41	Main 2	99765	100	DFT-S-OFDM	QPSK	135	69	20.0	19.35	0	-0.03	1:1	1.400	1.161	1.625	
2592.99	518598	Md	bottom	0 mm	NR Band n41	Main 2	99765	100	DFT-S-OFDM	QPSK	270	0	20.0	19.23	0	-0.02	1:1	1.530	1.194	1.827	
2592.99	518598	Md	bottom	0 mm	NR Band n41	Main 2	99765	100	CP-OFDM	QPSK	1	1	20.0	19.13	0	-0.04	1:1	1.840	1.222	2.248	A70
ANSI / IEEE C95.1 1992 - SAFETY LIMIT Spatial Peak Uncontrolled Exposure/General Population										Phablet 4.0 W/kg (mW/g) averaged over 10 grams											

**Table 11-58
NR Band n77 Phablet SAR**

MEASUREMENT RESULTS																					
FREQUENCY			Side	Spacing	Mode	Antenna Config	Serial Number	Bandwidth [MHz]	Waveform	Modulation	RB Size	RB Offset	Maximum Allowed Power [dBm]	Conducted Power [dBm]	MPR [dB]	Power Drift [dB]	Duty Cycle	SAR (10g) (W/kg)	Scaling Factor	Reported SAR (10g) (W/kg)	Plot #
MHz	Ch.																				
3930.00	662000	High	front	0 mm	NR Band n77	Main 1	99765	100	DFT-S-OFDM	QPSK	1	137	18.0	17.52	0	0.06	1:1	0.711	1.117	0.794	
3930.00	662000	High	front	0 mm	NR Band n77	Main 1	99765	100	DFT-S-OFDM	QPSK	135	0	18.0	17.42	0	0.01	1:1	0.736	1.143	0.841	
3930.00	662000	High	bottom	0 mm	NR Band n77	Main 1	99765	100	DFT-S-OFDM	QPSK	1	137	18.0	17.52	0	-0.05	1:1	0.774	1.117	0.865	
3930.00	662000	High	bottom	0 mm	NR Band n77	Main 1	99765	100	DFT-S-OFDM	QPSK	135	0	18.0	17.42	0	-0.03	1:1	0.741	1.143	0.847	
3930.00	662000	High	bottom	0 mm	NR Band n77	Main 1	99765	100	CP-OFDM	QPSK	1	1	18.0	17.10	0	0.04	1:1	0.692	1.230	0.851	
3750.00	650000	Low	back	0 mm	NR Band n77	4th path	99765	100	DFT-s-OFDM	QPSK	1	137	17.3	16.87	0	0.01	1:1	1.260	1.104	1.391	A71
3930.00	662000	High	back	0 mm	NR Band n77	4th path	99765	100	DFT-s-OFDM	QPSK	1	137	17.3	17.30	0	-0.04	1:1	1.240	1.000	1.240	
3750.00	650000	Low	back	0 mm	NR Band n77	4th path	99765	100	DFT-s-OFDM	QPSK	135	0	17.3	16.81	0	0.02	1:1	1.140	1.119	1.276	
3930.00	662000	High	back	0 mm	NR Band n77	4th path	99765	100	DFT-s-OFDM	QPSK	135	69	17.3	17.30	0	-0.04	1:1	1.230	1.000	1.230	
3930.00	662000	High	back	0 mm	NR Band n77	4th path	99765	100	DFT-s-OFDM	QPSK	270	0	17.3	17.09	0	0.01	1:1	1.230	1.050	1.292	
3930.00	662000	High	back	0 mm	NR Band n77	4th path	99765	100	CP-OFDM	QPSK	1	1	17.3	17.07	0	0.01	1:1	1.220	1.054	1.286	
ANSI / IEEE C95.1 1992 - SAFETY LIMIT Spatial Peak Uncontrolled Exposure/General Population										Phablet 4 W/kg (mW/g) averaged over 10 grams											

FCC ID: PY7-76056F	SAR EVALUATION REPORT	Approved by: Technical Manager
Document S/N: 1M2205240063-03.PY7	DUT Type: Portable Handset	Page 101 of 111

**Table 11-59
WLAN Phablet SAR**

MEASUREMENT RESULTS																			
FREQUENCY		Side	Spacing	Mode	Service	Antenna Config.	Device Serial Number	Bandwidth [MHz]	Data Rate (Mbps)	Maximum Allowed Power [dBm]	Conducted Power [dBm]	Power Drift [dB]	Duty Cycle (%)	Peak SAR of Area Scan	SAR (10g)	Scaling Factor (Power)	Scaling Factor (Duty Cycle)	Reported SAR (10g)	Plot #
MHz	Ch.													W/kg	(W/kg)			(W/kg)	
5290	58	back	0 mm	802.11ac	OFDM	Chain 0	99823	80	29.3	11.5	10.73	0.09	98.90	2.190	-	1.194	1.011	-	
5290	58	front	0 mm	802.11ac	OFDM	Chain 0	99823	80	29.3	11.5	10.73	0.01	98.90	1.050	-	1.194	1.011	-	
5290	58	top	0 mm	802.11ac	OFDM	Chain 0	99823	80	29.3	11.5	10.73	-0.01	98.90	0.184	-	1.194	1.011	-	
5290	58	left	0 mm	802.11ac	OFDM	Chain 0	99823	80	29.3	11.5	10.73	-0.01	98.90	3.380	0.347	1.194	1.011	0.419	
5290	58	back	0 mm	802.11ac	OFDM	Chain 1	99823	80	29.3	11.5	11.20	0.00	99.00	1.270	0.205	1.072	1.010	0.222	
5290	58	front	0 mm	802.11ac	OFDM	Chain 1	99823	80	29.3	11.5	11.20	0.09	99.00	0.079	-	1.072	1.010	-	
5290	58	bottom	0 mm	802.11ac	OFDM	Chain 1	99823	80	29.3	11.5	11.20	0.04	99.00	0.035	-	1.072	1.010	-	
5290	58	left	0 mm	802.11ac	OFDM	Chain 1	99823	80	29.3	11.5	11.20	0.06	99.00	0.095	-	1.072	1.010	-	
5690	138	back	0 mm	802.11ac	OFDM	Chain 0	99823	80	29.3	11.5	11.28	0.18	98.90	0.992	-	1.052	1.011	-	
5690	138	front	0 mm	802.11ac	OFDM	Chain 0	99823	80	29.3	11.5	11.28	0.14	98.90	0.518	-	1.052	1.011	-	
5690	138	top	0 mm	802.11ac	OFDM	Chain 0	99823	80	29.3	11.5	11.28	-0.04	98.90	0.121	-	1.052	1.011	-	
5690	138	left	0 mm	802.11ac	OFDM	Chain 0	99823	80	29.3	11.5	11.28	-0.09	98.90	4.010	0.491	1.052	1.011	0.522	A72
5530	106	back	0 mm	802.11ac	OFDM	Chain 1	99823	80	29.3	11.5	11.36	0.17	99.00	1.510	0.362	1.033	1.010	0.378	
5530	106	front	0 mm	802.11ac	OFDM	Chain 1	99823	80	29.3	11.5	11.36	0.05	99.00	0.042	-	1.033	1.010	-	
5530	106	bottom	0 mm	802.11ac	OFDM	Chain 1	99823	80	29.3	11.5	11.36	0.08	99.00	0.028	-	1.033	1.010	-	
5530	106	left	0 mm	802.11ac	OFDM	Chain 1	99823	80	29.3	11.5	11.36	0.02	99.00	0.020	-	1.033	1.010	-	
ANSI / IEEE C95.1 1992 - SAFETY LIMIT Spatial Peak Uncontrolled Exposure/General Population											Phablet 4.0 W/kg (mW/g) averaged over 10 grams								

**Table 11-60
NFC Phablet SAR**

MEASUREMENT RESULTS							
FREQUENCY	Side	Test Position	Mode	Device Serial Number	Power Drift	SAR (10g)	Plot #
MHz						(W/kg)	
13.56	back	0 mm	NFC	99542	0.08	0.017	A73
13.56	front	0 mm	NFC	99542	-0.19	0.000	
13.56	top	0 mm	NFC	99542	-0.12	0.000	
13.56	right	0 mm	NFC	99542	-0.06	0.000	
13.56	left	0 mm	NFC	99542	0.20	0.000	
ANSI / IEEE C95.1 1992 - SAFETY LIMIT Spatial Peak Uncontrolled Exposure/General Population					Phablet 4.0 W/kg (mW/g) averaged over 10 grams		

11.5 SAR Test Notes

General Notes:

1. The test data reported are the worst-case SAR values according to test procedures specified in IEEE 1528-2013, and FCC KDB Publication 447498 D04v01.
2. Batteries are fully charged at the beginning of the SAR measurements.
3. Liquid tissue depth was at least 15.0 cm for all frequencies.

FCC ID: PY7-76056F	SAR EVALUATION REPORT	Approved by: Technical Manager
Document S/N: 1M2205240063-03.PY7	DUT Type: Portable Handset	Page 102 of 111

4. The manufacturer has confirmed that the device(s) tested have the same physical, mechanical and thermal characteristics and are within operational tolerances expected for production units.
5. SAR results were scaled to the maximum allowed power to demonstrate compliance per FCC KDB Publication 447498 D04v01.
6. Device was tested using a fixed spacing for body-worn accessory testing. A separation distance of 10 mm was considered because the manufacturer has determined that there will be body-worn accessories available in the marketplace for users to support this separation distance.
7. Per FCC KDB Publication 648474 D04v01r03, body-worn SAR was evaluated without a headset connected to the device. Since the standalone reported body-worn SAR was ≤ 1.2 W/kg, no additional body-worn SAR evaluations using a headset cable were required.
8. Per FCC KDB 865664 D01v01r04, variability SAR tests were performed when the measured SAR results for a frequency band were greater than or equal to 0.8 W/kg. Repeated SAR measurements are highlighted in the tables above for clarity. Please see Section 12 for variability analysis.
9. During SAR Testing for the Wireless Router conditions per FCC KDB Publication 941225 D06v02r01, the actual Portable Hotspot operation (with actual simultaneous transmission of a transmitter with WIFI) was not activated (See Section 6.7 for more details).
10. Per FCC KDB Publication 648474 D04v01r03, this device is considered a "phablet" since the diagonal dimension is > 160 mm and < 200 mm. Therefore, phablet SAR tests are required when wireless router mode does not apply or if wireless router 1g SAR > 1.2 W/kg.
11. Additional SAR tests for phablet SAR were evaluated per KDB 616217 Section 6 (See Section 6.9 for more information).
12. Unless otherwise noted, when 10g SAR measurement is considered, a factor of 2.5 is applied to the 1g thresholds for the equivalent test cases.
 This device uses Qualcomm Smart Transmit for 2G/3G/4G/5G operations to control and manage transmitting power in real time to ensure RF Exposure compliance. Per FCC Guidance, compliance for was assessed at the minimum of the time averaged power and the maximum output power for each band/mode/exposure condition (DSI).

FCC ID: PY7-76056F	SAR EVALUATION REPORT	Approved by: Technical Manager
Document S/N: 1M2205240063-03.PY7	DUT Type: Portable Handset	Page 103 of 111

GSM Test Notes:

1. Body-Worn accessory testing is typically associated with voice operations. Therefore, GSM voice was evaluated for body-worn SAR.
2. Justification for reduced test configurations per KDB Publication 941225 D01v03r01 and October 2013 TCB Workshop Notes: The source-based frame-averaged output power was evaluated for all GPRS/EDGE slot configurations. The configuration with the highest target frame averaged output power was evaluated for hotspot SAR. When the maximum frame-averaged powers are equivalent across two or more slots (within 0.25 dB), the configuration with the most number of time slots was tested.
3. Per FCC KDB Publication 447498 D04v01, if the reported (scaled) SAR measured at the highest output power channel for each test configuration is ≤ 0.8 W/kg for 1g evaluations then testing at the other channels is not required for such test configuration(s).
4. DTM SAR was evaluated with CMW500 Radio Communication Tester FW version 3.7.26 when the device was operating in DTM using maximum CS and PS slots according to FCC KDB 941225 D01v03r01.

UMTS Notes:

1. UMTS mode was tested under RMC 12.2 kbps with HSPA Inactive per KDB Publication 941225 D01v03r01. AMR and HSPA SAR was not required per the 3G Test Reduction Procedure in KDB Publication 941225 D01v03r01.
2. Per FCC KDB Publication 447498 D04v01, if the reported (scaled) SAR measured at the highest output power channel for each test configuration is ≤ 0.8 W/kg for 1g evaluations then testing at the other channels is not required for such test configuration(s).

LTE Notes:

1. LTE test configurations are determined according to SAR Evaluation Considerations for LTE Devices in FCC KDB Publication 941225 D05v02r04. The general test procedures used for testing can be found in Section 8.5.4.
2. MPR is permanently implemented for this device by the manufacturer. The specific manufacturer target MPR is indicated alongside the SAR results. MPR is enabled for this device, according to 3GPP TS36.101 Section 6.2.3 – 6.2.5 under Table 6.2.3-1.
3. A-MPR was disabled for all SAR tests by setting NS=01 and MCC=001 on the base station simulator. SAR tests were performed with the same number of RB and RB offsets transmitting on all TTI frames (maximum TTI).
4. Per FCC KDB Publication 447498 D04v01, when the reported LTE Band 41 SAR measured at the highest output power channel in a given a test configuration was > 0.6 W/kg for 1g evaluations, testing at the other channels was required for such test configurations.
5. TDD LTE was tested per the guidance provided in FCC KDB Publication 941225 D05v02r04. Testing was performed using UL-DL configuration 0 with 6 UL subframes and 2 S subframes using extended cyclic prefix only and special subframe configuration 6. SAR tests were performed at maximum output power and worst-case transmission duty factor in extended cyclic prefix. Per 3GPP 36.211 Section 4, the duty factor for special subframe configuration 6 using extended cyclic prefix is 0.633.
6. Per KDB Publication 941225 D05Av01r02, SAR for downlink only LTE CA operations was not needed since the maximum average output power in LTE CA mode was not >0.25 dB higher than the maximum output power when downlink carrier aggregation was inactive.

NR Notes:

7. NR implementation supports SA and NSA mode. In EN-DC mode, NR operates with the LTE Bands shown in the NR FR1 checklist acting as anchor bands. Per FCC guidance, SAR tests for NR Bands and LTE Anchors Bands were performed separately due to limitations in SAR probe calibration factors.
8. Due to test setup limitations, SAR testing for NR TDD was performed using test mode software to establish the connection.
9. Simultaneous transmission analysis for EN-DC operations is addressed in the Part 2 Test Report (Serial Number can be found in the bibliography).

FCC ID: PY7-76056F	SAR EVALUATION REPORT	Approved by: Technical Manager
Document S/N: 1M2205240063-03.PY7	DUT Type: Portable Handset	Page 104 of 111

10. This device additionally supports some EN-DC conditions where additional LTE carriers are added on the downlink only.
11. Per FCC Guidance, NR modulations and RB Sizes/Offsets were selected for testing such that configurations with the highest output power were evaluated for SAR tests.
12. Per FCC KDB Publication 447498 D04v01, when the reported NR Band n77 C-Band SAR measured at the highest output power channel in a given a test configuration was > 0.4 W/kg for 1g evaluations and > 1 W/kg for 10g evaluation, testing at the other channels was required for such test configurations.
13. Per FCC KDB Publication 447498 D04v01, when the reported NR Band n41 SAR measured at the highest output power channel in a given a test configuration was > 0.6 W/kg for 1g evaluations and > 1.5 W/kg for 10g evaluation, testing at the other channels was required for such test configurations.

WLAN Notes:

1. For held-to-ear, and hotspot, and phablet operations, the initial test position procedures were applied. The test position with the highest extrapolated peak SAR will be used as the initial test position. When reported SAR for the initial test position is ≤ 0.4 W/kg for 1g evaluations, no additional testing for the remaining test positions was required. Otherwise, SAR is evaluated at the subsequent highest peak SAR positions until the reported SAR result is ≤ 0.8 W/kg or all test positions are measured.
2. Justification for test configurations for WLAN per KDB Publication 248227 D01v02r02 for 2.4 GHz WIFI single transmission chain operations, the highest measured maximum output power channel for DSSS was selected for SAR measurement. SAR for OFDM modes (2.4 GHz 802.11g/n/ax) was not required due to the maximum allowed powers and the highest reported DSSS SAR. See Section 8.6.5 for more information.
3. Justification for test configurations for WLAN per KDB Publication 248227 D01v02r02 for 5 GHz WIFI operations, the initial test configuration was selected according to the transmission mode with the highest maximum allowed powers. Other transmission modes were not investigated since the highest reported SAR for initial test configuration adjusted by the ratio of maximum output powers is less than 1.2 W/kg for 1g evaluations. See Section 8.6.6 for more information.
4. When the maximum reported 1g averaged SAR is ≤ 0.8 W/kg, SAR testing on additional channels was not required. Otherwise, SAR for the next highest output power channel was required until the reported SAR result was ≤ 1.20 W/kg for 1g evaluations or all test channels were measured.
5. The device was configured to transmit continuously at the required data rate, channel bandwidth and signal modulation, using the highest transmission duty factor supported by the test mode tools. The reported SAR was scaled to the 100% transmission duty factor to determine compliance. Procedures used to measure the duty factor are identical to that in the associated EMC test reports.
6. When 10g SAR measurement is considered, a factor of 2.5 is applied to the thresholds above.

Bluetooth Notes

1. Bluetooth SAR was evaluated with a test mode with hopping disabled with DH5 operation. The reported SAR was scaled to the 83.3% transmission duty factor to determine compliance since the duty factor of the device is limited to 83.3% per the manufacturer. See Section 9 for the time domain plot and calculation for the duty factor of the device.
2. Head and Hotspot Bluetooth SAR were evaluated for BT BR tethering applications.

FCC ID: PY7-76056F	SAR EVALUATION REPORT	Approved by: Technical Manager
Document S/N: 1M2205240063-03.PY7	DUT Type: Portable Handset	Page 105 of 111

12 SAR MEASUREMENT VARIABILITY

12.1 Measurement Variability

Per FCC KDB Publication 865664 D01v01r04, SAR measurement variability was assessed for each frequency band, which was determined by the SAR probe calibration point and tissue-equivalent medium used for the device measurements. When both head and body tissue-equivalent media were required for SAR measurements in a frequency band, the variability measurement procedures were applied to the tissue medium with the highest measured SAR, using the highest measured SAR configuration for that tissue-equivalent medium. These additional measurements were repeated after the completion of all measurements requiring the same head or body tissue-equivalent medium in a frequency band. The test device was returned to ambient conditions (normal room temperature) with the battery fully charged before it was re-mounted on the device holder for the repeated measurement(s) to minimize any unexpected variations in the repeated results.

SAR Measurement Variability was assessed using the following procedures for each frequency band:

- 1) When the original highest measured SAR is ≥ 0.80 W/kg, the measurement was repeated once.
- 2) Repeated measurements are not required when the original highest measured SAR is < 0.80 W/kg
- 3) When 10g SAR measurement is considered, a factor of 2.5 is applied to the thresholds above.

Table 12-1
Head SAR Measurement Variability Results

HEAD VARIABILITY RESULTS														
Band	FREQUENCY		Mode	Service	Side	Test Position	Antenna Config	Measured SAR (1g)	1st Repeated SAR (1g)	Ratio	2nd Repeated SAR (1g)	Ratio	3rd Repeated SAR (1g)	Ratio
	MHz	Ch.						(W/kg)	(W/kg)		(W/kg)		(W/kg)	
2600	2592.99	518598	NR Band n41, 100 MHz Bandwidth	CP-OFDM, QPSK, 273 RB, 0 RB Offset	Left	Cheek	Sub	0.928	0.865	1.07	N/A	N/A	N/A	N/A
ANSI / IEEE C95.1 1992 - SAFETY LIMIT Spatial Peak Uncontrolled Exposure/General Population							Head 1.6 W/kg (mW/g) averaged over 1 gram							

12.2 Measurement Uncertainty

The measured SAR was < 1.5 W/kg for 1g and < 3.75 W/kg for 10g for all frequency bands. Therefore, per KDB Publication 865664 D01v01r04, the extended measurement uncertainty analysis per IEEE 1528-2013 was not required.

FCC ID: PY7-76056F	SAR EVALUATION REPORT	Approved by: Technical Manager
Document S/N: 1M2205240063-03.PY7	DUT Type: Portable Handset	Page 106 of 111

REV 22.0
03/30/2022

13 EQUIPMENT LIST

Manufacturer	Model	Description	Cal Date	Cal Interval	Cal Due	Serial Number
Agilent	E4404B	Spectrum Analyzer	N/A	N/A	N/A	MY45113242
Agilent	E4438C	ESG Vector Signal Generator	5/10/2022	Annual	5/10/2023	MY42082659
Agilent	E4438C	ESG Vector Signal Generator	2/14/2022	Annual	2/14/2023	MY42082385
Agilent	N5182A	MXG Vector Signal Generator	6/21/2022	Annual	6/21/2023	MY47420651
Agilent	8753E5	S-Parameter Vector Network Analyzer	2/11/2022	Annual	2/11/2023	MY40003841
Agilent	8753E5	S-Parameter Vector Network Analyzer	12/17/2021	Annual	12/17/2022	MY40000670
Agilent	E5515C	Wireless Communications Test Set	5/12/2022	Annual	5/12/2023	GB43304278
Agilent	E5515C	Wireless Communications Test Set	1/14/2020	Triennial	1/14/2023	GB43304447
Agilent	N4010A	Wireless Connectivity Test Set	N/A	N/A	N/A	GB46170464
Amplifier Research	1551G6	Amplifier	CBT	N/A	CBT	433974
Amplifier Research	1551G6	Amplifier	9/15/2021	Annual	9/15/2022	433971
Rohde & Schwarz	NRX	Power Meter	11/22/2021	Annual	11/22/2022	102583
Anritsu	ML2496A	Power Meter	3/31/2022	Annual	3/31/2023	1138001
Anritsu	MA2411B	Pulse Power Sensor	4/29/2022	Annual	4/29/2023	1207470
Anritsu	MA2411B	Pulse Power Sensor	9/21/2021	Annual	9/21/2022	1339008
Anritsu	MT8821C	Radio Communication Analyzer MT8821C	3/31/2022	Annual	3/31/2023	6201664756
Anritsu	MT8821C	Radio Communication Analyzer MT8821C	9/26/2021	Annual	9/26/2022	6201524637
Anritsu	MT8821C	Radio Communication Analyzer MT8821C	8/10/2021	Annual	8/10/2022	6262150000
Anritsu	MT8000A	Radio Communication Test Station	8/2/2021	Annual	8/2/2022	6272337438
Anritsu	MT8000A	Radio Communication Test Station	8/2/2021	Annual	8/2/2022	6272337436
Anritsu	MT8000A	Radio Communication Test Station	4/20/2022	Annual	4/20/2023	6262036828
Anritsu	MA24106A	USB Power Sensor	6/1/2022	Annual	6/1/2023	1349514
Anritsu	MA24106A	USB Power Sensor	3/22/2022	Annual	3/22/2023	2205501
Control Company	4353	Long Stem Thermometer	10/28/2020	Biennial	10/28/2022	200670623
Control Company	4353	Long Stem Thermometer	10/28/2020	Biennial	10/28/2022	200670633
Control Company	4353	Long Stem Thermometer	10/28/2020	Biennial	10/28/2022	200670635
Control Company	4040	Therm./ Clock/ Humidity Monitor	1/21/2022	Annual	1/21/2023	160574418
Control Company	4040	Therm./ Clock/ Humidity Monitor	3/12/2021	Biennial	3/12/2023	210202100
Mitutoyo	500-196-30	CD-6"ASX 6inch Digital Caliper	2/16/2022	Triennial	2/16/2025	A20238413
Keysight Technologies	N6705B	DC Power Analyzer	5/5/2021	Triennial	5/5/2024	MV53004059
MCL	BW-N6W5+	6dB Attenuator	CBT	N/A	CBT	1139
Mini-Circuits	VLF-6000+	Low Pass Filter DC to 6000 MHz	7/6/2021	Annual	7/6/2022	31634
Mini-Circuits	VLF-6000+	Low Pass Filter DC to 6000 MHz	CBT	N/A	CBT	N/A
Mini-Circuits	BW-N20W5+	DC to 18 GHz Precision Fixed 20 dB Attenuator	CBT	N/A	CBT	N/A
Mini-Circuits	NLP-1200+	Low Pass Filter DC to 1000 MHz	CBT	N/A	CBT	N/A
Mini-Circuits	NLP-2950+	Low Pass Filter DC to 2700 MHz	CBT	N/A	CBT	N/A
Mini-Circuits	BW-N20W5	Power Attenuator	CBT	N/A	CBT	1226
Mini-Circuits	ZUDC10-83-S	Directional Coupler	CBT	N/A	CBT	2050
Mini-Circuits	ZUDC10-83-S+	Directional Coupler	9/15/2021	Annual	9/15/2022	2111
Narda	4772-3	Attenuator (3dB)	CBT	N/A	CBT	9406
Narda	BW-53W2	Attenuator (3dB)	CBT	N/A	CBT	120
Seekonk	TSF-100	Torque Wrench	7/8/2021	Annual	7/8/2022	47639-29
Seekonk	NC-100	Torque Wrench (8" lb)	8/5/2020	Biennial	8/5/2022	N/A
Rohde & Schwarz	CMW500	Wideband Radio Communication Tester	4/18/2022	Annual	4/18/2023	128633
Rohde & Schwarz	CMW500	Wideband Radio Communication Tester	3/29/2022	Annual	3/29/2023	171075
Rohde & Schwarz	CMW500	Wideband Radio Communication Tester	4/8/2022	Annual	4/8/2023	162125
Rohde & Schwarz	CMW500	Wideband Radio Communication Tester	4/7/2022	Annual	4/7/2023	167283
SPEAG	DAK-3.5	Dielectric Assessment Kit	1/6/2022	Annual	1/6/2023	1278
SPEAG	DAK-3.5	Dielectric Assessment Kit	10/20/2021	Annual	10/20/2022	1091
SPEAG	DAKS-3.5	Portable Dielectric Assessment Kit	8/18/2021	Annual	8/18/2022	1041
SPEAG	DAK-3.5	Dielectric Assessment Kit	1/6/2022	Annual	1/6/2023	1278
SPEAG	MAIA	Modulation and Audio Interference Analyzer	N/A	N/A	N/A	1379
SPEAG	CLA13	13 MHz SAR Dipole	9/16/2021	Annual	9/16/2022	1002
SPEAG	D750V3	750 MHz SAR Dipole	3/14/2022	Annual	3/14/2023	1054
SPEAG	D750V3	750 MHz SAR Dipole	10/19/2021	Annual	10/19/2022	1161
SPEAG	D835V2	835 MHz SAR Dipole	1/21/2021	Biennial	1/21/2023	4d132
SPEAG	D835V2	835 MHz SAR Dipole	3/14/2022	Annual	3/14/2023	4d047
SPEAG	D1765V2	1750 MHz SAR Dipole	5/14/2021	Biennial	5/14/2023	1008
SPEAG	D1750V2	1750 MHz SAR Dipole	1/18/2022	Annual	1/18/2023	1148
SPEAG	D1750V2	1750 MHz SAR Dipole	10/22/2021	Annual	10/22/2022	1150
SPEAG	D1900V2	1900 MHz SAR Dipole	2/21/2022	Annual	2/21/2023	5d148
SPEAG	D1900V2	1900 MHz SAR Dipole	9/21/2021	Annual	9/21/2022	5d149
SPEAG	D1900V2	1900 MHz SAR Dipole	10/22/2021	Annual	10/22/2022	5d080
SPEAG	D2450V2	2450 MHz SAR Dipole	11/25/2021	Annual	11/25/2022	981
SPEAG	D2450V2	2450 MHz SAR Dipole	9/20/2020	Biennial	9/20/2022	797
SPEAG	D2600V2	2600 MHz SAR Dipole	11/12/2019	Triennial	11/12/2022	1071
SPEAG	D3700V2	3700 MHz SAR Dipole	1/19/2021	Biennial	1/19/2023	1018
SPEAG	D3900V2	3900 MHz SAR Dipole	6/10/2021	Biennial	6/10/2023	1073
SPEAG	D5GHV2	5 GHz SAR Dipole	1/10/2022	Annual	1/10/2023	1057
SPEAG	DAE4	Dasy Data Acquisition Electronics	8/3/2021	Annual	8/3/2022	1681
SPEAG	DAE4	Dasy Data Acquisition Electronics	11/10/2021	Annual	11/10/2022	1323
SPEAG	DAE4	Dasy Data Acquisition Electronics	3/16/2022	Annual	3/16/2023	1272
SPEAG	DAE4	Dasy Data Acquisition Electronics	5/10/2022	Annual	5/10/2023	1678
SPEAG	DAE4	Dasy Data Acquisition Electronics	6/14/2022	Annual	6/14/2023	1334
SPEAG	DAE4	Dasy Data Acquisition Electronics	2/22/2022	Annual	2/22/2023	665
SPEAG	DAE4	Dasy Data Acquisition Electronics	8/4/2021	Annual	8/4/2022	1680
SPEAG	DAE4	Dasy Data Acquisition Electronics	4/13/2022	Annual	4/13/2023	1407
SPEAG	EX3DV4	SAR Probe	9/20/2021	Annual	9/20/2022	7552
SPEAG	EX3DV4	SAR Probe	8/5/2021	Annual	8/5/2022	7670
SPEAG	EX3DV4	SAR Probe	6/16/2022	Annual	6/16/2023	7409
SPEAG	EX3DV4	SAR Probe	11/16/2021	Annual	11/16/2022	7538
SPEAG	EX3DV4	SAR Probe	2/22/2022	Annual	2/22/2023	7417
SPEAG	EX3DV4	SAR Probe	4/20/2022	Annual	4/20/2023	7659
SPEAG	EX3DV4	SAR Probe	5/18/2022	Annual	5/18/2023	7660
SPEAG	EX3DV4	SAR Probe	3/21/2022	Annual	3/21/2023	7527
Amplifier Research	150A100C	Amplifier	CBT	N/A	CBT	350132
SPEAG	DAK-12	Dielectric Assessment Kit (10MHz - 3GHz)	3/21/2022	Annual	3/21/2023	1102
Mini-Circuits	PWR-4GH5	Power Sensor	5/3/2022	Annual	5/3/2023	12108190029

Note: 1) All equipment was used solely within its respective calibration period. 2) CBT (Calibrated Before Testing). Prior to testing, the measurement paths containing a cable, amplifier, attenuator, coupler or filter were connected to a calibrated source (i.e. a signal generator) to determine the losses of the measurement path. The power meter offset was then adjusted to compensate for the measurement system losses. This level offset is stored within the power meter before measurements are made. This calibration verification procedure applies to the system verification and output power measurements. The calibrated reading is then taken directly from the power meter after compensation of the losses for all final power measurements.

FCC ID: PY7-76056F	SAR EVALUATION REPORT	Approved by: Technical Manager
Document S/N: 1M2205240063-03.PY7	DUT Type: Portable Handset	Page 107 of 111

14 MEASUREMENT UNCERTAINTIES

a	b	c	d	e= f(d,k)	f	g	h = c x f/e	i = c x g/e	k
Uncertainty Component	IEEE 1528 Sec.	Tol. (± %)	Prob. Dist.	Div.	c _i 1gm	c _i 10 gms	1gm u _i (± %)	10gms u _i (± %)	v _i
Measurement System									
Probe Calibration	E.2.1	7	N	1	1	1	7.0	7.0	∞
Axial Isotropy	E.2.2	0.25	N	1	0.7	0.7	0.2	0.2	∞
Hemishperical Isotropy	E.2.2	1.3	N	1	0.7	0.7	0.9	0.9	∞
Boundary Effect	E.2.3	2	R	1.732	1	1	1.2	1.2	∞
Linearity	E.2.4	0.3	N	1	1	1	0.3	0.3	∞
System Detection Limits	E.2.4	0.25	R	1.732	1	1	0.1	0.1	∞
Modulation Response	E.2.5	4.8	R	1.732	1	1	2.8	2.8	∞
Readout Electronics	E.2.6	0.3	N	1	1	1	0.3	0.3	∞
Response Time	E.2.7	0.8	R	1.732	1	1	0.5	0.5	∞
Integration Time	E.2.8	2.6	R	1.732	1	1	1.5	1.5	∞
RF Ambient Conditions - Noise	E.6.1	3	R	1.732	1	1	1.7	1.7	∞
RF Ambient Conditions - Reflections	E.6.1	3	R	1.732	1	1	1.7	1.7	∞
Probe Positioner Mechanical Tolerance	E.6.2	0.8	R	1.732	1	1	0.5	0.5	∞
Probe Positioning w/ respect to Phantom	E.6.3	6.7	R	1.732	1	1	3.9	3.9	∞
Extrapolation, Interpolation & Integration algorithms for Max. SAR Evaluation	E.5	4	R	1.732	1	1	2.3	2.3	∞
Test Sample Related									
Test Sample Positioning	E.4.2	3.12	N	1	1	1	3.1	3.1	35
Device Holder Uncertainty	E.4.1	1.67	N	1	1	1	1.7	1.7	5
Output Power Variation - SAR drift measurement	E.2.9	5	R	1.732	1	1	2.9	2.9	∞
SAR Scaling	E.6.5	0	R	1.732	1	1	0.0	0.0	∞
Phantom & Tissue Parameters									
Phantom Uncertainty (Shape & Thickness tolerances)	E.3.1	7.6	R	1.73	1.0	1.0	4.4	4.4	∞
Liquid Conductivity - measurement uncertainty	E.3.3	4.3	N	1	0.78	0.71	3.3	3.0	76
Liquid Permittivity - measurement uncertainty	E.3.3	4.2	N	1	0.23	0.26	1.0	1.1	75
Liquid Conductivity - Temperature Uncertainty	E.3.4	3.4	R	1.732	0.78	0.71	1.5	1.4	∞
Liquid Permittivity - Temperature Uncertainty	E.3.4	0.6	R	1.732	0.23	0.26	0.1	0.1	∞
Liquid Conductivity - deviation from target values	E.3.2	5.0	R	1.73	0.64	0.43	1.8	1.2	∞
Liquid Permittivity - deviation from target values	E.3.2	5.0	R	1.73	0.60	0.49	1.7	1.4	∞
Combined Standard Uncertainty (k=1)	RSS						12.2	12.0	191
Expanded Uncertainty (95% CONFIDENCE LEVEL)	k=2						24.4	24.0	

The above measurement uncertainties are according to IEEE Std. 1528-2013

FCC ID: PY7-76056F	SAR EVALUATION REPORT	Approved by: Technical Manager
Document S/N: 1M2205240063-03.PY7	DUT Type: Portable Handset	Page 108 of 111

REV 22.0
03/30/2022

15 CONCLUSION

15.1 Measurement Conclusion

The SAR evaluation indicates that the EUT complies with the RF radiation exposure limits of the FCC and Innovation, Science, and Economic Development Canada, with respect to all parameters subject to this test. These measurements were taken to simulate the RF effects of RF exposure under worst-case conditions. Precise laboratory measures were taken to assure repeatability of the tests. The results and statements relate only to the item(s) tested.

Please note that the absorption and distribution of electromagnetic energy in the body are very complex phenomena that depend on the mass, shape, and size of the body, the orientation of the body with respect to the field vectors, and the electrical properties of both the body and the environment. Other variables that may play a substantial role in possible biological effects are those that characterize the environment (e.g. ambient temperature, air velocity, relative humidity, and body insulation) and those that characterize the individual (e.g. age, gender, activity level, debilitation, or disease). Because various factors may interact with one another to vary the specific biological outcome of an exposure to electromagnetic fields, any protection guide should consider maximal amplification of biological effects as a result of field-body interactions, environmental conditions, and physiological variables. [3]

FCC ID: PY7-76056F	SAR EVALUATION REPORT	Approved by: Technical Manager
Document S/N: 1M2205240063-03.PY7	DUT Type: Portable Handset	Page 109 of 111

REV 22.0
03/30/2022

16 REFERENCES

- [1] Federal Communications Commission, ET Docket 93-62, Guidelines for Evaluating the Environmental Effects of Radiofrequency Radiation, Aug. 1996.
- [2] ANSI/IEEE C95.1-2005, American National Standard safety levels with respect to human exposure to radio frequency electromagnetic fields, 3kHz to 300GHz, New York: IEEE, 2006.
- [3] ANSI/IEEE C95.1-1992, American National Standard safety levels with respect to human exposure to radio frequency electromagnetic fields, 3kHz to 300GHz, New York: IEEE, Sept. 1992.
- [4] ANSI/IEEE C95.3-2002, IEEE Recommended Practice for the Measurement of Potentially Hazardous Electromagnetic Fields - RF and Microwave, New York: IEEE, December 2002.
- [5] IEEE Standards Coordinating Committee 39 –Standards Coordinating Committee 34 – IEEE Std. 1528-2013, IEEE Recommended Practice for Determining the Peak Spatial-Average Specific Absorption Rate (SAR) in the Human Head from Wireless Communications Devices: Measurement Techniques.
- [6] NCRP, National Council on Radiation Protection and Measurements, Biological Effects and Exposure Criteria for RadioFrequency Electromagnetic Fields, NCRP Report No. 86, 1986. Reprinted Feb. 1995.
- [7] T. Schmid, O. Egger, N. Kuster, Automated E-field scanning system for dosimetric assessments, IEEE Transaction on Microwave Theory and Techniques, vol. 44, Jan. 1996, pp. 105-113.
- [8] K. Pokovic, T. Schmid, N. Kuster, Robust setup for precise calibration of E-field probes in tissue simulating liquids at mobile communications frequencies, ICECOM97, Oct. 1997, pp. 1 -124.
- [9] K. Pokovic, T. Schmid, and N. Kuster, E-field Probe with improved isotropy in brain simulating liquids, Proceedings of the ELMAR, Zadar, Croatia, June 23-25, 1996, pp. 172-175.
- [10] Schmid & Partner Engineering AG, Application Note: Data Storage and Evaluation, June 1998, p2.
- [11] V. Hombach, K. Meier, M. Burkhardt, E. Kuhn, N. Kuster, The Dependence of EM Energy Absorption upon Human Modeling at 900 MHz, IEEE Transaction on Microwave Theory and Techniques, vol. 44 no. 10, Oct. 1996, pp. 1865-1873.
- [12] N. Kuster and Q. Balzano, Energy absorption mechanism by biological bodies in the near field of dipole antennas above 300MHz, IEEE Transaction on Vehicular Technology, vol. 41, no. 1, Feb. 1992, pp. 17-23.
- [13] G. Hartsgrove, A. Kraszewski, A. Surowiec, Simulated Biological Materials for Electromagnetic Radiation Absorption Studies, University of Ottawa, Bioelectromagnetics, Canada: 1987, pp. 29-36.
- [14] Q. Balzano, O. Garay, T. Manning Jr., Electromagnetic Energy Exposure of Simulated Users of Portable Cellular Telephones, IEEE Transactions on Vehicular Technology, vol. 44, no.3, Aug. 1995.
- [15] W. Gander, Computermathematik, Birkhaeuser, Basel, 1992.
- [16] W.H. Press, S.A. Teukolsky, W.T. Vetterling, and B.P. Flannery, Numerical Recipes in C, The Art of Scientific Computing, Second edition, Cambridge University Press, 1992.
- [17] N. Kuster, R. Kastle, T. Schmid, Dosimetric evaluation of mobile communications equipment with known precision, IEEE Transaction on Communications, vol. E80-B, no. 5, May 1997, pp. 645-652.
- [18] CENELEC CLC/SC111B, European Prestandard (prENV 50166-2), Human Exposure to Electromagnetic Fields High-frequency: 10kHz-300GHz, Jan. 1995.

FCC ID: PY7-76056F	SAR EVALUATION REPORT	Approved by: Technical Manager
Document S/N: 1M2205240063-03.PY7	DUT Type: Portable Handset	Page 110 of 111

REV 22.0
03/30/2022

- [19] Prof. Dr. Niels Kuster, ETH, Eidgenössische Technische Hochschule Zürich, Dosimetric Evaluation of the Cellular Phone.
- [20] IEC 62209-1, Measurement procedure for the assessment of specific absorption rate of human exposure to radio frequency fields from hand-held and body-mounted wireless communication devices - Part 1: Devices used next to the ear (Frequency range of 300 MHz to 6 GHz), July 2016.
- [21] Innovation, Science, Economic Development Canada RSS-102 Radio Frequency Exposure Compliance of Radiocommunication Apparatus (All Frequency Bands) Issue 5, March 2015.
- [22] Health Canada Safety Code 6 Limits of Human Exposure to Radio Frequency Electromagnetic Fields in the Frequency Range from 3 kHz – 300 GHz, 2015
- [23] FCC SAR Test Procedures for 2G-3G Devices, Mobile Hotspot and UMPC Devices KDB Publications 941225, D01-D07
- [24] SAR Measurement Guidance for IEEE 802.11 Transmitters, KDB Publication 248227 D01
- [25] FCC SAR Considerations for Handsets with Multiple Transmitters and Antennas, KDB Publications 648474 D03-D04
- [26] FCC SAR Evaluation Considerations for Laptop, Notebook, Netbook and Tablet Computers, FCC KDB Publication 616217 D04
- [27] FCC SAR Measurement and Reporting Requirements for 100MHz – 6 GHz, KDB Publications 865664 D01-D02
- [28] FCC General RF Exposure Guidance and SAR Procedures for Dongles, KDB Publication 447498, D01-D02
- [29] Anexo à Resolução No. 533, de 10 de Setembro de 2009.
- [30] IEC 62209-2, Human exposure to radio frequency fields from hand-held and body-mounted wireless communication devices - Human models, instrumentation, and procedures - Part 2: Procedure to determine the specific absorption rate (SAR) for wireless communication devices used in close proximity to the human body (frequency range of 30 MHz to 6 GHz), Mar. 2010.

FCC ID: PY7-76056F	SAR EVALUATION REPORT	Approved by: Technical Manager
Document S/N: 1M2205240063-03.PY7	DUT Type: Portable Handset	Page 111 of 111

REV 22.0
03/30/2022