

FCC SAR TEST REPORT

FCC ID : PY7-72623E
Equipment : GSM/WCDMA/LTE Phone with BT, DTS/UNII
a/b/g/n/ac, GPS, FM Receiver and NFC
Brand Name : SONY
Applicant : Sony Corporation
1-7-1 Konan Minato-ku Tokyo, 108-0076 Japan
Manufacturer : Sony Corporation
1-7-1 Konan Minato-ku Tokyo, 108-0076 Japan
Standard : FCC 47 CFR Part 2 (2.1093)

We, Sporton International Inc. (Kunshan), would like to declare that the tested sample provide by manufacturer and the test data has been evaluated in accordance with the test procedures given in 47 CFR Part 2.1093 and FCC KDB and has been pass the FCC requirement.

The test results in this report apply exclusively to the tested model / sample. Without written approval of Sporton International Inc. (Kunshan), the test report shall not be reproduced except in full.

Tony Zhang

Reviewed by: Tony Zhang / Supervisor

Kat Yin

Approved by: Kat Yin / Manager



Sporton International Inc. (Kunshan)

**No. 1098, Pengxi North Road, Kunshan Economic Development Zone Jiangsu Province 215300
People's Republic of China**



Table of Contents

1. Statement of Compliance 4

2. Guidance Applied..... 4

3. Equipment Under Test (EUT) Information 5

 3.1 General Information 5

 3.2 Device Serial Number 5

 3.3 General LTE SAR Test and Reporting Considerations 6

4. RF Exposure Limits..... 7

 4.1 Uncontrolled Environment..... 7

 4.2 Controlled Environment..... 7

5. Specific Absorption Rate (SAR)..... 8

 5.1 Introduction 8

 5.2 SAR Definition..... 8

6. System Description and Setup 9

 6.1 Test Site Location..... 9

 6.2 E-Field Probe10

 6.3 Data Acquisition Electronics (DAE)10

 6.4 Phantom.....11

 6.5 Device Holder.....12

7. Measurement Procedures13

 7.1 Spatial Peak SAR Evaluation.....13

 7.2 Power Reference Measurement.....14

 7.3 Area Scan14

 7.4 Zoom Scan.....15

 7.5 Volume Scan Procedures.....15

 7.6 Power Drift Monitoring.....15

8. Test Equipment List16

9. System Verification17

 9.1 Tissue Verification17

 9.2 System Performance Check Results.....18

10. RF Exposure Positions19

 10.1 Ear and handset reference point19

 10.2 Definition of the cheek position20

 10.3 Definition of the tilt position21

 10.4 Body Worn Accessory21

 10.5 Product Specific Exposure22

 10.6 Wireless Router.....22

11. UMTS Output Power (Unit: dBm)23

12. Spot Check Verification power for Conducted Power27

13. RF Exposure Conditions28

14. SAR Test Results28

 14.1 Head SAR29

 14.2 Hotspot SAR30

 14.3 Body Worn Accessory SAR31

15. Simultaneous Transmission Analysis32

 15.1 Head Exposure Conditions33

 15.2 Hotspot Exposure Conditions.....34

 15.3 Body-Worn Accessory Exposure Conditions35

16. Uncertainty Assessment36

17. References36

Appendix A. Plots of System Performance Check

Appendix B. Plots of High SAR Measurement

Appendix C. DASYS Calibration Certificate

Appendix D. Test Setup Photos and Antenna Location



1. Statement of Compliance

Table with 2 columns: Field Name and Value. Fields include Applicant Name (Sony Corporation), EUT Description (GSM/WCDMA/LTE Phone with BT, DTS/UNII a/b/g/n/ac, GPS, FM Receiver and NFC), Brand Name (SONY), FCC ID (PY7-72623E), HW Version (A), SW Version (0.150), RF Exposure Conditions (Equipment Class: Licensed), Head (1g SAR W/kg) (0.32), Body-Worn (1g SAR W/kg) (0.33), Hotspot (1g SAR W/kg) (0.42), Highest Simultaneous Transmission (1g SAR W/kg) (0.71), Date Tested (2021/11/16~2021/11/23), Test Result (Pass), and Remark (3 points regarding 2.4GHz WLAN, 5GHz WLAN, and variant report details).

This device is in compliance with Specific Absorption Rate (SAR) for general population/uncontrolled exposure limits (1.6 W/kg) specified in FCC 47 CFR part 2 (2.1093) and ANSI/IEEE C95.1-1992, and had been tested in accordance with the measurement methods and procedures specified in IEEE 1528-2013 and FCC KDB publications.

2. Guidance Applied

The Specific Absorption Rate (SAR) testing specification, method, and procedure for this device is in accordance with the following standards:

- FCC 47 CFR Part 2 (2.1093)
- ANSI/IEEE C95.1-1992
- IEEE 1528-2013
- FCC KDB 865664 D01 SAR Measurement 100 MHz to 6 GHz v01r04
- FCC KDB 865664 D02 SAR Reporting v01r02
- FCC KDB 447498 D01 General RF Exposure Guidance v06
- FCC KDB 648474 D04 SAR Evaluation Considerations for Wireless Handsets v01r03
- FCC KDB 248227 D01 802.11 Wi-Fi SAR v02r02
- FCC KDB 941225 D01 3G SAR Procedures v03r01
- FCC KDB 941225 D05 SAR for LTE Devices v02r05
- KDB 941225 D05A Rel.10 LTE SAR Test Guidance v01r02
- FCC KDB 941225 D06 Hotspot Mode SAR v02r01



3. Equipment Under Test (EUT) Information

3.1 General Information

Wireless Technologies	Frequency	Operating Mode	
GSM	850 1900	. GSM Voice . GPRS (GMSK) . EDGE (8PSK)	Multi-Slot Class: Class 33
	Does device support dual transfer mode? (No)		
W-CDMA (UMTS)	Band 4	. AMR / RMC 12.2Kbps . HSDPA . HSUPA . DC-HSDPA	
LTE (FDD)	Band 12	. QPSK . 16QAM . 64QAM	
WiFi	2.4GHz: 2412 MHz ~ 2462 MHz	. 11b . 11g . 11g/n (HT20)	
	5GHz: 5.2GHz: 5180 MHz ~ 5240 MHz 5.3GHz: 5260 MHz ~ 5320 MHz 5.5GHz: 5500 MHz ~ 5720 MHz 5.8GHz: 5745 MHz ~ 5825 MHz	. 11a . 11n (HT20) . 11n (HT40) . 11ac (VHT20) . 11ac (VHT40) . 11ac (VHT80)	
Bluetooth	2.4GHz	. BR / EDR / LE	
NFC	13.56MHz	. ASK	

3.2 Device Serial Number

Band	SN
WWAN/WLAN	HQ61AW0441



3.3 General LTE SAR Test and Reporting Considerations

Summarized necessary items addressed in KDB 941225 D05 v02r05																																																															
FCC ID	PY7-72623E																																																														
Equipment Name	GSM/WCDMA/LTE Phone with BT, DTS/UNII a/b/g/n/ac, GPS, FM Receiver and NFC																																																														
Operating Frequency Range of each LTE transmission band	LTE Band 12: 699 MHz ~ 716 MHz																																																														
Channel Bandwidth	LTE Band 12: 1.4MHz, 3MHz, 5MHz, 10MHz																																																														
uplink modulations used	QPSK / 16QAM / 64QAM																																																														
LTE Voice / Data requirements	Voice and Data																																																														
LTE MPR permanently built-in by design	Table 6.2.3-1: Maximum Power Reduction (MPR) for Power Class 1, 2 and 3																																																														
	<table border="1"> <thead> <tr> <th rowspan="2">Modulation</th> <th colspan="6">Channel bandwidth / Transmission bandwidth (N_{RB})</th> <th rowspan="2">MPR (dB)</th> </tr> <tr> <th>1.4 MHz</th> <th>3.0 MHz</th> <th>5 MHz</th> <th>10 MHz</th> <th>15 MHz</th> <th>20 MHz</th> </tr> </thead> <tbody> <tr> <td>QPSK</td> <td>> 5</td> <td>> 4</td> <td>> 8</td> <td>> 12</td> <td>> 16</td> <td>> 18</td> <td>≤ 1</td> </tr> <tr> <td>16 QAM</td> <td>≤ 5</td> <td>≤ 4</td> <td>≤ 8</td> <td>≤ 12</td> <td>≤ 16</td> <td>≤ 18</td> <td>≤ 1</td> </tr> <tr> <td>16 QAM</td> <td>> 5</td> <td>> 4</td> <td>> 8</td> <td>> 12</td> <td>> 16</td> <td>> 18</td> <td>≤ 2</td> </tr> <tr> <td>64 QAM</td> <td>≤ 5</td> <td>≤ 4</td> <td>≤ 8</td> <td>≤ 12</td> <td>≤ 16</td> <td>≤ 18</td> <td>≤ 2</td> </tr> <tr> <td>64 QAM</td> <td>> 5</td> <td>> 4</td> <td>> 8</td> <td>> 12</td> <td>> 16</td> <td>> 18</td> <td>≤ 3</td> </tr> <tr> <td>256 QAM</td> <td colspan="6" style="text-align: center;">≥ 1</td> <td>≤ 5</td> </tr> </tbody> </table>	Modulation	Channel bandwidth / Transmission bandwidth (N _{RB})						MPR (dB)	1.4 MHz	3.0 MHz	5 MHz	10 MHz	15 MHz	20 MHz	QPSK	> 5	> 4	> 8	> 12	> 16	> 18	≤ 1	16 QAM	≤ 5	≤ 4	≤ 8	≤ 12	≤ 16	≤ 18	≤ 1	16 QAM	> 5	> 4	> 8	> 12	> 16	> 18	≤ 2	64 QAM	≤ 5	≤ 4	≤ 8	≤ 12	≤ 16	≤ 18	≤ 2	64 QAM	> 5	> 4	> 8	> 12	> 16	> 18	≤ 3	256 QAM	≥ 1						≤ 5
	Modulation		Channel bandwidth / Transmission bandwidth (N _{RB})							MPR (dB)																																																					
		1.4 MHz	3.0 MHz	5 MHz	10 MHz	15 MHz	20 MHz																																																								
	QPSK	> 5	> 4	> 8	> 12	> 16	> 18	≤ 1																																																							
	16 QAM	≤ 5	≤ 4	≤ 8	≤ 12	≤ 16	≤ 18	≤ 1																																																							
	16 QAM	> 5	> 4	> 8	> 12	> 16	> 18	≤ 2																																																							
64 QAM	≤ 5	≤ 4	≤ 8	≤ 12	≤ 16	≤ 18	≤ 2																																																								
64 QAM	> 5	> 4	> 8	> 12	> 16	> 18	≤ 3																																																								
256 QAM	≥ 1						≤ 5																																																								
LTE A-MPR	In the base station simulator configuration, Network Setting value is set to NS_01 to disable A-MPR during SAR testing and the LTE SAR tests was transmitting on all TTI frames (Maximum TTI)																																																														
Spectrum plots for RB configuration	A properly configured base station simulator was used for the SAR and power measurement; therefore, spectrum plots for each RB allocation and offset configuration are not included in the SAR report.																																																														

LTE Band 12								
	Bandwidth 1.4 MHz		Bandwidth 3 MHz		Bandwidth 5 MHz		Bandwidth 10 MHz	
	Ch. #	Freq. (MHz)	Ch. #	Freq. (MHz)	Ch. #	Freq. (MHz)	Ch. #	Freq. (MHz)
L	23017	699.7	23025	700.5	23035	701.5	23060	704
M	23095	707.5	23095	707.5	23095	707.5	23095	707.5
H	23173	715.3	23165	714.5	23155	713.5	23130	711

4. RF Exposure Limits

4.1 Uncontrolled Environment

Uncontrolled Environments are defined as locations where there is the exposure of individuals who have no knowledge or control of their exposure. The general population/uncontrolled exposure limits are applicable to situations in which the general public may be exposed or in which persons who are exposed as a consequence of their employment may not be made fully aware of the potential for exposure or cannot exercise control over their exposure. Members of the general public would come under this category when exposure is not employment-related; for example, in the case of a wireless transmitter that exposes persons in its vicinity.

4.2 Controlled Environment

Controlled Environments are defined as locations where there is exposure that may be incurred by persons who are aware of the potential for exposure, (i.e. as a result of employment or occupation). In general, occupational/controlled exposure limits are applicable to situations in which persons are exposed as a consequence of their employment, who have been made fully aware of the potential for exposure and can exercise control over their exposure. The exposure category is also applicable when the exposure is of a transient nature due to incidental passage through a location where the exposure levels may be higher than the general population/uncontrolled limits, but the exposed person is fully aware of the potential for exposure and can exercise control over his or her exposure by leaving the area or by some other appropriate means.

Limits for Occupational/Controlled Exposure (W/kg)

Whole-Body	Partial-Body	Hands, Wrists, Feet and Ankles
0.4	8.0	20.0

Limits for General Population/Uncontrolled Exposure (W/kg)

Whole-Body	Partial-Body	Hands, Wrists, Feet and Ankles
0.08	1.6	4.0

1. Whole-Body SAR is averaged over the entire body, partial-body SAR is averaged over any 1gram of tissue defined as a tissue volume in the shape of a cube. SAR for hands, wrists, feet and ankles is averaged over any 10 grams of tissue defined as a tissue volume in the shape of a cube.

5. Specific Absorption Rate (SAR)

5.1 Introduction

SAR is related to the rate at which energy is absorbed per unit mass in an object exposed to a radio field. The SAR distribution in a biological body is complicated and is usually carried out by experimental techniques or numerical modeling. The standard recommends limits for two tiers of groups, occupational/controlled and general population/uncontrolled, based on a person's awareness and ability to exercise control over his or her exposure. In general, occupational/controlled exposure limits are higher than the limits for general population/uncontrolled.

5.2 SAR Definition

The SAR definition is the time derivative (rate) of the incremental energy (dW) absorbed by (dissipated in) an incremental mass (dm) contained in a volume element (dv) of a given density (ρ). The equation description is as below:

$$\text{SAR} = \frac{d}{dt} \left(\frac{dW}{dm} \right) = \frac{d}{dt} \left(\frac{dW}{\rho dv} \right)$$

SAR is expressed in units of Watts per kilogram (W/kg)

$$\text{SAR} = \frac{\sigma |E|^2}{\rho}$$

Where: σ is the conductivity of the tissue, ρ is the mass density of the tissue and E is the RMS electrical field strength.

6. System Description and Setup

The DASY system used for performing compliance tests consists of the following items:

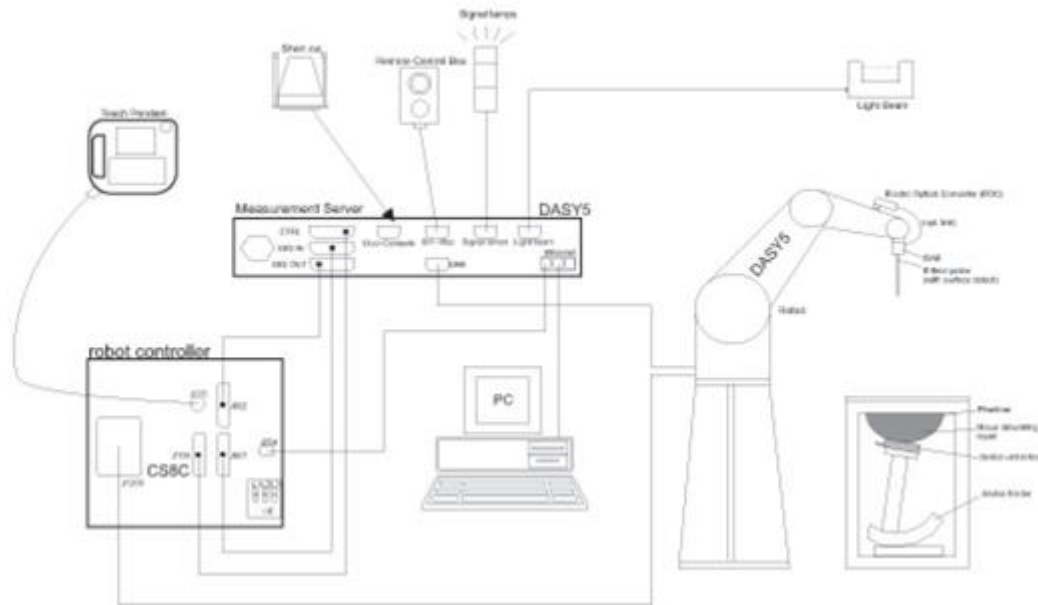

- A standard high precision 6-axis robot with controller, teach pendant and software. An arm extension for accommodating the data acquisition electronics (DAE).
- An isotropic Field probe optimized and calibrated for the targeted measurement.
- A data acquisition electronics (DAE) which performs the signal amplification, signal multiplexing, AD-conversion, offset measurements, mechanical surface detection, collision detection, etc. The unit is battery powered with standard or rechargeable batteries. The signal is optically transmitted to the EOC.
- The Electro-optical converter (EOC) performs the conversion from optical to electrical signals for the digital communication to the DAE. To use optical surface detection, a special version of the EOC is required. The EOC signal is transmitted to the measurement server.
- The function of the measurement server is to perform the time critical tasks such as signal filtering, control of the robot operation and fast movement interrupts.
- The Light Beam used is for probe alignment. This improves the (absolute) accuracy of the probe positioning.
- A computer running WinXP or Win7 and the DASY5 software.
- Remote control and teach pendant as well as additional circuitry for robot safety such as warning lamps, etc.
- The phantom, the device holder and other accessories according to the targeted measurement.

6.1 Test Site Location

Sporton International Inc. (Kunshan) is accredited to ISO/IEC 17025:2017 by American Association for Laboratory Accreditation with Certificate Number 5145.02.

Testing Laboratory			
Test Firm	Sporton International Inc. (Kunshan)		
Test Site Location	No. 1098, Pengxi North Road, Kunshan Economic Development Zone Jiangsu Province 215300 People's Republic of China TEL : +86-512-57900158 FAX : +86-512-57900958		
Test Site No.	Sporton Site No.	FCC Designation No.	FCC Test Firm Registration No.
	SAR07-KS	CN1257	314309

6.2 E-Field Probe

The SAR measurement is conducted with the dosimetric probe (manufactured by SPEAG). The probe is specially designed and calibrated for use in liquid with high permittivity. The dosimetric probe has special calibration in liquid at different frequency. This probe has a built in optical surface detection system to prevent from collision with phantom.

<EX3DV4 Probe>

Construction	Symmetric design with triangular core Built-in shielding against static charges PEEK enclosure material (resistant to organic solvents, e.g., DGBE)	
Frequency	10 MHz – >6 GHz Linearity: ±0.2 dB (30 MHz – 6 GHz)	
Directivity	±0.3 dB in TSL (rotation around probe axis) ±0.5 dB in TSL (rotation normal to probe axis)	
Dynamic Range	10 µW/g – >100 mW/g Linearity: ±0.2 dB (noise: typically <1 µW/g)	
Dimensions	Overall length: 337 mm (tip: 20 mm) Tip diameter: 2.5 mm (body: 12 mm) Typical distance from probe tip to dipole centers: 1 mm	

6.3 Data Acquisition Electronics (DAE)

The data acquisition electronics (DAE) consists of a highly sensitive electrometer-grade preamplifier with auto-zeroing, a channel and gain-switching multiplexer, a fast 16 bit AD-converter and a command decoder and control logic unit. Transmission to the measurement server is accomplished through an optical downlink for data and status information as well as an optical uplink for commands and the clock.

The input impedance of the DAE is 200 MOhm; the inputs are symmetrical and floating. Common mode rejection is above 80 dB.



Fig 5.1 Photo of DAE

6.4 Phantom

<SAM Twin Phantom>

Shell Thickness	2 ± 0.2 mm; Center ear point: 6 ± 0.2 mm	
Filling Volume	Approx. 25 liters	
Dimensions	Length: 1000 mm; Width: 500 mm; Height: adjustable feet	
Measurement Areas	Left Hand, Right Hand, Flat Phantom	

The bottom plate contains three pair of bolts for locking the device holder. The device holder positions are adjusted to the standard measurement positions in the three sections. A white cover is provided to tap the phantom during off-periods to prevent water evaporation and changes in the liquid parameters. On the phantom top, three reference markers are provided to identify the phantom position with respect to the robot.

<ELI Phantom>

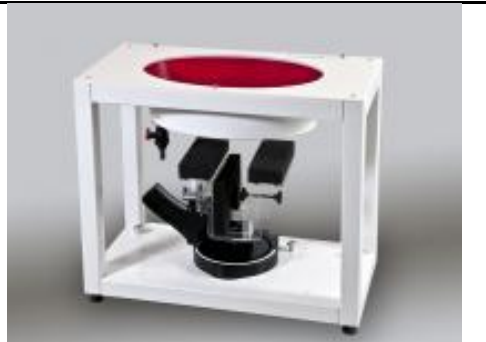
Shell Thickness	2 ± 0.2 mm (sagging: <1%)	
Filling Volume	Approx. 30 liters	
Dimensions	Major ellipse axis: 600 mm Minor axis: 400 mm	

The ELI phantom is intended for compliance testing of handheld and body-mounted wireless devices in the frequency range of 30 MHz to 6 GHz. ELI4 is fully compatible with standard and all known tissue simulating liquids.

6.5 Device Holder

<Mounting Device for Hand-Held Transmitter>

In combination with the Twin SAM V5.0/V5.0c or ELI phantoms, the Mounting Device for Hand-Held Transmitters enables rotation of the mounted transmitter device to specified spherical coordinates. At the heads, the rotation axis is at the ear opening. Transmitter devices can be easily and accurately positioned according to IEC 62209-1, IEEE 1528, FCC, or other specifications. The device holder can be locked for positioning at different phantom sections (left head, right head, flat). And upgrade kit to Mounting Device to enable easy mounting of wider devices like big smart-phones, e-books, small tablets, etc. It holds devices with width up to 140 mm.



Mounting Device for Hand-Held Transmitters



Mounting Device Adaptor for Wide-Phones

<Mounting Device for Laptops and other Body-Worn Transmitters>

The extension is lightweight and made of POM, acrylic glass and foam. It fits easily on the upper part of the mounting device in place of the phone positioned. The extension is fully compatible with the SAM Twin and ELI phantoms.



Mounting Device for Laptops

7. Measurement Procedures

The measurement procedures are as follows:

<Conducted power measurement>

- (a) For WWAN power measurement, use base station simulator to configure EUT WWAN transmission in conducted connection with RF cable, at maximum power in each supported wireless interface and frequency band.
- (b) Read the WWAN RF power level from the base station simulator.
- (c) For WLAN/BT power measurement, use engineering software to configure EUT WLAN/BT continuously transmission, at maximum RF power in each supported wireless interface and frequency band
- (d) Connect EUT RF port through RF cable to the power meter, and measure WLAN/BT output power

<SAR measurement>

- (a) Use base station simulator to configure EUT WWAN transmission in radiated connection, and engineering software to configure EUT WLAN/BT continuously transmission, at maximum RF power, in the highest power channel.
- (b) Place the EUT in the positions as Appendix D demonstrates.
- (c) Set scan area, grid size and other setting on the DASY software.
- (d) Measure SAR results for the highest power channel on each testing position.
- (e) Find out the largest SAR result on these testing positions of each band
- (f) Measure SAR results for other channels in worst SAR testing position if the reported SAR of highest power channel is larger than 0.8 W/kg

According to the test standard, the recommended procedure for assessing the peak spatial-average SAR value consists of the following steps:

- (a) Power reference measurement
- (b) Area scan
- (c) Zoom scan
- (d) Power drift measurement

7.1 Spatial Peak SAR Evaluation

The procedure for spatial peak SAR evaluation has been implemented according to the test standard. It can be conducted for 1g and 10g, as well as for user-specific masses. The DASY software includes all numerical procedures necessary to evaluate the spatial peak SAR value.

The base for the evaluation is a "cube" measurement. The measured volume must include the 1g and 10g cubes with the highest averaged SAR values. For that purpose, the center of the measured volume is aligned to the interpolated peak SAR value of a previously performed area scan.

The entire evaluation of the spatial peak values is performed within the post-processing engine (SEMCAD). The system always gives the maximum values for the 1g and 10g cubes. The algorithm to find the cube with highest averaged SAR is divided into the following stages:

- (a) Extraction of the measured data (grid and values) from the Zoom Scan
- (b) Calculation of the SAR value at every measurement point based on all stored data (A/D values and measurement parameters)
- (c) Generation of a high-resolution mesh within the measured volume
- (d) Interpolation of all measured values from the measurement grid to the high-resolution grid
- (e) Extrapolation of the entire 3-D field distribution to the phantom surface over the distance from sensor to surface
- (f) Calculation of the averaged SAR within masses of 1g and 10g

7.2 Power Reference Measurement

The Power Reference Measurement and Power Drift Measurements are for monitoring the power drift of the device under test in the batch process. The minimum distance of probe sensors to surface determines the closest measurement point to phantom surface. This distance cannot be smaller than the distance of sensor calibration points to probe tip as defined in the probe properties.

7.3 Area Scan

The area scan is used as a fast scan in two dimensions to find the area of high field values, before doing a fine measurement around the hot spot. The sophisticated interpolation routines implemented in DASY software can find the maximum found in the scanned area, within a range of the global maximum. The range (in dB) is specified in the standards for compliance testing. For example, a 2 dB range is required in IEEE standard 1528 and IEC 62209 standards, whereby 3 dB is a requirement when compliance is assessed in accordance with the ARIB standard (Japan), if only one zoom scan follows the area scan, then only the absolute maximum will be taken as reference. For cases where multiple maximums are detected, the number of zoom scans has to be increased accordingly.

Area scan parameters extracted from FCC KDB 865664 D01v01r04 SAR measurement 100 MHz to 6 GHz.

	≤ 3 GHz	> 3 GHz
Maximum distance from closest measurement point (geometric center of probe sensors) to phantom surface	5 ± 1 mm	$\frac{1}{2} \cdot \delta \cdot \ln(2) \pm 0.5$ mm
Maximum probe angle from probe axis to phantom surface normal at the measurement location	30° ± 1°	20° ± 1°
Maximum area scan spatial resolution: $\Delta x_{Area}, \Delta y_{Area}$	≤ 2 GHz: ≤ 15 mm 2 – 3 GHz: ≤ 12 mm	3 – 4 GHz: ≤ 12 mm 4 – 6 GHz: ≤ 10 mm
	When the x or y dimension of the test device, in the measurement plane orientation, is smaller than the above, the measurement resolution must be ≤ the corresponding x or y dimension of the test device with at least one measurement point on the test device.	

7.4 Zoom Scan

Zoom scans are used assess the peak spatial SAR values within a cubic averaging volume containing 1 gram and 10 gram of simulated tissue. The zoom scan measures points (refer to table below) within a cube shoes base faces are centered on the maxima found in a preceding area scan job within the same procedure. When the measurement is done, the zoom scan evaluates the averaged SAR for 1 gram and 10 gram and displays these values next to the job's label.

Zoom scan parameters extracted from FCC KDB 865664 D01v01r04 SAR measurement 100 MHz to 6 GHz.

		≤ 3 GHz	> 3 GHz	
Maximum zoom scan spatial resolution: $\Delta x_{Zoom}, \Delta y_{Zoom}$		≤ 2 GHz: ≤ 8 mm 2 – 3 GHz: ≤ 5 mm*	3 – 4 GHz: ≤ 5 mm* 4 – 6 GHz: ≤ 4 mm*	
Maximum zoom scan spatial resolution, normal to phantom surface	uniform grid: $\Delta z_{Zoom}(n)$	≤ 5 mm	3 – 4 GHz: ≤ 4 mm 4 – 5 GHz: ≤ 3 mm 5 – 6 GHz: ≤ 2 mm	
	graded grid	$\Delta z_{Zoom}(1)$: between 1 st two points closest to phantom surface	≤ 4 mm	3 – 4 GHz: ≤ 3 mm 4 – 5 GHz: ≤ 2.5 mm 5 – 6 GHz: ≤ 2 mm
		$\Delta z_{Zoom}(n>1)$: between subsequent points	$\leq 1.5 \cdot \Delta z_{Zoom}(n-1)$	
Minimum zoom scan volume	x, y, z	≥ 30 mm	3 – 4 GHz: ≥ 28 mm 4 – 5 GHz: ≥ 25 mm 5 – 6 GHz: ≥ 22 mm	
Note: δ is the penetration depth of a plane-wave at normal incidence to the tissue medium; see draft standard IEEE P1528-2011 for details. * When zoom scan is required and the <i>reported</i> SAR from the <i>area scan based 1-g SAR estimation</i> procedures of KDB 447498 is ≤ 1.4 W/kg, ≤ 8 mm, ≤ 7 mm and ≤ 5 mm zoom scan resolution may be applied, respectively, for 2 GHz to 3 GHz, 3 GHz to 4 GHz and 4 GHz to 6 GHz.				

7.5 Volume Scan Procedures

The volume scan is used for assess overlapping SAR distributions for antennas transmitting in different frequency bands. It is equivalent to an oversized zoom scan used in standalone measurements. The measurement volume will be used to enclose all the simultaneous transmitting antennas. For antennas transmitting simultaneously in different frequency bands, the volume scan is measured separately in each frequency band. In order to sum correctly to compute the 1g aggregate SAR, the EUT remain in the same test position for all measurements and all volume scan use the same spatial resolution and grid spacing. When all volume scan were completed, the software, SEMCAD postprocessor can combine and subsequently superpose these measurement data to calculating the multiband SAR.

7.6 Power Drift Monitoring

All SAR testing is under the EUT install full charged battery and transmit maximum output power. In DASy measurement software, the power reference measurement and power drift measurement procedures are used for monitoring the power drift of EUT during SAR test. Both these procedures measure the field at a specified reference position before and after the SAR testing. The software will calculate the field difference in dB. If the power drifts more than 5%, the SAR will be retested.



8. Test Equipment List

Manufacturer	Name of Equipment	Type/Model	Serial Number	Calibration	
				Last Cal.	Due Date
SPEAG	750MHz System Validation Kit	D750V3	1087	2019/3/27	2022/3/24
SPEAG	835MHz System Validation Kit	D835V2	4d258	2020/5/7	2023/5/6
SPEAG	1750MHz System Validation Kit	D1750V2	1090	2019/3/27	2022/3/25
SPEAG	1900MHz System Validation Kit	D1900V2	5d170	2019/3/26	2022/3/24
SPEAG	2450MHz System Validation Kit	D2450V2	908	2019/3/25	2022/3/23
SPEAG	5000MHz System Validation Kit	D5GHzV2	1113	2019/9/24	2022/9/22
SPEAG	Data Acquisition Electronics	DAE4	1649	2021/2/3	2022/2/2
SPEAG	Dosimetric E-Field Probe	EX3DV4	7627	2021/2/10	2022/2/9
SPEAG	SAM Twin Phantom	SAM Twin	TP-2024	NCR	NCR
Testo	Thermo-Hygrometer	608-H1	1241332126	2021/1/7	2022/1/6
SPEAG	Phone Positioner	N/A	N/A	NCR	NCR
Anritsu	Radio Communication Analyzer	MT8821C	6201432831	2021/4/13	2022/4/12
Agilent	ENA Series Network Analyzer	E5071C	MY46106933	2021/7/31	2022/7/30
SPEAG	Dielectric Probe Kit	DAK-3.5	1144	2020/12/2	2021/12/1
Anritsu	Vector Signal Generator	MG3710A	6201682672	2021/1/7	2022/1/6
Rohde & Schwarz	Power Meter	NRVD	102081	2021/8/12	2022/8/11
Rohde & Schwarz	Power Sensor	NRV-Z5	100538	2021/8/12	2022/8/11
Rohde & Schwarz	Power Sensor	NRV-Z5	100539	2021/8/12	2022/8/11
R&S	CBT BLUETOOTH TESTER	CBT	101246	2021/4/12	2022/4/11
EXA	Spectrum Analyzer	FSV7	101632	2021/1/7	2022/1/6
FLUKE	DIGITAC THERMOMETER	51II	97240029	2021/8/13	2022/8/12
BONN	POWER AMPLIFIER	BLMA 0830-3	087193A	2021/8/12	2022/8/11
BONN	POWER AMPLIFIER	BLMA 2060-2	087193B	2021/7/31	2022/7/30
Agilent	Dual Directional Coupler	778D	20500	Note1	
Agilent	Dual Directional Coupler	11691D	MY48151020	Note1	
ARRA	Power Divider	A3200-2	N/A	Note1	
MCL	Attenuation1	BW-S10W5+	N/A	Note1	
MCL	Attenuation2	BW-S10W5+	N/A	Note1	
MCL	Attenuation3	BW-S10W5+	N/A	Note1	

General Note:

1. Prior to system verification and validation, the path loss from the signal generator to the system check source and the power meter, which includes the amplifier, cable, attenuator and directional coupler, was measured by the network analyzer. The reading of the power meter was offset by the path loss difference between the path to the power meter and the path to the system check source to monitor the actual power level fed to the system check source.
2. The dipole calibration interval can be extended to 3 years with justification according to KDB 865664 D01. The dipoles are also not physically damaged, or repaired during the interval. The justification data in appendix C can be found which the return loss is < -20dB, within 20% of prior calibration, the impedance is within 5 ohm of prior calibration for each dipole.

9. System Verification

9.1 Tissue Verification

The tissue dielectric parameters of tissue-equivalent media used for SAR measurements must be characterized within a temperature range of 18°C to 25°C, measured with calibrated instruments and apparatuses, such as network analyzers and temperature probes. The temperature of the tissue-equivalent medium during SAR measurement must also be within 18°C to 25°C and within ± 2°C of the temperature when the tissue parameters are characterized. The tissue dielectric measurement system must be calibrated before use. The dielectric parameters must be measured before the tissue-equivalent medium is used in a series of SAR measurements.

The liquid tissue depth was at least 15cm in the phantom for all SAR testing

<Tissue Dielectric Parameter Check Results>

Frequency (MHz)	Liquid Temp. (°C)	Conductivity (σ)	Permittivity (ε _r)	Conductivity Target (σ)	Permittivity Target (ε _r)	Delta (σ) (%)	Delta (ε _r) (%)	Limit (%)	Date
750	22.8	0.915	43.396	0.89	41.90	2.81	3.57	±5	2021.11.16
835	22.6	0.936	43.121	0.90	41.50	4.00	3.91	±5	2021.11.17
1750	22.6	1.401	40.492	1.37	40.10	2.26	0.98	±5	2021.11.18
1900	22.9	1.458	40.307	1.40	40.00	4.14	0.77	±5	2021.11.18
2450	22.7	1.872	40.810	1.80	39.20	4.00	4.11	±5	2021.11.19
5250	22.7	4.580	36.300	4.71	35.90	-2.76	1.11	±5	2021.11.21
5600	22.6	4.947	35.740	5.07	35.50	-2.43	0.68	±5	2021.11.22
5750	22.6	5.129	35.552	5.22	35.40	-1.74	0.43	±5	2021.11.23

9.2 System Performance Check Results

Comparing to the original SAR value provided by SPEAG, the verification data should be within its specification of 10 %. Below table shows the target SAR and measured SAR after normalized to 1W input power. The table below indicates the system performance check can meet the variation criterion and the plots can be referred to Appendix A of this report.

Date	Frequency (MHz)	Input Power (mW)	Dipole S/N	Probe S/N	DAE S/N	Measured 1g SAR (W/kg)	Targeted 1g SAR (W/kg)	Normalized 1g SAR (W/kg)	Deviation (%)	Measured 10g SAR (W/kg)	Targeted 10g SAR (W/kg)	Normalized 10g SAR (W/kg)	Deviation (%)
2021.11.16	750	50	1087	7627	1649	0.437	8.36	8.74	4.55	0.287	5.65	5.74	1.59
2021.11.17	835	50	4d258	7627	1649	0.501	9.44	10.02	6.14	0.328	6.13	6.56	7.01
2021.11.18	1750	50	1090	7627	1649	1.900	36.40	38	4.40	1.010	19.20	20.2	5.21
2021.11.18	1900	50	5d170	7627	1649	2.040	39.00	40.8	4.62	1.060	20.30	21.2	4.43
2021.11.19	2450	50	908	7627	1649	2.570	52.80	51.4	-2.65	1.210	24.20	24.2	0.00
2021.11.21	5250	50	1113	7627	1649	3.770	80.50	75.4	-6.34	1.170	23.10	23.4	1.30
2021.11.22	5600	50	1113	7627	1649	3.920	83.40	78.4	-6.00	1.140	23.80	22.8	-4.20
2021.11.23	5750	50	1113	7627	1649	3.710	80.00	74.2	-7.25	1.210	22.80	24.2	6.14

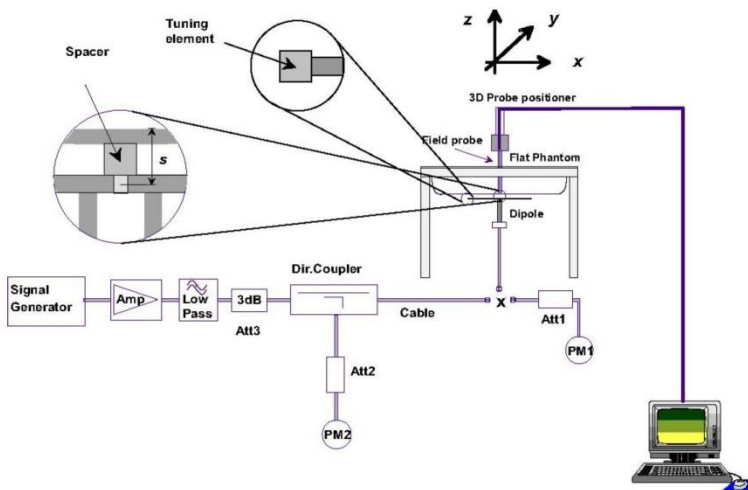

Fig 9.2.1 System Performance Check Setup



Fig 9.2.2 Setup Photo

10. RF Exposure Positions

10.1 Ear and handset reference point

Figure 10.1.1 shows the front, back, and side views of the SAM phantom. The center-of-mouth reference point is labeled “M,” the left ear reference point (ERP) is marked “LE,” and the right ERP is marked “RE.” Each ERP is 15 mm along the B-M (back-mouth) line behind the entrance-to-ear-canal (EEC) point, as shown in Figure 10.1.2 The Reference Plane is defined as passing through the two ear reference points and point M. The line N-F (neck-front), also called the reference pivoting line, is normal to the Reference Plane and perpendicular to both a line passing through RE and LE and the B-M line (see Figure 10.1.3). Both N-F and B-M lines should be marked on the exterior of the phantom shell to facilitate handset positioning. Posterior to the N-F line the ear shape is a flat surface with 6 mm thickness at each ERP, and forward of the N-F line the ear is truncated, as illustrated in Figure 10.1.2. The ear truncation is introduced to preclude the ear lobe from interfering with handset tilt, which could lead to unstable positioning at the cheek.

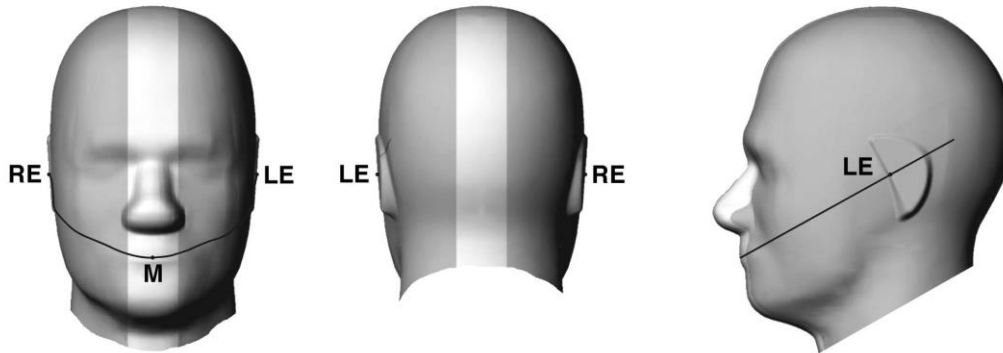

Fig 10.1.1 Front, back, and side views of SAM twin phantom

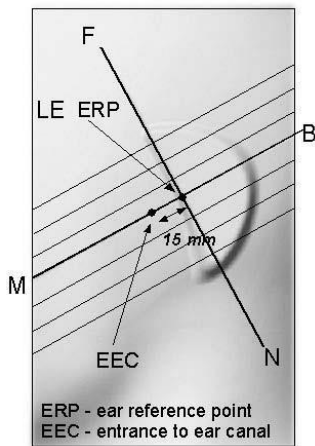

Fig 10.1.2 Close-up side view of phantom showing the ear region.

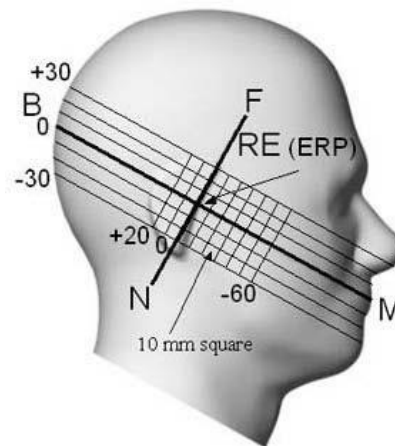

Fig 10.1.3 Side view of the phantom showing relevant markings and seven cross-sectional plane locations

10.2 Definition of the cheek position

1. Ready the handset for talk operation, if necessary. For example, for handsets with a cover piece (flip cover), open the cover. If the handset can transmit with the cover closed, both configurations must be tested.
2. Define two imaginary lines on the handset—the vertical centerline and the horizontal line. The vertical centerline passes through two points on the front side of the handset—the midpoint of the width w_t of the handset at the level of the acoustic output (point A in Figure 10.2.1 and Figure 10.2.2), and the midpoint of the width w_b of the bottom of the handset (point B). The horizontal line is perpendicular to the vertical centerline and passes through the center of the acoustic output (see Figure 10.2.1). The two lines intersect at point A. Note that for many handsets, point A coincides with the center of the acoustic output; however, the acoustic output may be located elsewhere on the horizontal line. Also note that the vertical centerline is not necessarily parallel to the front face of the handset (see Figure 10.2.2), especially for clamshell handsets, handsets with flip covers, and other irregularly-shaped handsets.
3. Position the handset close to the surface of the phantom such that point A is on the (virtual) extension of the line passing through points RE and LE on the phantom (see Figure 10.2.3), such that the plane defined by the vertical centerline and the horizontal line of the handset is approximately parallel to the sagittal plane of the phantom.
4. Translate the handset towards the phantom along the line passing through RE and LE until handset point A touches the pinna at the ERP.
5. While maintaining the handset in this plane, rotate it around the LE-RE line until the vertical centerline is in the plane normal to the plane containing B-M and N-F lines, i.e., the Reference Plane.
6. Rotate the handset around the vertical centerline until the handset (horizontal line) is parallel to the N-F line.
7. While maintaining the vertical centerline in the Reference Plane, keeping point A on the line passing through RE and LE, and maintaining the handset contact with the pinna, rotate the handset about the N-F line until any point on the handset is in contact with a phantom point below the pinna on the cheek. See Figure 10.2.3. The actual rotation angles should be documented in the test report.

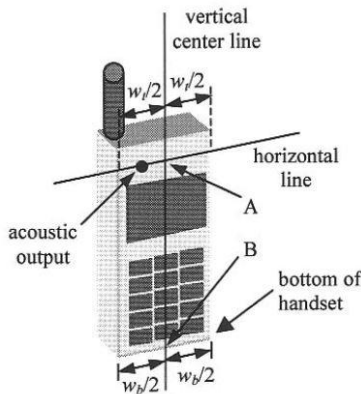

Fig 10.2.1 Handset vertical and horizontal reference lines—“fixed case”

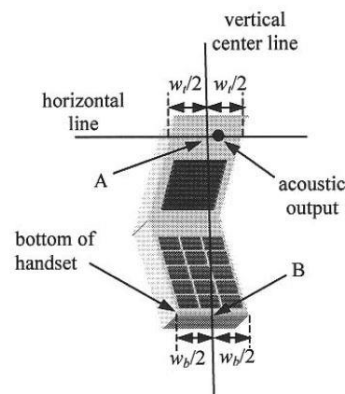

Fig 10.2.2 Handset vertical and horizontal reference lines—“clam-shell case”

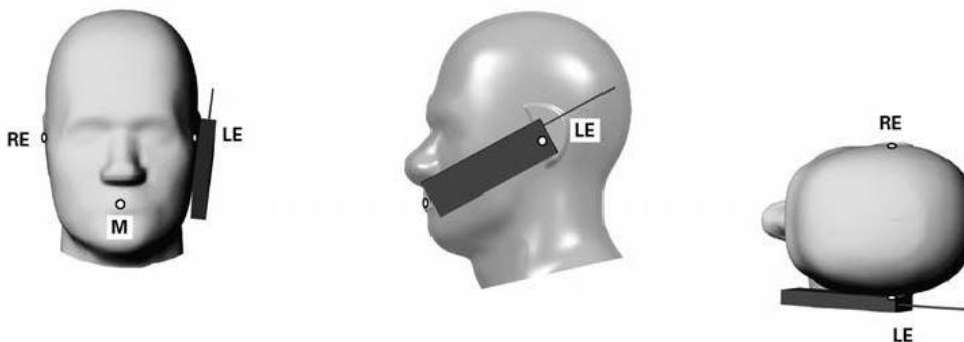

Fig 10.2.3 cheek or touch position. The reference points for the right ear (RE), left ear (LE), and mouth (M), which establish the Reference Plane for handset positioning, are indicated.

10.3 Definition of the tilt position

1. Ready the handset for talk operation, if necessary. For example, for handsets with a cover piece (flip cover), open the cover. If the handset can transmit with the cover closed, both configurations must be tested.
2. While maintaining the orientation of the handset, move the handset away from the pinna along the line passing through RE and LE far enough to allow a rotation of the handset away from the cheek by 15°.
3. Rotate the handset around the horizontal line by 15°.
4. While maintaining the orientation of the handset, move the handset towards the phantom on the line passing through RE and LE until any part of the handset touches the ear. The tilt position is obtained when the contact point is on the pinna. See Figure 10.3.1. If contact occurs at any location other than the pinna, e.g., the antenna at the back of the phantom head, the angle of the handset should be reduced. In this case, the tilt position is obtained if any point on the handset is in contact with the pinna and a second point

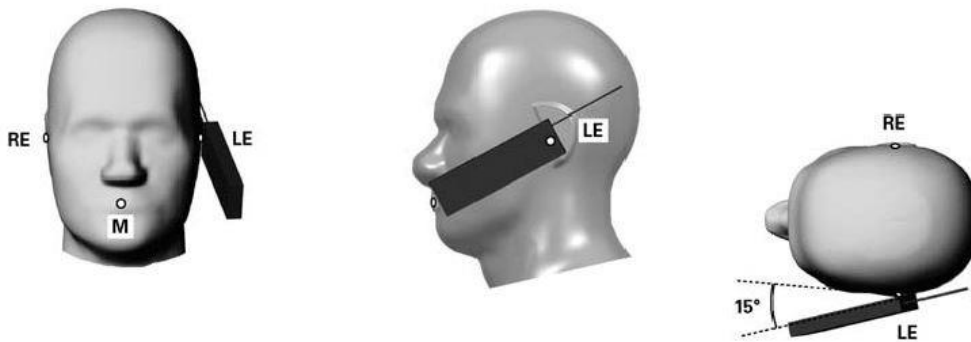

Fig 10.3.1 Tilt position. The reference points for the right ear (RE), left ear (LE), and mouth (M), which define the Reference Plane for handset positioning, are indicated.

10.4 Body Worn Accessory

Body-worn operating configurations are tested with the belt-clips and holsters attached to the device and positioned against a flat phantom in a normal use configuration (see Figure 10.4). Per KDB648474 D04v01r03, body-worn accessory exposure is typically related to voice mode operations when handsets are carried in body-worn accessories. The body-worn accessory procedures in FCC KDB 447498 D01v06 should be used to test for body-worn accessory SAR compliance, without a headset connected to it. This enables the test results for such configuration to be compatible with that required for hotspot mode when the body-worn accessory test separation distance is greater than or equal to that required for hotspot mode, when applicable. When the reported SAR for body-worn accessory, measured without a headset connected to the handset is > 1.2 W/kg, the highest reported SAR configuration for that wireless mode and frequency band should be repeated for that body-worn accessory with a handset attached to the handset.

Accessories for body-worn operation configurations are divided into two categories: those that do not contain metallic components and those that do contain metallic components. When multiple accessories that do not contain metallic components are supplied with the device, the device is tested with only the accessory that dictates the closest spacing to the body. Then multiple accessories that contain metallic components are test with the device with each accessory. If multiple accessories share an identical metallic component (i.e. the same metallic belt-chip used with different holsters with no other metallic components) only the accessory that dictates the closest spacing to the body is tested.

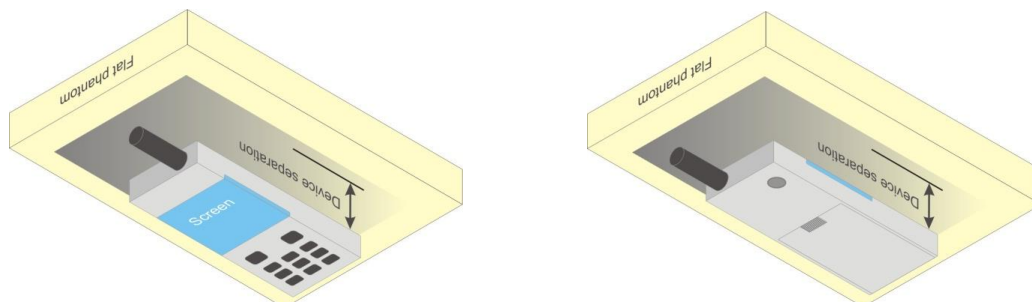

Fig 10.4 Body Worn Position



10.5 Product Specific Exposure

For smart phones with a display diagonal dimension > 15.0 cm or an overall diagonal dimension > 16.0 cm that provide similar mobile web access and multimedia support found in mini-tablets or UMPC mini-tablets that support voice calls next to the ear, According to KDB648474 D04v01r03, the following phablet procedures should be applied to evaluate SAR compliance for each applicable wireless modes and frequency band. Devices marketed as phablets, regardless of form factors and operating characteristics must be tested as a phablet to determine SAR compliance

1. The normally required head and body-worn accessory SAR test procedures for handsets, including hotspot mode, must be applied.
2. The UMPC mini-tablet procedures must also be applied to test the SAR of all surfaces and edges with an antenna located at ≤ 25 mm from that surface or edge, in direct contact with a flat phantom, for 10-g extremity SAR according to the body-equivalent tissue dielectric parameters in KDB 865664 to address interactive hand use exposure conditions.6 The UMPC mini-tablet 1-g SAR at 5 mm is not required. When hotspot mode applies, 10-g extremity SAR is required only for the surfaces and edges with hotspot mode 1-g reported SAR > 1.2 W/kg.

10.6 Wireless Router

Some battery-operated handsets have the capability to transmit and receive user through simultaneous transmission of WIFI simultaneously with a separate licensed transmitter. The FCC has provided guidance in FCC KDB Publication 941225 D06 v02r01 where SAR test considerations for handsets (L x W ≥ 9 cm x 5 cm) are based on a composite test separation distance of 10mm from the front, back and edges of the device containing transmitting antennas within 2.5cm of their edges, determined from general mixed use conditions for this type of devices. Since the hotspot SAR results may overlap with the body-worn accessory SAR requirements, the more conservative configurations can be considered, thus excluding some body-worn accessory SAR tests.

When the user enables the personal wireless router functions for the handset, actual operations include simultaneous transmission of both the WIFI transmitter and another licensed transmitter. Both transmitters often do not transmit at the same transmitting frequency and thus cannot be evaluated for SAR under actual use conditions due to the limitations of the SAR assessment probes. Therefore, SAR must be evaluated for each frequency transmission and mode separately and spatially summed with the WIFI transmitter according to FCC KDB Publication 447498 D01v06 publication procedures. The "Portable Hotspot" feature on the handset was NOT activated during SAR assessments, to ensure the SAR measurements were evaluated for a single transmission frequency RF signal at a time.

11. UMTS Output Power (Unit: dBm)

<WCDMA Conducted Power>

1. The following tests were conducted according to the test requirements outlines in 3GPP TS 34.121 specification.
2. The procedures in KDB 941225 D01v03r01 are applied for 3GPP Rel. 6 HSPA to configure the device in the required sub-test mode(s) to determine SAR test exclusion.
3. For DC-HSDPA, the device was configured according to the H-Set 12, Fixed Reference Channel (FRC) configuration in Table C.8.1.12 of 3GPP TS 34.121-1, with the primary and the secondary serving HS-DSCH Cell enabled during the power measurement.

A summary of these settings are illustrated below:

HSDPA Setup Configuration:

- a. The EUT was connected to Base Station Agilent E5515C referred to the Setup Configuration.
- b. The RF path losses were compensated into the measurements.
- c. A call was established between EUT and Base Station with following setting:
 - i. Set Gain Factors (β_c and β_d) and parameters were set according to each
 - ii. Specific sub-test in the following table, C10.1.4, quoted from the TS 34.121
 - iii. Set RMC 12.2Kbps + HSDPA mode.
 - iv. Set Cell Power = -86 dBm
 - v. Set HS-DSCH Configuration Type to FRC (H-set 1, QPSK)
 - vi. Select HSDPA Uplink Parameters
 - vii. Set Delta ACK, Delta NACK and Delta CQI = 8
 - viii. Set Ack-Nack Repetition Factor to 3
 - ix. Set CQI Feedback Cycle (k) to 4 ms
 - x. Set CQI Repetition Factor to 2
 - xi. Power Ctrl Mode = All Up bits
- d. The transmitted maximum output power was recorded.

Table C.10.1.4: β values for transmitter characteristics tests with HS-DPCCH

Sub-test	β_c	β_d	β_d (SF)	β_c/β_d	β_{hs} (Note 1, Note 2)	CM (dB) (Note 3)	MPR (dB) (Note 3)
1	2/15	15/15	64	2/15	4/15	0.0	0.0
2	12/15 (Note 4)	15/15 (Note 4)	64	12/15 (Note 4)	24/15	1.0	0.0
3	15/15	8/15	64	15/8	30/15	1.5	0.5
4	15/15	4/15	64	15/4	30/15	1.5	0.5

Note 1: Δ_{ACK} , Δ_{NACK} and $\Delta_{CQI} = 30/15$ with $\beta_{hs} = 30/15 * \beta_c$.

Note 2: For the HS-DPCCH power mask requirement test in clause 5.2C, 5.7A, and the Error Vector Magnitude (EVM) with HS-DPCCH test in clause 5.13.1A, and HSDPA EVM with phase discontinuity in clause 5.13.1AA, Δ_{ACK} and $\Delta_{NACK} = 30/15$ with $\beta_{hs} = 30/15 * \beta_c$, and $\Delta_{CQI} = 24/15$ with $\beta_{hs} = 24/15 * \beta_c$.

Note 3: CM = 1 for $\beta_c/\beta_d = 12/15$, $\beta_{hs}/\beta_c = 24/15$. For all other combinations of DPDCH, DPCCH and HS-DPCCH the MPR is based on the relative CM difference. This is applicable for only UEs that support HSDPA in release 6 and later releases.

Note 4: For subtest 2 the β_c/β_d ratio of 12/15 for the TFC during the measurement period (TF1, TF0) is achieved by setting the signalled gain factors for the reference TFC (TF1, TF1) to $\beta_c = 11/15$ and $\beta_d = 15/15$.

Setup Configuration

HSUPA Setup Configuration:

- a. The EUT was connected to Base Station Agilent E5515C referred to the Setup Configuration.
- b. The RF path losses were compensated into the measurements.
- c. A call was established between EUT and Base Station with following setting * :
 - i. Call Configs = 5.2B, 5.9B, 5.10B, and 5.13.2B with QPSK
 - ii. Set the Gain Factors (β_c and β_d) and parameters (AG Index) were set according to each specific sub-test in the following table, C11.1.3, quoted from the TS 34.121
 - iii. Set Cell Power = -86 dBm
 - iv. Set Channel Type = 12.2k + HSPA
 - v. Set UE Target Power
 - vi. Power Ctrl Mode= Alternating bits
 - vii. Set and observe the E-TFCl
 - viii. Confirm that E-TFCl is equal to the target E-TFCl of 75 for sub-test 1, and other subtest's E-TFCl
- d. The transmitted maximum output power was recorded.

Table C.11.1.3: β values for transmitter characteristics tests with HS-DPCCH and E-DCH

Sub-test	β_c	β_d	β_d (SF)	β_c/β_d	β_{HS} (Note1)	β_{ec}	β_{ed} (Note 4) (Note 5)	β_{ed} (SF)	β_{ed} (Codes)	CM (dB) (Note 2)	MPR (dB) (Note 2) (Note 6)	AG Index (Note 5)	E-TFCl
1	11/15 (Note 3)	15/15 (Note 3)	64	11/15 (Note 3)	22/15	209/25	1309/225	4	1	1.0	0.0	20	75
2	6/15	15/15	64	6/15	12/15	12/15	94/75	4	1	3.0	2.0	12	67
3	15/15	9/15	64	15/9	30/15	30/15	$\beta_{ed1}: 47/15$ $\beta_{ed2}: 47/15$	4 4	2	2.0	1.0	15	92
4	2/15	15/15	64	2/15	4/15	2/15	56/75	4	1	3.0	2.0	17	71
5	15/15	0	-	-	5/15	5/15	47/15	4	1	1.0	0.0	12	67

Note 1: For sub-test 1 to 4, Δ_{ACK} , Δ_{NACK} and $\Delta_{CQI} = 30/15$ with $\beta_{hs} = 30/15 * \beta_c$. For sub-test 5, Δ_{ACK} , Δ_{NACK} and $\Delta_{CQI} = 5/15$ with $\beta_{hs} = 5/15 * \beta_c$.

Note 2: CM = 1 for $\beta_c/\beta_d = 12/15$, $\beta_{hs}/\beta_c = 24/15$. For all other combinations of DPDCH, DPCCH, HS-DPCCH, E-DPDCH and E-DPCCH the MPR is based on the relative CM difference.

Note 3: For subtest 1 the β_c/β_d ratio of 11/15 for the TFC during the measurement period (TF1, TF0) is achieved by setting the signalled gain factors for the reference TFC (TF1, TF1) to $\beta_c = 10/15$ and $\beta_d = 15/15$.

Note 4: In case of testing by UE using E-DPDCH Physical Layer category 1, Sub-test 3 is omitted according to TS25.306 Table 5.1g.

Note 5: β_{ed} can not be set directly; it is set by Absolute Grant Value.

Note 6: For subtests 2, 3 and 4, UE may perform E-DPDCH power scaling at max power which could results in slightly smaller MPR values.

Setup Configuration

DC-HSDPA 3GPP release 8 Setup Configuration:

- a. The EUT was connected to Base Station Agilent E5515C referred to the Setup Configuration below
- b. The RF path losses were compensated into the measurements.
- c. A call was established between EUT and Base Station with following setting:
 - i. Set RMC 12.2Kbps + HSDPA mode.
 - ii. Set Cell Power = -25 dBm
 - iii. Set HS-DSCH Configuration Type to FRC (H-set 12, QPSK)
 - iv. Select HSDPA Uplink Parameters
 - v. Set Gain Factors (β_c and β_d) and parameters were set according to each Specific sub-test in the following table, C10.1.4, quoted from the TS 34.121
 - a). Subtest 1: $\beta_c/\beta_d=2/15$
 - b). Subtest 2: $\beta_c/\beta_d=12/15$
 - c). Subtest 3: $\beta_c/\beta_d=15/8$
 - d). Subtest 4: $\beta_c/\beta_d=15/4$
 - vi. Set Delta ACK, Delta NACK and Delta CQI = 8
 - vii. Set Ack-Nack Repetition Factor to 3
 - viii. Set CQI Feedback Cycle (k) to 4 ms
 - ix. Set CQI Repetition Factor to 2
 - x. Power Ctrl Mode = All Up bits
- d. The transmitted maximum output power was recorded.

The following tests were conducted according to the test requirements outlines in 3GPP TS 34.121 specification. A summary of these settings are illustrated below:

C.8.1.12 Fixed Reference Channel Definition H-Set 12

Table C.8.1.12: Fixed Reference Channel H-Set 12

Parameter	Unit	Value
Nominal Avg. Inf. Bit Rate	kbps	60
Inter-TTI Distance	TTI's	1
Number of HARQ Processes	Processes	6
Information Bit Payload (N_{INF})	Bits	120
Number Code Blocks	Blocks	1
Binary Channel Bits Per TTI	Bits	960
Total Available SML's in UE	SML's	19200
Number of SML's per HARQ Proc.	SML's	3200
Coding Rate		0.15
Number of Physical Channel Codes	Codes	1
Modulation		QPSK
Note 1: The RMC is intended to be used for DC-HSDPA mode and both cells shall transmit with identical parameters as listed in the table. Note 2: Maximum number of transmission is limited to 1, i.e., retransmission is not allowed. The redundancy and constellation version 0 shall be used.		

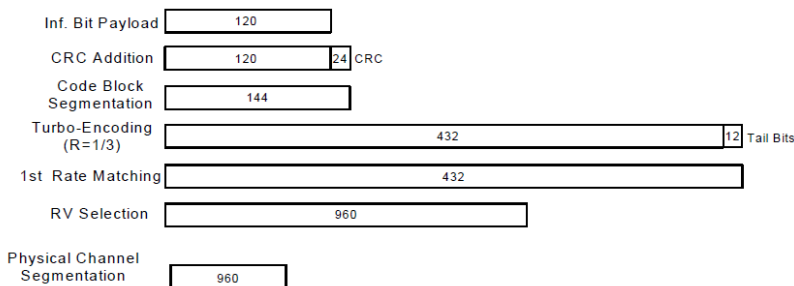

Figure C.8.19: Coding rate for Fixed reference Channel H-Set 12 (QPSK)

Setup Configuration



<WCDMA Conducted Power>

General Note:

1. Per KDB 941225 D01v03r01, for SAR testing is measured using a 12.2 kbps RMC with TPC bits configured to all "1's".
2. Per KDB 941225 D01v03r01, RMC 12.2kbps setting is used to evaluate SAR. The maximum output power and tune-up tolerance specified for production units in HSDPA / HSUPA / DC-HSDPA is $\leq \frac{1}{4}$ dB higher than RMC 12.2Kbps or when the highest reported SAR of the RMC12.2Kbps is scaled by the ratio of specified maximum output power and tune-up tolerance of HSDPA / HSUPA / DC-HSDPA to RMC12.2Kbps and the adjusted SAR is ≤ 1.2 W/kg, SAR measurement is not required for HSDPA / HSUPA / DC-HSDPA, and according to the following RF output power, the output power results of the secondary modes (HSUPA, HSDPA, DC-HSDPA) are less than $\frac{1}{4}$ dB higher than the primary modes; therefore, SAR measurement is not required for HSDPA / HSUPA / DC-HSDPA.

Band		WCDMA IV			Tune-up Limit (dBm)
TX Channel		1312	1413	1513	
Rx Channel		1537	1638	1738	
Frequency (MHz)		1712.4	1732.6	1752.6	
3GPP Rel 99	AMR 12.2Kbps	17.45	17.47	17.42	18.00
3GPP Rel 99	RMC 12.2Kbps	17.48	17.50	17.44	18.00
3GPP Rel 6	HSDPA Subtest-1	16.52	16.53	16.47	17.00
3GPP Rel 6	HSDPA Subtest-2	16.56	16.62	16.48	17.00
3GPP Rel 6	HSDPA Subtest-3	16.03	16.02	15.98	16.50
3GPP Rel 6	HSDPA Subtest-4	16.08	16.02	15.99	16.50
3GPP Rel 8	DC-HSDPA Subtest-1	16.62	16.42	16.54	17.00
3GPP Rel 8	DC-HSDPA Subtest-2	16.53	16.50	16.54	17.00
3GPP Rel 8	DC-HSDPA Subtest-3	16.13	16.05	16.09	16.50
3GPP Rel 8	DC-HSDPA Subtest-4	15.99	16.03	16.08	16.50
3GPP Rel 6	HSUPA Subtest-1	16.40	16.48	16.54	17.00
3GPP Rel 6	HSUPA Subtest-2	14.50	14.51	14.37	15.00
3GPP Rel 6	HSUPA Subtest-3	15.49	15.44	15.51	16.00
3GPP Rel 6	HSUPA Subtest-4	14.46	14.54	14.47	15.00
3GPP Rel 6	HSUPA Subtest-5	16.50	16.53	16.46	17.00





12. Spot Check Verification power for Conducted Power

Note: Conducted power test against the variant model based on the worst-case SAR condition from the original model was performed in this filing to demonstrate the test data from original model remains representative for the variant model.

Summary for power spot check for each rule entry and technology is listed as below:

Band	BW (MHz)	Modulation	RB Size	RB offset	Mode	Antenna	Ch.	Freq. (MHz)	Average Power (dBm) for original	Average Power (dBm) For Variant	Difference (dB)
LTE Band 12	10M	QPSK	1	0	-	Ant 0	23095	707.5	22.76	22.71	0.05
GSM850	-	-	-	-	GPRS (4 Tx slots)	Ant 0	189	836.4	24.92	24.88	0.04
GSM1900	-	-	-	-	GPRS (3 Tx slots)	Ant 1	661	1880	22.35	22.32	0.03
WLAN2.4GHz	-	-	-	-	802.11b 1Mbps	Ant 6	6	2437	13.89	13.79	0.10
Bluetooth	-	-	-	-	1Mbps	Ant 6	78	2480	8.82	8.81	0.01
WLAN5GHz	-	-	-	-	802.11ac-VHT80 MCS0	Ant 6	42	5210	12.09	12.03	0.06
WLAN5GHz	-	-	-	-	802.11ac-VHT80 MCS0	Ant 6	58	5290	12.04	12.01	0.03
WLAN5GHz	-	-	-	-	802.11ac-VHT80 MCS0	Ant 6	138	5690	12.44	12.59	-0.15
WLAN5GHz	-	-	-	-	802.11ac-VHT80 MCS0	Ant 6	155	5775	12.06	12.11	-0.05

13. RF Exposure Conditions

Distance of the Antenna to the EUT surface/edge						
Antennas	Back	Front	Top Side	Bottom Side	Right Side	Left Side
WWAN Ant 0	≤ 25mm	≤ 25mm	>25mm	≤ 25mm	≤ 25mm	≤ 25mm
WWAN Ant 1	≤ 25mm	≤ 25mm	>25mm	≤ 25mm	>25mm	≤ 25mm
BT & 2.4GHz WLAN Ant 6	≤ 25mm	≤ 25mm	≤ 25mm	>25mm	>25mm	≤ 25mm

Positions for SAR tests; Hotspot mode						
Antennas	Back	Front	Top Side	Bottom Side	Right Side	Left Side
WWAN Ant 0	Yes	Yes	No	Yes	Yes	Yes
WWAN Ant 1	Yes	Yes	No	Yes	No	Yes
BT & 2.4GHz WLAN Ant 6	Yes	Yes	Yes	No	No	Yes

General Note:

Referring to KDB 941225 D06 v02r01, when the overall device length and width are ≥ 9cm*5cm, the test distance is 10 mm. SAR must be measured for all sides and surfaces with a transmitting antenna located within 25mm from that surface or edge, The detail antenna location please refers to Appendix D.

14. SAR Test Results

General Note:

1. Per KDB 447498 D01v06, the reported SAR is the measured SAR value adjusted for maximum tune-up tolerance.
 - a. Tune-up scaling Factor = tune-up limit power (mW) / EUT RF power (mW), where tune-up limit is the maximum rated power among all production units.
 - b. For SAR testing of WLAN/Bluetooth signal with non-100% duty cycle, the measured SAR is scaled-up by the duty cycle scaling factor which is equal to "1/(duty cycle)"
 - c. For WWAN: Reported SAR(W/kg)= Measured SAR(W/kg)*Tune-up Scaling Factor
 - d. For WLAN/Bluetooth: Reported SAR(W/kg)= Measured SAR(W/kg)* Duty Cycle scaling factor * Tune-up scaling factor
 - e. For TDD LTE SAR measurement, the duty cycle 1:1.59 (62.9 %) was used perform testing and considering the theoretical duty cycle of 63.3% for extended cyclic prefix in the uplink, and the theoretical duty cycle of 62.9% for normal cyclic prefix in uplink, a scaling factor of extended cyclic prefix 63.3%/62.9% = 1.006 is applied to scale-up the measured SAR result. The Reported TDD LTE SAR = measured SAR (W/kg)* Tune-up Scaling Factor* scaling factor for extended cyclic prefix.
2. Per KDB 447498 D01v06, for each exposure position, testing of other required channels within the operating mode of a frequency band is not required when the *reported* 1-g or 10-g SAR for the mid-band or highest output power channel is:
 - ≤ 0.8 W/kg or 2.0 W/kg, for 1-g or 10-g respectively, when the transmission band is ≤ 100 MHz
 - ≤ 0.6 W/kg or 1.5 W/kg, for 1-g or 10-g respectively, when the transmission band is between 100 MHz and 200 MHz
 - ≤ 0.4 W/kg or 1.0 W/kg, for 1-g or 10-g respectively, when the transmission band is ≥ 200 MHz
3. Per KDB 865664 D01v01r04, for each frequency band, repeated SAR measurement is required only when the measured SAR is ≥0.8W/kg.
4. Per KDB 648474 D04v01r03, when the reported SAR for a body-worn accessory measured without a headset connected to the handset is ≤ 1.2 W/kg, SAR testing with a headset connected to the handset is not required.
5. For WWAN Ant 1 at hotspot exposure condition, SAR testing is not required at right side, but we still perform additional testing for right side which keeps for more conservatively for simultaneous transmission analysis.



14.1 Head SAR

<GSM SAR>

Plot No.	Band	Mode	Test Position	Gap (mm)	Antenna	Ch.	Freq. (MHz)	Average Power (dBm)	Tune-Up Limit (dBm)	Tune-up Scaling Factor	Power Drift (dB)	Measured 1g SAR (W/kg)	Reported 1g SAR (W/kg)
01	GSM850	GPRS (4 Tx slots)	Right Cheek	0mm	Ant 0	189	836.4	24.88	26.00	1.294	0.11	0.110	0.142
02	GSM1900	GPRS (3 Tx slots)	Left Cheek	0mm	Ant 1	661	1880	22.32	23.50	1.312	-0.06	0.055	0.072

<WCDMA SAR>

Plot No.	Band	Mode	Test Position	Gap (mm)	Antenna	Ch.	Freq. (MHz)	Average Power (dBm)	Tune-Up Limit (dBm)	Tune-up Scaling Factor	Power Drift (dB)	Measured 1g SAR (W/kg)	Reported 1g SAR (W/kg)
	WCDMA IV	RMC 12.2Kbps	Right Cheek	0mm	Ant 1	1413	1732.6	17.50	18.00	1.122	0.06	0.016	0.018
	WCDMA IV	RMC 12.2Kbps	Right Tilted	0mm	Ant 1	1413	1732.6	17.50	18.00	1.122	0.04	0.006	0.007
03	WCDMA IV	RMC 12.2Kbps	Left Cheek	0mm	Ant 1	1413	1732.6	17.50	18.00	1.122	-0.04	0.026	0.029
	WCDMA IV	RMC 12.2Kbps	Left Tilted	0mm	Ant 1	1413	1732.6	17.50	18.00	1.122	-0.02	0.006	0.007

<FDD LTE SAR>

Plot No.	Band	BW (MHz)	Modulation	RB Size	RB offset	Test Position	Gap (mm)	Antenna	Ch.	Freq. (MHz)	Average Power (dBm)	Tune-Up Limit (dBm)	Tune-up Scaling Factor	Power Drift (dB)	Measured 1g SAR (W/kg)	Reported 1g SAR (W/kg)
04	LTE Band 12	10M	QPSK	1	0	Right Cheek	0mm	Ant 0	23095	707.5	22.71	24.00	1.346	-0.09	0.188	0.253

<WLAN2.4GHz SAR>

Plot No.	Band	Mode	Test Position	Gap (mm)	Antenna	Ch.	Freq. (MHz)	Average Power (dBm)	Tune-Up Limit (dBm)	Tune-up Scaling Factor	Duty Cycle %	Duty Cycle Scaling Factor	Power Drift (dB)	Measured 1g SAR (W/kg)	Reported 1g SAR (W/kg)
05	WLAN2.4GHz	802.11b 1Mbps	Right Tilted	0mm	Ant 6	6	2437	13.79	15.00	1.321	100	1.000	-0.13	0.263	0.348

<Bluetooth SAR>

Plot No.	Band	Mode	Test Position	Gap (mm)	Antenna	Ch.	Freq. (MHz)	Average Power (dBm)	Tune-Up Limit (dBm)	Tune-up Scaling Factor	Duty Cycle %	Duty Cycle Scaling Factor	Power Drift (dB)	Measured 1g SAR (W/kg)	Reported 1g SAR (W/kg)
06	Bluetooth	1Mbps	Right Tilted	0mm	Ant 6	78	2480	8.81	10.50	1.476	77.06	1.298	0.06	0.053	0.102

<WLAN5GHz SAR>

Plot No.	Band	Mode	Test Position	Gap (mm)	Antenna	Ch.	Freq. (MHz)	Average Power (dBm)	Tune-Up Limit (dBm)	Tune-up Scaling Factor	Duty Cycle %	Duty Cycle Scaling Factor	Power Drift (dB)	Measured 1g SAR (W/kg)	Reported 1g SAR (W/kg)
07	WLAN5.3GHz	802.11ac-VHT80 MCS0	Right Tilted	0mm	Ant 6	58	5290	12.01	14.00	1.581	93.02	1.075	0.04	0.060	0.101
08	WLAN5.5GHz	802.11ac-VHT80 MCS0	Right Tilted	0mm	Ant 6	138	5690	12.59	14.00	1.384	93.02	1.075	-0.07	0.148	0.220
09	WLAN5.8GHz	802.11ac-VHT80 MCS0	Right Cheek	0mm	Ant 6	155	5775	12.11	14.00	1.545	93.02	1.075	-0.01	0.165	0.274



14.2 Hotspot SAR

<GSM SAR>

Plot No.	Band	Mode	Test Position	Gap (mm)	Antenna	Ch.	Freq. (MHz)	Average Power (dBm)	Tune-Up Limit (dBm)	Tune-up Scaling Factor	Power Drift (dB)	Measured 1g SAR (W/kg)	Reported 1g SAR (W/kg)
10	GSM850	GPRS (4 Tx slots)	Front	10mm	Ant 0	189	836.4	24.88	26.00	1.294	-0.19	0.117	0.151
11	GSM1900	GPRS (3 Tx slots)	Back	10mm	Ant 1	661	1880	22.32	23.50	1.312	-0.13	0.132	0.173

<WCDMA SAR>

Plot No.	Band	Mode	Test Position	Gap (mm)	Antenna	Ch.	Freq. (MHz)	Average Power (dBm)	Tune-Up Limit (dBm)	Tune-up Scaling Factor	Power Drift (dB)	Measured 1g SAR (W/kg)	Reported 1g SAR (W/kg)
	WCDMA IV	RMC 12.2Kbps	Front	10mm	Ant 1	1413	1732.6	17.50	18.00	1.122	0.03	0.106	0.119
12	WCDMA IV	RMC 12.2Kbps	Back	10mm	Ant 1	1413	1732.6	17.50	18.00	1.122	-0.05	0.119	0.134
	WCDMA IV	RMC 12.2Kbps	Left Side	10mm	Ant 1	1413	1732.6	17.50	18.00	1.122	0.01	0.085	0.095
	WCDMA IV	RMC 12.2Kbps	Right Side	10mm	Ant 1	1413	1732.6	17.50	18.00	1.122	0.02	0.017	0.019
	WCDMA IV	RMC 12.2Kbps	Bottom Side	10mm	Ant 1	1413	1732.6	17.50	18.00	1.122	-0.09	0.005	0.006

<FDD LTE SAR>

Plot No.	Band	BW (MHz)	Modulation	RB Size	RB offset	Test Position	Gap (mm)	Antenna	Ch.	Freq. (MHz)	Average Power (dBm)	Tune-Up Limit (dBm)	Tune-up Scaling Factor	Power Drift (dB)	Measured 1g SAR (W/kg)	Reported 1g SAR (W/kg)
13	LTE Band 12	10M	QPSK	1	0	Right Side	10mm	Ant 0	23095	707.5	22.71	24.00	1.346	-0.09	0.237	0.319

<WLAN2.4GHz SAR>

Plot No.	Band	Mode	Test Position	Gap (mm)	Antenna	Ch.	Freq. (MHz)	Average Power (dBm)	Tune-Up Limit (dBm)	Tune-up Scaling Factor	Duty Cycle %	Duty Cycle Scaling Factor	Power Drift (dB)	Measured 1g SAR (W/kg)	Reported 1g SAR (W/kg)
14	WLAN2.4GHz	802.11b 1Mbps	Back	10mm	Ant 6	6	2437	13.79	15.00	1.321	100	1.000	0.02	0.078	0.103

<Bluetooth SAR>

Plot No.	Band	Mode	Test Position	Gap (mm)	Antenna	Ch.	Freq. (MHz)	Average Power (dBm)	Tune-Up Limit (dBm)	Tune-up Scaling Factor	Duty Cycle %	Duty Cycle Scaling Factor	Power Drift (dB)	Measured 1g SAR (W/kg)	Reported 1g SAR (W/kg)
15	Bluetooth	1Mbps	Back	10mm	Ant 6	78	2480	8.81	10.50	1.476	77.06	1.298	-0.02	0.021	0.041



14.3 Body Worn Accessory SAR

<GSM SAR>

Plot No.	Band	Mode	Test Position	Gap (mm)	Antenna	Ch.	Freq. (MHz)	Average Power (dBm)	Tune-Up Limit (dBm)	Tune-up Scaling Factor	Power Drift (dB)	Measured 1g SAR (W/kg)	Reported 1g SAR (W/kg)
16	GSM850	GPRS (4 Tx slots)	Front	15mm	Ant 0	189	836.4	24.88	26.00	1.294	-0.06	0.121	0.157
17	GSM1900	GPRS (3 Tx slots)	Back	15mm	Ant 1	661	1880	22.32	23.50	1.312	0.07	0.073	0.095

<WCDMA SAR>

Plot No.	Band	Mode	Test Position	Gap (mm)	Antenna	Ch.	Freq. (MHz)	Average Power (dBm)	Tune-Up Limit (dBm)	Tune-up Scaling Factor	Power Drift (dB)	Measured 1g SAR (W/kg)	Reported 1g SAR (W/kg)
	WCDMA IV	RMC 12.2Kbps	Front	15mm	Ant 1	1413	1732.6	17.50	18.00	1.122	0.03	0.062	0.070
18	WCDMA IV	RMC 12.2Kbps	Back	15mm	Ant 1	1413	1732.6	17.50	18.00	1.122	0.01	0.063	0.071

<FDD LTE SAR>

Plot No.	Band	BW (MHz)	Modulation	RB Size	RB offset	Test Position	Gap (mm)	Antenna	Ch.	Freq. (MHz)	Average Power (dBm)	Tune-Up Limit (dBm)	Tune-up Scaling Factor	Power Drift (dB)	Measured 1g SAR (W/kg)	Reported 1g SAR (W/kg)
19	LTE Band 12	10M	QPSK	1	0	Back	15mm	Ant 0	23095	707.5	22.71	24.00	1.346	-0.16	0.242	0.326

<WLAN2.4GHz SAR>

Plot No.	Band	Mode	Test Position	Gap (mm)	Antenna	Ch.	Freq. (MHz)	Average Power (dBm)	Tune-Up Limit (dBm)	Tune-up Scaling Factor	Duty Cycle %	Duty Cycle Scaling Factor	Power Drift (dB)	Measured 1g SAR (W/kg)	Reported 1g SAR (W/kg)
20	WLAN2.4GHz	802.11b 1Mbps	Back	15mm	Ant 6	6	2437	13.79	15.00	1.321	100	1.000	-0.03	0.034	0.045

<Bluetooth SAR>

Plot No.	Band	Mode	Test Position	Gap (mm)	Antenna	Ch.	Freq. (MHz)	Average Power (dBm)	Tune-Up Limit (dBm)	Tune-up Scaling Factor	Duty Cycle %	Duty Cycle Scaling Factor	Power Drift (dB)	Measured 1g SAR (W/kg)	Reported 1g SAR (W/kg)
21	Bluetooth	1Mbps	Back	15mm	Ant 6	78	2480	8.81	10.50	1.476	77.06	1.298	-0.02	0.011	0.021

<WLAN5GHz SAR>

Plot No.	Band	Mode	Test Position	Gap (mm)	Antenna	Ch.	Freq. (MHz)	Average Power (dBm)	Tune-Up Limit (dBm)	Tune-up Scaling Factor	Duty Cycle %	Duty Cycle Scaling Factor	Power Drift (dB)	Measured 1g SAR (W/kg)	Reported 1g SAR (W/kg)
23	WLAN5.3GHz	802.11ac-VHT80 MCS0	Back	15mm	Ant 6	58	5290	12.01	14.00	1.581	93.02	1.075	0.01	0.037	0.063
24	WLAN5.5GHz	802.11ac-VHT80 MCS0	Back	15mm	Ant 6	138	5690	12.59	14.00	1.384	93.02	1.075	0.02	0.087	0.130
25	WLAN5.8GHz	802.11ac-VHT80 MCS0	Back	15mm	Ant 6	155	5775	12.11	14.00	1.545	93.02	1.075	0.03	0.141	0.234

15. Simultaneous Transmission Analysis

No.	Simultaneous Transmission Configurations	Portable Handset		
		Head	Body-worn	Hotspot
1.	WWAN + WLAN 2.4GHz	Yes	Yes	Yes
2.	WWAN + Bluetooth	Yes	Yes	Yes
3.	WWAN + WLAN 5GHz + Bluetooth	Yes	Yes	No

General Note:

1. This device supports VoIP in GPRS, EGPRS, WCDMA and LTE (e.g. for 3rd-party VoIP), LTE supports VoLTE operation.
2. EUT will choose each GSM, WCDMA and LTE according to the network signal condition; therefore, they will not operate simultaneously at any moment.
3. This device 2.4GHz WLAN support hotspot operation and Bluetooth support tethering applications.
4. This device 2.4GHz WLAN supports hotspot operation, and 5.2GHz / 5.3GHz / 5.5GHz / 5.8GHz WLAN does not support hotspot operation.
5. WLAN 2.4GHz and Bluetooth share the same antenna so can't transmit simultaneously.
6. According to the EUT characteristic, WLAN 5GHz and Bluetooth can transmit simultaneously.
7. According to the EUT characteristic, WLAN 5GHz and WLAN 2.4GHz can't transmit simultaneously.
8. Chose the worst zoom scan SAR of WLAN correspondingly for co-located with WWAN analysis.
9. The reported SAR summation is calculated based on the same configuration and test position.
10. Per KDB 447498 D01v06, simultaneous transmission SAR is compliant if,
 - i) 1g Scalar SAR summation < 1.6W/kg and.
 - ii) $SPLSR = (SAR1 + SAR2)^{1.5} / (\text{min. separation distance, mm})$, and the peak separation distance is determined from the square root of $[(x1-x2)^2 + (y1-y2)^2 + (z1-z2)^2]$, where (x1, y1, z1) and (x2, y2, z2) are the coordinates of the extrapolated peak SAR locations in the zoom scan.
 - iii) If $SPLSR \leq 0.04$ for 1g SAR, simultaneously transmission SAR measurement is not necessary.
 - iv) Simultaneously transmission SAR measurement, and the reported multi-band 1g SAR < 1.6W/kg.
11. This is a variant report, based on the similarity between current and previous project, added WCDMA Band IV for full SAR testing, other bands only the worse cases from reference original report (Sporton Report Number FA1O1907) were verified for difference. Chose higher SAR between original application and verified to perform co-located SAR analysis.



15.1 Head Exposure Conditions

WWAN Band	Exposure Position	1	2	3	4	1+2	1+3+4
		WWAN	2.4GHz WLAN Ant 6	5GHz WLAN Ant 6	Bluetooth Ant 6	Summed	Summed
		1g SAR (W/kg)	1g SAR (W/kg)	1g SAR (W/kg)	1g SAR (W/kg)	1g SAR (W/kg)	1g SAR (W/kg)
GSM850Ant 0	Right Cheek	0.206	0.394	0.306	0.031	0.600	0.543
	Right Tilted	0.100	0.429	0.300	0.124	0.529	0.524
	Left Cheek	0.123	0.257	0.218	0.037	0.380	0.378
	Left Tilted	0.077	0.341	0.245	0.043	0.418	0.365
GSM1900Ant 1	Right Cheek	0.012	0.394	0.306	0.031	0.406	0.349
	Right Tilted	0.009	0.429	0.300	0.124	0.438	0.433
	Left Cheek	0.072	0.257	0.218	0.037	0.329	0.327
	Left Tilted	0.010	0.341	0.245	0.043	0.351	0.298
WCDMA IVAnt 1	Right Cheek	0.018	0.394	0.306	0.031	0.412	0.355
	Right Tilted	0.007	0.429	0.300	0.124	0.436	0.431
	Left Cheek	0.029	0.257	0.218	0.037	0.286	0.284
	Left Tilted	0.007	0.341	0.245	0.043	0.348	0.295
LTE Band 12Ant 0	Right Cheek	0.315	0.394	0.306	0.031	0.709	0.652
	Right Tilted	0.158	0.429	0.300	0.124	0.587	0.582
	Left Cheek	0.209	0.257	0.218	0.037	0.466	0.464
	Left Tilted	0.136	0.341	0.245	0.043	0.477	0.424



15.2 Hotspot Exposure Conditions

WWAN Band	Exposure Position	1	2	3	1+2	1+3
		WWAN	2.4GHz WLAN Ant 6	Bluetooth Ant 6	Summed	Summed
		1g SAR (W/kg)	1g SAR (W/kg)	1g SAR (W/kg)	1g SAR (W/kg)	1g SAR (W/kg)
GSM850Ant 0	Front	0.164	0.110	0.010	0.274	0.174
	Back	0.147	0.120	0.041	0.267	0.188
	Left Side	0.150	0.063	0.008	0.213	0.158
	Right Side	0.126	0.083	0.006	0.209	0.132
	Top Side		0.089	0.015	0.089	0.015
	Bottom side	0.103			0.103	0.103
GSM1900Ant 1	Front	0.146	0.110	0.010	0.256	0.156
	Back	0.232	0.120	0.041	0.352	0.273
	Left Side	0.087	0.063	0.008	0.150	0.095
	Right Side	0.132	0.083	0.006	0.215	0.138
	Top Side		0.089	0.015	0.089	0.015
	Bottom side	0.111			0.111	0.111
WCDMA IVAnt 1	Front	0.119	0.110	0.010	0.229	0.129
	Back	0.134	0.120	0.041	0.254	0.175
	Left Side	0.095	0.063	0.008	0.158	0.103
	Right Side	0.019	0.083	0.006	0.102	0.025
	Top Side		0.089	0.015	0.089	0.015
	Bottom side	0.006			0.006	0.006
LTE Band 12Ant 0	Front	0.367	0.110	0.010	0.477	0.377
	Back	0.387	0.120	0.041	0.507	0.428
	Left Side	0.281	0.063	0.008	0.344	0.289
	Right Side	0.424	0.083	0.006	0.507	0.430
	Top Side		0.089	0.015	0.089	0.015
	Bottom side	0.198			0.198	0.198



15.3 Body-Worn Accessory Exposure Conditions

WWAN Band	Exposure Position	1	2	3	4	1+2	1+3+4
		WWAN	2.4GHz WLAN Ant 6	5GHz WLAN Ant 6	Bluetooth Ant 6	Summed	Summed
		1g SAR (W/kg)	1g SAR (W/kg)	1g SAR (W/kg)	10g SAR (W/kg)	1g SAR (W/kg)	1g SAR (W/kg)
GSM850Ant 0	Front	0.159	0.021	0.069	0.010	0.159	0.228
	Back	0.144	0.050	0.274	0.021	0.144	0.418
GSM1900Ant 1	Front	0.074	0.021	0.069	0.010	0.074	0.143
	Back	0.146	0.050	0.274	0.021	0.146	0.420
WCDMA IVAnt 1	Front	0.070	0.021	0.069	0.010	0.091	0.149
	Back	0.071	0.050	0.274	0.021	0.121	0.366
LTE Band 12Ant 0	Front	0.322	0.021	0.069	0.010	0.343	0.401
	Back	0.327	0.050	0.274	0.021	0.377	0.622

Test Engineer: Nick Hu, Seven Xu, Bruce Li, Tony Zhang



16. Uncertainty Assessment

Per KDB 865664 D01 SAR measurement 100MHz to 6GHz, when the highest measured 1-g SAR within a frequency band is < 1.5 W/kg and the measured 10-g SAR within a frequency band is < 3.75 W/kg. The expanded SAR measurement uncertainty must be $\leq 30\%$, for a confidence interval of $k = 2$. If these conditions are met, extensive SAR measurement uncertainty analysis described in IEEE Std 1528-2013 is not required in SAR reports submitted for equipment approval. For this device, the highest measured 1-g SAR is less 1.5W/kg and highest measured 10-g SAR is less 3.75W/kg. Therefore, the measurement uncertainty table is not required in this report.

Declaration of Conformity:

The test results with all measurement uncertainty excluded is presented in accordance with the regulation limits or requirements declared by manufacturers.

Comments and Explanations:

The declared of product specification for EUT presented in the report are provided by the manufacturer, and the manufacturer takes all the responsibilities for the accuracy of product specification.

17. References

- [1] FCC 47 CFR Part 2 "Frequency Allocations and Radio Treaty Matters; General Rules and Regulations"
- [2] ANSI/IEEE Std. C95.1-1992, "IEEE Standard for Safety Levels with Respect to Human Exposure to Radio Frequency Electromagnetic Fields, 3 kHz to 300 GHz", September 1992
- [3] IEEE Std. 1528-2013, "IEEE Recommended Practice for Determining the Peak Spatial-Average Specific Absorption Rate (SAR) in the Human Head from Wireless Communications Devices: Measurement Techniques", Sep 2013
- [4] SPEAG DASY System Handbook
- [5] FCC KDB 248227 D01 v02r02, "SAR Guidance for IEEE 802.11 (WiFi) Transmitters", Oct 2015.
- [6] FCC KDB 447498 D01 v06, "Mobile and Portable Device RF Exposure Procedures and Equipment Authorization Policies", Oct 2015
- [7] FCC KDB 648474 D04 v01r03, "SAR Evaluation Considerations for Wireless Handsets", Oct 2015.
- [8] FCC KDB 941225 D01 v03r01, "3G SAR MEAUREMENT PROCEDURES", Oct 2015
- [9] FCC KDB 941225 D05 v02r05, "SAR Evaluation Considerations for LTE Devices", Dec 2015
- [10] FCC KDB 941225 D05A v01r02, "Rel. 10 LTE SAR Test Guidance and KDB Inquiries", Oct 2015
- [11] FCC KDB 941225 D06 v02r01, "SAR Evaluation Procedures for Portable Devices with Wireless Router Capabilities", Oct 2015.
- [12] FCC KDB 865664 D01 v01r04, "SAR Measurement Requirements for 100 MHz to 6 GHz", Aug 2015.
- [13] FCC KDB 865664 D02 v01r02, "RF Exposure Compliance Reporting and Documentation Considerations" Oct 2015.



Appendix A. Plots of System Performance Check

The plots are shown as follows.

System Check_Head_750MHz

DUT: D750V3 - SN:1087

Communication System: UID 0, CW (0); Frequency: 750 MHz; Duty Cycle: 1:1

Medium: HSL_750 Medium parameters used: $f = 750 \text{ MHz}$; $\sigma = 0.915 \text{ S/m}$; $\epsilon_r = 43.396$; $\rho = 1000 \text{ kg/m}^3$

Ambient Temperature : 23.3 °C; Liquid Temperature : 22.8 °C

DASY5 Configuration:

- Probe: EX3DV4 - SN7627; ConvF(10.47, 10.47, 10.47); Calibrated: 2021.2.10
- Sensor-Surface: 1.4mm (Mechanical Surface Detection)
- Electronics: DAE4 Sn1649; Calibrated: 2021.2.3
- Phantom: SAM Twin Phantom; Type: SAM Twin; Serial: TP-2024
- Measurement SW: DASY52, Version 52.10 (4); SEMCAD X Version 14.6.14 (7483)

Pin=50mW/Area Scan (61x61x1): Interpolated grid: $dx=1.500 \text{ mm}$, $dy=1.500 \text{ mm}$
Maximum value of SAR (interpolated) = 0.583 W/kg

Pin=50mW/Zoom Scan (5x5x7)/Cube 0: Measurement grid: $dx=8\text{mm}$, $dy=8\text{mm}$, $dz=5\text{mm}$
Reference Value = 26.12 V/m; Power Drift = 0.03 dB
Peak SAR (extrapolated) = 0.677 W/kg
SAR(1 g) = 0.437 W/kg; SAR(10 g) = 0.287 W/kg
Maximum value of SAR (measured) = 0.592 W/kg

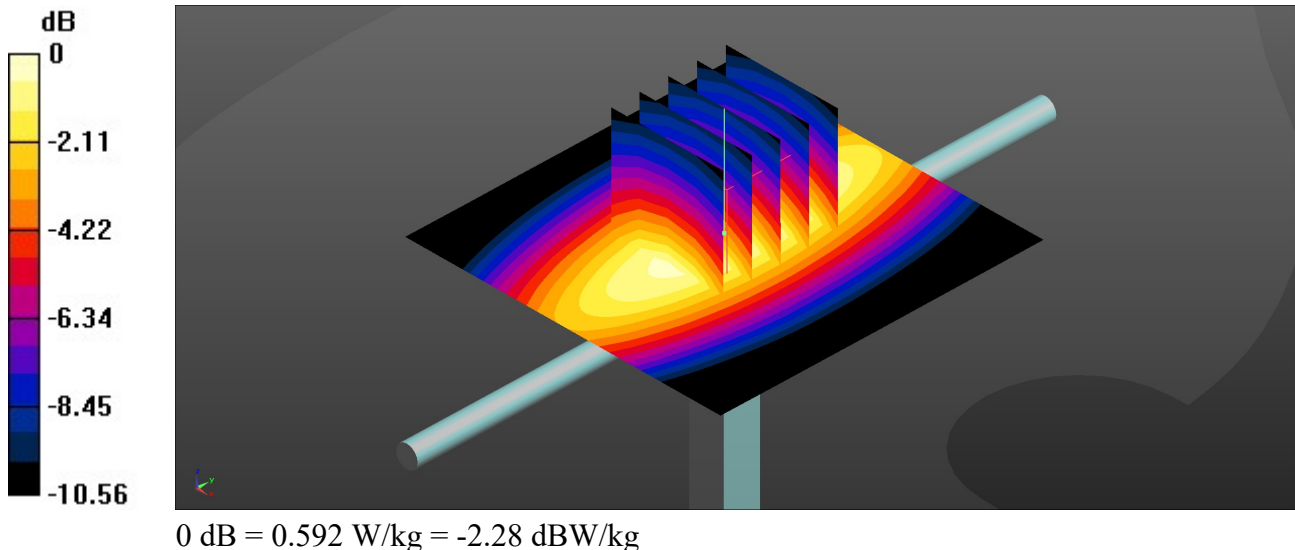

System Check_Head_835MHz

DUT: D835V2 - SN:4d258

Communication System: UID 0, CW (0); Frequency: 835 MHz; Duty Cycle: 1:1

Medium: HSL_835 Medium parameters used: $f = 835 \text{ MHz}$; $\sigma = 0.936 \text{ S/m}$; $\epsilon_r = 43.121$; $\rho = 1000 \text{ kg/m}^3$

Ambient Temperature : 23.2 °C; Liquid Temperature : 22.6 °C

DASY5 Configuration:

- Probe: EX3DV4 - SN7627; ConvF(10.21, 10.21, 10.21); Calibrated: 2021.2.10
- Sensor-Surface: 1.4mm (Mechanical Surface Detection)
- Electronics: DAE4 Sn1649; Calibrated: 2021.2.3
- Phantom: SAM Twin Phantom; Type: SAM Twin; Serial: TP-2024
- Measurement SW: DASY52, Version 52.10 (4); SEMCAD X Version 14.6.14 (7483)

Pin=50mW/Area Scan (61x61x1): Interpolated grid: $dx=1.500 \text{ mm}$, $dy=1.500 \text{ mm}$
Maximum value of SAR (interpolated) = 0.671 W/kg

Pin=50mW/Zoom Scan (5x5x7)/Cube 0: Measurement grid: $dx=8\text{mm}$, $dy=8\text{mm}$, $dz=5\text{mm}$
Reference Value = 27.84 V/m; Power Drift = 0.02 dB
Peak SAR (extrapolated) = 0.765 W/kg
SAR(1 g) = 0.501 W/kg; SAR(10 g) = 0.328 W/kg
Maximum value of SAR (measured) = 0.673 W/kg

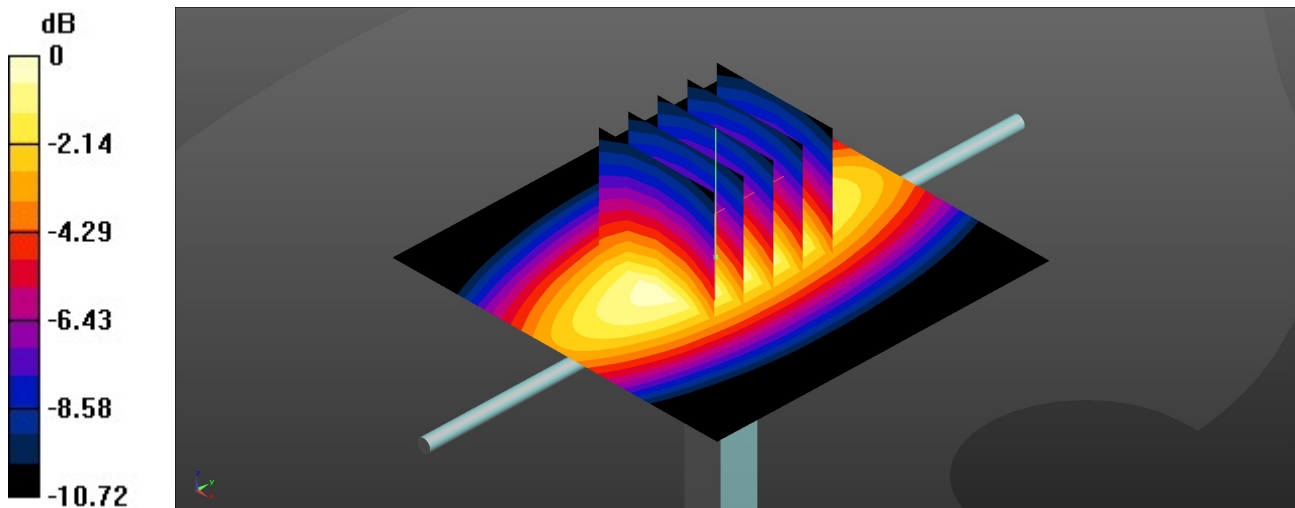

0 dB = 0.673 W/kg = -1.72 dBW/kg

System Check_Head_1750MHz

DUT: D1750V2 - SN:1090

Communication System: UID 0, CW (0); Frequency: 1750 MHz; Duty Cycle: 1:1
Medium: HSL_1750 Medium parameters used: $f = 1750$ MHz; $\sigma = 1.401$ S/m; $\epsilon_r = 40.492$; $\rho = 1000$

kg/m³

Ambient Temperature : 23.3 °C; Liquid Temperature : 22.6 °C

DASY5 Configuration:

- Probe: EX3DV4 - SN7627; ConvF(8.73, 8.73, 8.73); Calibrated: 2021.2.10
- Sensor-Surface: 1.4mm (Mechanical Surface Detection)
- Electronics: DAE4 Sn1649; Calibrated: 2021.2.3
- Phantom: SAM Twin Phantom; Type: SAM Twin; Serial: TP-2024
- Measurement SW: DASY52, Version 52.10 (4); SEMCAD X Version 14.6.14 (7483)

Pin=50mW/Area Scan (61x61x1): Interpolated grid: dx=1.500 mm, dy=1.500 mm
Maximum value of SAR (interpolated) = 2.91 W/kg

Pin=50mW/Zoom Scan (5x5x7)/Cube 0: Measurement grid: dx=8mm, dy=8mm, dz=5mm

Reference Value = 46.72 V/m; Power Drift = 0.06 dB

Peak SAR (extrapolated) = 3.48 W/kg

SAR(1 g) = 1.9 W/kg; SAR(10 g) = 1.01 W/kg

Maximum value of SAR (measured) = 2.92 W/kg

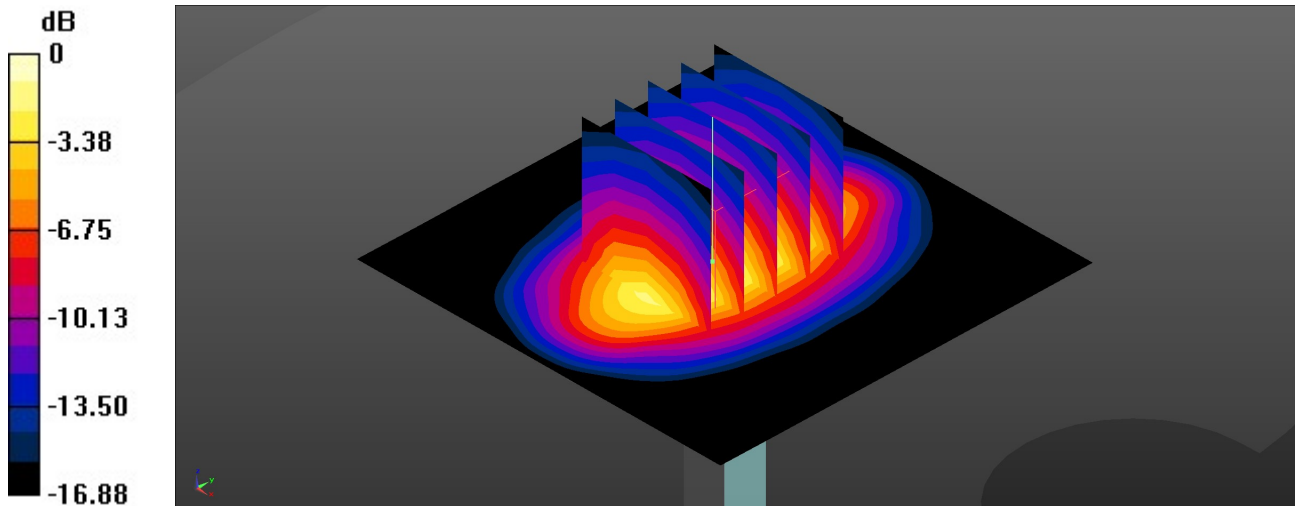

0 dB = 2.92 W/kg = 4.65 dBW/kg

System Check_Head_1900MHz

DUT: D1900V2 - SN:5d170

Communication System: UID 0, CW (0); Frequency: 1900 MHz; Duty Cycle: 1:1

Medium: HSL_1900 Medium parameters used: $f = 1900$ MHz; $\sigma = 1.458$ S/m; $\epsilon_r = 40.307$; $\rho = 1000$ kg/m³

Ambient Temperature : 23.1 °C; Liquid Temperature : 22.9 °C

DASY5 Configuration:

- Probe: EX3DV4 - SN7627; ConvF(8.46, 8.46, 8.46); Calibrated: 2021.2.10
- Sensor-Surface: 1.4mm (Mechanical Surface Detection)
- Electronics: DAE4 Sn1649; Calibrated: 2021.2.3
- Phantom: SAM Twin Phantom; Type: SAM Twin; Serial: TP-2024
- Measurement SW: DASY52, Version 52.10 (4); SEMCAD X Version 14.6.14 (7483)

Pin=50mW/Area Scan (61x61x1): Interpolated grid: dx=1.500 mm, dy=1.500 mm
Maximum value of SAR (interpolated) = 3.21 W/kg

Pin=50mW/Zoom Scan (5x5x7)/Cube 0: Measurement grid: dx=8mm, dy=8mm, dz=5mm
Reference Value = 47.31 V/m; Power Drift = 0.01 dB
Peak SAR (extrapolated) = 3.87 W/kg
SAR(1 g) = 2.04 W/kg; SAR(10 g) = 1.06 W/kg
Maximum value of SAR (measured) = 3.22 W/kg

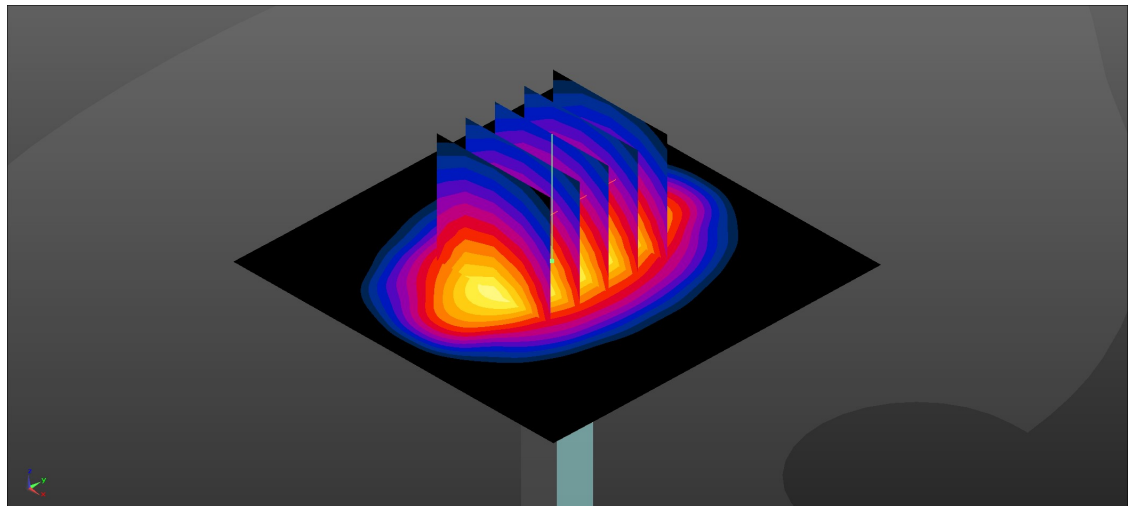
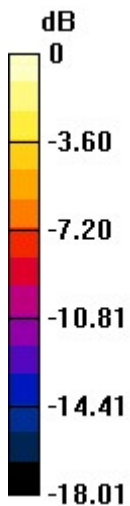

0 dB = 3.22 W/kg = 5.08 dBW/kg

System Check_Head_2450MHz

DUT: D2450V2 - SN:908

Communication System: UID 0, CW (0); Frequency: 2450 MHz; Duty Cycle: 1:1

Medium: HSL_2450 Medium parameters used: $f = 2450$ MHz; $\sigma = 1.872$ S/m; $\epsilon_r = 40.81$; $\rho = 1000$ kg/m³

Ambient Temperature : 23.4 °C; Liquid Temperature : 22.7 °C

DASY5 Configuration:

- Probe: EX3DV4 - SN7627; ConvF(8, 8, 8); Calibrated: 2021.2.10
- Sensor-Surface: 1.4mm (Mechanical Surface Detection)
- Electronics: DAE4 Sn1649; Calibrated: 2021.2.3
- Phantom: SAM Twin Phantom; Type: SAM Twin; Serial: TP-2024
- Measurement SW: DASY52, Version 52.10 (4); SEMCAD X Version 14.6.14 (7483)

Pin=50mW/Area Scan (71x71x1): Interpolated grid: dx=1.200 mm, dy=1.200 mm
Maximum value of SAR (interpolated) = 4.23 W/kg

Pin=50mW/Zoom Scan (7x7x7)/Cube 0: Measurement grid: dx=5mm, dy=5mm, dz=5mm
Reference Value = 49.78 V/m; Power Drift = -0.03 dB
Peak SAR (extrapolated) = 5.22 W/kg
SAR(1 g) = 2.57 W/kg; SAR(10 g) = 1.21 W/kg
Maximum value of SAR (measured) = 4.25 W/kg

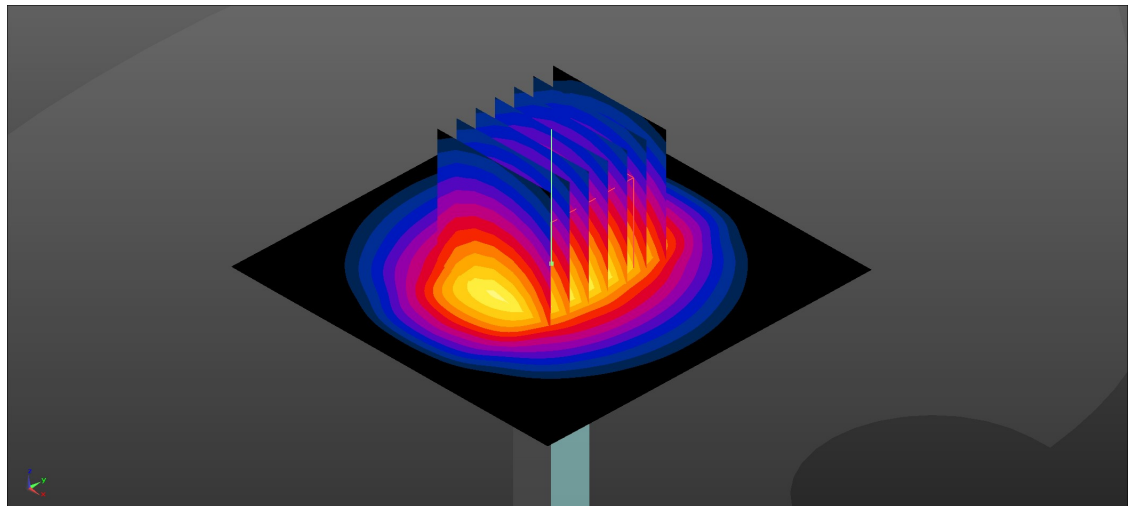
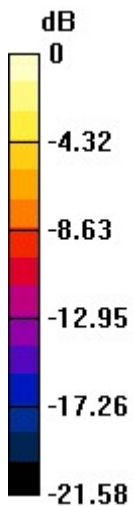

0 dB = 4.25 W/kg = 6.28 dBW/kg

System Check_Head_5250MHz

DUT: D5GHzV2 - SN:1113

Communication System: UID 0, CW (0); Frequency: 5250 MHz; Duty Cycle: 1:1

Medium: HSL_5000 Medium parameters used: $f = 5250$ MHz; $\sigma = 4.58$ S/m; $\epsilon_r = 36.3$; $\rho = 1000$ kg/m³

Ambient Temperature : 23.3 °C; Liquid Temperature : 22.7 °C

DASY5 Configuration:

- Probe: EX3DV4 - SN7627; ConvF(5.69, 5.69, 5.69); Calibrated: 2021.2.10
- Sensor-Surface: 1.4mm (Mechanical Surface Detection)
- Electronics: DAE4 Sn1649; Calibrated: 2021.2.3
- Phantom: SAM Twin Phantom; Type: SAM Twin; Serial: TP-2024
- Measurement SW: DASY52, Version 52.10 (4); SEMCAD X Version 14.6.14 (7483)

Pin=50mW/Area Scan (91x91x1): Interpolated grid: dx=1.000 mm, dy=1.000 mm

Maximum value of SAR (interpolated) = 7.85 W/kg

Pin=50mW/Zoom Scan (9x9x7)/Cube 0: Measurement grid: dx=4mm, dy=4mm, dz=1.4mm

Reference Value = 47.20 V/m; Power Drift = -0.02 dB

Peak SAR (extrapolated) = 13.4 W/kg

SAR(1 g) = 3.77 W/kg; SAR(10 g) = 1.17 W/kg

Maximum value of SAR (measured) = 8.36 W/kg

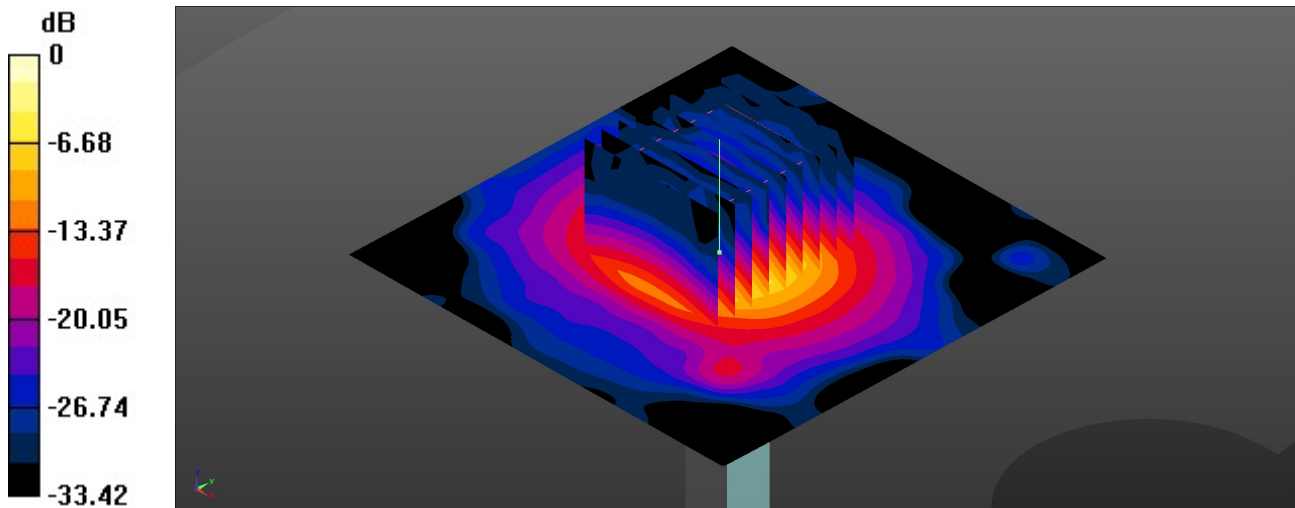

System Check_Head_5600MHz

DUT: D5GHzV2 - SN:1113

Communication System: UID 0, CW (0); Frequency: 5600 MHz; Duty Cycle: 1:1

Medium: HSL_5000 Medium parameters used: $f = 5600$ MHz; $\sigma = 4.947$ S/m; $\epsilon_r = 35.74$; $\rho = 1000$ kg/m³

Ambient Temperature : 23.1 °C; Liquid Temperature : 22.6 °C

DASY5 Configuration:

- Probe: EX3DV4 - SN7627; ConvF(4.89, 4.89, 4.89); Calibrated: 2021.2.10
- Sensor-Surface: 1.4mm (Mechanical Surface Detection)
- Electronics: DAE4 Sn1649; Calibrated: 2021.2.3
- Phantom: SAM Twin Phantom; Type: SAM Twin; Serial: TP-2024
- Measurement SW: DASY52, Version 52.10 (4); SEMCAD X Version 14.6.14 (7483)

Pin=50mW/Area Scan (91x91x1): Interpolated grid: dx=1.000 mm, dy=1.000 mm
Maximum value of SAR (interpolated) = 8.96 W/kg

Pin=50mW/Zoom Scan (7x7x7)/Cube 0: Measurement grid: dx=4mm, dy=4mm, dz=1.4mm
Reference Value = 47.91 V/m; Power Drift = 0.04 dB
Peak SAR (extrapolated) = 16.1 W/kg
SAR(1 g) = 3.92 W/kg; SAR(10 g) = 1.14 W/kg
Maximum value of SAR (measured) = 9.61 W/kg

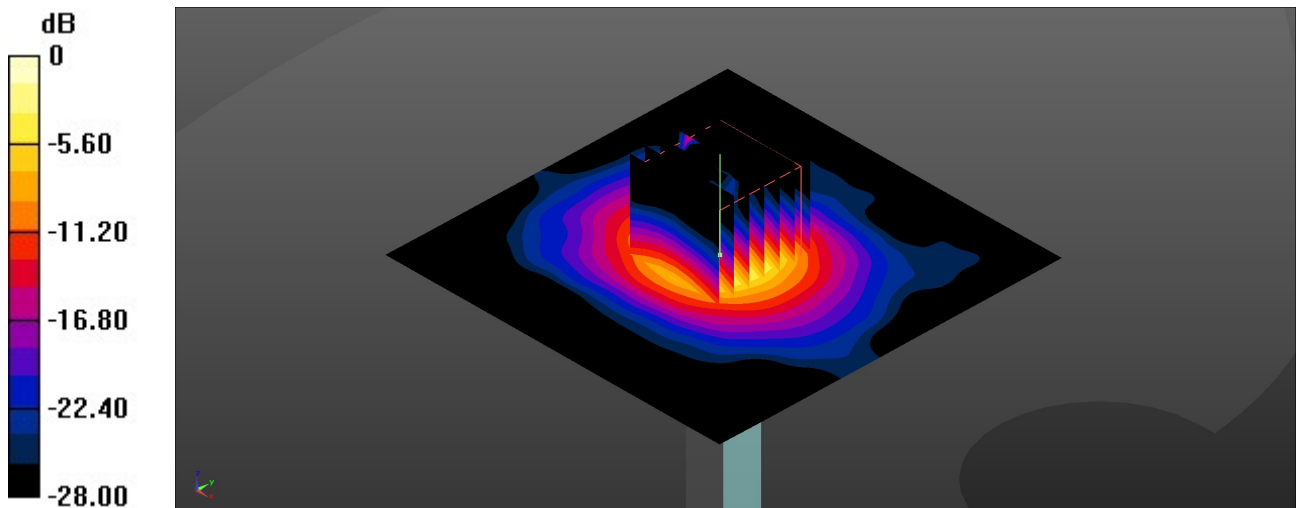

0 dB = 9.61 W/kg = 9.83 dBW/kg

System Check_Head_5750MHz

DUT: D5GHzV2 - SN:1113

Communication System: UID 0, CW (0); Frequency: 5750 MHz;Duty Cycle: 1:1

Medium: HSL_5000 Medium parameters used: $f = 5750$ MHz; $\sigma = 5.129$ S/m; $\epsilon_r = 35.552$; $\rho = 1000$ kg/m³

Ambient Temperature : 23.4 °C; Liquid Temperature : 22.6 °C

DASY5 Configuration:

- Probe: EX3DV4 - SN7627; ConvF(4.92, 4.92, 4.92); Calibrated: 2021.2.10
- Sensor-Surface: 1.4mm (Mechanical Surface Detection)
- Electronics: DAE4 Sn1649; Calibrated: 2021.2.3
- Phantom: SAM Twin Phantom; Type: SAM Twin; Serial: TP-2024
- Measurement SW: DASY52, Version 52.10 (4); SEMCAD X Version 14.6.14 (7483)

Pin=50mW/Area Scan (91x91x1): Interpolated grid: dx=1.000 mm, dy=1.000 mm
Maximum value of SAR (interpolated) = 8.19 W/kg

Pin=50mW/Zoom Scan (7x7x7)/Cube 0: Measurement grid: dx=4mm, dy=4mm, dz=1.4mm
Reference Value = 45.27 V/m; Power Drift = 0.01 dB
Peak SAR (extrapolated) = 15.5 W/kg
SAR(1 g) = 3.71 W/kg; SAR(10 g) = 1.21 W/kg
Maximum value of SAR (measured) = 8.99 W/kg

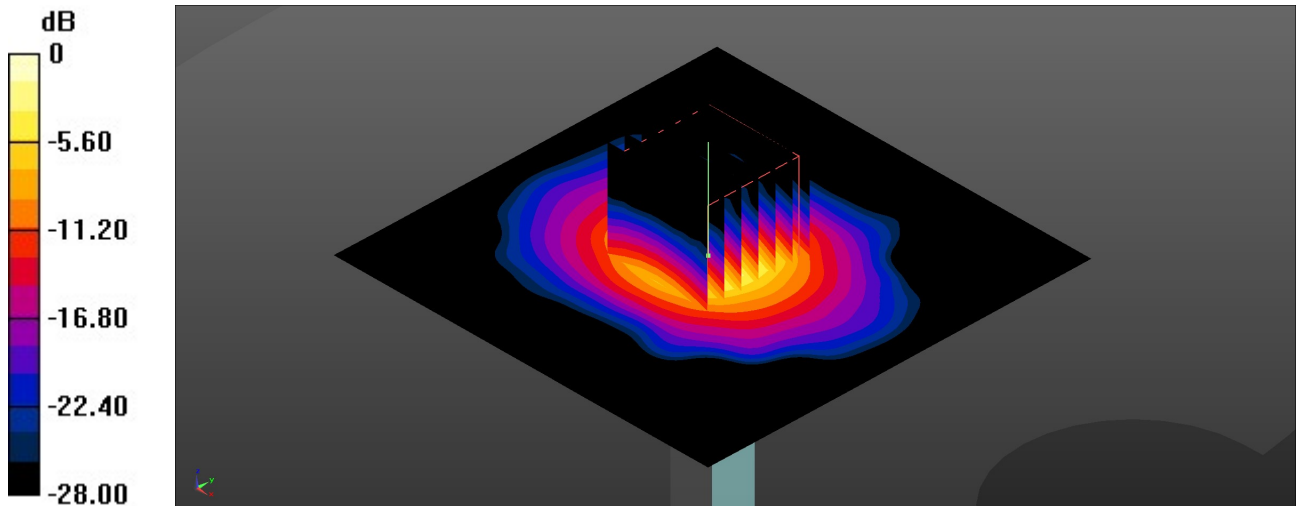

0 dB = 8.99 W/kg = 9.54 dBW/kg



Appendix B. Plots of SAR Measurement

The plots are shown as follows.

01_GSM850_GPRS (4 Tx slots)_Right Cheek_0mm_Ch189

Communication System: UID 0, GSM850 (0); Frequency: 836.4 MHz; Duty Cycle: 1:2.08
Medium: HSL_835 Medium parameters used: $f = 836.4$ MHz; $\sigma = 0.94$ S/m; $\epsilon_r = 43.121$; $\rho = 1000$ kg/m³

Ambient Temperature : 23.2 °C; Liquid Temperature : 22.6 °C

DASY5 Configuration:

- Probe: EX3DV4 - SN7627; ConvF(10.21, 10.21, 10.21); Calibrated: 2021.2.10
- Sensor-Surface: 1.4mm (Mechanical Surface Detection)
- Electronics: DAE4 Sn1649; Calibrated: 2021.2.3
- Phantom: SAM Twin Phantom; Type: SAM Twin; Serial: TP-2024
- Measurement SW: DASY52, Version 52.10 (4); SEMCAD X Version 14.6.14 (7483)

Area Scan (81x81x1): Interpolated grid: dx=1.500 mm, dy=1.500 mm
Maximum value of SAR (interpolated) = 0.128 W/kg

Zoom Scan (5x5x7)/Cube 0: Measurement grid: dx=8mm, dy=8mm, dz=5mm
Reference Value = 12.25 V/m; Power Drift = 0.11 dB
Peak SAR (extrapolated) = 0.139 W/kg
SAR(1 g) = 0.110 W/kg; SAR(10 g) = 0.087 W/kg
Maximum value of SAR (measured) = 0.127 W/kg

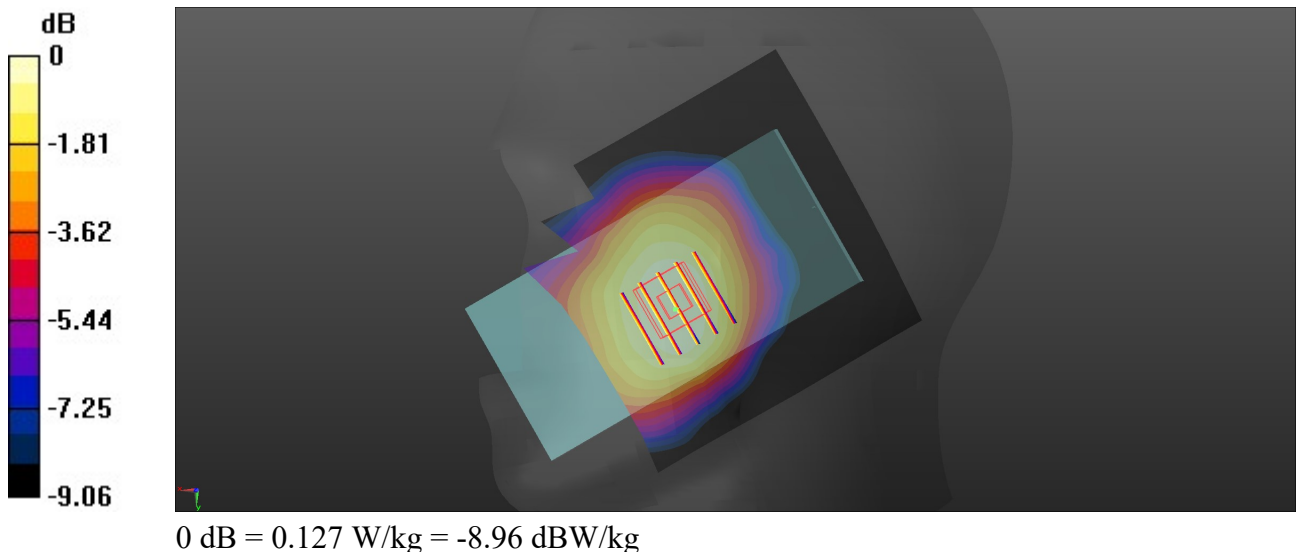

02_GSM1900_GPRS (3 Tx slots)_Left Cheek_0mm_Ch661

Communication System: UID 0, PCS (0); Frequency: 1880 MHz; Duty Cycle: 1:8.3

Medium: HSL_1900 Medium parameters used: $f = 1880$ MHz; $\sigma = 1.466$ S/m; $\epsilon_r = 40.309$; $\rho = 1000$ kg/m³

Ambient Temperature : 23.1 °C; Liquid Temperature : 22.9 °C

DASY5 Configuration:

- Probe: EX3DV4 - SN7627; ConvF(8.46, 8.46, 8.46); Calibrated: 2021.2.10
- Sensor-Surface: 1.4mm (Mechanical Surface Detection)
- Electronics: DAE4 Sn1649; Calibrated: 2021.2.3
- Phantom: SAM Twin Phantom; Type: SAM Twin; Serial: TP-2024
- Measurement SW: DASY52, Version 52.10 (4); SEMCAD X Version 14.6.14 (7483)

Area Scan (71x81x1): Interpolated grid: dx=1.500 mm, dy=1.500 mm

Maximum value of SAR (interpolated) = 0.117 W/kg

Zoom Scan (6x7x7)/Cube 0: Measurement grid: dx=8mm, dy=8mm, dz=5mm

Reference Value = 7.866 V/m; Power Drift = -0.06 dB

Peak SAR (extrapolated) = 0.121 W/kg

SAR(1 g) = 0.055 W/kg; SAR(10 g) = 0.0226 W/kg

Maximum value of SAR (measured) = 0.121 W/kg

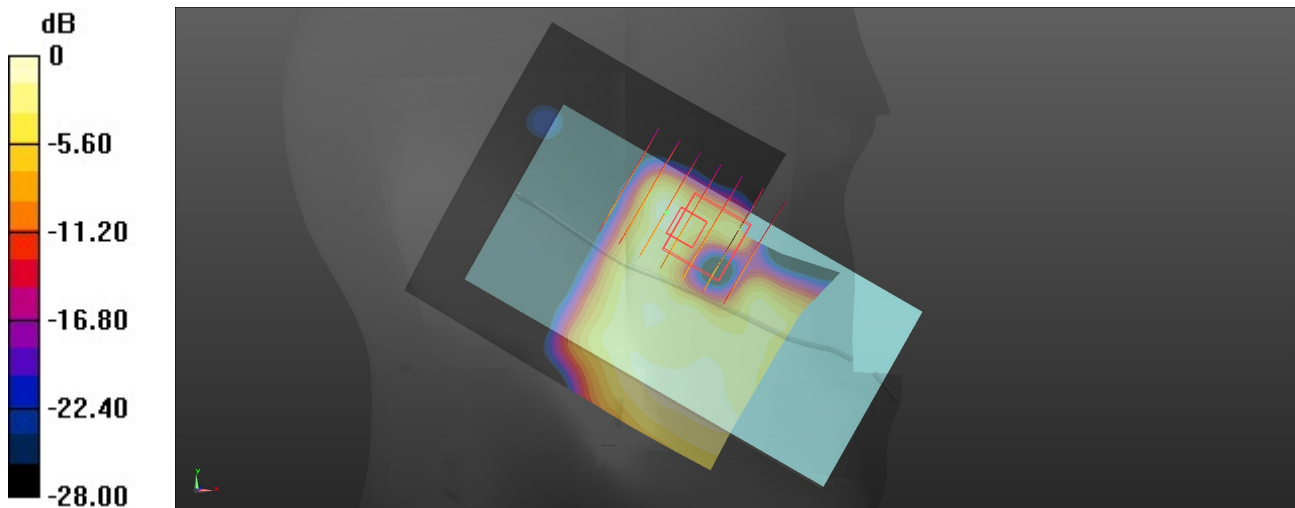

0 dB = 0.121 W/kg = -9.17 dBW/kg

03_WCDMA IV_RMC 12.2Kbps_Left Cheek_0mm_Ch1413

Communication System: UID 0, WCDMA (0); Frequency: 1732.6 MHz; Duty Cycle: 1:1
Medium: HSL_1750 Medium parameters used: $f = 1732.6$ MHz; $\sigma = 1.391$ S/m; $\epsilon_r = 40.57$; $\rho = 1000$ kg/m³

Ambient Temperature : 23.3 °C; Liquid Temperature : 22.6 °C

DASY5 Configuration:

- Probe: EX3DV4 - SN7627; ConvF(8.73, 8.73, 8.73); Calibrated: 2021.2.10
- Sensor-Surface: 1.4mm (Mechanical Surface Detection)
- Electronics: DAE4 Sn1649; Calibrated: 2021.2.3
- Phantom: SAM Twin Phantom; Type: SAM Twin; Serial: TP-2024
- Measurement SW: DASY52, Version 52.10 (4); SEMCAD X Version 14.6.14 (7483)

Area Scan (81x91x1): Interpolated grid: dx=1.500 mm, dy=1.500 mm

Maximum value of SAR (interpolated) = 0.0341 W/kg

Zoom Scan (6x8x7)/Cube 0: Measurement grid: dx=8mm, dy=8mm, dz=5mm

Reference Value = 6.208 V/m; Power Drift = -0.04 dB

Peak SAR (extrapolated) = 0.0379 W/kg

SAR(1 g) = 0.026 W/kg; SAR(10 g) = 0.0171 W/kg

Maximum value of SAR (measured) = 0.0329 W/kg

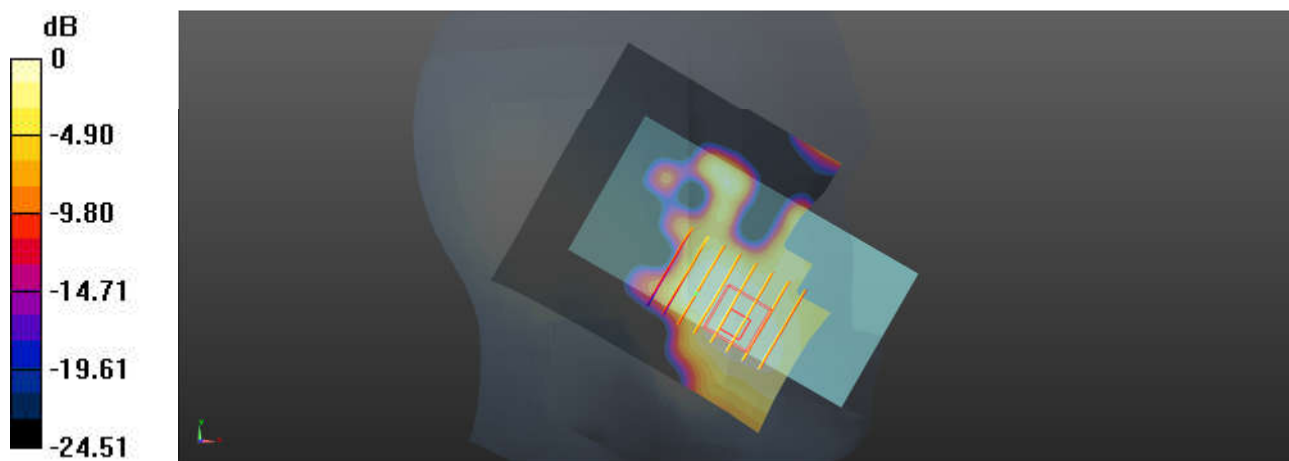

0 dB = 0.0329 W/kg = -14.83 dBW/kg

04_LTE Band 12_10M_QPSK_1RB_0Offset_Right Cheek_0mm_Ch23095

Communication System: UID 0, LTE-FDD (0); Frequency: 707.5 MHz; Duty Cycle: 1:1
Medium: HSL_750 Medium parameters used: $f = 707.5$ MHz; $\sigma = 0.899$ S/m; $\epsilon_r = 43.509$; $\rho = 1000$ kg/m³

Ambient Temperature : 23.3 °C; Liquid Temperature : 22.8 °C

DASY5 Configuration:

- Probe: EX3DV4 - SN7627; ConvF(10.47, 10.47, 10.47); Calibrated: 2021.2.10
- Sensor-Surface: 1.4mm (Mechanical Surface Detection)
- Electronics: DAE4 Sn1649; Calibrated: 2021.2.3
- Phantom: SAM Twin Phantom; Type: SAM Twin; Serial: TP-2024
- Measurement SW: DASY52, Version 52.10 (4); SEMCAD X Version 14.6.14 (7483)

Area Scan (71x81x1): Interpolated grid: dx=1.500 mm, dy=1.500 mm
Maximum value of SAR (interpolated) = 0.207 W/kg

Zoom Scan (5x5x7)/Cube 0: Measurement grid: dx=8mm, dy=8mm, dz=5mm
Reference Value = 17.64 V/m; Power Drift = -0.09 dB
Peak SAR (extrapolated) = 0.222 W/kg
SAR(1 g) = 0.188 W/kg; SAR(10 g) = 0.134 W/kg
Maximum value of SAR (measured) = 0.205 W/kg

