



# **CERTIFICATION TEST REPORT**

**Report Number. :** 12097277-E5V2

**Applicant :** SONY MOBILE COMMUNICATIONS INC.  
4-12-3 HIGASHI-SHINAGAWA, SHINAGAWA-KU  
TOKYO, 140-0002, JAPAN

**FCC ID :** PY7-72474U

**EUT Description :** GSM/WCDMA/LTE PHONE with BT, DTS/UNII a/b/g/n/ac & NFC

**Test Standard(s) :** FCC 47 CFR PART 15 SUBPART E (EXCEPT DFS)

**Date Of Issue:**

January 29, 2018

**Prepared by:**

UL Verification Services Inc.  
47173 Benicia Street  
Fremont, CA 94538, U.S.A.  
TEL: (510) 771-1000  
FAX: (510) 661-0888



---

Revision History

<u>Rev.</u>	<u>Issue Date</u>	<u>Revisions</u>	<u>Revised By</u>
V1	01/24/18	Initial Issue	Dan Corona
V2	01/29/18	Updated Section 5.3, 9.4.1, 9.4.2 & 9.8.3	Kiya Kedida

---

## TABLE OF CONTENTS

<b>1. ATTESTATION OF TEST RESULTS .....</b>	<b>6</b>
<b>2. TEST METHODOLOGY.....</b>	<b>7</b>
<b>3. FACILITIES AND ACCREDITATION .....</b>	<b>7</b>
<b>4. CALIBRATION AND UNCERTAINTY .....</b>	<b>7</b>
4.1. MEASURING INSTRUMENT CALIBRATION.....	7
4.2. SAMPLE CALCULATION.....	7
4.3. MEASUREMENT UNCERTAINTY.....	8
<b>5. EQUIPMENT UNDER TEST .....</b>	<b>9</b>
5.1. DESCRIPTION OF EUT.....	9
5.2. MAXIMUM OUTPUT POWER.....	9
5.3. DESCRIPTION OF AVAILABLE ANTENNAS.....	10
5.4. SOFTWARE AND FIRMWARE.....	10
5.5. LIST OF TEST REDUCTION AND MODES .....	10
5.6. WORST-CASE CONFIGURATION AND MODE .....	11
5.7. DESCRIPTION OF TEST SETUP.....	12
<b>6. TEST AND MEASUREMENT EQUIPMENT .....</b>	<b>15</b>
<b>7. MEASUREMENT METHODS .....</b>	<b>16</b>
<b>8. ON TIME, DUTY CYCLE AND MEASUREMENT METHODS.....</b>	<b>17</b>
8.1. ON TIME AND DUTY CYCLE.....	17
<b>9. ANTENNA PORT TEST RESULTS .....</b>	<b>20</b>
9.1. 11a 2TX CDD MIMO MODE IN THE 5.2GHz BAND .....	20
9.1.1. 26 dB BANDWIDTH .....	20
9.1.2. 99% BANDWIDTH .....	24
9.1.3. OUTPUT POWER AND PPSD .....	28
9.2. 11n HT20 2TX CDD MIMO MODE IN THE 5.2GHz BAND.....	34
9.2.1. 26 dB BANDWIDTH.....	34
9.2.2. 99% BANDWIDTH .....	38
9.2.3. OUTPUT POWER AND PPSD .....	42
9.3. 11n HT40 2TX CDD MIMO MODE IN THE 5.2GHz BAND.....	48
9.3.1. 26 dB BANDWIDTH.....	48
9.3.2. 99% BANDWIDTH .....	51
9.3.3. OUTPUT POWER AND PPSD .....	54

---

9.4.	11ac HT80 2TX CDD MIMO MODE IN THE 5.2GHz BAND.....	59
9.4.1.	26 dB BANDWIDTH.....	59
9.4.2.	99% BANDWIDTH.....	61
9.4.3.	OUTPUT POWER AND PPSD.....	63
9.5.	11a 2TX CDD MIMO MODE IN THE 5.3GHz BAND.....	67
9.5.1.	26 dB BANDWIDTH.....	67
9.5.2.	99% BANDWIDTH.....	71
9.5.3.	OUTPUT POWER AND PPSD.....	75
9.6.	11n HT20 2TX CDD MIMO MODE IN THE 5.3GHz BAND.....	81
9.6.1.	26 dB BANDWIDTH.....	81
9.6.2.	99% BANDWIDTH.....	85
9.6.3.	OUTPUT POWER AND PPSD.....	89
9.7.	11n HT40 2TX CDD MIMO MODE IN THE 5.3GHz BAND.....	95
9.7.1.	26 dB BANDWIDTH.....	95
9.7.2.	99% BANDWIDTH.....	98
9.7.3.	OUTPUT POWER AND PPSD.....	101
9.8.	11ac HT80 2TX CDD MIMO MODE IN THE 5.3GHz BAND.....	106
9.8.1.	26 dB BANDWIDTH.....	106
9.8.2.	99% BANDWIDTH.....	108
9.8.3.	OUTPUT POWER AND PPSD.....	110
9.9.	11a 2TX CDD MIMO MODE IN THE 5.6GHz BAND.....	113
9.9.1.	26 dB BANDWIDTH.....	113
9.9.2.	99% BANDWIDTH.....	119
9.9.3.	OUTPUT POWER AND PPSD.....	125
9.10.	11n HT20 2TX CDD MIMO MODE IN THE 5.6GHz BAND.....	132
9.10.1.	26 dB BANDWIDTH.....	132
9.10.2.	99% BANDWIDTH.....	138
9.10.3.	OUTPUT POWER AND PPSD.....	144
9.11.	11n HT40 2TX CDD MIMO MODE IN THE 5.6GHz BAND.....	151
9.11.1.	26 dB BANDWIDTH.....	151
9.11.2.	99% BANDWIDTH.....	157
9.11.3.	OUTPUT POWER AND PPSD.....	163
9.12.	11ac HT80 2TX CDD MIMO MODE IN THE 5.6GHz BAND.....	170
9.12.1.	26 dB BANDWIDTH.....	170
9.12.2.	99% BANDWIDTH.....	174
9.12.3.	OUTPUT POWER AND PPSD.....	178
9.13.	11a 2TX CDD MIMO MODE IN THE 5.8GHz BAND.....	183
9.13.1.	6 dB BANDWIDTH.....	183
9.13.2.	99% BANDWIDTH.....	188
9.13.3.	OUTPUT POWER AND PSD.....	192
9.14.	11n HT20 2TX CDD MIMO MODE IN THE 5.8GHz BAND.....	197
9.14.1.	6 dB BANDWIDTH.....	197
9.14.2.	99% BANDWIDTH.....	202
9.14.3.	OUTPUT POWER AND PSD.....	206
9.15.	11n HT40 2TX CDD MIMO MODE IN THE 5.8GHz BAND.....	211
9.15.1.	6 dB BANDWIDTH.....	211
9.15.2.	99% BANDWIDTH.....	215

---

9.15.3.	OUTPUT POWER AND PSD .....	218
9.16.	11ac HT80 2TX CDD MIMO MODE IN THE 5.8GHz BAND .....	222
9.16.1.	6 dB BANDWIDTH .....	222
9.16.2.	99% BANDWIDTH.....	225
9.16.3.	OUTPUT POWER AND PSD .....	227
<b>10.</b>	<b>RADIATED TEST RESULTS .....</b>	<b>230</b>
10.1.	LIMITS AND PROCEDURE.....	230
10.1.1.	11a 2TX CDD MIMO MODE IN THE 5.2GHz BAND.....	231
10.1.2.	11n HT20 2TX CDD MIMO MODE IN THE 5.2GHz BAND .....	239
10.1.3.	11n HT40 2TX CDD MIMO MODE IN THE 5.2GHz BAND .....	247
10.1.4.	11ac HT80 2TX CDD MIMO MODE IN THE 5.2GHz BAND .....	253
10.1.5.	11a 2TX CDD MIMO MODE IN THE 5.3GHz BAND.....	257
10.1.6.	11n HT20 2TX CDD MIMO MODE IN THE 5.3GHz BAND .....	265
10.1.7.	11n HT40 2TX CDD MIMO MODE IN THE 5.3GHz BAND .....	273
10.1.8.	11ac HT80 2TX CDD MIMO MODE IN THE 5.3GHz BAND .....	279
10.1.9.	11a 2TX CDD MIMO MODE IN THE 5.6GHz BAND.....	283
10.1.10.	11n HT20 2TX CDD MIMO MODE IN THE 5.6GHz BAND .....	297
10.1.11.	11n HT40 2TX CDD MIMO MODE IN THE 5.6GHz BAND .....	311
10.1.12.	11ac HT80 2TX CDD MIMO MODE IN THE 5.6GHz BAND .....	325
10.1.13.	11a 2TX CDD MIMO MODE IN THE 5.8GHz BAND.....	335
10.1.14.	11n HT20 2TX CDD MIMO MODE IN THE 5.8GHz BAND .....	345
10.1.15.	11n HT40 2TX CDD MIMO MODE IN THE 5.8GHz BAND .....	355
10.1.16.	11ac HT80 2TX CDD MIMO MODE IN THE 5.8GHz BAND .....	363
10.2.	WORST CASE BELOW 30 MHz .....	369
10.3.	WORST-CASE BELOW 1 GHz .....	371
10.4.	WORST-CASE 18 to 26 GHz .....	373
10.5.	WORST-CASE 26 to 40 GHz .....	375
<b>11.</b>	<b>AC POWER LINE CONDUCTED EMISSIONS .....</b>	<b>377</b>
<b>12.</b>	<b>SETUP PHOTOS.....</b>	<b>380</b>

# 1. ATTESTATION OF TEST RESULTS

**COMPANY NAME:** SONY MOBILE COMMUNICATIONS INC.  
4-12-3 HIGASHI-SHINAGAWA, SHINAGAWA-KU  
TOKYO, 140-0002, JAPAN

**EUT DESCRIPTION:** GSM/WCDMA/LTE PHONE with BT, DTS/UNII a/b/g/n/ac, & NFC

**SERIAL NUMBER:** BH90007VAY & BH900064AY (CONDUCTED)  
BH9000A9AY & BH90009SAY (RADIATED)

**DATE TESTED:** DECEMBER 20, 2017 – JANUARY 12, 2018

APPLICABLE STANDARDS	
STANDARD	TEST RESULTS
CFR 47 Part 15 Subpart E (EXCEPT DFS)	Complies

UL Verification Services Inc. tested the above equipment in accordance with the requirements set forth in the above standards. All indications of Pass/Fail in this report are opinions expressed by UL Verification Services Inc. based on interpretations and/or observations of test results. Measurement Uncertainties were not taken into account and are published for informational purposes only. The test results show that the equipment tested is capable of demonstrating compliance with the requirements as documented in this report.

**Note:** The results documented in this report apply only to the tested sample, under the conditions and modes of operation as described herein. This document may not be altered or revised in any way unless done so by UL Verification Services Inc. and all revisions are duly noted in the revisions section. Any alteration of this document not carried out by UL Verification Services Inc. will constitute fraud and shall nullify the document. This report must not be used by the client to claim product certification, approval, or endorsement by NVLAP, NIST, any agency of the Federal Government, or any agency of any government.

Approved & Released For  
UL Verification Services Inc By:



Dan Corona  
Operations Leader / Project Engineer  
UL Verification Services Inc.

Prepared By:



Clifford Susa  
Project Engineer  
UL Verification Services Inc.

## 2. TEST METHODOLOGY

The tests documented in this report were performed in accordance with FCC CFR 47 Part 2, FCC CFR 47 Part 15, FCC KDB 662911 D01 v02r01, FCC KDB 789033 D02 v02r01, ANSI C63.10-2013.

## 3. FACILITIES AND ACCREDITATION

The test sites and measurement facilities used to collect data are located at 47173 and 47266 Benicia Street, Fremont, California, USA. Line conducted emissions are measured only at the 47173 address. The following table identifies which facilities were utilized for radiated emission measurements documented in this report. Specific facilities are also identified in the test results sections.

47173 Benicia Street	47266 Benicia Street
<input type="checkbox"/> Chamber A(ISED: 2324B-1)	<input checked="" type="checkbox"/> Chamber D(ISED: 22541-1)
<input checked="" type="checkbox"/> Chamber B(ISED: 2324B-2)	<input checked="" type="checkbox"/> Chamber E(ISED: 22541-2)
<input type="checkbox"/> Chamber C(ISED: 2324B-3)	<input type="checkbox"/> Chamber F(ISED: 22541-3)
	<input type="checkbox"/> Chamber G(ISED: 22541-4)
	<input type="checkbox"/> Chamber H(ISED: 22541-5)

The above test sites and facilities are covered under FCC Test Firm Registration # 208313. UL Verification Services Inc. is accredited by NVLAP, Laboratory Code 200065-0. Chambers A through C are covered under Industry Canada company address code 2324B with site numbers 2324B -1 through 2324B-3, respectively. Chambers D through H are covered under Industry Canada company address code 22541 with site numbers 22541 -1 through 22541-5, respectively.

## 4. CALIBRATION AND UNCERTAINTY

### 4.1. MEASURING INSTRUMENT CALIBRATION

The measuring equipment utilized to perform the tests documented in this report has been calibrated in accordance with the manufacturer's recommendations, and is traceable to recognized national standards.

### 4.2. SAMPLE CALCULATION

Where relevant, the following sample calculation is provided:

$$\begin{aligned} \text{Field Strength (dBuV/m)} &= \text{Measured Voltage (dBuV)} + \text{Antenna Factor (dB/m)} + \text{Cable} \\ &\text{Loss (dB)} - \text{Preamp Gain (dB)} \\ 36.5 \text{ dBuV} + 18.7 \text{ dB/m} + 0.6 \text{ dB} - 26.9 \text{ dB} &= 28.9 \text{ dBuV/m} \end{aligned}$$

### 4.3. MEASUREMENT UNCERTAINTY

Where relevant, the following measurement uncertainty levels have been estimated for tests performed on the apparatus:

Where relevant, the following measurement uncertainty levels have been estimated for tests performed on the apparatus:

Parameter	Uncertainty
Worst Case Conducted Disturbance, 9KHz to 0.15 MHz	3.84 dB
Worst Case Conducted Disturbance, 0.15 to 30 MHz	3.65 dB
Worst Case Radiated Disturbance, 9KHz to 30 MHz	3.15 dB
Worst Case Radiated Disturbance, 30 to 1000 MHz	5.36 dB
Worst Case Radiated Disturbance, 1000 to 18000 MHz	4.32 dB
Worst Case Radiated Disturbance, 18000 to 26000 MHz	4.45 dB
Worst Case Radiated Disturbance, 26000 to 40000 MHz	5.24 dB

Uncertainty figures are valid to a confidence level of 95%.



## 5. EQUIPMENT UNDER TEST

### 5.1. DESCRIPTION OF EUT

The EUT is a GSM/WCDMA/LTE Phone with BT, DTS/UNII a/b/g/n/ac, & NFC.

### 5.2. MAXIMUM OUTPUT POWER

The transmitter has a maximum conducted output power as follows:

#### 5.2GHz Band

Frequency Range (MHz)	Mode	Output Power (dBm)	Output Power (mW)
5180 - 5240	802.11a CDD 2TX	13.86	24.32
	802.11n HT20 CDD 2TX	13.88	24.43
5190 - 5230	802.11n HT40 CDD 2TX	14.07	25.53
5210	802.11ac VHT80 CDD 2TX	13.91	24.60

#### 5.3GHz Band

Frequency Range (MHz)	Mode	Output Power (dBm)	Output Power (mW)
5260 - 5320	802.11a CDD 2TX	14.45	27.86
	802.11n HT20 CDD 2TX	14.24	26.55
5270 - 5310	802.11n HT40 CDD 2TX	14.11	25.76
5290	802.11ac VHT80 CDD 2TX	13.85	24.27

#### 5.6GHz Band

Frequency Range (MHz)	Mode	Output Power (dBm)	Output Power (mW)
5500 - 5720	802.11a CDD 2TX	12.59	18.16
5500 - 5720	802.11n HT20 CDD 2TX	12.74	18.79
5510 - 5710	802.11n HT40 CDD 2TX	12.77	18.92
5530-5690	802.11ac VHT80 CDD 2TX	12.29	16.94

#### 5.8GHz Band

Frequency Range (MHz)	Mode	Output Power (dBm)	Output Power (mW)
5745 - 5825	802.11a CDD 2TX	13.34	21.58
5745 - 5825	802.11n HT20 CDD 2TX	11.19	13.15
5755 - 5795	802.11n HT40 CDD 2TX	11.08	12.82
5775	802.11ac VHT80 CDD 2TX	11.13	12.97

### 5.3. DESCRIPTION OF AVAILABLE ANTENNAS

The radio utilizes Loop Type antennas for Chain 0 and Monopole antennas for Chain 1, with the following maximum gains:

Frequency (GHz)	Peak Antenna Gain (dBi)	
	Main (Chain 0)	Sub (Chain 1)
5180-5320	-2.10	-4.30
5500-5700	-0.80	-5.40
5725-5850	-1.40	-5.10

### 5.4. SOFTWARE AND FIRMWARE

The firmware installed in the EUT during testing was SONY, s\_atp\_1\_00139\_B\_10\_5.  
 The test utility software used during testing was Tera Term Ver 4.79.

### 5.5. LIST OF TEST REDUCTION AND MODES

Antenna port & Radiated Testing	
Mode	Covered by
802.11a Legacy	802.11a 2TX CDD
802.11HT20 2TX STBC	802.11n HT20 2TX CDD
	802.11n HT20 2TX CDD
802.11ac VHT20 2TX STBC	802.11n HT20 2TX CDD
	802.11n HT20 2TX CDD
802.11n HT40 2TX STBC	802.11n HT40 2TX CDD
	802.11n HT40 2TX CDD
802.11ac VHT40 2TX STBC	802.11n HT40 2TX CDD
	802.11n HT40 2TX CDD
802.11ac VHT80 2TX STBC	802.11ac VHT80 2TX CDD
	802.11ac VHT80 2TX CDD

---

## 5.6. WORST-CASE CONFIGURATION AND MODE

Radiated emissions below 30MHz, 1GHz, above 18GHz, and power line conducted emission were performed with the EUT set to transmit at the channel with highest output power as worst-case scenario.

The fundamental of the EUT was investigated in three orthogonal orientations X, Y, & Z, using the following two configurations, AC/DC Adapter and headphone. It was determined that X-Axis with only AC/DC Adapter was worst-case orientation; therefore, all final radiated testing was performed with the EUT in X-Axis with AC/DC Adapter orientation.

Worst-case data rates as provided by the client were:

802.11a mode: 6 Mbps  
802.11n HT20 mode: 13 Mbps (MCS8)  
802.11n HT40 mode: 27 Mbps (MCS8)  
802.11ac VHT80 mode: 58.5 Mbps (MCS0)

802.11ac VHT20 and VHT40 mode are different from 802.11nHT20 and HT40 only in control messages and have the same power settings.

The simultaneous mode (SISO 2.4GHz Chain 0 and 5GHz chain 1) was checked and stand-alone (MIMO) 2.4 GHz / 5GHz remain worst case.

NOTE: SISO mode is covered by MIMO mode due to same maximum tune-up limit (power).

## 5.7. DESCRIPTION OF TEST SETUP

### SUPPORT EQUIPMENT

Support Equipment List				
Description	Manufacturer	Model	Serial Number	FCC ID
Laptop	Lenovo	20B7S0A200	PC015REW	NA
AC Adapter	SONY	1309-8864.1	VB17W46601037	NA
DC Power Supply	Ametek	XT 15-4	T463	NA

### I/O CABLES (CONDUCTED TEST)

I/O Cable List						
Cable No	Port	# of identical ports	Connector Type	Cable Type	Cable Length (m)	Remarks
1	Antenna	1	RF	Shielded	0.2	To spectrum Analyzer
2	USB	1	USB	Shielded	1	N/A
3	DC	1	DC	Shielded	0.3	N/A

### I/O CABLES (RADIATED AND CONDUCTED EMISSIONS)

I/O Cable List						
Cable No	Port	# of identical ports	Connector Type	Cable Type	Cable Length (m)	Remarks
1	USB	1	USB	Shielded	3	N/A

**TEST SETUP**

**CONDCUTED TEST SETUP DIAGRAM**

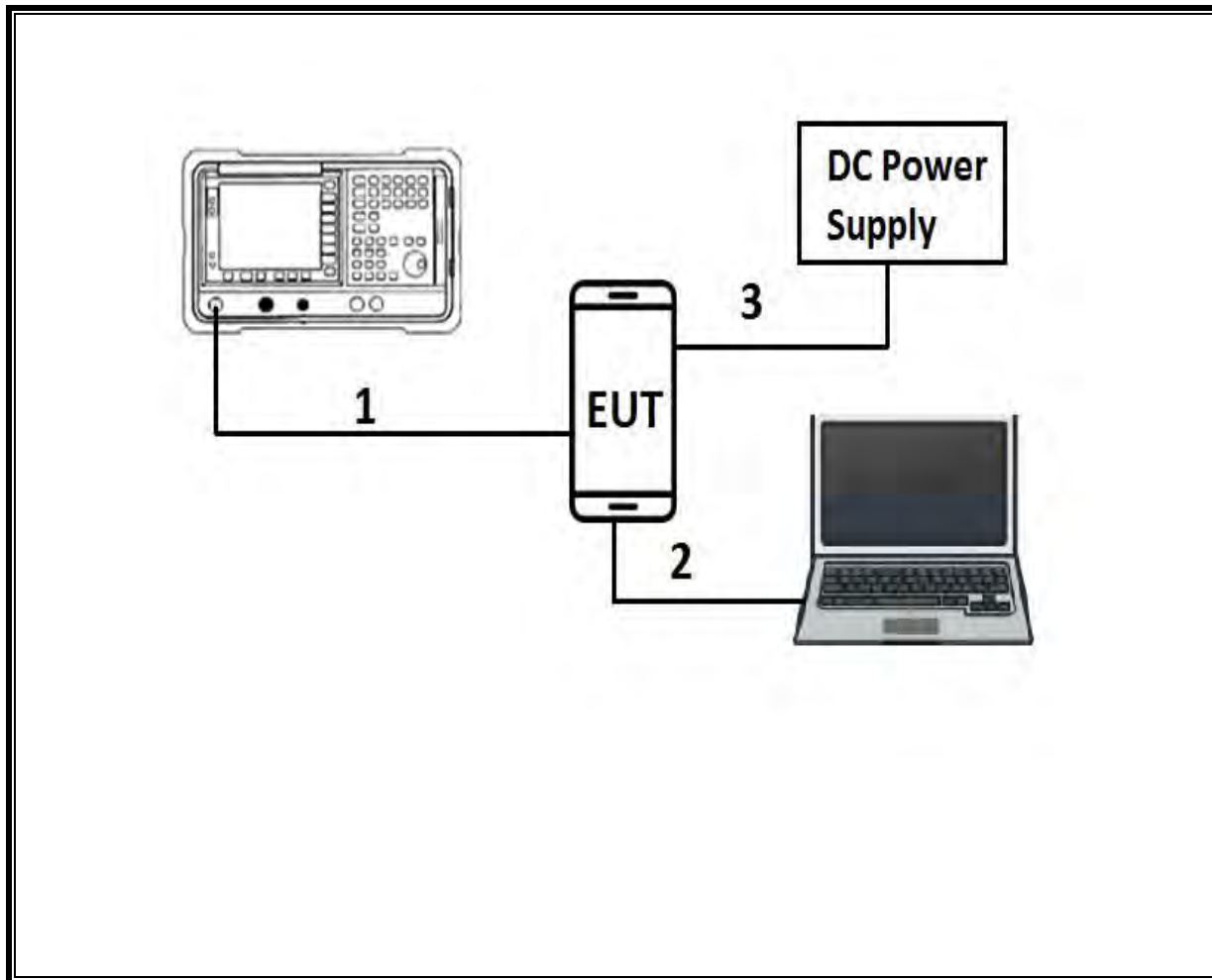

**TEST SETUP**

**RADIATED AND AC LINE CONDUCTED EMISSIONS SETUP DIAGRAM**

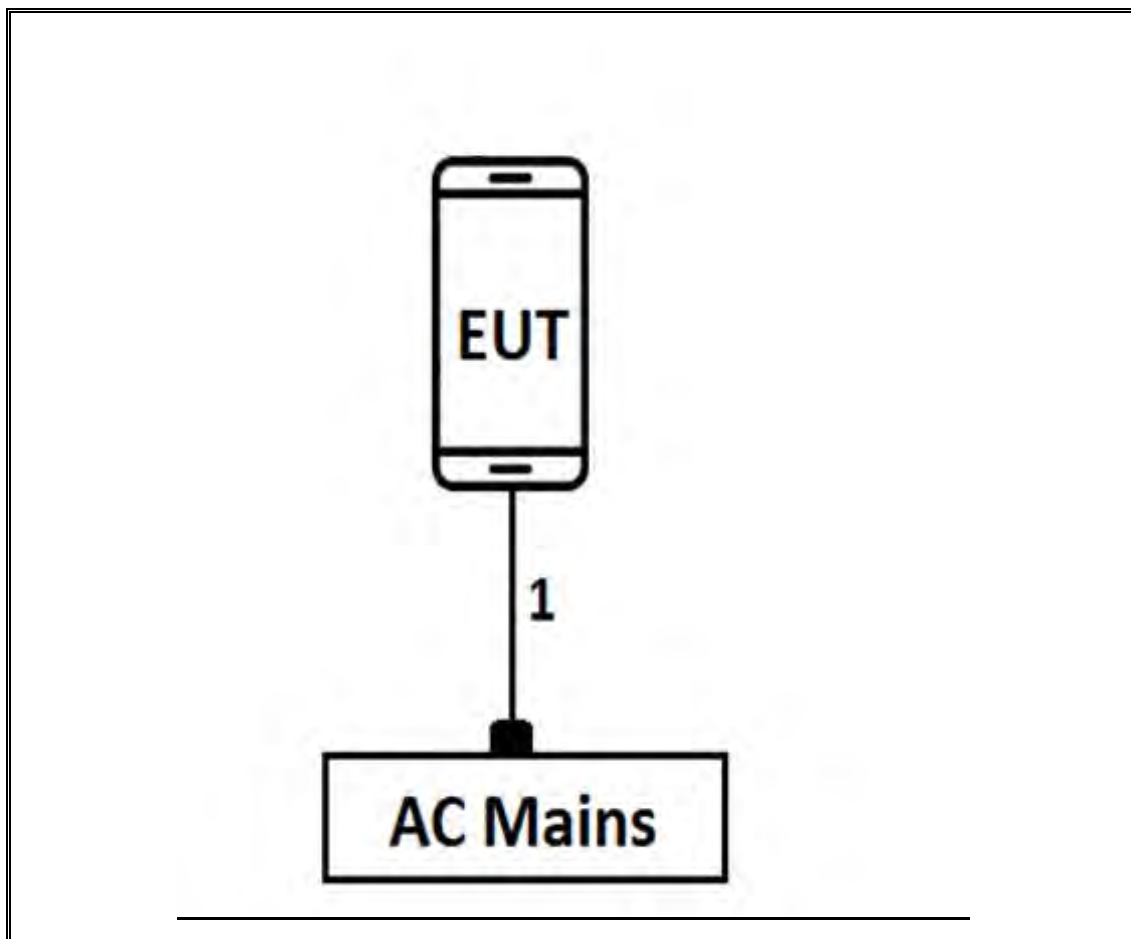

## 6. TEST AND MEASUREMENT EQUIPMENT

The following test and measurement equipment was utilized for the tests documented in this report:

TEST EQUIPMENT LIST				
Description	Manufacturer	Model	ID Num	Cal Due
Antenna, Broadband Hybrid, 30MHz to 2000MHz w/4dB Pad	Sunol Sciences Corp.	JB3	T899	06/15/2018
Antenna, Active Loop 9kHz-30MHz	Com-Power Corp.	AL-130R	T1866	10/10/2018
Antenna, Horn 1-18GHz	ETS-Lindgren	3117	T711	01/30/2018
Antenna, Horn 1-18GHz	ETS-Lindgren	3117	T346	03/28/18
Antenna, Horn 18-26.5GHz	ARA	MWH-1826	T89	01/04/2018
Antenna, Horn 26.5 - 40GHz	ARA	MWH-2640	T90	08/25/2018
Power Meter, P-series single channel	Agilent (Keysight) Technologies	N1911A	T1268	06/15/2018
Power Sensor, P – series, 50MHz to 18GHz, Wideband	Agilent (Keysight) Technologies	N1921A	T1223	03/29/2018
Amplifier, 1 - 18GHz	MITEQ	AFS42-00101800-25-S-42	T742	11/29/2018
Amplifier, 1 - 18GHz	MITEQ	AFS42-00101800-25-S-42	T1131	06/29/2018
Pre Amplifier, 1-26.5GHz	Agilent	8449B	T404	7/23/2018
Pre-Amplifier, 26-40 GHz	MITEQ	TTA2640-35-HG	T1864	9/21/2018
Amplifier, 10kHz-1GHz	Agilent (Keysight) Technologies	8447D	T10	02/15/2018
Amplifier, 1-8GHz	MITEQ	AMF-4D-01000800-30-29P	T1169	6/29/2018
Filter, LPF 5.0GHz	MICRO-TRONICS	LPS17541	T422	11/29/2018
Filter, LPF 5.0GHz	MICRO-TRONICS	LPS17541	T420	6/29/2018
Filter, High Pass 6.0GHz	MICRO-TRONICS	HPS17542	T423	11/29/2018
Filter, High Pass 6.0GHz	MICRO-TRONICS	HPS17542	T424	6/29/2018
Spectrum Analyzer, PXA, 3Hz to 44GHz	Agilent (Keysight) Technologies	N9030A	T1210	07/17/2018
Spectrum Analyzer, PXA, 3Hz to 44GHz	Agilent (Keysight) Technologies	N9030A	T341	11/12/2018
Spectrum Analyzer, PXA, 3Hz to 44GHz	Agilent (Keysight) Technologies	N9030A	T906	02/14/2018
Spectrum Analyzer, PXA, 3Hz to 44GHz	Agilent (Keysight) Technologies	N9030A	T1466	04/11/2018
Spectrum Analyzer, PXA, 3Hz to 44GHz	Agilent (Keysight) Technologies	N9030A	T907	01/23/2018
Test Receiver, EMI, 10Hz-7GHz	Rhode&Schwarz	ESR	T1436	01/06/2018
LISN	FISCHER	FCC-LISN-50/250-25-2-01	T1310	01/17/2018

Test Software List			
Description	Manufacturer	Model	Version
Radiated Software	UL	UL EMC	Ver 9.5, Dec 01, 2016
Conducted Software	UL	UL EMC	Ver 9.5, May 26, 2015
Antenna Port Software	UL	UL RF	Ver 7.7, Dec 14, 2017

NOTE: \*testing is completed before equipment calibration expiration date.

## 7. MEASUREMENT METHODS

On Time and Duty Cycle: KDB 789033 D02 v02r01, Section B.

6 dB Emission BW: KDB 789033 D02 v02r01, Section C.2.

26 dB Emission BW: KDB 789033 D02 v02r01, Section C.1.

99% Occupied BW: KDB 789033 D02 v02r01, Section D.

Conducted Output Power: KDB 789033 D02 v02r01, Section E.3.b (Method PM-G)

Power Spectral Density: KDB 789033 D02 v02r01, Section F

Unwanted emissions in restricted bands: KDB 789033 D02 v02r01, Sections G.3, G.4, G.5, and G.6

Unwanted emissions in non-restricted bands: KDB 789033 D02 v02r01, Sections G.3, G.4, and G.5

AC Power Line Conducted Emissions: ANSI C63.10-2013, Section 6.2.



## 8. ON TIME, DUTY CYCLE AND MEASUREMENT METHODS

### 8.1. ON TIME AND DUTY CYCLE

#### LIMITS

None; for reporting purposes only.

#### PROCEDURE

KDB 789033 Zero-Span Spectrum Analyzer Method.

#### RESULTS

Mode	ON Time B (msec)	Period (msec)	Duty Cycle x (linear)	Duty Cycle (%)	Duty Cycle Correction Factor (dB)	1/T Minimum VBW (kHz)
802.11a	2.020	2.059	0.981	98.1%	0.00	0.010
802.11n HT20	2.509	2.589	0.969	96.9%	0.14	0.399
802.11n HT40	1.194	1.334	0.895	89.5%	0.48	0.838
802.11ac VHT80	0.580	0.686	0.845	84.5%	0.73	1.724

**DUTY CYCLE PLOTS**

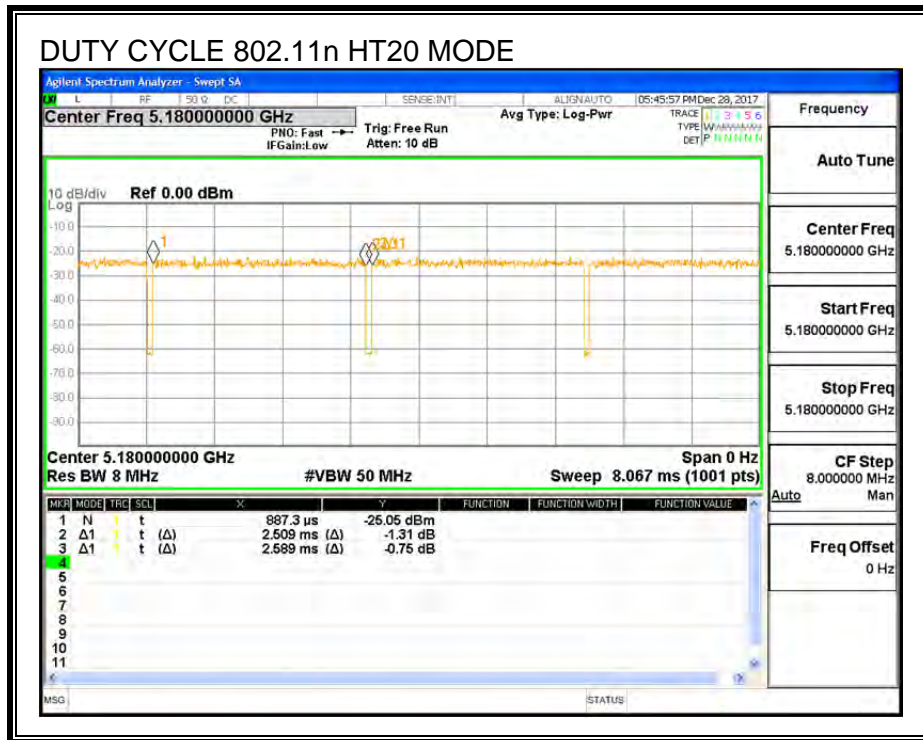
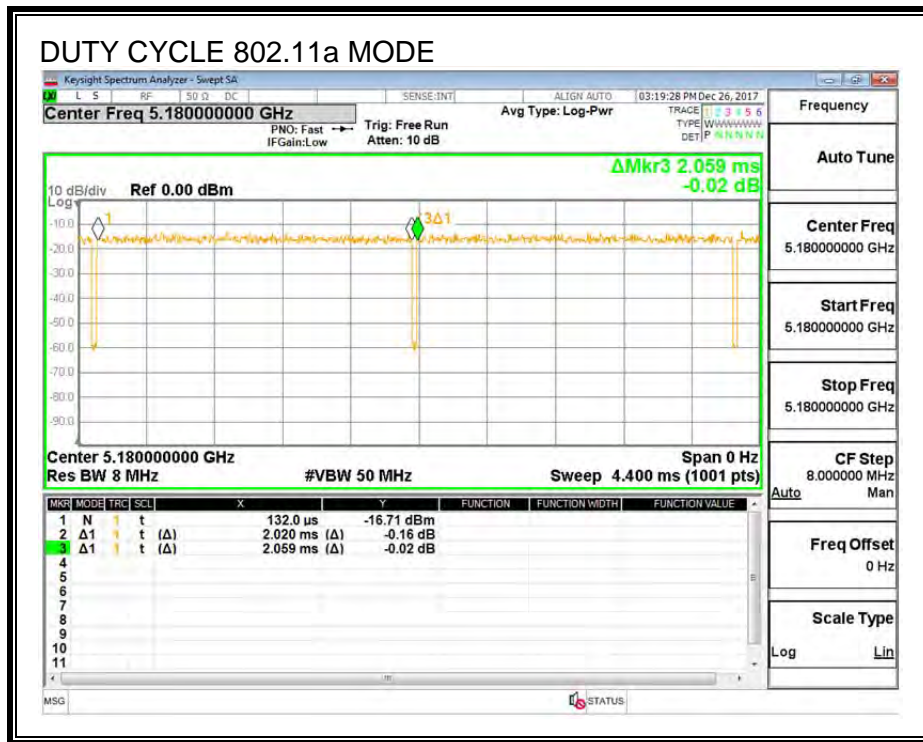

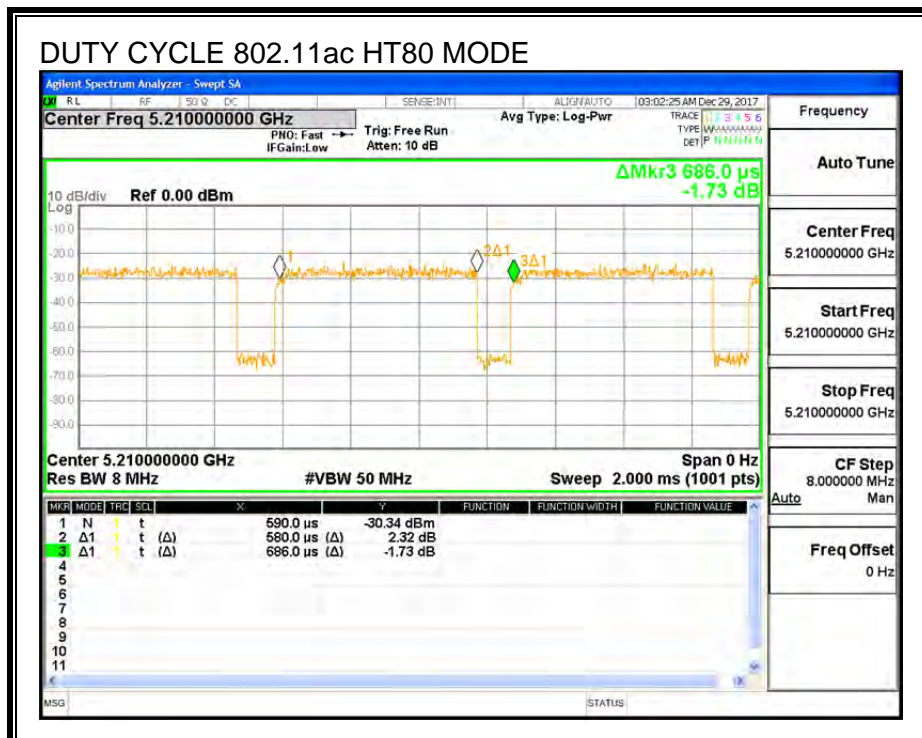
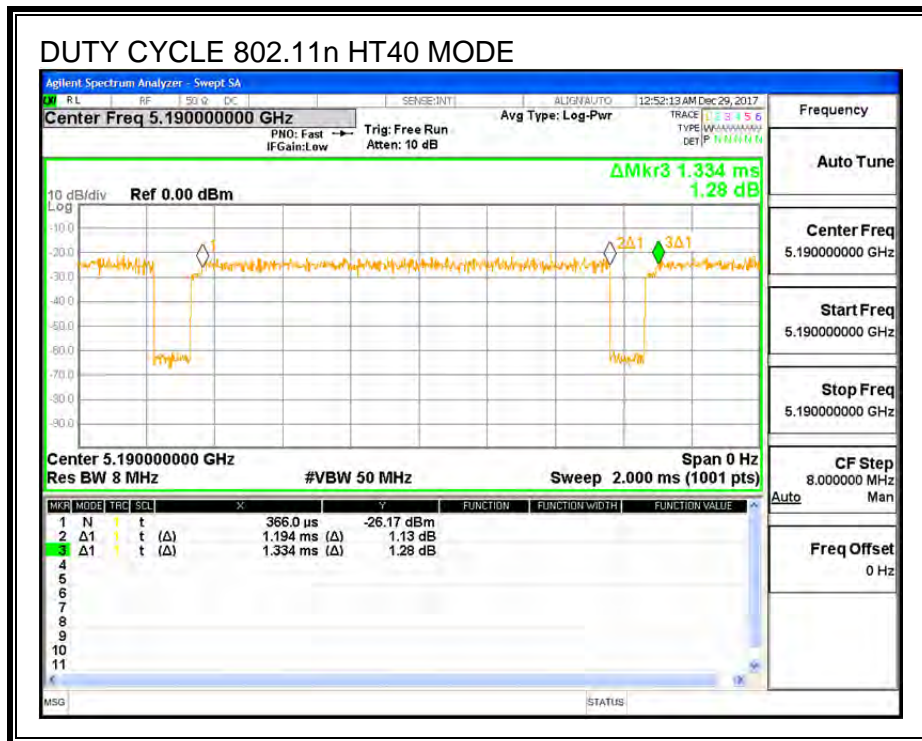

## 9. ANTENNA PORT TEST RESULTS

### 9.1. 11a 2TX CDD MIMO MODE IN THE 5.2GHz BAND

#### 9.1.1. 26 dB BANDWIDTH

##### LIMITS

None; for reporting purposes only.

##### RESULTS

Channel	Frequency	26 dB BW Chain 0 (MHz)	26 dB BW Chain 1 (MHz)
Low	5180	21.90	21.15
Mid	5200	21.90	20.75
High	5240	21.35	20.85

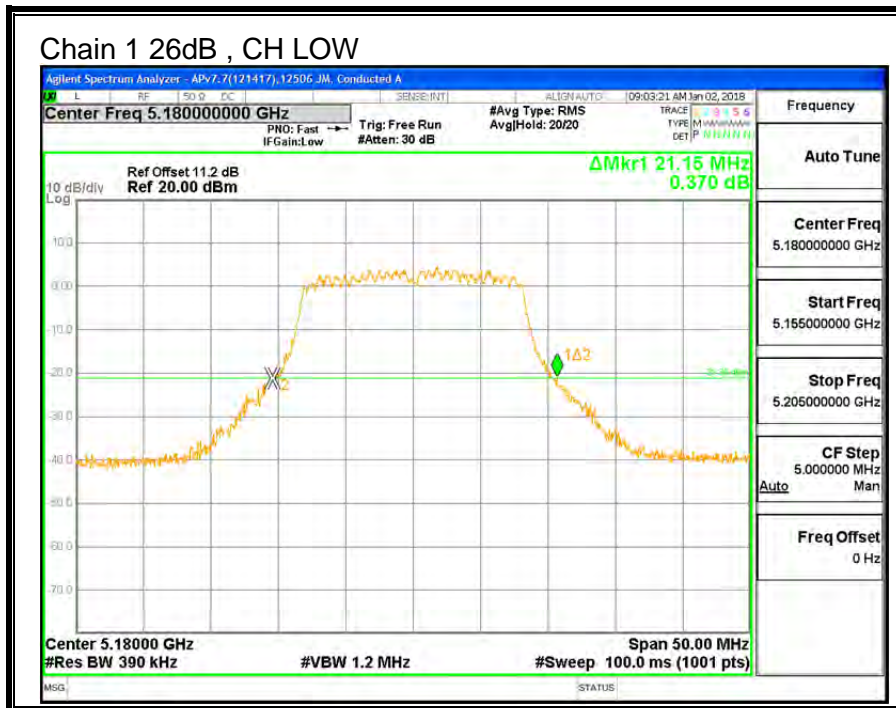
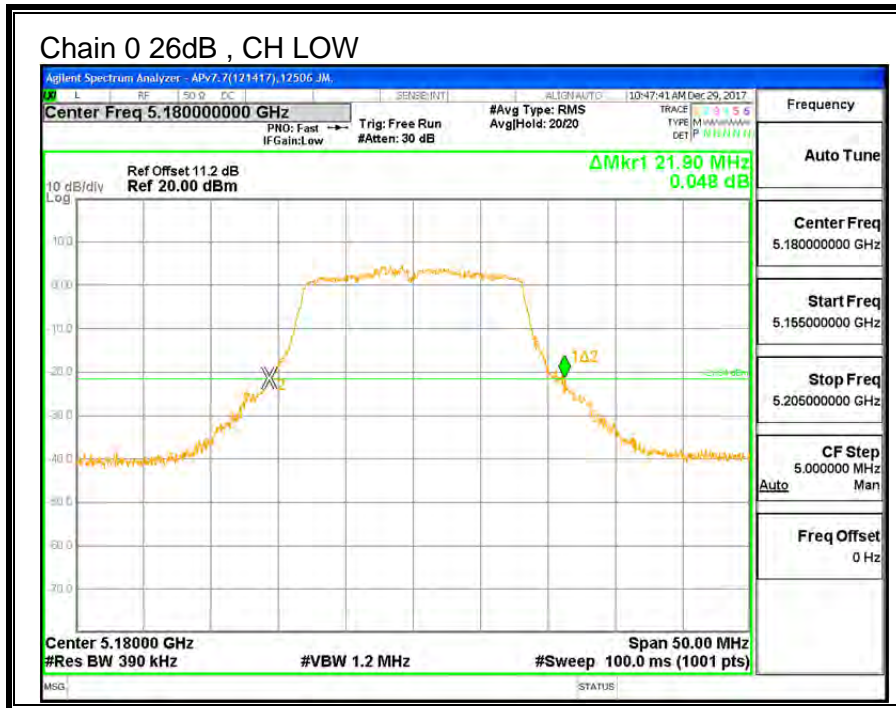



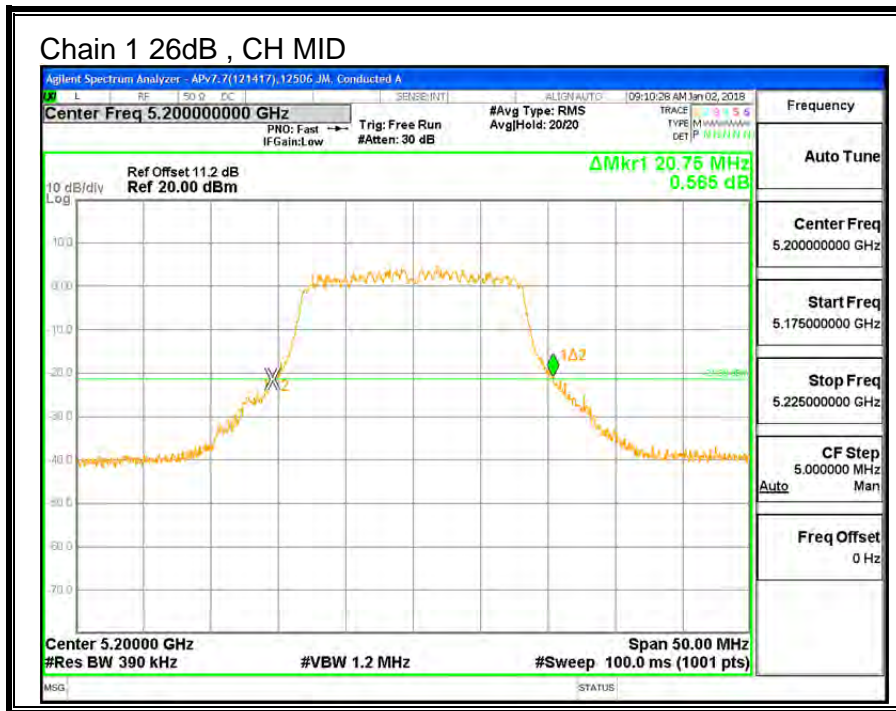
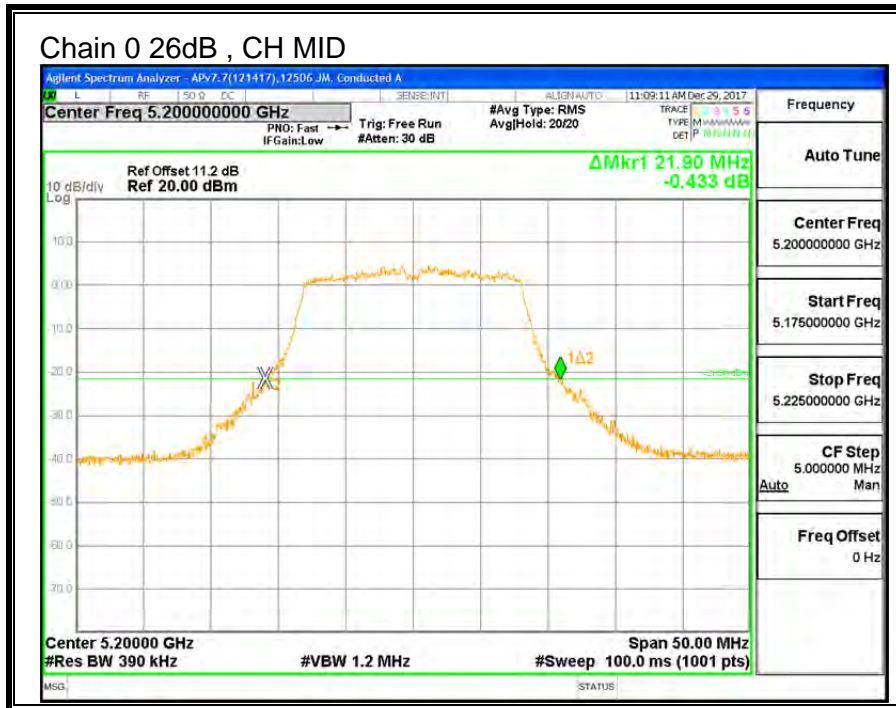

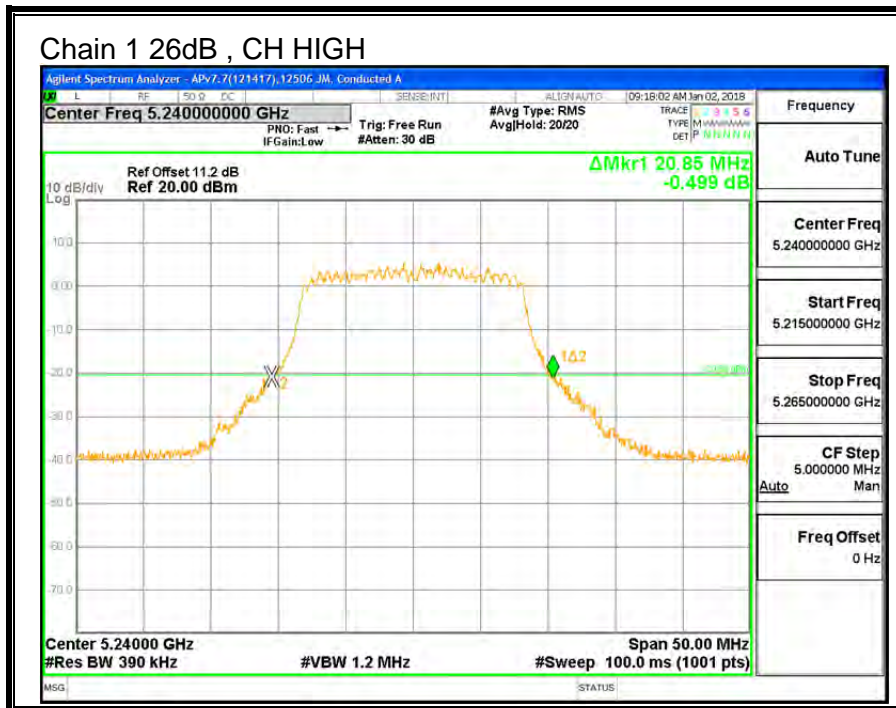
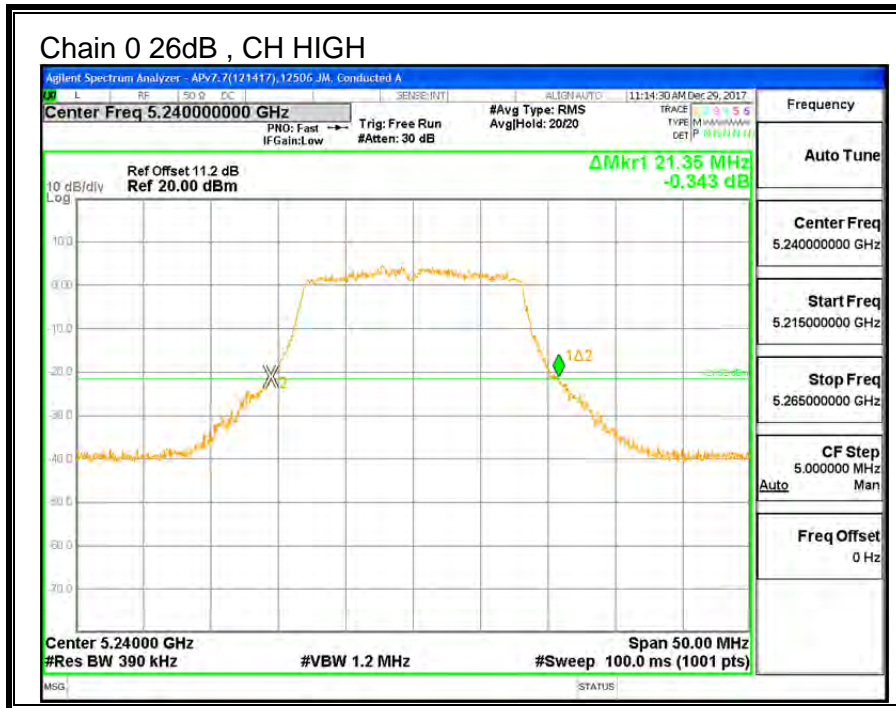

### 9.1.2. 99% BANDWIDTH

#### LIMITS

None; for reporting purposes only.

#### RESULTS

Channel	Frequency	99% BW Chain 0 (MHz)	99% BW Chain 1 (MHz)
Low	5180	16.539	16.514
Mid	5200	16.502	16.498
High	5240	16.429	16.546



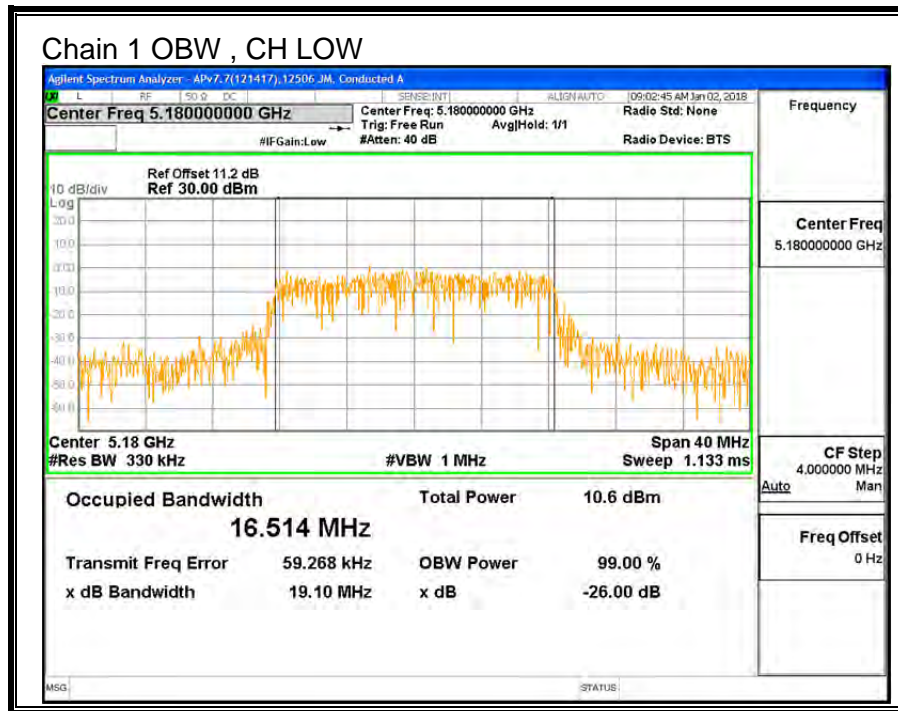
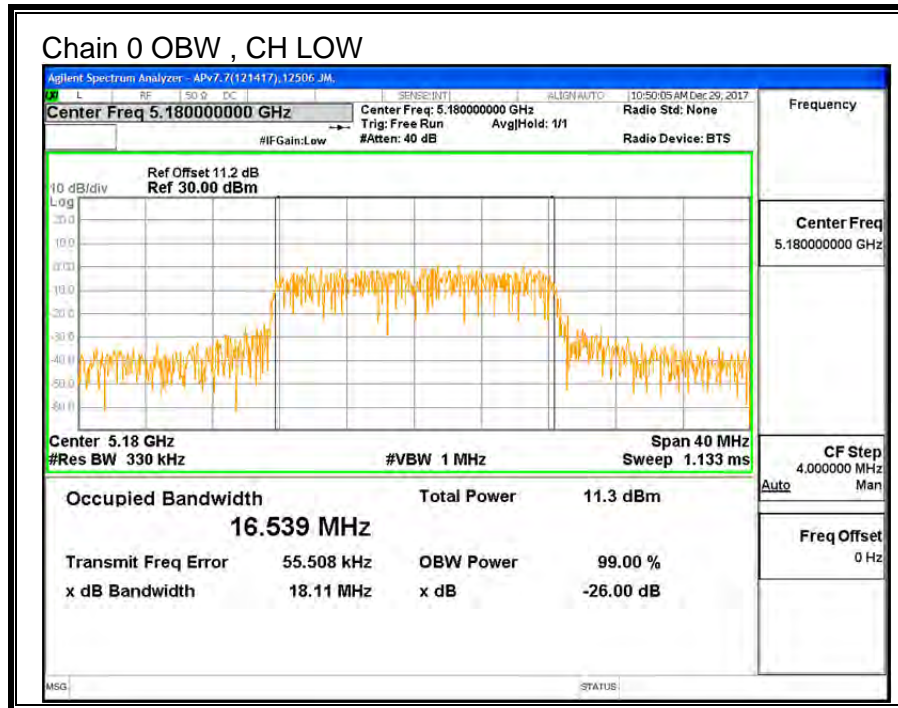

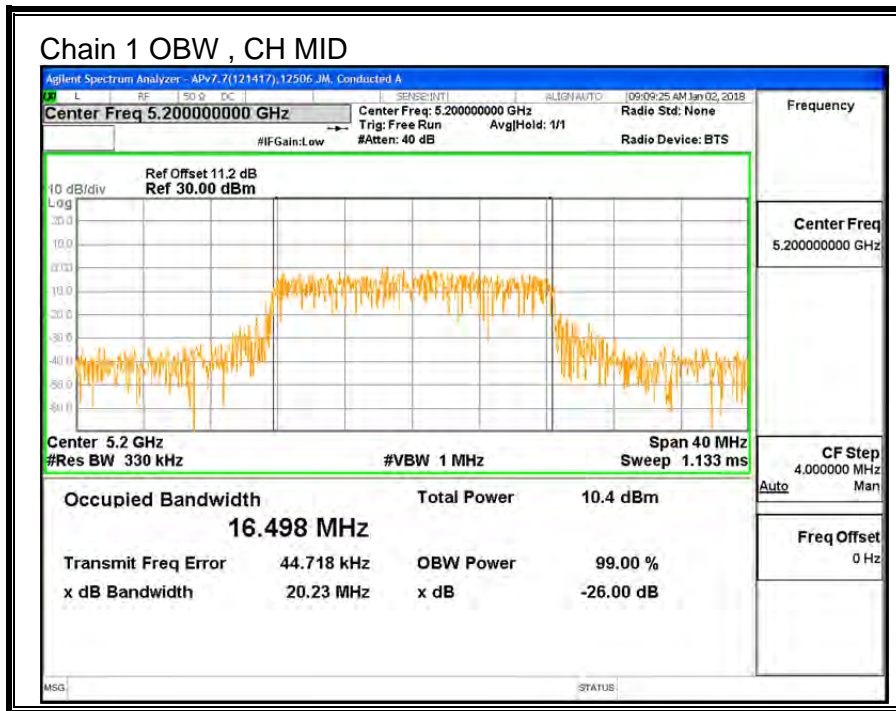
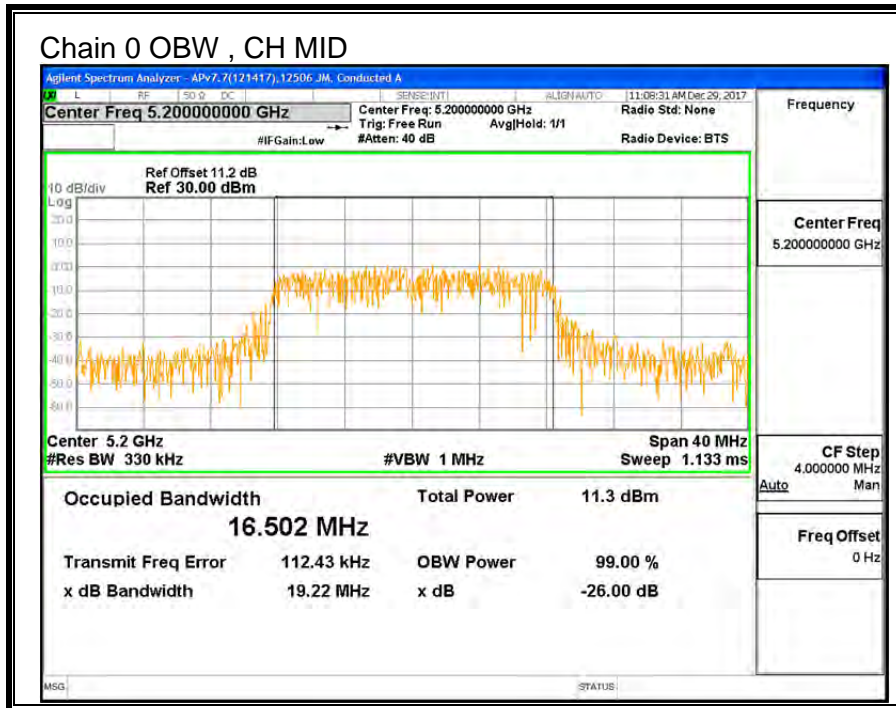

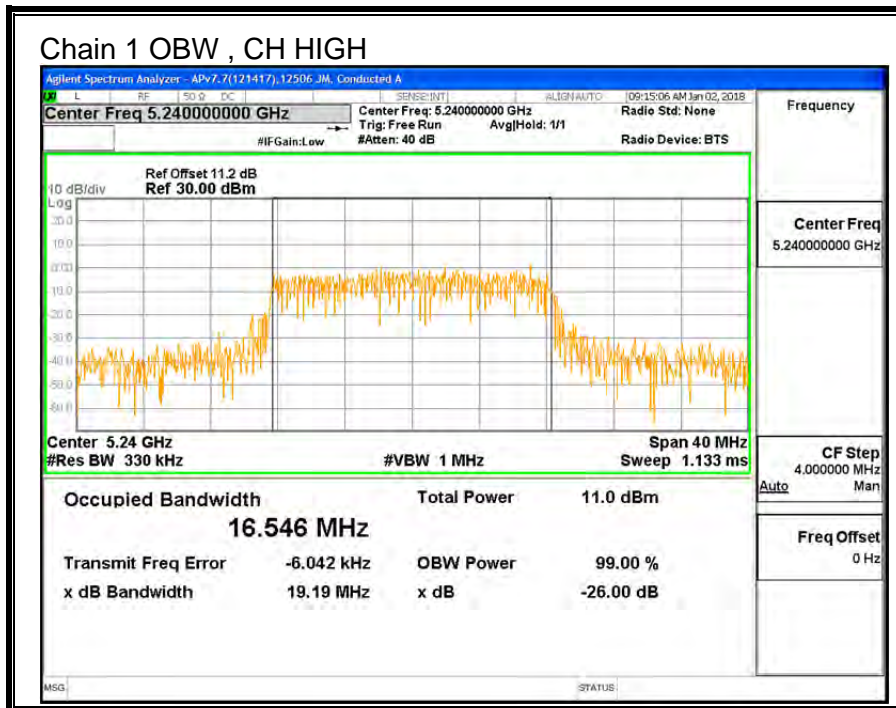
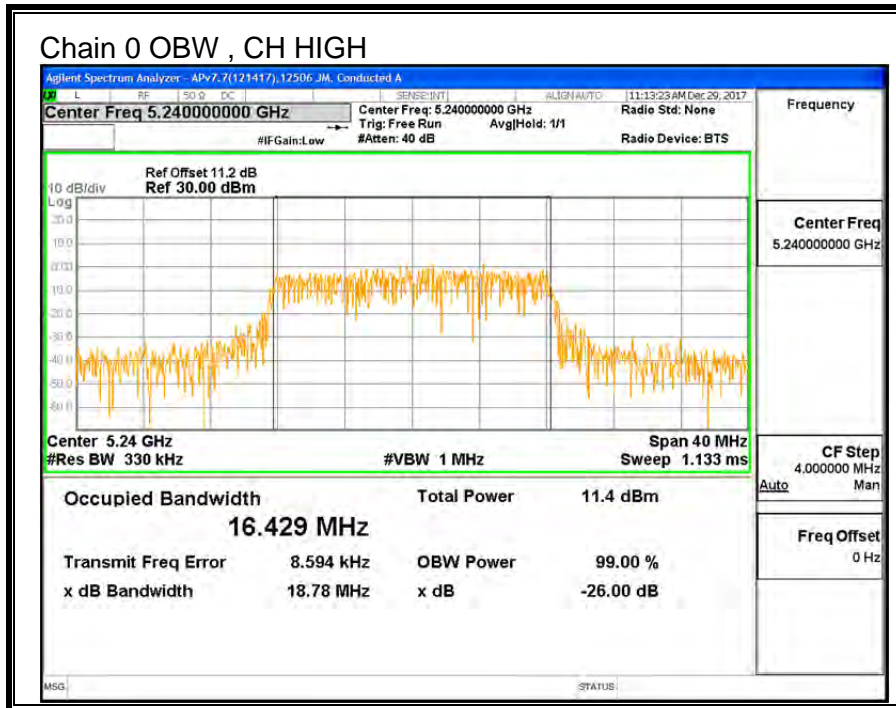

### 9.1.3. OUTPUT POWER AND PPSD

#### **LIMITS**

FCC §15.407 (a) (1)

(i) For an outdoor access point operating in the band 5.15-5.25 GHz, the maximum conducted output power over the frequency band of operation shall not exceed 1 W provided the maximum antenna gain does not exceed 6 dBi. In addition, the maximum power spectral density shall not exceed 17 dBm in any 1 megahertz band. If transmitting antennas of directional gain greater than 6 dBi are used, both the maximum conducted output power and the maximum power spectral density shall be reduced by the amount in dB that the directional gain of the antenna exceeds 6 dBi. The maximum e.i.r.p. at any elevation angle above 30 degrees as measured from the horizon must not exceed 125 mW (21 dBm).

(ii) For an indoor access point operating in the band 5.15-5.25 GHz, the maximum conducted output power over the frequency band of operation shall not exceed 1 W provided the maximum antenna gain does not exceed 6 dBi. In addition, the maximum power spectral density shall not exceed 17 dBm in any 1 megahertz band. If transmitting antennas of directional gain greater than 6 dBi are used, both the maximum conducted output power and the maximum power spectral density shall be reduced by the amount in dB that the directional gain of the antenna exceeds 6 dBi.

(iii) For fixed point-to-point access points operating in the band 5.15-5.25 GHz, the maximum conducted output power over the frequency band of operation shall not exceed 1 W. Fixed point-to-point U-NII devices may employ antennas with directional gain up to 23 dBi without any corresponding reduction in the maximum conducted output power or maximum power spectral density. For fixed point-to-point transmitters that employ a directional antenna gain greater than 23 dBi, a 1 dB reduction in maximum conducted output power and maximum power spectral density is required for each 1 dB of antenna gain in excess of 23 dBi. Fixed, point-to-point operations exclude the use of point-to-multipoint systems, omnidirectional applications, and multiple collocated transmitters transmitting the same information. The operator of the U-NII device, or if the equipment is professionally installed, the installer, is responsible for ensuring that systems employing high gain directional antennas are used exclusively for fixed, point-to-point operations.

(iv) For mobile and portable client devices in the 5.15-5.25 GHz band, the maximum conducted output power over the frequency band of operation shall not exceed 250 mW provided the maximum antenna gain does not exceed 6 dBi. In addition, the maximum power spectral density shall not exceed 11 dBm in any 1 megahertz band. If transmitting antennas of directional gain greater than 6 dBi are used, both the maximum conducted output power and the maximum power spectral density shall be reduced by the amount in dB that the directional gain of the antenna exceeds 6 dBi.

#### **TEST PROCEDURE**

Measurements perform using a wideband gated RF power meter provided that the gate parameters are adjusted such that the power is measured only when the EUT is transmitting at its maximum power control level. Since the measurement is made only during the ON time of the transmitter, no duty cycle correction factor is required.

**DIRECTIONAL ANTENNA GAIN**

For power, the TX chains are uncorrelated and the antenna gain is unequal among the chains. The directional gain is:

**5150-5250 MHz**

<b>Chain 0 Antenna Gain (dBi)</b>	<b>Chain 1 Antenna Gain (dBi)</b>	<b>Uncorrelated Chains Directional Gain (dBi)</b>
-2.10	-4.30	-3.06

For PSD the TX chains are correlated and the antenna gain is unequal among the chains. The directional gain is:

**5150-5250 MHz**

<b>Chain 0 Antenna Gain (dBi)</b>	<b>Chain 1 Antenna Gain (dBi)</b>	<b>Correlated Chains Directional Gain (dBi)</b>
-2.10	-4.30	-0.12

**RESULTS**

<b>ID:</b>	12506 JM	<b>Date:</b>	01/08/18
------------	----------	--------------	----------

**Bandwidth and Antenna Gain**

Channel	Frequency (MHz)	Min 26 dB BW (MHz)	Min 99% BW (MHz)	Directional Gain for Power (dBi)	Directional Gain for PPSD (dBi)
Low	5180	21.15	16.514	-3.06	-0.12
Mid	5200	20.75	16.498	-3.06	-0.12
High	5240	20.85	16.429	-3.06	-0.12

**Limits**

Channel	Frequency (MHz)	FCC Power Limit (dBm)	IC EIRP Limit (dBm)	Max IC Power (dBm)	Power Limit (dBm)	FCC PPSD Limit (dBm)	IC eirp PSD Limit (dBm)	PPSD Limit (dBm)
Low	5180	24.00	22.18	25.24	24.00	11.00	10.00	10.12
Mid	5200	24.00	22.17	25.23	24.00	11.00	10.00	10.12
High	5240	24.00	22.16	25.22	24.00	11.00	10.00	10.12

<b>Duty Cycle CF (dB)</b>	0.00	<b>Included in Calculations of Corr'd PPSD</b>
---------------------------	------	--

**Output Power Results**

Channel	Frequency (MHz)	Chain 0 Meas Power (dBm)	Chain 1 Meas Power (dBm)	Total Corr'd Power (dBm)	Power Limit (dBm)	Power Margin (dB)
Low	5180	11.42	10.20	13.86	24.00	-10.14
Mid	5200	11.36	10.17	13.82	24.00	-10.18
High	5240	11.05	10.61	13.85	24.00	-10.15

**PPSD Results**

Channel	Frequency (MHz)	Chain 0 Meas PPSD (dBm)	Chain 1 Meas PPSD (dBm)	Total Corr'd PPSD (dBm)	PPSD Limit (dBm)	PPSD Margin (dB)
Low	5180	0.792	0.194	3.51	10.12	-6.61
Mid	5200	1.016	-0.153	3.48	10.12	-6.64
High	5240	0.836	0.447	3.66	10.12	-6.46

**Note:** the power readings above were measured with gated method, and the measurement was taken only during the ON time. No duty cycle correction was necessary.



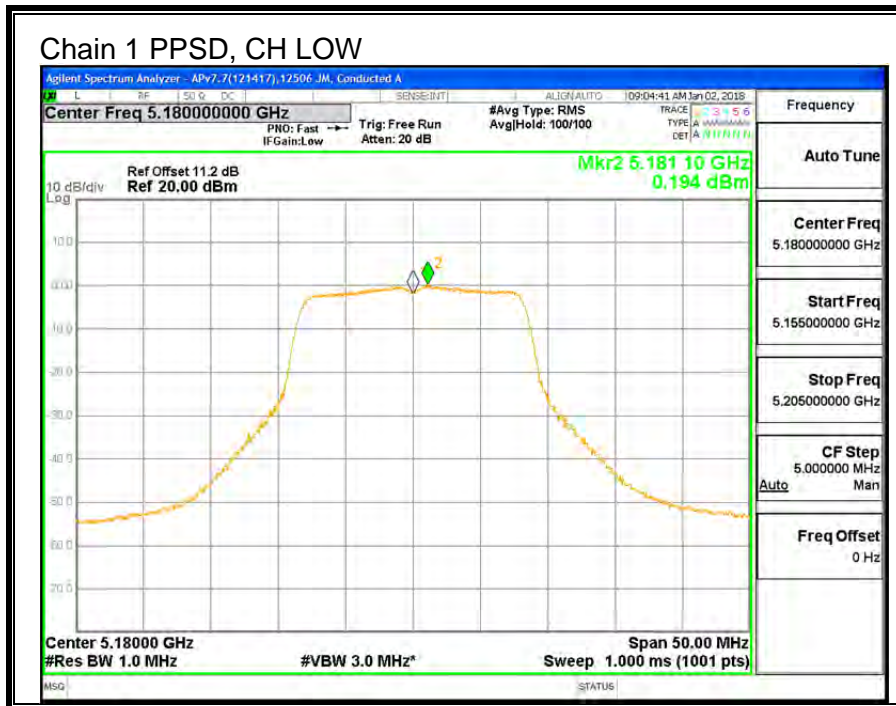
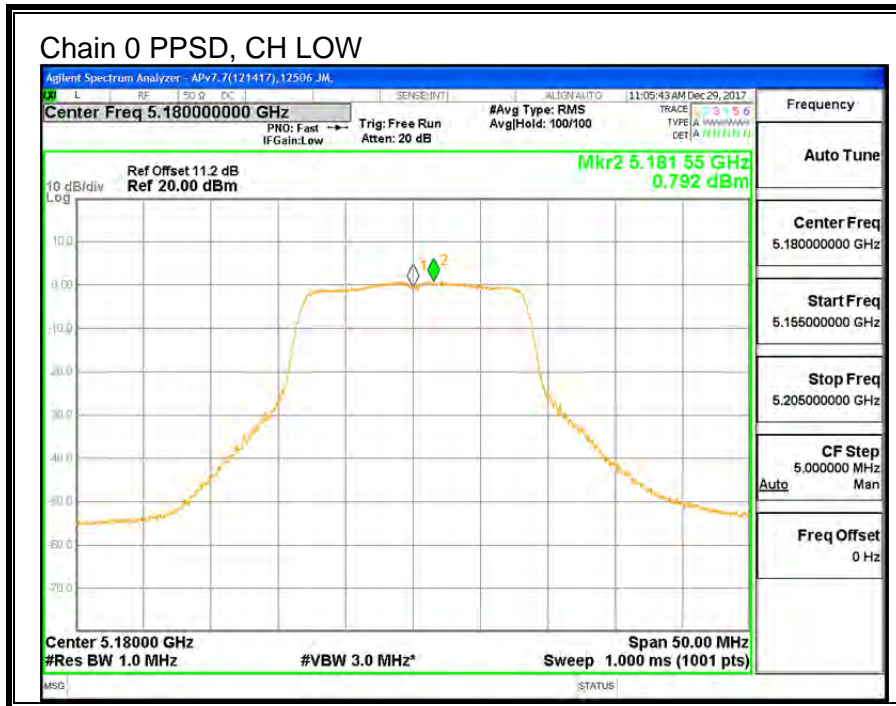

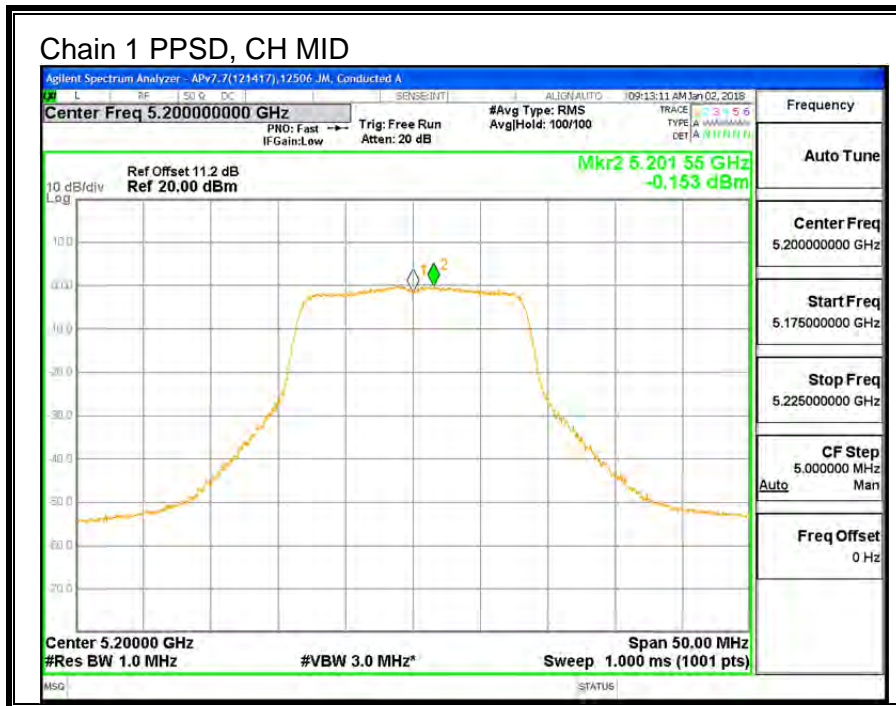
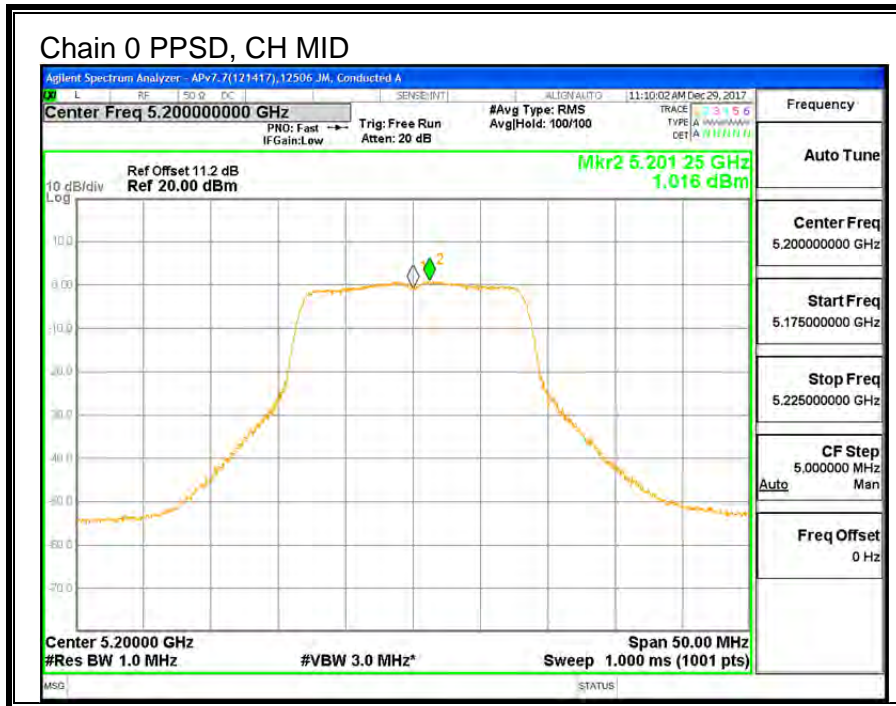



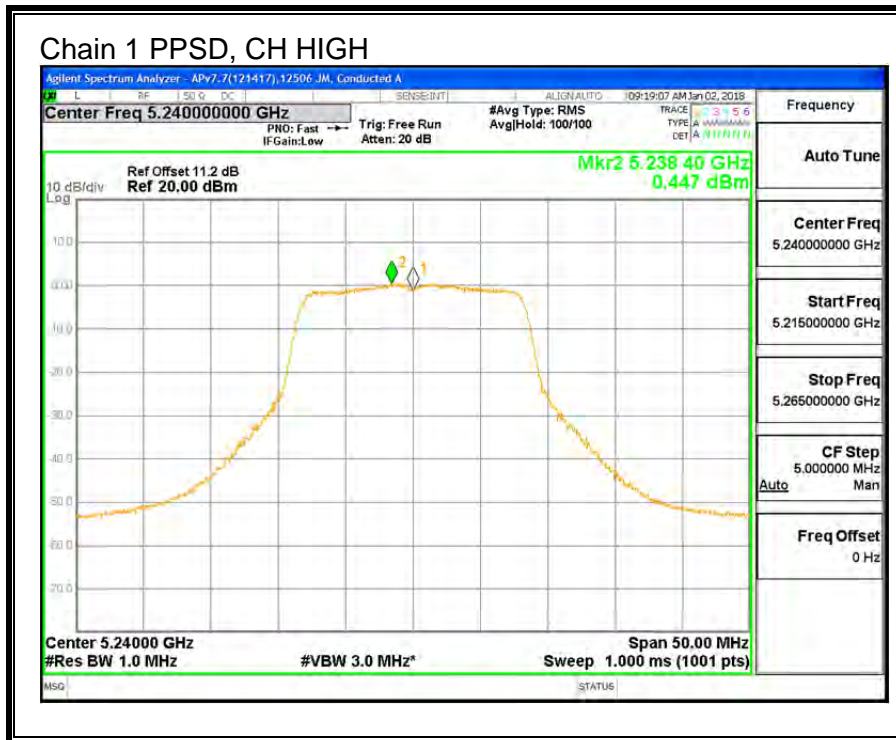
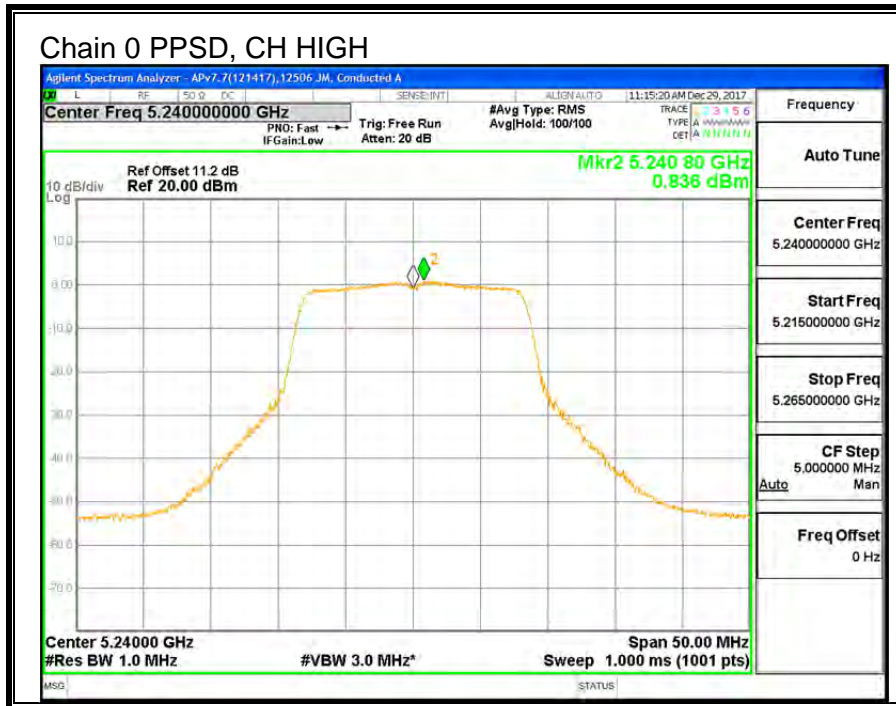

## 9.2. 11n HT20 2TX CDD MIMO MODE IN THE 5.2GHz BAND

### 9.2.1. 26 dB BANDWIDTH

#### LIMITS

None; for reporting purposes only.

#### RESULTS

Channel	Frequency	26 dB BW Chain 0 (MHz)	26 dB BW Chain 1 (MHz)
Low	5180	22.85	21.80
Mid	5200	22.30	22.35
High	5240	22.75	22.00

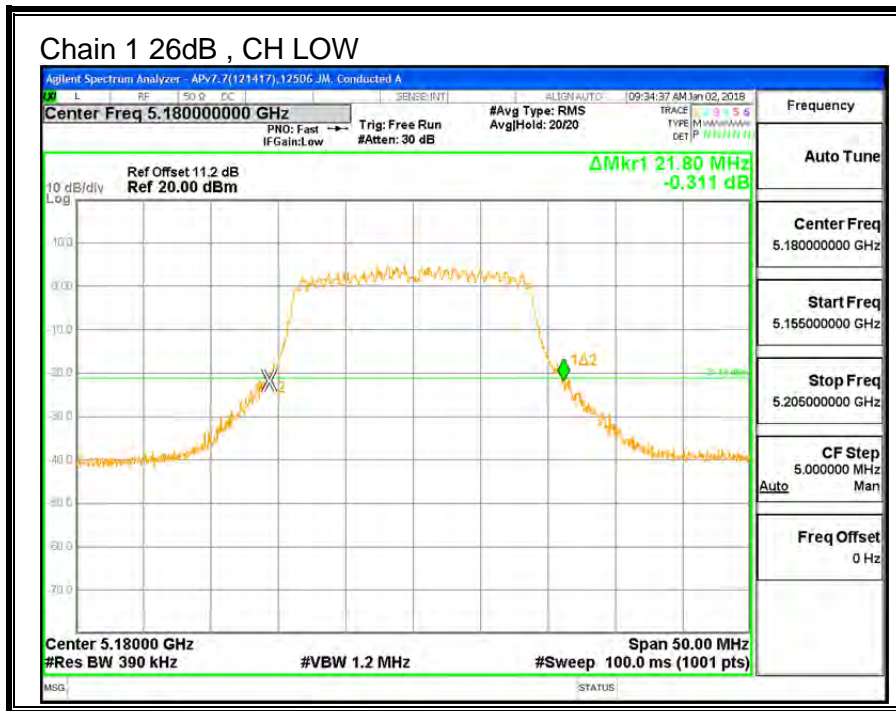
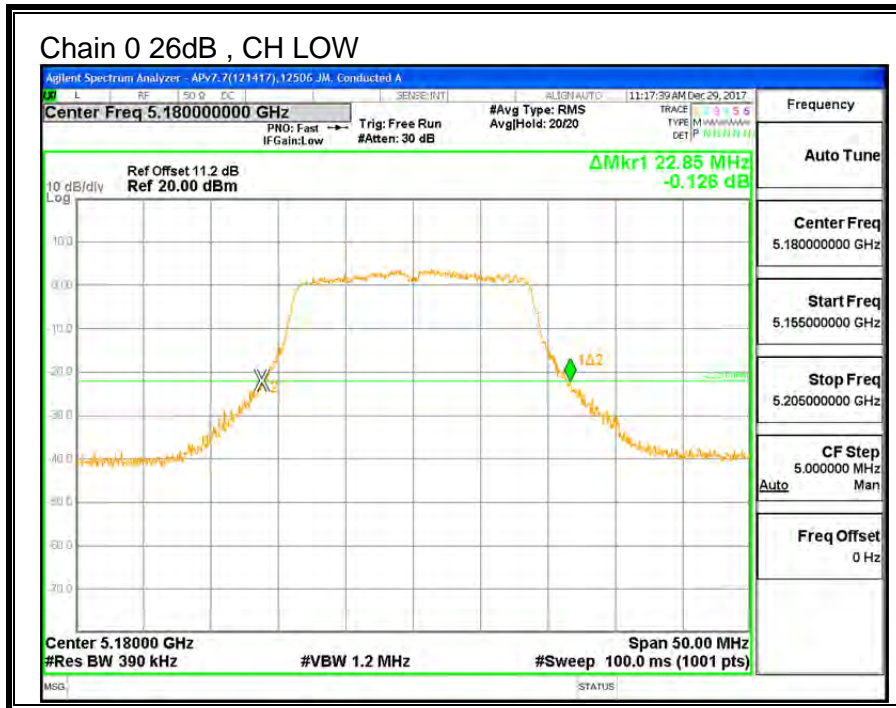

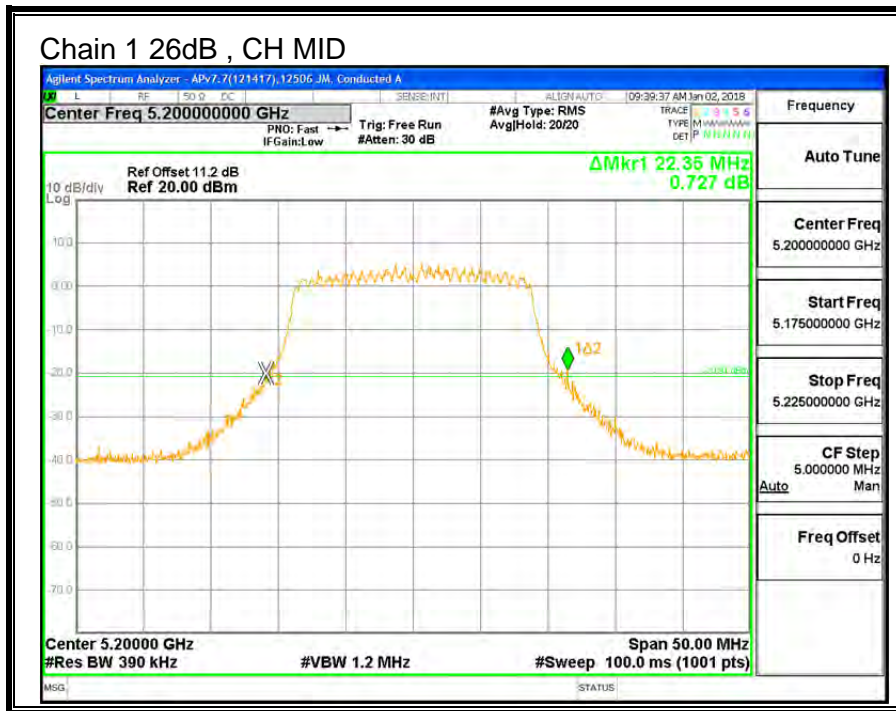
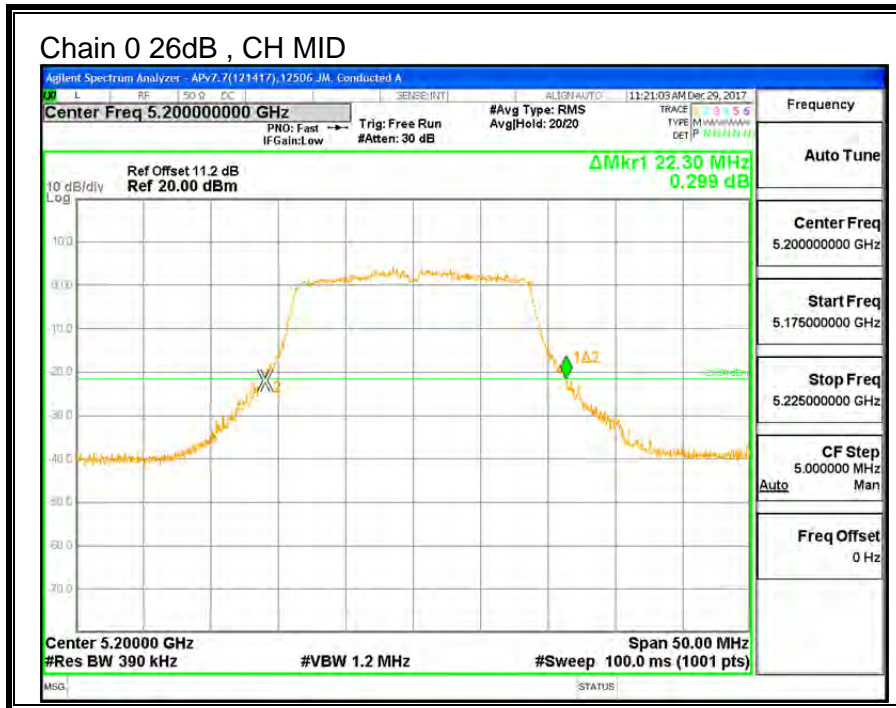



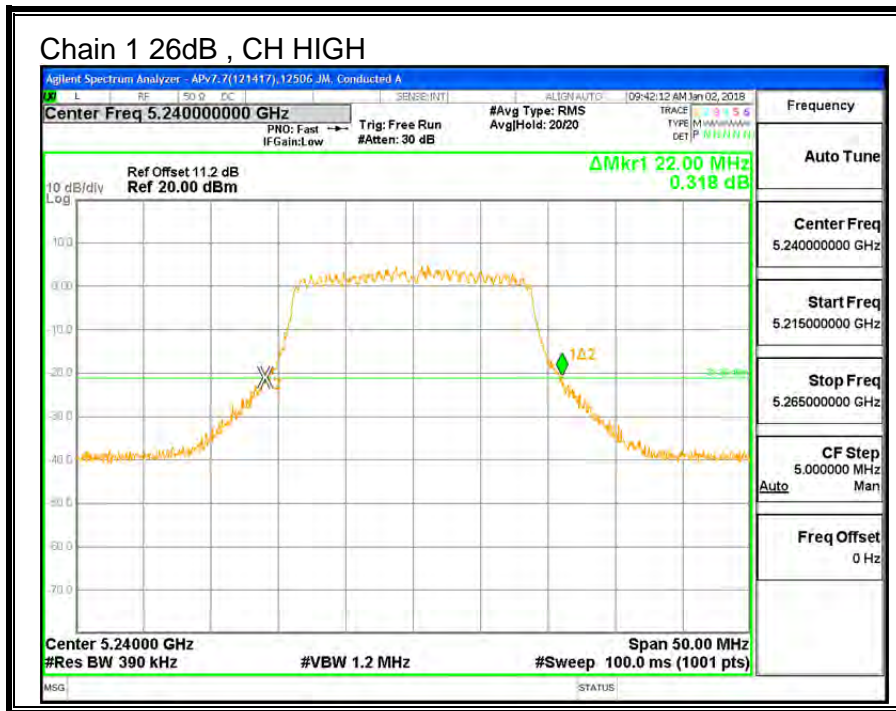
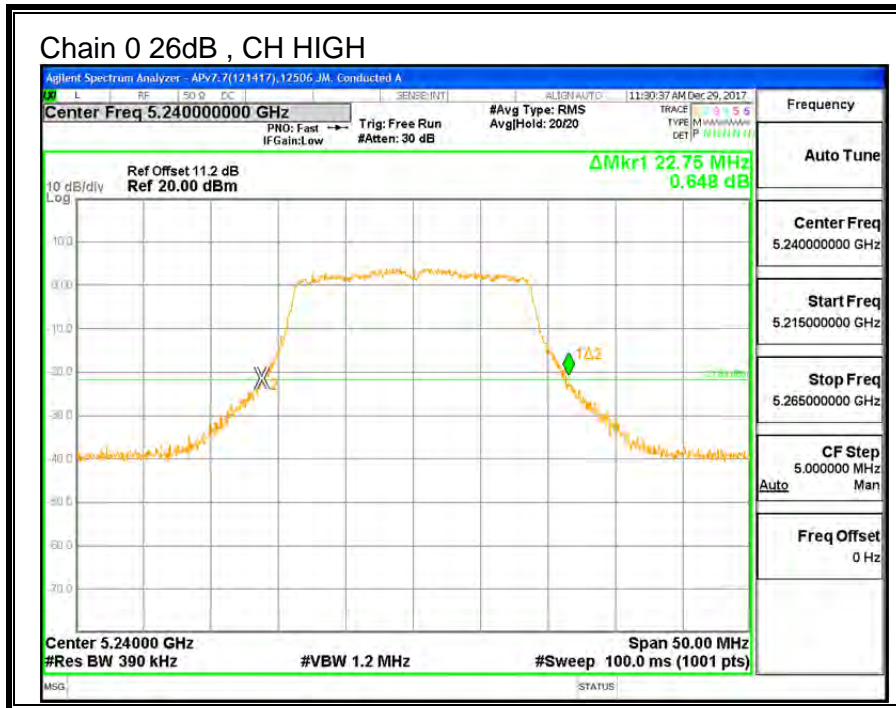

### 9.2.2. 99% BANDWIDTH

#### LIMITS

None; for reporting purposes only.

#### RESULTS

Channel	Frequency	99% BW Chain 0 (MHz)	99% BW Chain 1 (MHz)
Low	5180	17.806	17.736
Mid	5200	17.693	17.708
High	5240	17.624	17.735

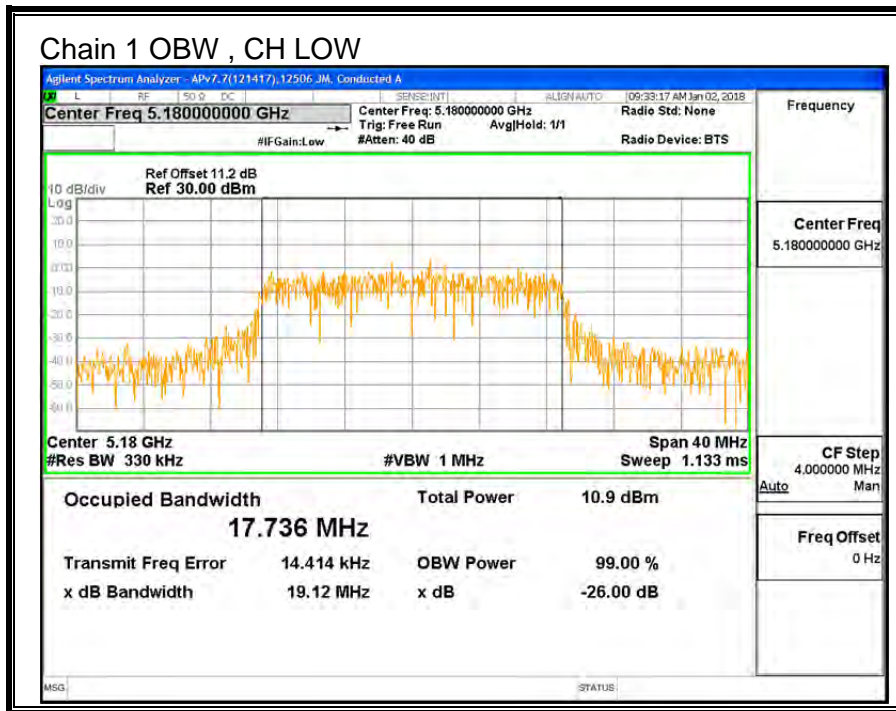
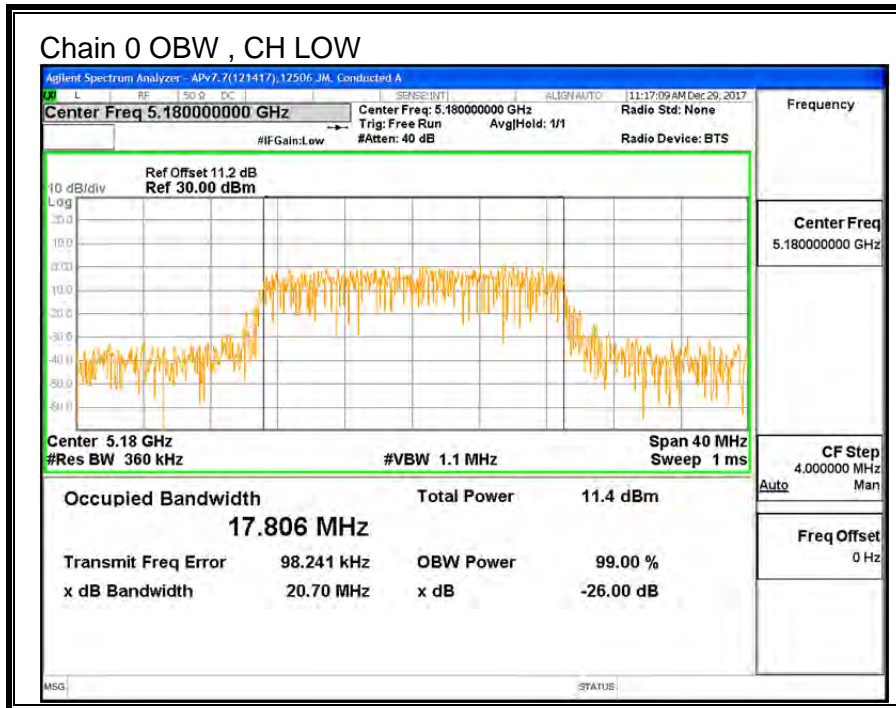

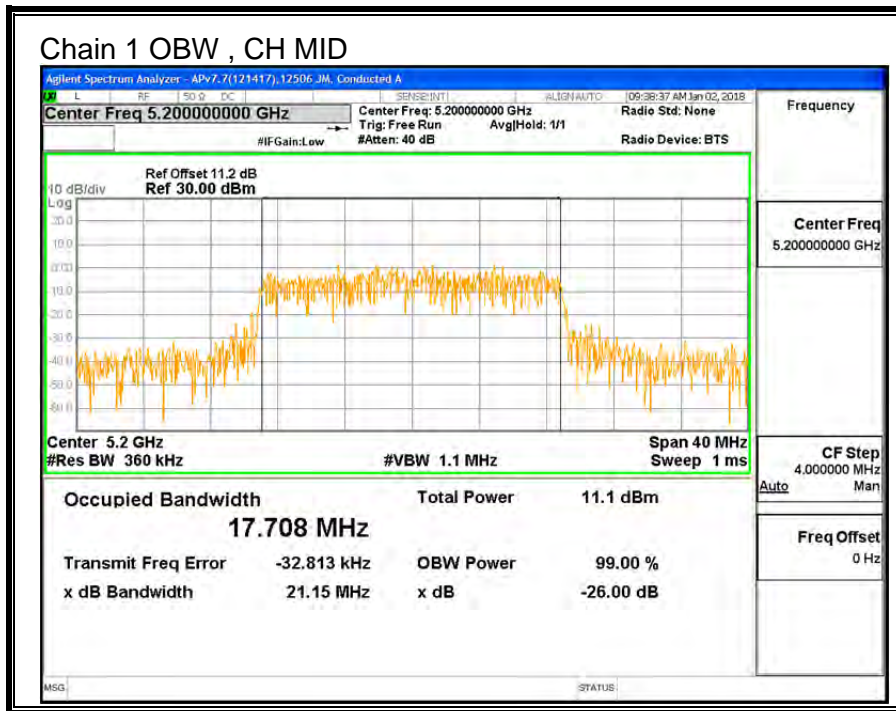
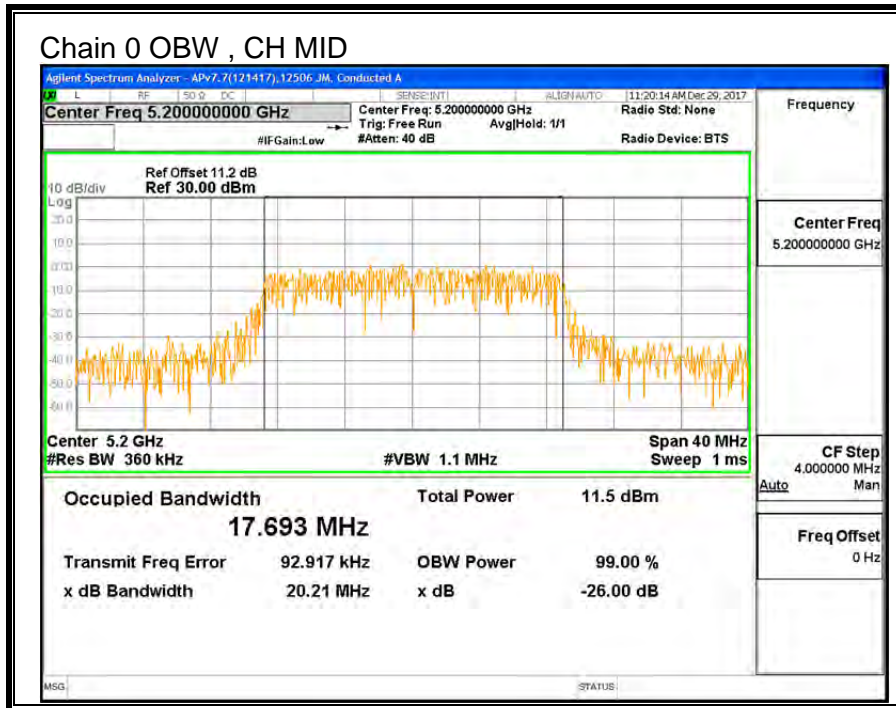



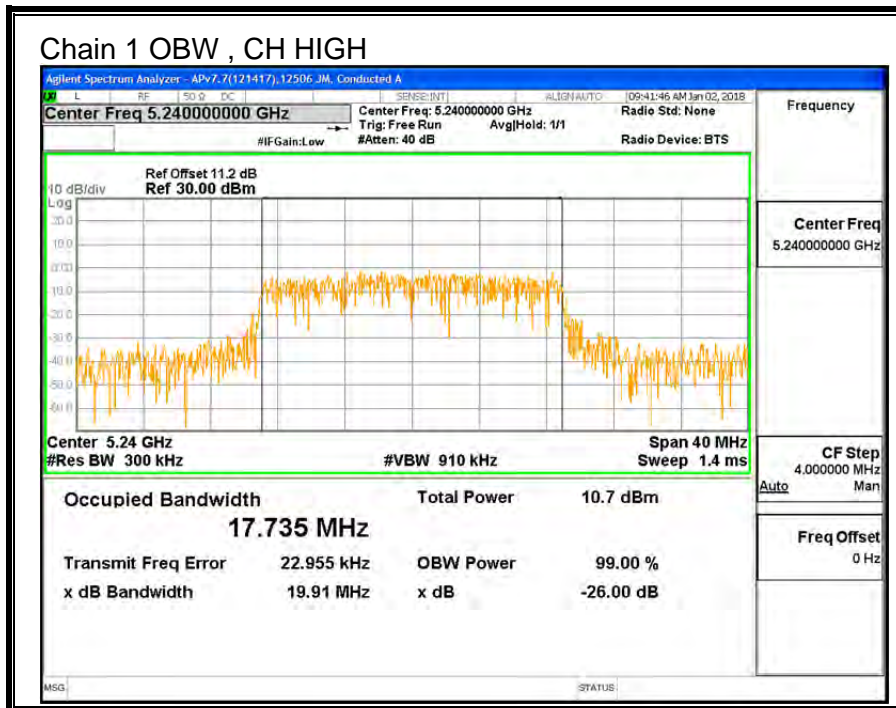
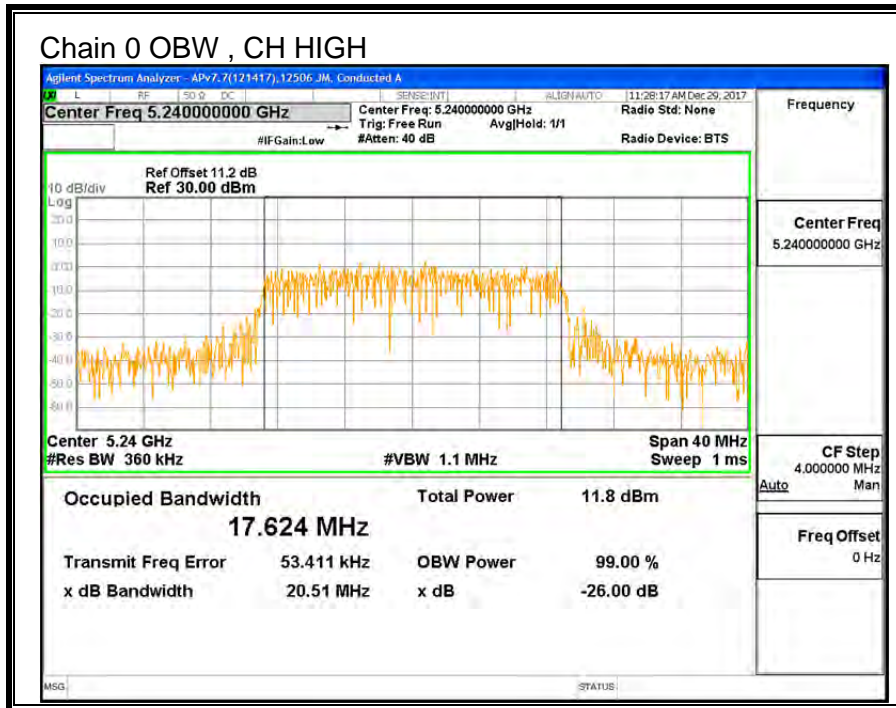

### 9.2.3. OUTPUT POWER AND PPSD

#### **LIMITS**

FCC §15.407 (a) (1)

(i) For an outdoor access point operating in the band 5.15-5.25 GHz, the maximum conducted output power over the frequency band of operation shall not exceed 1 W provided the maximum antenna gain does not exceed 6 dBi. In addition, the maximum power spectral density shall not exceed 17 dBm in any 1 megahertz band. If transmitting antennas of directional gain greater than 6 dBi are used, both the maximum conducted output power and the maximum power spectral density shall be reduced by the amount in dB that the directional gain of the antenna exceeds 6 dBi. The maximum e.i.r.p. at any elevation angle above 30 degrees as measured from the horizon must not exceed 125 mW (21 dBm).

(ii) For an indoor access point operating in the band 5.15-5.25 GHz, the maximum conducted output power over the frequency band of operation shall not exceed 1 W provided the maximum antenna gain does not exceed 6 dBi. In addition, the maximum power spectral density shall not exceed 17 dBm in any 1 megahertz band. If transmitting antennas of directional gain greater than 6 dBi are used, both the maximum conducted output power and the maximum power spectral density shall be reduced by the amount in dB that the directional gain of the antenna exceeds 6 dBi.

(iii) For fixed point-to-point access points operating in the band 5.15-5.25 GHz, the maximum conducted output power over the frequency band of operation shall not exceed 1 W. Fixed point-to-point U-NII devices may employ antennas with directional gain up to 23 dBi without any corresponding reduction in the maximum conducted output power or maximum power spectral density. For fixed point-to-point transmitters that employ a directional antenna gain greater than 23 dBi, a 1 dB reduction in maximum conducted output power and maximum power spectral density is required for each 1 dB of antenna gain in excess of 23 dBi. Fixed, point-to-point operations exclude the use of point-to-multipoint systems, omnidirectional applications, and multiple collocated transmitters transmitting the same information. The operator of the U-NII device, or if the equipment is professionally installed, the installer, is responsible for ensuring that systems employing high gain directional antennas are used exclusively for fixed, point-to-point operations.

(iv) For mobile and portable client devices in the 5.15-5.25 GHz band, the maximum conducted output power over the frequency band of operation shall not exceed 250 mW provided the maximum antenna gain does not exceed 6 dBi. In addition, the maximum power spectral density shall not exceed 11 dBm in any 1 megahertz band. If transmitting antennas of directional gain greater than 6 dBi are used, both the maximum conducted output power and the maximum power spectral density shall be reduced by the amount in dB that the directional gain of the antenna exceeds 6 dBi.

#### **TEST PROCEDURE**

Measurements perform using a wideband gated RF power meter provided that the gate parameters are adjusted such that the power is measured only when the EUT is transmitting at its maximum power control level. Since the measurement is made only during the ON time of the transmitter, no duty cycle correction factor is required.

**DIRECTIONAL ANTENNA GAIN**

For power, the TX chains are uncorrelated and the antenna gain is unequal among the chains. The directional gain is:

**5150-5250 MHz**

<b>Chain 0 Antenna Gain (dBi)</b>	<b>Chain 1 Antenna Gain (dBi)</b>	<b>Uncorrelated Chains Directional Gain (dBi)</b>
-2.10	-4.30	-3.06

For PSD the TX chains are correlated and the antenna gain is unequal among the chains. The directional gain is:

**5150-5250 MHz**

<b>Chain 0 Antenna Gain (dBi)</b>	<b>Chain 1 Antenna Gain (dBi)</b>	<b>Correlated Chains Directional Gain (dBi)</b>
-2.10	-4.30	-0.12

**RESULTS**

<b>ID:</b>	12506 JM	<b>Date:</b>	01/08/18
------------	----------	--------------	----------

**Bandwidth and Antenna Gain**

Channel	Frequency (MHz)	Min 26 dB BW (MHz)	Min 99% BW (MHz)	Directional Gain for Power (dBi)	Directional Gain for PPSD (dBi)
Low	5180	21.80	17.736	-3.06	-0.12
Mid	5200	22.30	17.693	-3.06	-0.12
High	5240	22.00	17.624	-3.06	-0.12

**Limits**

Channel	Frequency (MHz)	FCC Power Limit (dBm)	IC EIRP Limit (dBm)	Max IC Power (dBm)	Power Limit (dBm)	FCC PPSD Limit (dBm)	IC eirp PSD Limit (dBm)	PPSD Limit (dBm)
Low	5180	24.00	22.49	25.55	24.00	11.00	10.00	10.12
Mid	5200	24.00	22.48	25.54	24.00	11.00	10.00	10.12
High	5240	24.00	22.46	25.52	24.00	11.00	10.00	10.12

<b>Duty Cycle CF (dB)</b>	0.14	<b>Included in Calculations of Corr'd PPSD</b>
---------------------------	------	--

**Output Power Results**

Channel	Frequency (MHz)	Chain 0 Meas Power (dBm)	Chain 1 Meas Power (dBm)	Total Corr'd Power (dBm)	Power Limit (dBm)	Power Margin (dB)
Low	5180	10.98	10.76	13.88	24.00	-10.12
Mid	5200	10.95	10.71	13.84	24.00	-10.16
High	5240	11.14	10.53	13.86	24.00	-10.14

**PPSD Results**

Channel	Frequency (MHz)	Chain 0 Meas PPSD (dBm)	Chain 1 Meas PPSD (dBm)	Total Corr'd PPSD (dBm)	PPSD Limit (dBm)	PPSD Margin (dB)
Low	5180	0.508	0.288	3.55	10.12	-6.57
Mid	5200	0.498	0.188	3.50	10.12	-6.62
High	5240	1.023	0.028	3.70	10.12	-6.42

**Note:** the power readings above were measured with gated method, and the measurement was taken only during the ON time. No duty cycle correction was necessary.

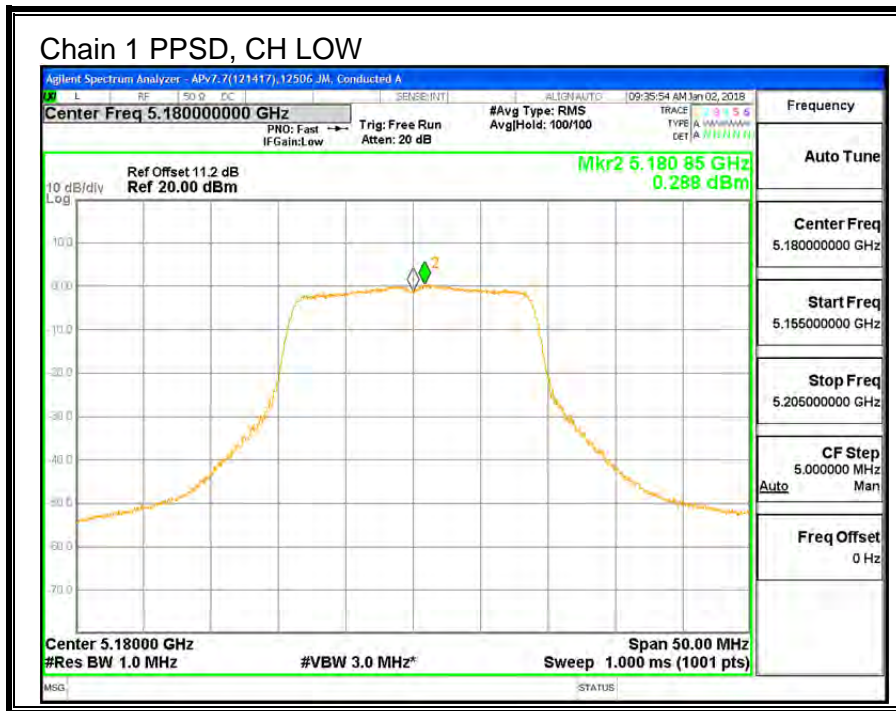
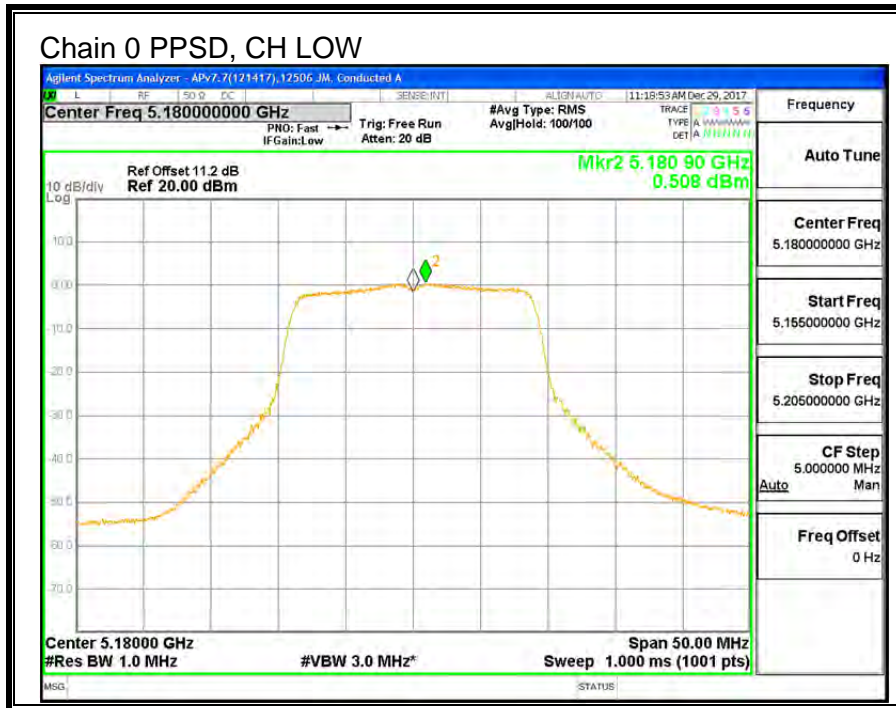

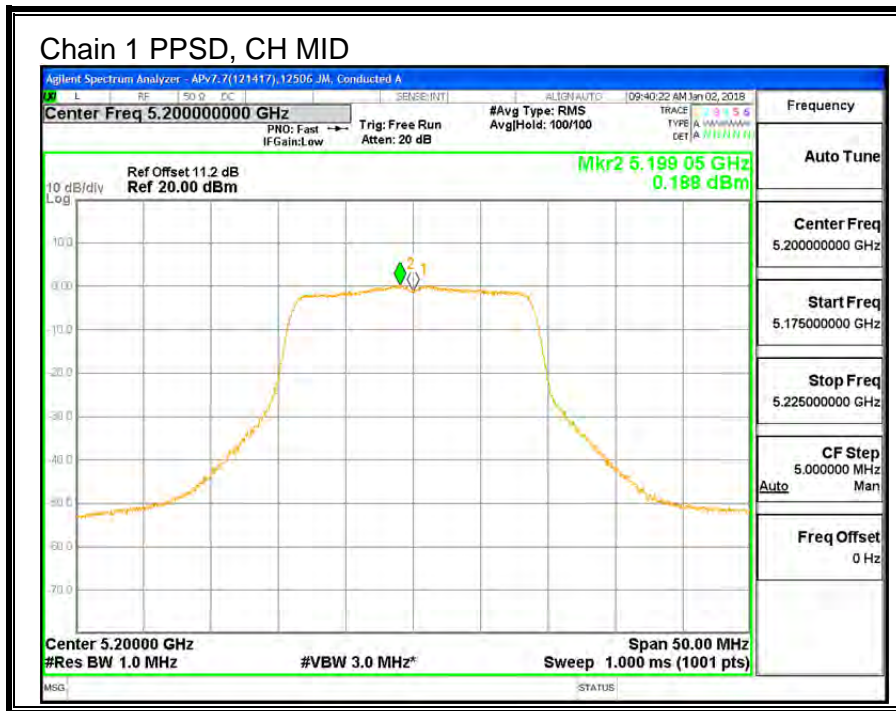
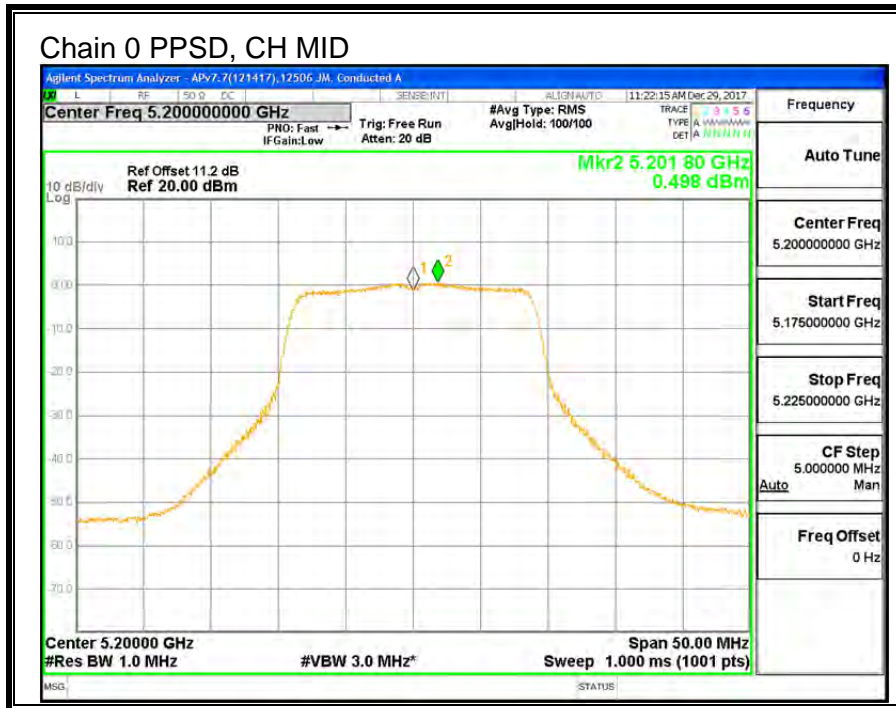



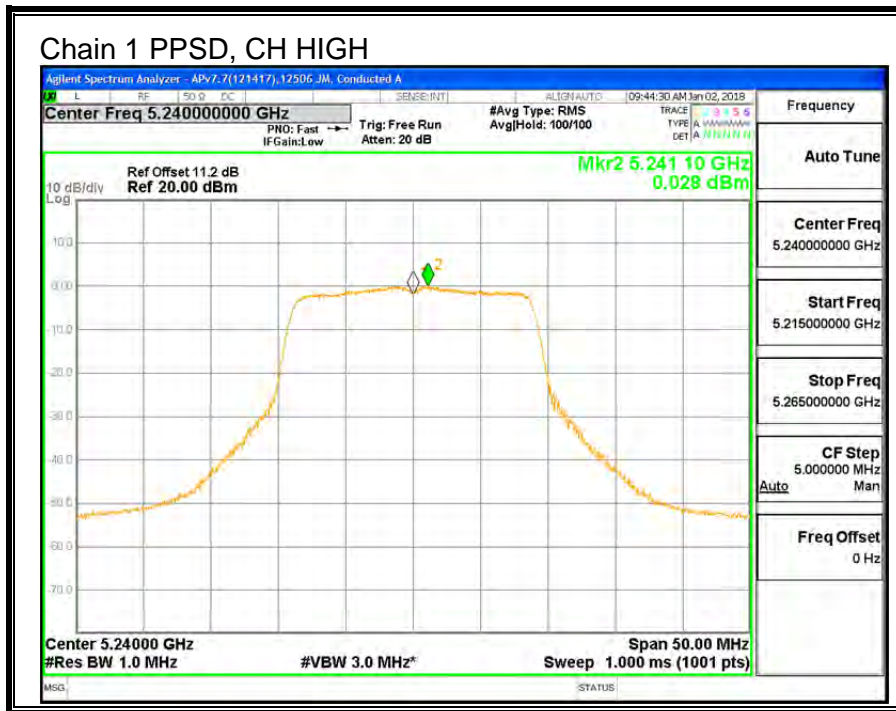
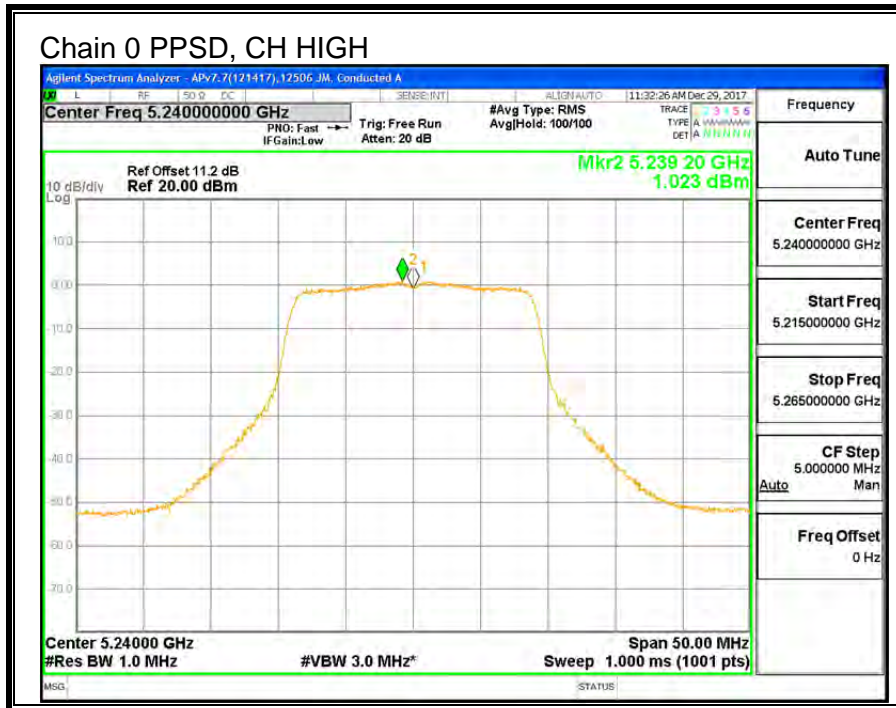

### 9.3. 11n HT40 2TX CDD MIMO MODE IN THE 5.2GHz BAND

#### 9.3.1. 26 dB BANDWIDTH

##### LIMITS

None; for reporting purposes only.

##### RESULTS

Channel	Frequency	26 dB BW Chain 0 (MHz)	26 dB BW Chain 1 (MHz)
Low	5190	41.5	41.0
High	5230	41.3	41.1



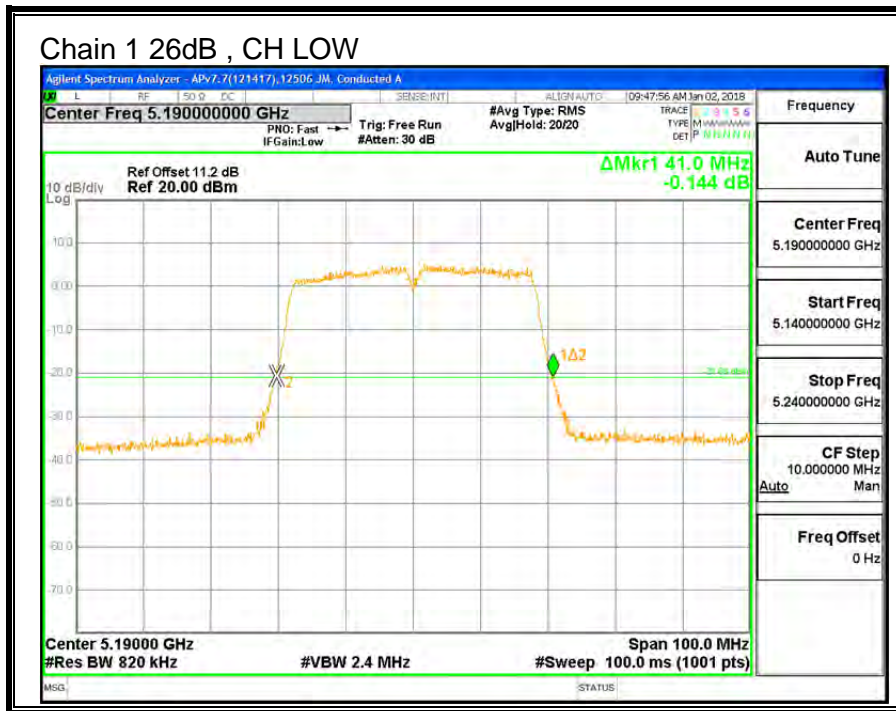
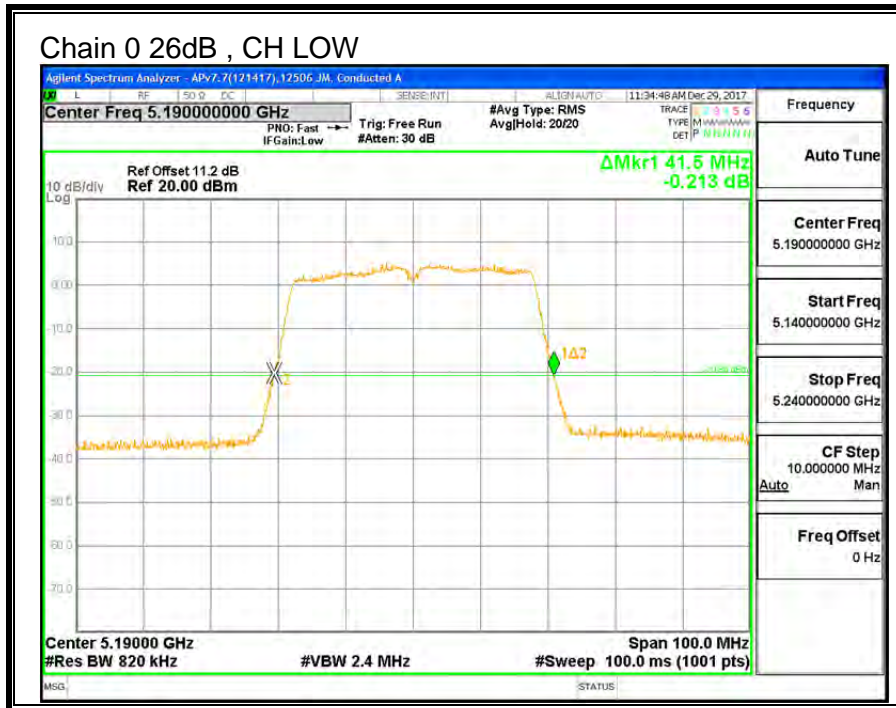

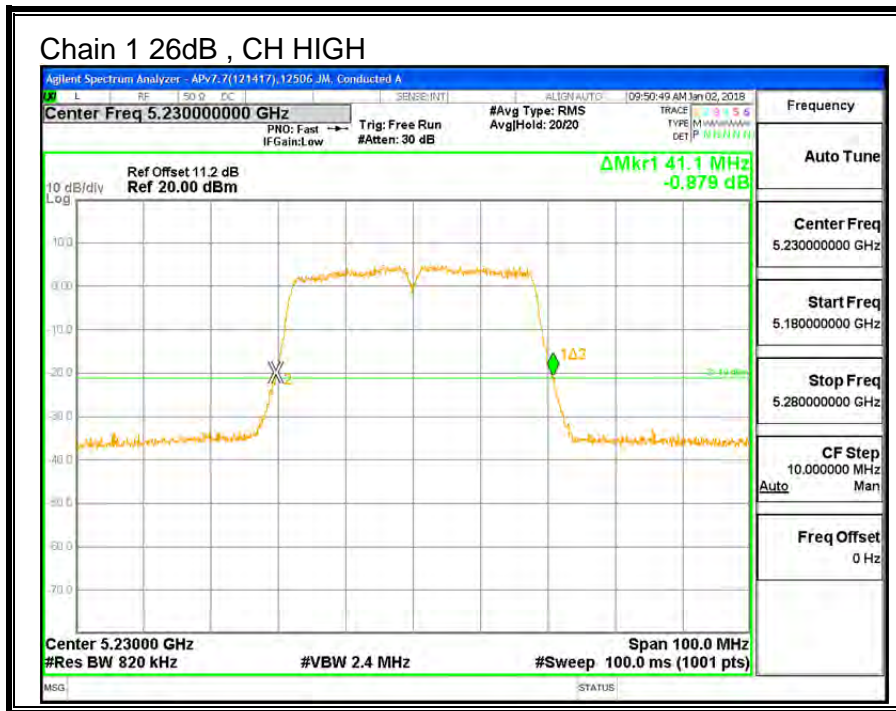
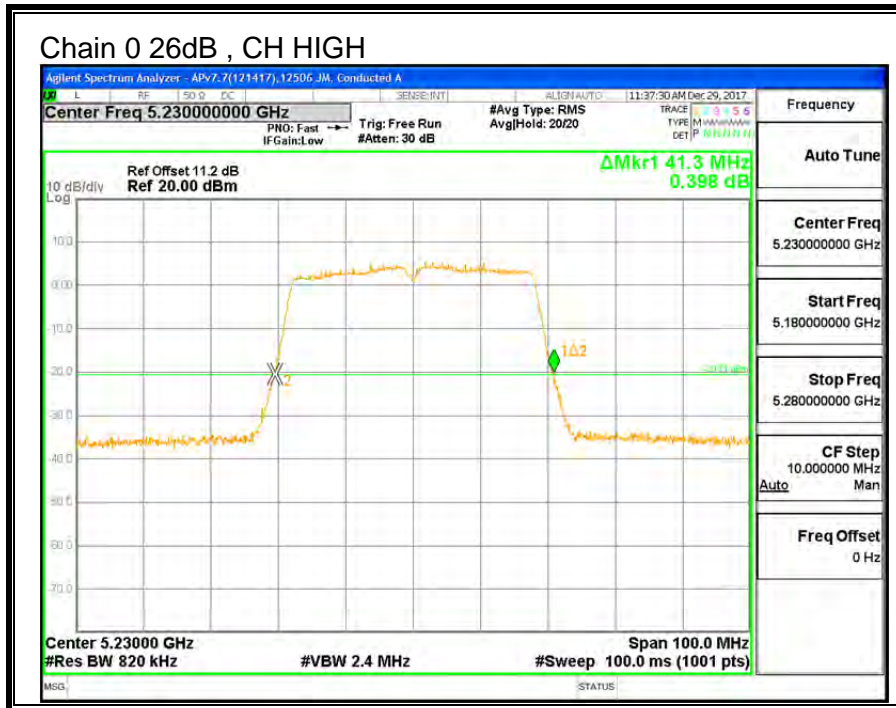

---

### 9.3.2. 99% BANDWIDTH

#### LIMITS

None; for reporting purposes only.

#### RESULTS

Channel	Frequency	99% BW Chain 0 (MHz)	99% BW Chain 1 (MHz)
Low	5190	36.251	36.268
High	5230	36.335	36.375

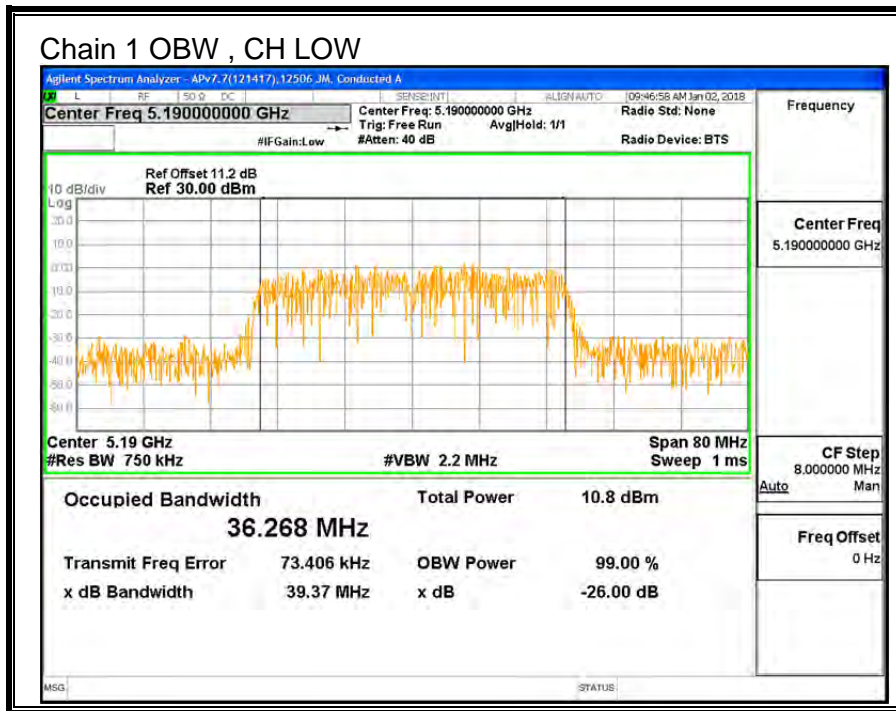
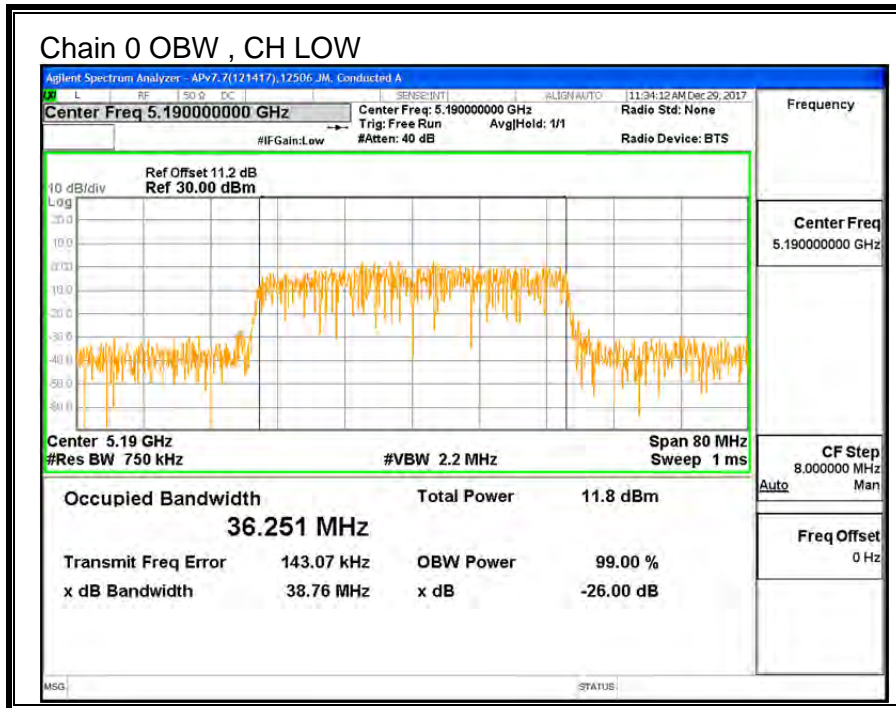



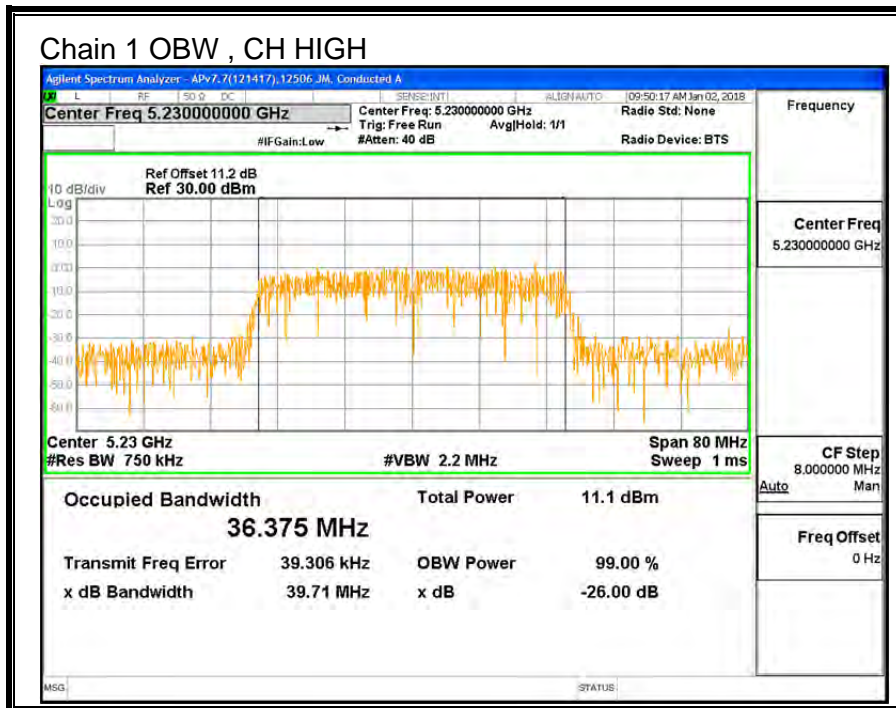
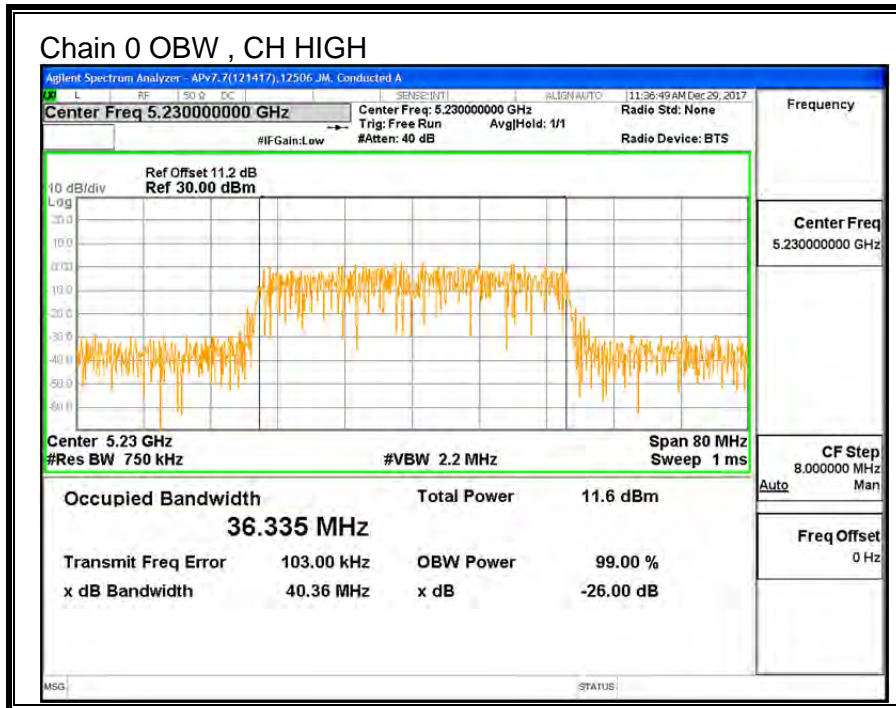

---

### 9.3.3. OUTPUT POWER AND PPSD

#### LIMITS

FCC §15.407 (a) (1)

(i) For an outdoor access point operating in the band 5.15-5.25 GHz, the maximum conducted output power over the frequency band of operation shall not exceed 1 W provided the maximum antenna gain does not exceed 6 dBi. In addition, the maximum power spectral density shall not exceed 17 dBm in any 1 megahertz band. If transmitting antennas of directional gain greater than 6 dBi are used, both the maximum conducted output power and the maximum power spectral density shall be reduced by the amount in dB that the directional gain of the antenna exceeds 6 dBi. The maximum e.i.r.p. at any elevation angle above 30 degrees as measured from the horizon must not exceed 125 mW (21 dBm).

(ii) For an indoor access point operating in the band 5.15-5.25 GHz, the maximum conducted output power over the frequency band of operation shall not exceed 1 W provided the maximum antenna gain does not exceed 6 dBi. In addition, the maximum power spectral density shall not exceed 17 dBm in any 1 megahertz band. If transmitting antennas of directional gain greater than 6 dBi are used, both the maximum conducted output power and the maximum power spectral density shall be reduced by the amount in dB that the directional gain of the antenna exceeds 6 dBi.

(iii) For fixed point-to-point access points operating in the band 5.15-5.25 GHz, the maximum conducted output power over the frequency band of operation shall not exceed 1 W. Fixed point-to-point U-NII devices may employ antennas with directional gain up to 23 dBi without any corresponding reduction in the maximum conducted output power or maximum power spectral density. For fixed point-to-point transmitters that employ a directional antenna gain greater than 23 dBi, a 1 dB reduction in maximum conducted output power and maximum power spectral density is required for each 1 dB of antenna gain in excess of 23 dBi. Fixed, point-to-point operations exclude the use of point-to-multipoint systems, omnidirectional applications, and multiple collocated transmitters transmitting the same information. The operator of the U-NII device, or if the equipment is professionally installed, the installer, is responsible for ensuring that systems employing high gain directional antennas are used exclusively for fixed, point-to-point operations.

(iv) For mobile and portable client devices in the 5.15-5.25 GHz band, the maximum conducted output power over the frequency band of operation shall not exceed 250 mW provided the maximum antenna gain does not exceed 6 dBi. In addition, the maximum power spectral density shall not exceed 11 dBm in any 1 megahertz band. If transmitting antennas of directional gain greater than 6 dBi are used, both the maximum conducted output power and the maximum power spectral density shall be reduced by the amount in dB that the directional gain of the antenna exceeds 6 dBi.

#### TEST PROCEDURE

Measurements perform using a wideband gated RF power meter provided that the gate parameters are adjusted such that the power is measured only when the EUT is transmitting at its maximum power control level. Since the measurement is made only during the ON time of the transmitter, no duty cycle correction factor is required.

**DIRECTIONAL ANTENNA GAIN**

For power, the TX chains are uncorrelated and the antenna gain is unequal among the chains. The directional gain is:

**5150-5250 MHz**

<b>Chain 0 Antenna Gain (dBi)</b>	<b>Chain 1 Antenna Gain (dBi)</b>	<b>Uncorrelated Chains Directional Gain (dBi)</b>
-2.10	-4.30	-3.06

For PSD the TX chains are correlated and the antenna gain is unequal among the chains. The directional gain is:

**5150-5250 MHz**

<b>Chain 0 Antenna Gain (dBi)</b>	<b>Chain 1 Antenna Gain (dBi)</b>	<b>Correlated Chains Directional Gain (dBi)</b>
-2.10	-4.30	-0.12



**RESULTS**

<b>ID:</b>	12506 JM	<b>Date:</b>	01/08/18
------------	----------	--------------	----------

**Bandwidth and Antenna Gain**

Channel	Frequency (MHz)	Min 26 dB BW (MHz)	Min 99% BW (MHz)	Directional Gain for Power (dBi)	Directional Gain for PPSD (dBi)
Low	5190	41.00	36.251	-3.06	-0.12
High	5230	41.10	36.335	-3.06	-0.12

**Limits**

Channel	Frequency (MHz)	FCC Power Limit (dBm)	IC EIRP Limit (dBm)	Max IC Power (dBm)	Power Limit (dBm)	FCC PPSD Limit (dBm)	IC eirp PSD Limit (dBm)	PPSD Limit (dBm)
Low	5190	24.00	23.00	26.06	24.00	11.00	10.00	10.12
High	5230	24.00	23.00	26.06	24.00	11.00	10.00	10.12

<b>Duty Cycle CF (dB)</b>	0.48	<b>Included in Calculations of Corr'd PPSD</b>
---------------------------	------	--

**Output Power Results**

Channel	Frequency (MHz)	Chain 0 Meas Power (dBm)	Chain 1 Meas Power (dBm)	Total Corr'd Power (dBm)	Power Limit (dBm)	Power Margin (dB)
Low	5190	11.49	10.59	14.07	24.00	-9.93
High	5230	11.21	10.65	13.95	24.00	-10.05

**PPSD Results**

Channel	Frequency (MHz)	Chain 0 Meas PPSD (dBm)	Chain 1 Meas PPSD (dBm)	Total Corr'd PPSD (dBm)	PPSD Limit (dBm)	PPSD Margin (dB)
Low	5190	-2.225	-3.160	0.82	10.12	-9.30
High	5230	-2.129	-2.951	0.97	10.12	-9.15

**Note:** the power readings above were measured with gated method, and the measurement was taken only during the ON time. No duty cycle correction was necessary.

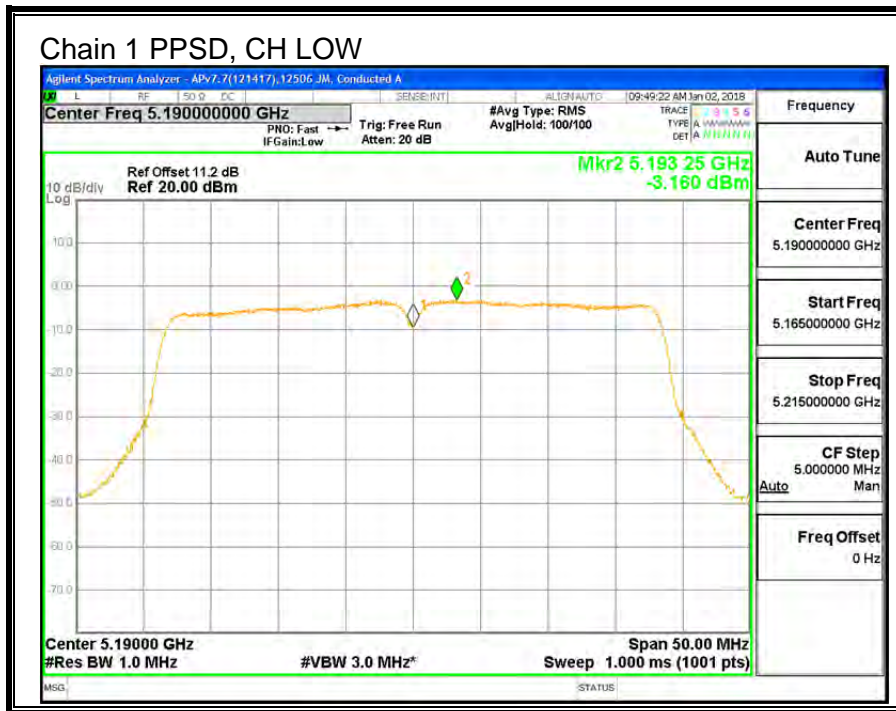
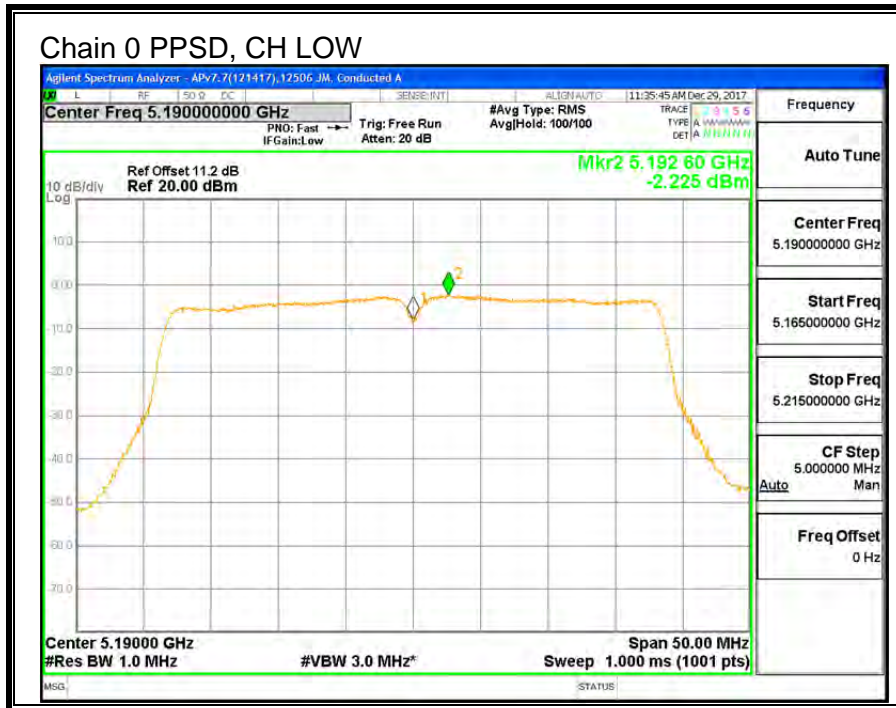

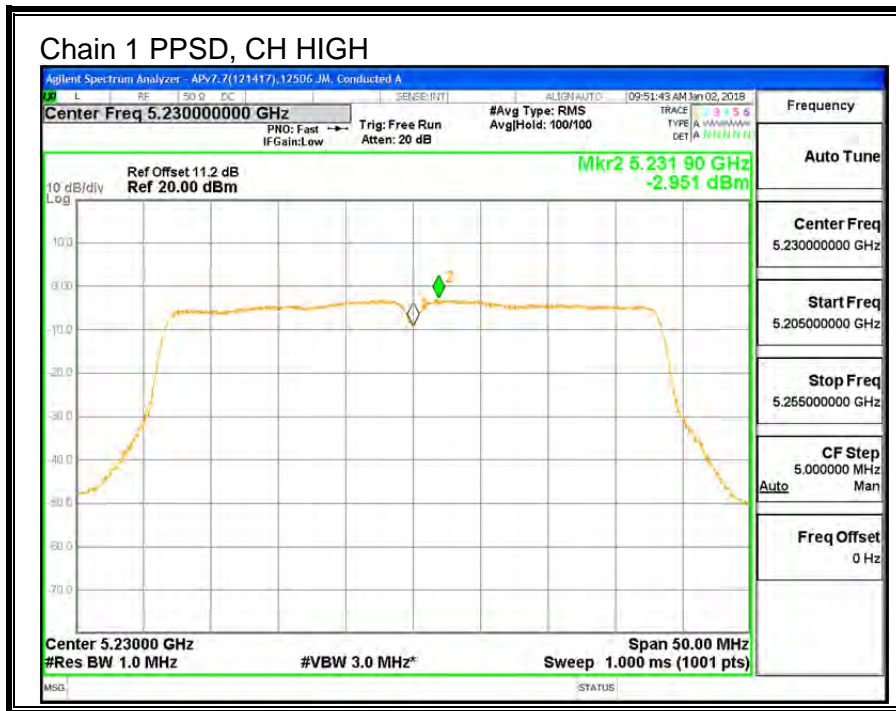
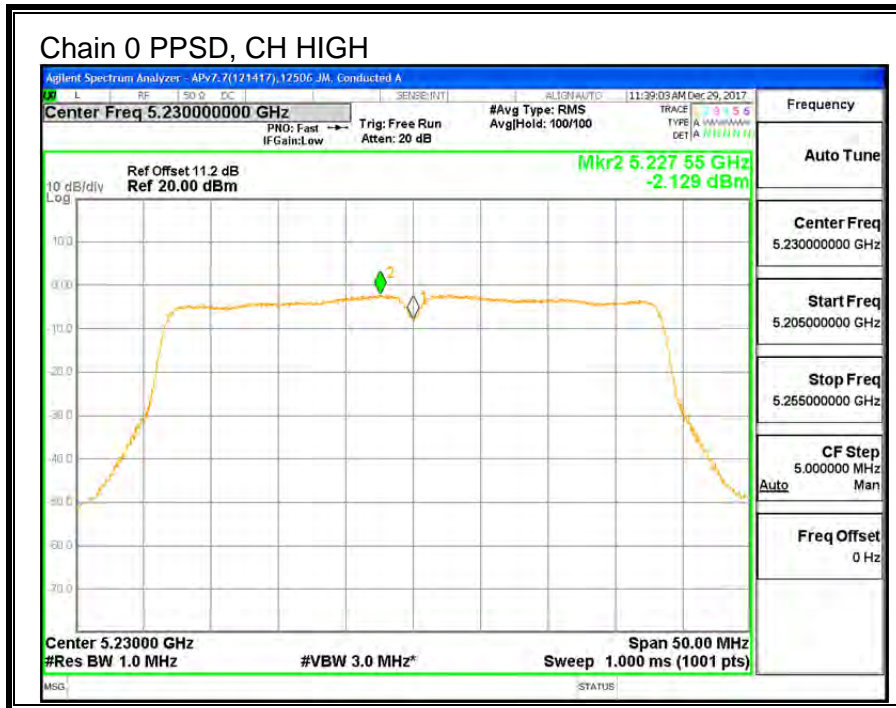

---

**9.4. 11ac HT80 2TX CDD MIMO MODE IN THE 5.2GHz BAND**

**9.4.1. 26 dB BANDWIDTH**

**LIMITS**

None; for reporting purposes only.

**RESULTS**

<b>Channel</b>	<b>Frequency</b>	<b>26 dB BW Chain 0 (MHz)</b>	<b>26 dB BW Chain 1 (MHz)</b>
Low	5210	83.4	83.4

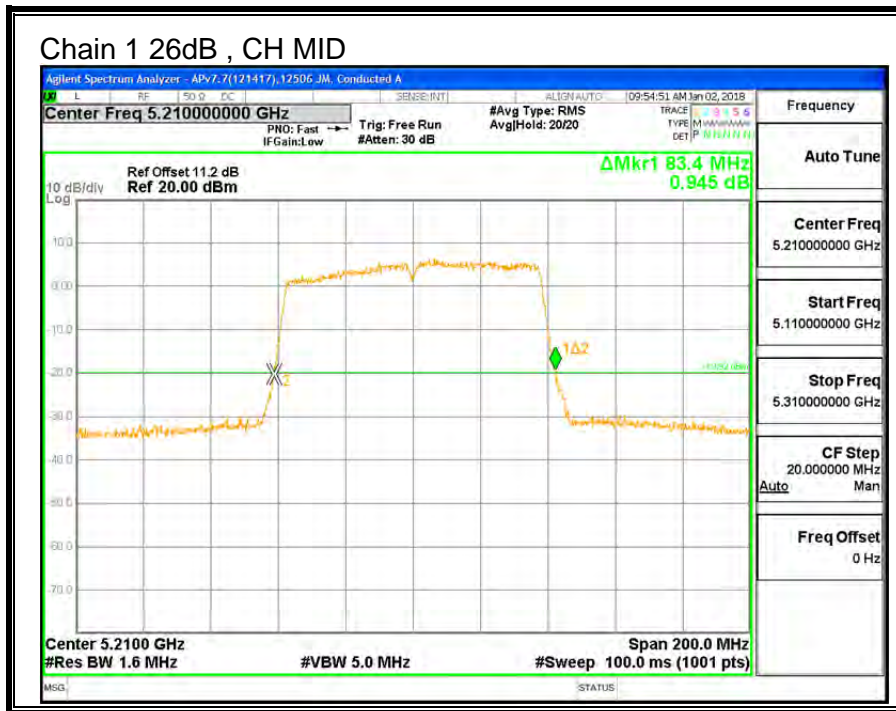
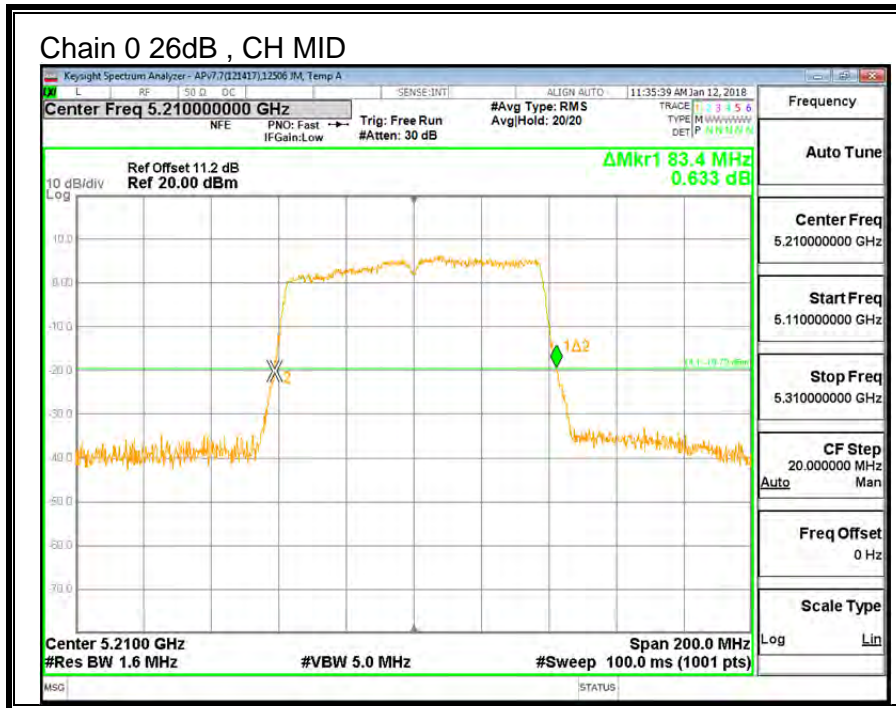

---

**9.4.2. 99% BANDWIDTH**

**LIMITS**

None; for reporting purposes only.

**RESULTS**

<b>Channel</b>	<b>Frequency</b>	<b>99% BW Chain 0 (MHz)</b>	<b>99% BW Chain 1 (MHz)</b>
Low	5210	75.687	75.872



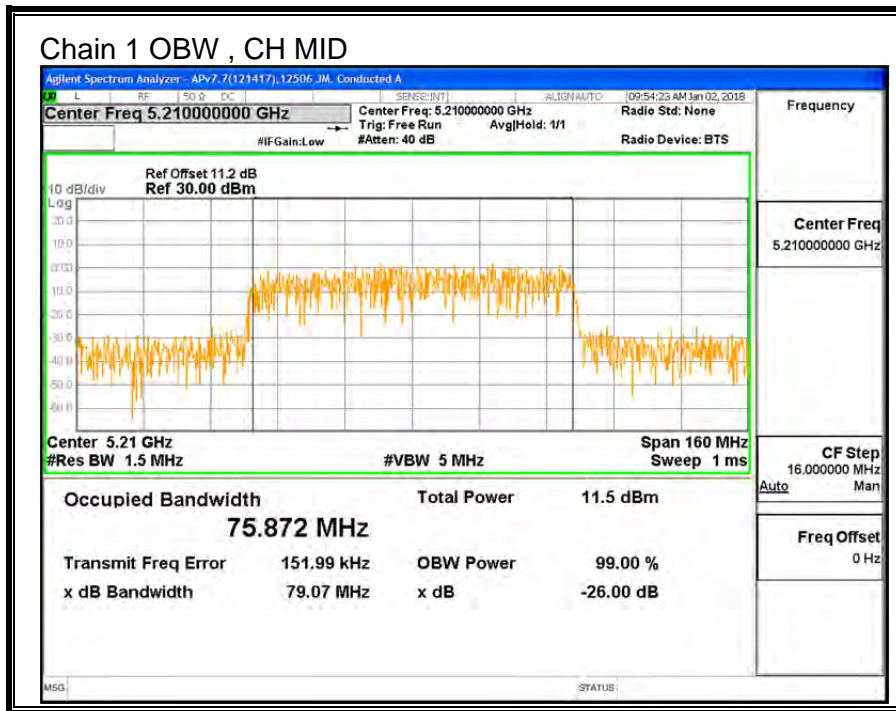
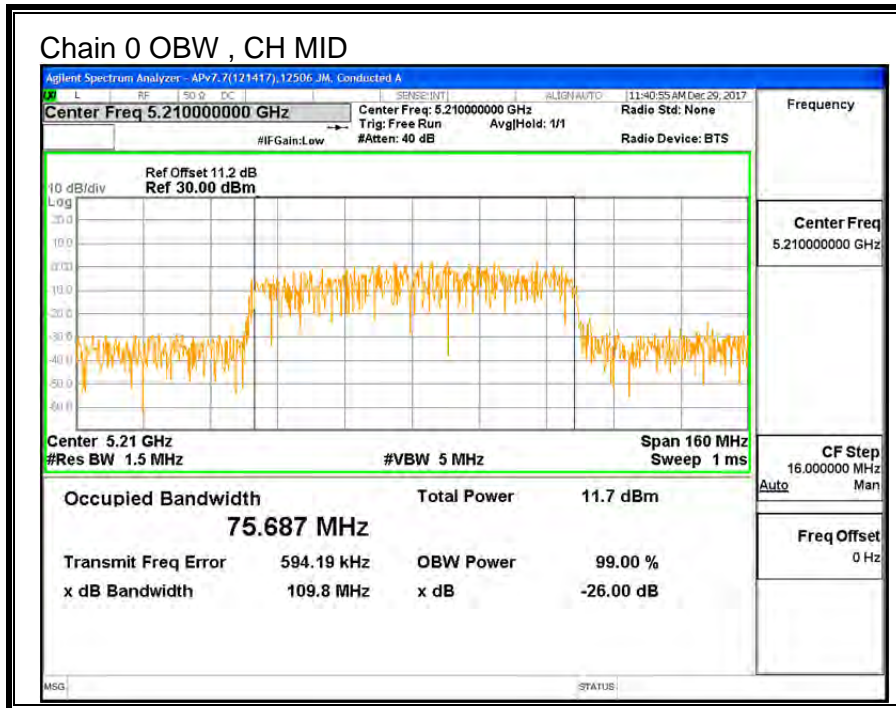



---

### 9.4.3. OUTPUT POWER AND PPSD

#### **LIMITS**

FCC §15.407 (a) (1)

(i) For an outdoor access point operating in the band 5.15-5.25 GHz, the maximum conducted output power over the frequency band of operation shall not exceed 1 W provided the maximum antenna gain does not exceed 6 dBi. In addition, the maximum power spectral density shall not exceed 17 dBm in any 1 megahertz band. If transmitting antennas of directional gain greater than 6 dBi are used, both the maximum conducted output power and the maximum power spectral density shall be reduced by the amount in dB that the directional gain of the antenna exceeds 6 dBi. The maximum e.i.r.p. at any elevation angle above 30 degrees as measured from the horizon must not exceed 125 mW (21 dBm).

(ii) For an indoor access point operating in the band 5.15-5.25 GHz, the maximum conducted output power over the frequency band of operation shall not exceed 1 W provided the maximum antenna gain does not exceed 6 dBi. In addition, the maximum power spectral density shall not exceed 17 dBm in any 1 megahertz band. If transmitting antennas of directional gain greater than 6 dBi are used, both the maximum conducted output power and the maximum power spectral density shall be reduced by the amount in dB that the directional gain of the antenna exceeds 6 dBi.

(iii) For fixed point-to-point access points operating in the band 5.15-5.25 GHz, the maximum conducted output power over the frequency band of operation shall not exceed 1 W. Fixed point-to-point U-NII devices may employ antennas with directional gain up to 23 dBi without any corresponding reduction in the maximum conducted output power or maximum power spectral density. For fixed point-to-point transmitters that employ a directional antenna gain greater than 23 dBi, a 1 dB reduction in maximum conducted output power and maximum power spectral density is required for each 1 dB of antenna gain in excess of 23 dBi. Fixed, point-to-point operations exclude the use of point-to-multipoint systems, omnidirectional applications, and multiple collocated transmitters transmitting the same information. The operator of the U-NII device, or if the equipment is professionally installed, the installer, is responsible for ensuring that systems employing high gain directional antennas are used exclusively for fixed, point-to-point operations.

(iv) For mobile and portable client devices in the 5.15-5.25 GHz band, the maximum conducted output power over the frequency band of operation shall not exceed 250 mW provided the maximum antenna gain does not exceed 6 dBi. In addition, the maximum power spectral density shall not exceed 11 dBm in any 1 megahertz band. If transmitting antennas of directional gain greater than 6 dBi are used, both the maximum conducted output power and the maximum power spectral density shall be reduced by the amount in dB that the directional gain of the antenna exceeds 6 dBi.

#### **TEST PROCEDURE**

Measurements perform using a wideband gated RF power meter provided that the gate parameters are adjusted such that the power is measured only when the EUT is transmitting at its maximum power control level. Since the measurement is made only during the ON time of the transmitter, no duty cycle correction factor is required.

**DIRECTIONAL ANTENNA GAIN**

For power, the TX chains are uncorrelated and the antenna gain is unequal among the chains. The directional gain is:

**5150-5250 MHz**

<b>Chain 0 Antenna Gain (dBi)</b>	<b>Chain 1 Antenna Gain (dBi)</b>	<b>Uncorrelated Chains Directional Gain (dBi)</b>
-2.10	-4.30	-3.06

For PSD the TX chains are correlated and the antenna gain is unequal among the chains. The directional gain is:

**5150-5250 MHz**

<b>Chain 0 Antenna Gain (dBi)</b>	<b>Chain 1 Antenna Gain (dBi)</b>	<b>Correlated Chains Directional Gain (dBi)</b>
-2.10	-4.30	-0.12

**RESULTS**

<b>ID:</b>	12506 JM	<b>Date:</b>	01/08/18
------------	----------	--------------	----------

**Bandwidth and Antenna Gain**

Channel	Frequency (MHz)	Min 26 dB BW (MHz)	Min 99% BW (MHz)	Directional Gain for Power (dBi)	Directional Gain for PPSD (dBi)
Low	5210	83.40	75.687	-3.06	-0.12

**Limits**

Channel	Frequency (MHz)	FCC Power Limit (dBm)	IC EIRP Limit (dBm)	Max IC Power (dBm)	Power Limit (dBm)	FCC PPSD Limit (dBm)	IC eirp PSD Limit (dBm)	PPSD Limit (dBm)
Low	5210	24.00	23.00	26.06	24.00	11.00	10.00	10.12

<b>Duty Cycle CF (dB)</b>	0.73	<b>Included in Calculations of Corr'd PPSD</b>
---------------------------	------	--

**Output Power Results**

Channel	Frequency (MHz)	Chain 0 Meas Power (dBm)	Chain 1 Meas Power (dBm)	Total Corr'd Power (dBm)	Power Limit (dBm)	Power Margin (dB)
Low	5210	10.97	10.82	13.91	24.00	-10.09

**PPSD Results**

Channel	Frequency (MHz)	Chain 0 Meas PPSD (dBm)	Chain 1 Meas PPSD (dBm)	Total Corr'd PPSD (dBm)	PPSD Limit (dBm)	PPSD Margin (dB)
Low	5210	-5.683	-6.047	-2.12	10.12	-12.24

**Note:** the power readings above were measured with gated method, and the measurement was taken only during the ON time. No duty cycle correction was necessary.

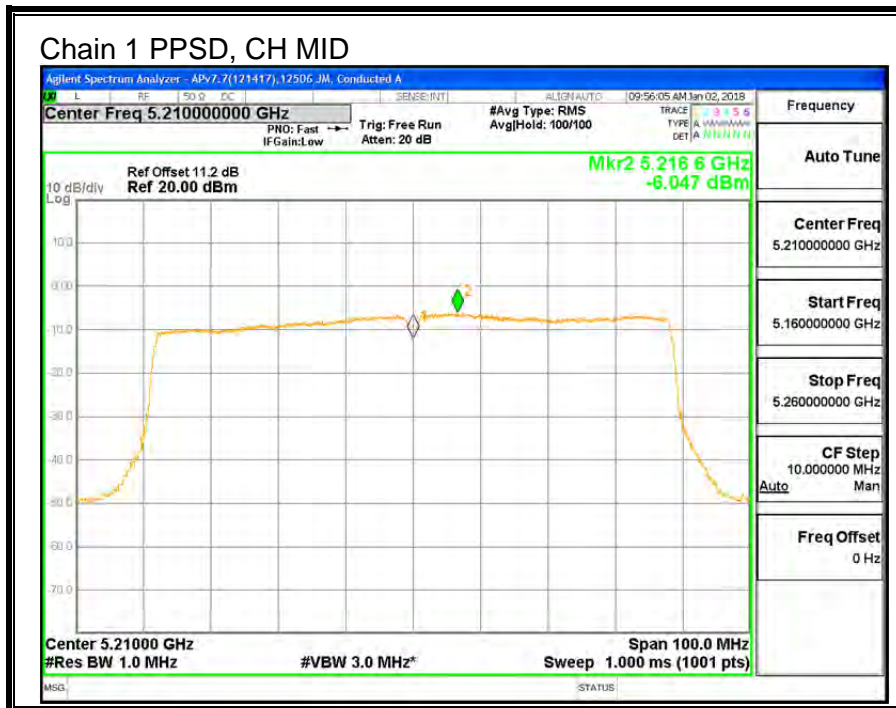
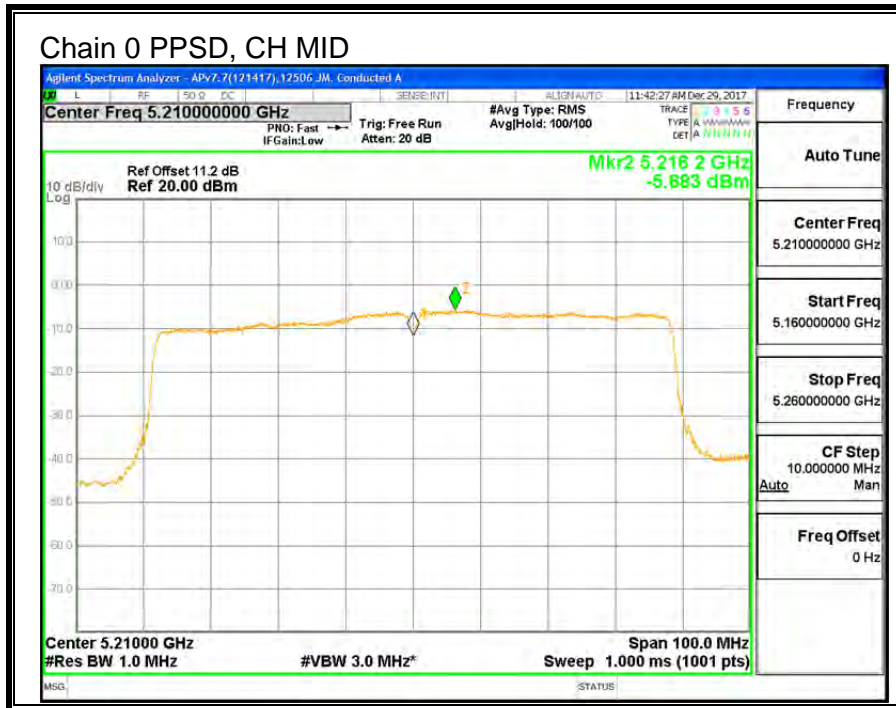

---

**9.5. 11a 2TX CDD MIMO MODE IN THE 5.3GHz BAND**

**9.5.1. 26 dB BANDWIDTH**

**LIMITS**

None; for reporting purposes only.

**RESULTS**

<b>Channel</b>	<b>Frequency</b>	<b>26 dB BW Chain 0 (MHz)</b>	<b>26 dB BW Chain 1 (MHz)</b>
Low	5260	21.80	21.10
Mid	5300	21.85	21.00
High	5320	21.65	20.95

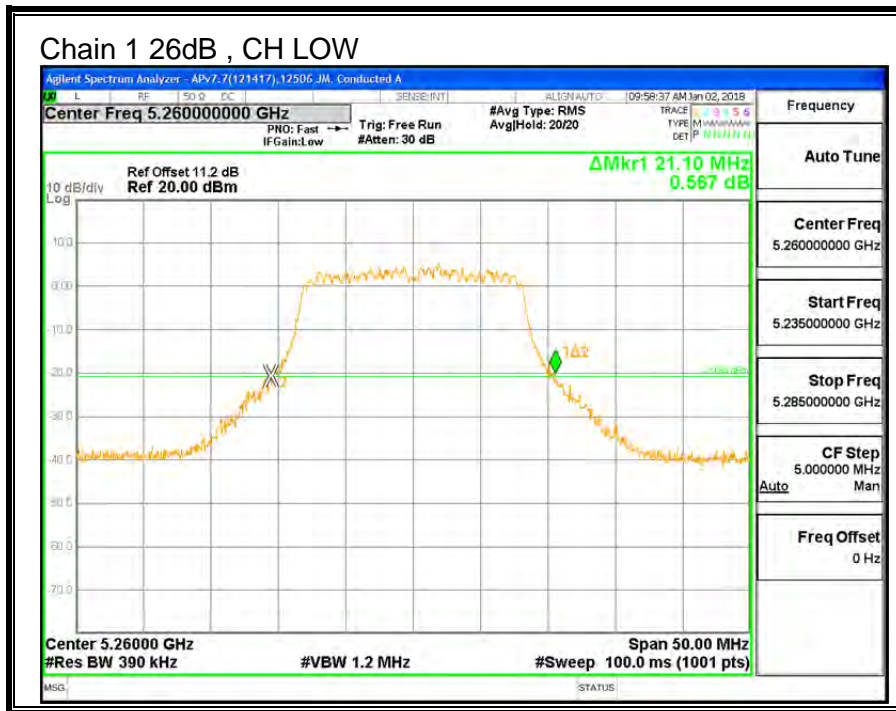
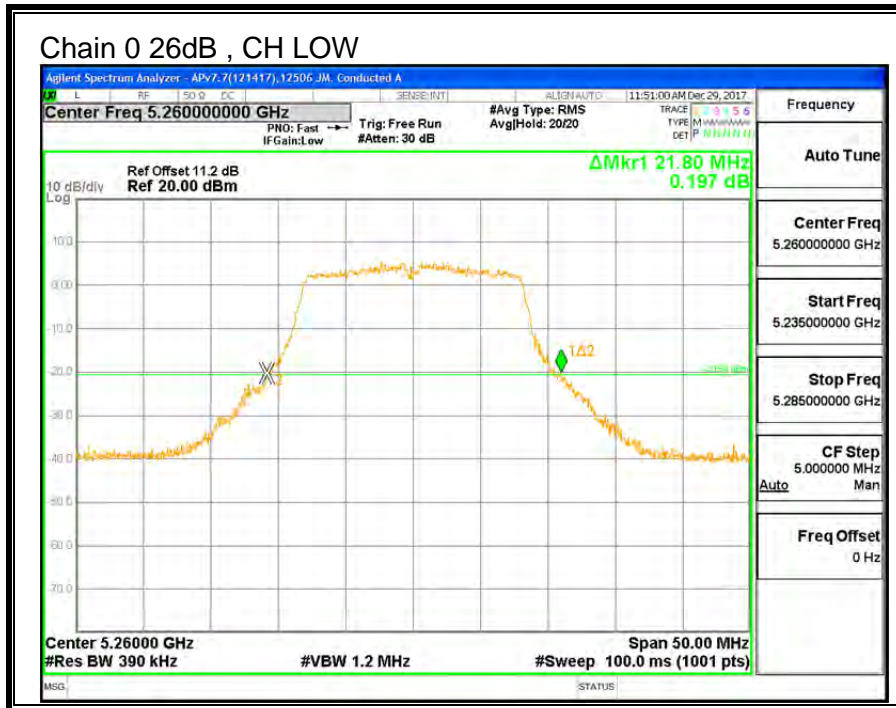

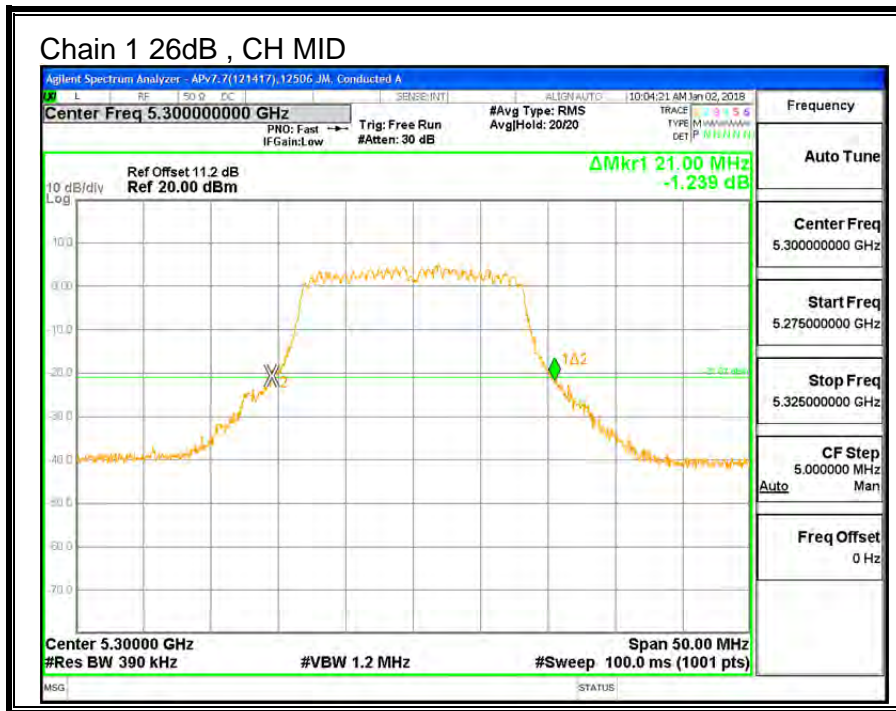
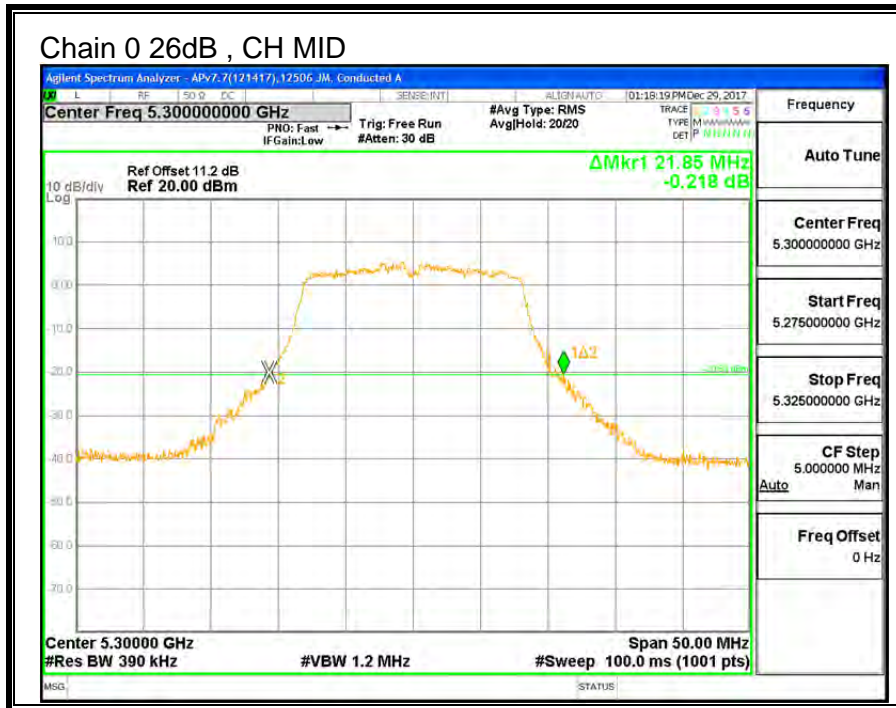



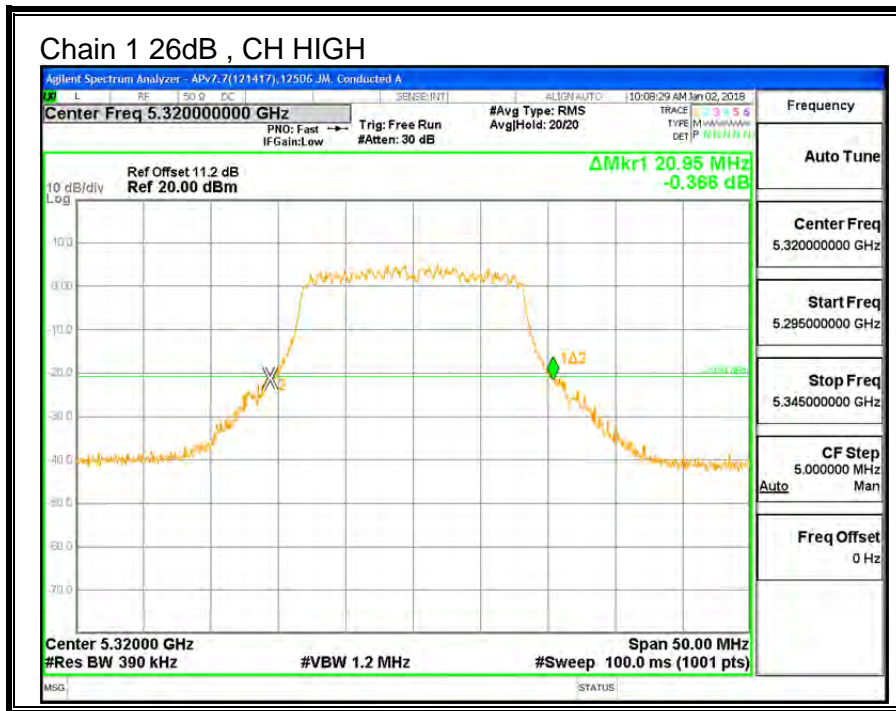
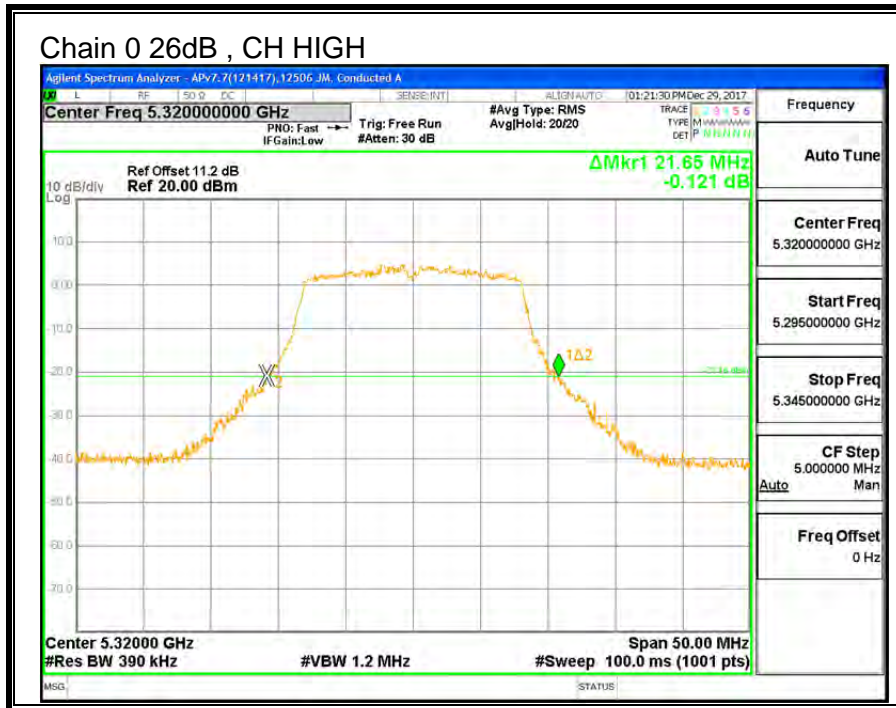

---

**9.5.2. 99% BANDWIDTH**

**LIMITS**

None; for reporting purposes only.

**RESULTS**

<b>Channel</b>	<b>Frequency</b>	<b>99% BW Chain 0 (MHz)</b>	<b>99% BW Chain 1 (MHz)</b>
Low	5260	16.427	16.454
Mid	5300	16.443	16.581
High	5320	16.528	16.469

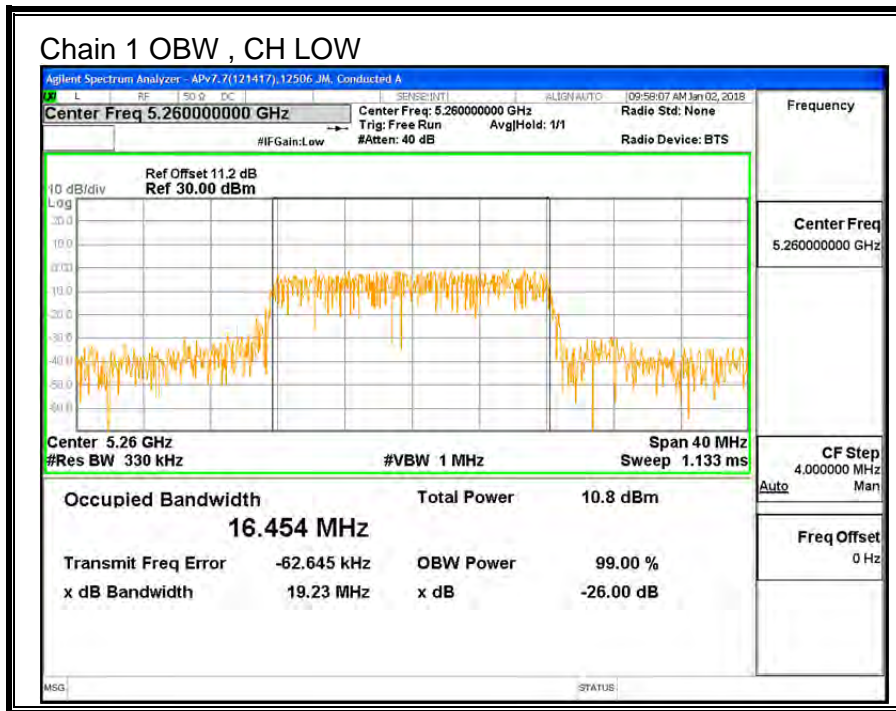
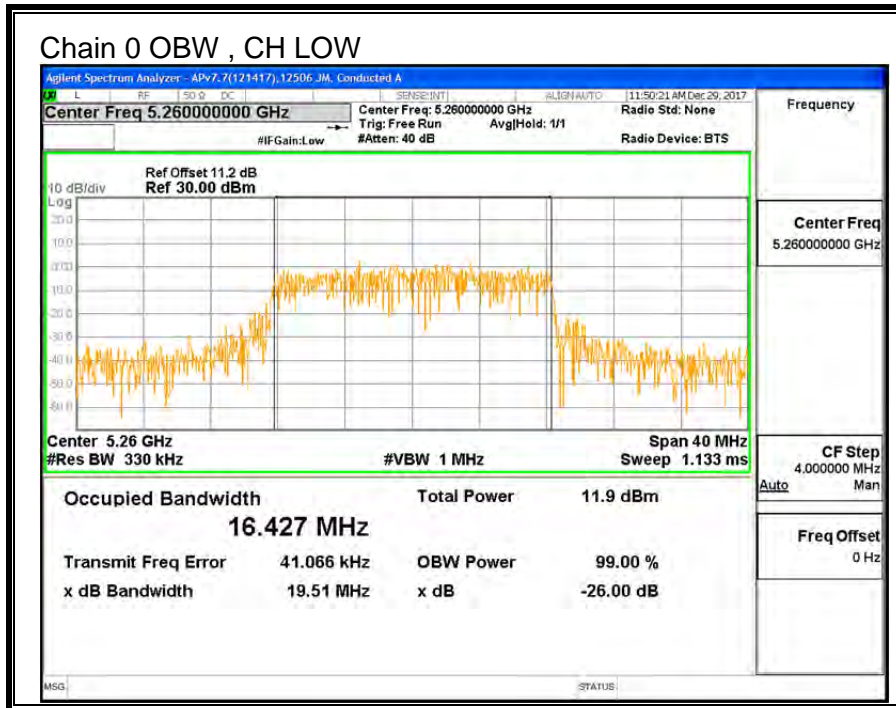

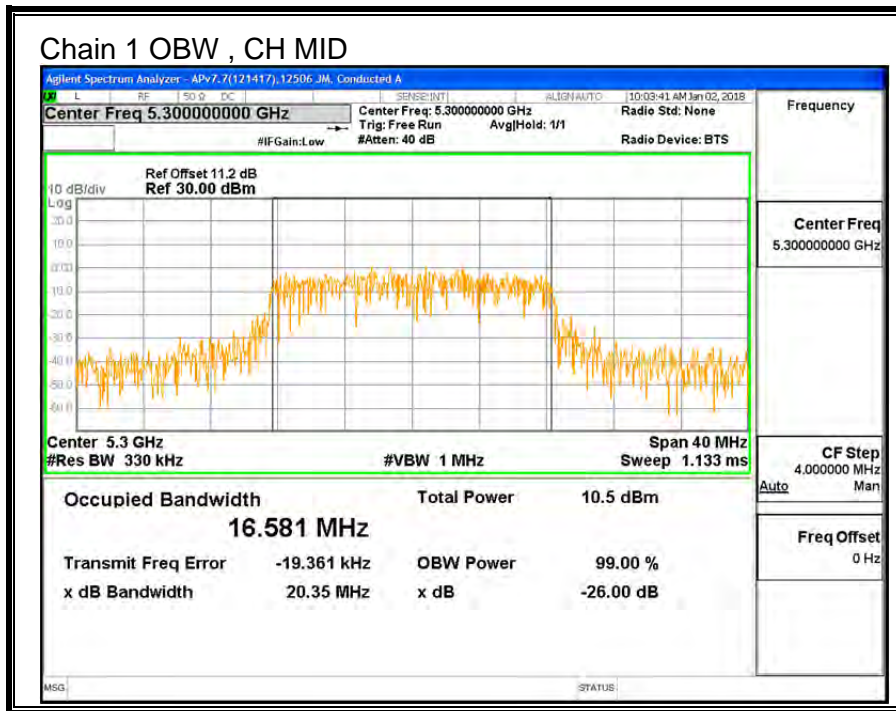
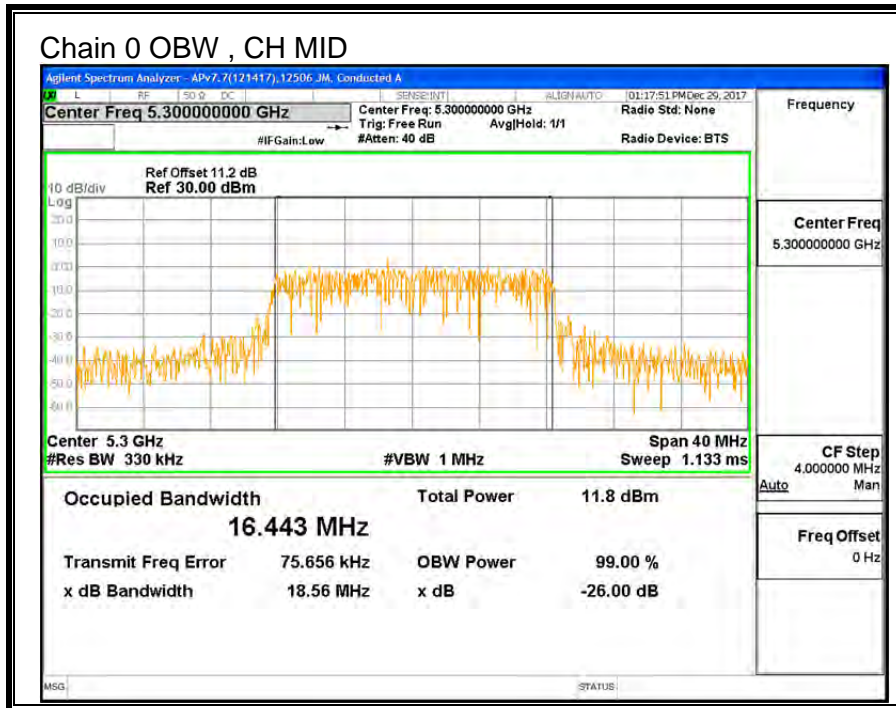



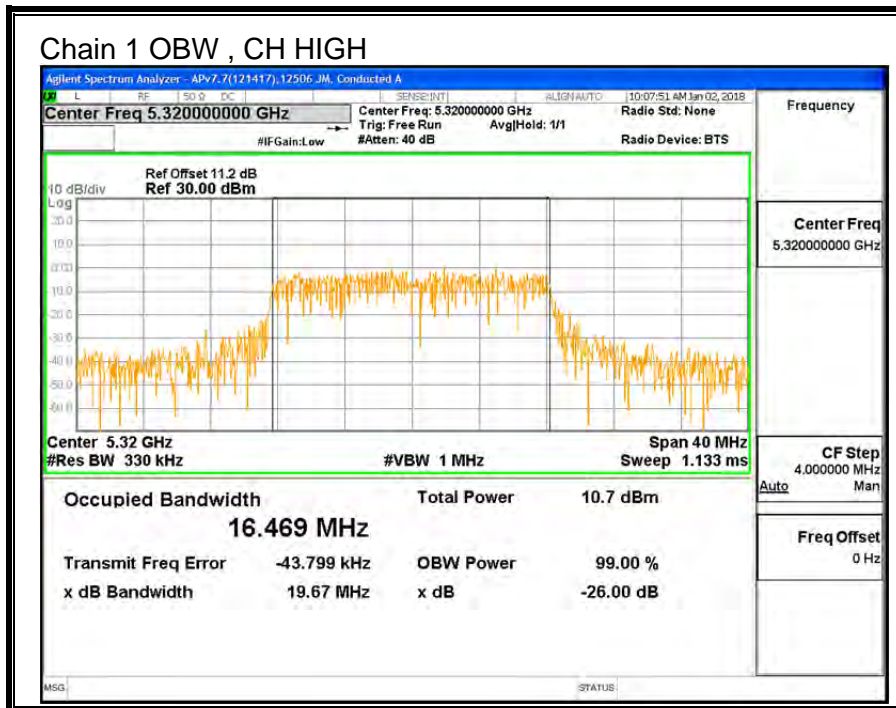
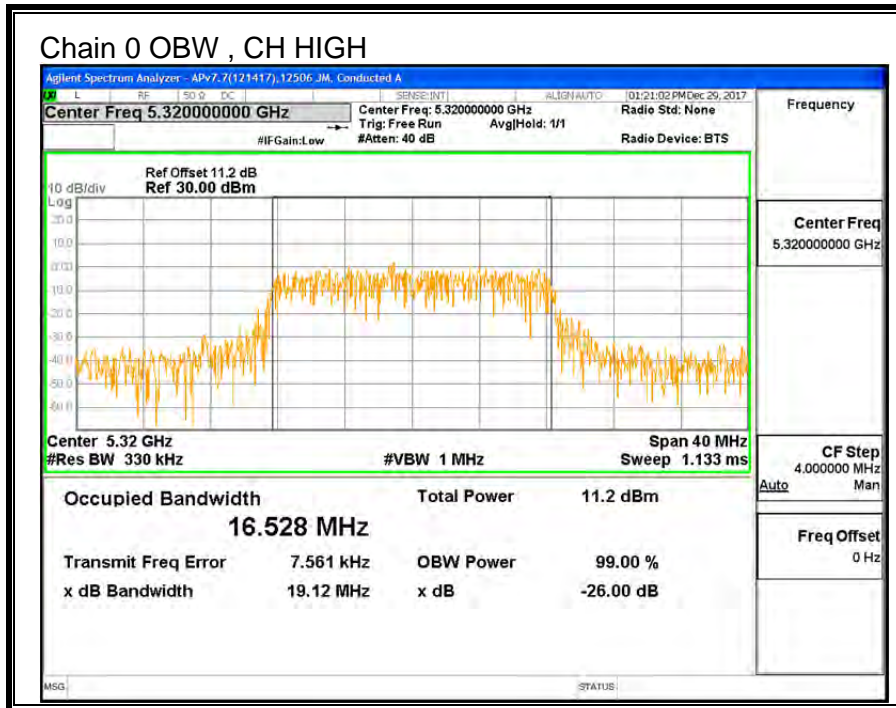

---

### 9.5.3. OUTPUT POWER AND PPSD

#### **LIMITS**

FCC §15.407 (a) (2)

For the band 5.25–5.35 GHz, the maximum conducted output power over the frequency band of operation shall not exceed the lesser of 250 mW or  $11 \text{ dBm} + 10 \log B$ , where B is the 26–dB emission bandwidth in MHz. In addition, the maximum power spectral density shall not exceed 11 dBm in any 1–MHz band. If transmitting antennas of directional gain greater than 6 dBi are used, both the maximum conducted output power and the peak power spectral density shall be reduced by the amount in dB that the directional gain of the antenna exceeds 6 dBi.

#### **TEST PROCEDURE**

Measurements perform using a wideband gated RF power meter provided that the gate parameters are adjusted such that the power is measured only when the EUT is transmitting at its maximum power control level. Since the measurement is made only during the ON time of the transmitter, no duty cycle correction factor is required.

**DIRECTIONAL ANTENNA GAIN**

For power, the TX chains are uncorrelated and the antenna gain is unequal among the chains. The directional gain is:

**5250-5350 MHz**

<b>Chain 0 Antenna Gain (dBi)</b>	<b>Chain 1 Antenna Gain (dBi)</b>	<b>Uncorrelated Chains Directional Gain (dBi)</b>
-2.10	-4.30	-3.06

For PSD the TX chains are correlated and the antenna gain is unequal among the chains. The directional gain is:

**5250-5230 MHz**

<b>Chain 0 Antenna Gain (dBi)</b>	<b>Chain 1 Antenna Gain (dBi)</b>	<b>Correlated Chains Directional Gain (dBi)</b>
-2.10	-4.30	-0.12



**RESULTS**

<b>ID:</b>	12506 JM	<b>Date:</b>	01/08/18
------------	----------	--------------	----------

**Bandwidth and Antenna Gain**

Channel	Frequency (MHz)	Min 26 dB BW (MHz)	Min 99% BW (MHz)	Directional Gain for Power (dBi)	Directional Gain for PPSD (dBi)
Low	5260	21.10	16.427	-3.06	-0.12
Mid	5300	21.00	16.443	-3.06	-0.12
High	5320	20.95	16.469	-3.06	-0.12

**Limits**

Channel	Frequency (MHz)	FCC Power Limit (dBm)	IC Power Limit (dBm)	IC EIRP Limit (dBm)	Power Limit (dBm)	FCC PSD Limit (dBm)	IC PSD Limit (dBm)	PPSD Limit (dBm)
Low	5260	24.00	23.16	29.16	23.16	11.00	11.00	11.00
Mid	5300	24.00	23.16	29.16	23.16	11.00	11.00	11.00
High	5320	24.00	23.17	29.17	23.17	11.00	11.00	11.00

<b>Duty Cycle CF (dB)</b>	0.00	<b>Included in Calculations of Corr'd PPSD</b>
---------------------------	------	--

**Output Power Results**

Channel	Frequency (MHz)	Chain 0 Meas Power (dBm)	Chain 1 Meas Power (dBm)	Total Corr'd Power (dBm)	Power Limit (dBm)	Power Margin (dB)
Low	5260	11.65	10.54	14.14	23.16	-9.01
Mid	5300	12.13	10.61	14.45	23.16	-8.71
High	5320	11.63	10.76	14.23	23.17	-8.94

**PPSD Results**

Channel	Frequency (MHz)	Chain 0 Meas PPSD (dBm)	Chain 1 Meas PPSD (dBm)	Total Corr'd PPSD (dBm)	PPSD Limit (dBm)	PPSD Margin (dB)
Low	5260	1.493	0.448	4.01	11.00	-6.99
Mid	5300	1.226	0.047	3.69	11.00	-7.31
High	5320	0.792	-0.039	3.41	11.00	-7.59

**Note:** the power readings above were measured with gated method, and the measurement was taken only during the ON time. No duty cycle correction was necessary.

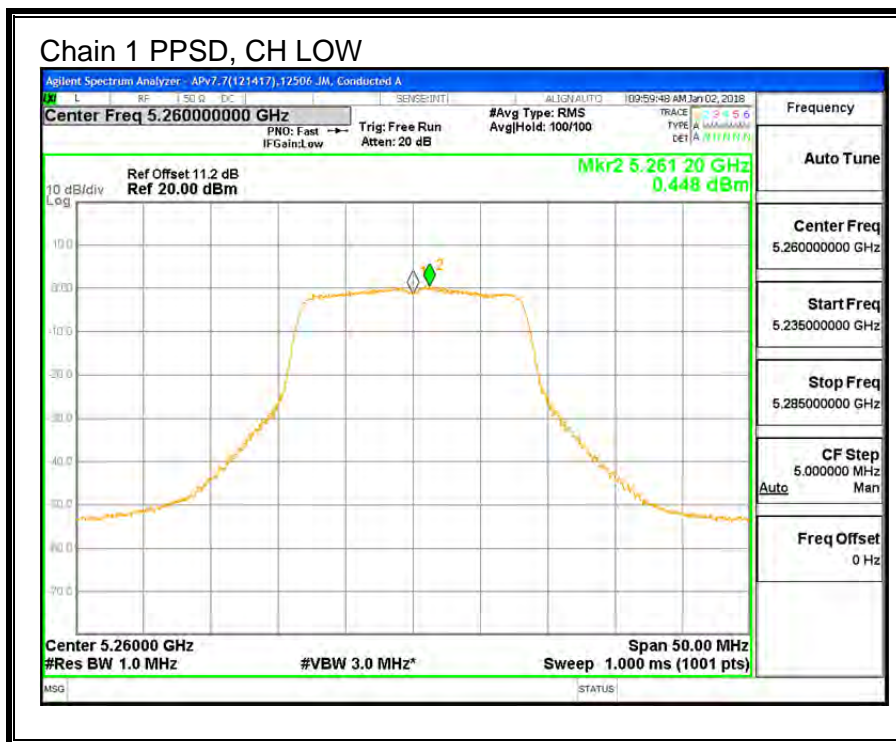
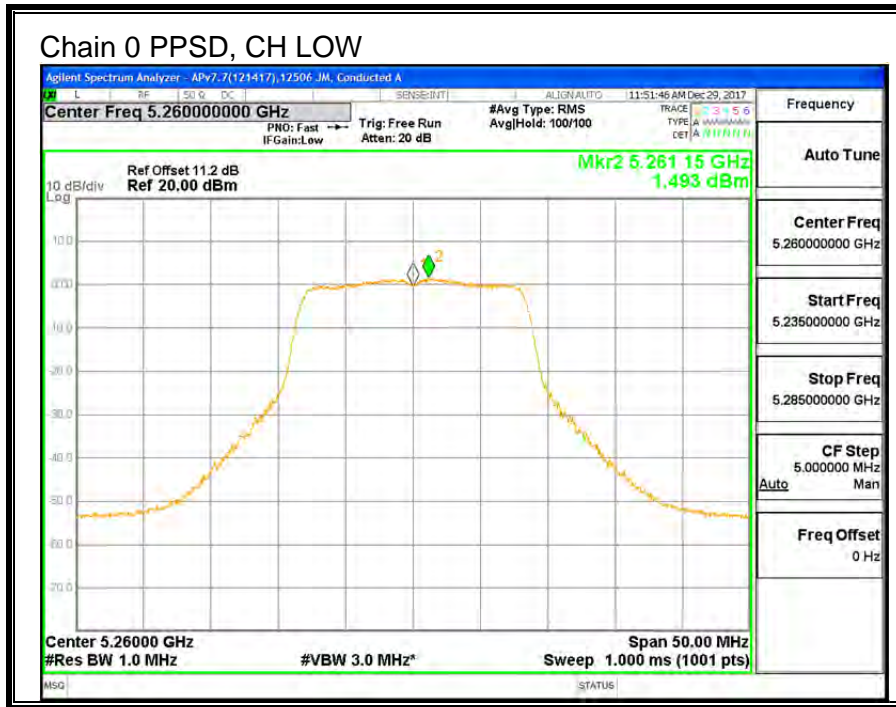

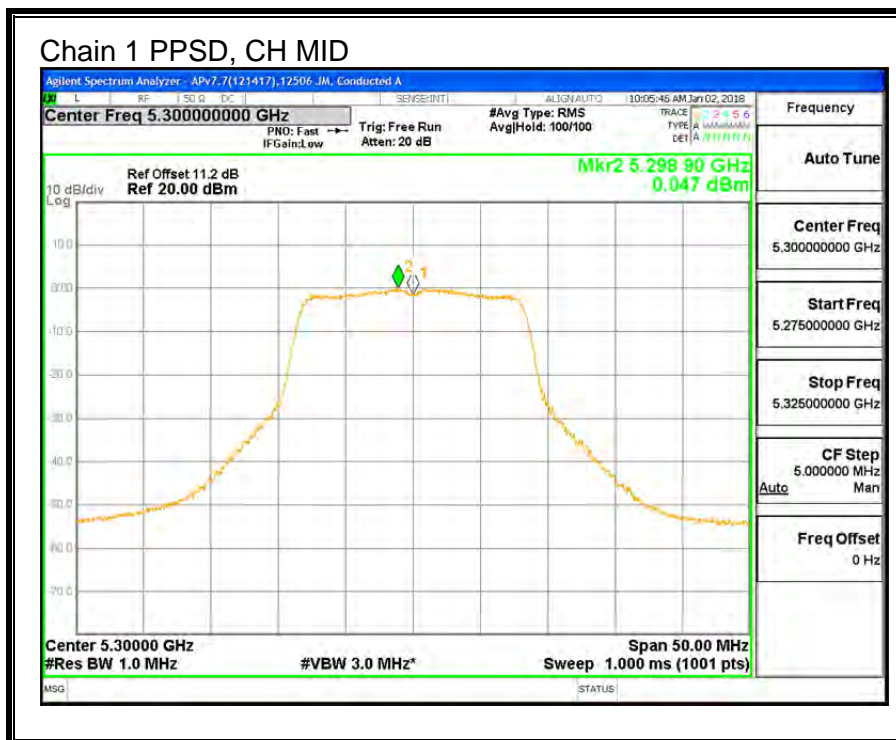
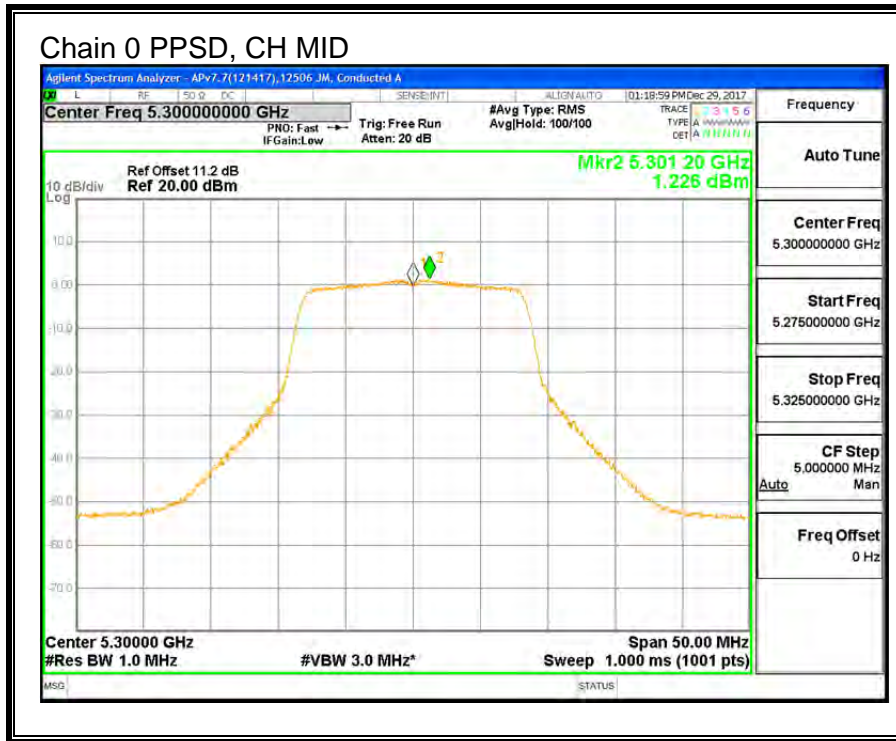

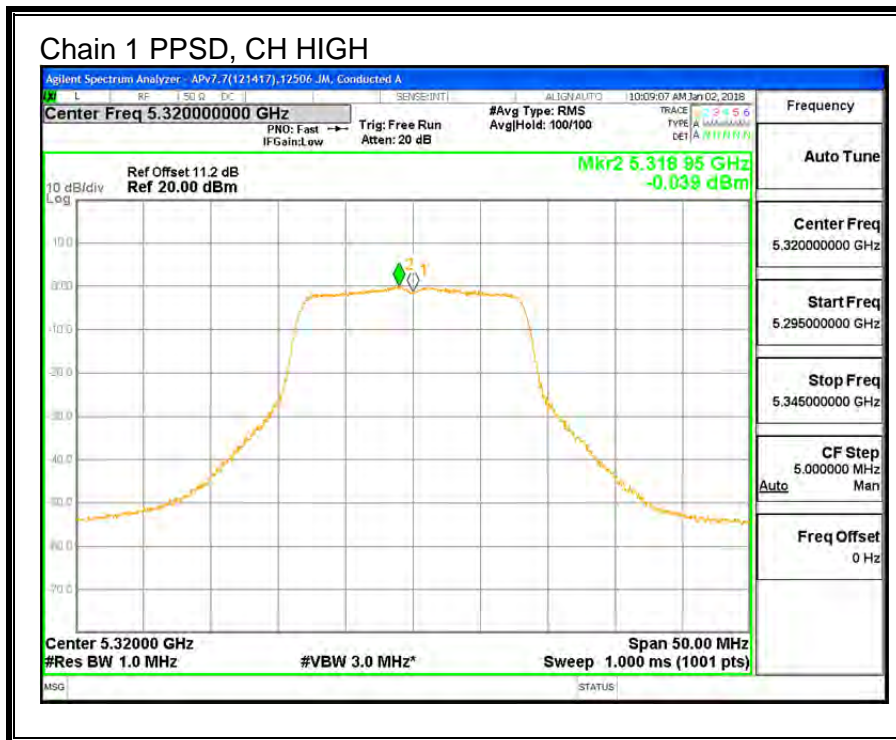
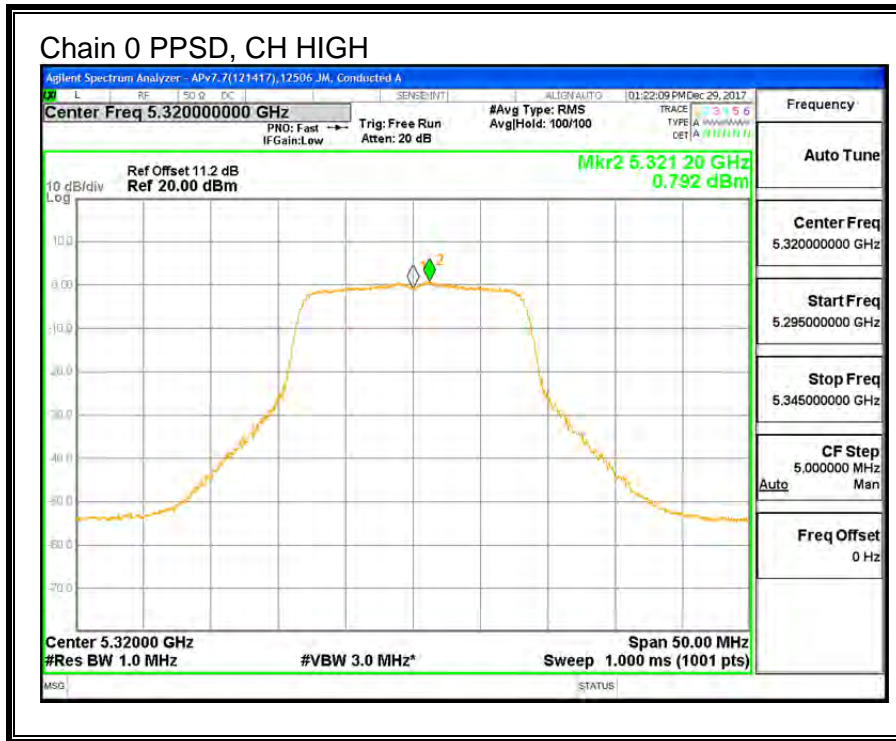

---

**9.6. 11n HT20 2TX CDD MIMO MODE IN THE 5.3GHz BAND**

**9.6.1. 26 dB BANDWIDTH**

**LIMITS**

None; for reporting purposes only.

**RESULTS**

<b>Channel</b>	<b>Frequency</b>	<b>26 dB BW Chain 0 (MHz)</b>	<b>26 dB BW Chain 1 (MHz)</b>
Low	5260	22.65	22.60
Mid	5300	22.70	22.20
High	5320	22.50	21.65



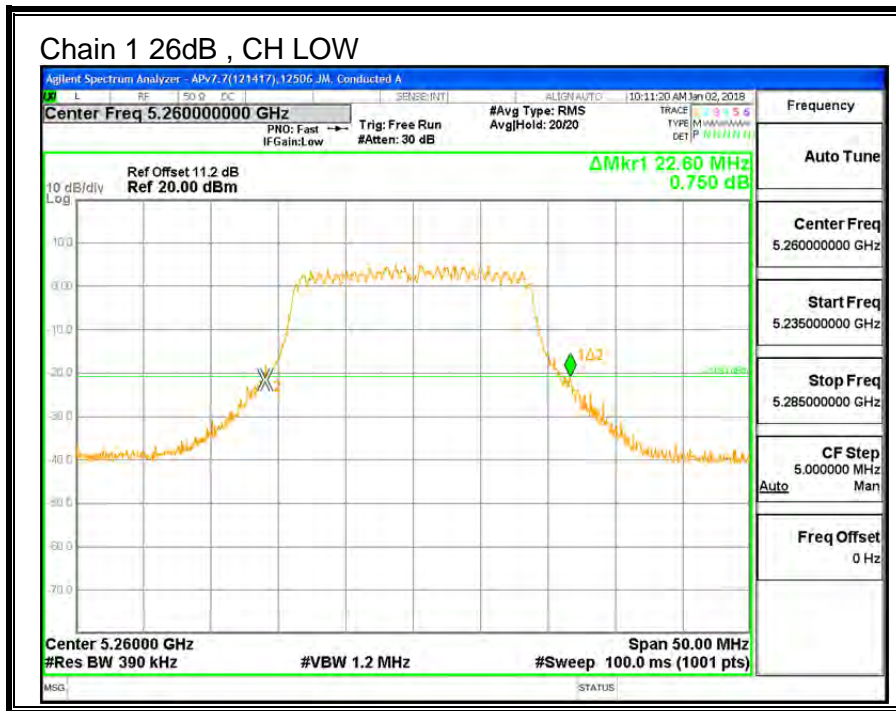
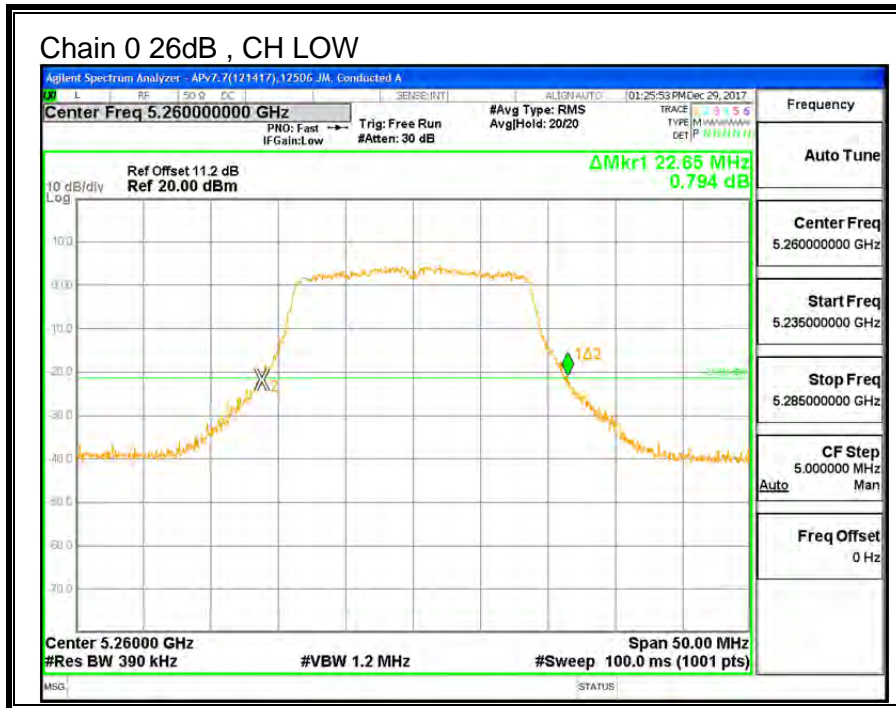

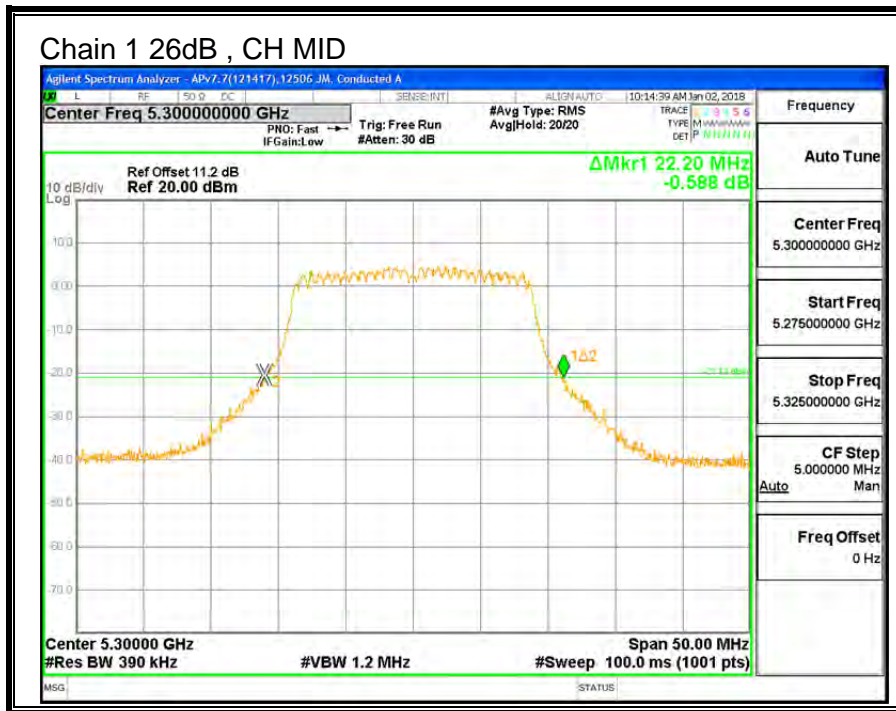
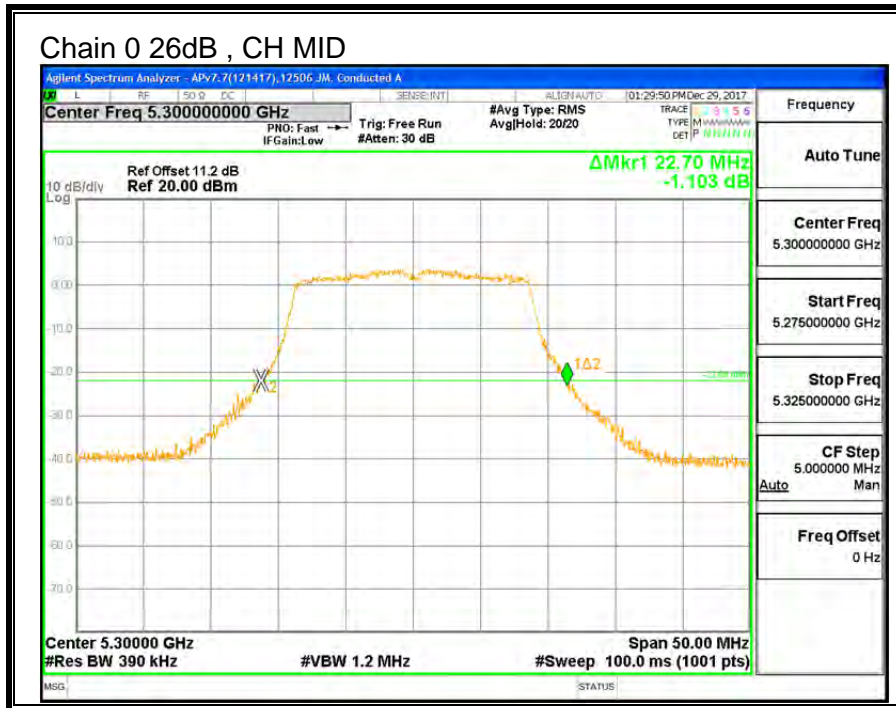



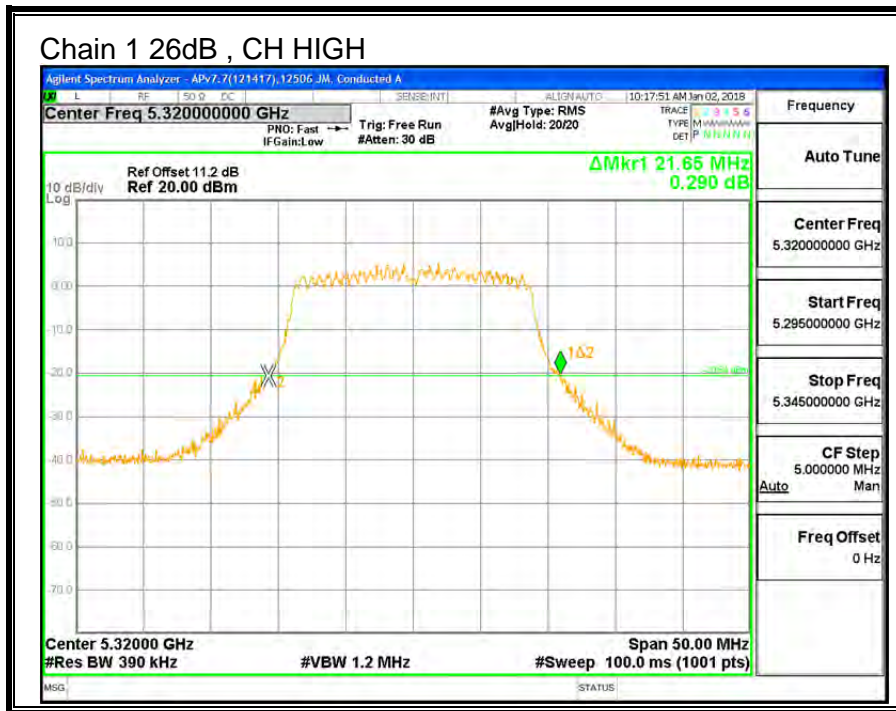
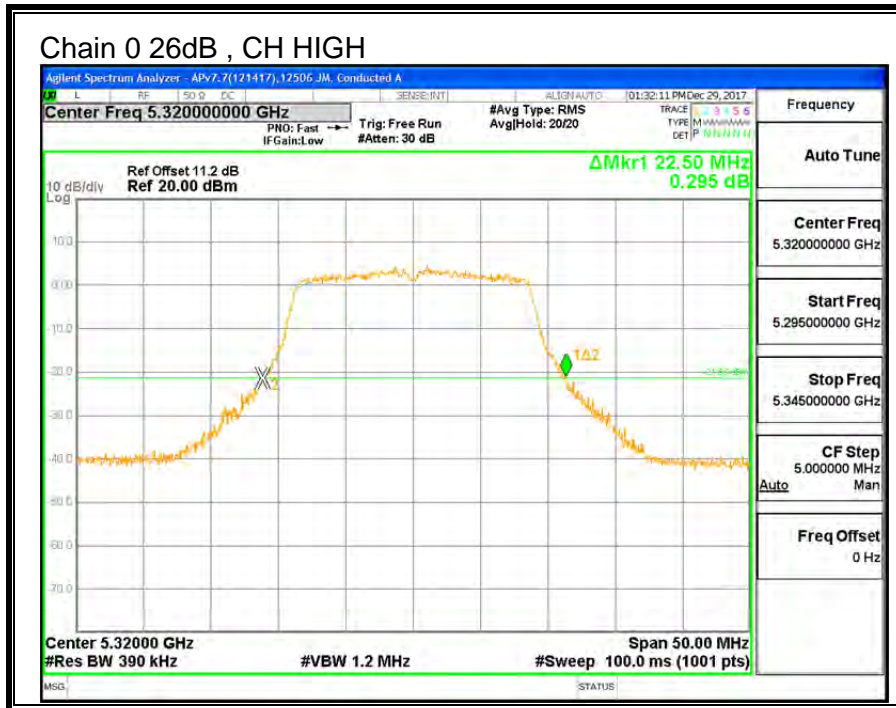

---

**9.6.2. 99% BANDWIDTH**

**LIMITS**

None; for reporting purposes only.

**RESULTS**

<b>Channel</b>	<b>Frequency</b>	<b>99% BW Chain 0 (MHz)</b>	<b>99% BW Chain 1 (MHz)</b>
Low	5260	17.715	17.762
Mid	5300	17.710	17.657
High	5320	17.738	17.803

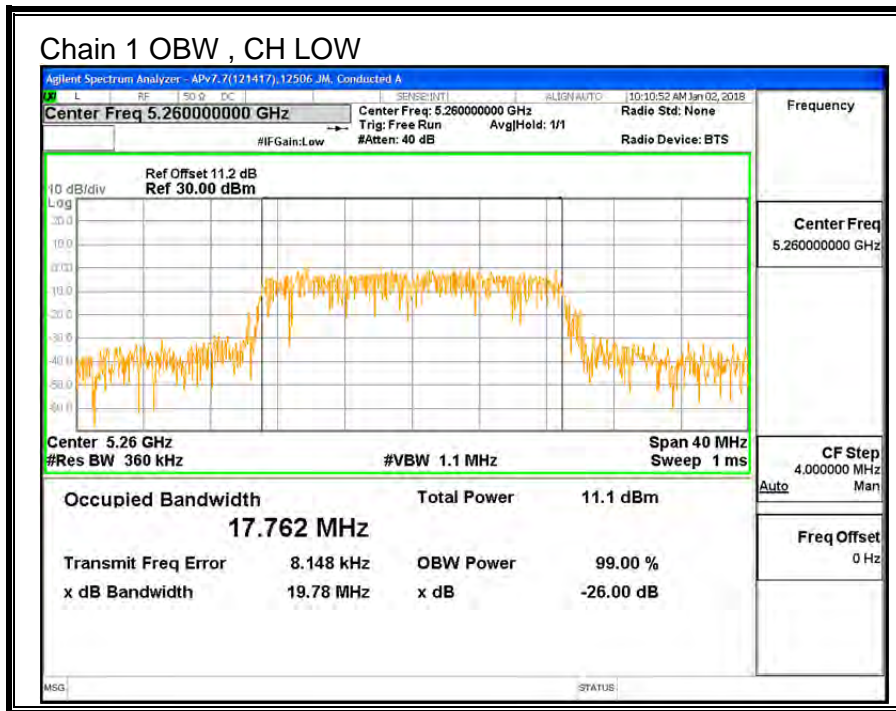
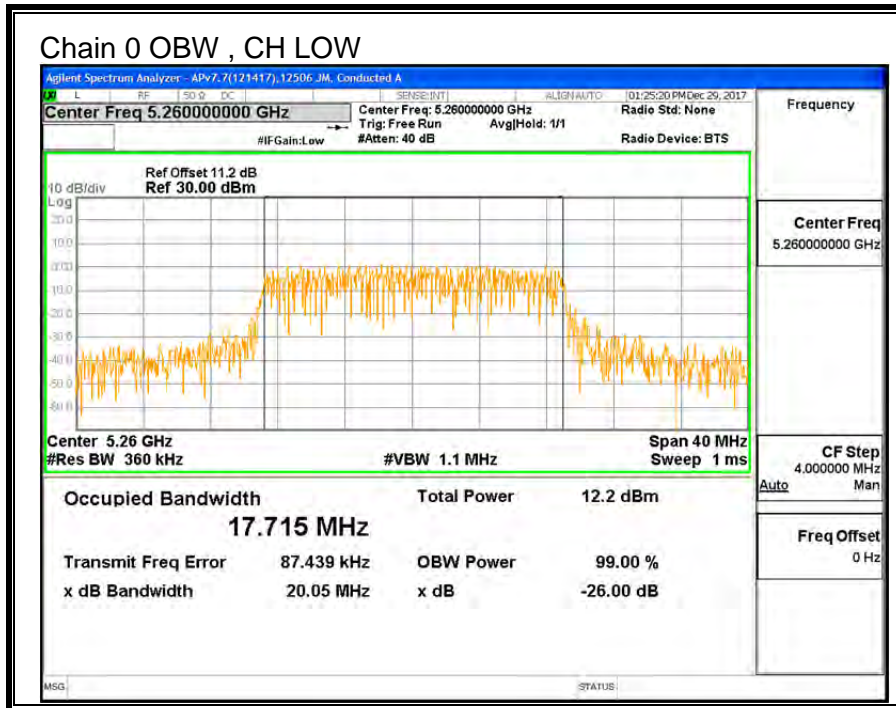

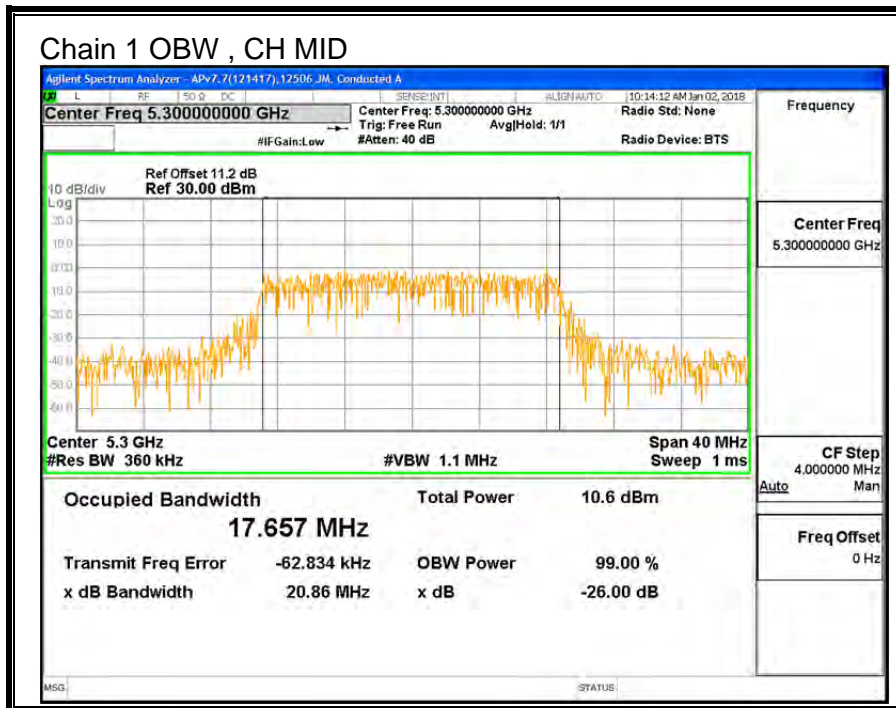
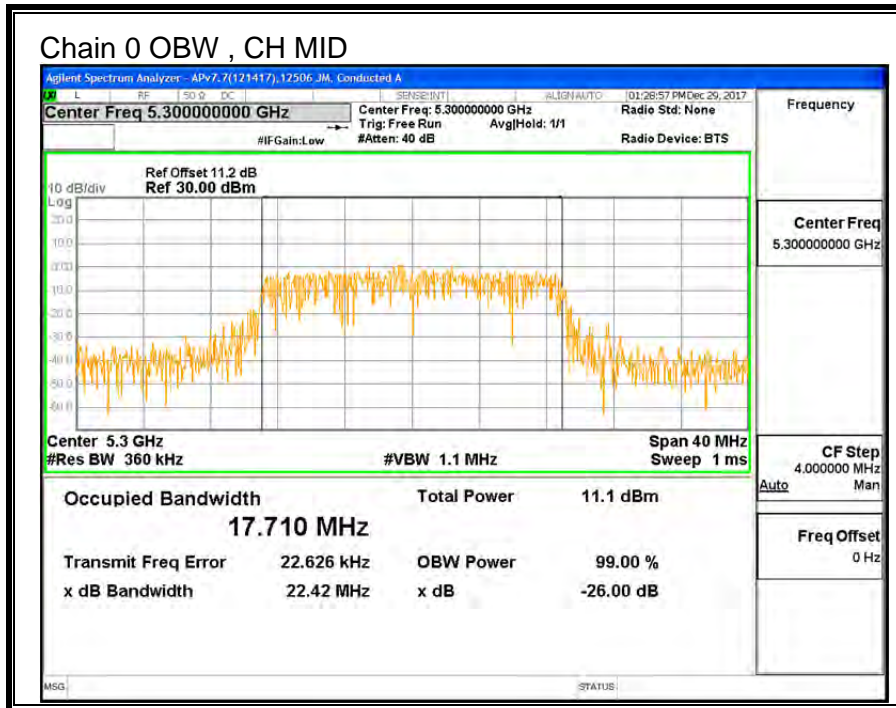



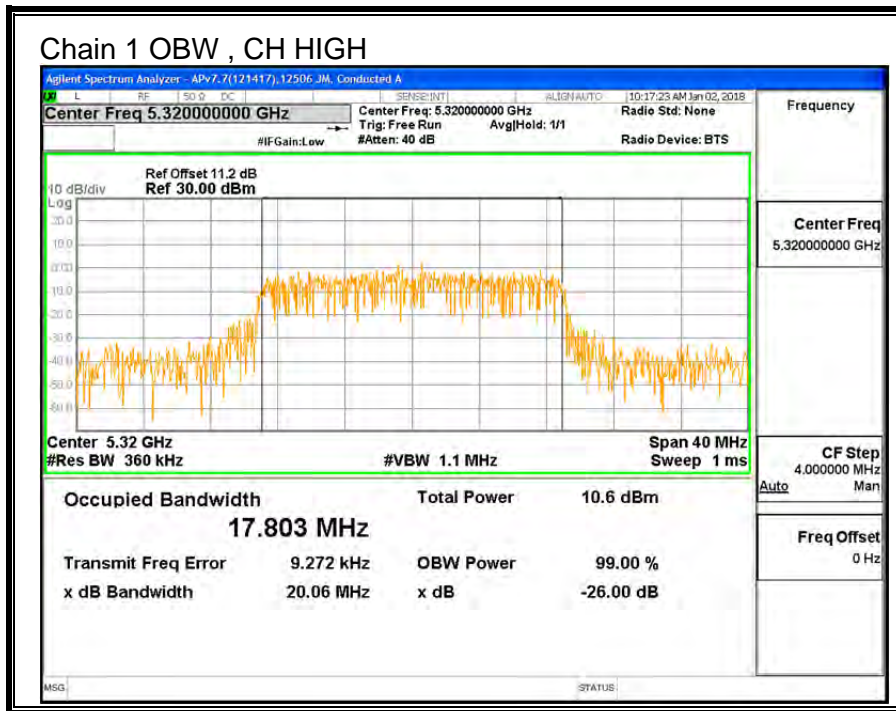
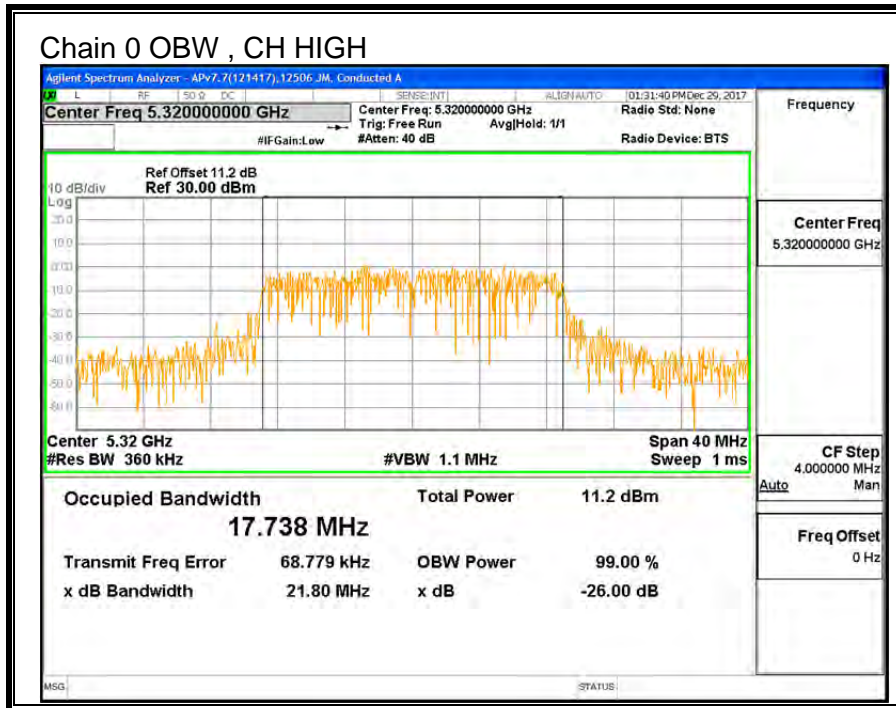

---

### 9.6.3. OUTPUT POWER AND PPSD

#### **LIMITS**

FCC §15.407 (a) (2)

For the band 5.25–5.35 GHz, the maximum conducted output power over the frequency band of operation shall not exceed the lesser of 250 mW or  $11 \text{ dBm} + 10 \log B$ , where B is the 26–dB emission bandwidth in MHz. In addition, the maximum power spectral density shall not exceed 11 dBm in any 1–MHz band. If transmitting antennas of directional gain greater than 6 dBi are used, both the maximum conducted output power and the peak power spectral density shall be reduced by the amount in dB that the directional gain of the antenna exceeds 6 dBi.

#### **TEST PROCEDURE**

Measurements perform using a wideband gated RF power meter provided that the gate parameters are adjusted such that the power is measured only when the EUT is transmitting at its maximum power control level. Since the measurement is made only during the ON time of the transmitter, no duty cycle correction factor is required.

**DIRECTIONAL ANTENNA GAIN**

For power, the TX chains are uncorrelated and the antenna gain is unequal among the chains. The directional gain is:

**5250-5350 MHz**

<b>Chain 0 Antenna Gain (dBi)</b>	<b>Chain 1 Antenna Gain (dBi)</b>	<b>Uncorrelated Chains Directional Gain (dBi)</b>
-2.10	-4.30	-3.06

For PSD the TX chains are correlated and the antenna gain is unequal among the chains. The directional gain is:

**5250-5230 MHz**

<b>Chain 0 Antenna Gain (dBi)</b>	<b>Chain 1 Antenna Gain (dBi)</b>	<b>Correlated Chains Directional Gain (dBi)</b>
-2.10	-4.30	-0.12



**RESULTS**

<b>ID:</b>	12506 JM	<b>Date:</b>	01/08/18
------------	----------	--------------	----------

**Bandwidth and Antenna Gain**

Channel	Frequency (MHz)	Min 26 dB BW (MHz)	Min 99% BW (MHz)	Directional Gain for Power (dBi)	Directional Gain for PPSD (dBi)
Low	5260	22.60	17.715	-3.06	-0.12
Mid	5300	22.20	17.657	-3.06	-0.12
High	5320	21.65	17.738	-3.06	-0.12

**Limits**

Channel	Frequency (MHz)	FCC Power Limit (dBm)	IC Power Limit (dBm)	IC EIRP Limit (dBm)	Power Limit (dBm)	FCC PPSD Limit (dBm)	IC PSD Limit (dBm)	PPSD Limit (dBm)
Low	5260	24.00	23.48	29.48	23.48	11.00	11.00	11.00
Mid	5300	24.00	23.47	29.47	23.47	11.00	11.00	11.00
High	5320	24.00	23.49	29.49	23.49	11.00	11.00	11.00

<b>Duty Cycle CF (dB)</b>	0.14	<b>Included in Calculations of Corr'd PPSD</b>
---------------------------	------	--

**Output Power Results**

Channel	Frequency (MHz)	Chain 0 Meas Power (dBm)	Chain 1 Meas Power (dBm)	Total Corr'd Power (dBm)	Power Limit (dBm)	Power Margin (dB)
Low	5260	11.48	10.97	14.24	23.48	-9.24
Mid	5300	11.07	10.99	14.04	23.47	-9.43
High	5320	11.11	10.87	14.00	23.49	-9.49

**PPSD Results**

Channel	Frequency (MHz)	Chain 0 Meas PPSD (dBm)	Chain 1 Meas PPSD (dBm)	Total Corr'd PPSD (dBm)	PPSD Limit (dBm)	PPSD Margin (dB)
Low	5260	1.308	0.533	4.09	11.00	-6.91
Mid	5300	0.212	0.213	3.36	11.00	-7.64
High	5320	0.246	-0.312	3.13	11.00	-7.87

**Note:** the power readings above were measured with gated method, and the measurement was taken only during the ON time. No duty cycle correction was necessary.

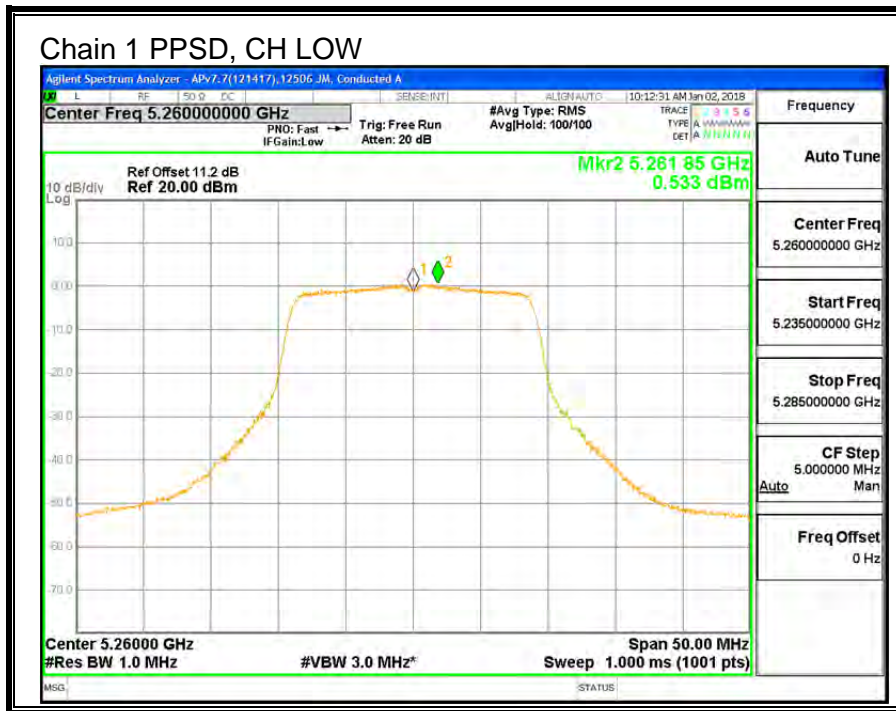
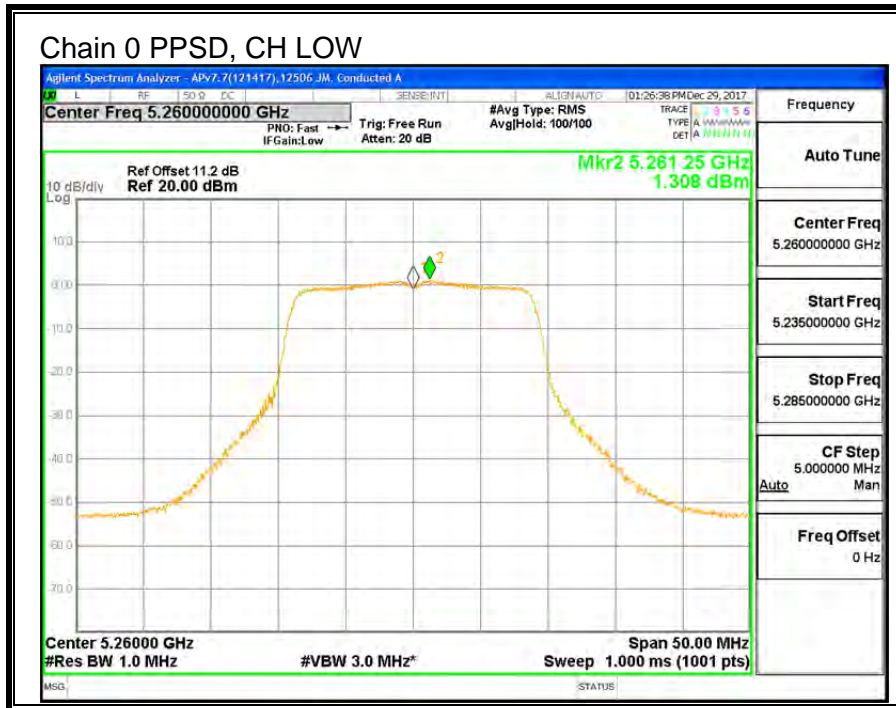

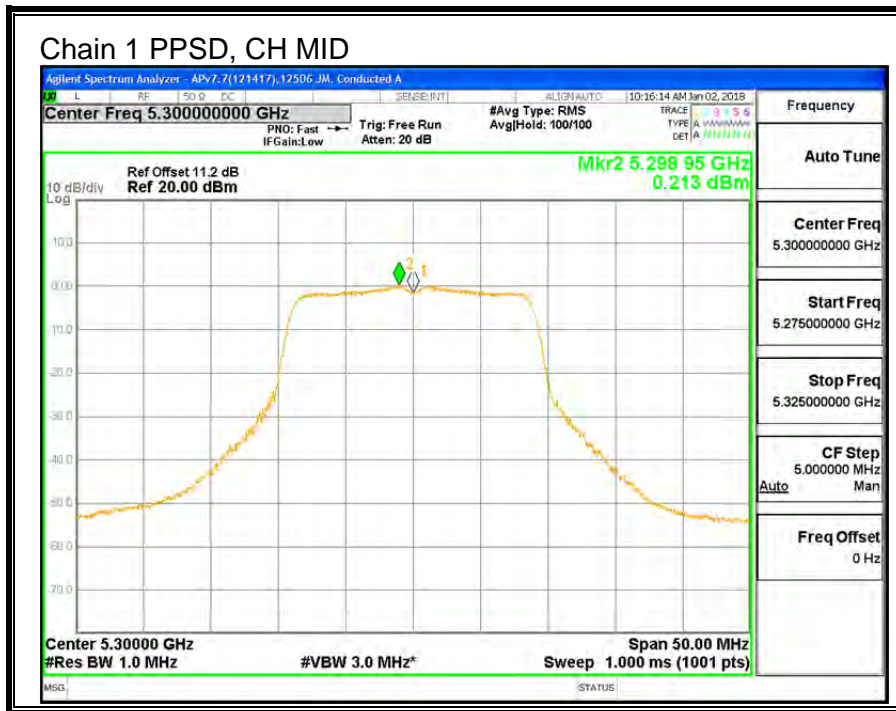
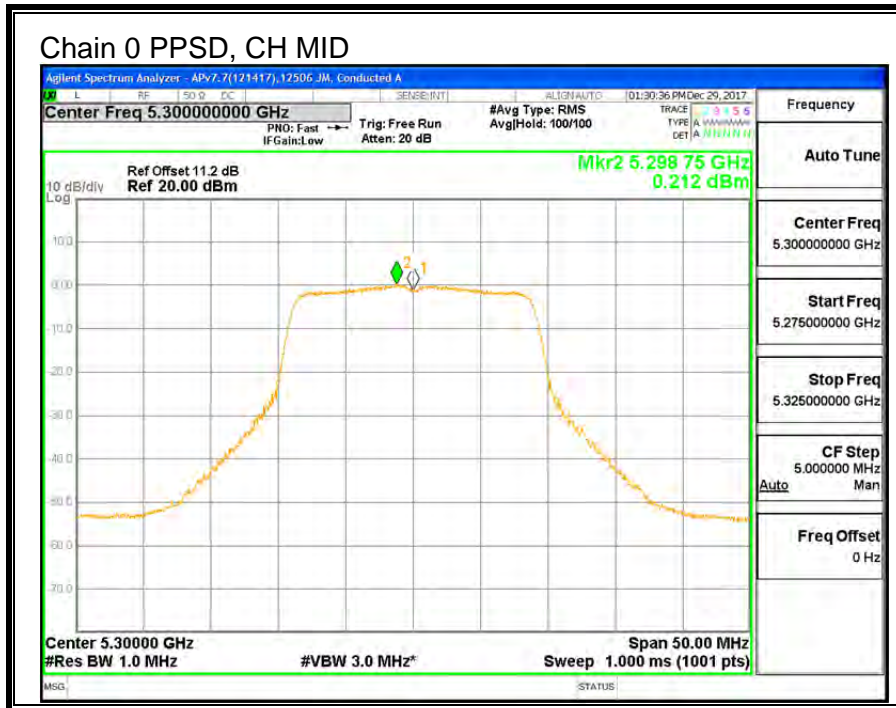

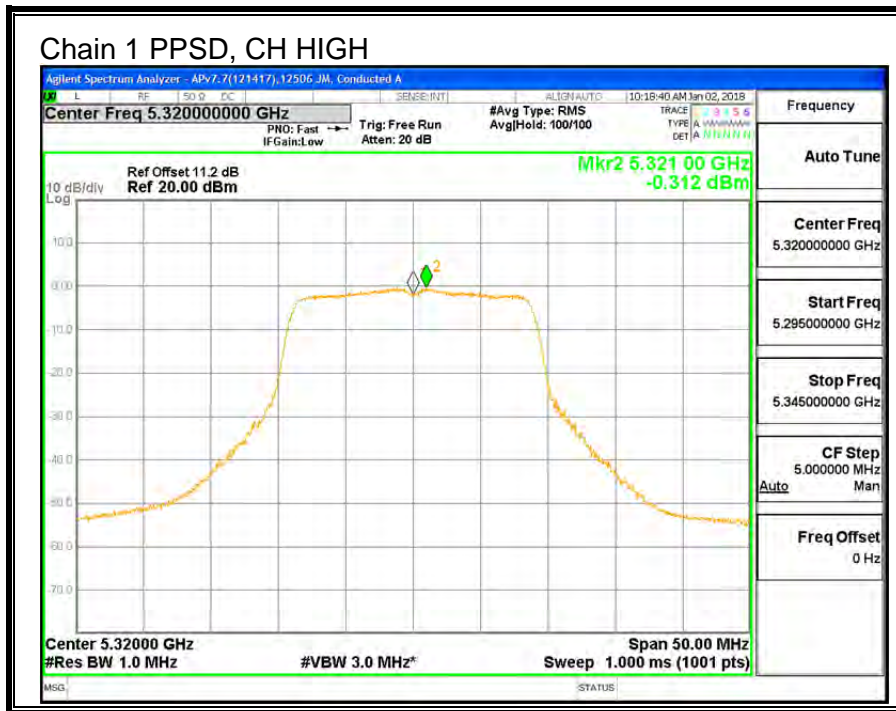
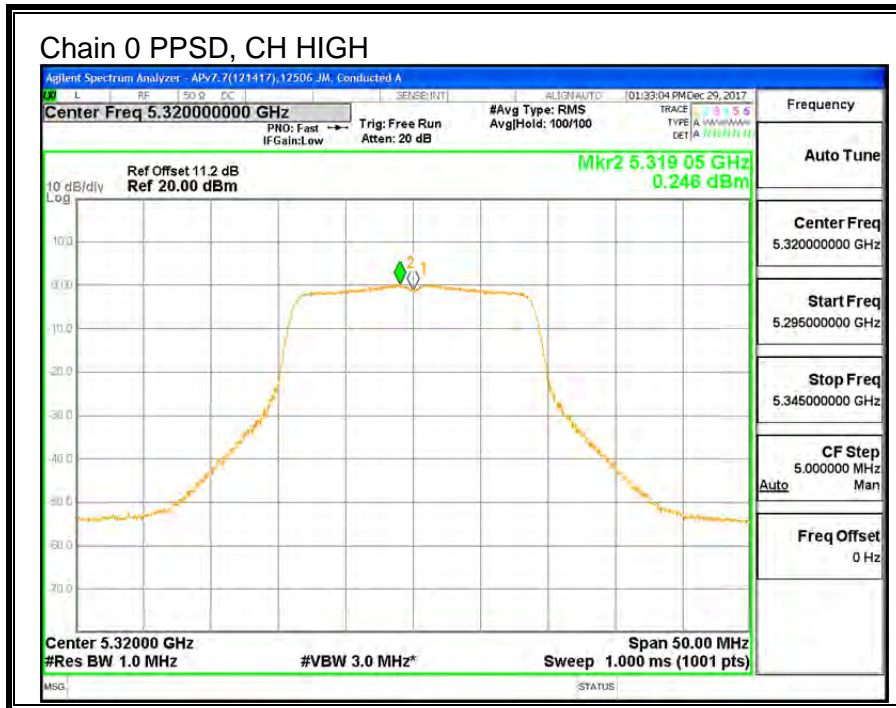

---

**9.7. 11n HT40 2TX CDD MIMO MODE IN THE 5.3GHz BAND**

**9.7.1. 26 dB BANDWIDTH**

**LIMITS**

None; for reporting purposes only.

**RESULTS**

<b>Channel</b>	<b>Frequency</b>	<b>26 dB BW Chain 0 (MHz)</b>	<b>26 dB BW Chain 1 (MHz)</b>
Low	5270	41.6	40.9
High	5310	41.7	41.1





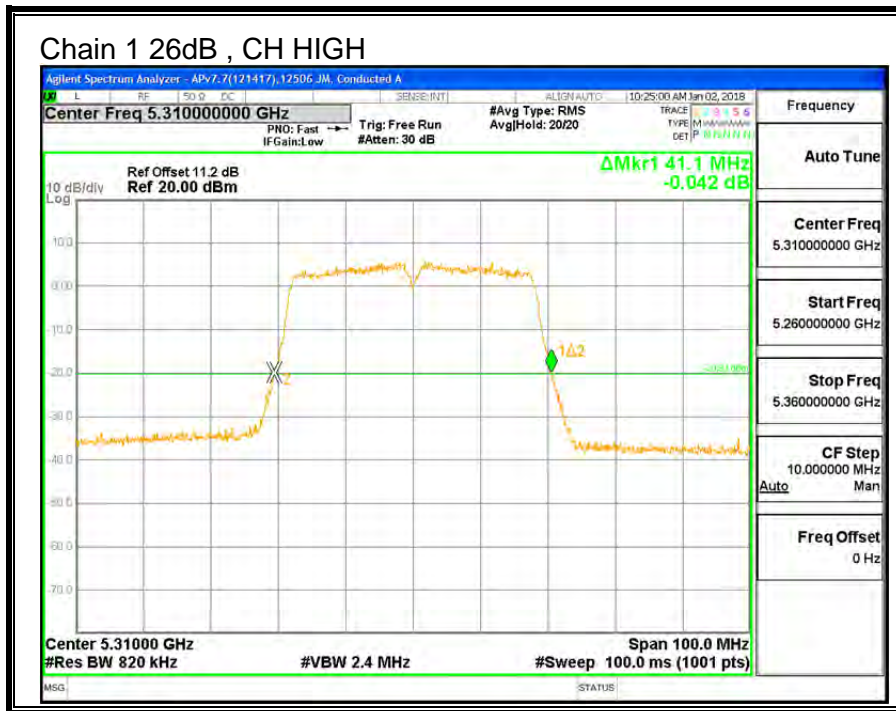
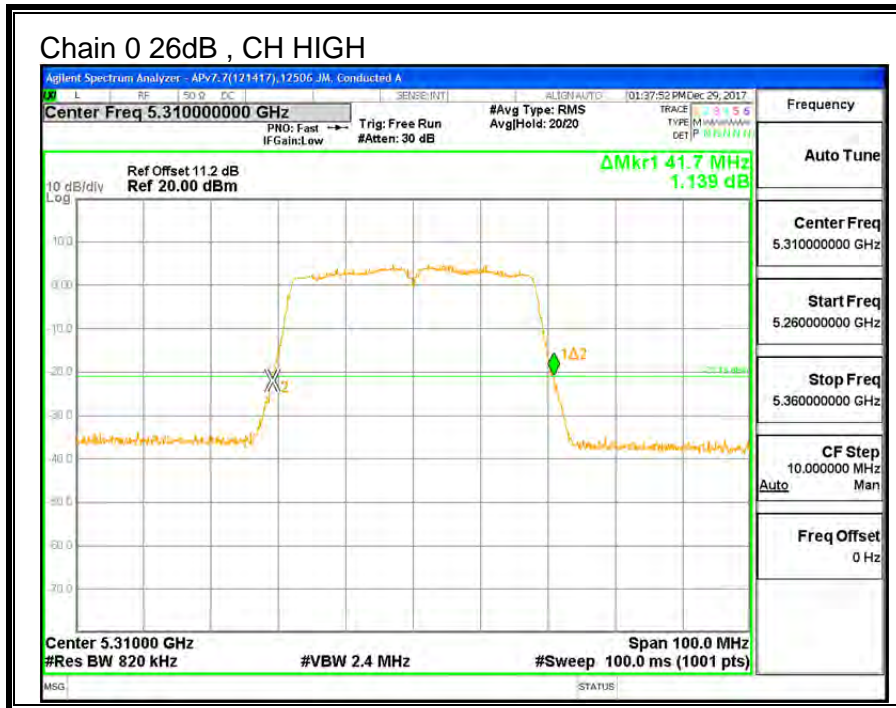



### 9.7.2. 99% BANDWIDTH

#### LIMITS

None; for reporting purposes only.

#### RESULTS

Channel	Frequency	99% BW Chain 0 (MHz)	99% BW Chain 1 (MHz)
Low	5270	36.343	36.360
High	5310	36.455	36.384

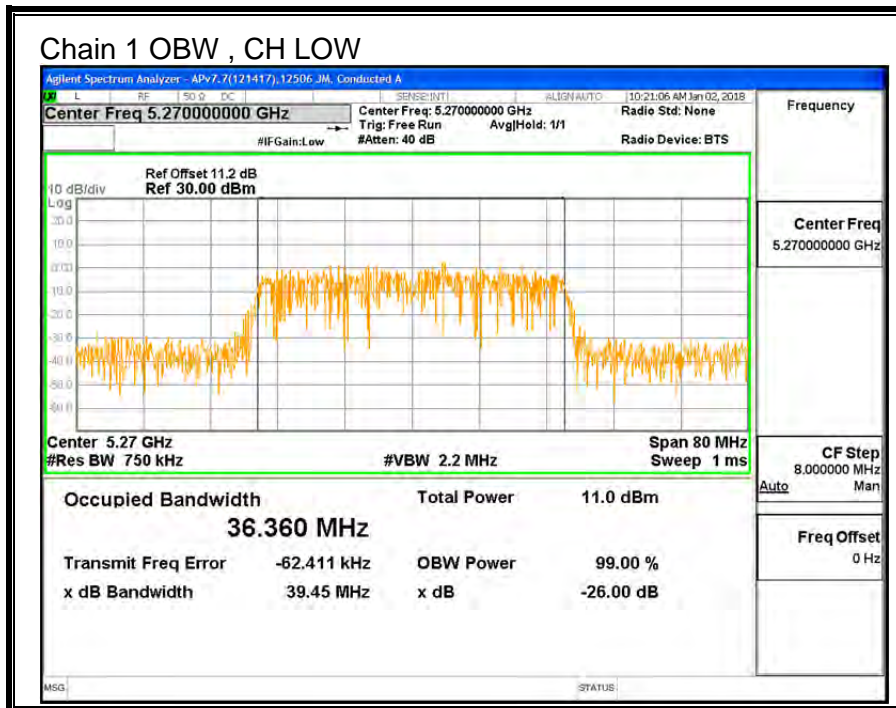
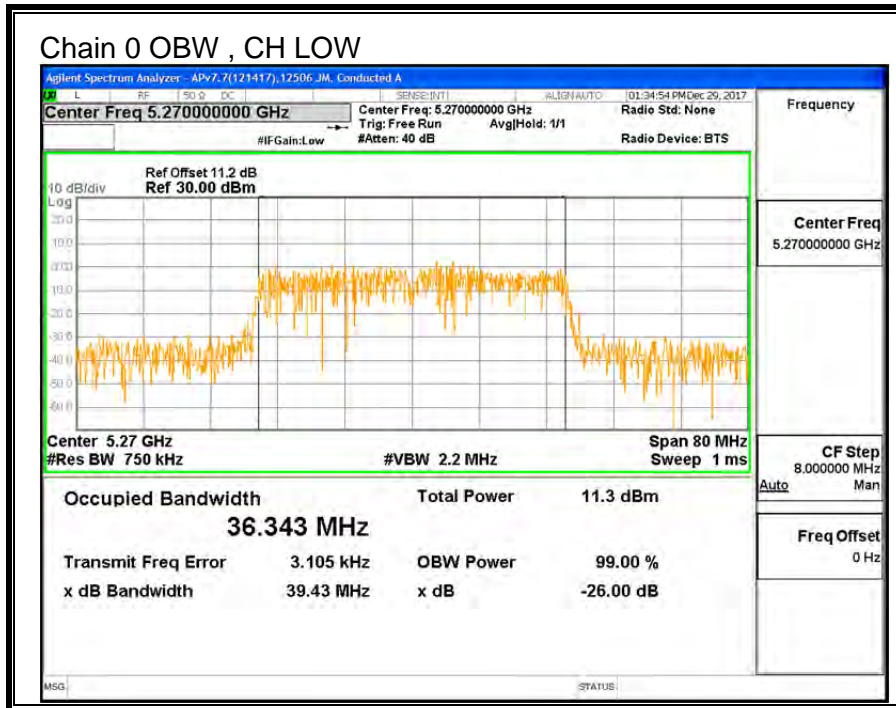

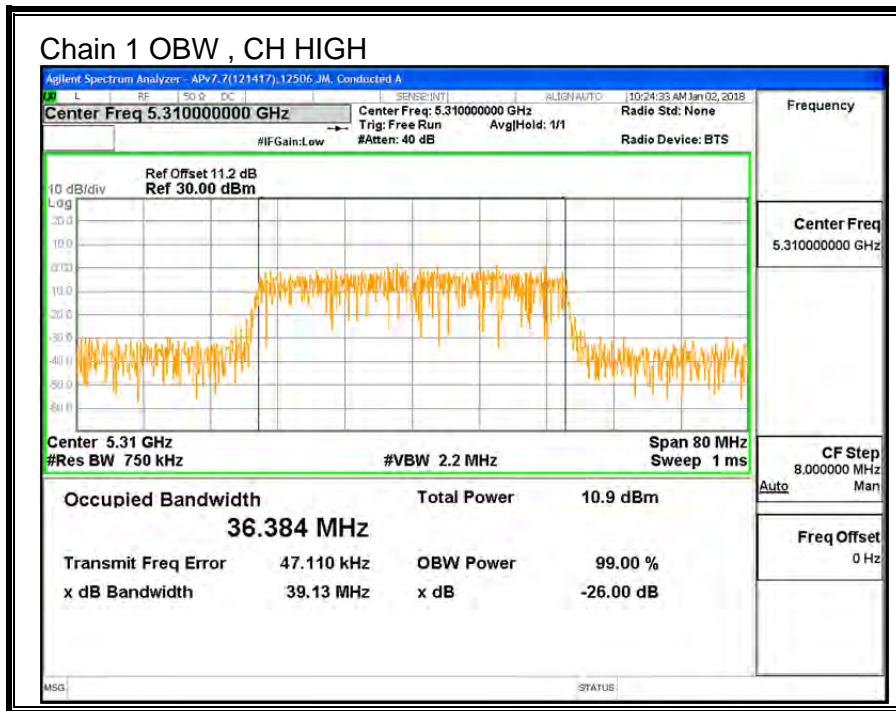
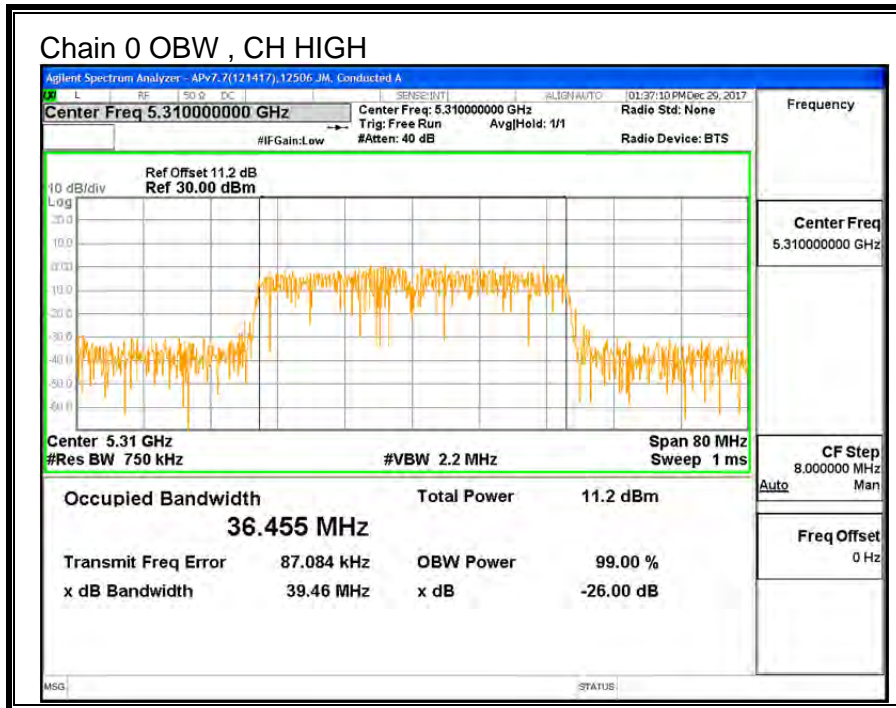

---

### 9.7.3. OUTPUT POWER AND PPSD

#### LIMITS

FCC §15.407 (a) (2)

For the band 5.25–5.35 GHz, the maximum conducted output power over the frequency band of operation shall not exceed the lesser of 250 mW or  $11 \text{ dBm} + 10 \log B$ , where B is the 26–dB emission bandwidth in MHz. In addition, the maximum power spectral density shall not exceed 11 dBm in any 1–MHz band. If transmitting antennas of directional gain greater than 6 dBi are used, both the maximum conducted output power and the peak power spectral density shall be reduced by the amount in dB that the directional gain of the antenna exceeds 6 dBi.

#### TEST PROCEDURE

Measurements perform using a wideband gated RF power meter provided that the gate parameters are adjusted such that the power is measured only when the EUT is transmitting at its maximum power control level. Since the measurement is made only during the ON time of the transmitter, no duty cycle correction factor is required.

**DIRECTIONAL ANTENNA GAIN**

For power, the TX chains are uncorrelated and the antenna gain is unequal among the chains. The directional gain is:

**5250-5350 MHz**

<b>Chain 0 Antenna Gain (dBi)</b>	<b>Chain 1 Antenna Gain (dBi)</b>	<b>Uncorrelated Chains Directional Gain (dBi)</b>
-2.10	-4.30	-3.06

For PSD the TX chains are correlated and the antenna gain is unequal among the chains. The directional gain is:

**5250-5230 MHz**

<b>Chain 0 Antenna Gain (dBi)</b>	<b>Chain 1 Antenna Gain (dBi)</b>	<b>Correlated Chains Directional Gain (dBi)</b>
-2.10	-4.30	-0.12

**RESULTS**

<b>ID:</b>	12506 JM	<b>Date:</b>	01/08/18
------------	----------	--------------	----------

**Bandwidth and Antenna Gain**

Channel	Frequency (MHz)	Min 26 dB BW (MHz)	Min 99% BW (MHz)	Directional Gain for Power (dBi)	Directional Gain for PPSD (dBi)
Low	5270	40.90	36.343	-3.06	-0.12
High	5310	41.10	36.384	-3.06	-0.12

**Limits**

Channel	Frequency (MHz)	FCC Power Limit (dBm)	IC Power Limit (dBm)	IC EIRP Limit (dBm)	Power Limit (dBm)	FCC PPSD Limit (dBm)	IC PSD Limit (dBm)	PPSD Limit (dBm)
Low	5270	24.00	24.00	30.00	24.00	11.00	11.00	11.00
High	5310	24.00	24.00	30.00	24.00	11.00	11.00	11.00

<b>Duty Cycle CF (dB)</b>	0.48	<b>Included in Calculations of Corr'd PPSD</b>
---------------------------	------	--

**Output Power Results**

Channel	Frequency (MHz)	Chain 0 Meas Power (dBm)	Chain 1 Meas Power (dBm)	Total Corr'd Power (dBm)	Power Limit (dBm)	Power Margin (dB)
Low	5270	11.38	10.81	14.11	24.00	-9.89
High	5310	11.02	11.02	14.03	24.00	-9.97

**PPSD Results**

Channel	Frequency (MHz)	Chain 0 Meas PPSD (dBm)	Chain 1 Meas PPSD (dBm)	Total Corr'd PPSD (dBm)	PPSD Limit (dBm)	PPSD Margin (dB)
Low	5270	-2.250	-2.976	0.89	11.00	-10.11
High	5310	-2.840	-3.007	0.57	11.00	-10.43

**Note:** the power readings above were measured with gated method, and the measurement was taken only during the ON time. No duty cycle correction was necessary.

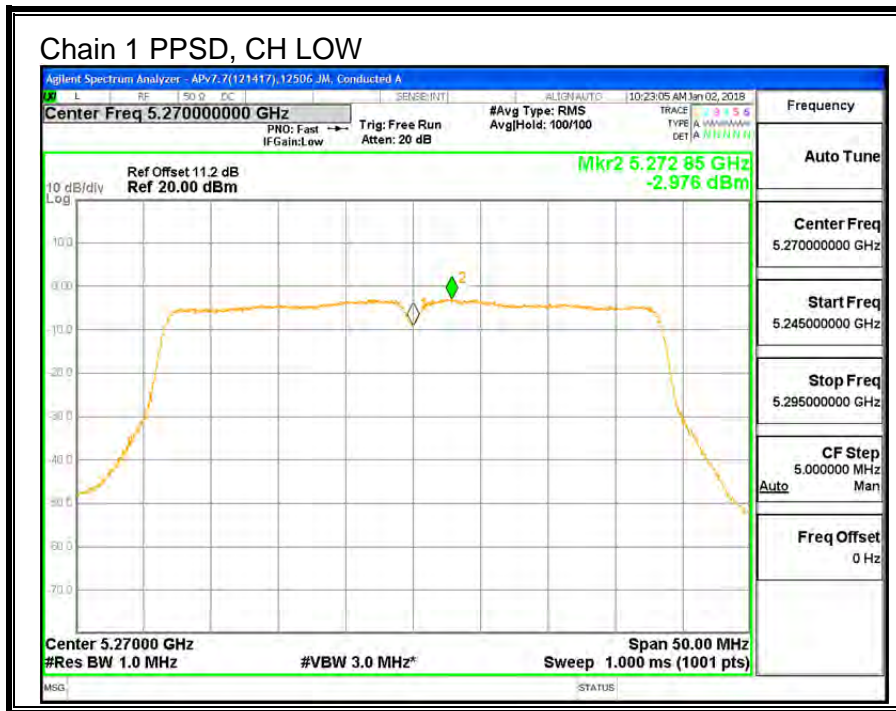
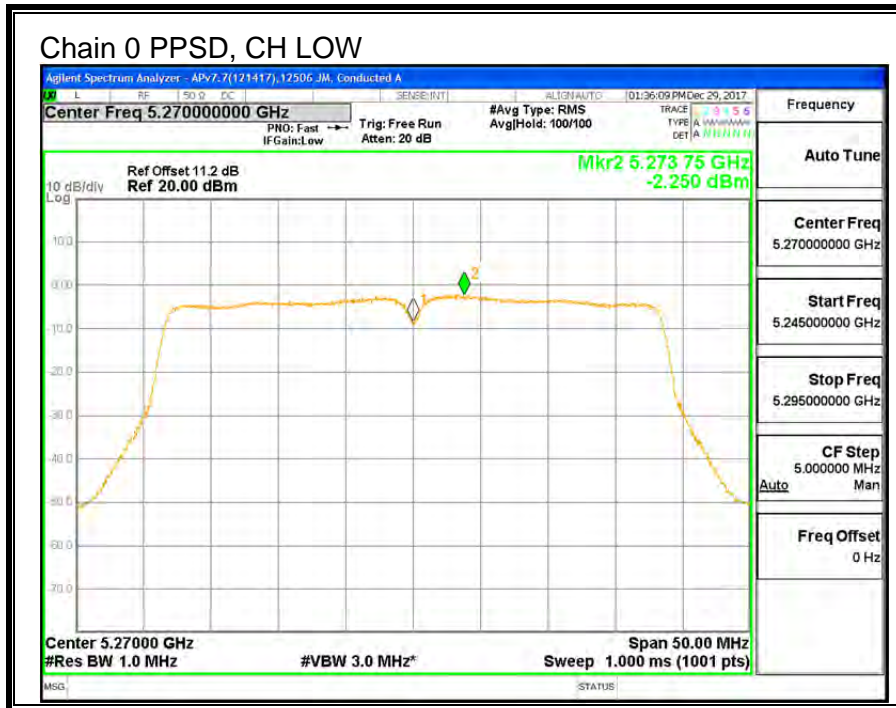



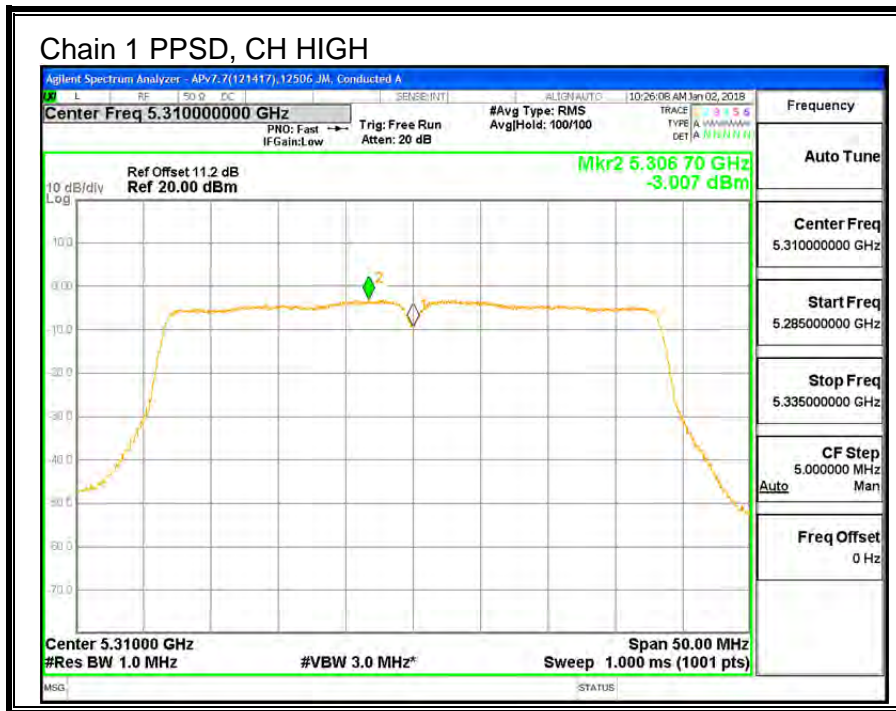
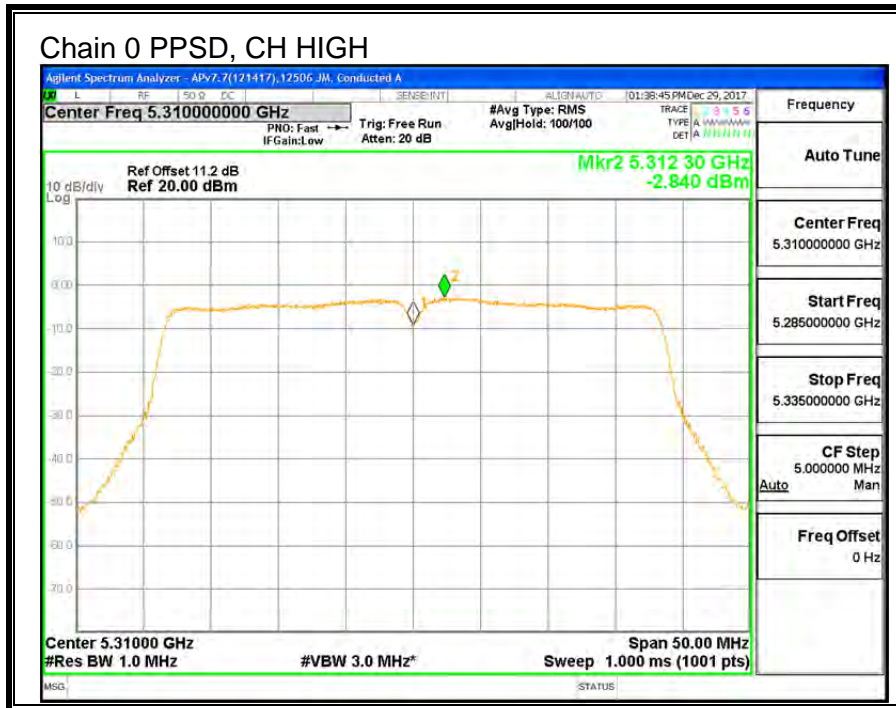

---

**9.8. 11ac HT80 2TX CDD MIMO MODE IN THE 5.3GHz BAND**

**9.8.1. 26 dB BANDWIDTH**

**LIMITS**

None; for reporting purposes only.

**RESULTS**

Channel	Frequency	26 dB BW Chain 0 (MHz)	26 dB BW Chain 1 (MHz)
Mid	5290	83.8	83.6

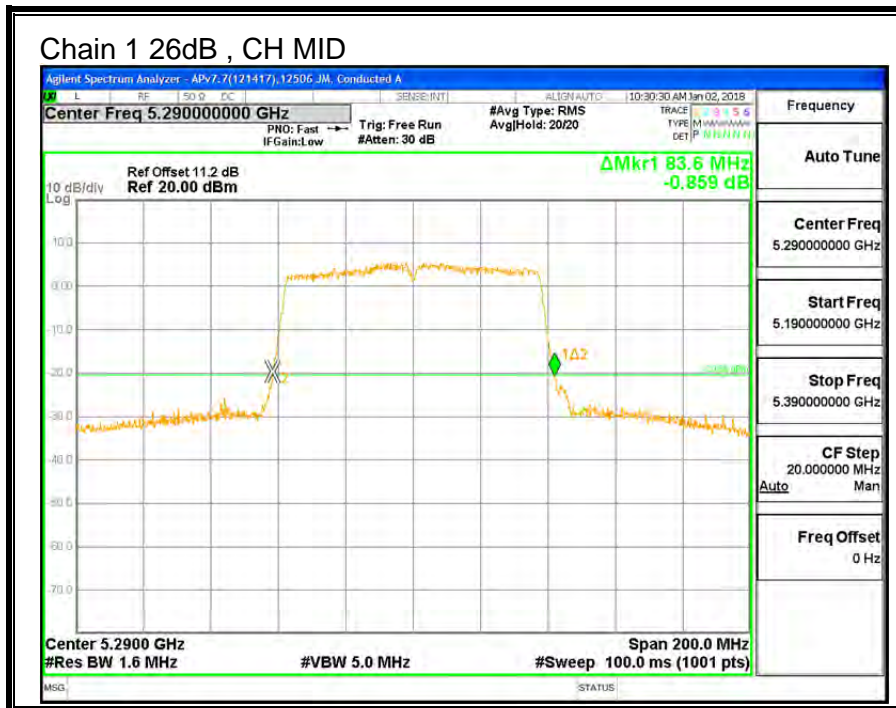
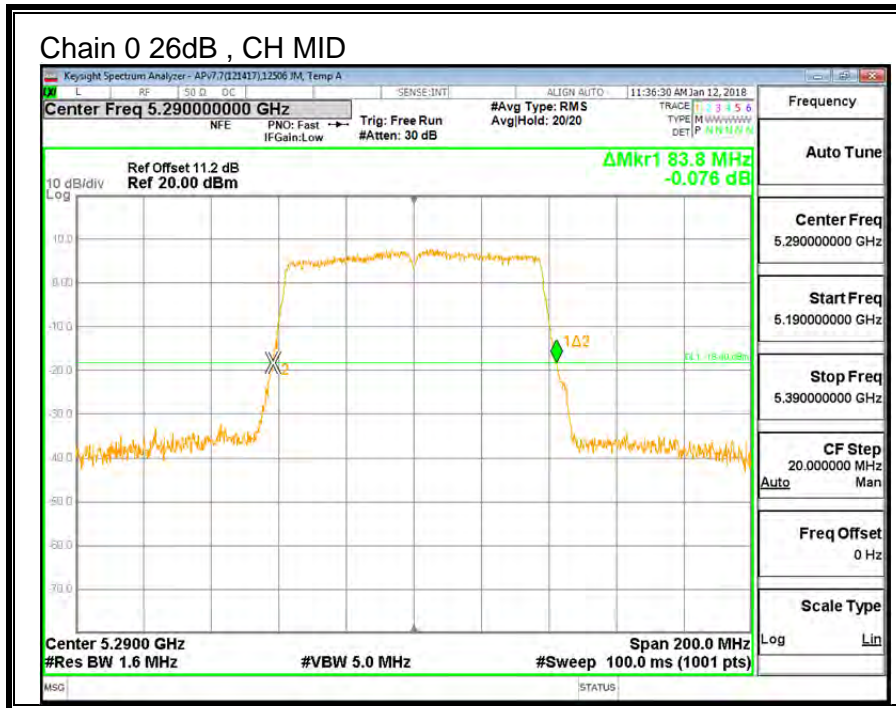

---

**9.8.2. 99% BANDWIDTH**

**LIMITS**

None; for reporting purposes only.

**RESULTS**

<b>Channel</b>	<b>Frequency</b>	<b>99% BW Chain 0 (MHz)</b>	<b>99% BW Chain 1 (MHz)</b>
Mid	5290	76.000	75.951

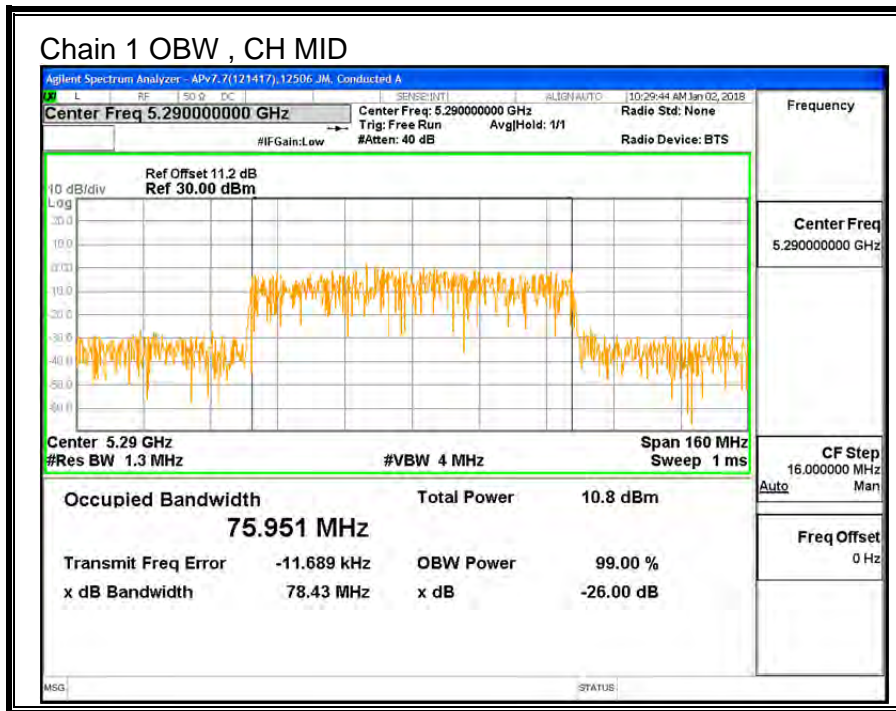
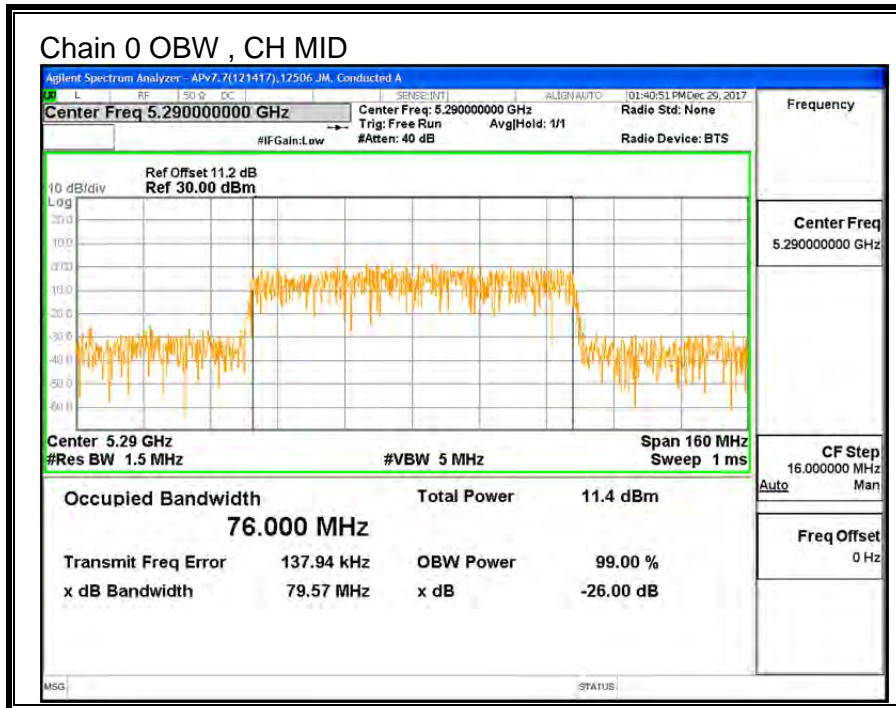

**9.8.3. OUTPUT POWER AND PPSD**

**LIMITS**

FCC §15.407 (a) (2)

For the band 5.25–5.35 GHz, the maximum conducted output power over the frequency band of operation shall not exceed the lesser of 250 mW or 11 dBm + 10 log B, where B is the 26–dB emission bandwidth in MHz. In addition, the maximum power spectral density shall not exceed 11 dBm in any 1–MHz band. If transmitting antennas of directional gain greater than 6 dBi are used, both the maximum conducted output power and the peak power spectral density shall be reduced by the amount in dB that the directional gain of the antenna exceeds 6 dBi.

**TEST PROCEDURE**

Measurements perform using a wideband gated RF power meter provided that the gate parameters are adjusted such that the power is measured only when the EUT is transmitting at its maximum power control level. Since the measurement is made only during the ON time of the transmitter, no duty cycle correction factor is required.

**DIRECTIONAL ANTENNA GAIN**

For power, the TX chains are uncorrelated and the antenna gain is unequal among the chains. The directional gain is:

**5250-5350 MHz**

Chain 0 Antenna Gain (dBi)	Chain 1 Antenna Gain (dBi)	Uncorrelated Chains Directional Gain (dBi)
-2.10	-4.30	-3.06

For PSD the TX chains are correlated and the antenna gain is unequal among the chains. The directional gain is:

**5250-5230 MHz**

Chain 0 Antenna Gain (dBi)	Chain 1 Antenna Gain (dBi)	Correlated Chains Directional Gain (dBi)
-2.10	-4.30	-0.12



**RESULTS**

<b>ID:</b>	12506 JM	<b>Date:</b>	01/08/18
------------	----------	--------------	----------

**Bandwidth and Antenna Gain**

Channel	Frequency (MHz)	Min 26 dB BW (MHz)	Min 99% BW (MHz)	Directional Gain for Power (dBi)	Directional Gain for PPSD (dBi)
Mid	5290	83.60	75.951	-3.06	-0.12

**Limits**

Channel	Frequency (MHz)	FCC Power Limit (dBm)	IC Power Limit (dBm)	IC EIRP Limit (dBm)	Power Limit (dBm)	FCC PPSD Limit (dBm)	IC PSD Limit (dBm)	PPSD Limit (dBm)
Mid	5290	24.00	24.00	30.00	24.00	11.00	11.00	11.00

<b>Duty Cycle CF (dB)</b>	0.73	<b>Included in Calculations of Corr'd PPSD</b>
---------------------------	------	--

**Output Power Results**

Channel	Frequency (MHz)	Chain 0 Meas Power (dBm)	Chain 1 Meas Power (dBm)	Total Corr'd Power (dBm)	Power Limit (dBm)	Power Margin (dB)
Mid	5290	11.04	10.62	13.85	24.00	-10.15

**PPSD Results**

Channel	Frequency (MHz)	Chain 0 Meas PPSD (dBm)	Chain 1 Meas PPSD (dBm)	Total Corr'd PPSD (dBm)	PPSD Limit (dBm)	PPSD Margin (dB)
Mid	5290	-6.076	-7.083	-2.81	11.00	-13.81

**Note:** the power readings above were measured with gated method, and the measurement was taken only during the ON time. No duty cycle correction was necessary.

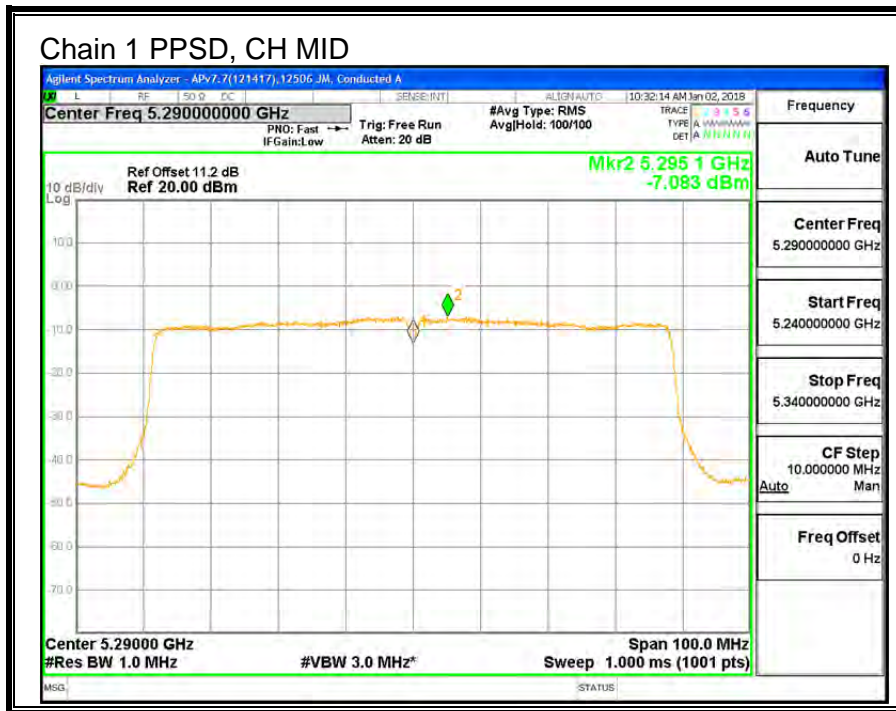
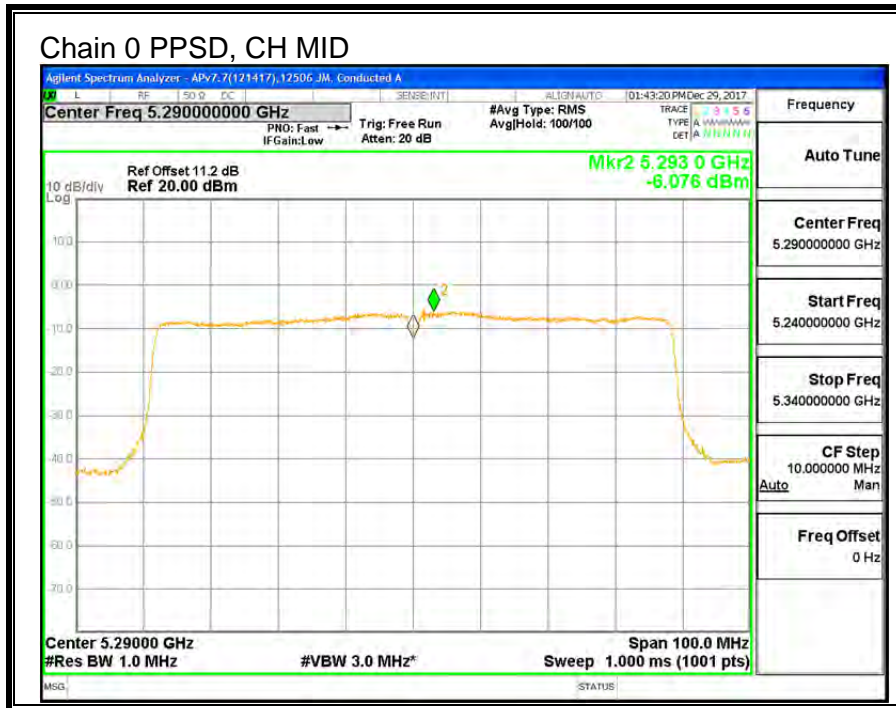

## 9.9. 11a 2TX CDD MIMO MODE IN THE 5.6GHz BAND

### 9.9.1. 26 dB BANDWIDTH

#### LIMITS

None; for reporting purposes only.

#### RESULTS

Channel	Frequency	26 dB BW Chain 0 (MHz)	26 dB BW Chain 1 (MHz)
Low	5500	21.65	21.10
Mid	5580	21.85	21.00
Mid (FCC)	5640	21.20	21.05
High	5700	21.75	21.40
144	5720	21.60	21.15

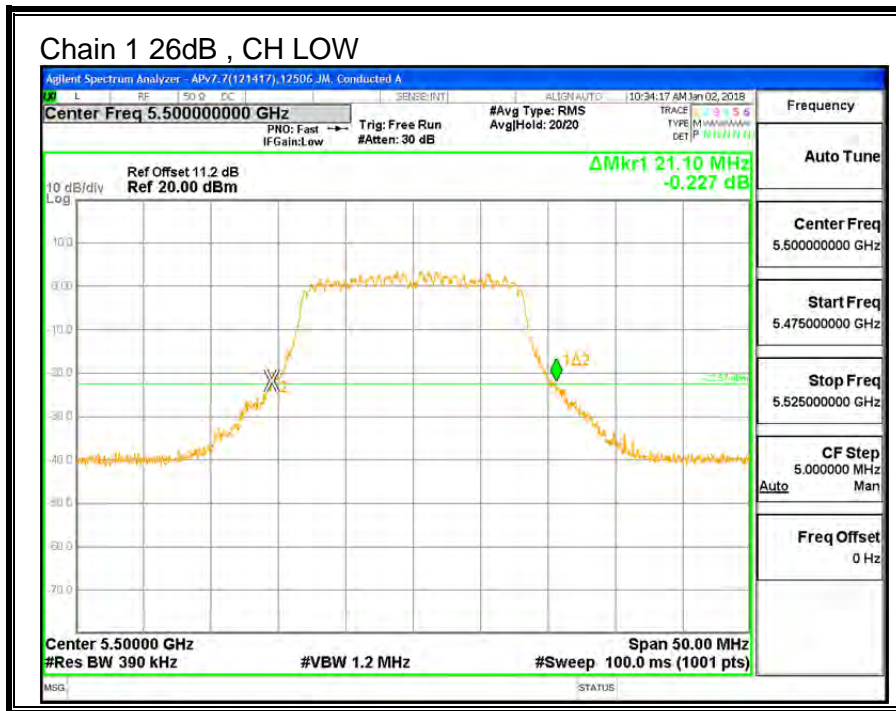
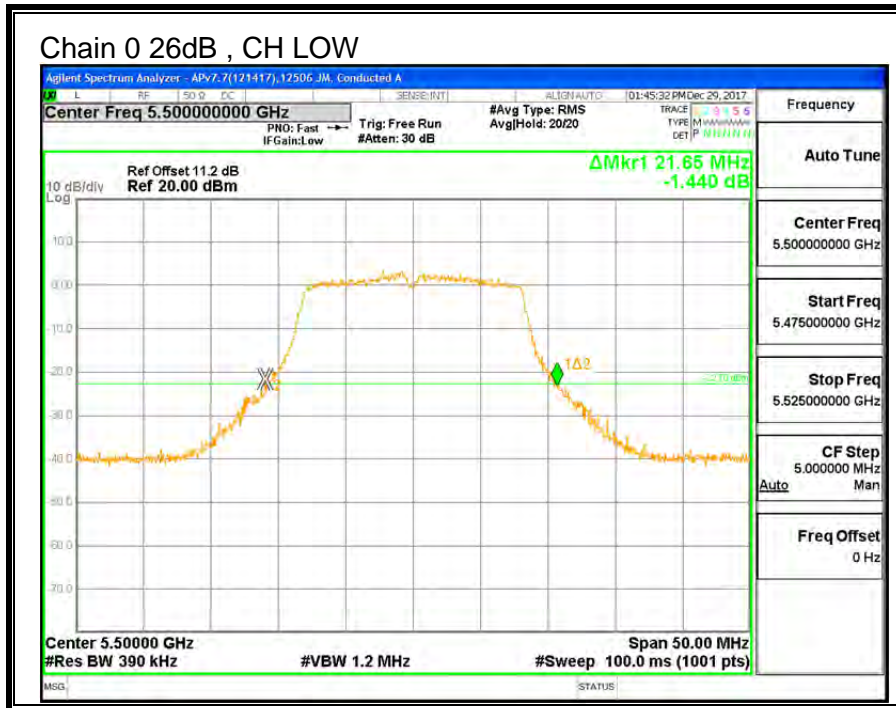

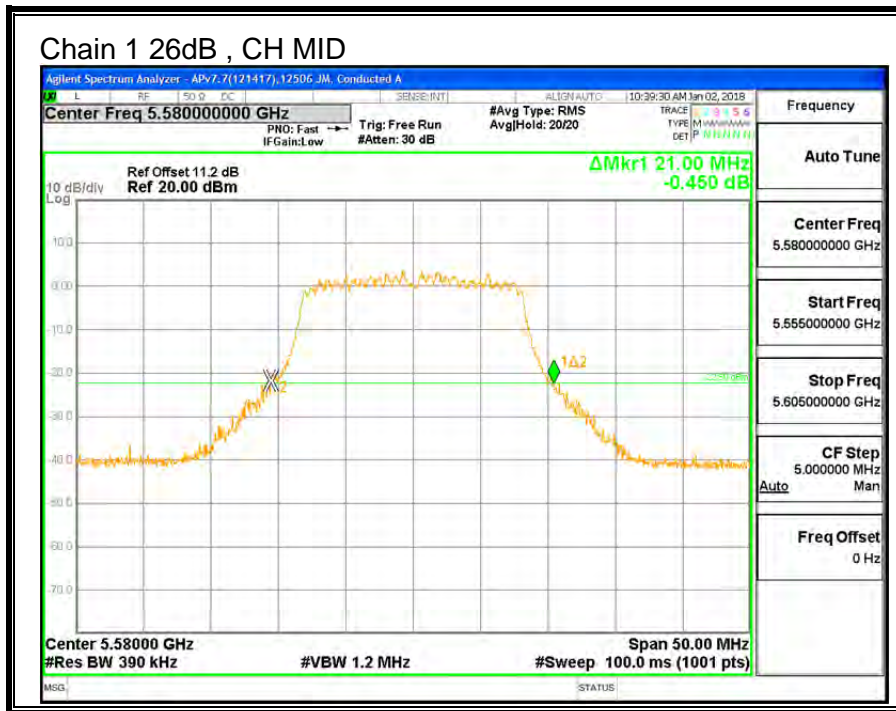
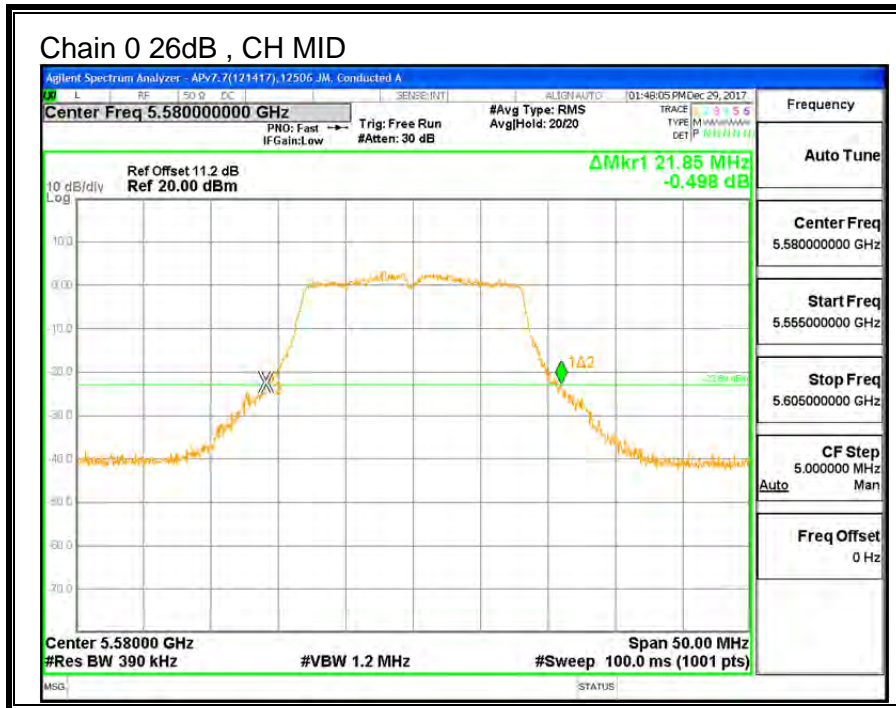



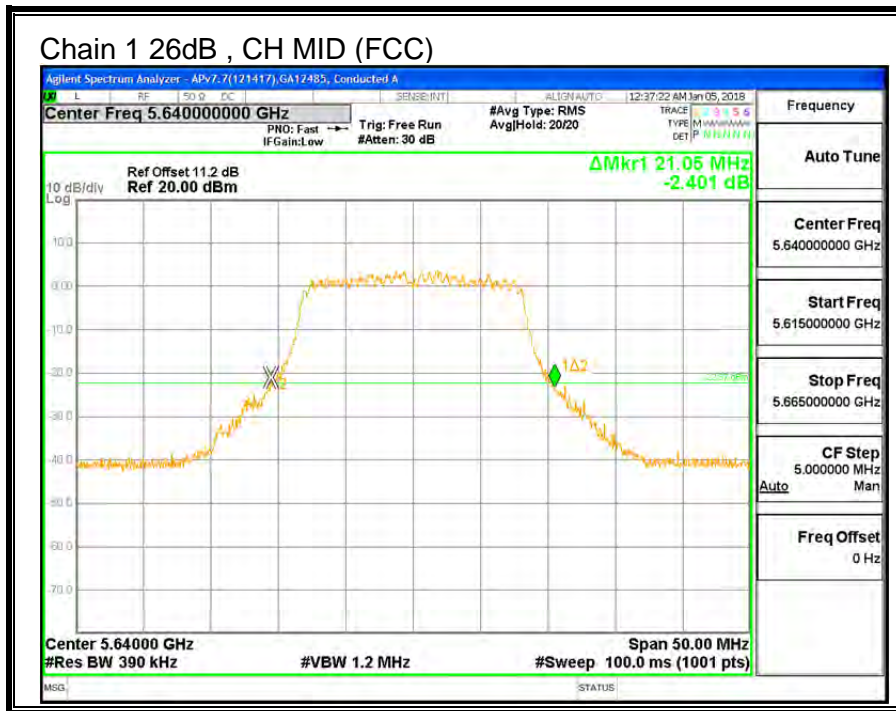
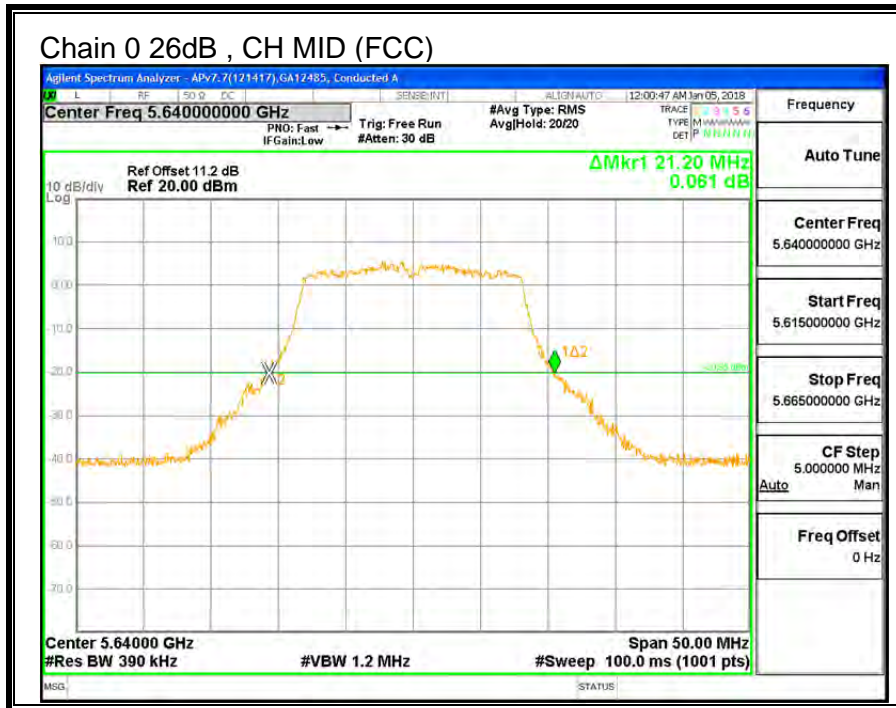



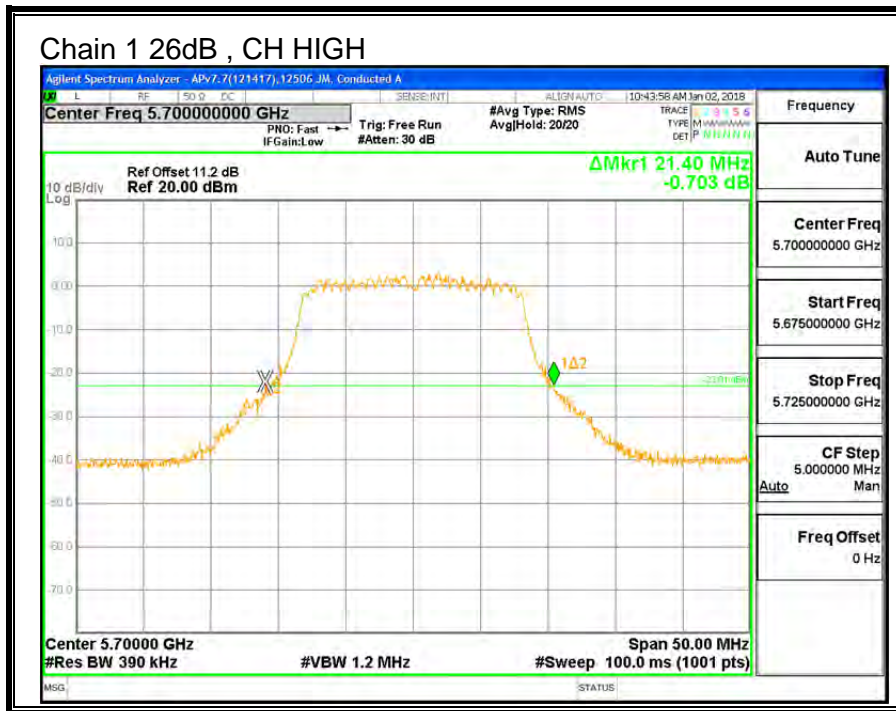
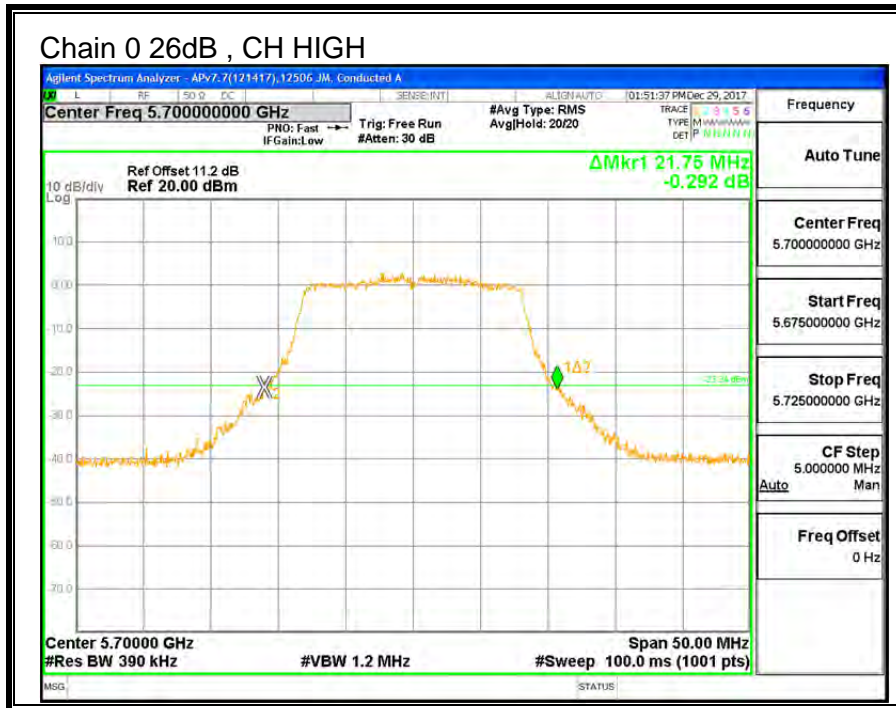

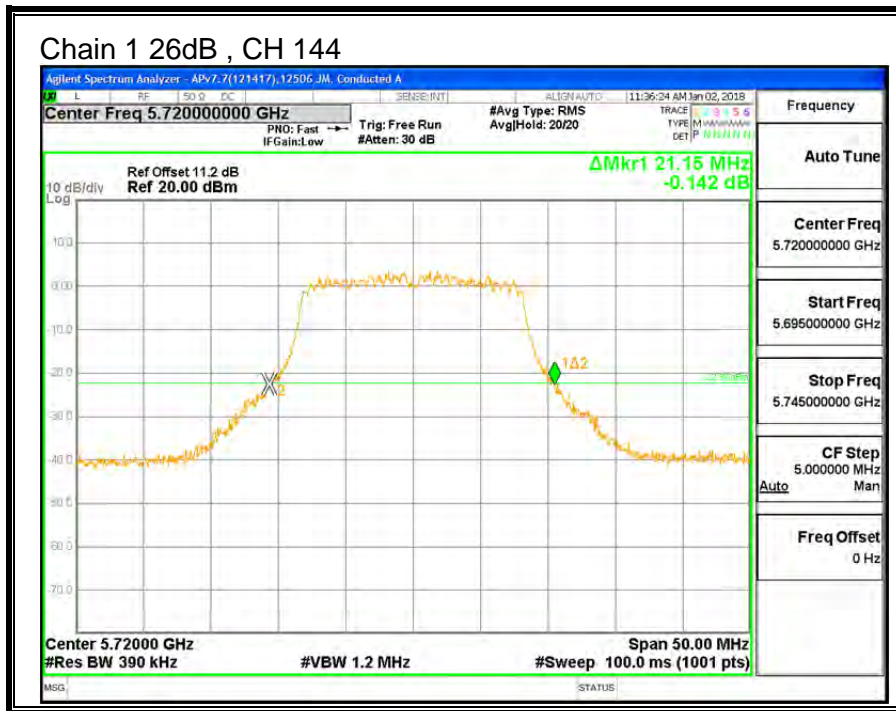
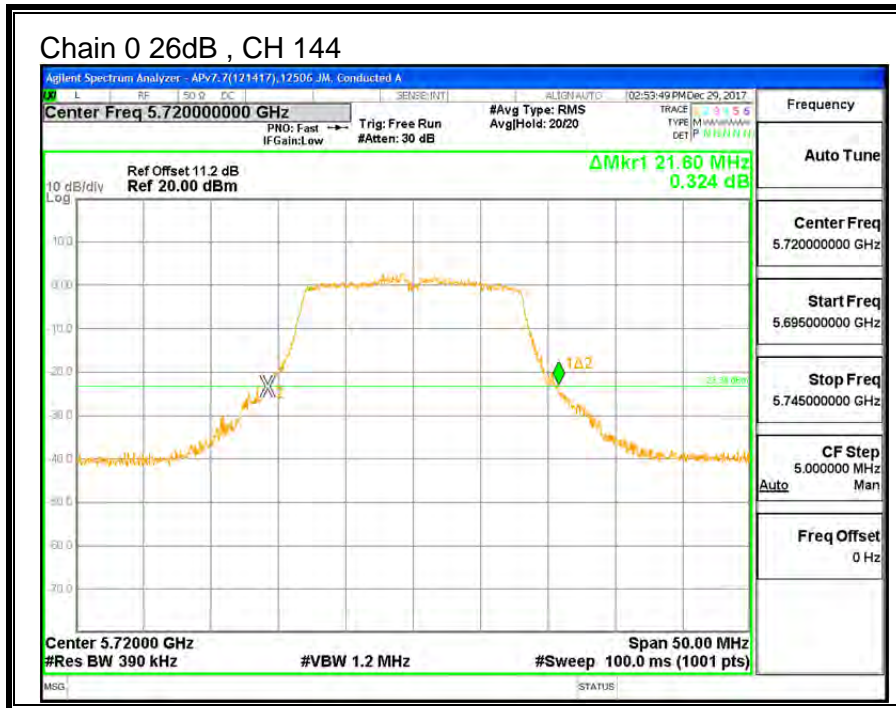

---

### 9.9.2. 99% BANDWIDTH

#### LIMITS

None; for reporting purposes only.

#### RESULTS

Channel	Frequency	99% BW Chain 0 (MHz)	99% BW Chain 1 (MHz)
Low	5500	16.501	16.517
Mid	5580	16.521	16.479
Mid (FCC)	5640	16.453	16.413
High	5700	16.469	16.458
144	5720	16.528	16.500

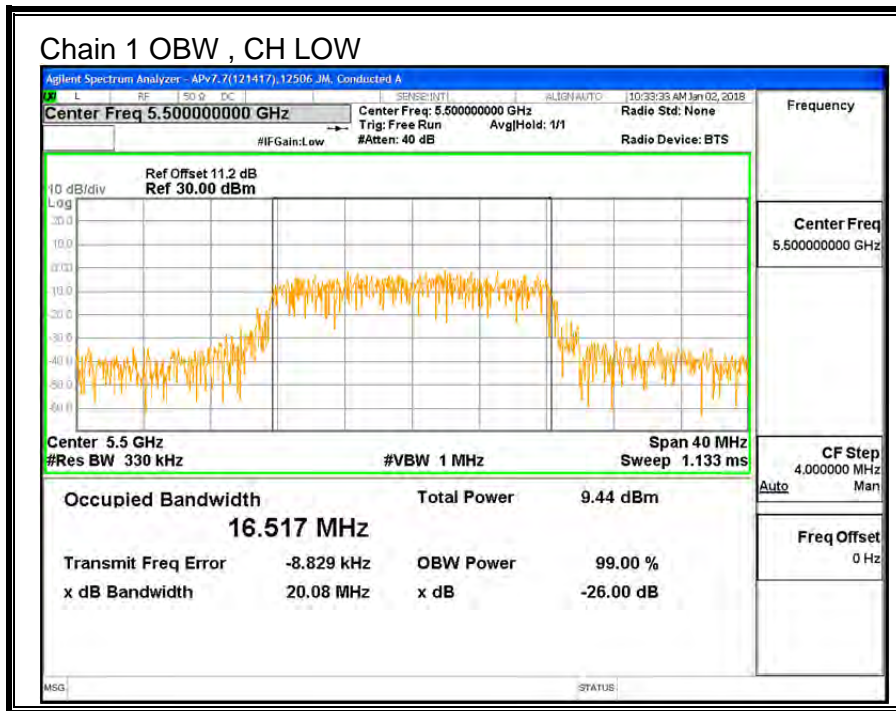
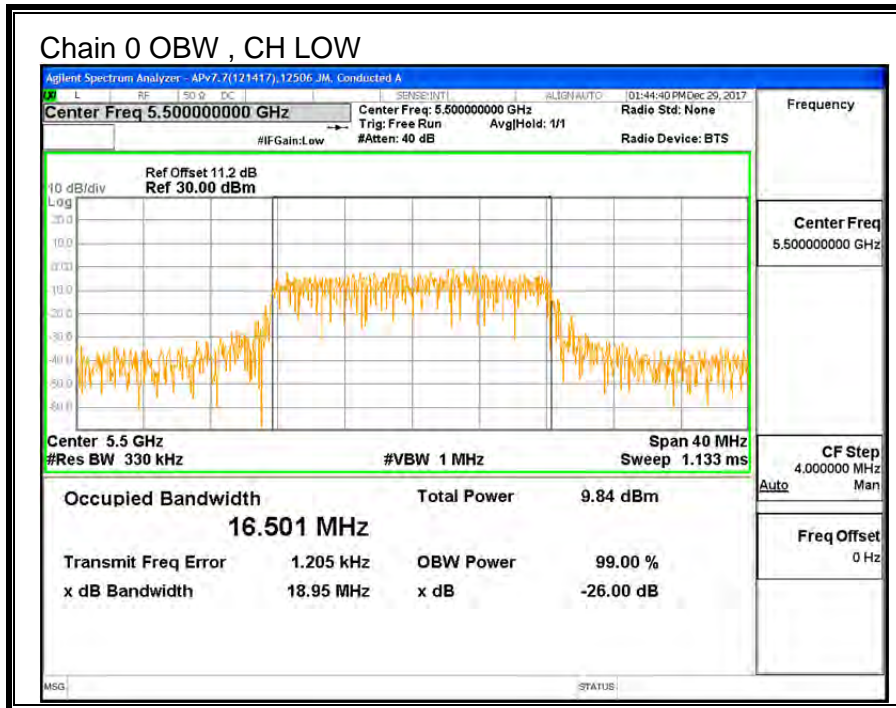



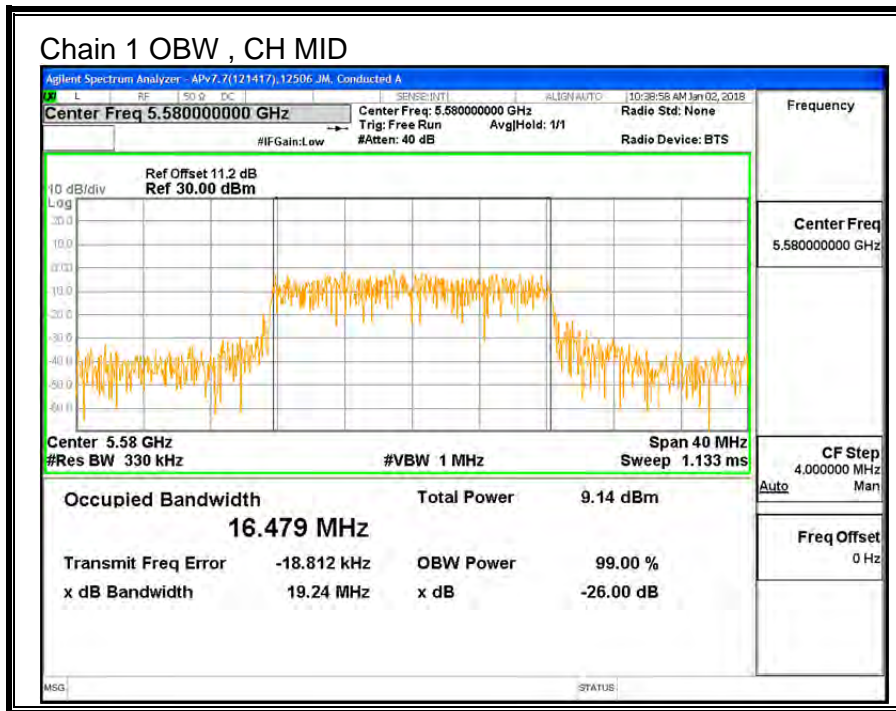
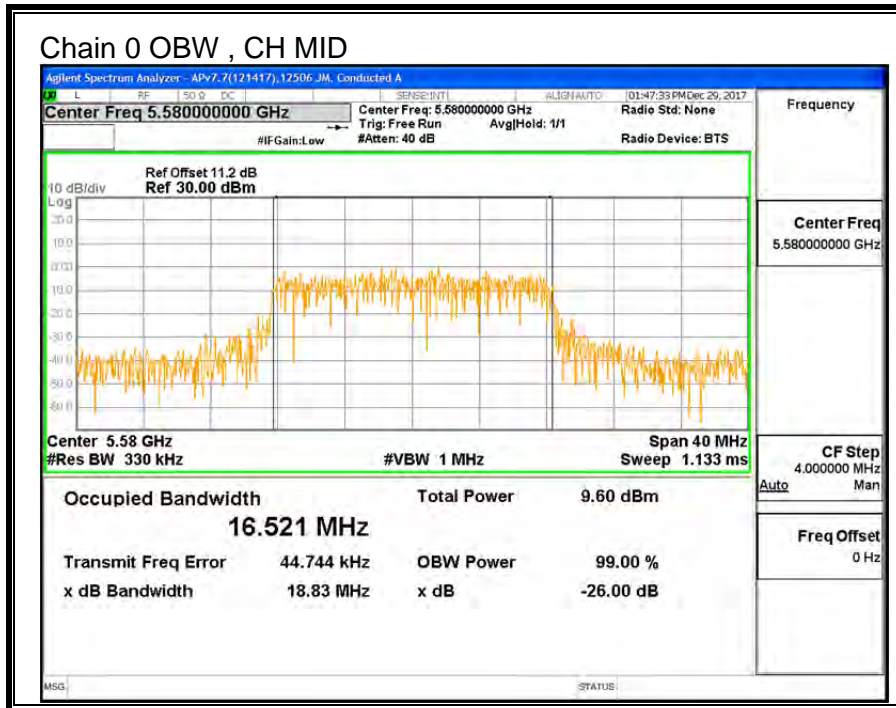

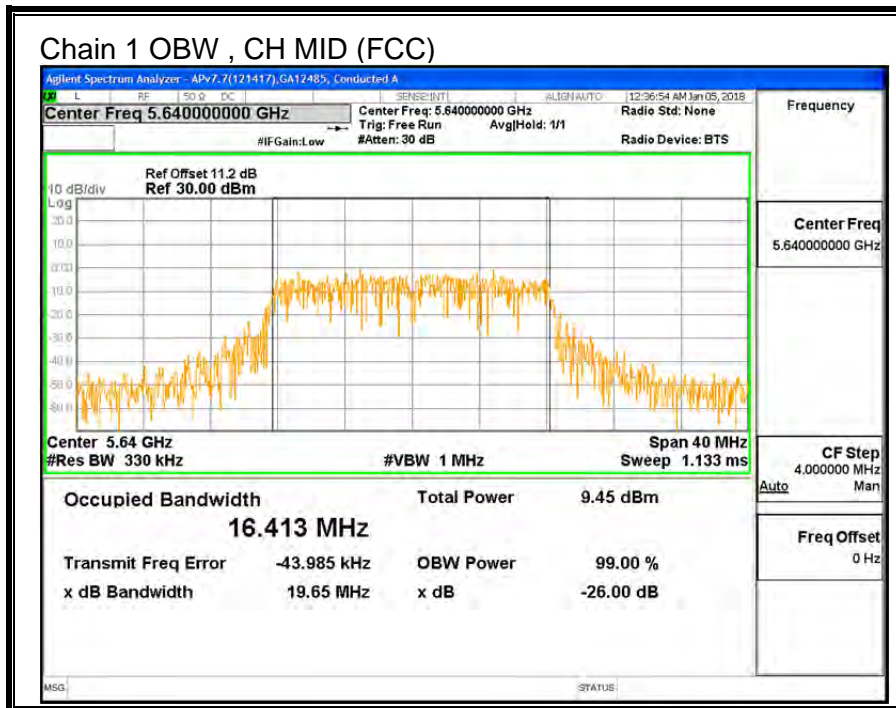
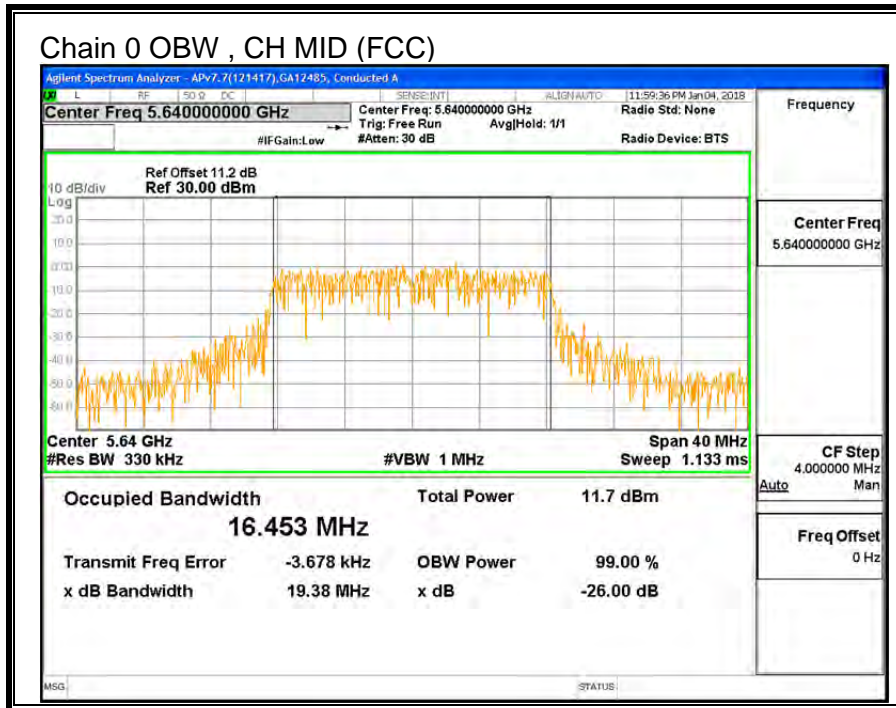



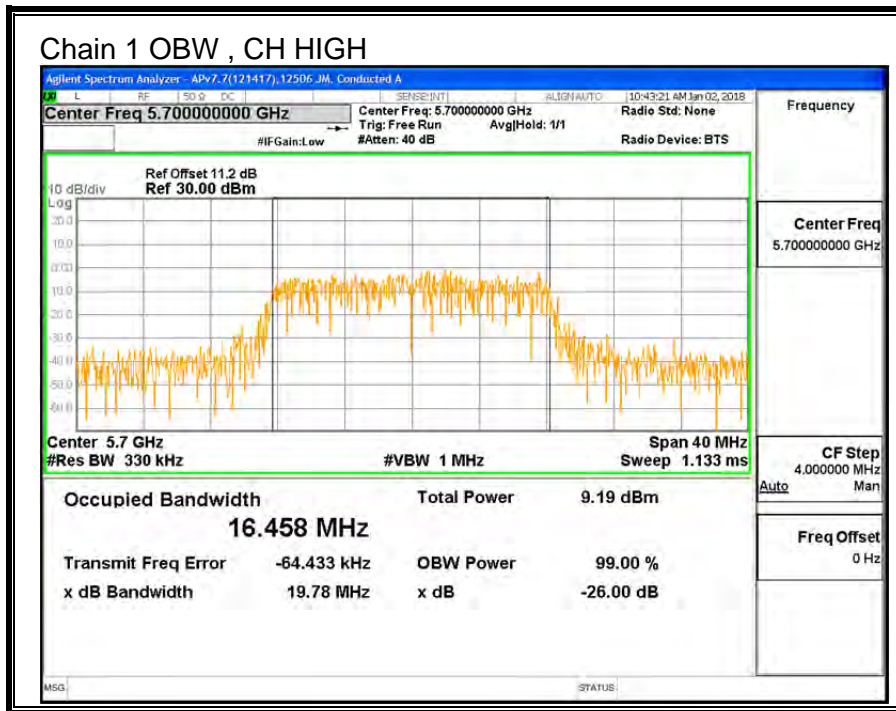
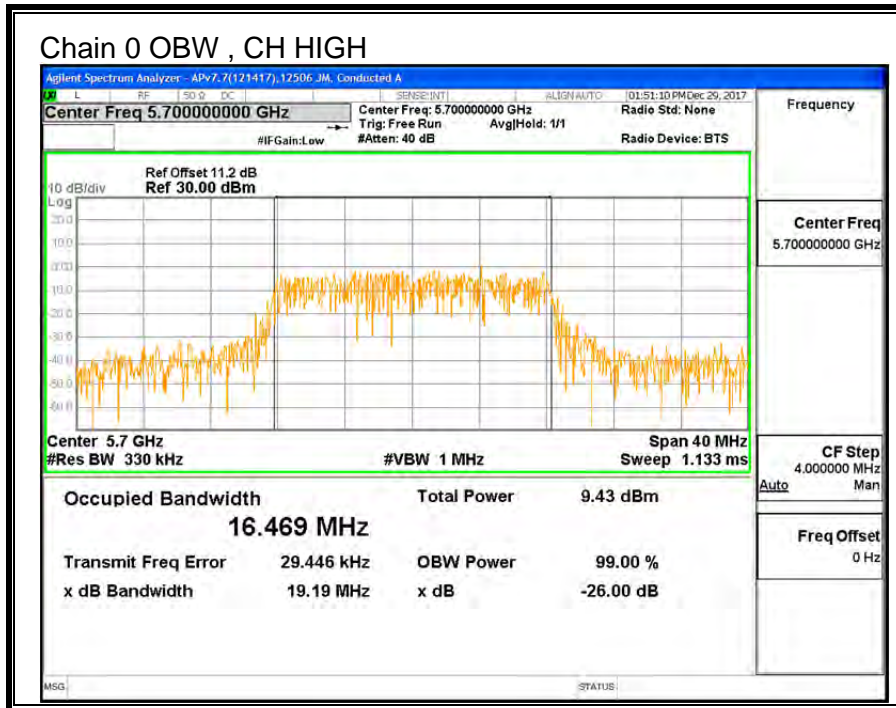

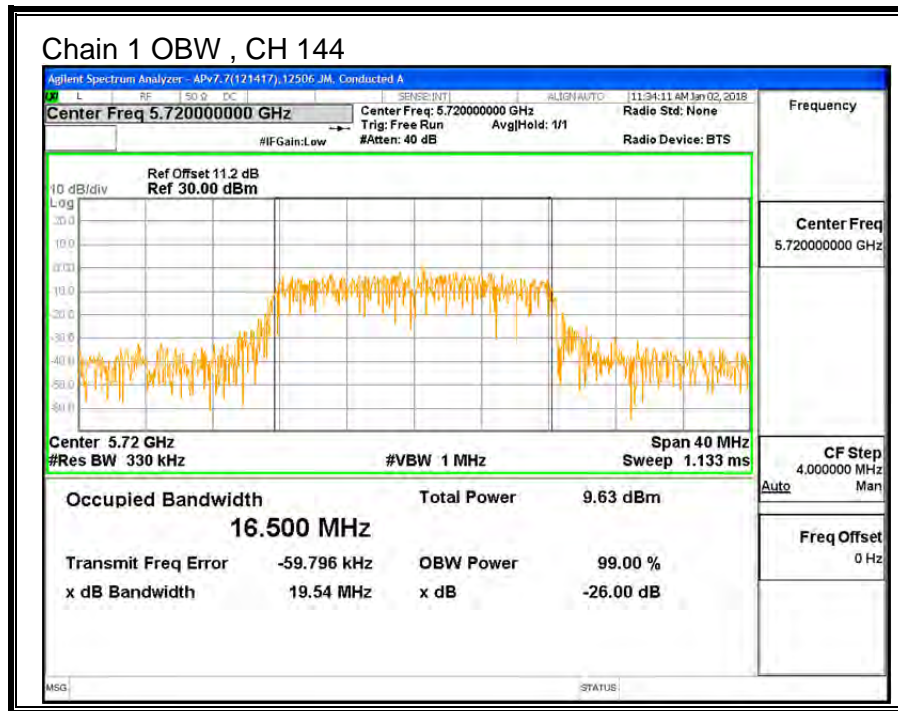
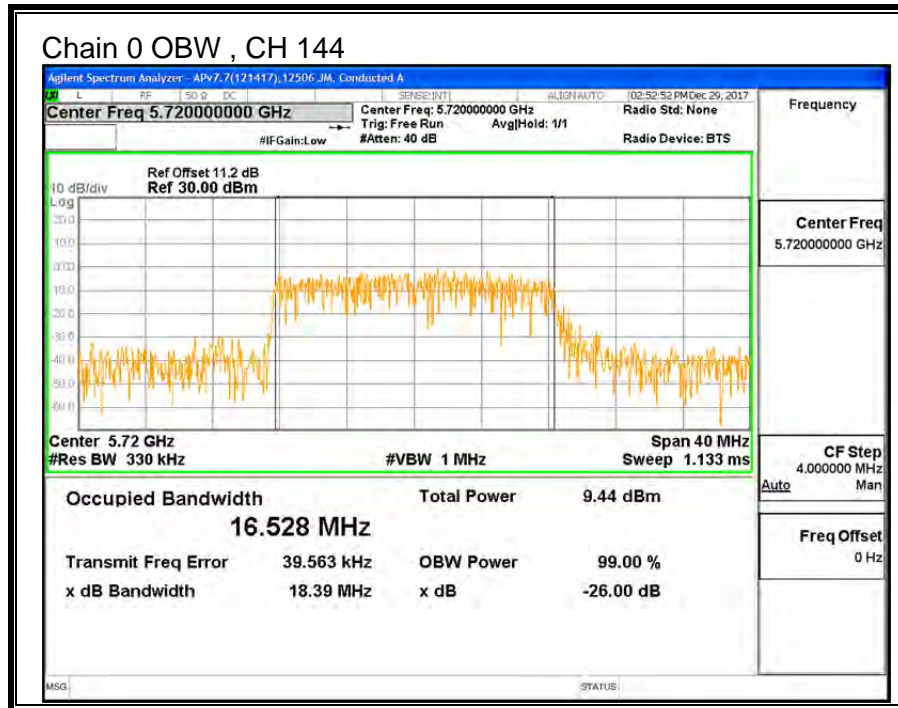

### 9.9.3. OUTPUT POWER AND PPSD

#### LIMITS

FCC §15.407 (a) (2)

For the band 5.47–5.725 GHz, the maximum conducted output power over the frequency band of operation shall not exceed the lesser of 250 mW or 11 dBm + 10 log B, where B is the 26–dB emission bandwidth in MHz. In addition, the maximum power spectral density shall not exceed 11 dBm in any 1–MHz band. If transmitting antennas of directional gain greater than 6 dBi are used, both the maximum conducted output power and the peak power spectral density shall be reduced by the amount in dB that the directional gain of the antenna exceeds 6 dBi.

#### TEST PROCEDURE

Measurements perform using a wideband gated RF power meter provided that the gate parameters are adjusted such that the power is measured only when the EUT is transmitting at its maximum power control level. Since the measurement is made only during the ON time of the transmitter, no duty cycle correction factor is required.

#### DIRECTIONAL ANTENNA GAIN

For power, the TX chains are uncorrelated and the antenna gain is unequal among the chains. The directional gain is:

**5470-5725 MHz**

Chain 0 Antenna Gain (dBi)	Chain 1 Antenna Gain (dBi)	Uncorrelated Chains Directional Gain (dBi)
-0.80	-5.40	-2.52

For PSD the TX chains are correlated and the antenna gain is unequal among the chains. The directional gain is:

**5470-5725 MHz**

Chain 0 Antenna Gain (dBi)	Chain 1 Antenna Gain (dBi)	Correlated Chains Directional Gain (dBi)
-0.80	-5.40	0.21

**RESULTS**

<b>ID:</b>	12506 JM	<b>Date:</b>	01/08/18
------------	----------	--------------	----------

**Bandwidth and Antenna Gain**

Channel	Frequency (MHz)	Min 26 dB BW (MHz)	Min 99% BW (MHz)	Directional Gain for Power (dBi)	Directional Gain for PPSD (dBi)
Low	5500	21.10	16.501	-2.52	0.21
Mid	5580	21.00	16.479	-2.52	0.21
Mid (FCC)	5640	21.05	16.413	-2.52	0.21
High	5700	21.40	16.458	-2.52	0.21
144	5720	15.58	13.250	-2.52	0.21

**Limits**

Channel	Frequency (MHz)	FCC Power Limit (dBm)	IC Power Limit (dBm)	IC EIRP Limit (dBm)	Power Limit (dBm)	FCC PPSD Limit (dBm)	IC PSD Limit (dBm)	PPSD Limit (dBm)
Low	5500	24.00	23.18	29.18	23.18	11.00	11.00	11.00
Mid	5580	24.00	23.17	29.17	23.17	11.00	11.00	11.00
Mid (FCC)	5640	24.00	23.15	29.15	23.15	11.00	11.00	11.00
High	5700	24.00	23.16	29.16	23.16	11.00	11.00	11.00
144	5720	22.92	22.22	28.22	22.22	11.00	11.00	11.00

<b>Duty Cycle CF (dB)</b>	0.00	<b>Included in Calculations of Corr'd PPSD</b>
---------------------------	------	--

**Output Power Results**

Channel	Frequency (MHz)	Chain 0 Meas Power (dBm)	Chain 1 Meas Power (dBm)	Total Corr'd Power (dBm)	Power Limit (dBm)	Power Margin (dB)
Low	5500	9.87	9.27	12.59	23.18	-10.58
Mid	5580	9.71	9.27	12.51	23.17	-10.66
Mid (FCC)	5640	9.37	9.22	12.31	23.15	-10.85
High	5700	9.37	8.87	12.14	23.16	-11.03
144	5720	9.29	9.36	12.34	22.22	-9.89

**PPSD Results**

Channel	Frequency (MHz)	Chain 0 Meas PPSD (dBm)	Chain 1 Meas PPSD (dBm)	Total Corr'd PPSD (dBm)	PPSD Limit (dBm)	PPSD Margin (dB)
Low	5500	-0.925	-1.068	2.01	11.00	-8.99
Mid	5580	-1.209	-1.445	1.68	11.00	-9.32
Mid (FCC)	5640	-1.178	-0.724	2.07	11.00	-8.93
High	5700	-0.846	-1.294	1.95	11.00	-9.05
144	5720	-1.092	-1.066	1.93	11.00	-9.07

**Note:** the power readings above were measured with gated method, and the measurement was taken only during the ON time. No duty cycle correction was necessary.

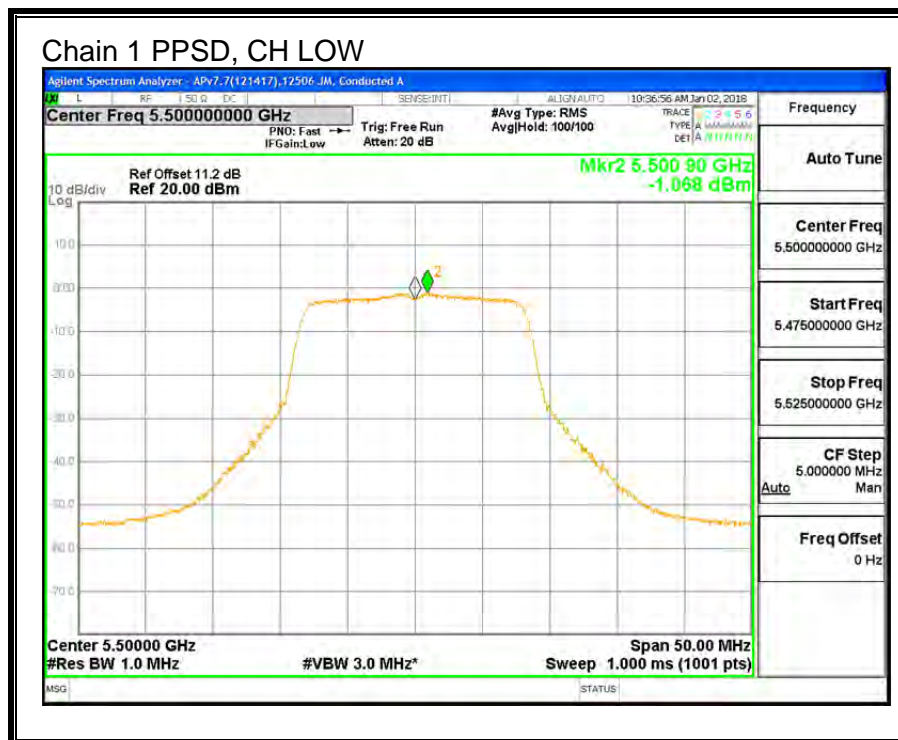
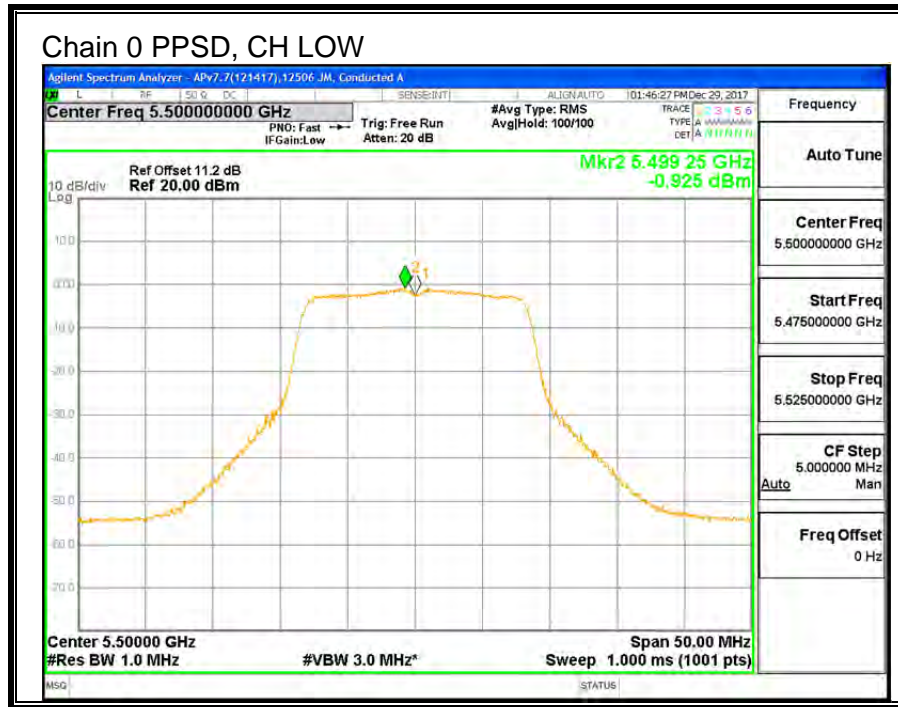



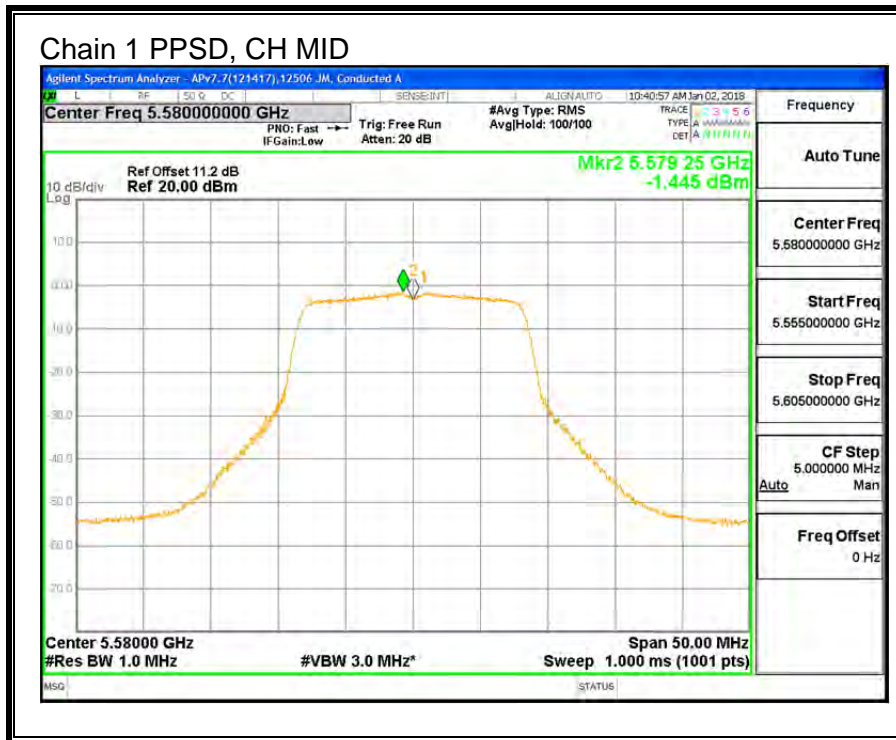
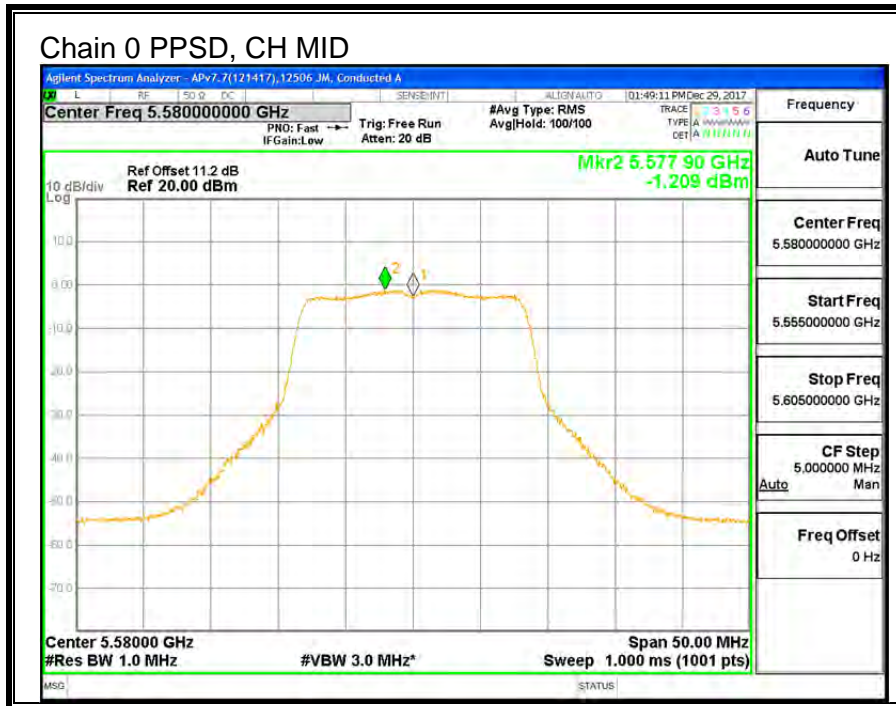



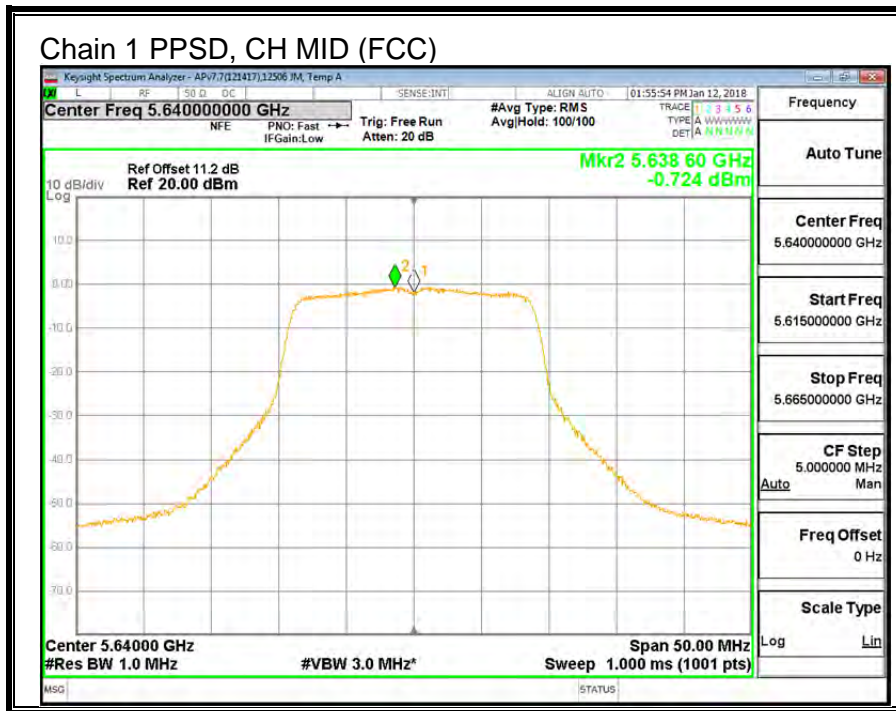
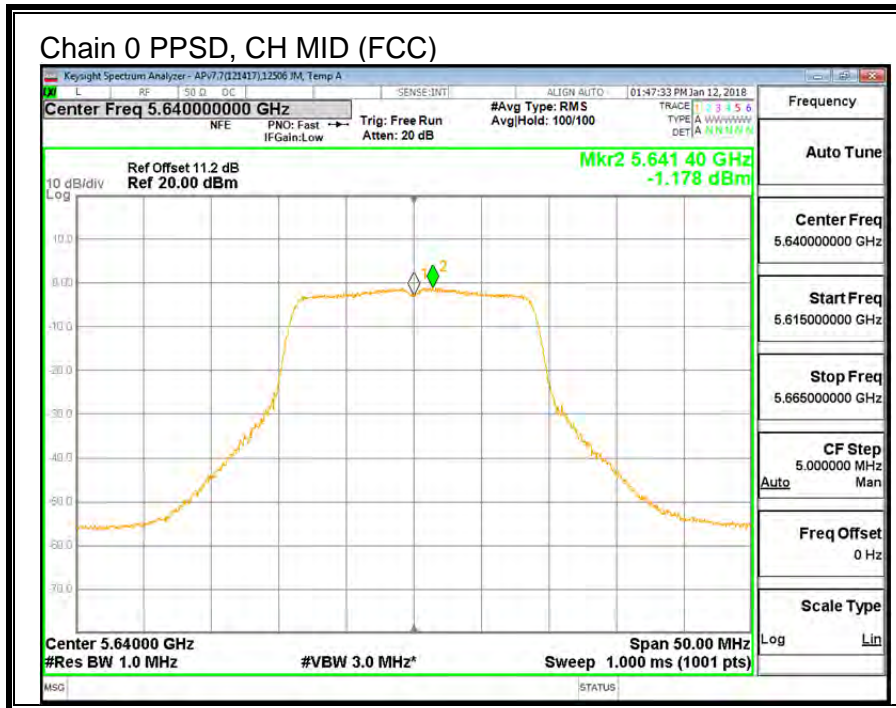

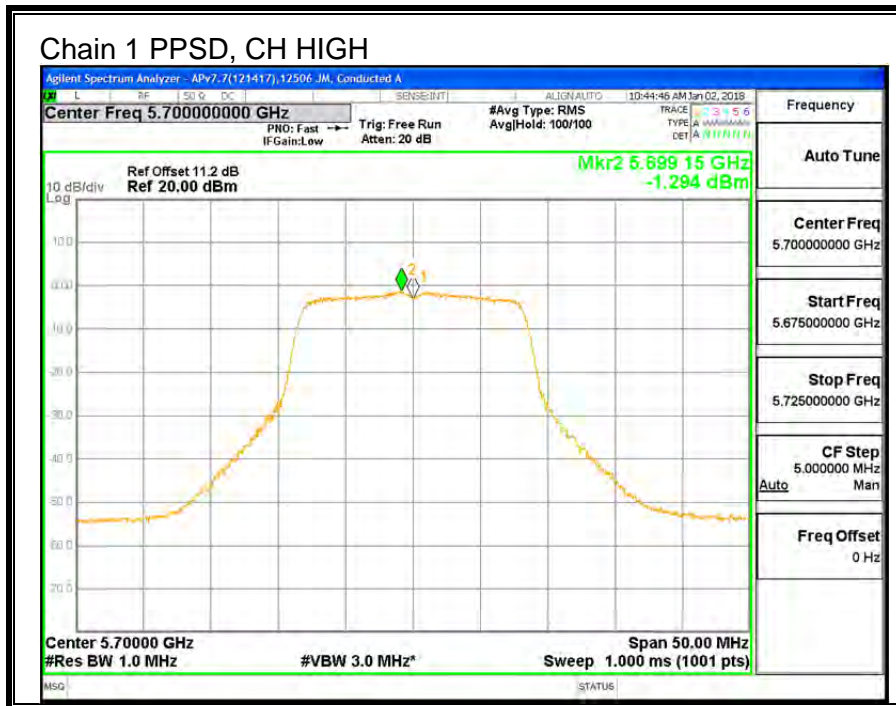
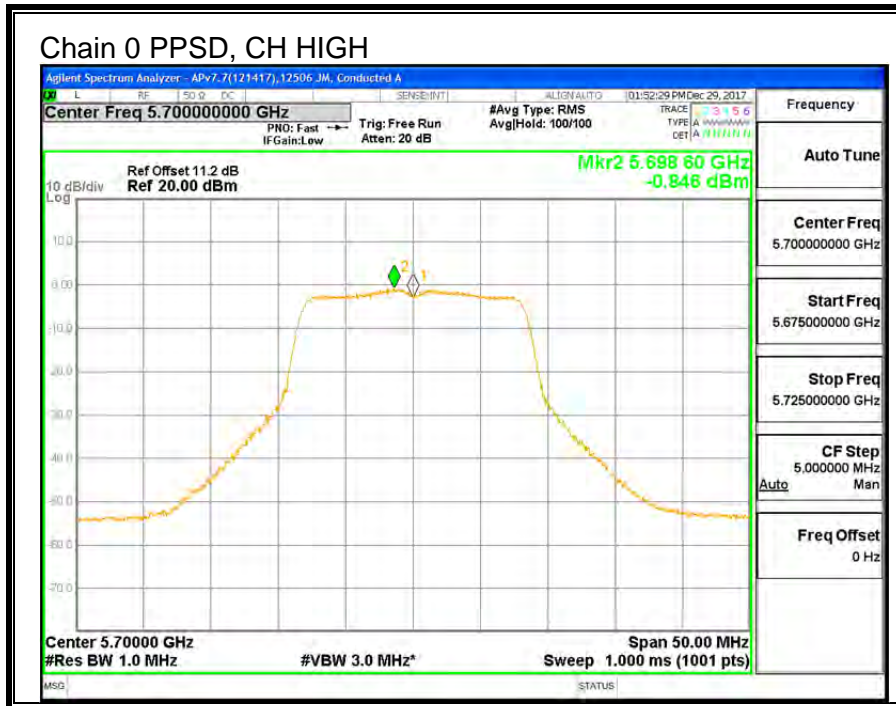

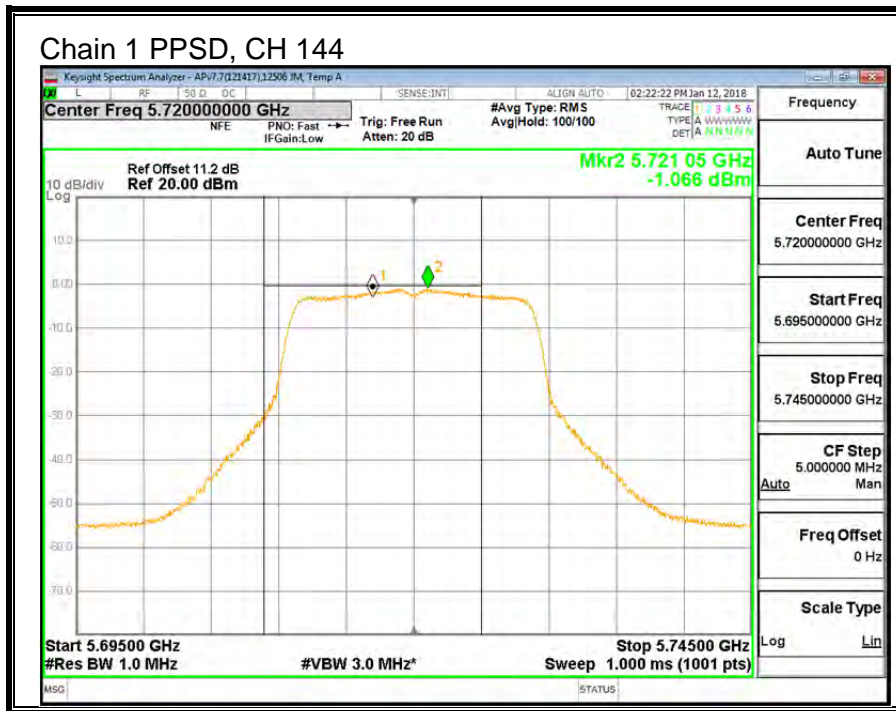
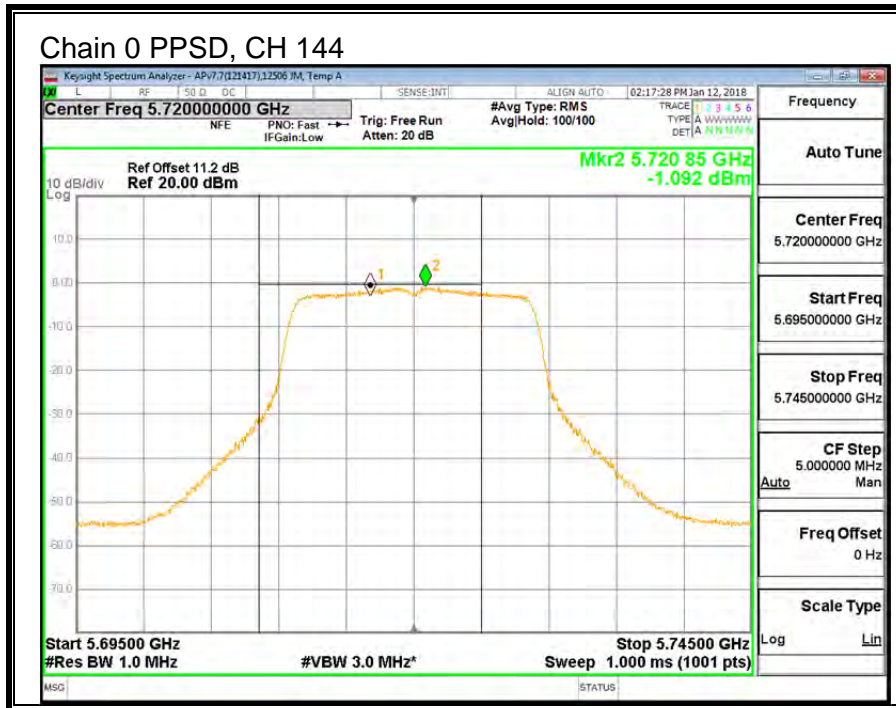

---

**9.10. 11n HT20 2TX CDD MIMO MODE IN THE 5.6GHz BAND**

**9.10.1. 26 dB BANDWIDTH**

**LIMITS**

None; for reporting purposes only.

**RESULTS**

<b>Channel</b>	<b>Frequency</b>	<b>26 dB BW Chain 0 (MHz)</b>	<b>26 dB BW Chain 1 (MHz)</b>
Low	5500	23.25	21.70
Mid	5580	22.65	22.10
Mid (FCC)	5640	22.55	21.75
High	5700	22.60	22.35
144	5720	22.95	21.75



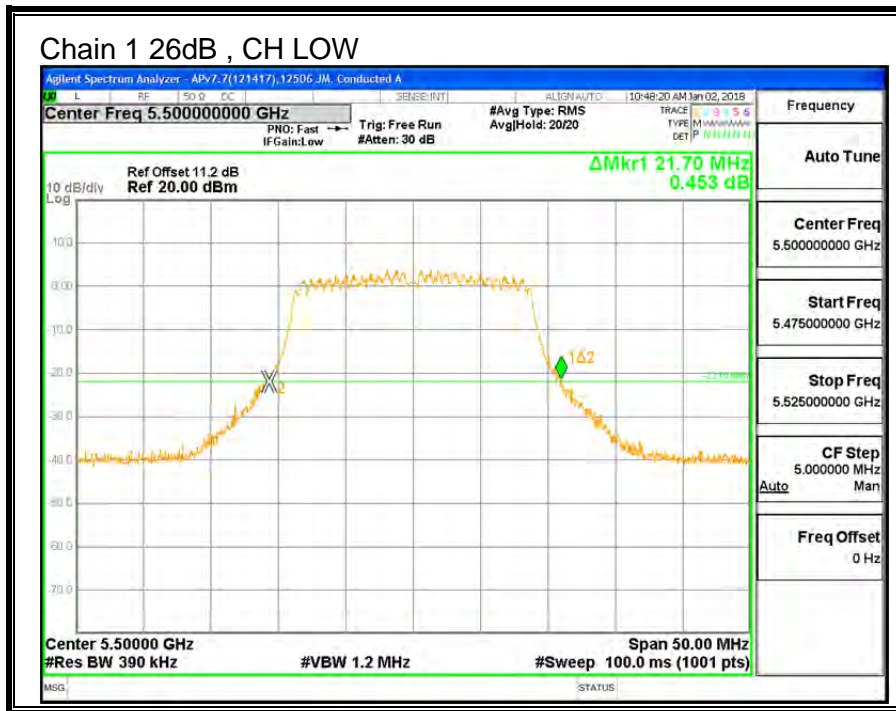
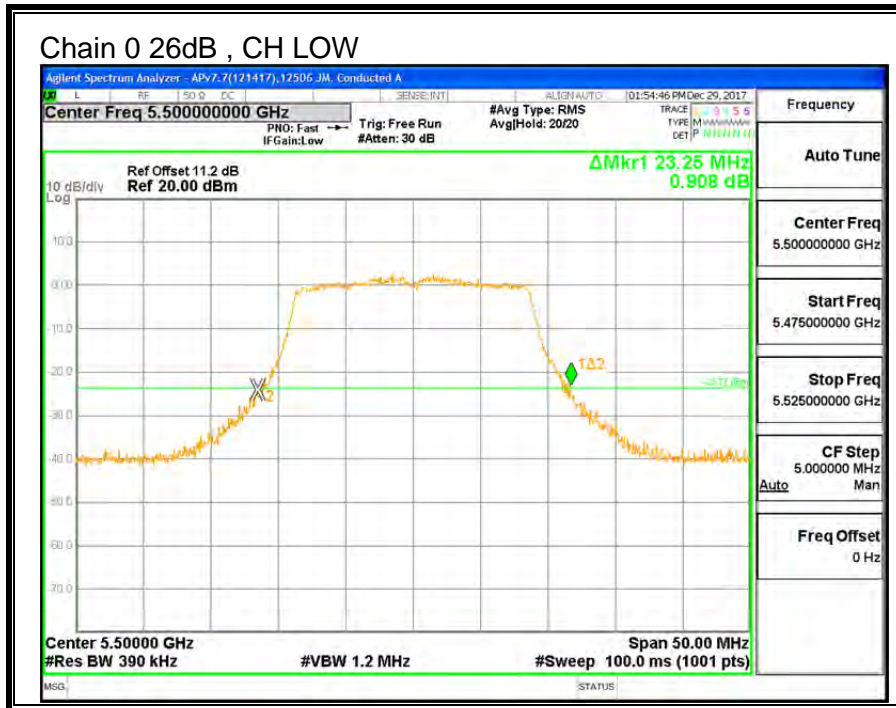

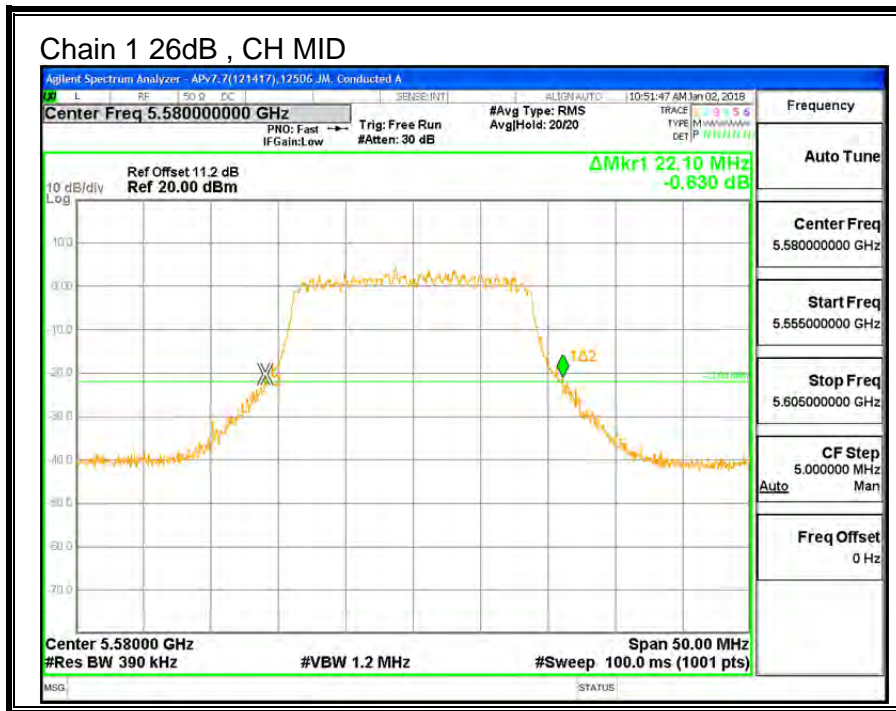
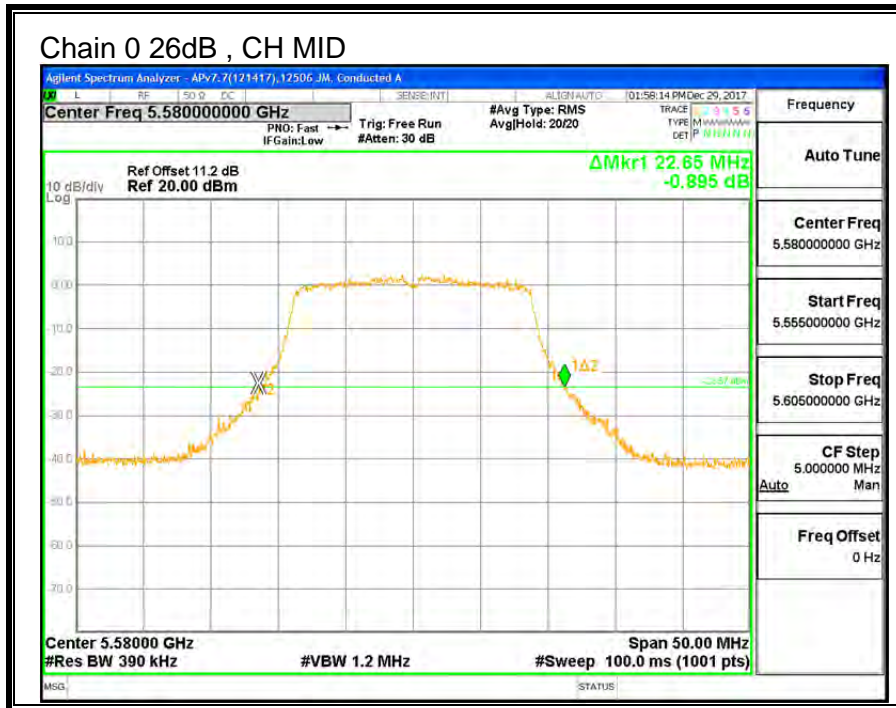



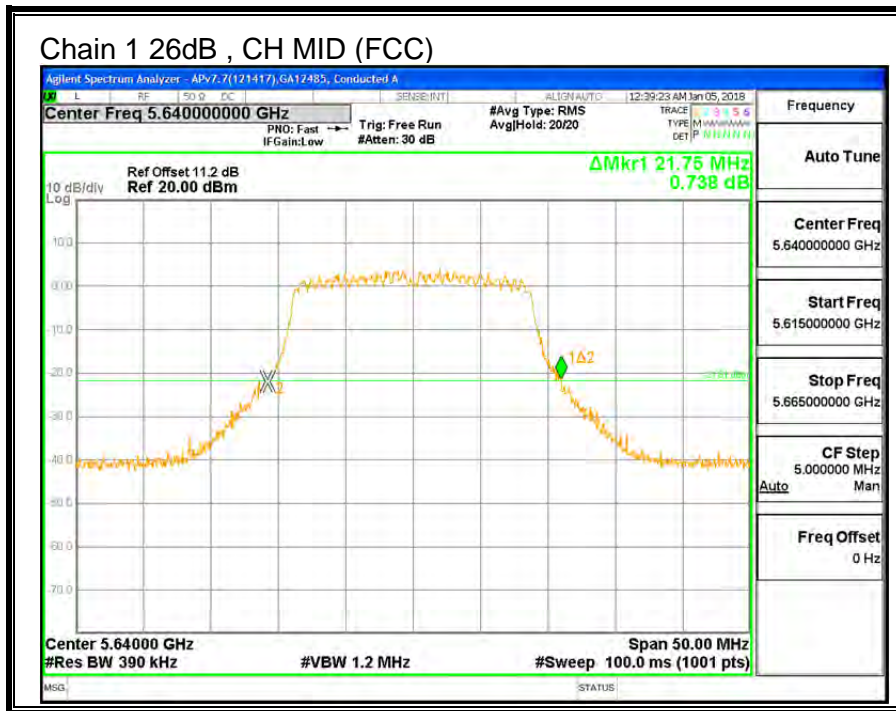
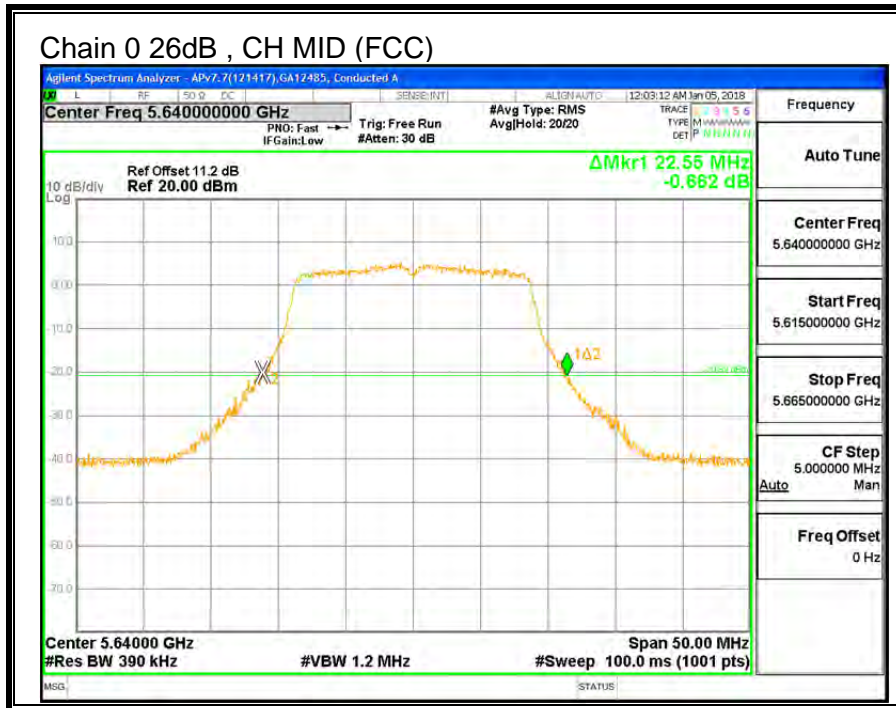

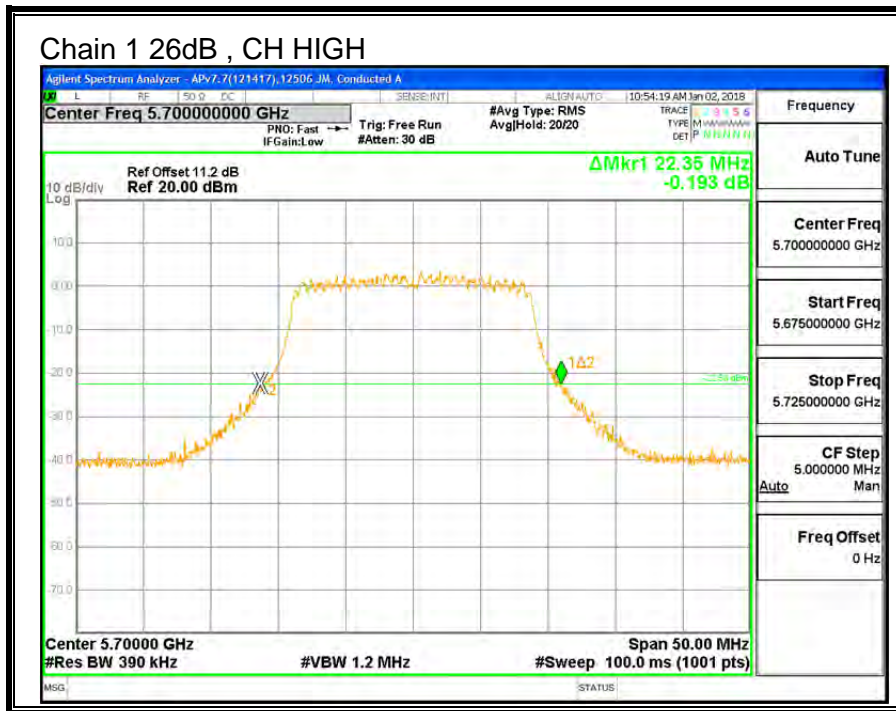
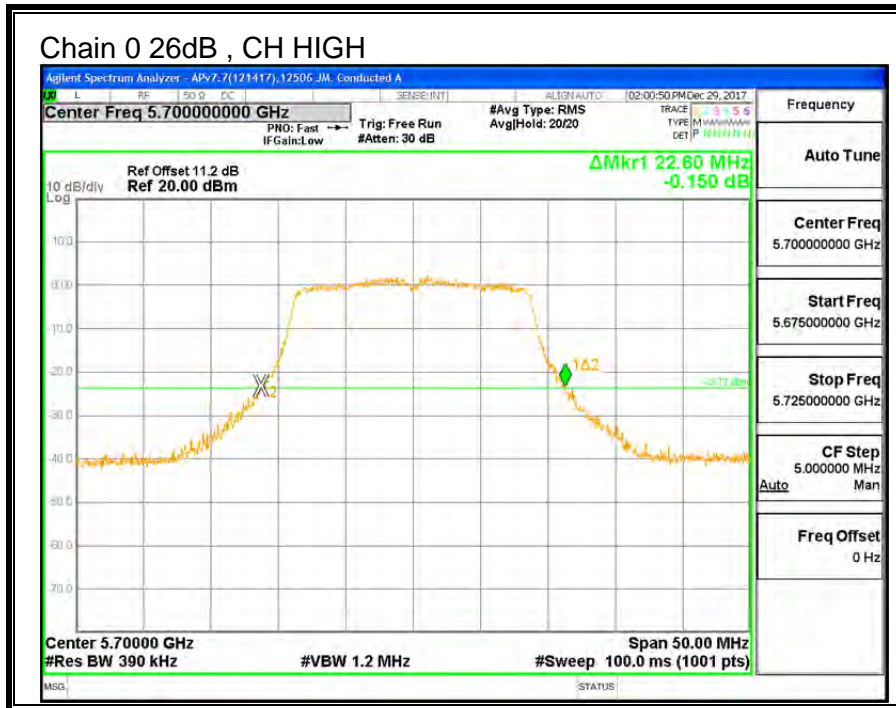

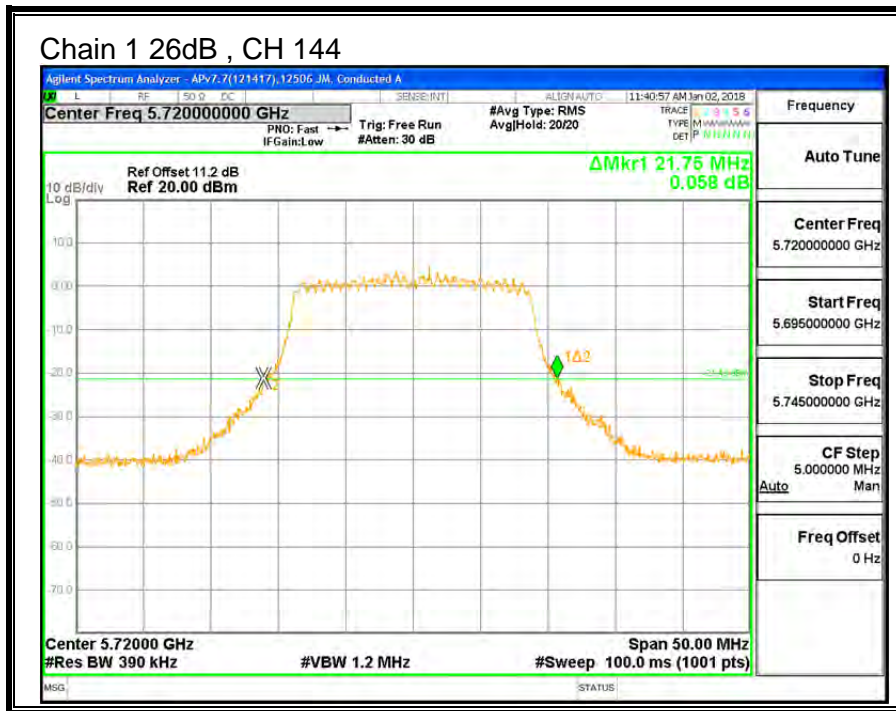
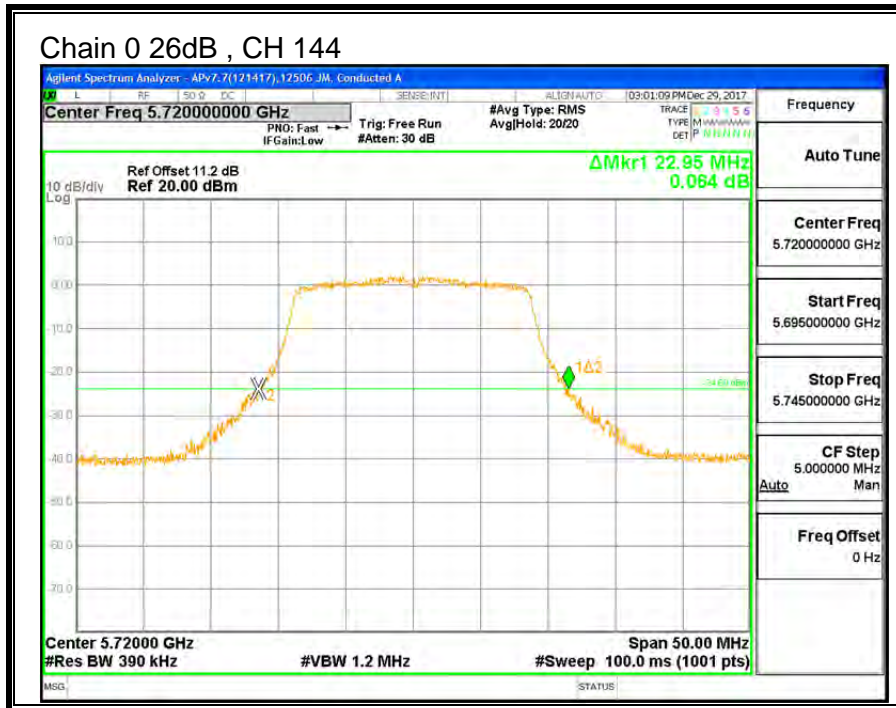

### 9.10.2. 99% BANDWIDTH

#### LIMITS

None; for reporting purposes only.

#### RESULTS

Channel	Frequency	99% BW Chain 0 (MHz)	99% BW Chain 1 (MHz)
Low	5500	17.721	17.704
Mid	5580	17.669	17.763
Mid (FCC)	5640	17.710	17.751
High	5700	17.753	17.739
144	5720	17.786	17.691



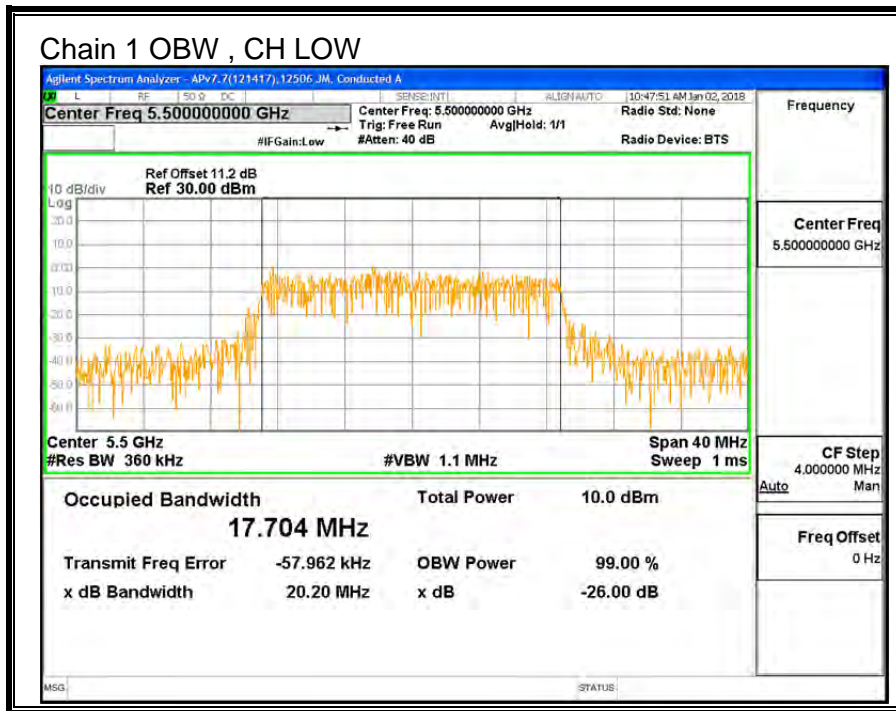
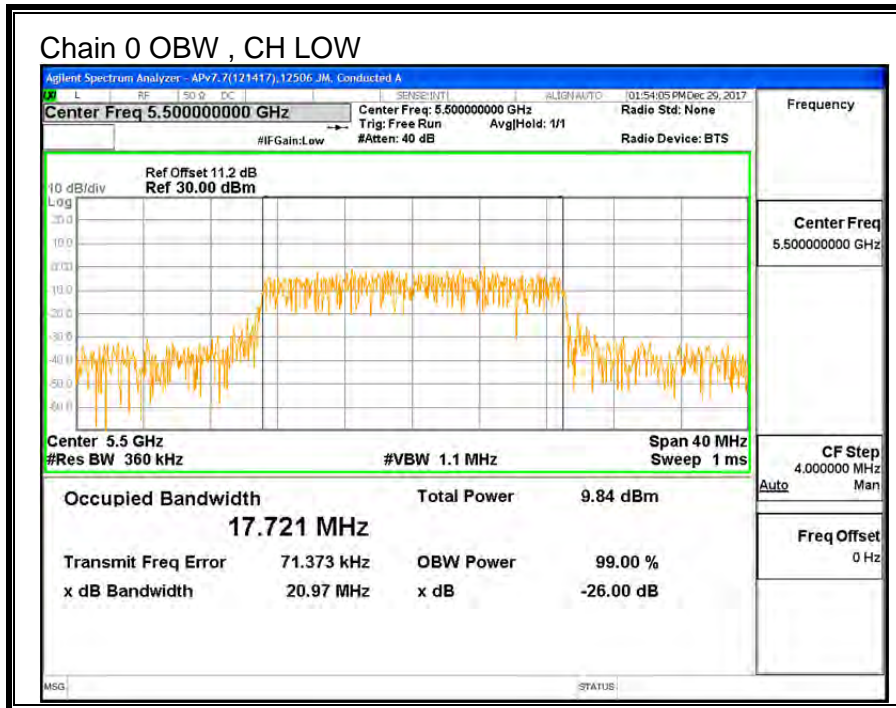

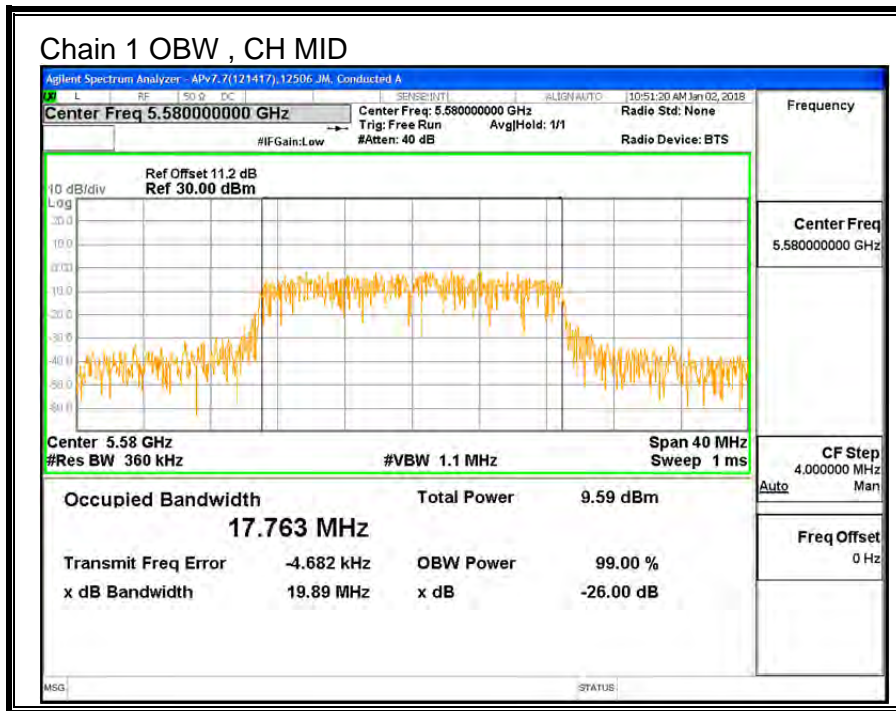
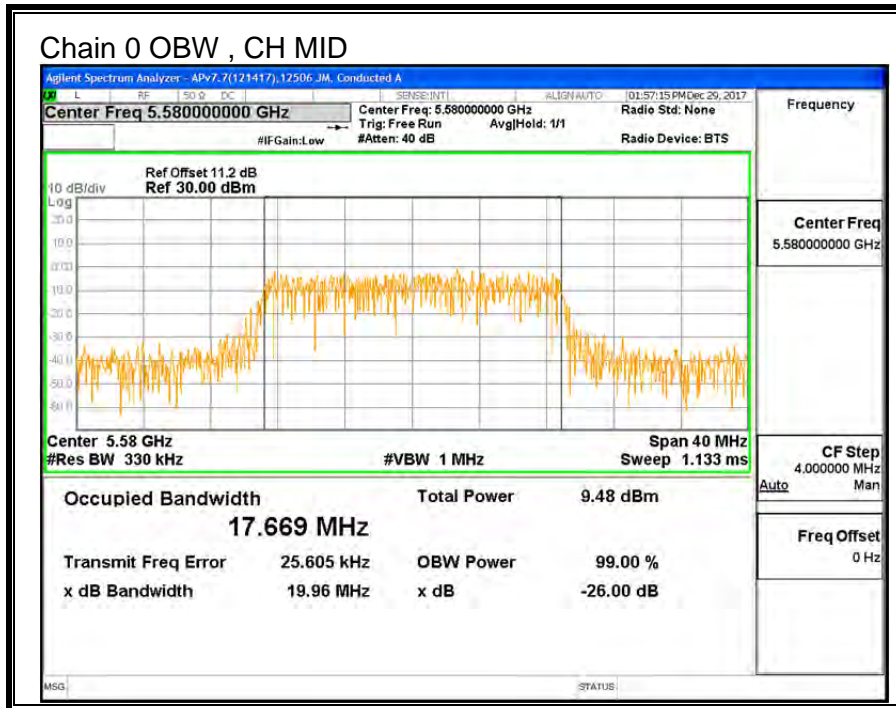



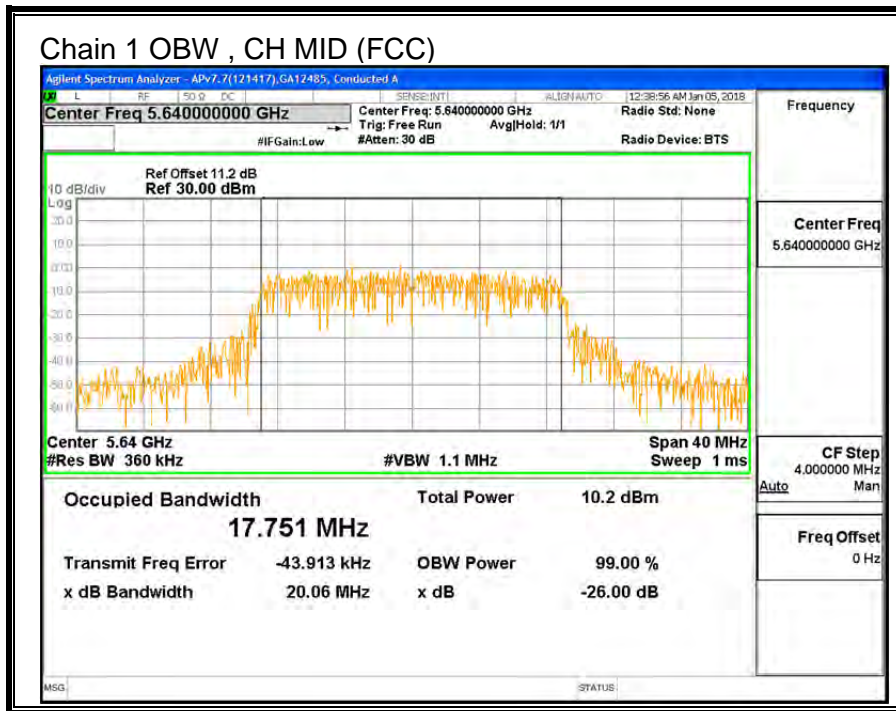
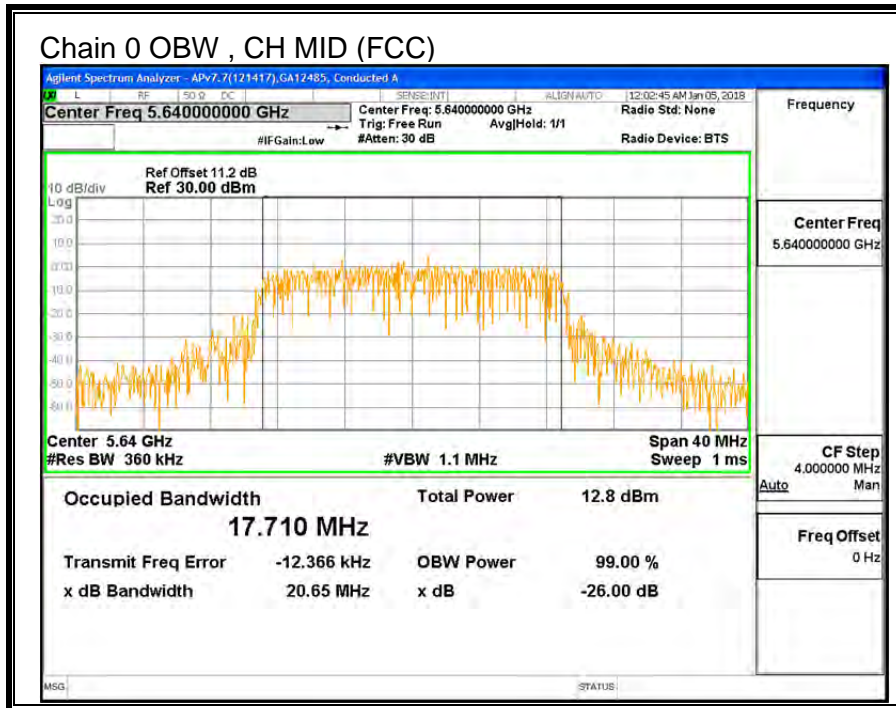

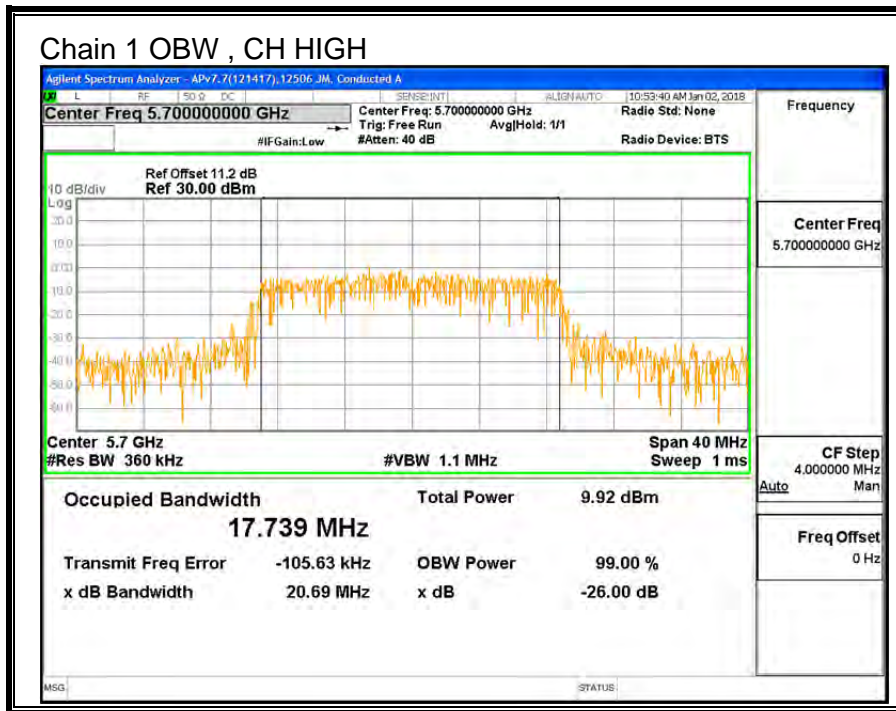
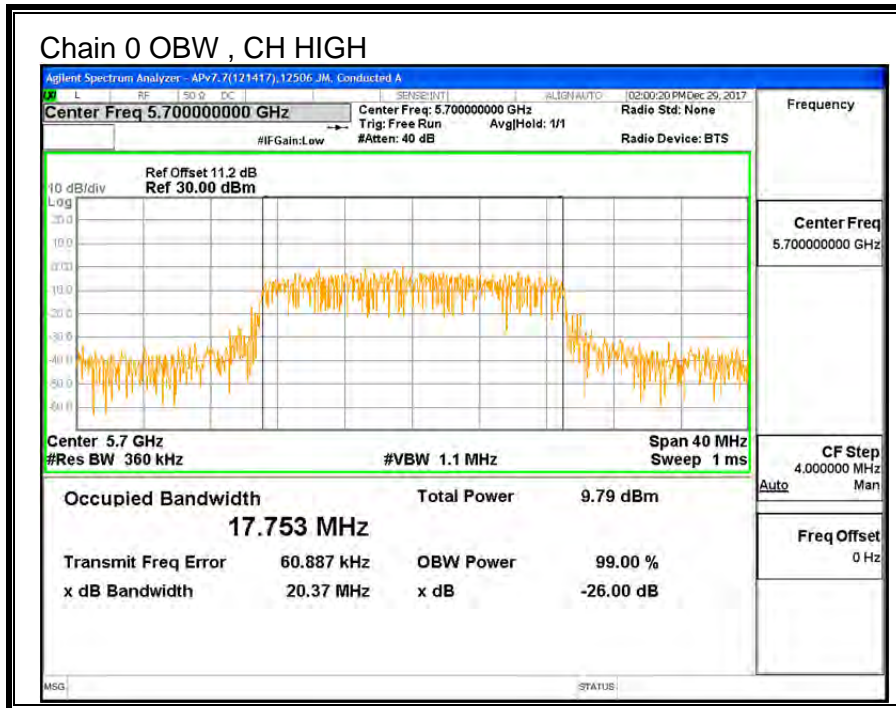

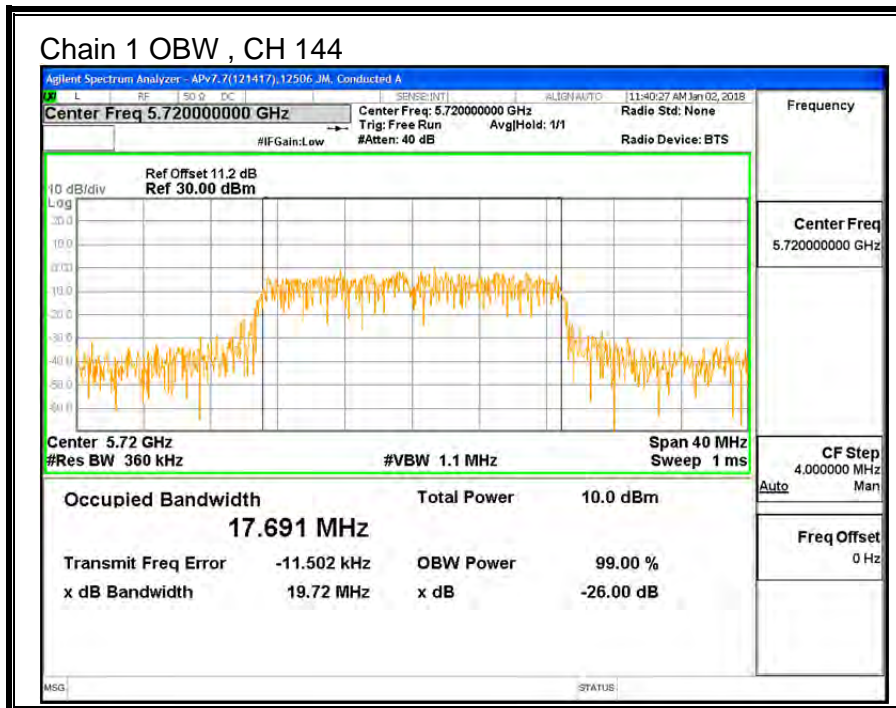
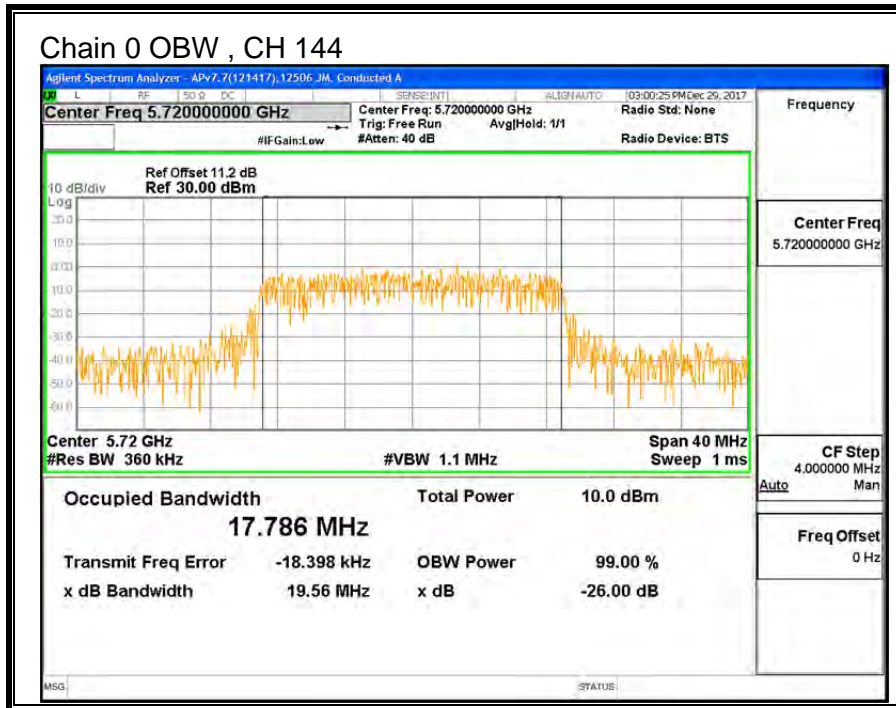

**9.10.3. OUTPUT POWER AND PPSD**

**LIMITS**

FCC §15.407 (a) (2)

For the band 5.47–5.725 GHz, the maximum conducted output power over the frequency band of operation shall not exceed the lesser of 250 mW or 11 dBm + 10 log B, where B is the 26–dB emission bandwidth in MHz. In addition, the maximum power spectral density shall not exceed 11 dBm in any 1–MHz band. If transmitting antennas of directional gain greater than 6 dBi are used, both the maximum conducted output power and the peak power spectral density shall be reduced by the amount in dB that the directional gain of the antenna exceeds 6 dBi.

**TEST PROCEDURE**

Measurements perform using a wideband gated RF power meter provided that the gate parameters are adjusted such that the power is measured only when the EUT is transmitting at its maximum power control level. Since the measurement is made only during the ON time of the transmitter, no duty cycle correction factor is required.

**DIRECTIONAL ANTENNA GAIN**

For power, the TX chains are uncorrelated and the antenna gain is unequal among the chains. The directional gain is:

**5470-5725 MHz**

Chain 0 Antenna Gain (dBi)	Chain 1 Antenna Gain (dBi)	Uncorrelated Chains Directional Gain (dBi)
-0.80	-5.40	-2.52

For PSD the TX chains are correlated and the antenna gain is unequal among the chains. The directional gain is:

**5470-5725 MHz**

Chain 0 Antenna Gain (dBi)	Chain 1 Antenna Gain (dBi)	Correlated Chains Directional Gain (dBi)
-0.80	-5.40	0.21

**RESULTS**

<b>ID:</b>	12506 JM	<b>Date:</b>	01/08/18
------------	----------	--------------	----------

**Bandwidth and Antenna Gain**

Channel	Frequency (MHz)	Min 26 dB BW (MHz)	Min 99% BW (MHz)	Directional Gain for Power (dBi)	Directional Gain for PPSD (dBi)
Low	5500	21.70	17.704	-2.52	0.21
Mid	5580	22.10	17.669	-2.52	0.21
Mid (FCC)	5640	21.75	17.710	-2.52	0.21
High	5700	22.35	17.739	-2.52	0.21
144	5720	15.88	13.846	-2.52	0.21

**Limits**

Channel	Frequency (MHz)	FCC Power Limit (dBm)	IC Power Limit (dBm)	IC EIRP Limit (dBm)	Power Limit (dBm)	FCC PPSD Limit (dBm)	IC PSD Limit (dBm)	PPSD Limit (dBm)
Low	5500	24.00	23.48	29.48	23.48	11.00	11.00	11.00
Mid	5580	24.00	23.47	29.47	23.47	11.00	11.00	11.00
Mid (FCC)	5640	24.00	23.48	29.48	23.48	11.00	11.00	11.00
High	5700	24.00	23.49	29.49	23.49	11.00	11.00	11.00
144	5720	23.01	22.41	28.41	22.41	11.00	11.00	11.00

<b>Duty Cycle CF (dB)</b>	0.14	<b>Included in Calculations of Corr'd PPSD</b>
---------------------------	------	--

**Output Power Results**

Channel	Frequency (MHz)	Chain 0 Meas Power (dBm)	Chain 1 Meas Power (dBm)	Total Corr'd Power (dBm)	Power Limit (dBm)	Power Margin (dB)
Low	5500	9.55	9.81	12.69	23.48	-10.79
Mid	5580	9.63	9.83	12.74	23.47	-10.73
Mid (FCC)	5640	9.27	9.79	12.55	23.48	-10.93
High	5700	9.25	9.57	12.42	23.49	-11.07
144	5720	9.63	9.47	12.56	22.41	-9.85

**PPSD Results**

Channel	Frequency (MHz)	Chain 0 Meas PPSD (dBm)	Chain 1 Meas PPSD (dBm)	Total Corr'd PPSD (dBm)	PPSD Limit (dBm)	PPSD Margin (dB)
Low	5500	-1.236	-0.551	2.27	11.00	-8.73
Mid	5580	-1.248	-1.393	1.83	11.00	-9.17
Mid (FCC)	5640	1.747	-0.715	3.84	11.00	-7.16
High	5700	-1.201	-0.778	2.17	11.00	-8.83
144	5720	-0.793	-0.917	2.30	11.00	-8.70

**Note:** the power readings above were measured with gated method, and the measurement was taken only during the ON time. No duty cycle correction was necessary.



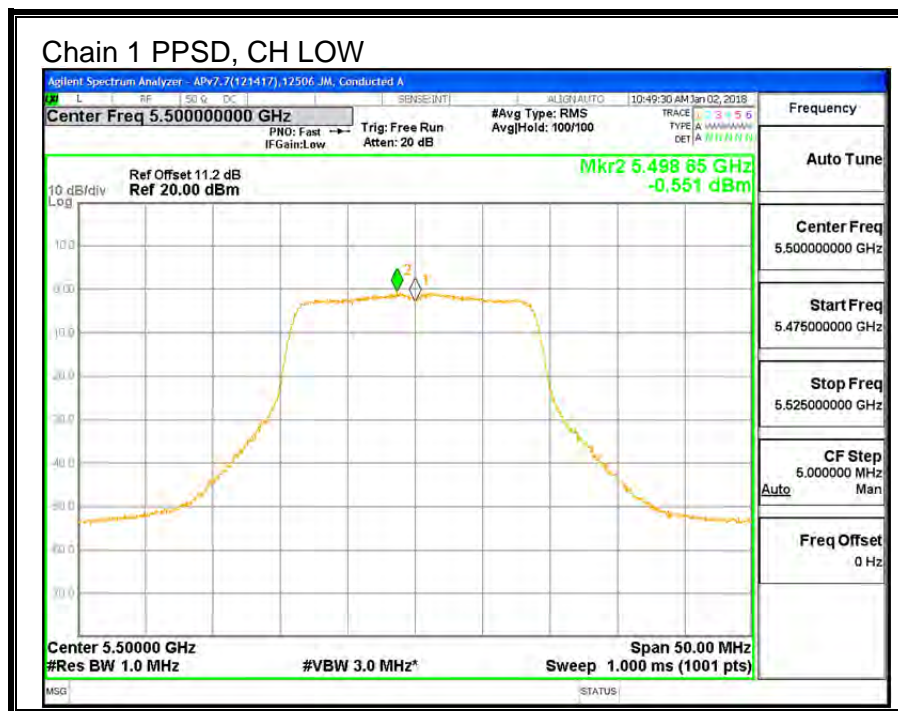
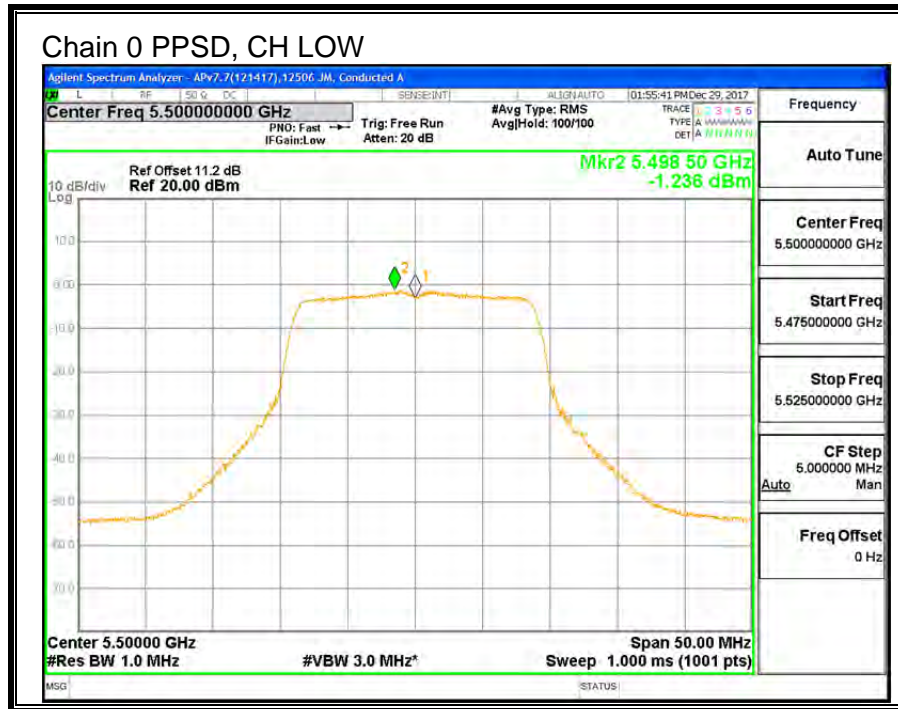



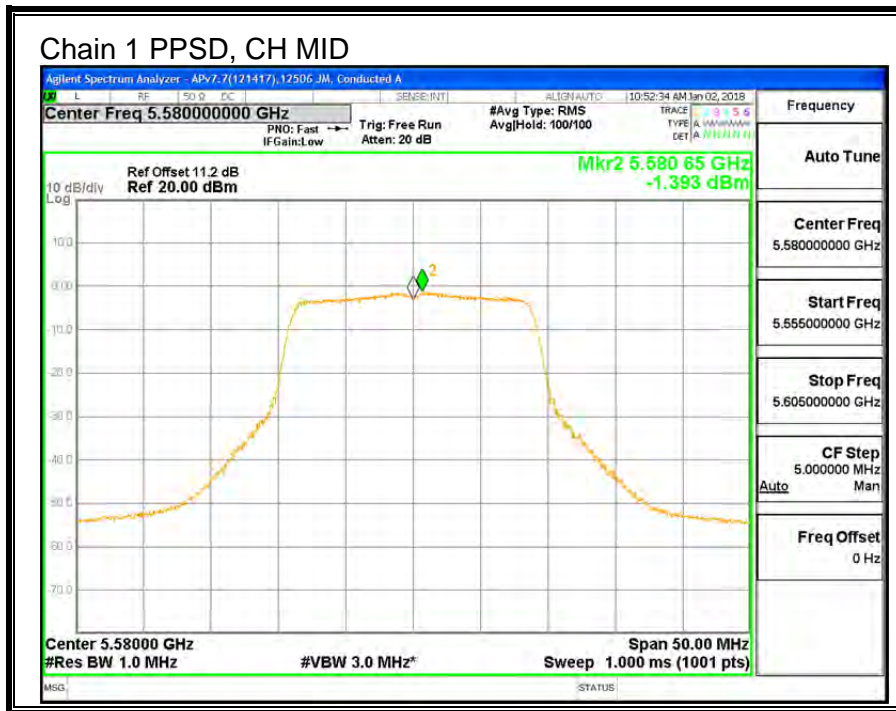
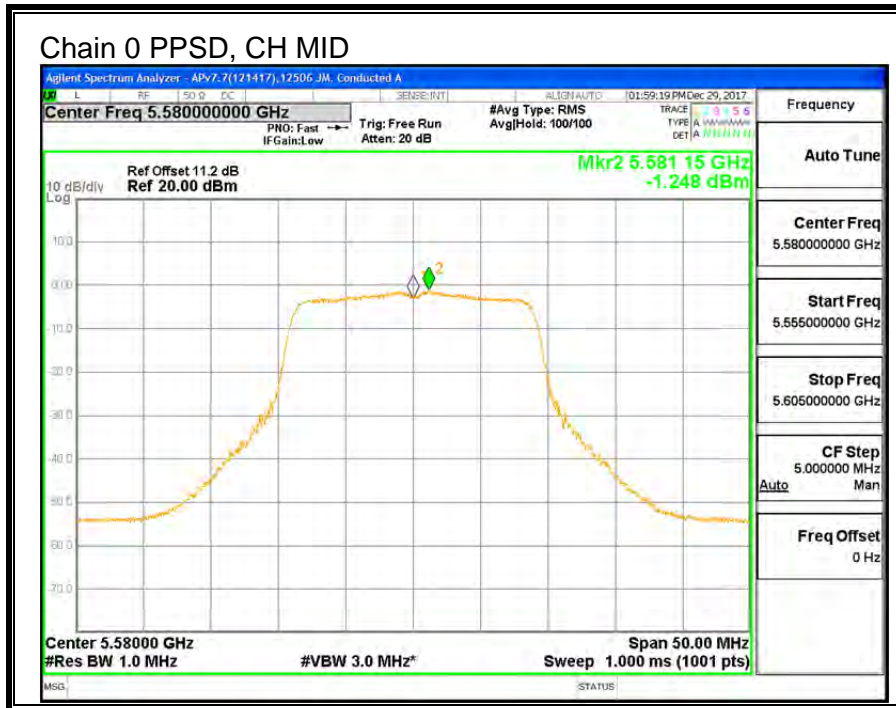

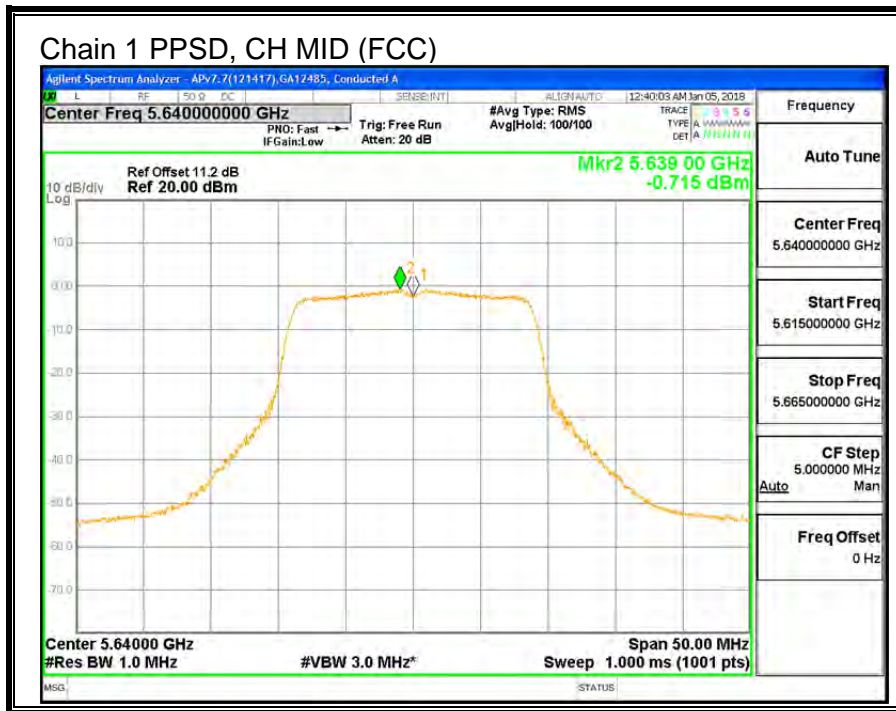
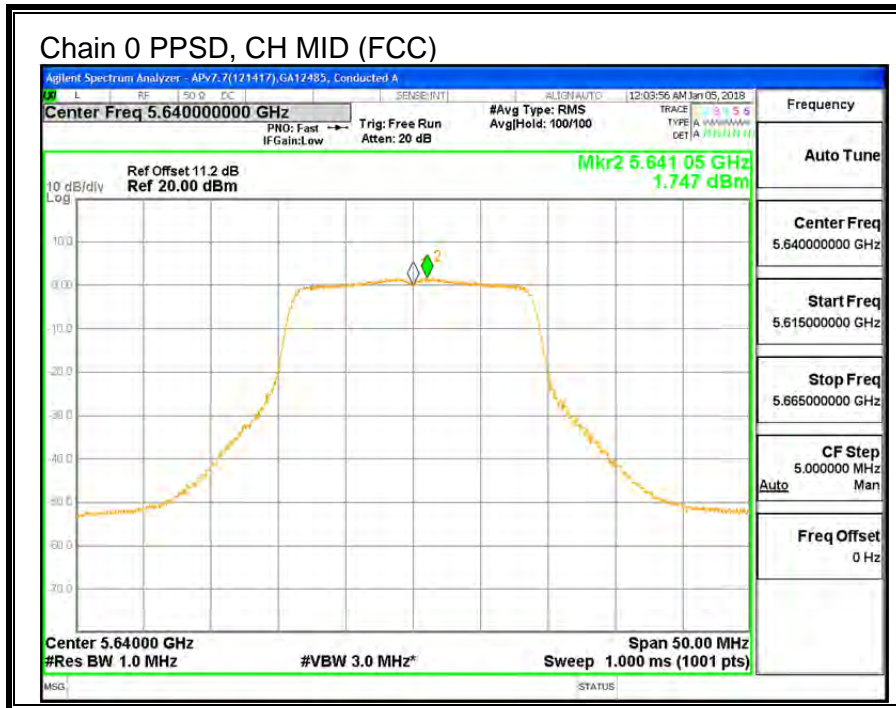

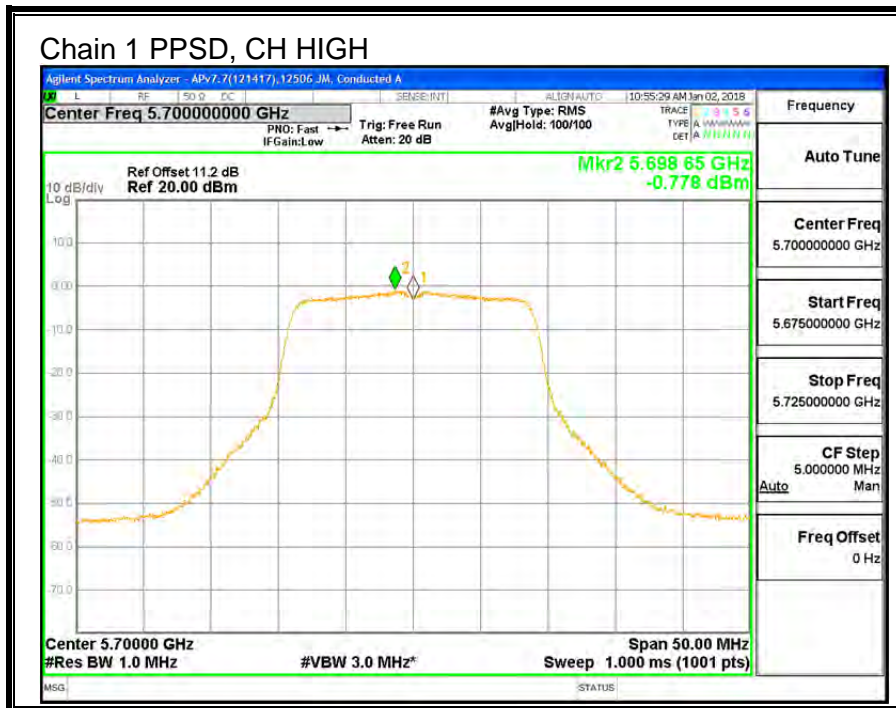
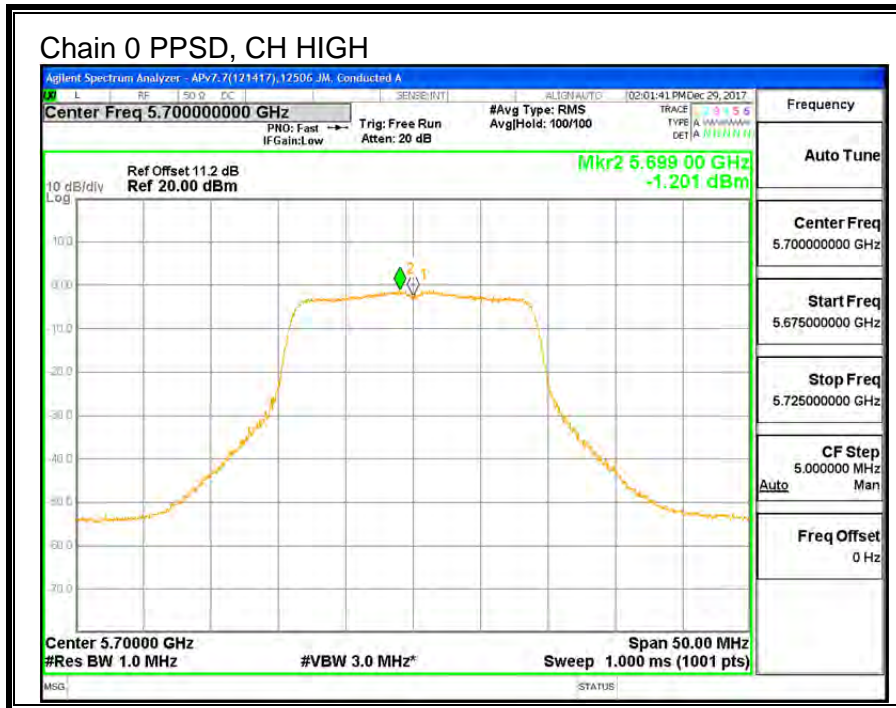



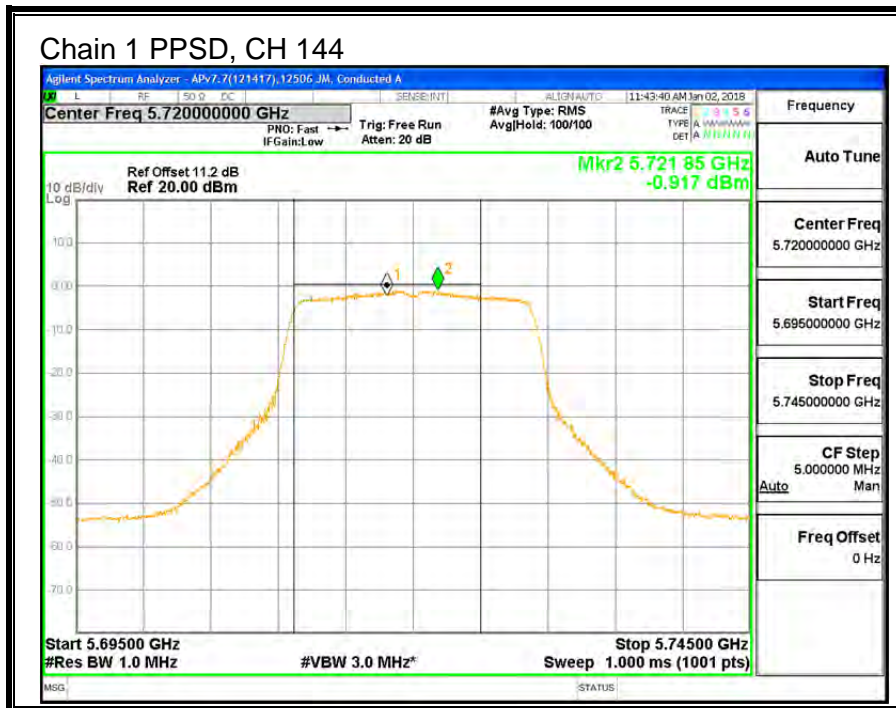
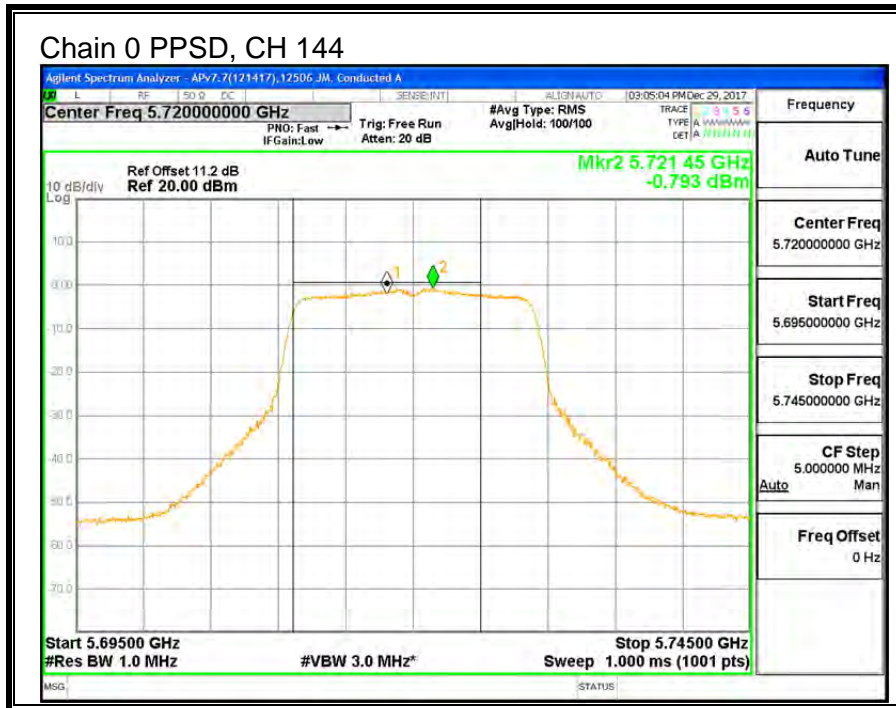

## 9.11. 11n HT40 2TX CDD MIMO MODE IN THE 5.6GHz BAND

### 9.11.1. 26 dB BANDWIDTH

#### LIMITS

None; for reporting purposes only.

#### RESULTS

Channel	Frequency	26 dB BW Chain 0 (MHz)	26 dB BW Chain 1 (MHz)
Low	5510	41.7	41.1
Mid	5550	41.7	41.2
Mid (FCC)	5630	41.9	41.2
High	5670	41.7	41.1
142	5710	42.0	40.9

