



CERTIFICATION TEST REPORT

Report Number. : 12097277-E4V1

Applicant : SONY MOBILE COMMUNICATIONS, INC.
4-12-3 HIGASHI-SHINAGAWA,
SHINAGAWA -KU,TOKYO, 140-0002, JAPAN

FCC ID : PY7-72474U

EUT Description : GSM/WCDMA/LTE PHONE with BT, DTS/UNII a/b/g/n/ac & NFC

Test Standard(s) : FCC 47 CFR PART 15 SUBPART C

Date Of Issue:

January 24, 2018

Prepared by:

UL Verification Services Inc.
47173 Benicia Street
Fremont, CA 94538, U.S.A.
TEL: (510) 771-1000
FAX: (510) 661-0888



Revision History

<u>Rev.</u>	<u>Issue Date</u>	<u>Revisions</u>	<u>Revised By</u>
V1	01/24/18	Initial Issue	Dan Corona

TABLE OF CONTENTS

1. ATTESTATION OF TEST RESULTS	5
2. TEST METHODOLOGY	6
3. FACILITIES AND ACCREDITATION	6
4. CALIBRATION AND UNCERTAINTY	6
4.1. <i>MEASURING INSTRUMENT CALIBRATION</i>	6
4.2. <i>SAMPLE CALCULATION</i>	6
4.3. <i>MEASUREMENT UNCERTAINTY</i>	7
5. EQUIPMENT UNDER TEST	8
5.1. <i>DESCRIPTION OF EUT</i>	8
5.2. <i>MAXIMUM OUTPUT POWER</i>	8
5.3. <i>DESCRIPTION OF AVAILABLE ANTENNAS</i>	8
5.4. <i>SOFTWARE AND FIRMWARE</i>	8
5.5. <i>WORST-CASE CONFIGURATION AND MODE</i>	9
5.6. <i>DESCRIPTION OF TEST SETUP</i>	10
6. TEST AND MEASUREMENT EQUIPMENT	13
7. MEASUREMENT METHODS	14
8. SUMMARY TABLE	15
9. ANTENNA PORT TEST RESULTS	16
9.1. <i>ON TIME AND DUTY CYCLE</i>	16
9.2. <i>11b 2TX MIMO MODE IN THE 2.4GHz BAND</i>	19
9.2.1. 6 dB BANDWIDTH	19
9.2.2. 99% BANDWIDTH	25
9.2.3. OUTPUT POWER	31
9.2.4. POWER SPECTRAL DENSITY	33
9.2.5. CONDUCTED BANDEDGE AND SPURIOUS EMISSIONS	39
9.3. <i>11g 2TX CDD MIMO MODE IN THE 2.4GHz BAND</i>	49
9.3.1. 6 dB BANDWIDTH	49
9.3.2. 99% BANDWIDTH	55
9.3.3. OUTPUT POWER	61
9.3.4. POWER SPECTRAL DENSITY	63
9.3.5. CONDUCTED BANDEDGE AND SPURIOUS EMISSIONS	69
9.4. <i>11n HT20 2TX CDD MIMO MODE IN THE 2.4GHz BAND</i>	79
9.4.1. 6 dB BANDWIDTH	79
9.4.2. 99% BANDWIDTH	85

9.4.3.	OUTPUT POWER	91
9.4.4.	POWER SPECTRAL DENSITY	93
9.4.5.	CONDUCTED BANDEDGE AND SPURIOUS EMISSIONS	99
10.	RADIATED TEST RESULTS.....	109
10.1.	LIMITS AND PROCEDURE.....	109
10.2.	TRANSMITTER ABOVE 1 GHz.....	110
10.2.1	11b MIMO MODE IN THE 2.4GHz BAND	110
10.2.2	11g MIMO MODE IN THE 2.4GHz BAND	124
10.2.3	11n HT20 MIMO MODE IN THE 2.4GHz BAND	138
10.3	WORST-CASE BELOW 30 MHz.....	152
10.4	WORST-CASE BELOW 1 GHz	153
10.5.	WORST-CASE 18 to 26 GHz	155
11.	AC POWER LINE CONDUCTED EMISSIONS	157
12.	SETUP PHOTOS.....	160

1. ATTESTATION OF TEST RESULTS

COMPANY NAME: SONY MOBILE COMMUNICATIONS, INC.
4-12-3 HIGASHI-SHINAGAWA,
SHINAGAWA -KU, TOKYO, 140-0002, JAPAN

EUT DESCRIPTION: GSM/WCDMA/LTE Phone with BT, DTS/UNII a/b/g/n/ac & NFC

SERIAL NUMBER: RADIATED: BH90006RAY & BH900083AY
CONDUCTED: BH90005MAY & BH9000ALAY

DATE TESTED: December 26, 2017 – January 19, 2018

APPLICABLE STANDARDS	
STANDARD	TEST RESULTS
CFR 47 Part 15 Subpart C	Complies

UL Verification Services Inc. tested the above equipment in accordance with the requirements set forth in the above standards. All indications of Pass/Fail in this report are opinions expressed by UL Verification Services Inc. based on interpretations and/or observations of test results. Measurement Uncertainties were not taken into account and are published for informational purposes only. The test results show that the equipment tested is capable of demonstrating compliance with the requirements as documented in this report.

Note: The results documented in this report apply only to the tested sample, under the conditions and modes of operation as described herein. This document may not be altered or revised in any way unless done so by UL Verification Services Inc. and all revisions are duly noted in the revisions section. Any alteration of this document not carried out by UL Verification Services Inc. will constitute fraud and shall nullify the document. This report must not be used by the client to claim product certification, approval, or endorsement by NVLAP, NIST, any agency of the Federal Government, or any agency of any government.

Approved & Released For
UL Verification Services Inc. By:



DAN CORONIA
OPERATIONS LEADER
UL VERIFICATION SERVICES INC.

Prepared By:



KIYA KEDIDA
PROJECT ENGINEER
UL VERIFICATION SERVICES INC.

2. TEST METHODOLOGY

The tests documented in this report were performed in accordance with FCC CFR 47 Part 2, FCC CFR 47 Part 15, KDB 558074 D01 v04, KDB 662911 D01 v02r01 and ANSI C63.10-2013.

3. FACILITIES AND ACCREDITATION

The test sites and measurement facilities used to collect data are located at 47173 and 47266 Benicia Street, Fremont, California, USA. Line conducted emissions are measured only at the 47173 address. The following table identifies which facilities were utilized for radiated emission measurements documented in this report. Specific facilities are also identified in the test results sections.

47173 Benicia Street	47266 Benicia Street
<input checked="" type="checkbox"/> Chamber A(IC: 2324B-1)	<input checked="" type="checkbox"/> Chamber D(IC: 22541-1)
<input checked="" type="checkbox"/> Chamber B(IC: 2324B-2)	<input checked="" type="checkbox"/> Chamber E(IC: 22541-2)
<input type="checkbox"/> Chamber C(IC: 2324B-3)	<input type="checkbox"/> Chamber F(IC: 22541-3)
	<input type="checkbox"/> Chamber G(IC: 22541-4)
	<input type="checkbox"/> Chamber H(IC: 22541-5)

The above test sites and facilities are covered under FCC Test Firm Registration # 208313. UL Verification Services Inc. is accredited by NVLAP, Laboratory Code 200065-0. Chambers A through C are covered under Industry Canada company address code 2324B with site numbers 2324B -1 through 2324B-3, respectively. Chambers D through H are covered under Industry Canada company address code 22541 with site numbers 22541 -1 through 22541-5, respectively.

4. CALIBRATION AND UNCERTAINTY

4.1. MEASURING INSTRUMENT CALIBRATION

The measuring equipment utilized to perform the tests documented in this report has been calibrated in accordance with the manufacturer's recommendations, and is traceable to recognized national standards.

4.2. SAMPLE CALCULATION

Where relevant, the following sample calculation is provided:

$$\begin{aligned} \text{Field Strength (dBuV/m)} &= \text{Measured Voltage (dBuV)} + \text{Antenna Factor (dB/m)} + \\ &\text{Cable Loss (dB)} - \text{Preamp Gain (dB)} \\ 36.5 \text{ dBuV} + 18.7 \text{ dB/m} + 0.6 \text{ dB} - 26.9 \text{ dB} &= 28.9 \text{ dBuV/m} \end{aligned}$$

4.3. MEASUREMENT UNCERTAINTY

Where relevant, the following measurement uncertainty levels have been estimated for tests performed on the apparatus:

Parameter	Uncertainty
Worst Case Conducted Disturbance, 9KHz to 0.15 MHz	3.84 dB
Worst Case Conducted Disturbance, 0.15 to 30 MHz	3.65 dB
Worst Case Radiated Disturbance, 9KHz to 30 MHz	3.15 dB
Worst Case Radiated Disturbance, 30 to 1000 MHz	5.36 dB
Worst Case Radiated Disturbance, 1000 to 18000 MHz	4.32 dB
Worst Case Radiated Disturbance, 18000 to 26000 MHz	4.45 dB
Worst Case Radiated Disturbance, 26000 to 40000 MHz	5.24 dB

Uncertainty figures are valid to a confidence level of 95%.

5. EQUIPMENT UNDER TEST

5.1. DESCRIPTION OF EUT

The EUT is a GSM/WCDMA/LTE Phone with BT, DTS/UNII a/b/g/n/ac & NFC.

5.2. MAXIMUM OUTPUT POWER

The transmitter has a maximum conducted output power as follows:

Frequency Range (MHz)	Mode	Output Power (dBm)	Output Power (mW)
2412 - 2472	802.11b 2TX	15.73	37.41
2412 - 2472	802.11g 2TX	15.35	34.28
2412 - 2472	802.11n HT20 2TX CDD	15.55	35.89

5.3. DESCRIPTION OF AVAILABLE ANTENNAS

The radio utilizes a loop antenna for chain 0 and a monopole antenna for chain 1, with the maximum gains:

Frequency Band (GHz)	Antenna Gain (dBi)	
	Chain 0	Chain 1
2.4	-1.90	-8.80

5.4. SOFTWARE AND FIRMWARE

The firmware installed in the EUT during testing was SONY, s_atp_1_00139_B_10_5.
 The test utility software used during testing was Tera Term Ver 4.79.

5.5. WORST-CASE CONFIGURATION AND MODE

Radiated bandedge, harmonics, and spurious emissions from 1 GHz to 18GHz were performed. The EUT was set to transmit at the Low/Middle/High channels.

Radiated emission below 1GHz, above 18GHz, and power line conducted emission were performed with the EUT was set to transmit at the channel with highest output power as worst-case scenario.

The fundamental of the EUT was investigated in three orthogonal orientations X, Y, & Z, using the following two configurations, AC/DC Adapter and headphone. It was determined that X-Axis with only AC/DC Adapter was worst-case orientation; therefore, all final radiated testing was performed with the EUT in X-Axis with AC/DC Adapter orientation.

Worst-case data rates as provided by the client were:

802.11b mode: 1 Mbps
802.11g mode: 6 Mbps
802.11n HT20mode: MCS0

The simultaneous mode (SISO 2.4GHz Chain 0 and 5GHz chain 1) was checked and stand-alone (MIMO) 2.4 GHz / 5GHz remain worst case.

NOTE: SISO mode is covered by MIMO mode due to same maximum tune-up limit (power).

5.6. DESCRIPTION OF TEST SETUP

SUPPORT EQUIPMENT

Support Equipment List				
Description	Manufacturer	Model	Serial Number	FCC ID
Laptop	Lenovo	20B7S0A200	PC015REW	NA
AC Adapter	SONY	1309-8864.1	VB17W46601037	NA
DC Power Supply	Ametek	XT 15-4	T463	NA

I/O CABLES (CONDUCTED TEST)

I/O Cable List						
Cable No	Port	# of identical ports	Connector Type	Cable Type	Cable Length (m)	Remarks
1	Antenna	1	RF	Shielded	0.2	To Spectrum Analyzer
2	USB	1	USB	Shielded	1	N/A
3	DC	1	DC	Shielded	0.3	N/A

I/O CABLES (RADIATED AND CONDUCTED EMISSIONS)

I/O Cable List						
Cable No	Port	# of identical ports	Connector Type	Cable Type	Cable Length (m)	Remarks
1	USB	1	USB	Shielded	3	N/A

TEST SETUP

CONDUCTED TEST SETUP DIAGRAM

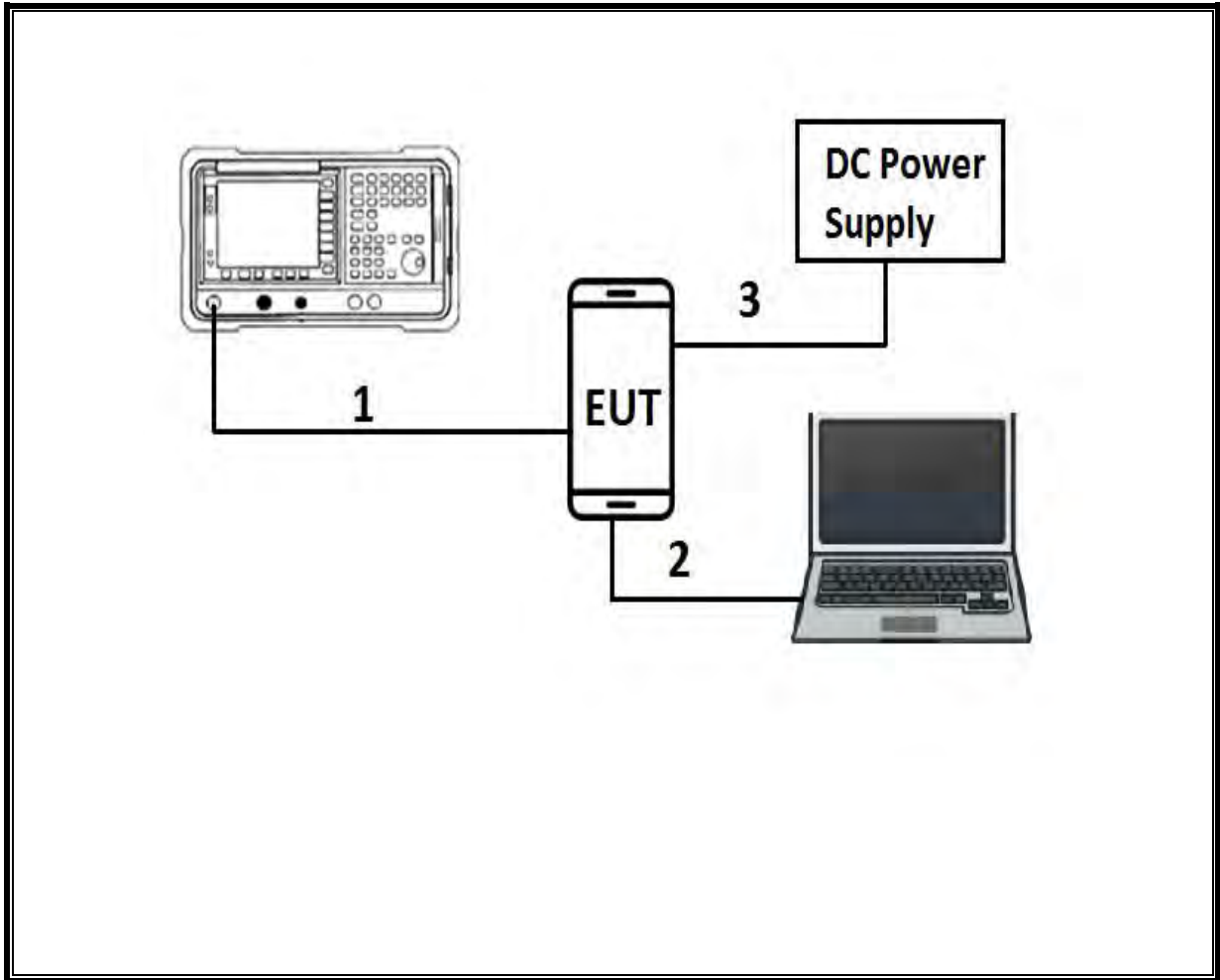

TEST SETUP

RADIATED AND AC LINE CONDUCTED EMISSIONS SETUP DIAGRAM

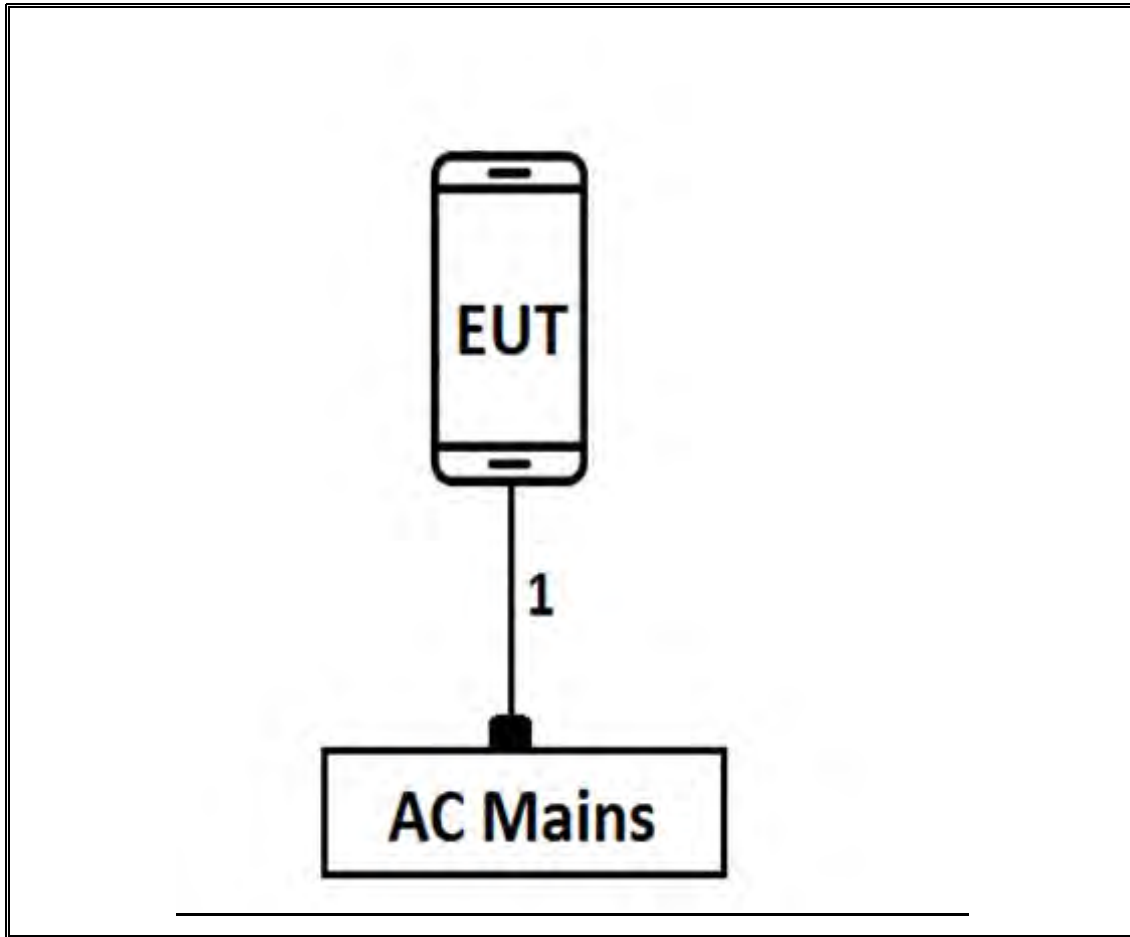

6. TEST AND MEASUREMENT EQUIPMENT

The following test and measurement equipment was utilized for the tests documented in this report:

TEST EQUIPMENT LIST				
Description	Manufacturer	Model	Asset	Cal Due
Antenna, Broadband Hybrid, 30MHz to 2000MHz w/4dB Pad	Sunol Sciences Corp.	JB3	T899	06/15/2018
Antenna, Active Loop 9kHz-30MHz	Com-Power Corp.	AL-130R	T1866	10/10/2018
Antenna, Horn 1-18GHz	ETS-Lindgren	3117	T863	06/09/2018
Antenna, Horn 1-18GHz	ETS-Lindgren	3117	T711	01/30/2018
Antenna, Horn 18-26.5GHz	ARA	MWH-1826	T449	06/12/2018
Power Meter, P-series single channel	Agilent (Keysight) Technologies	N1911A	T1268	06/15/2018
Power Sensor, P – series, 50MHz to 18GHz, Wideband	Agilent (Keysight) Technologies	N1921A	T1223	03/29/2018
Amplifier, 1 - 18GHz	MITEQ	AFS42-00101800-25-S-42	T742	11/29/2018
Amplifier, 1 - 18GHz	MITEQ	AFS42-00101800-25-S-42	T1131	06/29/2018
Pre Amplifier, 1-26.5GHz	Agilent	8449B	T404	7/23/2018
Amplifier, 10kHz-1GHz	Agilent (Keysight) Technologies	8447D	T10	02/15/2018
Amplifier, 1-8GHz	MITEQ	AMF-4D-01000800-30-29P	T1169	06/29/2018
Filter, HPF 3.0GHz	MICRO-TRONICS	HPM17543	T428	11/29/2018
Filter, HPF 3.0GHz	MICRO-TRONICS	HPM17543	T426	06/29/2018
Spectrum Analyzer, PXA, 3Hz to 44GHz	Agilent (Keysight) Technologies	N9030A	T1210	07/17/2018
Spectrum Analyzer, PXA, 3Hz to 44GHz	Agilent (Keysight) Technologies	N9030A	T341	11/12/2018
Spectrum Analyzer, PXA, 3Hz to 44GHz	Agilent (Keysight) Technologies	N9030A	T1113	12/21/2018
Spectrum Analyzer, PXA, 3Hz to 44GHz	Agilent (Keysight) Technologies	N9030A	T907	01/23/2018
Test Receiver, EMI, 10Hz-7GHz	Rhode&Schwarz	ESR	T1436	01/06/2018
LISN	FISCHER	FCC-LISN-50/250-25-2-01	T1310	01/17/2018

Test Software List			
Description	Manufacturer	Model	Version
Radiated Software	UL	UL EMC	Ver 9.5, Dec 01, 2016
Conducted Software	UL	UL EMC	Ver 9.5, May 26, 2015
Antenna Port Software	UL	UL RF	Ver 7.7, Dec 14, 2017

NOTE: *testing is completed before equipment calibration expiration date.

7. MEASUREMENT METHODS

On Time and Duty Cycle: KDB 558074 D01 v04, Section 6.

6 dB BW: KDB 558074 D01 v04, Section 8.1.

99% BW: ANSI C63.10-2013, Section 6.9.3.

Output Power: KDB 558074 D01 v04, Section 9.2.3.2.

Power Spectral Density: KDB 558074 D01 v04, Section 10.3.

Out-of-band emissions in non-restricted bands: KDB 558074 D01 v04, Section 11.1 (b).

Out-of-band emissions in restricted bands: KDB 558074 D01 v04, Section 12.1.

Band-edge: KDB 558074 D01 v04, Section 12.1.

AC Power Line Conducted Emissions: ANSI C63.10-2013, Section 6.2.

8. SUMMARY TABLE

FCC Part Section	Test Description	Test Limit	Test Condition	Test Result
15.247 (a)(2)	Occupied Band width (6dB)	>500KHz	Conducted	Pass
2.1051, 15.247 (d)	Band Edge / Conducted Spurious Emission	-30dBc		Pass
15.247 (b) (3)	TX conducted output power	<30dBm		Pass
15.247 (e)	PSD	<8dBm		Pass
15.207 (a)	AC Power Line conducted emissions	Section 10	Radiated	Pass
15.205, 15.209, 15.247(d)	Radiated Spurious Emission	< 54dBuV/m		Pass

9. ANTENNA PORT TEST RESULTS

9.1. ON TIME AND DUTY CYCLE

LIMITS

None; for reporting purposes only.

PROCEDURE

KDB 558074 Zero-Span Spectrum Analyzer Method.

ON TIME AND DUTY CYCLE RESULTS

Mode	ON Time (msec)	Period (msec)	Duty Cycle x (linear)	Duty Cycle (%)	Duty Cycle Correction Factor (dB)	1/T Minimum VBW (kHz)
802.11b	12.220	12.340	0.99	99.03%	0.00	0.01
802.11g	2.030	2.065	0.98	98.31%	0.00	0.01
802.11n HT20 CDD	2.510	2.585	0.97	97.10%	0.13	0.40

Note: Chain 1 was tested to represent the worst chain.

DUTY CYCLE PLOTS

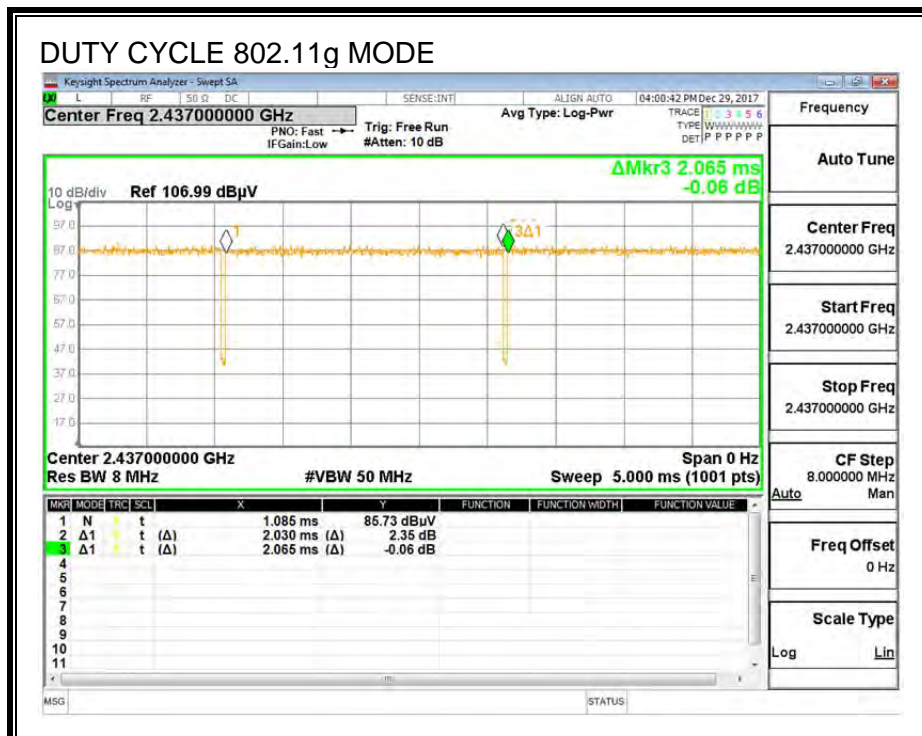
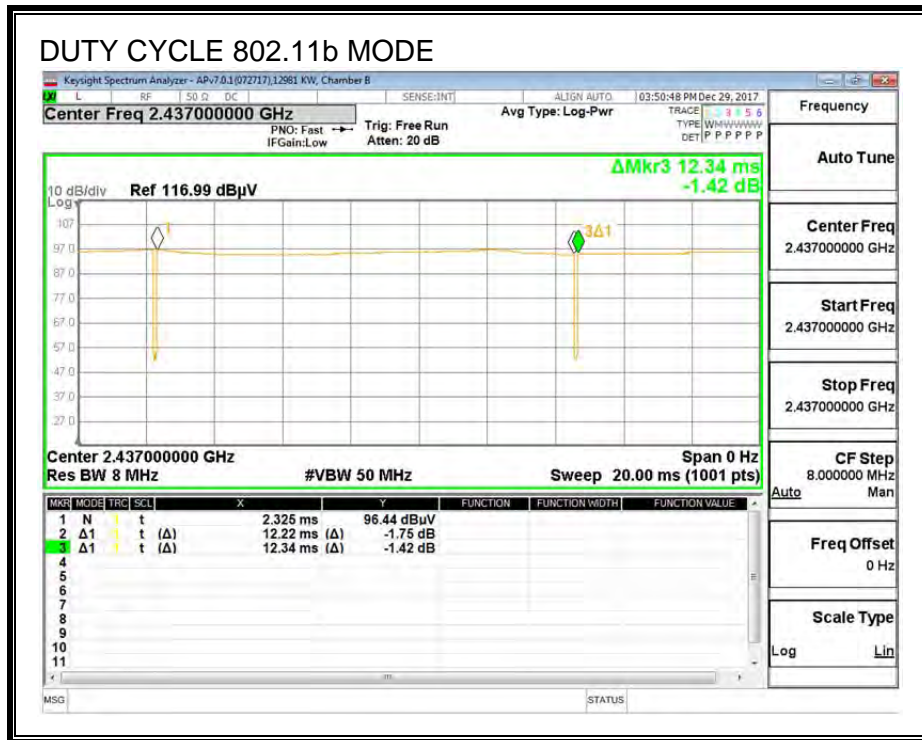

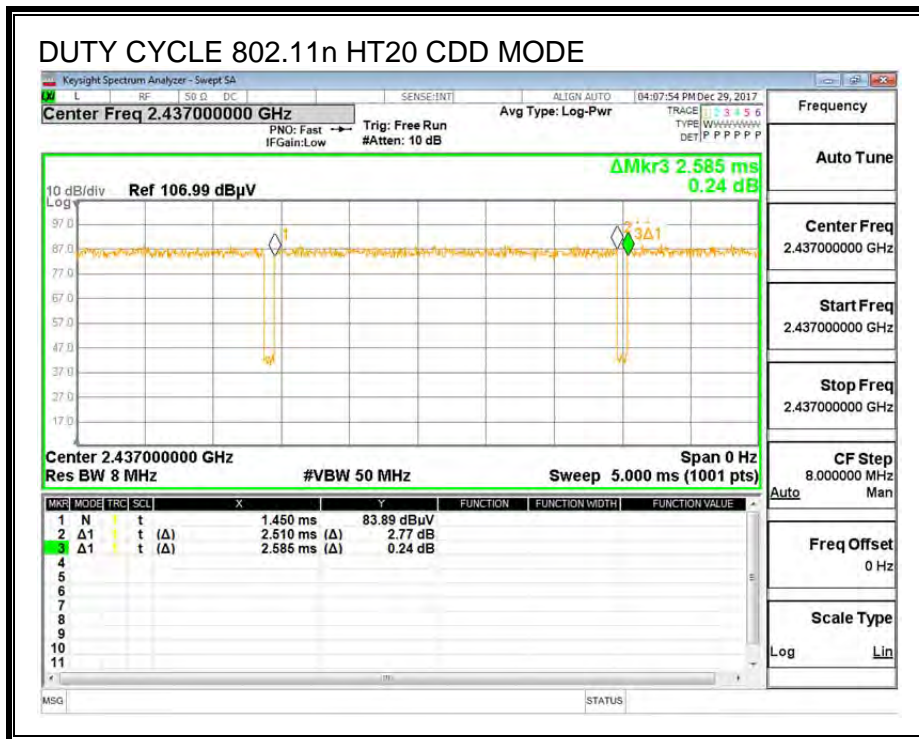

9.2. 11b 2TX MIMO MODE IN THE 2.4GHz BAND

9.2.1. 6 dB BANDWIDTH

LIMITS

FCC §15.247 (a) (2)

The minimum 6 dB bandwidth shall be at least 500 kHz.

RESULTS

Channel	Frequency (MHz)	6 dB BW Chain 0 (MHz)	6 dB BW Chain 1 (MHz)	Minimum Limit (MHz)
CH1	2412	9.08	9.04	0.5
CH6	2437	8.28	8.68	0.5
CH11	2462	9.08	9.08	0.5
CH12	2467	8.08	8.56	0.5
CH13	2472	8.12	9.08	0.5

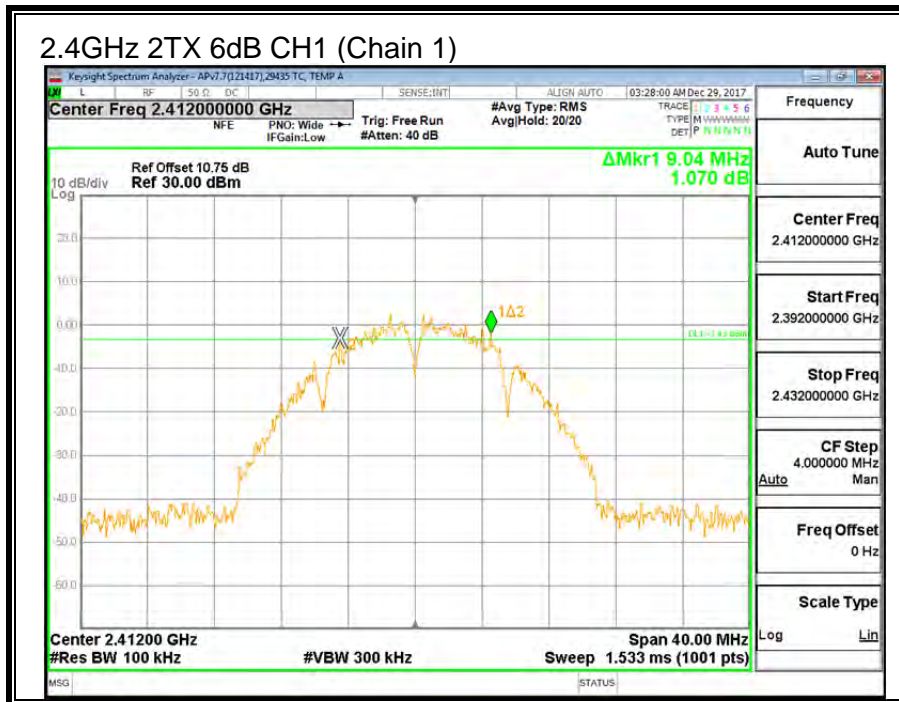
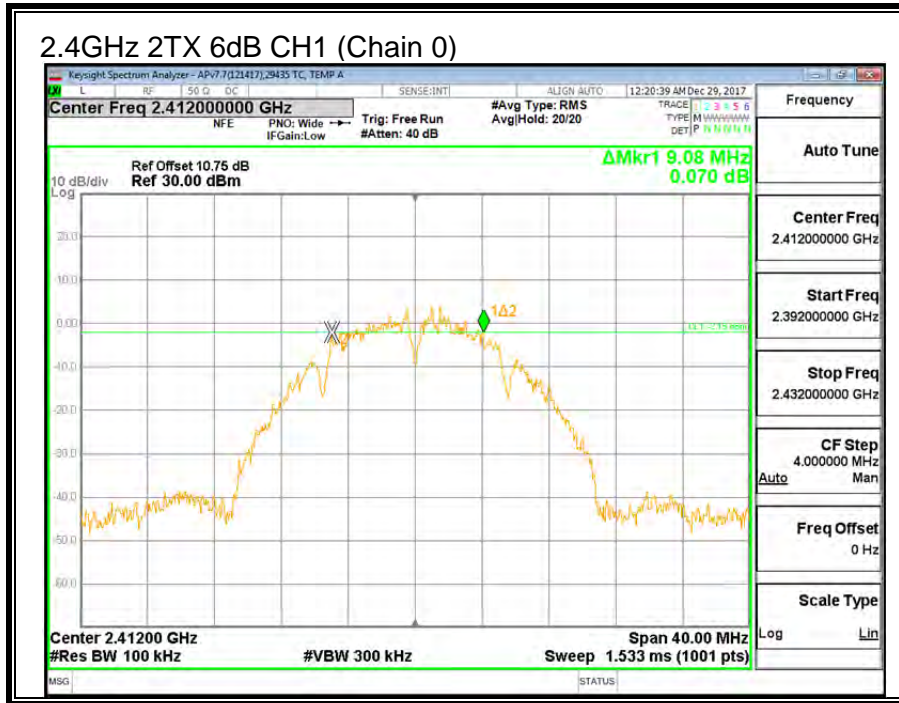

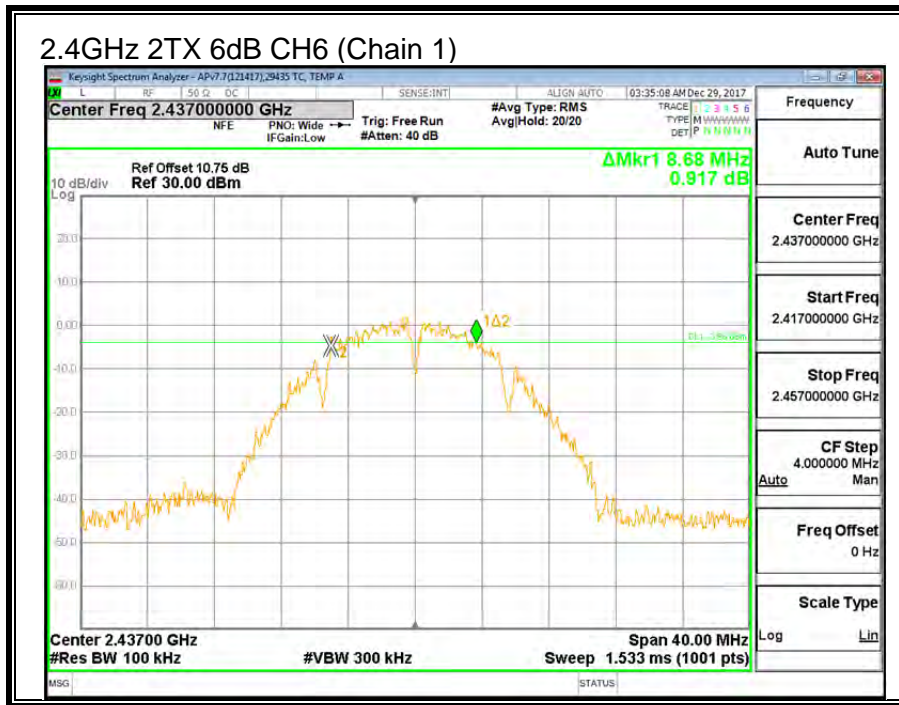
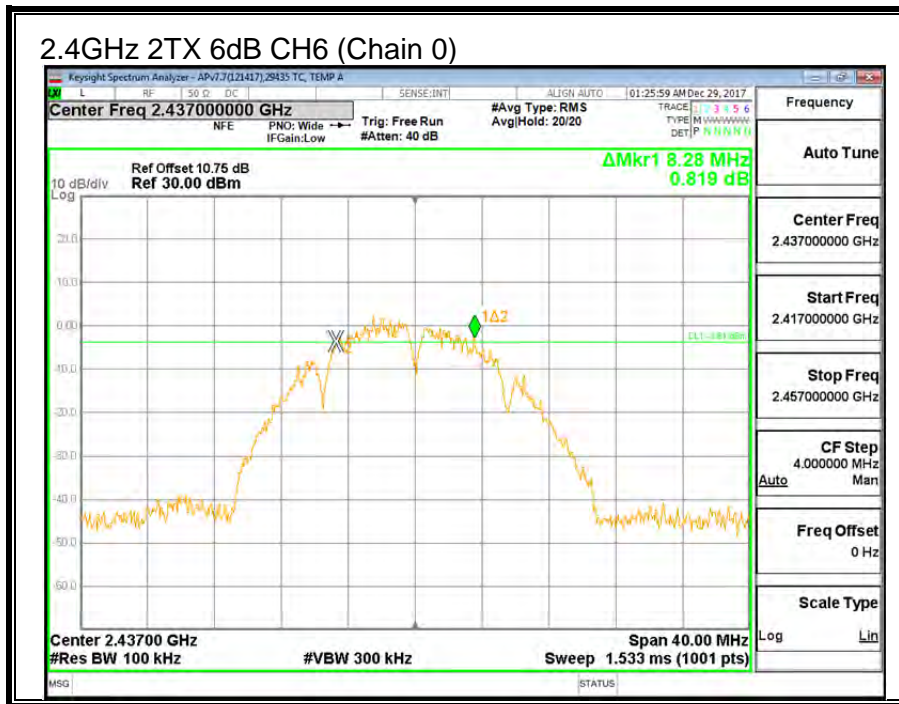

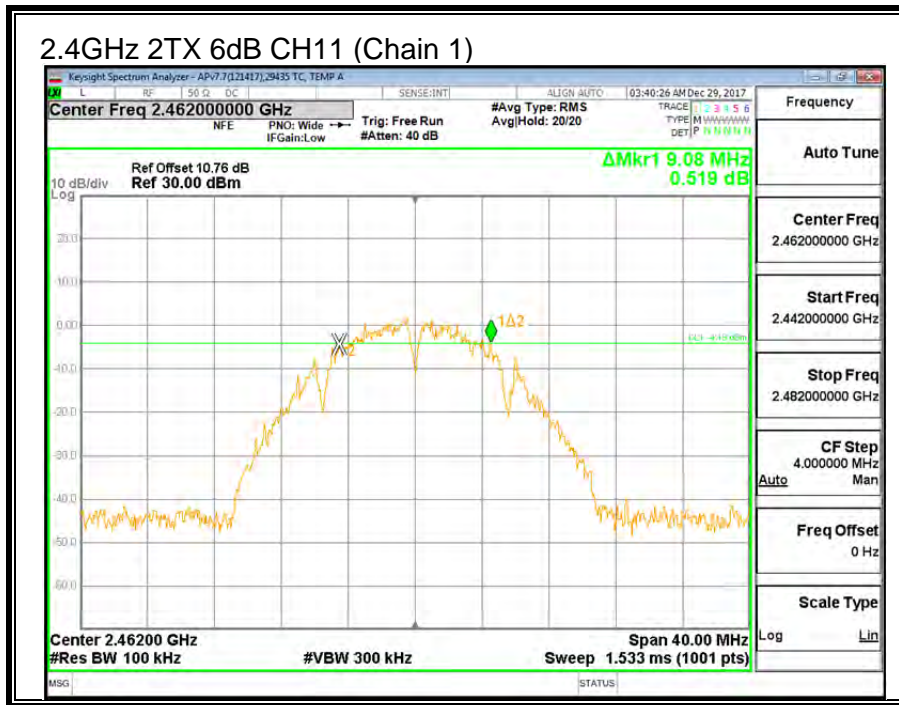
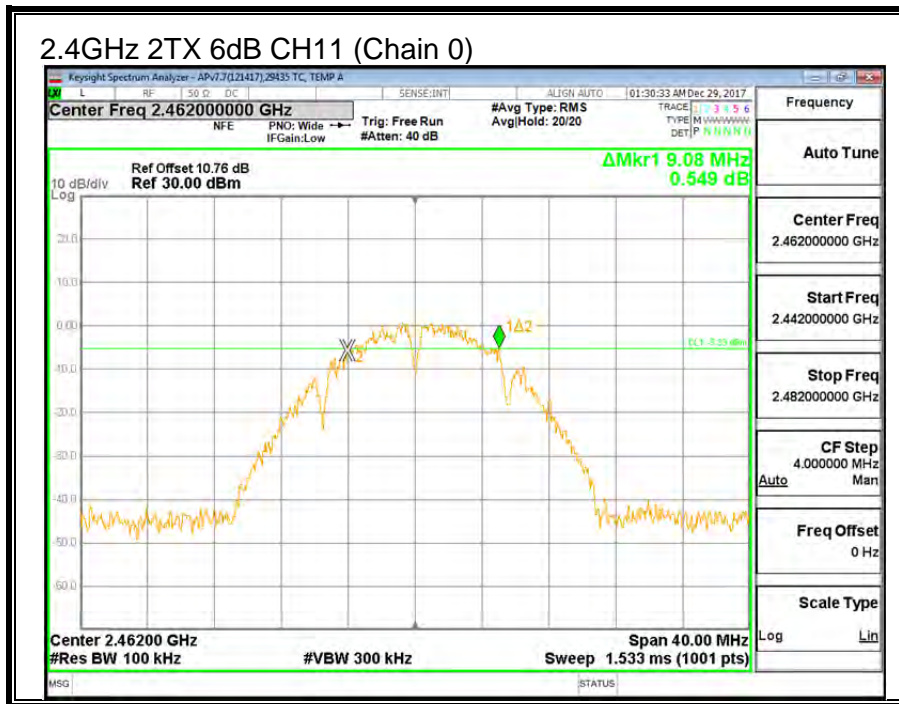

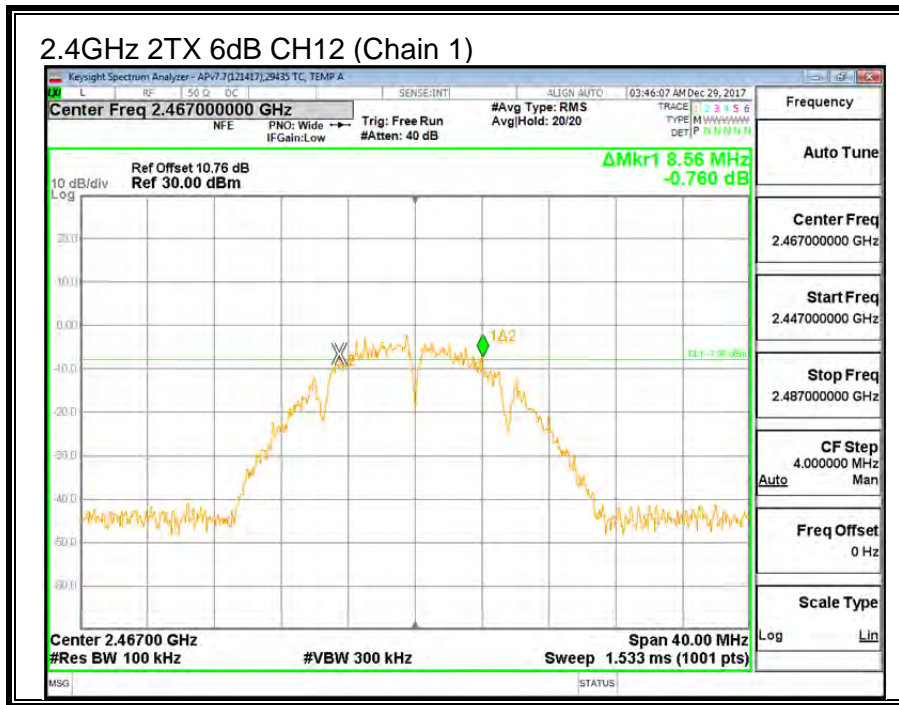
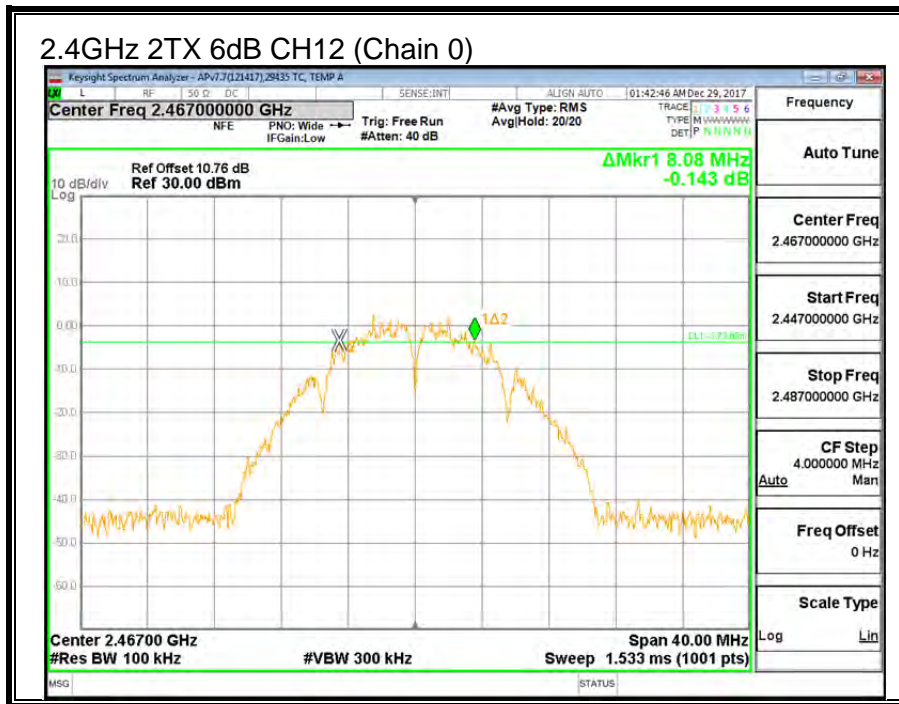

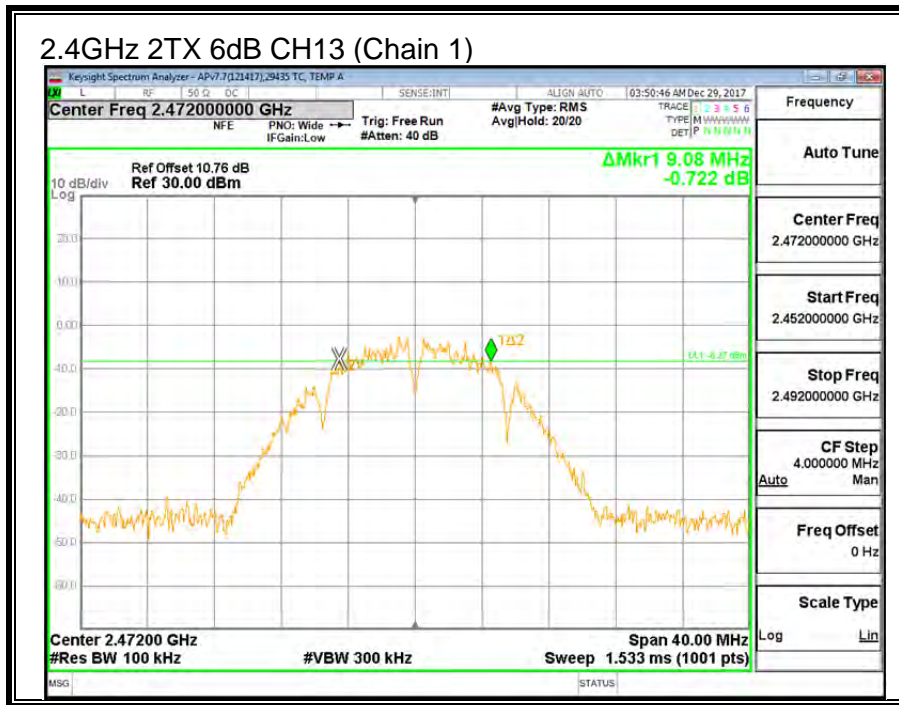
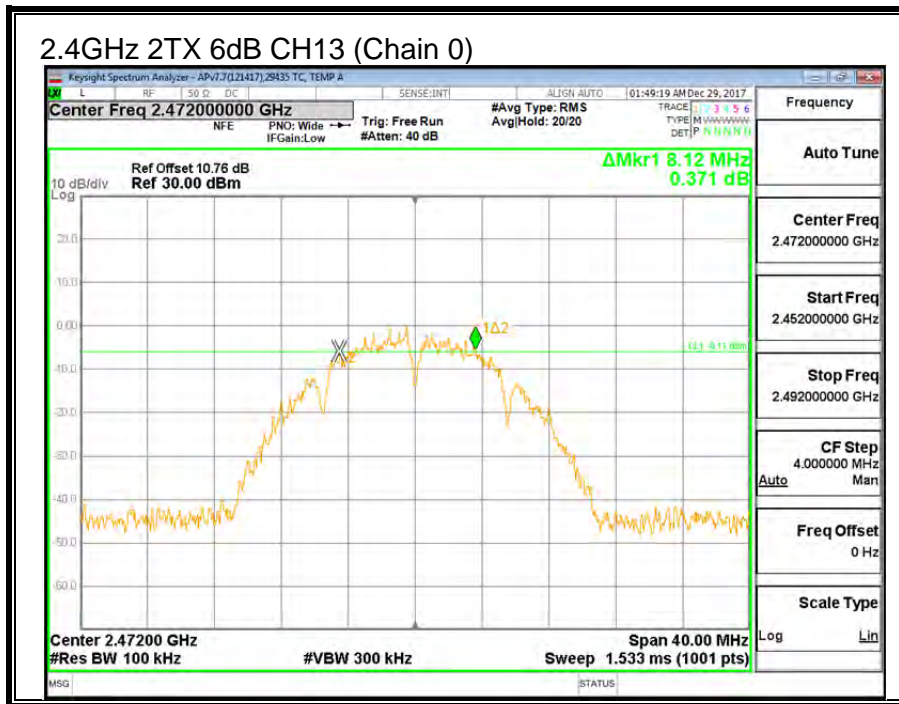

9.2.2. 99% BANDWIDTH

LIMITS

None; for reporting purposes only.

RESULTS

Channel	Frequency (MHz)	99% Bandwidth Chain 0 (MHz)	99% Bandwidth Chain 1 (MHz)
CH1	2412	14.542	14.049
CH6	2437	13.983	14.349
CH11	2462	13.547	13.958
CH12	2467	13.681	14.188
CH13	2472	14.091	13.999

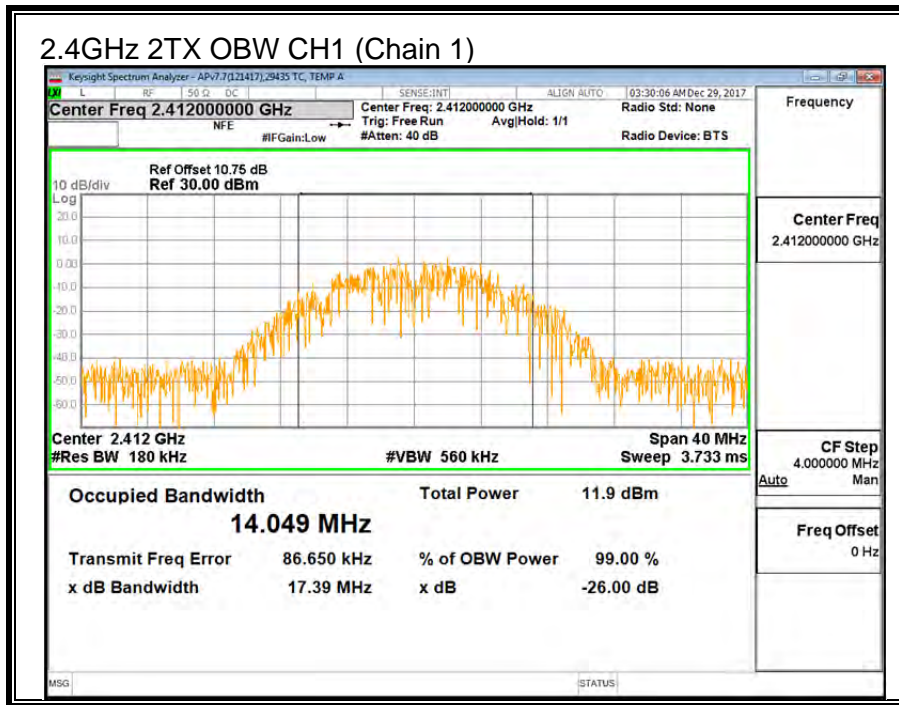
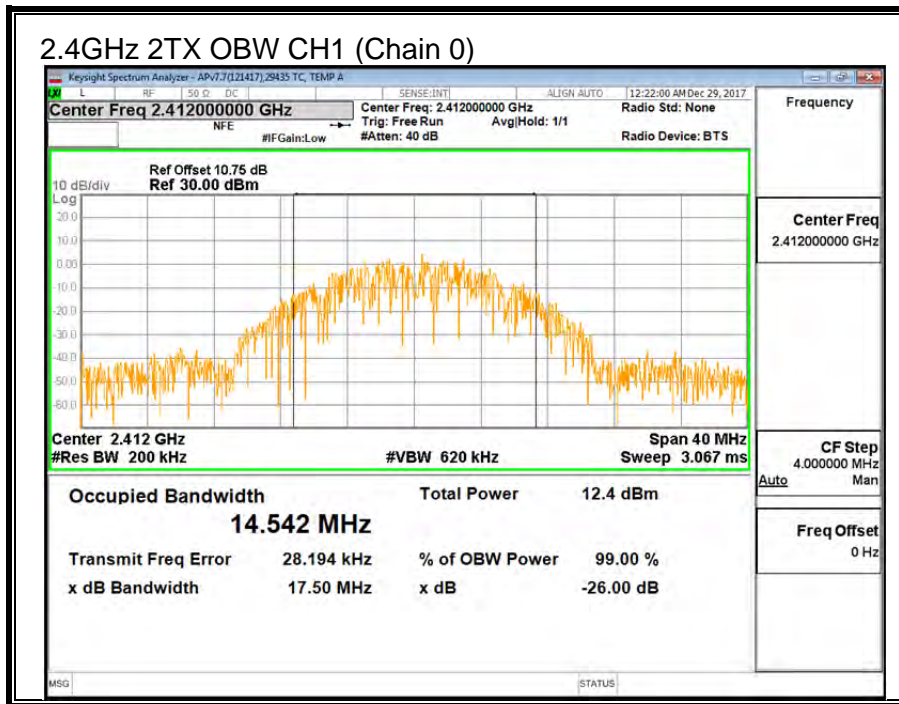

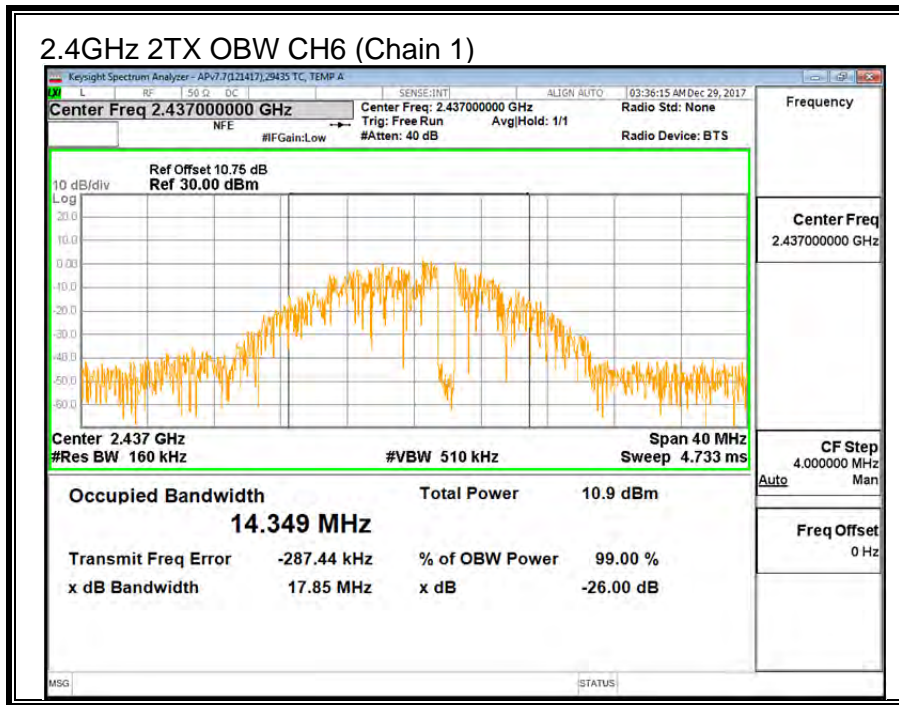
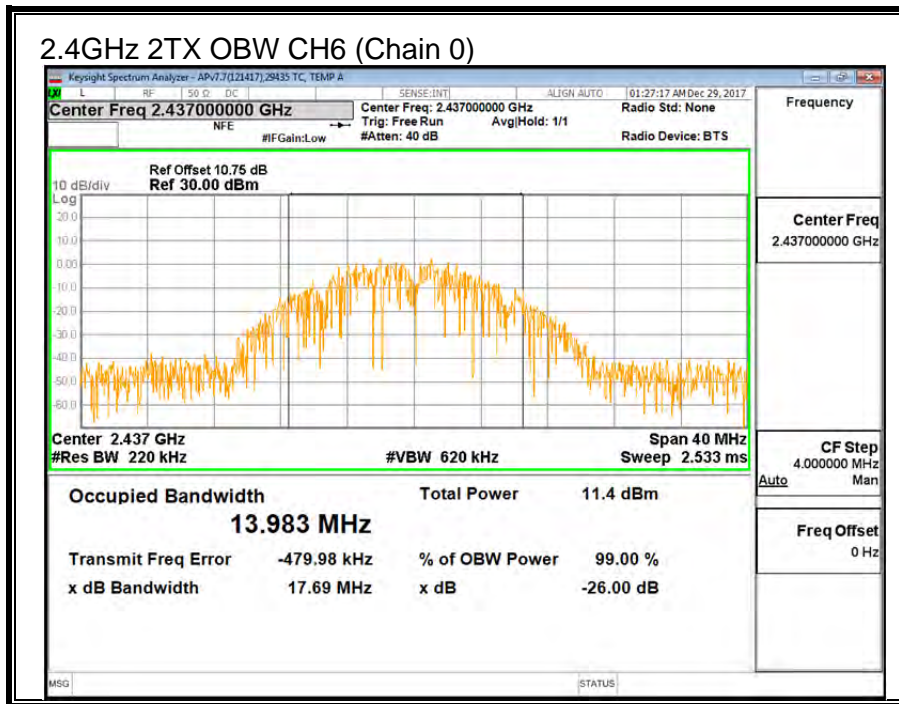

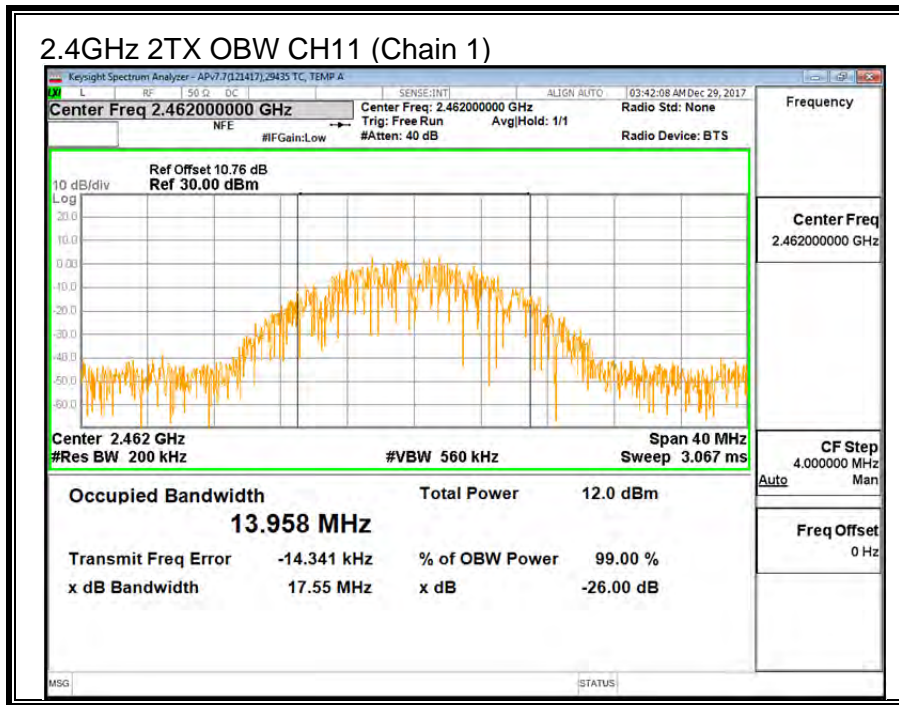
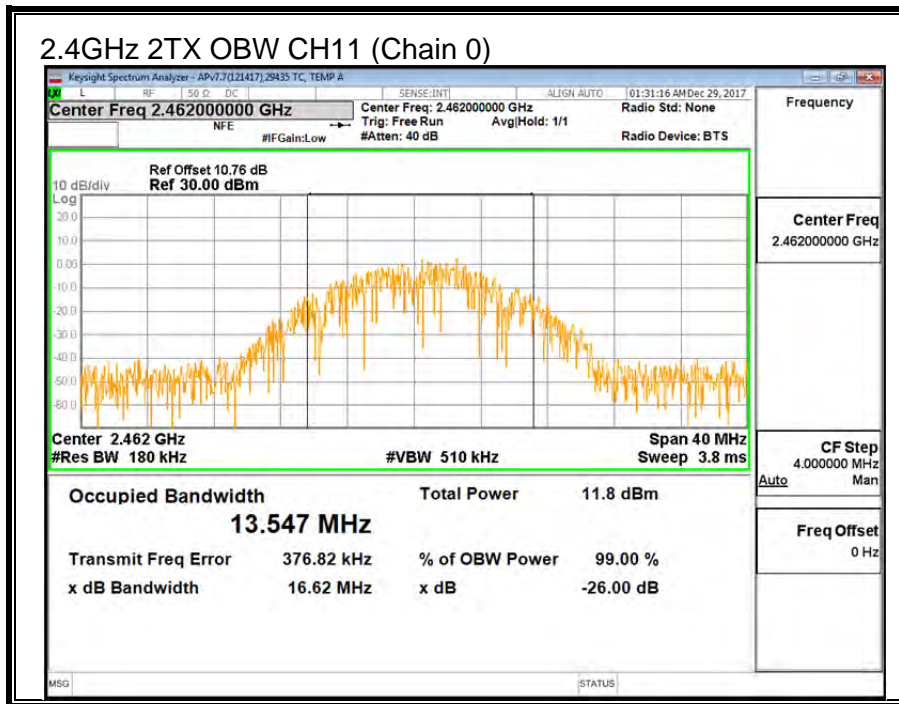

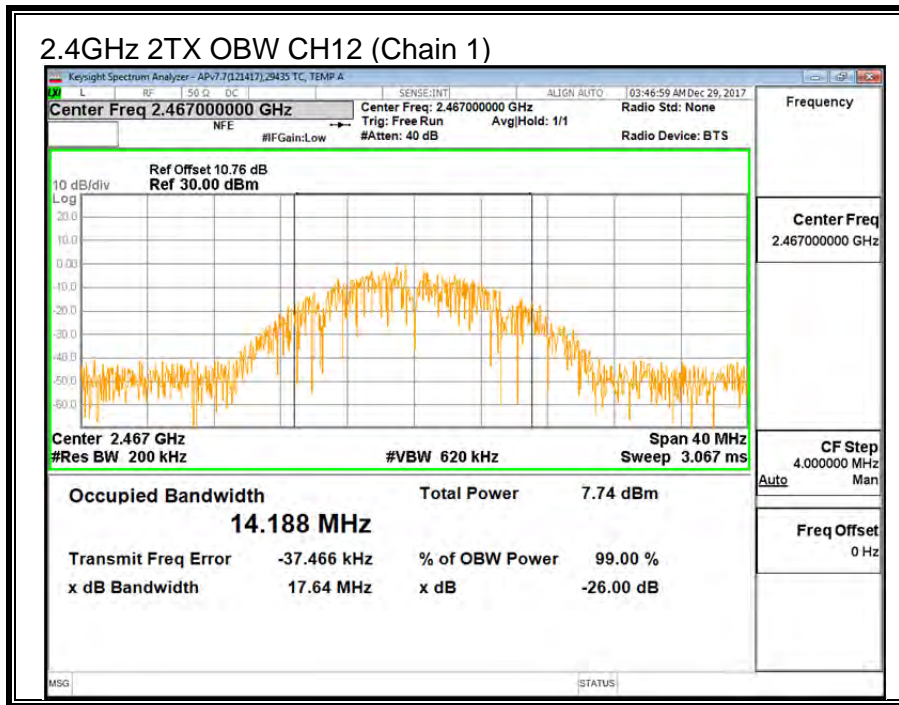
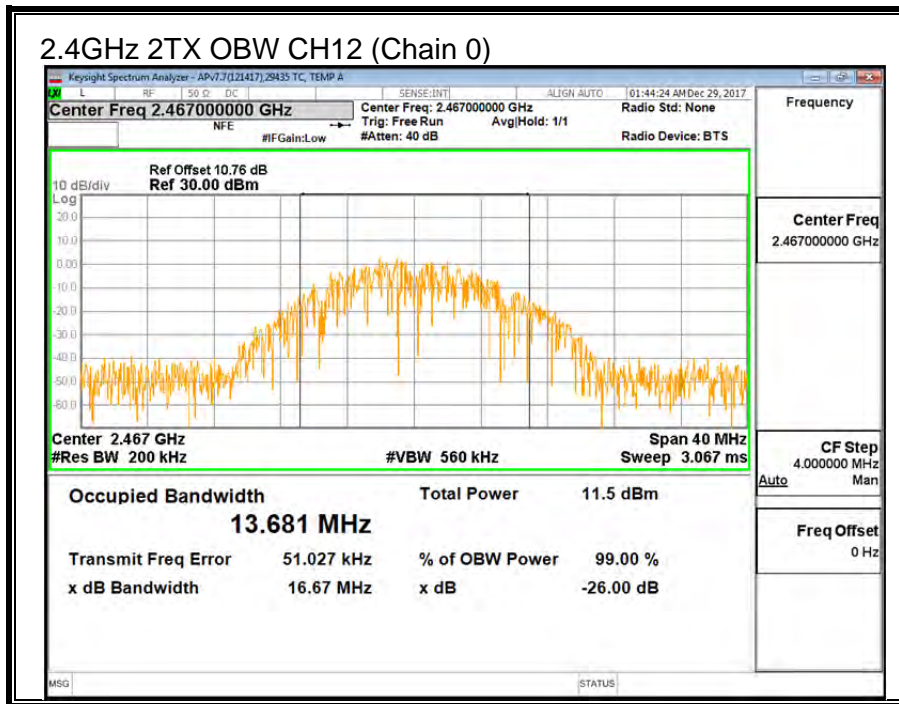

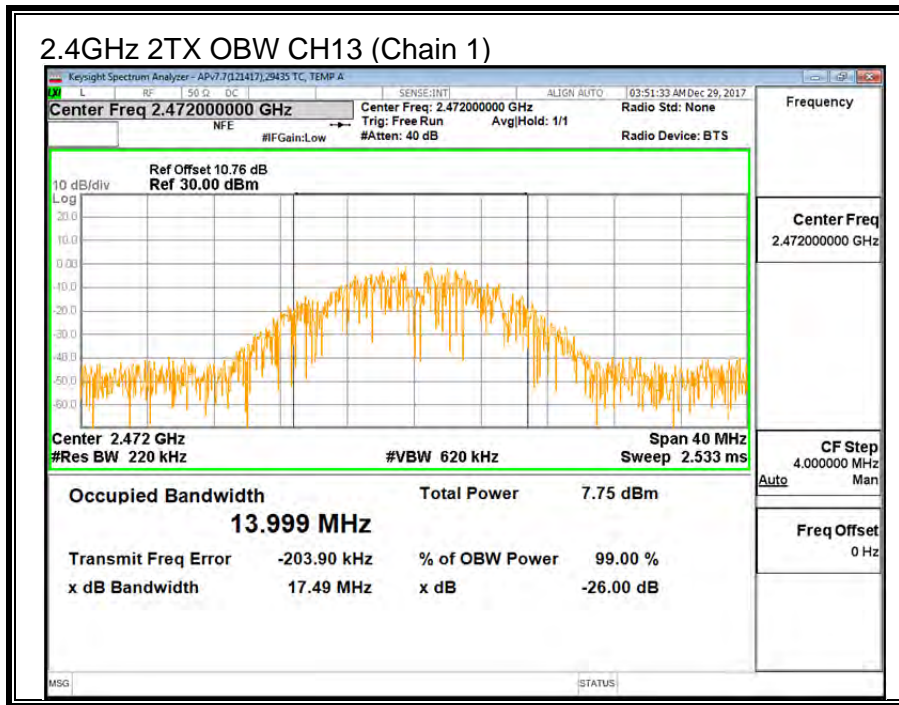
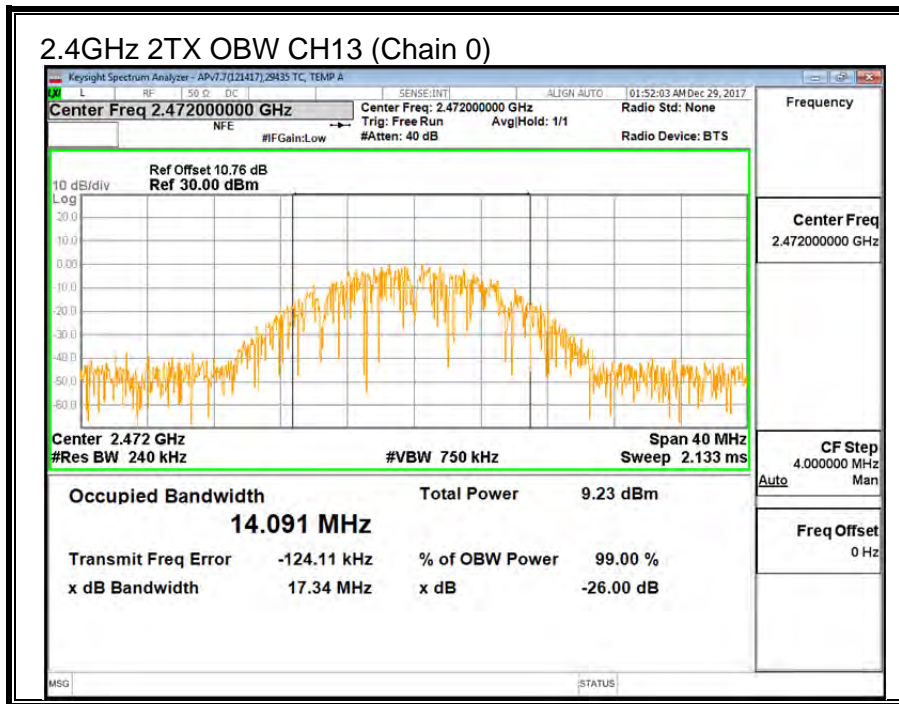

9.2.3. OUTPUT POWER

LIMITS

FCC §15.247 (b) (3)
IC RSS-247 (5.4) (4)

For systems using digital modulation in the 2400–2483.5 MHz, and 5725–5850 MHz bands: 1 Watt, based on the use of antennas with directional gains that do not exceed 6 dBi. If transmitting antennas of directional gain greater than 6 dBi are used, the conducted output power from the intentional radiator shall be reduced by the amount in dB that the directional gain of the antenna exceeds 6 dBi.

TEST PROCEDURE

KDB 58074 D01 v04 Section 9.2.3.2

DIRECTIONAL ANTENNA GAIN

The TX chains are uncorrelated and the antenna gain is unequal among the chains. The directional gain is:

Chain 0 Antenna Gain (dBi)	Chain 1 Antenna Gain (dBi)	Uncorrelated Chains Directional Gain (dBi)
-1.90	-8.80	-4.10

RESULTS

ID:	GE43578	Date:	1/7/17
------------	---------	--------------	--------

Limits

Channel	Frequency (MHz)	Directional Gain (dBi)	FCC Power Limit (dBm)	IC Power Limit (dBm)	IC EIRP Limit (dBm)	Max Power (dBm)
CH1	2412	-4.10	30.00	30	36	30.00
CH6	2437	-4.10	30.00	30	36	30.00
CH11	2462	-4.10	30.00	30	36	30.00
CH12	2467	-4.10	30.00	30	36	30.00
CH13	2472	-4.10	30.00	30	36	30.00

Results

Channel	Frequency (MHz)	Chain 0 Meas Power (dBm)	Chain 1 Meas Power (dBm)	Total Corr'd Power (dBm)	Power Limit (dBm)	Margin (dB)
CH1	2412	12.47	12.71	15.60	30.00	-14.40
CH6	2437	12.53	12.90	15.73	30.00	-14.27
CH11	2462	12.10	12.84	15.50	30.00	-14.50
CH12	2467	12.15	12.81	15.50	30.00	-14.50
CH13	2472	9.88	12.88	14.64	30.00	-15.36

Note: the power readings above were measured with gated method, and the measurement was taken only during the ON time. No duty cycle correction was necessary.

9.2.4. POWER SPECTRAL DENSITY

LIMITS

FCC §15.247 (e)

For digitally modulated systems, the power spectral density conducted from the intentional radiator to the antenna shall not be greater than 8 dBm in any 3 KHz band during any time interval of continuous transmissions.

RESULTS

Duty Cycle CF (dB)	0.00	Included in Calculations of Corr'd PSD
---------------------------	------	---

PSD Results

Channel	Frequency (MHz)	Chain 0 Meas (dBm)	Chain 1 Meas (dBm)	Total Corr'd PSD (dBm)	Limit (dBm)	Margin (dB)
CH1	2412	-8.94	-9.92	-6.39	8.0	-14.4
CH6	2437	-10.67	-9.85	-7.23	8.0	-15.2
CH11	2462	-10.03	-9.61	-6.80	8.0	-14.8
CH12	2467	-10.06	-9.24	-6.62	8.0	-14.6
CH13	2472	-12.96	-9.55	-7.92	8.0	-15.9

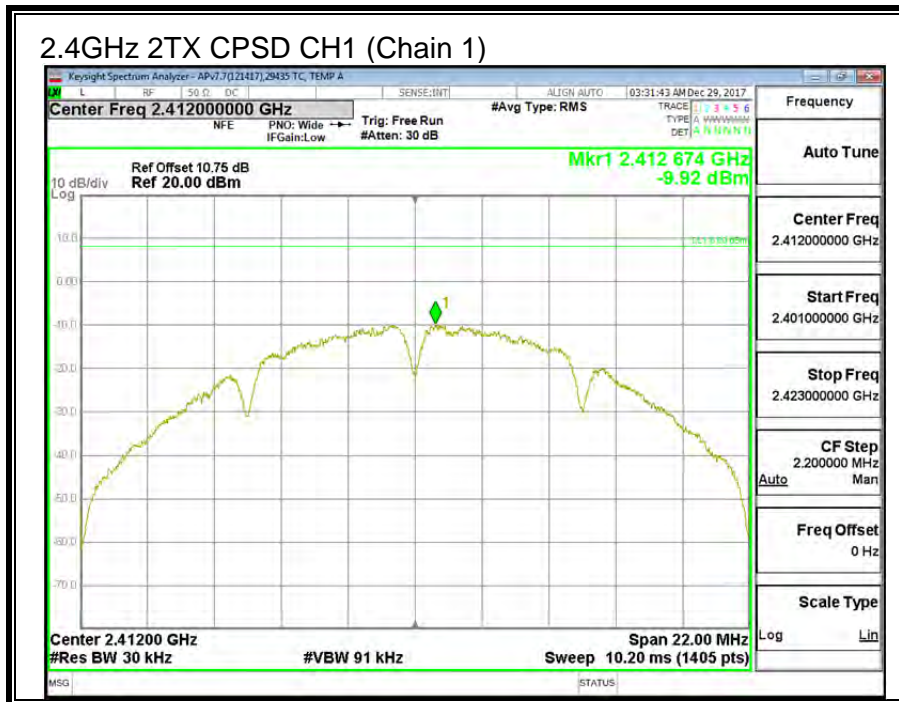
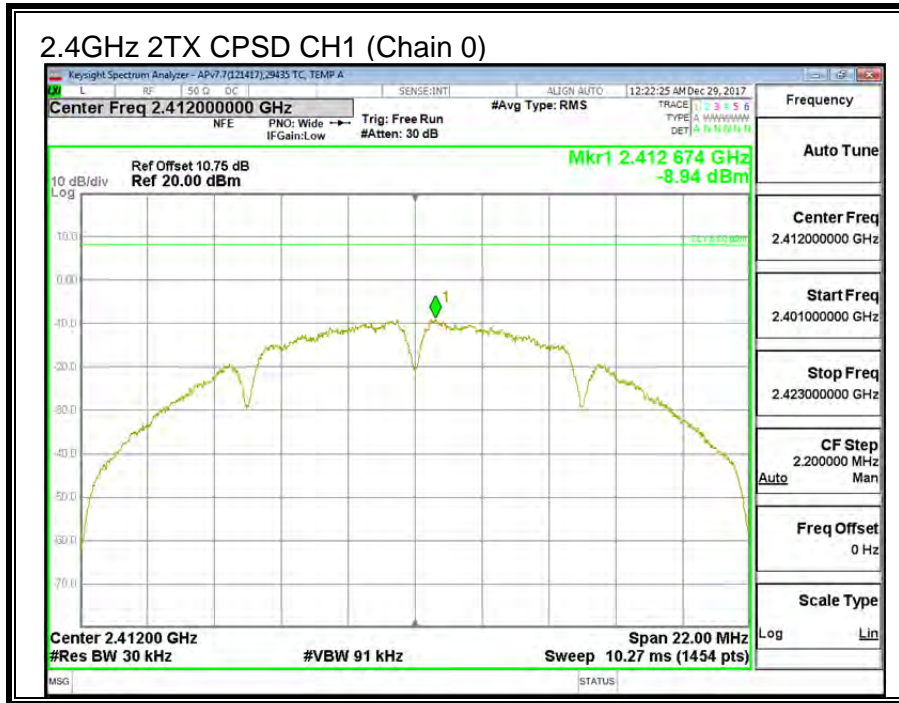

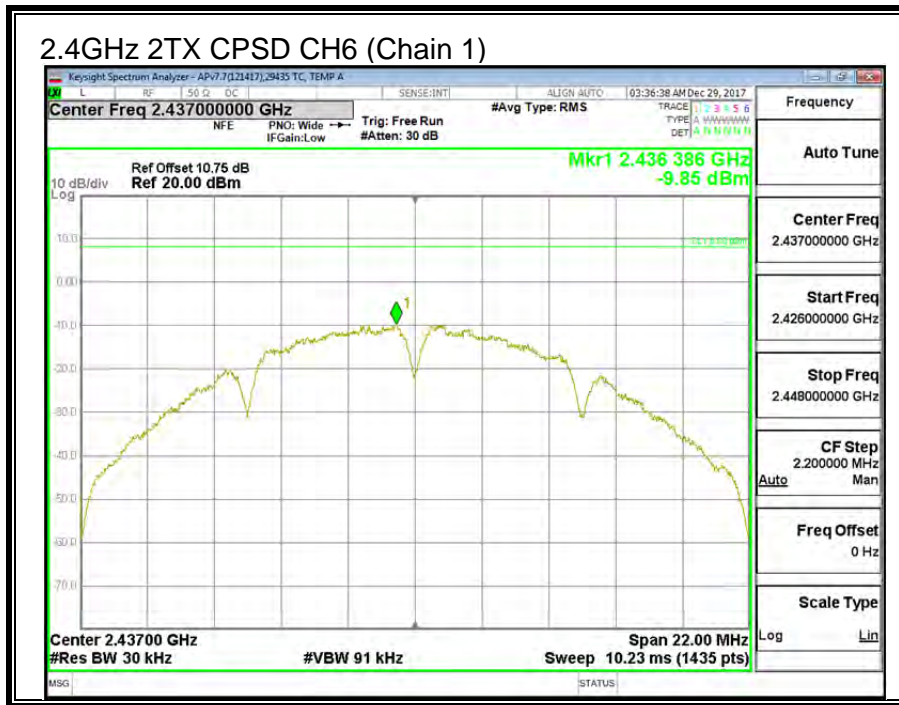
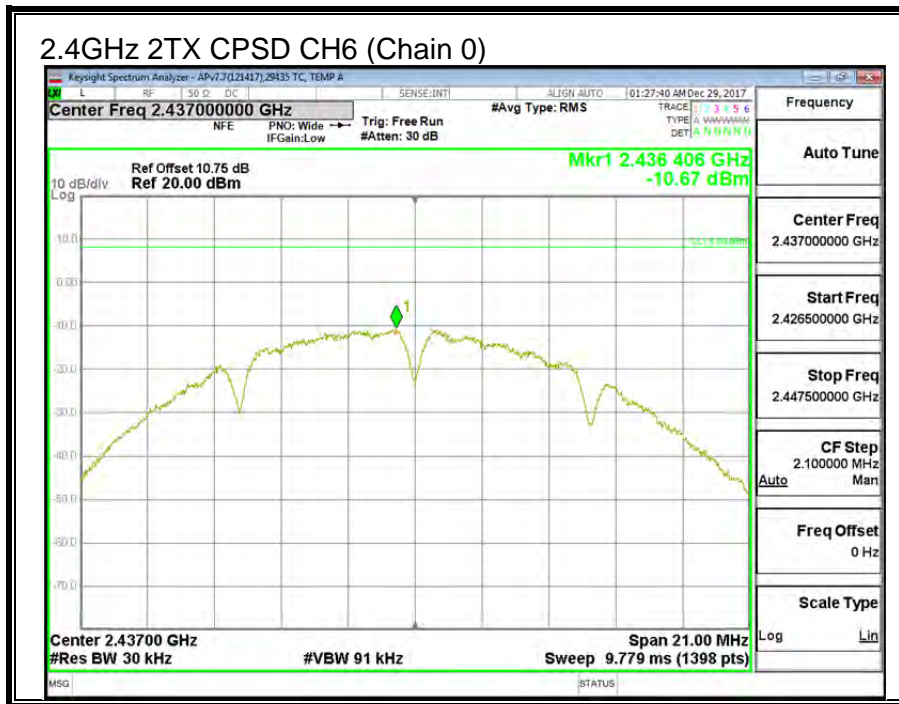

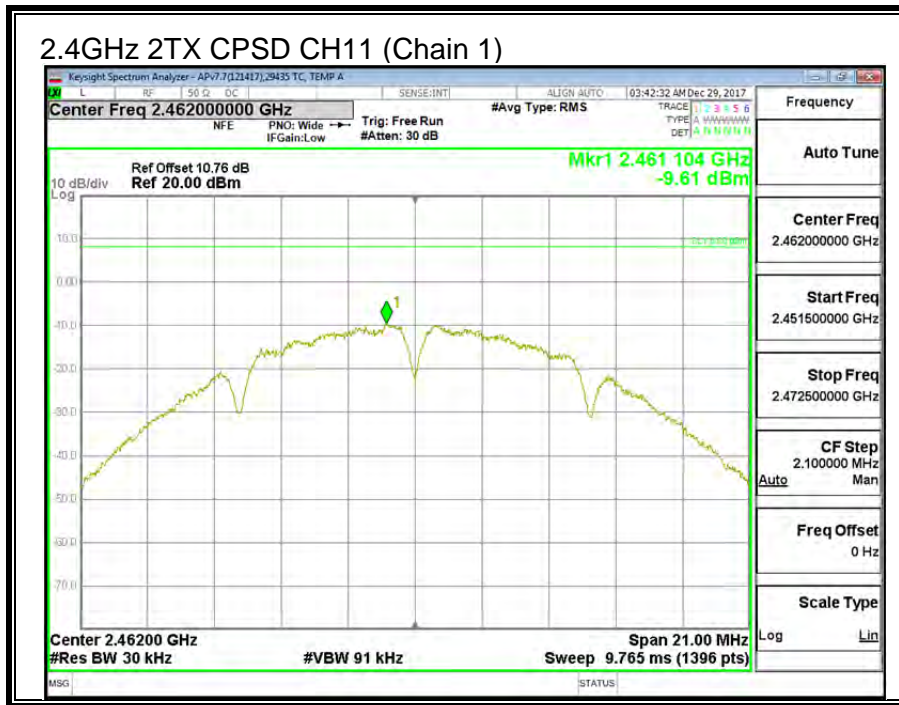
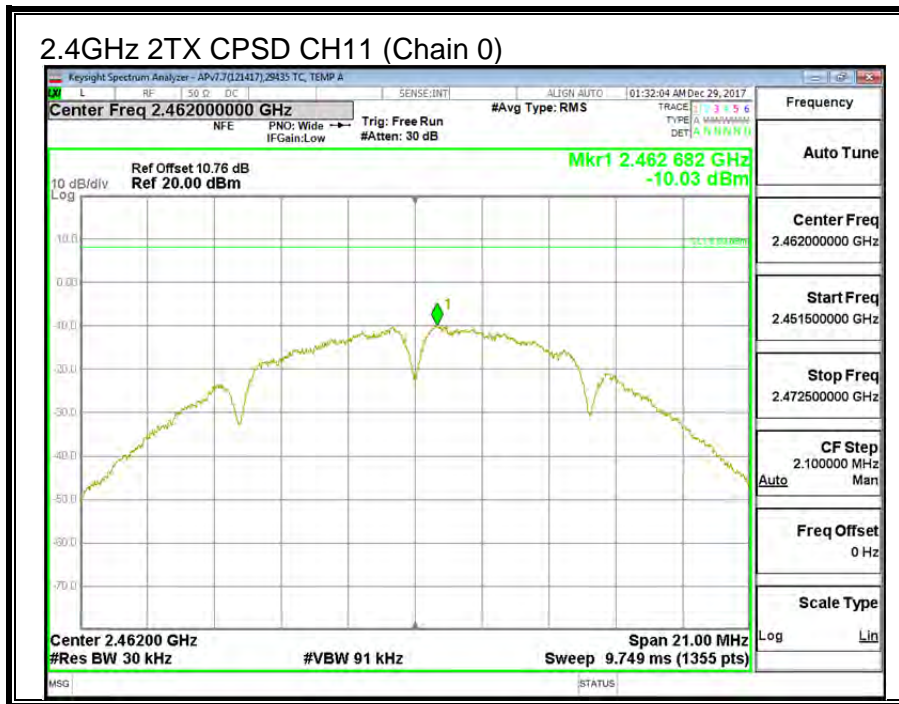

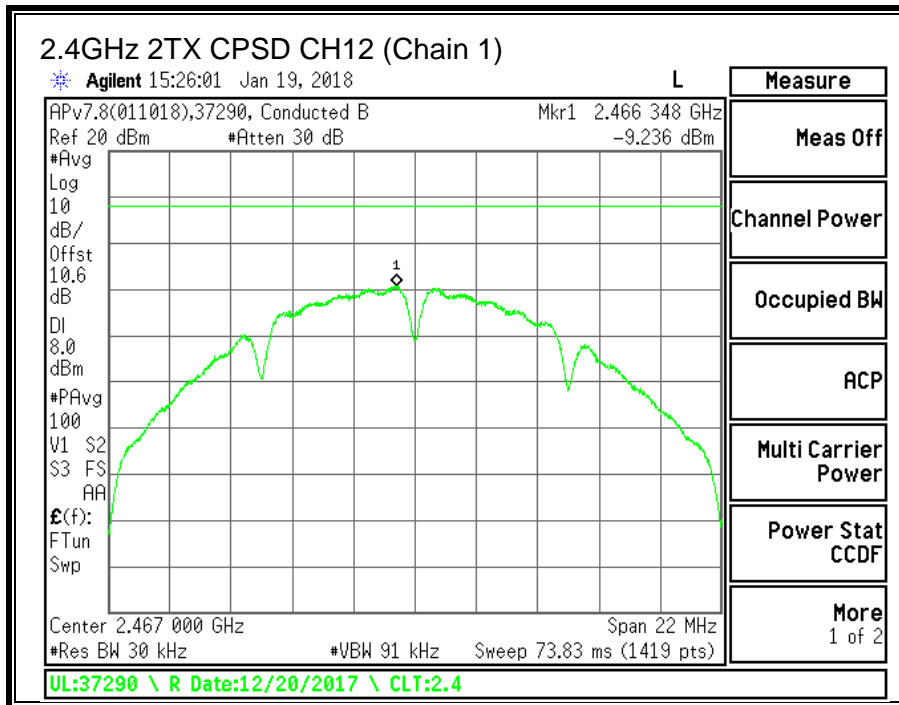
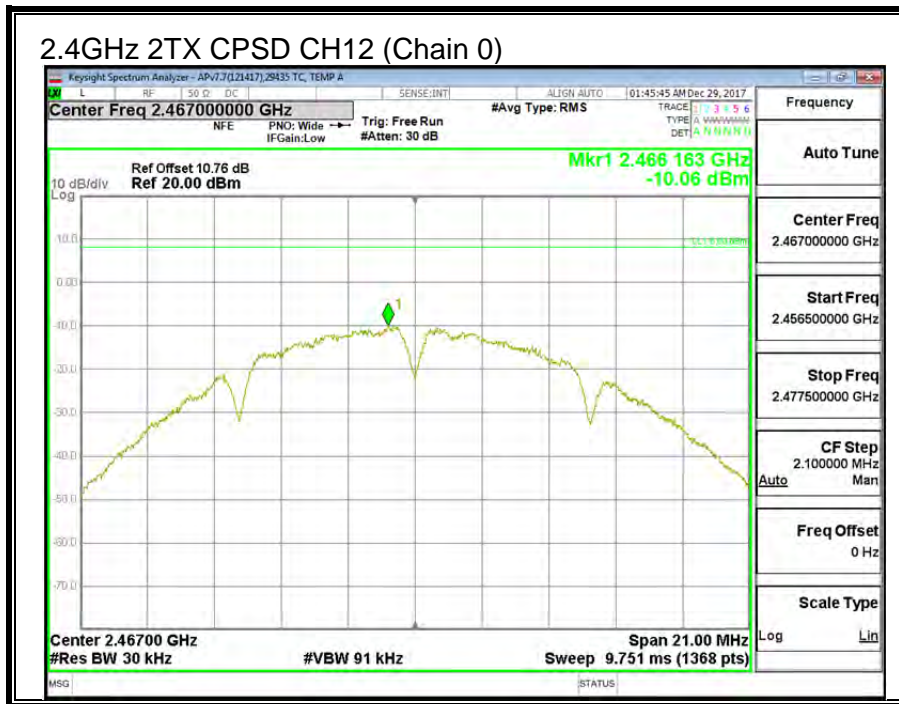

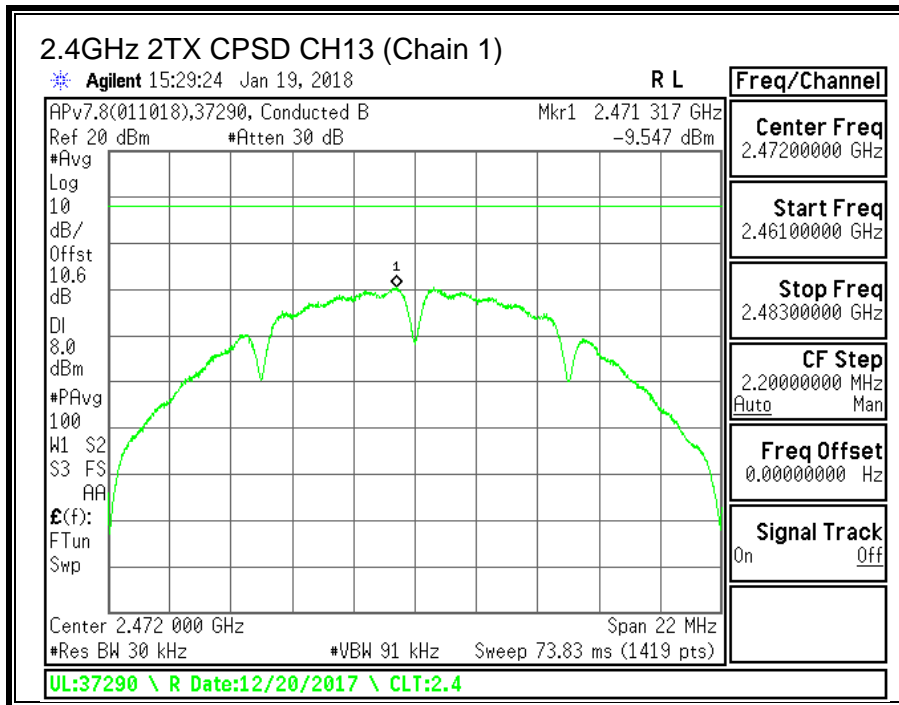
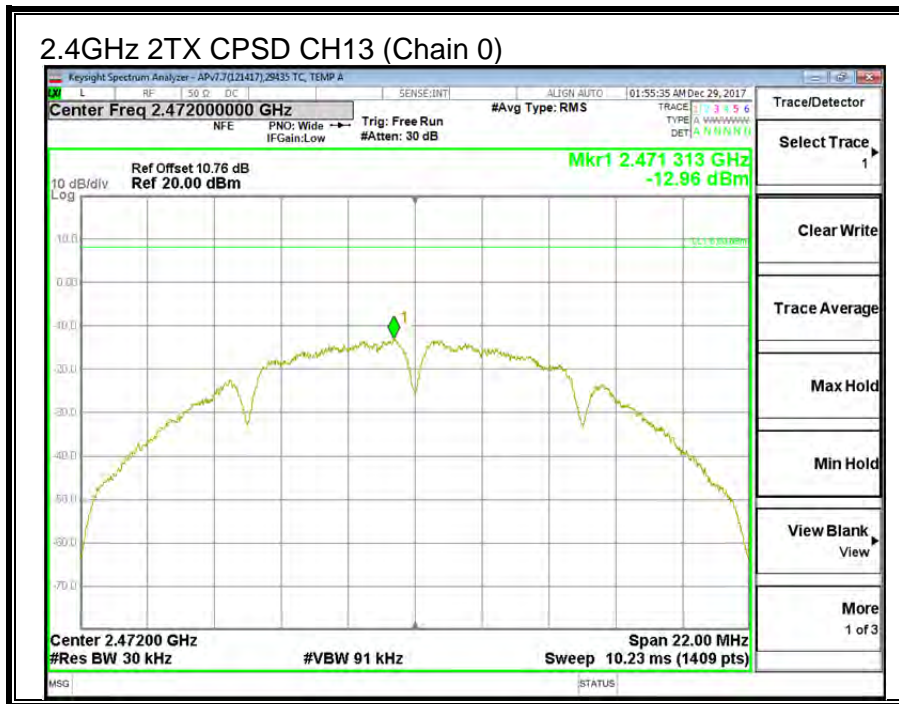

9.2.5. CONDUCTED BANEDGE AND SPURIOUS EMISSIONS

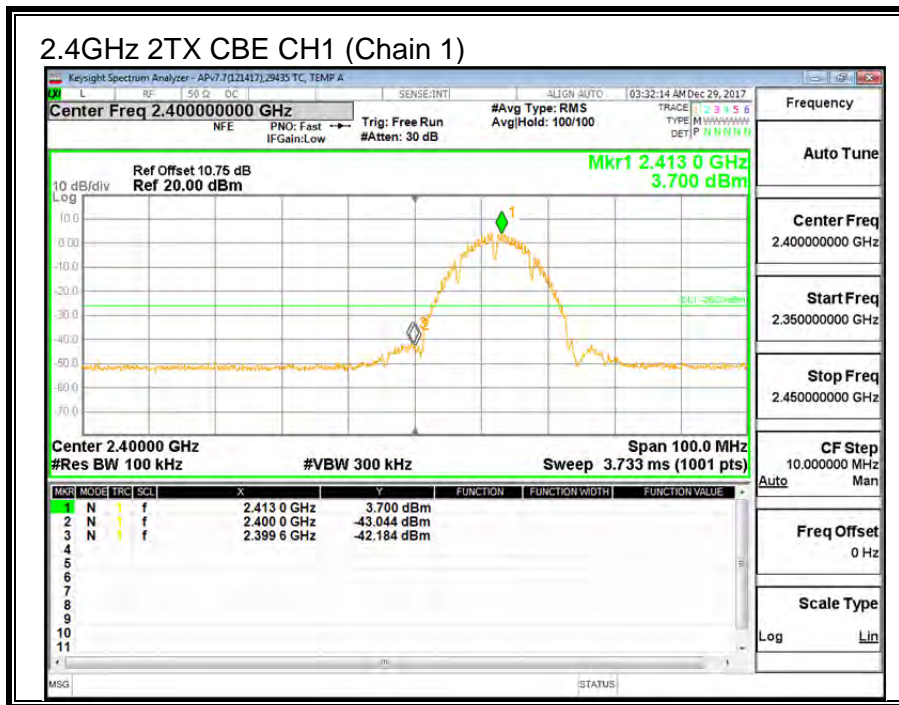
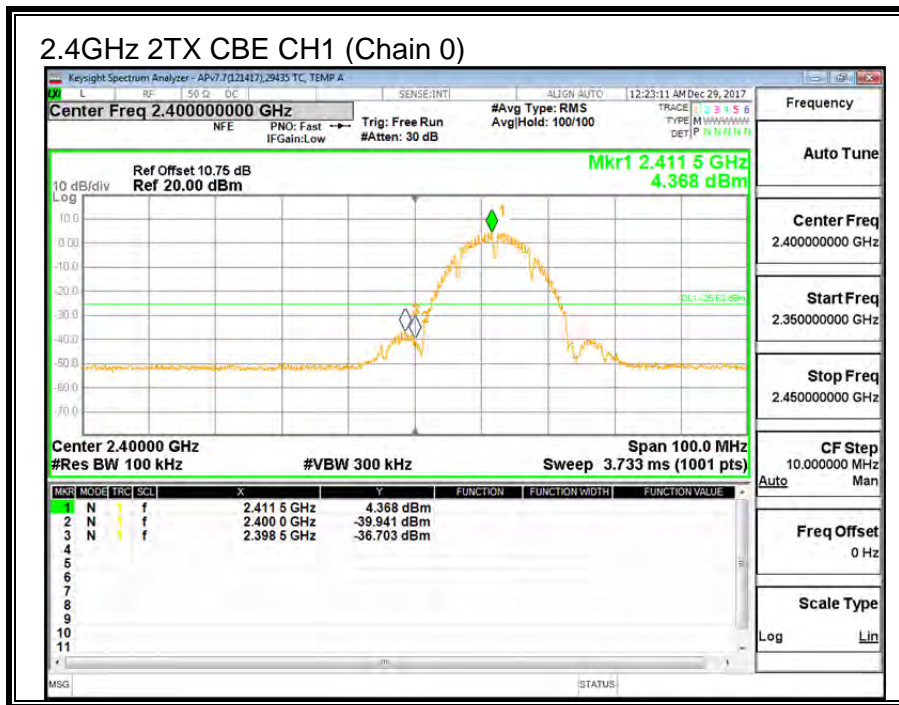

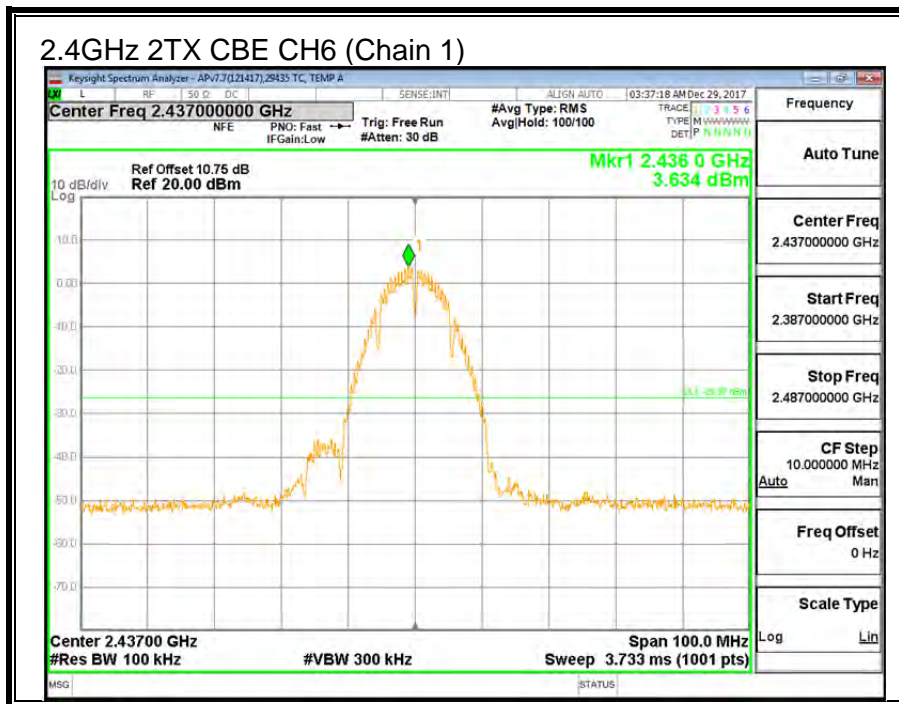
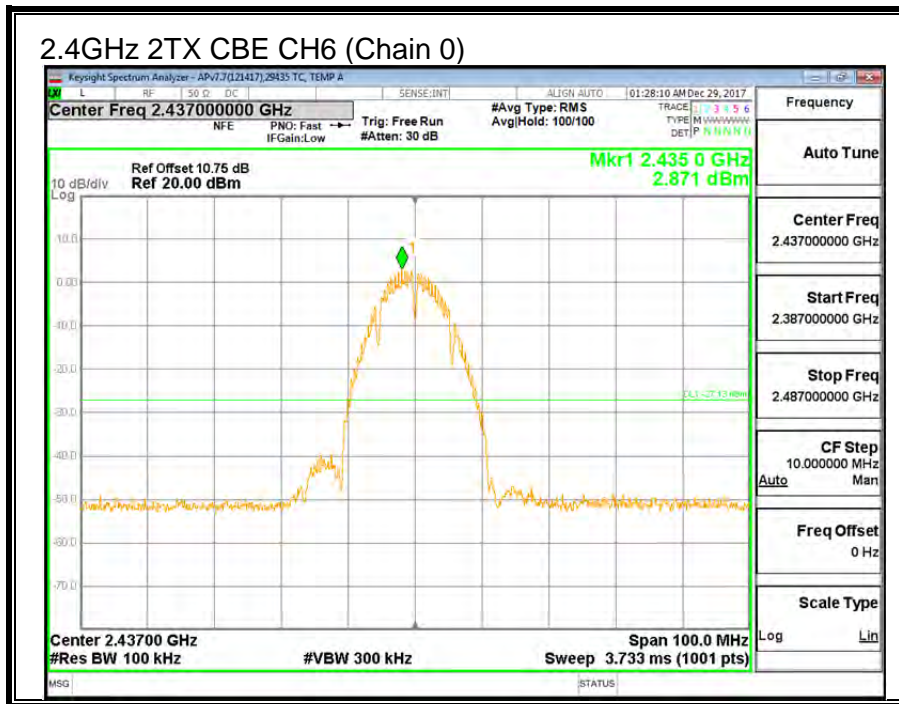

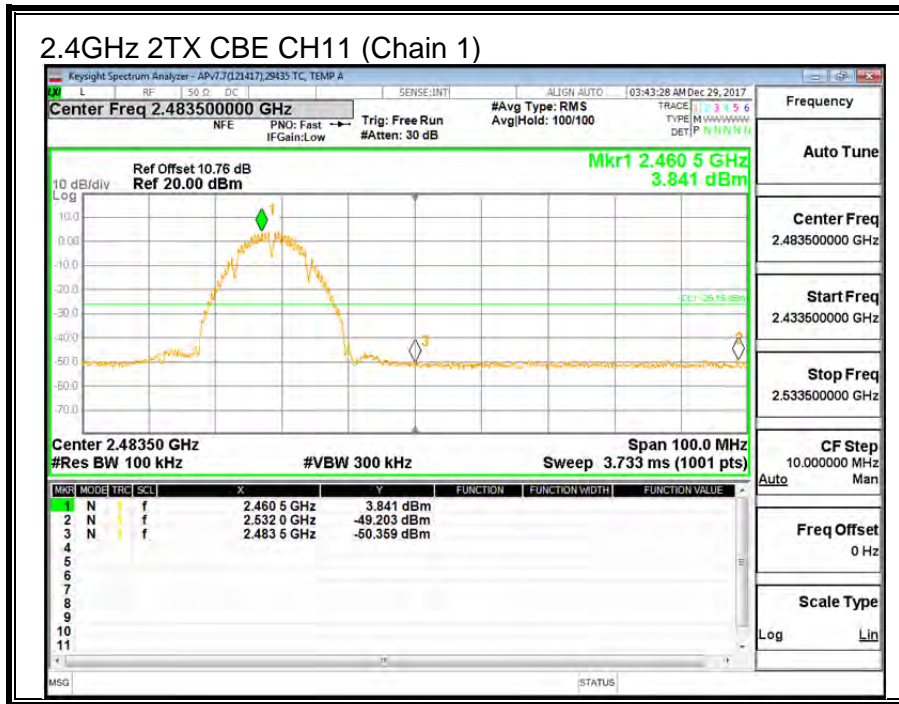
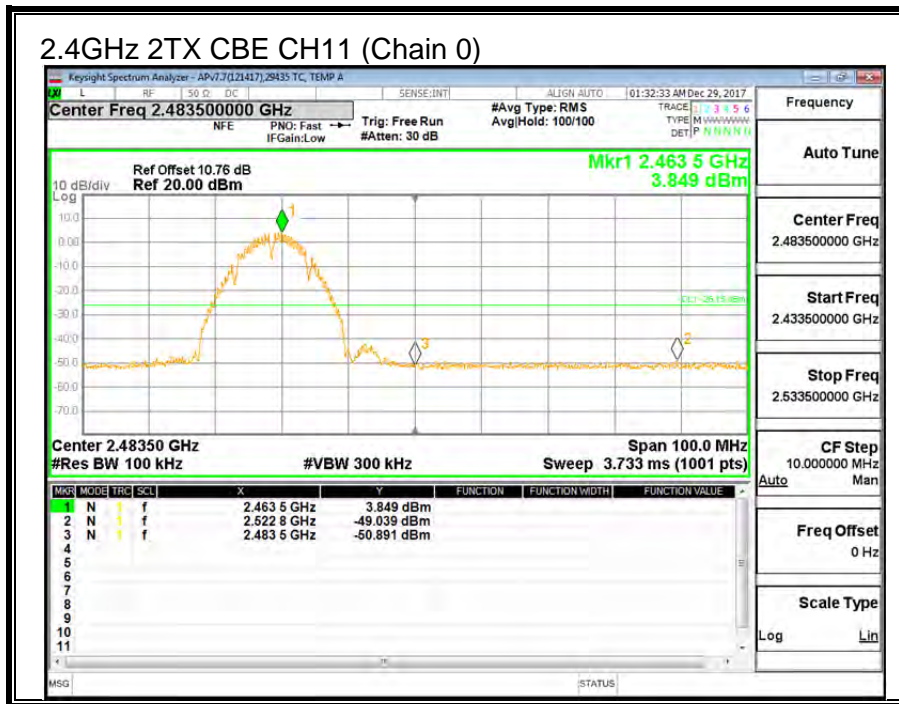

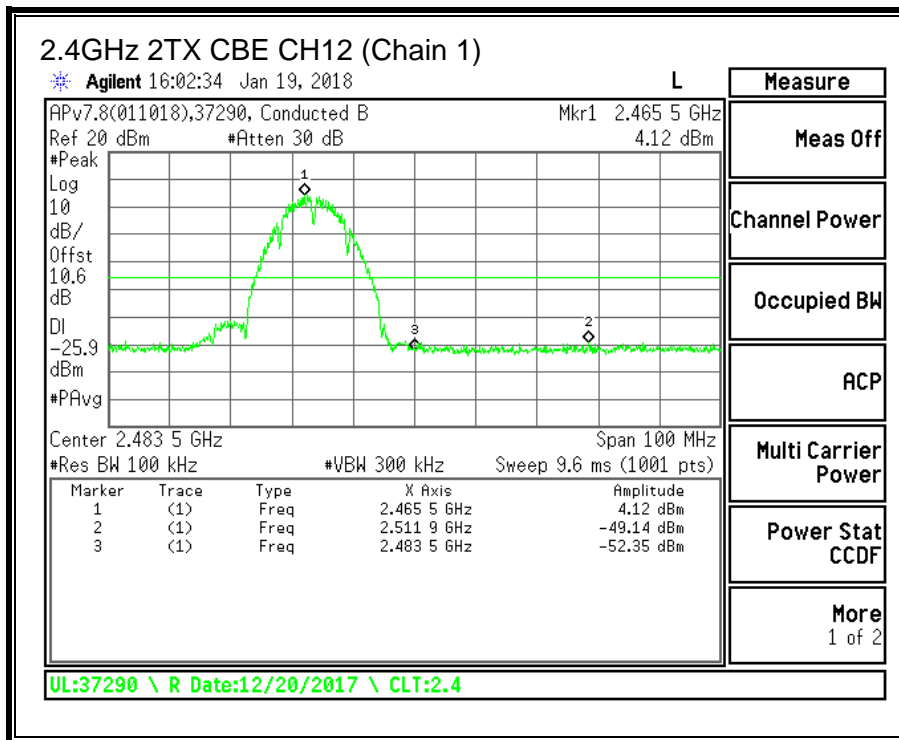
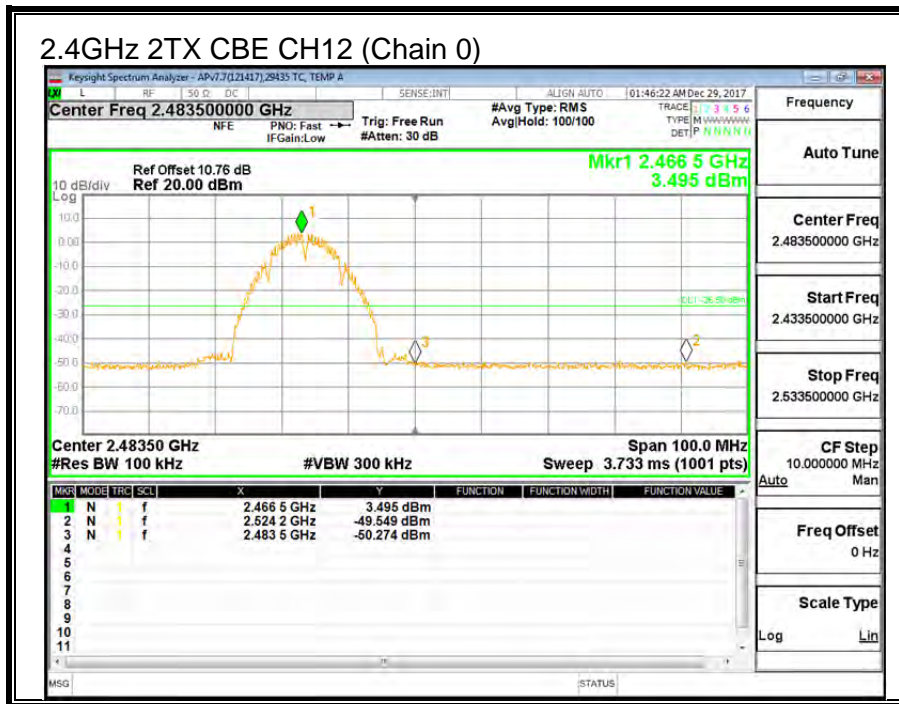

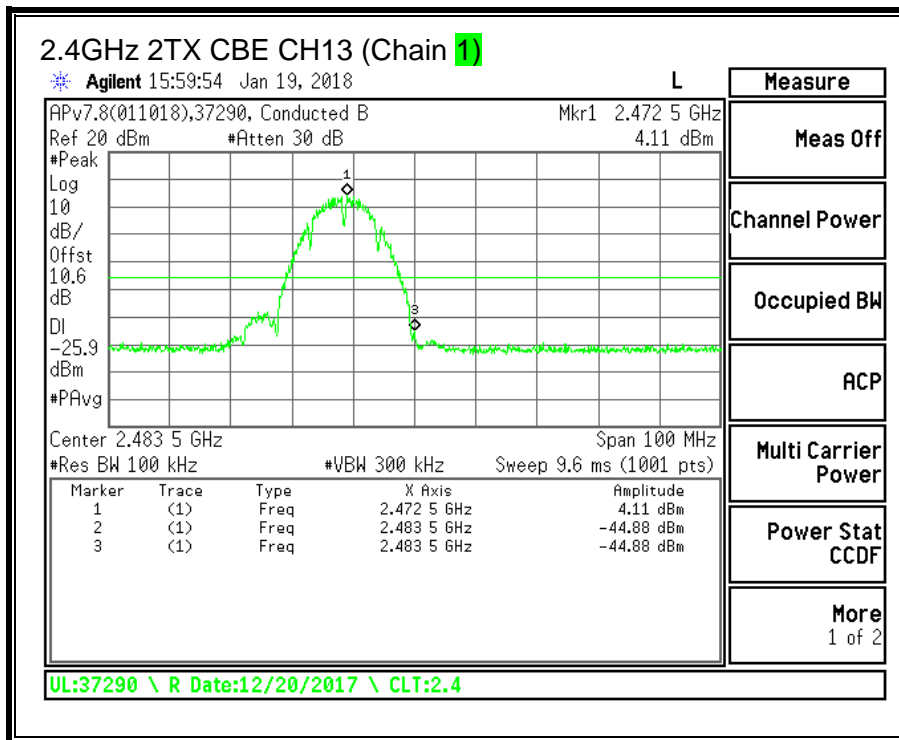
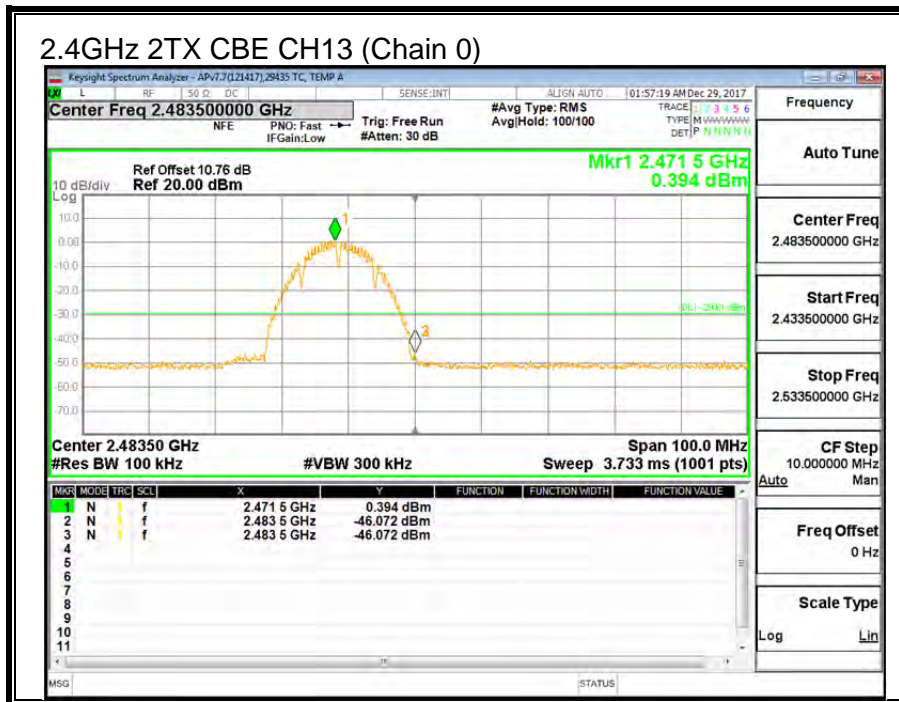

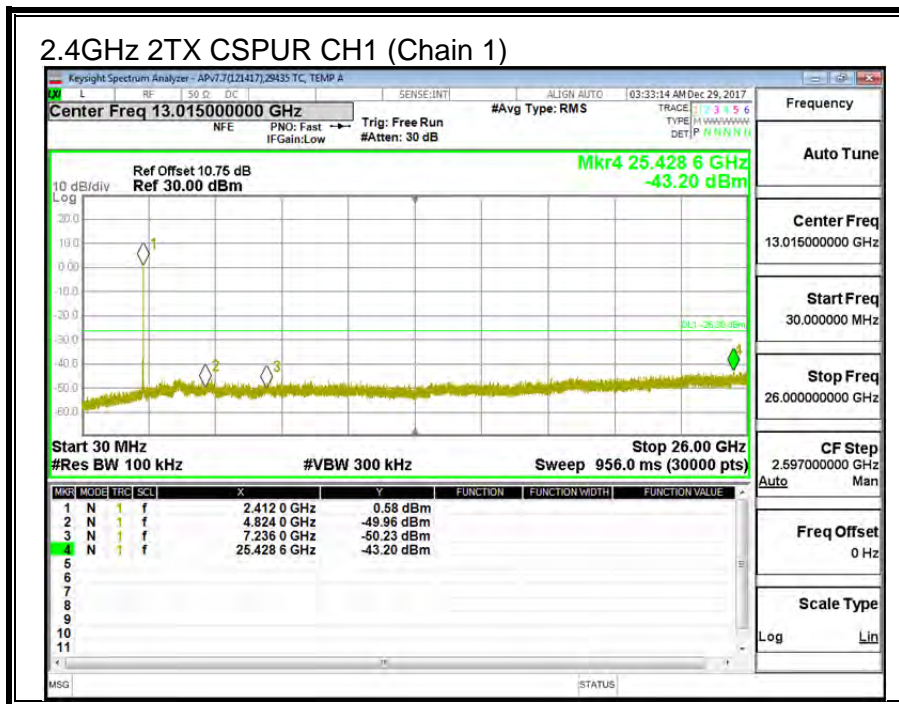
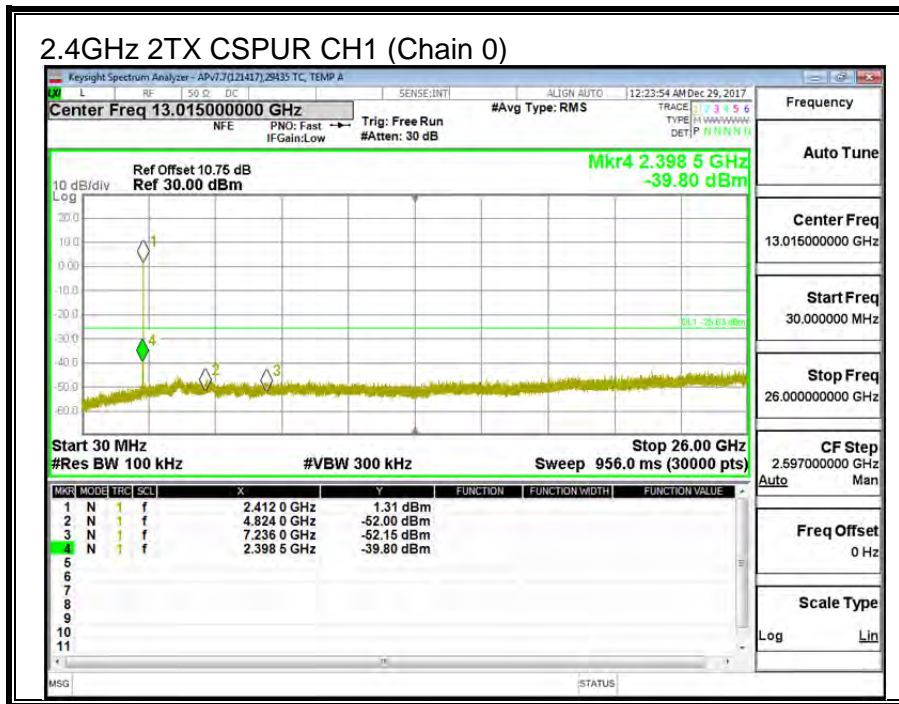

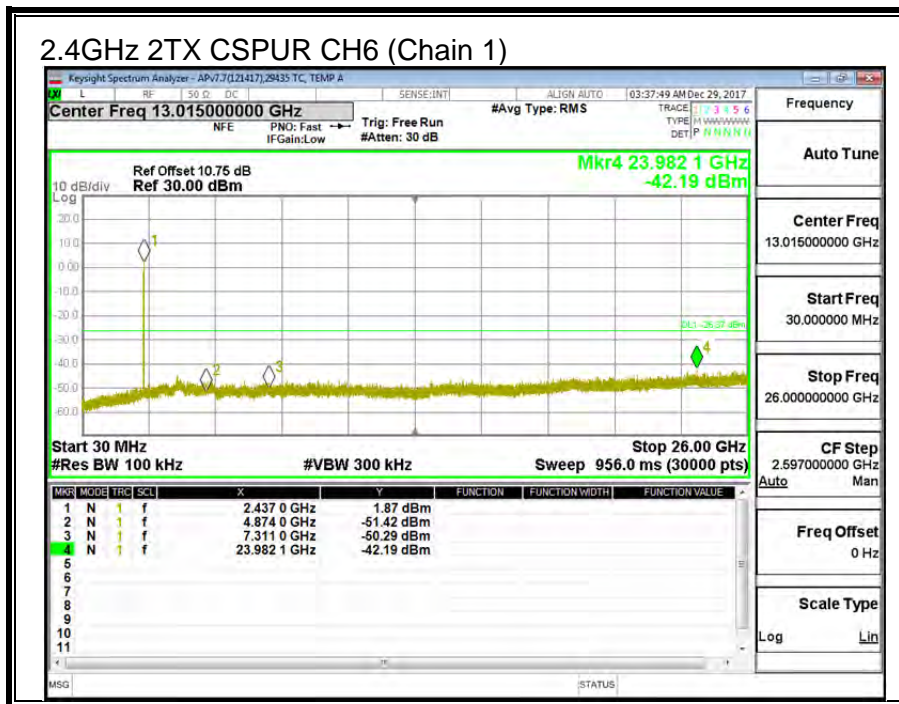
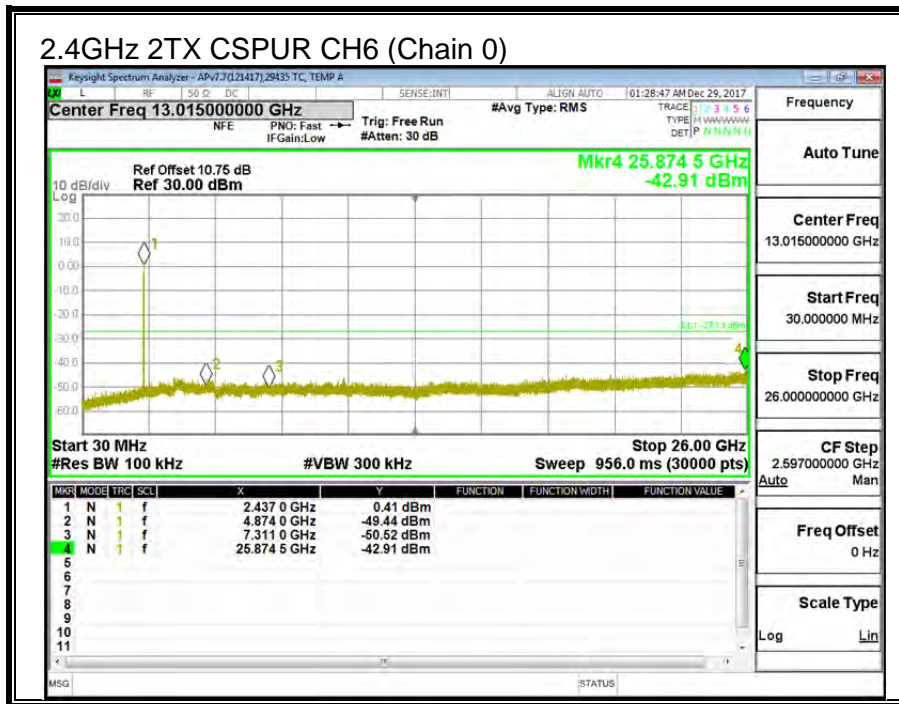

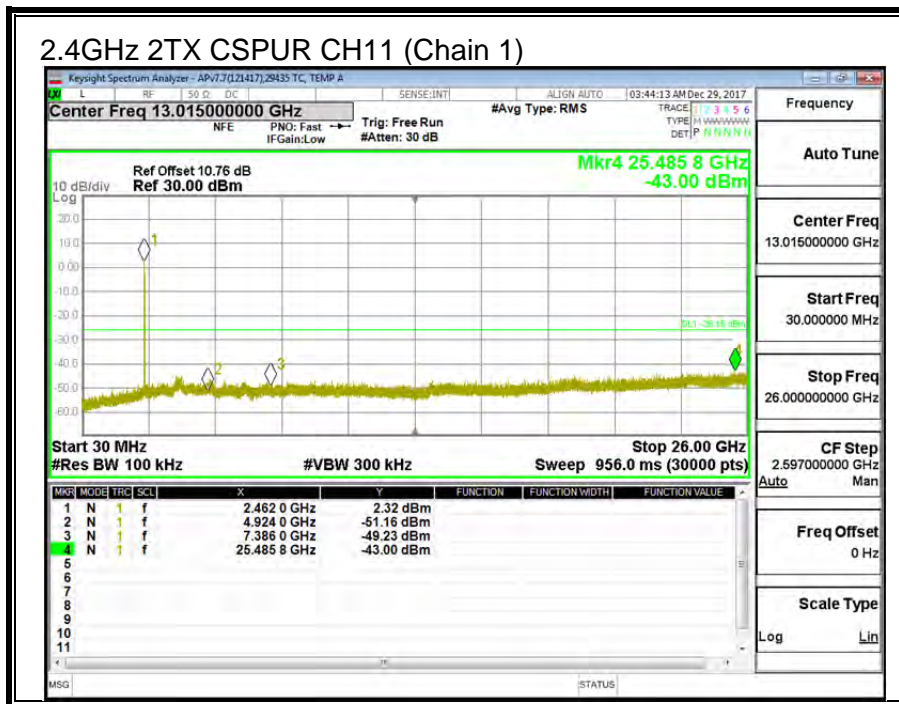
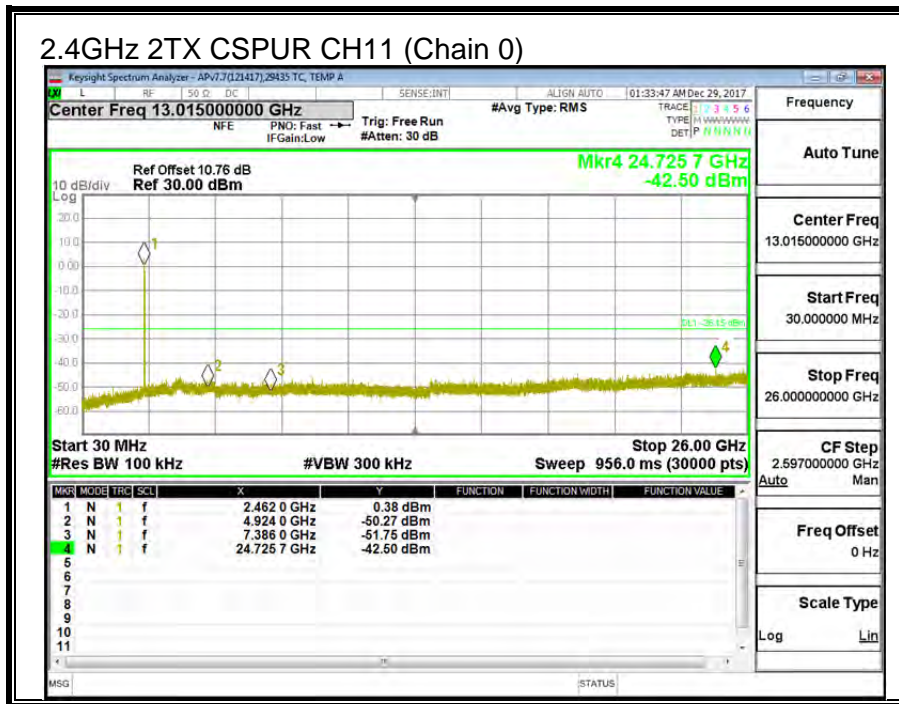

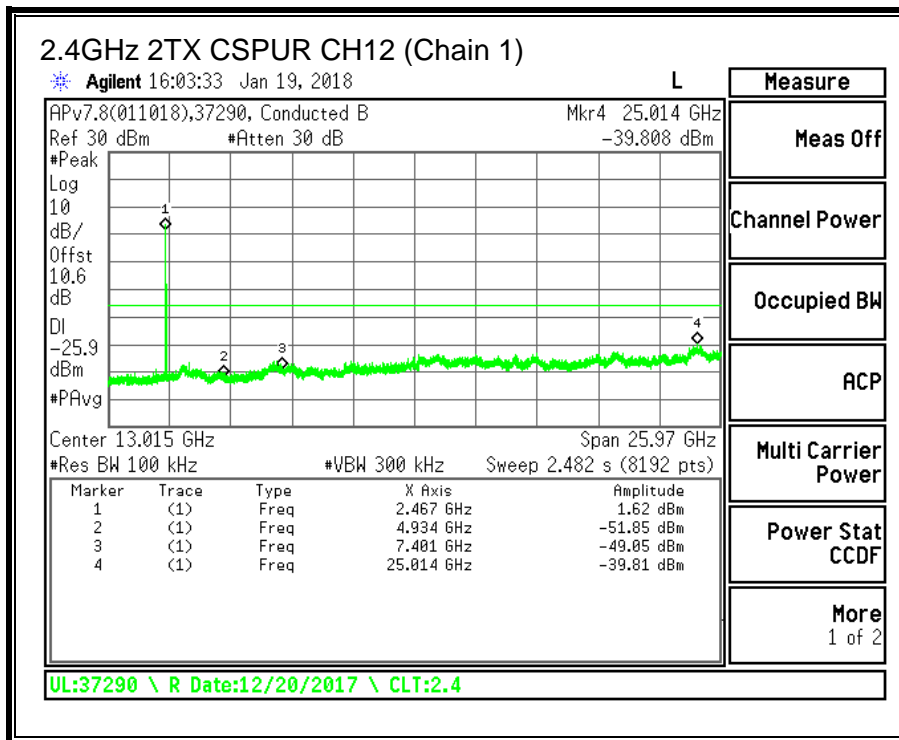
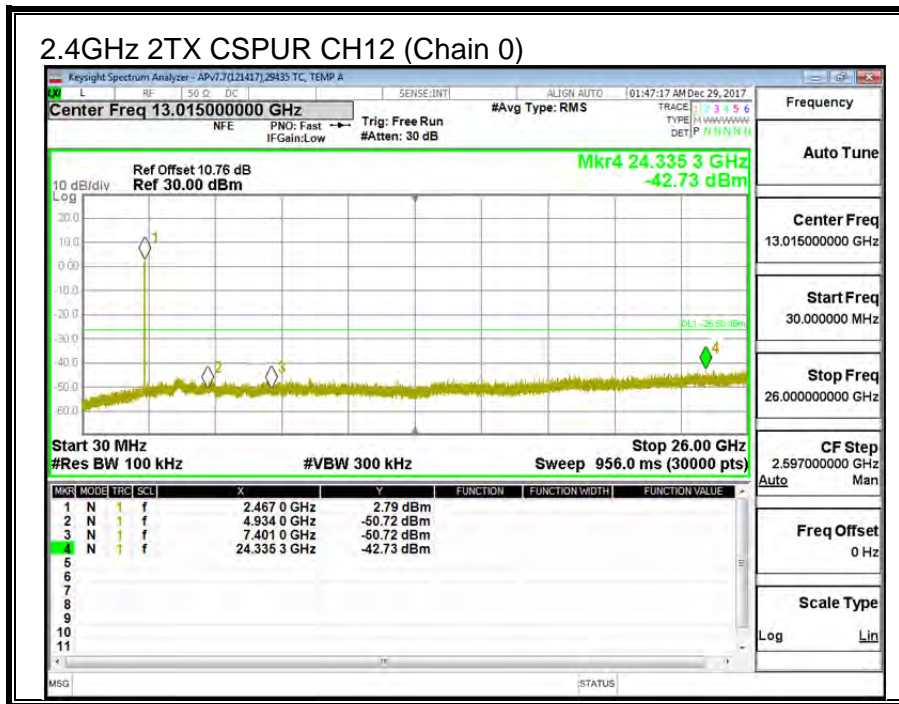

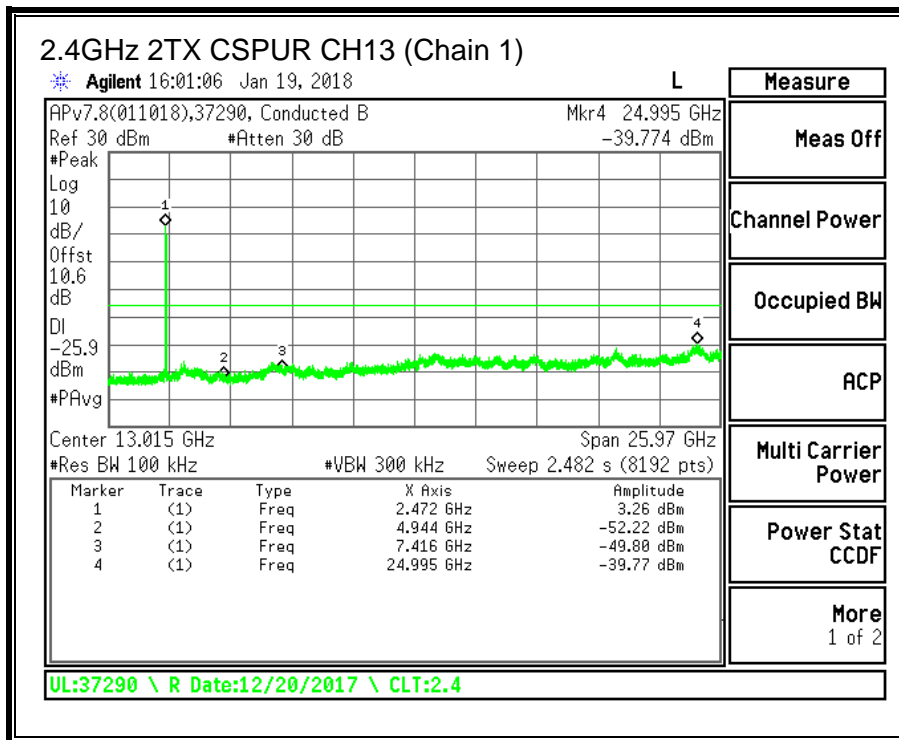
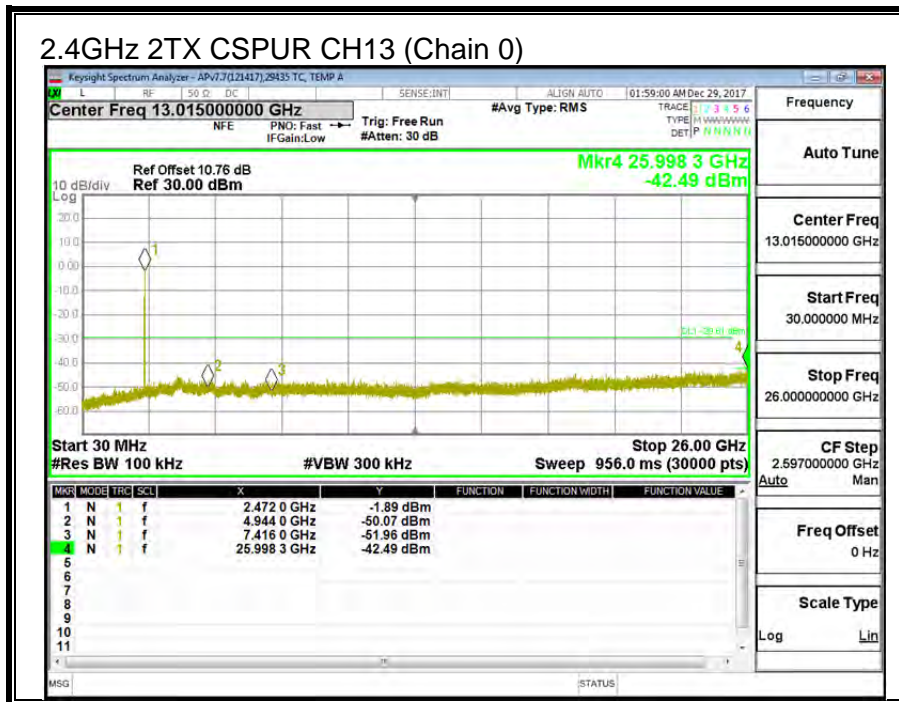

9.3. 11g 2TX CDD MIMO MODE IN THE 2.4GHZ BAND

9.3.1. 6 dB BANDWIDTH

LIMITS

FCC §15.247 (a) (2)

The minimum 6 dB bandwidth shall be at least 500 kHz.

RESULTS

Channel	Frequency	6 dB BW Chain 0 (MHz)	6 dB BW Chain 1 (MHz)	Minimum Limit (MHz)
CH1	2412	16.52	16.44	0.5
CH6	2437	16.46	16.40	0.5
CH11	2462	16.36	16.36	0.5
CH12	2467	16.36	16.40	0.5
CH13	2472	16.52	16.40	0.5

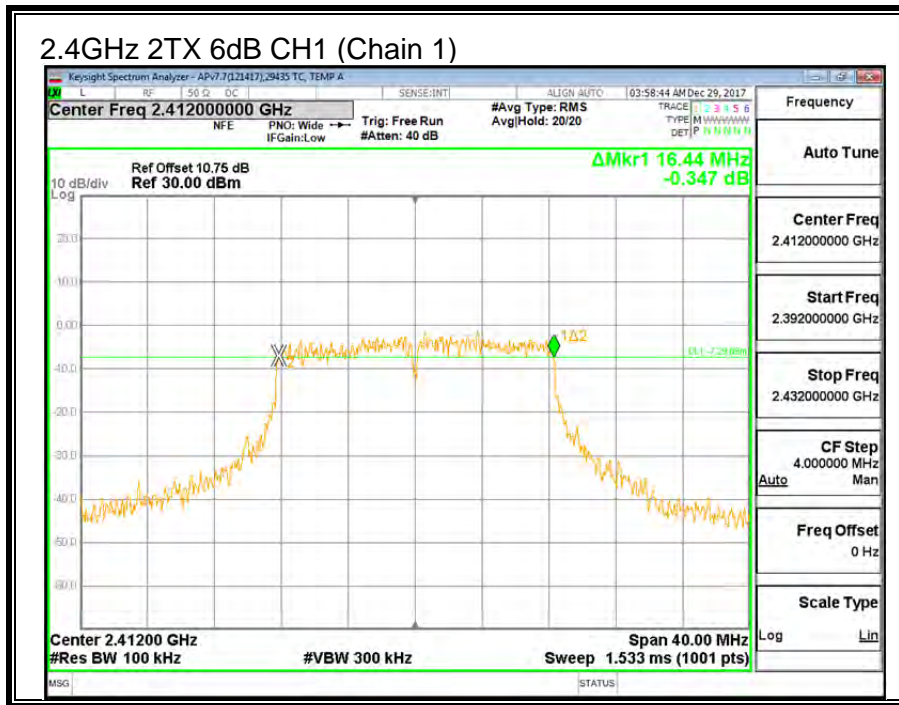
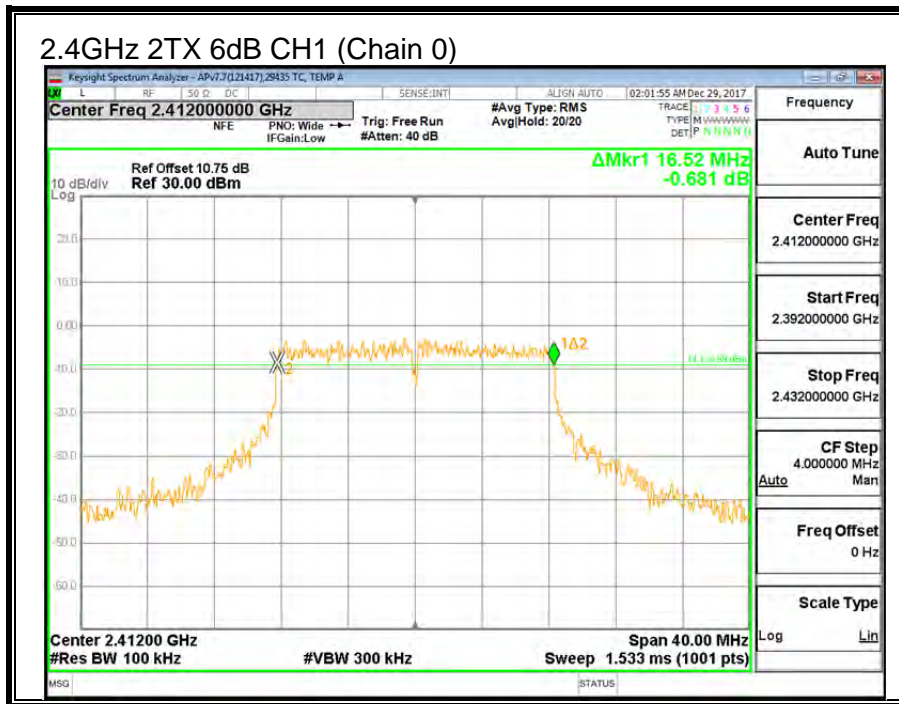

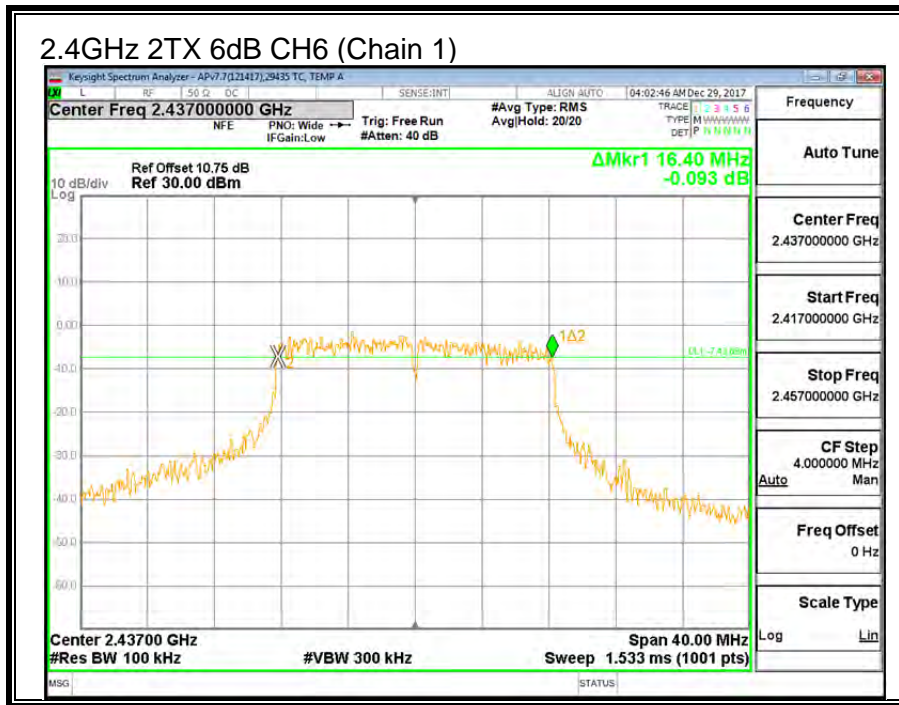
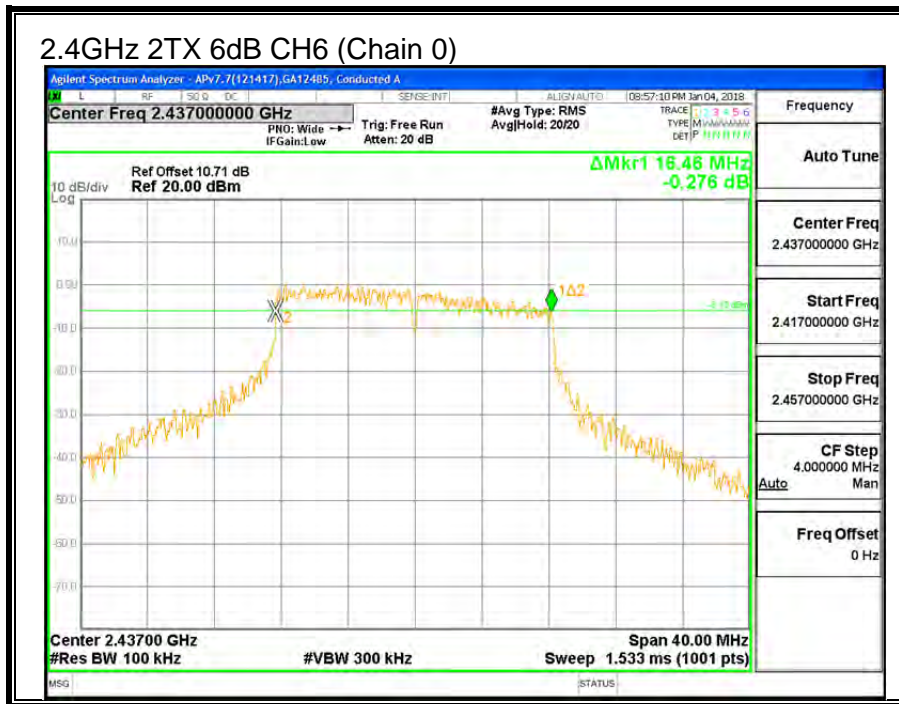

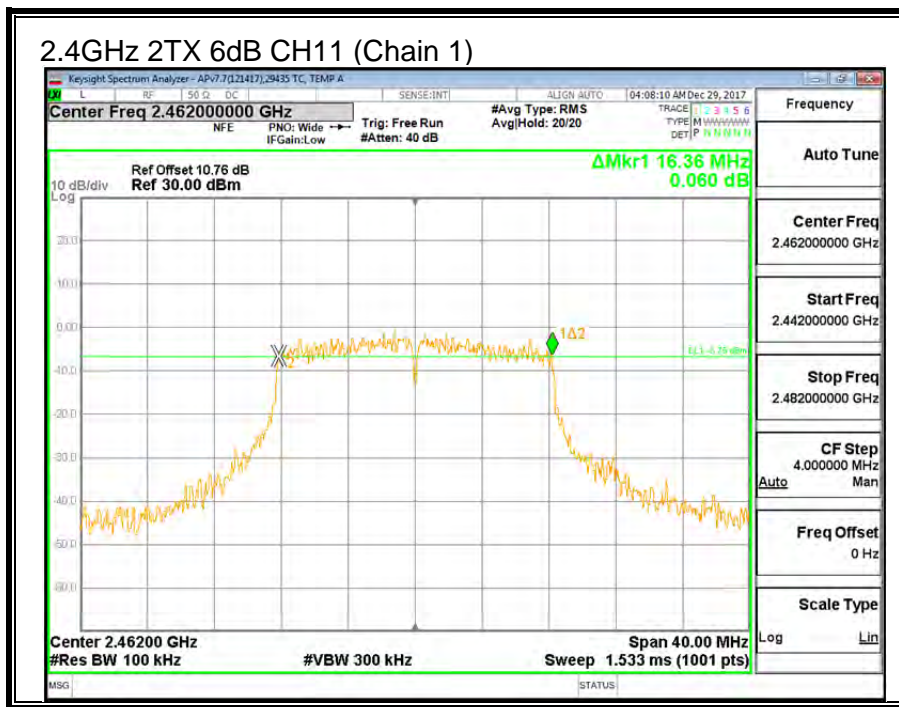
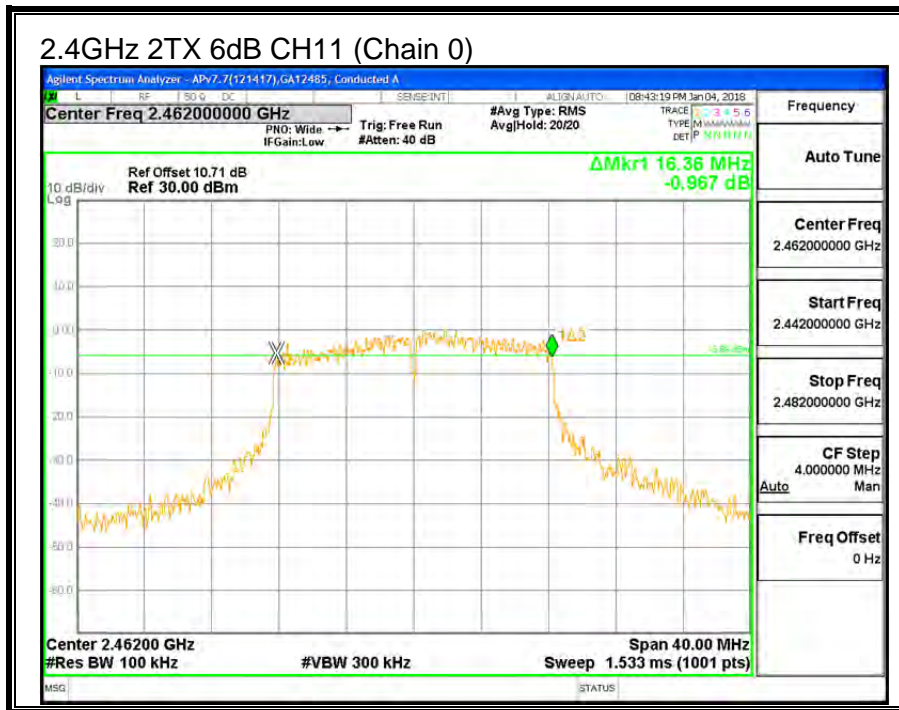

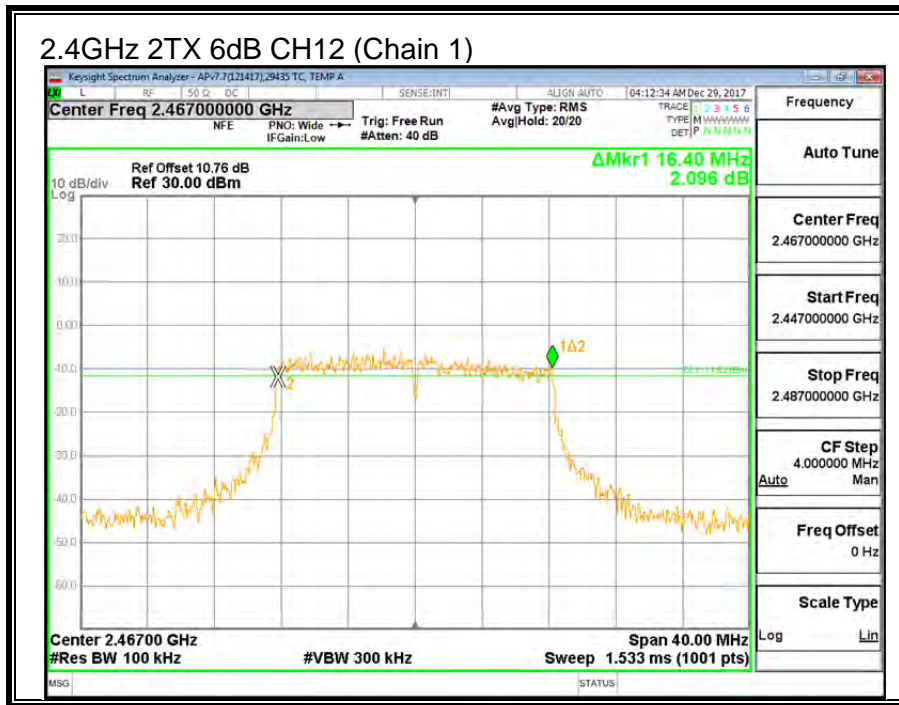
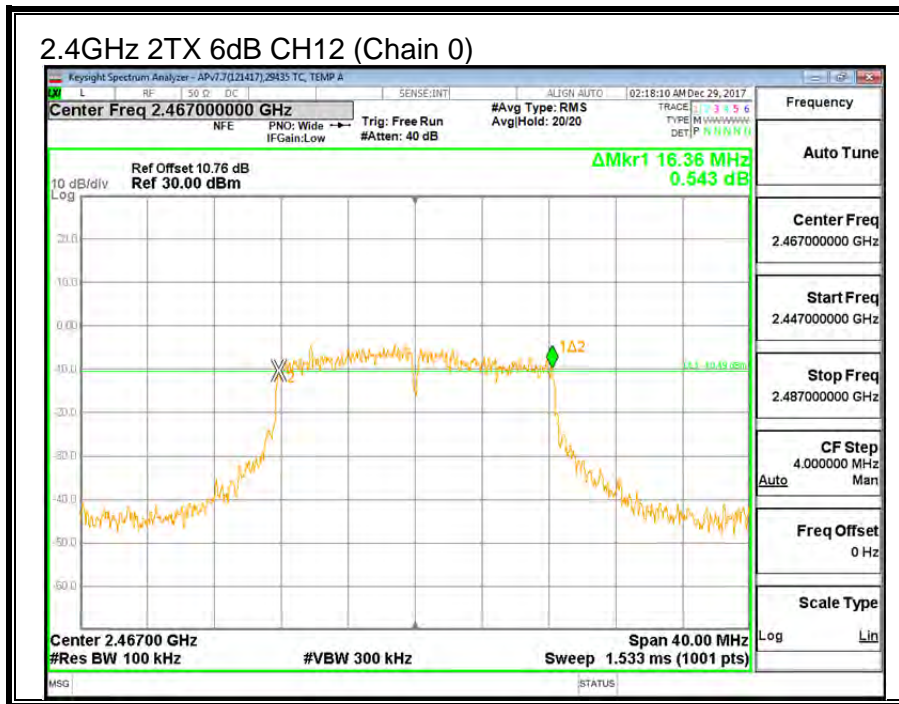

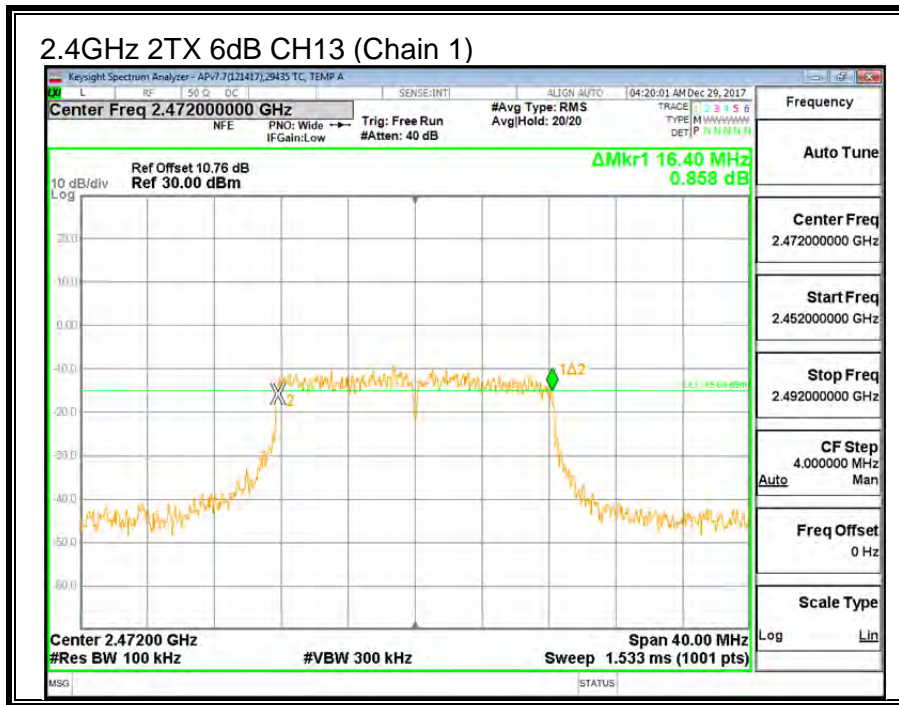
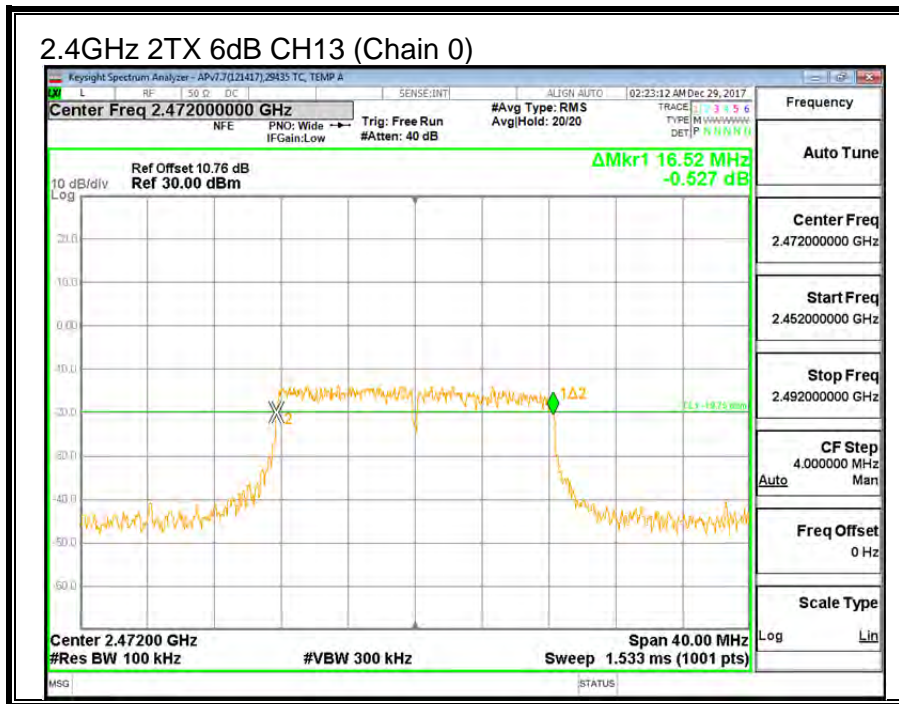

9.3.2. 99% BANDWIDTH

LIMITS

None; for reporting purposes only.

RESULTS

Channel	Frequency (MHz)	99% Bandwidth Chain 0 (MHz)	99% Bandwidth Chain 1 (MHz)
CH1	2412	16.643	16.418
CH6	2437	16.497	16.592
CH11	2462	16.324	16.415
CH12	2467	16.397	16.459
CH13	2472	16.503	16.518

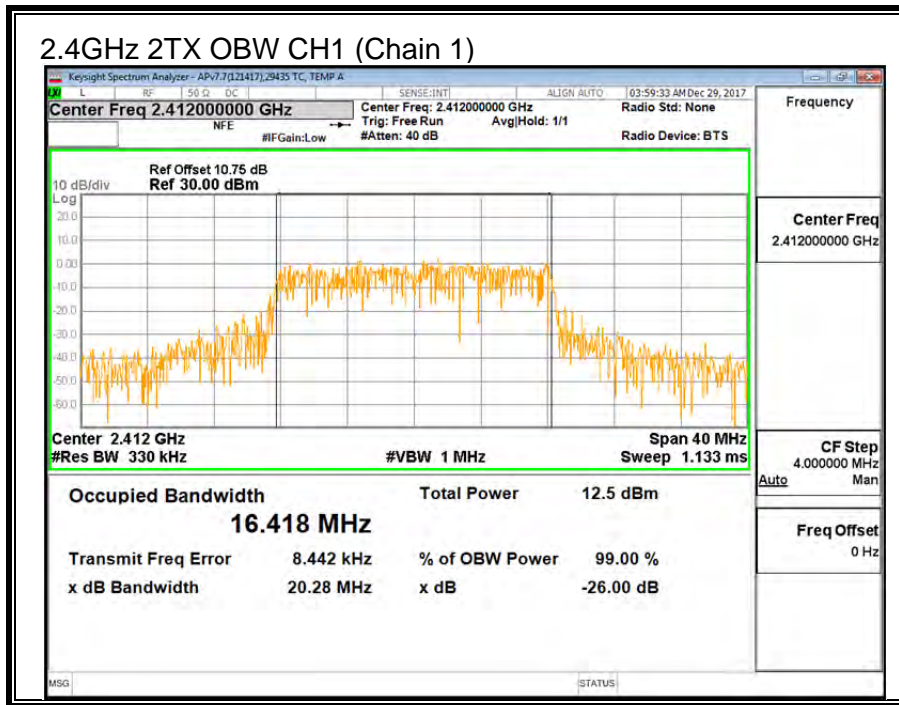
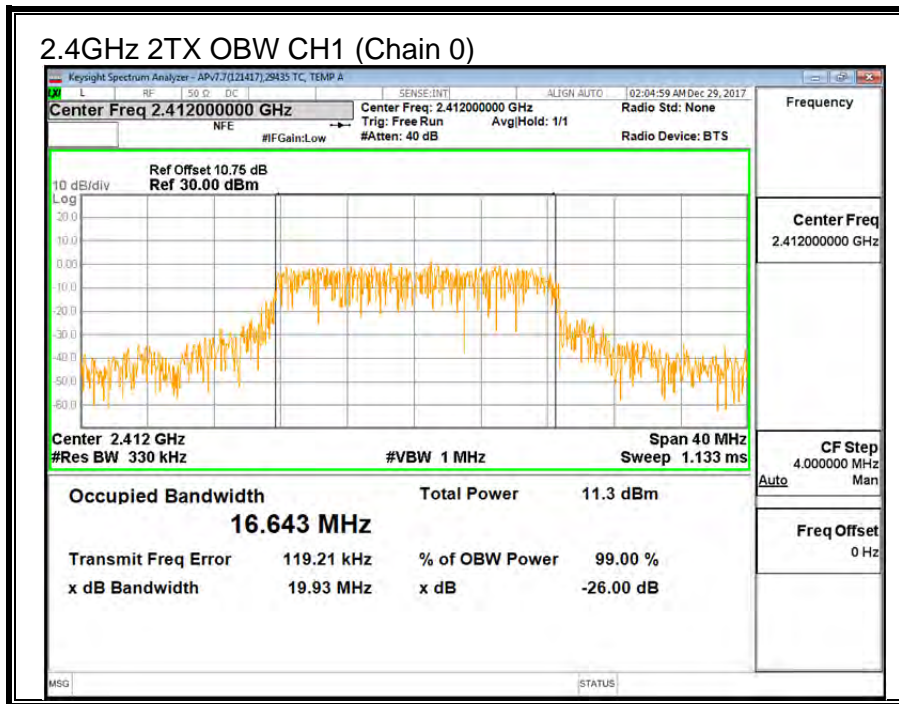

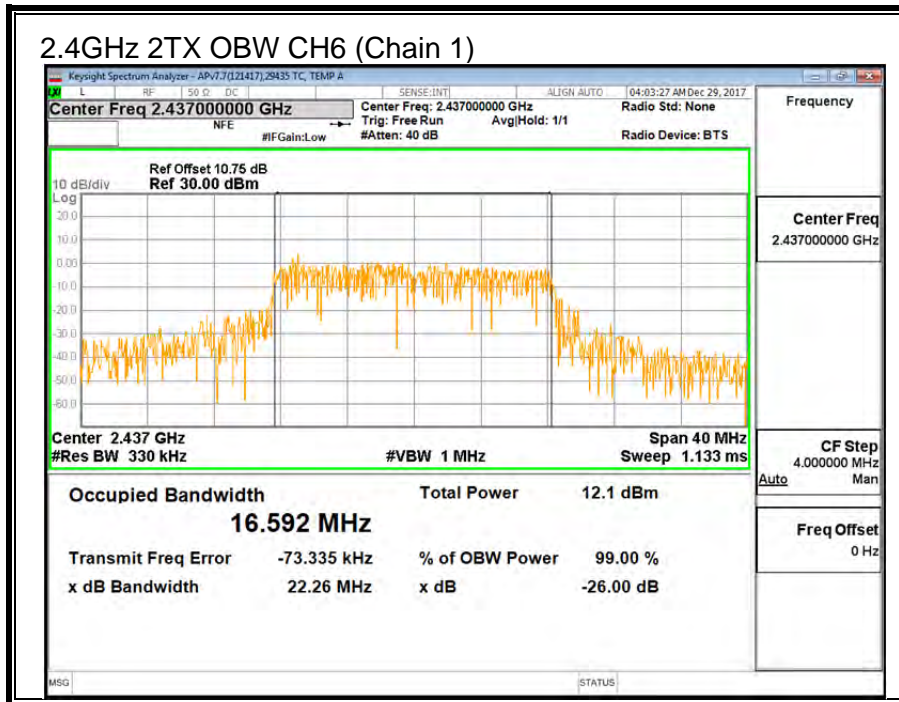
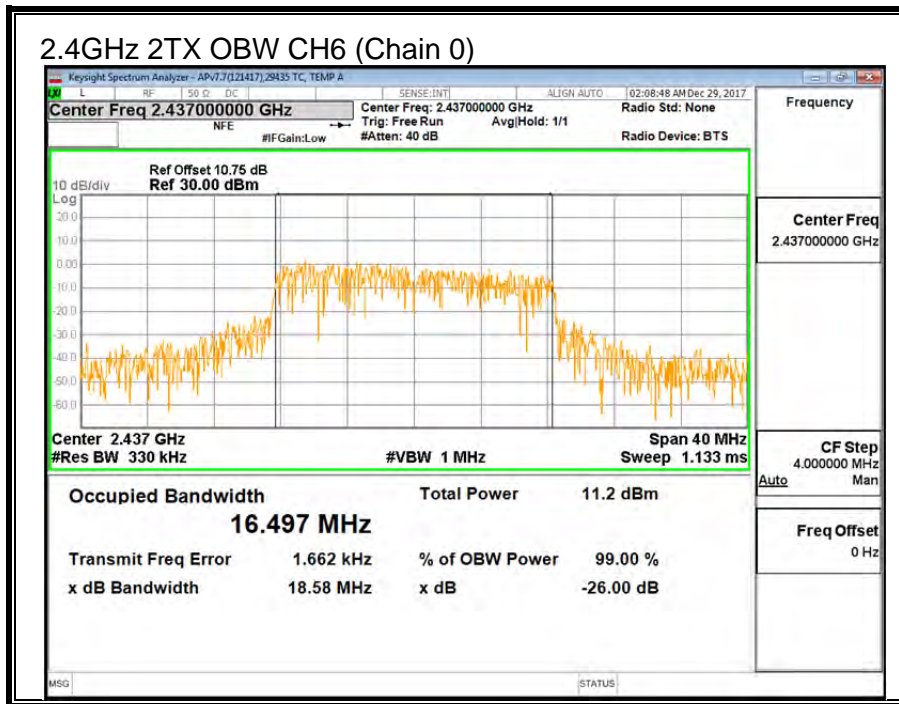

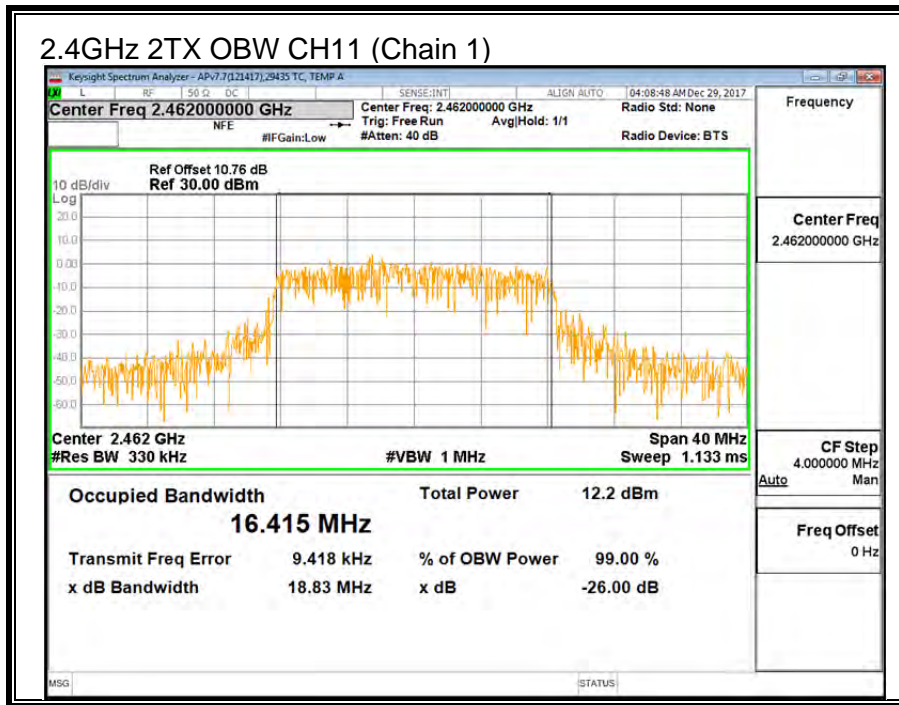
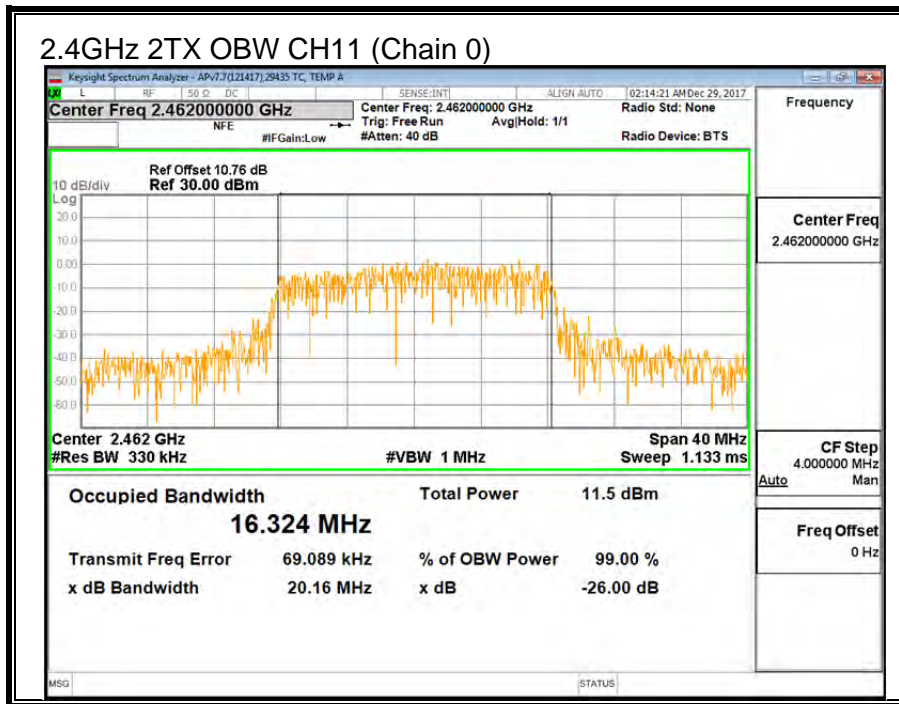

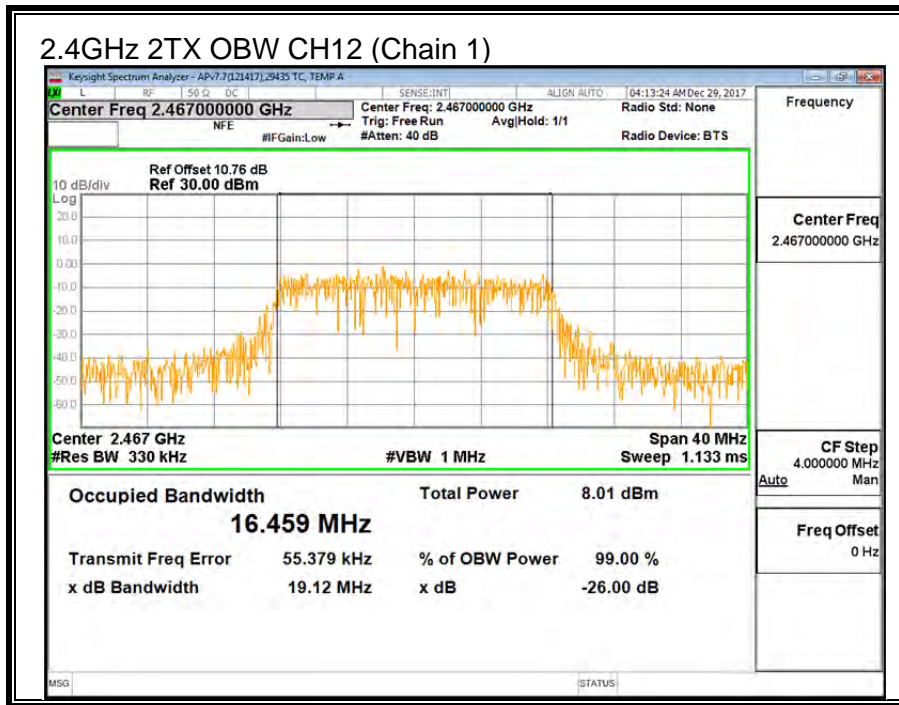
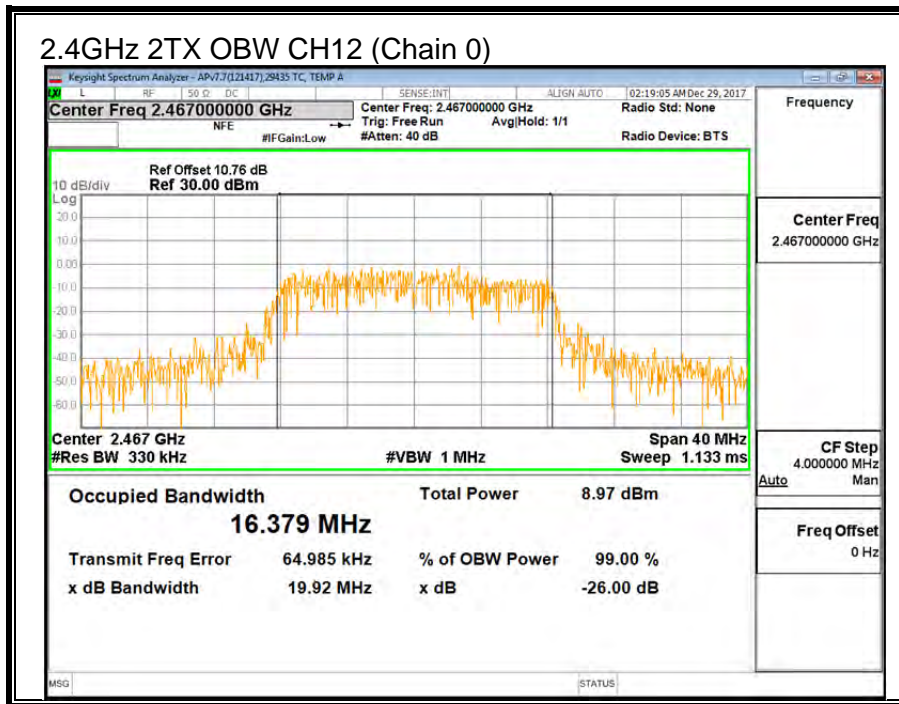

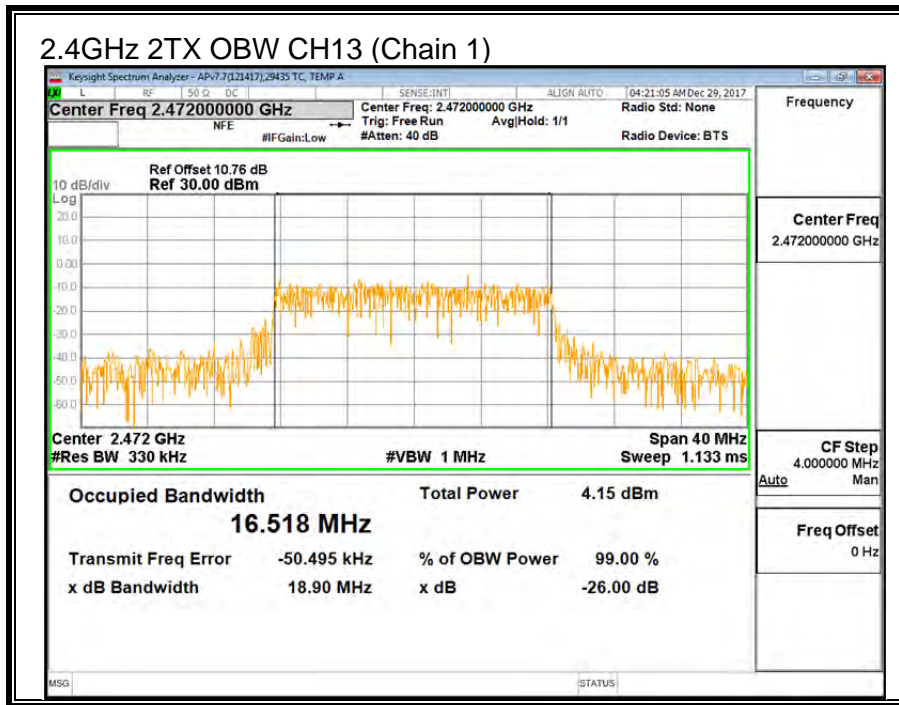
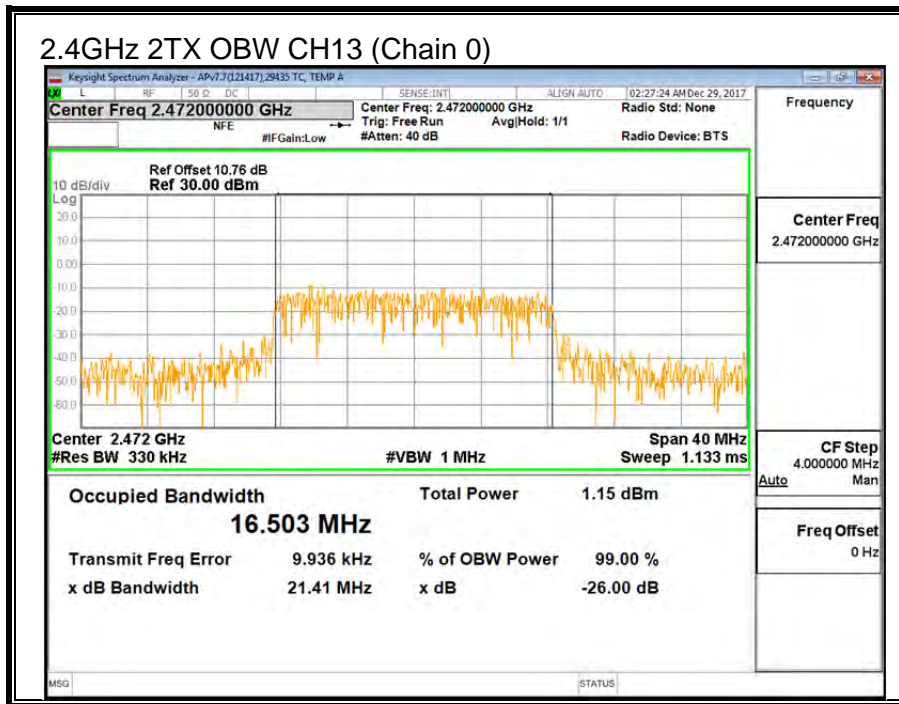

9.3.3. OUTPUT POWER

LIMITS

FCC §15.247 (b) (3)

For systems using digital modulation in the 2400–2483.5 MHz, and 5725–5850 MHz bands: 1 Watt, based on the use of antennas with directional gains that do not exceed 6 dBi. If transmitting antennas of directional gain greater than 6 dBi are used, the conducted output power from the intentional radiator shall be reduced by the amount in dB that the directional gain of the antenna exceeds 6 dBi.

TEST PROCEDURE

KDB 58074 D01 v04 Section 9.2.3.2

DIRECTIONAL ANTENNA GAIN

The TX chains are uncorrelated and the antenna gain is unequal among the chains. The directional gain is:

Chain 0 Antenna Gain (dBi)	Chain 1 Antenna Gain (dBi)	Uncorrelated Chains Directional Gain (dBi)
-1.90	-8.80	-4.10

RESULTS

ID:	GE43578	Date:	1/7/17
------------	---------	--------------	--------

Limits

Channel	Frequency (MHz)	Directional Gain (dBi)	FCC Power Limit (dBm)	IC Power Limit (dBm)	IC EIRP Limit (dBm)	Max Power (dBm)
CH1	2412	-4.10	30.00	30	36	30.00
CH6	2437	-4.10	30.00	30	36	30.00
CH11	2462	-4.10	30.00	30	36	30.00
CH12	2467	-4.10	30.00	30	36	30.00
CH13	2472	-4.10	30.00	30	36	30.00

Results

Channel	Frequency (MHz)	Chain 0 Meas Power (dBm)	Chain 1 Meas Power (dBm)	Total Corr'd Power (dBm)	Power Limit (dBm)	Margin (dB)
CH1	2412	11.72	12.62	15.20	30.00	-14.80
CH6	2437	11.43	12.99	15.29	30.00	-14.71
CH11	2462	11.62	12.96	15.35	30.00	-14.65
CH12	2467	9.36	8.14	11.80	30.00	-18.20
CH13	2472	1.24	-0.03	3.66	30.00	-26.34

Note: the power readings above were measured with gated method, and the measurement was taken only during the ON time. No duty cycle correction was necessary.

9.3.4. POWER SPECTRAL DENSITY

LIMITS

FCC §15.247 (e)

For digitally modulated systems, the power spectral density conducted from the intentional radiator to the antenna shall not be greater than 8 dBm in any 3 KHz band during any time interval of continuous transmissions.

RESULTS

Duty Cycle CF (dB)	0.00	Included in Calculations of Corr'd PSD
---------------------------	------	---

PSD Results

Channel	Frequency (MHz)	Chain 0 Meas (dBm)	Chain 1 Meas (dBm)	Total Corr'd PSD (dBm)	Limit (dBm)	Margin (dB)
CH1	2412	-13.15	-12.05	-9.55	8.0	-17.6
CH6	2437	-12.48	-12.16	-9.31	8.0	-17.3
CH11	2462	-12.26	-11.48	-8.84	8.0	-16.8
CH12	2467	-14.88	-16.27	-12.51	8.0	-20.5
CH13	2472	-23.67	-20.50	-18.79	8.0	-26.8

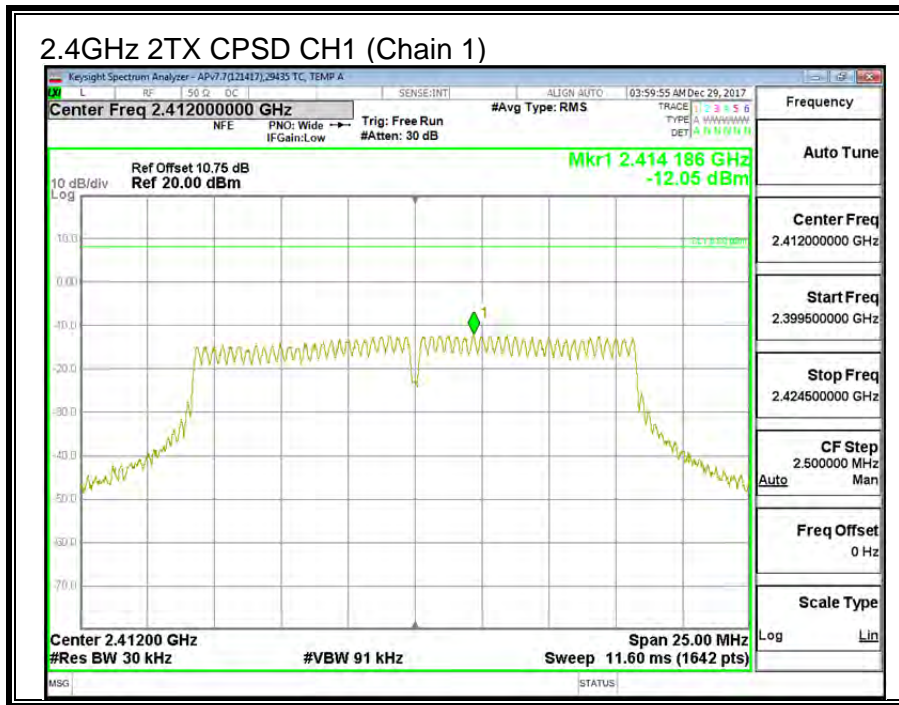
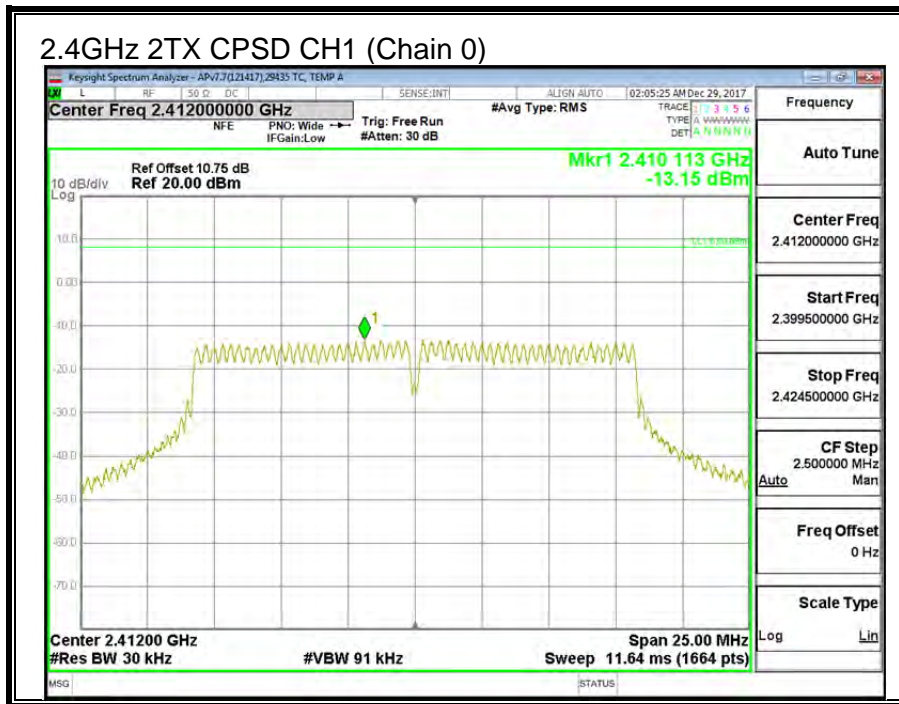

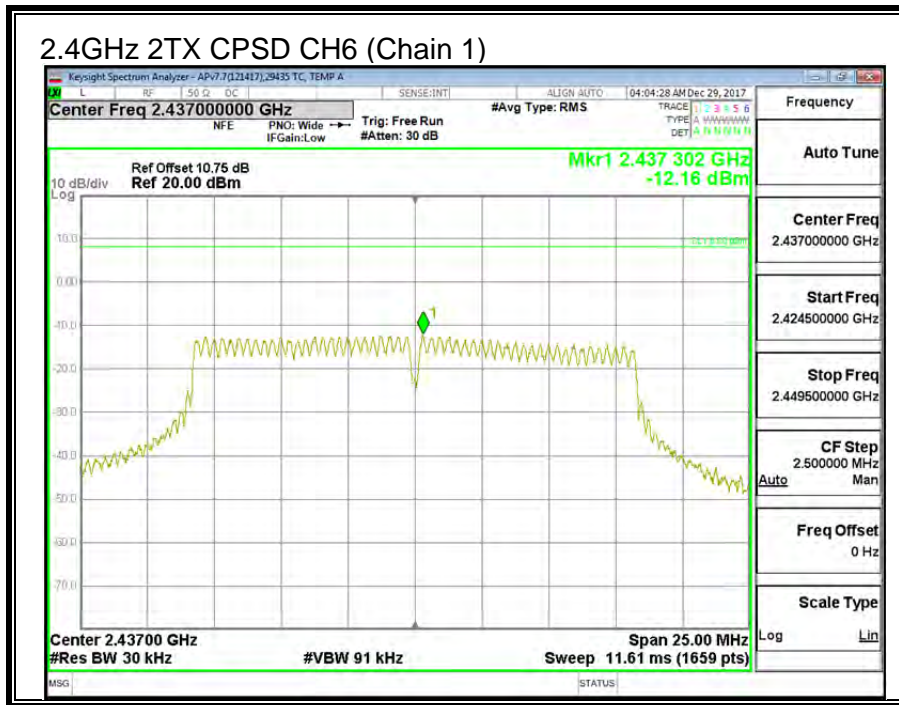
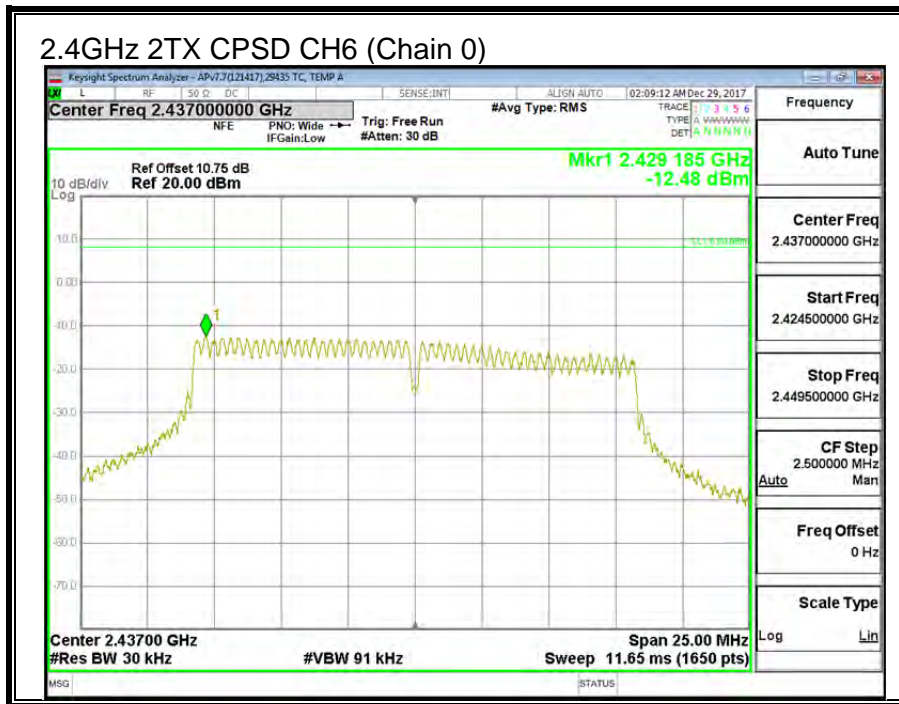

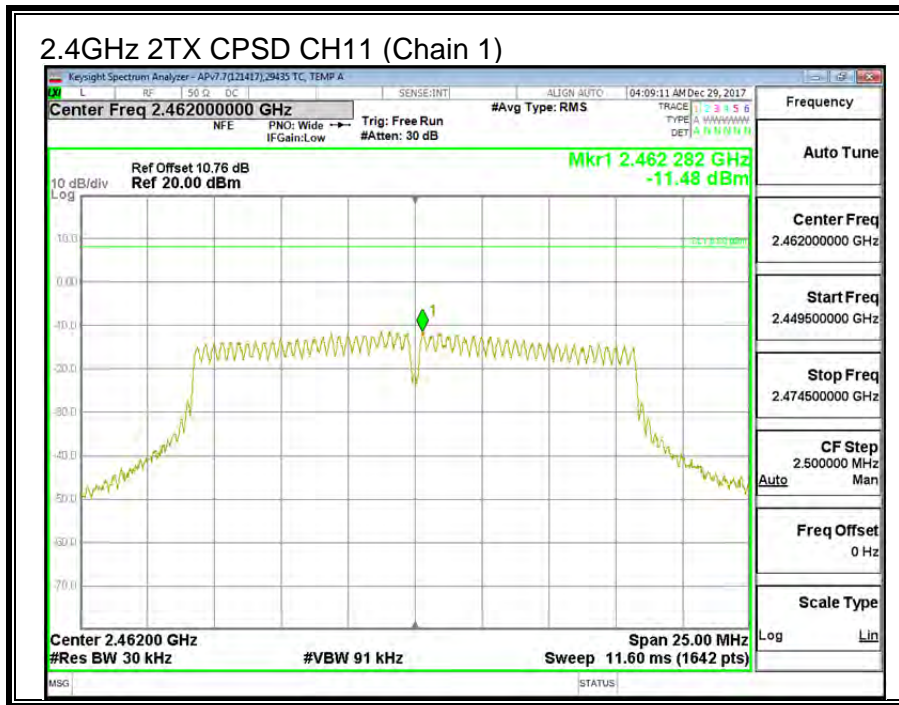
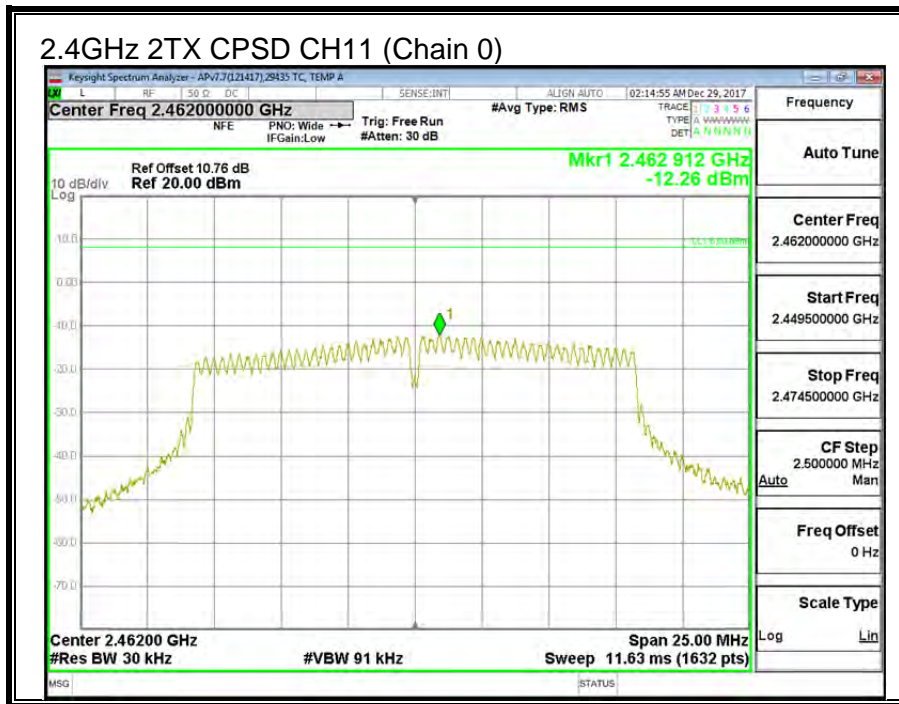

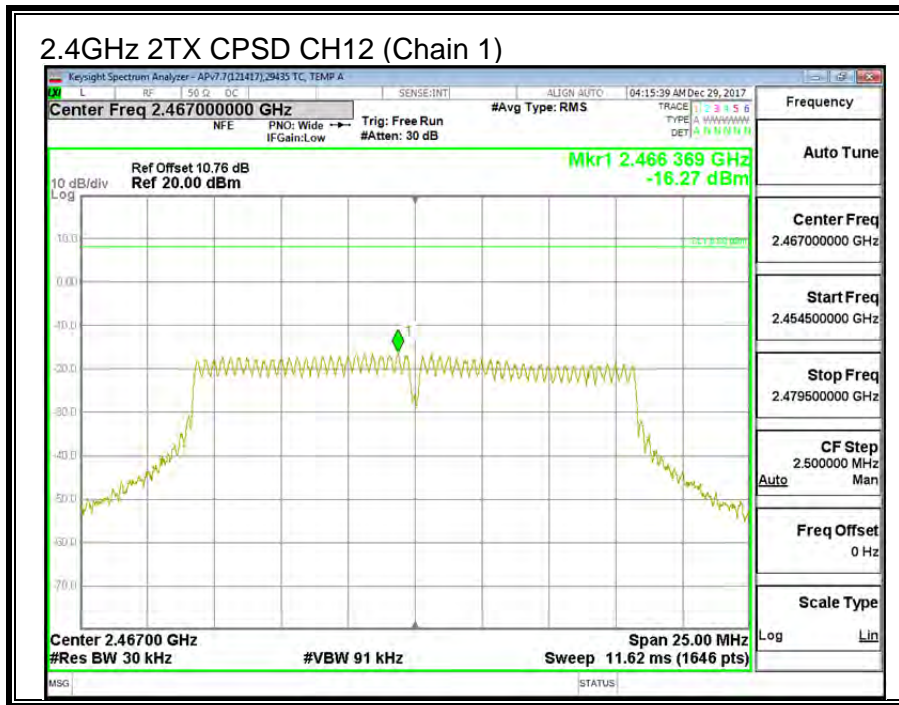
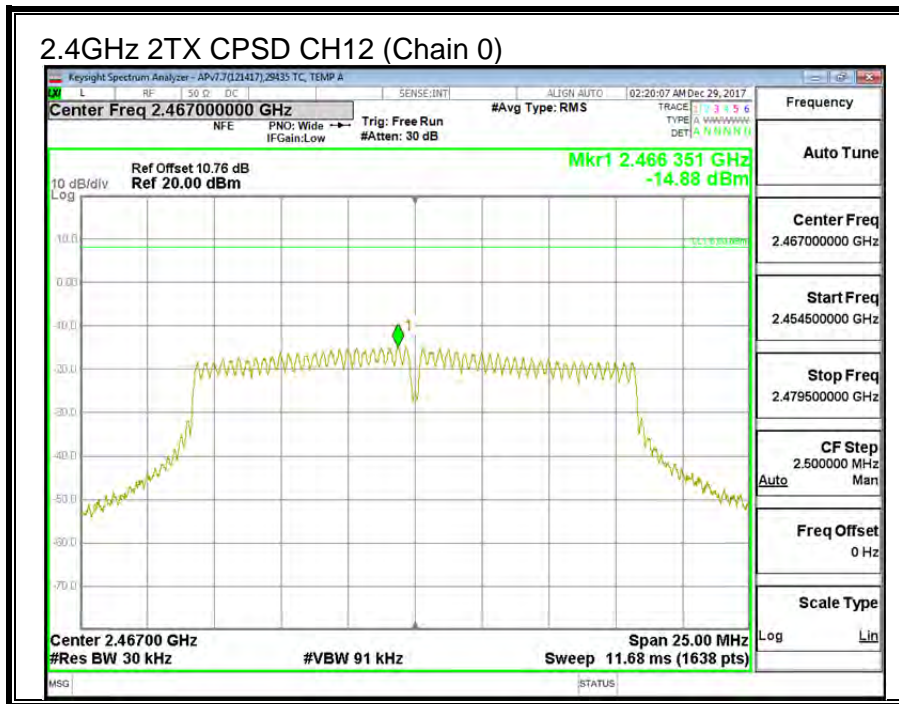

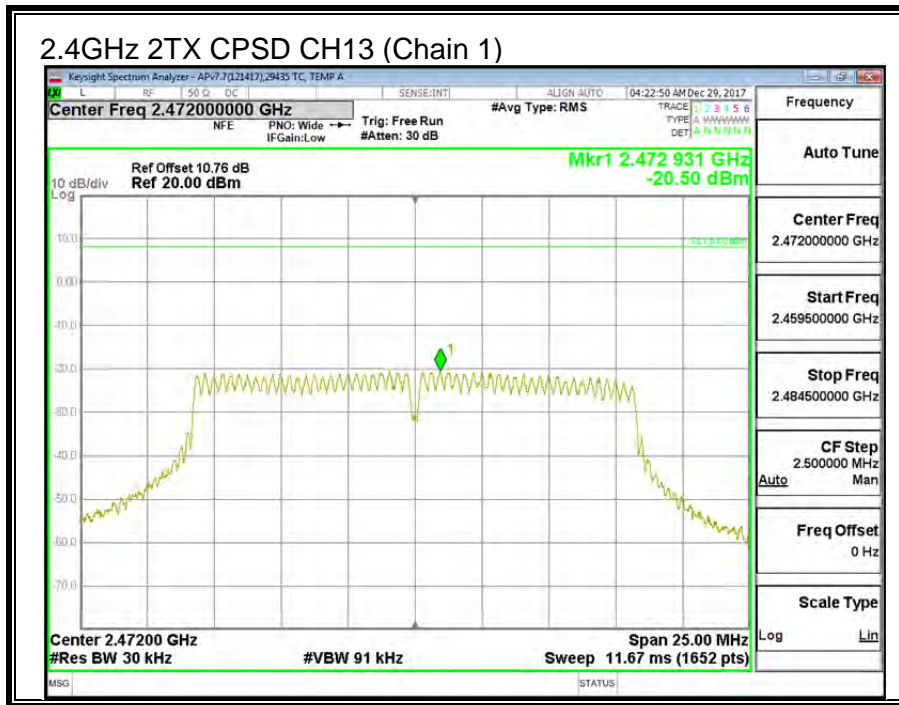
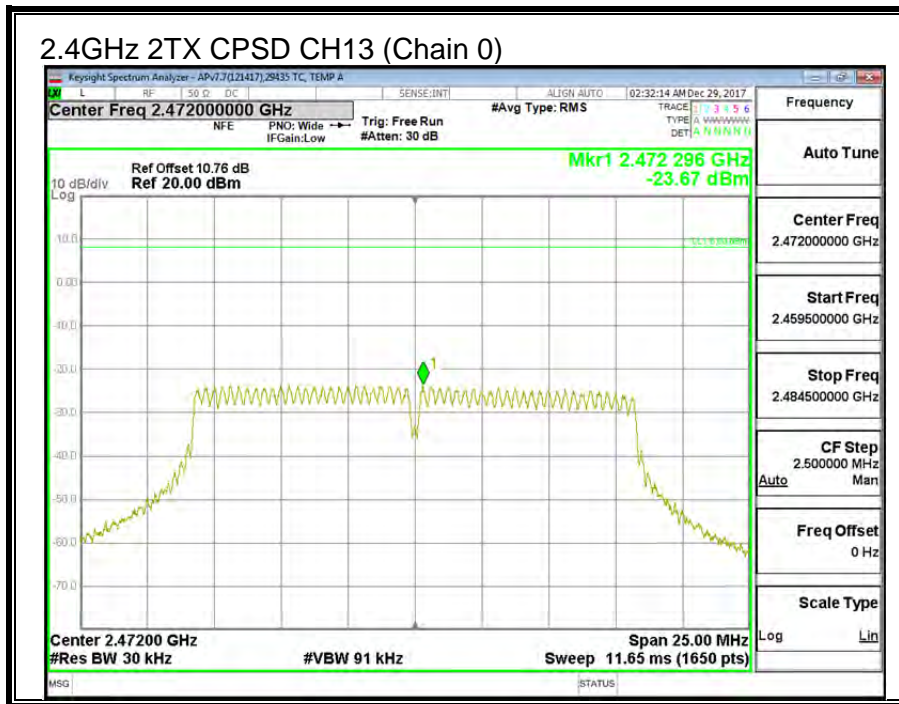

9.3.5. CONDUCTED BANEDGE AND SPURIOUS EMISSIONS

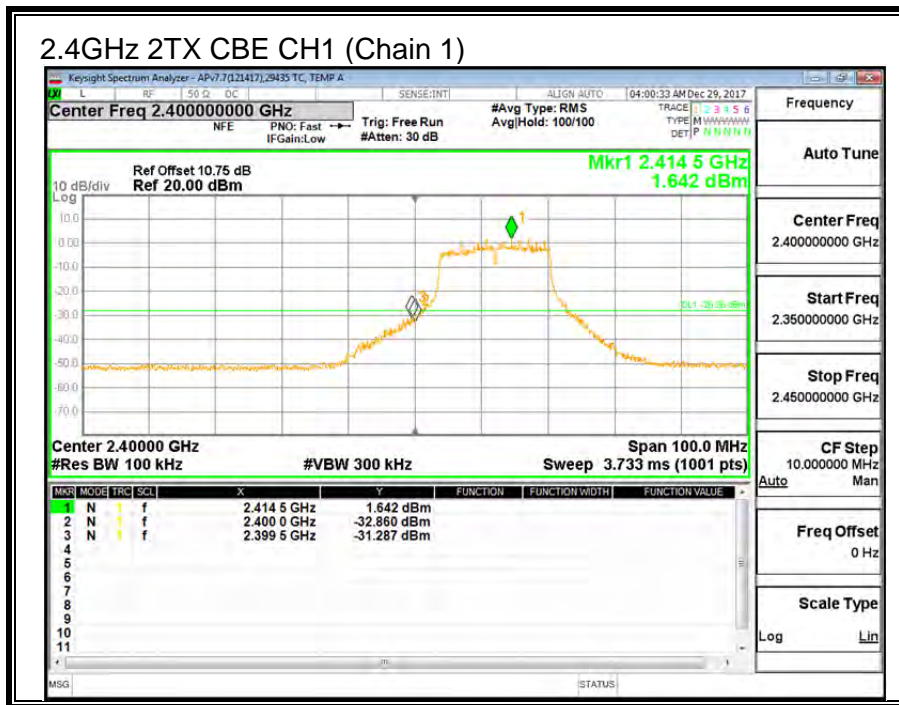
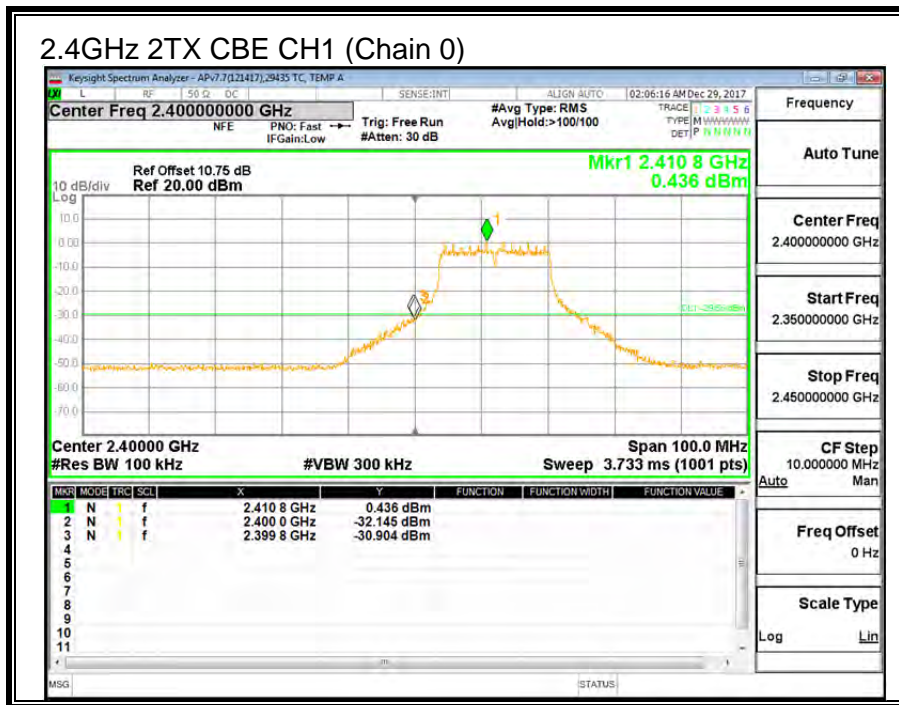

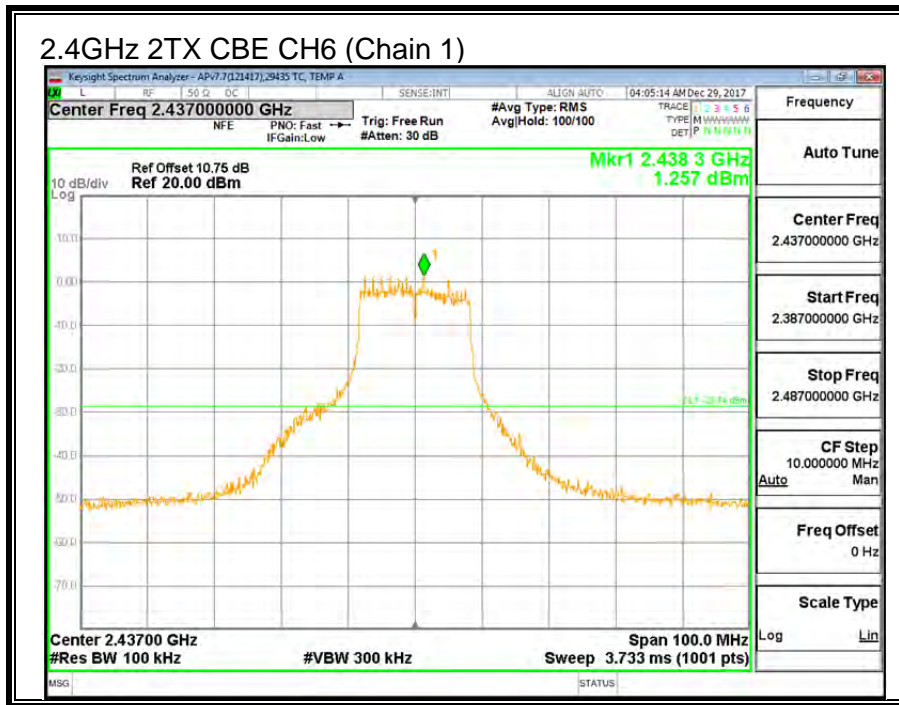
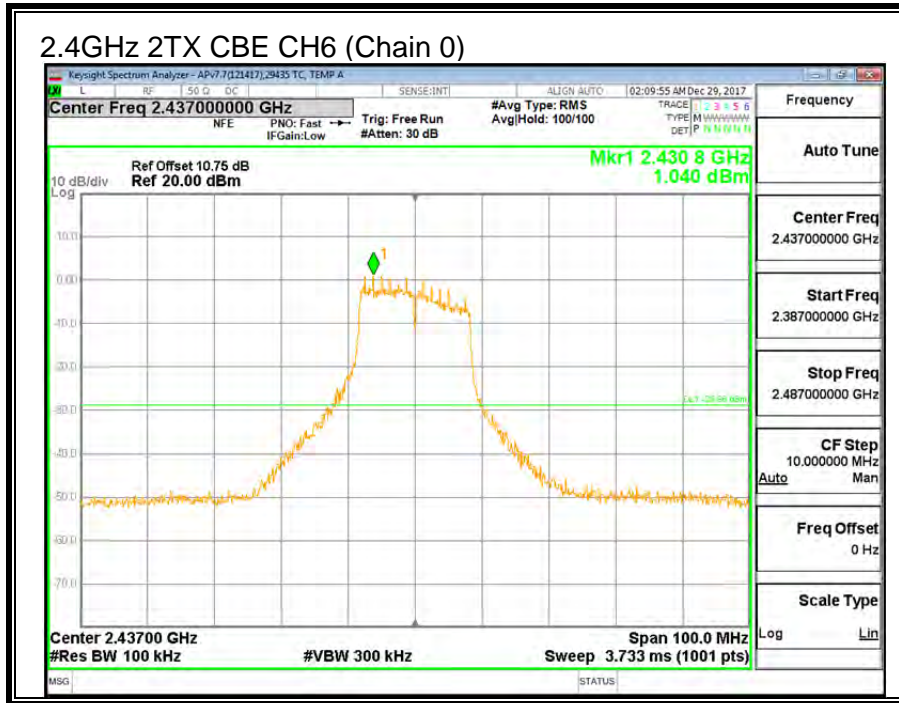

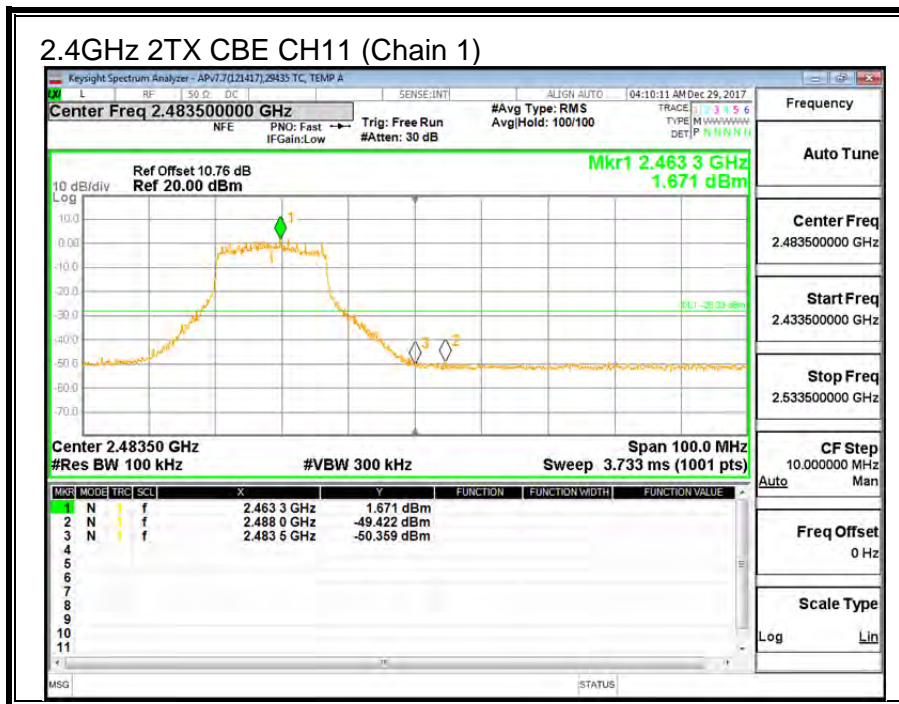
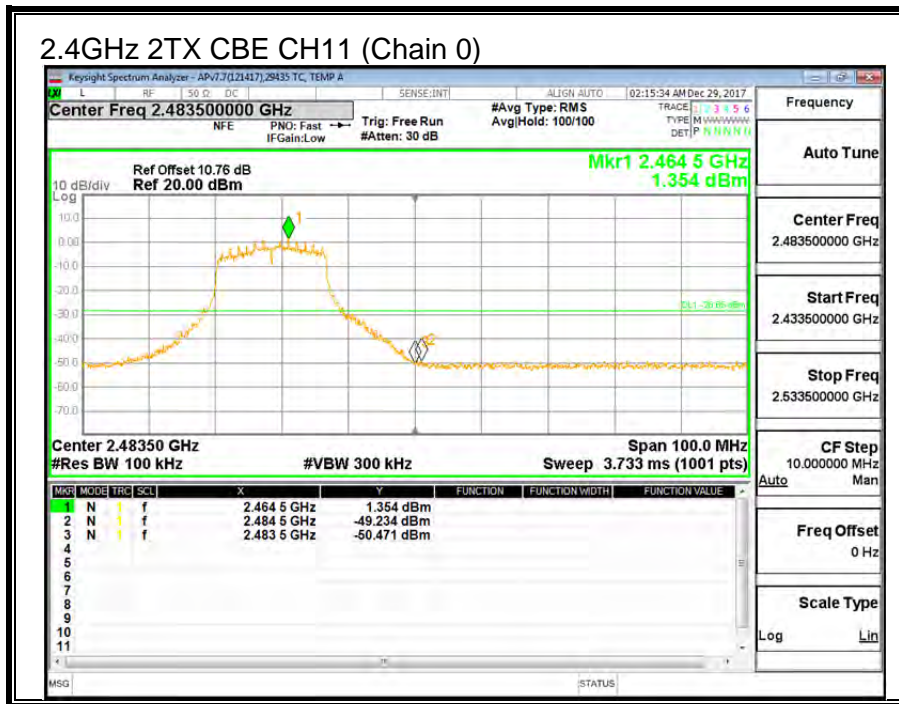

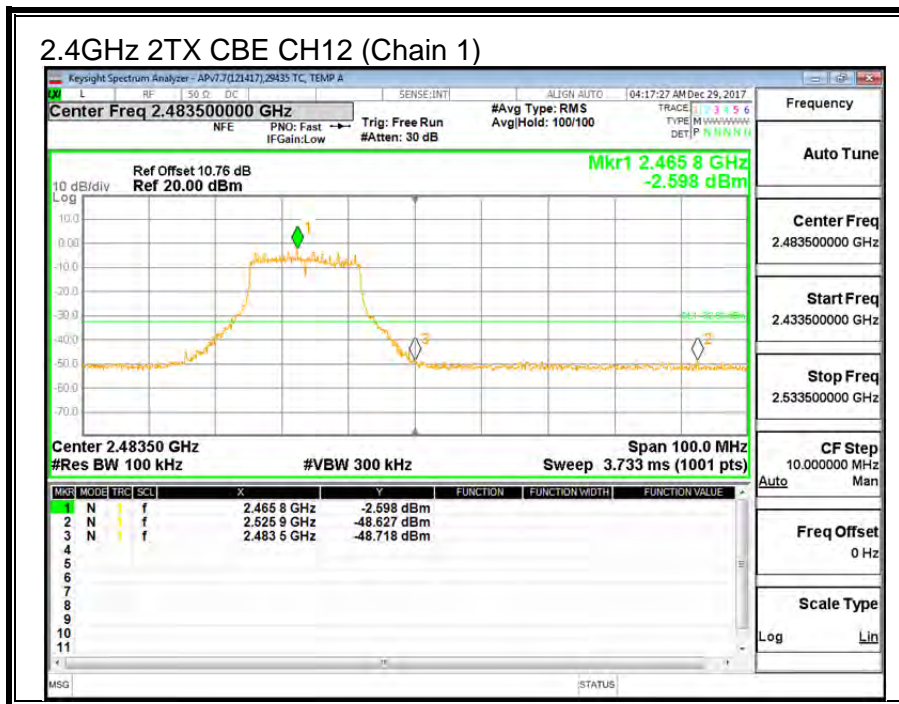
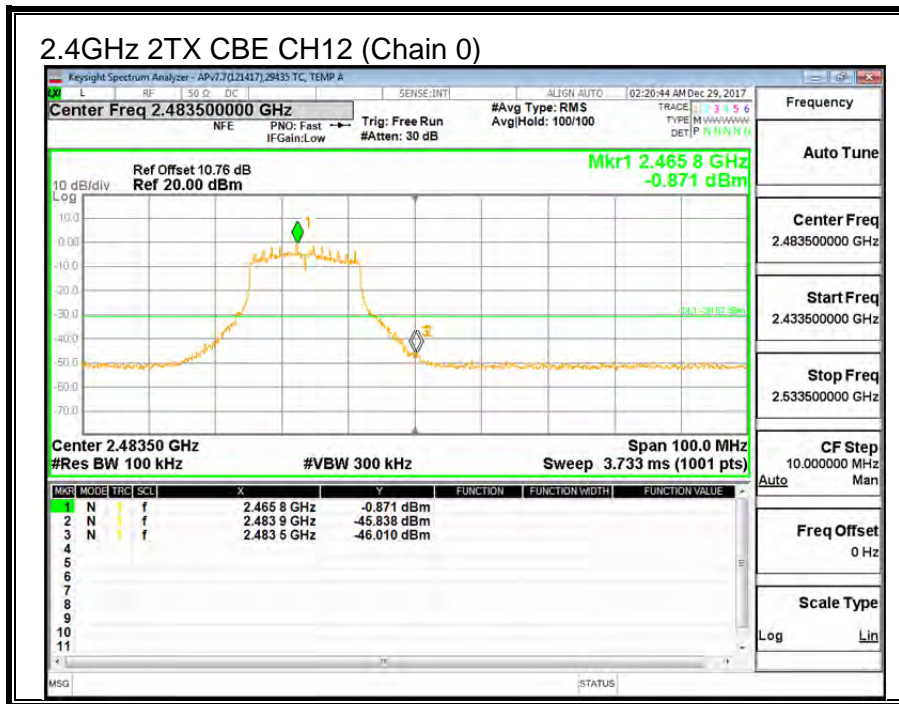

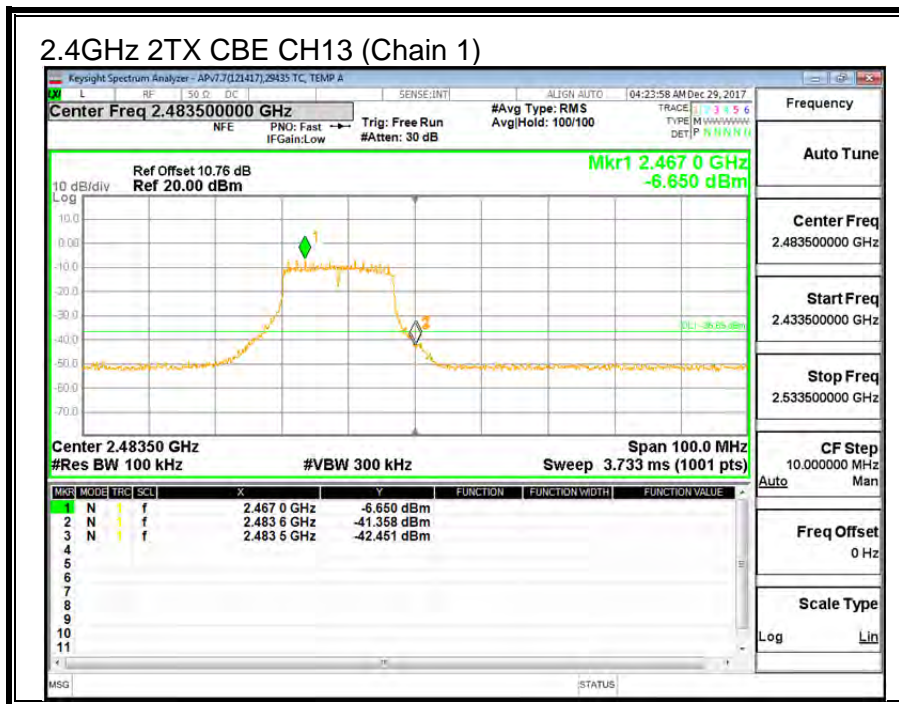
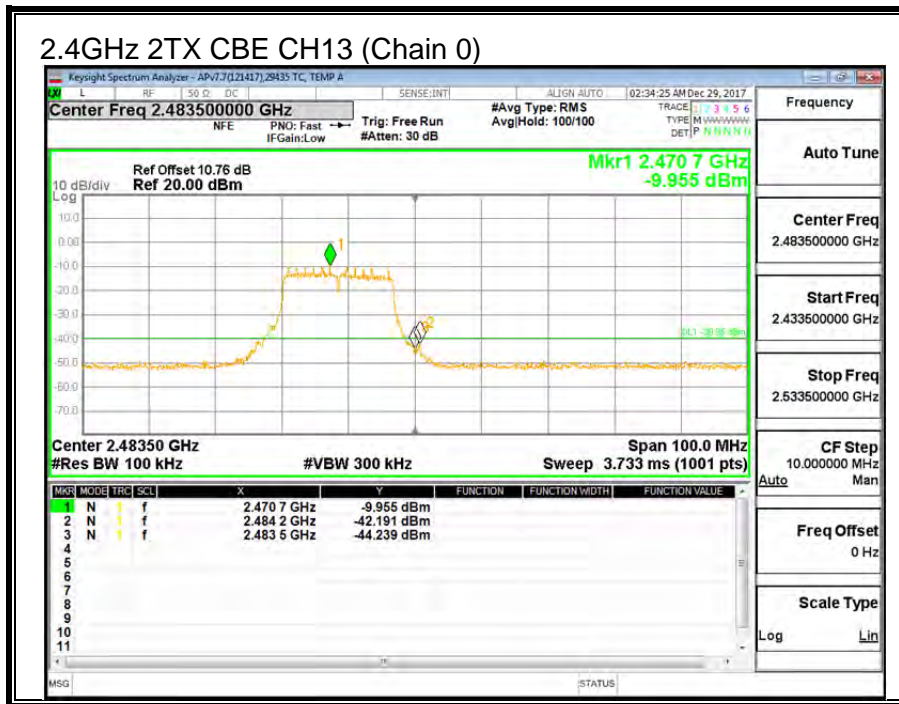

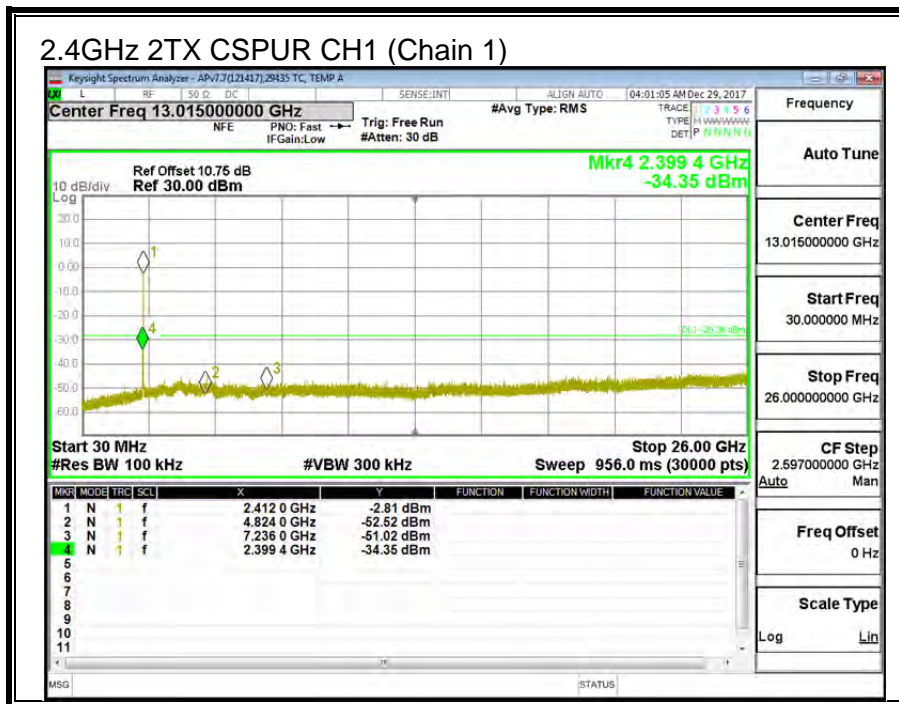
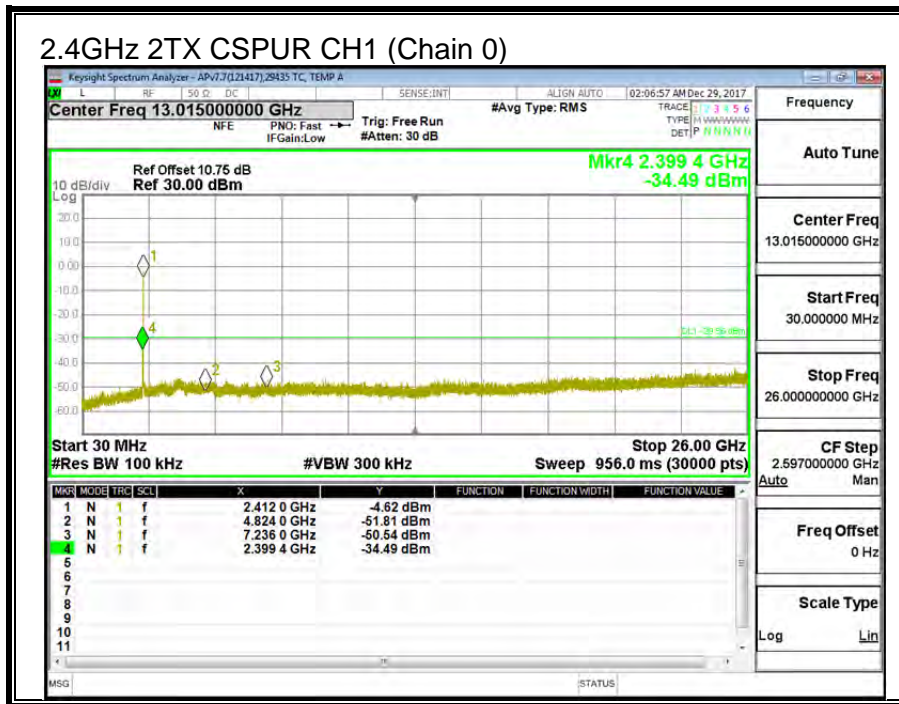

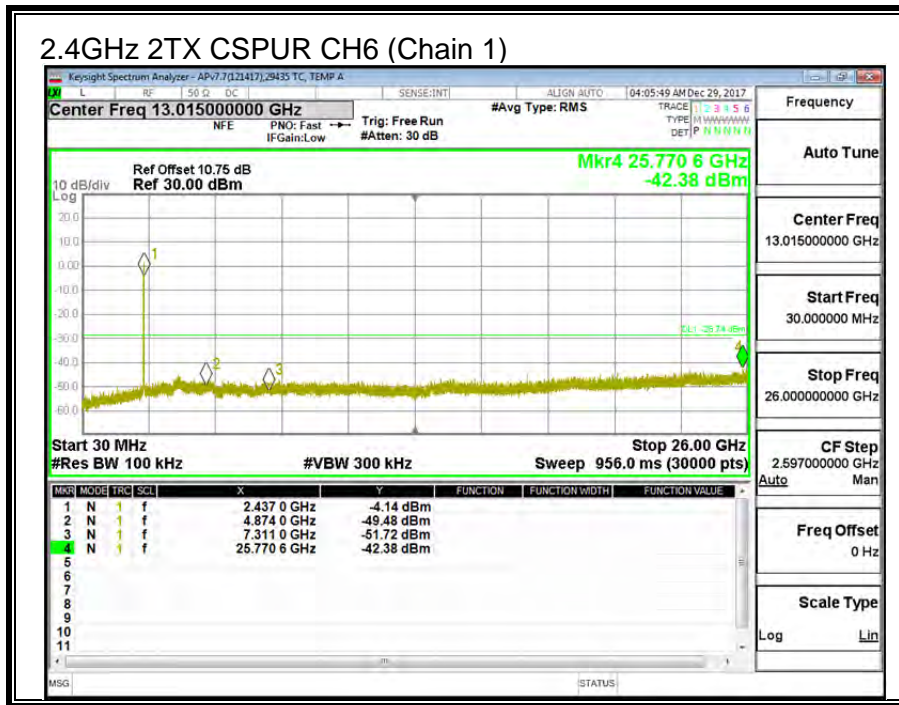
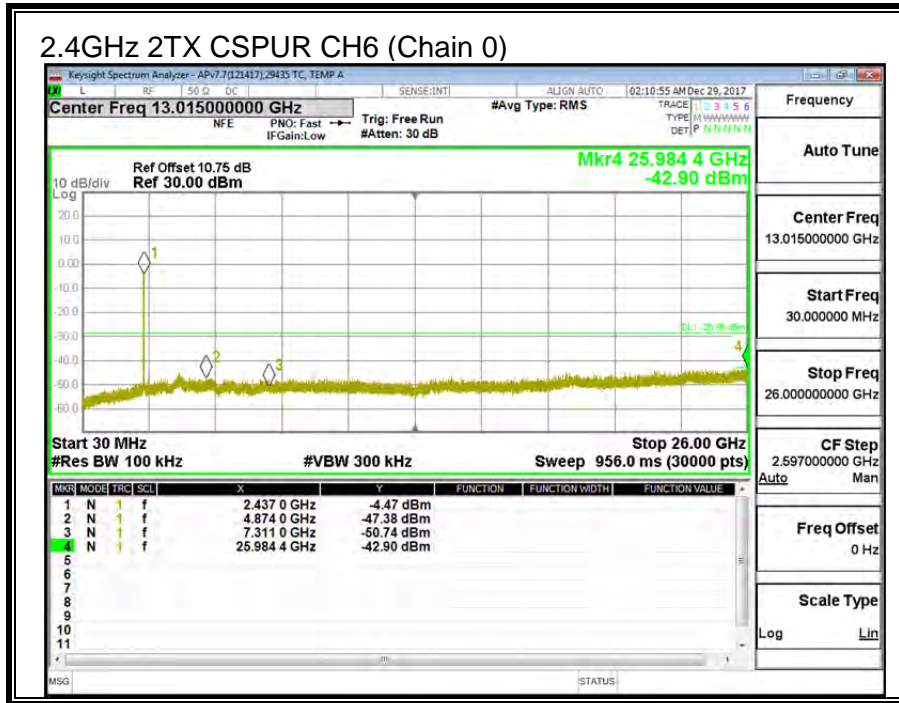

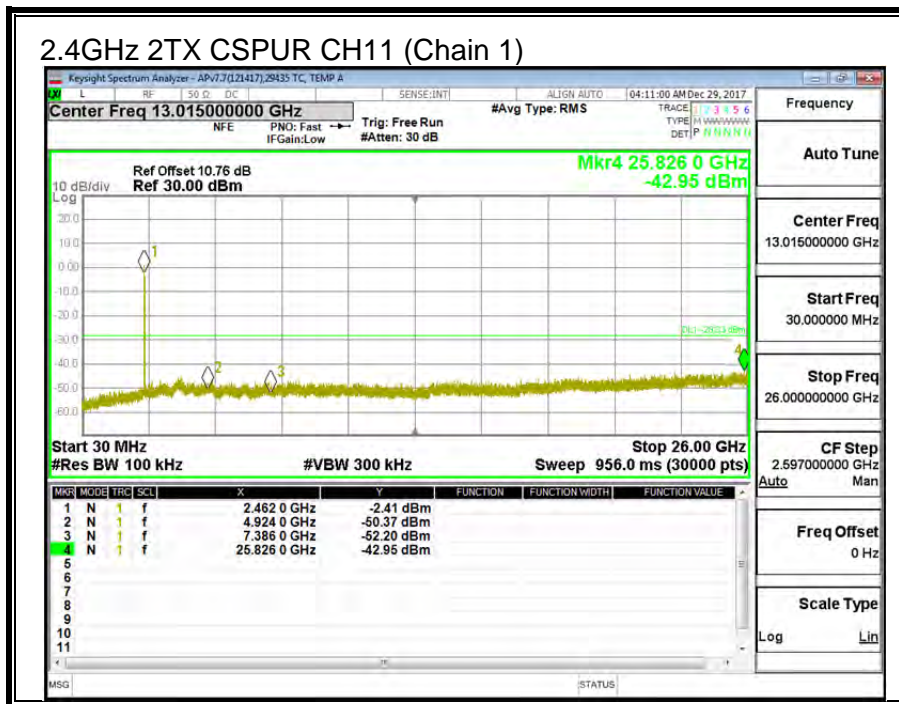
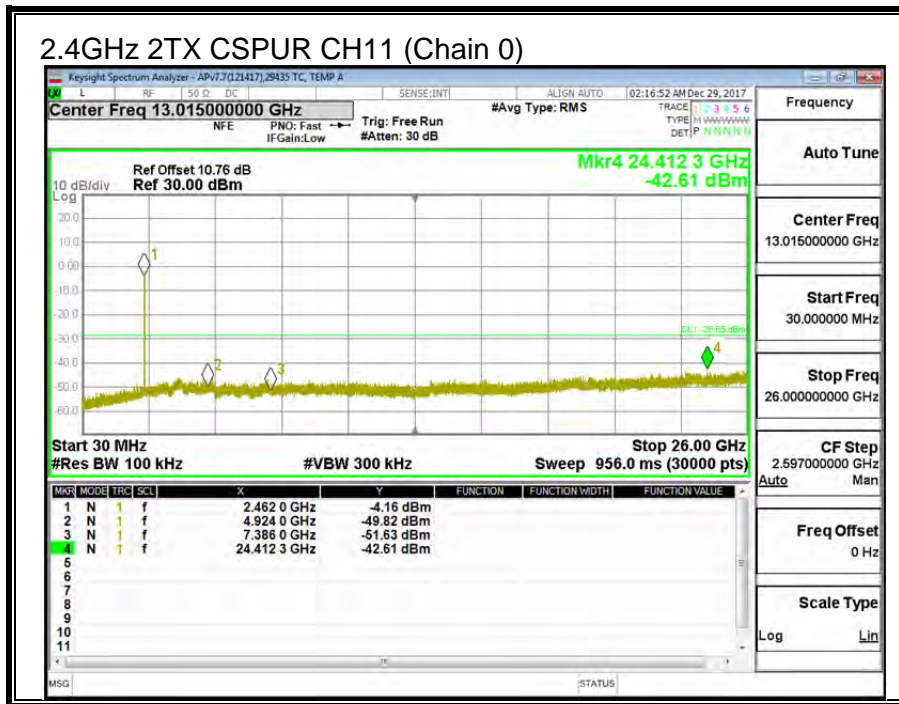

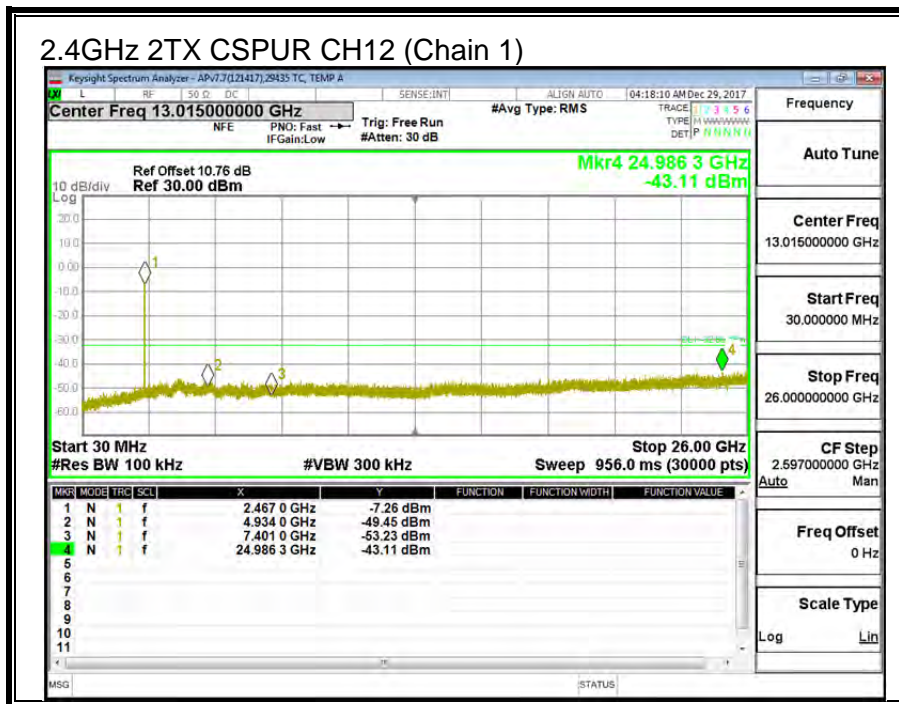
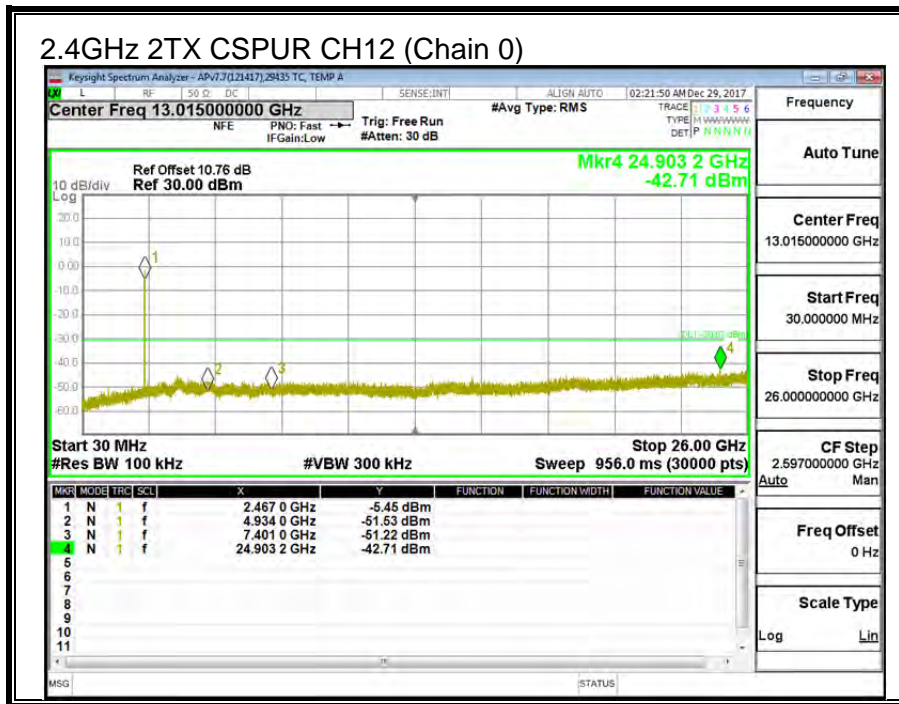

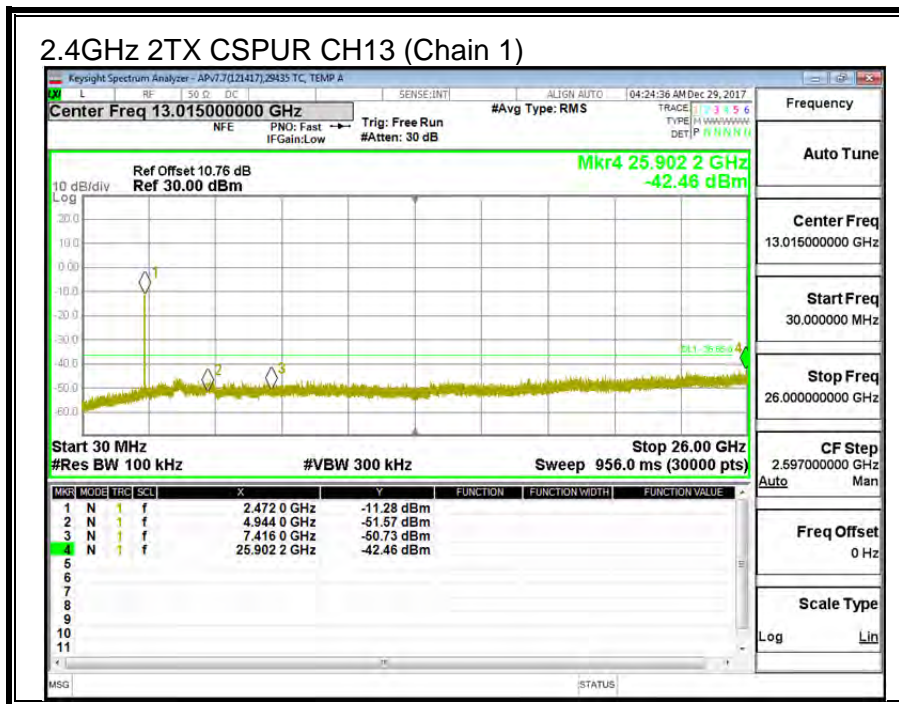
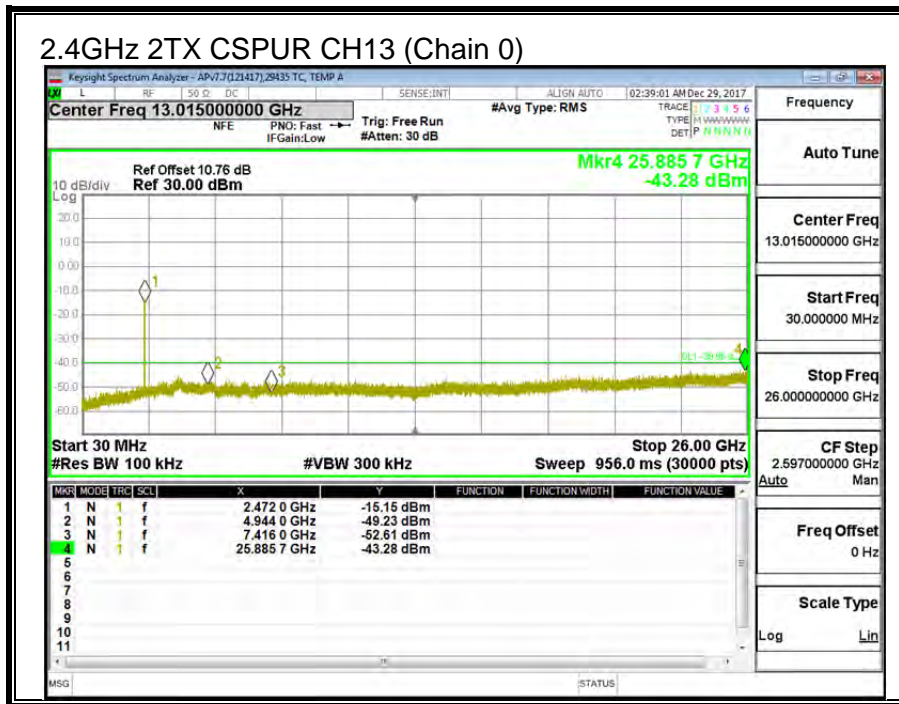

9.4. 11n HT20 2TX CDD MIMO MODE IN THE 2.4GHz BAND

9.4.1. 6 dB BANDWIDTH

LIMITS

FCC §15.247 (a) (2)

The minimum 6 dB bandwidth shall be at least 500 kHz.

RESULTS

Channel	Frequency	6 dB BW Chain 0 (MHz)	6 dB BW Chain 1 (MHz)	Minimum Limit (MHz)
CH1	2412	17.64	17.72	0.5
CH6	2437	17.72	17.64	0.5
CH11	2462	17.64	17.60	0.5
CH12	2467	17.60	17.60	0.5
CH13	2472	17.64	17.60	0.5

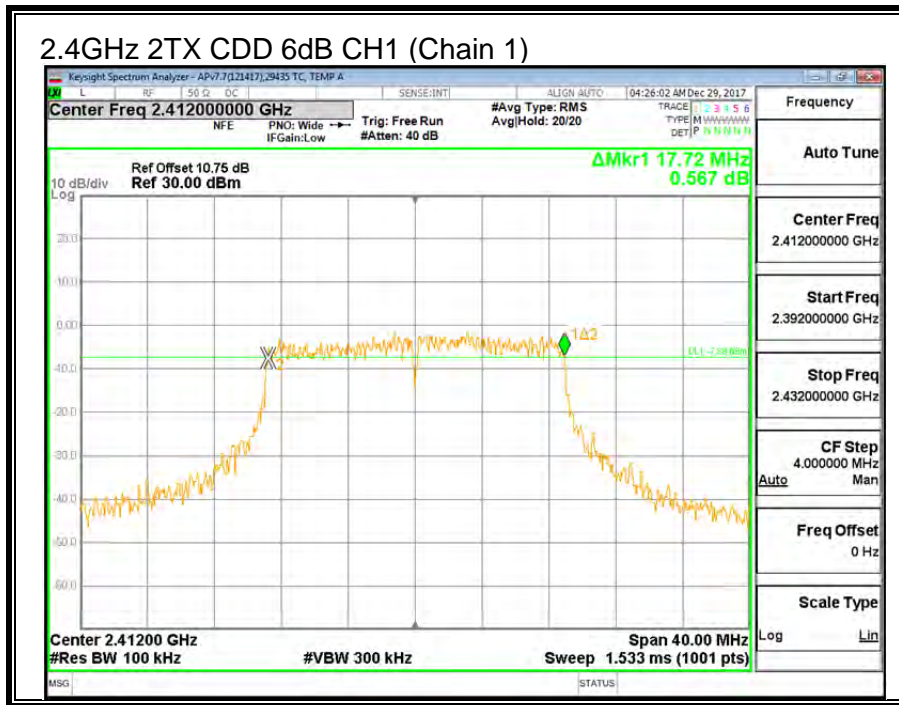
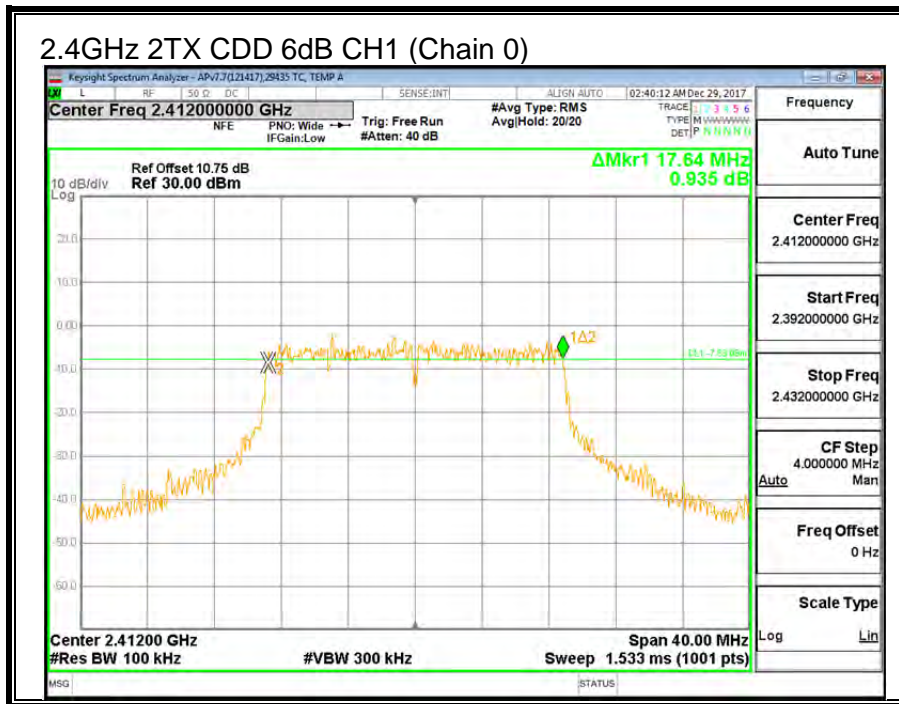

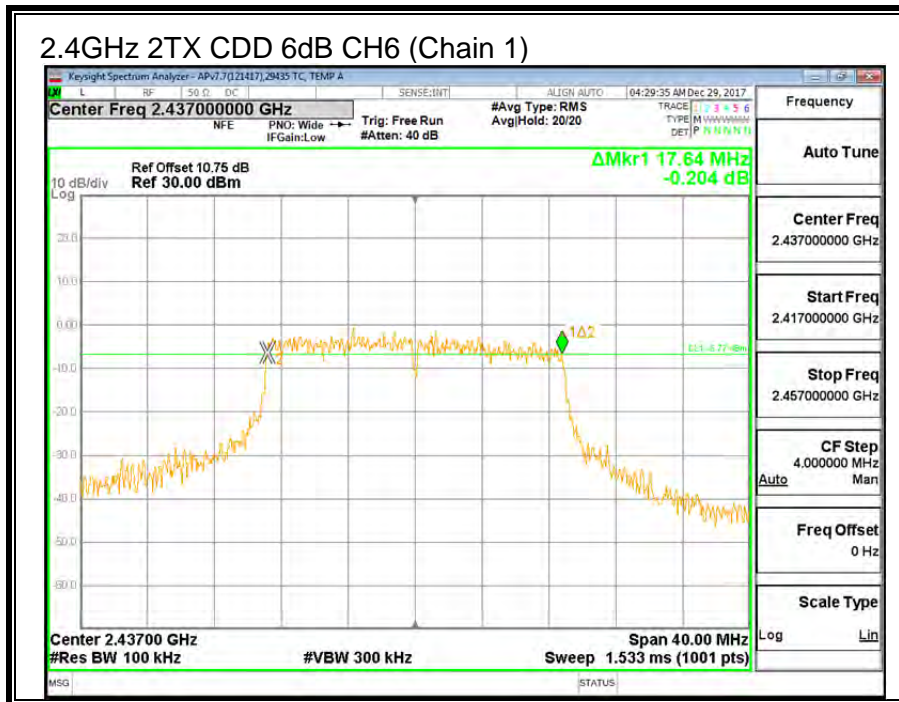
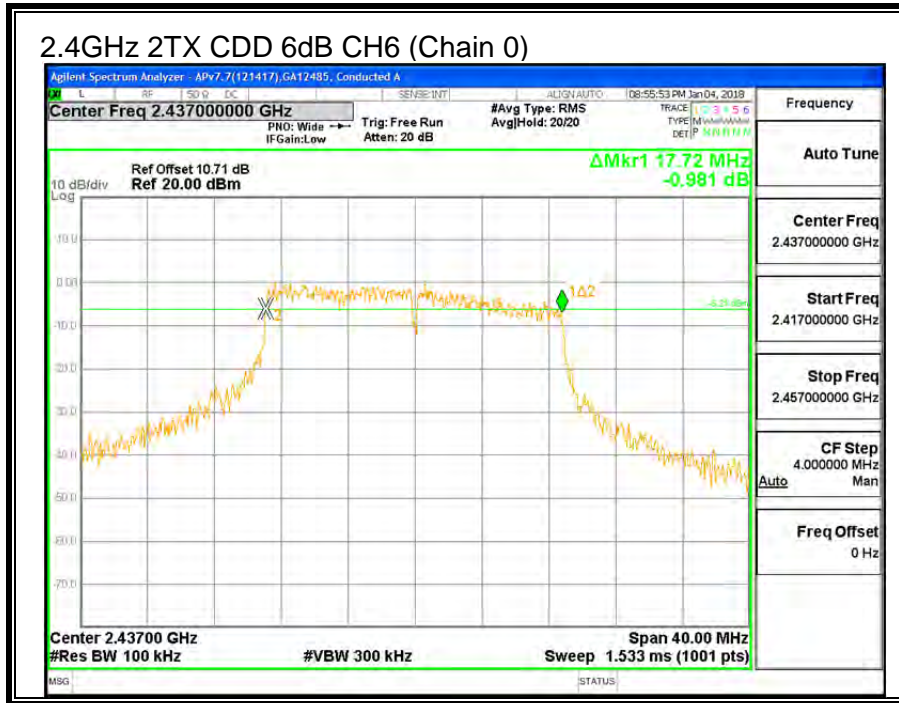

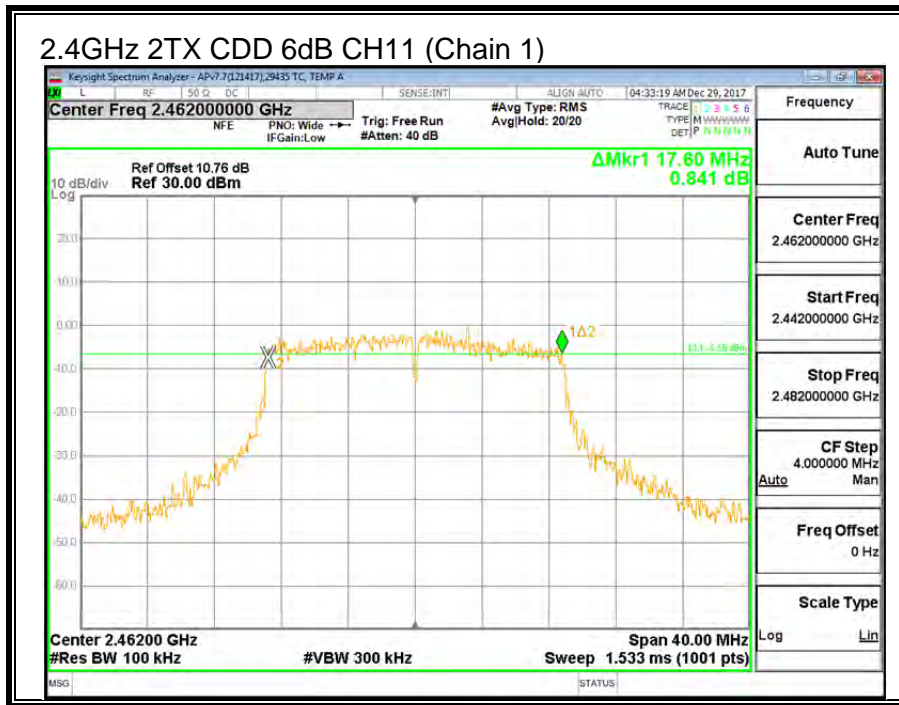
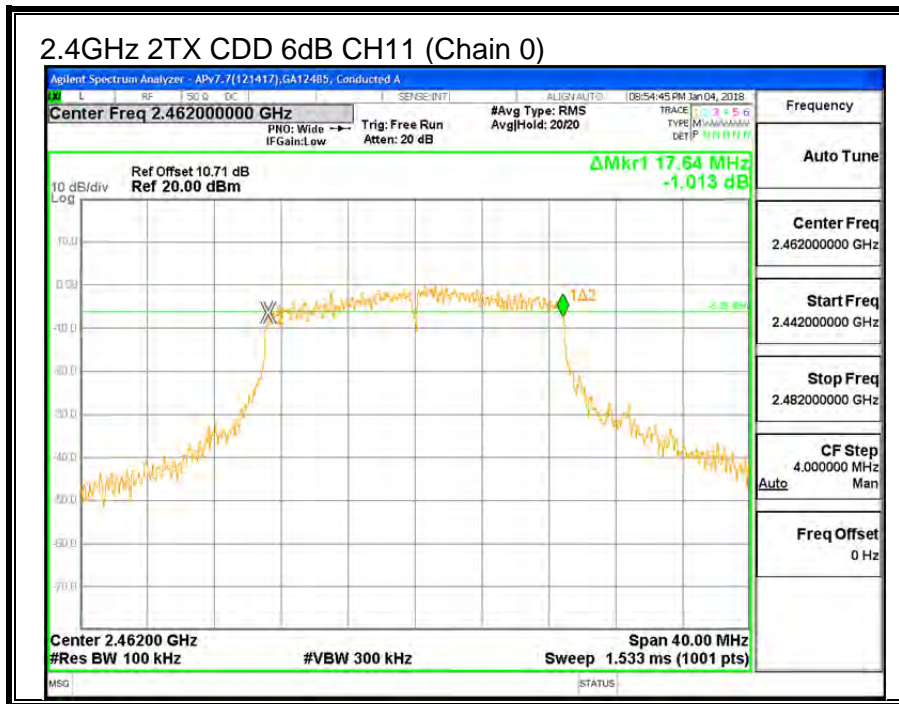

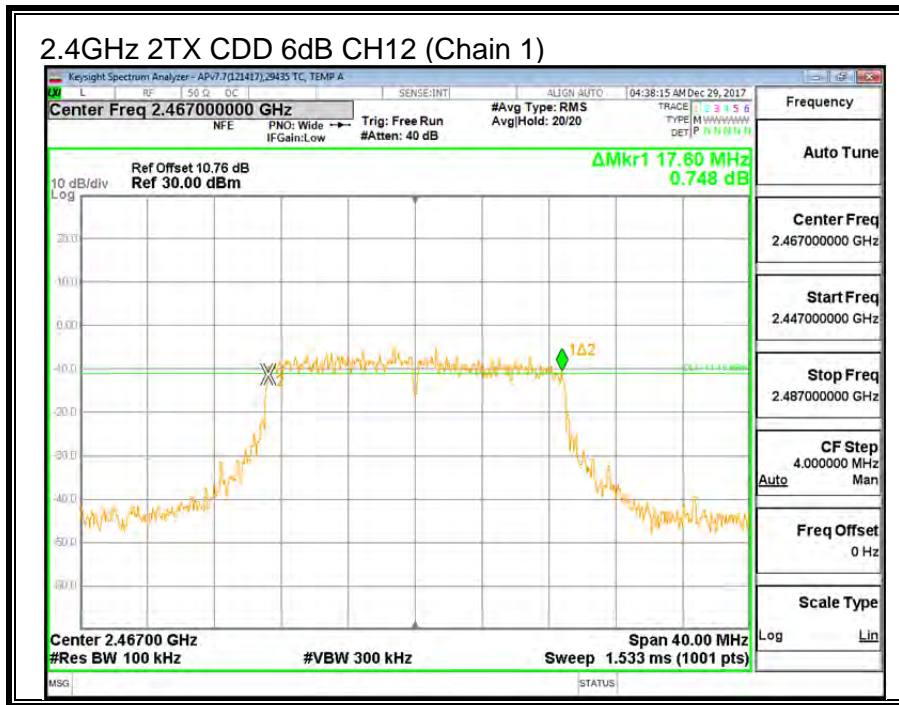
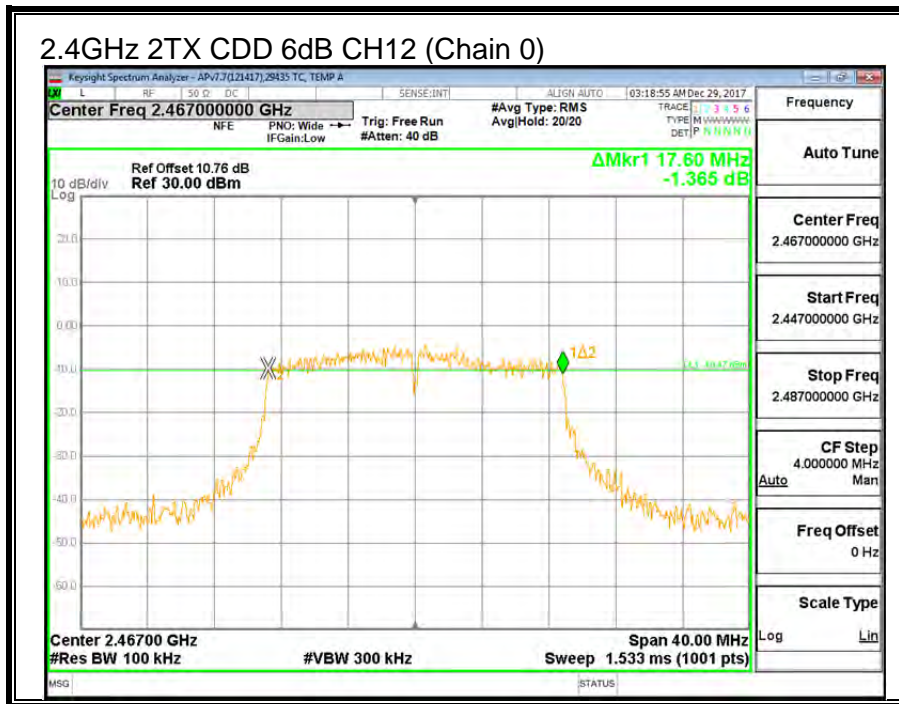

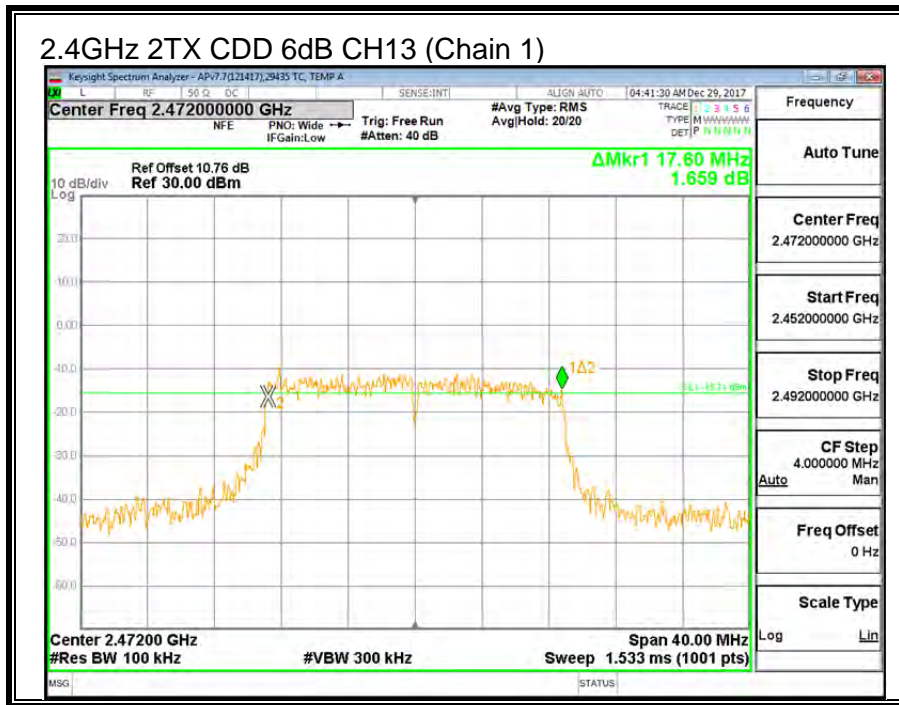
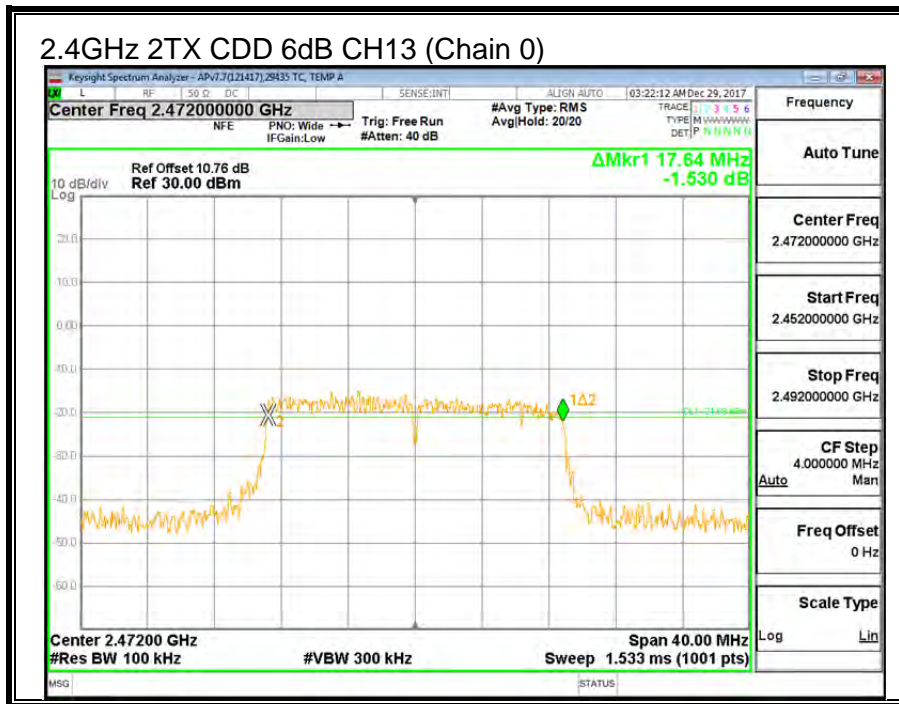

9.4.2. 99% BANDWIDTH

LIMITS

None; for reporting purposes only.

RESULTS

Channel	Frequency (MHz)	99% Bandwidth Chain 0 (MHz)	99% Bandwidth Chain 1 (MHz)
CH1	2412	17.856	17.705
CH6	2437	17.705	17.832
CH11	2462	17.514	17.680
CH12	2467	17.584	17.800
CH13	2472	17.885	17.709

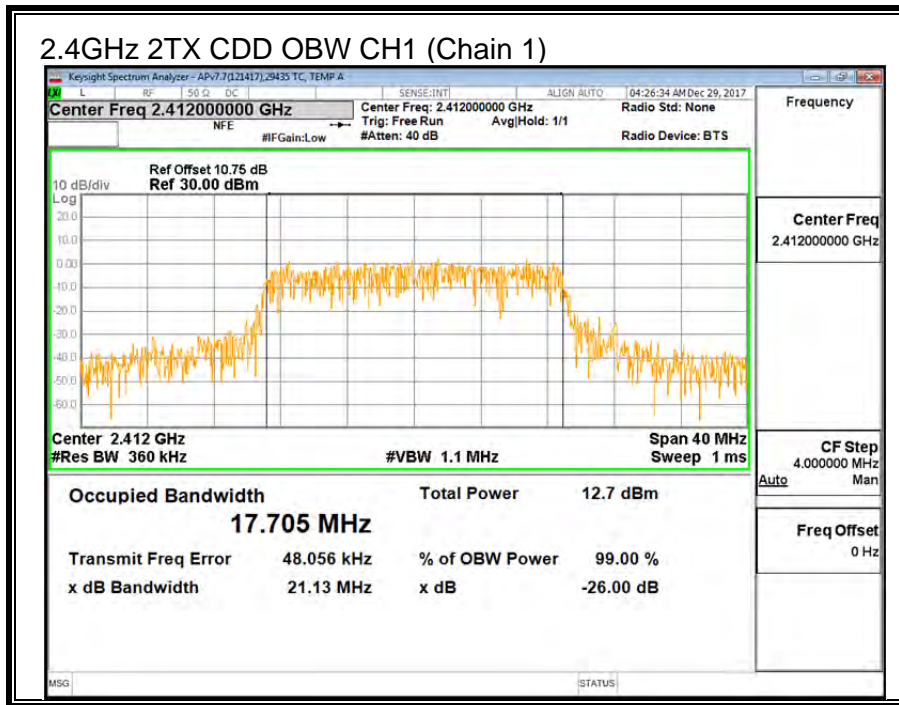
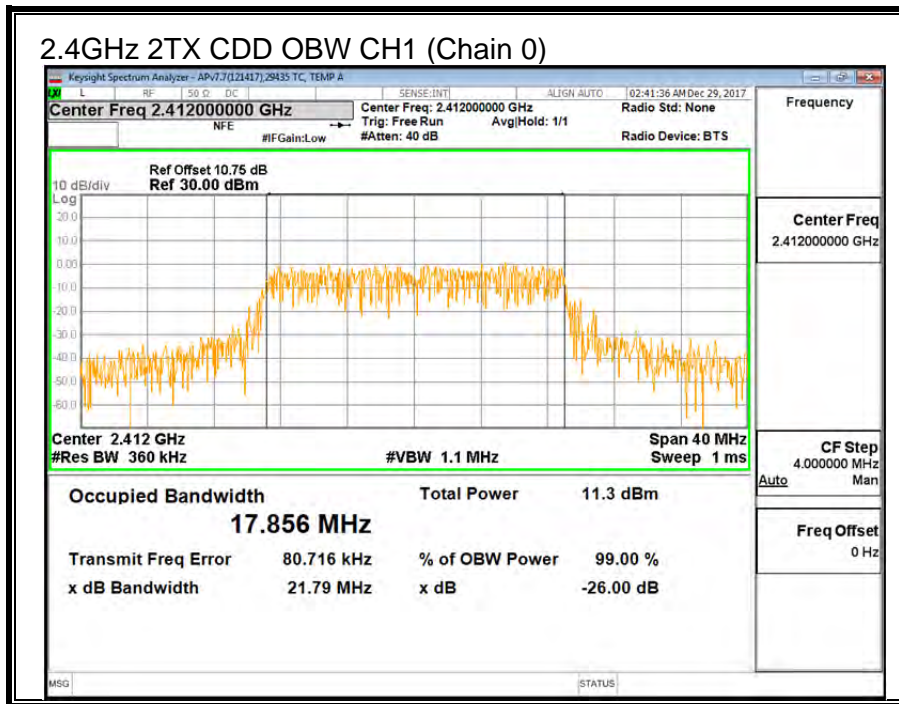

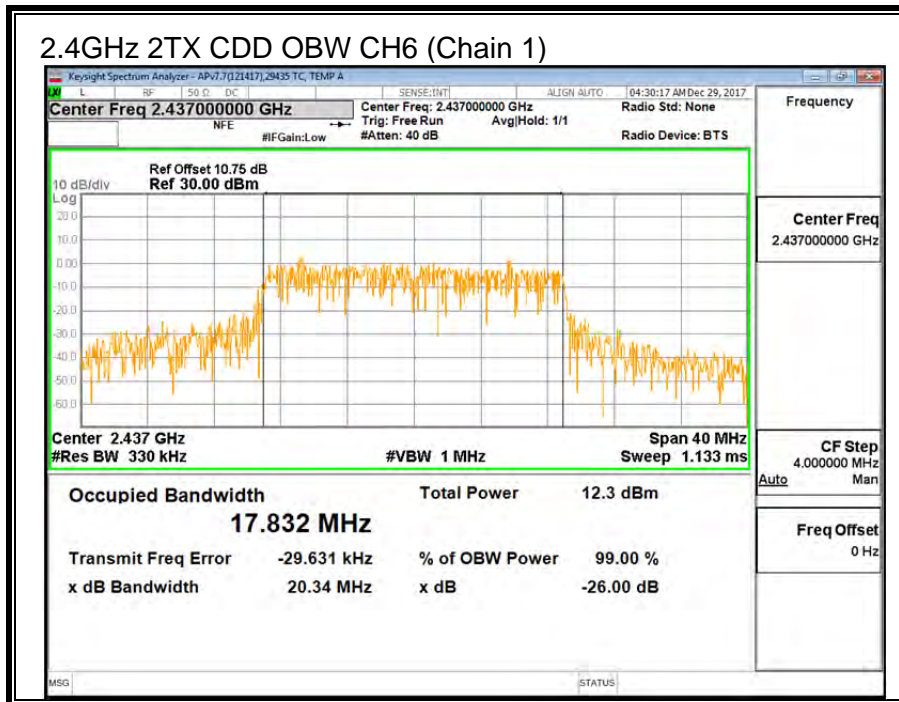
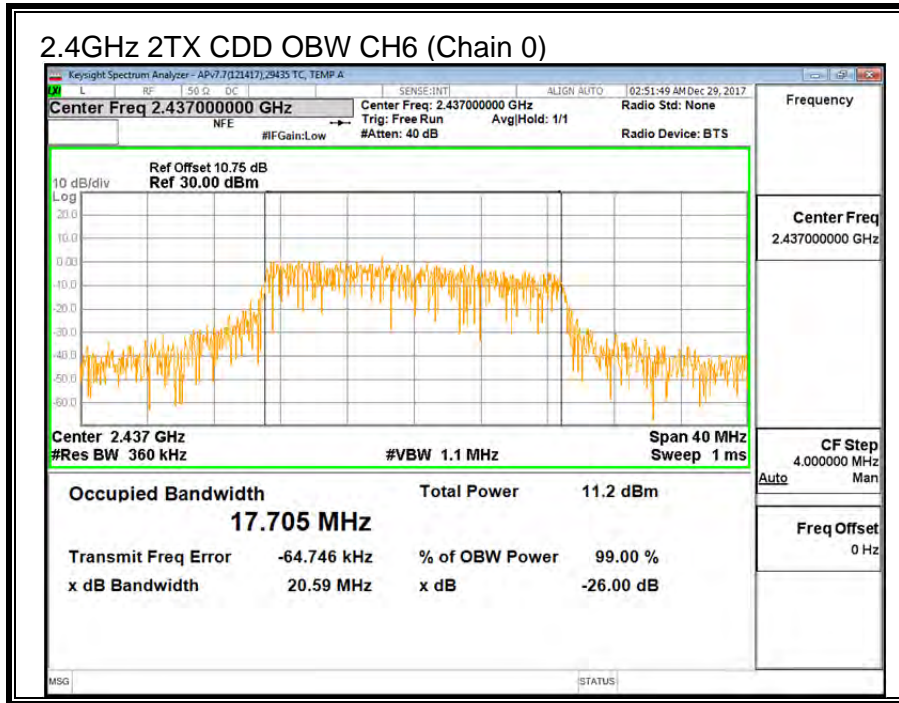

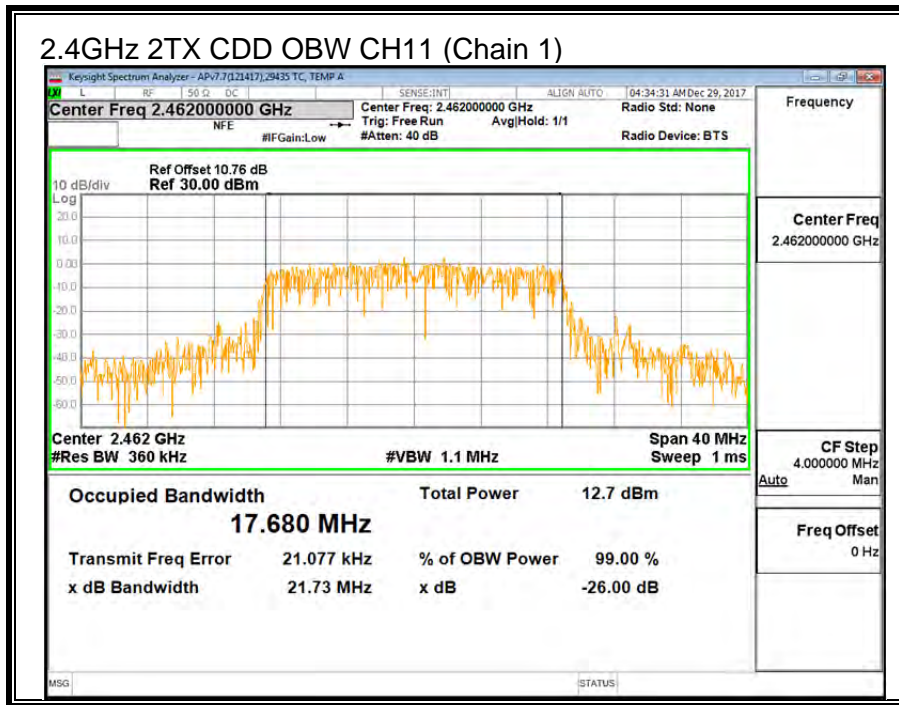
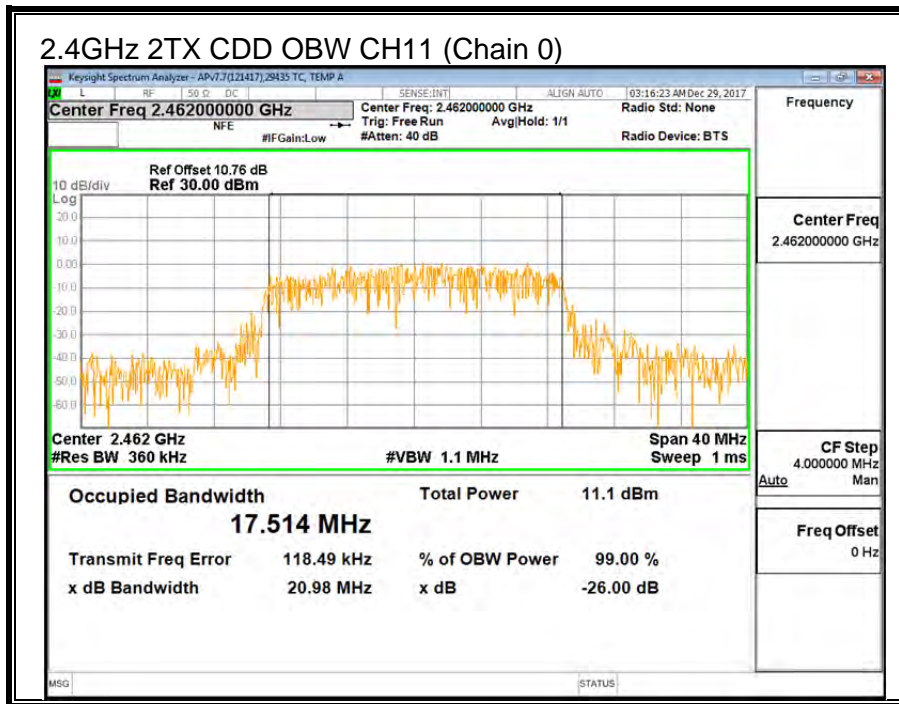

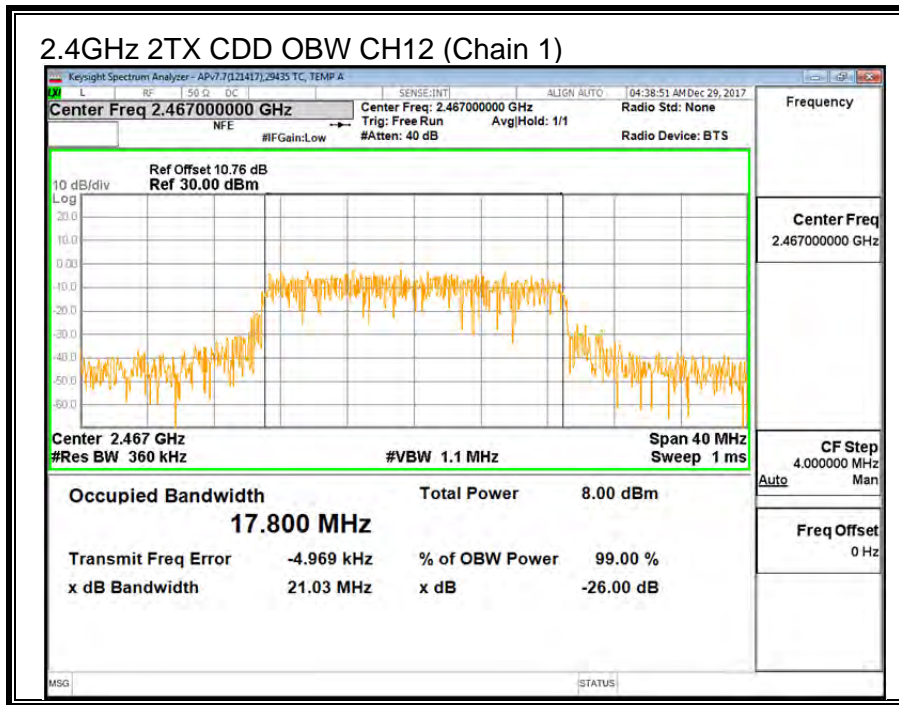
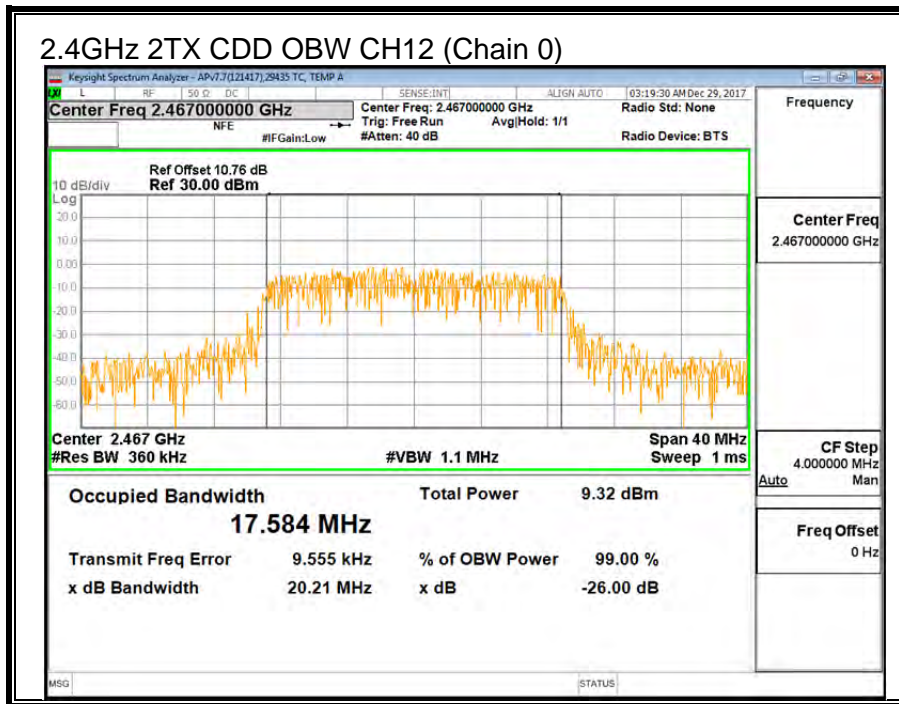

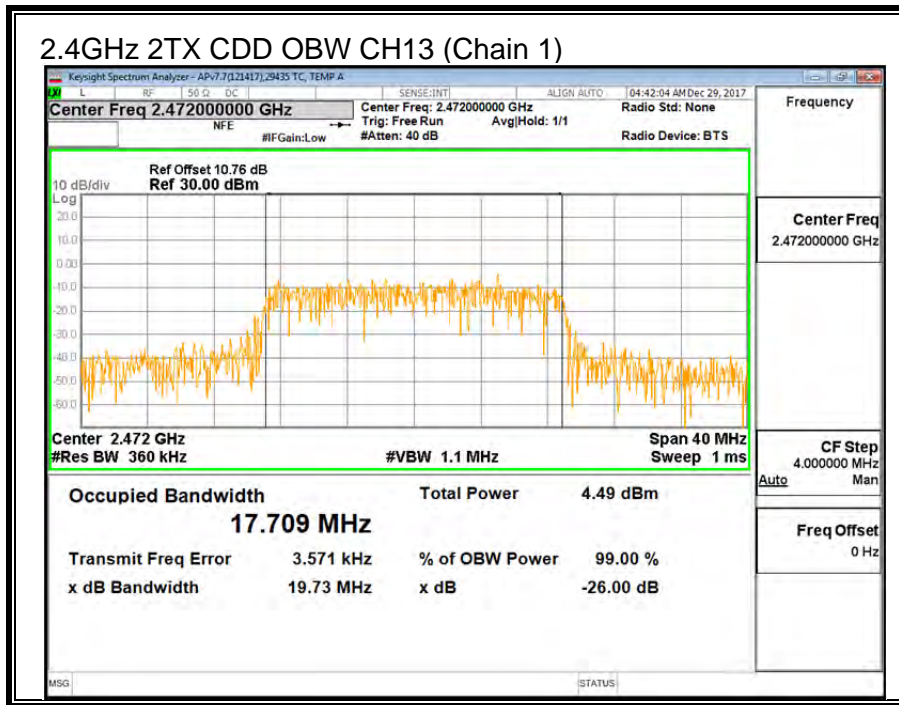
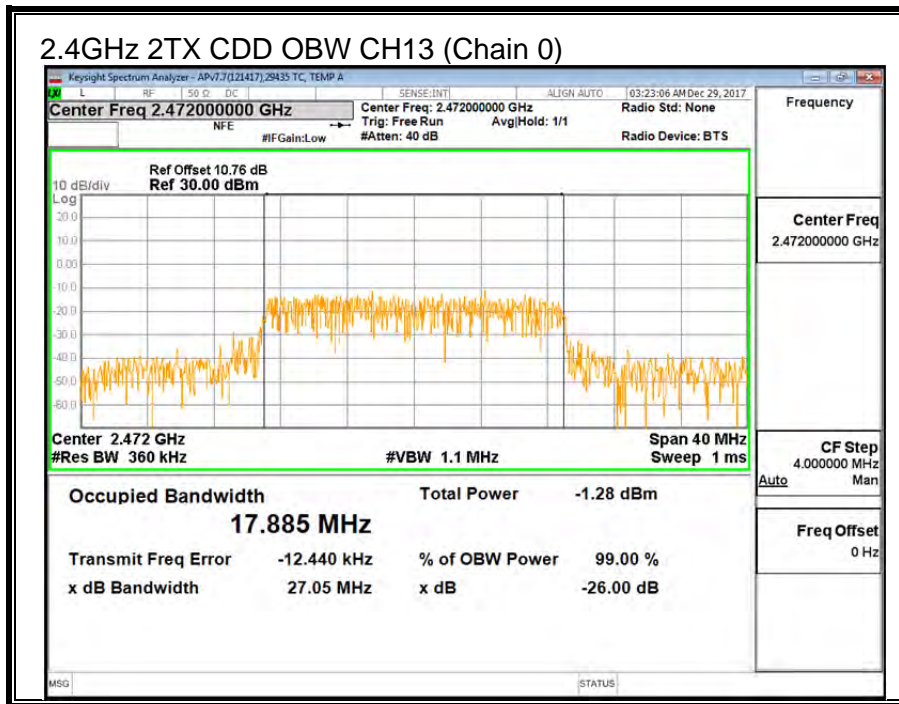

9.4.3. OUTPUT POWER

LIMITS

FCC §15.247 (b) (3)

For systems using digital modulation in the 2400–2483.5 MHz, and 5725–5850 MHz bands: 1 Watt, based on the use of antennas with directional gains that do not exceed 6 dBi. If transmitting antennas of directional gain greater than 6 dBi are used, the conducted output power from the intentional radiator shall be reduced by the amount in dB that the directional gain of the antenna exceeds 6 dBi.

TEST PROCEDURE

KDB 58074 D01 v04 Section 9.2.3.2

DIRECTIONAL ANTENNA GAIN

The TX chains are uncorrelated and the antenna gain is unequal among the chains. The directional gain is:

Chain 0 Antenna Gain (dBi)	Chain 1 Antenna Gain (dBi)	Uncorrelated Chains Directional Gain (dBi)
-1.90	-8.80	-4.10

RESULTS

ID:	GE43578	Date:	1/7/17
------------	---------	--------------	--------

Limits

Channel	Frequency (MHz)	Directional Gain (dBi)	FCC Power Limit (dBm)	IC Power Limit (dBm)	IC EIRP Limit (dBm)	Max Power (dBm)
CH1	2412	-4.10	30.00	30	36	30.00
CH6	2437	-4.10	30.00	30	36	30.00
CH11	2462	-4.10	30.00	30	36	30.00
CH12	2467	-4.10	30.00	30	36	30.00
CH13	2472	-4.10	30.00	30	36	30.00

Results

Channel	Frequency (MHz)	Chain 0 Meas Power (dBm)	Chain 1 Meas Power (dBm)	Total Corr'd Power (dBm)	Power Limit (dBm)	Margin (dB)
CH1	2412	11.96	13.05	15.55	30.00	-14.45
CH6	2437	11.96	12.96	15.50	30.00	-14.50
CH11	2462	11.37	13.23	15.41	30.00	-14.59
CH12	2467	9.26	8.01	11.69	30.00	-18.31
CH13	2472	-0.45	-1.55	2.05	30.00	-27.95

Note: the power readings above were measured with gated method, and the measurement was taken only during the ON time. No duty cycle correction was necessary.

9.4.4. POWER SPECTRAL DENSITY

LIMITS

FCC §15.247 (e)

For digitally modulated systems, the power spectral density conducted from the intentional radiator to the antenna shall not be greater than 8 dBm in any 3 KHz band during any time interval of continuous transmissions.

RESULTS

Duty Cycle CF (dB)	0.13	Included in Calculations of Corr'd PSD
---------------------------	------	---

PSD Results

Channel	Frequency (MHz)	Chain 0 Meas (dBm)	Chain 1 Meas (dBm)	Total Corr'd PSD (dBm)	Limit (dBm)	Margin (dB)
CH1	2412	-13.74	-11.83	-9.54	8.0	-17.5
CH6	2437	-12.59	-12.20	-9.25	8.0	-17.3
CH11	2462	-12.34	-11.12	-8.55	8.0	-16.5
CH12	2467	-14.22	-16.50	-12.07	8.0	-20.1
CH13	2472	-25.90	-20.97	-19.63	8.0	-27.6

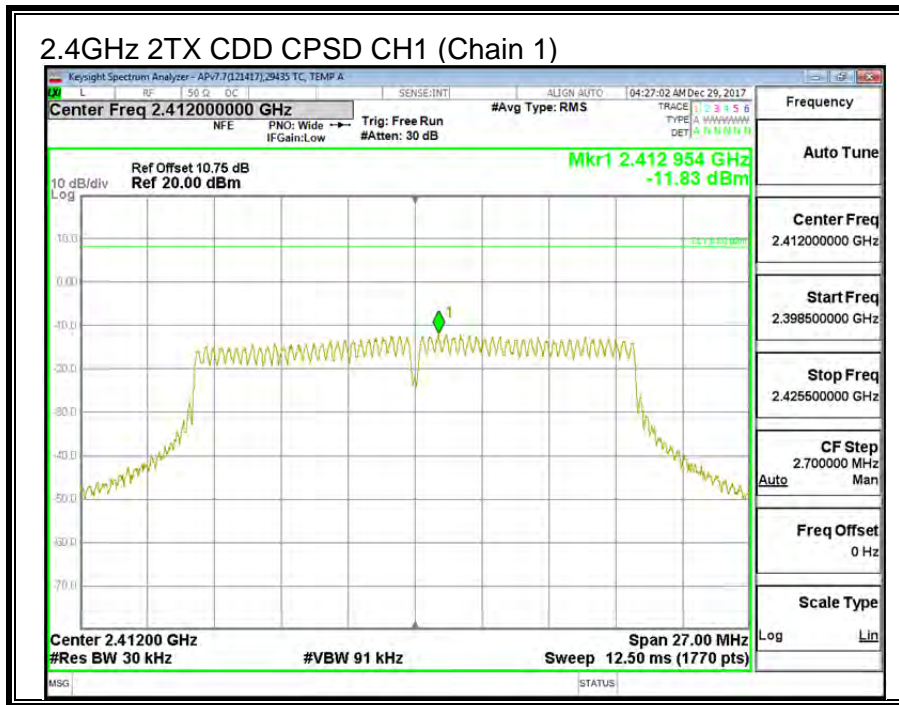
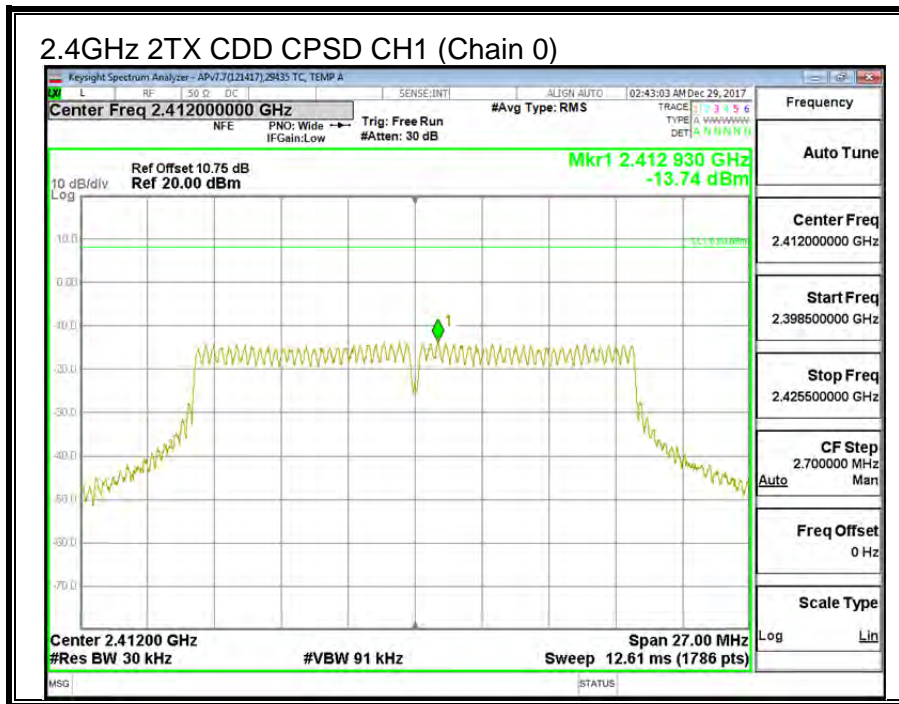

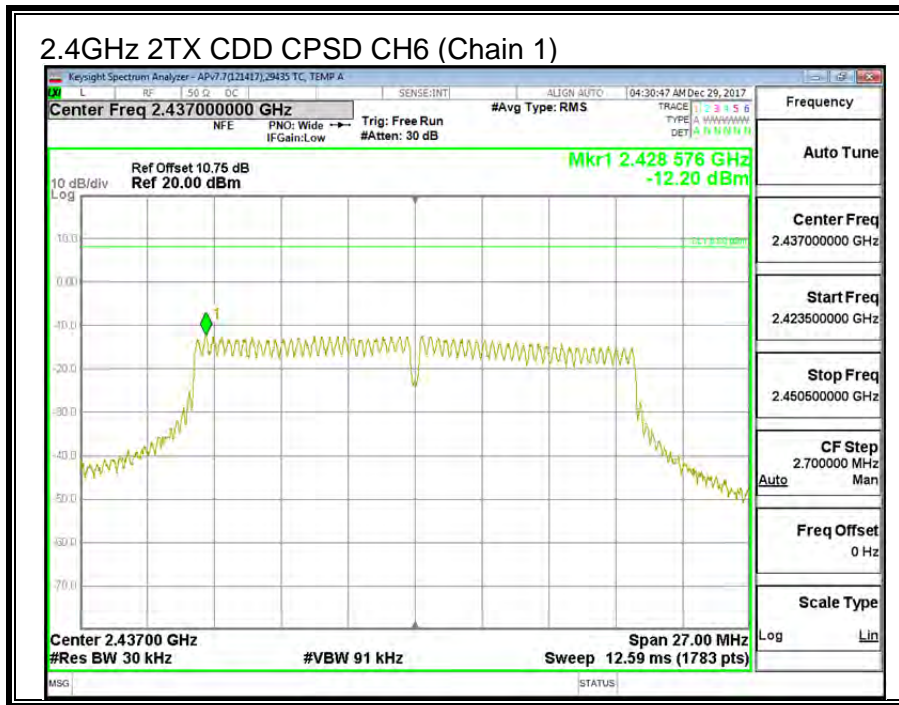
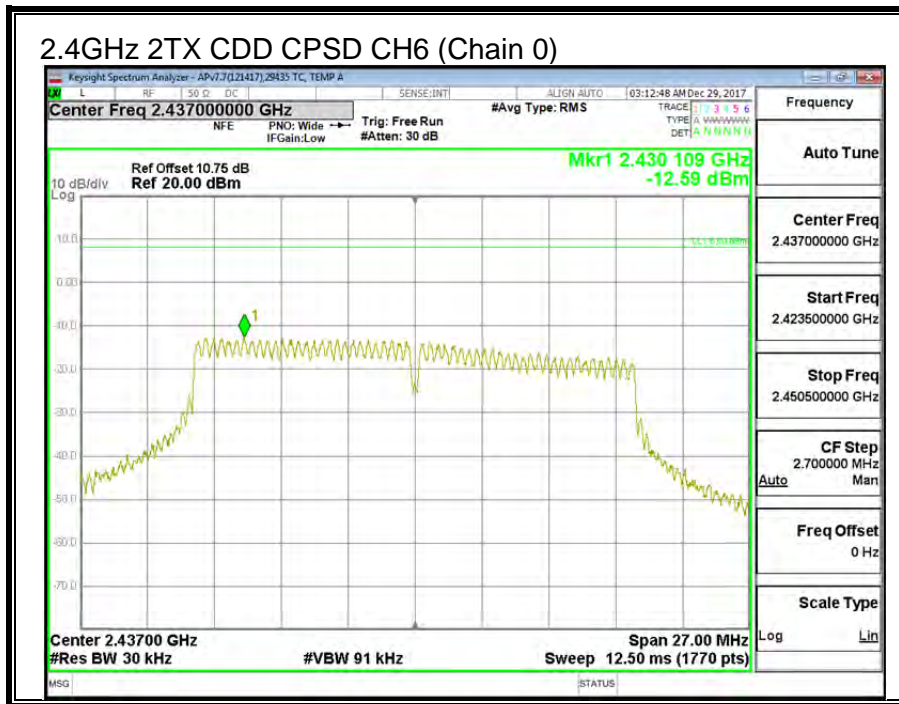

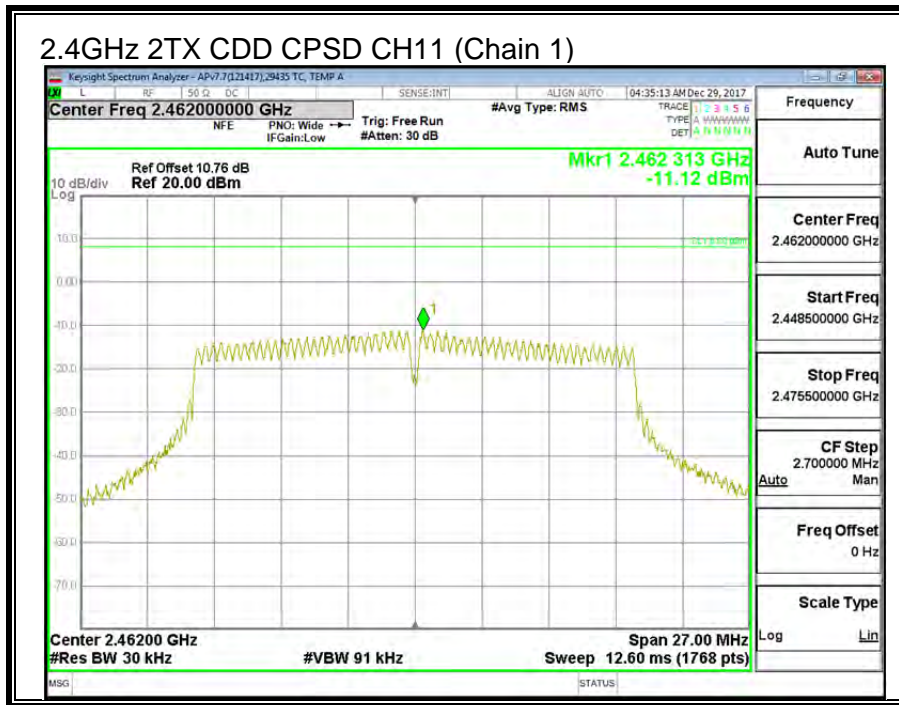
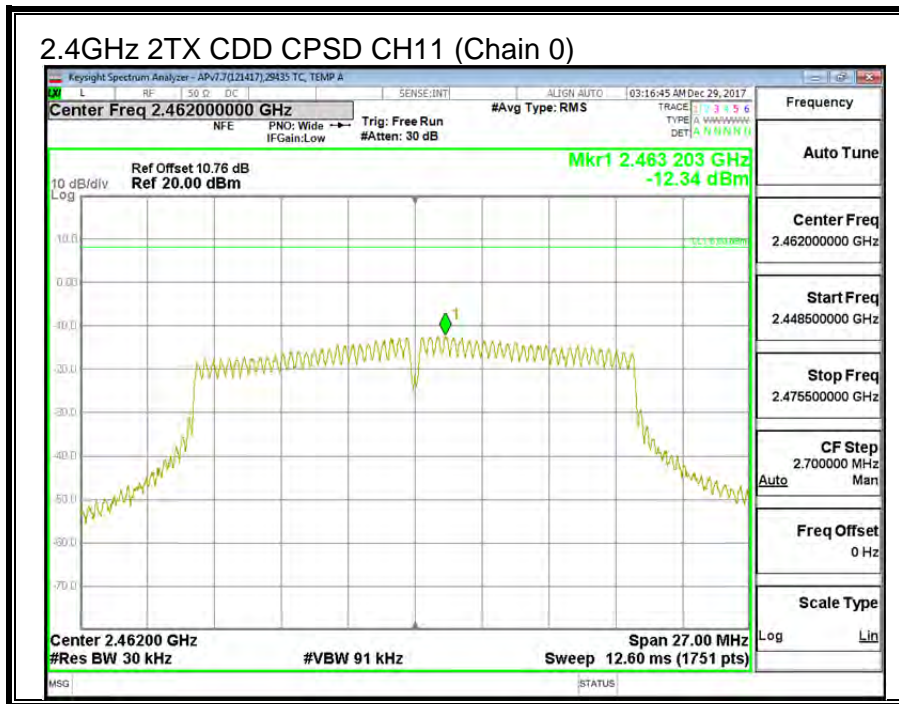

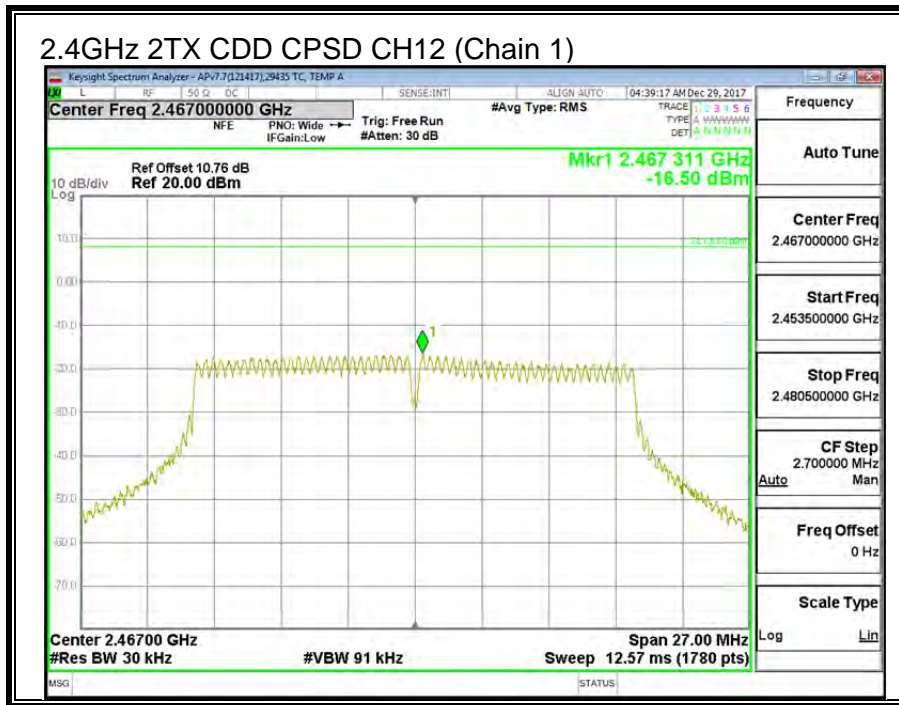
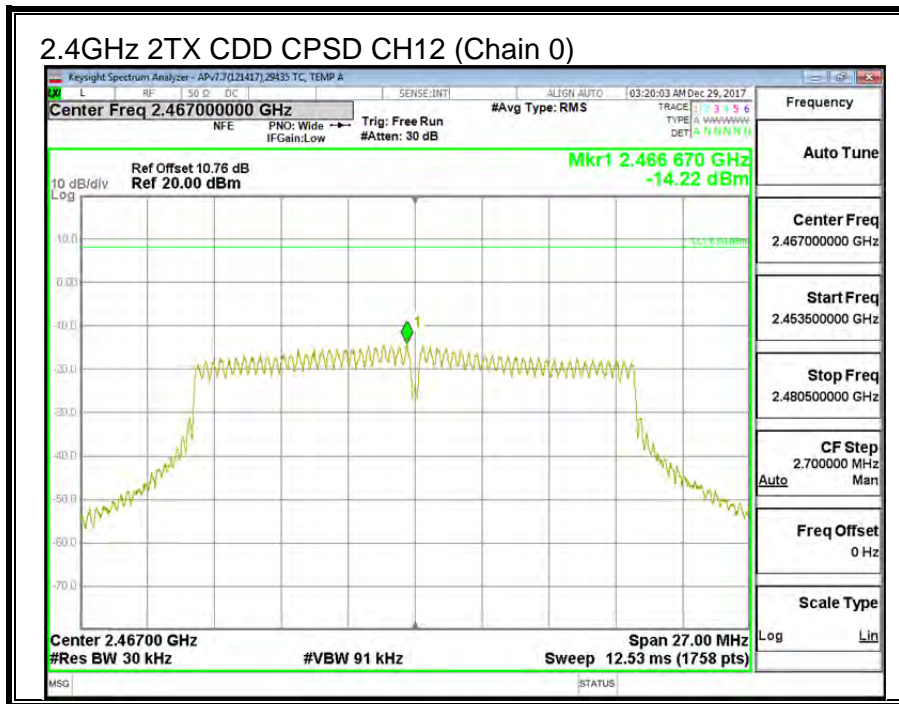

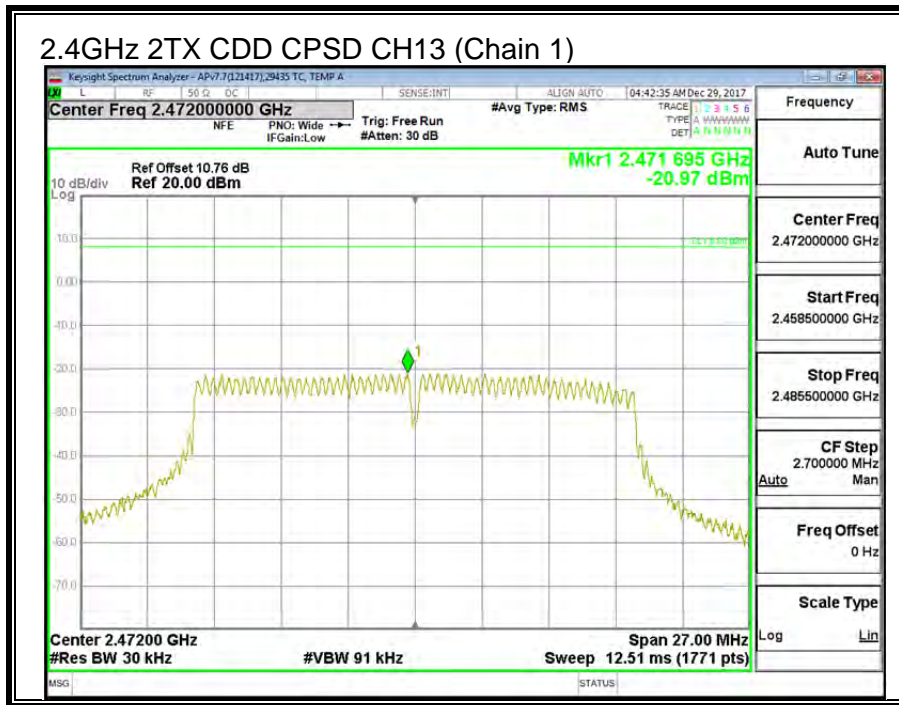
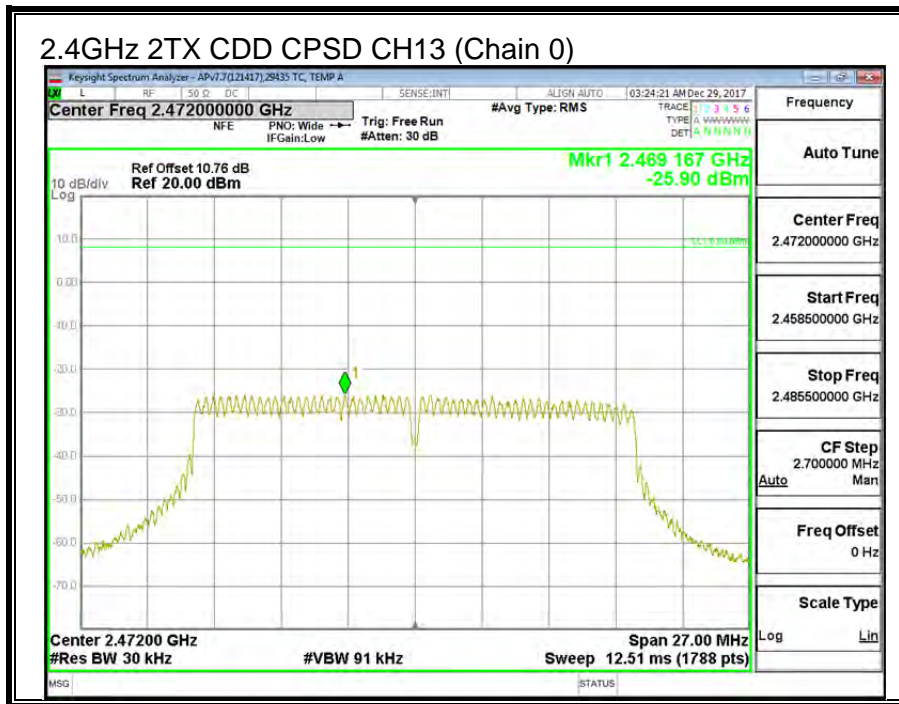

9.4.5. CONDUCTED BANEDGE AND SPURIOUS EMISSIONS

