



# **CERTIFICATION TEST REPORT**

**Report Number. :** 12097277-E3V2

**Applicant :** SONY MOBILE COMMUNICATIONS, INC.  
4-12-3 HIGASHI-SHINAGAWA,  
SHINAGAWA -KU, TOKYO, 140-0002, JAPAN

**FCC ID :** PY7-72474U

**EUT Description :** GSM/WCDMA/LTE Phone with BT, DTS/UNII a/b/g/n/ac & NFC

**Test Standard(s) :** FCC 47 CFR PART 15 SUBPART C

**Date Of Issue:**

January 29, 2018

**Prepared by:**

UL Verification Services Inc.  
47173 Benicia Street  
Fremont, CA 94538, U.S.A.  
TEL: (510) 771-1000  
FAX: (510) 661-0888



Revision History

<u>Rev.</u>	<u>Issue Date</u>	<u>Revisions</u>	<u>Revised By</u>
V1	01/24/18	Initial Issue	Dan Corona
V2	01/29/18	Updated Section 6	Kiya Kedida

## TABLE OF CONTENTS

<b>1. ATTESTATION OF TEST RESULTS</b> .....	<b>5</b>
<b>2. TEST METHODOLOGY</b> .....	<b>6</b>
<b>3. FACILITIES AND ACCREDITATION</b> .....	<b>6</b>
<b>4. CALIBRATION AND UNCERTAINTY</b> .....	<b>7</b>
4.1. <i>MEASURING INSTRUMENT CALIBRATION</i> .....	7
4.2. <i>SAMPLE CALCULATION</i> .....	7
4.3. <i>MEASUREMENT UNCERTAINTY</i> .....	7
<b>5. EQUIPMENT UNDER TEST</b> .....	<b>8</b>
5.1. <i>DESCRIPTION OF EUT</i> .....	8
5.2. <i>MAXIMUM OUTPUT POWER</i> .....	8
5.3. <i>DESCRIPTION OF AVAILABLE ANTENNAS</i> .....	8
5.4. <i>SOFTWARE AND FIRMWARE</i> .....	8
5.5. <i>WORST-CASE CONFIGURATION AND MODE</i> .....	9
5.6. <i>DESCRIPTION OF TEST SETUP</i> .....	10
<b>6. TEST AND MEASUREMENT EQUIPMENT</b> .....	<b>13</b>
<b>7. SUMMARY TABLE</b> .....	<b>14</b>
<b>8. ANTENNA PORT TEST RESULTS</b> .....	<b>15</b>
8.1. <i>MEASUREMENT METHODS</i> .....	15
8.2. <i>ON TIME, DUTY CYCLE</i> .....	16
8.3. <i>6 dB BANDWIDTH</i> .....	17
8.4. <i>99% BANDWIDTH</i> .....	21
8.5. <i>AVERAGE POWER</i> .....	25
8.6. <i>OUTPUT POWER</i> .....	26
8.7. <i>POWER SPECTRAL DENSITY</i> .....	27
8.8. <i>CONDUCTED BANDEDGE AND SPURIOUS EMISSIONS</i> .....	31
<b>9. RADIATED TEST RESULTS</b> .....	<b>39</b>
9.1. <i>LIMITS AND PROCEDURE</i> .....	39
9.2. <i>TRANSMITTER ABOVE 1 GHz 1Mbps</i> .....	40
9.2.1. <i>RESTRICTED BANDEDGE (LOW CHANNEL)</i> .....	40
9.2.2. <i>AUTHORIZED BANDEDGE (HIGH CHANNEL)</i> .....	42

---

9.2.3.	HARMONICS AND SPURIOUS .....	44
9.3.	TRANSMITTER ABOVE 1 GHz 2Mbps.....	50
9.3.1.	RESTRICTED BANDEDGE (LOW CHANNEL).....	50
9.3.2.	AUTHORIZED BANDEDGE (HIGH CHANNEL) .....	52
9.3.3.	HARMONICS AND SPURIOUS .....	54
9.4.	SPURIOUS EMISSIONS BELOW 30 MHz (WORST-CASE CONFIGURATION).....	60
9.5.	SPURIOUS EMISSIONS 30 TO 1000 MHz (WORST-CASE CONFIGURATION).....	61
9.1.	SPURIOUS EMISSIONS 18 TO 26 GHz (WORST-CASE CONFIGURATION).....	63
<b>10.</b>	<b>AC POWER LINE CONDUCTED EMISSIONS .....</b>	<b>65</b>
<b>11.</b>	<b>SETUP PHOTOS .....</b>	<b>68</b>

# 1. ATTESTATION OF TEST RESULTS

**COMPANY NAME:** SONY MOBILE COMMUNICATIONS INC.  
4-12-3 HIGASHI-SHINAGAWA, SHINAGAWA-KU  
TOKYO, 140-0002, JAPAN

**EUT DESCRIPTION:** GSM/WCDMA/LTE Phone with BT, DTS/UNII a/b/g/n/ac & NFC

**SERIAL NUMBER:** RADIATED: BH90006RAY & BH900083AY  
CONDUCTED: BH90005MAY & BH9000ALAY

**DATE TESTED:** December 13, 2017 – January 05, 2018

APPLICABLE STANDARDS	
STANDARD	TEST RESULTS
CFR 47 Part 15 Subpart C	Complies

UL Verification Services Inc. tested the above equipment in accordance with the requirements set forth in the above standards. All indications of Pass/Fail in this report are opinions expressed by UL Verification Services Inc. based on interpretations and/or observations of test results. Measurement Uncertainties were not taken into account and are published for informational purposes only. The test results show that the equipment tested is capable of demonstrating compliance with the requirements as documented in this report.

**Note:** The results documented in this report apply only to the tested sample, under the conditions and modes of operation as described herein. This document may not be altered or revised in any way unless done so by UL Verification Services Inc. and all revisions are duly noted in the revisions section. Any alteration of this document not carried out by UL Verification Services Inc. will constitute fraud and shall nullify the document. This report must not be used by the client to claim product certification, approval, or endorsement by NVLAP, NIST, any agency of the Federal Government, or any agency of any government.

Approved & Released For  
UL Verification Services Inc. By:



DAN CORONIA  
OPERATIONS LEADER  
UL VERIFICATION SERVICES INC.

Prepared By:



KIYA KEDIDA  
PROJECT ENGINEER  
UL VERIFICATION SERVICES INC.

## 2. TEST METHODOLOGY

The tests documented in this report were performed in accordance with FCC CFR 47 Part 2, FCC CFR 47 Part 15, KDB 558074 D01 v04 and ANSI C63.10-2013.

## 3. FACILITIES AND ACCREDITATION

The test sites and measurement facilities used to collect data are located at 47173 and 47266 Benicia Street, Fremont, California, USA. Line conducted emissions are measured only at the 47173 address. The following table identifies which facilities were utilized for radiated emission measurements documented in this report. Specific facilities are also identified in the test results sections.

47173 Benicia Street	47266 Benicia Street
<input type="checkbox"/> Chamber A(IC: 2324B-1)	<input checked="" type="checkbox"/> Chamber D(IC: 22541-1)
<input checked="" type="checkbox"/> Chamber B(IC: 2324B-2)	<input type="checkbox"/> Chamber E(IC: 22541-2)
<input type="checkbox"/> Chamber C(IC: 2324B-3)	<input type="checkbox"/> Chamber F(IC: 22541-3)
	<input type="checkbox"/> Chamber G(IC: 22541-4)
	<input type="checkbox"/> Chamber H(IC: 22541-5)

The above test sites and facilities are covered under FCC Test Firm Registration # 208313.

UL Verification Services Inc. is accredited by NVLAP, Laboratory Code 200065-0.

Chambers A through C is covered under Industry Canada company address code 2324B with site numbers 2324B -1 through 2324B-3, respectively. Chambers D through H are covered under Industry Canada company address code 22541 with site numbers 22541 -1 through 22541-5, respectively.

## 4. CALIBRATION AND UNCERTAINTY

### 4.1. MEASURING INSTRUMENT CALIBRATION

The measuring equipment utilized to perform the tests documented in this report has been calibrated in accordance with the manufacturer's recommendations, and is traceable to recognized national standards.

### 4.2. SAMPLE CALCULATION

Where relevant, the following sample calculation is provided:

$$\begin{aligned} \text{Field Strength (dBuV/m)} &= \text{Measured Voltage (dBuV)} + \text{Antenna Factor (dB/m)} + \\ &\text{Cable Loss (dB)} - \text{Preamp Gain (dB)} \\ 36.5 \text{ dBuV} + 18.7 \text{ dB/m} + 0.6 \text{ dB} - 26.9 \text{ dB} &= 28.9 \text{ dBuV/m} \end{aligned}$$

### 4.3. MEASUREMENT UNCERTAINTY

Where relevant, the following measurement uncertainty levels have been estimated for tests performed on the apparatus:

Parameter	Uncertainty
Worst Case Conducted Disturbance, 9KHz to 0.15 MHz	3.84 dB
Worst Case Conducted Disturbance, 0.15 to 30 MHz	3.65 dB
Worst Case Radiated Disturbance, 9KHz to 30 MHz	3.15 dB
Worst Case Radiated Disturbance, 30 to 1000 MHz	5.36 dB
Worst Case Radiated Disturbance, 1000 to 18000 MHz	4.32 dB
Worst Case Radiated Disturbance, 18000 to 26000 MHz	4.45 dB
Worst Case Radiated Disturbance, 26000 to 40000 MHz	5.24 dB

Uncertainty figures are valid to a confidence level of 95%.

## 5. EQUIPMENT UNDER TEST

### 5.1. DESCRIPTION OF EUT

The EUT is a GSM/WCDMA/LTE Phone with BT, DTS/UNII a/b/g/n/ac, & NFC.

### 5.2. MAXIMUM OUTPUT POWER

The transmitter has a maximum peak conducted output power as follows:

Frequency Range (MHz)	Mode	Output Power (dBm)	Output Power (mW)
2402 - 2480	BLE (1Mbps)	5.04	3.19
2402 - 2480	BLE (2Mbps)	5.37	3.44

### 5.3. DESCRIPTION OF AVAILABLE ANTENNAS

The radio utilizes a Loop antenna, with the maximum gains:

Frequency Band (GHz)	Antenna Gain (dBi)
2402-2480	-1.90

### 5.4. SOFTWARE AND FIRMWARE

The firmware installed in the EUT during testing was SONY, s\_atp\_1\_00139\_B\_10\_5.  
The test utility software used during testing was Tera Term Ver 4.79.



## 5.5. WORST-CASE CONFIGURATION AND MODE

Radiated band edge, harmonics, and spurious emissions from 1 GHz to 18GHz were performed with the EUT was set to transmit at the Low/Middle/High channels.

Radiated emission below 30MHz, below 1GHz, above 18GHz, and power line conducted emission were performed with the EUT was set to transmit at the channel with highest output power as worst-case scenario.

The fundamental of the EUT was investigated in three orthogonal orientations X, Y, & Z, using the following two configurations, AC/DC Adapter and headphone. It was determined that X-Axis with only AC/DC Adapter was worst-case orientation; therefore, all final radiated testing was performed with the EUT in X-Axis with AC/DC Adapter orientation.

Worst-case data rates as provided by the client were:

1Mbps

2Mbps

## 5.6. DESCRIPTION OF TEST SETUP

### SUPPORT EQUIPMENT

Support Equipment List				
Description	Manufacturer	Model	Serial Number	FCC ID
Laptop	Lenovo	20B7S0A200	PC015REW	NA
AC Adapter	SONY	1309-8864.1	VB17W46601037	NA
DC Power Supply	Ametek	XT 15-4	T463	NA

### I/O CABLES (CONDUCTED TEST)

I/O Cable List						
Cable No	Port	# of identical ports	Connector Type	Cable Type	Cable Length (m)	Remarks
1	Antenna	1	RF	Shielded	0.2	To spectrum Analyzer
2	USB	1	USB	Shielded	1	N/A
3	DC	1	DC	Shielded	0.3	N/A

### I/O CABLES (RADIATED AND CONDUCTED EMISSIONS)

I/O Cable List						
Cable No	Port	# of identical ports	Connector Type	Cable Type	Cable Length (m)	Remarks
1	USB	1	USB	Shielded	3	N/A

**TEST SETUP**

**CONDCUTED TEST SETUP DIAGRAM**

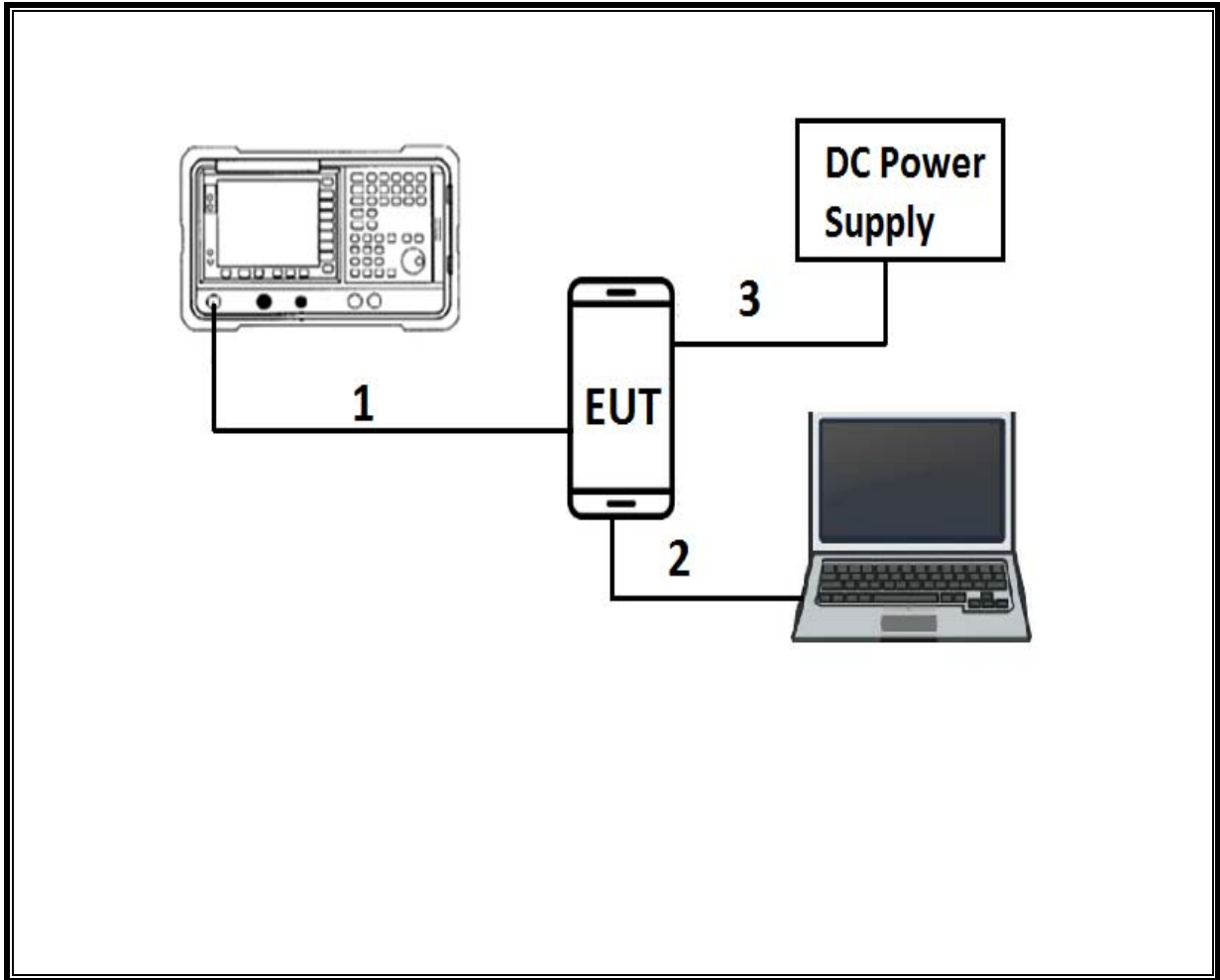

**TEST SETUP**

**RADIATED AND AC LINE CONDUCTED EMISSIONS SETUP DIAGRAM**

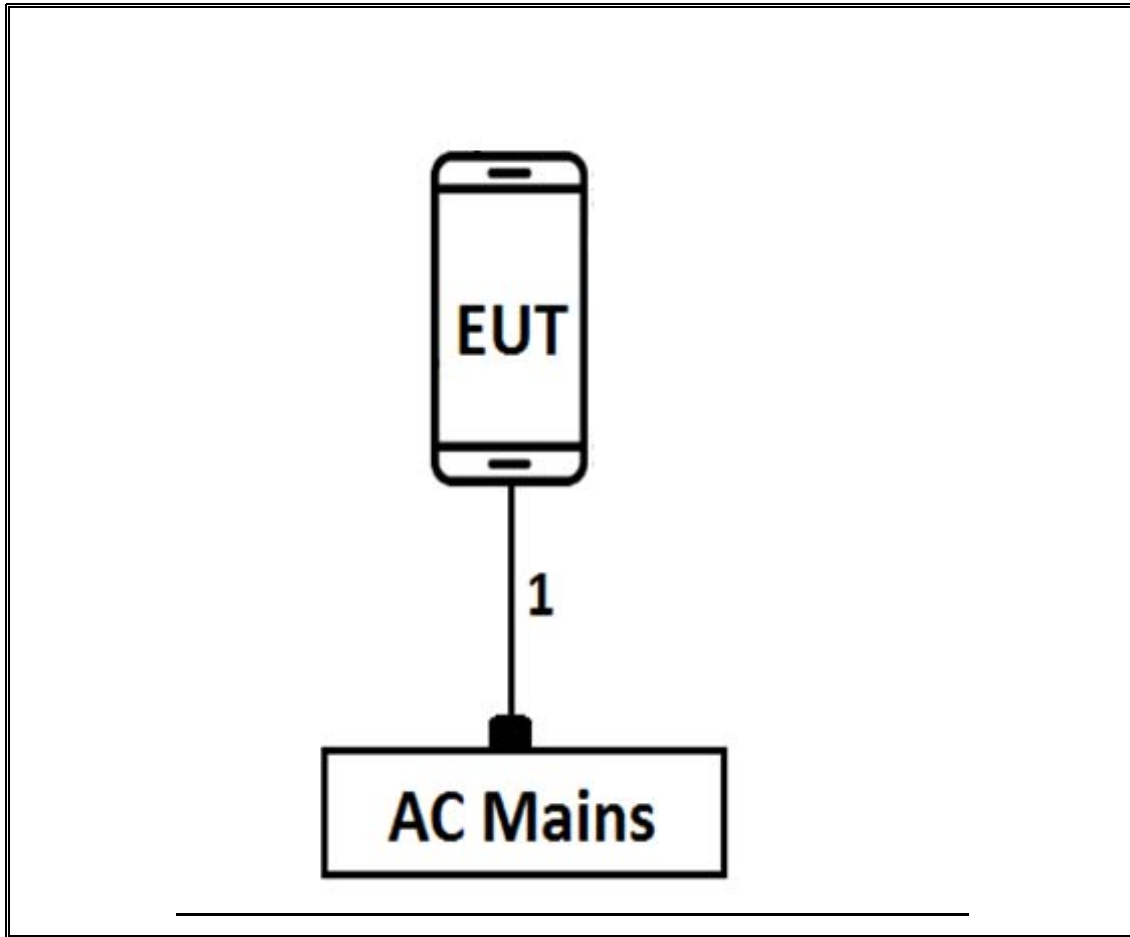

## 6. TEST AND MEASUREMENT EQUIPMENT

The following test and measurement equipment was utilized for the tests documented in this report:

TEST EQUIPMENT LIST				
Description	Manufacturer	Model	Asset	Cal Due
Antenna, Broadband Hybrid, 30MHz to 2000MHz	Sunol Sciences	JB3	T899	06/15/2018
Antenna, Active Loop 9kHz-30MHz	Com-Power Corp.	AL-130R	T1866	10/10/2018
Antenna, Horn 1-18GHz	ETS-Lindgren	3117	T711	01/30/2018
Antenna, Horn 18-26.5GHz	ARA	MWH-1826	T89	01/18/2019
Power Meter, P-series single channel	Agilent (Keysight) Technologies	N1911A	T1268	06/15/2018
Power Sensor, P – series, 50MHz to 18GHz, Wideband	Agilent (Keysight) Technologies	N1921A	T1223	03/29/2018
Amplifier, 1 - 18GHz	MITEQ	AFS42-00101800-25-S-42	T740	12/30/2018
Pre Amplifier, 1-26.5GHz	Agilent	8449B	T404	7/23/2018
Amplifier, 10kHz-1GHz	Agilent (Keysight) Technologies	8447D	T15	08/14/2018
Spectrum Analyzer, PXA, 3Hz to 44GHz	Agilent (Keysight) Technologies	N9030A	T1210	07/17/2018
Spectrum Analyzer, PXA, 3Hz to 44GHz	Agilent (Keysight) Technologies	N9030A	T905	01/11/2018
Spectrum Analyzer, PXA, 3Hz to 44GHz	Agilent (Keysight) Technologies	N9030A	T907	01/23/2018
Test Receiver, EMI, 10Hz-7GHz	Rhode&Schwarz	ESR	T1436	01/06/2018
LISN	FISCHER	FCC-LISN-50/250-25-2-01	T1310	01/17/2018

Test Software List			
Description	Manufacturer	Model	Version
Radiated Software	UL	UL EMC	Ver 9.5, Dec 01, 2016
Conducted Software	UL	UL EMC	Ver 9.5, May 26, 2015
Antenna Port Software	UL	UL RF	Ver 7.7, Dec 14, 2017

NOTE: \*testing is completed before equipment calibration expiration date.

## 7. SUMMARY TABLE

FCC Part Section	Test Description	Test Limit	Test Condition	Test Result
15.247 (a)(2)	Occupied Band width (6dB)	>500KHz	Conducted	Pass
2.1051, 15.247 (d)	Band Edge / Conducted Spurious Emission	-20dBc		Pass
15.247	TX conducted output power	<30dBm		Pass
15.247	PSD	<8dBm		Pass
15.207 (a)	AC Power Line conducted emissions	Section 10	Radiated	Pass
15.205, 15.209, 15.247(d)	Radiated Spurious Emission	< 54dBuV/m		Pass

## 8. ANTENNA PORT TEST RESULTS

### 8.1. MEASUREMENT METHODS

On Time and Duty Cycle: KDB 558074 D01 v04, Section 6.

6 dB BW: KDB 558074 D01 v04, Section 8.1.

Output Power: KDB 558074 D01 v04, Section 9.1.3.

Power Spectral Density: KDB 558074 D01 v04, Section 10.2.

Out-of-band emissions in non-restricted bands: KDB 558074 D01 v04, Section 11.0.

Out-of-band emissions in restricted bands: KDB 558074 D01 v04, Section 12.1.

Band-edge: KDB 558074 D01 v04, Section 12.1.

AC Power Line Conducted Emissions: ANSI C63.10-2013, Section 6.2.

## 8.2. ON TIME, DUTY CYCLE

### LIMITS

None; for reporting purposes only.

### PROCEDURE

KDB 558074 Zero-Span Spectrum Analyzer Method.

### ON TIME AND DUTY CYCLE RESULTS

ON TIME AND DUTY CYCLE RESULTS						
Mode	ON Time B (msec)	Period (msec)	Duty Cycle x (linear)	Duty Cycle (%)	Duty Cycle Correction Factor (dB)	1/T Minimum VBW (kHz)
BLE, 1Mbps	2.135	2.498	0.855	85.47%	0.68	0.468
BLE, 2Mbps	1.075	1.875	0.573	57.33%	2.42	0.930

### DUTY CYCLE PLOTS



NOTE:



### 8.3. 6 dB BANDWIDTH

#### LIMITS

FCC §15.247 (a) (2)

The minimum 6 dB bandwidth shall be at least 500 kHz.

#### RESULTS

##### 6 dB BANDWIDTH (1Mbps)

Channel	Frequency	6 dB Bandwidth (MHz)	Minimum Limit (MHz)
Low	2402	0.680	0.5
Middle	2440	0.642	0.5
High	2480	0.626	0.5

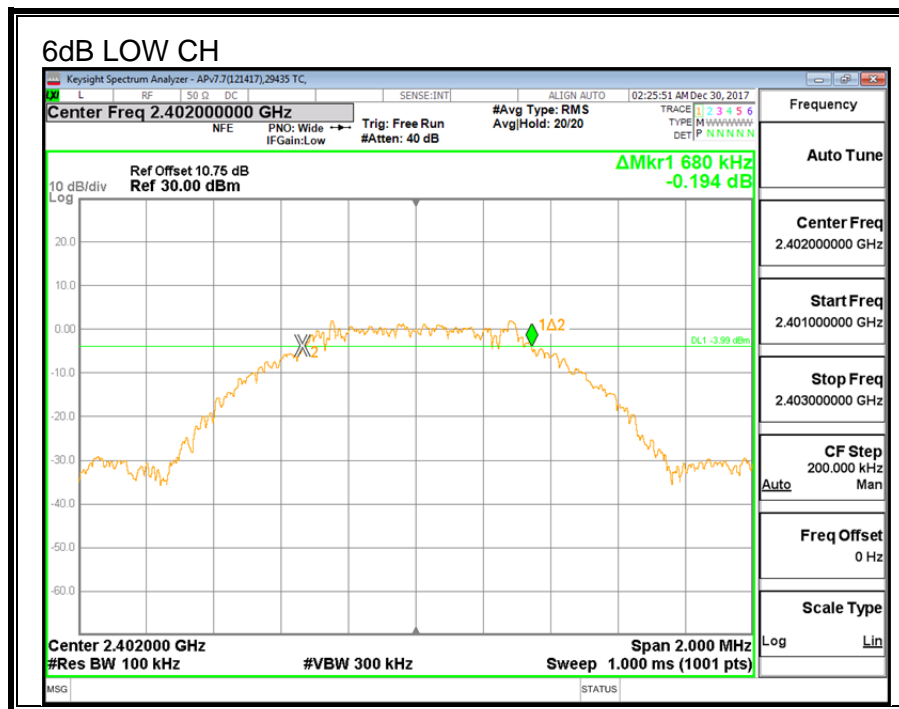

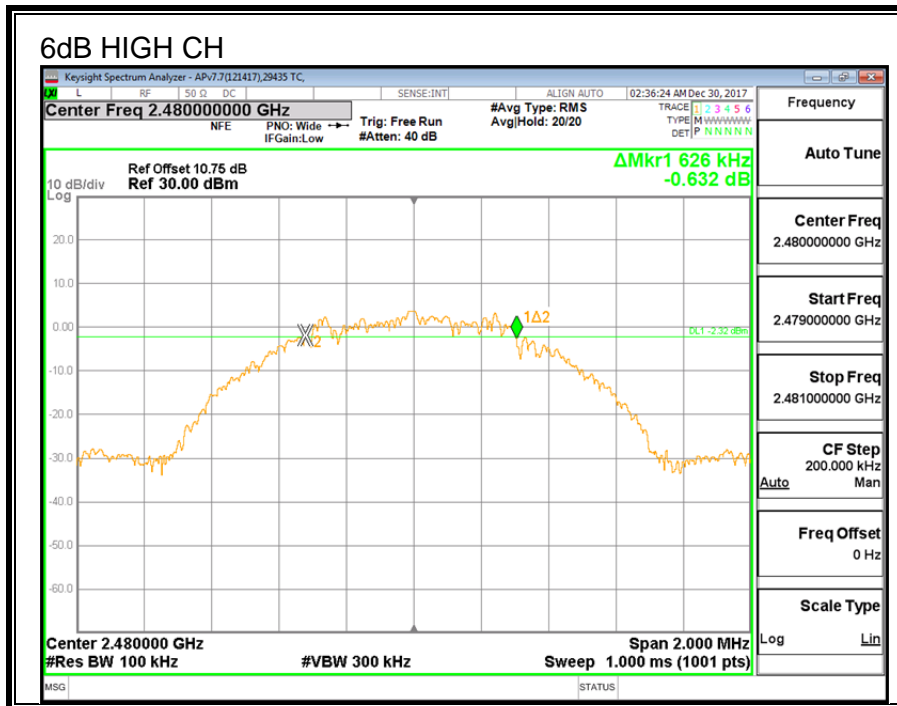
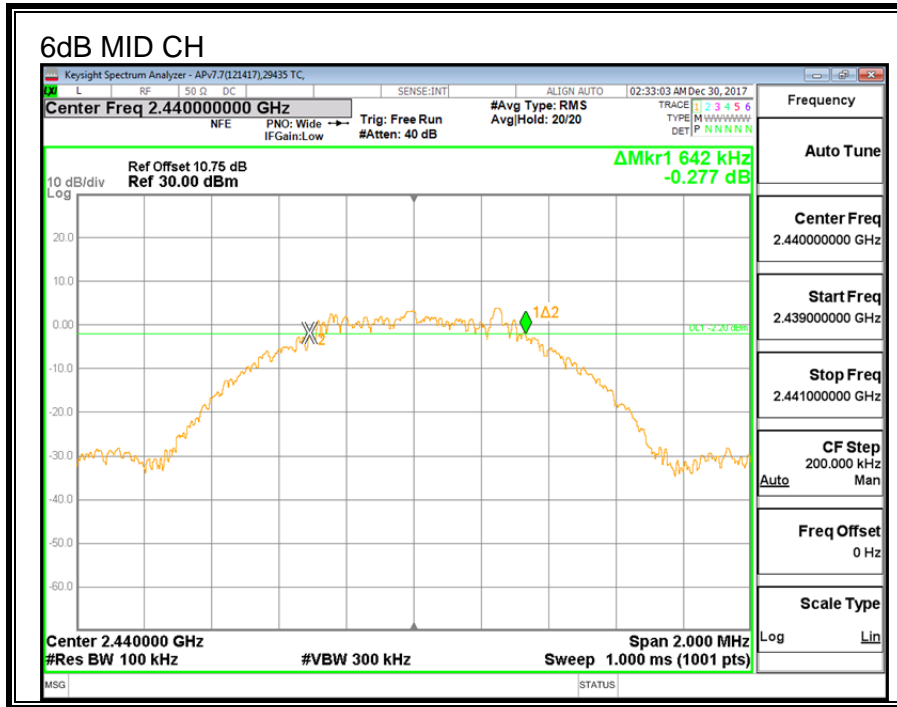

**6 dB BANDWIDTH (2Mbps)**

Channel	Frequency	6 dB Bandwidth (MHz)	Minimum Limit (MHz)
Low	2402	1.076	0.5
Middle	2440	<b>1.086</b>	0.5
High	2480	1.020	0.5

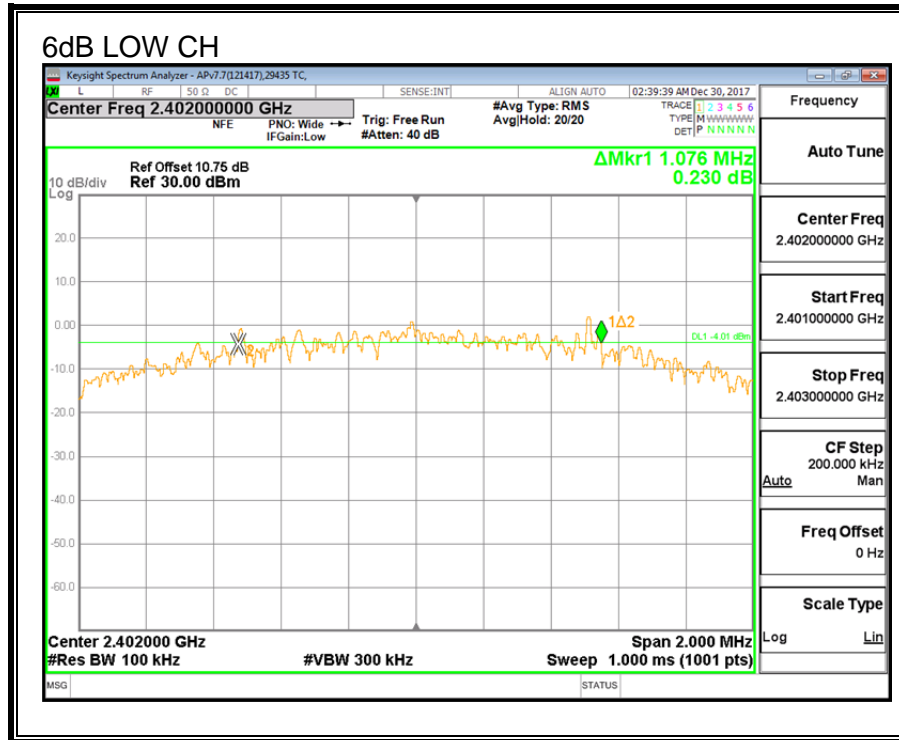

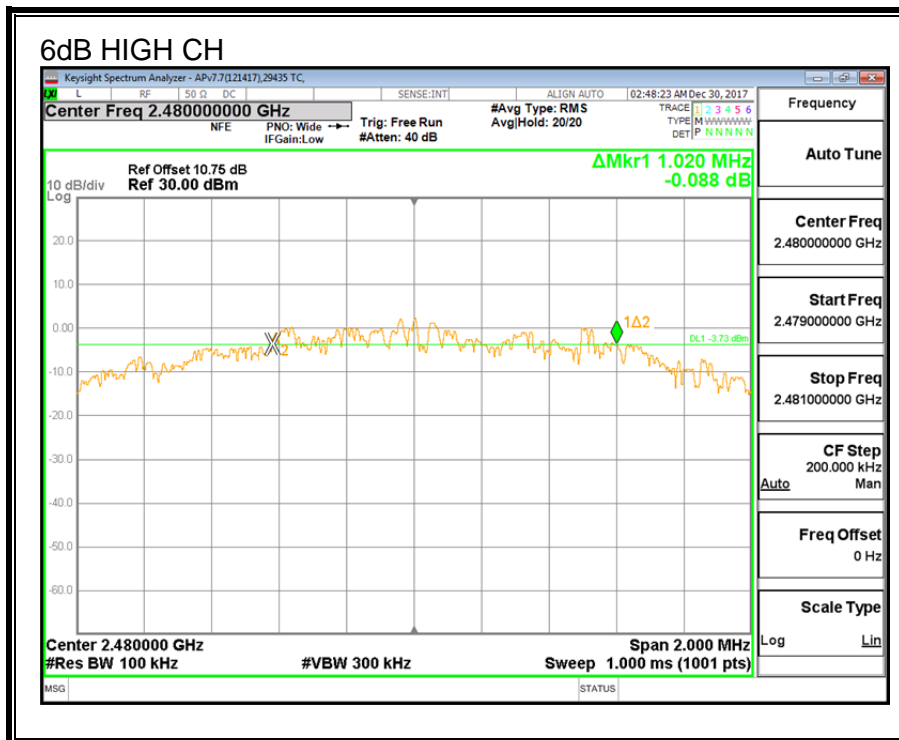
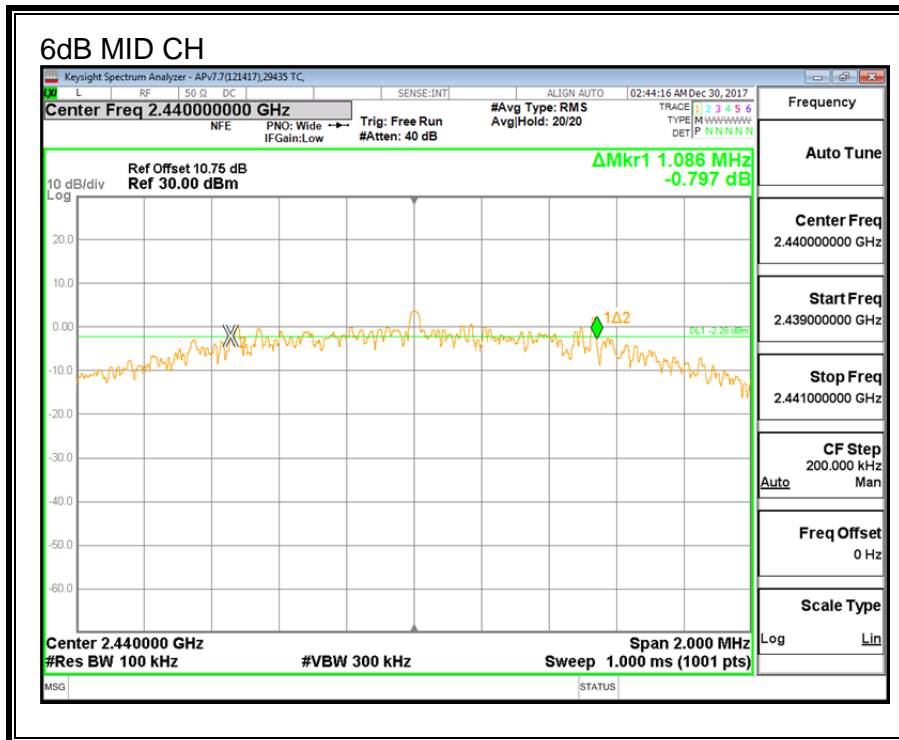

## 8.4. 99% BANDWIDTH

### LIMITS

None; for reporting purposes only.

### Test Procedure

The transmitter output is connected to the spectrum analyzer. The RBW is set to 1% to 3% of the 99 % bandwidth and to 1% of the span. The VBW is set to 3 times the RBW. The sweep time is coupled. The spectrum analyzer internal 99% bandwidth function is utilized.

### RESULTS

#### 99% BANDWIDTH (1Mbps)

Channel	Frequency (MHz)	99% Bandwidth (MHz)
Low	2402	1.0361
Middle	2440	1.0389
High	2480	<b>1.0401</b>

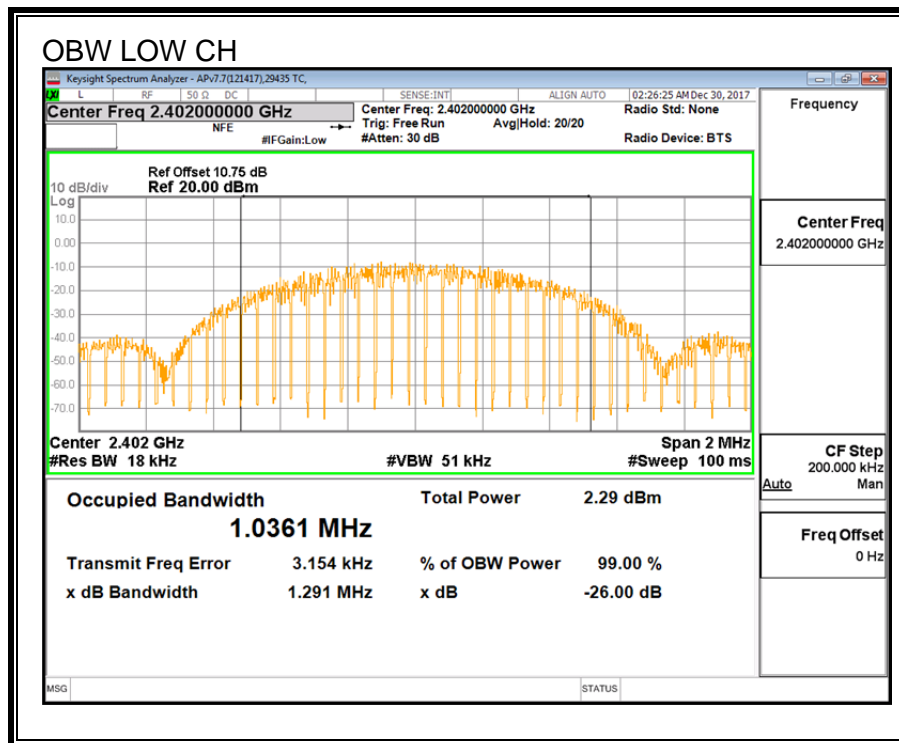

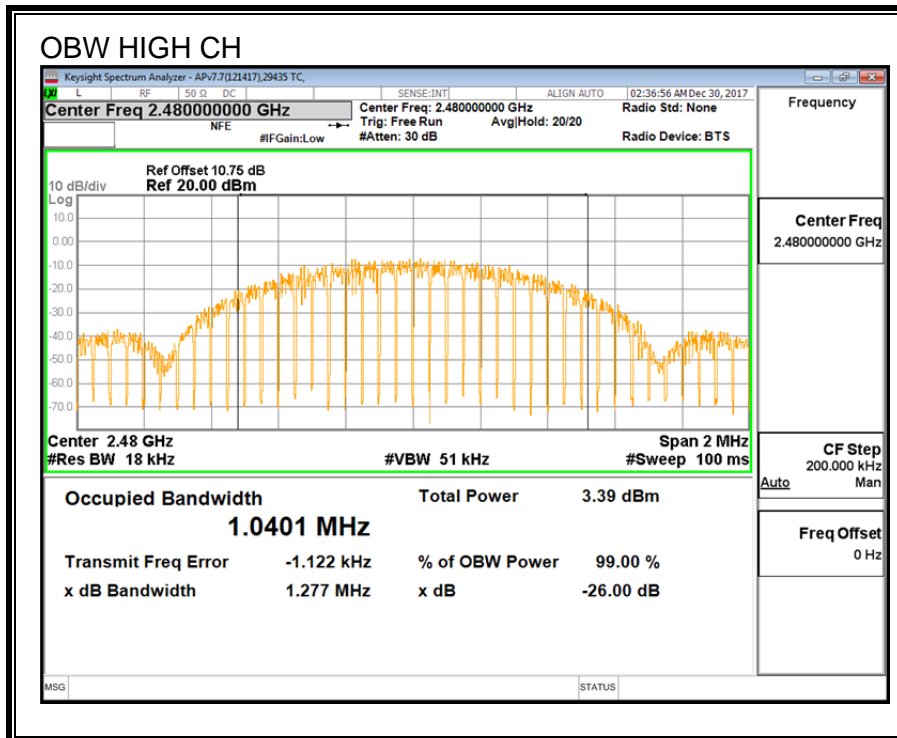
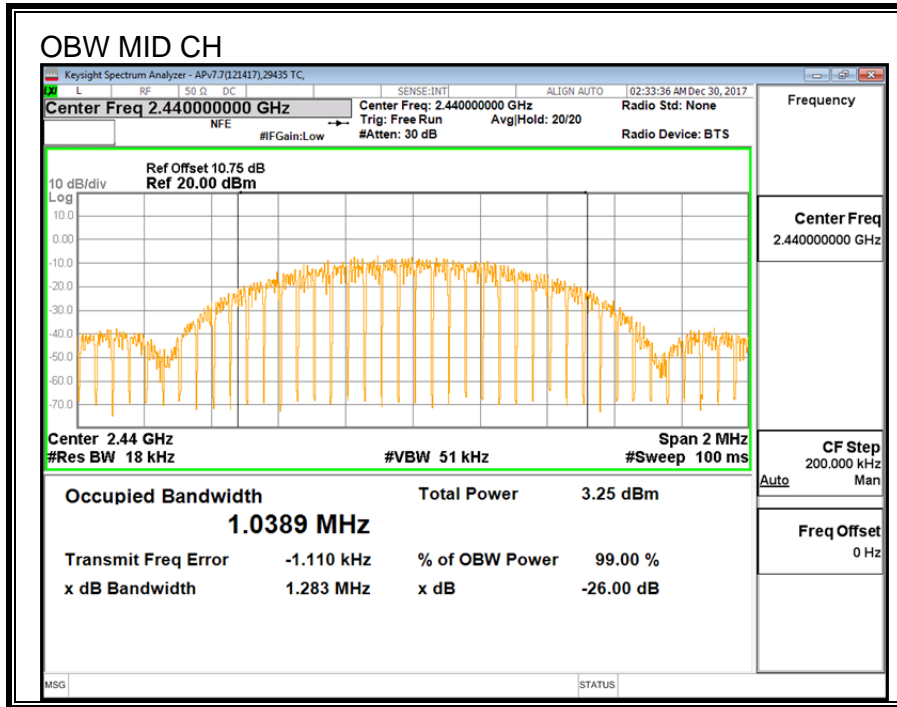

**99% BANDWIDTH (2Mbps)**

Channel	Frequency (MHz)	99% Bandwidth (MHz)
Low	2402	<b>2.0625</b>
Middle	2440	2.0619
High	2480	2.0588

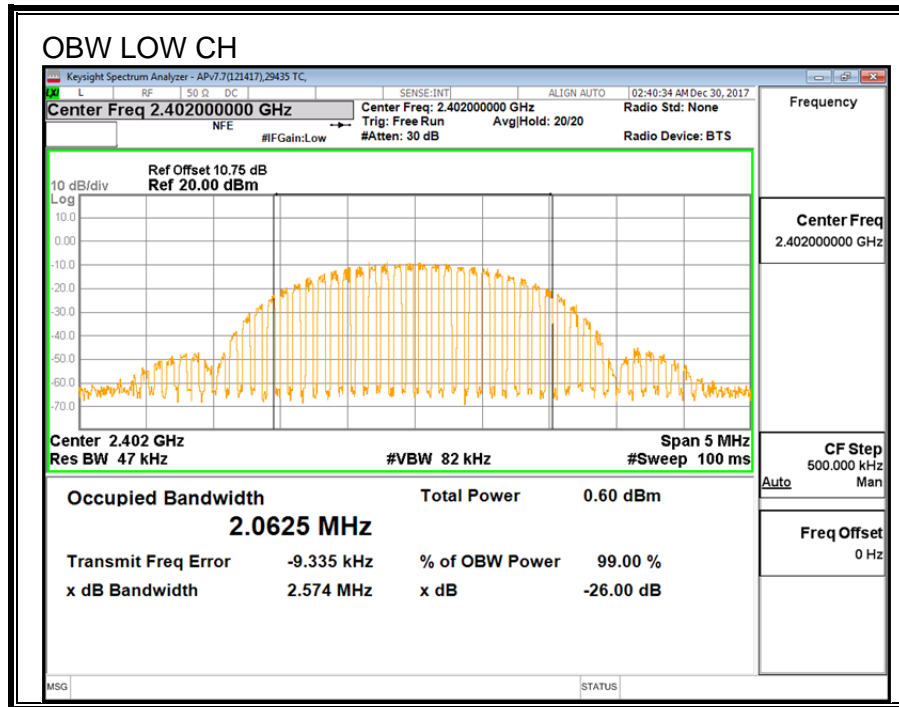

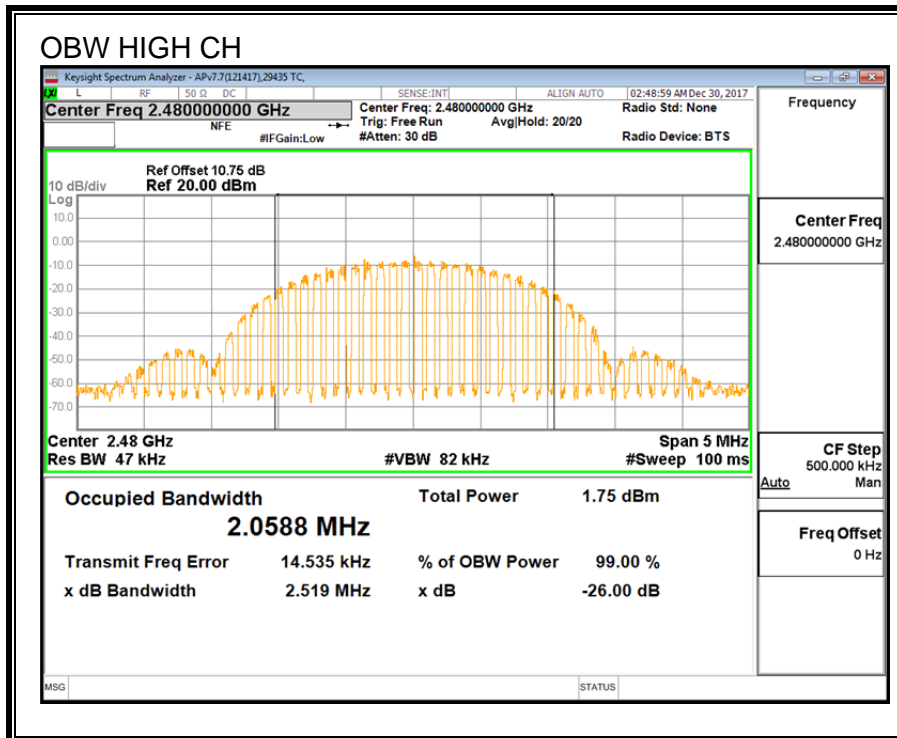
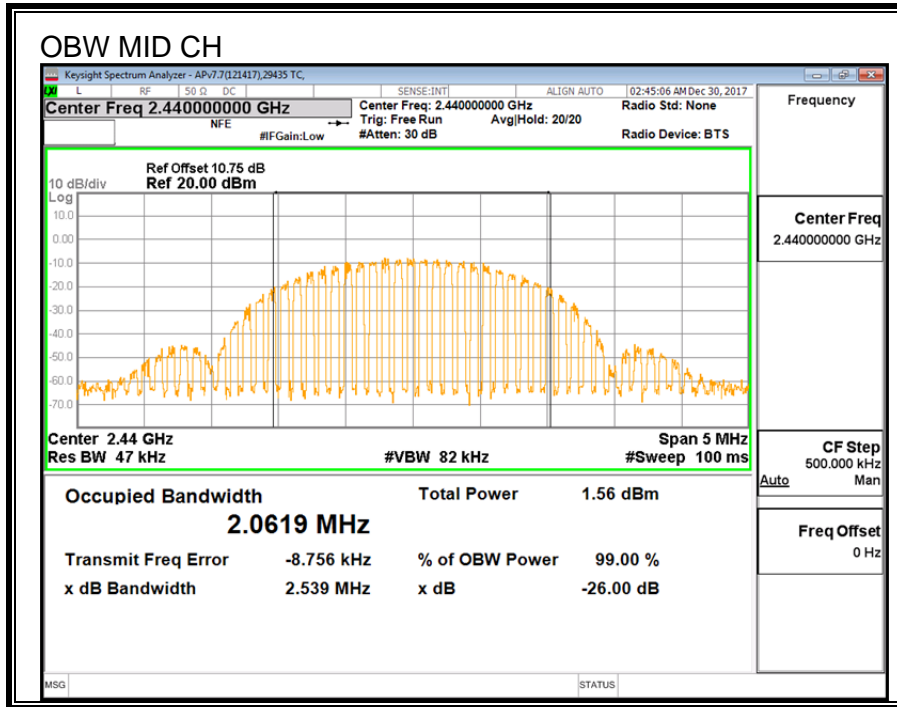



## 8.5. AVERAGE POWER

### LIMITS

None; for reporting purposes only.

The cable assembly insertion loss of 10.6 dB (including 10 dB pad and 0.6 dB cable) was entered as an offset in the power meter to allow for direct reading of power.

### RESULTS

<b>TEST ENGINEER:</b>	12506 JM	<b>Date:</b>	01/05/18
-----------------------	----------	--------------	----------

#### 1Mbps

Channel	Frequency (MHz)	AV Power (dBm)
Low	2402	3.57
Middle	2440	4.74
High	2480	<b>4.88</b>

#### 2Mbps

Channel	Frequency (MHz)	AV Power (dBm)
Low	2402	3.59
Middle	2440	4.69
High	2480	<b>4.87</b>

## 8.6. OUTPUT POWER

### LIMITS

FCC §15.247 (b)

The maximum antenna gain is less than or equal to 6 dBi, therefore the limit is 30 dBm.

The transmitter output is connected to a power meter.

The cable assembly insertion loss of 10.6 dB (including 10 dB pad and 0.6 dB cable) was entered as an offset in the power meter to allow for a gated peak reading of power.

### RESULTS

<b>TEST ENGINEER:</b>	12506 JM	<b>Date:</b>	01/05/18
-----------------------	----------	--------------	----------

### OUTPUT POWER (1Mbps)

Channel	Frequency (MHz)	Peak Power Reading (dBm)	Limit (dBm)	Margin (dB)
Low	2402	3.79	30.00	-26.31
Middle	2440	4.90	30.00	-25.10
High	2480	<b>5.04</b>	30.00	-24.96

### OUTPUT POWER (2Mbps)

Channel	Frequency (MHz)	Peak Power Reading (dBm)	Limit (dBm)	Margin (dB)
Low	2402	4.09	30.00	-25.91
Middle	2440	5.17	30.00	-24.83
High	2480	<b>5.37</b>	30.00	-24.63

## 8.7. POWER SPECTRAL DENSITY

### LIMITS

FCC §15.247 (e)

The power spectral density conducted from the transmitter to the antenna shall not be greater than 8 dBm in any 3 kHz band during any time interval of continuous transmission.

### RESULTS

#### POWER SPECTRAL DENSITY (1Mbps)

Channel	Frequency (MHz)	PSD (dBm)	Limit (dBm)	Margin (dB)
Low	2402	-13.370	8	-21.370
Middle	2440	-12.404	8	-20.404
High	2480	<b>-12.190</b>	8	-20.190

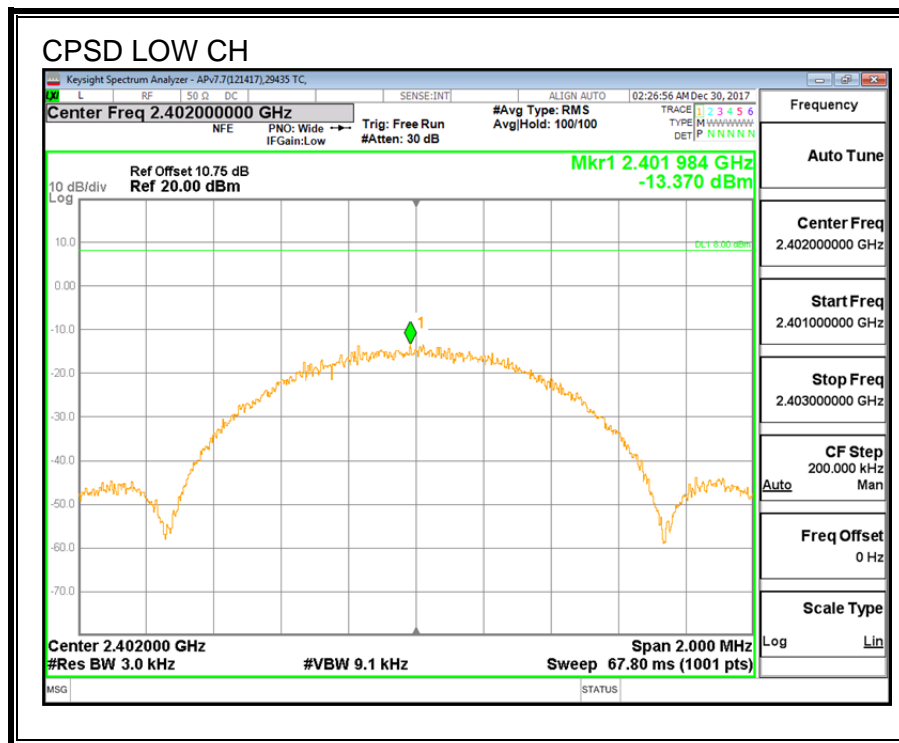

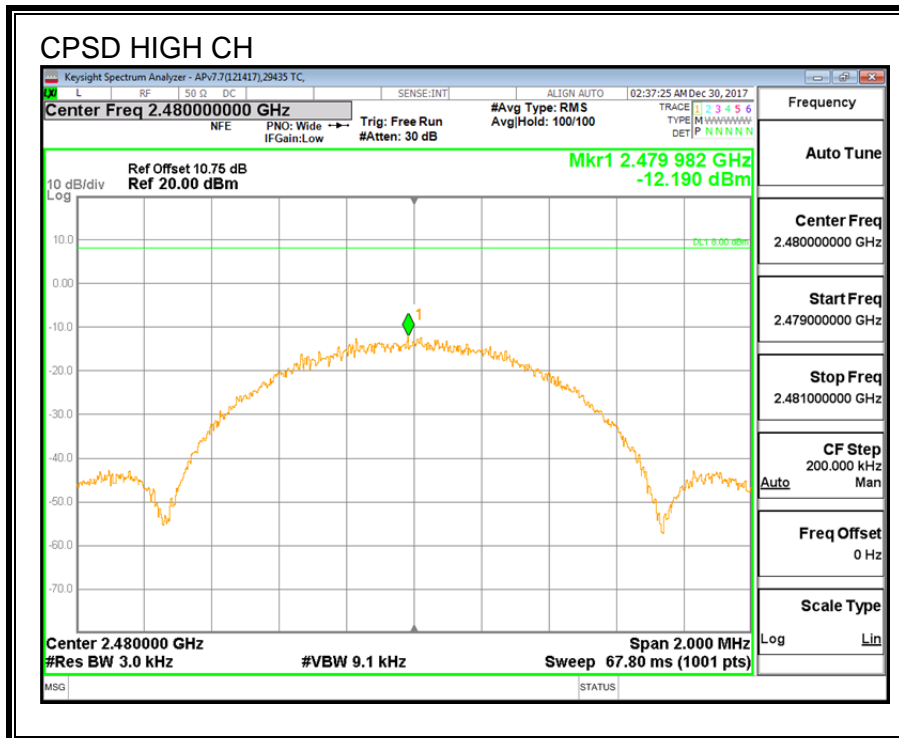
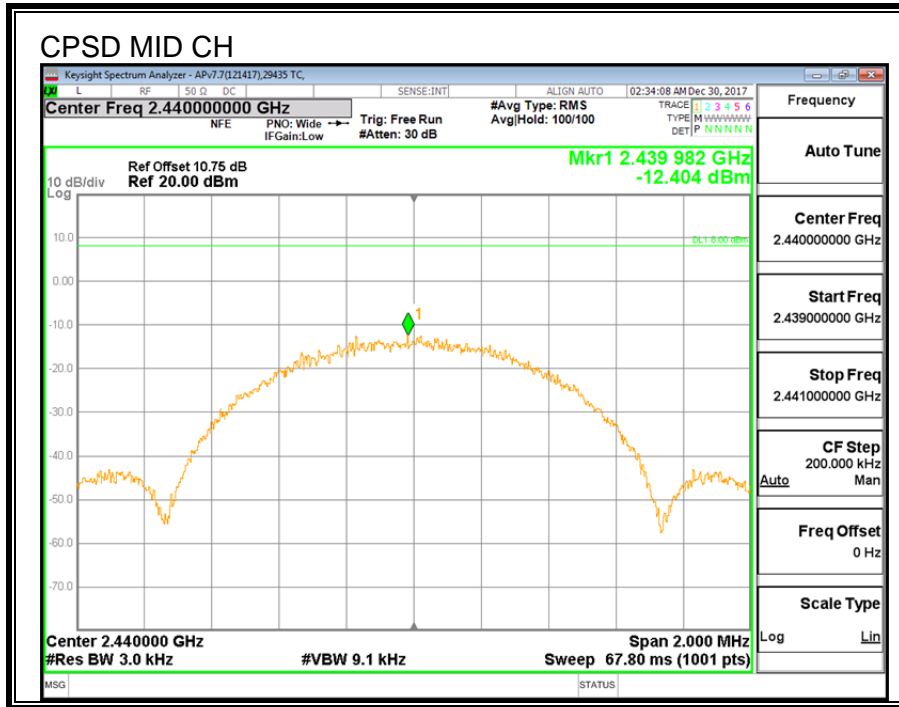

**POWER SPECTRAL DENSITY (2Mbps)**

Channel	Frequency (MHz)	PSD (dBm)	Limit (dBm)	Margin (dB)
Low	2402	-15.884	8	-23.884
Middle	2440	-14.856	8	-22.856
High	2480	<b>-14.686</b>	8	-22.686

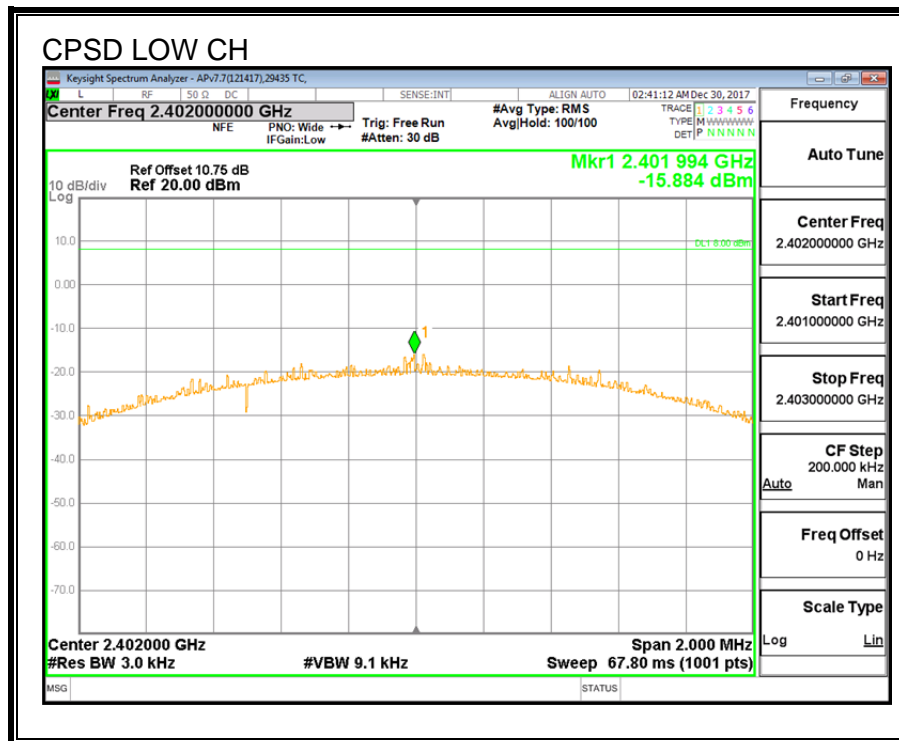

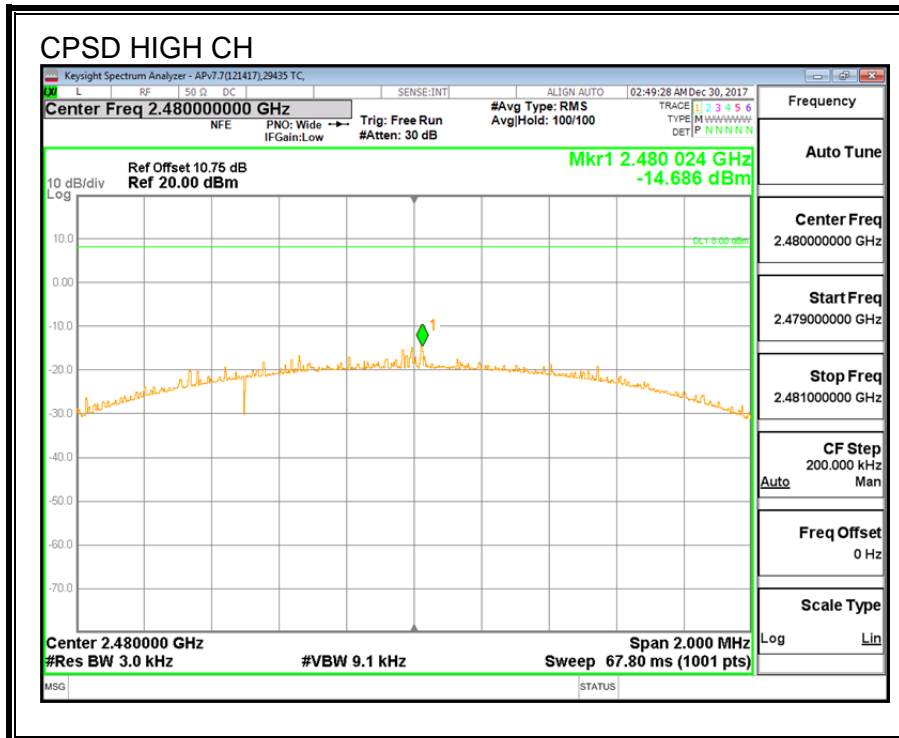
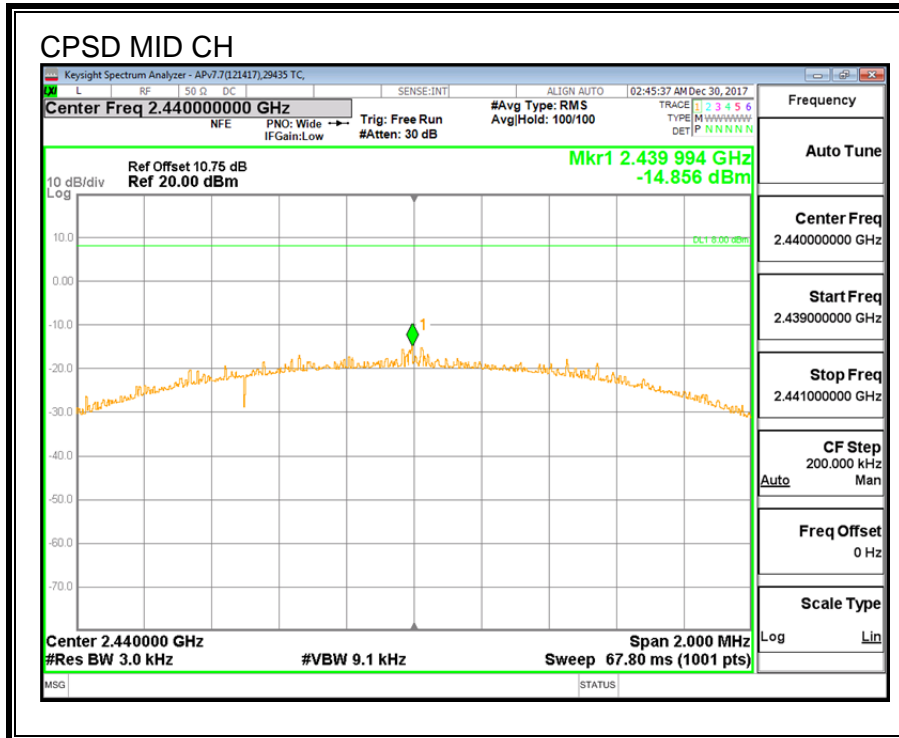

## 8.8. CONDUCTED BANDEGE AND SPURIOUS EMISSIONS

### LIMITS

FCC §15.247 (d)

Output power was measured based on the use of a peak measurement, therefore the required attenuation is 20 dB.

### RESULTS

#### CONDUCTED BANDEGE AND SPURIOUS EMISSIONS (1Mbps)

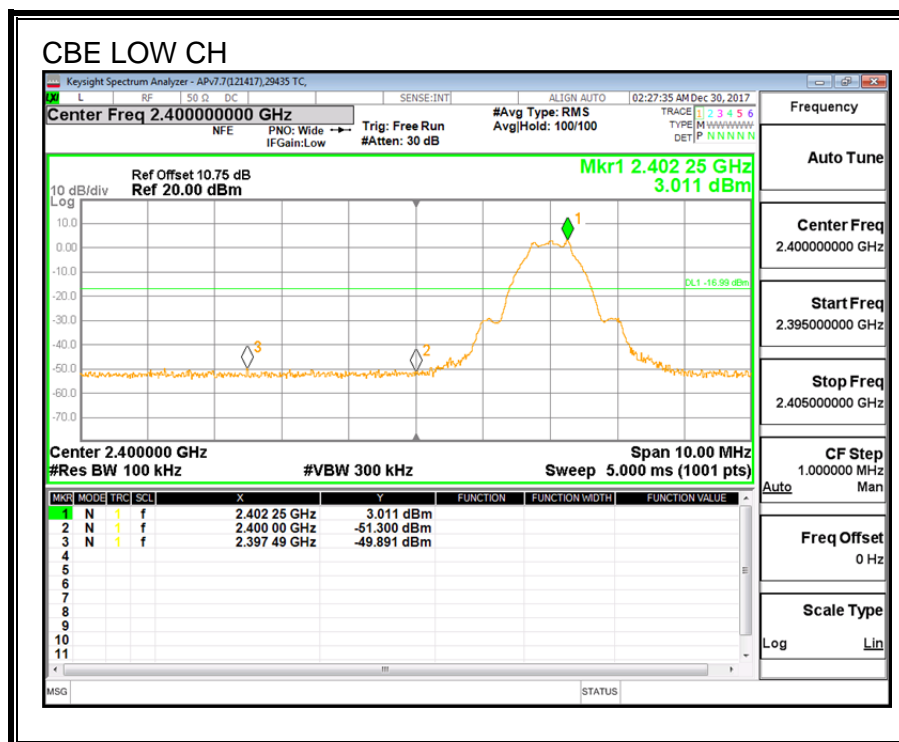

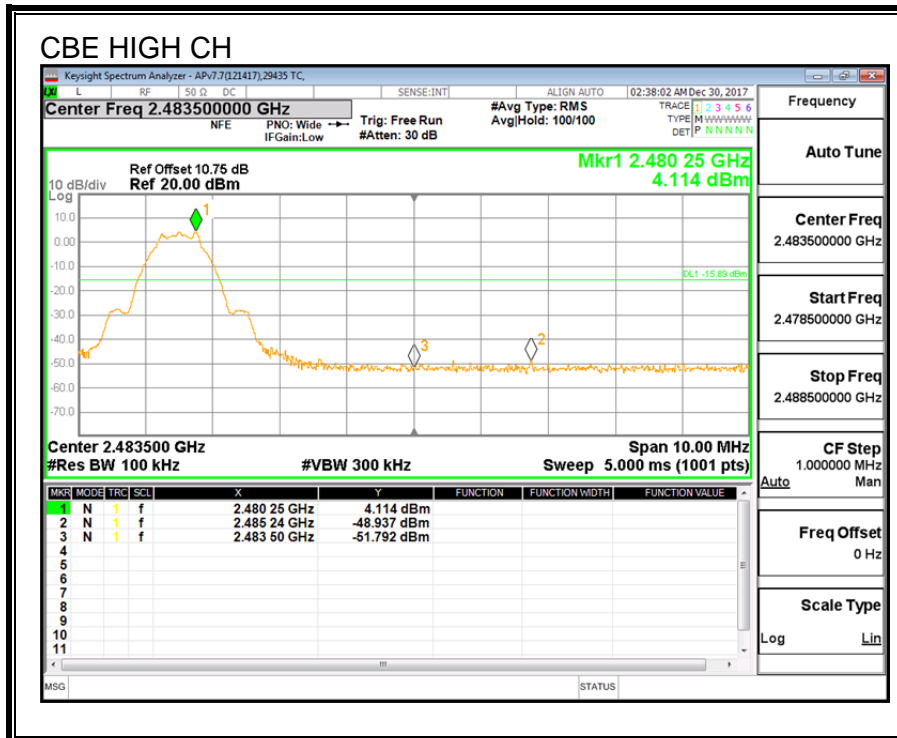
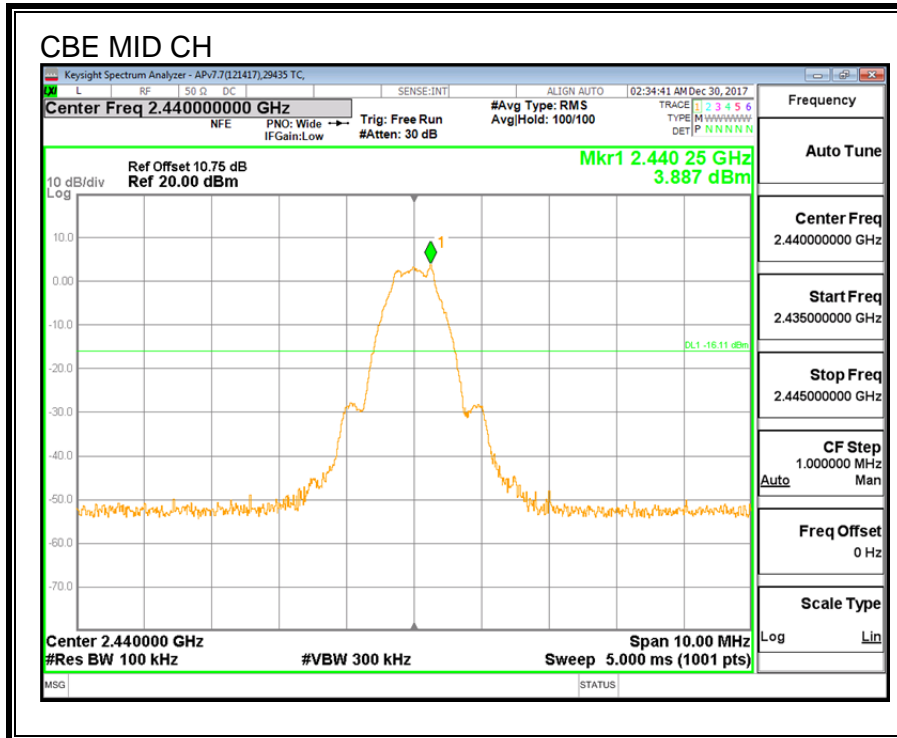



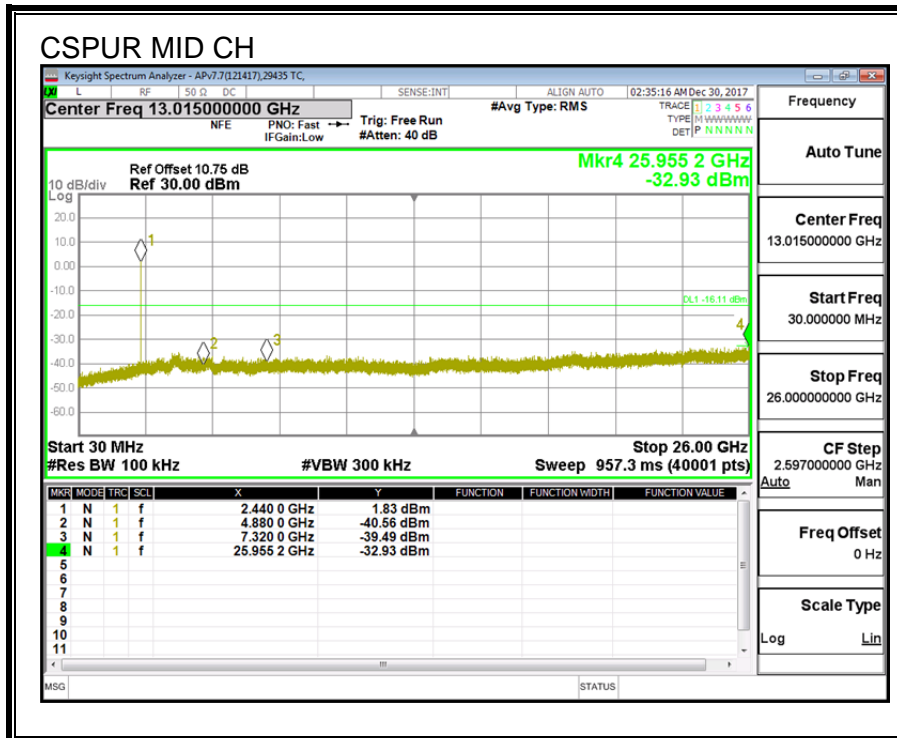
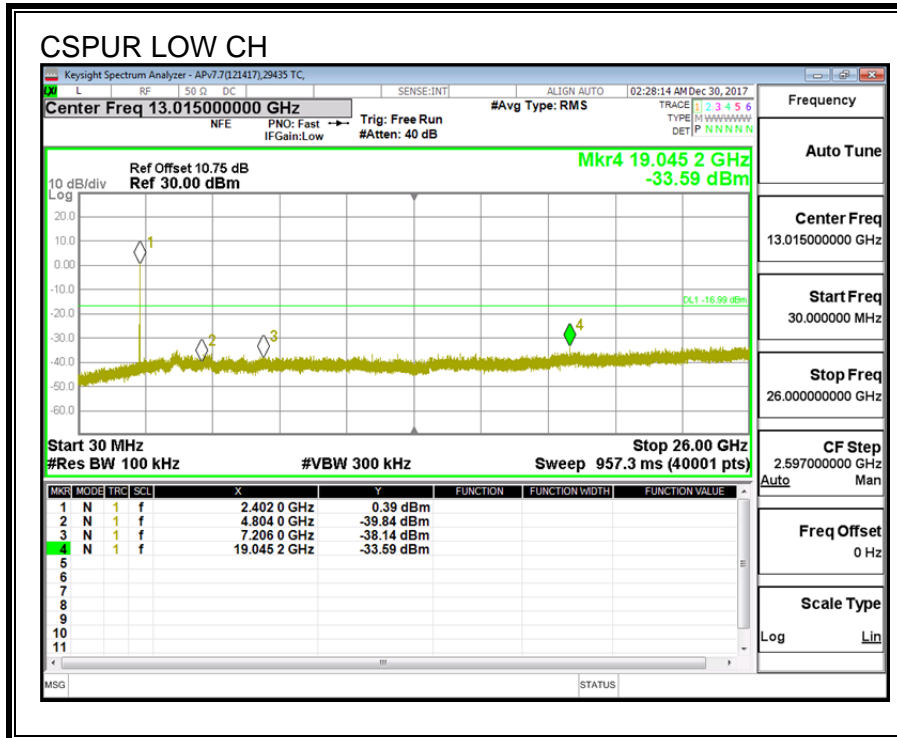

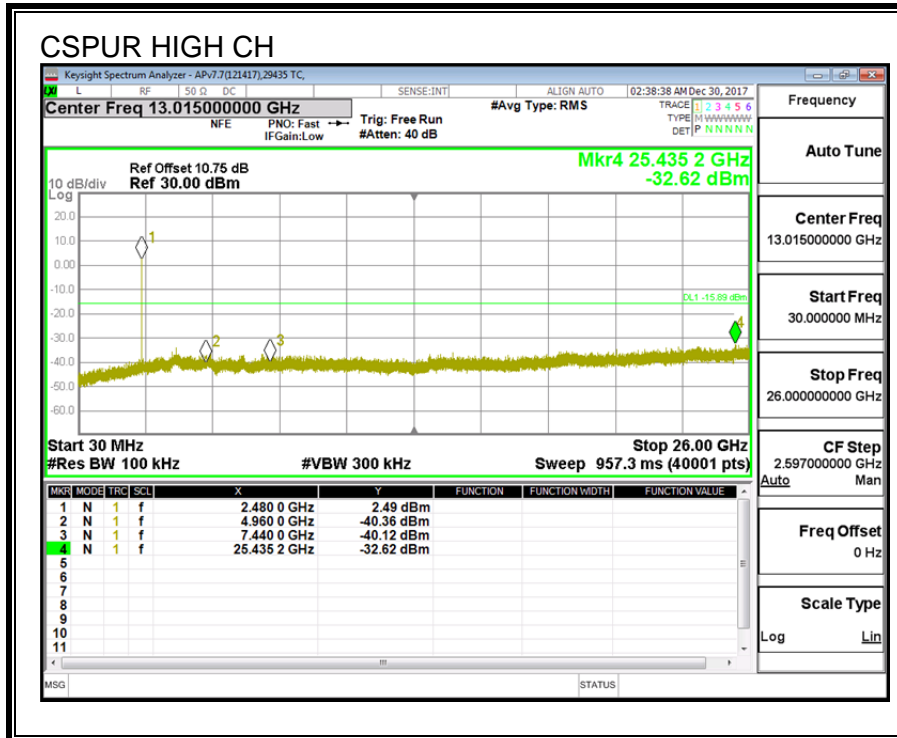

**CONDUCTED BANEDGE AND SPURIOUS EMISSIONS (2Mbps)**

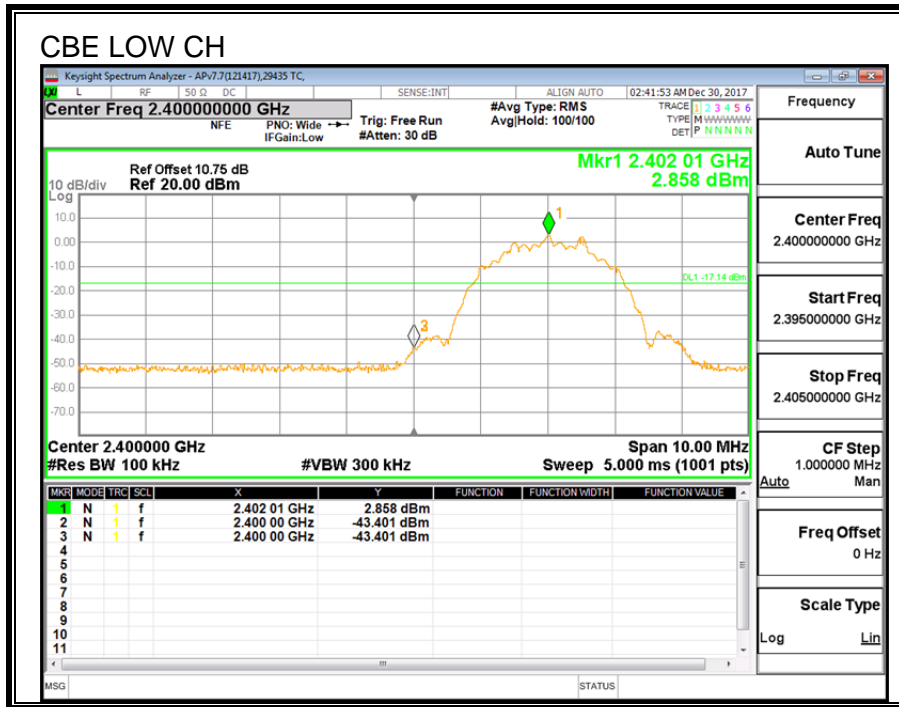

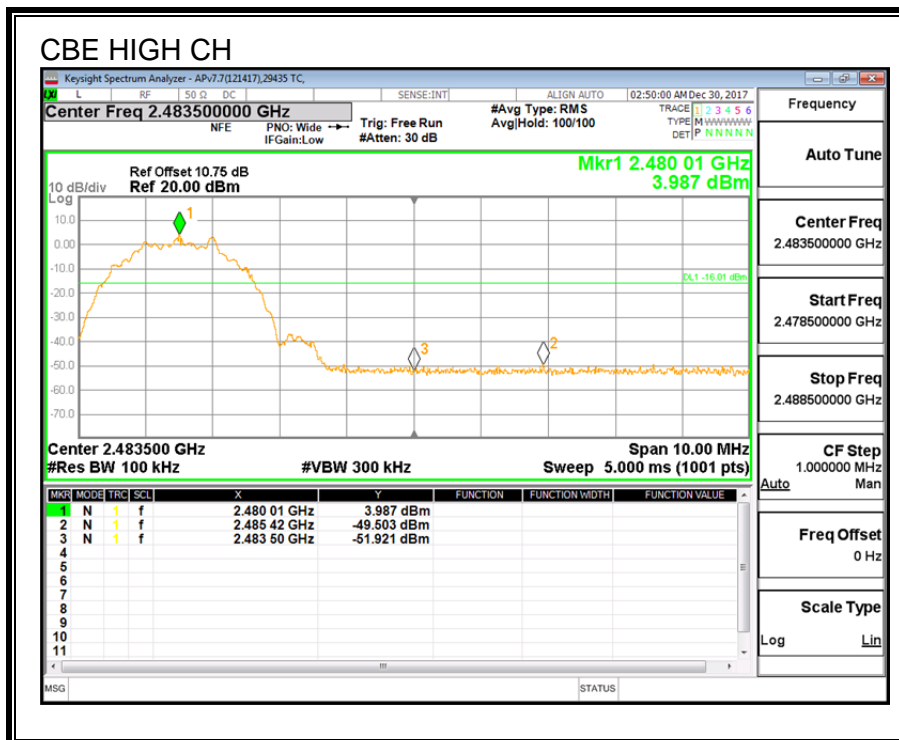
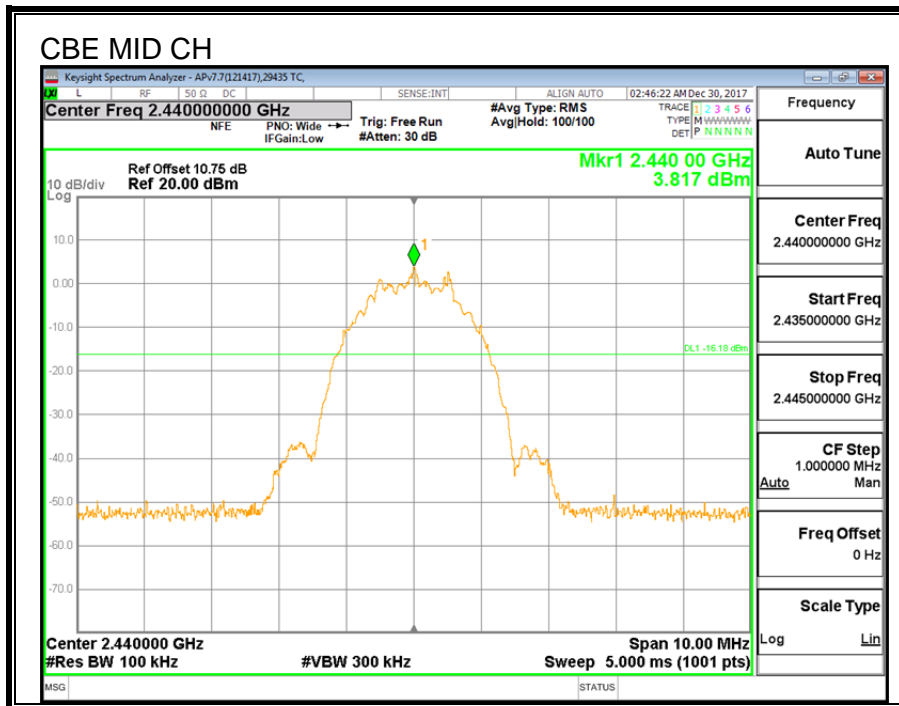

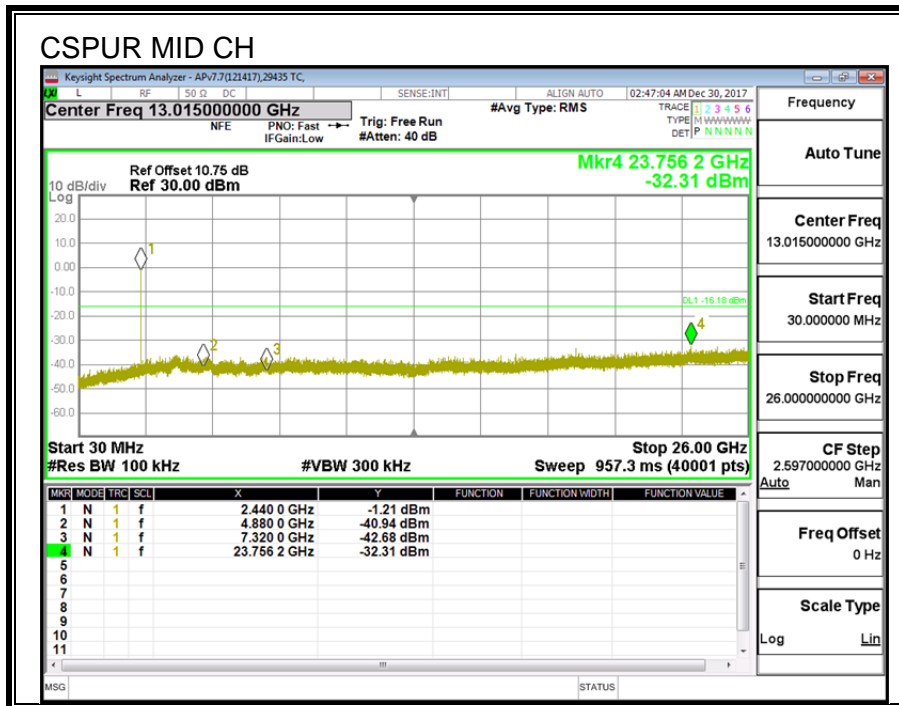
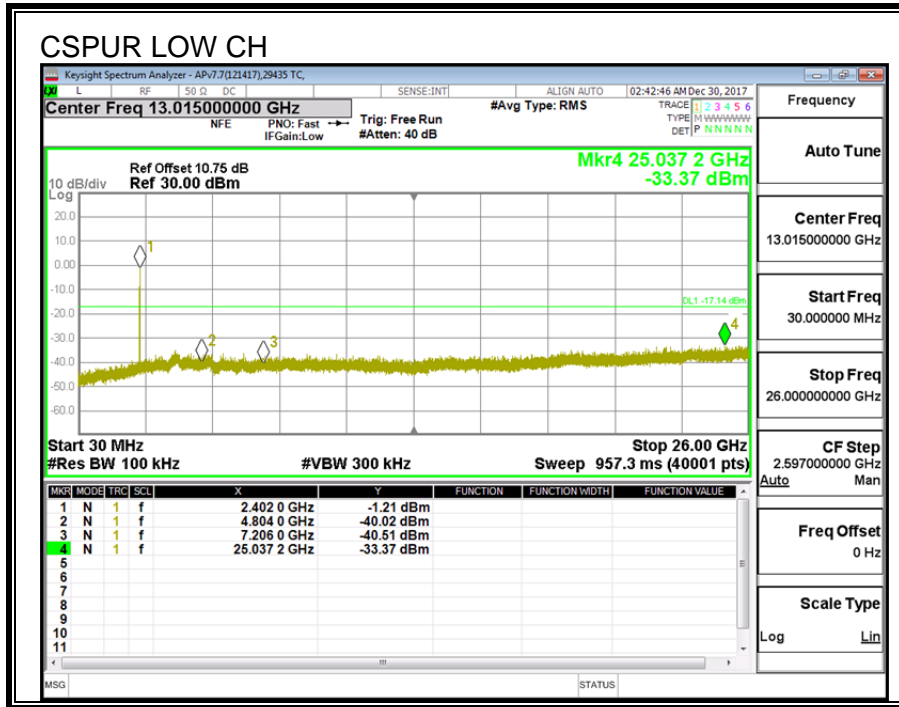

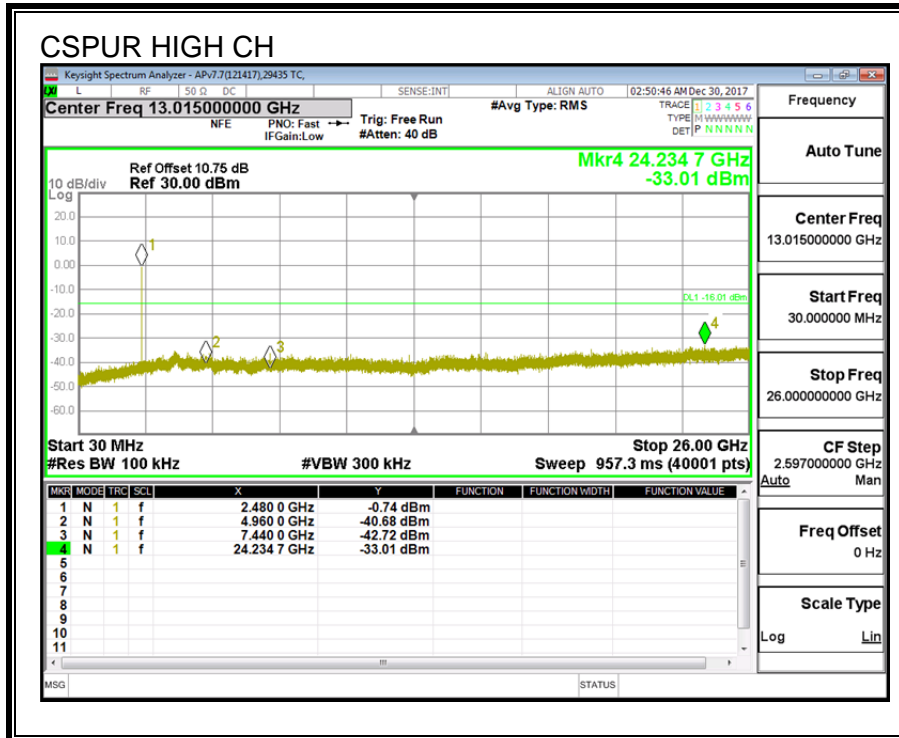

## 9. RADIATED TEST RESULTS

### 9.1. LIMITS AND PROCEDURE

#### LIMITS

FCC §15.205 and §15.209

Frequency Range (MHz)	Field Strength Limit (uV/m) at 3 m	Field Strength Limit (dBuV/m) at 3 m
0.009-0.490	2400/F(kHz) @ 300 m	-
0.490-1.705	24000/F(kHz) @ 30 m	-
1.705 - 30	30 @ 30m	-
30 - 88	100	40
88 - 216	150	43.5
216 - 960	200	46
Above 960	500	54

#### TEST PROCEDURE

The EUT is placed on a non-conducting table 80 cm above the ground plane for measurement below 1GHz; 1.5 m above the ground plane for measurement above 1GHz. The antenna to EUT distance is 3 meters. The EUT is configured in accordance with ANSI C63.10. The EUT is set to transmit in a continuous mode.

For measurements below 1 GHz the resolution bandwidth is set to 100 kHz for peak detection measurements or 120 kHz for quasi-peak detection measurements. Peak detection is used unless otherwise noted as quasi-peak.

For pre-scans above 1 GHz the resolution bandwidth is set to 1 MHz; the video bandwidth is set to 30 KHz for peak measurements.

For final measurements above 1 GHz the resolution bandwidth is set to 1 MHz; the video bandwidth is set to 3 MHz for peak measurements and as applicable for average measurements.

The spectrum from 1 GHz to 18 GHz is investigated with the transmitter set to the lowest, middle, and highest channels in each applicable band. Below 1GHz and above 18GHz emissions, the channel with the highest output power was tested.

The frequency range of interest is monitored at a fixed antenna height and EUT azimuth. The EUT is rotated through 360 degrees to maximize emissions received. The antenna is scanned from 1 to 4 meters above the ground plane to further maximize the emission. Measurements are made with the antenna polarized in both the vertical and the horizontal positions.

#### Results

## 9.2. TRANSMITTER ABOVE 1 GHz 1Mbps

### 9.2.1. RESTRICTED BANDEDGE (LOW CHANNEL)

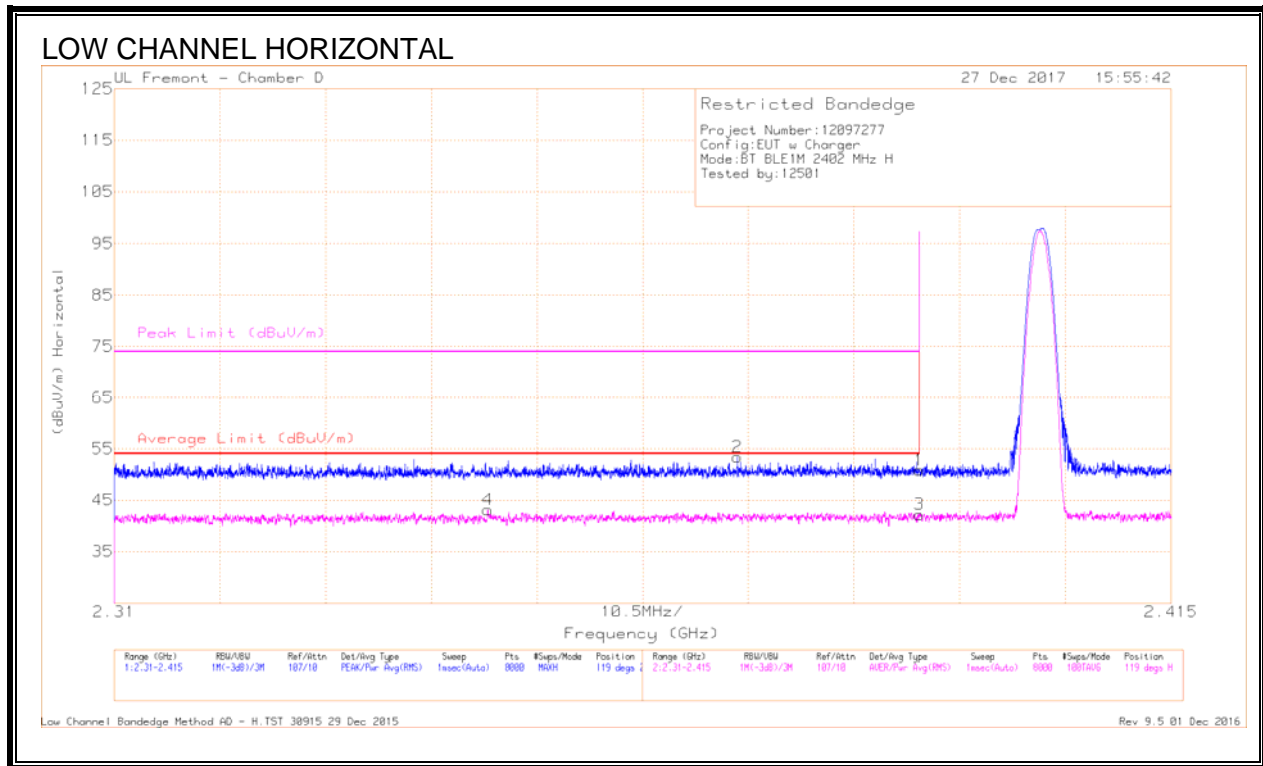

#### Trace Markers

Marker	Frequency (GHz)	Meter Reading (dBuV)	Det	AF T211 (dB/m)	Amp/Ch/Flt/Pad (dB)	DC Corr (dB)	Corrected Reading (dBuV/m)	Average Limit (dBuV/m)	Margin (dB)	Peak Limit (dBuV/m)	PK Margin (dB)	Azimuth (Degs)	Height (cm)	Polarity
1	* 2.39	39.2	Pk	32.1	-20.5	0	50.8	-	-	74	-23.2	119	222	H
2	* 2.372	41.89	Pk	32.1	-20.6	0	53.39	-	-	74	-20.61	119	222	H
3	* 2.39	29.91	RMS	32.1	-20.5	.68	42.2	54	-11.8	-	-	119	222	H
4	* 2.347	31.01	RMS	32	-20.6	.68	43.1	54	-10.9	-	-	119	222	H

\* - indicates frequency in CFR47 Pt 15 - Restricted Band

Pk - Peak detector

RMS - RMS detection



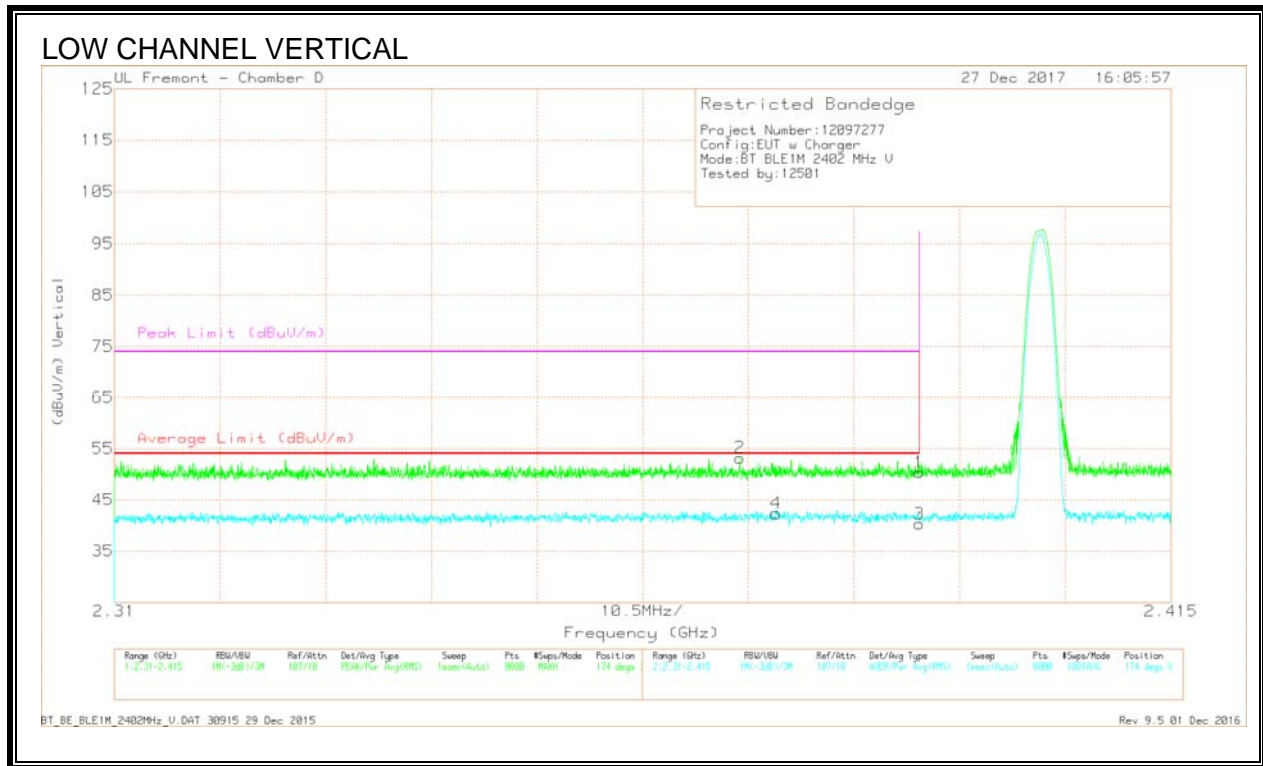

Trace Markers

Marker	Frequency (GHz)	Meter Reading (dBuV)	Det	Af T711 (dB/m)	Amp/Cbl/Ftr/Pad (dB)	DC Corr (dB)	Corrected Reading (dBuV/m)	Average Limit (dBuV/m)	Margin (dB)	Peak Limit (dBuV/m)	PK Margin (dB)	Azimuth (Degs)	Height (cm)	Polarity
1	* 2.39	38.74	Pk	32.1	-20.5	0	50.34	-	-	74	-23.66	174	387	V
2	* 2.372	41.67	Pk	32.1	-20.6	0	53.17	-	-	74	-20.83	174	387	V
3	* 2.39	28.72	RMS	32.1	-20.5	.68	41.01	54	-12.99	-	-	174	387	V
4	* 2.376	30.74	RMS	32.1	-20.5	.68	43.03	54	-10.97	-	-	174	387	V

\* - indicates frequency in CFR47 Pt 15 - Restricted Band

Pk - Peak detector

RMS - RMS detection

### 9.2.2. AUTHORIZED BANDEDGE (HIGH CHANNEL)

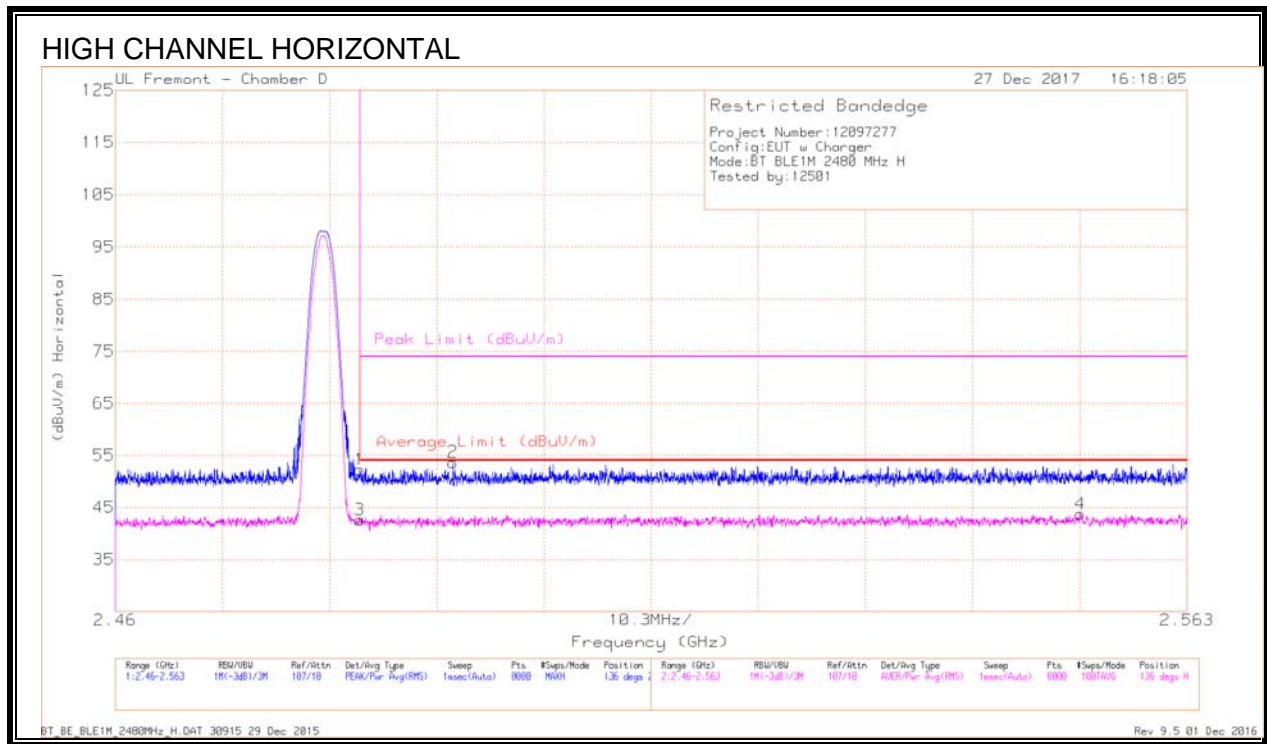

#### Trace Markers

Marker	Frequency (GHz)	Meter Reading (dBuV)	Det	AF T711 (dB/m)	Amp/Cb/Ftr/Pad (dB)	DC Corr (dB)	Corrected Reading (dBuV/m)	Average Limit (dBuV/m)	Margin (dB)	Peak Limit (dBuV/m)	PK Margin (dB)	Azimuth (Degs)	Height (cm)	Polarity
1	* 2.484	40.25	PK	32.5	-20.5	0	52.25	-	-	74	-21.75	136	245	H
3	* 2.484	29.95	RMS	32.5	-20.5	.68	42.64	54	-11.36	-	-	136	245	H
2	* 2.492	41.67	PK	32.6	-20.6	0	53.67	-	-	74	-20.33	136	245	H
4	2.553	30.85	RMS	32.6	-20.4	.68	43.74	54	-10.26	-	-	136	245	H

\* - indicates frequency in CFR47 Pt 15 - Restricted Band

PK - Peak detector

RMS - RMS detection

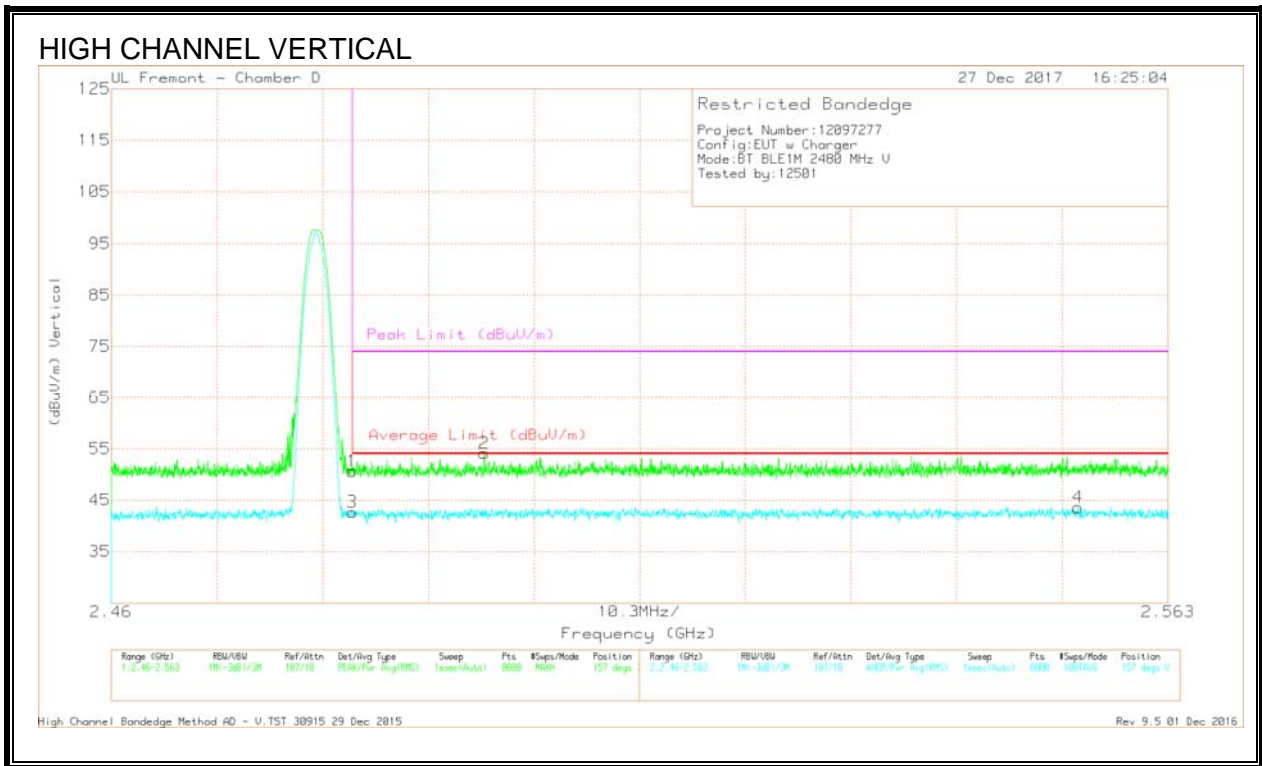

Trace Markers

Marker	Frequency (GHz)	Meter Reading (dBuV)	Det	AF T711 (dB/m)	Amp/Ch/Fltr/Pad (dB)	DC Corr (dB)	Corrected Reading (dBuV/m)	Average Limit (dBuV/m)	Margin (dB)	Peak Limit (dBuV/m)	PK Margin (dB)	Azimuth (Degs)	Height (cm)	Polarity
1	* 2.484	38.64	Pk	32.5	-20.5	0	50.64	-	-	74	-23.36	157	355	V
2	* 2.496	41.88	Pk	32.6	-20.4	0	54.08	-	-	74	-19.92	157	355	V
3	* 2.484	29.96	RMS	32.5	-20.5	.68	42.65	54	-11.35	-	-	157	355	V
4	2.554	30.67	RMS	32.6	-20.4	.68	43.56	54	-10.44	-	-	157	355	V

\* - indicates frequency in CFR47 Pt 15 - Restricted Band

Pk - Peak detector

RMS - RMS detection

### 9.2.3. HARMONICS AND SPURIOUS

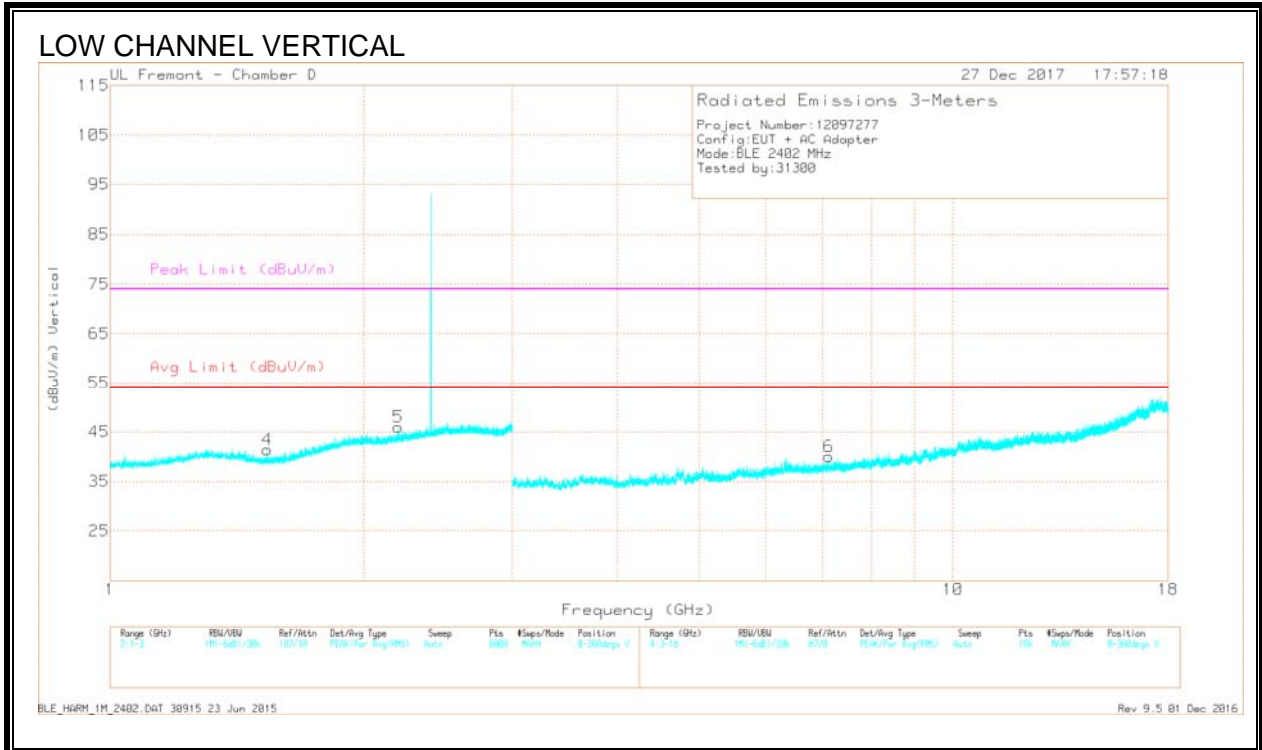
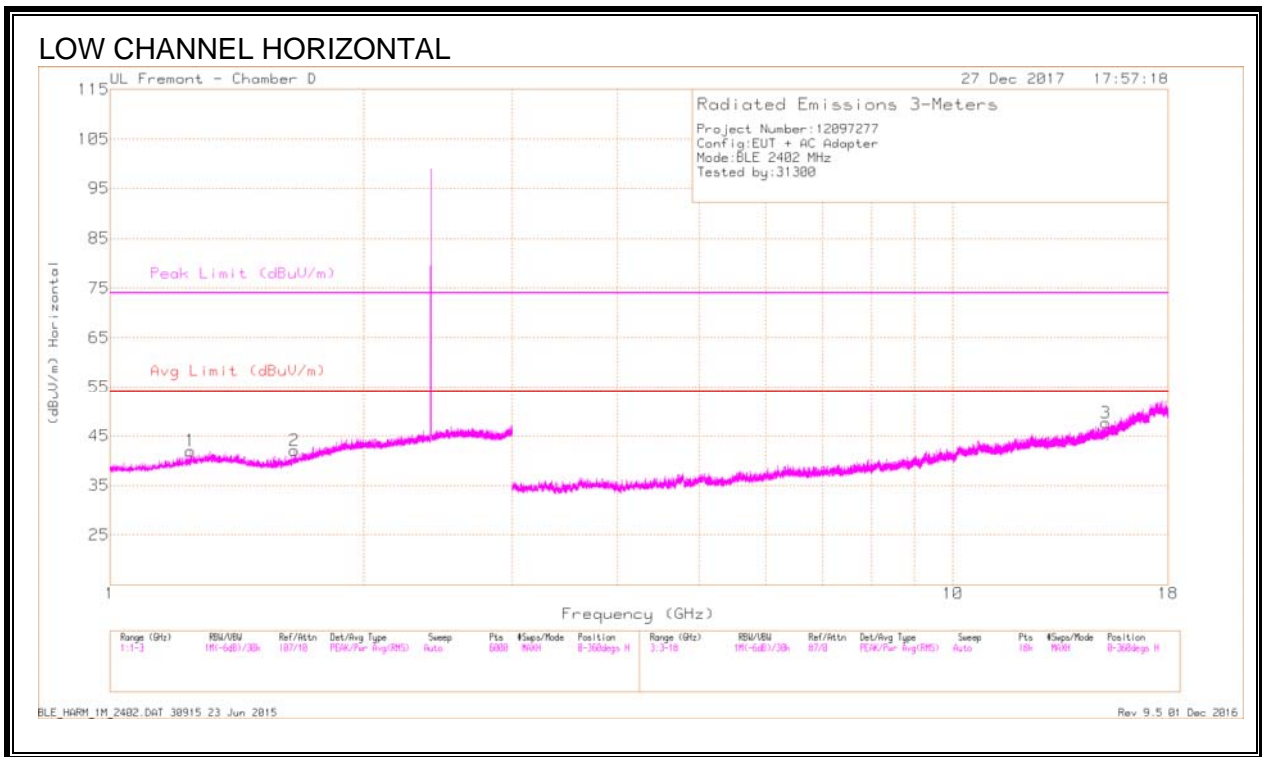

Radiated Emissions

Frequency (GHz)	Meter Reading (dBuV)	Det	AF T711 (dB/m)	Amp/Cbl/Filtr/ Pad (dB)	DC Corr (dB)	Corrected Reading (dBuV/m)	Avg Limit (dBuV/m)	Margin (dB)	Peak Limit (dBuV/m)	PK Margin (dB)	Azimuth (Degs)	Height (cm)	Polarity
* 1.246	40.11	PK2	29.1	-22.1	0	47.11	-	-	74	-26.89	205	141	H
* 1.248	28.21	MAv1	29.1	-22.1	.68	35.9	54	-18.1	-	-	205	141	H
* 1.538	39.84	PK2	28.2	-21.7	0	46.34	-	-	74	-27.66	267	261	V
* 1.535	28.01	MAv1	28.1	-21.7	.68	35.1	54	-18.9	-	-	267	261	V
* 2.218	40.06	PK2	31.7	-20.8	0	50.96	-	-	74	-23.04	216	161	V
* 2.299	28.04	MAv1	31.9	-20.7	.68	39.93	54	-13.07	-	-	216	161	V
1.653	28.06	MAv1	28.8	-21.5	.68	36.05	54	-	-	-	354	228	H
1.658	40.31	PK2	28.8	-21.4	0	47.71	-	-	74	-26.29	354	228	H
7.114	22.36	MAv1	35.5	-24.7	.68	33.85	54	-20.15	-	-	49	380	V
7.117	33.65	PK2	35.5	-24.7	0	44.45	-	-	74	-29.55	49	380	V
15.177	32.63	PK2	39.9	-20.4	0	52.13	-	-	74	-21.87	285	368	H
15.18	21.56	MAv1	39.9	-20.4	.68	41.75	54	-13.25	-	-	285	368	H

\* - indicates frequency in CFR47 Pt 15 - Restricted Band  
 PK2 - KDB558074 Method: Maximum Peak  
 MAv1 - KDB558074 Option 1 Maximum RMS Average

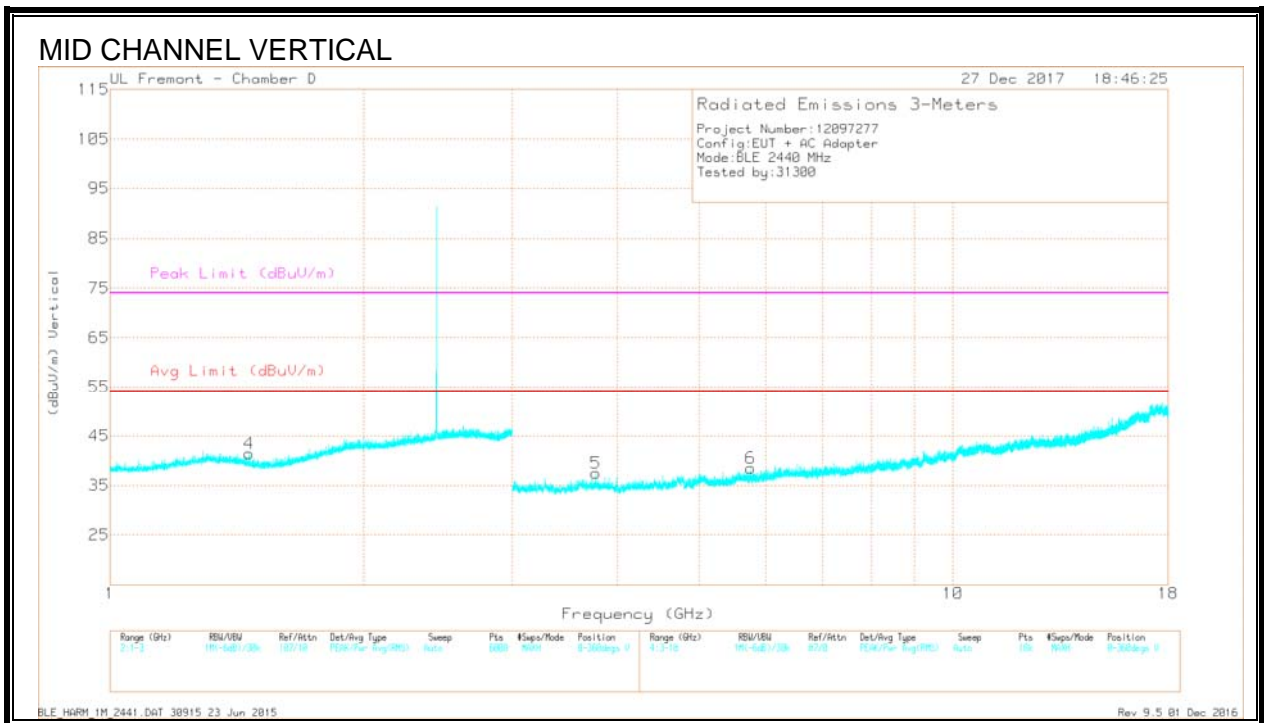
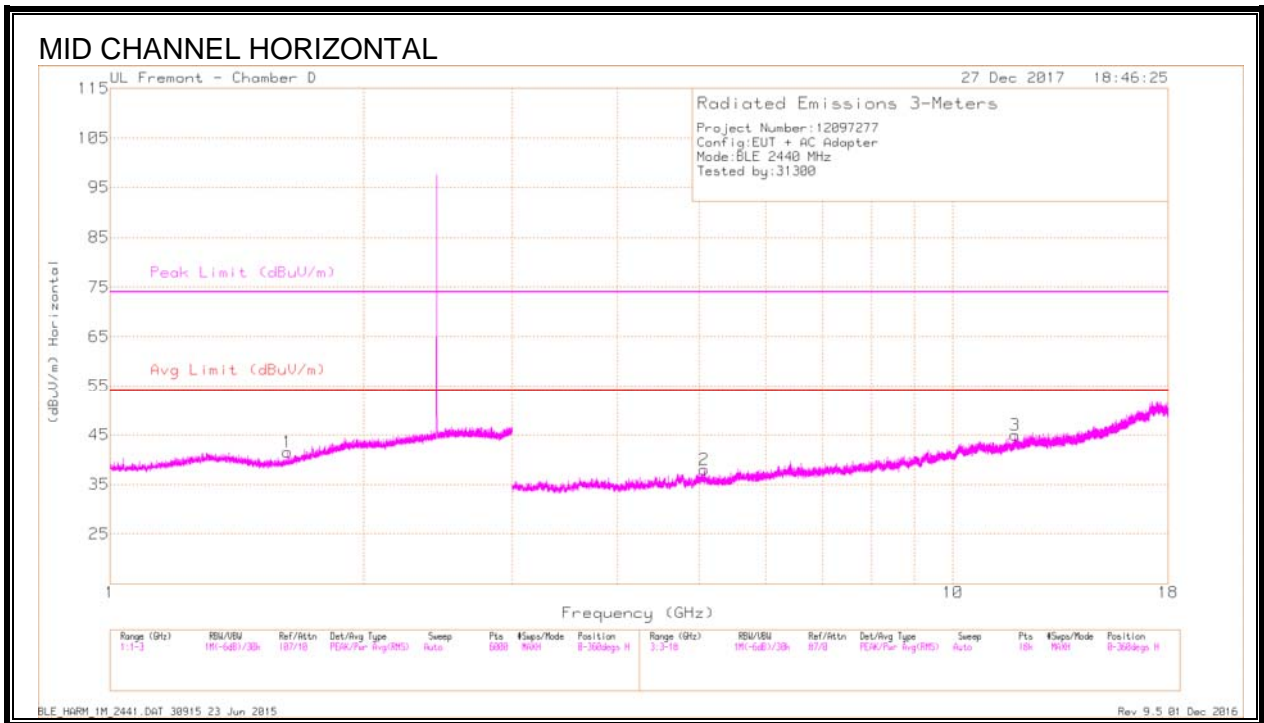

Radiated Emissions

Frequency (GHz)	Meter Reading (dBuV)	Det	AF T345 (dB/m)	Amp/Cbl/Filtr/ Pad (dB)	DC Corr (dB)	Corrected Reading (dBuV/m)	Avg Limit (dBuV/m)	Margin (dB)	Peak Limit (dBuV/m)	PK Margin (dB)	Azimuth (Degs)	Height (cm)	Polarity
* 2.368	42.09	PK2	31.9	-24.3	0	49.69	-	-	74	-24.31	129	130	H
* 2.371	30.3	MAv1	31.9	-24.3	.68	38.59	54	-15.41	-	-	129	130	H
* 4.544	39.71	PK2	34.2	-32.3	0	41.61	-	-	74	-32.39	321	368	H
* 4.543	27.69	MAv1	34.2	-32.3	.68	30.28	54	-23.72	-	-	321	368	H
* 3.855	40.98	PK2	33.5	-32.8	0	41.68	-	-	74	-32.32	38	197	V
* 3.855	28.59	MAv1	33.5	-32.8	.68	29.98	54	-24.02	-	-	38	197	V
2.148	30.26	MAv1	31.7	-24.5	.68	38.15	54	-15.75	-	-	235	271	V
2.149	42.65	PK2	31.7	-24.5	0	49.85	-	-	74	-24.15	235	271	V
3.362	28.37	MAv1	32.8	-32.7	.68	29.16	54	-24.84	-	-	278	400	H
3.364	40.43	PK2	32.8	-32.7	0	40.53	-	-	74	-33.47	278	400	H
4.46	28.37	MAv1	34.1	-32.5	.68	30.66	54	-13.34	-	-	283	360	V
4.461	39.59	PK2	34.1	-32.5	0	41.19	-	-	74	-32.81	283	360	V

\* - indicates frequency in CFR47 Pt 15 - Restricted Band

PK2 - KDB558074 Method: Maximum Peak

MAv1 - KDB558074 Option 1 Maximum RMS Average

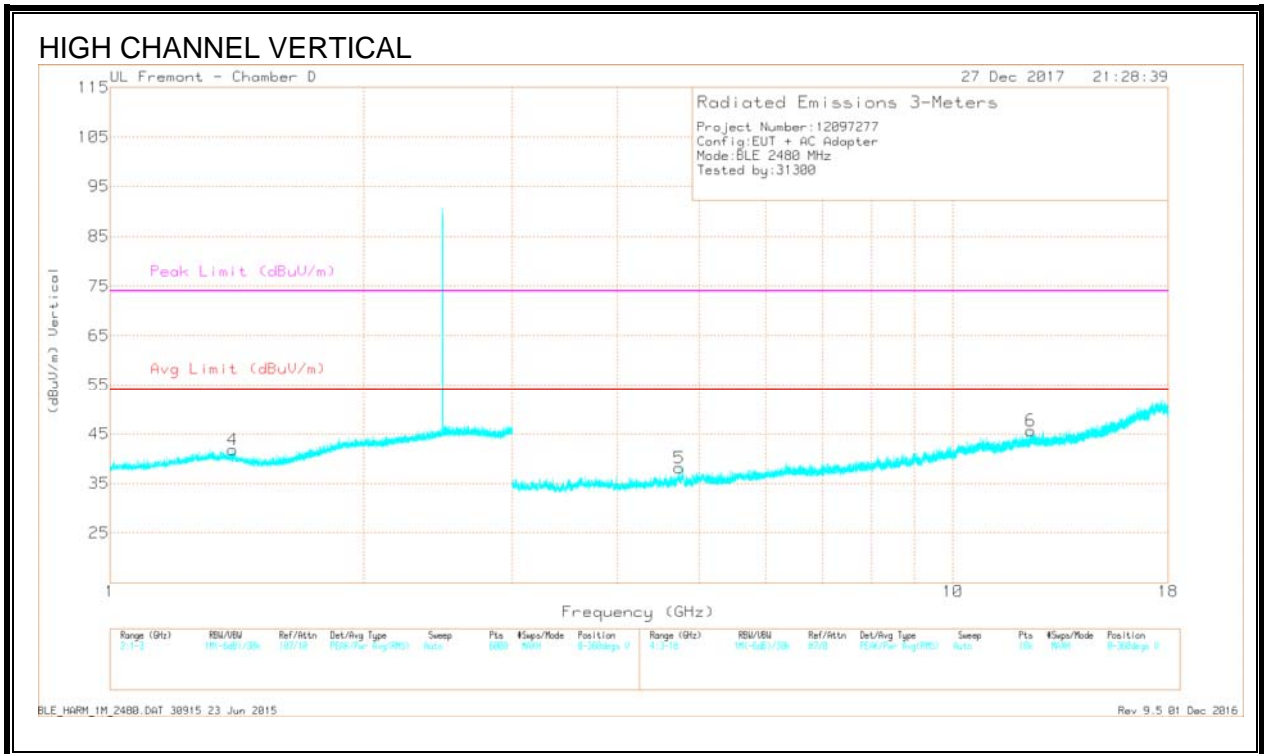
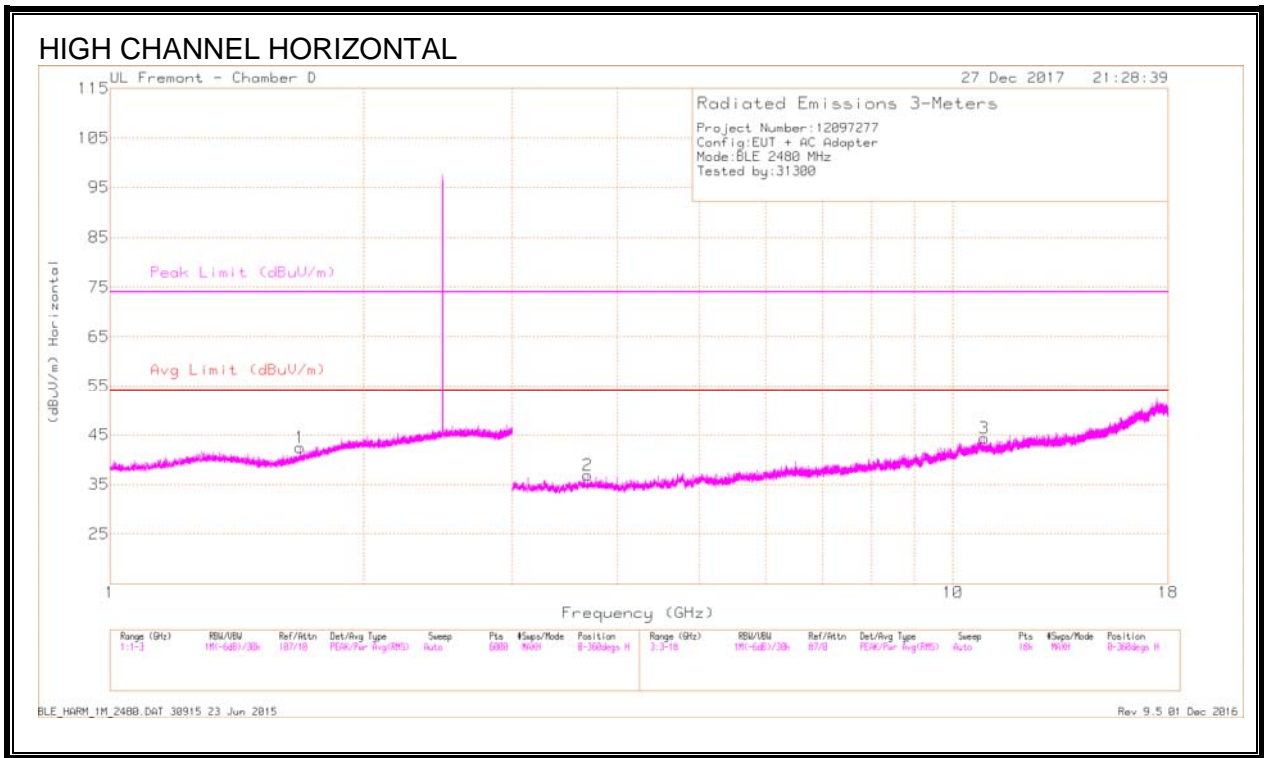



Radiated Emissions

Frequency (GHz)	Meter Reading (dBuV)	Det	AF T711 (dB/m)	Amp/Cbl/Filtr/ Pad (dB)	DC Corr (dB)	Corrected Reading (dBuV/m)	Avg Limit (dBuV/m)	Margin (dB)	Peak Limit (dBuV/m)	PK Margin (dB)	Azimuth (Degs)	Height (cm)	Polarity
* 1.681	40.02	PK2	29.1	-21.5	0	47.62	-	-	74	-26.38	15	272	H
* 1.68	27.99	MAV1	29	-21.5	.68	36.18	54	-17.72	-	-	15	272	H
* 1.397	39.68	PK2	29.2	-21.9	0	46.98	-	-	74	-27.02	315	174	V
* 1.396	28.04	MAV1	29.2	-21.9	.68	36.03	54	-17.93	-	-	315	174	V
* 3.687	36.9	PK2	33	-28.8	0	41.1	-	-	74	-32.9	44	202	H
* 3.686	25.33	MAV1	33	-28.8	.68	30.22	54	-13.78	-	-	44	202	H
* 10.884	31.45	PK2	37.9	-20.2	0	49.15	-	-	74	-24.85	6	196	H
* 10.888	20.01	MAV1	37.9	-20.2	.68	38.4	54	-15.60	-	-	6	196	H
* 4.735	35.77	PK2	33.9	-26.4	0	43.27	-	-	74	-30.73	66	128	V
* 4.737	23.85	MAV1	33.9	-26.4	.68	32.04	54	-11.96	-	-	66	128	V
* 12.366	32.1	PK2	38.9	-20.1	0	50.9	-	-	74	-23.1	12	229	V
* 12.364	20.31	MAV1	38.9	-20.1	.68	39.8	54	-14.20	-	-	12	229	V

\* - indicates frequency in CFR47 Pt 15 - Restricted Band

PK2 - KDB558074 Method: Maximum Peak

MAV1 - KDB558074 Option 1 Maximum RMS Average

### 9.3. TRANSMITTER ABOVE 1 GHz 2Mbps

#### 9.3.1. RESTRICTED BANDEDGE (LOW CHANNEL)

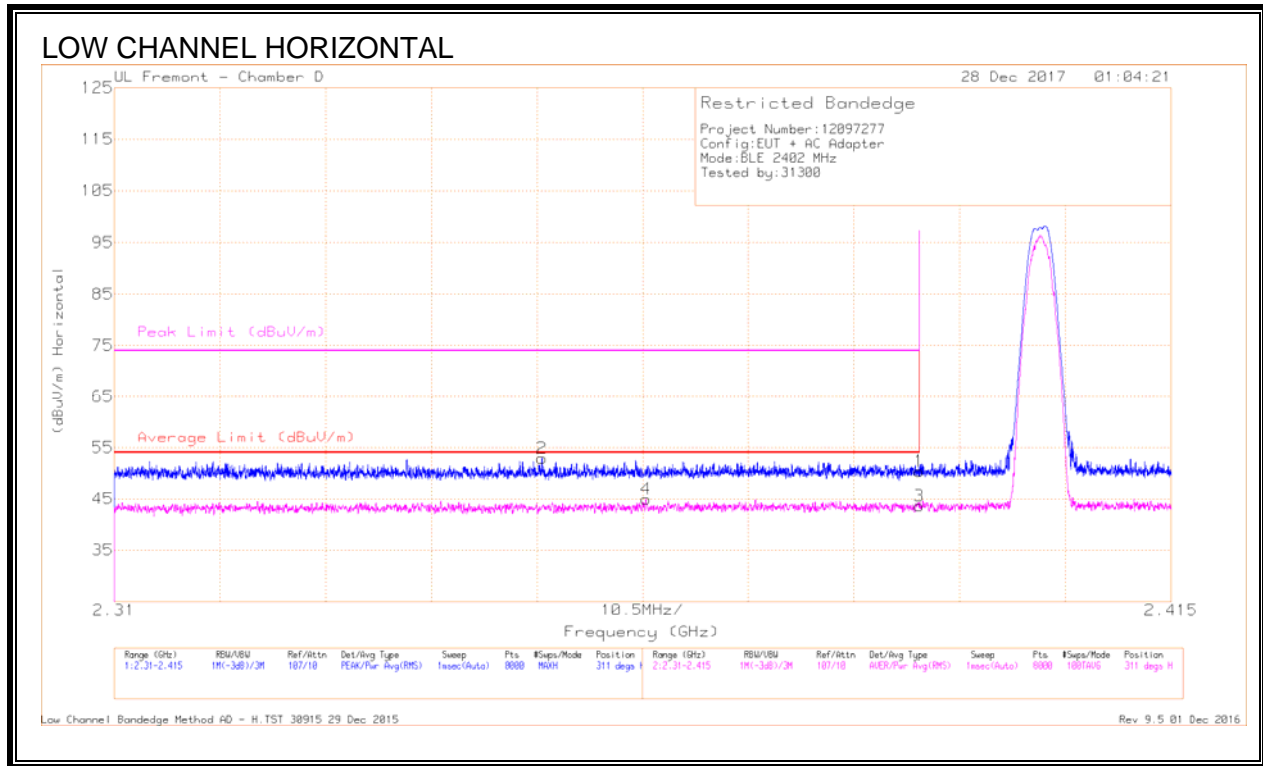

#### Trace Markers

Marker	Frequency (GHz)	Meter Reading (dBuV)	Det	Af T711 (dB/m)	Amp/Ch/Filt/Pad (dB)	DC Corr (dB)	Corrected Reading (dBuV/m)	Average Limit (dBuV/m)	Margin (dB)	Peak Limit (dBuV/m)	PK Margin (dB)	Azimuth (Degs)	Height (cm)	Polarity
1	* 2.39	38.77	Pk	32.1	-20.5	0	50.37	-	-	74	-23.63	311	294	H
2	* 2.352	41.5	Pk	32	-20.6	0	52.9	-	-	74	-21.1	311	294	H
3	* 2.39	29.58	RMS	32.1	-20.5	2.42	43.6	54	-10.4	-	-	311	294	H
4	* 2.363	31.03	RMS	32.1	-20.6	2.42	44.95	54	-9.05	-	-	311	294	H

\* - indicates frequency in CFR47 Pt 15 - Restricted Band

Pk - Peak detector

RMS - RMS detection

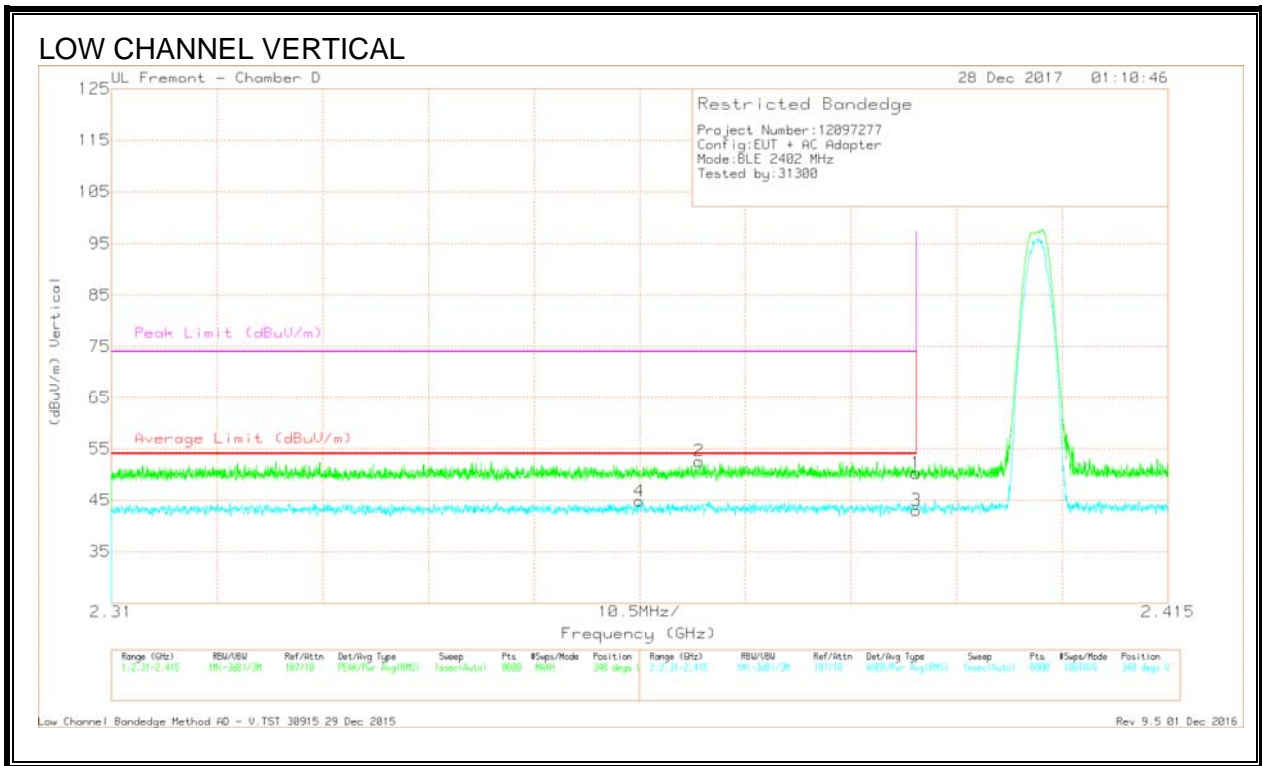

Trace Markers

Marker	Frequency (GHz)	Meter Reading (dBuV)	Det	AF T711 (dB/m)	Amp/Ch/Fltr/Pad (dB)	DC Corr (dB)	Corrected Reading (dBuV/m)	Average Limit (dBuV/m)	Margin (dB)	Peak Limit (dBuV/m)	PK Margin (dB)	Azimuth (Degs)	Height (cm)	Polarity
1	* 2.39	38.67	Pk	32.1	-20.5	0	50.27	-	-	74	-23.73	348	395	V
2	* 2.368	41.09	Pk	32.1	-20.6	0	52.59	-	-	74	-21.41	348	395	V
3	* 2.39	28.99	RMS	32.1	-20.5	2.42	43.01	54	-10.99	-	-	348	395	V
4	* 2.362	30.88	RMS	32.1	-20.6	2.42	44.8	54	-9.2	-	-	348	395	V

\* - indicates frequency in CFR47 Pt 15 - Restricted Band

Pk - Peak detector

RMS - RMS detection

### 9.3.2. AUTHORIZED BANDEDGE (HIGH CHANNEL)

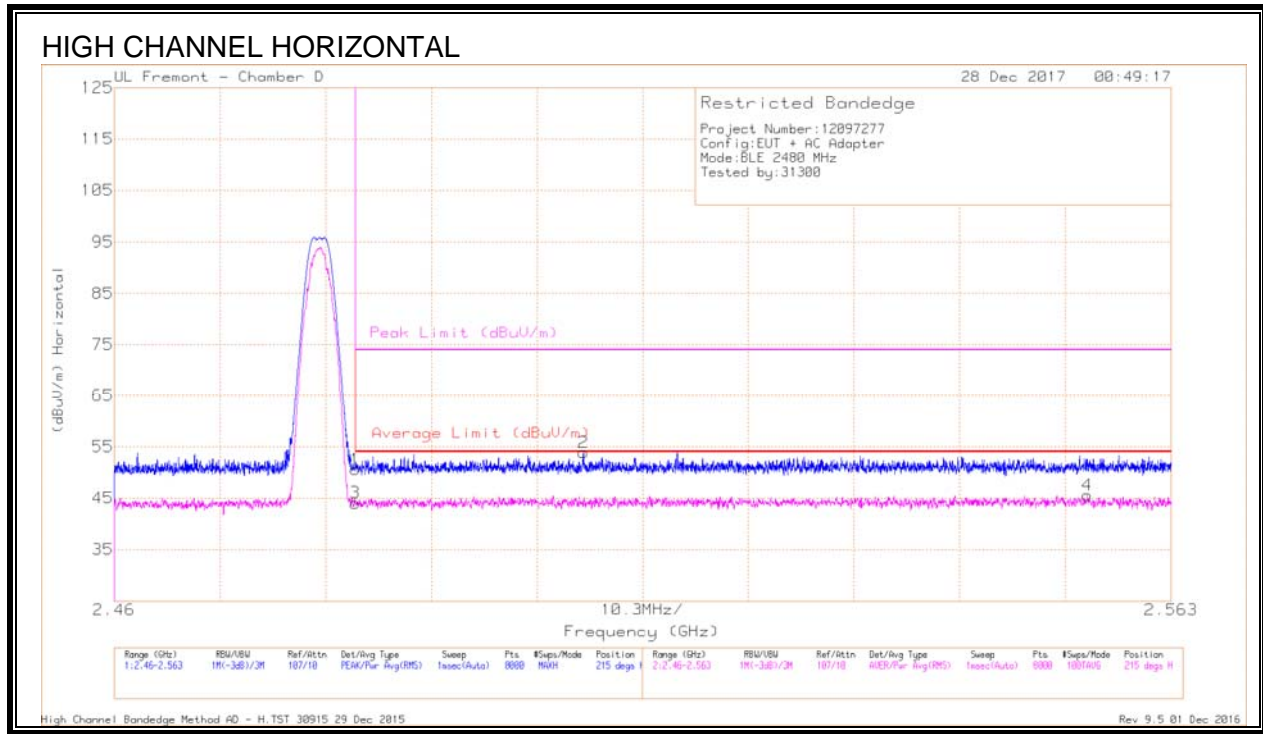

#### Trace Markers

Marker	Frequency (GHz)	Meter Reading (dBuV)	Det	Af T711 (dB/m)	Amp/Ch/Filt/Pad (dB)	DC Corr (dB)	Corrected Reading (dBuV/m)	Average Limit (dBuV/m)	Margin (dB)	Peak Limit (dBuV/m)	PK Margin (dB)	Asimuth (Degs)	Height (cm)	Polarity
1	* 2.484	38.55	Pk	32.5	-20.5	0	50.55	-	-	74	-23.45	215	302	H
3	* 2.484	29.62	RMS	32.5	-20.5	2.42	44.04	54	-9.96	-	-	215	302	H
2	2.506	41.66	Pk	32.6	-20.4	0	53.86	-	-	74	-20.14	215	302	H
4	2.555	30.82	RMS	32.6	-20.3	2.42	45.54	54	-8.46	-	-	215	302	H

\* - indicates frequency in CFR47 Pt 15 - Restricted Band

Pk - Peak detector

RMS - RMS detection

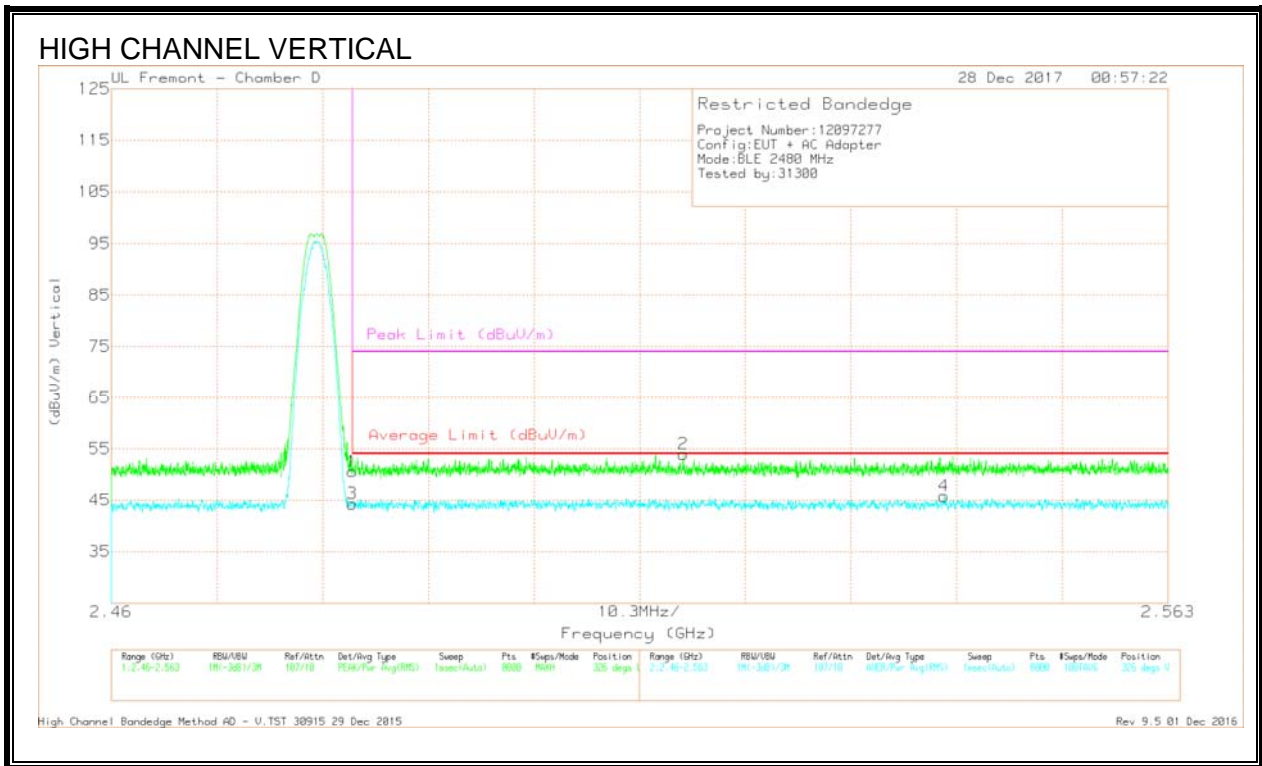

Trace Markers

Marker	Frequency (GHz)	Meter Reading (dBuV)	Det	AF T711 (dB/m)	Amp/Cbi/Filt/Pad (dB)	DC Corr (dB)	Corrected Reading (dBuV/m)	Average Limit (dBuV/m)	Margin (dB)	Peak Limit (dBuV/m)	PK Margin (dB)	Azimuth (Degs)	Height (cm)	Polarity
1	* 2.484	38.55	PK	32.5	-20.5	0	50.55	-	-	74	-23.45	326	355	V
3	* 2.484	29.87	RMS	32.5	-20.5	2.42	44.29	54	-9.71	-	-	326	355	V
2	2.516	41.75	PK	32.6	-20.4	0	53.95	-	-	74	-20.05	326	355	V
4	2.541	31.14	RMS	32.6	-20.4	2.42	45.76	54	-8.24	-	-	326	355	V

\* - indicates frequency in CFR47 Pt 15 - Restricted Band

PK - Peak detector

RMS - RMS detection

### 9.3.3. HARMONICS AND SPURIOUS

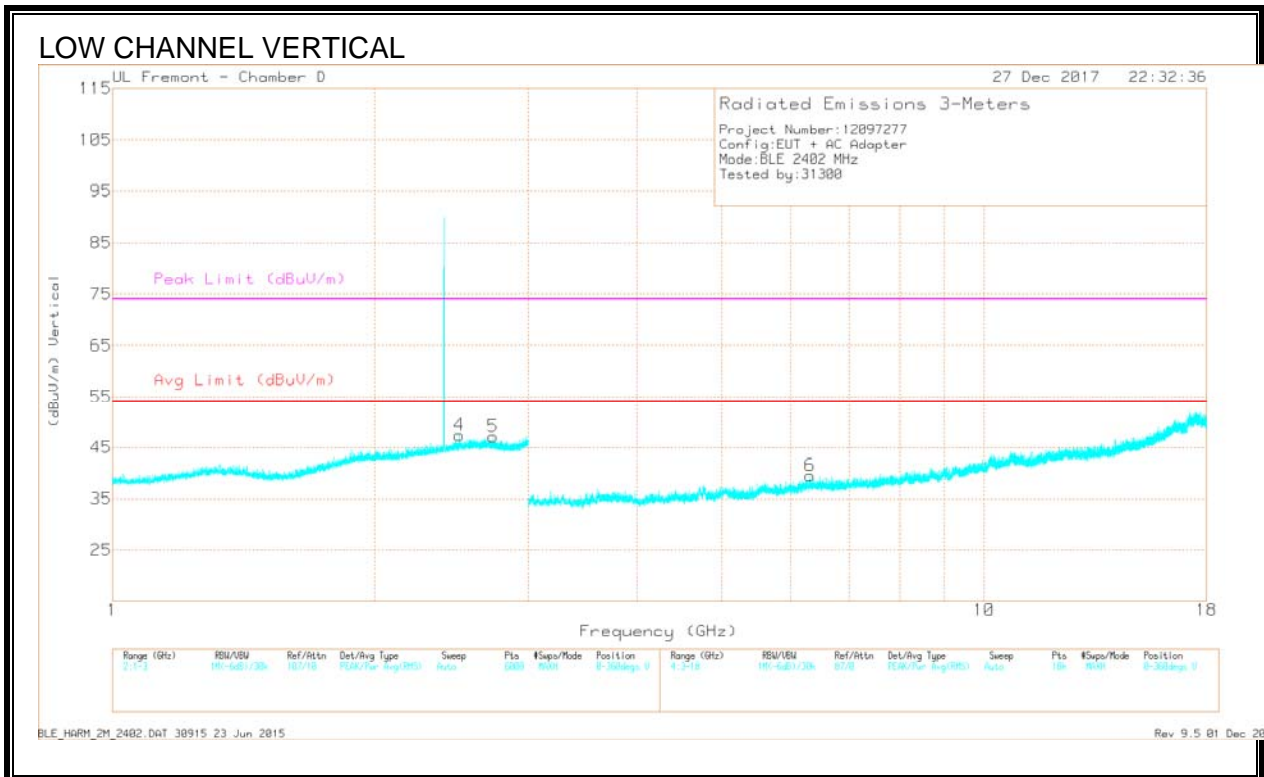
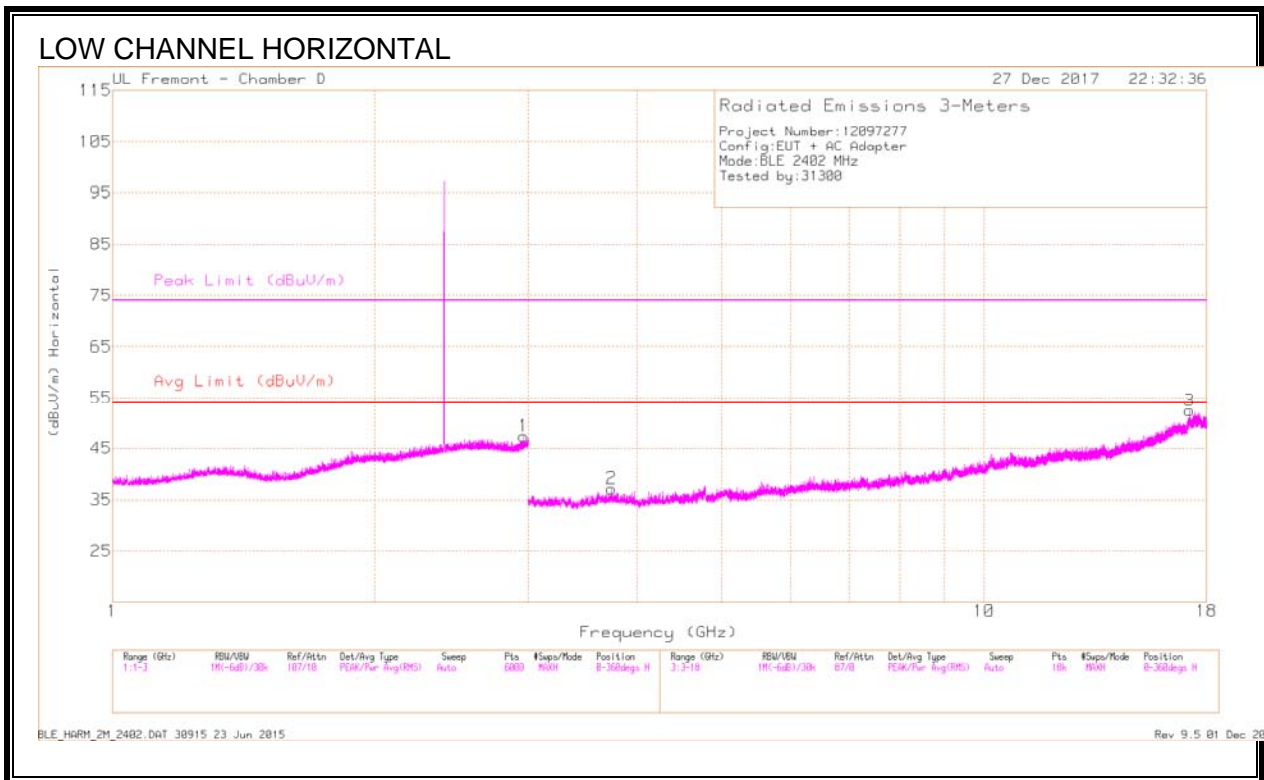

Radiated Emissions

Frequency (GHz)	Meter Reading (dBuV)	Det	AF T711 (dB/m)	Amp/Cbl/Fitr/Paid (dB)	DC Corr (dB)	Corrected Reading (dBuV/m)	Avg Limit (dBuV/m)	Margin (dB)	Peak Limit (dBuV/m)	PK Margin (dB)	Azimuth (Degs)	Height (cm)	Polarity
* 2.494	39.94	PK2	32.6	-20.5	0	52.04	-	-	74	-21.96	166	124	V
* 2.485	28.08	MAv1	32.6	-20.5	2.42	42.6	54	-11.40	-	-	166	124	V
* 2.739	40.52	PK2	32.6	-20.2	0	52.92	-	-	74	-21.08	6	329	V
* 2.732	27.93	MAv1	32.6	-20.2	2.42	42.75	54	-11.25	-	-	6	329	V
* 3.741	36.41	PK2	33.1	-28.2	0	41.31	-	-	74	-32.69	180	251	H
* 3.737	24.89	MAv1	33.1	-28.3	2.42	32.11	54	-21.89	-	-	180	251	H
2.96	27.9	MAv1	32.4	-19.9	2.42	42.82	54	-11.18	-	-	280	155	H
2.965	40.35	PK2	32.5	-19.9	0	52.95	-	-	74	-21.05	280	155	H
6.309	23.25	MAv1	35.4	-25.7	2.42	35.37	54	-18.63	-	-	219	123	V
6.314	34.56	PK2	35.4	-25.6	0	44.36	-	-	74	-29.64	219	123	V
17.21	20.03	MAv1	41.4	-15.8	2.42	48.05	54	-7.95	-	-	115	240	H
17.216	31.31	PK2	41.4	-15.7	0	57.01	-	-	74	-16.99	115	240	H

\* - indicates frequency in CFR47 Pt 15 - Restricted Band

PK2 - KDB558074 Method: Maximum Peak

MAv1 - KDB558074 Option 1 Maximum RMS Average

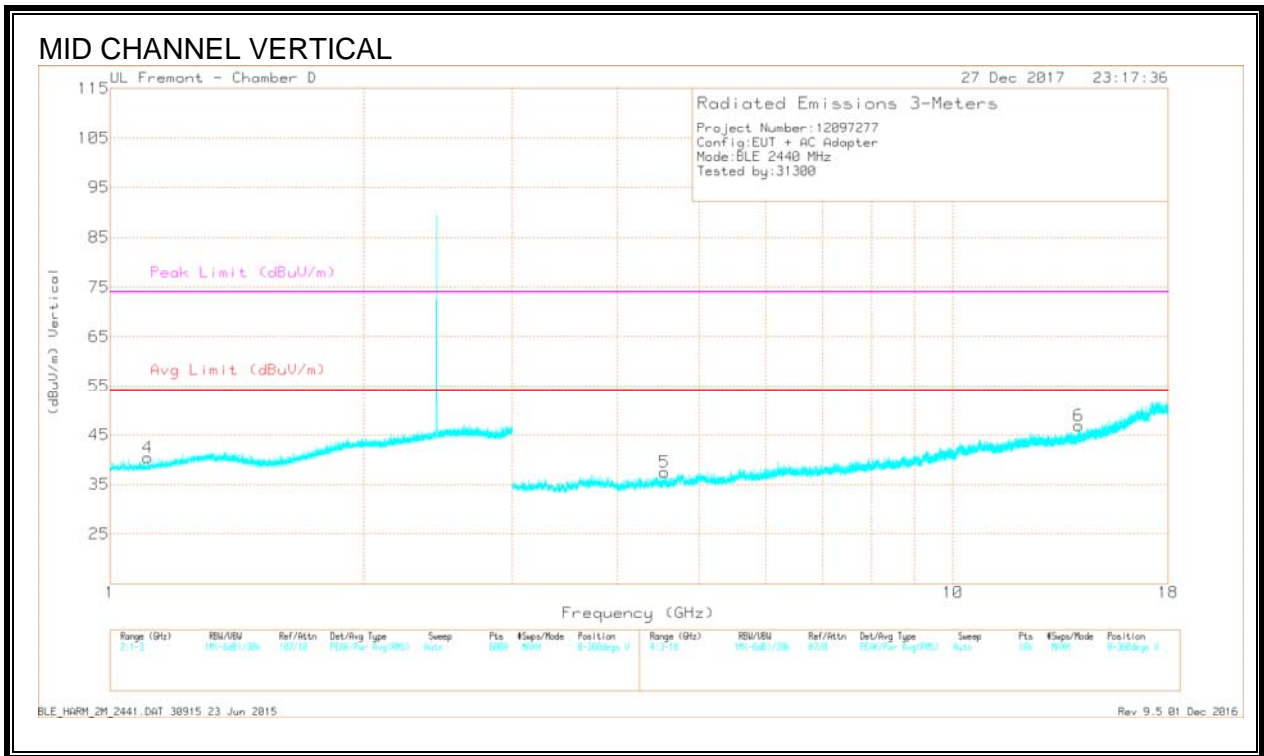
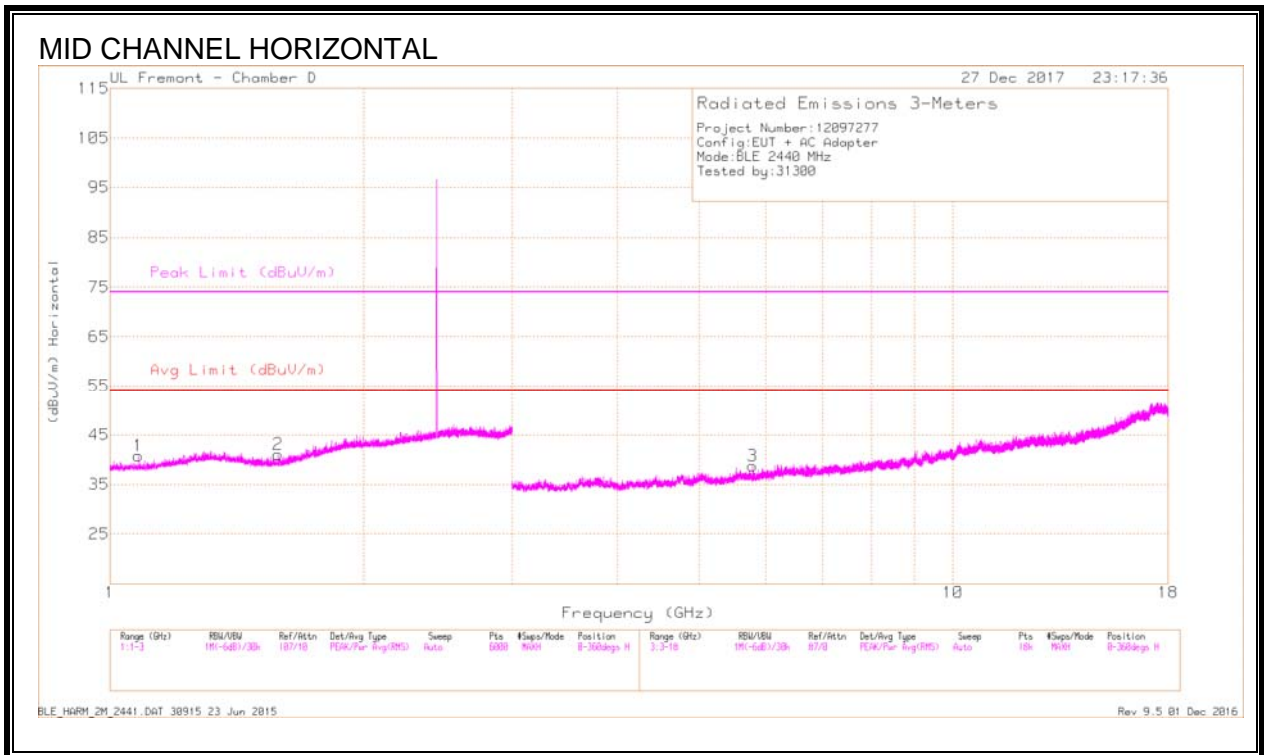



Radiated Emissions

Frequency (GHz)	Meter Reading (dBuV)	Det	AF T711 (dB/m)	Amp/Cbl/Filtr/ Pad (dB)	DC Corr (dB)	Corrected Reading (dBuV/m)	Avg Limit (dBuV/m)	Margin (dB)	Peak Limit (dBuV/m)	PK Margin (dB)	Azimuth (Degs)	Height (cm)	Polarity
* 1.081	40.26	PK2	27.8	-22.3	0	45.76	-	-	74	-28.24	116	348	H
* 1.08	28.38	MAv1	27.8	-22.3	2.42	36.3	54	-17.70	-	-	116	348	H
* 1.582	39.74	PK2	28.2	-21.6	0	46.34	-	-	74	-27.66	74	141	H
* 1.58	27.95	MAv1	28.2	-21.6	2.42	36.97	54	-17.03	-	-	74	141	H
* 1.11	40.47	PK2	27.9	-22.3	0	46.07	-	-	74	-27.93	140	118	V
* 1.108	28.31	MAv1	27.8	-22.3	2.42	36.23	54	-17.77	-	-	140	118	V
* 4.545	36.45	PK2	33.7	-27.6	0	42.55	-	-	74	-31.45	3	231	V
* 4.545	24.48	MAv1	33.7	-27.6	2.42	33	54	-21.0	-	-	3	231	V
5.79	35.97	PK2	34.7	-26.7	0	43.97	-	-	74	-30.03	352	101	H
5.79	23.51	MAv1	34.7	-26.7	2.42	33.93	54	-20.07	-	-	352	101	H
14.104	22.28	MAv1	38.9	-21.4	2.42	42.2	54	-11.80	-	-	134	196	V
14.108	34.21	PK2	38.9	-21.5	0	51.61	-	-	74	-22.39	134	196	V

\* - indicates frequency in CFR47 Pt 15 - Restricted Band

PK2 - KDB558074 Method: Maximum Peak

MAv1 - KDB558074 Option 1 Maximum RMS Average

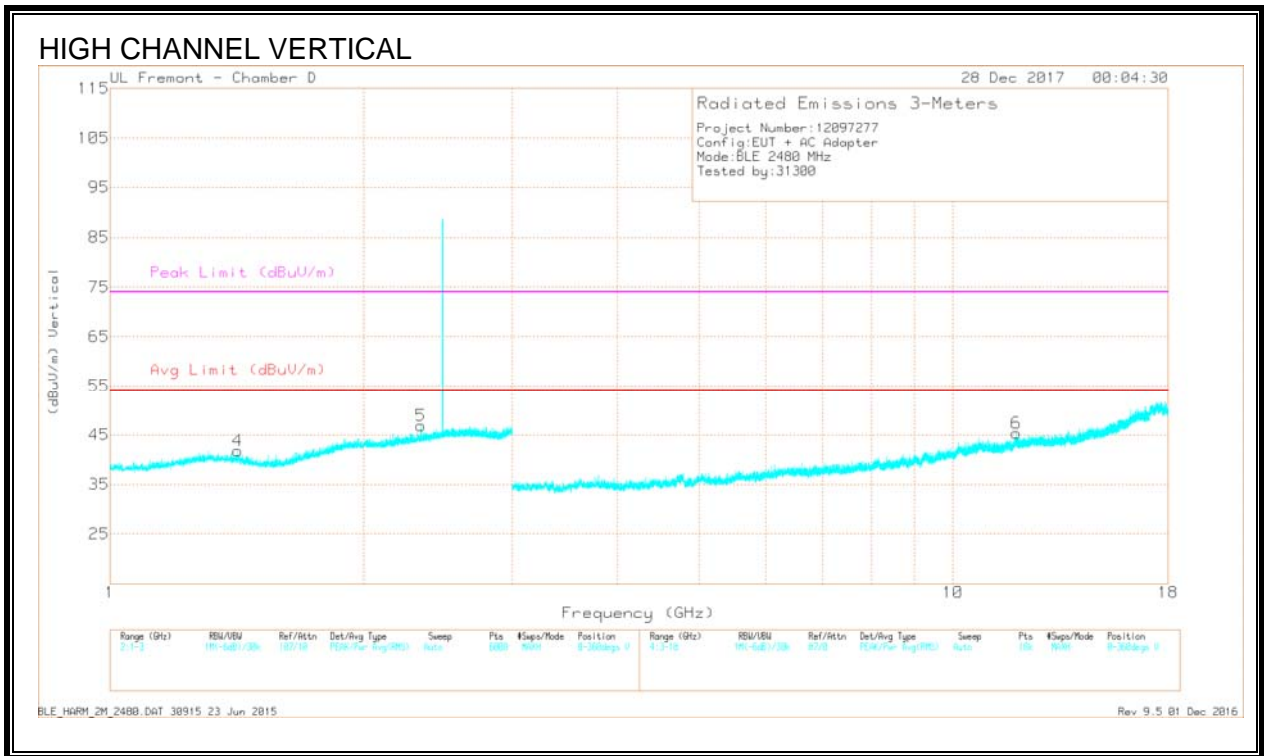
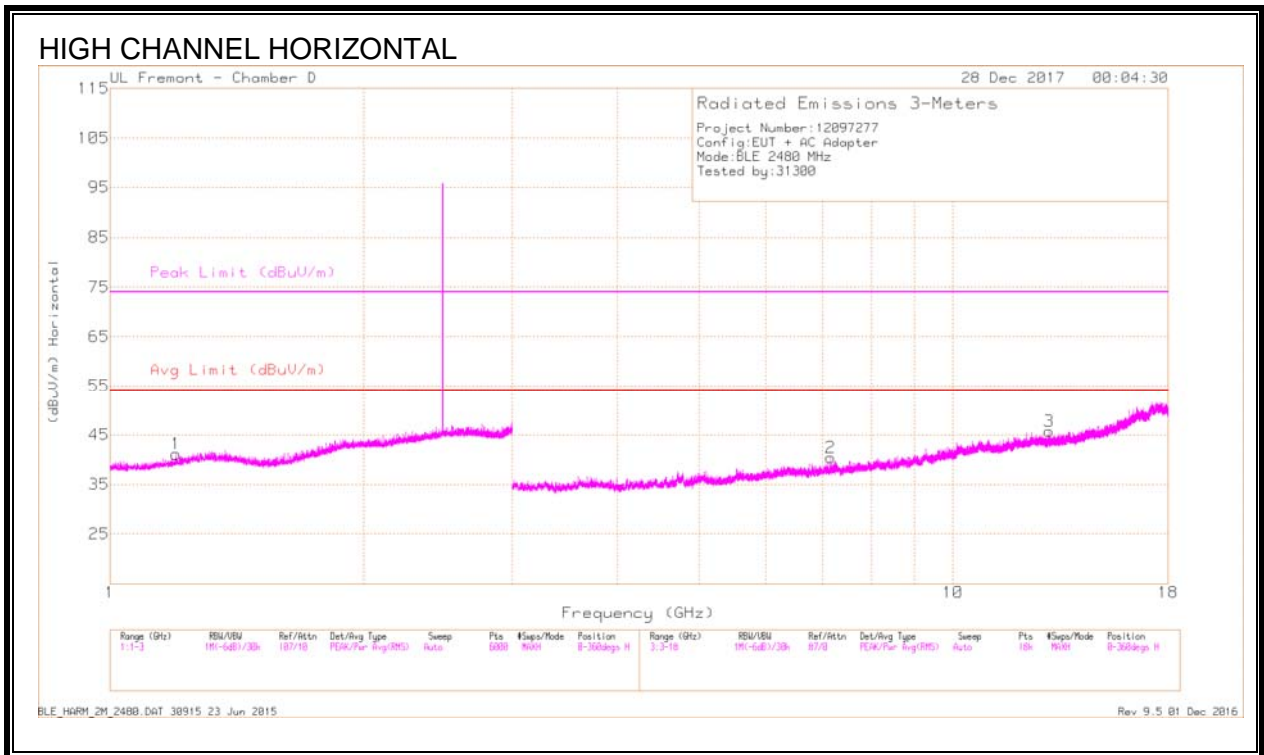

Radiated Emissions

Frequency (GHz)	Meter Reading (dBuV)	Det	AF T711 (dB/m)	Amp/Cbl/Filtr/ Pad (dB)	DC Corr (dB)	Corrected Reading (dBuV/m)	Avg Limit (dBuV/m)	Margin (dB)	Peak Limit (dBuV/m)	PK Margin (dB)	Azimuth (Degs)	Height (cm)	Polarity
* 1.199	40.42	PK2	28.6	-22.2	0	46.82	-	-	74	-27.18	279	149	H
* 1.196	28.3	MAv1	28.6	-22.2	2.42	37.12	54	-16.88	-	-	279	149	H
* 1.413	40.29	PK2	29.1	-21.8	0	47.59	-	-	74	-26.41	352	101	V
* 1.418	28.03	MAv1	29	-21.8	2.42	37.65	54	-16.35	-	-	352	101	V
* 2.336	39.87	PK2	32	-20.6	0	51.27	-	-	74	-22.73	113	400	V
* 2.34	28.02	MAv1	32	-20.6	2.42	41.84	54	-12.16	-	-	113	400	V
* 11.899	31.42	PK2	38.5	-19.8	0	50.12	-	-	74	-23.88	108	271	V
* 11.895	19.89	MAv1	38.5	-19.7	2.42	41.11	54	-12.89	-	-	108	271	V
7.154	33.64	PK2	35.5	-24.8	0	44.34	-	-	74	-29.66	178	190	H
7.156	22.6	MAv1	35.5	-24.7	2.42	35.82	54	-19.18	-	-	178	190	H
12.994	20.29	MAv1	39	-20.2	2.42	41.51	54	-12.49	-	-	159	318	H
13	31.62	PK2	39	-20.2	0	50.42	-	-	74	-23.58	159	318	H

\* - indicates frequency in CFR47 Pt 15 - Restricted Band

PK2 - KDB558074 Method: Maximum Peak

MAv1 - KDB558074 Option 1 Maximum RMS Average

### 9.4. SPURIOUS EMISSIONS BELOW 30 MHz (WORST-CASE CONFIGURATION)

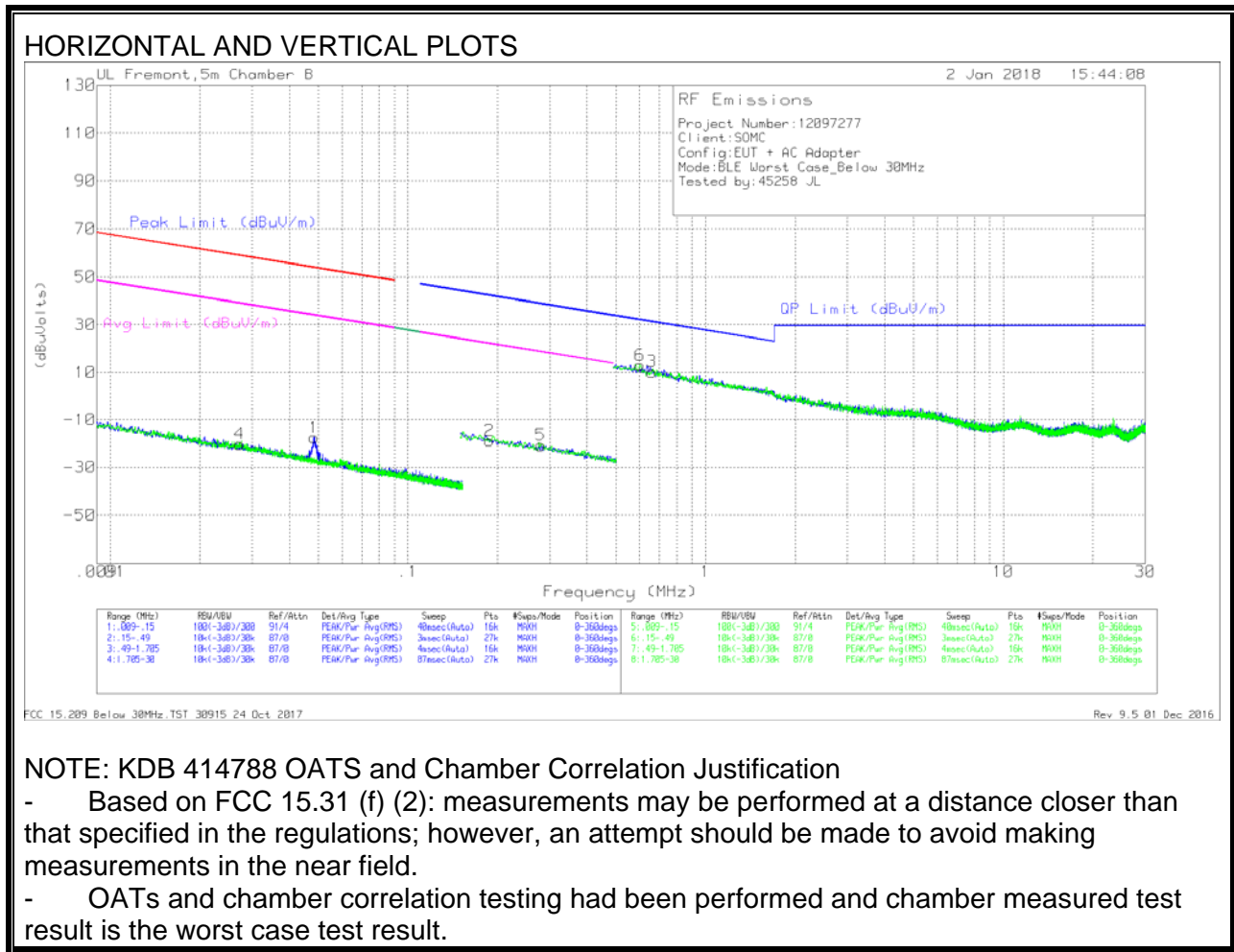

#### Trace Markers

Marker	Frequency (MHz)	Meter Reading (dBuV)	Det	Loop Antenna (dB/m)	ChI (dB)	Dist Corr 300m	Corrected Reading (dBuV/m)	Peak Limit (dBuV/m)	Margin (dB)	Avg Limit (dBuV/m)	Margin (dB)	Peak Limit (dBuV/m)	Margin (dB)	Avg Limit (dBuV/m)	Margin (dB)	Azimuth (Deg)
4	.02727	43.03	Pk	15.3	1.4	-80	-20.27	58.87	-79.14	38.87	-59.14	-	-	-	-	0-360
1	.04842	46.62	Pk	14.4	1.4	-80	-17.58	53.88	-71.46	33.88	-51.46	-	-	-	-	0-360
2	.18792	45.71	Pk	13.9	1.5	-80	-18.89	-	-	-	-	42.14	-61.03	22.14	-41.03	0-360
5	.27929	43.94	Pk	13.8	1.5	-80	-20.76	-	-	-	-	38.69	-59.45	18.69	-39.45	0-360

#### Pk - Peak detector

Marker	Frequency (MHz)	Meter Reading (dBuV)	Det	Loop Antenna (dB/m)	ChI (dB)	Dist Corr (dB) 40Log	Corrected Reading (dBuV/m)	QP Limit (dBuV/m)	Margin (dB)	Azimuth (Deg)
6	.60244	37.57	Pk	14	1.5	-40	13.07	32.01	-18.94	0-360
3	.65963	34.79	Pk	14	1.5	-40	10.29	31.23	-20.94	0-360

#### Pk - Peak detector

### 9.5. SPURIOUS EMISSIONS 30 TO 1000 MHz (WORST-CASE CONFIGURATION)

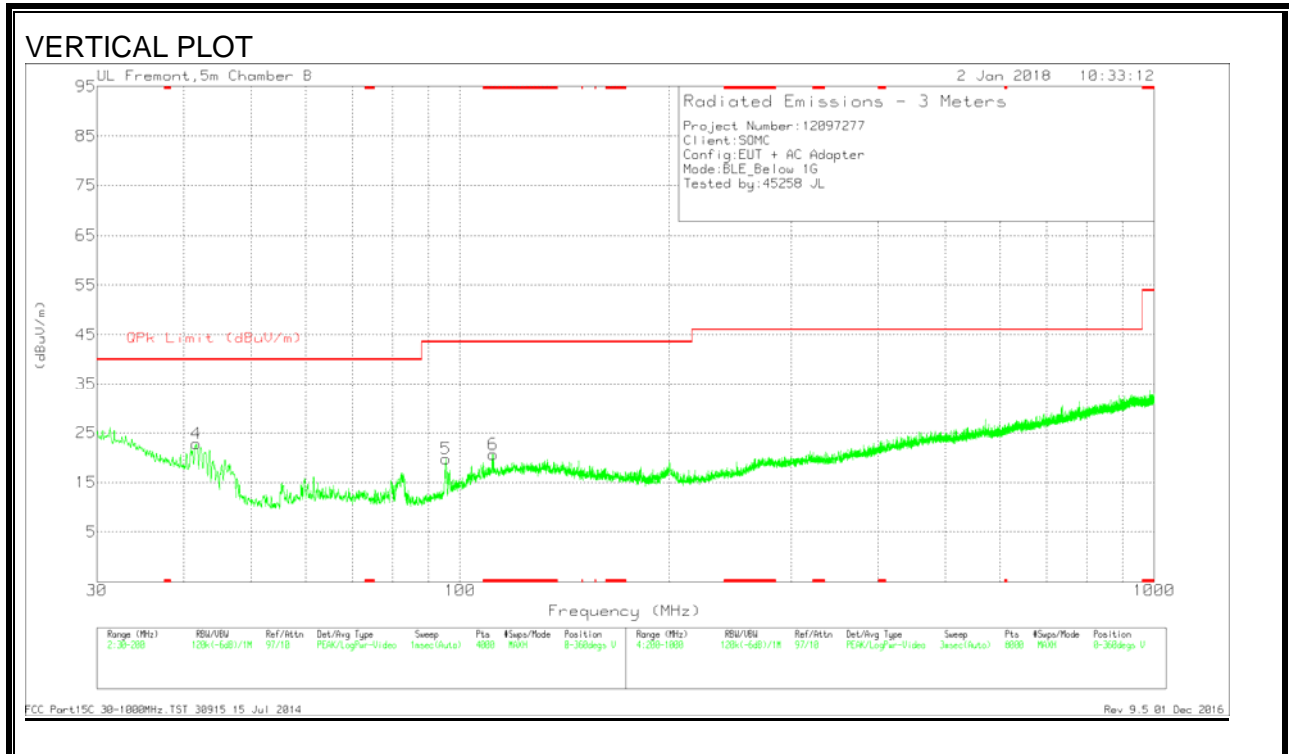
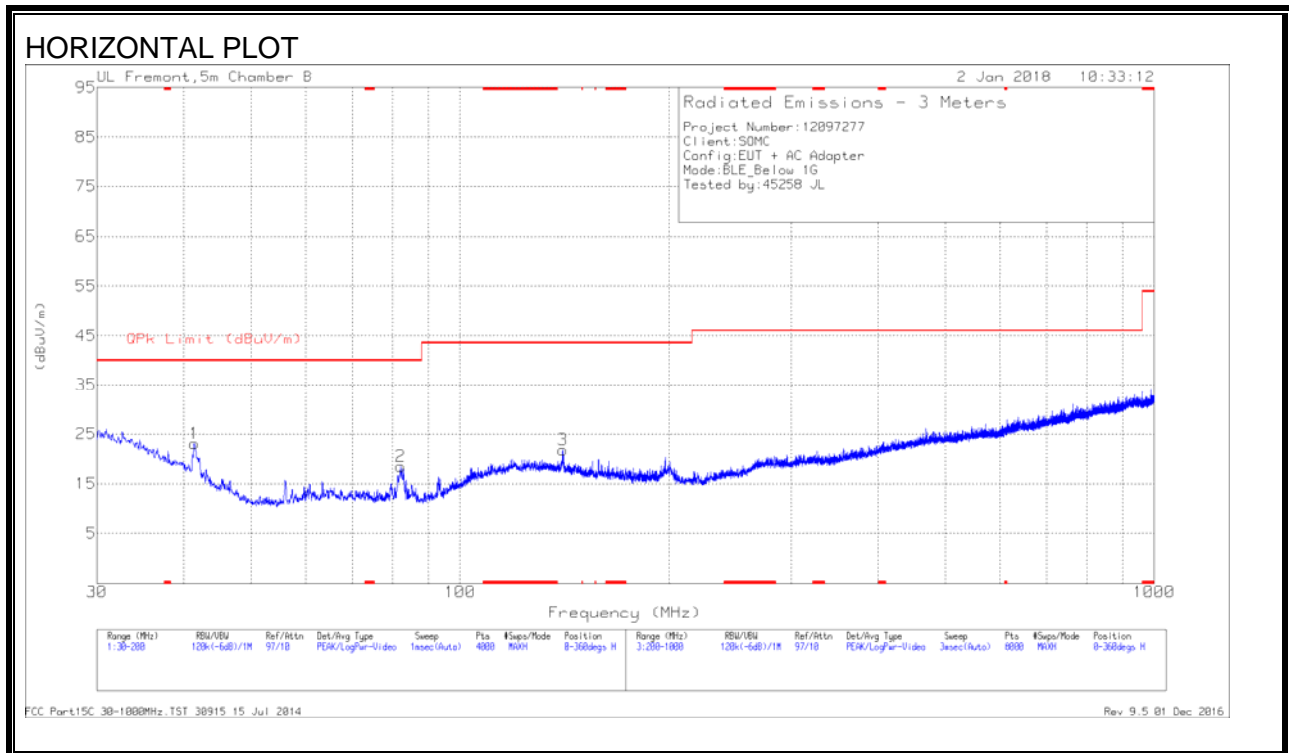

Trace Markers

Marker	Frequency (MHz)	Meter Reading (dBuV)	Det	AF T899 (dB/m)	Amp/Cbl (dB)	Corrected Reading (dBuV/m)	QPk Limit (dBuV/m)	Margin (dB)	Azimuth (Degs)	Height (cm)	Polarity
6	* 111.5574	31.55	Pk	16.9	-27.8	20.65	43.52	-22.87	0-360	100	V
1	41.4355	34.62	Pk	17.1	-28.7	23.02	40	-16.98	0-360	300	H
4	41.733	34.56	Pk	16.9	-28.7	22.76	40	-17.24	0-360	100	V
2	82.1185	35.64	Pk	11	-28.2	18.44	40	-21.56	0-360	200	H
5	95.4882	34.86	Pk	12.9	-28	19.76	43.52	-23.76	0-360	100	V
3	140.7837	32.09	Pk	17.1	-27.4	21.79	43.52	-21.73	0-360	200	H

\* - indicates frequency in CFR47 Pt 15 - Restricted Band

Pk - Peak detector

### 9.1. SPURIOUS EMISSIONS 18 TO 26 GHz (WORST-CASE CONFIGURATION)

#### SPURIOUS EMISSIONS 18 TO 26 GHz (WORST-CASE CONFIGURATION, HORIZONTAL & VERTICAL)

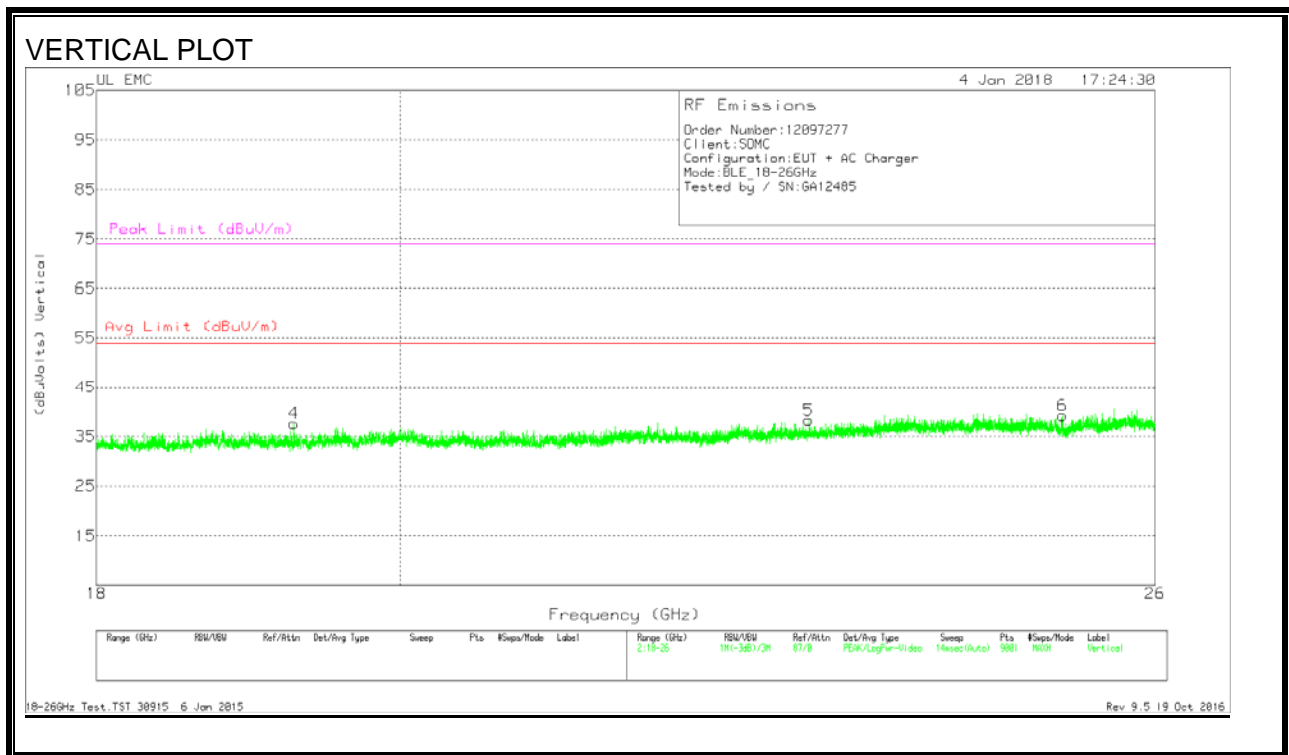
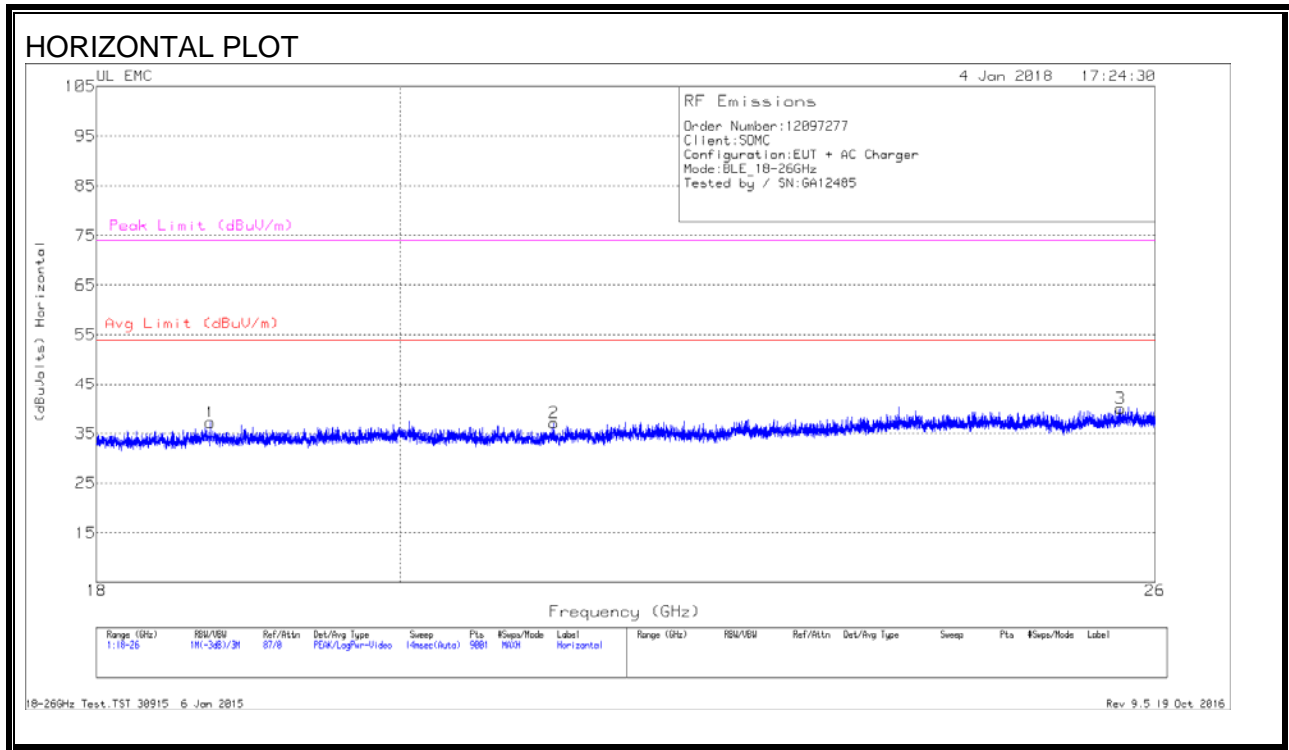

Trace Markers

Marker	Frequency (GHz)	Meter Reading (dBuV)	Det	T89 AF (dB/m)	Amp/Cbl (dB)	Dist Corr (dB)	Corrected Reading (dBuVolts)	Avg Limit (dBuV/m)	Margin (dB)	Peak Limit (dBuV/m)	PK Margin (dB)
1	18.726	38.93	Pk	32.5	-24.7	-9.5	37.23	54	-16.77	74	-36.77
2	21.099	39.04	Pk	32.7	-25.1	-9.5	37.14	54	-16.86	74	-36.86
3	25.687	40.11	Pk	34.1	-24.7	-9.5	40.01	54	-13.99	74	-33.99
4	19.276	39.59	Pk	32.3	-24.8	-9.5	37.59	54	-16.41	74	-36.41
5	23.052	39.34	Pk	33.6	-25.2	-9.5	38.24	54	-15.76	74	-35.76
6	25.175	39.8	Pk	33.7	-24.8	-9.5	39.2	54	-14.8	74	-34.8

Pk - Peak detector



## 10. AC POWER LINE CONDUCTED EMISSIONS

### LIMITS

FCC §15.207 (a)  
RSS-Gen 8.8

Frequency of Emission (MHz)	Conducted Limit (dB $\mu$ V)	
	Quasi-peak	Average
0.15-0.5	66 to 56 *	56 to 46 *
0.5-5	56	46
5-30	60	50

\*Decreases with the logarithm of the frequency.

### TEST PROCEDURE

The EUT is placed on a non-conducting table 40 cm from the vertical ground plane and 80 cm above the horizontal ground plane. The EUT is configured in accordance with ANSI C63.10.

The receiver is set to a resolution bandwidth of 9 kHz. Peak detection is used unless otherwise noted as quasi-peak or average.

Line conducted data is recorded for both NEUTRAL and HOT lines.

### RESULTS

**LINE 1 RESULTS**

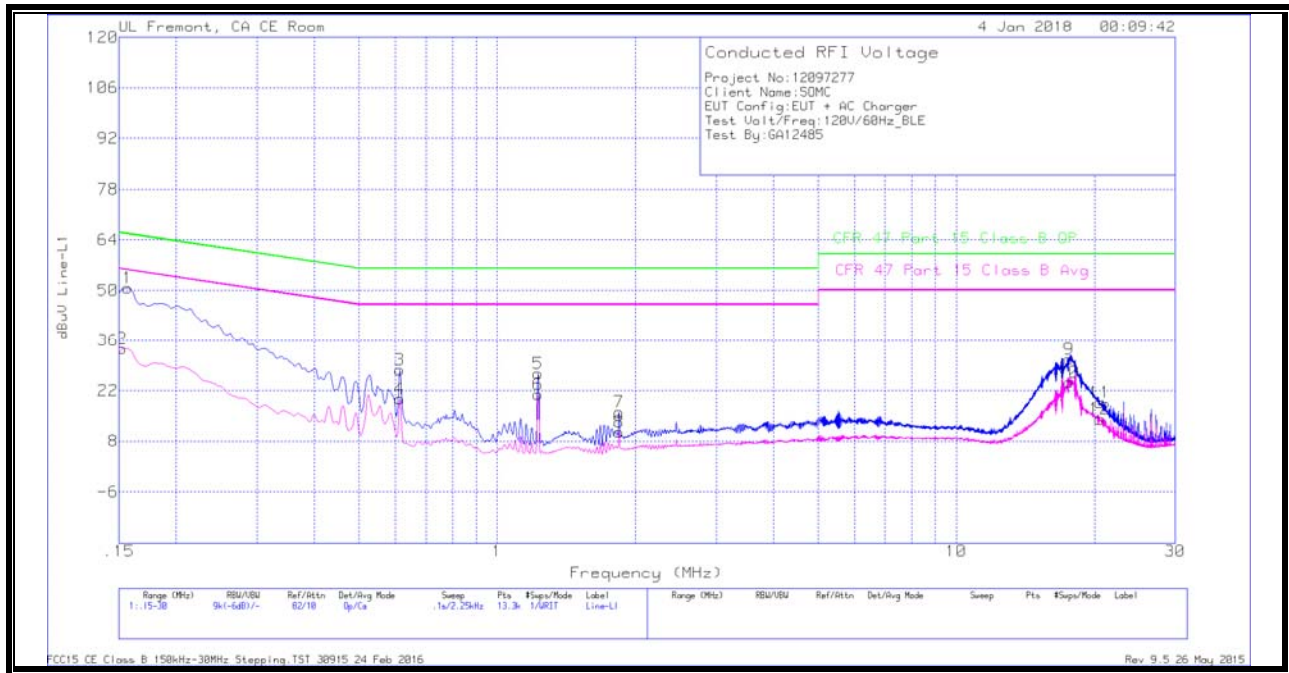

**WORST EMISSIONS**

Range 1: Line-L1 .15 - 30MHz

Marker	Frequency (MHz)	Meter Reading (dBuV)	Det	LISN L1	LC Cables C1&C3	Limiter (dB)	Corrected Reading dBuV	CFR 47 Part 15 Class B QP	QP Margin (dB)	CFR 47 Part 15 Class B Avg	Av(CISPR) Margin (dB)
1	.15675	40.56	Qp	.1	0	10.1	50.76	65.63	-14.87	-	-
2	.15225	23.54	Ca	.1	0	10.1	33.74	-	-	55.88	-22.14
3	.6135	17.59	Qp	0	0	10.1	27.69	56	-28.31	-	-
4	.6135	9.68	Ca	0	0	10.1	19.78	-	-	46	-26.22
5	1.22775	16.48	Qp	0	.1	10.1	26.68	56	-29.32	-	-
6	1.22775	10.82	Ca	0	.1	10.1	21.02	-	-	46	-24.98
7	1.842	5.82	Qp	0	.1	10.1	16.02	56	-39.98	-	-
8	1.842	.34	Ca	0	.1	10.1	10.54	-	-	46	-35.46
9	17.59088	20.04	Qp	0	.3	10.3	30.64	60	-29.36	-	-
10	17.592	13.68	Ca	0	.3	10.3	24.28	-	-	50	-25.72
11	20.53163	7.88	Qp	.1	.3	10.4	18.68	60	-41.32	-	-
12	20.5305	3.31	Ca	.1	.3	10.4	14.11	-	-	50	-35.89

Qp - Quasi-Peak detector

Ca - CISPR average detection

**LINE 2 RESULTS**

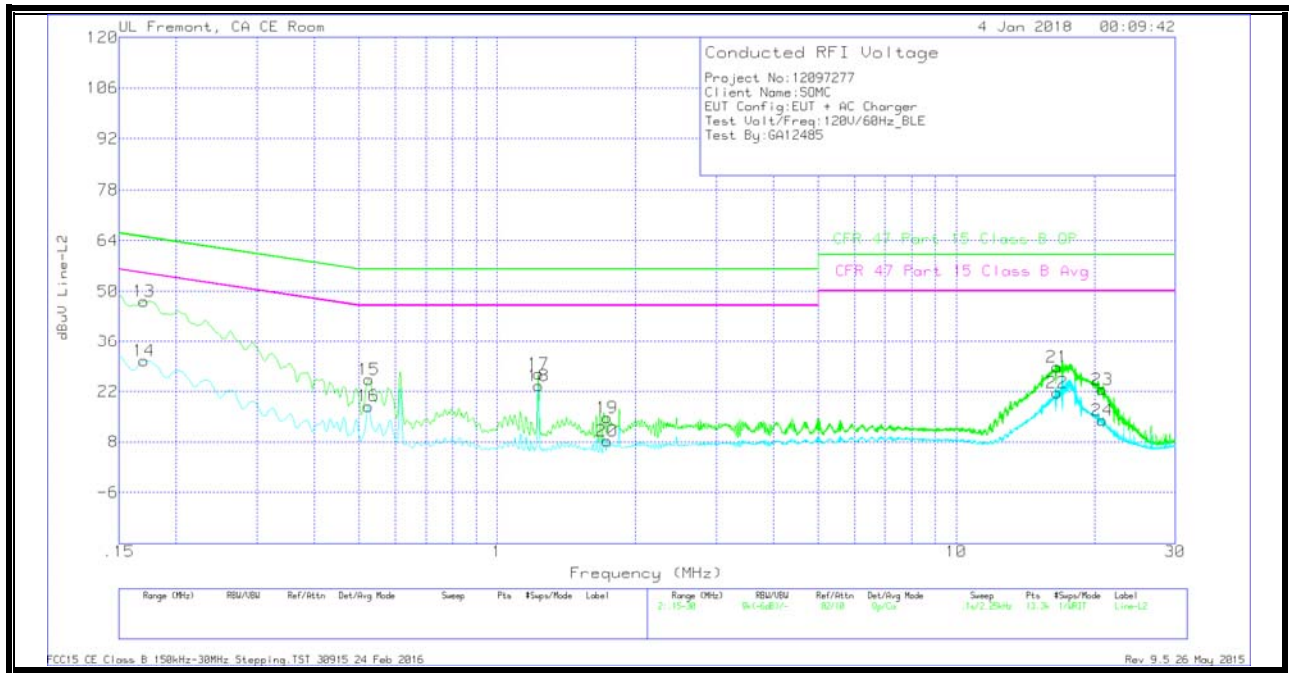

**WORST EMISSIONS**

Range 2: Line-L2 .15 - 30MHz											
Marker	Frequency (MHz)	Meter Reading (dBuV)	Det	LISN L2	LC Cables C2&C3	Limiter (dB)	Corrected Reading dBuV	CFR 47 Part 15 Class B QP	QP Margin (dB)	CFR 47 Part 15 Class B Avg	Av(CISPR) Margin (dB)
13	.17025	37.17	Qp	0	0	10.1	47.27	64.95	-17.68	-	-
14	.17025	20.5	Ca	0	0	10.1	30.6	-	-	54.95	-24.35
15	.52575	15.15	Qp	0	0	10.1	25.25	56	-30.75	-	-
16	.5235	7.83	Ca	0	0	10.1	17.93	-	-	46	-28.07
17	1.23	16.73	Qp	0	.1	10.1	26.93	56	-29.07	-	-
18	1.23	13.31	Ca	0	.1	10.1	23.51	-	-	46	-22.49
19	1.73625	4.51	Qp	0	.1	10.1	14.71	56	-41.29	-	-
20	1.73625	-1.98	Ca	0	.1	10.1	8.22	-	-	46	-37.78
21	16.56825	18.14	Qp	0	.3	10.3	28.74	60	-31.26	-	-
22	16.56825	11.14	Ca	0	.3	10.3	21.74	-	-	50	-28.26
23	20.80163	11.8	Qp	0	.3	10.4	22.5	60	-37.5	-	-
24	20.81175	3.26	Ca	0	.3	10.4	13.96	-	-	50	-36.04

Qp - Quasi-Peak detector

Ca - CISPR average detection